



Government of Bombay  
Public Works Department

Technical Paper No. 56

# Land Drainage in the Deccan Canal Areas

BY

W. A. EVERSHED, B.Sc., M.INST.C.E.  
*Executive Engineer, Irrigation Research Division*

WITH

Prefatory Note by

( C. C. INGLIS, B.A., B.A.I., M.INST.C.E., C.I.E. )  
*Superintending Engineer, Deccan Irrigation Circle*



BOMBAY

PRINTED AT THE GOVERNMENT CENTRAL PRESS

1937

Obtainable from the Superintendent, Government Printing and Stationery,  
Bombay, or through the High Commissioner for India, India House,  
Aldwych, London, W.C. 2, or through any recognized Bookseller

[Price—Rs. 3 As. 5 or 5s. 9d.]

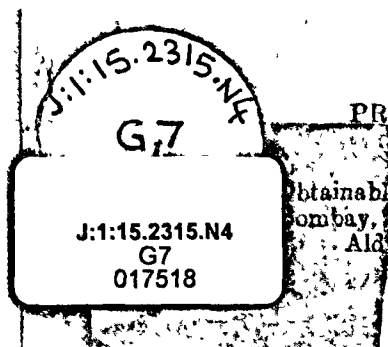

17518

SERVANTS OF INDIA SOCIETY'S LIBRARY  
PUNE 411 004

FOR INTERNAL CIRCULATION

To be returned on or before the last date stamped below.

6 JUN 1977

Dhananjayrao Gadgil Library



GIPE-PUNE-017518

J:1:15.2315.N4

G7

17518

**List of Bombay Public Works Department Technical Papers.**

Paper No.	Subject.	Price.	Year of publication.	Number of copies in stock (April 1935).
		Rs. s. p.		
1	Reinforced Concrete Flooring in the Hostel for the High School at Satara (Bombay Presidency), by W. L. C. Trench, B.A.I., A.M.I.C.E., Executive Engineer, and T. S. Mirchandani, B.Sc. (Edn.), Assistant Engineer.	....	1913	Out of stock.
2	Famine Relief Road Works carried out in the Banda District, United Provinces, in the famine of 1913-14, by D. R. H. Browne, A.K.C., Executive Engineer.	....	1915	Do.
3	Note on the Lower Ganges Bridge Works at Sara, Bengal, by D. R. H. Browne, A.K.C., Executive Engineer.	....	1915	Do.
4	Report on experiments on Concrete Flooring carried out at Poona (Bombay Presidency), by Conductor T. H. Naughton, Sub-Engineer.	....	1917	Do.
5	Reinforced Concrete Work in the Bombay Presidency, by J. C. Gammon, B.Sc., A.C.G.I., late Assistant Engineer, Bombay Public Works Department.	....	1917	Do.
6	Reinforced Concrete Roof Construction for use with ceiling tiles, by J. M. Mackay, A.M.I.C.E., Executive Engineer.	....	1917	Do.
7	Report on the Felling of the Masonry Chimney at Dapuri (Bombay Presidency), by H. W. Oddin Taylor, A.C.G.I., B.Sc., Executive Engineer.	....	1920	Do.
8	Note on the Tests carried out with Reinforced Concrete Brick Walling Loaded as a Beam, by Khan Saheb J. D. Dubash, Assistant Engineer.	....	1920	Do.
9	Note on the Manufacture of Hydraulic Lime in the Nasik and Ahmednagar Districts of the Bombay Presidency, 1920, by Rao Saheb V. K. Chapekar, Temporary Engineer.	....	1921	Do.
✓ 10	Glossary of Irrigation Terms applicable to the Deccan Canals.	....	1921	Do.
11	Report on the Malir River Boring Investigations for the Karachi Water Supply, by W. C. Doors, Executive Engineer, Boring Works, Bombay Presidency, with a note by H. O. B. Shoubridge, M.Inst.C.E., Chief Engineer for Irrigation.	....	1925	Do.
12	A Note on the Design, Application and Construction of Masonry Semi-Modules as used on the Jamrao Canal, by W. Kirkpatrick, Executive Engineer. (2nd Edition.)	....	1925	Do.
✓ 13	Soil and Sub-soil Surveys in the Deccan Canal areas, by C. C. Inglis, Executive Engineer, and V. K. Gokhale, Deputy Soil Physicist. (2nd Edition.)	....	1929	Do.
14	A Short Note on the Improvement of Damaged Lands in the Canal Irrigated Tracts of the Bombay Deccan, by C. C. Inglis, Executive Engineer.	....	1927	Do.
15	Notes on Standing Wave Flumes and Flume Meter Falls, by C. C. Inglis, Executive Engineer, Special Irrigation Division.	....	1928	Do.
16	Note on Irrigation on the Block System in the Deccan Canal Tracts, by C. C. Inglis, I.S.E., Executive Engineer, Special Irrigation Division.	....	1927	Do.
17	Note on the Effluent Farm near Poona (1918-19 to 1925-26), by C. C. Inglis, B.A., B.A.I., M.Inst.C.E., Executive Engineer, Special Irrigation Division.	....	1927	Do.
18	Note on the Use of Hydro-Electric Power by Small Industries in Switzerland, Norway and Sweden, by F. O. J. Roose, M.I.M.E., M.I.E.E., F.C.S., Electrical Engineer to Government.	1 14 0	1928	105
19	Note on the Design of Distributaries and their Outlets in the Bombay Deccan, by C. C. Inglis, B.A.I., A.M.Inst.C.E., Executive Engineer, Special Irrigation Division.	....	1928	Out of stock.
	Note dated November 1927 on "Model experiments to ascertain the effect of Partial Lining of the Malegaon Cut" in miles 38 and 39 of the Nira Left Bank Canal, by C. C. Inglis, B.A.I., M.Inst.C.E., Executive Engineer, Special Irrigation Division, and D. V. Joglekar, B.E., Assistant Engineer.	1 0 0	1928	108

Paper No.	Subject.	Price.	Year of publication.	Number of copies in stock (April 1935).
		Rs. a. p.		
✓ 21	Note on the Outturn and Profit from Sugarcane Crops grown in the Deccan Canal Tracts, by C. C. Inglis, B.A.I., M.Inst.C.E., Superintending Engineer, Irrigation Development and Research Circle, and V. K. Gokhale, B.Ag., Deputy Soil Physicist.	1 3 0	1928	17
22	Note on Experiments carried out at the Hydraulic Testing Station at Distributary No. 5, Mutha Right Bank Canal, near Poona, with a Lindlay type Standing Wave Flume, by C. C. Inglis, B.A.I., M.Inst.C.E., Superintending Engineer, Irrigation Development and Research Circle, Bombay, with the assistance of D. V. Joglekar, B.E., Assistant Engineer.	0 10 0	1928	5
23	A Note on Standing Wave Pipe Outlets, by C. C. Inglis, B.A., B.A.I., M.Inst.C.E., Superintending Engineer, Irrigation Development and Research Circle, Bombay.	....	1928	Out of stock.
24	Report on Land Drainage Experiments at Baramati, by C. C. Inglis, B.A., B.A.I., M.Inst.C.E., Superintending Engineer, Irrigation Development and Research Circle, with V. K. Gokhale, B.Ag., Deputy Soil Physicist, and the staff of Baramati Development Sub-division.	2 1 0	1928	49
25	Moduling Operations on Distributary No. 8, Nira Left Bank Canal, and application of the Results to other Distributaries, by C. C. Inglis, B.A.I., M.Inst.C.E., Superintending Engineer, Irrigation Development and Research Circle, with D. V. Joglekar, Assistant Engineer.	0 12 0	1928	16
26	Report on Tests made on a Model of the Group of Regulators at Oderolal at mile 169 approximately of the Rohri Main Canal, Sind, by C. G. Hawes, M.C., B.Sc. (Lond.), A.C.G.I., A.M.Inst.C.E., Executive Engineer, Central Designs Division, Karachi, and C. C. Inglis, B.A.I., A.M.Inst.C.E., Superintending Engineer, Irrigation Development and Research Circle, Poona.	1 11 0	1928	32
27	Report on Experiments on Model Culverts made with Hume Pipes, by C. G. Hawes, M.C., B.Sc. (Lond.), A.C.G.I., A.M.Inst.C.E., Executive Engineer, Central Designs Division, and H. S. Kahai, Assistant Engineer, with Appendix containing a Note on the use of Hume Pipes for Irrigation purposes based on Notes by C. C. Inglis, B.A.I., M.Inst.C.E., Superintending Engineer, Irrigation Development and Research Circle.	1 3 0	1929	51
28	Note on "Research Work done by the Special Irrigation Division since its formation in June 1916," by C. C. Inglis, B.A., B.A.I., M.Inst.C.E., Superintending Engineer, Irrigation Development and Research Circle.	0 8 0	1929	78
29	Note on "Experiments carried out with various designs of piers and sills in connection with the Lloyd Barrage at Sukkur," by C. C. Inglis, B.A.I., M.Inst.C.E., Superintending Engineer, Irrigation Development and Research Circle, and C. G. Hawes, M.C., B.Sc., A.M.Inst.C.E., Executive Engineer, Central Designs Division, with J. S. Reid, B.Sc., Assistant Executive Engineer, D. V. Joglekar, B.E., Assistant Engineer, and H. V. Katakhar, B.E., Temporary Engineer.	2 10 0	1929	64
30	A Note on "A Critical study of Run off and floods of catchments of the Bombay Presidency with a short note on losses from lakes by evaporation," by C. C. Inglis, B.A.I., M.Inst.C.E., Superintending Engineer, Irrigation Development and Research Circle, with A. J. DeSouza, B.E., Assistant Engineer.	4 7 0	1930	52
31	Report on Experiments carried out at the Karachi Model Testing Station on a Model of a Flumed Regulator, by C. G. Hawes, M.C., B.Sc. (Lond.), A.M.Inst.C.E., Executive Engineer, Central Designs Division, and H. S. Kahai, Assistant Engineer, with a note, by W. A. Evershed, B.Sc. (Lond.), A.M.Inst.C.E., Superintending Engineer, Irrigation Development and Research Circle.	0 7 0	1929	49
32	Note on Experiment on a model of the Bifurcation on the North Western Perennial Canal at the head of the Warah Branch, by C. G. Hawes, M.C., B.Sc. (Lond.), A.C.G.I., A.M.Inst.C.E., Executive Engineer, Central Designs Division, and H. S. Kahai, Assistant Engineer.	0 12 0	1929	82

Paper No.	Subject.	Price.	Year of publication.	Number of copies in stock (April 1935).
		Rs. a. p.		
33	Report on experiments carried out in the Central Designs Division, Lloyd Barrage and Canals Construction, in the Karachi Testing Station on a model of syphon proposed to be constructed on the North-Western Railway, by C. G. Hawes, M.C., B.Sc. (Lond.), A.C.G.I., A.M.Inst.C.E., Executive Engineer, Central Designs Division, and H. S. Kahai, Assistant Engineer.	0 12 0	1930	70
34	Report on experiments carried out on a model of the Makhu Right Distributary of Mithrao Canal, Eastern Nara Division (Sind), by C. G. Hawes, M.C., B.Sc. (Lond.), A.C.G.I., M.Inst.C.E., Executive Engineer, Central Designs Division, and H. S. Kahai, Assistant Engineer.	3 2 0	1930	34
35	Report on the installation and testing of various types of radial gates on the 84th mile Jamrao Canal, by C. G. Hawes, M.C., B.Sc. (Lond.), A.C.G.I., M.Inst.C.E., Executive Engineer, Central Designs Division.	1 6 0	1931	81
36	Note on road construction in the Nili Bar Colony, Punjab, by H. B. Parikh, L.C.E., M.I.E. (Ind.), Executive Engineer on Special Duty, Sind Roads, including summaries of important details.	0 3 0	1931	53
37	Standard type buildings for the Forest Department, Bombay Presidency—Abstract estimates, block plans, specifications, etc., by T. S. Pipe, B.Sc., M.Inst.C.E., Executive Engineer, Poona Division (formerly Superintending Engineer, Forest Department, Bombay Presidency).	1 8 0	1932	184
38	Standard Forest Roads—Cross sections and earthwork tables, by T. S. Pipe, B.Sc., M.Inst.C.E., Executive Engineer, Poona Division (formerly Superintending Engineer, Forest Department, Bombay Presidency).	0 11 0	1931	36
39	Note on the resurfacing of the Nasik Station Road with various asphalts, cement macadam and cement concrete, by L. E. Greening, A.M.Inst.C.E., M.Inst.Struct.E., Executive Engineer, Nasik Division.	1 9 0	1931	94
40	Note on cement concrete roads in the United Provinces and on the financial aspects of cement concrete and asphalt surfaces, by T. C. Kantawala, L.C.E., M.R.San.I., Special Officer, Road Development Schemes.	0 4 0	1931	90
41	Note on boring operations in the Bombay Presidency by A. P. Maddocks, B.Sc., M.Inst.C.E., Superintending Engineer, Public Health, Bombay.	0 5 0	1931	123
42	Notes on (1) Flumed Aqueducts, (2) Remodelling an existing Canal or Distributary to pass an increased discharge, (3) Afflux caused by heading up water at regulators of a Canal and the extent of backwater and (4) Distribution of velocities in channels, by C. C. Inglis, B.A., B.A.I., M.Inst.C.E., Superintending Engineer, Irrigation Development and Research Circle.	0 4 0	1932	Out of stock.
43	Concise Report on the Punjab Irrigation Works, by M. T. Gibling, B.A. (Cantab.), I.S.E., Executive Engineer, Northern Dadu Division.	0 14 0	1932	14
44	The dissipation of energy below falls, by C. C. Inglis, B.A., B.A.I., M.Inst.C.E., Superintending Engineer, Irrigation Development and Research Circle, and D. V. Joglekar, B.E., Assistant Engineer.	5 5 0	1933	66
45	Note of May 1931 on Silt Exclusion from Canals, "Still Pond" versus "Open Flow," Part I, by C. C. Inglis, B.A., B.A.I., M.Inst.C.E., I.S.E., Superintending Engineer, Irrigation Development and Research Circle.	0 15 0	1933	82
46	Note on Silt Exclusion from Canals, Part II—First report on experiments with the full width model of the Sukkur Barrage at Khadakvasla with Appendices on the design of dynamically similar models in accordance with Lacey's formulas, by C. C. Inglis, B.A., B.A.I., M.Inst.C.E., I.S.E., Superintending Engineer, Irrigation Development and Research Circle, and D. V. Joglekar, B.E., Assistant Engineer.	2 1 0	1933	70
47	Report on experiments carried out on Models of Standard Vertical Screw Gates adopted in the Lloyd Barrage and Canals Scheme, by C. G. Hawes, M.C., B.Sc. (Lond.), A.C.G.I., M.Inst.C.E., I.S.E., Executive Engineer, Development and Research Division.	0 15 0	1933	67

Paper No.	Subject.	Price.	Year of publication.	Number of copies in stock (April 1935).
		Rs. s p.		
48	Report on reclamation and drainage of alkali lands in Hungary by C. G. Hawes, M. C., B.Sc. (Lond.), A.C.G.I., M.Inst.C.E., I.S.E., Executive Engineer, Development and Research Division.	0 7 0	1933	66
49	Development of Irrigation in the Deccan Canal areas by C. C. Inglis, B.A., B.A.I., M.Inst.C.E., Superintending Engineer, Deccan Irrigation Circle, and V. K. Gokhale, B.Ag., Deputy Soil Physicist, Irrigation Research Division.	1 13 0	1934	28
50	Bridge over Krishna River at Udgaon on the Kolhapur-Muraj Road by A. Bhattacharya, L.C.E., I.S.E., Executive Engineer, Belgaum Division.	1 6 0	1934	43
51	Note on experiments carried out with a short-crested weir model by C. C. Inglis, B.A., B.A.I., M.Inst.C.E., Superintending Engineer, Deccan Irrigation Circle, Poona and D. V. Joglekar, B.E., Assistant Engineer.	0 14 0	1934	30
52	Factors affecting exclusion of bed silt from Canals taking off from alluvial Rivers by C. C. Inglis, B.A., B.A.I., M.Inst.C.E., Superintending Engineer, Deccan Irrigation Circle and D. V. Joglekar, B.E., Assistant Engineer.	2 3 0	1935	7
53	Note on the results of silt Analysis carried out in the Development and Research Division by C. G. Hawes, M.C., B.Sc. (Lond.), A.C.G.I., M.Inst.C.E., I.S.E., Executive Engineer, Development and Research Division.	0 10 0	1935	32
54	Note on experiments with a model of the head sluices of the Nira Left Bank Canal by C. C. Inglis, B.A., B.A.I., M.Inst.C.E., Superintending Engineer, Deccan Irrigation Circle, and D. V. Joglekar, B.E., Assistant Engineer.	0 5 0	1935	65
55	Report on experiments carried out with models in connection with the protection of the Hardinge Bridge, on the Eastern Bengal Railway, by C. C. Inglis, B.A., B.A.I., M.Inst.C.E., Superintending Engineer, Deccan Irrigation Circle, Poona.	For official use only.	In Press.	

Copies obtainable from the Superintendent, Government Printing and Stationery, Bombay, or through the High Commissioner for India, India House, Aldwych, London, W.C.-2, or through any recognised bookseller.

PREFATORY NOTE BY C. C. INGLIS, SUPERINTENDING ENGINEER,  
DECCAN IRRIGATION CIRCLE, ON "LAND DRAINAGE" BY W. A.  
EVERSHED, EXECUTIVE ENGINEER, IRRIGATION RESEARCH  
DIVISION.

This Technical Paper is meant mainly for reference ; but for those who can only spare a little time I append a short summary of important points connected with land drainage :—

(1) Deccan rock is generally impervious vertically, but is fissured horizontally, and so transmits water under pressure. In general, all strata in the Deccan are much more porous horizontally than vertically, due to horizontal stratification ; and even in the case of colluvial deposition, the porosity is much higher horizontally than vertically, due to the material having been laid down in alternating layers of coarse and fine materials.

(2) Water reaches the low land—

(a) by percolating down the slope from the ridge, which may stretch for miles, or

(b) by spreading from the noses of ridges.

Where it is possible to tap the spring at the nose of a ridge the result is exceedingly successful over a wide area.

Where this is not possible, relief drains located in porous sub-strata have to be adopted.

(3) Drains are divided into—

(i) pipe lines and (ii) open drains.

The former act as—

(a) relief drains.

The latter act as either—

(a) relief or (b) carrier drains.

The former remove water from porous sub-strata, the latter carry it away.

(4) Relief drains are most effective where constructed down the slope. Where relief drains are constructed across the slope they drain the upstream side but do not act as intercepting drains ; because pressure is transmitted through fissures or porous strata underlying the drain, and the sub-soil water level downstream of a drain may be little affected by the drain.

(5) Where porosity ( $K/A$ ) is less than 0.7, a drain acts only to a small extent as a relief drain ; and may be looked on as a carrier drain ; however  $K/A$  values may be moderate (1.0) and yet drainage excellent—as in Shenya Murum which contains isolated fissures.

(6) Carrier drains are fed by drains from subsidiary ridge noses, relief drains down the slope, and drains located in subsidiary valleys.

(7) Where the sub-stratum in a valley is at a depth of more than 8 feet below ground level it is generally rock or impervious material and the drain then becomes merely a carrier drain, except where it cuts the nose of a subsidiary ridge or is diverted to act as a valley-side drain.

Deep valleys frequently contain liquid mud (clay dispersed due to alkalinity) which makes the construction of drains exceedingly difficult and expensive.

(8) A drain in sand or mān lowers the water level over a large area—water conditions in these materials being analogous to conditions in a lake. In other strata the effect is much more uneven and local, as in the case of drainage into a river.



(9) In general the sub-soil water level is some 2 feet higher than in the drains, and so a drain should in general be at least 6 feet deep—to keep the water level down to 4 feet below ground level.

(10) A short length of deep drain cutting into highly porous strata is in general much more effective than a long length of drain at a higher level in less porous material. Sub-artesian bores are rarely satisfactory, but trenches cut down to porous material filled with stones, gravel and finally sand—i.e. a reversed filter—give satisfactory results.

(11) *Murum* may be hard, yet it may be fissured and therefore suitable for drainage and a murum that is hard to excavate may disintegrate quickly thereafter especially if exposed to the air.

(12) Intercepting drains do not intercept; and though valley-side drains may be useful, yet in general, it is better to tap the nose of the ridge or to drain down the slope; but the great secret of land drainage is to find the points where there is a highly porous stratum ( $K/A > 2$ ) and tap them.

(13) Work connected with sub-soil surveys and land drainage cannot be reduced to fixed rules, because the data is generally conflicting. Thus: though certain trees and weeds normally indicate a particular soil condition—yet trees and weeds which normally indicate shallow soils are not infrequently found in deep soils and *vice versa*.

(14) Each drain should justify its cost.

(15) Pipe lines should be constructed where practicable and open drains where that is not practicable. It should however be remembered that pipe lines cannot be enlarged or deepened except at great cost. They should therefore be generally constructed larger and deeper than seems necessary, i.e., for 50 per cent. more flow than estimated and a foot deeper than necessary.

(16) A day in the field is worth six in the office.

(17) No single indication is a reliable guide. Experience, judgment and a natural gift for diagnosis are essential.

**LAND DRAINAGE**  
in the  
**DECCAN CANAL AREAS**  
by

W. A. EVERSHED, B.Sc., M.Inst.C.E., Executive Engineer, Irrigation Research Division.

*Subject Index by paras.*

Prefatory Note by C. C. Inglis, C.I.E., I.S.E., Superintending Engineer, Deccan Irrigation Circle .. .. .	v-vi
List of Abbreviations .. .. .	xi
List of Plates .. .. .	xiii
Photographs .. .. .	..xv-xix

PARAS.	PAGES
1-7 INTRODUCTORY.	1

**PART I.**

**SOIL AND SUB-SOILS.**

**CHAPTER I.**

**SOIL AND SUB-SOILS.**

8	What drainage means .. .. .	2
9	Rocks and Soils of the Deccan .. .. .	2
10	Properties of the soil—structure and porosity .. .. .	2
11	Perviousness of soils .. .. .	3
12	Soil moisture .. .. .	3
13	Soil moisture and plant growth .. .. .	3
14	Capillary action .. .. .	4
15	Zone of root growth .. .. .	4
16	Soil alkalis .. .. .	4
17	How damage occurs .. .. .	4
18	Alkalization or base exchange.. .. .	4-6
19-20	Baramati Experimental Salt Area .. .. .	6-7

**CHAPTER II.**

**THE SUBSOIL WATER TABLE.**

21	Factors leading to the rise of subsoil water .. .. .	7
22	Percolation from canal and distributaries .. .. .	7
23	Percolation from irrigated areas .. .. .	8
24	The subsoil water table .. .. .	8
25	Factors which help in controlling the water table .. .. .	8
26	Effects of drains on the subsoil water table .. .. .	9
27	Movement of subsoil water .. .. .	9-10
28	Result of subsoil drainage .. .. .	10

**CHAPTER III.**

**CO-ORDINATION.**

29	Desirability of early drainage .. .. .	11
30	Relative importance of drainage schemes .. .. .	11
31	Finance .. .. .	11-12
32	Staff .. .. .	12
33	Co-ordination .. .. .	12

## PART II.

## PREPARATION OF THE PROJECT.

## CHAPTER IV.

## SURVEY WORK.

PARAS.		PAGES
34-35	Procedure .. .. .	13
36	Preliminary plan for the survey work .. .. .	14
37	Survey estimate .. .. .	14-15
38-39	Formation of soils in the Bombay Deccan .. .. .	15
✓40	Soil classification .. .. .	15-16
41	Survey of damage .. .. .	16-17
42	Other miscellaneous details in topography and soil survey .. .. .	17-18
43	Relation of soil series and murum isobaths .. .. .	19
44	The 1½ ft. and 8 ft. M. I. Bs .. .. .	19
45	Rates for soil classification items .. .. .	19
46	Use of augers for subsoil surveys .. .. .	20-21
47	Rates for sub-soil survey .. .. .	21
48	Examination of sub-soil .. .. .	21
49	Recuperation .. .. .	21-22
50	Coefficient of recuperation .. .. .	22-24
51	Plotting of sub-soil information .. .. .	25
52	Location of cross sections .. .. .	26-28
53	Pit work for cross sections .. .. .	28
54	Nala surveys .. .. .	28
55	Location of drains from cross sections and longitudinal sections .. .. .	28

## CHAPTER V.

## DESIGN OF DRAINS, ALIGNMENTS, AND SUBSIDIARY WORKS.

56	Intercepting drains .. .. .	28
57	Relief drains .. .. .	29
58	Deep and shallow drains .. .. .	29
59	Conditions which make deep sub-soil drains necessary .. .. .	29-30
60	Shallow drains .. .. .	30
61	Carrier drains .. .. .	30
62	Fixing the alignment .. .. .	30
63	The outfall drain .. .. .	30-31
64	Main drain and branch drains .. .. .	31
65	Numbering of drains .. .. .	31
66	Length of drains .. .. .	31-33
67	Sub-artesian bores .. .. .	33
68	Gradient of a drain .. .. .	33
69	Miscellaneous points in the alignment of drains .. .. .	34
70	Pit-work, surveys and plotting of drainage lines .. .. .	34
71	Record of important points along drains .. .. .	34
72	Note books and field books .. .. .	35
73	Land acquisition .. .. .	35
74	Type of drain—open trench or pipe line .. .. .	35
75-76	Section of an open trench .. .. .	35-37
77	Ramps .. .. .	37-38
78	Causeways and bridges .. .. .	38
79	Inlets .. .. .	39
80	Standing wave flumes .. .. .	39
81	Subartesian bores .. .. .	39
82	Falls .. .. .	39
83	Aqueducts or syphons .. .. .	39
84	Observation tubes .. .. .	39-40
85	Bedstones .. .. .	40
86	Mile stones, furlong stones and boundary stones .. .. .	40
87	Design of pipe lines .. .. .	40-41
88	Manholes .. .. .	41
89	Pipe outfall .. .. .	41-42
90	Headwall .. .. .	42
91	Rubble drains .. .. .	42

## CHAPTER VI.

## SUBMISSION OF THE PROJECT.

PARAS.		PAGES
92	Plans .. .. .	42-43
93	General index plan .. .. .	43
94	Index plan showing damages and areas to be reclaimed .. .. .	43
95	Index plan showing progressive damage and areas going out of cultivation .. .. .	43
96	Detailed plan .. .. .	43-44
97	Longitudinal section of open drains .. .. .	44-45
98	Cross sections .. .. .	45
99	Type design .. .. .	45
100	Estimates for drainage projects .. .. .	45-46
101	Information required while preparing the project .. .. .	46-47
102	Report on the project .. .. .	47

## PART III.

## CONSTRUCTION.

## CHAPTER VII.

## PRELIMINARIES.

103	Preliminaries .. .. .	47
104	Land acquisition .. .. .	48
105	Land valuation .. .. .	48-49
106	Land acquisition proceedings .. .. .	49-50
107	Necessity for working drawings .. .. .	50
108-109	Working drawings .. .. .	50-51
110	Observations to be recorded previous to and during construction—salinity of drainage water and soil improvements.	51-52
111	Form of contract .. .. .	52
112	Specifications .. .. .	52-57
113	Working faces .. .. .	57
114	Work not to be rushed .. .. .	57

## CHAPTER VIII.

## CONSTRUCTION.

115	Machinery <i>versus</i> manual labour .. .. .	57-58
116	General .. .. .	58
117	Works order book .. .. .	58
118	Progress reports .. .. .	58-59
119	Clearing scrubs, bulrushes, etc. .. .. .	59
120	Setting out .. .. .	59-60
121	Setting out curves .. .. .	60-61
122	Length of work in progress .. .. .	61
123	Curves .. .. .	61
124	Service roads and spoil banks .. .. .	61-62
125	Approval to work done .. .. .	62
126	Subsidiary works .. .. .	62
127	Maintenance .. .. .	62
128	Grassing .. .. .	62
129	Pipe drains .. .. .	62
130	Length of work in progress .. .. .	62
131	Laying pipes .. .. .	62-63
132	Backfill .. .. .	63
133	Curves .. .. .	63
134	Approval to work done .. .. .	63
135	Trees .. .. .	63
136	Maintenance .. .. .	63
137	Quality of pipes .. .. .	63
138	Kinds of pipes .. .. .	63-64
139	Outfall .. .. .	64
140	Headwall .. .. .	64
141	Manholes .. .. .	64
142	Irrigation channels .. .. .	64
143	Rubble drains .. .. .	64
144	Liquid mud .. .. .	65-66

**PART IV.**  
**MAINTENANCE.**  
**CHAPTER IX.**  
**MAINTENANCE.**

<b>PARAS.</b>		<b>PAGES</b>
145	Importance .. .. .	66
146	Maintenance of open trenches.. .. .	66
147	Central channel .. .. .	67
148	Sand in open trenches .. .. .	67-68
149	Tarvad revetting .. .. .	68
150	Tarvad hurdles to encourage silting .. .. .	68
151	Grassing .. .. .	68
152	Kinds of grass .. .. .	69
153	Grazing .. .. .	69
154	Soil banks .. .. .	69
155	Service roads .. .. .	70
156	Slips .. .. .	70
157	Trees .. .. .	70
158	Boundary .. .. .	71
159	Subsidiary works .. .. .	71
160	Maintenance of pipe drains .. .. .	71
161	Manholes .. .. .	72
162	Headwalls .. .. .	72
163	Nala keepers (Rakhwaldars) and their duties .. .. .	72
164	Estimates .. .. .	72-74
165	Conclusion .. .. .	74

LIST OF ABBREVIATIONS.

	Abbreviation
(1) Murum isobath .. .. .	.. M. I. B.
(2) 8 foot murum isobath .. .. .	.. 8' M. I. B.
(3) Hydro-isobath .. .. .	.. H. I. B.
(4) 4 foot hydro-isobath .. .. .	.. 4' H. I. B.
(5) First strong flow .. .. .	.. F. S. F.
(6) Final water level .. .. .	.. F. W. L.
(7) Sub-soil water level .. .. .	.. S. S. W. L.
(8) Well observation (of water level) .. .. .	.. W. O.
(9) Open trench .. .. .	.. O. T.
(10) Pipe line .. .. .	.. P. L.
(11) Rubble drain .. .. .	.. R. D.
(12) Standing wave flume .. .. .	.. S. W. F.
(13) Manhole .. .. .	.. M. H.
(14) Hard murum .. .. .	.. H. M.
(15) Soft murum .. .. .	.. S. M.
(16) Lime kankar .. .. .	.. L. K.
(17) Not properly commanded .. .. .	.. N. P. C.
(18) Ground level .. .. .	.. G. L.
(19) Formation level .. .. .	.. F. L.
(20) Chainage .. .. .	.. Ch.
(21) Longitudinal section .. .. .	.. L. S.
(22) Cross section .. .. .	.. C. S.
(23) Centre line .. .. .	.. C. L.
(24) Baramati Experimental Salt Area .. .. .	.. B. E. S. A.
(25) Technical Paper .. .. .	.. T. P.

**LIST OF PLATES.**

	<b>To face para.</b>	<b>To face page</b>
I Soils and Sub-strata .. .. .	17	4
II Figure 1A of Technical Paper No. 24 .. ..	19	6
III Chart showing increase of cane, damage, and hydro-isobath areas, and rise of sub-soil water level.	29	11
IV Symbols used in sub-soil drainage drawings .. ..	39	15
V Plotting of sub-soil data .. .. .	51	25
VI Type sizes of Open Trenches -- .. ..	75	35
VII Discharge chart for Open Trenches .. .. .	75	37
VIII Chart showing depth of trench, width of spoil bank and width of land to be acquired.	76	37
IX Type design of ramp .. .. .	77	37
X Type design of grass inlet .. .. .	79	39
XI Type design of standing wave flume .. .. .	80	39
XII Type design of artesian bore .. .. .	81	39
XIII Type design of observation tubes .. .. .	84	39
XIV Type design of mile, furlong and boundary stones ..	86	40
XV Discharge chart for Pipe Drains .. .. .	87	40
XVI Type design of Manholes .. .. .	88	41
XVII Type design of Pipe outfall .. .. .	89	42
XVIII Type design of Headwall .. .. .	90	42
XIX Type design of Rubble drain .. .. .	91	42
XX Progress of damage .. .. .	95	43
XXI Type design for a barrier across service road for drainage schemes.	155	70



No. 1

Typical salt affected land at the Baramati Experimental Salt Area when first acquired. There is an encrustation of salt at the surface due to efflorescence.



No. 2

Salt in sugarcane plots at Baramati.



No. 3

Salt efflorescence at the Baramati Experimental Salt Area on clumps of 'mol' grass (*Pennisetum Alopecuros*). Note the size of the match box in the foreground.

The object of acquiring this area was research—first to drain the land and then to reclaim it, i.e. restore its physical condition to that required for the cultivation of crops, particularly sugarcane.





*No. 4*

Land partially reclaimed, but still in bad physical condition as seen by the **stagnant water** between the furrows, showing that it will not drain naturally.



*No. 5*

Similar to the above, but improvement noticeable. It is seen that **Pundia cane in the foreground** has not done well, but that an 'arrowing' variety in the **background has succeeded** indicating the suitability of the variety for soils in **bad physical condition**.



No. 6

**Example of fully reclaimed land at Baramati Experimental Salt Area which produced over 80 tons of *Pundia* cane per acre.**



No. 7

**Planting cane sets at the Baramati Experimental Salt Area. This particular plot was originally so bad that it was left as a babul plantation for some ten years. It has already produced a moderate crop of cane, the soil having improved vastly except in one or two small patches. The planting now done was for the second crop. Note the crop in the distance (P. O. J. 2878)—plots which were reclaimed comparatively quickly.**

*No. 8*

**Maujri Drainage Scheme.** While excavating the main O. T. a spring was met discharging more than 0.5 cusecs. The waterway shown in the photograph is about 18 inches wide at the water surface, and the spring is immediately below the head of the dog. The result of releasing this subsoil water was to dry out about 30 acres above in less than three months.

*No. 9*

**Manjri Drainage Scheme.** No. 9 is typical of the area drained, which had been badly waterlogged for some 40 years. In many parts, quaking bogs occurred, due, it is thought, to the formation of liquid mud beneath the grass. This grass is 'mol' and the root system had formed a mattress of fibre about 8 inches thick. Drainage effected rapid drying out, and reclamation required special ploughing by tractor and complete overturning of this mattress in order to kill the roots by exposure to the sun—thereafter ordinary ploughing and cultivation sufficed to produce the cane crop shown in No. 10, the outturn of which was about 30 tons (the first crop taken).

*No. 10*

*No. 11**No. 12**No. 13*

Hol, Murum, Karanja Drainage Scheme—Main Open Trench just above the Baramati-Indapur Road. No. 11 shows grassing of the sideslopes, which were formed of layers of soil and sand alternately, just after completion of the work. No. 12 shows the same length of O. T. 5 years after, indicating the excellent protection afforded by well established grass. No. 13 shows grass laid above a subsoil layer of mán a little further up the O. T. than Nos. 11 and 12.

## LAND DRAINAGE IN THE DECCAN CANAL AREAS.

### INTRODUCTORY.

1. In June 1916, the Special Irrigation Division was first opened to investigate how to drain successfully the irrigated lands commanded by the Deccan Canals. Since then the following Technical Papers have been published :—

*Technical Paper No. 13.*

Soil and Sub-soil Surveys in the Deccan Canal Areas by C. C. Inglis and V. K. Gokhale.

*Technical Paper No. 14.*

A Short Note on the Improvement of the Damaged Lands in the Canal Irrigated Tracts of the Bombay Deccan by C. C. Inglis, Executive Engineer.

*Technical Paper No. 24.*

Report on Land Drainage Experiments at Baramati by C. C. Inglis with V. K. Gokhale.

As each of these three publications deal with fundamental research on different factors pertaining to drainage, it is impossible to avoid some overlapping in this Paper, which is intended to record the whole of the experience of drainage that has been obtained up to date.

2. With the advent of the Special Irrigation Division, one of the considerations found necessary for drainage was Sub-soil Survey. This introduced the need for some knowledge of the geology of the area (it has been termed history of the geological formation elsewhere). The damage already in evidence required a considerable investigation of the physics of the Subsoil—a subject still incomplete as regards its application to reclamation and irrigation-agriculture in general. Drainage is therefore not the simple excavation of a trench, embodying a few simple rules of engineering. It consists of many factors, any one of which omitted from consideration might vitiate completely the success of a scheme.

3. This Paper co-ordinates the results of eighteen years research and experience. It is impossible to state how every idea originated—. Some have resulted from research, pure and simple, in the laboratory ; others from observations in the field ; while much is due to direct observation of conditions from time to time details having been modified to suit the changing conditions in the light of results and the experience gained year by year.

4. It may also be asserted that our experience cannot necessarily be final, especially in details. Sub-soil survey work continually furnishes new information, which, after correlation with the experience and data already on record, may necessitate alterations of our previous ideas and methods. Some of these modifications may have far reaching effects ; some may affect petty detail only ; but all such information and resultant changes lead to a better understanding of the subject and to more efficient drainage.

5. Anyone, familiar with canal conditions, cannot have failed to observe areas of waterlogged and barren land. The former, produces a tremendous growth of bullrushes and waterloving grasses, which has rendered such lands useless for cultivation and valueless except for a little grazing, while the latter has been rendered barren either due to an excess of salts or to deflocculation of the soil resulting from sodiumisation.

6. Drainage is not only intended to rectify damage but also is even more desirable to prevent damage occurring, or at least to minimize and localize it. Eighteen years of research now make this possible.

7. The subject naturally divides itself into four heads :—

Part I—Soil and Sub-seils.

Part II—Preparation of projects.

Part III—Construction.

Part IV—Maintenance.

## PART I.

## SOILS AND SUB-SOILS.

## CHAPTER I.

## Soils and Sub-soils.

## WHAT DRAINAGE MEANS.

8. Drainage of an area consists in providing an outlet for the excess water in the sub-soil. To be successful, it depends mainly upon (a) the possibility of a free outfall from the natural line of drainage according to the topographical features of the country, and (b) the existence of a pervious substratum at such a depth that the drain which will cut into it, will be deep enough for the root zone of the crops to be grown, yet not so deep as to be uneconomical. The manner in which soils react to drainage depends upon the physical condition and composition of those soils. It is therefore necessary, before coming to the drainage project proper to consider the nature of the soils in the Deccan Canal areas and the effect of the sub-soil water table on those soils.

## ROCKS AND SOILS OF THE DECCAN.

9. The soils in the Deccan are derived from Deccan Trap, an igneous rock. The layers of rock seen in the Ghats and along the ranges of hills tailing off to the east, are of varying qualities, some exceedingly durable and hard, others very soft, easily broken up, and liable to very rapid disintegration. The chemical action of water and air and the mechanical action of heat, rain, and wind are continuously changing the rock into soil. The cracks in the rock, which may be of great extent, allow water to pass through them more or less freely according to the nature of the fissures. When a drain is aligned so as to tap such fissures in the original rock or in later formations resultant from decay, the water imprisoned in the porous strata below the impervious soils is freed; and hence success depends on locating porous substrata by cheap, quick, methods—to be described later.

## PROPERTIES OF THE SOIL.

10. Texture depends upon the size of individual soil particles. Soil particles are grouped into arbitrary divisions each having a defined range of diameter. The groups are designated as soil separates, such as "sand", "silt", "clay", and the relative proportions of these in a soil determine its textural class. The following table is according to general practice :—

Class of soil.	Effective diameter of soil particles in mm.	Percentage of pore space.	Effective surface area per cubic foot of soil particles in sq. ft.
Clay and loams .. ..	below 0.05	44 to 53	9,100 to 173,300
Sandy soils .. ..	between 0.05 and 2.00	about 35	8,380 to 15,870

This shows why water will pass more freely through sandy soil than through clay, the reason being that in the latter despite a higher percentage of pore space there is a far greater surface area of soil particles and thus much greater surface tension.

*Structure.*

The arrangement of the soil particles clinging together and forming clusters or crumbs is known as the structure of a soil. The purpose of ploughing and other operation is to maintain between the soil particles a good structural relation, which is called "good tilth".

*Porosity.*

Porosity, or measure of pore space of a soil, depends both upon size and gradation of individual particles (texture) and upon the manner in which they are arranged in groups or clusters (structure).

### PVIOUSNESS OF SOILS.

11. Resistance to the flow of water is dependent upon the space in the fissures and upon the area of surface in contact with the water in the pore space. In the case of large fissures, the surface resistance is comparatively small and the sectional area of crevice space along which the water flows is correspondingly large. Perviousness may be defined as the capacity of a given soil to allow the passage of water between its particles. Texture and physical structure are the factors that determine the size and extent of pores and also govern the soil fertility and perviousness. In the Deccan soils the fissures are usually of far greater importance than the pore space, but both must be fully appreciated when planning drainage of the canal areas.

### SOIL MOISTURE.

12. The capacity of a soil to retain moisture bears a very close relation to its textural and structural characteristics, but it is difficult, if not impossible, to test this capacity without destroying the original structure. Whenever a soil is saturated with water for a considerable period of time, any structure it may have possessed breaks down. Soil moisture is divided into three forms—hygroscopic, capillary, and gravitational.

(a) Hygroscopic moisture is relatively unimportant in drainage because it can only be driven out by the application of heat, and upon cooling is immediately reabsorbed from the air.

(b) Capillary, or film, moisture surrounds each individual particle and is held by surface tension against the pull of gravity. The amount present in a given soil depends upon the film thickness, the size and arrangement of the particles, and upon the source of supply.

(c) Gravitational moisture is free to obey the laws of gravity. If there be more than enough water to saturate a soil to its greatest capillary capacity, the excess in the pores and cracks will gradually work its way downwards to a natural outfall, or if that be obstructed in any way, will accumulate until all the pores and crevices are entirely filled and the soil becomes supersaturated. In such a condition, the structure is destroyed, air is forced out of the pore space, and vegetation, after a time, is suffocated and drowned, especially in the black soil areas.

The diagram (Figure 1) below shows conventionally the three forms of soil moisture and their effectiveness.

DIAGRAM SHOWING MOISTURE IN SOILS.

Hygroscopic			Capillary		Gravitational	
Dry-too	Little	Moisture	Moisture available	suffi-	Saturated moisture	in
available	for	crop	cient and useful for	cient	excess and injurious to	crop growth.
growth.			crop growth.			

Fig. 1

### SOIL MOISTURE AND PLANT GROWTH.

13. The particular moisture content of a soil which is best for plant growth is the "optimum moisture content". It varies for soils of different texture and to a small degree for different kinds of crops. The plant roots extract water from the thin film surrounding the soil particles. It follows that the amount of water adhering to the particles in a fine grained soil is greater than in a coarse grained soil on account of the greater surface area of the more numerous and finer particles. The optimum moisture content corresponds closely to the amount which renders the soil most friable and in the best condition for cultivation. With moisture exceeding this optimum the pore space becomes partly filled, aeration is deficient, and conditions are less favourable for cultivation and plant-growth. The result of such conditions is commonly known as water-logging.

## PART I.

## SOILS AND SUB-SOILS.

## CHAPTER I.

## Soils and Sub-soils.

## WHAT DRAINAGE MEANS.

8. Drainage of an area consists in providing an outlet for the excess water in the sub-soil. To be successful, it depends mainly upon (a) the possibility of a free outfall from the natural line of drainage according to the topographical features of the country, and (b) the existence of a pervious substratum at such a depth that the drain which will cut into it, will be deep enough for the root zone of the crops to be grown, yet not so deep as to be uneconomical. The manner in which soils react to drainage depends upon the physical condition and composition of those soils. It is therefore necessary, before coming to the drainage project proper to consider the nature of the soils in the Deccan Canal areas and the effect of the sub-soil water table on those soils.

## ROCKS AND SOILS OF THE DECCAN.

9. The soils in the Deccan are derived from Deccan Trap, an igneous rock. The layers of rock seen in the Ghats and along the ranges of hills tailing off to the east, are of varying qualities, some exceedingly durable and hard, others very soft, easily broken up, and liable to very rapid disintegration. The chemical action of water and air and the mechanical action of heat, rain, and wind are continuously changing the rock into soil. The cracks in the rock, which may be of great extent, allow water to pass through them more or less freely according to the nature of the fissures. When a drain is aligned so as to tap such fissures in the original rock or in later formations resultant from decay, the water imprisoned in the porous strata below the impervious soils is freed; and hence success depends on locating porous substrata by cheap, quick, methods—to be described later.

## PROPERTIES OF THE SOIL.

10. Texture depends upon the size of individual soil particles. Soil particles are grouped into arbitrary divisions each having a defined range of diameter. The groups are designated as soil separates, such as "sand", "silt", "clay", and the relative proportions of these in a soil determine its textural class. The following table is according to general practice :—

Class of soil.	Effective diameter of soil particles in mm.	Percentage of pore space.	Effective surface area per cubic foot of soil particles in sq. ft.
Clay and loams .. ..	below 0.05	44 to 53	9,100 to 173,300
Sandy soils .. ..	between 0.05 and 2.00	about 35	8,380 to 15,870

This shows why water will pass more freely through sandy soil than through clay, the reason being that in the latter despite a higher percentage of pore space there is a far greater surface area of soil particles and thus much greater surface tension.

*Structure.*

The arrangement of the soil particles clinging together and forming clusters or crumbs is known as the structure of a soil. The purpose of ploughing and other operation is to maintain between the soil particles a good structural relation, which is called "good tilth".

*Porosity.*

Porosity, or measure of pore space of a soil, depends both upon size and gradation of individual particles (texture) and upon the manner in which they are arranged in groups or clusters (structure).



### PERVIOUSNESS OF SOILS.

11. Resistance to the flow of water is dependent upon the space in the fissures or pores and upon the area of surface in contact with the water in the pore space. In the case of large fissures, the surface resistance is comparatively small and the cross sectional area of crevice space along which the water flows is correspondingly large. Perviousness may be defined as the capacity of a given soil to allow the passage of water between its particles. Texture and physical structure are the two factors that determine the size and extent of pores and also govern the soil porosity and perviousness. In the Deccan soils the fissures are usually of far greater importance than the pore space, but both must be fully appreciated when considering drainage of the canal areas.

### SOIL MOISTURE.

12. The capacity of a soil to retain moisture bears a very close relation to its textural and structural characteristics, but it is difficult, if not impossible, to test this capacity without destroying the original structure. Whenever a soil is saturated with water for a considerable period of time, any structure it may have possessed breaks down. Soil moisture is divided into three forms—hygroscopic, capillary, and gravitational.

(a) Hygroscopic moisture is relatively unimportant in drainage because it can only be driven out by the application of heat, and upon cooling is immediately reabsorbed from the air.

(b) Capillary, or film, moisture surrounds each individual particle and is held by surface tension against the pull of gravity. The amount present in a given soil depends upon the film thickness, the size and arrangement of the particles, and upon the source of supply.

(c) Gravitational moisture is free to obey the laws of gravity. If there be more than enough water to saturate a soil to its greatest capillary capacity, the excess in the pores and cracks will gradually work its way downwards to a natural outfall, or if that be obstructed in any way, will accumulate until all the pores and crevices are entirely filled and the soil becomes supersaturated. In such a condition, the structure is destroyed, air is forced out of the pore space, and vegetation, after a time, is suffocated and drowned, especially in the black soil areas.

The diagram (Figure 1) below shows conventionally the three forms of soil moisture and their effectiveness.

DIAGRAM SHOWING MOISTURE IN SOILS.

Hygroscopic			Capillary		Gravitational	
Dry-too	Little	Moisture	Moisture available	suffi-	Saturated moisture	in
available	for	crop	cient and useful for	crop growth.	excess and injurious to	crop growth.
growth.						

Fig. 1

### SOIL MOISTURE AND PLANT GROWTH.

13. The particular moisture content of a soil which is best for plant growth is the "optimum moisture content". It varies for soils of different texture and to a small degree for different kinds of crops. The plant roots extract water from the thin film surrounding the soil particles. It follows that the amount of water adhering to the particles in a fine grained soil is greater than in a coarse grained soil on account of the greater surface area of the more numerous and finer particles. The optimum moisture content corresponds closely to the amount which renders the soil most friable and in the best condition for cultivation. With moisture exceeding this optimum the pore space becomes partly filled, aeration is deficient, and conditions are less favourable for cultivation and plant-growth. The result of such conditions is commonly known as water-logging.

## CAPILLARY ACTION.

14. In finely grained and well compacted soils capillary action is greatest. Instances have been observed where water in the soil rose from 4 to 5 feet by capillary action emerging salts to the surface. On the other hand cases of free ground-water at a depth of 2 or 3 feet in coarse grained soils can be seen, causing no appreciable moisture at the surface, and permitting the growth of excellent crops.

In the Deccan, where the sub-soil water table is at more than 4 feet damage does not normally occur.

## ZONE OF ROOT GROWTH.

15. A zone of plant-growth sufficient for the deep-rooted crops is essential. Experience indicates that a depth of 4 feet of unsaturated soil is ordinarily sufficient for the expansion and growth of the root systems of crops in general, which tallies with the depth at which water should be kept to prevent damage.

## SOIL ALKALIS.

16. The water that is raised from below by capillary action in soils brings with it mineral salts in solution. When this solution approaches ground level and comes under the influence of wind, air, and sun, the water evaporates and the salts are deposited at or near the surface. The salts so deposited are chiefly salts of sodium and are termed alkali salts. Actually, however, only sodium carbonates and bicarbonates are alkaline, the other sodium salts being neutral.

These salts occur most commonly as (1) Sodium Chloride ( $\text{NaCl}$ ), (2) Sodium Sulphate ( $\text{Na}_2\text{SO}_4$ ), (3) Magnesium Sulphate ( $\text{MgSO}_4$ ), (4) Calcium Chloride ( $\text{CaCl}_2$ ), (5) Sodium Bicarbonate ( $\text{NaHCO}_3$ ) and (6) Sodium Carbonate ( $\text{Na}_2\text{CO}_3$ ). These may be found as mixtures in almost any proportion of two or more of the salts. Alkalinity (black alkali) usually represented as  $\text{Na}_2\text{CO}_3$  has the most deleterious effect on plant life and also is most difficult to remove. The limit of tolerance of vegetation to different alkali salts in the soil is roughly as follows:—

- (1) Sodium Carbonate 0·1 per cent. 0·15 per cent.
- (2) Sodium Chloride 0·2 per cent. 0·3 per cent.
- (3) Sodium Sulphate 0·4 per cent. 0·6 per cent.

The salts usually found in the Deccan are sulphates on the Nira Left Bank Canal, chlorides of sodium and calcium in the Godavari Valley, while carbonate of soda occurs in rare cases.

## HOW DAMAGE OCCURS.

17. Plate I opposite illustrates how damage frequently occurs in a Deccan Valley. The hydraulic gradient of the sub-soil water table from a canal into the valley is fairly steep near the canal, due to the steepness of the ground and of the murum surface. Further away the water moving through the fine soils overlying the murum, and through the murum itself, meets with an obstruction in the shape of impervious chopan substratum. The hydraulic gradient also flattens and the water appears at ground level (or just below) near the line of demarcation between the fine black soil and chopan black soil. In the fine black soils water comes to the surface readily, causing water-logging. Lower down in the deep chopan soils the water is trapped under the almost impervious chopan and, being under pressure (artesian), forces its way slowly upwards carrying sodium salts in solution. When the sub-soil water table is within 4 feet water rises by capillary action to the soil surface where it evaporates depositing the salts at the surface. This is generally known as "salt efflorescence". Further less water is brought to the surface owing to the greater depth of impervious chopan.

## ALKALIZATION OR BASE EXCHANGE.

18. The real trouble is not due to the "Salt efflorescence" because this can easily be washed out of the soil by flooding, following drainage, but is due to the effect of alkalinity on a heavy soil. Alkalinity deflocculates the soil.

A TYPICAL SECTION SHOWING RELATIVE POSITIONS  
OF SOILS AND SUBSTRATA IN THE DECCAN CANAL TRACTS  
 (VERTICAL SCALE EXAGGERATED)

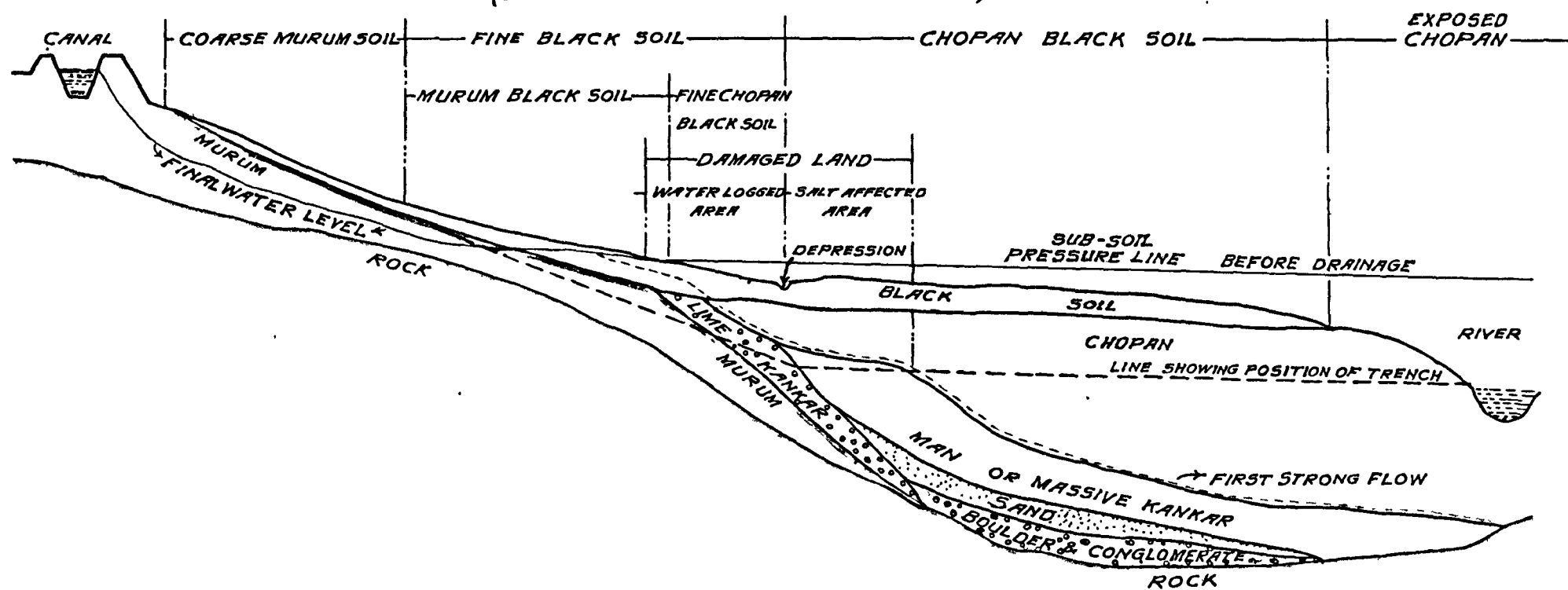

Until recently alkalinity in the soil was considered to be due to  $\text{Na}_2\text{CO}_3$  and was represented as such. Its formation was ascribed to the action of sodium salts on  $\text{CaCO}_3$  in the soil by the process of base exchange.



the direction of the action depending on the concentration of the reacting solutions. Recent researches have however shown that the finest soil (clay) particles when in contact with salt solution absorb bases retaining them on their surfaces.

This is as shown diagrammatically below :—

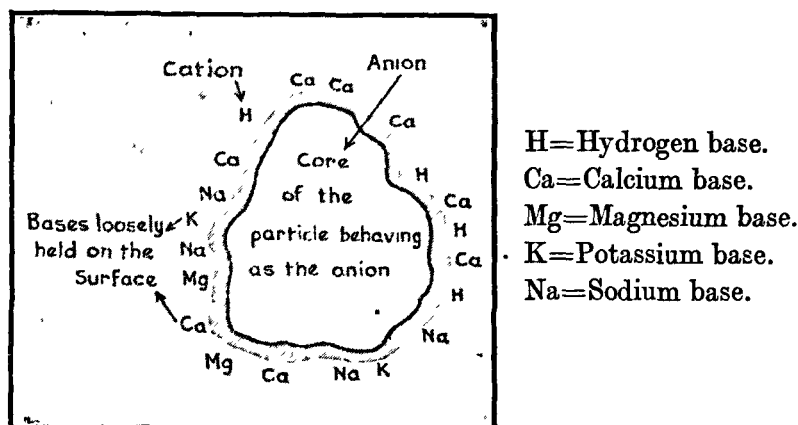

The soil particle with its cations is regarded as a kind of salt in which the colloidal bodies of the particles constitute the anion.

If a soil is kept in contact with a concentrated solution of a salt ( $\text{KCl}$ ,  $\text{NaCl}$ ,  $\text{CaCl}_2$ ,  $\text{MgCl}_2$ ) for a long time, practically the whole of the bases originally present in the soil will be replaced by the cations of the salt used. In this way soils can be prepared containing any base. The physical properties of a soil are considerably altered when a change of cation takes place. The surplus salt solution in contact with the soil which has a flocculating effect must however be washed off before the physical changes can be observed. Sodium soil for instance is sticky and remains dispersed for a long time in pure water in suspension whereas calcium soil is granular and settles rapidly in such a suspension. Replacing power varies with different bases, e.g.,  $\text{Ca} > (\text{can displace}) \text{Mg} > \text{K} > \text{Na}$ .

The soil particles behaving as a salt as mentioned above, the reaction shown in equation (1) takes place when sodium salts in contact with the soil obtain a concentration sufficient to exchange bases with the soil thus :—



$\text{Na}$ -clay being unstable hydrolyses, i.e., absorbs  $\text{OH}$  ion.



$\text{NaOH}$  strongly absorbs  $\text{CO}_2$  in the soil and is converted into  $\text{Na}_2\text{CO}_3$  partially or wholly depending on the amount of  $\text{CO}_2$  present in the soil

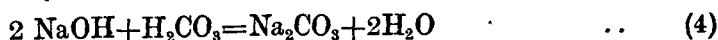

Alkalies have a dispersing or deflocculating action on clay causing the soil to lose its tilth and become impervious and highly retentive. The circulation of air is completely stopped with the result that nothing is able to grow in the soil. Areas of this type are devoid of vegetation.

When the concentration of sodium salts rises still further they have a flocculating action because the hydrolysis of Na-clay shown in equation (3) is suppressed and alkalinity is thus reduced. A more saline soil can thus be in a better state physically than a less saline sodium soil. The land however does not become fit for cultivation due to the toxic action on vegetation (see paragraph 16 for limiting concentration of different salts) of the salts themselves.

#### BARAMATI EXPERIMENTAL SALT AREA.

19. No better practical illustration of this can be given than the actual subsoil conditions of the valley of which the Baramati Experimental Salt Area forms a part. Plate II is identical with Figure 1-A of Technical Paper No. 24 ("Report on Land Drainage at Baramati" by C. C. Inglis with V. K. Gokhale) and is reproduced on the opposite page. Paragraph 17 of that Paper is also quoted in full in order to explain what the data showed:—

"17. The subsoil data calculated at Baramati showed that there was a large volume of subsoil water moving slowly downwards from the ridge—through the porous strata—towards the Experimental Area. This subsoil water was due to percolation from the heavily irrigated fields of cane on the higher-lying lands, and the water had been prevented from reaching the Karha river by a ridge of rock and layers of chopan and black soil. The movement of the water was further retarded owing to the stratification of the rock and other material—at the lower side of the Area—being counter to the direction of water flow, as shown in sketch I (figure 2 below).

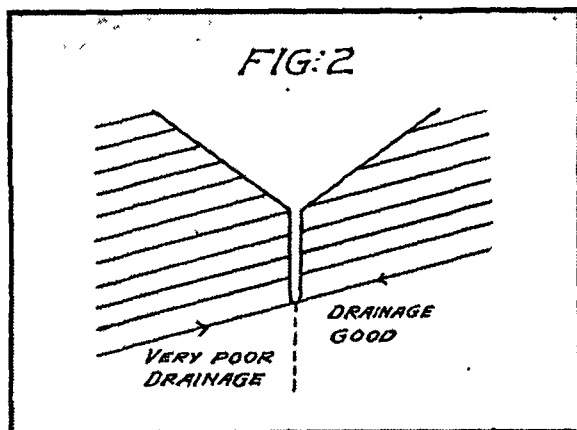

Water under pressure, was therefore forced to the surface when the permeable massive kankar was confronted by impermeable material; and this explained the prevailing artesian conditions, which existed even where the subsoil water level—as observed in shallow bores—was below the ground surface; as shown in sketch II (figure 3 below)."

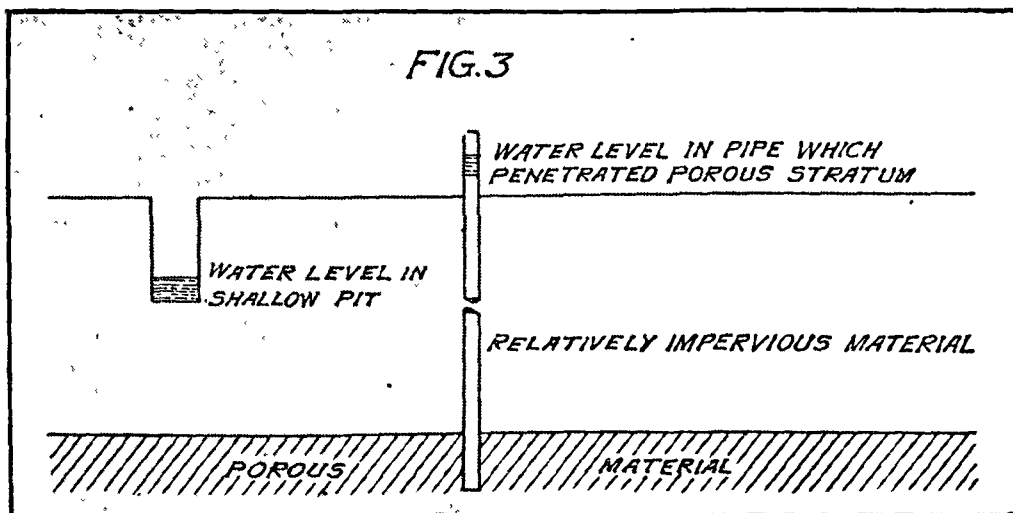

BARAMATI EXPERIMENTAL SALT AREA

PLATE No II

NIRA L. B. CANAL

SOIL SECTION

SCALE.      HOR: 4" = 1 MILE  
                 VER: 20" = 1 INCH

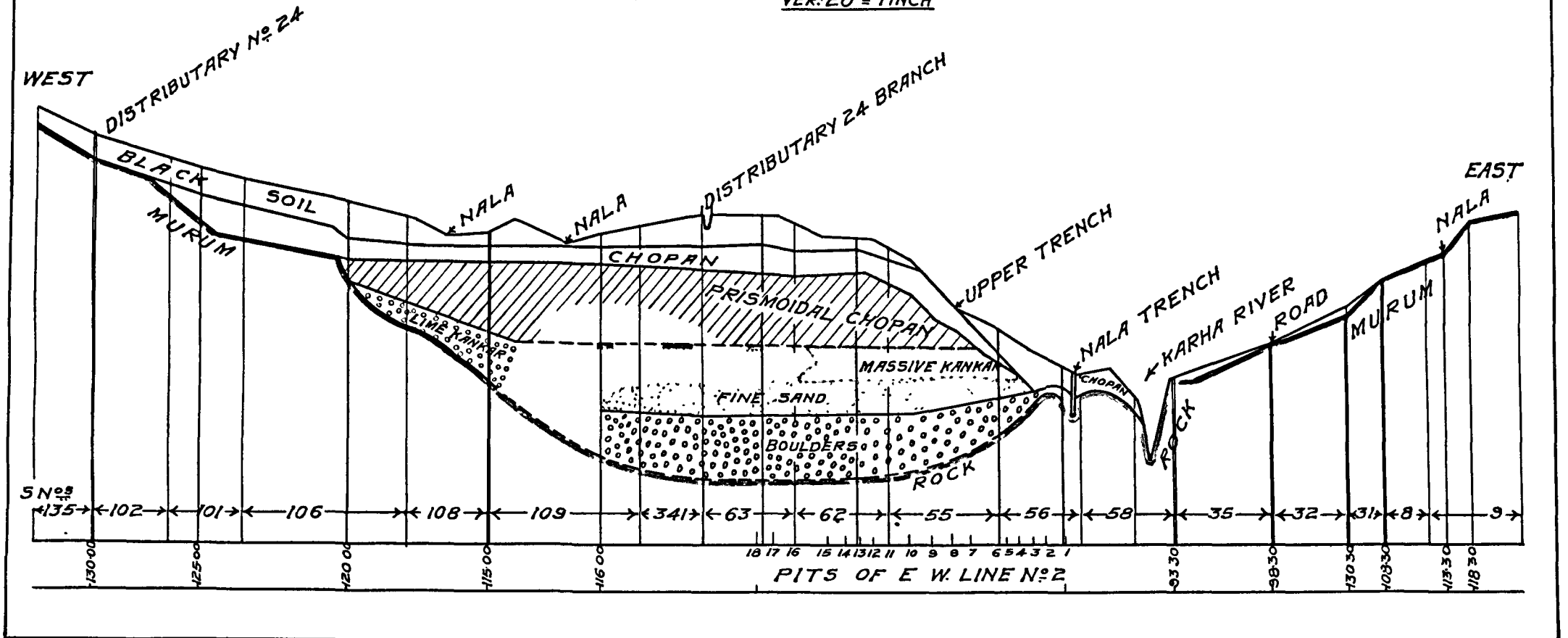

It is interesting to note here how the Karha river has changed its course—a phenomenon which is constantly occurring and can be observed in the case of the smaller nalas from year to year, particularly where “ thals ” have been built.

20. An extremely interesting development of the difficulty has occurred in draining the upper area of the Baramati Experimental Salt Area. Parts of this area have so far defied reclamation and the subsoil water level has remained very high in spite of the pipe lines which have been in existence for more than ten years.

Some few years ago (1931) it was decided to investigate the possibility of tapping the murum nose near by, on the grounds that the high subsoil water level was due to water pressure being transmitted through a porous layer under the chopan.

This investigation was at first reported to yield negative results due, it is now seen, to the top m $\ddot{a}$ n layer being local and underlain by chopan. Recently the bores have been deepened and it has been found that the trouble has been due to a deep porous substratum of m $\ddot{a}$ n carrying water under pressure under the chopan layer.

The question of lines of flow was next investigated by measuring the changes of electrical conductivity in a grid of bores, caused by irrigation. Conductivity indicates salinity and hence changes in salinity indicate changes in dilution and direction and freedom of flow.

Data was collected over several irrigation rotations, and it was seen that as irrigation progressed salinity fluctuated in each pit, which made it possible to trace the direction and velocity of flow.

As explained above, successful drainage necessitates reduction of the water level to more than 4 feet below ground level. This can only be done at a reasonable cost by locating and tapping porous substrata. Where waterlogging or salt efflorescence already exists, drains will provide an outlet for the excess water contained in the subsoil and wilt, as explained in paragraph 20, eventually result, in conjunction with appropriate treatment and cultivation (reclamation), in the restoration of the soil to a good condition. But it is to be noted that success can only be achieved by the co-ordination of land drainage engineering with hydrological, subsoil and soil physics ; work which does not come under ordinary engineering or agriculture ; but is a highly special branch of its own.

## CHAPTER II.

### The Subsoil Water Table.

#### FACTORS LEADING TO THE RISE OF SUBSOIL WATER.

21. There are three main factors which affect the subsoil water table in the Deccan Canal areas :—

- (a) percolation of water from the canals and distributaries,
- (b) irrigation of crops,
- (c) rainfall.

Of these, rainfall alone rarely causes any appreciable damage to soils. But it may aggravate bad conditions already in existence and primarily caused by (a) and (b).

#### PERCOLATION FROM CANAL AND DISTRIBUTARIES.

22. As the Deccan is undulating, the main Canals are aligned either along a falling contour (*e.g.*, the older canals) in sidelong ground or along a less devious route by means of cuttings and banks (*i.e.*, the new Nira Right Bank Canal). In both cases the canals have generally been partly excavated in pervious strata such as soft rock and murum, and it is these pervious strata and particularly the transition sections where bank merges into cutting (and *vice versa*) which are the most important sources of percolation from a Canal. The effect of such percolation is carried far into the low-lying lands ; initial damage being mainly to lands in the vicinity of the Canals. This initial damage later diminishes as a result of the reduction of percolation due to the formation of a colloidal, vegetable and bacterial

silt-film on the bed and sides of Canals ; but damage steadily increases in the valleys due to water getting imprisoned below non-porous soils and then rising under pressure up to, or near to, the surface. Distributaries, which follow a falling contour or run along ridges, generally cut into murum and hence are a further source of considerable damage.

#### PERCOLATION FROM IRRIGATED AREAS.

23. As the development of a canal tract proceeds, a more important cause of damage to low-lying lands becomes apparent ; that caused by the heavy irrigation of crops situated on the ridges. The amount of damage due to this depends on—

- (i) nature of substrata ;\*
- (ii) topography of the area ;
- (iii) nature, extent, and concentration of crops grown ;
- (iv) intervals between, and depth of, waterings ;
- (v) seasonal and climatic conditions ; and
- (vi) method of irrigation.

Item (vi) includes several factors not easily controllable as a whole, such as—

- (a) waste of water ;
- (b) administrative difficulties in the distribution of water ;
- (c) inexperience of irrigators.

Generally speaking, heavy waterings and waste of water are the most important.

#### THE SUBSOIL WATER TABLE.

24. From our experience and from the data collected, the following general deductions may be drawn :—

An initial rise of subsoil water level takes place rapidly during the first few years after the opening of a canal. For example, although the cane area on the Nira Right Bank Canal which was opened for irrigation in 1926, was only 1,000 acres in 1933, and the discharge was less than 30 per cent. of that for which it was designed, yet the subsoil water level had risen by 25 feet from the original depth of 40 feet below ground level. This rise has not as yet reached stability, owing to the slow development of irrigation, but the water is already at less than 10 feet in 29,281 acres or 8·3 per cent. of the culturable commanded area ; and within 4 feet in 4,014 acres (1·14 per cent.).

Generally the greater the distance from the canal, the less is the tendency of the canal percolation to affect the subsoil water table. For areas at a distance from the canal, the main factor affecting the subsoil water level is percolation from channels and perennial irrigation, the canal percolation being subsidiary only.

In non-irrigated tracts rainfall causes an annual fluctuation in the subsoil water level of up to 15 feet, but where there is perennial irrigation rainfall mainly affects the subsoil conditions indirectly, as a result of variations in canal discharges, method of distribution, nature and concentration of crops, etc.

#### FACTORS WHICH HELP IN CONTROLLING THE WATER TABLE.

25. The gradual formation of a silt-film in the canals and distributaries, the lining of channels†, the control of distribution by modules, the selection of soils for various crops, efficient supervision, prevention of avoidable waste, all these go far towards keeping the subsoil water table low, reducing damage, and protecting the land from further damage. But no irrigation system embodying these devices can be said to be perfect without an efficient system of drains capable of carrying away the excess water and of maintaining the subsoil water level at a depth suitable for the crops to be grown.

\*Vide Technical Paper No. 13 "Soils and Subsoil Surveys in the Deccan Canal Areas" by C. C. Inghs, Executive Engineer, and V. K. Gokhale, Deputy Soil Physicist (1926).

†So far no lining has been devised as a practical proposition by which percolation can be stopped entirely. Even if it were possible, the justification for high expenditure on such work would depend on the possibility of making the work pay by means of increased revenue from the use of the water saved in other parts of the area.



EFFECTS OF DRAINS ON THE SUBSOIL WATER TABLE.

26. In the drainage schemes already constructed, observation tubes have been sunk to observe the water level and thus watch the effect of the drains. The tubes are situated in rows approximately at right angles to the drain, and the highest subsoil water level will be found furthest away from the drain. From the highest point, the slope of the line of subsoil water levels is gradually downwards but becomes much steeper as it approaches the drain. The resulting curve is illustrated in figure 4.

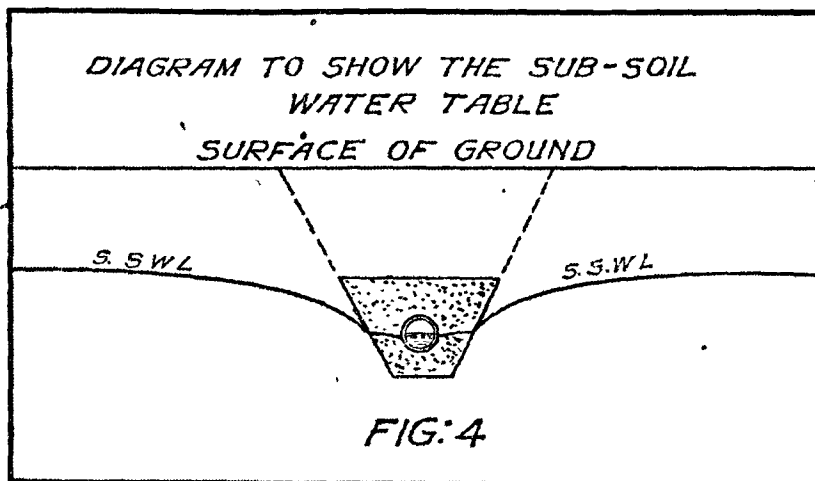

Just after heavy irrigation, the soil is saturated. A short time after the completion of irrigation, the subsoil water table assumes the shape shown, becoming flatter day by day until the next watering is given to the crop.

From the data so obtained, it can be shown that the equation of the curve is hyperbolic. Work on this subject has been done by the Engineering Experiment Station of Iowa State College\*. It was then shown that the equation of the curve for fine sand was of the general form

$$Y = \frac{X}{a - bx}$$

Where 'a' = constant for a specific curve

b = Do. do.

and this has been corroborated by results obtained at the Baramati Experimental Salt Area.†

The practical application of this equation is not easy because of ever varying factors such as nature of the substrata, differences in physical condition of the soils and other factors, which, in the Deccan, change with extraordinary rapidity and frequency. It is in fact rather of academic interest now that experience of some twelve drainage schemes in the Deccan has corroborated our earlier research.

MOVEMENT OF SUBSOIL WATER.

27. The velocity with which ground water will move between any two points depends upon a number of variable factors, chief among which are :—

- (a) physical characteristics of the soils ;
- (b) perviousness of the substrata ;
- (c) difference in height between the two points ;
- (d) length of the path taken.

The practical requirement in this connection is the quantity of water which may be expected from a given catchment, allowing for the nature of the irrigation.

The direction of flow of subsoil water may also be required in particular cases. This has been ascertained by observations of one or two rings of pits round a central pit into which a quantity of fluorescence (a colouring matter) has been poured.

\* "Land Drainage and Reclamation" by Ayres and Seates.

† See Technical Paper No. 24, Figure 11—"Report on Land Drainage at Baramati" by C. C. Inglis and V. K. Gokhale.

The arrival of the fluorescenc can be observed in the surrounding pits periodically. In such experiments as have already been done, the rate of flow is tabulated below :—

Experiment No.	Situation.	Soil.	Time in hours to travel a distance of 2 feet.	Apparent rate of flow per year in miles.
1	Survey No. 60, Baramati Experimental Salt Area.	Heavy chopan black soil ..	2.54	1½
2	Survey No. 276, Karanja ..	Fine chopan black soil ..	1.50	2½

#### RESULT OF SUB-SOIL DRAINAGE.

28. Sub-soil drainage causes a lowering of the sub-soil water level. As the excess water percolates into the drain, air is drawn into the soil to take its place, thus improving the soil aeration. The root zone increases in depth and this improves the supply of plant food. The increase in the depth of the root system also enables crops to withstand drought to a greater degree. Lowering of the zone of saturation also results in a warmer soil. Wet or waterlogged soils are slow to warm up, because of the higher specific heat of water.

By drainage the physical condition of the soil is improved. Drainage permits the development of the granular structure of the soil, so essential to good tilth, and lengthens the period during which the optimum moisture content prevails. Drained land becomes more easily workable, reducing the cost of cultivation.

The improvement of the soil after drainage will largely depend on cultivation. Little care may be needed to restore fertility in some types of damage for example on murum black soil (black soil on pervious murum) but a great deal is required in heavier soils like chopan black soil (black clay soil on chopan subsoil). The process of damage in heavy soil by sodiumization has been explained in paragraph 18. Reclamation or the restoration of the soil to its original condition is extremely difficult in such cases; because after the soluble salts have been reduced to a limit of about 0.4 to 0.5 per cent. deflocculation of the soil, due to alkali produced by the hydrolysis of sodium clay, occurs inhibiting the movement of water in the soil and so preventing further reclamation.

When this occurs the movement of water can only be re-established slowly. This may be done by flooding the land with water containing salts;  $\text{CaCl}_2$ , which, strange as it may seem, is in such cases the first step towards reclamation. Under such conditions reclamation has also been successfully effected by the addition of gypsum (about 3 tons per acre) to neutralize the alkali. Alternatively heavy doses of farm yard manure may be given. This produces free  $\text{CO}_2$  in the soil which converts the  $\text{Na}_2\text{CO}_3$  into the leachable bicarbonate,  $\text{NaHCO}_3$ . The soil is then flooded, and the salts driven down into the substratum, whence it passes into the drains. This process is known as "leaching out" the salts. Dr. Mackenzie Taylor, Director of the Punjab Irrigation Research Institute, has shown that a crop of rice grown rapidly improves the soil through the  $\text{CO}_2$  emitted by the roots, which convert alkalinity into the easily leachable bicarbonate form. This has also been found to hold in Deccan soils provided the crop is established by a liberal dressing of farm yard manure (20 carts per acre) coupled with adequate drainage.

It is clear that the reclamation of heavy soils is expensive, but areas of the type suitable for drainage do not normally include more than a small proportion of such soils.

Drainage thus helps the irrigator to get better crops and is a dominant factor in the general prosperity of the tract. In addition it leads to many indirect advantages of which two of the most important are the benefits obtained in better transport facilities, and the improvement of health.

IRRIGATION RESEARCH DIVISION

CHART SHOWING RELATION BETWEEN CANE,  
HYDRO-ISOBATHS AND DAMAGED AREAS

SCALE: 1000 ACRES = 1" INCH

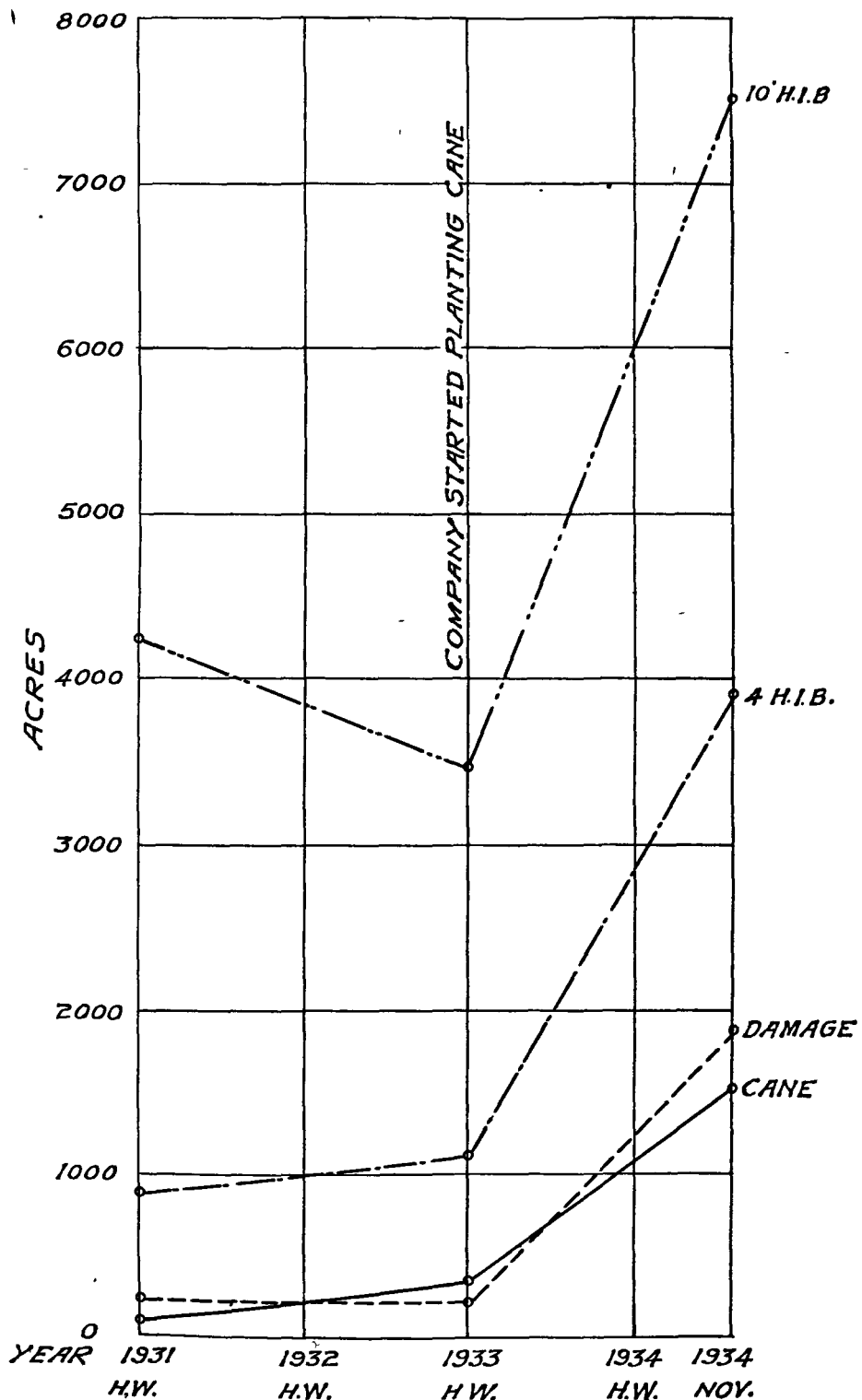

## CHAPTER III.

## Co-ordination.

## DESIRABILITY OF EARLY DRAINAGE.

29. The original object underlying the construction of storage reservoirs and irrigation works in the Deccan was to protect those areas most liable to famine.

Whatever may be the trend of development in future, it is abundantly borne out by data already on record that drainage in the initial stage of damage—that is, as soon as the sub-soil water level rises to within 4 feet of ground level—, would entail no expenditure on reclamation, and that the land would still remain fit for cultivation. Hence it may be laid down for Deccan conditions that drainage should be provided as soon as development of irrigation shows that the natural drainage of an area is insufficient. As an illustration the chart on the opposite page (Plate No. III) shows the relation between rise of sub-soil water level (observed in wells), increase of areas within the 4 feet and 10 feet hydro-isobaths (H.I.B.), increase of damaged areas and the increase of cane in the case of the sugar factory area at Kalamb, Distributary No. 46 of the Nira Left Bank Canal. This indicates the rapid rise of sub-soil water level and the immediate necessity of drainage.

## RELATIVE IMPORTANCE OF DRAINAGE SCHEMES.

30. It is desirable to indicate the considerations which are necessary to formulate an order of urgency for drainage schemes on the various canals.

The chief data are crops, soil, sub-soil, topography, proximity to markets, proximity to head of canal and distributary heads, transport facilities, drainage outfall, etc. Crop and soil suitability must be considered together in order to ascertain what increase of irrigation might be expected after drainage. The sub-soil survey indicates the feasibility of drainage and therefore whether a scheme is likely to be financially successful or not. Proximity to markets is of great importance. Naturally the areas close to the markets are favoured by cultivators and it may be of no use to drain more suitable areas at greater distances if distance is likely to be a limiting factor. Closely connected with distance is transport facility. Here again, a project may be ideal in every way, but handicapped by lack of reasonably good communications. Proximity to canal head of a proposed scheme must not be neglected, because it is desirable to concentrate cane cultivation near the head of a canal or distributary rather than near the tail in order to reduce losses in channels. This needs careful balancing with other factors, as in some cases it has been found better to subordinate this factor to that of proximity to a market town.

## FINANCE.

31. The method of financing drainage schemes has undergone changes. It was first thought that cultivators owning damaged land would be keen to have it drained and reclaimed and that a Co-operative Drainage Society would be suitable, the work being carried out as a contribution work. This method was tried for the Manjri Drainage Scheme near Poona, involving some 300 acres of land which had been badly water-logged for nearly 40 years. Although the majority of cultivators concerned were sufficiently enlightened to agree to this method of procedure and to subscribe their quotas, the minority unfortunately either could not, or would not, subscribe; and because of the minority, this method fell through.

The probable results of drainage were then forecasted and translated into terms of revenue, drainage making it possible to utilise the water nearer to the head of the Canal, to increase intensity of irrigation and to save water by improved distribution. Most of the schemes projected were found to pay between 5 per cent. and 10 per cent.—subject to the necessary demand. If the indirect revenue also could have been included, the financial prospects would, of course, have been much better. On these grounds, therefore, Government decided that drainage schemes should be financed and carried out by themselves. The financing of drainage schemes for Sugar Companies is, however, on a different footing entirely. The intensity of cane required by such Companies far exceeds anything which has been allowed previously, where gul was the objective, and although the factory

“ areas ” were selected on account of their good natural drainage, artificial drainage is necessary.

#### STAFF.

32. It is appropriate here to describe briefly the composition of the Special Irrigation Division (now Irrigation Research Division) staff. It will be seen that although drainage is the main consideration other branches of research are involved, especially soil physics.

Originally there were Sub-divisions on each Canal system ; the headquarters being at Phaltan for the Nira Right Bank Canal ; Baramati, the Nira Left Bank Canal ; Belapur, the Pravara Canals ; and Kopargaon for the Godavari Canals. Each Sub-divisional Officer had four subordinates and great headway was made with soil classification and projects for drainage schemes, several of the latter being constructed. Later on the staff had to be reduced on account of retrenchment and the Sub-divisions at Phaltan and Belapur were merged into those at Baramati and Kopargaon. With the further reorganisation carried out in 1933, all construction and maintenance of drainage schemes was transferred to the regular irrigation Division, leaving two Sub-divisions at Baramati and Kopargaon for project work and such other research as was necessary, e.g., well observation and damage classification.

One trained subordinate can work on two sub-projects of normal size at a time, so that while one is being scrutinized by the Executive Engineer, survey of the second can be continued—and so on alternately. He requires at least three but not more than four trained men of the auger staff, supplemented by khalashis according to the work being done. The auger staff consists of auger Mukadams, Karkuns and Measurers, who are specially trained in soil and sub-soil survey work.

In addition to the subordinate staff soil classifiers, graduates in agriculture have been employed on drainage and research connected with sub-soil surveys. The sub-soil physical research carried on in the laboratory at Baramati followed as a matter of course in connection with the feasibility of draining the various soils ; and in close co-operation with the work on the Baramati Experimental Salt Area, it has solved the problems of reclaiming land damaged by water-logging, salt efflorescence and sodiumisation. Another factor, not hitherto mentioned in connection with drainage, is the salinity of sub-soil water. In the laboratories, samples taken from time to time from wells all over the irrigated areas and from drainage schemes are tested for salinity.

It has been mentioned that trained subordinates are necessary for drainage work. But although trained in soil and sub-soil survey, conditions vary so much that new features are constantly coming to notice ; and, where the trained subordinates would naturally fail in the technical requirements of some new aspect of a soil problem, the matter is referred for elucidation to the laboratories and the Soil Physicist.

Hydrodynamic Research also plays an important part in drainage as problems connected with flow and silting of drainage channels, and the design of standing wave flumes, falls, meters, and other matters are involved in preparing drainage projects.

#### CO-ORDINATION.

33. It has now been shown how drainage entails not mere excavation of trenches, but primarily a consideration of the physics of the substrata of an area, whether they are of a previous nature and will therefore be conducive to successful drainage ; how a drainage scheme, though technically sound, may be undesirable on account of other factors, such as distance from markets and inadequate communications ; and above all, that successful drainage depends entirely on close co-ordination of all the factors which arise.

That drainage is popular and that cultivators fully appreciate its advantages, is obvious—and has been corroborated in no uncertain manner in the past by the numerous applications received from individuals, as well as from whole villages, for drainage of their areas or for advice ; some wanting to construct shallow and complementary drains to a completed sub-soil system, others requiring advice concerning suitable treatment for the reclamation of their land.

**PART II.****PREPARATION OF THE PROJECT.****CHAPTER IV.****Survey Work.****PROCEDURE.**

34. Sub-soil surveys, damage surveys and sub-soil water level surveys are already being carried out. From these it is possible to decide whether an area can be drained and reclaimed at a reasonable cost and whether the land after drainage and reclamation will be suitable for intensive irrigation.

Having decided that a scheme is likely to be successful—physically and economically—then the question of drainage should be investigated. The following is the general procedure :

(1) The Subdivisional Officer should first submit a plan of the area (scale 660' = 1") showing all the available information about the area. This plan should be accompanied by a survey estimate, which should provide for all additional survey work needed to obtain complete information.

(2) On receipt of orders to commence work on the project, the Subdivisional Officer will, with the assistance of his classifier, have the area surveyed in detail as regards sub-soil classification and damage, at the same time adding to, and correcting, other details—such as exact position of all wells, their latest hot weather water levels, nala courses, channels, communications and other topographical features, with special attention to outfall conditions. When complete, the plan should be submitted to the Executive Engineer with the Subdivisional Officer's proposals for taking bores on cross sections to verify substrata and ascertain porosities. The Executive Engineer and the Soil Physicist should then inspect the scheme.

(3) After the Executive Engineer's approval, pit work—i.e. bores to verify substrata and porosities—and levelling along cross sections, and levels for the longitudinal sections of the existing nalas and depressions (the latter without pits) should be done. As much of the information as possible should then be shown on the preliminary plan [*vide* (1) above] and this, together with plans showing the cross sections and nala longitudinal sections, should be again submitted to the Executive Engineer with the Subdivisional Officer's notes on the work and proposals for alignment of drains.

(4) After approval, or modification, of the proposed alignments of drains by the Executive Engineer, the sub-soil survey (pit work) along each alignment proposed should be started, deviating where necessary to avoid hard murum or rock out-crops, or deep and impervious soils. With this information complete and plotted, the plans and sections should again be sent to the Executive Engineer, in the rough, showing thereon in pencil details of the proposed drains (with gradients) and other subsidiary works. These, of course, may be further modified or returned for fuller particulars or survey of alternative lines.

(5) On issue of final orders on the alignment and details of drains and their subsidiary works, which should as far as possible be issued after personal inspection, the Sub-divisional Officer should complete the designs of all works as far as possible, fair copy the plans, and submit them to the Executive Engineer with all necessary statements, notes of any special problems concerning the project, and other data. This set of plans is generally kept as the office copy, a new set being prepared for submission to Government.

35. The procedure described above is the outcome of several years accumulated experience of a number of schemes.

It cannot be over-emphasised that inspection by the Executive Engineer and (Soil Physicist) at all stages of the preparation of the scheme is desirable and that on no account should the design be altered in the Executive Engineer's office except by the Executive Engineer himself for recorded reasons. That is to say, the Engineering staff in the Executive Engineer's office, who have not inspected the area, must not be allowed to change the Sub-divisional Officer's designs, based on knowledge of the area, except for very clear reasons.

## PRELIMINARY PLAN FOR THE SURVEY WORK.

36. For preliminary consideration of a drainage project, data regarding rainfall, cane areas, S.S.W.L. (well observations) existing and past damage, areas out of cultivation, and other information of which a record is kept, should be collected for as many years as available. These data should then be shown on a plan drawn to the scale of 660' = 1", showing in addition the following details— which should be obtained from village maps, irrigation records, etc., namely survey numbers (with pot and phalni numbers, if available); village boundaries; foot-paths, cart tracks and roads with existing crossings; canal, distributaries, watercourses and other field and pazar channels with piches\*; wells, with recent S.S.W.L., rivers, nalas and depressions; lands not properly commanded (N.P.C.) quarter mile limits from village gaothans; perennial irrigation blocks; and the latest soil classification data available.

All this is office work and should be available locally.

## SURVEY ESTIMATE.

37. The following is an estimate of the cost of preparing a drainage scheme for a normal catchment of 1,000 acres of protected area. The damaged area may be assumed to be roughly one quarter of the protected area in the normal catchment, i.e. 250 acres :—

## (i) Classification of Soil and Damage.

An auger measurer or karkun will classify completely about 33 acres per day on an average. This includes everything. Taking 20 working days in a month, it would require 1½ month for soil classification.

## (ii) Pit Work for Sub-soil Survey.

Longitudinal sections :—

Main open trench (say)	..	..	..	..	2 miles.
5 Branch drains each 1 mile long (say)	..	..	..	..	5 "
					<u>7 "</u>

Pits are taken at 200 ft. apart, approximately, with an average depth of 8 ft.

Total number of pits for drains  $\frac{7 \times 5280}{200} =$  (say) 180.

Cross sections.—Assume five, each of 500 ft. length, per mile of main Open Trench and three for each branch. If pits be taken at distances 100 ft. apart, cross sections would require 150 in all.

Total pit length = (180 plus 150) × 8 = 2,640 Rft.

One auger mukadam with four khalashis should complete five to six pits per day.

Taking 44 Rft. of pit work daily and 20 working days in a month, it would require two auger mukadams and eight khalasis for 1½ month in this particular example.

## (iii) Other Items.

One overseer for two months; and two tracers for 1½ month.

The following is an abstract of the establishment required :—

Staff required.	Rate per month.	No.	Period in months.	Amount.
<i>Outdoor Establishment.</i>				
	Rs.			Rs.
Auger measurer .. ..	40	1	1½	60
Auger mukadams .. ..	30	2	1½	90
Auger khalasis .. ..	Annas 8 per day.	8	1½ of 20 working days.	120
Khalasis for levels .. ..	15	4	½	30
Sub-Overseer's pay .. ..	80	1	2	160
<i>Indoor Establishment.</i>				
Tracers .. ..	40	2	1½	120
			Total ..	580

or say Re. 0-8-0 per acre of protected area.

\* Pich—Point from which a field or plot is irrigated, indicated by arrow.

**SYMBOLS USED IN SUB SOIL DRAINAGE DRAWINGS PLATE No IV**

1	CANAL	
2	DISTRIBUTARY AND IRRIGATION CHANNELS	
3	EXISTING PAZAR CHANNELS	
4	PROPOSED PAZAR CHANNELS	
5	VILLAGE BOUNDARY	
6	METALLED ROADS	
7	CART TRACKS	
8	FOOT PATHS	
9	1/4 MILE LIMIT OF A VILLAGE SITE	
10	LINE OF DEMARCATION BETWEEN LINE OF FINE SOIL CHOPAN BLACK SOIL	
11	NALAS WITH DEFINED BANKS WITH NATURE OF CROSSINGS	
12	NALAS WITHOUT DEFINED BANKS BUT WITH FLOWING WATER	
13	NALAS WITHOUT DEFINED BANKS WITH STAGNANT POOLS OF WATER	
14	NALAS WITHOUT FLOWING WATER (OR DEPRESSIONS) DRY	
15	CULTIVATORS DRAINAGE TRENCHES	
16	UNCOMMANDED AREA	
17	EXPOSED ROCK	
18	EXPOSED MURUM	
19	KAR RIDGE	
20	HARD MURUM COARSE SOIL	
21	SOFT MURUM COARSE SOIL	
22	FINE SOIL WITH BOULDER	
23	CHOPAN RED SOIL	
24	EXPOSED CHOPAN	
25	SILT EXPOSED	
26	CUT-UP LANDS	
27	STEEPLY SLOPING LANDS	
28	BABUL AND TARVAD	
29	PERENNIAL BLOCKS	
30	SLIGHTLY WATER LOGGED AREA	
31	FULLY WATER LOGGED AREA	
32	SLIGHTLY SALT AFFECTED AREA	
33	FULLY SALT AFFECTED AREA	
34	WELLS WITH WATER LEVELS	
35	LINE OF CROSS SECTIONS	
36	LINE OF SECTIONS WITH PIT INFORMATION	
37	OPEN TRENCHES	
38	PIPE LINES SHOWING MANHOLES	
39	RUBBLE DRAINS	
40	MURUM ISOBATH	
41	HYDRO ISOBATH	
42	CATCHMENT BOUNDARY OF DRAINS	
43	GROUND CONTOUR	



To this is to be added the cost of sundry articles such as bamboos (ranging rods), cloth for flags, string, and it is also wise to add (say) 20 per cent. to the above lengths of drain to allow for the survey of alternative alignments if required. The cost should not however as a rule exceed annas twelve per acre in ordinary schemes.

#### FORMATION OF SOILS IN THE BOMBAY DECCAN.

38. Where the soil in the Deccan exceeds about 2 ft. over murum it is generally either colluvial or alluvial.\* The majority of soils except those which are actually forming at the surfaces consist almost entirely of materials which having disintegrated on the hills and ridges have been gradually washed or rolled down into the valleys. They therefore fall under Hilgard's definition of colluvial soils.

Alluvial soils are those which have been transported by and deposited under water. In the Deccan they are found as small patches of silt occurring invariably along river banks or where rivers once flowed; lake alluvium being unknown such small patches along rivers do not require drainage.

Murum is the first stage of disintegration of rock in situ. Fine soils, and chopan soils (the later stages of the soil formation) and even mān, have been rolled down into the valleys and are colluvial.

39. The soil survey of an area implies all topographical features of the surface soils and conditions of land at the time of the survey; included in this are exposed rock, exposed murum (soft or hard), coarse soils, fine soils, kar ridges, chopan black and red soils, exposed chopan, lime kankar, sand, silt, cut-up land steeply sloping land, land left fallow for over five years (with or without babul, trees or "tarvad" shrubs), lands damaged by waterlogging or salt, nalas and depressions (indicating heights of banks and strata exposed in bed and banks), line of demarcation between murum black soil and chopan black soil, cultivators' drains, etc. Plate No. IV shows the symbols for denoting such features on drainage scheme plans.

#### SOIL CLASSIFICATION.

40. The following instructions will be useful in classifying the soils but Government of Bombay, Public Works Department Technical Paper No. 13 "Soil and Subsoil surveys in the Deccan Canal Areas" should in any case be carefully studied at the same time.

As soil series classification deals with sub-soils, advantage should be taken of every opportunity to see and note the sub-soil where exposed in nala banks, canal and other cuttings, in wells, trenches, and other artificial works.

Work should be commenced from the main nala of a catchment to be drained. That is to say, nala banks, silt, chopan and chopan red soils should be shown first.

Exposed rock or murum on the ridges and coarse murum soil (i.e., shallow soil containing pieces of murum) should be shown next. The exposed rock should be carefully distinguished from exposed hard murum and the latter from exposed soft murum.

If the underlying murum in the coarse soil area is soft, greenish, and readily pulverizable down to a depth of 18", the soil should be shown as "soft murum coarse soil"; because by deep ploughing—especially with a Gyrotiller (Fowler's)—followed by good cultivation, such areas can be turned into good sugarcane lands within a few years. Generally in areas where there is soft murum exposed, the sub-soil is likely to be soft murum. The type of murum can be ascertained from wells, pits or holes. Again if there is 9" depth of soil, and the probe can be easily forced another three inches into murum, it is safe to assume that the sub-soil is soft murum. Where the murum ploughed up is soft, it will readily crumble in the hand; but when the murum ploughed up consists of pieces which will not crumble in the hand, it is hard murum. The soil probe should be used freely.

In certain places it has been found that soils deeper than one foot and as much as eight feet in depth, contain boulders. These soils are usually fine and the underlying stratum generally consists of gravel or boulders, which is good for drainage, while on the surface there may be shingle.

\*For a full description, see Bombay Public Works Department Technical Paper No. 13 "Soil and Sub-soil surveys in the Deccan Canal Areas" by C. C. Inglis and V. K. Gokhale.

“Kar” ridges consist of small prisms of exceedingly hard rock and are volcanic in origin. The crystalline formation varies considerably; it may be vertical or it may be horizontal. The dykes so formed may be but 2 or 3 feet in width or up to 20 or 30 feet wide and traceable for considerable distance. At Unch Khadak, between Maladevi Dam and Indore (just above Akola on the Pravara River), several formations can be seen. There are small cubic crystalline forms and vertical hexagonal forms and the steps to a temple on the river bank when closely examined will be found to be a horizontal formation in a dyke of 5 feet width. Such dykes are exceedingly porous, and allow very heavy leakage of water where any channel crossing the dyke is not protected by lining.

The black soil belt lying between coarse soils and chopan soils should then be divided into fine soil and chopan black soil.

Fine black soil is a fine textured loose retentive soil of any colour from dark brown to almost black. The cracks in such soils, if they occur, are small and numerous. The clods break easily and tilth can be maintained in spite of heavy irrigation. This soil naturally drains well if the substrata be free from obstruction.

Chopan black soil is a black or medium black soil with a dull black appearance, very retentive, difficult to drain and overlies a deep impervious chopan sub-soil. The soil when dry forms deep and wide cracks. Heavy irrigation in such soils destroys tilth, and ploughing brings up large clods not easy to break up.

It is almost impossible to detect any difference in appearance between this soil and fine soil when actually under cane, or heavily irrigated. But in many places the line of demarcation between fine soil and chopan black soil can be easily seen from the change of colour when exposed and not under irrigation. Where there has been no denudation, this line of demarcation agrees very closely, with the line of the 8 feet M.I.B. except where there is sand or other such pervious substratum below. While surveying this line, the nature, colour, depth of soil and sub-soil and plant life, should be carefully noted. This demarcation between fine and chopan black soils should be done after the other soil classification has been done.

Chopan is a yellow or reddish, stiff, sub-soil underlying black soils or exposed by denudation. It forms an impervious whitish crust at the surface unsuitable for crops and quickly develops salt. Sometimes there is a great deal of lime kankar in it.

Silts are variously coloured varying from red to brown and medium black and are uniform and loose in texture. They are found along the banks of nalas in rivers and are suitable for a large variety of crops. Soil or silt accumulated above “tals” should not be shown as silt.

When there are many ravines close together in murum or chopan soils, the area is termed “cut up” land. Such land is generally under the process of denudation, is uncultivable, and produces nothing but scrub and cactus. If such land is sloping steeply, arrows should be shown on the plans to indicate the direction of slope.

Those lands which have gone out of cultivation owing to damage should be investigated and noted by personal enquiry and from the local Revenue authorities; similarly good land which has been lying fallow for more than five years should be shown distinctly. The proper signs for babul forest and “tarvad” scrub should be used where their growth is profuse.

#### SURVEY OF DAMAGE.

41. The damage to land due to the rise of sub-soil water table has already been shown to be of two kinds, (i) waterlogging in areas of comparatively shallow soil, and (ii) salt efflorescence in deep or fairly deep soils. In the case of waterlogging there is a growth of vegetation (mainly grasses and reeds) more or less profuse even in the hot weather. Salt efflorescence produces a brown or white coloured crust on the surface of the ground. If there is no definite crust of salt, the soil will be powdery on the surface. When the salt is slight, such patches of brown or white crust are comparatively few but are void of crops or vegetation. When the percentage of salt in the soil exceeds the limit of tolerance, the proportion of barren patches will become greater until the land becomes totally devoid of vegetation. With the proportion of barren or salt-affected patches predominating, the area is marked as fully salt affected.

Damaged areas should be surveyed accurately so as to check improvements during and after drainage operations. "Pot" numbers should for this purpose be shown in all portions where the lands are damaged or are likely to be damaged.

In order to show progressive damage or improvement from year to year the method shown on Figure No. 5 below has been found successful.

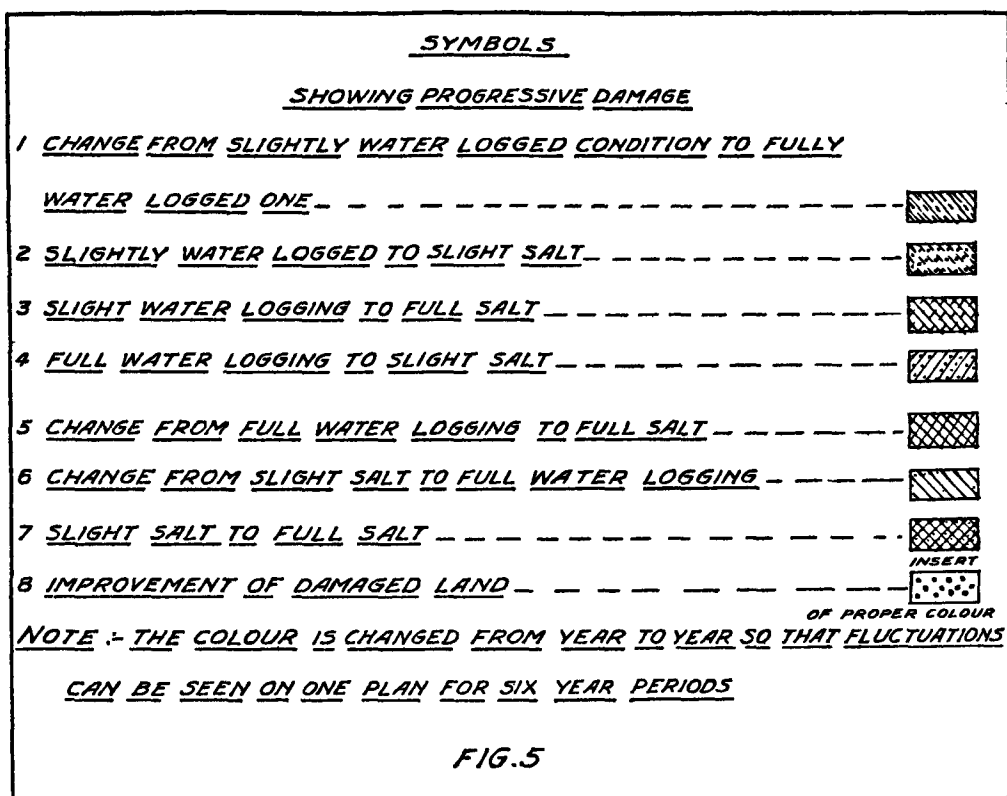

The damage so shown, in order to indicate increase or decrease may in subsequent years be in a different colour for each of the six years of a block period. The block periods are different for each canal system, and it is therefore immaterial what colours be used provided the same rotation is kept up every six years. For convenience, when the whole of this work was done in the Special Irrigation Division, and when damage demarcation affected not only drainage schemes but block selection work, it was more convenient to fix six colours for six years irrespective of the block periods and applying to all canal systems.

#### OTHER MISCELLANEOUS DETAILS IN TOPOGRAPHY AND SOIL SURVEY.

42. Where the N. P. C. area is not already available, it should be surveyed by running a falling contour of 1 in 1,000 with a fall of 6" for full supply level at each of the intermediate outlet openings.

The positions of minor depressions, in addition to the positions of rivers and nalas mentioned before, should be *verified on the ground* for each survey number. In the case of nalas, the nature of the nalas—whether flowing or not, with or without defined banks, without flow but with stagnant pools or altogether dry—should be shown correctly on the plan, with the feasibility of crossings indicated by F (foot) H (horse) or C (cart). The strata exposed in the bed and banks, with heights of banks and width of nalas in feet, should also be given. All existing drainage channels excavated by irrigators should be given. The positions of irrigation and pazar channels, whether used or in disuse, should be verified and shown with piches. Similarly the positions of roads, cart tracks, and foot paths should be verified and corrected where necessary. It is important that the soil surveyor while observing the water levels of wells should note on the plan the date of such observations.

A statement should finally be prepared in the form given on the next page showing the suitability of soils in the catchment.

*Statement showing suitability of soil for the area.*

1	2	3	4	5	6	7	8	9	10	11	12	13	14	15	16	17	18	19	20	21
Serial Number.	Owner's name.	Village.	S. No. & Pot No.	Class of area A—B—C.	Area as per record of Rights.	Block area.	Good area after deducting columns, 14 and 21.	Soft murum coarse soil area.	Slightly water-logged.	Fully water-logged.	Slightly salt affected.	Uncultivated for five years.	Total of Columns 9 to 13.	Fully salt affected.	Not properly commanded.	Hard murum coarse soil.	Exposed chopan.	Cut up.	Area within quarter mile.	Total of columns 15 to 20.

- Note.*—(1) Areas in columns 9 and 13 are easily reclaimable and hence grouped separately.  
 (2) Areas in columns 15 to 20 are to be excluded being unfit for future development.  
 (3) Survey Numbers should be grouped in such a way as to give the total area in each sub-valley to be drained by a pipe line or an open trench separately. Sub-valleys are to be carefully marked on plan before preparing the statement.  
 (4) When preparing a statement, if a survey number is divided by the ridge only that part of the survey number lying in the Drainage valley should be given and not the whole area of the survey number.

## RELATION OF SOIL SERIES TO MURUM ISOBATH.

43. As mentioned before, the suitability of soils for crops depends both upon soils and sub-soils (implying drainage feasibility). The soil series classification indicates the sub-soils approximately as seen from the lines of demarcation between soil types thus:—

<i>Coarse murum soil</i>	.. 1 ft. M. I. B.	4" to 12"
<i>Murum black soil</i>	.. 4 ft. M. I. B.	1 ft. to 4 ft.
<i>Fine chopan black soil</i>	.. 8 ft. M. I. B.	4 ft. to 8 ft.
Chopan black soil	..	over 8 ft.

[*Note.*—A murum isobath is a line along which murum lies at a constant depth. Similarly hydro-isobath (H. I. B.) denote the points at which the S. S. W. L. is the same, those in use being the 4 feet and 10 feet H. I. B.s

If, as seen from the soils and soil series classification, the catchment does not possess a fairly high percentage of areas suitable for heavy irrigation, it will not be worth while draining the area, and it would be better to restrict perennial irrigation. But if a drainage scheme is to be carried out, the 8' M. I. B. must be located accurately.

In doing this work, the soils which indicate the approximate position of the 8' M. I. B. line should be taken as a guide and bores should be made on this line. If murum is found at less than 8' then bores on the deeper side will be necessary; whereas if murum is not found at 8' then further bores will be necessary to locate it on the shallower side.

## THE 1½ AND 8 FT. M. I. B.S.

44. It is necessary here to state why M. I. B.s have been fixed at 1½ and 8 feet: When sub-soil classification was first started, M. I. B.s were surveyed for 1½, 4 and 10 feet depths.

The 1½' M. I. B. depth is the limit of shallow soil suitable for cane under normal conditions. Where cane is planted in shallow soils excellent crops may result, provided the soil is in good tilth and water is given at shorter intervals; but more water is then required—especially if irrigation is not done with great care—and any delay in watering leads to damage to the crop. Hence irrigation of cane in soils less than 18" deep is risky for the crop and becomes increasingly wasteful as the depth decreases, and most of the extra water required finds its way into the substratum and thence percolates to the valleys causing water-logging and damage to the low-lying land.

[*Note.*—The Mutha Canals rare an exception to this and shallow soils have been allowed here—as also a biennial rotation—because the whole area is naturally so well drained that excellent cane can be grown in the waterlogged lands. Damage on this Canal either by waterlogging or salt has not been serious except in the catchment of the Manjri Drainage Scheme which has recently been drained and being only waterlogged for the most part is easily reclaimable.)

The 10' M. I. B. was originally purely arbitrary and considered to indicate the economical limit of depth for drains. With the addition of data from year to year greater knowledge of the sub-soils, and particularly the experience gained on the early constructed drainage schemes, it was found that 8 feet was the economical depth for drains (except in rare cases such as carriers from one depression to another through an intervening ridge), and it has also been found that the line of demarcation between the fine black and chopan black soils closely agrees with the 8 feet M. I. B., and the area lying between the 1½ and 8 feet M. I. B.s is, in general, suitable for cane.

## RATES FOR SOIL CLASSIFICATION ITEMS.

45. One Auger Karkun at Rs. 40 under a Soil Classifier can classify\* by eye 100 acres of soil per day or 2,000 acres per month. This works out to an average of Re. 1 for 50 acres.

Soft murum survey can be done at 50 acres to the rupee by an individual classifier.

Damaged area classification can be done at the rate of 60 acres per day.

One good soil classifier or trained overseer can demarcate about a mile of the line between fine and chopan black soil per day.

\*Exposed rock, murum, coarse murum soil, chopan red, chopan cut up land in non-cropped or in the non-perennial areas.

## USE OF AUGERS FOR SUB-SOIL SURVEYS.

46. The augers used for sub-soil survey are posthole augers and screw augers.

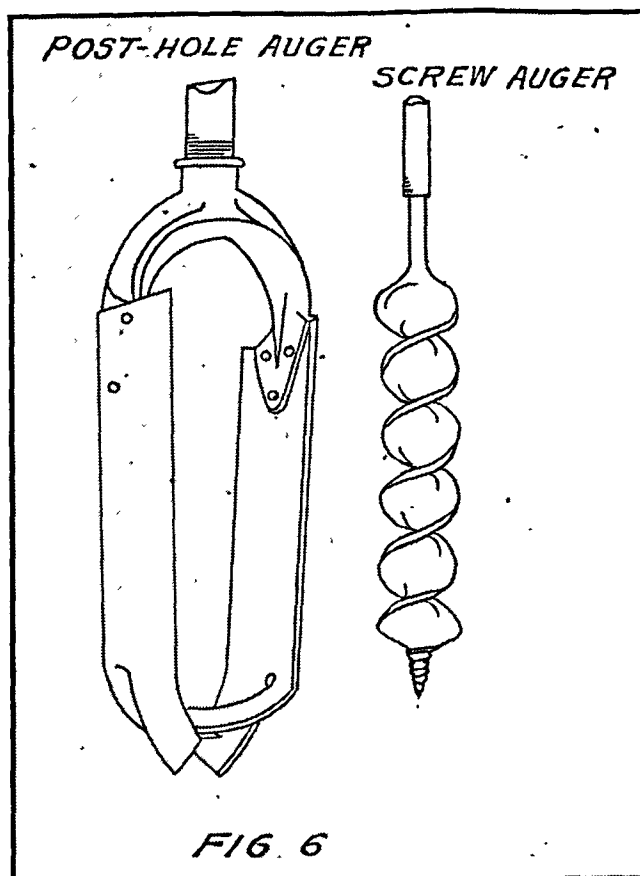

In wet tracts where water is within 10' of the ground surface and where the bore is not to go more than 10' in depth nor to penetrate hard strata, the posthole auger gives the best results at a minimum of cost. In dry tracts, where there is no water within 10', where a posthole bore has to be deepened from 10' to 16' or more, or where loose sand is met, a screw auger is more suitable.

The posthole augers generally used are of 6" diameter. A gang of 4 auger khalasis with a mukadam in charge is employed for the work. The auger mukadam should be capable of taking notes on the nature and depth of strata, and of recording the rate of rise of water levels in bores, and the level of first strong flow (F. S. F.) i.e., the depth at which the water rushes into a pit rapidly.

While making a bore, great care should be taken to start the hole vertically. The auger should be lifted every second turn, or so, to break off the soil core. If difficulty is experienced in removing an auger it should be rotated counter-clockwise; and hence couplings should be joined by cotter pins in preference to screw joints. It is essential that the khalasis should place each foot depth of soil as excavated in small heaps in a circle round the bore to enable the overseer or Sub-divisional Officer to check the sub-soil classification recorded in pit books. To avoid accidents, bore holes must be protected with thorns until filled in, and the filling as soon as the work has been checked) should be with earth other than the soil obtained from the bores.

The bores should usually be at every 110 feet for C. Ss.; 220 feet for L. S. and 330 feet for determining the 8 feet M. I. B. and should be continued to a depth of 10 feet unless murum or other hard and pervious material is found within that limit.

In dry places the posthole auger is not so easy to work; and a screw auger is used. It is generally advisable to make a hole about 1 foot deep before using the screw auger. If the soil is too dry to be conveniently worked, water may be

poured into the bore to make it easier. In loose sand, the deepening of the bore to find the substrata should be done with a screw auger weighted on the top.

#### RATES FOR SUB-SOIL SURVEY.

47. The following are approximate rates of pit work in dry and wet tracts respectively :—

(a) *Dry*.—Two auger khalasis can do two to three pits a day averaging 8 feet in depth.

Depending on his other work, such as levelling, checking maps, surface classification, etc., one overseer should manage at least two mukadams and four auger khalasis at a cost of :

Overseer.	2 Auger Mukadams.	4 Auger Khalasis.
Rs.	Rs.	Rs.
80	+	44
		+
		60
= Rs. 184 per mensem.		

They can do about 40 feet of pit a day.

At Phaltan and Malsiras, the rates were :

Rs. 50	per mile for	8'	M. I. B.
Rs. 30	„ „ „	4'	„
Rs. 5	„ „ „	1'	„

(b) *Wet*.—Each auger khalasi can do two pits per day of 8 feet and

Overseer.	2 Auger Mukadams.	4 Auger Khalasis.
Rs.	Rs.	Rs.
80	+	44
		+
		60
= Rs. 184 per mensem.		

can do 64 feet of pit per day.

#### EXAMINATION OF SUB-SOIL.

48. Sub-soil samples should be taken from the tips of the auger, taking care to see that the auger has cut into the material and has not merely revolved and puddled it.

The sample should be broken up and it should be noticed if it breaks along definite planes, giving an indication of the structure and porosity. The material which remains after washing a sample should be carefully examined for rock fragments, flint, or kankar, noticing whether they are sharp-edged or rounded. The nature of strata above and below the sample and their relative position in the section should be considered. To make certain whether murum is soft or hard, a bore should penetrate as far into the murum as possible. In close sub-soil surveys, rock, hard murum, soft murum, and mān should be carefully distinguished, and bores driven as deep as possible.

The substrata usually met with in the Deccan Canals areas are chopan, murum (soft or hard), conglomerate (equivalent to lime-cemented gravel) massive kankar or mān (particles of fine sand cemented together), calcareous mān, lime kankar (alone or mixed with chopan), sand, and rock.

#### RECUPERATION.

49. When a bore is made in deepish soils, especially where artesian conditions are to be expected, no free water is, as a rule, met until the impervious soil has been out through and a more porous sub-soil has been pierced. This may occur at depths from three to ten feet. At this point, which is called the level of first strong flow (F. S. F.), water rushes into the bore—sometimes with a hissing noise—and rises with an appreciable velocity which gradually diminishes until, after some hours, the water level remains stationary. This point is called the final water level (F. W. L.). The difference between the F. W. L. and the F. S. F. level may vary from 1 to 8 feet.

Usually the stratum at which the F. S. F. appears is quite different from the super-incumbent soil and contains sand or kankar. The formation level of drains should normally be located below this level. The F. S. F. is not to be confused with the *first* flow, which may occur before the real F. S. F. is observed. If a test be taken at the time of the first flow, the result will be incorrect and misleading. Hence after the first flow is noted a bore should be deepened by at least one foot before recuperation is observed, in order to ensure that such permeable stratum as is available has been actually penetrated. In the meantime, the water in the hole will begin to rise. Before commencing a test therefore, a bore should be unwatered as far as possible by means of a small tin fixed to a bamboo pole. This ensures a greater head and reduces the chance of mistakes in readings and consequently in the calculations of recuperation coefficients.

When the unwatering is completed, the water level in the bore should be read, and the time of subsequent rise of water level after five minutes should be taken using a stop watch.

A recuperation test for all bores in soils deeper than 4 feet should invariably be carried out as soon as possible after excavation ; because the coefficient may decrease rapidly due to the deposition of silt on the sides of the bore. If, for any reason, the recuperation test cannot be carried out, full reasons should be noted in the pit book. When a recuperation test is required for a bore which requires further deepening to determine the substrata, the post-hole auger should be used at least down to F. S. F., while a screw auger may be used below this level being quicker to work.

#### COEFFICIENT OF RECUPERATION.

50. The rate of rise of water level varies in different bores depending upon the nature of strata cut and the pressure head. It may be expressed conveniently as a percentage rise in a fixed period (five minutes is the standard used in the Deccan) when compared with the total rise to F. W. L. The coefficient of recuperation, 'K' is a measure of the porosity. The recuperation formula is:—

$$K/A = 1/T \log H/h$$

where

K = a coefficient,

A = area of the bore in square feet,

T = time in hours,

H = total head of depression in feet at the commencement of the test,

h = head of depression after T hours,

= (H - R) feet,

R being the rise of water level in feet after T hours.

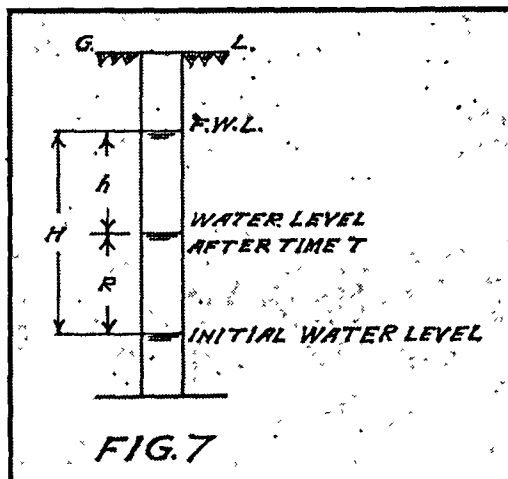

The formula is derived as follows:—

For an infinitely short time  $dt$  when the depression head is 'x', the value of



'K' by definition is :—

$$K = - \frac{A \cdot dx}{x \cdot dt} \quad \therefore \quad \dots \quad \dots \quad \dots \quad \dots \quad (1)$$

NOTE.—x and dx are opposite in sign as x is a rise and x a depression, vide Figure 8.

$$\text{or } K/A \, dt = -1/x \, dx \quad \dots \quad \dots \quad \dots \quad (2)$$

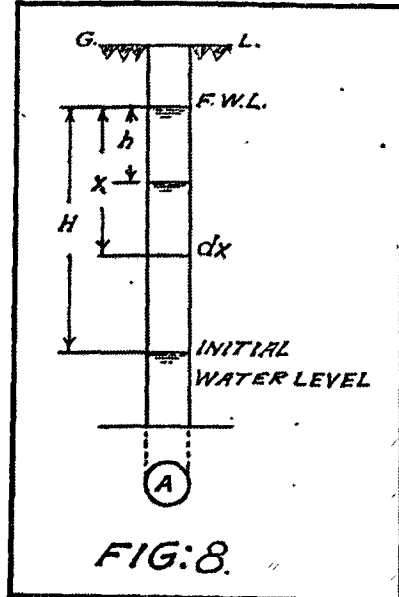

Integrating both the sides between the limits of time, zero and T, and between H and h we get :—

$$\begin{aligned} K/A \int_0^T dt &= - \int_H^h dx/x \\ \therefore K/A \cdot T &= - \int_H^h dx/x = - (\log_e h - \log_e H) \\ &= (\log_e H - \log_e h) = \log_e \frac{H}{h} \\ \text{or } K/A &= 1/T \cdot \log_e (H/h) \quad \dots \quad \dots \quad \dots \quad (3) \end{aligned}$$

Comparing the values given by equation (3) above with those given in the pit books, it will be found that in preparing the tables, common logarithms have been used, while in the equation the logarithms are "natural". This does not affect the relative recuperation capacity of various strata.

In preparing the tables :—

$$T = \text{time,} = 5 \text{ minutes} = 5/60 \text{ hours}$$

$$\therefore 1/T = 12.$$

$R_5$  being the rise of water level in time T (5 minutes) is expressed as a percentage rise 'p' of the total head of depression H, i.e.,

$$R_5 = p/100 \cdot H.$$

$$\text{But } h = H - R_5.$$

$$= H - pH/100 = H/100 (100 - p) \quad \dots \quad (4)$$

$$\begin{aligned} \therefore \log \frac{H}{h} &= \log \frac{H}{H \left( \frac{100-p}{100} \right)} = \frac{\log 100}{100 - p} \\ &= \log 100 - \log \overline{100 - p} = 2 - \log \overline{100 - p} \quad \dots \quad (5) \end{aligned}$$

substituting :

$$K/A = 1/T \log H/h = 12 (2 - \log \overline{100 - p}) \quad \dots \quad (6)$$

Table (a) below gives the values of K/A for different values of p. The observations are recorded in the form shown in Table (b) below. Both are reproduced from a standard pit book.

TABLE A.  
Table of Percentages.

Percentage rise of $\frac{r}{H} \times 100$	K A	Percentage rise of $\frac{r_s}{H} \times 100$	K A
2 per cent. .. ..	.10	24 per cent. .. ..	1.38
3 " " " " " "	.16	26 " " " " " "	1.50
4 " " " " " "	.22	28 " " " " " "	1.63
5 " " " " " "	.27	30 " " " " " "	1.77
6 " " " " " "	.32	32 " " " " " "	1.92
7 " " " " " "	.38	34 " " " " " "	2.03
8 " " " " " "	.43	36 " " " " " "	2.25
9 " " " " " "	.49	38 " " " " " "	2.43
10 " " " " " "	.54	40 " " " " " "	2.61
11 " " " " " "	.60	42 " " " " " "	2.80
12 " " " " " "	.66	44 " " " " " "	3.00
13 " " " " " "	.72	46 " " " " " "	3.20
14 " " " " " "	.78	48 " " " " " "	3.40
15 " " " " " "	.84	50 " " " " " "	3.60
16 " " " " " "	.90	55 " " " " " "	4.10
17 " " " " " "	.96	60 " " " " " "	4.85
18 " " " " " "	1.02	65 " " " " " "	5.40
19 " " " " " "	1.08	70 " " " " " "	6.10
20 " " " " " "	1.14	75 " " " " " "	7.00
22 " " " " " "	1.26	80 " " " " " "	8.20

TABLE B.

Subsoil Survey of the Catchment of Nala

Cross section No.                      Bore No.                                      Distributary No.  
Survey No.                      of                      Village                                      Outlet No.  
Size of Auger.

R. L. G. L.

1 \_\_\_\_\_ : : \_\_\_\_\_ : 13 : \_\_\_\_\_ : : \_\_\_\_\_ :  
2 \_\_\_\_\_ : : \_\_\_\_\_ : 14 : \_\_\_\_\_ : : \_\_\_\_\_ :  
3 \_\_\_\_\_ : : \_\_\_\_\_ : 15 : \_\_\_\_\_ : : \_\_\_\_\_ :  
4 \_\_\_\_\_ : : \_\_\_\_\_ : 16 : \_\_\_\_\_ : : \_\_\_\_\_ :  
5 \_\_\_\_\_ : : \_\_\_\_\_ : 17 : \_\_\_\_\_ : : \_\_\_\_\_ :  
6 \_\_\_\_\_ : : \_\_\_\_\_ : 18 : \_\_\_\_\_ : : \_\_\_\_\_ :  
7 \_\_\_\_\_ : : \_\_\_\_\_ : 19 : \_\_\_\_\_ : : \_\_\_\_\_ :  
8 \_\_\_\_\_ : : \_\_\_\_\_ : 20 : \_\_\_\_\_ : : \_\_\_\_\_ :  
9 \_\_\_\_\_ : : \_\_\_\_\_ : 21 : \_\_\_\_\_ : : \_\_\_\_\_ :  
10 \_\_\_\_\_ : : \_\_\_\_\_ : 22 : \_\_\_\_\_ : : \_\_\_\_\_ :  
11 \_\_\_\_\_ : : \_\_\_\_\_ : 23 : \_\_\_\_\_ : : \_\_\_\_\_ :  
12 \_\_\_\_\_ : : \_\_\_\_\_ : 24 : \_\_\_\_\_ : : \_\_\_\_\_ :

position  
sketch in  
survey  
No.

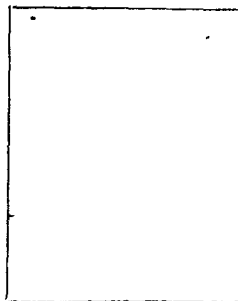

Final water level below ground.  
Water level at start.  
after 2½ minutes  
after 5 " "  
H  
r for minutes  
percentage of rise.  
K/A for 5 minutes  
-K-for 5 minutes.

K A IF BORE UNIFORM	-K- IF OF VARYING SEC.

Name.      Date

Observer \_\_\_\_\_

Checker \_\_\_\_\_

IRRIGATION RESEARCH DIVISION  
 TYPICAL LONGITUDINAL SECTION OF DRAIN

SCALE: - HORIZONTAL 330' = 1" INCH  
 VERTICAL 10' = 1" INCH

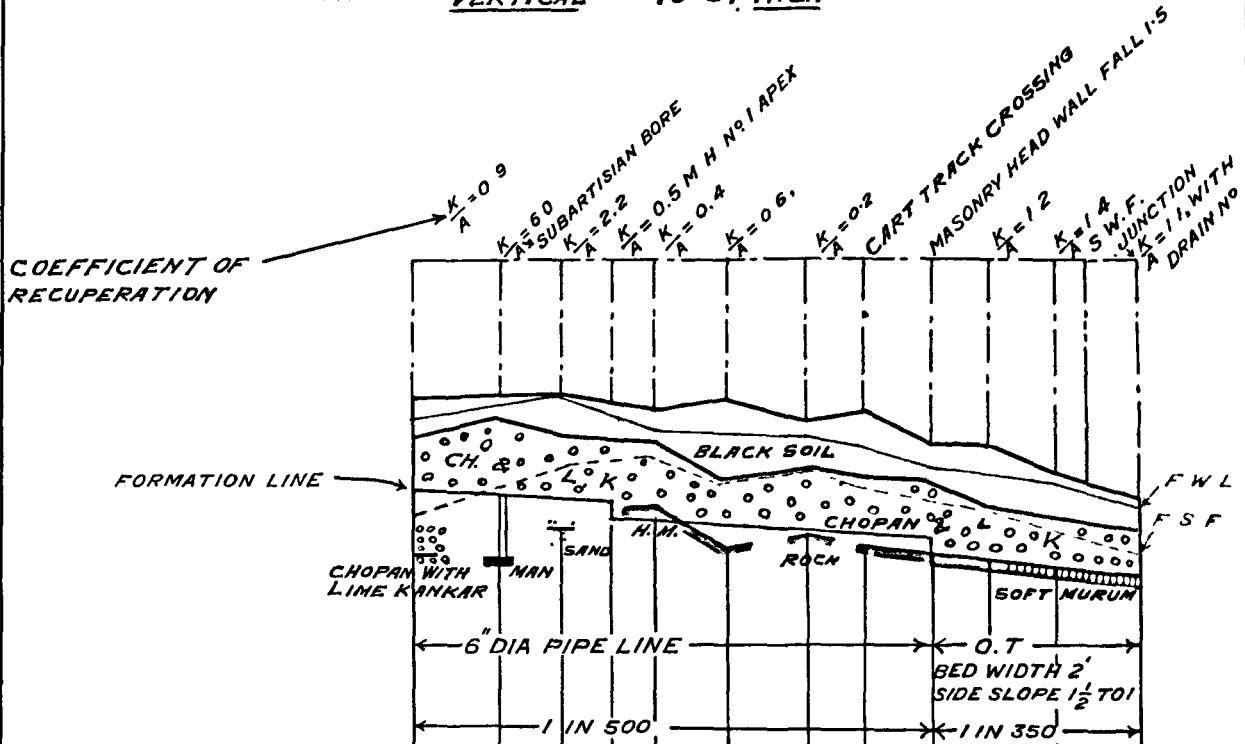

DATUM 1700.00 FT BELOW VILLAGE	VILLAGE									
SURVEY NUMBERS	5		7		10		13			
Nº OF PITS	1	2	3	4	5	6	7	8	9	10
TOTAL DEPTH OF PITS	8.0	8.0	7.0	6.0	6.0	9.0	7.0	8.0	6.5	4.5
FIRST LAYER	2.0 B.S.	1.5 B.S.	2.5 B.S.	2.5 B.S.	2.0 B.S.	4.5 B.S.	2.5 B.S.	3.5 B.S.	3.0 B.S.	2.0 B.S.
SECOND LAYER	6.0 CH LK	6.5 CH LK	4.0 CH LK	3.5 CH LK	3.5 CH LK	4.0 CH LK	4.0 CH LK	4.0 CH LK	3.0 CH LK	2.5 CH LK
THIRD LAYER	7.5 CH LK	MAN	0.5 SAND	0.5 CH	0.5 M.	0.5 M.	0.5 ROCK	0.5 M.	0.5 M.	5.0 S.M.
SUBSTRATUM OR BOTTOM LAYER	5.0 CH LK	MAN	0.5 SAND	0.5 CH	0.5 M.	0.5 M.	0.5 ROCK	0.5 M.	0.5 M.	5.0 S.M.
FIRST STRONG FLOW	6.5	5.5	4.5	3.5	2.5	4.0	2.5	4.2	3.0	3.5
FINAL WATER LEVEL	7.3	0.75	0.50	0.50	0.00	2.00	1.00	2.00	1.50	1.20
DEPTH OF CUTTING	4.96	5.56	5.88	5.68	6.68	7.24	5.97	6.92	7.02	4.62
FORMATION LEVELS	1716.54	1716.24	1716.02	1715.82	1714.82	1714.36	1714.03	1713.83	1711.78	1710.98
DATE OF BORE	13-2-1935									
BANK LEVELS										
BED OR GROUND LEVELS	1721.50	1721.80	1721.90	1721.50	1721.00	1721.60	1722.00	1722.70	1719.00	1718.80
DISTANCES IN FEET	1350	1200	1090	990	891	760	595	495	425	280
										100
										0

## PLOTING OF SUBSOIL INFORMATION.

51. From the subsoil survey of an area, the following information becomes available :—

- (i) Kind and nature of the soil and substrata,
- (ii) F. S. F. and F. W. L., and
- (iii) Values of K/A.

All this information should be plotted on the plans within 24 hours so that any extraordinary results or discrepancies can be investigated at once. Cross sections or longitudinal sections of drains should be ready for this subsoil information as soon as it is obtained (Plate V).

Further information available for the M. I. B.s and H. I. B.s should be shown on the plans in their correct colours.

While plotting sections, the lowest level of a pit should be shown by a short line. Different strata in adjoining bores must not be joined as shown in Figure 9 ; but should be shown as in Figure 10 below :—

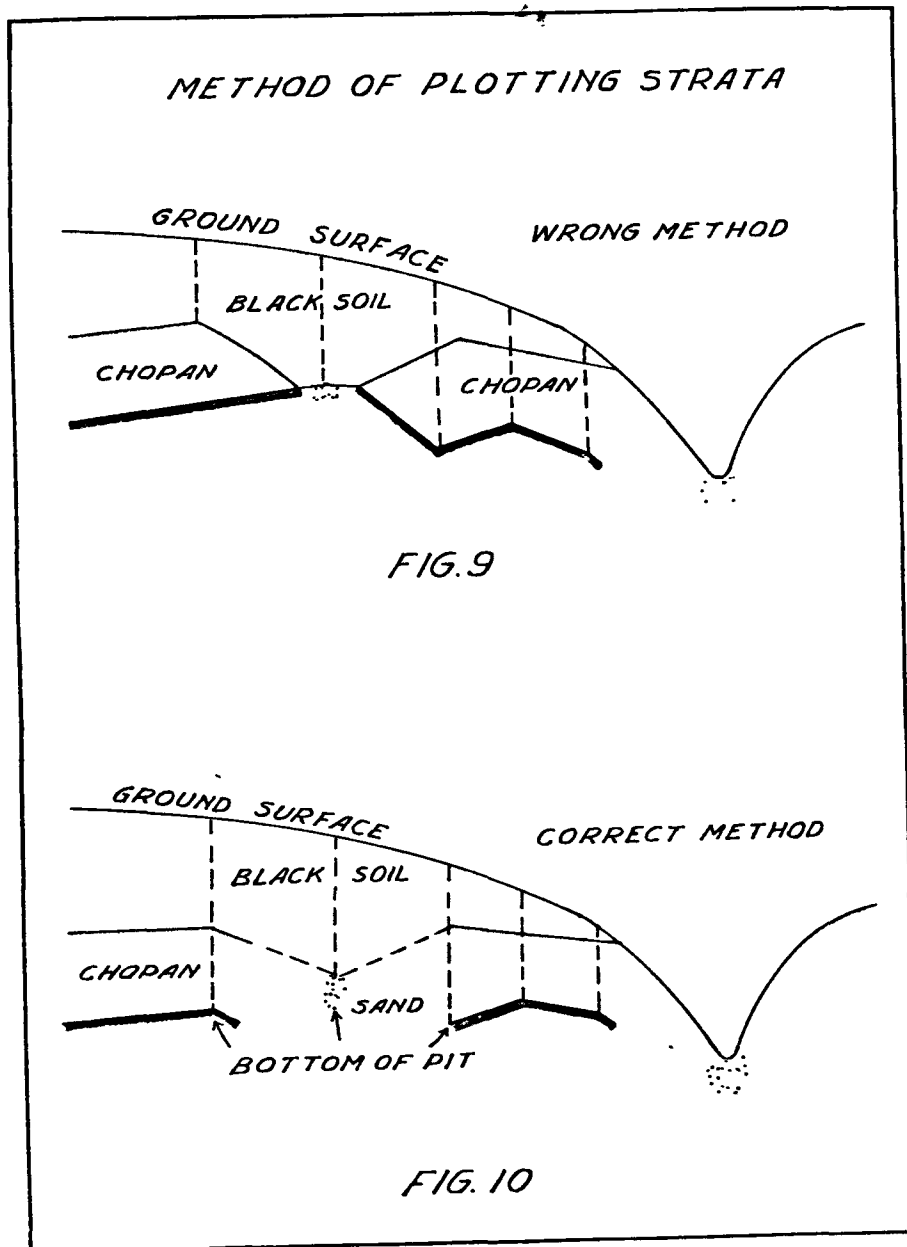

## LOCATION OF CROSS SECTIONS.

52. When the 8' M. I. B. has been drawn on the plan, the relation of this line to the 4' H. I. B. and to the damage shown should be considered. In this connection attention is drawn to the part of the Foreword which reads:—

“ Water reaches the low land

(a) by percolating down the slope from the ridge, which may stretch for miles, or

(b) by spreading from the nose of ridges.

Where it is possible to tap the spring at the nose of a ridge the result is exceedingly successful over a wide area.

Where this is not possible, relief drains located in porous substrata have to be adopted.”

The 8 feet M. I. B., the 4 feet H. I. B. and the boundary of damage in any catchment will be approximately concentric. Wherever this is not the case, the cause should be investigated by taking a short cross section. The following are other reasons for taking further sections:—

(a) Where the limit of damage extends far beyond one or both isobaths, then either one or both are likely to be wrong. In that case one or more cross sections, such as those marked AA' and BB' in Figure No. 11 and CC' in Figure 12, may be necessary to locate them correctly.

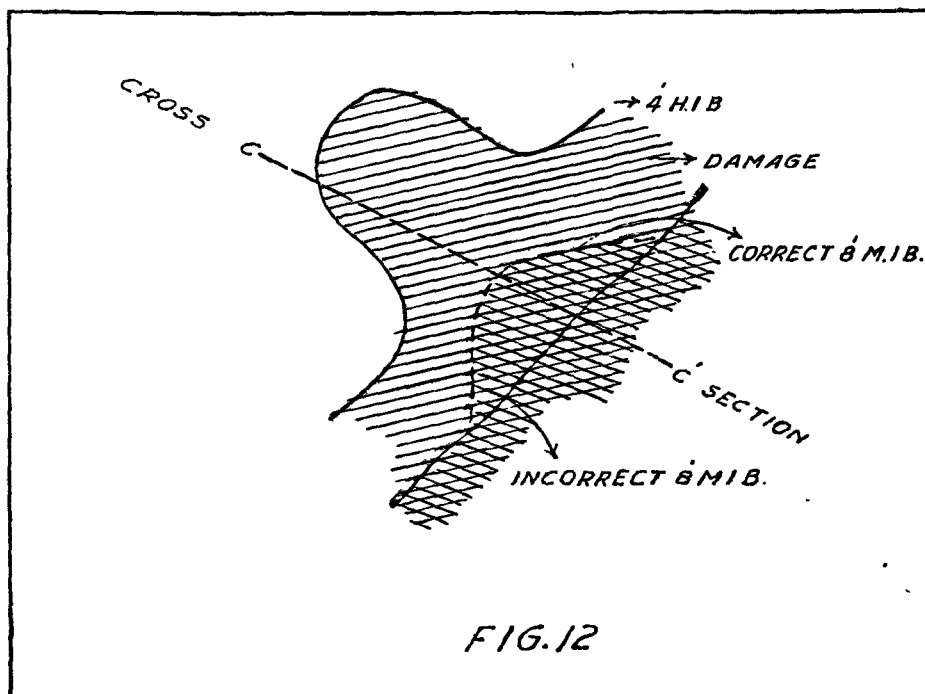
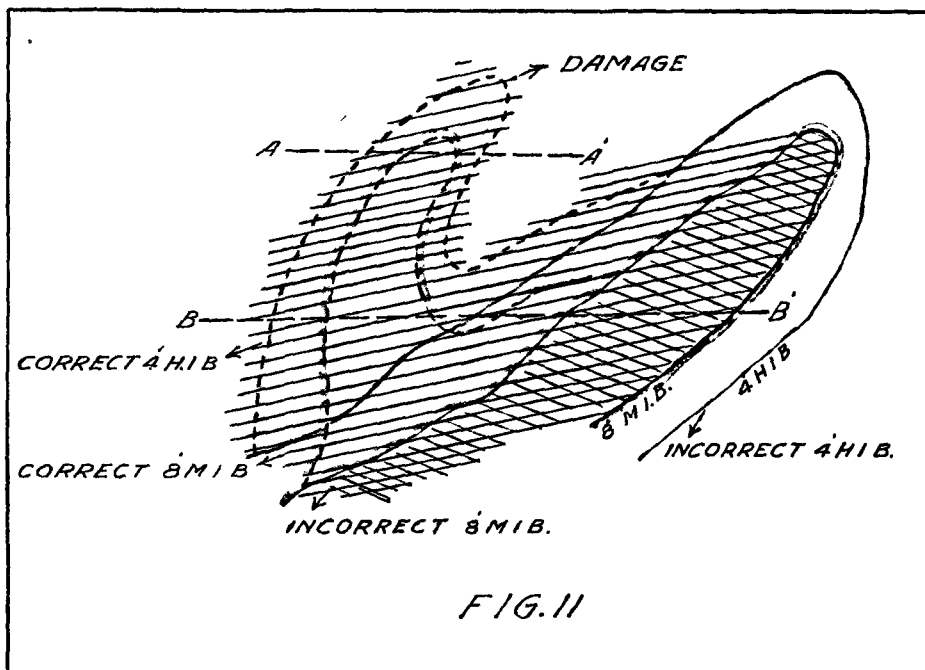

(b) Even in the absence of damage, if the 4' H. I. B. and 8' M. I. B. show pronounced eccentricity (4' H. I. B. indicating a sub-soil valley and the 8' M. I. B. showing the approach to shallow soil without a sub-soil valley) a cross section DD' as in Figure No. 13 is advisable.

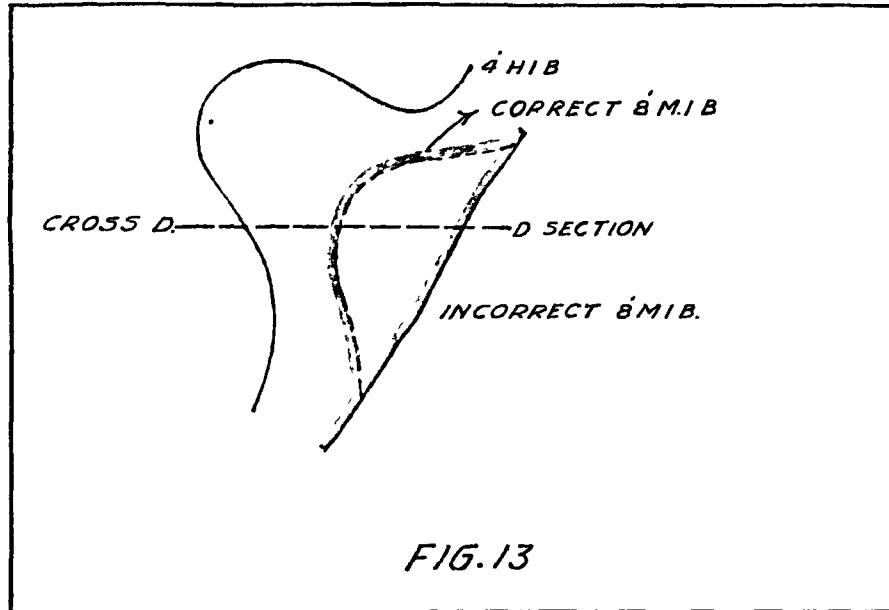

(c) Where the zone of damage has abruptly narrowed down, the murum data will generally show a murum valley in the 4' H. I. B. zone—see Figure 14—. If not the M. I. Bs. should be verified by a cross section EE' as shown in Figure No. 14.

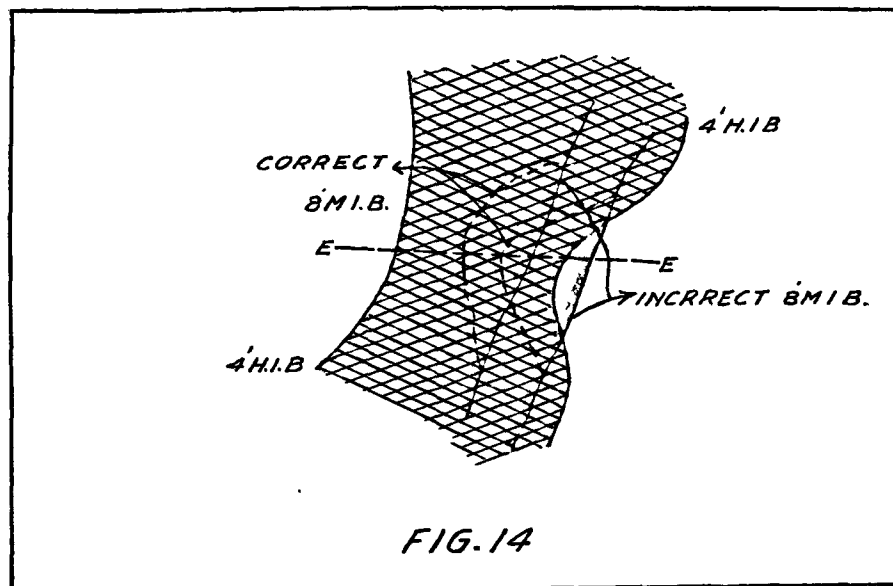

(ā) Where the murum valley is likely to be within 8' from the ground surface, short cross sections should be taken to locate it exactly as a drain in this portion should as a rule be aligned to follow the murum valley.

(e) To locate a murum nose. Where the 8' or 4' M. I. B. changes direction or where for other reasons a murum nose is expected pits at close intervals should be taken, as a short drain carefully aligned to cut a nose may unwater a large area.

The following may be taken as a rough guide for the intervals between cross sections :

- (i) At half a mile intervals where surface slopes and subsoils are uniform.
- (ii) At one-fourth mile intervals for slightly varying slopes and subsoils.
- (iii) At from one-sixteenth to one-eighth mile intervals for rough areas or where subsoils vary greatly.

If feasible, it is desirable to locate cross-sections along boundaries of Survey numbers.

#### PIT WORK FOR CROSS-SECTIONS.

53. For cross-sections, the pits should usually be 110 feet apart to obtain the fullest information at reasonable cost. Where there is a sudden dip in the murum they should be taken at closer intervals. Where both sides of a nala are damaged and are to be drained, the sections should extend invariably to the limit of damage, and generally up to the 4 feet M. I. B. Where only one side of a catchment is affected, the section need only be carried to two pits beyond the nala on the unaffected side.

#### NALA SURVEYS.

54. While the pit work of the cross sections is in progress, the subordinate should collect data for detailed longitudinal sections of all the nalas in the catchment. The surveys should include levelling and chain survey of all main and subsidiary nalas, noting bed and bank levels, strata, etc. and widths. The nature and position of obstructions to natural drainage in the nala bed—generally rock outcrops—should be carefully ascertained. At the upper end the survey of the nala should finish a little upstream of where the damage first appears. The question of outfall must be carefully investigated, especially where silt or pankanis are likely to cause future obstruction and the survey should extend downstream to a point at least half a mile below where the nala shows a clear outfall, but preferably as far as the main river. No pit work is necessary while doing this survey work. The plotting of the longitudinal sections of the nalas should invariably be done before proposing the lines of drains, in order to show clearly the nature of the valley, its outfall and the general conditions.

#### LOCATION OF DRAINS FROM CROSS AND LONGITUDINAL SECTIONS.

55. The reduced levels, the K/A values, M. I. Bs., H. I. Bs., and the F. S. F. data of various cross and longitudinal sections of a catchment should furnish enough information to plot approximate drain alignments and to determine the grades required before they are finally fixed on the site. The final location of a drain is best decided by considering such data as are shown on the plans and sections at the actual site and then fixing the exact line. By this means it is possible to avoid obstructions, deep cutting, and other objectionable features which may not have been shown on the plans. This may however be done when preparing working drawings (see Part III—Construction of Drainage Schemes).

### CHAPTER V.

#### Design of Drains, Alignment and Subsidiary Works.

##### DRAINS.

56. In general the more effective drains either tap the nose of a ridge or run down the slope, acting as relief drains. Drains laid across the line of natural drainage do not intercept subsoil flow because pressure is transmitted through fissures or porous strata underlying the drains, as shown in Figure 15 :—

- (a) does not cut porous stratum and so will have very little effect.
- (b) will drain land above but will not intercept the drainage nor prevent damage to land downstream.
- (c) A valley-side drain. Its formation level is lower than the ground surface in the valley.

*EXPLANATION WHY INTERCEPTING DRAINS DO NOT  
PROTECT LAND BELOW THEM*

*(a & b) LAND ABOVE DRAINED BUT LAND BELOW NEITHER  
DRAINED NOR PROTECTED*

*(c) EFFECTIVE — LAND ABOVE DRAINED AND BELOW  
PROTECTED*

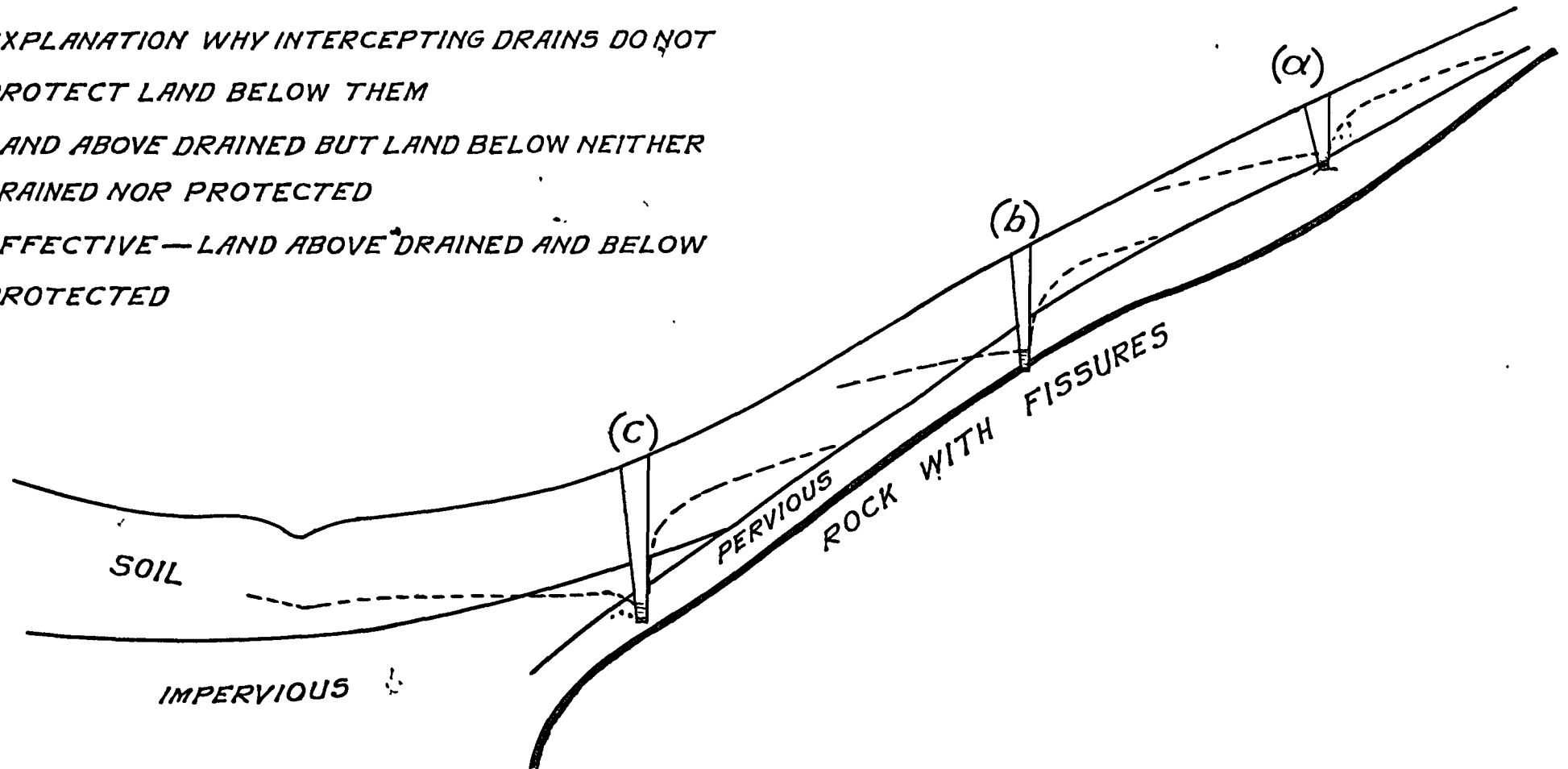

*NOTE:*

*DOTTED LINES INDICATE S.S.W.L. AFTER DRAINAGE*

*FIG. 15*



## RELIEF DRAINS.

57. This term is applied to drains designed to reduce the subsoil water pressure and so effect a general lowering of the S. S. W. L. Relief drains are generally adapted to conditions where excess water is distributed more or less uniformly over the area to be drained.

Water is collected by lateral percolation through fissures, sand layers and porous substrata—chiefly the latter.

If mān, sand or gravel strata are tapped the effect is general. This lowering of the subsoil water, beginning near a drain gradually affords an outlet for land farther away, and ultimately its influence extends until a condition of equilibrium between porosity, discharge, and slopes is established. Of these three, the first two conditions are seldom definite and the theoretical determinations of the distance to which a drain will be effective is often incorrect.

Observations on different classes of soils show that some are so impervious as to almost totally prevent the passage of water through them. Drains in such soils are entirely ineffective and produce no change whatever in the S. S. W. L. The maximum distance to which drains, under average Deccan conditions, may be expected to be effective in impervious subsoils does not generally exceed 200 feet; in porous soils their effect may extend to one mile or more. Where drainage schemes are infeasible, due to poor recuperation, the land should be protected as far as possible, by restriction of perennial irrigation.

## DEEP AND SHALLOW DRAINS.

58. Deep drains are those excavated sufficiently deep to effect the removal of subsoil water. Shallow or surface drains are designed primarily to carry away surface water. It is to be understood that there is no sharply defined limit between these two types of drain. Generally, however, drains less than four feet may be classed as shallow, while those over 6 feet depth may be termed deep. This definition can however only be used for those conditions applying in the Deccan, or elsewhere if similar subsoil conditions prevail.

Deep drains should be located where subsoil water can be most readily lowered, which necessitates consideration both of porosity and water levels. Shallow drains intended to carry drainage or to collect water from the surface, should be located where surface water can be carried away most conveniently. Location of deep drains depends on subsoil conditions, that of shallow ones on surface conditions. It follows therefore that the two systems are entirely different as regards location of the drains.

## CONDITIONS WHICH MAKE DEEP SUB-SOIL DRAINS NECESSARY.

59. The necessity for deep drains may be the result of the character of the soil formation, the presence of alkali in the soil, the amount and seasonal distribution of water, or the kind and character of the crops grown.

The conditions under which deep or subsoil drains are required may be enumerated as follows :—

(a) Where a deep soil of a semi-pervious or impervious character is underlaid by porous materials, deep drains are required to tap the porous substratum and provide an outlet for the imprisoned water.

(b) In deep homogenous soils through which water moves with relative freedom but the supply is in excess of plant requirements and natural drainage capacity of the subsoil, deep drains will lower the high subsoil water table on either side.

(c) Deep drains are necessary in reclaiming and protecting lands from injury due to alkali by keeping the water table at a sufficient depth below ground to prevent harmful soluble salts being brought to the surface by capillary action.

(d) Deep drains are required for deep rooted crops and trees.

In general, however, it may be said that the cost of deep drains can only be justified when they tap a porous substratum. Pot transpiration experiments at the Experimental Effluent Area have shown that of the quantity of water supplied

to cane 75 times the green weight of the crop at the time of harvest is lost by transpiration and 15" to 20" is lost by evaporation. The rest drains into the sub-soil. Thus if we assume 100" of water given to cane for a 40-ton crop the distribution of water is as under :--

Transpiration ..	40 tons × 75 = 3,000 tons = 30" acre (inches approx.).		
Evaporation ..	.. ..	.. 15" to 20"	
Drainage ..	.. ..	.. 55" to 60"	
		100"	

Thus about 50 per cent. of the water in this case is lost in drainage. This is confirmed by observations in the Baramati Experimental Salt Area. So that where there is not good natural or artificial drainage the water rises to the surface.

#### SHALLOW DRAINS.

60. Shallow drains are only useful as carrier drains or where the conditions are suitable for "theta" irrigation, i.e., a highly porous sub-soil and high S. S. W. L.

#### CARRIER DRAINS.

61. There will, in any project, be drains whose sole function is to carry the water drained. This will occur generally, where, below the area damaged and to be drained, there is a considerable distance to be traversed before a suitable outfall can be found. Such carrier drains may be required in an existing nala or to provide an outlet from a shallow depression across a ridge into another nala. In the former case, the existing nala may be tortuous, choked with weeds and with insufficient gradient. In such cases designing for a straight alignment, with a suitable gradient, will probably suffice to lead the water drained from above to the point decided upon for the outfall. In the latter case, a carrier drain cut through an intervening ridge is often cheaper than extending the drain down the existing depression. In any case, a carrier drain does not require the same consideration from the sub-soil point of view as a relief drain, and may be aligned as straight as possible with due regard to economy. Before, however, deciding whether a drain is wholly a carrier or not, a careful consideration of the land on either side of the proposed alignment is necessary in order to decide whether it may subsequently be required as a relief drain.

#### FIXING THE ALIGNMENT.

62. The longitudinal and cross-sections showing all information should be carefully scrutinised. If the natural slope of the nalas is very slight at the surface, the outfall drain is likely to be very long, costly, and perhaps impracticable on account of the flat gradient. Again if the recuperation tests give poor results and the sub-stratum is found to be impervious, the drains are not likely to be of any great use.

In either of the above cases it is probable that a scheme might have to be abandoned altogether as being infeasible, and perennial irrigation in the area should then be restricted.

If the nala survey indicates a good outfall and if the pit-work shows good or fairly good recuperation zones, proposals for aligning drains should be continued.

It is important to note that a comparatively flat drain in impervious soil, i.e., a carrier drain only, may be invaluable if connected with branch drains which have optimum conditions for good drainage.

#### THE OUTFALL DRAIN.

63. Downstream of the point where the damage terminates, the drain will usually be merely a carrier drain along a nala, so that straightening it where

necessary, regrading in portions, and leading the water to its outfall at the minimum of cost is the main object. The depth and gradient of this drain should be such as will not cause any heading up or obstruction to the flow of water, need no reference to the perviousness of soils through which the drain passes, and should if possible provide for a slightly greater than critical or non-silting velocity. In doing this, natural obstructions in the form of rock or chopan in the natural nala bed should be cut through. Where the removal of an obstruction in a nala proves too costly, due for instance to flatness of the bed slope and the impossibility of providing a suitable gradient, a possible diversion of the nala by a cut to an adjoining nala should be carefully investigated.

#### MAIN DRAIN.

64. Above the point where the damage begins, the alignment should invariably be in accordance with the principles of deep sub-soil drains.

Main drains intended to serve the combined purpose of sub-soil drain and carrier drain for several branches, or which, for other reasons, may be required to carry a large quantity of water, should generally be located along the cheapest alignment; but its capacity to drain must not be ignored. Where a branch drain joins a main drain sufficient drop should be provided (never less than six inches) to enable the main drain to fulfill its proper function as a carrier and to avoid any heading up in the branch.

#### BRANCH DRAINS.

While the main drain will generally have considerable effect, especially if it cuts pervious strata, branch drains will be required for damage which has occurred in adjoining branch nalas. These are most important.

In the general layout of drains the aim should be the smallest possible number of drains compatible with efficient drainage. A knowledge of the source of sub-soil water is necessary to locate the most effective alignments. In the case of perennial irrigation over a large area the damage and the sub-soil water table will show major and minor sub-soil valleys as also the 8 feet M. I. B. All such major and minor valleys are likely to require drains for the reclamation of the overlying damaged areas and protection of these where the water table has risen, thus determining the number of drains to be proposed.

#### NUMBERING OF DRAINS.

65. Here it is appropriate to emphasize the need for systematic numbering of drains. Drains are numbered serially, No. 1, 2, 3 and so on, from the outfall to the head irrespective of whether they are likely to be open trenches or pipe lines, and whether on the right or left bank. To distinguish types (O. T.) and (P. L.) are inserted after the number. Drain No. 1 is always the Main Drain of the project (or sub-project). Branches or a branch drain are numbered on the same principle. For instance Drain No. 4/2 would mean the second branch drain of Drain No. 4 (itself a branch of the Main Drain No. 1). If a system of some sort is not rigidly enforced, confusion is bound to result or time is wasted in looking for drains numbered haphazard.

A similar system is also adopted for numbering cross-sections. Those across the main drain are *lettered* A, B, C, etc., from the tail upwards; and those across branch drains likewise, but with the number of the drain prefixed. Intermediate sections taken subsequently may have numbers affixed to the letter of the original C. S. immediately downstream. For example, C. S. No. 2-B would mean the second cross-section on Drain No. 1 taken between C. S. B and C subsequently; C. S. No. 3/1-A would be the first on Branch No. 1 of Drain No. 3 from its outfall.

#### LENGTH OF DRAINS.

66. The direction of a drain in a catchment will generally conform to the contours of the land to be drained and the point of outfall. If it cuts sand, mān

or murum it will act as a relief drain and be efficient. If it does not cut a porous sub-stratum it will merely act as a carrier drain.

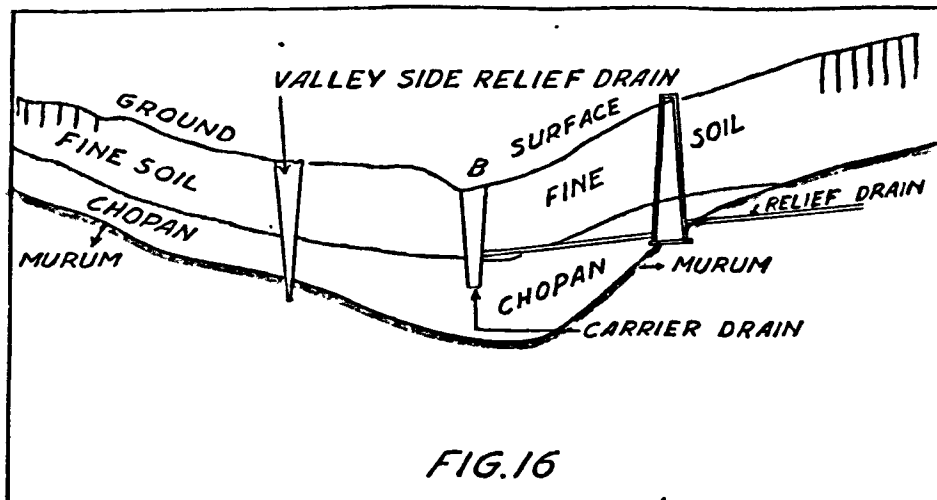

Murum when at a great depth is usually only slightly porous. In general it is not worth tapping sub-soil murum unless at less than 8 feet depth, and it is wise to avoid deep valleys if  $K/A < 0.6$ ; because there is always the danger of finding a valley filled in with liquid mud. Valley-side drains cutting murum at less than 8 feet are therefore safer and usually better. Porous murum is usually found in branch drains, which for this reason are likely to act as relief drains for the greater part of their lengths; but drains which tap the nose of a sub-soil ridge of mān or porous murum give the best results of all. In practice, efficiency has to be balanced against expenditure; and alternatives have to be investigated.

Drains should be cut as straight as possible, unless this adds to the cost or leads to the drain traversing patches of inferior recuperation, because a straight drain is cheaper to maintain.

High recuperation along a nala is often deceptive. It may result from local sandy pockets and the sub-soil may be chopan with an intervening zone of very poor recuperation between the nala and the 8 feet M. I. B. (see Fig. 17).

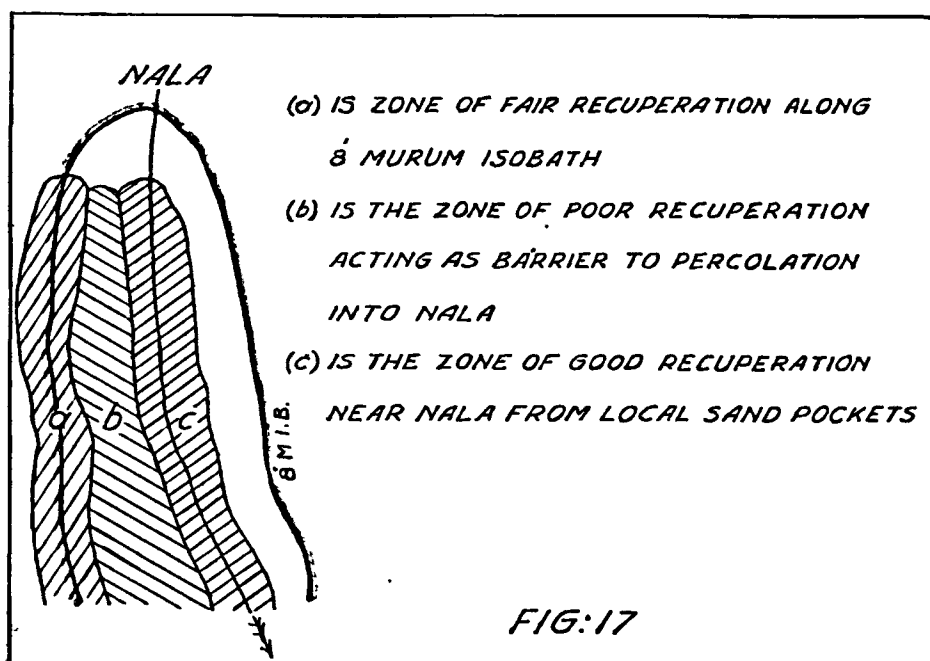

A drain in the nala bed in such a case will not act as a relief drain; and it may be better—if the levels permit—to construct a valley-side drain. Pits taken in the banks give more reliable data.

A type of drain which has proved very effective is where the nose of a murum or mān ridge has been tapped and the water led to the main drain.

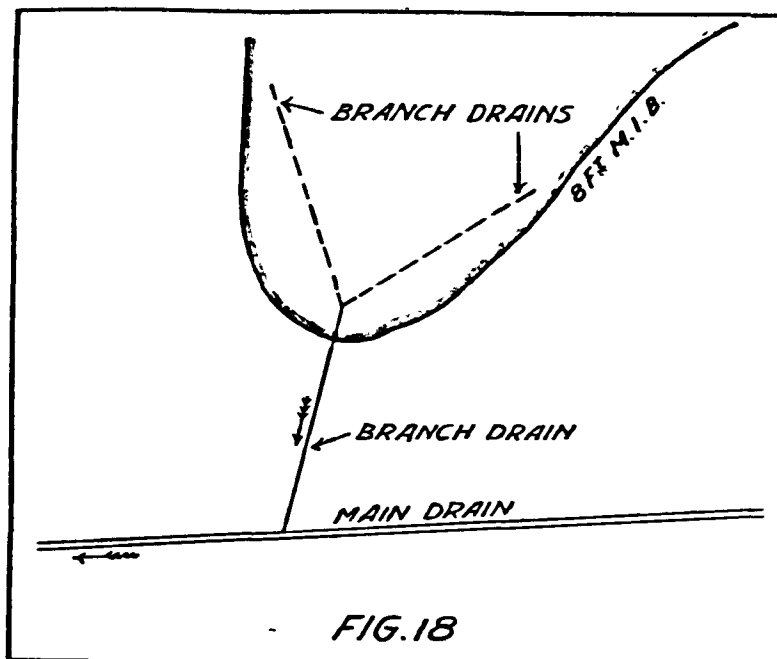

At the Baramati Experimental Salt Area drainage failed completely until the noses of two mān ridges were tapped after which the S. S. W. L. in over 150 acres fell at once to between 4 and 7 feet below ground level, though previously at less than 2 feet. In some cases where a well has been tapped, the lowering of the S. S. W. L. has been remarkable.

The length of a drain in its upper lengths will be determined by the extent of damage in the area. The drain should penetrate the areas that have already been damaged or are likely to be damaged but should not usually be taken into soils less than 3 feet in depth.

#### SUB-ARTESIAN BORES.

67. Where there is a highly pervious sub-stratum at more than 12 feet depth it is sometimes desirable to construct sub-artesian bores in the bed of the drain. These are simply bores at the bottom of the drain into a lower pervious strata, lined appropriately to prevent choking by mud or sand from the drain itself (see paragraph 81 and Plate XII). They may be spaced at furlong intervals and more intermediate bores made after observation of results where necessary.

#### GRADIENT OF A DRAIN.

68. The bed slope of a drain should afford as far as possible a non-silting and non-scouring velocity. It has generally been found that the latter is not important as most drains cut into murum or chopan and do not therefore scour easily. Trouble occurs mostly where layers of sand are encountered in sides, and from damage caused by monsoon floods. The remedy is considered in Part IV—Maintenance.

The gradients of open trenches should, as far as possible, be uniform. Drains constructed with varying slopes tend to erode where slopes are steep and silt due to deposition of the eroded material where they are flat. Silting and obstruction generally occur on flat gradients where drainage is most needed. Drains with varying slopes require a greater amount of maintenance to keep them at maximum efficiency than those with uniform slopes.

#### MISCELLANEOUS POINTS IN THE ALIGNMENT OF DRAINS.

69. Sudden changes of direction of an open drain should be avoided. The angle formed at an apex should be as wide as possible to allow of a smooth curve of large radius. Such curves should be accurately designed and laid out.

In this connection it should be borne in mind when choosing an alignment for an open drain that owing to these curves the strata shown at the apex will not be those of the drain, which will be located a short distance away.

Wells, which show high recuperation and are situated near the drainage lines, should be connected with the drains as their influence on the S. S. W. L. may be very considerable.

Existing cultivators' drainage channels should be connected with the drains by providing grass inlets.

#### PIT-WORK, SURVEYS AND PLOTTING OF DRAINAGE LINES.

70. The preliminary layout of the drains having been duly approved on the considerations so far mentioned, the pit-work should be commenced from the tail upwards. The pits should usually be taken every 330 feet apart, except where special factors, such as a sudden murum dip, require them at nearer intervals. The depth of pit should be at least ten feet if no murum or m $\ddot{a}$ n occurs nearer the surface.

If the proposed line passes through very shallow soil or a very deep soil of low permeability for a considerable distance, short additional cross-sections must be run and an alternative alignment considered there and then.

If the line passes through flowing or stagnant water, the test bore for porosity should be made on higher ground above W. L. in line with the point chained; but a pit must also be taken on the line in order to ascertain the sub-strata. Levels should invariably be taken for both.

The pit-work information should be plotted on the plan daily, correcting the H. I. B. and M. I. Bs. where required. If any pit information cannot be shown, reasons should be noted. The plan should then be completed in all respects. The month and year of classification and survey, with the names of classifier, surveyor, tracer, and Sub-Divisional Officer should invariably be shown.

#### RECORD OF IMPORTANT POINTS ALONG DRAINS.

71. Too much stress cannot be laid on the necessity for recording positions of chainage points (zero and final), junctions of drains, apices, tangents to curves, and changes of gradient, etc. The chief reason for this is that as a rule such projects are surveyed a considerable time before the work is carried out and it is generally impossible to pick up an exact point by memory after one monsoon has passed. Where the staff has been changed it is absolutely impossible to do so.

The only sure method of recording such points is to have them measured and sketched with notes made in a Field Book in exactly the same manner as a Bench Mark is recorded. Measurements should be taken to at least two (preferably three) definite landmarks, such as wells, culverts, corners of survey numbers, trees, etc.; or, where such landmarks are not available, the measurement from the peg to where a perpendicular to the survey number boundary meets that boundary, and again from that point along the boundary to the corner of the survey number. With such a record, it should be possible for anyone not concerned with the survey to arrive within a circle of about 10 feet diameter from the original peg.

Such measurements and sketches should invariably be scrutinised by the Sub-Divisional Officer before being traced, and they should be sent up with the project plans and papers as part of the project.

Similarly with Bench Marks—temporary Bench Marks, which may have been used for the survey work, should be invariably recorded—for the benefit of those who have to carry out the work in the future. As far as possible Bench Marks which are reasonably permanent should be selected—such as on plinths of buildings, culverts and wells. Sites for Bench Marks may be chiselled on rock in a nala bed provided the position is easily traceable from the sketch. A list of such Bench Marks should be sent up with the project.

# IRRIGATION RESEARCH DIVISION TYPE SECTIONS FOR OPEN TRENCHES

SCALE 2' = 1"

**NOTE:-**

- (1) SECTIONS ASSUMED TO BE RUNNING 0.8 DEPTH FULL DURING HOT WEATHER
- (2) GRADIENT ADOPTED IN CALCULATION 1 IN 500

15" OPEN TRENCH

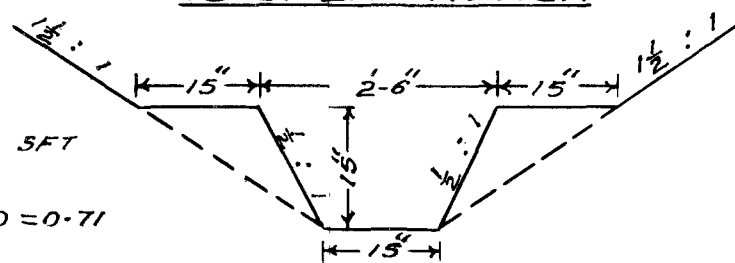

24" OPEN TRENCH

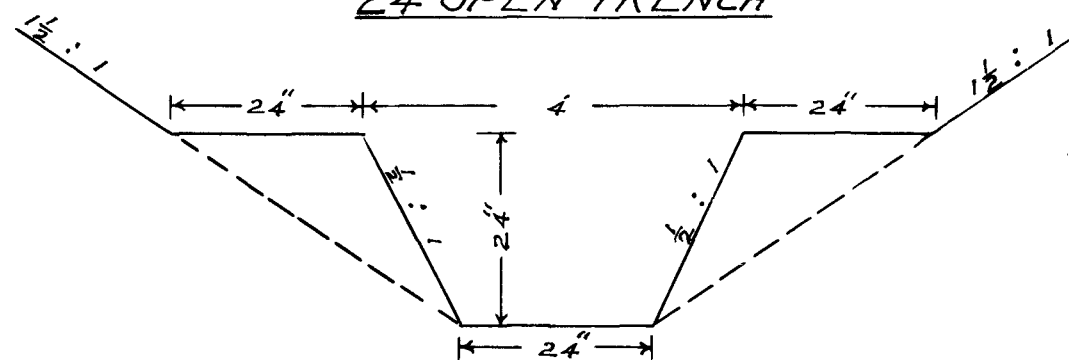

$$A = \frac{3.5}{2} \times 100 = 1.75 \text{ 5FT}$$

$$P = 3.5 \text{ FT}$$

$$\sqrt{\frac{A}{P}} = \sqrt{\frac{1.75}{3.5}} = \sqrt{0.50} = 0.71$$

$$Q = A \times \sqrt{\frac{A}{P}} \times 3.63$$

$$Q = 1.75 \times 0.71 \times 3.63$$

$$Q = 4.51 \text{ CUSECS FOR 1125 ACRES}$$

OF CATCHMENT FOR 1:3 BLOCKS

EQUIVALENT TO THE OLD TWO FEET

SECTION WITH BED LEVEL 3" BELOW

OLD FORMATION LEVEL INSTEAD OF 6"

18" OPEN TRENCH

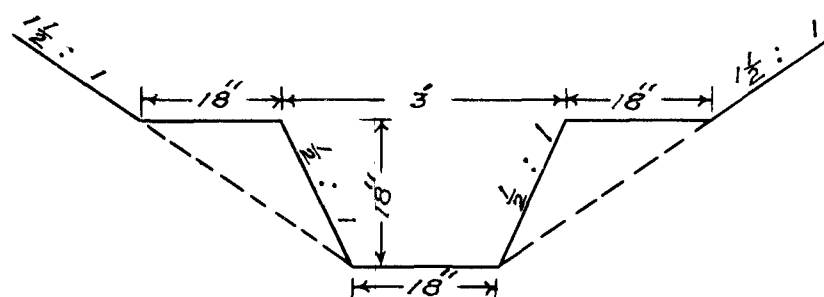

27" OPEN TRENCH

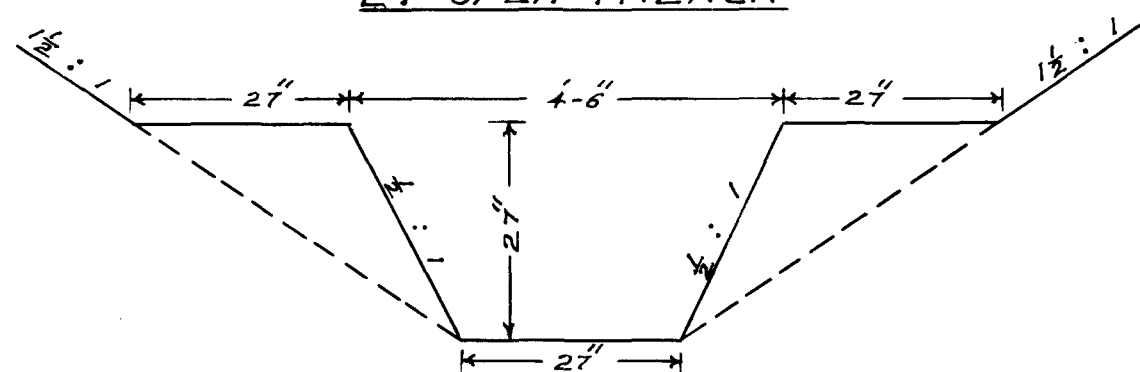

21" OPEN TRENCH

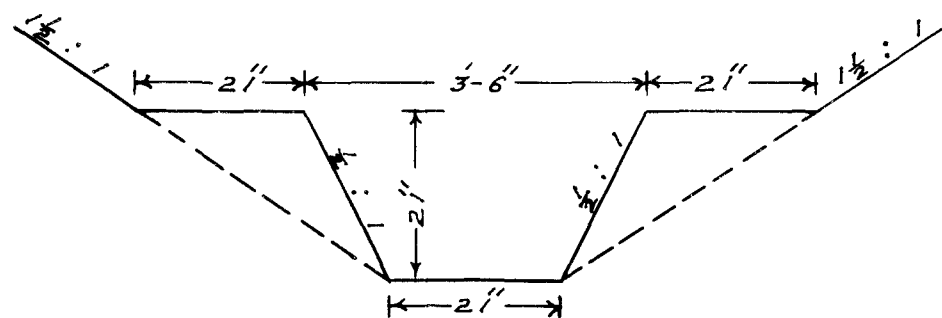

30" OPEN TRENCH

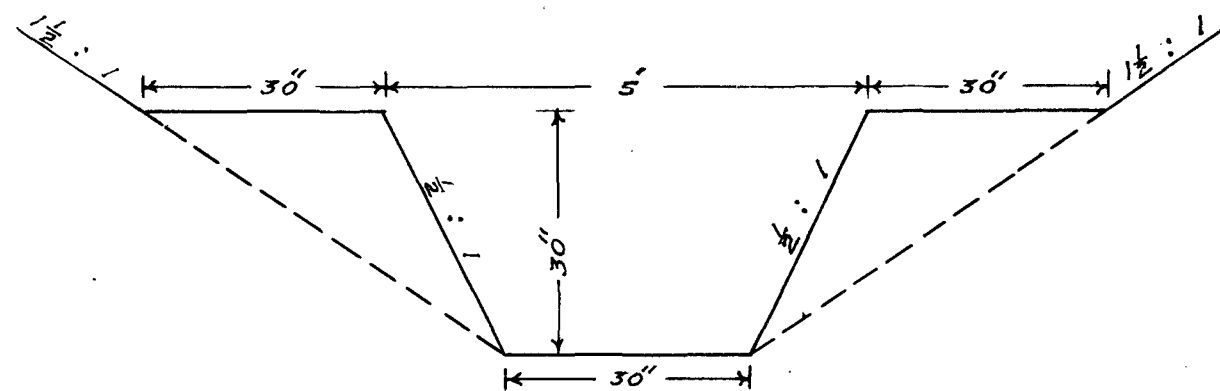

## NOTE BOOKS AND FIELD BOOKS.

72. Note books should form a most valuable record for the preparation of the Concise Record of a project after construction. Note books and field books should therefore each be used for one project only, and subordinates should on no account be allowed to take them away, even if transferred to another section in the same Sub-division.

## LAND ACQUISITION.

73. Once the general alignment of the drains has been decided, a strip 300' in width along the centre line of each drain should be valued by the expert staff of the Irrigation Research Division, who have been specially trained for the work. This valuation, with an appropriate plan, is to be forwarded to the Collector of the district in order that it may be approved by the Revenue authorities, in accordance with the orders of Government, before submission of the estimates.

The further advantages of this preliminary valuation become apparent when acquisition proceedings are commenced.

The object of valuing (and notifying for construction) a 300 feet wide strip, but including only a 100 feet wide strip in the estimate, is because the working drawings may reveal subsoil information which was not apparent during the original survey. This new data may necessitate changes of alignment within the 300 feet strip.

## TYPE OF DRAIN—OPEN TRENCH OR PIPE LINE.

74. The next question is to decide whether a particular drain should be an open trench or a pipe line. The main factors to be considered are :—

- (a) Value of the land.
- (b) Discharge anticipated.
- (c) Capital cost of the drain, and
- (d) Capitalised cost of maintenance and repairs.

Pipe drains are preferable where run-off has not to be dealt with ; because their maintenance is much cheaper than that of an open drain ; and they are less likely to be rendered useless by temporary neglect. If, however, the cold weather discharge exceeds 1 cusec a pipe line is very expensive and where floods have to be got rid of, an open drain is necessary. The main drain of a scheme should invariably be an open trench.

## SECTION OF AN OPEN TRENCH.

75. At first the open trenches were designed with a bed of  $1\frac{1}{2}$  feet to 4 feet width and uniform side slopes of  $1\frac{1}{2}$  to 1 feet (Figure 19).

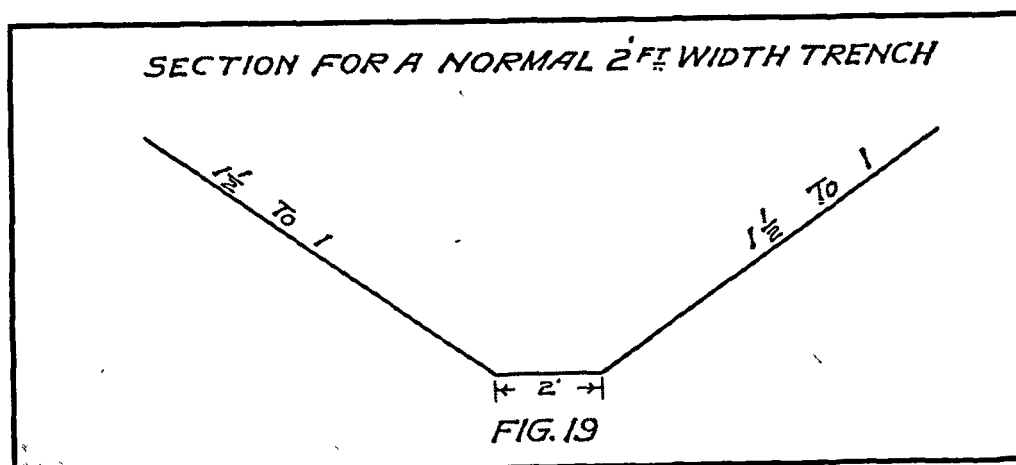



This section, however, was not satisfactory and a semi-circular bottom channel was tried. (*vide* Figure 20).

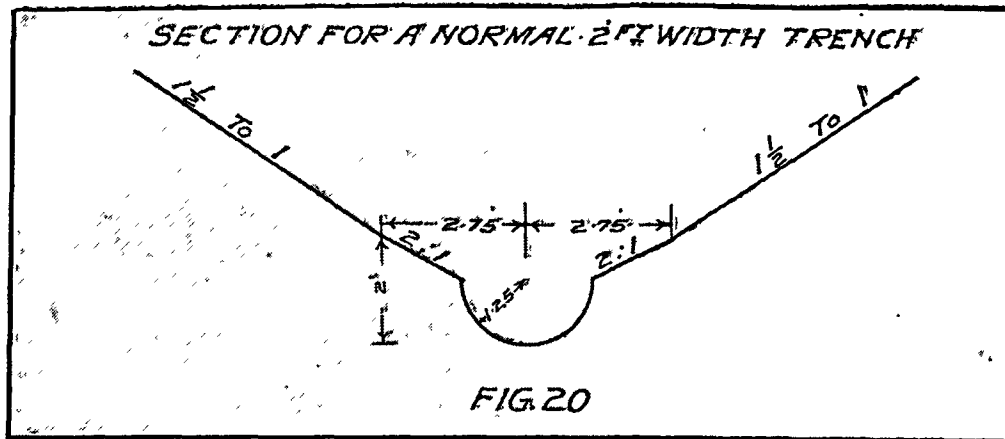

This section gave better results, especially for the low discharge of the hot weather, and provided a better seed bed for grass in the lower portions of the side slopes. The difficulty was to excavate the semi-circular portion. Hence it was modified to that given in figure 21.

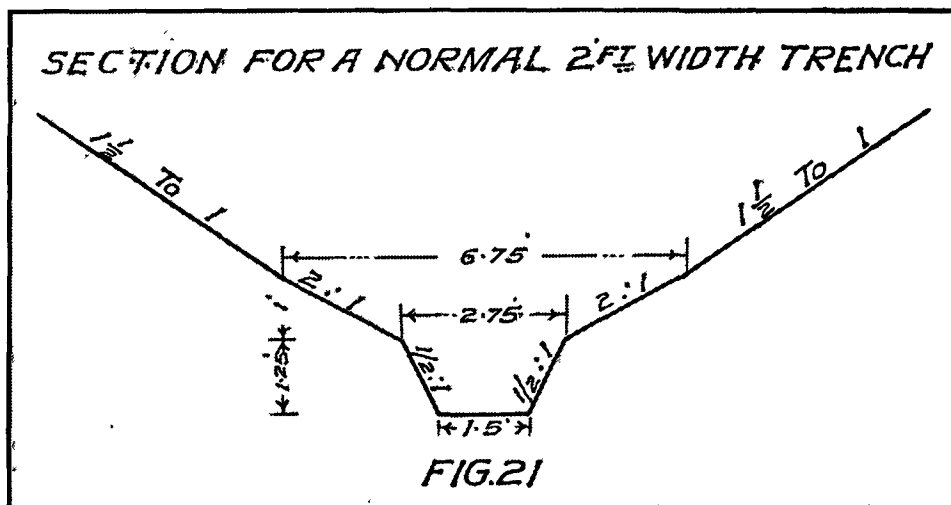

The small berm was subsequently modified and made horizontal for simplicity in construction (Figure 22) and this now constitutes the standard section for an open trench.

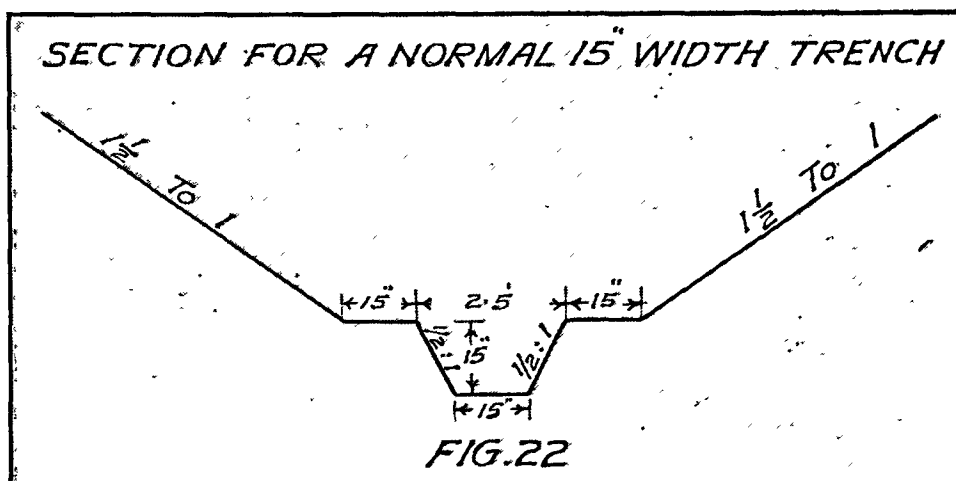
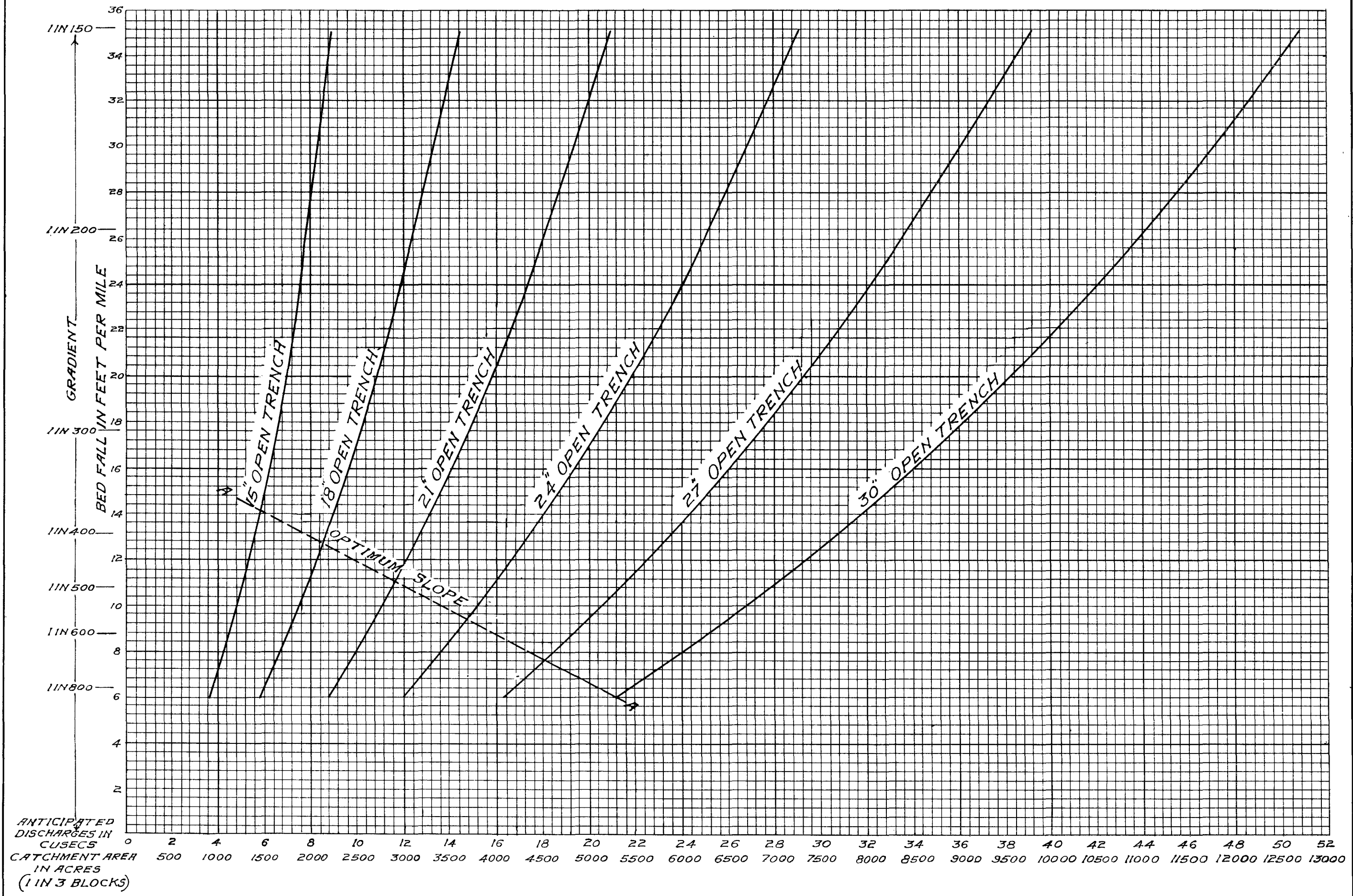

Plate No. VI shows the type designs of open trench now in force. They consist of 15", 18", 21", 24", and 30" sections.

IRRIGATION RESEARCH DIVISION  
GRAPH SHOWING SECTIONS OF OPEN TRENCHES  
TO BE ADOPTED FOR VARIOUS CATCHMENTS AND WITH  
VARYING GRADIENTS



IRRIGATION RESEARCH DIVISION

CHART & TYPE SECTIONS SHOWING HEIGHTS OF SPOIL BANK AND  
WIDTHS OF LAND TO BE ACQUIRED FOR VARIOUS DEPTHS OF  
CUTTING ON OPEN TRENCHES

SCALE { VER: 2' = 1"  
HOR: 1' = 1"  
20 = 1" FOR WIDTH OF LAND  
TO BE ACQUIRED

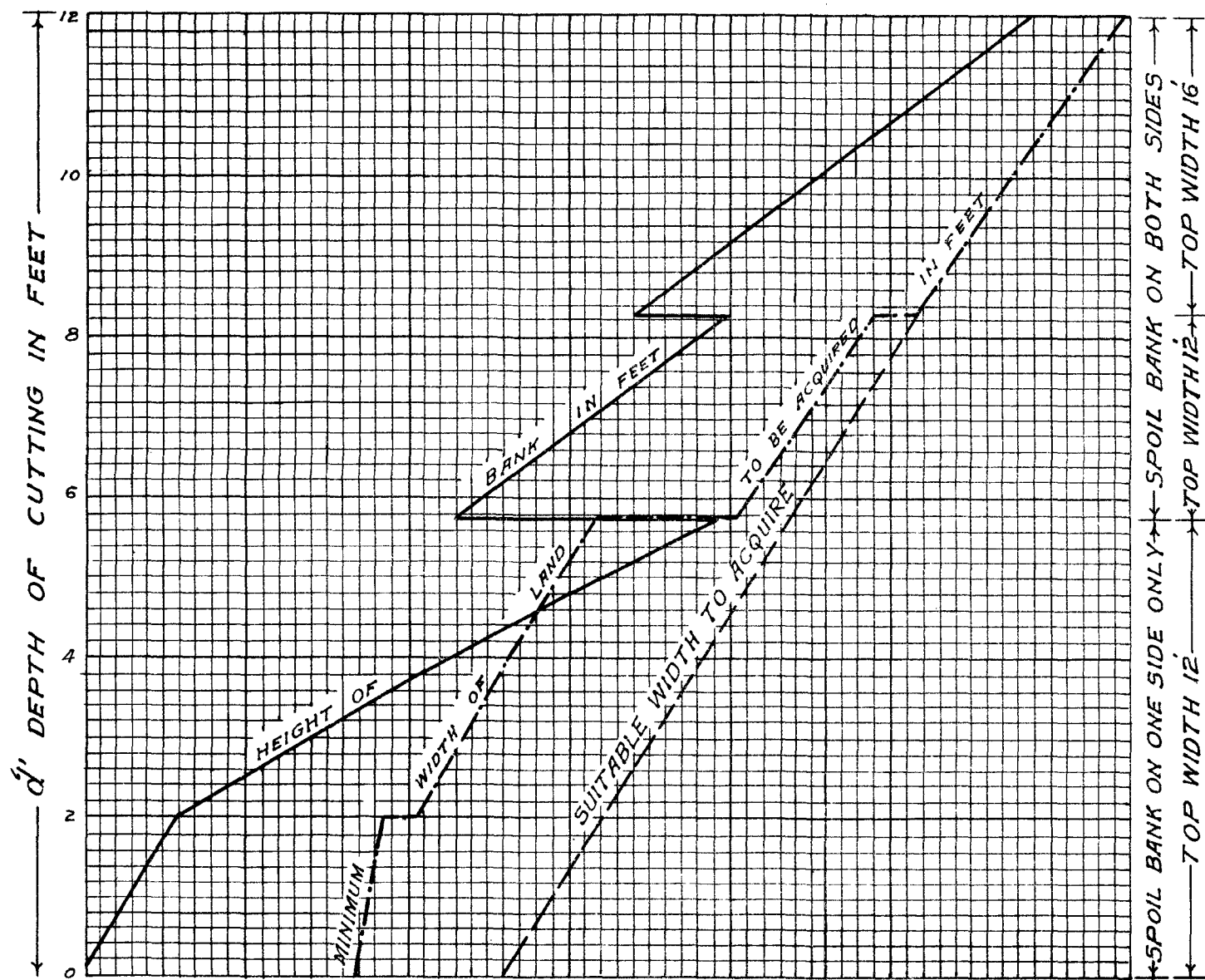

HEIGHT OF BANK $d$ IN FEET	1	2	3	4	5	6	6 1/2
WIDTHS OF LAND $W$ TO BE ACQUIRED IN FEET	20	40	60	80	100	120	130

SCALE 10' = 1"

FIG:1

SPOIL BANK ON ONE SIDE ONLY FOR  
 $d$  LESS THAN 5.75'

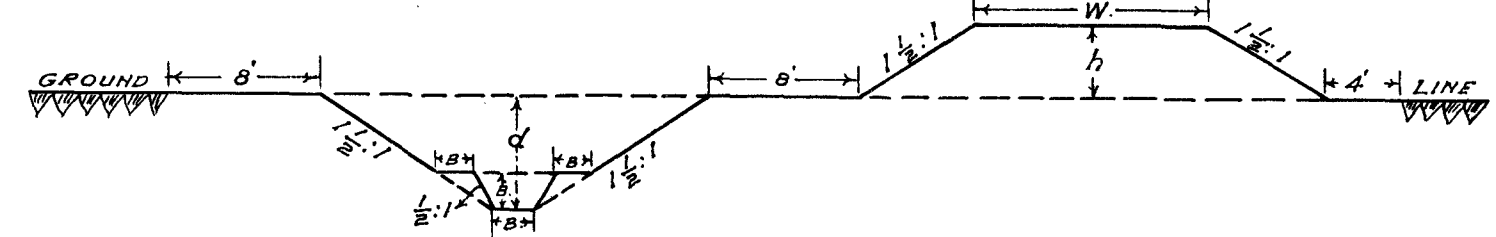
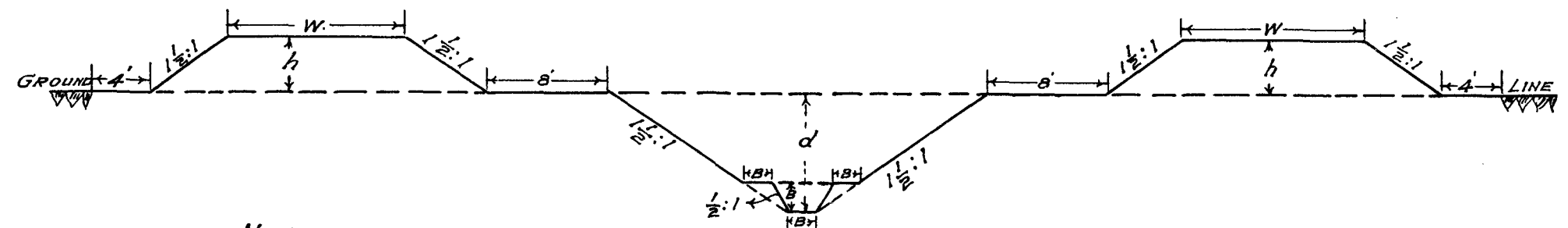

FIG:2

SPOIL BANKS ON BOTH SIDES FOR  
 $d$  GREATER THAN 5.75'



NOTE:-

$B = 15, \text{ OR } 18, \text{ OR } 21, \text{ OR } 24, \text{ OR } 27, \text{ OR } 30$

ACCORDING TO THE SECTION ADOPTED

$d$  = DEPTH OF CUTTING.

$W$  = WIDTH OF SERVICE ROAD ON TOP

$h$  = HEIGHT OF SERVICE ROAD

IRRIGATION RESEARCH DIVISION  
DESIGN FOR A MASONRY RAMP  
ACROSS OPEN TRENCH

SCALE 10' = 1"

PLAN

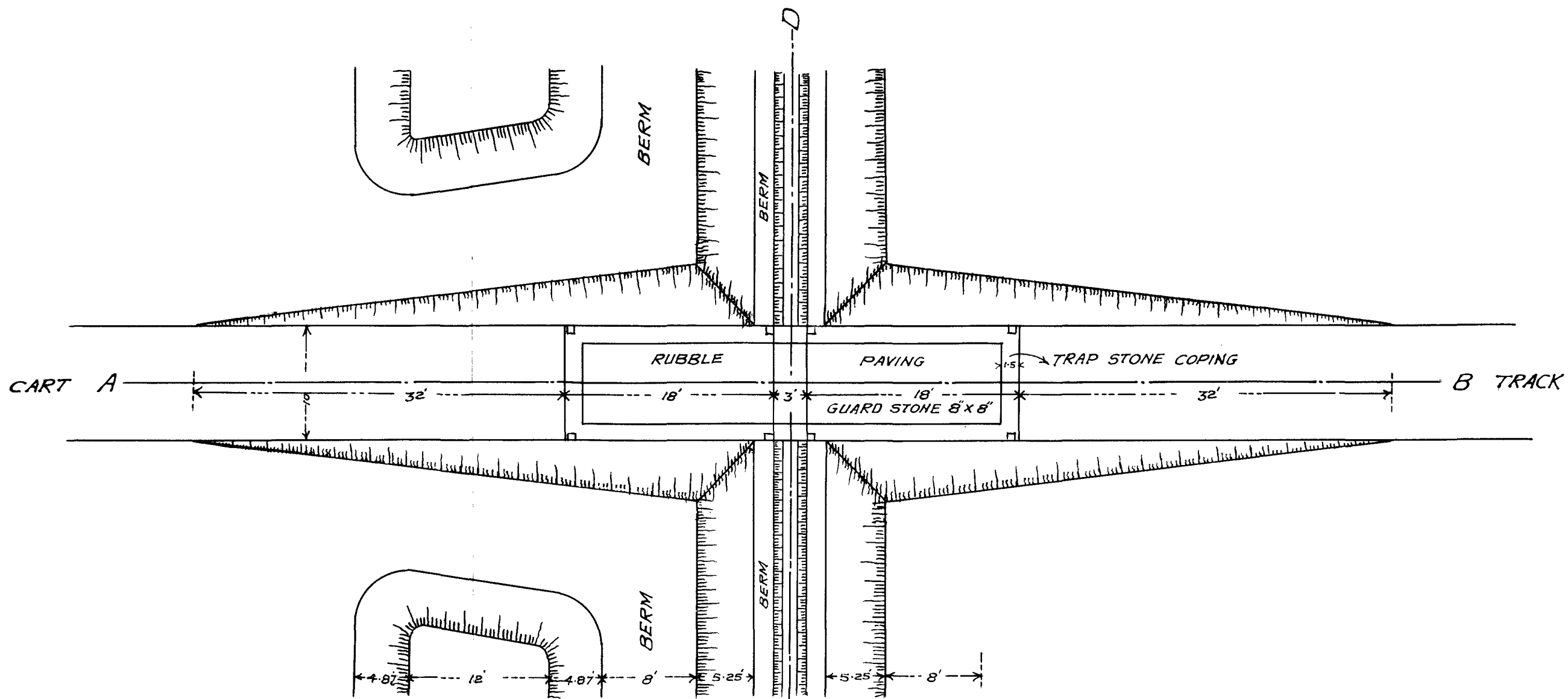

SECTION ON A B

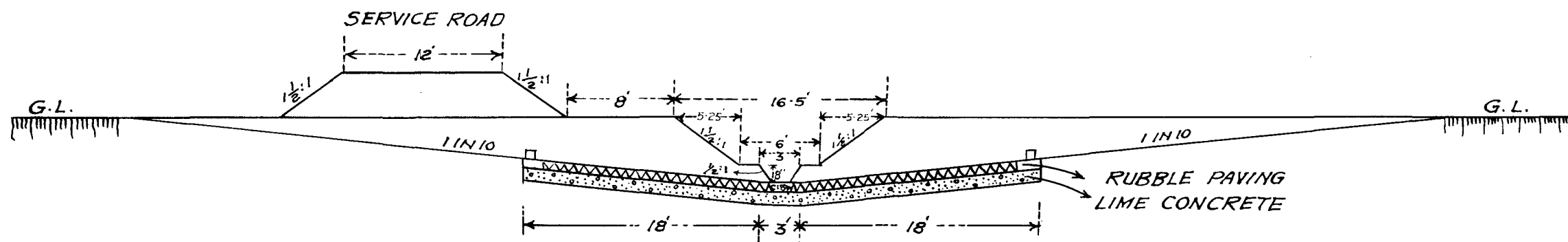

SECTION ON C D

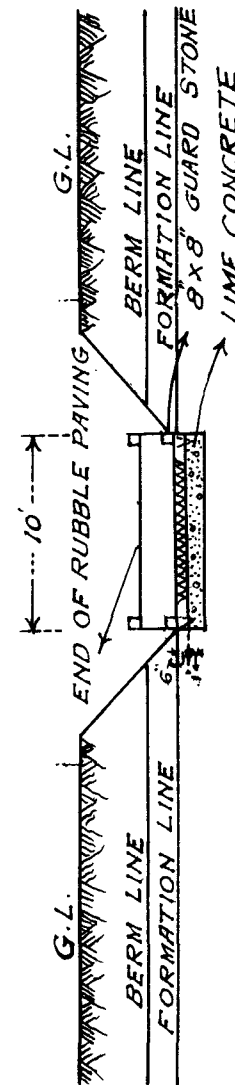

To find the section necessary, the anticipated discharge must first be calculated. Assuming that drainage implies full development of 1:3 blocks (the concentration would probably be higher in factory areas) a discharge due to percolation from perennials and seasonals combined may be expected amounting to 1 cusec per 250 acres of land suitable for perennial irrigation. This has been worked out from canal percolation at  $\frac{1}{2}$  cusec per mile, percolation from distributary and outlet channels at 5 per cent. of the discharge at distributary head per mile, and percolation from cane irrigation in blocks at 1 cusec per 100 acres of cane or 250 acres of block. This assumption has so far proved sufficient for all practical purposes when designing open trenches in areas under block irrigation, but in factory areas, where the cane concentration is high and soil frequently shallow,  $1\frac{1}{2}$  cusecs per 200 acres of cane land has been assumed for design purposes.

The hot weather discharge over a catchment may then be worked out and an open trench sufficient to carry that discharge flowing at  $(0.8 \times \text{depth})$  may be found from the empirical formula (Elliot's):—

$$Q = AV \text{ and } V = \sqrt{A/P \times 3/2 H}$$

Where A = area in s. ft.

V = velocity in ft./sec.

P = wetted perimeter in ft.

and H = fall in ft./mile.

The chart,—Plate No. VII—correlates Q, H, acreage to be drained, and size of open trench. The line A . . . A shows optimum slope.

76. In actual practice open trenches cut soils which are never uniform. They change not only in different lengths of trenches but also at various heights in the same length. It would therefore be impracticable to change the side slopes as required by the theoretical considerations of the strata met except were they are very hard and expensive to excavate. Hence except in the case of mān, hard murum, and rock, the side slopes usually adopted are  $1\frac{1}{2}$  to 1 for all kinds of soils. With sand, it may be necessary to take special precautions by revetting the sides in some manner suitable to the actual circumstances. The main object would be eventually to provide a good growth of suitable grass on the side slopes which would effectually protect the sand from scour. This protection is fully dealt with under maintenance (Part IV).

A berm at ground level should be left 8 feet in width. A berm is needed for inspection after completion, and reduces the likelihood of slips into the trench.

Using the spoil from the main trench, a service road or inspection path should be made on one side. When the depth of excavation is more than 5.75 feet spoil should be disposed on both banks, the inspection path or road on one side only being dressed. Plate No. VIII gives the relation between width of spoil banks to depths of open trenches and the width of the strip to be acquired. It is desirable to limit the height of spoil banks to 4 feet after allowing for shrinkage. Curves in an open trench, should, where possible, be located in hard subsoil strata to minimise scour. Soil on the slopes should be protected by grass pitching at the earliest opportunity. Where a short radius in curve in soft strata is unavoidable, grass pitching must be done very carefully, deep sods being used.

#### RAMPS.

77. Ramps or other means should be provided for all important cart tracks and roads crossing O. T.s. The slopes of the approaches should not be steeper than 1 in 10. In rare cases steeper grades may be necessary; or permissible—where for instance a distributary service road used for cars, cycles, and horses of the staff only, crosses an O. T. The most suitable site should be fixed in consultation with the Revenue authorities and after consideration of the foundations available.

The standard approved type of ramp is shown in Plate IX and is constructed of stone paving over a foundation of lime concrete, and costs about Rs. 350. Another type of crossing can be made of cement concrete consisting of an 18 inch pipe set in the central channel with the roadway on top.

The surface of the concrete, however, needs chequering to prevent slipping. The objection to this design is that it obstructs floods causing silting upstream and scour downstream. The design would be unobjectionable if the bridge were a shallow reinforced concrete slab supported by abutments designed to conform with the shape of the central channel. The slab may be in pre-cast sections to facilitate construction.

Another (bridge) design constructed on the Manjri Drainage Scheme consists of two girders supporting an R. C. C. roadway at G. L., and might be adopted where there is no possibility of restriction of the waterway by the girders and where the abutment foundations are satisfactory. The alternatives which are to be considered depend on two factors; firstly, heading up and consequent silting should not be allowed under any circumstances and secondly, cost. Concerning the latter, it must not be forgotten that for all drainage works it is frequently cheaper to provide for a more expensive design initially in order to avoid expensive maintenance thereafter; maintenance should be as simple and cheap as possible.

#### CAUSEWAYS AND BRIDGES.

78. Where metalled roads cross drains, ramps will not suffice and designs for road dams, causeways, or bridges will be necessary. In estimating, a lump sum may be provided, as the detailed design of a work of this nature is best left until the time of construction, when factors such as a slight change from the original alignment, variation in formation level of the drain etc., can be taken into account.

It should however be remembered in the case of causeways or road-dams that we cannot fight against Nature but can only help her. Water has a tendency to cut a bell mouth immediately below a causeway on a road, and hence 1 : 1 stone pitching on the sides of the type section of drain would interfere badly with natural conditions and might lead to scour behind the pitching and damage. It is therefore better to allow natural scour to occur first and then to guide the bell mouth formed into the channel downstream by grass pitching, *vide* sketch in Figure No. 23. A large culvert opening should be provided to minimise obstruction, and reduce the quantity of water overtopping the structure.

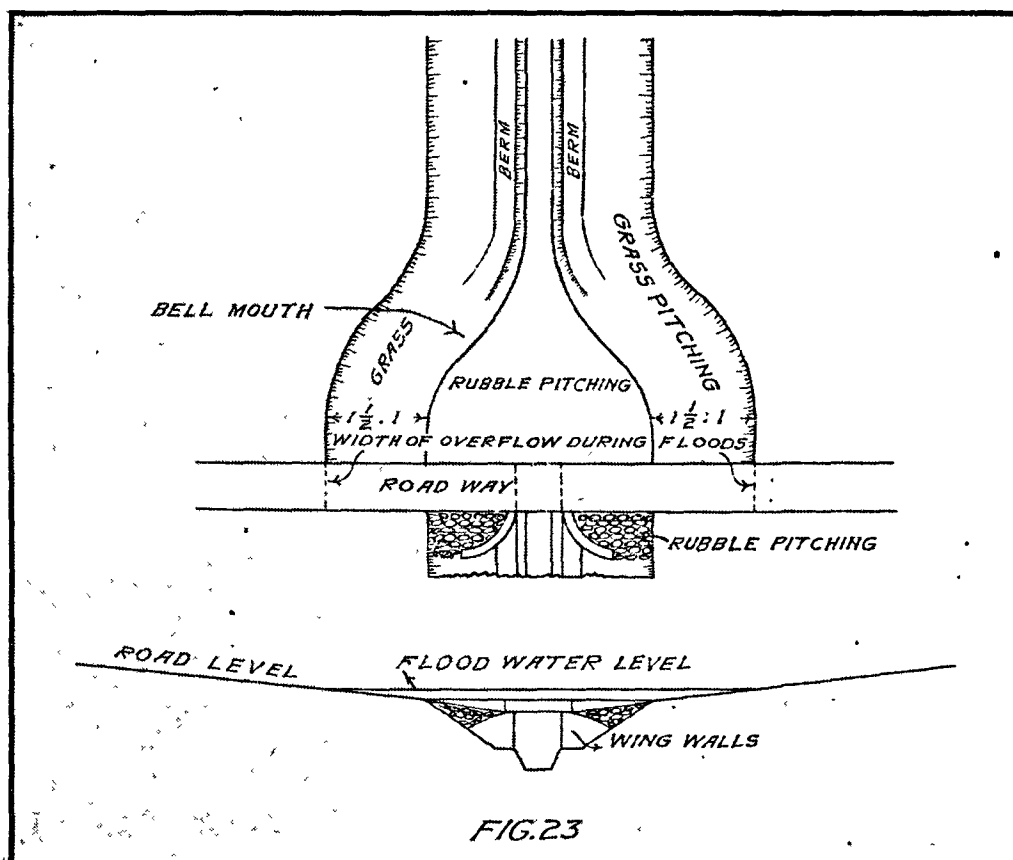

IRRIGATION RESEARCH DIVISION  
TYPE DESIGN FOR GRASS INLET

SCALE 10' = 1"

PLAN

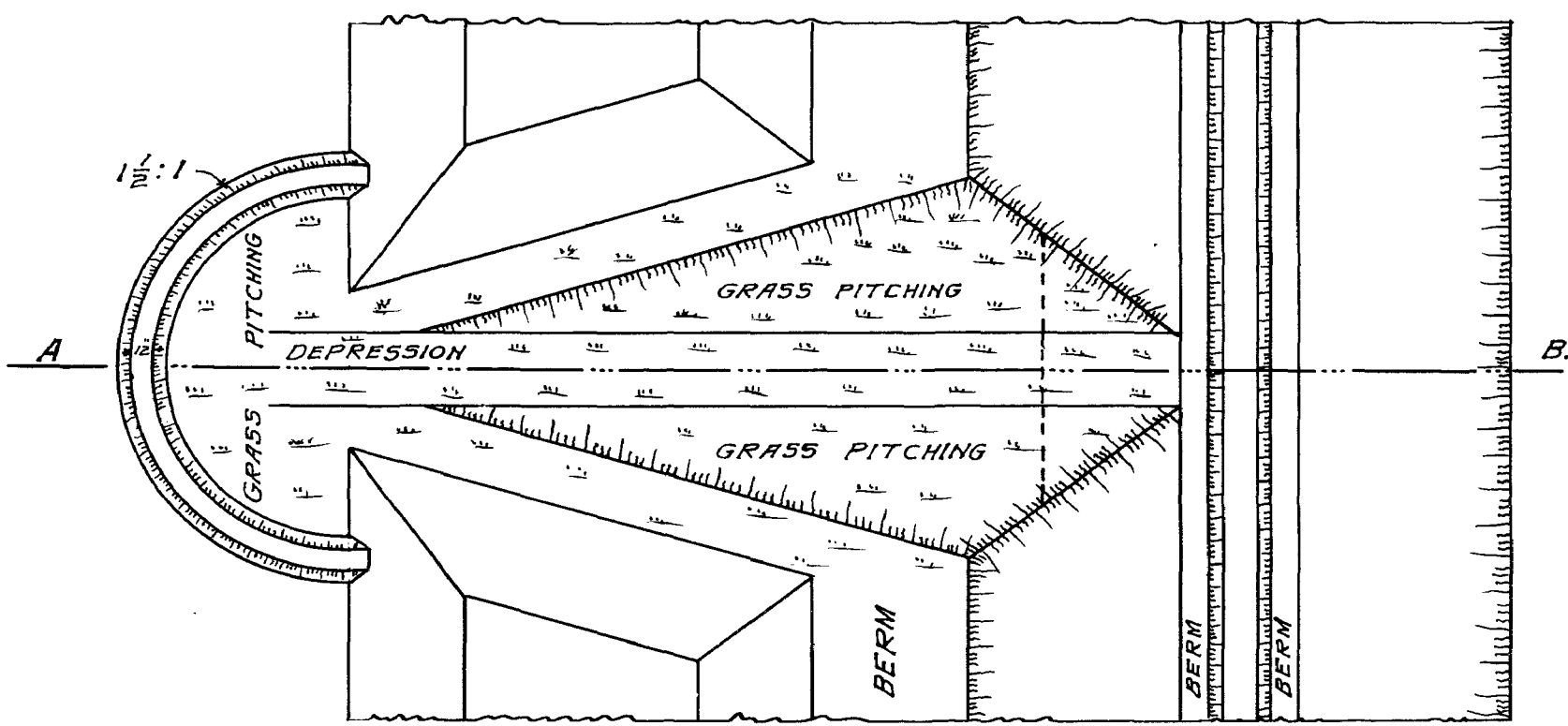

SECTION ON A. B.

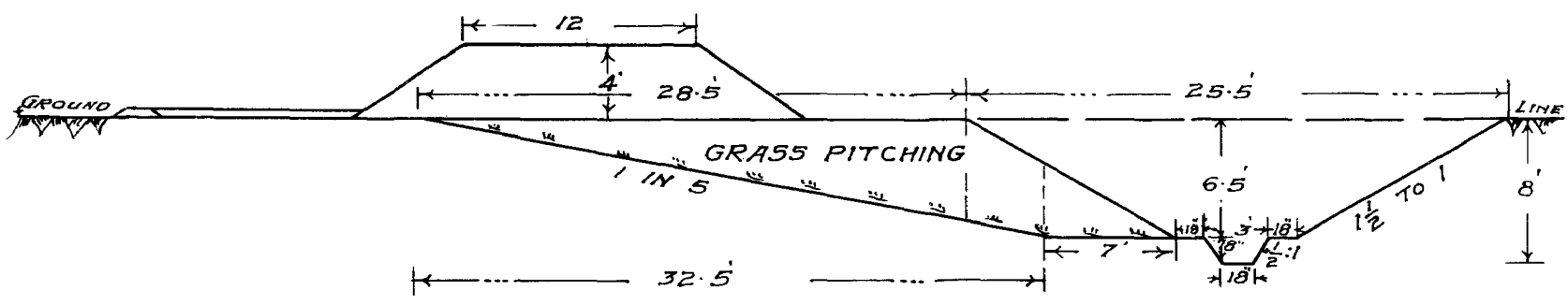

IRRIGATION RESEARCH DIVISION  
STANDARD DESIGN FOR A STANDING WAVE FLUME NARROW THROATED  
FOR DRAINAGE SCHEMES

SCALE: 2" = 1"

S.W.F. FOR PASSING A MAX. DISCHARGE OF 3 CU SECS

$$Q = 3 \times B \times D^{1.5}$$

$$= 3 \times 1 \times 1^{1.5}$$

$$= 3 \text{ CU SECS}$$

PLAN

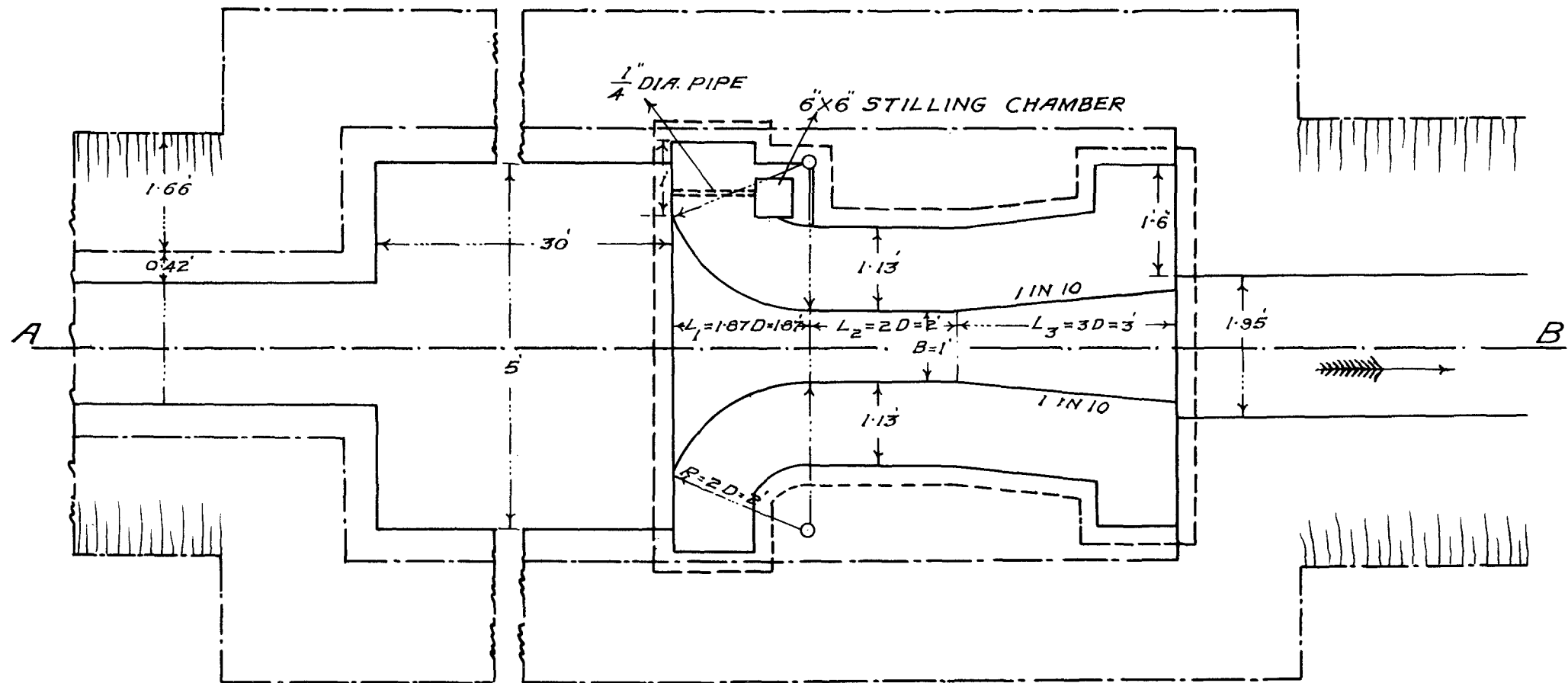

SECTION ON A. B.

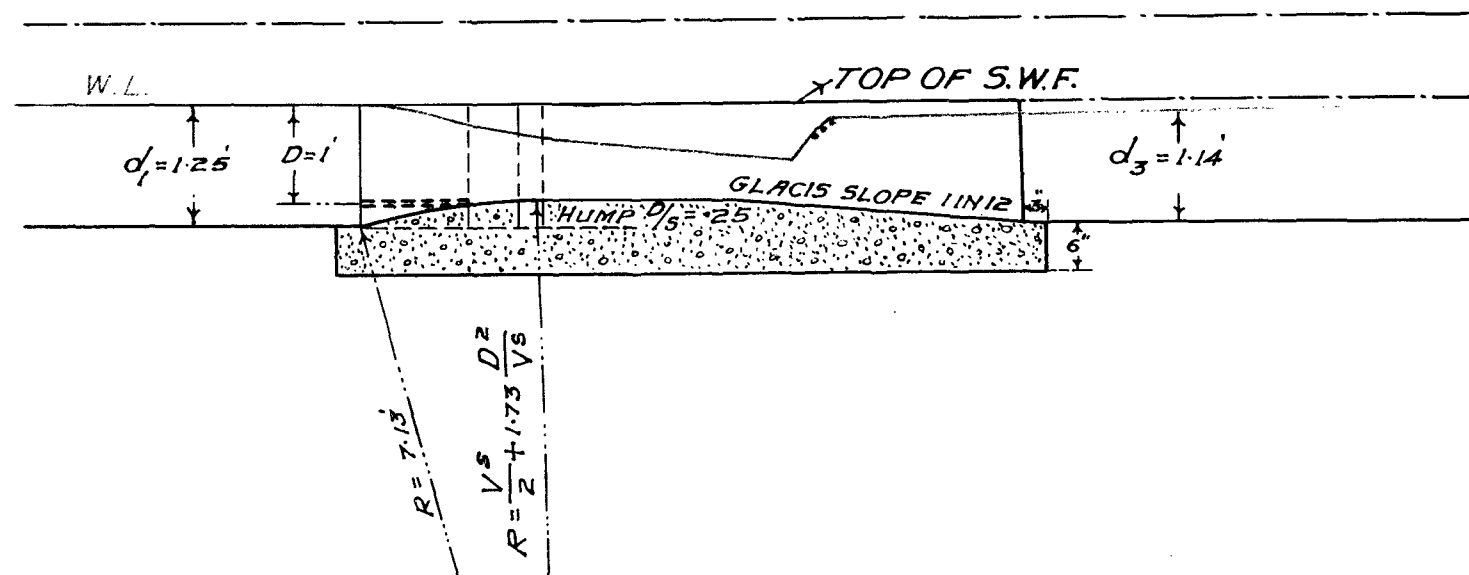



IRRIGATION RESEARCH DIVISION

SUB-ARTESIAN BORE

SCALE:- 2" = 1"

PLAN AFTER REMOVING  
TOP COVERING

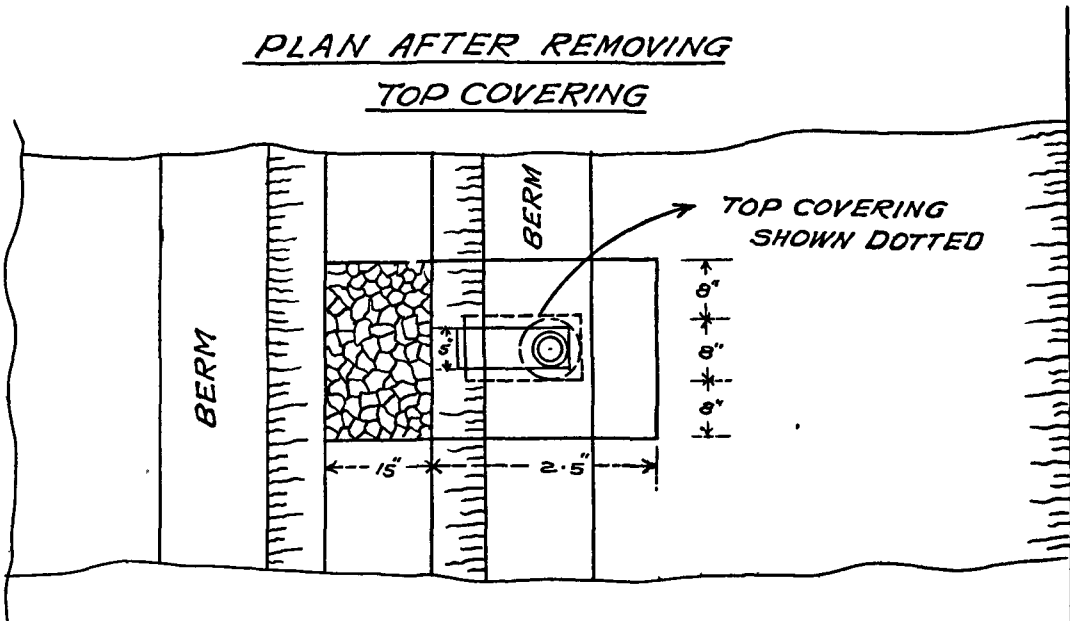

SECTION

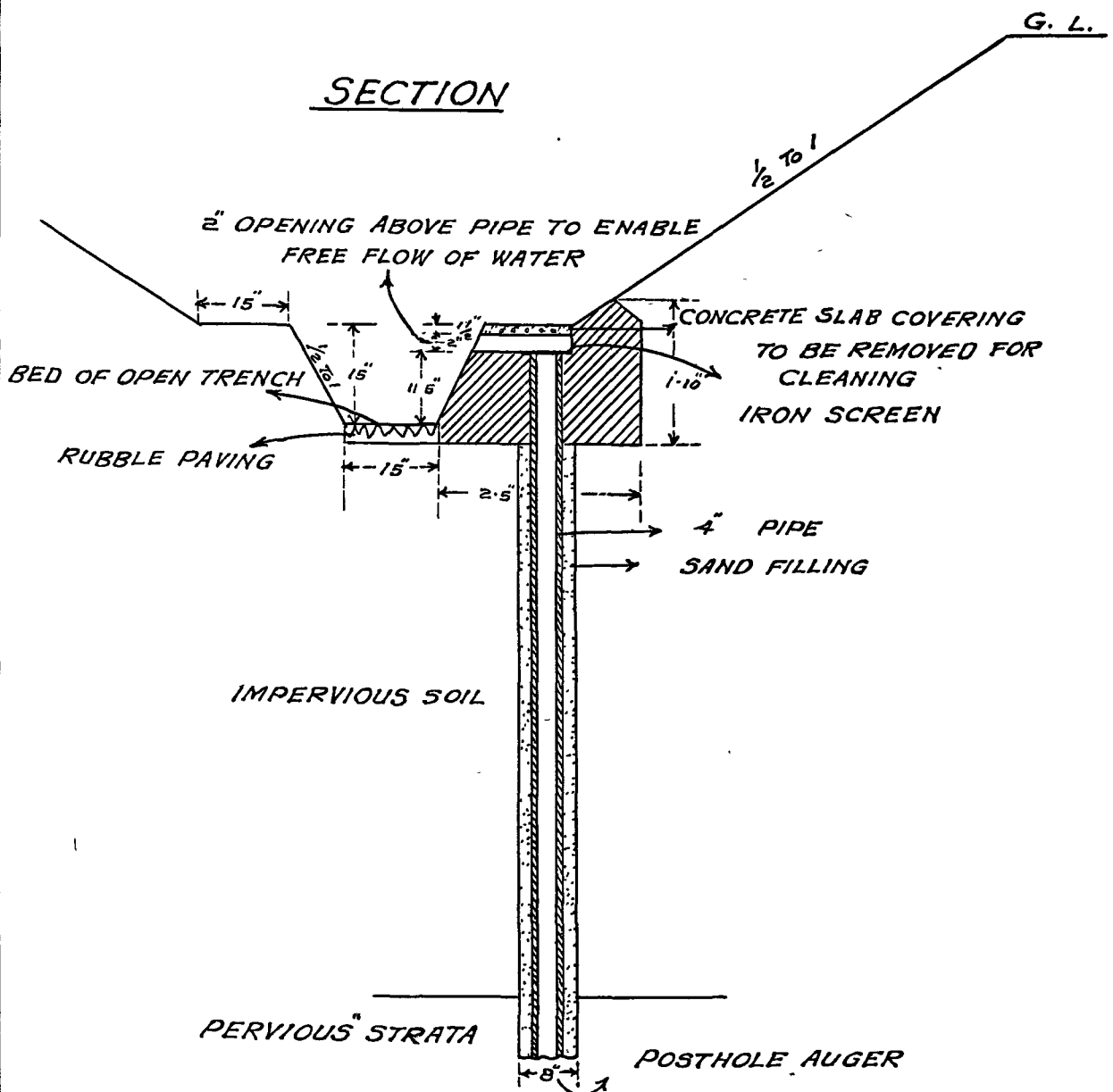

SECTION OF OBSERVATION TUBE

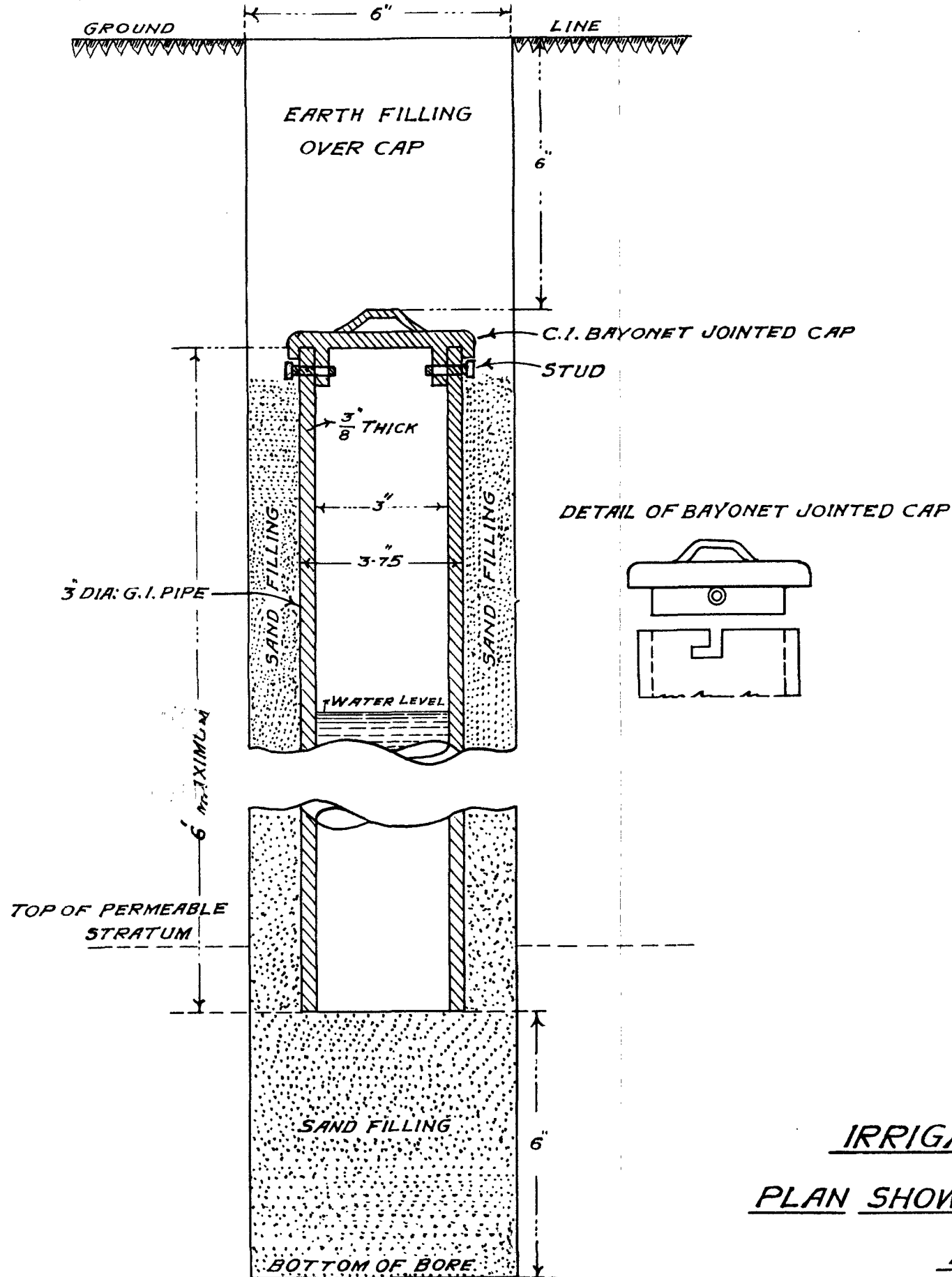

SKETCH PLAN SHOWING POSITIONS OF OBSERVATION TUBES

NOTE:-

- (a) TO BE PLACED WITHIN THE BOUNDARY OF DAMAGED AREA
- (b) TO BE FIXED ALONG BANDS AS FAR AS POSSIBLE.
- (c) POSITION SHOULD USUALLY BE 100', 200', 400', 800', 1600', 3200' FEET AND SO ON FROM THE CENTRE LINE OF DRAIN
- (d) SAY 1000' APART ALONG THE DRAIN
- (e) NO TUBES NEED BE PLACED WHERE THE STRIP OF DAMAGE IS NARROW SAY ONE FURLONG IN ALL OR  $\frac{1}{2}$  FURLONG FROM THE CENTRE OF THE DRAIN

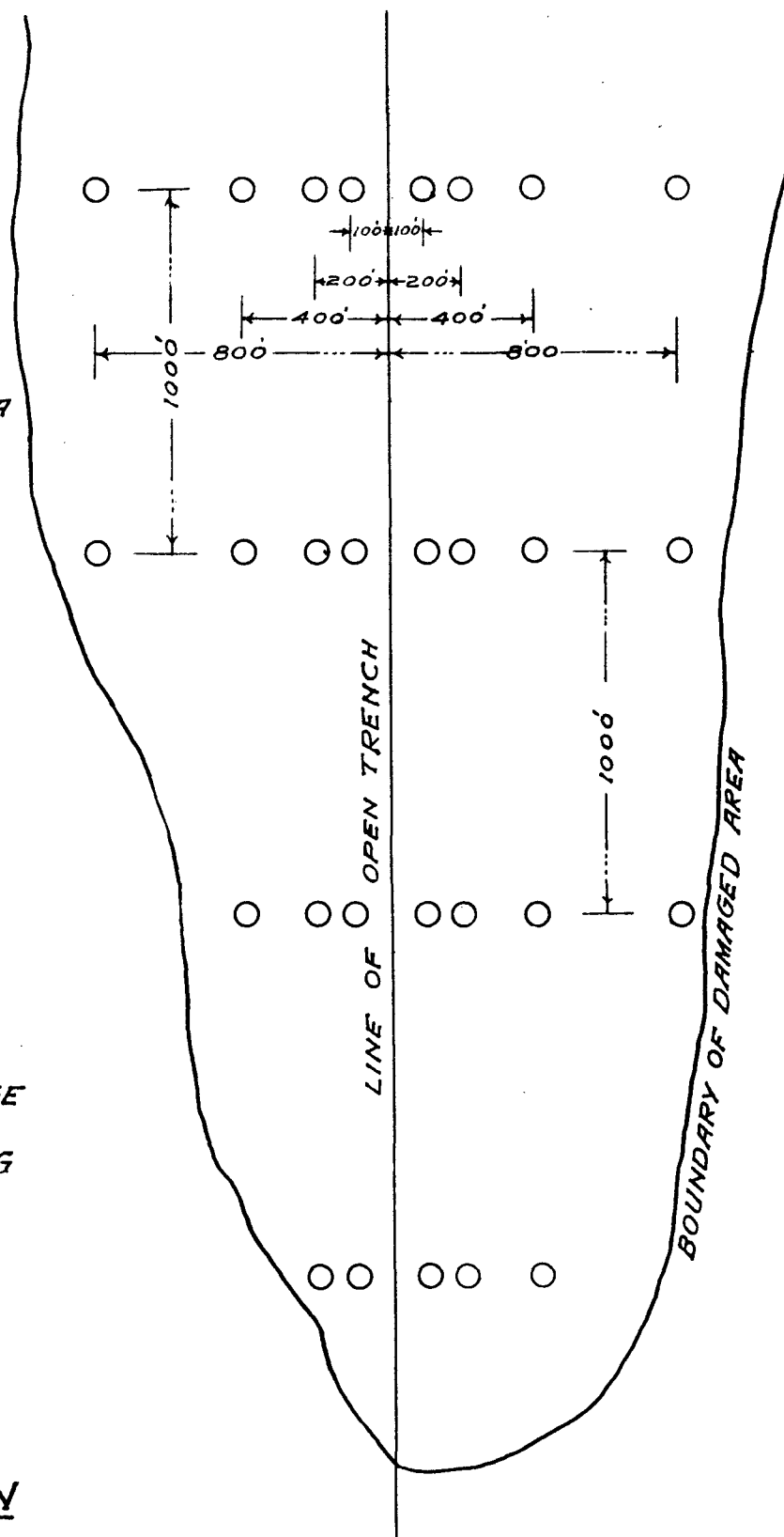

IRRIGATION RESEARCH DIVISION  
PLAN SHOWING DETAILS OF OBSERVATION TUBES  
FOR DRAINAGE SCHEME

SCALE 1" = 4'

## INLETS.

79. Wherever an open trench crosses a natural minor depression or where there is any possibility of water accumulating, inlets should be provided. Plate No. X shows a type design for a grass inlet.

Well grassed inlets have been found the most satisfactory type on the whole, being cheap in first cost and easy to maintain. The grass must however be given every chance to establish itself properly, otherwise it will be easily scoured, and if scour begins it must be set right at once.

Omission to make a good job of such inlets results in the depression cutting back into the fields and filling the open trench with good soil which has to be removed at comparatively great cost.

## STANDING WAVE FLUMES.

80. At the tail of each open trench, a standing wave flume should be constructed to enable the discharge to be measured and the effectiveness of the drains to be ascertained. This also applies to pipe drains, where feasible.

The discharge to be passed by a standing wave flume should be the normal discharge of the nala as ascertained previously by measurement, plus 0.50 cusec per 100 acres of waterlogged area or 0.25 cusec per 100 acres of salt affected areas. The standing wave flume should be designed for the nearest cusec discharge above the calculated amount (*vide* Plate No. XI). In all cases the height of the side walls should equal the calculated depth of water over the sill of the flume, no free board being left, so that during floods there will be as little obstruction as possible. The design should be such that the standing wave below the flume will not be drowned out.

## SUBARTESIAN BORES.

81. Subartesian bores should be constructed only where a very highly pervious stratum such as an old nala bed lies below; the bores should penetrate this stratum by not less than 6"; the bores should be of as great a diameter as possible compatible with economy and the size of post hole auger available.

Even if a bore is working well when new, its efficiency may be reduced by becoming choked up. The choking up of the bore is generally due to rubbish and to the filling up of the pores of the pervious substratum by a deposit of finely suspended silt. To prevent as far as possible the flood water coming into direct contact with the pervious stratum, the opening of the pipe should be closed with a perforated cap or plug which can be easily removed for cleaning occasionally. Plate No. XII shows the design adopted on the Kopergaon Drainage Scheme.

## FALLS.

82. Cement concrete falls of S.W.F.F. type (see Technical Papers Nos. 15 and 44) should be provided where the drop is over 2 feet and the strata not sufficiently hard to withstand scour.

## AQUEDUCTS OR SYPHONS.

83. Whenever an open trench is crossed by an irrigation channel for carrying water for irrigating areas lower down, an aqueduct or a syphon should be provided. For a distributary with a service road, a syphon combined with a ramp has proved satisfactory; but no type design has been evolved as there are always local factors to be considered in each case.

## OBSERVATION TUBES.

84. Observation tubes 3" in diameter, to observe the effect of a drainage scheme and to correlate water drained, damaged land reclaimed, increase of cultivation, rainfall, etc., year by year, should be fixed, penetrating the permeable substratum. They should be placed in the damaged areas affected by drains. The tubes should be at least 200 feet inside the boundary of the damaged area and 200 feet away from a drain. As far as possible they should be placed along S. No. boundaries to avoid damage by cultivation. The layout of a system of observation

tubes is illustrated diagrammatically in Plate No. XIII. The Government Central Workshops and Training Centre, Dapuri, have facilities for supplying the tubes cut to any length, with caps.

#### BEDSTONES.

85. Bedstones should be placed at every furlong length of an open trench and also at all changes of gradient and tangent points of curves. The top of the stone should be at the correct level of the bed of the drain to enable those in charge to clear silt and otherwise preserve the correct gradient by means of boning rods (usually required to be done immediately after each monsoon). It is usually convenient to make the bed stones in the form of a cement concrete slab cast *in situ* not less than 18 inches in length. The figure below, No. 24, shows the latest design which embodies an iron plate embedded in the concrete and standing out above the bank to facilitate finding them. It is however the duty of every rakhwadar to know the exact position of those hitherto constructed without the plates. The plates shown in the figure were originally used for block demarcation, but being no longer used, are surplus and available for the purpose from the Sub-divisional Officer, Kopargaon Research.

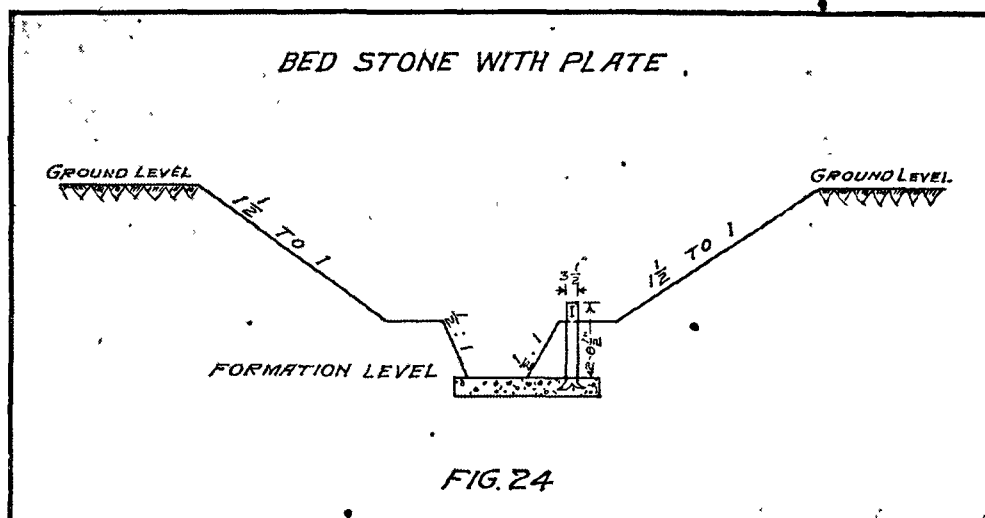

#### MILE STONES, FURLONG STONES AND BOUNDARY STONES.

86. Mile, boundary and furlong stones made of cement concrete, are as good as, and in general cheaper than, stone headers. They can be precast under proper supervision and adequately cured in a nala or the newly excavated trench and should not cost more than Re. 1-0-0 each, including carriage and fixing (except mile stones which may be about Rs. 3-8-0). Further economy may be effected by combining boundary and furlong stones, the Government arrow being cast in front and the figure denoting mile and furlong at the sides. Plate No. XIV shows the type design.

#### DESIGN OF PIPE LINES.

87. The first consideration in the design of a pipe drain is the size of the pipe. The anticipated discharge where irrigation is under the block system may be taken as 1 cusec per 250 acres of land suitable for perennial irrigation. In factory areas  $1\frac{1}{2}$  cusecs per 200 acres has been assumed. See also notes on next page.

The chart on Plate No. XV correlates Q, S, and diameter of pipe from the formula (Manning) :—

$$V = 138 R^{2/3} S^{1/2};$$

$$\text{and } Q = A V;$$

Where V is the mean velocity (ft. 1 sec.);

R is the hydraulic mean depth (ft.);

S is the gradient;

Q is the discharge (cusecs);

A is the area of the opening of the pipe (square feet).

The minimum desirable gradient for pipe drains is shown on Plate XV.

IRRIGATION RESEARCH DIVISION  
TYPE DESIGN FOR MILE STONES AND  
COMBINED BOUNDARY & FURLONG STONES  
FOR DRAINAGE SCHEMES

SCALE 1" = 1 INCH

MILE STONE OF  
CEMENT CONCRETE 4' X 1' X 9'

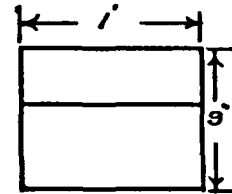

PLAN

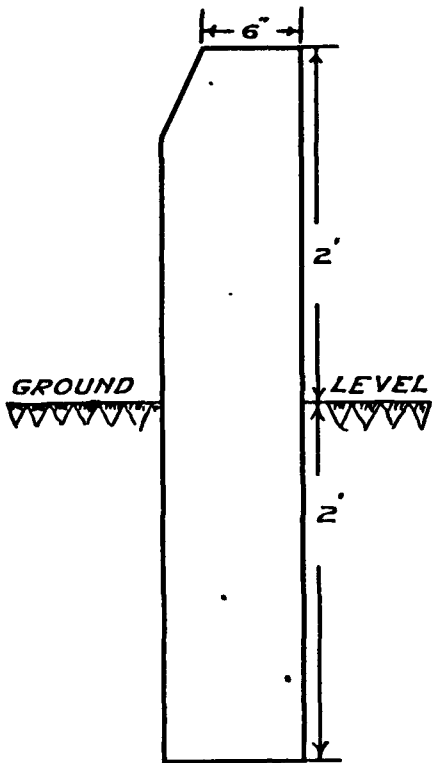

SIDE ELEVATION

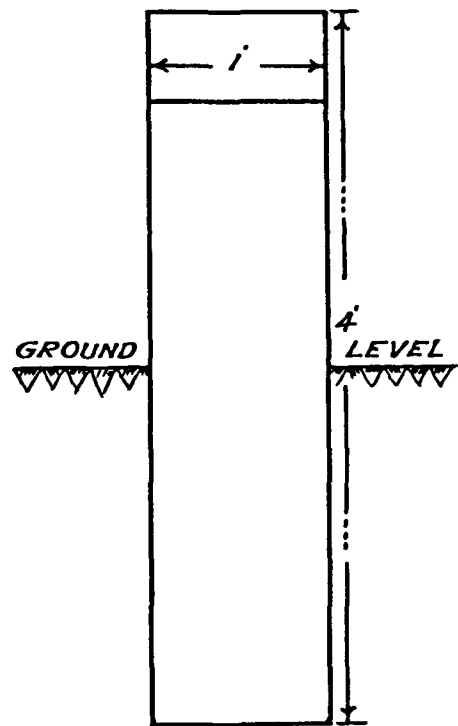

FRONT ELEVATION

COMBINED BOUNDARY AND  
FURLONG STONES  
OF CEMENT CONCRETE 2' X 8" X 8"

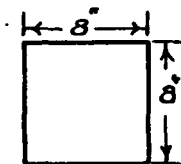

PLAN

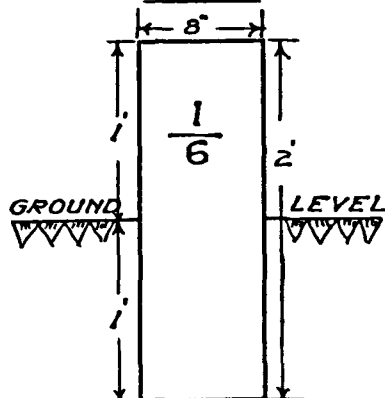

SIDE ELEVATION  
(WHERE REQUIRED)

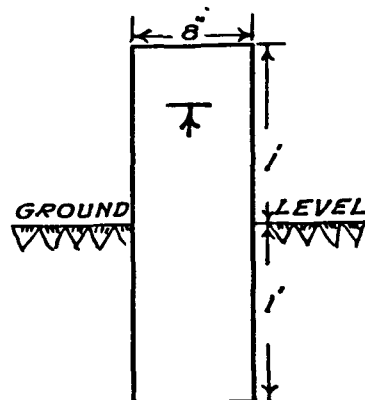

FRONT ELEVATION

IRRIGATION RESEARCH DIVISION  
DISCHARGES OF PIPE LINES (DRAINAGE)  
 FORMULA USED  $V = 138R^{3/5} S^{1/2}$

DIAMETER	R <sup>3/5</sup> FEET	AREA SQ FT
12"	0.397	0.785
9"	0.313	0.441
8"	0.295	0.342
6"	0.243	0.136
4"	0.187	0.087

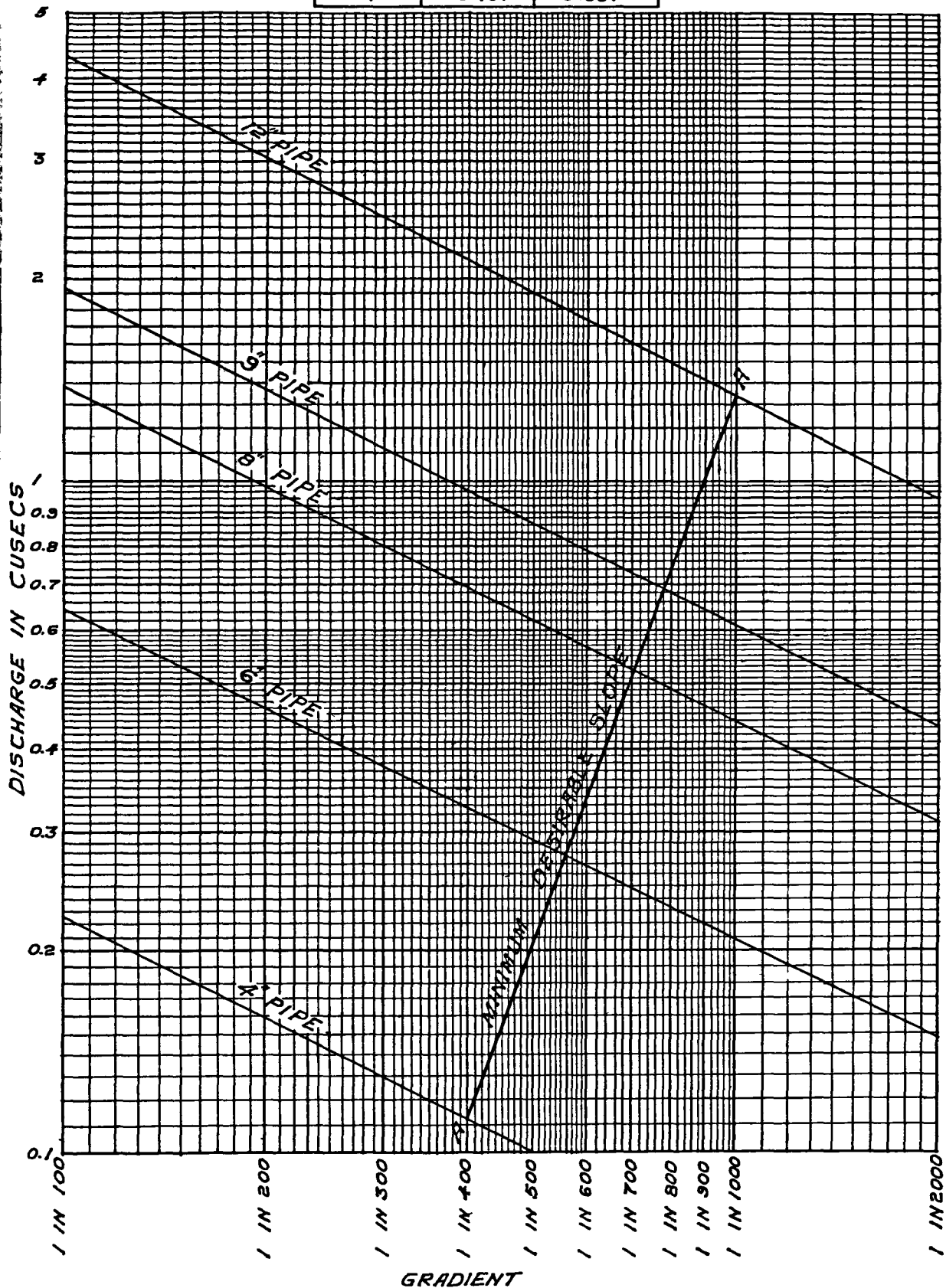

IRRIGATION RESEARCH DIVISION  
TYPE DESIGN OF MANHOLE FOR PIPE LINES  
FOR LAND DRAINAGE

SCALE: 2 FT = 1 INCH

DETAIL OF MANHOLE COVER

SCALE 1 FT = 1 INCH

PLAN AT TOP

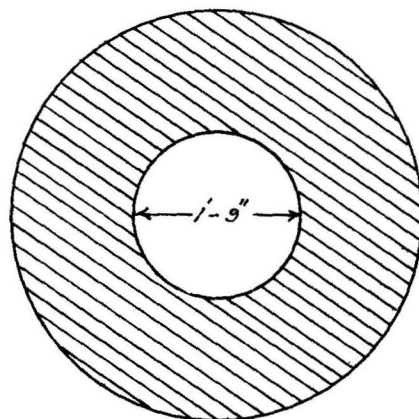

PLAN AT PIPE LINE LEVEL

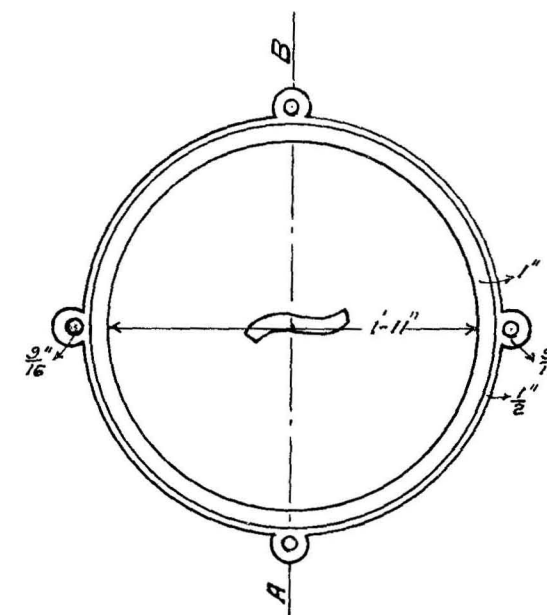
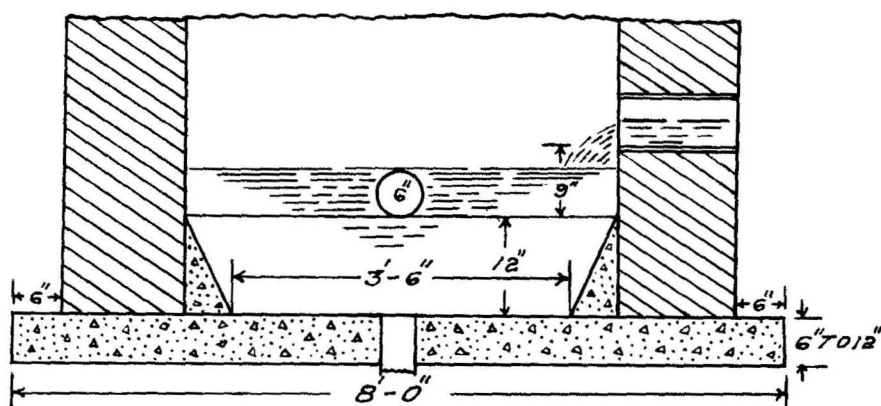
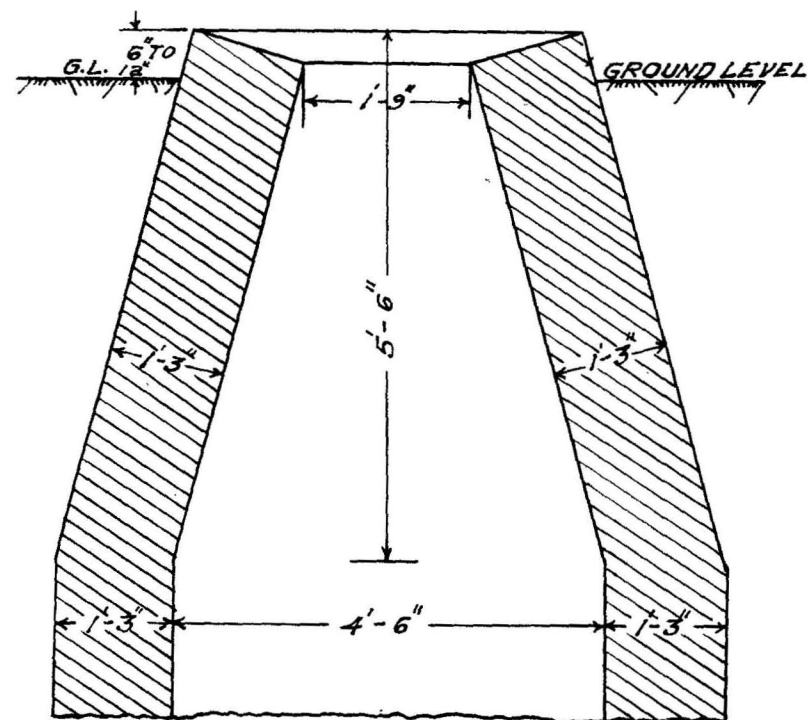
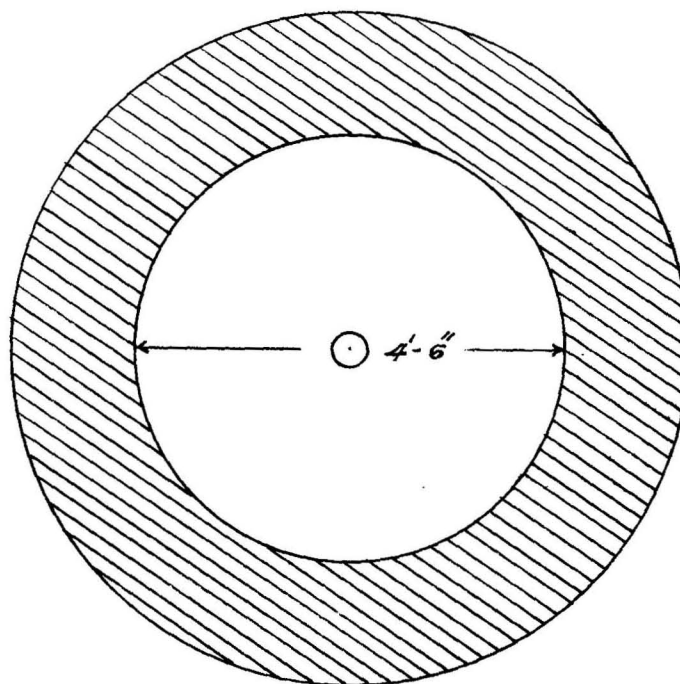

SECTION ON AB

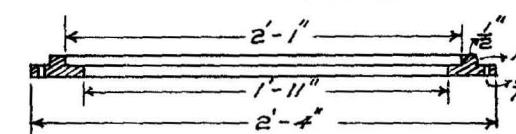

BOLTS REQUIRED 4 FOR EACH WITH 8 NUTS

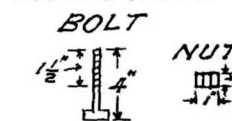

IRON STRAP THICKNESS 1/8"

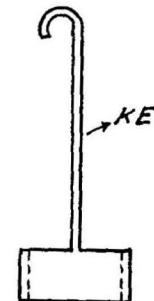
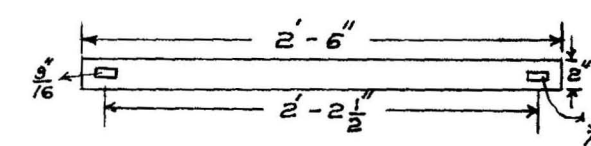

SECTIONAL VIEW OF MANHOLE WHEN REBATE FRAME AND MANHOLE COVER ARE FIXED IN MASONRY

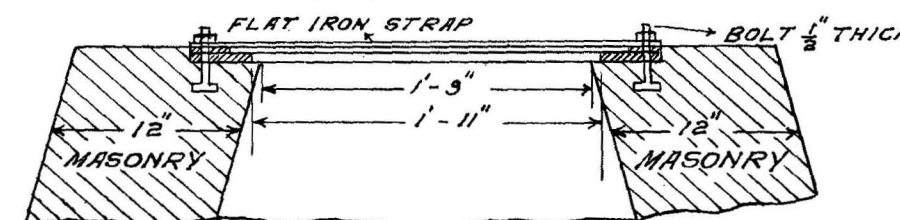

NOTE:-

BY REMOVING ONE NUT, THE STRAP CAN BE MOVED TO ONE SIDE AND THE COVER LIFTED. SPANNER AND KEY ONLY REQUIRED.

The formation line should be at least a foot below the level of F. S. F., as in the case of the open trenches. Figure 25 shows the type section of a pipe line. The pipes should be unglazed, plain pipes (Perfect Pottery Co. Jubbulpore have been found suitable) and they should be laid butting end to end, on a bed of not less than 6 inches clean coarse sand. Round the joints broken pieces of pipe should be placed to stop and or other material entering the drain.

Notes.—(i) The anticipated discharge due to percolation from fields and irrigation channels may be calculated on the above basis at any point of a Pipe line.

(ii) The discharge observed in a drain on the Baramati Experimental Salt area by percolation through prismoidal chopan was 0.25 cusec per mile; through massive kankar it was 1.00 cusec per mile, while the average was 0.50 cusec per mile of drain.

(iii) The observed nala discharge and evaporation from damaged areas may also be utilized by taking the existing discharge of the nala plus 0.50 cusec per 100 acres of waterlogged area plus 0.25 cusec per 100 acres of salt affected area, the total of the two being the anticipated discharge. The actual evaporation from the salt affected land at Baramati was found to be as much as 0.014 feet per day, the same as from a free water surface. This is equivalent to 0.7 cusec per 100 acres, but this is unusual.

Fig. 25.

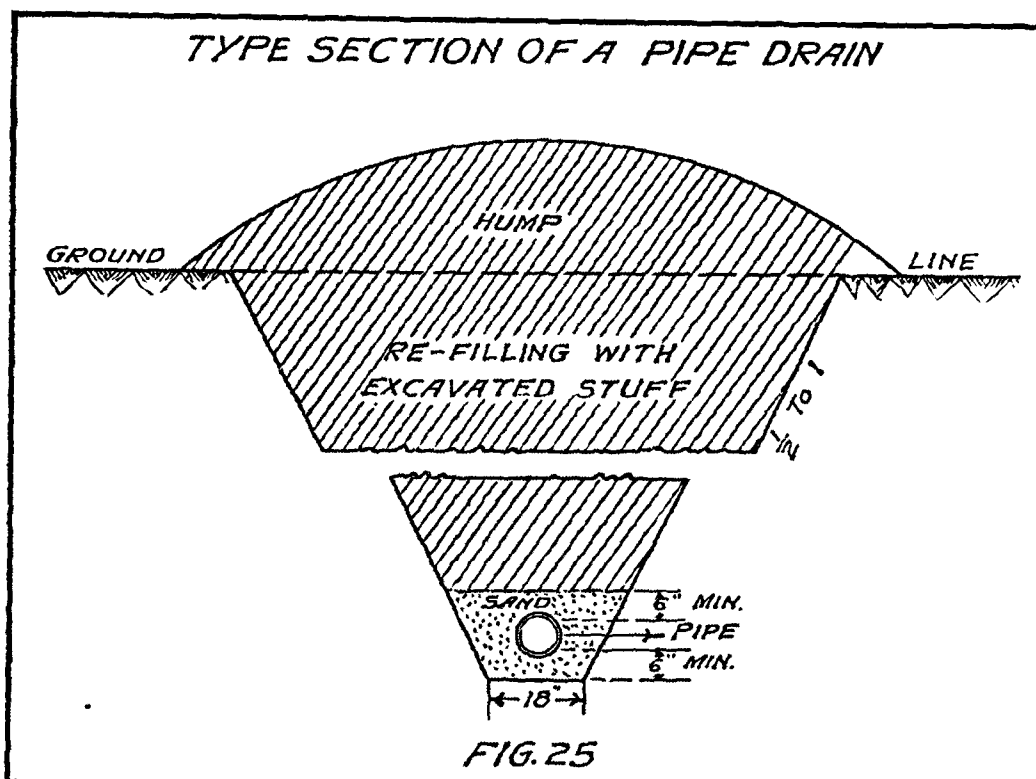

When a pipe line trench is dug the top foot of earth should be put on one side, and when refilling it should be placed on top again—because crops do not thrive in newly exposed sub-soil. The extra earth available when refilling is due to the natural expansion which occurs when compacted soil is broken up. For this reason the filling should allow for settlement. When a pipe drain passes beneath an irrigation channel, socketted glazed pipes with cement joints should be used, with no sand round them, and the replaced spoil should be well rammed for a length of 50 feet on each side of the channel to prevent percolation of the irrigation water directly into the drain.

#### MANHOLES.

88. Manholes should be placed at every change of direction and at every change of gradient, and in between at intervals of 600 feet—never greater. A fall of 6" should be allowed at every manhole. Plate No. XVI shows the type design for a brick manhole and the detail of the manhole cover and frame with the locking arrangement (obtainable from the Government Central Workshop and Training Centre, Dapuri).

#### PIPE OUTFALL.

89. At the junction of a pipe drain with an open trench, a drop of 12 inches minimum should be allowed above the bed of the open trench. Spigot and socket



pipes should be used here for a short distance, protected by concrete as shown in Plate No. XVII. The concrete should extend across the bed, to protect the other side of the open trench, and may be used as a bed stone if desirable.

#### HEADWALL.

90. At the end of an open trench, where a pipe line is to be used in continuation of the open drain, a headwall is necessary. Plate No. XVIII shows the type design. Grass pitching must be carefully attended to for protection upstream and downstream of the wall. Grassing of the ring bund upstream is most important, as otherwise cutting back by flood water will occur in the fields upstream, washing good soil into the open trench from which it will have to be removed at considerable cost. For coping stones, cement gauged lime mortar (1 : 8 cement to lime in the mortar) has been found suitable, and is much better and cheaper than Shahabad stone, especially at considerable distances from railway stations. Where there is the possibility of a second pipe line being required in the future, provision should be made by inserting pipes in the headwall at the time of construction taking care to lay them in the correct direction.

#### RUBBLE DRAINS.

91. Rubble drains have proved satisfactory and convenient where—

- (i) the length of drain required was not greater than 150 feet ;
- (ii) the expense of earthenware pipes was not justified ;
- (iii) the depth was not great ;
- (iv) it was possible to excavate into murum, mān, or other pervious material, to a depth of at least 12 inches.

They are comparatively cheap and can be used for short distances with good effect. They are not desirable in soil, because there is always the likelihood of their becoming choked even if carefully graded sand is laid round them.

On the Hol, Murum, Karanja Scheme, it was found to be a very cheap form of relief drain to small areas of waterlogging caused by an intervening ridge of rock.

Rubble drains which tap the murum noses have been successfully used on the Manjri Drainage Scheme as short subsidiaries to pipe drains.

The direction of rubble drains should be carefully marked after completion by means of stones on S. No. bands (cement concrete boundary stones with no figures are useful for the purpose).

Plate No. XIX shows the design adopted and the manhole built for the change from pipe to rubble drain.

---

## CHAPTER VI.

### Submission of the Project.

#### PLANS.

92. The following is the list of drawings required for a complete drainage project :—

- (1) General index plan, scale 2 inches to 1 mile showing general details.
- (2) An index plan, scale 2 inches to 1 mile showing areas damaged, likely to be damaged in absence of drainage, and areas to be reclaimed by drainage.
- (3) An index plan, 2 inches to 1 mile showing progressive increase of damage and increase of uncultivated area year by year.
- (4) Detailed plan, scale 660 feet to 1 inch (or 330' = 1 inch if there be too many details) showing complete sub-soil information.
- (5) Longitudinal Sections of Nalas :—  
Scale—Horizontal 660 feet = 1 inch.  
Vertical 10 feet = 1 inch.
- (6) Longitudinal sections of drains.

IRRIGATION RESEARCH DIVISION  
TYPE DESIGN FOR A CONCRETE OUTFALL  
FOR A PIPE LINE ENTERING AN OPEN TRENCH

SCALE 5' = 1"

PLAN

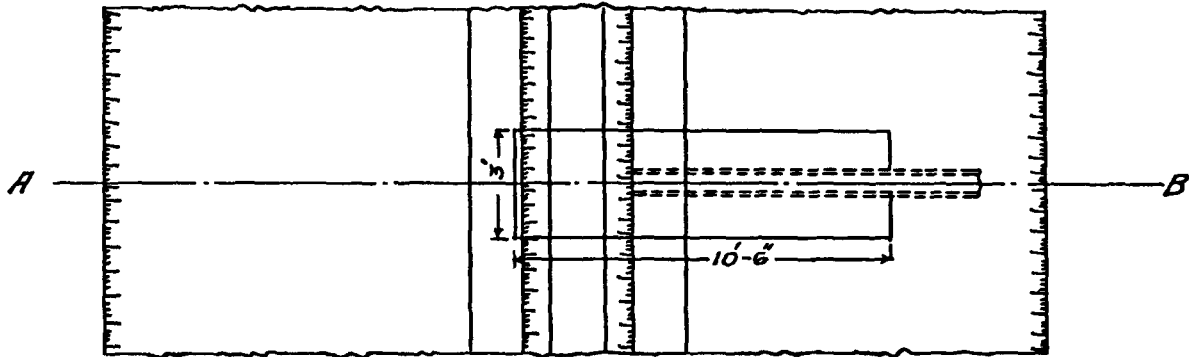

SECTION ON A.B.

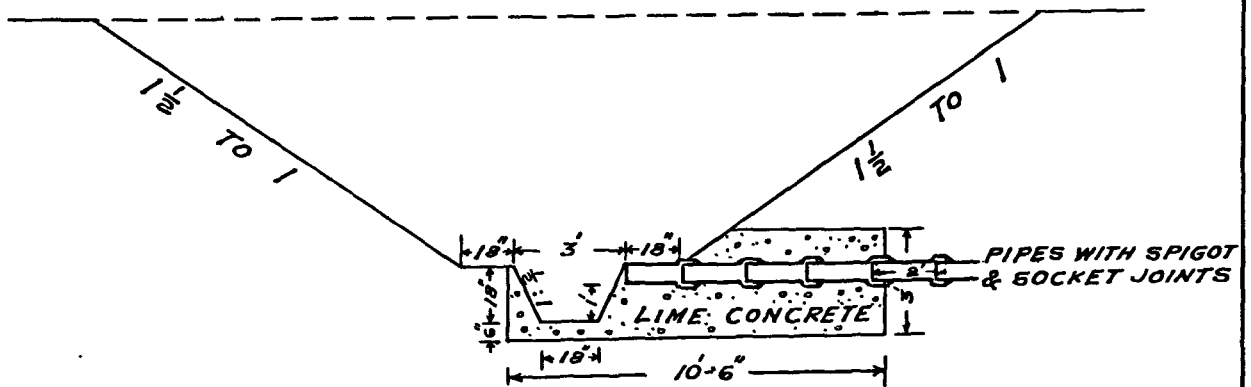

FRONT ELEVATION OF OUTFALL

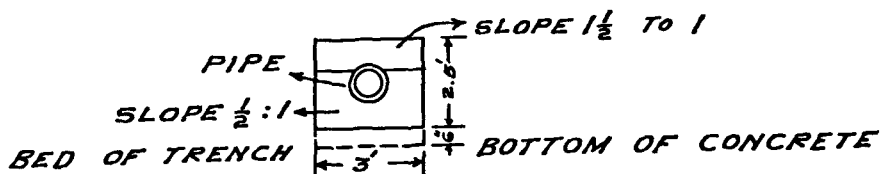

TYPE DESIGN FOR MASONRY HEAD WALL

SCALE 10' = 1"

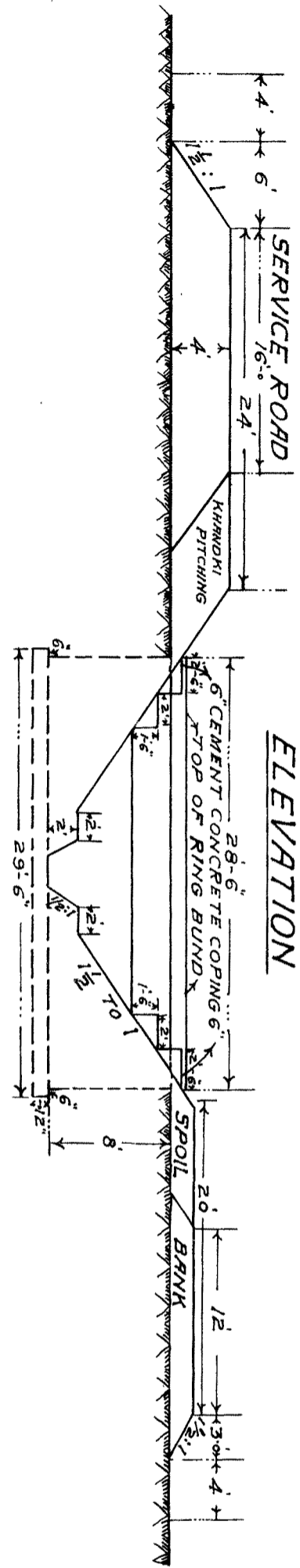

ELEVATION

PLAN AT TOP

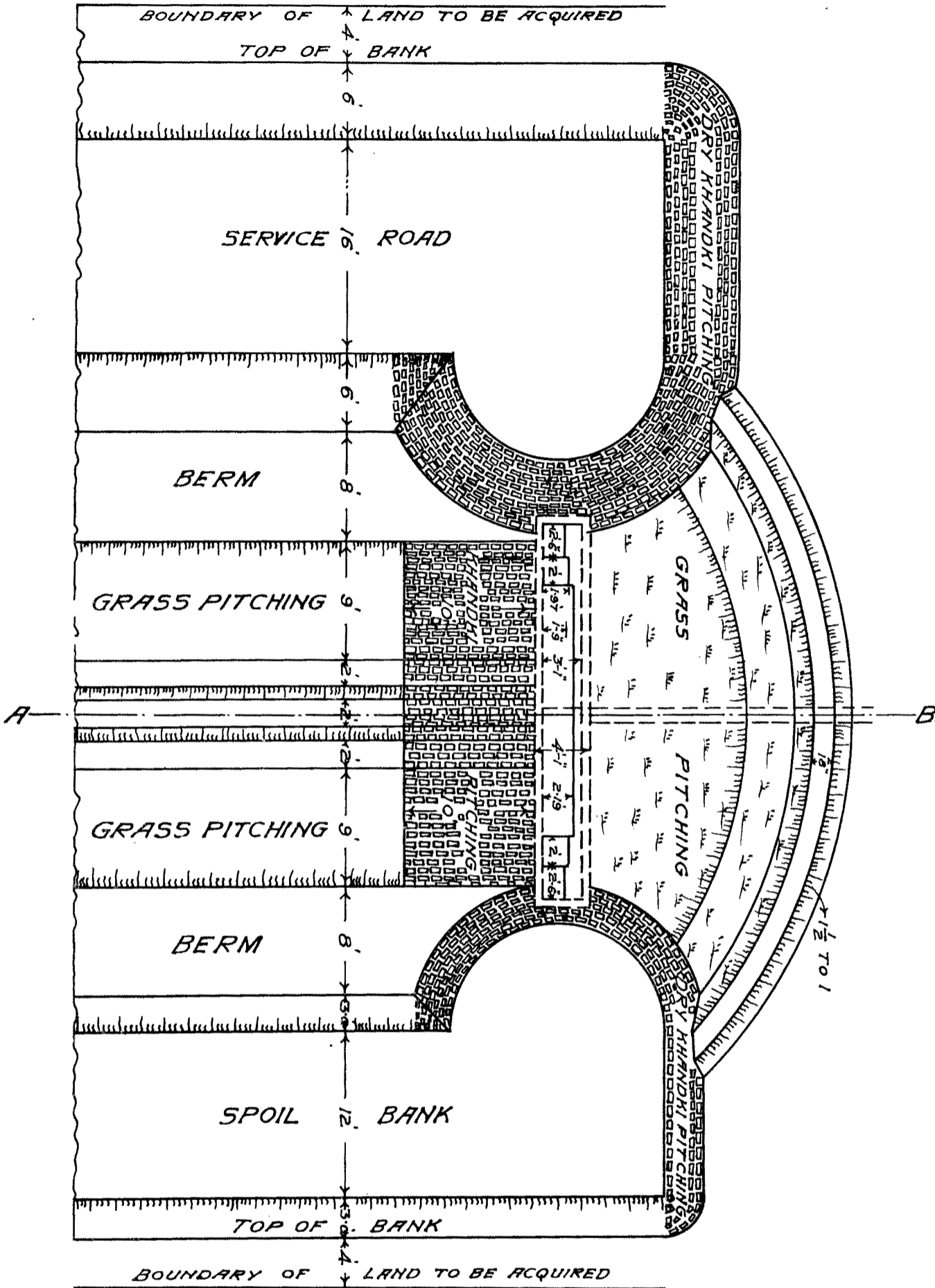

SECTION ON A.B.

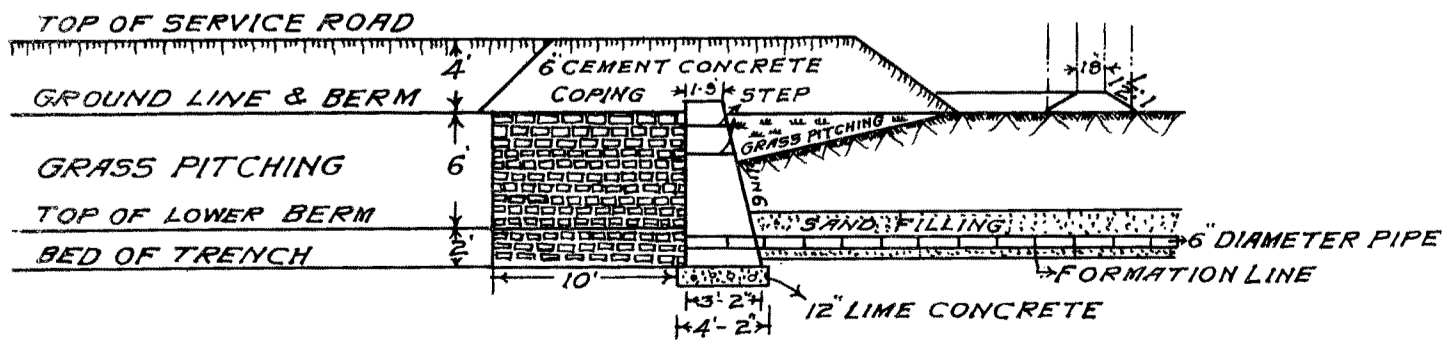

IRRIGATION RESEARCH DIVISION  
 TYPE DESIGN FOR A MASONRY CHAMBER  
 ON A RUBBLE DRAIN

SCALE: 2' = 1" INCH

SECTION ON CD

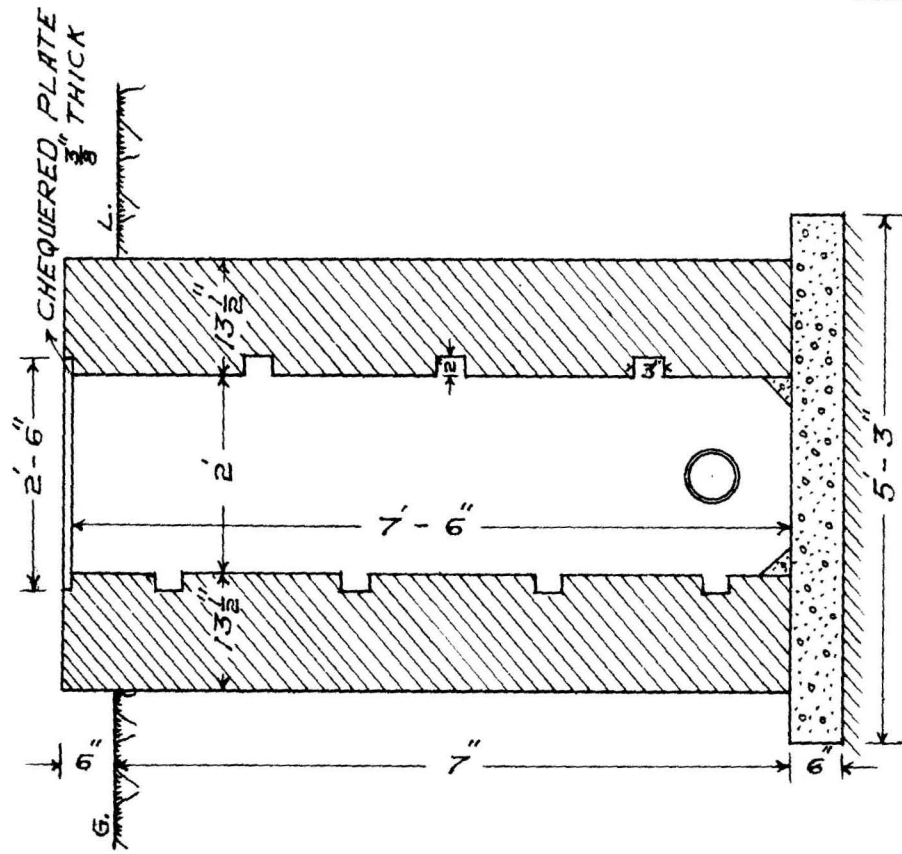

PLAN

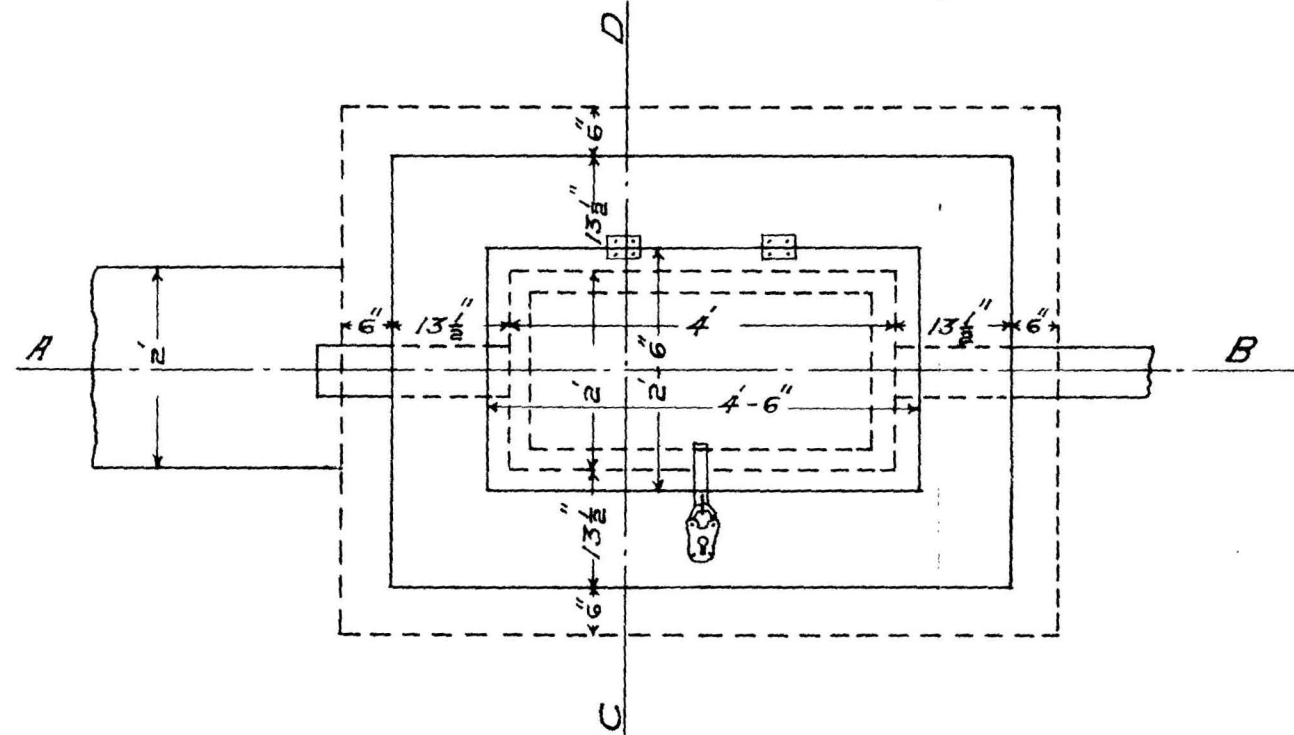

SECTION OF RUBBLE DRAIN

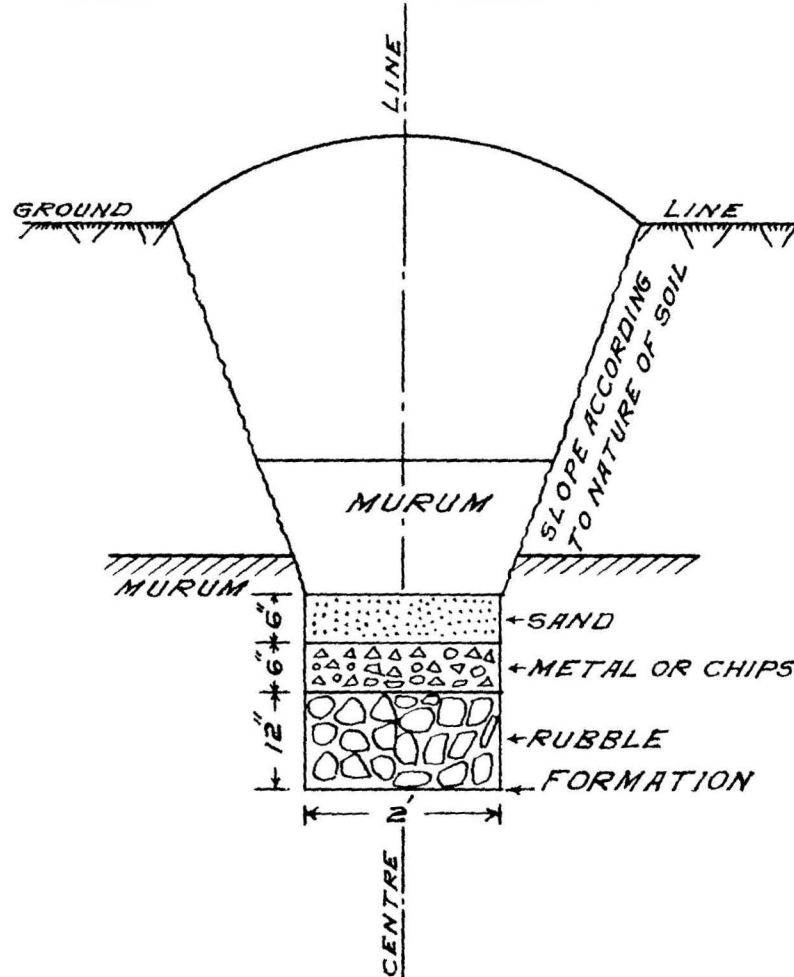

SECTION ON AB

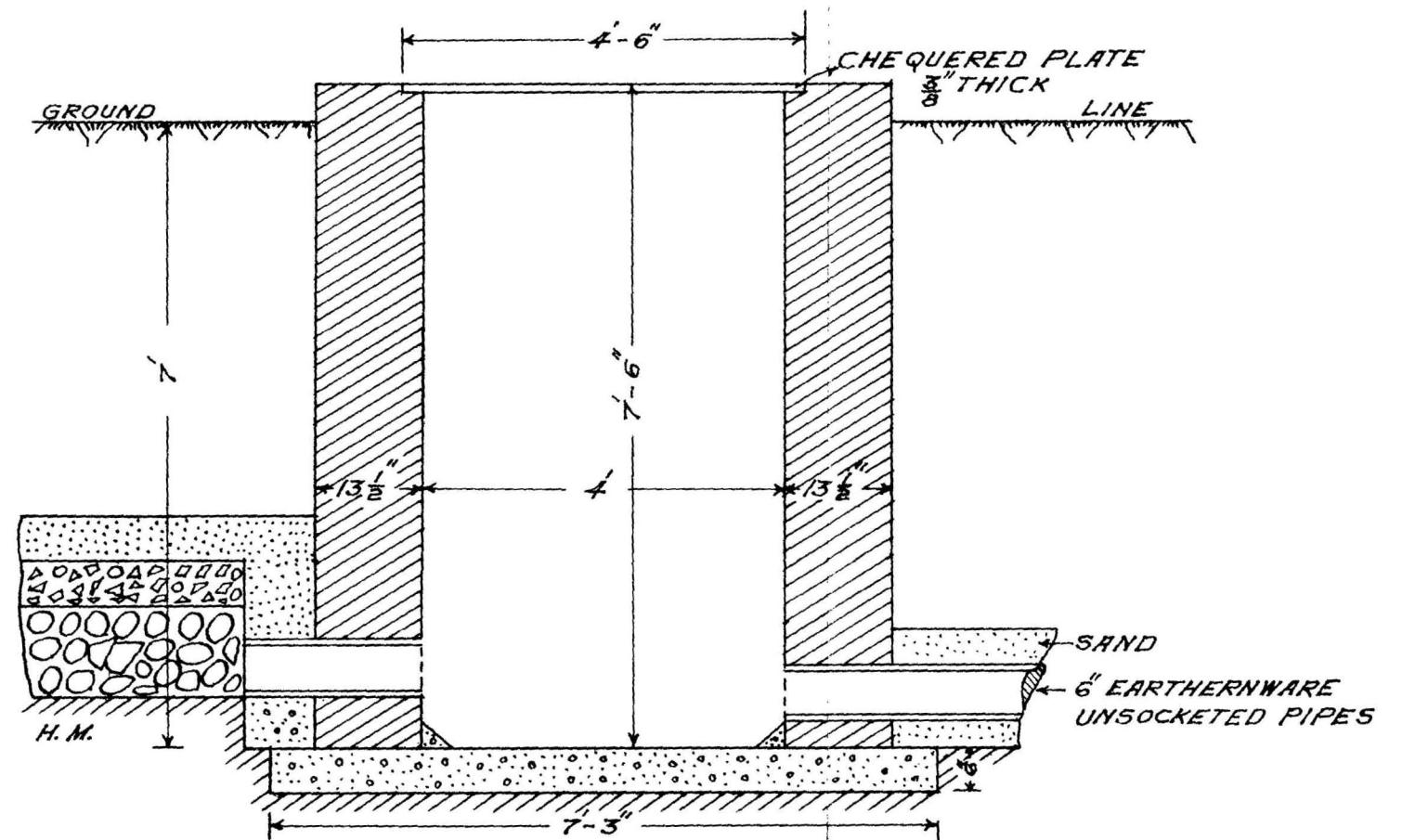

IRRIGATION RESEARCH DIVISION  
INDEX PLAN SHOWING LAND ABANDONED  
FOR CULTIVATION YEAR BY YEAR  
TYPICAL CASE

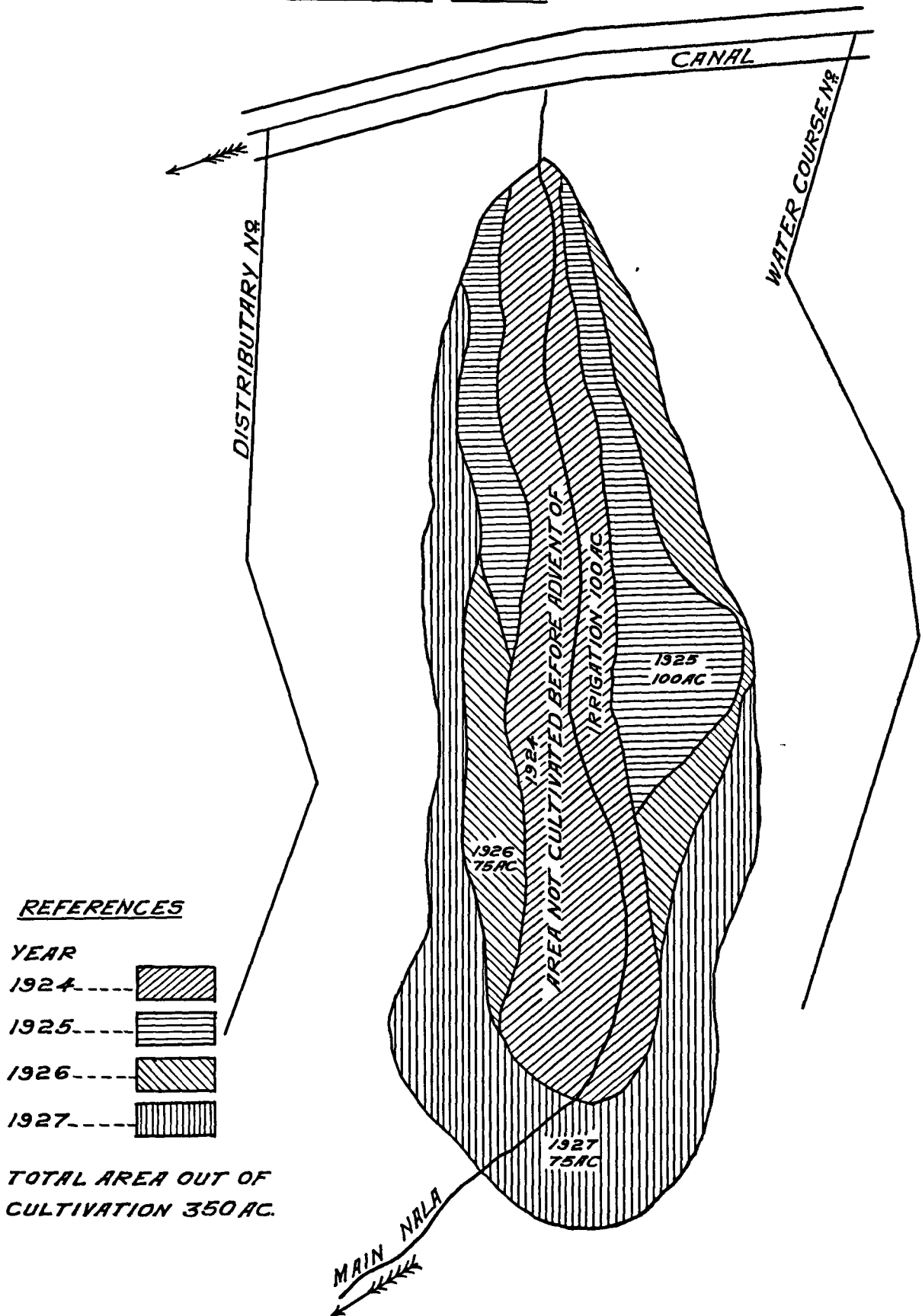

- (7) Cross sections of drains.
- (8) Plan showing sketches of all important points on drains and their location as recorded in Field Books.
- (9) Type designs of various works such as main open trench ; pipe lines ; ramps ; inlets ; standing wave flumes ; subartesian bores and rubble relief pits (if any) ; mile, furlong and boundary stones ; bed-stones ; manholes ; pipe outfall ; headwalls, etc.

#### GENERAL INDEX PLAN.

93. The general index plan should be on a scale of 2"=1 mile and should show the general details given on the detailed plan as far as possible but not damage and pit information.

#### INDEX PLAN SHOWING DAMAGE AND AREAS TO BE RECLAIMED.

94. To show the effect of a scheme clearly this index plan on a scale of 2 inches to 1 mile should show—

- (i) area damaged ;  
 (ii) areas that will be protected ; and  
 (iii) areas that will be reclaimed.

It should include canal, distributaries, main water courses, nalas and banks, proposed drains and areas (i), (ii) and (iii) above denoted by coloured borders as shown in Figure 26 :

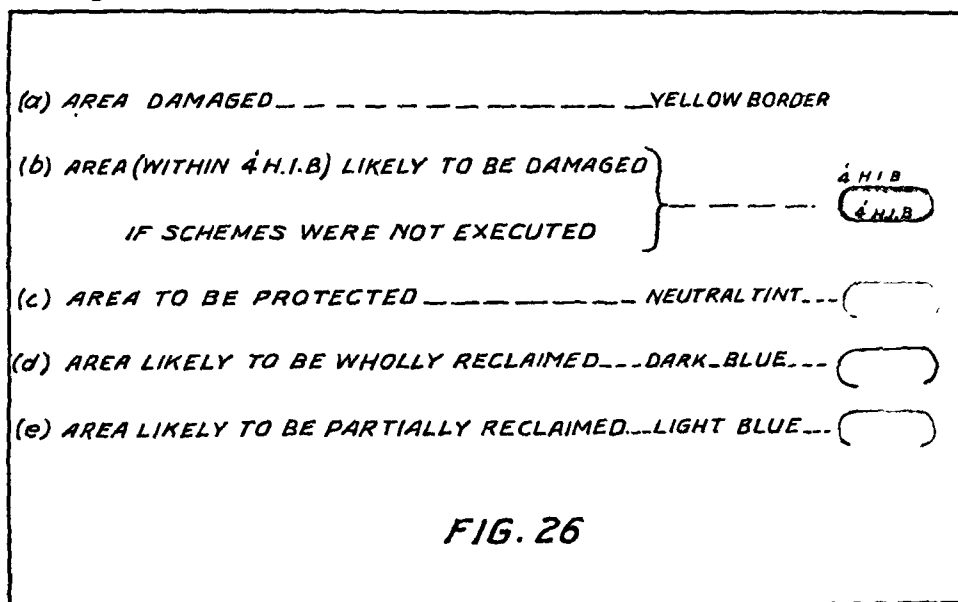

A table should be given on the map showing the acreage of these areas.

#### INDEX PLAN SHOWING PROGRESSIVE DAMAGE AND AREAS GOING OUT OF CULTIVATION.

95. With the project, a statement of S. Nos. which became uncultivable each year should be prepared, with an index plan showing these survey numbers and the appropriate year. Nothing but S. Nos., canal, nalas, distributaries and water courses should be shown.

The progress of damage should be indicated as shown in Plate No. XX. No standard colouring, shading, or hatching is necessary provided each year's area becoming uncultivable is quite distinct.

#### DETAILED PLAN.

96. The detailed plan of the main schemes should be on a scale of 660 feet to 1 inch (or 330 feet = 1" if necessary to avoid crowding of many details). It should show all topographical features already described.

In addition, it should show cross sections and lines of drains with complete information, M. I. B.s for 1 foot and 8 feet and H. I. B.s for 4 feet and 10 feet depth of S. S. W. L.

The open trenches should be indicated by double vermilion and the pipe drains by single vermilion lines.

Along drain alignments the following information should be given : ramps, bridges, inlets, standing wave flumes, falls, headwalls, manholes, etc. The correct chainage on the main drain should be given at the confluence of branch drains. The boundary of the catchment of each drain should be shown. The month and year of classification should be mentioned. The plan should also contain a complete reference table. The canal should be at the top and outfall at the bottom—and orientation of the area should be shown. Hatching to denote damaged area should be drawn on the plan after the pit work is completed to avoid confusion.

As the original plans will probably contain much information pertaining to alternative drains surveyed, great care should be taken, especially with regard to pit work, to omit unnecessary detail which may confuse.

The plan should give complete information of the proposed scheme.

#### LONGITUDINAL SECTIONS OF OPEN DRAINS.

97. The longitudinal sections of drains should be drawn to a horizontal scale of 660 feet to 1 inch and vertical scale of 10 feet to 1 inch. It should show continuous chainage from tail to head, ground levels, bed and bank levels—if in a nala, formation levels, depth of cutting, total depth of pits, nature and depth of strata (with correct colouring of various layers), line of F. S. F., line of F. W. L., S. Nos. and boundaries, names of villages and their boundaries, gradients, bed width and side slopes of open trenches or diameter of pipe lines, K/A values and dates of taking bores.

The direction of plotting of the longitudinal sections should be such that for the main drain, the flow is from left to right and for branch drains, from left or from right, as one were looking up the main valley (*vide* Figure No. 27 below).

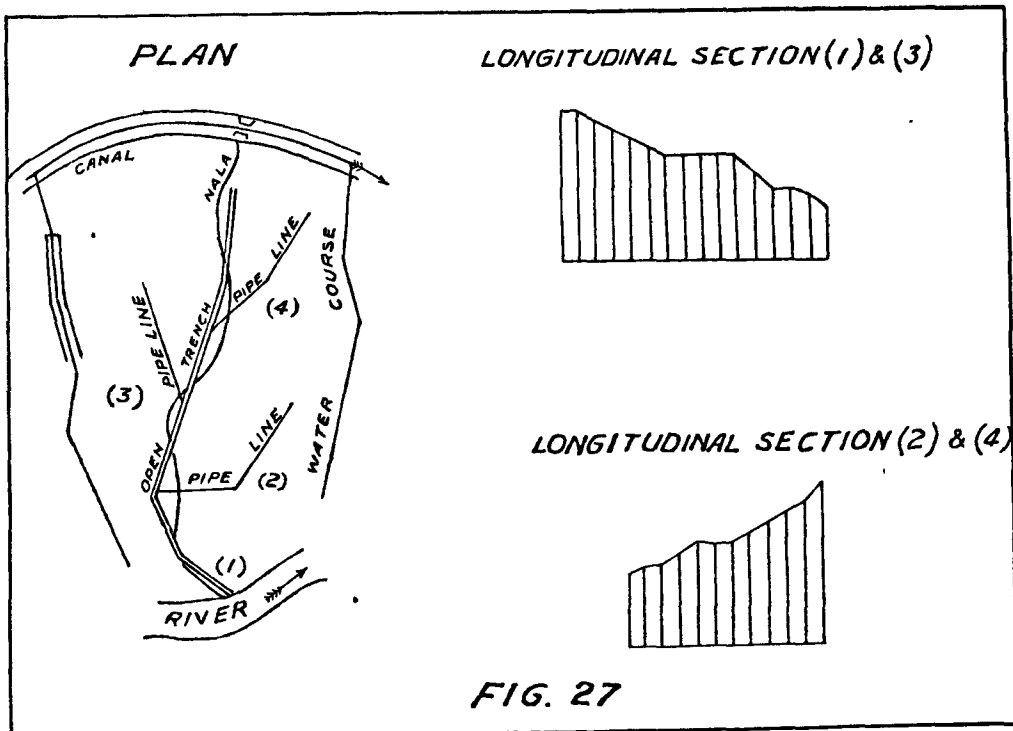

The following details should be noted on the longitudinal sections at the correct chainage :—

Apices, curves, junctions of drains, intersection with cross-section, falls, ramps, bridges, inlets, sub-artesian bores, rubble relief pits, standing wave flumes, headwalls and manholes for pipe drains. All numbering serially (for apices, ramps, etc.) should commence from the tail and continue towards the head.

The following information must always be given on the plan : field book and pit book No. and pages, name of the observer, subordinate, and tracer with dates.

#### CROSS SECTIONS.

98. These should be drawn to the same scale as the longitudinal sections and should show similar information in all respects.

Where information about a point, such as reduced levels, contours, H.I.B., M.I.B., formation line and levels of the proposed drain, S. No. boundaries, etc., is common to the detailed plan, to a longitudinal section and a cross section, it is necessary carefully to verify that the data given for that point is the same on each of the drawings on which it appears.

#### TYPE DESIGN.

99. Prints, preferably white, of miscellaneous type designs of masonry and other works in connection with all drains, may be submitted with the project as they are common to all schemes.

#### ESTIMATES FOR DRAINAGE PROJECTS.

100. The following statement gives the items ordinarily to be provided in an estimate with their approximate rates (1935). The list does not include every item which might be required. Items such as bridges, aqueducts, etc., are not typical and require special consideration of purely local factors and so are omitted. The rates given must, of course, be taken as a guide only, as they may vary in different localities :—

#### Schedule of Rates for Works on Drainage Schemes.

Serial No.	Items.	Rate.	Per	Remarks.
	<i>Open Trenches.</i>	Rs. a. p.		
1	Preliminary Survey for working drawings, setting out work etc.	100 0 0	Mile.	
2	Diversion of nala water, cutting pankanis, babul trees and removing stumps.	Lump	....	Up to Rs. 300 per mile.
3	Excavation of trench in soil, soft murum and lime kankar in percolating water.	1 8 0	100 Cft.	Less in many localities.
4	Excavation of hard murum in percolating water ..	2 8 0	100 Cft.	
5	Excavation in hard rock ..	10 0 0	100 Cft.	
6	Dressing banks for service road or path ..	5 0 0	100 Rft.	
7	Grass planting on side slopes ..	Lump	....	Rs. 50 to 120 per furlong depending on depth to be grassed.
8	Grass inlets .. ..	Lump	....	Rs. 30 per furlong.
9	Cement concrete ramp .. ..	Lump	....	Rs. 350.
10	Boundary stones, Mile stones, Furlong stones ..	Lump	....	
11	Bed stones .. ..	32 0 0	Mile.	
12	Alce fencing .. ..	50 0 0	Mile.	
13	Maintenance during construction .. ..	Lump	....	Rs. 250 per mile per annum.
14	Observation tubes .. ..	80 0 0	Mile.	
15	Standing Wave Flumes .. ..	100 0 0	Each.	
16	Land acquisition .. ..	Local rates.	Acre.	
17	Measuring land and preparing land plans ..	0 12 0	Acre.	
	<i>Pipe Lines.</i>			
1	Preliminary Survey for working drawings, setting out work etc.	100	Mile.	
2	Diversion of nala water, cutting pankanis, babul trees and removing stumps.	Lump	....	Up to Rs. 300 per mile.
3	Excavation of trench in soil, soft murum and lime kankar in percolating water.	1 8 0	100 Cft.	Less in many localities.



Serial No.	Items.	Rate.	Per	Remarks.
	<i>Pipe Lines—contd.</i>	Rs. a. p.		
4	Excavation in hard murum in percolating water ..	2 8 0	100 Cft.	
5	Excavation in hard rock ..	10 0 0	100 Cft.	
6	Pipes —			
	6" diameter ..	35 0 0	} 100 Rft.	Subject to fluctuation.
	8" diameter ..	71 0 0		
	9" diameter ..	85 0 0		
7	Collecting sand ..	Local rates	100 Cft.	Depending on lead.
8	Filling in sand and laying pipes ..	3 2 0	100 Rft.	
9	Refilling trench ..	0 6 0	100 Cft.	
10	Outfall of concrete ..	90 0 0	Each.	
11	Headwall—			
	4' headwall ..	123 0 0	} Each.	
	5' headwall ..	152 0 0		
	6' headwall ..	198 0 0		
	7' headwall ..	251 0 0		
	8' headwall ..	313 0 0		
12	Observation tubes ..	80 0 0	Mile.	
13	Maintenance during construction ..	Lump	....	Say Rs. 150 per mile per annum.
14	Brick masonry manholes ..	Lump	....	Up to Rs. 163 each.

INFORMATION REQUIRED WHILE PREPARING THE PROJECT.

101. The following data will be required for preparing the project :—

- (1) Suitability statement.
- (2) Statement giving for each drain the following information :—
  - (i) Catchment area of the drain ;
  - (ii) Area not suitable for perennial irrigation such as N. P. C. (not properly commanded) area, exposed murum, exposed chopan, hard murum, coarse soils, areas within quarter mile limit of village sites, etc. ;
  - (iii) Protected area suitable for perennial irrigation ;
  - (iv) Area of soil deeper than 8 feet ;
  - (v) Area between the 4 feet and 8 feet M. I. Bs. ;
  - (vi) Area of soils less than 4 feet in depth suitable for perennial irrigation of cane.
- (3) Statement correlating the damaged areas, cane areas, areas within 4 feet H. I. Bs. and rainfall, year by year.
- (4) Statement of land to be acquired with the present assessment.
- (5) Statement giving well observations year by year.
- (6) Statement of—
  - (a) Nala discharges in various years and seasons,
  - (b) Water-way allowed in the existing bridges and culverts,
  - (c) Anticipated discharges for trenches and for pipe lines with calculations.
- (7) Statement of important points recorded in Field Books fixing the alignment of all drains.

A Note, giving the following information, is desirable from the aspect of soil physics :—

- (1) History of the area to be drained, with Notes on the continuous, or otherwise, use of wells, etc.,
  - (i) previous to canal irrigation,
  - (ii) previous to the area being damaged, and of damage,
  - (iii) under existing conditions of damage.

Mention should be made of the kinds of crops grown, etc., as found in the crop registers maintained by village officers.

- (2) Physical condition of the land bordering on the spoilt area, from the aspect of future increase in damage if the area be not drained.

- (3) Salt content and pH values of damaged lands.
- (4) Nature and area of damage in various soil types.
- (5) Probable valuation of the spoilt area with reference to its pre-canal value and in its present deteriorated condition, supported by extracts of sales and rentals for the last five years, if available.
- (6) Suitability of damaged lands for various kinds of crops, its probable valuation and rentals after reclamation, and
- (7) Conductivity and pH value of the drainage water, whether fit for pazar irrigation or not.

#### REPORT ON THE PROJECT.

102. A comprehensive report on the project, to include the following points, should then be compiled for submission with the project.

- (1) Situation in the canal tract ; market and transport facilities (both by rail and road).
- (2) Natural drainage ; features of the banks, heights, slopes, strata exposed, nature and position of obstructions etc., discrepancies between the survey for the project and current village maps, if any.
- (3) Features of the area protected ; extent of exposed murum, coarse and shallow soils, chopan black soils, position of kar ridges, if any, M.I.Bs., H.I.Bs.; catchments and " X " classification of each ; pre and post-canal crops.
- (4) Kind, and extent, of damage for the various years ; comparison thereof with area to be protected.
- (5) Rainfall for 10 years.
- (6) Cane areas in the catchment year by year ; areas of past, present and future cane blocks, etc.
- (7) Consideration of water levels in wells year by year, wells going out of use, salinity of well water, increase or decrease of area within the H.I.Bs.
- (8) History of the scheme.
- (9) Nala discharges, recuperation values, and anticipated discharges of drains.
- (10) Detailed proposals of the scheme.
- (11) Possibility of pazar irrigation.
- (12) Estimated cost, and
- (13) Financial aspect of the scheme.

---

### PART III.

#### CONSTRUCTION.

#### CHAPTER VII.

##### Preliminaries.

103. At the outset of construction it is necessary to realise fully that drains are not straightforward works like others in connection with irrigation, because the whole of the survey and preparation thereof has dealt with under ground conditions. These conditions vary with time ; and especially when a considerable period of time elapses between survey and construction, they may change to a very great extent. Nakas may silt up to a depth of three or four feet in a few years ; the catchment to be drained may have dried out considerably due to natural staunching of a canal and its distributaries ; or due to a decrease in cane area and *vice versa* ; what may have appeared to be good soil when surveyed may be found to be almost entirely denuded leaving exposed chopan after a few years ; such changes can only be properly considered by close attention to detail when preparing working drawings. With greater detail, more data will be available, in fact it is safe to say that on the average little more than half of the designs, alignments, gradients, and other features, as executed will be the same as those of the original project.

## LAND ACQUISITION.

104. The first thing after orders to commence construction have been received is to acquire the necessary land. As this invariably takes time, the plans and statements should be prepared immediately.

The land to be acquired is that necessary for the drainage works proper. Land for open trenches must be acquired outright. For pipe lines, the land is not required provided the owner (and lessee, if any) agrees to allow the construction of the drain. This they seldom refuse knowing the advantage of drainage. A form of stamped agreement is in use, whereby the owner agrees to allow construction, to permit future repairs and agrees not to plant trees within 100 feet of the drain. Where an owner will not sign such an agreement the land must be acquired.

The valuation by specially trained personnel of the Irrigation Research Division has already been mentioned in paragraph 73 *ante* in connection with the estimates. It is desirable, now that the construction stage has been reached, to explain the matter in greater detail, and because a fresh joint valuation with the revenue authorities has to be made before acquisition proceedings commence.

## LAND VALUATION.

105. The land to be acquired for drainage schemes in the Deccan is mostly damaged. Sometimes, though rarely, good lands have also to be acquired. Where damaged land has fallen out of cultivation such damage is almost always permanent till after the land is drained. Hence the value of such land, to all intents and purposes, remains constant for the period from the time of preparation of a drainage project to the date of notification under section 4 (I) of the Land Acquisition Act for construction.

The only use to which such damaged land can be put is small amount of grazing for cattle and goats. As the basic principle involved is to estimate as accurately as possible the return from the land at the time when the valuation is made, the primary consideration is therefore the probable extent of grazing that can be obtained from the land, and this depends mainly upon the nature and extent of the damage.

The values given below, which are intended as a guide only, are worked out on this basis :

Extent of grazing.	Alternative types and extent of damage.			Approximate valuation per acre.
	Extent of waterlogging.	Extent of salt.	Nature of land if out up.	
Good grazing ..	Fully or partially water-logged— $W_0$	....	....	Rs. 50 to Rs. 60 per acre.
Moderate grazing ..	Fully or partially water-logged— $W_1$	Slightly salt— $S_1$	Uneven— $C_1$	Rs. 40 to Rs. 50 per acre.
Poor grazing ..	Fully or partially water-logged— $W_1$	Patches of salt— $S_2$	Slightly cut up— $C_2$	Rs. 30 to Rs. 40 per acre.
No grazing ..	Nala bed with bul-rush— $W_2$	Thick salt— $S_3$	Badly cut up— $C_3$	Rs. 20 to Rs. 30 per acre.

Information regarding the extent of grazing and the nature and extent of damage should be obtained by actual inspection. Acquisition of good land for drainage schemes is rarely necessary ; and the valuation of good land in irrigated tracts differs essentially from that of non-irrigated land. The following information is required for arriving at the correct valuation for such land—

- (1) Suitability of lands for perennial, two seasonal or seasonal irrigation from the point of view of soils and sub-soils, including drainage facility.
- (2) Position of the lands with regard to the quarter mile limit from village sites, and consequent prohibition of perennial irrigation in these limits.
- (3) Facility or otherwise for irrigation water due to its being at the head or tail of a canal or an irrigation channel etc.
- (4) Sales and rentals for the previous five years as officially recorded.

Hence the first step when construction is ordered is to make a fresh valuation, which should be based on that obtained for estimating purposes and on the subsequent data which has been collected during the intervening period. This up to date valuation should then form the basis of the acquisition proceedings. If this valuation is not made at the time of notification under Section 4 and used as an approximate basis for the final award, there is a possibility of great divergence in estimated and actual rates paid, and consequently excess over the estimate. This actually occurred on the Hol, Murum, Karanja Drainage Scheme where the awards were made long after work had been completed and the lands improved.

Neither the estimated valuation nor this preliminary valuation at the time of notification under Section 4 (1) are legally binding on the Land Acquisition Officer who frames the awards. But it may be emphasised that the valuation made for the final award should not differ substantially from the former valuation unless some factors have been brought to light which operated prior to notification viz. changed the value of the land after the estimate valuation and before that made at the time of notification under Section 4 (1). The value of the land to be awarded is that at the time of notification under Section 4 (1) and any improvement of the land thereafter due to commencement of drainage works should not affect the value in any way.

Government have ordered that all rates of assessments and land compensation must invariably have been confirmed as accepted by the responsible revenue official who is the Collector of the District and no one subordinate to him, before such rates are incorporated in any estimate to be submitted to Government. A further development of this was enacted by arranging that the preliminary valuation just before notification under Section 4 (1) should be a joint valuation with the revenue authorities. This procedure has been entirely satisfactory as regards valuation and has also speeded up the acquisition proceedings generally.

#### LAND ACQUISITION PROCEEDINGS.

106. When the preliminary (joint) valuation is complete, the 300 feet wide strip of land within which the drain is to be aligned should be notified under Section 4 (1). After the alignment is definitely decided—by approval of the working drawings—, that portion of the strip which is to be acquired outright should be notified under Section 6 and the remainder should be withdrawn. Withdrawal is however not always desirable immediately and it may be better to await the submission of the completion reports before doing so in some cases.

After notification under Section 4 (1) of the Act has been published in the *Bombay Government Gazette* and a public notice has been issued by the Collector concerned,—

“ It shall be lawful for any officer, either generally or specially authorised by such Government in this behalf, and for his servants and workmen

“ to enter upon and survey and take levels of any land in such locality ;

“ to dig or bore into the sub-soil ;

“ to do all other acts necessary to ascertain whether the land is adapted for such purposes ;

“ to set out the boundaries of the land proposed to be taken and the intended line of the work (if any) proposed to be made thereon ;

“ to mark such levels, boundaries and line by placing marks and cutting trenches, and

“ where otherwise the survey cannot be completed and the levels taken and the boundaries and line marked, to cut down and clear away a part of any standing crop, fence or jungle ;

“ provided that no person shall enter into any building or upon any enclosed court or garden attached to a dwelling house (unless with the consent of the occupier thereof) without previously giving such occupier at least 7 days notice in writing of his intention to do so.”

Under the third item above, it is stated that workmen may dig or bore into the sub-soil. There is still some slight misapprehension whether this entitles Government to commence the excavation of an open trench duly approved according to

the working drawings or not. Generally however no difficulty arises because cultivators are only too glad to see the commencement and rapid progress of work. To be on the safe side, actual construction should not be commenced until the working drawings have been approved and notification under section 6 of the Act has been made.

Hand in hand with the preliminary valuation for notification under section 4 (1), working drawings can generally be commenced because practically no owner would object to the survey work. When it is desirable to start excavation with the least possible delay (working drawings having been approved), agreements from owners are necessary if the notification under section 4 (1) has not issued, but it is preferable to avoid this procedure if possible. Occasionally an owner remains obstinate in which case it is better to acquire compulsorily under section 9, as the extra payment required is usually small compared with the stoppage of progress indefinitely, especially if the land in question be near the tail of a longer carrier drain.

#### NECESSITY FOR WORKING DRAWINGS.

107. The survey work for a drainage project pertains mainly to sub-soil conditions. It is therefore inevitable that however accurate the original survey work for the preparation of a project may have been, a new survey at the time of construction will be required. The chief reasons for this are that damage may have increased or decreased in the meantime and that our knowledge of drainage may have increased both theoretically and practically. The work done afresh will be embodied in the working plans and should be as up to date and accurate as possible.

There are other reasons for preparing working plans. Nalas in which open trenches have been proposed may be found to have silted up very considerably at the time of construction. Conversely, open trenches through fields may disclose that the land has been denuded. Both conditions may entail quite different alignments and gradients from those sanctioned with the project originally. It is frequently necessary to observe the results of drains already constructed before sound conclusions can be reached as to what other drains will be ultimately required. It is also most desirable for the subordinate in charge of the work to have plans showing accurately alignment, gradient, etc. and the exact position of all subsidiary works. Hence the first works should be so planned as to form an integral part of the complete system with necessary provisions for future extensions and additions. After a main open trench has been excavated, it may be found that some of the sanctioned branch drains are unnecessary. Elsewhere, additional drainage may be required. All such matters are to be decided at the time of preparing working plans and before execution is taken in hand.

If the working drawings of any particular drain disclose any excess in cost of more than 5 per cent. over the sanctioned estimate, the matter should be investigated.

#### WORKING DRAWINGS.

108. The working drawings for a drainage scheme comprise the following :—

- (1) One plan 660' = 1".
- (2) Two plans 100' = 1", including 12 chains on each.
- (3) Longitudinal Section 100' = 1" horizontal, and 10' = 1" vertical.
- (4) Subsidiary works.

(2) and (3) should be combined whenever possible.

This provides for about half a mile of drain being submitted at a time, as if extended to allow of plans for one mile, there is the risk of progress being delayed.

The index plan (1) should show all existing information according to the project plans and all corrections and additional data. M.I.B.s should be amplified where necessary, a new set of K/A values embodied thereon, and the exact layout of observation tubes shown.

The detailed plan (2) should show the above information in the vicinity of the proposed drain. All data necessary—for locating apexes, curves, service roads

and spoil banks ; land to be acquired ; mile, furlong, boundary and bedstones ; subsidiary works of all kinds including ramps, inlets, flumes, subartesian bores, falls, irrigation channel crossings, head-walls, manholes, changes of gradient ;— must be shown accurately. The line must be surveyed for this purpose. Where, based on these plans and data, deviations in alignment are necessary, the sanctioned line should be shown dotted, and the new proposals in pencil, pending the Executive Engineer's approval. It is of advantage to include a table of temporary B.M.s if possible, giving their location and value.

The longitudinal section (3) is best shown on the above detail plan if possible. It should mainly be an amplification of the project plan with additional intermediate pit results, and all similar data for any proposed deviation therefrom.

109. For subsidiary works there are type designs. It is therefore convenient to supply the Sub-divisional Officer preparing working drawings with white prints of all type designs, upon which he can show in red ink such modifications according to the levels he will have to obtain, as are required. These modified designs are then to be approved by the Executive Engineer and tracings issued for the actual work. The type designs show the general principle upon which such works are to be constructed. No deviations from such principles should be allowed without the special approval of the Executive Engineer, and these only after careful consideration seeing the designs are the result of many years' experience.

Estimates in accordance with the working drawings will be required when there is any substantial deviation from the project estimate, or where the cost is likely to be  $\pm$  more than 5 per cent. of the sanctioned estimate. Estimates for subsidiary works should always be prepared in order to compare with the sanctioned provision which is generally a lump sum.

A note should be submitted with the drawings pointing out deviations proposed and the pros and cons for the change.

No additions to, extensions to, or deviations from, working drawings should be allowed during construction as they form the basis of the record drawings to be prepared after completion. Where some alteration, however, slight, is considered necessary, the Sub-divisional Officer should obtain the Executive Engineer's prior approval. It is particularly undesirable that so-called improvements or facilities in the shape of cattle drinking ramps, bathing ghats, temporary crossings of a semi-permanent nature, etc., should be wangled out of savings on a drain or a subsidiary work, as there is almost always some other improvement or extension to a drain of much greater value which would be preferable.

#### OBSERVATIONS TO BE RECORDED PREVIOUS TO AND DURING CONSTRUCTION.

110. (1) Photographs of damaged areas may be taken at selected points (which must be exactly recorded) to compare conditions before, during, and after construction. The photographs should be described suitably.

(2) Observation tubes should be fixed at the earliest opportunity and S.S.W. L.s should be observed monthly from the start of work, during construction, and continued after construction. The frequency of observations after construction may gradually be reduced in (say) 3 years to one in each of the months, November, February and May.

(3) Weekly observations of nala discharges should be made below the point on the outfall where work is to commence, six months before starting, during construction, and after completion of the drains.

(4) In addition, the discharge of each section of work above and below branches should be ascertained by means of a portable standing wave flume to observe the progressive effect of individual drains.

(5) Notes should be recorded on observations of any springs or heavy percolation entering drains, places where soil is lacking in cohesion and may result in slips of the banks, and other special factors.

#### SALINITY OF DRAINAGE WATER AND SOIL IMPROVEMENT.

Samples of water should be taken from selected places on drains and from wells once yearly. They should be sent to the Irrigation Research Division for test to ascertain the salt content.

A plan of the damaged areas (wherever possible, supported by figures of analysis of soil and water samples) should be prepared every year, showing :—

- (a) Area under cultivation with annual valuation of the crop grown.
- (b) Areas ploughed up with a view to cultivation in the following year.
- (c) Areas which show partial improvements.
- (d) Observations about weeds and other rank vegetation in the damaged areas.

These two matters pertain to the soil physical work of the Irrigation Research Division who should be referred to for expert advice or assistance.

#### FORM OF CONTRACT.

111. While land acquisition proceedings and the preparation of working drawings are in progress, it is desirable to call for tenders so that work can be started on the ground as soon as the notification under section 4 (1) and that by the Collector of the District have issued. There are special orders with regard to the form of contract on which drainage works in the Deccan should be carried out. On account of liability to deviations during construction, the possibility of omitting some drains and requiring additional ones, and other unforeseen changes which might be necessary because of the project being based on sub-soil data, it was considered that no form of contract involving specific quantities, specific materials, or a specific time for completion, would be justifiable either on behalf of the contractor or the staff supervising the work. Hence tenders on K2 form have been approved by Government as a special case ; they specify rates for work done only.

#### SPECIFICATIONS.

112. The organization for the excavation of a drain is not as simple as that of a large distributary where labour can be employed anywhere throughout its length. Most main open trenches have to be dug in percolating, if not flowing water, for they are generally though not always near the natural nala. Work can only be commenced from the outfall and continued up the valley. Pipe drains present the same difficulty for the formation level is generally below the line of F. S. F. The following specifications which were in force in the Irrigation Research Division have been designed to cover the difficulties and to prevent the execution of inferior work.

##### *Specifications for Open Trenches.*

1. The trench shall be excavated to the designed depth, gradient, side slopes and alignment, as set out by the Sub-divisional Officer or an Officer deputed by him.

2. The trench shall be excavated from the lower end upwards so that all percolating water will be drained away naturally. No claim from the contractor for bailing out or diverting water will be entertained.

3. Work shall not proceed in lengths of more than 400 feet without special written authority from the Executive Engineer, Irrigation Research Division. The contractor should arrange his labour so that the gangs working in the upper and drier portions do not complete their work before those working the lower and wetter portions. As soon as one chain or suitable length of trench at the lower end is complete in all respects to the satisfaction of the Sub-divisional Officer, or officer deputed by him, the fact will be recorded in the works Order Book and one new chain or equivalent length at the upper end will be set out and work allowed thereon (this fact also, with details, being recorded in the Order Book).

4. The contractor must maintain at his cost 300 feet length of completed trench immediately below the work, free from silt, spoil or other material which may be washed down from the contractor's work in progress, or from any other obstruction.

5. All excavated materials shall be placed so as to provide a berm of at least 8 feet width from the edge of the cutting at natural ground level, and so as to form spoil banks or a service road according to a profile to be set out by the Sub-divisional Officer or Officer deputed by him.

6. The height of spoil bank or service road shall not exceed 4 feet at any place and where likely to do so, the contractor must carry the spoil to places directed by the Sub-divisional Officer where the height of the bank or road will be less than 4 feet. Dressing of these banks will be paid for according to rates to be tendered for heights above or below 2 feet.

7. Hard material, muram, and sand, excavated from the trenches shall be stacked as directed by the Sub-divisional Officer for spreading on the spoil bank to be used as a service road. The double handling entailed by this spreading will be paid for separately provided that the materials have been stacked as directed.

8. The edge of the roadway so formed is to be kept parallel to the edge of the cutting as far as possible and is to be in straight lengths of not less than one furlong or as set out.

9. Masonry works such as ramps, falls, manholes, etc. shall be constructed according to type design with any necessary modifications approved by the Executive Engineer.

10. Measurements for open trenches will normally be taken for completed lengths of not less than 50 feet.

11. A length of trench shall be considered as completed after the trench has been excavated to correct gradient depths, and widths, as specified or set out after the side slopes have been neatly trimmed, after service roads or spoil banks have been dressed to the heights and widths specified or set out, and provided 300 feet length downstream of the work is free from obstruction (*vide* item 5 above). Payment will not be made for any length of trench until so completed except at the rate for incomplete work.

12. In the event of a tender being cancelled, incomplete work will be paid for at a rate not exceeding annas 12 per 100 cubic feet of the excavation done and depending on the amount necessary for completion.

13. Sight rails, templates, and boning rods will be supplied by Government.

14. The contractor should visit the work on at least 3 days in every 10 days. If a contractor cannot be present on work daily the name of the person appointed by the contractor as his agent and who is authorised by him to take instructions regarding the work and to execute them accordingly from time to time must be intimated in writing as soon as work commences. Such agent appointed by the contractor must be present on the work every day. If such agent be found unsuitable, the contractor may be required to replace him.

15. All instructions written by the Sub-divisional Officer or Officer deputed by him in the Order Book must be signed by the contractor or his agent as soon as possible.

16. The contractor shall not sublet any portion of his contract and if he does so, his tender will be liable to cancellation. This however does not apply to agreements made by the contractor with petty piece-workers.

#### *Explanatory Notes.*

*Item 2.*—The contractor's responsibility for bailing out and diverting water has been included in order to ensure that he does such work of this nature as may be reasonably expected and does not later put in excessive claims under this head. Actually the rates tendered are cut so fine that no contractor can be expected to make any profit if all such work be done by him, and it has been customary to make main diversions of flowing nalas, and to pump out water departmentally.

*Item 3.*—This is very important and originated where a contractor had been allowed to work on more than one mile of open trench. The result was that he did the work in the dry, cancelled his tender, and left the wet excavation entirely drawing the full rate.

*Item 4.*—Originally a contractor was expected to maintain in good repair the whole length of an open trench during construction. This meant when (say) one mile out of two had been finished, that a gang of men had to be kept permanently for the purpose. It was found that the tendered rates were not sufficient for the purpose, so only a short length is now to be maintained, the maintenance and repairs during construction being provided in the estimates.



*Item 9.*—These works are included in the general specifications, although it has always been the practice to carry them out quite independently of the main excavation work. It is also better to keep a gang specially for these works which can be trained to look for unexpected factors arising.

*Items 10 and 11.*—These form the corollary to item 3.

*Item 12.*—This was intended to ensure that a contractor leaving the work in an incomplete state was not paid the full rate for work in percolating water. Since this was introduced, it has been found that contractors wishing to cancel tenders generally complete their section in order to be paid the full rate.

*Item 14.*—The reason for this clause was that the work being underground, factors arise requiring immediate orders. There must therefore be some representative on the work continuously.

*Item 16.*—This clause is essential.

The items for which tenders are invited are listed below :—

#### *Open Trenches.*

- (1) Excavation in dry soil.
- (2) Excavation in dry hard murum.
- (3) Excavation in soil chopan, lime kankar, soft murum and soft mān in percolating water.
- (4) Excavation in hard mān in percolating water.
- (5) Excavation in hard murum in percolating water.
- (6) Excavation in hard murum and boulders in percolating water.
- (7) Excavation in soft rock in percolating water.
- (8) Excavation in hard rock in percolating water.
- (9) Dressing spoil bank or service road where height is greater than 2 feet.
- (10) Dressing spoil bank or service road where height is less than 2 feet.

*Note.*—For items 1 to 8 (inclusive) :

- (i) The above rates shall include lead up to 200 feet and all lift.
- (ii) The above rates shall include all bailing out and diversion of water where necessary.

#### *Specifications for Pipe Lines.*

1. The pipes shall be laid to the approved design, levels, measurements, and alignment, as set out by the Sub-divisional Officer or Officer deputed by him.

2. The pipes shall be laid end on, abutting against each other with as little intervening space as possible. Where necessary the pipe joints shall be surrounded with broken pieces of pipe or other material as ordered and supplied at the site of work by the Sub-divisional Officer. The pipes shall be laid on a bed of sand which shall in no case be less than six inches in depth. The pipes shall also be covered with sand to a depth to be ordered by the Sub-divisional Officer which shall in no case be less than 6 inches.

3. The rate for laying shall include the lift and lead of all materials at the site of the work. Where Government agency is employed to bring materials to the site of the work, the words "the site of the work" shall be understood to mean anywhere within 200 feet distance of the place where the materials are required.

4. The sand used for bedding and covering the pipes shall be clean coarse river sand and shall be obtained from a source approved by the Sub-divisional Officer in writing.

5. The rate for excavation shall include the cost of shoring wherever necessary. Excavation of the trench does not generally necessitate a flatter batter than  $\frac{1}{2}$  to 1 and work done on flatter batters than  $\frac{1}{2}$  to 1 will not be paid for. The excavation will be paid for on a depth basis, the quantity being worked out on the assumption that the side batters are  $\frac{1}{2}$  to 1 and bed width according to the approved design.

6. No claim for bailing out water or extra excavation due to slips from any cause whatever will be allowed. The rate should make allowance for any such contingency.

7. The trenches are to be refilled properly and all spoil replaced over the trench in the form of a hump, in order to allow for subsequent settlement, unevenness of the ground, and to form a path for inspection. Measurements for refilling will be calculated on the quantity of excavation paid for. The work will not be considered complete until this has been done.

8. Masonry works such as ramps, falls, manholes, etc., shall be constructed according to type design with any necessary modifications approved by the Executive Engineer.

9. Work will not be allowed in stretches of more than 200 feet at one time. After a portion of this 200 feet length from the lower end is completed, passed by the Sub-divisional Officer or the Officer deputed by him and recorded in the order book, and then refilled, an equivalent length will be set out and work allowed to be started thereon at the upper end (this also being recorded in the order book with details).

10. The work will be considered as complete only when the refilling of the trench is complete (*vide* item 7 above) and the whole pipe line between two manholes is flowing freely without heading up at the upper manhole, which would indicate distortion or uneven laying of the pipes. In the case of any such fault, the defective portion must be set right by the contractor at his own expense before the final payment for the pipe line is made.

11. Sight rails, templates and boning rods will be provided by Government.

12. The contractor should visit the work on 3 days in every 10 days. If the contractor cannot be present on work daily the name of the person appointed by the contractor as his agent and who is authorised by him to take instructions regarding the work and to execute them accordingly from time to time must be intimated in writing as soon as work commences. Such agent appointed by the contractor must be present on the work every day. If such agent be found unsuitable, the contractor may be required to replace him.

13. All instructions written by the Sub-divisional Officer or Officer deputed by him in the Order Book must be signed by the contractor or his agent as soon as possible.

14. The contractor shall not sublet any portion of his contract and if he does so, his tender will be liable to cancellation. This however does not apply to agreements made by the contractor with petty pieceworkers.

The reasons for framing these specifications are similar to those concerning open trenches with necessary modifications added. The items for which tenders are invited are listed below :—

*Pipe Line.*

- (1) Excavation in dry soil.
- (2) Excavation in dry hard murum.
- (3) Excavation in soil chopan, lime kankar, soft murum and soft mān in percolating water.
- (4) Excavation in hard mān in percolating water.
- (5) Excavation in hard murum in percolating water.
- (6) Excavation in hard murum and boulders in percolating water.
- (7) Excavation in soft rock in percolating water.
- (8) Excavation in hard rock in percolating water.
- (9) Collecting sand, lead up to.....miles.
- (10) Filling in sand and laying pipes.
- (11) Refilling trench with the excavated material.

*Note.*—Items 1 to 8 inclusive :

- (i) } As for open trenches.  
(ii) }

*Specifications for Rubble Drains.*

1. The rubble stone, quarry chips, and metal used shall be hard, durable and tough. The size of rubble used shall in no case be less than 4" in any direction and that of metal or chips such as will be retained on a  $1\frac{1}{2}$ " screen. The sand used for covering the chips shall be clean coarse river sand and shall be obtained from a source approved by the Sub-divisional Officer in writing.

2. The rubble shall be laid to the approved design, levels, measurements, and alignment, as set out by the Sub-divisional Officer, or Officer deputed by him.

3. The rubble shall be laid to a minimum depth of 12" on a properly prepared bed which shall in no case be less than two feet in width. The rubble shall be covered with metal or quarry chips to a depth to be ordered by the Sub-divisional Officer, followed by a layer of sand to a similar depth. Such depth shall in no case be less than six inches for metal or chips and 6" for sand.

4. The rate for laying rubble, metal or chips, and sand, shall include the lift and lead of all materials at the site of the work. Where Government agency is employed to bring materials to the site of the work, the words "the site of the work" shall be understood to mean anywhere within 200 feet distance of the place where the materials are required. The work of laying rubble shall not be commenced before the formation level is checked by the subordinate in charge and passed by him in writing in the order book.

5. The rate for excavation shall include the cost of shoring wherever found necessary. Excavation of the trench does not generally necessitate a flatter batter than  $\frac{1}{2}$  to 1 in soil, and vertical in murum, and work done on flatter batters than those mentioned will not be paid for. The excavation will be paid for on a depth basis, the quantity being worked out on the assumption that the side batters are  $\frac{1}{2}$  to 1 for soil, and vertical for murum, and bed width according to the approved design. The excavated murum must be heaped quite separately so as not to mix it with excavated soil.

6. No claim for bailing out water or extra excavation due to slips from any cause whatever will be allowed. The rate should make allowance for any such contingency.

7. The trenches are to be refilled properly with murum just above the sand, and soil above; all remaining spoil is to be replaced in and over the trench in the form of a hump, in order to allow for subsequent settlement, unevenness of the ground, and to form a path for inspection.

8. Measurements for refilling will be calculated on the quantity of excavation paid for. The work will not be considered complete until this has been done.

9. Masonry works such as ramps, falls, manholes, etc., shall be constructed according to type design with any necessary modifications, approved by the Executive Engineer.

10. Work will not be allowed in stretches of more than 200 feet at one time. After a portion of this 200 feet length from the lower end is completed, passed by the Sub-divisional Officer or the Officer deputed by him and recorded in the order book, and then refilled, an equivalent length will be set out and work allowed to be started thereon at the upper end (this also being recorded in the order book with details).

11. Sight rails, templates and boning rods will be provided by Government.

12. The work will be considered as complete only when the refilling of the trench is complete (*vide* item 7 above) and the whole drain is flowing freely. In the case of any fault, the defective portion must be set right by the contractor at his own expense before the final payment for the drain is made.

13. The contractor should visit the work on 3 days in every 10 days. If the contractor cannot be present on work daily the name of the person appointed by the contractor as his agent and who is authorised by him to take instructions regarding the work and to execute them accordingly from time to time must be intimated in writing as soon as work commences. Such agent appointed by the contractor must be present on the work every day. If such agent be found unsuitable, the contractor may be required to replace him.

14. All instructions written by the Sub-divisional Officer or Officer deputed by him in the order book must be signed by the contractor or his agent as soon as possible.

15. The contractor shall not sublet any portion of his contract and if he does so, his tender will be liable to cancellation. This however does not apply to agreement made by the contractor with petty pieceworkers.

These need no comment being mainly a repetition of the previous specifications. The list of tendered items follows :—

*Items for Rubble Drains.*

- (1 to 8) As in the case of Open Trench.
- (9) Supplying rubble at quarry.
- (10) Lead for above.
- (11) Metal at quarry.
- (12) Lead for above.
- (13) Chips at quarry.
- (14) Lead for above.
- (15) Collecting sand leadup to . . . miles.
- (16) Filling rubble.
- (17) Filling chips.
- (18) Filling sand.
- (19) Refilling trench with excavated material.

It is not advisable to depart from the specifications without very careful consideration, specially if relaxation be the intention. On the other hand, further experience will probably indicate the need for improvement in some respects.

WORKING FACES.

113. Where a drainage scheme depends on one main open trench, there is only one working face on which work can be started, that is, the outfall. In exceptional cases, outfall conditions of a branch drain may permit of starting work at the same time. As a rule therefore tenders are called for the main open trench and such pipe lines as are directly connected thereto. Where a branch open trench joins the main drain further up forming with its own branches a small subsidiary scheme, it is sometimes desirable to call for separate tenders and a different contractor. But in any case, no branch drain (except such as have suitable outfall which will not interfere with work below) should be commenced until the junction of it and the main (carrier) drain has been reached. Hence as the work progresses more working faces and greater progress may be expected.

WORK NOT TO BE RUSHED.

114. The work should not be hurried unnecessarily. It has been found from experience that Rs. 20,000 can be conveniently expended on a main open trench and its branches in a year under one subordinate (though the preparation of all working drawings by that same subordinate is almost too much).

In spite of experienced subordinates, great care is necessary throughout as far as design and programme are concerned, and special steps have to be taken to ensure punctuality of labour and progress reports so that allotments can be spent in spite of deviations which may be necessary. But on the subject of allotments it should be impressed on all concerned that expenditure of the full allotment is not an essential factor of construction. It is preferable, in fact, to allow funds to lapse rather than spend money on a drain which is not going to be really useful—if the latest time for surrenders has passed.

CHAPTER. VIII.

Construction.

MACHINERY *versus* MANUAL LABOUR.

115. Drains of all types may be excavated by hand or by machinery. The essence of successful machinery in any sphere is continuous running at the maximum designed capacity, and with such facilities it is likely to be the cheapest

form of excavation. Deccan conditions do not however provide such facilities. Formation level is as a rule below hard strata, which would have to be finished by hand; the work would be done so quickly that there would be great danger of slips because the soils had not had time to drain gradually and sufficiently; great difficulty might be experienced in finding support for a small machine of several tons in weight in deep waterlogged parts; it has never been possible to frame a continuous programme suitable for machinery in the Deccan as the work in hand has not justified so large an expense. For these and other reasons of minor importance, machinery is not advocated in the Deccan irrigated areas. Moreover, manual labour has been found cheap and efficient.

#### GENERAL.

116. There is one great difficulty in construction—that of working in water continuously—which requires continual consideration both for the work under progress and for the contractor. While it is desirable to make a contractor fulfil his obligations, it is not always necessary nor desirable to force him to comply with the exact letter of his agreement, for additional difficulties crop up which must be allowed for each on its own merits. Water either flowing or percolating affects construction throughout and the labour employed thereon. Any drain is affected to some degree and to get rid of such water as far as possible by diversions is essential. Labour is not affected adversely during the fair season, but after the break of the monsoon it is generally impossible to continue. The programme mapped out should therefore aim at completion of drains as far as possible—on pipe lines the season's work must reach a completed manhole. The labour usually disperses for the monsoon and fresh arrangements are necessary thereafter.

In planning a season's work, allowance should therefore be made for such factors and in no case can such work be treated on the same footing as work in the "dry".

#### WORKS ORDER BOOK.

117. The necessity for making very full use of the Order Book—a separate one for each subordinate in charge of a section of a scheme—must be emphasized. Instructions given to contractors on the spot are very easily omitted, and also dates on which work has been set out or completed, all of which noted at the time may avoid future difficulties in accounting. The Order Book should be regarded as a primary document for accounts purposes, especially as the levels given when setting out from the basis of subsequent measurement on completion. Details of setting out should be initialled by the subordinate in charge who does the work, also by the contractor in token of acceptance that it has been set out on a certain date (most important if difficulties occur later) and the Sub-divisional Officer should initial and date them at the first opportunity after his approval. This of course applies equally to all drains.

#### PROGRESS REPORTS.

118. Fortnightly reports of progress were in force in the Irrigation Research Division and the following form which can be renewed and issued for use, has been found very useful. From the information supplied a plan and a chart may be kept up to date for reference.

.....Scheme. Fortnight ending .....

Drain No.....Open Trench or pipe line

(Strike out whichever does not apply)

1. Length on which work was in progress as per last report. Ch. ... to Ch. ..,
2. Quantity of work done during fortnight .. .. Cft.
3. Total labour employed .. .. Donkeys  
Men  
Women  
Children

4. Total number of working days .. .. days
5. Chainage up to which work has been completed during fortnight .. .. Chainage
6. Chainage up to which work has been extended during fortnight .. .. Chainage.

Forms should be submitted punctually by the 3rd and 18th of each month.

The measurements taken are not to be entered into the measurement books as they are only to show progress and need not be so accurate. At the same time they will be used as a check against the total work done on a drain. Notes of the figures submitted should be kept in subordinates' Note Books or the Order Book for reference when required.

#### CLEARING SCRUB BULRUSHES ETC.

##### *Open Trenches.*

119. The first item is to clear the land of jungle, particularly babul and bulrush. Babul trees should be cut down and the roots removed completely, the produce being sold if worth while and in any case stacked out of the way. Bulrushes should be cut down and spread along the edge of the cutting to be set out in order to provide a better foothold for all concerned. The roots when excavated may be thrown at the bottom of the spoil banks, as there is no danger of them sprouting again once the water level has been reduced. Tarvad bushes cut down should be stacked on one side, as they are frequently of use later on for revetting where slips are likely. Clearance is made much easier if diversion of flowing water is effected beforehand.

##### SETTING OUT.

120. The centre line of a drain is best aligned by the usual method of sight rails every 200 feet, boning rods and templates being used freely between the rails. The supports to the sight rails should be sunk to below formation level if possible from the start by using a 6 inch post hole auger. These posts may be about  $3\frac{1}{2}$  feet on each side of the centre line as they will then be just outside the berm for the central channel at the bottom.

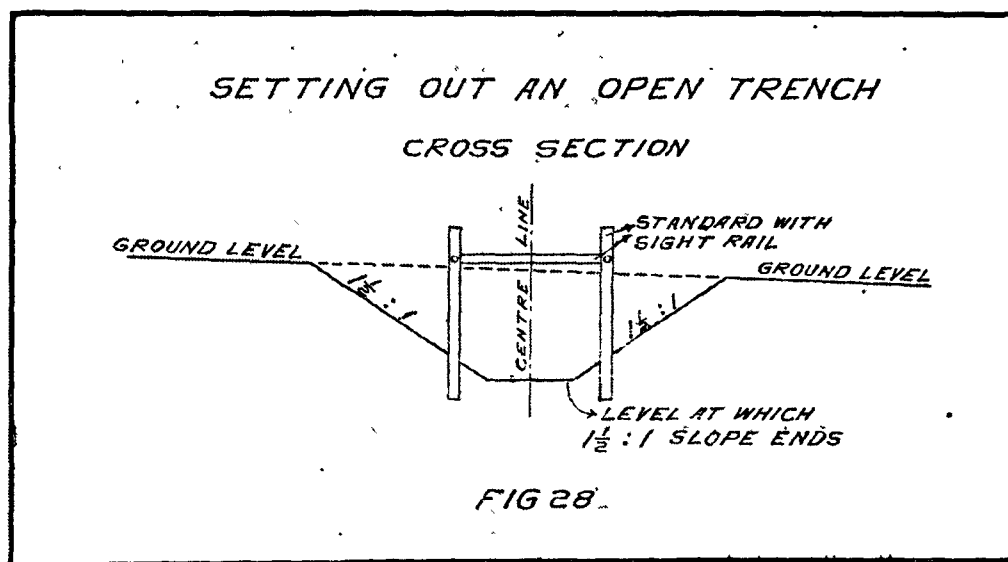

A cross section at every 50 feet along centre line should be levelled, especially in sloping ground, from which to calculate the edge of the cutting and set it out with pegs. It is advisable at each of these pegs as work proceeds to excavate a short strip say 2 feet wide from edge to edge of the trench departmentally. Such strips will then facilitate the use of boning rods intermediately. At the same time templates should be used freely.

Pegs should also be fixed to show the limit of the 8 feet berms within which no spoil should be placed. The profile for the service road and spoil bank on the other side (if any) can also be set out conveniently at the same time (Figure No. 29).

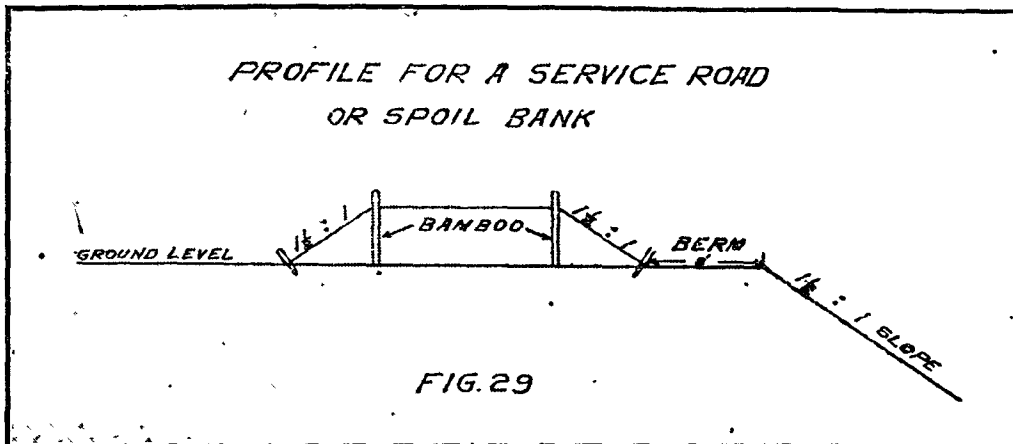

#### SETTING OUT CURVES.

121. The setting out of curves should be accurate and a suitable formula to apply is contained in Molesworth's pocket book, an example of which is amplified below :—

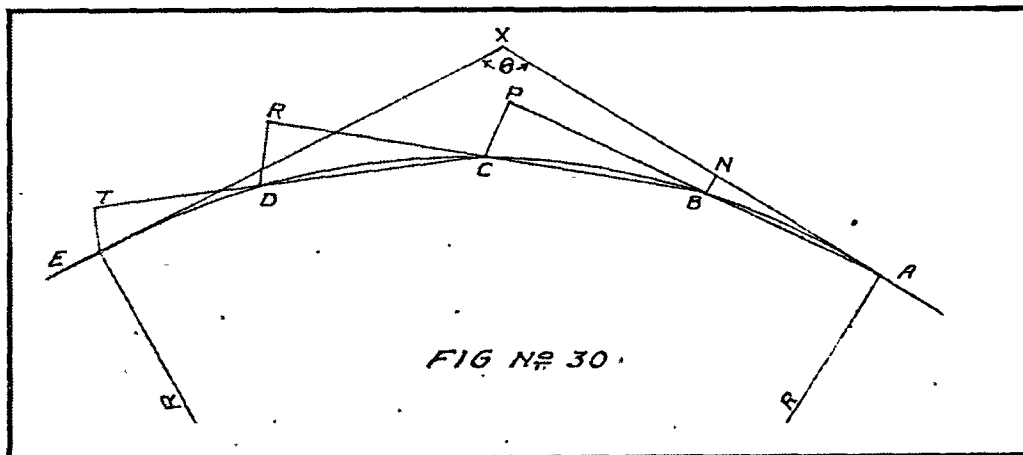

X, the apex, A and E tangent points, R the radius, and  $\Theta$  the angle enclosed by the tangents X A and X E, are all known from the working drawings.

Assume chainage at A is 2150.

Ch. at E = 2150 + length of curve A, B, C, D, E.

$$= 2150 + \pi R \left( \frac{180 - \Theta}{180} \right)$$

Let the length of curve be divided into a suitable number of equal parts say of 44' each. Mark out N such that A N = 44 feet.

Set off  $NB = \frac{\text{chord}^2}{2 \cdot R}$  ( $= \frac{44^2}{2 \cdot R}$  here) and A B = A N

The point B will be chainage 2194 on the curve. Produce A B to B P, making B P = 44, feet. Mark P C =  $\frac{\text{chord}^2}{R}$  ( $= \frac{44^2}{R}$  here) and B C = 44'. C will then be at ch. 2238 on the curve. Produce B C to R such that C R = B C. Mark R D =  $\frac{\text{chord}^2}{R}$  ( $= P C$ ) and C D = 44 to obtain ch. 2282 at D, and so on.

The last point set out should coincide with E as calculated (the tangent point).

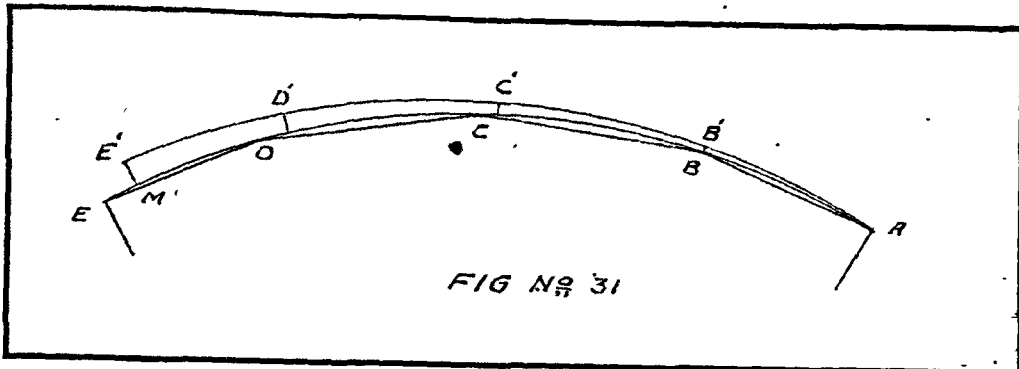

Any error between E, the tangent point, and E', the final point set out, is made up of

- (a) E M, error in chaining,
- (b) E' M, error in offset.

These errors are cumulative from A, and should therefore be tabled so that the cumulative error can be adjusted for each peg.

With a string round each peg throughout the length of the curve, a "good eye" can detect errors at a glance to within an inch which is sufficient for the purpose.

Sight rails will be required at much smaller intervals depending on its radius and the length of the arc. 50 feet and 25 feet pegs are suitable for large and small radii respectively.

#### LENGTH OF WORK IN PROGRESS.

122. It is important to restrict the length of work set out to 400 feet and to arrange with the contractor for the gangs working in the upper and drier portions not to excavate deeper than those working lower down. The work is conveniently done in steps to facilitate water flowing off naturally. The longer the length allowed the less easy is it for water to flow away, and hence progress may actually be retarded in spite of greater numbers of labourers being employed.

Advice should invariably be given to a contractor—for instance they frequently double handle spoil from trench to berm and again from berm to bank. Helpful advice about such matters is a considerable factor in progress.

#### CURVES.

123. It has already been stated that curves should if possible be located in hard strata to minimize scour. It pays to select a line specially for this purpose even at a greater cost, because the expense of maintenance afterwards may be very high. But this is not always possible, and particularly where a very short radius (minimum should be 200 feet) is essential, the outer side slopes should be grassed as soon as possible. It may be necessary to provide stone pitching in which case the masonry should be laid in mortar to avoid the danger of crab holes.

#### SERVICE ROADS AND SPOIL BANKS.

124. Service roads and spoil banks as specified should have the inner slopes trimmed. Incidentally it is not always easy to persuade a contractor to do this quickly, yet it should be obvious that the longer it is delayed the more the spoil will have consolidated. The inner edge of the service road should be parallel to the edge of the cutting as far as possible. Any additional width of bank required on account of deeper cutting should not encroach on the 8 feet berm. In some cases a service road is not necessary, but a 4 feet service path suitable for a cycle



should never be omitted. A completed service road should not show abrupt undulations on the top nor a zigzag edge on the inside ; changes in depth or width should be gradual. Harder spoil such as murum, sand, etc., should be specially stacked for spreading on the surface. Water tables on top of service roads and spoil banks are useful during the first monsoon and help consolidation. It is also very desirable that the inner edge of a spoil bank should be kept somewhat higher (say 6") than the outside to prevent rain water entering the drain direct and carrying with it large amounts of spoil.

#### APPROVAL TO WORK DONE.

125. An open trench should not be considered as passed until the excavation and dressing of spoil banks is complete and unless maintenance of the channel for 300 feet downstream of the work has been carried out. Some contractors leave considerable bulges on the side slopes of open trenches which, apart from the lack of supervision and use of templates so indicated, tends to cause slips. To enforce proper completion, no new work should be set out upstream until compliance of the specifications for the work downstream.

#### SUBSIDIARY WORKS.

126. After passing any length as complete, subsidiary works such as grassing, inlets, ramps, fixing of furlong and bedstones, should be done. These should be done as soon as possible so that the work is compactly arranged.

#### MAINTENANCE.

127. During construction it is necessary to maintain and repair an O. T. below the completed work. Everything described later in Part IV under that heading applies.

#### GRASSING.

128. Grassing side slopes was not provided in the early schemes constructed and had to be done out of savings and M. and R. But it was found to be such an important item that it is now provided in the project estimates and should be done as soon as possible after excavation is complete. Being primarily a protection against scour, it is described fully under Part IV—Maintenance.

#### PIPE DRAINS.

129. Much of what has already been written about open drains applies with equal force to pipe drains. The following details, however, require special notice.

#### LENGTH OF WORK IN PROGRESS.

130. Excavation is in the form of deep trenches with steep side slopes ( $\frac{1}{2}$  to 1), and should therefore never be allowed at distances more than 200 feet ahead of the pipes actually being laid, in order to avoid the possibility of collapse of the trench sides due to exposure, rain, springs, etc.

The uppermost foot of soil should be stacked quite separately from the subsoil (preferably on opposite sides), as it must be replaced at the top of the refilled trench.

As far as possible pipes should be laid on the same day as the full depth of the trench is reached. To attain this, it is advisable to arrange the labour so that lengths of 50 feet can be laid each day. No pipes should be covered before being passed by the subordinate in charge.

#### LAYING PIPES.

131. While laying, care should be taken to attend to the following points. 6 inches depth of clean coarse gravel must be laid, on which the pipes are to be bedded. The pipes must be laid to the correct gradient, touching each other end to end, and in a perfectly straight line between manholes. Pieces of broken tiles or drain pipes should be placed round the joints between pipes to prevent anything

passing direct into the drain. As the pipes are laid, gravel is filled in at the sides and on the top to a minimum depth of 6 inches.

Where pipes have been laid in a trench cut in pervious hard strata like murum, the portion of the trench above the top of the sand laid over the pipe, and up to the top of the hard strata, must not on any account be refilled with soil, but with hard murum (if really the hard kind) or gravel.

#### BACKFILL.

132. The trench should be refilled with the spoil, the top 12 inches of soil being carefully placed to form a hump. This hump may settle considerably and later can be ploughed over without objection. If it does not settle much, it will probably be used as an inspection path. Headers or spare boundary stones should be fixed over the drain on S. No. boundaries.

#### CURVES.

133. No curves whatever can be allowed in a pipe drain, and any change of direction should have a manhole as the apex.

#### APPROVAL TO WORK DONE.

134. A pipe drain can only be passed as complete by the Sub-divisional Officer when water flows freely without any heading up from one manhole to the next downstream. Heading up would indicate obstruction in some form which must be removed by the use of sewer rods. Distortion of the line, which does not necessarily result in heading up, can be located by noting the lengths of sewer rod inserted up to that point, and if accompanied by heading up, should be set right by the contractor at his own expense before final approval.

#### TREES.

135. No trees or shrubs, especially "babul" and "vad", should be allowed within 100 ft. of the drain, as the roots penetrate to considerable distances and are the most fruitful cause of stoppage and distortion. All should be cut down and the roots removed.

#### MAINTENANCE.

136. It is usual to insist on the contractor clearing the drain as far as the next manhole below. Below this, removal of silt from manholes—which is far more than might be expected during construction—should be done departmentally. This should not be neglected as any heading up which causes complaint from the contractor would delay his progress and justify special consideration.

#### QUALITY OF PIPES.

137. Good pipes should be regular in shape and colour, dense and strong, and should "ring" when struck lightly. Pipes which are oval or otherwise out of shape should be thrown out or may, if necessary, be broken up for use round the joints of the pipe line. The amount of water which a pipe will absorb is an indication of its strength. As a rule those absorbing large quantities of water are the weaker. The porosity of a pipe is no criterion of its drainage qualities, in fact a glazed pipe is just as good as any other, for water enters a drain through the joints only. An undue amount of absorption may be harmful where soils contain alkali or other substances causing disintegration. All pipes laid should of course be sound, free from cracks, chips, soft spots, blisters and other imperfections.

#### KINDS OF PIPES.

138. Pipes may be of concrete or earthenware. The former have not actually been tried in any drainage scheme so far constructed on account of expense, and where certain salts predominate, they are subject to corrosion. Originally earthenware pipes were burnt locally and used, but were of poor quality, unsatisfactory, and easily weathered. There is no doubt that good pipes could be burnt if good clay and suitable sand were available, but the clay is almost always highly

impregnated with salts. Unglazed earthenware, Hume and cement concrete pipes have been subjected to exhaustive tests under saline conditions during the last five years. They were tested in salt water (1,000 parts per 100,000), salty earth (5 per cent. total salts), and also under the conditions of alternate immersion and exposure to air. The last condition was far the most severe and resulted in almost complete disintegration of both concrete and earthenware pipes. It has been observed, however, that with constant immersion, i.e. without violent changes due to exposure to the elements, disintegration is comparatively little. Hence with economy to be considered, unglazed earthenware pipes (as supplied hitherto by the Perfect Pottery Co. Ltd. of Jubbulpore) are considered generally satisfactory for the purpose of drainage. Glazed earthenware pipes are not affected at all, and for this reason should be used invariably for a short distance (say 30 feet) at the outfall where atmospheric conditions prevail.

#### OUTFALL.

139. Some form of concrete wall at the outfall of a P. L. into an O. T. is necessary in order to protect the first two or three lengths of pipe. The usual outfall has been described in paragraph 89 and illustrated in Plate XVII. A drop of at least 12 inches is necessary, as when there is not space for a S. W. F. it is necessary to measure the discharge by hand, e.g. in 4 gallon kerosene tins.

#### HEADWALL.

140. Where a P. L. is a continuation of an O. T. the headwall described in paragraph 90 and on Plate XVIII is required. Good grassing above the wall is essential to prevent floods cutting back and eroding soil from fields just above. The ends of the spoil banks of the O. T. must be pitched well with stone to prevent the spoil being washed direct into the O. T. during the monsoon.

#### MANHOLES.

141. If the M. H. is to be of brick work, the bricks should be laid on edge or on end in order to avoid dressing of faces and joints and to better withstand the horizontal thrust of the surrounding earth. The inside of a manhole should never be pointed as the main source of percolating water is through the wall. It is of great advantage to "jump" holes through the foundation of a manhole into the pervious substratum below, even if founded on that stratum; where not so founded it is of even greater importance to do so in order to tap the sub-soil water. Such holes jumped through soil or chopan must be protected after enlargement by augars, the simplest method probably being by a length or two of ordinary drain piping. Manhole covers should be set at about 18 inches above ground level. This is not however a hard and fast rule. While 18 inches is suitable and even necessary in low situations in valleys where there is the possibility of accumulations of water from irrigation or rain, discretion should be used—it would be clearly ridiculous to allow 18 inches where the M. H. was situated on a well marked survey number "band".

#### IRRIGATION CHANNELS.

142. When a P. L. passes under any irrigation channel provision against direct percolation of irrigation water into a drain should be effected by using glazed and socketed pipes, jointed in cement, for 50 feet on each side of the channel. The pipes should also be surrounded by well rammed soil, not sand.

#### RUBBLE DRAINS.

143. There is only one important point to be noted in addition to what has been said about O. T.s and P. L.s. A rubble drain should never be laid in soil or chopan, but in some hard stratum such as murum or man. It follows that such drains will generally be required in shallower soils, as subsidiaries to deep drains, and as they entail opening up if choked, they should not as a rule be deeper than 5 feet. They have been used with success on the Hol-Murum-Karanja and the Manjri Drainage Schemes. In the latter area, they were designed to supplement P. L. s and so formed economical extensions well into murum noses.

## LIQUID MUD.

144. It has been emphasized throughout this Paper that drainage being underground, difficulties may unexpectedly present themselves. In spite of project plans, working plans, and other data, a ridge of rock may be encountered during excavation between the pits previously bored which might considerably alter future operations. Rock is a fairly easy material to account for in construction, and the removal of such barriers is often attended with results that prove economical in that further extension of a drain may be needless. But liquid mud, which may occur unexpectedly on any drain, is an exceedingly difficult material with which to contend.

Liquid mud is a deflocculated condition of the soil due to excess water especially in the presence of sodium salts. Plant growth at the surface and sub-soil strata have not yet been correlated with the presence of liquid mud beneath and this together with other factors is still under investigation. It occurs in deep clayey soils and has also been found where the substrata is not very deep.

It occurs at the surface where it can be seen but more often underneath. In the former case it will have already been noticed and allowed for in preparing working drawings, so that special arrangements can be made. It is in the latter case, where met unexpectedly, that trouble arises.

During construction it causes the greatest difficulty owing to the continuous oozing of mud into the trench as fast as it is excavated. At first all manner of shoring with planks, C. I. sheets, brushwood, and other material was tried with varying success. Where success was achieved it was invariably at great expense caused by delay to further work above the liquid portion and diversion of labour to some other trench—which was not always ready to be started.

It is advisable whenever mud—i.e., the real deflocculated soil—is encountered, to divert a contractor's labour elsewhere if possible. In all cases where a contractor has been allowed to continue, claims for extra work have been presented; and although justifiable, it has never been easy to determine what is a reasonable amount; it is therefore preferable to do liquid mud portions departmentally.

The simplest way to deal with liquid mud is of course to avoid it altogether by adopting an alternative alignment. But as already stated, it may escape notice while surveying the ground for the working drawings, and until clear indications—at the surface of weeds and soil, and below by the substrata—are known, its avoidance may be impossible.

If liquid mud is known to exist and is unavoidable, a pipe line is indicated in preference to an open trench because the latter invariably costs a great deal to maintain—if it can be maintained to the original design at all. Similarly if it be encountered suddenly while excavating an O. T., it is probably best to end the O. T. portion by building a headwall just downstream of the mud and to continue the drain as a pipe line.

The first ideas regarding conversion of the mud into a flocculated state arose from experiments for reclaiming certain soils then being carried out at the Malegaon Colony Laboratory. It was found that Calcium Chloride ( $\text{CaCl}_2$ ) when added to liquid mud would cause it to flocculate. Other chemicals were tested, but  $\text{CaCl}_2$  was found to be most rapid in its action—an all important factor in construction. The results were applied on a larger scale to pipe line No. 2 of the Kopargaon Drainage Scheme, which was completed successfully in a few days.

From the experience gained on the various drainage schemes constructed, and pending further research on the subject, the following steps are suggested when liquid mud is met.

The extent of the mud should be explored by taking pits at 10 feet intervals along the C. L., parallel to it, and across it. Probing should be carried down to hard strata if no deeper than 12 feet and a rough idea of the volume of mud to be dealt with obtained. Into 6" holes (post hole auger) in rows at a distance of 5 feet on both sides of the C. L., solution of  $\text{CaCl}_2$  should be injected at the rate of 200 lbs. per 1,000 cubic feet of mud. This is the correct dose for a highly sodiumized mud. It is suggested that samples of mud be sent to the officer in charge of the "Irrigation Research Division" Laboratory at Malegaon Colony, where the correct

dose would be ascertained in a few days. Each hole should be kept clear by introducing a 3" G. I. pipe, its lower end being tied up with gunny to prevent the ingress of mud. After the bores along the side of the trench have been injected *and not before*, those along the C. L., similarly spaced, should be injected. The action necessary to flocculate the mud may take up to 72 hours or more and may be tested periodically by intermediate bores if the sides of the trench have slipped. As soon as the mud becomes stiff, for instance like butter, work should be commenced and the trench completed.

## PART IV.

### CHAPTER IX.

#### Maintenance.

##### IMPORTANCE.

145. After the drains have been constructed, it is very important to see that the annual maintenance and repairs are properly carried out.

The object in irrigation is to conserve water and to distribute it over the land for the growing of crops. The Canals and Distributaries along which the water flows are provided with regulators to control the discharge. They are frequently inspected by the staff pursuing their ordinary duties, situated as they generally are along ridges where the more suitable soils lead to a greater concentration of cane. Any obstruction to that flow of water immediately brings forth complaints from the irrigators concerned, and the matter is set right.

Drainage is exactly the reverse. The object is to collect excess water from the sub-soil and to get rid of it. The drains lie off the beaten tracks of inspection. They consist of O. T.s near, if not in, depressions into which surface rain water and waste irrigation water naturally find a way; or pipe lines, hidden out of sight, underground, with access only at manholes, and with crops growing immediately over them. Ordinarily drains are not situated where inspection of irrigation would take the staff. Obstructions are much more likely to remain unnoticed, and irrigators do not much mind whether such obstructions exist as long as the excess water affecting their own particular pieces of land has been conveyed away. One has but to notice the state of cultivators' drains, often fully choked with bulrush and other weeds, to realise that once the excess water is out of their way, they do not concern themselves further—as long as canal water reaches their land, they are content.

There is a definite system for the distribution of water from the various channels with which both staff and cultivators know perfectly well they must comply. For drainage there is no system, no such system can be devised, and the comparatively small trickle in a drain, the result of dampness oozing out of the land, flows sweetly or not, as the case may be.

Drainage is in fact, the Cinderella of the various works which comprise an irrigation project. It is apt to be regarded as a nuisance and of no great import. But if a high intensity of cane is grown, such as occurs in sugar factory areas, it is of more importance to see that the drains function properly than to "turn on the tap" at the distributary head.

Maintenance is therefore the backbone of successful drainage and its adequate performance may have immense consequences for the community and Government. The staff concerned must understand their duties thoroughly, and hence the following paragraphs deal with the matter in what might be supposed by some to be unnecessary detail. Again, though the daily duties of a rakhwadar may be properly performed, the observations of sub-soil water levels and anna valuation throughout the catchment must not be neglected, because on these data depends the preservation of the fertility of the land.

##### MAINTENANCE OF OPEN TRENCHES.

146. The maintenance of open trenches consists of keeping the channel clear, preventing and repairing side slips and maintaining the roadway and other subsidiary works.

## CENTRAL CHANNEL.

147. As soon as possible after each year's monsoon, a gang of labourers is required for silt clearance. Bed stones give the correct bed levels and the use of honing rods is essential. Under no circumstances whatever should silt or sand be thrown on the inner slopes of an O. T. It must be placed on the outside of the spoil banks, if not used on the service roads. The usual excuse for throwing silt on the inner side slope is to allow it to dry, but its later removal again, i.e. double handling, is frequently omitted. Double handling is not necessary; during construction wet spoil is carried at once up to the ground level and above, and there is therefore no reason why exactly similar procedure should not be possible during maintenance. Placing silt on the inner slopes results in unsightliness, gradual building up of a bulge and hence the possibility of slips.

Obstructions such as loose branches of shrubs and trees, clumps of grass and shrubs restricting flow, stones (particularly flat stones used for washing clothes), should be removed immediately. Any tendency towards growth of water weeds in the channel should be checked. Anything which might tend to silting should be taken out.

One of the most important factors in maintaining an open trench is the early establishment of grass on the side slopes. Erosion of side slopes (and hence more than the normal silting of the bed) can almost be eliminated by a firm protection of grass. Details regarding grass pitching are given in the following paragraph. Stone pitching has not been successful. If it has to be used, it should be laid with the utmost care with a foundation sufficient to support its own weight. But stone pitching is likely to be undermined by crabs and should be avoided, if possible.

Animals should not be allowed to cross open trenches except where ramps or bridges have been provided.

The curves in an open trench require special care. The outer slope tends to erode, while the inner slope tends to silt up. Care should be taken to remove silt and weeds from the inner slope, and to protect the outside slope where necessary by revetting with babul stakes and tarvad.

## SAND IN OPEN TRENCHES.

148. Where an O. T. which cuts through sand, has been widened by slips and erosion in flood time, it is necessary to restore it and hold it by grass and revetting.

The Nandur Khandala Drainage Scheme on the Pravara Left Bank Canal gave great trouble in the upper reaches, due to the Main O. T. being excavated through layers of sand. Finally, after exceptional rain amounting to some 6" in 24 hours, the trench was badly eroded and silted up to a depth of 3 feet by the sand which had been washed out; and the channel widened up to 40 feet in places.

The whole of the length affected was revetted by means of stakes and tarvad at the sides of the central channel and grass pitched on the slopes above (Figure 32).

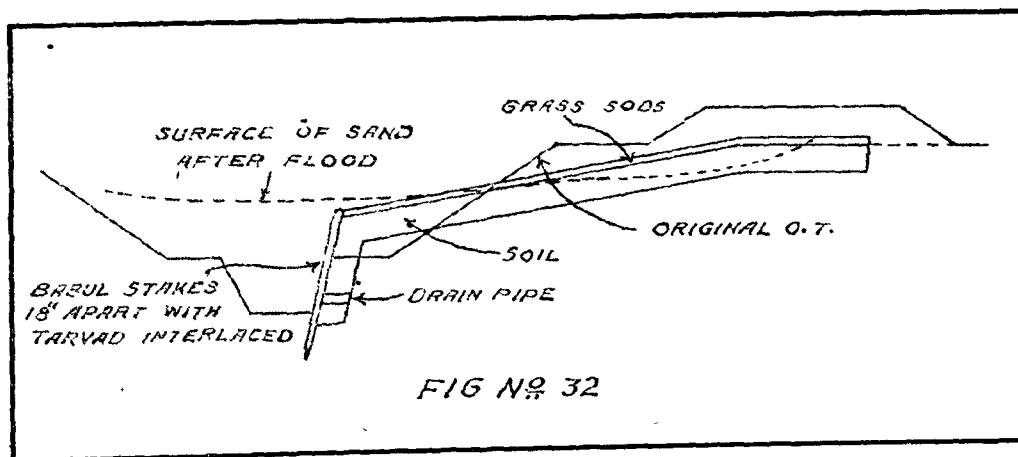

In doing such work however, certain precautions are necessary in the light of the experience then gained. To stop the sand being washed in through the tarvad a backing of black soil was laid behind the revetting, more or less vertical, and similarly a bed of 3 to 4 inches of soil was provided for the grass sods. Within a few months of doing this work pankanis appeared on the side slopes and it was realised that the vertical backing of soil was preventing the percolation of drainage water into the trench proper. This was partially remedied by small cuts about 6" deep through the grass at right angles to the O.T., but not proving sufficient, pipes were subsequently placed as low as possible through the vertical backing of soil. Once the bulrushes were eradicated—and this is easy if done in time, say, before they attain a height of 12"—the repair was entirely successful.

This also pointed to the fact that grass sods should not be taken from nearby if bulrushes have been established previous to drainage.

#### TARVAD REVETTING.

149. Regarding the use of tarvad revetting and stakes, it is important that the value of this protection should not be lost sight of. Such revetting will probably last for two or three years without much repair. When however it becomes necessary to replace stakes, it is better to encourage grass in lieu of the tarvad because no drain can be said to be perfect if it requires periodic patch work of any sort. Stakes and tarvad should therefore be regarded as a temporary expedient only, and as soon as possible the growth of grass, right down to the water edge, should be encouraged and started in good time.

Great trouble may also occur near the outfalls of drains where sand provides a constantly shifting bed, and erosion is taking place. Here again, babul and tarvad revetting will help enormously to keep the channel in place; and in a deep twisting nala, to prevent undue erosion and meandering.

In some cases, where full development of irrigation has not been reached but where bulrush is on the increase, it might be found desirable to wait until the bulrush has established itself, and then to cut a channel through it without removing the roots at the sides. The bulrush would eventually die out, enabling grass to grow naturally in its place, and the roots would give some protection to the sides of the channel.

#### TARVAD HURDLES TO ENCOURAGE SILTING.

150. Again it is desirable in some conditions to encourage silting, especially where an O.T. alternately cuts through high bank, short-cutting the natural course of a nala. This can be done by making hurdles interlaced with tarvad and placing them at right angles to the axis of the stream such that the distance between each is not greater than twice the length of the hurdle. The tarvad should not be so thickly bound to the hurdle that it stops the nala flow. The intention is that velocity should be reduced while passing through the hurdles to such an extent that the silt is deposited.

#### GRASSING.

151. The protection of sideslopes and inlets by means of grass is probably the most important item of any O. T. For the earlier schemes, grassing was provided out of savings, and from repairs after completion; and the funds available had to be made to go as far as possible. Accordingly grassing was generally started by planting sets or cuttings a few inches apart. This method was not as satisfactory as might be expected, owing to the time taken for the intervening spaces to become grassed, so that damage occurred before the roots had time to spread and knit together. It was then decided to provide for planting grass in the project estimates.

If available, strips of turf should be cut at least 9" wide taking care not to lose the soil held by the roots, and laid alongside each other so that the root system will quickly bind. Failing stretches of turf from which to cut such sods (strips), single clumps of roots should be used. They should be laid close to each other on a loosened bed of soil, well pressed in, and then watered regularly at least twice a week until the roots are thoroughly knit together.

## KINDS OF GRASS.

152. Different kinds of grass suit different conditions :—

(i) Where the side slopes consist of soil with percolating sweet water (water pressure positive) cyperaceous plants or “mol” (*pennisetum alopecuroides*) will grow. The latter is far superior to the former. It grows in thick clumps and withstands scour to a remarkable degree. “Marvel” (*andropogon annulatus*) grows best where the soil is not very moist.

(ii) Where the soil is too wet or salty for “mol” cyperaceous *laevigatus* will grow.

(iii) Where the soil overlies a well drained subsoil, where pressure in water films is negative, “marvel” and “harali” (*cynodon dactylon*) flourish. “Kunda” (*ischaemum pilosum*) will grow in the drier parts. “Harali” soon gets established; “kunda”, however, is better than “harali” as it mats the surface.

“Harali” and “kunda” can be grown on the side slopes where there is good undamaged soil; but they require special care till they get established, and are susceptible to salts—“kunda” in particular—“gonde gavati” (*chloris barbata*) will grow in the upper dry portions of the side slopes and “pan kunda” in the lower moist portions.

“Pan kunda” (*panicum fluitans*) resists both salt and waterlogging to a remarkable degree and is also useful as a fodder; but the cyperaceous weed “lavala” (*cyperus laevigatus*) is still more resistant than “pan kunda” and will grow where the latter fails. It has however no binding action on the soil, so is far inferior for protection; and hence should only be allowed to grow where all else fails.

A row of “lavala” or “pan kunda” may be planted along the water’s edge 12” to 15” apart. “Pan kunda” should be planted on the slopes up to the point where the soil ceases to be moist. Regular light waterings or spraying is necessary till the weeds are established—say for a month.

It will be generally found that the weeds recommended above for the two sets of conditions will be found naturally occurring in the adjoining area. Similarly any other weed occurring naturally will establish itself if planted on the side slopes, and it is always wise to plant local weeds where they are suitable for the conditions to be met.

After a time the weeds on the sides will be found growing downwards towards the water and hence the central channel has to be kept clear of excess growths. These weeds together with the accompanying slices of earth should be removed and used for filling up gaps. A line will be found above which “pan kunda” will not grow owing to the moisture being insufficient. Above this line (a) “gonde gavati” should be planted where alkali prevails, (b) “harali” where moderate alkali prevails, and (c) “kunda” where alkali is very slight or nil.

## GRAZING.

153. Permission to graze should never be given as the cost of repairing the damage done exceeds the return. Most of the grasses and weeds mentioned in the previous paragraph are more or less valuable for fodder and some revenue may be obtained by selling the cutting rights to people who are willing to cut the grass.

Cattle should be impounded if found within drainage boundaries or crossing drains at unauthorised places. Action may, as a last resort, be taken under the Irrigation Act. But if the cutting of grass be encouraged and auctioned, it is to the interest of the lessee to protect his grass by keeping other people’s cattle out. Hence the sale of grass is to be encouraged from all points of view.

## SPOIL BANKS.

154. The chief item to which attention is necessary is the filling up tunnels down the side of the bank caused by rain water. Maintenance of the inner top edge of a spoil bank 6 inches higher than the outer edge will minimize this and effect economy by lessening silt clearance after the monsoon. It is advisable to see to this matter just before the break of the monsoon.



## SERVICE ROADS.

155. The above paragraph holds good for banks on which service roads and paths have been made. Sand from the trench should be utilized to fill in ruts and hollows and otherwise to maintain the surface.

Where there is little sand to be removed, and where local cultivators use the service road, they should be induced to bring material for surfacing the road ; but this needs a keen and energetic Sub-divisional Officer. Local Boards should also be asked to help whenever there is a public demand for their use. On no account should funds primarily intended for M. & R. to drains be used for repairing a service road. Where the public are allowed to use the road no right of way should be allowed. The road should therefore be closed for traffic on at least one day every year. \ Plate No. XXI shows the type of gate used on drainage scheme service roads.

## SLIPS.

156. Slips are caused by—

- (i) bulges left on the side slopes by a contractor ;
- (ii) bulges formed by spoil dumped on the side slopes during silt clearance ;
- (iii) excess of water finding its way through side slopes in deep soils ;
- (iv) in the vicinity of liquid mud.

The remedy for bulges is obvious—they should not be allowed. An excess of water causing slips can generally be cured by opening up at the place and tapping the source allowing the water to flow away through a pipe. Liquid mud is extremely difficult to deal with, as it rises from underneath. It has already been suggested that alignments through mud should be avoided entirely, or else the mud must be flocculated by  $\text{CaCl}_2$  in order to lay a pipe drain.

## TREES.

157. If funds permit, trees may be planted along O.T.s in order to bring in some revenue. They should be planted on both sides of the trench, about 2 or 3 feet inside the boundary of the acquired land, according to the instructions contained in the Bombay P. W. D. Hand Book.

The drains are usually situated at the lowest points in the valleys in waterlogged and deep salt-affected areas, passing through some pervious strata, such as murum or sand, or through impervious chopan. After drainage, although the waterlogged sides remain moist, the soils overlying the former soon recover their natural friable structure ; but the soil overlying impervious chopan although dry, remains as stiff as ever. Thus a drain usually has two distinct sets of conditions, viz., loose wet soil ; and stiff dry soil.

The object of tree plantation along a drain being revenue, those mentioned below, in order of importance, can be suitably grown in the two sets of conditions :—

	Utility.
(a) <i>Loose wet soil.</i>	
(1) Mango— <i>Mangifera Indica</i> .. ..	.. Fruit.
(2) Jambul— <i>Eugenia Jambulana</i> .. ..	.. Fruit.
(3) Karanja— <i>Pongamia Glabra</i> .. ..	.. Oil cake.
(4) Sandalwood and <i>Eucalyptus</i> .. ..	.. Wood and oil.
(b) <i>Stiff dry soil.</i>	
(1) Tamarind— <i>Tamarindus Indica</i> .. ..	.. Fruit.
(2) Bor— <i>Zizyphus Jujuba</i> .. ..	.. Fruit and lac.
(3) Nimb— <i>Azadirachta Indica</i> .. ..	.. Wood.

Although the compounds of many inspection bungalows provide nurseries for trees, it is sometimes convenient and desirable to start a nursery on the main carrier drain of a scheme, preferably near where one set of conditions mentioned above verges into the other. If the rakhwadar lives at some point on an O. T.—an inducement being permission to grow a few papayas or vegetables within the boundary—there should be no difficulty in keeping a small nursery going at the same place. It should however not be allowed to interfere with his daily round.

**IRRIGATION RESEARCH DIVISION**      **PLATE No. XXI**  
**TYPE DESIGN FOR A BARRIER ACROSS**  
**SERVICE ROAD FOR DRAINAGE**  
**SCHEME**

**SIDE ELEVATION  
ON LEFT HAND POST 'A'  
SCALE 1/2"**

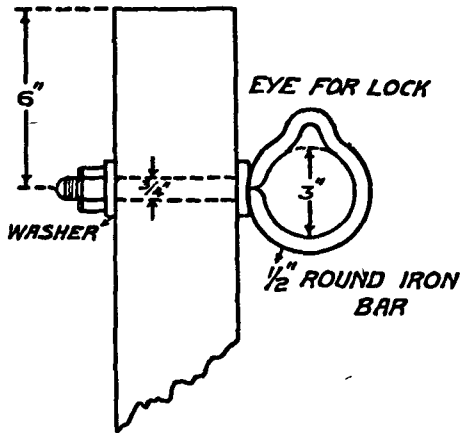

**SECTION OF CROSS BAR  
AND EYE-BOLT FOR  
LOCKING**

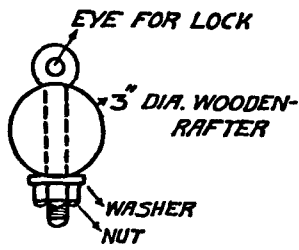

**SIDE ELEVATION  
ON RIGHT HAND POST 'B'  
SCALE 1/2"**

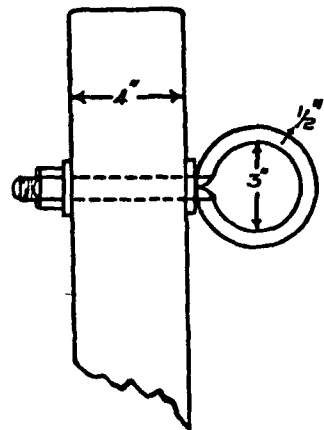

**FRONT ELEVATION  
SCALE 2' = 1"**

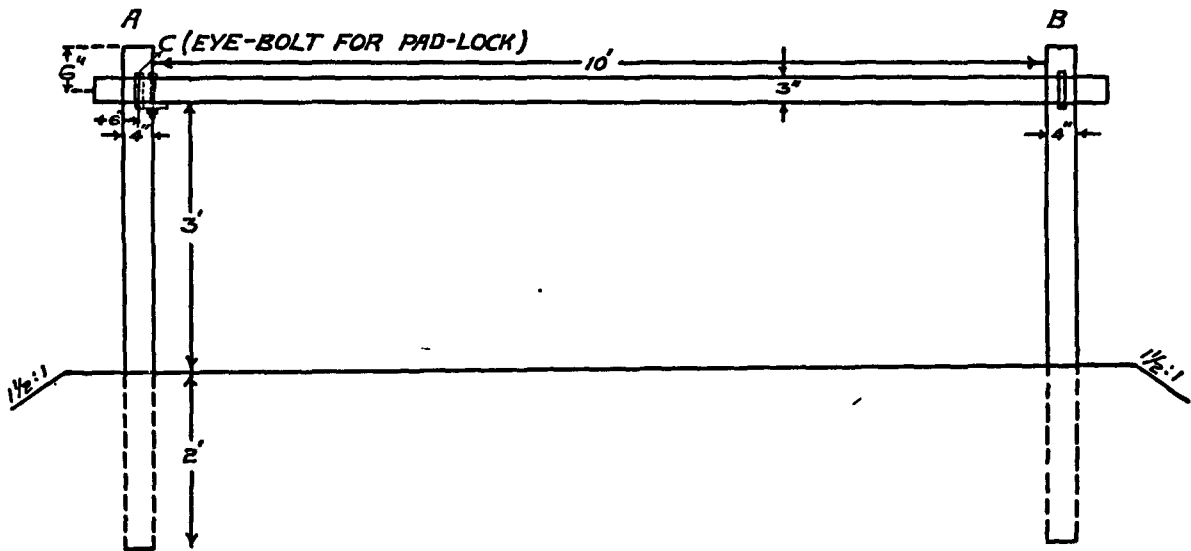

**ELEVATION ON POST 'A' SHOWING LOCKING ARRANGEMENTS  
SCALE 1/2"**

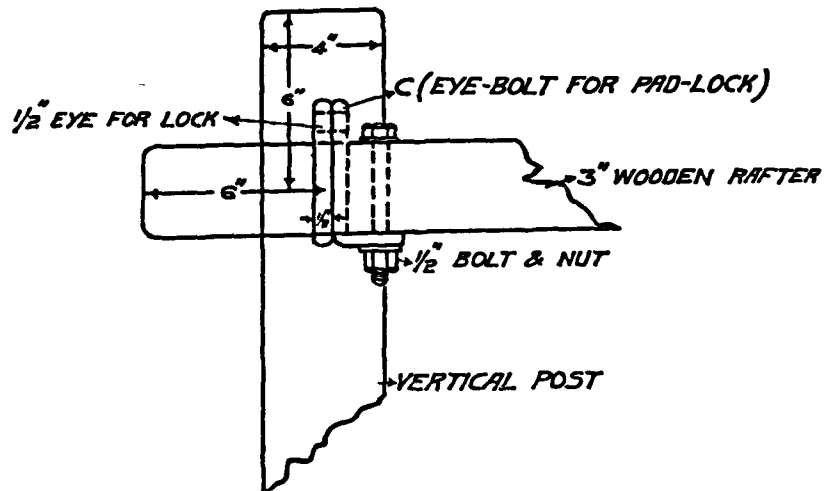

## BOUNDARY.

158. The Government boundary should be carefully maintained. Boundary stones should be whitewashed annually, if necessary, together with the mile and furlong stones. Gaps in aloe hedges should be filled up. When additional material to that obtained from silt clearance is required for repairing banks, a dogbell may be made along the boundary which will be useful as a catchwater drain, leading, of course, to the nearest inlet.

## SUBSIDIARY WORKS.

159. The small masonry works need repairs from time to time such as pointing, replacement of stones loosened by floods, etc. The following points should also be borne in mind.

Inlets, whether grass or masonry, need particular attention, because if not efficient, rain water flooding into an O.T. cuts channels back into the fields above, denuding the land and carrying large quantities of spoil into the O.T. which has to be removed later. It is far more economical to keep the inlets in proper repair than to have to clear silt from a long length of O.T.

Subartesian bores and observation tubes need inspection after each monsoon. The former may be partially choked and the latter filled with soil by mischievous boys.

Silt is sometimes deposited on the upper portions of ramps and should be removed at the end of the monsoon to facilitate cart traffic.

S. W. F.s are useless unless the stilling pond is kept clear and heading up below—causing the standing wave to be drowned—is prevented. Precautions should therefore be taken before any reading is recorded.

## MAINTENANCE OF PIPE DRAINS.

160. Provided the pipe drains are well laid, they should require little more than periodic inspection and occasional rodding for years together. All that is necessary is a weekly inspection to see if the flow has suddenly decreased or heading up has occurred in a manhole. As soon as water is seen to head up to the soffit of the outlet pipe in a manhole, the obstruction should be removed by sewer rods. The obstruction can in most cases be removed quickly. Rodding should not be done as a routine every month, as it is likely to damage the pipes. It should only be done when necessary to clear an obstruction. The most common obstruction is roots of trees which may extend for nearly 100 feet from the trees necessitating their prohibition. When rodding results in no improvement, the portion where the obstruction has occurred must be opened out. For this purpose the number of rods inserted should be counted, and the length should be carefully noted. The P. L. should then be opened at the point calculated, and the obstruction removed. While work is in progress the upper end of the drain should be closed by means of a plug to cut off all water and to prevent silt entering from the manhole. While replacing the pipes after removal of an obstruction, care must be taken to see that they are laid in the correct alignment and grade, with no large space between two adjoining pipes. Pieces of broken pipe should be laid round the points and new clean sand placed as if for a drain under construction. It should be arranged that the plug at the upper end can be removed easily after completion of the repairs. Water will have headed up in the manhole and may be under a pressure of several feet of water. The plug must be firmly fixed to a chain so that it can be pulled out without difficulty.

The fact that rods cannot be passed up a pipe drain does not necessarily denote an obstruction to the flow. Where liquid mud has been found during construction, the pipes may subsequently settle out of alignment but without interfering with the flow in any way. In such cases (for instance P. L. No. 2 of the Kopargaon Drainage Scheme) the line should not be opened up as long as the flow is free and no heading up occurs in the manhole above.

Pipe lines should be inspected every week without fail and an intelligent rakhwaddar should be able to know almost immediately if there is any obstruction from an inspection of the flow in the manholes.

## MANHOLES.

161. The only maintenance likely to be required in manholes is the clearance of silt periodically. Under repairs comes the fastening arrangement of the cover which is apt to be tampered with. At places where good drinking water is precarious cultivators and others living in vasties are allowed to take water from a manhole and they usually see that it is not damaged.

## HEADWALLS.

162. The masonry work and pitching require petty repairs annually, due to damage caused by floods. Here grassing of the approach to a headwall and the protection provided against out flanking of the spoil banks needs careful attention. Silt carried down the P. L. should of course be removed at the time of general silt clearance. Immediately below a headwall is a favourite place for washing. This should, if possible, be stopped, because it invariably results in displacement of the stone pitching by the *dhobis*.

## NALA KEEPERS (RAKHWALDARS) AND THEIR DUTIES.

163. After completion of a scheme, if not before, it is necessary to maintain "rakhwaldars" to look after the drains. The following are their duties:—

1. To remove stray cattle to the cattle pound.
2. To see that no improper use is made of the nala for bathing and washing purposes by people round about.
3. To prevent men and cattle from causing damage to any of the drainage works.
4. To keep the waterway clear from bushes, stones, grass, and other incidental obstructions.
5. To see that standing wave flumes are not used by people for any purpose and that a standing wave is maintained.
6. To look after the boundary stones and prevent encroachment on lands acquired by Government.
7. To look after trees, aloe fencing, grass on slopes, etc.
8. To clear all pipe drains by rodding when necessary.
9. To report any points of importance to the subordinate in charge.

For rodding, one or two extra coolies will be required to help. Annual silt clearance, masonry repairs, opening up of pipe drains, etc. requiring a gang of labourers, should be arranged by the subordinates in charge. All the other duties can be seen to by the rakhwaldar on his daily rounds. After several years of experience it has been possible to lay down a standard of work to be done by a rakhwaldar.

A rakhwaldar can look after 48 chains, say one mile of O. T., or can rod 12 chains of P. L., in one day.

One day should be allowed for bazar every week and one day for miscellaneous duties such as taking cattle to the pound, rodding a portion of P. L., or other items. This leaves five days of each week for routine inspection. Now each O. T. should be cleared once weekly, so if approximately four miles of O. T. be cleared on the first four days, the fifth day is available for pipe lines, which entail inspection at each manhole only. These rounds include everything which can be done by the rakhwaldar alone, including inspection for decreased flow at P. L. outfalls.

On the above data a daily programme for any week may be worked out for the drainage scheme, and this method has been found to be the best to ensure that the duties are performed—except of course when it might be necessary to clear a P. L. in a hurry.

## ESTIMATES.

164. After standardising the duties of a rakhwaldar the corollary is a standardised repair estimate. The type estimate which was in use until the transfer

of all drainage works to the Canal Divisions concerned is shown below, the only change needed being because the rates for labour at the time when it was adopted were annas 8 for men, 6 for women, and 4 for boys. It is recommended that this type estimate should be adhered to generally for annual M & R. Difficulty may arise if sufficient funds are not available in a particular year, but in such a case it would be better that the type estimate should be sanctioned in full, and, if the allotment does not suffice, that the Executive Engineer concerned should decide what items of the estimate can be omitted to keep within the allotment. Any departure from a type estimate nullifies standardisation.

*Type Estimate.*

Quantity.	Items.	Rate.	Per	Amount.
	<i>Maintenance and Repairs to Drainage Schemes.</i>			
		Rs. a. p.		
1.	Removing silt and clearing and maintaining channel to correct section.			
	15" section .. .. .	1 8 0	100 Rft.	
	18" " .. .. .	1 11 0	"	
	21" " .. .. .	2 0 0	"	
2.	Grassing and maintaining side slopes in order ..	0 8 0	"	
3.	Maintaining road banks and berms and clearing catch water drains .. .. .	1 0 0	"	
4.	Maintaining trees, also fencing and dogbell ..	0 8 0	"	
5.	Repairs to masonry works on Open Trenches :—			
	(a) Ramps and Road bridges .. .. .	4 0 0	Each.	
	(b) Inlets .. .. .	5 0 0	"	
	(c) Standing Wave Flumes .. .. .	1 0 0	"	
	(d) Masonry falls .. .. .	2 0 0	"	
	(e) Aqueduct .. .. .	3 0 0	"	
	(f) Subartesian bores .. .. .	0 4 0	"	
	(g) Observation tubes .. .. .	0 2 0	"	
	(h) Mile and furlong stones boundary stones and bed stones etc. .. .. .	3 0 0	Mile.	
6.	Pipe lines—pits to remove obstructions where necessary .. .. .	10 0 0	"	
7.	Repairs to masonry works on pipe lines :—			
	(a) Head walls .. .. .	1 0 0	Each.	
	(b) Manholes .. .. .	2 0 0	"	
	(c) Observation tubes .. .. .	0 2 0	"	
8.	One Nala keeper for every 196 chains of Open Trench and Pipe Lines connected thereto for 12 months .. .. .	18 0 0	Month.	
	Contingencies at 5 per cent. .. .. .			

The following details will explain how these rates have been arrived at :—

*Item No. 1.*

Removing silt and clearing and maintaining channel to correct section.

This will include removing silt, weeds, bushes, rubbish and grass from the central channel, repairing the section of channel by revetting and pitching where necessary—in fact complete maintenance of the central channel. It is assumed that a 9" depth of silt for the designed width (not restricted width) at Rs. 1-8-0 per brass will meet the cost.

*Item No. 2.*

Grassing and maintaining side slopes in order :—Means cutting shrubs, repairs to side slopes, grass planting on slopes and pitching where necessary. It is assumed that on an average one coolie will be able to look after the two slopes of 100 Rft. of trench in one day.

*Item No. 3.*

Maintaining road banks and berms, clearing catch water drain, includes :—

(a) Clearing weeds and bushes, etc.

(b) Filling ruts and hollows.

(c) Spreading silt as blindage and repairing banks.

(d) Clearing catch water drains of silt rubbish, etc. It is considered that on an average two coolies would be able to look after the banks and berms for 100 feet length in one day.

*Item No. 4.*

Maintaining trees, aloe fencing and dogbell :—

There would be 138 trees at 40 feet apart or 176 trees per mile if planted 30 feet apart. This item would include (assuming 176 trees) :

	Rs. a. p.
(a) Fencing for trees 5 per cent. at 4 annas each every 2nd year .. .. .	1 2 0
(b) Watering of trees one mile per day and 22 waterings at annas 8 per day .. .. .	11 0 0
(c) Weeding manuring pruning (when young) 45 trees a day twice a year .. .. .	4 0 0
(d) Filling gaps in aloe fencing (4 coolies per mile per day) .. .. .	2 0 0
(e) Replacing dead trees 10 per cent. every year and at annas 4 each.. .. .	4 8 0
Total ..	22 10 0 per mile.

or say annas 8 per chain length.

*Item No. 5.*

Repairs to masonry works on open trenches :—

These are taken out on the basis of 1 per cent. of the cost of the work approximately. The amounts given are for an average work of the type design mentioned.

*Item No. 6.*

Pipe lines—pits to remove obstructions where necessary assumes Rs. 10 per pit per mile of pipe line.

*Item No. 7.*

Repairs to masonry works on pipe lines, *vide* Item No. 5 above.

*Item No. 8.*

One nala keeper for every 196 chains of drains.

## CONCLUSION.

165. The writer apologizes for the length of this Technical Paper. The subject is not a simple engineering problem, but one which also necessitates a thorough grasp of the soil physical side, without which drainage has been shown to be useless. The great variety of soils in the Deccan further complicates the work, added to which is the fact that what affects the results of drainage takes place underground. Any tendency to cut down estimates unduly is to be deprecated because although it may remove the objection of high initial cost (say more than Rs. 150 per acre of cane) the result can only mean increased maintenance charges.

## INDEX

	Para.	Pages		Para.	Pages
Acquisition of land ..	73, 104	35, 48	Drains—main ..	64	31
Do. Proceeding of ..	106	49	Do. necessity for sub-soil ..	59	29
Alignment of drains ..	62, 69	30, 34	Do. numbering of ..	65	31
Alkalis in the soil ..	16	4	Do. open trench ..	75	35
Alkalization or base exchange ..	18	4-6	Do. outfall ..	63	30
Approval to work done ..			Do. pipe, design of ..	87	40
Do. open trench ..	125	62	Do. do. headwall for ..	90	42
Do. pipe drain ..	134	63	Do. do. manhole for ..	88	41
Aqueducts ..	83	39	Do. do. outfall of ..	89	41
Augers for sub-soil survey ..	46	20	Do. record of important ..		
Backfill in pipe drain ..	132	63	points along ..	71	34
Baramati Experimental Salt Area.			Do. relief ..	57	29
Do. sub-soil conditions.	19, 20	6, 7	Do. rubble ..	91	42
Bedstones ..	85	40	Do. shallow ..	58, 60	29, 30
Bores—pit work ..	70	34	Do. types of ..	74	35
Do. recuperation coefficient ..	50	22	Distributary crossings ..	83	39
Do. subartesian ..	67, 81	33, 39	Estimates—items of ..	100	45
Boundary stones ..	86	40	Do. maintenance ..	164	72-74
Branch drains ..	64	31	Do. survey ..	37	14
Bridges ..	78	38	Falls ..	82	39
Capillary action in soil ..	14	4	Financing of drainage ..		
Carrier drains ..	61	30	schemes ..	31	11
Causeways ..	78	38	Flumes—standing wave ..	80	39
Central channels—main-tenance of ..	147	67	Formation of soils in Bombay ..		
Channels—irrigation ..	142	64	Deccan ..	38, 39	15
Classification of the soils ..	40	15	Formula—discharge of ..		
Clearing scrub—open trench ..	119	59	open trench ..	75, 76	35-37
Coefficient of recuperation ..	50	22	Do. pipe line ..	87	40
Construction—maintenance ..	116, 127	58, 62	Do. recuperation ..	50	22
Contract—form of ..	111	52	Form of contract ..	111	52
Conclusion ..	165	74	Furlong stones ..	86	40
Cross sections—			Government boundary ..	158	71
location of ..	52	26	Gradient of a drain (open trench) ..	68	33
numbering of ..	65	31	Grassing—of inlets ..	151	68
pit work for ..	53	28	Do. side slopes ..	147, 128	67, 62
plans of ..	98	45	Grass—kinds of ..	152	69
Curves—	123, 147	61, 67	Do. grazing of ..	153	69
pipe drain ..	133	63	Grass inlets ..	79	39
setting out ..	121	60	Grazing of grass ..	153	69
Damage—how it occurs ..	17	4	Headwall—	90	42
Do. progressive ..	95	43	Do. pipe drain ..	140	64
Do. shown on index plan ..	94	43	Do. pipe lines ..	162	72
Do. survey of ..	41	16	Hurdle—tarvad ..	150	68
Data plotting of sub-soil ..	51, 70	25, 34	Hydrosoaths ..	43	19
Do. record of important ..	71	34	Importance of—main-tenance ..	145	66
Deep drains ..	58, 59	29	Inlets—grassing of ..	79, 151	39, 68
Designs—open trench ..	75	35	Irrigation channels ..	142	64
Do. pipe drain ..	87	40	Isobaths ..	43	19
Do. type ..	99	45	Intercepting drains ..	56	28
Desirability of early drainage ..	5	1	Introductory ..	1 to 7	1
Discharge—nala observations ..	110	51	Kinds of pipes ..	138	63
Do. open trench ..	75, 76	35, 37	Labour—machinery <i>versus</i> manual ..	115	57
Do. pipe drain ..	87	40	Land acquisition ..	73, 104	35, 48
Drainage—meaning of ..	8	2	Do. proceedings ..	106	49
Do. result of sub-soil ..	28	10	Do. valuation ..	105	48
Drainage schemes—			Laying pipes ..	131	62
desirability ..	29	11	Length of work in progress—		
estimates for ..	100	45	Do. open trench ..	122	61
financing of ..	31	11	Do. pipe drain ..	130	62
observation tubes ..	84	39	Liquid mud ..	144	65
preliminary data required ..	36	14	Longitudinal section—plan ..		
relative importance ..	30	11	of ..	97	44
report on ..	102	47	Machinery <i>versus</i> manual labour ..	115	57
staff for ..	32	12	Main drain ..	64	31
survey estimate for ..	37	14	Maintenance—		
Drainage lines—			Central channel ..	147	67
pit work surveys and plotting of ..	70	34	Estimate ..	164	72-74
Drains—acquisition of land for ..	73	35	Government boundary ..	158	71
Do. alignment of ..	62, 69	30, 34	Headwalls ..	162	72
Do. bedstones ..	85	40	Importance of ..	145	66
Do. branch ..	64	31	Manholes ..	161	72
Do. carner ..	61	30	Nala keepers ..	163	72
Do. deep ..	58, 59	29	Obstructions ..	147	67
Do. effect of on S. S. W. L. ..	26	9	Open trenches ..	146	66
Do. gradient of ..	68	33	Pipe line ..	160	71
Do. inlets ..	79	39	Rakhwaldars ..	163	72
Do. intercepting ..	56	28	Rodding ..	160	71
Do. kind of ..	46, 66	28	Service roads ..	155	70
Do. length of ..	66	31	Silt clearance ..	147	67
Do. location of ..	55	28	Slips ..	156	70
			Spoil banks ..	154	69
			Subsidiary works ..	159	71
			Trees (nursery) ..	157	70

	Para.	Pages		Para.	Pages
Maintenance during construction—			Proceedings of land acquisition ..	106	49
Open trench .. ..	127	62	Project—information required while preparing ..	101	46
Pipe drain .. ..	136	63	Properties of soil ..	10	2
Manholes .. ..	88, 141	41, 64	Quality of pipes ..	137	63
Do. on pipe lines ..	161	72	Rakhwaldars—duties of ..	163	72
Milestones .. ..	86	40	Ramps .. ..	77	37
Mud—liquid .. ..	144	65	Rates— for soil classification ..	45	16
Murum isobaths ..	43	19	Do. for subsol survey ..	47	21
Nala keepers—duties of ..	163	72	Recuperation .. ..	49	21
Nalas—survey of ..	54	28	Do. coefficient ..	50	22-24
Do. discharge observations ..	110	51	Do. formation of ..	50	22-24
Note books and field books ..	72	35	Relief drains .. ..	57	29
Numbering of—cross sections ..	65	31	Report—on project ..	102	47
Do. drains .. ..	65	31	Do. progress .. ..	118	58
Observation tubes ..	84	39	Revetting—by tarved and babul .. ..	148, 149	67, 68
Observations—to be recorded ..	110	51	Rodding .. ..	160	71
Occurrence of Damage ..	17	4	Root growth—zone of ..	15	4
Open trench—approval to work ..	125	62	Rubble drains .. ..	91, 143	42, 64
Do. central channel ..	147	67	Do. specifications ..	112	52
Do. clearing scrub, blurushes, etc. ..	119	59	Rush of work .. ..	114	57
Do. curves .. ..	123, 147	61, 67	Sand in open trenches ..	148	67
Do. discharge of ..	75, 76	35-37	Section—cross, location of ..	52	28
Do. gradient of ..	68	33	Do. numbering ..	85	31
Do. grassing .. ..	128, 151	62, 68	Do. plan of ..	98	45
Do. grazing .. ..	163	69	Do. longitudinal—plan ..	97	44
Do. length in progress ..	122	61	Do. open trench ..	75, 76	35-37
Do. maintenance ..	127, 146	62, 68	Do. pipe drain .. ..	87	40
Do. sand in layers ..	148	67	Service roads .. ..	124, 135	61, 63
Do. section of .. ..	75, 76	35-37	Setting out—curves ..	121	60
Do. service roads ..	124	61	Do. open trench ..	120	59
Do. setting out ..	120, 121	59, 60	Shallow drains .. ..	58, 60	29, 30
Do. silt clearance ..	147	67	Side slopes—grassing of ..	128, 147	62, 67
Do. slips .. ..	156	70	Silt—on inner slopes ..	147	67
Do. specifications ..	112	52	Do. clearance .. ..	147	67
Do. spoil banks ..	124	61	Slips .. ..	156	70
Do. subsidiary works ..	126	62	Slopes, inner—bulges on ..	147	67
Order Book—on works ..	117	58	Do. curves .. ..	147	67
Outfall drain .. ..	63	30	Do. grassing of ..	151	68
Do. of pipe drain ..	89, 139	41, 64	Do. grazing on ..	153	69
Percolation from canals and distributaries ..	22	7	Do. silt on .. ..	147	67
Do. from irrigated areas ..	23	8	Do. slips .. ..	156	70
Perviousness of soils ..	11	3	Specifications—Open trench ..		
Pipe drains .. ..	75, 129	35, 62	pipe drain rubble drain ..	112	52-57
Do. approval to work ..	134	63	Soil—classification .. ..	40	15
Do. backfill .. ..	132	63	Do. classification, rates ..	45	19
Do. curves .. ..	133	63	Do. formation of ..	38, 39	15
Do. design of .. ..	87	40	Do. improvement of ..	110	51
Do. discharge of .. ..	87	40	Do. suitability statement ..	42	17
Do. headwalls .. ..	90, 140	42, 64	Do. survey, details of ..	39	15
Do. laying .. ..	131	62	Spoil banks .. ..	124, 154	61, 69
Do. length in progress ..	130	62	Staff for drainage schemes ..	32	12
Do. maintenance ..	136	63	Standing wave flume ..	80	39
Do. manholes .. ..	88, 141	41, 64	Stone pitching .. ..	147	67
Do. outfalls .. ..	89, 139	41, 64	Stones—bed .. ..	85	40
Do. specifications ..	112	52	Do. boundary .. ..	86	40
Do. trees .. ..	135	63	Do. furlong .. ..	86	40
Pipe lines—			Do. mule .. ..	86	40
Do. headwalls .. ..	162	72	Structure of soil .. ..	10	2
Do. maintenance of ..	160	71	Subartesian bores .. ..	67, 81	33, 39
Do. manholes .. ..	161	72	Subsoil—conditions at B.E. S.A. ..	19, 20	6, 7
Pipes—kinds of .. ..	138	63	Do. examination of ..	48	21
Do. quality of .. ..	137	63	Do. information, plotting of ..	51	25
Do. tests of .. ..	138	63	Do. 1½' and 4' M.I.B. ..	44	19
Pit work for cross sections ..	53	28	Do. relation of soil to M.I.B. ..	43	19
Plan—cross section .. ..	98	45	Do. survey, augers for ..	46	20
Do. detailed .. ..	96	43-44	Do. survey, rates for ..	47	21
Do. general index ..	93	43	Sub-soil water table—	24	8
Do. index—damage shown on ..	94	43	Do. control of .. ..	25	8
Do. longitudinal section ..	97	44	Do. effect of drains on ..	26	9
Do. preliminary, for survey work ..	36	14	Do. movement of ..	27	9
Do. progressive damage ..	95	43	Do. rise of .. ..	21, 23	7, 8
Do. required for project ..	92	42	Subsidiary works .. ..	126, 159	62, 71
Plotting—of data .. ..	70	34	Do. aqueducts .. ..	83	39
Do. of sub-soil data ..	51	25	Do. bedstones .. ..	85	40
Porosity of soil .. ..	10	2	Do. boundary stones ..	86	40
Prevention—better than cure .. ..	147, 165	67, 74	Do. bridges .. ..	78	38
Procedure for preparation of drainage schemes ..	34, 35	13	Do. causeways .. ..	79	38
			Do. falls .. ..	82	39
			Do. furlong stones ..	86	40
			Do. inlets .. ..	79	39
			Do. manholes .. ..	88	41
			Do. milestones .. ..	86	40



	Para.	Pages		Para.	Pages
Subsidiary works observation			Tardad — revetment in sand.	148, 149	67, 68
tubes ..	84	39	Technical Papers — previous	1	1
Do. ramps ..	77	37	Topography — miscellaneous		
Do. standing wave			details of ..	42	17
flumes ..	80	39	Trees ..	157	70
Do. syphons ..	83	39	Do. removal of ..	135	63
Suitability statement of soil.	42	17	Tubes — observation ..	84	39
Survey — damage ..	41	16	Type designs for project ..	99	45
Do. estimate ..	37	14	Type of drain ..	74	35
Do. miscellaneous ..			Valuation of land ..	105	48
details ..	42	17	Working drawings ..	108, 109	50, 51
Do. nala ..	54	28	Do. necessity for ..	107	50
Do. preliminary, plan			Working faces ..	113	57
for ..	36	14	Work — done, approval to ..	125	62
Do. soil, details of ..	39	15	Do. in water, effect of ..	116	58
Do. sub-soil, augers for	46	20	Do. not to be rushed ..	114	57
Syphons ..	83	39	Works — order book ..	117	58
Tarvad — curves ..	147	67	Do. subsidiary ..	126	62
Do. hurdles to encourage silting up ..	150	68	Zones — of root growth ..	15	4
			Do. of recuperation ..	66	31-32