

CENSUS OF INDIA, 1911.

VOLUME XXI

MYSORE.

PART I—REPORT.

BY

V. R. THYAGARAJA AIYAR, M.A.,

SUPERINTENDENT OF CENSUS OPERATIONS, MYSORE STATE.



BANGALORE:
PRINTED AT THE GOVERNMENT PRESS.
1912.

TABLE OF CONTENTS.

	PAGE
INTRODUCTION.	i-v
CHAPTER I. DISTRIBUTION OF THE POPULATION—	
General description	1
Area, population and density	3
Towns and villages	8
Houses and families	12
Subsidiary Tables	14
CHAPTER II. MOVEMENT OF POPULATION—	
Introductory	17
Review of the conditions of the decade	19
Growth of population in districts	22
Growth of population from 1871	28
Subsidiary Tables	30
CHAPTER III. MIGRATION—	
General remarks	33
Conditions inducing migration	36
Review of results	38
Migration since 1871	42
Subsidiary Tables	43
CHAPTER IV. RELIGION—	
Statistics	47
Hindus	52
Musalmans	56
Christians	56
Animists, Jains and other religions	58
Descriptive	60
Subsidiary Tables	62
CHAPTER V. AGE—	
Introductory	67
Factors affecting age-distribution	69
Mean age	70
Birth and death-rates	73
Comparison with European countries	75
Subsidiary Tables	76
CHAPTER VI. THE PROPORTION OF THE SEXES—	
Review of statistics	83
Census figures and vital statistics	86
Contrast with European countries	87
Theories regarding causation of sex	89
Subsidiary Tables	90
CHAPTER VII. CIVIL CONDITION—	
General review	93
Child marriage	95
Polygamy	98
Marriage customs	99
Subsidiary Tables	101
Terms of relationship	106

	PAGE.
CHAPTER VIII. EDUCATION—	
General review	107
Literacy by religion and caste	109
Progress of literacy since 1891	111
Departmental statistics	112
Subsidiary Tables	113
CHAPTER IX. LANGUAGE—	
General linguistic distribution	119
Vernaculars of the State	121
Dialects	124
Language, birthplace and caste	126
Subsidiary Tables	130
CHAPTER X. INFIRMITIES—	
General review	133
Insanity	135
Deaf-mutism	138
Blindness	139
Leprosy	141
Subsidiary Tables	144
CHAPTER XI. CASTE—	
Introductory	147
Caste system as prevalent in the State	149
Caste and sub-caste	151
Caste characterised in proverbs	153
Review of statistics	154
Ethnographic glossary	163
Subsidiary Tables	179
CHAPTER XII. OCCUPATION—	
Introductory	181
Scheme of classification of occupations	183
Urban and rural occupations	184
Village economy	187
Actual workers and dependants	189
Review of the statistics by principal orders and groups	191
Special Industrial Census	197
Occupation by caste	204
Subsidiary Tables	206
Appendix A (classified scheme of occupations)	220

CENSUS OF INDIA, 1911.

MYSORE.

INTRODUCTION.

"The population Census is used by the financier, the legislator, the merchant, and the commercial traveller; political economists turn to it for light on the development of industry, and on the change of numbers in each trade; those interested in social questions will study the ages and sex distribution in various districts or occupations; the sociologist and the biologist will need accurate information as to the growth of population and the change of age distribution." (Bowley's Elements of Statistics, p. 74.)

The Census with which this Report deals was the fifth regular enumeration of the population of the Mysore State, the first being in 1871. The dates on which the five Censuses were taken are noted below:—

14th November 1871	26th February 1891
17th February 1881	1st March 1901
10th March 1911.	

The last four have been synchronous with the Censuses taken in British India. As to the first, the date of the Census taken in the Madras Presidency was 15th November 1871 and that in the Bombay Presidency was 21st February 1872. In selecting the 10th March 1911 for taking the Census, the circumstances that influenced the decision were that on that night there was enough moonlight for the enumerators to finish their rounds before midnight and that on that date fewer fairs and festivals fell which would take the people away from their homes.

2. The boundaries of the State remained unchanged since 1901. The variation in the recorded area is due to more correct measurements during the resurvey operations. There was, however, slight internal redistribution of tracts from one district to another which has been taken into account for purposes of comparison between decade and decade. The areas of districts, taluks and other tracts given in Part II—Tables—are based on the figures embodied in the "Season and Crop Report" for 1908-09.

3. The Census on the present occasion was taken on lines similar to those of 1901. A full account of the method and the machinery adopted for the taking of the Census has been given in a separate Volume of Administrative Report. A brief summary is, however, given below of the salient features connected with the operations.

4. The first step in pre-census work was taken by the Government ordering the preparation of a list of all villages in the State in the prescribed form to facilitate the formation of Census divisions.

5. As in 1901, the instructions for the taking of the Census were issued in the form of a code with a view to simplify correspondence, to facilitate the communication of additions and corrections and finally to place on record for future use the procedure followed on the present occasion. The instructions contained in the code were generally on the lines prescribed for British India, with such

adaptations as local conditions required. This code was supplemented by the issue of a set of circulars on points not provided for in the code. A Kanare translation of the code was also issued to meet the requirements of enumerators ignorant of the English language. This was in three parts, the first part consisting of Sections I to IV; second, Section V; and the third, Sections, VI to

Census divisions.

6. The next thing taken up was the formation of Census divisions designated as Charges, Circles and Blocks; being constituted into one or more blocks; village (or Municipal Division), a number of villages constituting a Circle, and number of Circles constituting a Charge which in most cases was the entire taluk or sub-taluk itself, except where the taluk was unwieldy or contained big municipal towns like Bangalore, Mysore, etc. In such cases special charges were formed. In making these arrangements care was taken that the Revenue Administrative divisions were composed of entire Census divisions. A careful preparation of lists of villages comprised in each circle and provisional lists of houses situated in each block, completed this stage of the work.

House numbering.

7. The next step was the numbering of all houses and buildings. On the work and on the preparation of the lists of villages and houses referred to in the previous paragraph, the ordinary local, municipal and village revenue servants were employed. For purposes of house-numbering, a dwelling house was defined to be the dwelling place of one or more families; and simple rules were prescribed, the governing principle of which was that every place where people habitually live or are likely to be found on the night of the 10th March should be numbered, and that the numbers being in a consecutive series for each village or Municipal division should be placed in the order best calculated on the one hand to avoid the mistake of twice numbering the same premises, and on the other hand to guide the enumerator who would come later on the scene.

Appointment of Census Officers.

8. Census Officers were next appointed; a Charge Superintendent for each charge, a supervisor for each circle comprised in that charge, and enumerators with one or more blocks assigned to each. There were 111 Charge Superintendents, 2,572 supervisors and 28,514 enumerators for the whole State.

Every village was made up of one or more entire blocks, with a view to facilitate the arrangement of schedule books by villages on the morning after the Census.

Instructions and district Conferences.

9. In the matter of instructing supervisors and enumerators, Charge Superintendents, as instructed by the Census Superintendent, held classes of instruction in all convenient centres within their charges and they were also made to fill up practice schedule forms whereby their errors were pointed out and corrected as indicated. Before the issue of instructions for the training of Census supervisors and enumerators, the Census Superintendent held conferences with the respective Deputy Commissioners, Assistant Commissioners and Charge Superintendents at the several district headquarters (except at Shimoga, to which the Assistant Census Superintendent had been deputed), with a view to explain to them generally the nature of the work before them. Opportunity was then taken to train up the Charge Superintendents, by making them fill up practice schedules which had been got printed for the purpose. Men on the permanent pay lists of Government in all departments, except the Palace, Press, Plague and Medical, were, far as possible, required to be employed on Census work without prejudice to their ordinary duties. This was practicable in all the grades except in that of enumerators for which unpaid volunteer agency had to be employed to a large extent.

10. As a guide to the Census Officers a Census Calendar was issued showing the dates on which the several operations had to be commenced and completed up to 20th March 1911. **Census Calendar**

11. With Census divisions and agency thus constituted and the house-numbering checked with reference to the block lists, a preliminary enumeration was started. This consisted in writing up for each numbered house, the name and particulars of every person living in it, by personal enquiry at each house by the enumerator himself and entered in a schedule, forms of which were supplied to each enumerator made up into books at the Government Press, one for each block and adapted to the size of the blocks assigned to him. The forms of these schedules were the same as those prescribed for British India, except that a sub-column was opened for entry of sub-castes under the main head "Caste." The columns of the Mysore schedule of 1901 providing for more particulars relating to conjugal condition and for sect, gotra, etc., were omitted. The preliminary enumeration commenced on or about the 15th January 1911 in rural areas and the 1st February in urban areas and was completed with more or less speed everywhere so as to allow of the schedules being well examined and all errors rectified before the final enumeration on the 10th March 1911. **Preliminary enumeration.**

12. In the meantime, notices were issued to all residents of villages and towns warning them as far as possible to remain in their houses on the night of the 10th March, to keep the front doors of their houses open, to keep their dogs muzzled and to help the Census enumerator with a light when he would call. **Notice to the public**

13. To allow of all available officials helping in this final enumeration and to facilitate the preparation of provisional totals, all Public Offices, Courts and Schools in the State were closed for three days on the 9th, 10th and 11th March 1911. **Closing public institutions.**

14. Special arrangements were made for the enumeration of jails, lock-ups, hospitals and dispensaries. Special enumerators were appointed in respect of jattras, fairs and festivals at which pilgrims, visitors, shop-keepers, etc., were likely to remain on the night of the 10th March 1911. Travellers' enumeration tickets were issued to persons enumerated at these fairs and festivals. **Special arrangements for Census in Jails, et**

15. The final enumeration or Census proper consisted in the enumerator going round the areas assigned to him, schedule book in hand, rapidly comparing the preliminary record with the facts subsisting on the night of the 10th March and correcting it by adding or striking off names as may be found necessary. In a few forest tracts of Bangalore, Mysore, Chitaldrug and Kadur districts, where night census was not possible owing to the nature of the country and danger of wild beasts, the final Census was taken on the morning of the 11th March. **Final enumeration**

16. For the purpose of quickly ascertaining the totals of population, special arrangements were made for making up totals. Enumerators and supervisors met at assigned places on the morning of 11th March 1911, the returns were added up by blocks and the figures thus obtained for the smallest unit of Census operations were combined for a series of larger units, Circles, Charges, Taluks and Districts and Cities, to make up the first totals. These first totals were telegraphed by Deputy Commissioners to the Census Superintendent, Bangalore. Special arrangements had been made in the Superintendent's Office to make up and telegraph the provisional totals to the Census Commissioner for India, which was done on the 17th March 1911. According to the provisional totals, the population of the Mysore State including the Civil and Military Station, **Provisional totals.**

Bangalore, numbered 5,806,796 persons, consisting of 2,934,651 males and 2,872,145 females.

Final totals.

17. The final totals, which have been made up after a variety of tests, show a population of 5,806,193 consisting of 2,934,621 males and 2,871,572 females. This final figure shows a decrease of 603, being a difference of only about '01 per cent, testifying to the general efficiency of the Census arrangements.

Industrial Census.

18. Simultaneously with the general population Census, a special Census of industries of the State employing not less than 20 persons in each factory, workshop, etc., on the 10th March 1911, was taken to collect reliable information regarding recent industrial developments in the State. The results of this Census are embodied in Table XV-E in four parts. As a preliminary to this, a Register of Mines, Factories, etc., was compiled and printed.

Census Regulation.

19. The Census Regulation, No. I of 1910, framed on the lines of the India Census Act, was passed on the 24th of August 1910, with such alterations as local conditions required. In pursuance of the provisions contained in this Regulation, Government directed that Census should be regarded as of paramount importance while it lasted. The instructions to enumerators began with the declaration that the object of the present Census had no reference whatever to the superiority or inferiority of one religion or caste in relation to another. These instructions were published in the *Mysore Gazette* for general information.

How they operated.

20. These assurances and the publicity given to the instructions and the familiarity of the people with the previous enumerations of persons and agricultural stock, combined with their general intelligence went far to make the Census work of 1911 a matter of routine in which all classes co-operated readily and willingly.

Sanads.

21. Sanads were, with the sanction of Government, issued for good Census work to enumerators and supervisors, and some of the sannad-holders who were otherwise qualified were later on employed in the Abstraction Office.

Census of Railways.

22. The Rules and Regulations passed by the State applied, of course, only to the Bangalore-Nanjangud and Birur-Shimoga Sections of the Railway Line. The Census of the Ceded Railways and the Civil and Military Station, Bangalore, was conducted by the British authorities according to the instructions of the Madras Census Superintendent.

Abstraction, tabulation and compilation.

23. As soon as the provisional totals were made up, the schedules including those of the Ceded Railways and the assigned tract were properly packed and sent up to the Abstraction Office for abstraction, tabulation and compilation. There was only one Abstraction Office and this was located in the Fort at Bangalore and was equipped with the requisite record racks and other furniture, slips, etc., before the receipt of the schedules.

Code for tabulation.

24. A Code of instructions for slip-copying, slip-sorting and compilation was issued laying down the procedure for adoption in the Abstraction Office.

The Slip system.

25. The slip system of abstraction which was worked with much success in the Mysore Census of 1901 was adopted in 1911 also. The size of the slips was reduced and the entries were all made on only one side of the slip instead of being distributed on both sides of the paper as in 1901. This was rendered possible by the reduction in the number of columns of the schedule owing to the omission of additional particulars regarding the conjugal condition, sect, gotra, etc., provided for in 1901. As in the Mysore Census of 1901, sex and civil condition were denoted by pictorial busts printed on the slips.

INTRODUCTION.

26. As a preliminary to slip-copying, the schedule entries were carefully examined as a check on the provisional totals. This process was commenced on the 20th March 1911 and completed on the 13th May 1911.

**Examina-
tion of
schedules**

27. Slip-copying was commenced on the 4th May 1911 and was completed by the end of June 1911. The average number of slips copied per day by a copyist was 264 in the first week, 683 when the work was in full swing and the general average worked up to 473. The maximum number of copyists exclusive of checkers and readers employed at one time was 310. The slips for infirms were separately written and separate slips were employed for the abstraction of entries in the Industrial Census Schedules. The slips were copied in the English language. Non-officials were paid by the job at the rate of annas two for every 100 slips correctly written up, while the officials were required to fill up not less than 400 slips per day.

**Slip-copy
ing.**

28. The staff employed consisted of officials and non-officials who were formed into sections, each section consisting of one supervisor, eleven examiners, two or three attenders and two or three readers and checkers.

**The staff
employed**

29. The sorting of slips for the several Imperial and Provincial Tables was then commenced. It closely followed the lines indicated in the Imperial Census Procedure Code with a few alterations as explained in detail in the Code on Abstraction and Tabulation and in the Administrative Volume. The unit of sorting was the *Hobli* (or the Revenue Circle) and *Town* (Municipality) in the case of slips of the Hindu Religion and the *Taluk* (or *tahsil*) in the case of other religions. In the case of *Cities*, however, the *Division*, *Mohalla* or *Ward* was the unit of sorting. During the sorting stage, a section of establishment consisted of a supervisor, ten sorters and two attenders. A standard outturn was prescribed based on the results of previous test-sorting. The largest number of sorters employed at any one time was 220. Sorting was commenced in July 1911 and completed by the end of December 1911.

**Slip-sort
ing.**

30. The work of compilation was proceeded with concurrently with slip-sorting in the Abstraction Office and the manuscript copies of the tables were sent to the Census Superintendent's Office. The Tables were checked in the Superintendent's Office before being passed for print. The first manuscript Table completed was the Imperial Table VI on the 26th July 1911 and by the 5th March 1912 the last of the Tables was completed. Advance copies of the Tables Volume were sent to the Census Commissioner on the 25th May 1912.

**Compila-
tion.**

31. The Resolution of the Government of India in the Home Department Nos. 192-208, dated the 28th June 1910, prescribed 22 Imperial Tables and two Provincial Tables of which three of the former were optional (*viz.*, XV-C and D and XVI). The Government of His Highness the Maharaja of Mysore, in their Order No. Fl. 1577—Cen. 3-10-2, dated the 24th September 1910, directed the compilation of all the Tables except that of XV-D, and the preparation of Tables IX, XII-A, XIV and XVI for all castes, tribes and races instead of for selected castes. The forms and designations of these Tables will be found in Part II—Tables.

**Census
Tables
compiled.**

32. Besides Parts I (Report) and II (Tables Volume) of the Census of India Series, (a) the Volume of Talukwar Tables, (b) the Village Population Tables and (c) the Administrative Report Volume embody the results of the Mysore Census.

**Provincia
Volumes.**

Cost of Census.

33. As the operations connected with the Census of 1911 are still incomplete owing to the fact that the Administrative Report and the Talukwar and the Village Population Tables have yet to be printed and issued, it may be premature to estimate the exact expenditure incurred for the Census of 1911. But the figures given below may be taken as very nearly correct for all practical purposes :—

Census, 1911				Census, 1901					
Year	Expenditure			Remarks	Year	Expenditure			Remarks
	Rs.	a.	p.			Rs.	a.	p.	
1909-10 ...	4,890	0	0	} Actuals	1899-00 ...	8	0	0	
1910-11 ...	57,396	0	0		1900-01 ...	39,362	0	0	
1911-12 ...	71,600	0	0		1901-02 ...	82,431	0	0	
1912-13 ...	35,000	0	0		1902-03 ...	45,757	0	0	
Total ...	1,68,886	0	0	Estimated. (May be taken as almost correct.)	1903-04 ...	23,943	0	0	
					1904-05 ...	3,423	0	0	
					Total ...	1,94,924	0	0	

The sum of Rs. 1,68,886 shown against the Census of 1911 includes the total of all charges actually incurred, while the expenditure of Rs. 1,94,924 shown against 1901 does not appear to include the pay of the then Director of Statistics in charge of the Census Operations. If that item be included, the expenditure will stand as: 1911—Rs. 1,68,886, 1901—Rs. 2,63,324.

From the above, it will be seen that the cost of the Census Operations will work up to 5.5 pies per head of population in 1911 as against 9.1 pies in 1901 (or 7 pies per head in 1901 if the Director's pay be excluded). It may be added that in this State, all Census expenditure is "Departmental," there being no difference between that and the "Treasury" accounts.

Acknowledgments.

34. A Census Superintendent has, from the nature of his work, to be indebted to the labours of a very large number of officials and non-officials, so that it is not possible for him to express his acknowledgments adequately to all of them. However, in the collection and tabulation of the Census Statistics and in the writing of this Report, I am under obligations to (a) the Deputy Commissioners of Districts who carried out the preliminary Census arrangements in addition to their ordinarily heavy work; (b) Mr. Mrityunjaya Iyer, Assistant, until he went on leave, for efficient help in spite of his indifferent health; and to the Assistants Messrs. Sadasiva Rao and Krishnaswami Iyengar for zealous and able co-operation; and (c) my office establishment among whom I desire specially to mention the work of Head Clerk Sitaramaiya who brought to bear in the discharge of his duties his valuable experience of the Census of 1901, and also of Venkataramaiya, Deputy Clerk. To Mr. C. H. Yates, Superintendent of the Government Press, and to Mr. D. B. Ramachandra Mudaliar, Officiating Superintendent during the absence of Mr. C. H. Yates, I desire to express my acknowledgments for their hearty co-operation in the laborious task of printing the Census forms and passing the Tables and the Report through the Press. Lastly, I am much indebted to the Hon'ble Mr. E. A. Gait, C.S.I., C.I.E., I.C.S., Census Commissioner for India, for advice and criticism at all stages of the Census Operations.

BANGALORE,
2nd September 1912.

V. R. THYAGARAJA AIYAR.

REPORT

ON THE

CENSUS OF MYSORE STATE, 1911.

CHAPTER I.

DISTRIBUTION OF THE POPULATION.

I. GENERAL DESCRIPTION.

1. Mysore is an important Native State in Southern India, and is ruled by His Highness Colonel Sir Sree Krishnaraja Wadiar Bahadur, G.C.S.I., who was invested with full powers of administration on the 8th August 1902. Mysore City is the capital, but Bangalore City is the Administrative Headquarters, where are situated the Public Offices and Archives of the State and where reside most of the principal officers of the State. Adjoining Bangalore City is the Civil and Military Station, Bangalore, a tract of 13.54 square miles assigned to the British Government for the purposes of a Civil and Military Station and administered by the Hon'ble the British Resident.

2. The State is situated between 11°36' and 15°2' North Latitude and 74°38' and 78°36' East Longitude. Its area is 29,474.82 square miles including the area of the Civil and Military Station, Bangalore. The greatest length north and south is about 230 miles, the extreme length from east to west being 290 miles. The State is nearly equal in extent to Scotland whose area is 30,405 square miles and to Bavaria whose area is 29,292 square miles.

3. The Province is surrounded on all sides by the Madras Presidency except on the north and north-west where it is bounded by the districts of Dharwar and North Kanara respectively of the Bombay Presidency and towards the south-west where Coorg adjoins it. On the eastern and western frontiers the nearest points are respectively 120 and 8 miles distant from the sea.

4. The plateau of Mysore is situated like a wedge between the Eastern and Western Ghats and the Nilgiris where the Ghats converge. The general elevation rises from about 2,000 feet above sea level along the north and south frontiers to about 3,000 feet at the central watershed which separates the basin of the Krishna to the north from that of the Cauvery to the south. Harihar in Chitaldrug District is probably the lowest point in Mysore with an elevation of 1,830 feet, Mulainagiri in the Bababudans in Kadur District with a height of 6,317 feet being the highest point.

Isolated peaks of massive rock called "drugs" form a prominent feature of the country, while chains of hills running chiefly north and south divide the tableland into numerous valleys.

5. With the exception of a few minor streams which flow on the west into the Arabian Sea, the chief rivers, viz., the Tungabhadra on the north, the Cauvery on the south and the North Pennar, the Southern Pennar and the Palar on the east, fall into the Bay of Bengal. The electric power generated from the Cauvery falls at Sivasamudram is made use of to drive the machinery in five mines on the Kolar Gold Fields and in a woollen mill in Bangalore City.

There are about 30,000 tanks in the country, of which the largest is the Marikanave lake in Chitaldrug District, recently constructed at an outlay of 44 lakhs of rupees.

**Climate,
season
and rain-
fall.**

6. The climate of Mysore, in spite of its situation within the tropics, is temperate, due chiefly to its elevation above sea level, and, notwithstanding the prevalence of fever at certain seasons, is considered generally healthy all round the year. There are no extremes of temperature, the lowest minimum averaging $51^{\circ}6$ and the highest maximum $98^{\circ}1$ in the shade at Bangalore. The absolute minimum recorded at the same station up to date is $45^{\circ}8$ and the absolute maximum $100^{\circ}8$; and this gives an absolute range of 55° . The year is divided into three seasons, the rainy, the cold, and the hot. The first commences with the bursting of the South-West Monsoon, generally in the first week of June and continues to the middle of November, closing with the rains of North-East Monsoon. The cold season, which is generally free from rain, then commences and lasts till the end of February. The hot season sets in during March and increases in intensity to the end of May and is characterized by occasional thunderstorms which sometimes produce heavy downpours. At Bangalore the mean maximum and minimum temperatures are $82^{\circ}3$ and $65^{\circ}3$ respectively for the rainy months, $82^{\circ}7$ and $59^{\circ}1$ for the cold season and $92^{\circ}2$ and $67^{\circ}7$ for the hot season. The rainfall ranges from an average of over 330 inches at Agumbe Ghat on the crest of the Western Ghats to 14 inches at Nayakanhatti in Challakere Taluk, Chitaldrug District. The zone of heavy rain, 60 inches and over, is confined to the Western Ghats region from Sorab to Manjarabad. The average rainfall in Bangalore City is 36.5 inches.

**Agricul-
ture.—**

(a) Soils.

7. The soils in Mysore vary from black cotton to light sandy loam. A red-coloured loam or clay loam predominates. Differing from other soils of India, they are generally deficient in phosphoric acid. In the hilly virgin forest region in the west of the State, where coffee is largely grown, the percentage of nitrogen is very high. In the eastern portion of the State where the land has been cultivated for a long time, less nitrogen is found. The surface is generally undulating (though flat in some parts and very hilly in others), here and there broken up by rocky hills and gravelly ridges.

(b) Crops.

Rice, coffee, cardamoms, pepper, arecanut and betel-leaf are cultivated in the forest region of heavy rainfall in the extreme west; ragi, cholam, pulses, oil plants, cotton, tobacco, rice and sugarcane being grown in the other parts of the State. Among the districts, Mysore, Bangalore and Tumkur grow the most ragi, Kolar, Hassan and Chitaldrug coming next in order. Mysore and Chitaldrug have the largest area under oilseeds and grow the most tobacco. Chitaldrug is pre-eminently a cotton-growing district, and it also takes the principal lead in the limited area under wheat. Shimoga is the chief rice-growing district in the State followed by Mysore. Next in order come the districts of Hassan, Kadur, Tumkur, Kolar, Bangalore and Chitaldrug. In the Shimoga District the cultivation of rice depends on the rains alone unlike Mysore which has for this purpose a splendid system of irrigation channels. Hassan, Kolar and Shimoga are the principal sugarcane districts in the State. Tumkur stands first in the matter of garden cultivation, cocoanut and arecanut forming the chief products. Kadur and Hassan are almost exclusively coffee districts. From the proportional figures given in Subsidiary Table I of this chapter, it will be seen that ragi takes up more than one-third of the gross cultivated area, rice and gram coming next in order as regards the extent cultivated.

**Mines and
minerals.**

8. Six gold mines were at work in the Kolar Gold Fields on 1st March 1911, and of these four pay dividends. The machinery in five of these mines is driven by electric power. Manganese ore is extracted in Shimoga District, and iron ore smelted in several places in the State.

**Revenue
and ex-
penditure.**

9. The total revenue and receipts of the State for the year 1910-11 were Rs. 2,46,73,315, the total expenditure being Rs. 2,22,70,758.

**Natural
Divisions.**

10. In Mysore, there are two regions of distinct character: the hill country called the *malnad* in the West; and the open country on the East known as the *maidan*. Some of the characteristics of the *malnad* country are tersely summed up in an old Kanarese ballad of which the following is a free rendering:—

“Twelve thousand hills,
Six thousand godlings,
In every forest champaka,
In every village, a local chief.”

For rough purposes, the *malnad* may be regarded as identical with Hassan, Kadur and Shimoga Districts which, however, contain a few *semi-malnad* and *maidan* taluks.

11. For administrative purposes, the Province is divided into 8 districts comprising 68 taluks excluding the Jahgirs of Yelandur and Sringeri and reckoning the sub-taluks (9 in number) as parts of the taluks to which they are attached. The three districts of Shimoga, Kadur and Hassan which mostly comprise either *malnad* or *semi-malnad* taluks are shown as the Western Division in the course of this Report and the Tables referred to therein, while the five districts of Bangalore, Kolar, Tumkur, Mysore and Chitaldrug corresponding to the *maidan* portion of the Province are shown as the Eastern Division. Administrative Divisions

For the purposes of the Imperial Census Code, Bangalore City, Kolar Gold Fields, Mysore City and the Civil and Military Station, Bangalore, have been classed as cities, the last alone containing more than 100,000 inhabitants and the rest being treated as cities in accordance with the discretion given to the Provincial Census Superintendent in the Imperial Code. The statistics for cities are, except where otherwise stated, given separately from the districts in which they are situated.

II. AREA, POPULATION AND DENSITY.

12. The statistics relating to area, population and density are contained in Imperial Table I, Subsidiary Tables I and II of this Chapter and in Provincial Table I. Before proceeding to discuss the statistics of districts and taluks, it will be convenient to recapitulate the main facts regarding the State and the two Natural Divisions. Reference to Statistical Table

13. The population of the Province on the 10th March 1911 was 5,806,193 persons consisting of 2,934,621 males and 2,871,572 females and was distributed into 16,831 towns and villages with 1,158,004 occupied houses. The mean density of population in the State is 197 per square mile and compares with the densities of certain Provinces in India and Europe as in the subjoined diagram. From Imperial Table I and Subsidiary Tables I and III, it will be observed that the Eastern Division which contains 67·8 per cent of the total area (excluding Civil and Military Station, Bangalore) and 74·8 per cent of the total population (excluding Civil and Military Station, Bangalore) is larger in extent and much more populous than the Western Division, and that the two divisions differ markedly from each other in several respects. (a) Analysis by Natural Divisions.

Diagram showing the Density of Population (i.e., average number of persons per square mile) in Mysore and certain other Provinces and Countries.
Scale 1" = 80 persons.

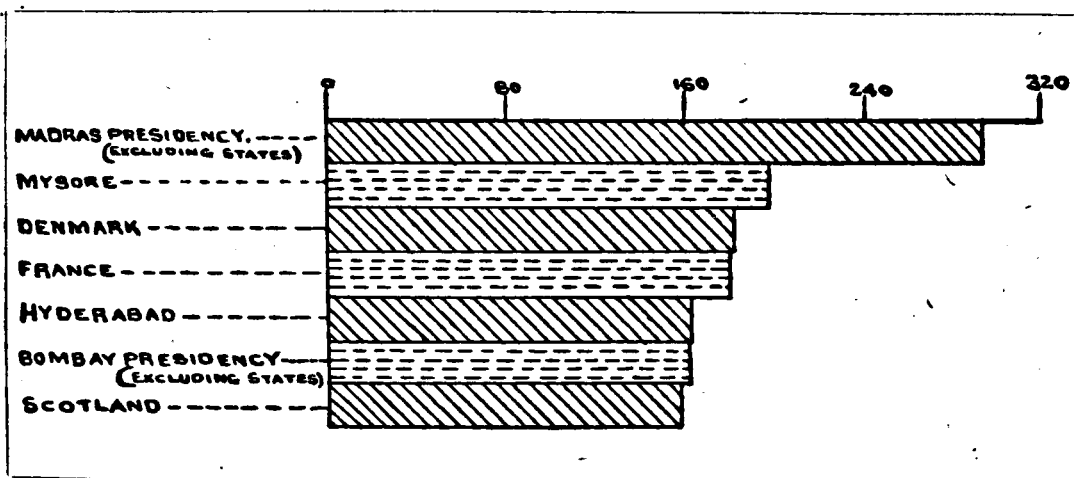

The annual rainfall in the Eastern Division averages 25·9 inches against 59 inches in the Western Division, the percentage of cultivable area to total area in the Eastern Division is 48·4 against 39·2 in the Western Division, the percentage

of gross cultivated area under rice in the Eastern Division is 7.6 against 26.3 in the Western Division, and the number of towns in the Eastern Division is 64 against 26 in the Western Division. The density per square mile is 214 in the Eastern Division against 151 in the Western Division. Similar differences between the two divisions, as regards longevity, civil condition, literacy, mother-tongue and occupations of the people are dealt with in Chapters V, VII, VIII, IX and XII respectively of the report.

(b) Analysis by Districts and Cities.

14. Of the several districts, the Mysore District has the largest area, then come Chitaldrug, Tumkur, Shimoga, Kolar, Bangalore and Kadur in the order named, Hassan taking the last place. As regards population, the Mysore District, which is the land of perennial rivers, again takes the lead followed by Bangalore, Kolar, Tumkur, Hassan and Shimoga in the order named, Kadur being the least populous.

The appended diagram shows the ratio which the area and population of each district bear to the total area and population of the State.

DIAGRAM SHOWING THE RELATION OF AREA AND POPULATION.

EACH WHITE DIAMOND REPRESENTS 1 PER CENT OF THE TOTAL AREA OF MYSORE STATE INCLUDING CIVIL AND MILITARY STATION, BANGALORE.

EACH BLACK DIAMOND REPRESENTS 1 PER CENT OF THE TOTAL POPULATION OF MYSORE STATE INCLUDING CIVIL AND MILITARY STATION, BANGALORE.

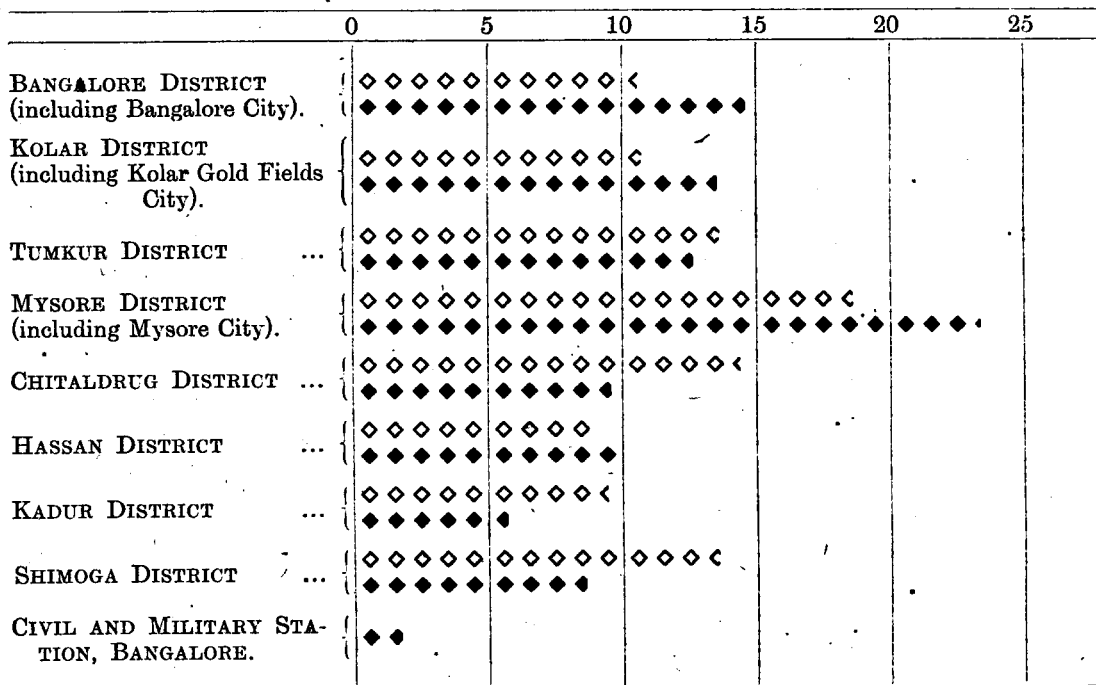

The density of population is "an abstract measure of the isolation, proximity or crowding of the population*" and may in certain cases afford an index of the pressure of population on the soil. As observed in para 39 of the India Census Report of 1901, the mean density is "a mere arithmetical expression which covers an infinite variety of different conditions and is of use mainly as an arbitrary standard or line of division in relation to which a large body of figures may be grouped or arranged."

The mean densities of population in the several districts differ from the mean density for the State, four of the districts having a mean density higher, and the other four less, than that of the State.

These facts are illustrated in the annexed map showing the densities of the several districts. Of the four districts having a higher density than the mean (197) for the Province, Bangalore District which is noted for its fertile soil and salubrious climate and is intersected by Railways radiating from Bangalore City in four directions stands first with the maximum density of 276 persons per square

* Professor Willcox in the Essays on the American Federal Census of 1890.

mile. Then come next in order, Kolar District in which

MAP OF MYSORE.

Showing Density of Population per square mile in the several Districts.
Scale 60 miles = 1".

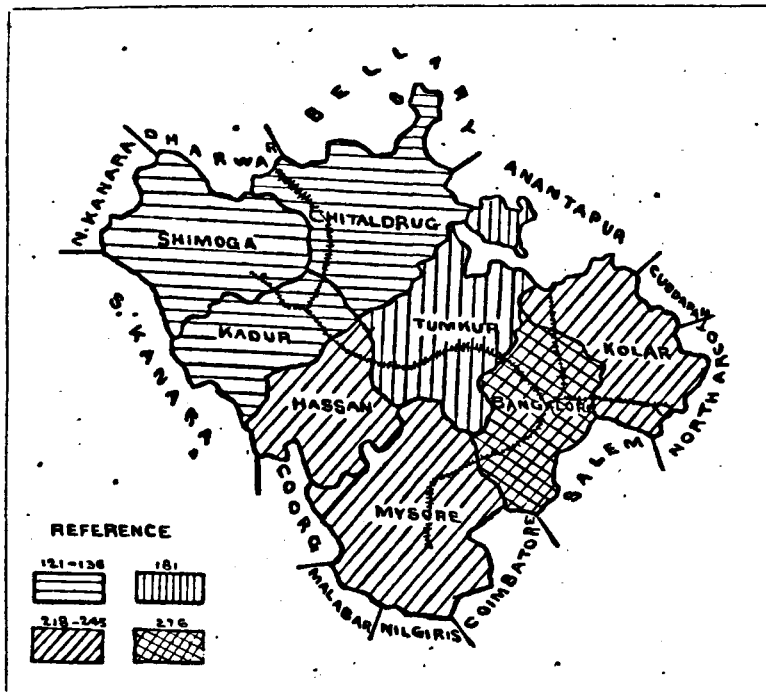

the irrigation under tanks has been more fully developed than in any other district and which contains the Kolar Gold Fields, Mysore District in which the river irrigation is more fully developed than in any other district, and Hassan District with its Hemavati valley and coffee industry. Of the four districts having a lower density than the mean, Kadur District which has been described as pre-eminently the *malnad* country and is the least populous, has the least density of 121 persons per square mile.

The density of population in each district will be found on analysing Subsidiary Table I to depend mainly on three factors:—

- (a) Percentage of net cultivated area to total area.
- (b) Percentage of cultivated area which is irrigated.
- (c) Percentage of gross cultivated area under ragi.

In the *maidan* districts of the Eastern Division, density varies as rainfall, but this does not hold good in the case of the districts of the Western Division, where, in fact, density varies inversely as rainfall owing to the configuration of the surface.

Among cities the Civil and Military Station is the most populous but Bangalore City has the greatest density per square mile.

15. Provincial Table I will be found to give in column 12 the density in the taluks and cities of the State, the maps appended illustrating, except in the three taluks specified below, the variation of density in the taluks of the two Natural Divisions.

As regards the three taluks of Bangalore, Mysore and Bowringpet, the densities given in Provincial Table I will be found to differ from those in the second map, as the populations of the cities have in the map been taken into account while they have been omitted for calculating the density of the taluks in the Provincial Table I.

In the Eastern Division, the taluk of the highest density is the Bangalore Taluk including the City; but if the cities are excluded, T.-Narsipur Taluk heads the list with a density of 410 per square mile, Hosdurga and Hiriyur being the taluks of minimum density with 99 per square mile. In the Western Division, Arkalgud Taluk with a maximum density of 312 per square mile ranks first, the taluk of Nagar having the minimum density of 71 per square mile.

In the T.-Narsipur Taluk, the annual rainfall is moderate, but sufficient, averaging 26.5 inches, the climate is salubrious, the soil is generally good, the Cauvery flowing from one end to the other, and the irrigated area, being 15.7 per cent of the total occupied area. The extent of hill, forest and other unculturable land is not large, the percentage to total area being 22.5. The extent of culturable waste is also inappreciable. All these factors go to produce the high density of 410.

(c) Analysis of Density in Divisions, Districts and Taluks.

MAP OF MYSORE.

Eastern Division.

Shewing Density of Population per square mile in the several taluks.

Scale 40 miles = 1".

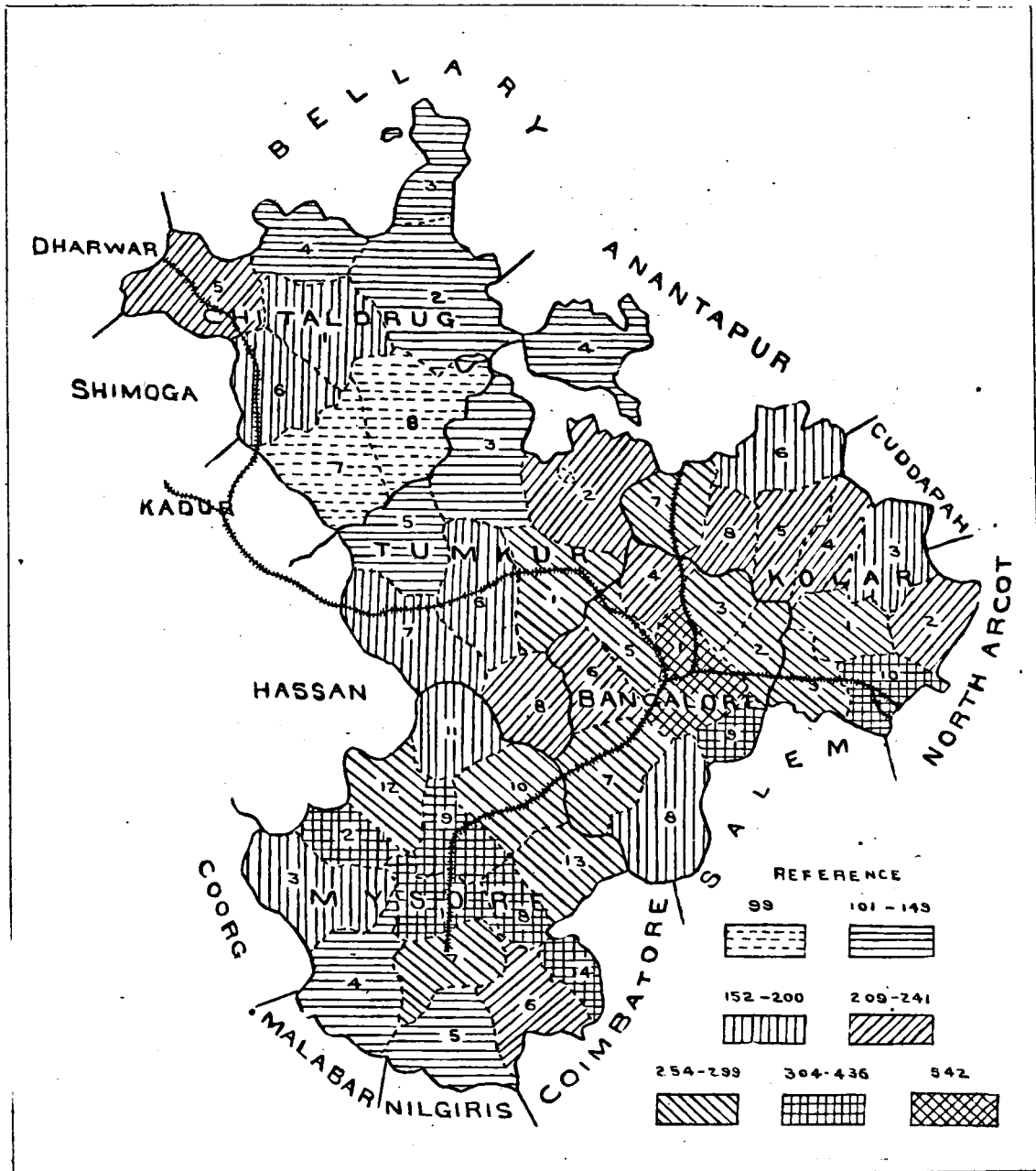

REFERENCES.

BANGALORE DISTRICT.

1. Bangalore.
2. Hoskote.
3. Devanhalli.
4. Dodballapur.
5. Nelamangala.
6. Magadi.
7. Channapatna and Closepet (Sub).
8. Kankanhalli.
9. Anekal.

KOLAR DISTRICT.

1. Kolar.
2. Mulbagal.
3. Srinivasapur.
4. Chintamani.
5. Sidlaghatta.
6. Bagepalli and Gudibanda (Sub).
7. Goribidnur.
8. Chikballapur.
9. Malur.
10. Bowringpet.

TUMKUR DISTRICT.

1. Tumkur.
2. Maddagiri and Koratagere (Sub).
3. Sira.
4. Pavagada.
5. Chiknayakanhalli.
6. Gubbi.
7. Tiptur and Turuvekere (Sub).
8. Kunigal.

MYSORE DISTRICT.

1. Mysore.
2. Yedatore.
3. Hunsur.
4. Heggaddevankote.
5. Gundlupet.
6. Chamrajnagar.
7. Nanjangud.
8. T. Narsipur.
9. Seringapatam and French Rocks (Sub).
10. Mandya.
11. Nagamangala.
12. Krishnarajpete.
13. Malvalli.
14. Yelandur Jahgir.

CHITALDRUG DISTRICT.

1. Chitaldrug.
2. Challakere.
3. Molakalmuru.
4. Jagalur.
5. Davangere and Harihar (Sub).
6. Holalkere.
7. Hosdurga.
8. Hiriyur.

In Hiriyur on the other hand the annual rainfall is precarious, averaging

MAP OF MYSORE.
Western Division.

Showing Density of Population per square mile in the several taluks.
Scale 40 miles = 1".

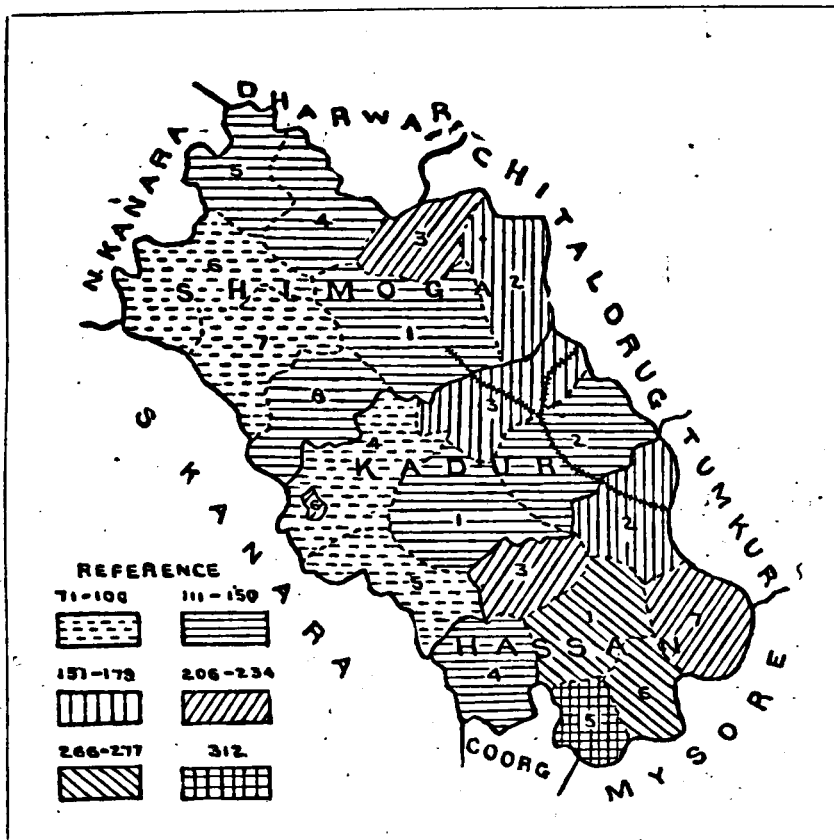

17.5 inches, the soil is stony and sterile and the extent of hill, forest and culturable waste is large exceeding 45 per cent of the total area.

In Arkalgud, the conditions are somewhat similar to those in T.-Narsipur Taluk.

In Nagar, although the annual rainfall is heavy amounting to 166.8 inches and the area under rice is 89 per cent of the total area cropped, these factors are more than counterbalanced by the existence of a large area of forest and hill forming 82.1 per cent of the total area and the unhealthiness of the climate at certain seasons of the year.

HASSAN DISTRICT.	REFERENCES.	SHIMOGA DISTRICT.
1. Hassan and Alur (Sub).	1. Chikmagalur.	1. Shimoga and Kumai (Sub).
2. Arsikere.	2. Kadur.	2. Channagiri.
3. Belur.	3. Tarikere.	3. Honnali.
4. Manjarabad.	4. Koppa and Yedahalli (Sub).	4. Shikarpur.
5. Arkalgud.	5. Mudgere.	5. Sorab.
6. Hole-Narsipur.	6. Sringeri Jahgir.	6. Sagar.
7. Channarayana.		7. Nagar.
		8. Tirthahalli.

A careful study of the maps showing the density of population in the two divisions will bring out the following facts:—

1. Most of the taluks in the density scale 300-450 possess river irrigation, the rest owing their high density to either the existence of cities or superior tank irrigation.
2. Within each district and on the border between two adjoining districts, taluks in any other density scale, say 100-150, are mostly contiguous to each other, the similarity of density being due to the existence of similar features such as, soil, climate, proximity to Railways, irrigation facilities and the like.

16. We shall conclude this part of the subject with the following general remarks by Dr. H. R. Mill regarding the density of population. (Article "Geography" in the 11th edition of the Encyclopædia Britannica.)

"The population which can be permanently supported by a given area of land differs greatly according to the nature of the resources and the requirements of the people. Pastoral communities are always scattered very thinly over large areas; agricultural populations may be almost equally sparse where advanced methods of agriculture and labour-saving machinery are employed; but where a frugal people are situated on a fertile and inexhaustible soil, such as the deltas and river plains of Egypt, India and China, an enormous population may be supported on a small area. In most cases, however, a very dense population can only be maintained in regions where mineral resources have fixed

Factors influencing density of population.

the site of great manufacturing industries. The maximum density of population which a given region can support is very difficult to determine; it depends partly on the race and standard of culture of the people, partly on the nature and origin of the resources on which they depend, partly on the artificial burdens imposed and very largely on the climate."

III. TOWNS AND VILLAGES.

**Statistics
re Towns
& Villages.**

17. The statistics relating to urban and rural population are contained in Imperial Tables III, IV and V and in Subsidiary Tables III, IV, V and VI of this chapter.

**Distinction
between
"Towns"
& "Villages."**

18. To understand the statistics it is necessary to differentiate between "towns" and "villages."

The definition of "town" adopted at this Census was the same as the one followed at the last Census and was as follows:—

"Town includes every Municipality of whatever size and every continuous collection of houses (if any such exists) which is not a Municipality but is permanently inhabited by not less than 5,000 persons and which the Provincial Superintendent may decide to treat as a town for Census purposes."

The definition of "Village" will be given later on; but it is sufficient to observe at this stage that villages are mostly inhabited by agriculturists and are units of Land Revenue Administration, while towns are governed under Municipal or other special laws and are in some cases centres of trade and industry.

There are 90 municipalities in the State including the Civil and Military Station, Bangalore, against 125 in 1901; of these, three, *i.e.*, Bangalore City, Mysore City and the Civil and Military Station, Bangalore, have been treated as cities.

The Kolar Gold Fields tract, which is not a municipality but is a Sanitary Board Area governed by a special Regulation, has also been classed as a city.

The decline in the number of municipalities from 125 in 1901 to 90 in 1911 is due to the passing of a Municipal Regulation in 1906 under which a reclassification of municipalities has been effected. The number of municipalities in 1891 and 1881 was 99 and 84 respectively, including the Civil and Military Station, Bangalore.

In the whole State there are only two villages each with a population of more than 5,000, Robertsonpet in Kolar District and Turuvanur in the Chitaldrug District; but it has not been considered necessary to class them as towns. It may be interesting to record the fact that in 1901 there were two such villages, Belakvadi and Agara in Mysore District, and that they have not maintained the same population at this Census.

**Number of
Towns,
their size
and sex
propor-
tions.**

19. The total number of towns (including cities) in the State is 91 against 128 in 1901, the total urban population being 658,329 persons and giving a percentage of 11.3 on the total population. Subsidiary Table V shows the classification of these towns according to size, there being only one town with a population exceeding 100,000. From this table, it will be further observed that for every thousand males living in towns there are 942 females, and from Imperial Table V it will be seen that this ratio of male numerical superiority holds good in the case of the urban population of all the districts, except Bangalore District (excluding city) where the females outnumber the males. Subsidiary Tables III and IV show that the average population per town in the State is 7,234, the marked difference between the conditions in Eastern and Western Divisions being indicated by the average population of 3,779 per town in Western Division against 7,176 in Eastern Division.

**Urban po-
pulation
distribut-
ed by
religion.**

20. Of the total urban population 500,159 are Hindus, 108,996 are Musalmans, 42,030 are Christians and 3,536 are Jains, the rest belonging to other religions (Imperial Table V); or in other words, of every 100 persons of urban population, 76 are Hindus, 17 are Musalmans, 6 are Christians. Subsidiary Table IV gives the ratio which the urban population of each main religion bears to the total population of that religion and shows that while the bulk of the Christians live in towns only 94 out of 1,000 Hindus do so. Of the 101 Parsis in the State 100 reside in towns.

21. We shall now proceed to trace the variation of urban population in each division. Variation of population in Towns.

1. EASTERN DIVISION:

There are 64 towns in this division inclusive of three cities and excluding the Civil and Military Station, Bangalore. All the three cities show increases of population during the decade. Bangalore City possesses excellent water-supply, drainage and lighting systems, is a railway centre and contains two mills besides other industrial concerns. Its population fell from 80,285 in 1891 to 69,447 in 1901 owing to the ravages of plague, but has now regained the normal strength. The increase of 27·3 per cent in the population of the Kolar Gold Fields during the intercensal period is an indication of the prosperity of the gold mining industry. It was during this decade (*i.e.*, in June 1902) that the industry received an impetus by the substitution for steam power driving the machinery, of the cheaper electric power generated from the Cauvery falls at Sivasamudram. In the Mysore City the increase (4·7 per cent) is moderate and is due to the operations of the Mysore City Improvement Trust Board during the decade; but the population is still less than what it was in 1891.

Each of the districts comprising the division will now be dealt with in turn:—

There are twelve towns (excluding Bangalore City) in this district and most of them have suffered a loss of population during the decennium. Nela-mangala, Tyamagondlu, Channapatna, Closepet, Kankanhalli and Anekal were more or less infected with plague on the date of final Census and many persons were living in sheds outside the towns. Hoskote has partly regained the population which it had lost in 1901 but its population has not yet come up to what it was in 1891. (a.) Ban-galore District.

Of the 11 towns in the district (excluding Kolar Gold Fields), 8 towns show an increase of population. The decrease of population in Kolar and Mulbagal is due to the prevalence of plague in them and their partial evacuation on the date of the Census. Although Chikballapur shows a large increase of population during the decennium, it has not yet regained the population which it had in 1891 and of which it lost nearly half in 1901 owing to plague. The decrease in Sidla-ghatta is due to the recrudescence of plague in it several times during the intercensal period. (a.) Kolar District.

Of the 10 towns in the district, 4, *i.e.*, Sira, Maddagiri, Koratagere and Turu-vekere, show an increase of population during the decade, the rest showing a decrease. Tumkur, Gubbi, Tiptur and Kunigal were partially evacuated on the date of the final enumeration owing to the outbreak of plague in them. The frequent appearance of plague in Chiknayakanhalli during the decade has led to a diminution of its population. (a.) Tum-kur Dis-trict.

Of the 19 towns in this district (excluding Mysore City), 9, *i.e.*, (1) Nanjan-gud, (2) Chamrajnagar, (3) Gundlupet, (4) Talkad, (5) T.-Narsipur, (6) Nagaman-gala, (7) Saligram, (8) Krishnarajpete and (9) Heggaddevankote, show an increase of population during the decade, the rest showing a decrease. The decreases are specially heavy in (1) Seringapatam, (2) Malvalli, (3) Hunsur, and (4) Yedatore. Plague and malaria account for the decrease in Seringapatam and Yedatore, while a falling birth-rate and an increasing death-rate due to the prevalence of plague explain the decreases in other towns. (a.) My-sore Dis-trict.

Of the 9 towns in this district, 6, *viz.*, (1) Chitaldrug, (2) Holalkere, (3) Jaga-lur, (4) Molakalmuru, (5) Hiriyur and (6) Challakere show an increase of population. The decreases in Davangere, Harihar and Hosdurga are accounted for by the prevalence of plague in them at the time of Census. (a.) Chital-drug Dis-trict.

Davangere is an important seat of trade and there has been a steady increase of population in it from 1881 to 1901.

2. WESTERN DIVISION.

There are no cities in this division. Of the 8 towns in the Hassan District, 3, *i.e.*, (1) Hole-Narsipur, (2) Arkalgud and (3) Arsikere, show an increase of population, the rest showing a decrease. The prevalence of plague at the time of (b.) Has-san Dis-trict.

In 1901, the corresponding percentages were 13 and 87 respectively, and the comparison shows that there has been a slight decrease of the population in the towns during the decade. This decrease is due to the decline in the number of towns during the decade—explained elsewhere—and to the prevalence of plague at certain seasons in many of the towns, leading to the movement of the urban population into villages. From Subsidiary Table III, it is apparent that of the urban population 47 per cent live in towns with a population of 20,000 and over, 20·4 per cent live in towns with a population of from 5,000 to 10,000, and 29·1 per cent reside in towns with a population of under 5,000. Of the rural population, 53·5 per cent live in villages with a population of under 500, 42·3 per cent living in villages with a population of from 500 to 2,000.

24. In England and Wales, 78 per cent of the population live in towns and only 22 per cent live in villages; in Scotland and Ireland, the urban population forms 69·8 per cent and 31 per cent respectively of the total population. In Baroda State the urban population forms 19·9 per cent of the total population, the corresponding percentages for Madras and Bombay Presidencies (including States) being 11·7 and 18·1 respectively. **Comparison with Province in Europe and India**

25. Readers of Mr. Baden Powell's and Sir T. Morison's works are familiar with the detailed descriptions of the types of Indian Village and the Village Community from the Administrative and Economic points of view respectively. This chapter is, however, concerned with villages as containing aggregates of population, and the barest outlines will therefore suffice. **Definition of "Village."**

In the Provincial Census Code, village was thus defined as in 1901:—

"Village" means the area constituted into a village by the Revenue Survey Department and includes all land belonging to such village and all hamlets, if any, (*i.e.*, groups of houses called by different names) formed within such area. In the case of some alienated tracts (Inam and Kayamgutta villages) to which the Survey operations have not been extended, the term 'village' shall refer to the 'asli' or parent village and include all hamlets which are subordinate thereto without forming independent units for revenue purposes.

It includes 'Bechirakh,' 'Amanikere,' 'Nalahanta,' 'Coffee Estate,' 'Kavals,' separately measured and mapped and other units of Revenue Administration, though they may contain no or but a few permanent human habitations."

A description of the powers and duties of the village officials (patel, shanbhog, etc.), will be found in paras 1 to 6 of Chapter IV of the Mysore Revenue Manual.

26. In the *maidan*, the village site forms a distinct and generally the central portion of the village and is surrounded by the cultivated and waste lands of the village. Each village site ordinarily contains the "Holgeri" where the depressed classes live. To every large house in the village site is annexed a 'hittal' or backyard. **Village sites.**

In the *malnad*, villages are often such only in name, being composed of scattered homesteads at various distances apart. Every large village whether in the *maidan* or *malnad* usually contains a temple, an irrigation tank and a village *chavadi*.

The mean distance between adjacent villages in the State varies from 1·13 mile in Kolar District to 1·97 in Chitaldrug District, the mean for the State being 1·43 mile.

27. The average area per village in the Eastern Division is 1·46 square mile, against 1·66 square mile in the Western Division, the average for the whole State being 1·52 square mile. The average area per village in the districts varies from ·92 square mile in Kolar District to 2·77 square miles in Chitaldrug District. **Average area and population per village in the Natural Divisions.**

The average population per village in the Eastern Division is 326 against 265 in the Western Division, the average for the whole State being 308.

The average population per village in the districts varies from 435 in Mysore District to 239 in Hassan and Kolar Districts.

28. From Imperial Table III combined with Subsidiary Table V, it will be seen that there are 13,999 villages, each with a population of under 500; 2,097 villages each with a population of between 500 and 1,000; 561 villages with a population of between 1,000 and 2,000; 81 villages with a population of between 2,000 and 5,000. About 47 per cent of the total population live in villages with **Villages classified according to population.**

* For a description, from an economic point of view, of an ordinary village in Mysore, see Chapter XII of this Report.

a population below 500, villages with a population of from 500 to 1,000 accounting for about 25 per cent of the total population and villages with a population ranging between 1,000 and 2,000 containing 13 per cent of the population.

IV. HOUSES AND FAMILIES.

Descriptions of dwellings: Definition of "House" etc.

29. Imperial Table I, Subsidiary Table VII and Provincial Table I will be found to give details of occupied houses and house-room.

The dwellings of the people are generally of mud, one-storeyed and with few openings outwards except the door but possessed of courtyards within, surrounded with verandahs and open to the sky. In the better class of houses, these are well paved and drained, while the wooden pillars are elaborately carved or painted. The cattle are generally tied in a separate part of the house and occasionally in separate sheds. The huts of the Holeyas, Madigas and other lower classes are thatched; but the houses of the higher classes are covered with either terraced or tiled roofs, the latter more especially in the *malnad* where the rainfall is heavy. In the *malnad*, the dwelling houses are few and far between. Since the appearance of plague in the State in 1898 great attention has been paid to the opening out of extensions in congested areas and to the erection of sanitary dwellings.

The definition of 'House' adopted at the present Census was the same as the one followed in 1901 and ran thus:—

"A dwelling house is defined to be the dwelling place of one or more families with their resident servants having a separate principal entrance from the common way. The common way, it must be remembered, is not necessarily a public way.

* * * Under such circumstances, the subordinate tenements should be separately numbered, the series being also painted on the main entrance to ensure that none of the subordinate tenements is overlooked."

According to the definition, the occupied house is synonymous with the tenement occupied by a family. Mills, factories, bar and silledar lines, jails, schools, plantations containing houses, mutts, makans, temples, shops; chat-trams, dharma-salas, travellers' bungalows, enclosed cart-stands, temporary sheds for accommodation of coolies, etc., were also numbered in the same way as houses. The total number of houses thus censused in the State was 1,509,265, the ratio borne by the number of occupied houses to the total number of houses censused being 76·7 per cent. In the Civil and Military Station, Bangalore, the houses were numbered in accordance with the instructions issued by the Superintendent of Census Operations, Madras Presidency. These differed from the above in the direction that one number should be given to a house even though two or more families were living in different rooms of the same house. This difference must be borne in mind whenever the figures for Civil and Military Station, Bangalore, come under examination.

Number of occupied houses per square mile.

30. The average number of occupied houses per square mile in the State has increased from 38 in 1901 to 39 in the present Census and may be accepted as a proof of growth in the number of houses in the extensions and elsewhere during the past decade. The increase in the average from 1881 has been steady. In the Western Division, however, the number of houses per square mile has fallen from 31 in 1901 to 30 in the present Census, while in the Eastern Division the number has increased from 40 in 1901 to 43 in 1911.

On reviewing by districts and cities, it will be seen that the average number of houses per square mile has increased in all the districts and cities of the Eastern Division except Mysore City, that it has remained stationary in the Hassan and Shimoga Districts and that it has decreased by one in Kadur District and by 255 in the Civil and Military Station, Bangalore.

The average number of houses per square mile in each district corresponds approximately with the density of population in each district.

Number of persons per house or average size of families.

31. The average number of persons per house in the State is 5 and has remained stationary since 1901.

On analysing by districts and cities, the average will be found to have increased from 5 to 6 in the Civil and Military Station, Bangalore, while in the Kolar Gold Fields, it has decreased from 5 to 4. Elsewhere the average has remained stationary.

The above facts lead to the conclusion that the increase in the number of houses has kept pace with the increase of population during the decade and that there is generally little or no overcrowding except perhaps in parts of the four cities. It is remarkable that the average number of persons per house in the State is very nearly the same as in Ireland for 1911 (5·1) and in England and Wales for 1901 (5·19). This identity of averages is not, of course, indicative of similarity in the urban and rural conditions of the countries compared.

Among the Hindus who form the bulk of the population in the State, the Joint Family System is the rule and all the coparceners generally live in the same house. The partition generally takes place on the death of the parents but may be deferred in exceptional cases. The size of the family varies generally with the caste or tribe and with their material condition.

The number of married women of fifteen years and upwards in the State is 1,126,379 (*vide* Imperial Table VII). If every one of these married women had a separate house, the number of occupied houses would be 1,126,379, it being assumed that the married women at age-period 0-15 would live with their parents or parents-in-law. As a matter of fact, the number of occupied houses in the State is 1,158,004 or 1,028·1 per 1,000 married women.

SUBSIDIARY TABLES.

I.—DENSITY, WATER SUPPLY AND CROPS.

District and Natural Division	Mean density per square mile in 1911	Percentage of total area		Percentage to cultivable area of		Percentage of cultivated area which is irrigated	Normal rainfall (inches)	Percentage of gross cultivated area under				
		Cultivable	Net cultivated	Net cultivated	Double cropped			Rice	Ragi	Cholum	Gram (pulse)	Other crops (including other pulses)
1	2	3	4	5	6	7	8	9	10	11	12	13
Mysore State, including Civil and Military Station, Bangalore ...	197	45.4	32.8	72.3	3.0	15.4	38.3	12.3	35.5	9.6	12.0	30.6
Mysore State, excluding Civil and Military Station, Bangalore ...	194	45.4	32.8	72.3	3.0	15.4	38.3	12.3	35.5	9.6	12.0	30.6
Eastern Division ...	214	48.4	36.0	74.4	3.8	10.2	25.9	7.6	37.3	10.3	13.6	31.2
Bangalore District (including Bangalore City) ...	276	43.3	33.9	78.3	0.1	10.3	29.8	8.0	61.4	0.2	8.4	22.0
Kolar District (including Kolar Gold Fields) ...	245	39.1	26.9	68.9	1.0	20.7	27.6	13.7	54.2	0.3	8.1	23.7
Tumkur District ...	181	54.3	37.0	68.2	1.4	9.3	24.8	7.9	40.5	1.8	13.3	36.5
Mysore District (including Mysore City) ...	244	44.1	38.6	87.4	11.8	9.7	26.9	8.1	34.6	15.0	19.6	22.7
Chitaldrug District ...	136	59.1	39.9	67.6	1.3	6.4	20.6	3.3	14.8	22.5	11.4	48.0
Western Division ...	151	39.2	26.2	66.8	0.9	30.2	59.0	26.3	30.2	7.6	7.1	28.8
Hassan District ...	218	52.0	37.6	72.4	1.5	19.5	35.8	16.0	42.6	2.6	9.1	29.7
Kadur District ...	121	34.5	23.4	67.8	1.0	28.7	78.0	22.4	24.4	6.6	3.9	42.7
Shimoga District ...	128	33.9	20.5	60.5	0.2	44.6	63.3	42.3	19.5	14.7	7.3	16.2
Civil and Military Station, Bangalore ...	7,447	33.4	Details not available.				34.7	Details not available.				

N.B.—By gross area is meant the net area plus the area which is double-cropped.

II.—DISTRIBUTION OF THE POPULATION CLASSIFIED ACCORDING TO DENSITY.

District and Natural Division	Taluku with a population per square mile of															
	Under 150		150—300		300—450		450—600		600—750		750—900		900—1,050		1,050 and over	
	Area	Population (,000's omitted)	Area	Population (,000's omitted)	Area	Population (,000's omitted)	Area	Population (,000's omitted)	Area	Population (,000's omitted)	Area	Population (,000's omitted)	Area	Population (,000's omitted)	Area	Population (,000's omitted)
1	2	3	4	5	6	7	8	9	10	11	12	13	14	15	16	17
Mysore State, including Civil and Military Station, Bangalore.	10,913.89	1,250	16,524.59	3,596	1,988.66	651	47.68	310
	37.0	21.5	56.1	62.0	6.7	11.2	0.2	5.3
Mysore State, excluding Civil and Military Station, Bangalore.	10,913.89	1,250	16,524.59	3,596	1,988.66	651	34.14	209
	37.0	21.9	56.1	63.0	6.8	11.4	0.1	3.7
Eastern Division ...	5,391.62	642	12,824.17	2,850	1,726.65	569	34.14	209
	27.0	15.0	64.2	66.8	8.6	13.3	0.2	4.9
Bangalore City	9.76	89
Bangalore District	2,508.17	582	565.34	178
Kolar Gold Fields (City)	14.88	49
Kolar District	2,842.44	635	321.68	97
Tumkur District	1,558.82	208	2,503.05	527
Mysore City	9.50	71
Mysore District	1,167.06	142	3,481.63	834	839.63	294
Chitaldrug District	2,665.74	292	1,493.88	272
Western Division ...	5,522.27	608	3,700.42	746	262.01	82
	58.2	42.3	39.0	52.0	2.8	5.7
Hassan District	455.78	51	1,948.06	448	262.01	82
Kadur District	2,277.20	258	511.39	80
Shimoga District	2,789.29	299	1,240.97	218
Civil and Military Station, Bangalore.	13.54	101

N.B.—The proportions per cent. which the area and population of each density-group bear to the total area and population of the Province or Division, as the case may be, are noted in italics below the absolute figures.

III.—DISTRIBUTION OF THE POPULATION BETWEEN TOWNS AND VILLAGES.

District and Natural Division	Average population per		Number per mille residing in		Number per mille of urban population residing in towns with a population of				Number per mille of rural population residing in villages with a population of			
	Town	Village	Towns	Villages	20,000 and over	10,000 to 20,000	5,000 to 10,000	Under 5,000	5,000 and over	2,000 to 5,000	500 to 2,000	Under 500
1	2	3	4	5	6	7	8	9	10	11	12	13
Mysore State, including Civil and Military Station, Bangalore	7,224	308	113	287	470	35	204	251	3	40	423	535
Mysore State, excluding Civil and Military Station, Bangalore	6,124	308	98	302	374	42	240	244	3	40	423	535
Eastern Division	7,178	328	108	292	454	22	217	307	3	48	445	504
Bangalore City	86,651	...	1,000	...	1,000
Bangalore District	4,458	285	70	330	398	604	...	30	373	536
Kolar Gold Fields (City)	48,635	...	1,000	...	1,000
Kolar District	4,108	239	63	398	496	504	8	80	285	677
Tumkur District	3,699	296	50	350	454	546	...	30	413	557
Mysore City	71,306	...	1,000	...	1,000
Mysore District	3,943	435	59	341	357	643	...	84	647	369
Chitaldrug District	4,457	422	71	329	...	251	309	440	11	35	561	398
Western Division	3,779	265	68	332	...	134	362	514	...	19	361	630
Hasan District	3,810	239	58	347	636	364	...	13	273	715
Kadur District	3,790	312	90	310	500	500	...	93	452	520
Shimoga District	3,746	274	72	328	...	350	...	650	...	20	406	575
Civil and Military Station, Bangalore	100,834	...	1,000	...	1,000

IV.—NUMBER PER MILLE OF THE TOTAL POPULATION AND OF EACH MAIN RELIGION WHO LIVE IN TOWNS.

District and Natural Division	Number per mille who live in towns				
	Total population	Hindu	Musalman	Christian	Jain
1	2	3	4	5	6
Mysore State, including Civil and Military Station, Bangalore	113	94	347	708	201
Mysore State, excluding Civil and Military Station, Bangalore	98	94	296	548	196
Eastern Division	108	88	314	660	214
Bangalore City	1,000	1,000	1,000	1,000	1,000
Bangalore District	70	61	320	55	3
Kolar Gold Fields (City)	1,000	1,000	1,000	1,000	...
Kolar District	63	50	311	234	72
Tumkur District	59	44	163	451	141
Mysore City	1,000	1,000	1,000	1,000	1,000
Mysore District	59	52	261	263	321
Chitaldrug District	71	61	264	341	491
Western Division	68	59	226	298	126
Hasan District	53	45	341	218	263
Kadur District	90	78	320	150	129
Shimoga District	72	68	191	513	61
Civil and Military Station, Bangalore	1,000	1,000	1,000	1,000	1,000

V.—TOWNS CLASSIFIED BY POPULATION.

Class of Town	Number of towns of each class in 1911	Proportion per mille of total urban population	Number of females per 1,000 males	Increase (+) or decrease (-) per cent. in the population of towns as classed at previous Censuses				Increase (+) or decrease (-) per cent. in urban population of each class from 1871 to 1911	
				1901 to 1911	1891 to 1901	1881 to 1891	1871 to 1881	(a) in towns as classed in 1871	(b) in the total of each class in 1911 as compared with the corresponding total in 1871
1	2	3	4	5	6	7	8	9	10
Total ...	91	1,000	942	+2.2	-2.7	+14.4	+4.7	+16.6	+92.2
I 100,000 and over ...	1	153	948	...	-10.5
II 50,000—100,000 ...	2	243	948	+14.8	-10.9	+17.7	+7.9	+30.2	-20.2
III 20,000—50,000 ...	1	74	739	+27.3
IV 10,000—20,000 ...	2	35	953	-30.0	-23.0	+3.1	+2.7	-18.9	-23.3
V 5,000—10,000 ...	20	204	985	-5.1	+8.0	+11.3	-3.4	-0.2	+23.6
VI Under 5,000 ...	65	291	960	-3.4	+6.8

VI.—CITIES.

City	Population in 1911	Number of persons per square mile	Number of females to 1,000 males	Proportion of foreign born per mille	Percentage of variation. Increase (+) Decrease (-)				
					1901 to 1911	1891 to 1901	1881 to 1891	1871 to 1881	Total 1871 to 1911
1	2	3	4	5	6	7	8	9	10
Bangalore City ...	88,651	9,083	927	299	+27.7	-13.5	+28.8	+2.7	+46.0
Kolar Gold Fields (City) ...	48,635	3,268	739	851	+27.3	+439.2
Mysore City ...	71,306	7,506	975	137	+4.7	-8.0	+22.8	+4.3	+23.3
Civil and Military Station, Bangalore ...	100,834	7,447	948	343	+12.5	-10.5	+7.0	+14.3	+23.3

N.B.—“Foreign-born” in the heading of column 5 has been taken to mean “born outside the district concerned.”

VII.—PERSONS PER HOUSE AND HOUSES PER SQUARE MILE.

District and Natural Division	Average number of persons per house				Average number of houses per square mile			
	1911	1901	1891	1881	1911	1901	1891	1881
1	2	3	4	5	6	7	8	9
Mysore State, including Civil and Military Station, Bangalore ...	5	5	6	6	39	38	30	25
Mysore State, excluding Civil and Military Station, Bangalore ...	5	5	6	6	39	37	30	25
Eastern Division ...	5	5	6	6	43	40	31	24
Bangalore City ...	5	5	7	...	1,963	1,329	978	...
Bangalore District ...	5	5	6	5	49	47	36	35
Kolar Gold Fields (City) ...	4	5	4	...	752	544	126	...
Kolar District ...	5	5	5	6	45	43	35	25
Tumkur District ...	5	5	5	5	36	33	26	22
Mysore City ...	5	5	5	...	1,569	1,939	2,081	...
Mysore District ...	5	5	6	7	48	47	32	25
Chitaldrug District ...	5	5	5	4	25	23	19	18
Western Division ...	5	5	5	5	30	31	27	26
Hassan District ...	5	5	5	4	44	44	37	38
Kadur District ...	5	5	5	5	25	26	22	23
Shimoga District ...	5	5	6	6	25	25	24	21
Civil and Military Station, Bangalore ...	6	5	5	...	1,163	1,418	1,542	...

N.B.—The figures for columns 3, 4, 5, 7, 8 and 9 have been taken from Subsidiary Table III of Chapter I [p. 52] of the Mysore Census Report of 1901.

CHAPTER II.

MOVEMENT OF POPULATION.

32. The preceding chapter dealt with the population as it stood on 10th March 1911, and except in the case of the population of towns did not deal with the variation during the decade. This chapter will treat primarily of the growth of population in districts and taluks during the decennium and secondarily of the variation from 1871.

Scope of the chapter.

33. The statistics referred to in this chapter are contained in Imperial Table II, Provincial Tables I and II and the Subsidiary Tables of this chapter as noted below :—

Reference to statistics.

- I. Variation in relation to Density since 1871.
- II. Variation in Natural Population.
- III. Comparison with Vital Statistics.
- IV-A. Variation by Taluks classified according to Density (Actual Variation).
- IV-B. Variation by Taluks classified according to Density (Proportional Variation).

Reference is also made to agricultural and other statistics where necessary.

34. The following extract from the Mysore Census Report, 1881, summarises the History from 1761 to 1799 :—

Historical Note regarding the population in early times.

“During the Muhammadan usurpation under Haidar Ali and Tippu Sultan which lasted from 1761 to 1799, unceasing warfare not only kept the whole country in continual turmoil but also led to a great intermingling of various classes in the population. A strong Mahratta element had been introduced into the northern and eastern districts by the settlements of the Biapur State during the 17th century and these had been followed by the Mughal Government of Sira. Subsequently, even after the Mysore Rajas had established their power, large tracts in the centre of the country were pledged to the Mahrattas to buy off their repeated invasions. Migrations of the people *en masse* from a district threatened with such inroads were so frequent that a special word, *Valsé* came into use to describe these fugitives. But under Haidar, wholesale transportations of population took place. In 1766, after the conquest of Malabar, 15,000 Nairs were deported to the less populous parts of Mysore, though only 200 are said to have survived. Large numbers of Coorgs were forcibly converted and removed to Seringapatam, of whom 10,000 made their escape on the night of Tippu's defeat by the British in February 1792. On Haidar's invasion of the Carnatic in 1780, when the district of Tanjore was ravaged, all the weavers and their families of that part were collected and driven to Seringapatam to people the Island. The population of Sira was bodily transferred to the same place to furnish inhabitants for the suburb of Ganjam, while large numbers of Bedar youth, forcibly converted to Islam, were formed into the effective *Chela* battalions of his army.”

Information regarding the extent to which the Province was inhabited from 1799 to 1871 is scanty and based on conjectural estimates. In his report dated 5th December 1804, Col. Wilks estimated the population at 2,171,754 persons while in 1833, according to Col. Morrison's estimate, the population was 4,500,000 persons. In the Khaneshumari estimates of 1841, 1851, 1860 and 1869-70, the population was returned at 3,050,713, 3,426,458, 3,821,000 and 4,108,607 persons respectively.

35. The results of the several Censuses and the rates of increase from one Census to the succeeding Census, are shown in the appended table :—

Results of the several Censuses.

Year of Census	Population	Increase (+) or decrease (-) per cent
1871	5,055,403
1881	4,186,188	- 17.2
1891	4,943,604	+ 18.1
1901	5,539,399	+ 12.1
1911	5,806,193	+ 4.8

The percentage of net variation during the 40 years (1871-1911) is 14.9 for the whole State. The State has received no accession of territory since 1871. The mean density of population per square mile has steadily increased from 142 in 1881 to 197 in 1911. The increase in the *natural* population during the decade as distinguished from the *actual* population is 5 per cent (*vide* Subsidiary Table II).

Factors affecting growth of population.

36. As the increase of population during a decennium is the combined effect of two factors, one being the excess of births over deaths and the other being the balance between immigration to and emigration from the country, it will be convenient to describe the machinery for the registration of Vital Statistics and of the statistics of migration.

Registration of Vital Statistics.

(a) Registration in urban areas.

37. Section 48 (1) (g) of the Municipal Regulation, No. VII of 1906, authorises the Municipal Council to make bye-laws for the registration of births, deaths and marriages. The following extract from the Government Proceedings, dated the 18th May 1911, No. 9484-50—Ml. 120-10-49, reviews the progress made by the Municipalities in this direction until the close of the year 1909-10 :—

“In the Bangalore and Mysore Cities, special establishments for the registration of vital statistics were maintained at a cost of Rs. 4,566. In the other Municipalities this work was done generally by the patel except in Shimoga and Sringeri where it was done by the Municipal staff. The report of births and deaths was obligatory under the bye-laws in force. In the Mysore City, bye-laws were framed for the compulsory report of births and deaths and they were sanctioned by Government during the year. In the Chikmagalur Town, the framing of the necessary bye-laws was under the consideration of the Municipal Council. * * * The report of births in the Bangalore City is stated to be not satisfactory as the public in general are still ignorant of the bye-laws. * * * Seven cases were prosecuted for failure to make a report in time of births and deaths in the Bangalore City. In four cases the accused were convicted and fined Rs. 2-4-0. The remaining three cases were pending at the close of the year.”

(b) Registration in rural areas.

38. In rural areas the registration of births and deaths is done by the patel of the village under the supervision and control of the Revenue Officers and the results are compiled and forwarded to the Sanitary Commissioner. Revenue Officers on tour and particularly on jamabandi duty are enjoined by the standing Orders of Government to check the registers written by the patel. As the patel is sometimes illiterate, he writes the register with the help of the shanbhog or some other person.

(c) Registration of Migration.

39. No machinery exists at present for recording the volume of emigration from and immigration to the Province each year and the only information available on the subject has to be obtained from the Census figures of the decades as shown in para 40 below.

Analysis of the growth of population by reference to Vital Statistics and Migration.

40. From Subsidiary Table III, it appears that the deficiency of births over deaths during the decade has aggregated 144,519 and that there has been no natural rate of increase during the period.

Subsidiary Table II shows that the immigrants have increased from 306,381 in 1901 to 312,908 in 1911 and that the emigrants have similarly increased from 132,342 in 1901 to 139,453 in 1911.

As pointed out in para 123 of the India Census Report, 1901, the real migration during the period is not measured by the difference in numbers between the two sets of statistics. The details of the working are given below :—

Immigrants in 1901	306,381
Do in 1911	312,908
				2)	619,289
			Mean	...	309,645
Mortality at 40 per mille per annum for 10 years $\frac{2}{5}$ of 309,645, <i>i.e.</i>	123,858
Census increase in Immigrants from 1901 to 1911	6,527
Probable number of actual Immigrants in the decade	130,385
Emigrants in 1901	132,342
Do in 1911	139,452*
				2)	271,794
			Mean	...	135,897
Mortality in the decade $\frac{2}{5}$ of 135,897, <i>i.e.</i>	54,359
Census increase in emigrants	7,110
Probable number of actual emigrants in the decade	61,469

Adopting the method described in the same para, we get 68,916 as the balance between immigration and emigration during the period. According to the Subsidiary Tables II and III interpreted in the light of the above method we ought to expect a net loss of 75,603 persons in the population of 1901. As the

* Since reported to be 139,574 as given in Subsidiary Table II.

Census figures of 1911 indicate an increase of 4·8 per cent over the population of 1901, and as there is no reason to doubt the approximate accuracy of the figure giving the balance between immigration and emigration, it is clear that the registration of vital statistics during the decade, as summarised in Subsidiary Table III, has been defective. That the inaccuracy in the registration of vital statistics is not peculiar to Mysore but is shared by all Provinces in British India, will appear from the following remarks of Mr. Hardy, in para 49 of his Memorandum on the Age Tables and Rates of Mortality of 1901:—

“It would appear hopeless for many years to come to expect anything like complete registration of births and deaths in India and I would suggest that it would be well to concentrate efforts in this direction upon certain small but representative areas in various parts of India.”

41. The inaccuracy of the registration of births may be proved from another set of considerations. According to Imperial Table VII of the Mysore Census of 1901, the number of married women at age 15-50 in the State including Civil and Military Station, Bangalore, was 882,711. From the Table of fecundity given at page 64 of Newsholme's Vital Statistics, the least number of births per 1,000 married women at age period 15-50 per annum is 173, and the average number of births in Europe is stated to be 250 in the Chapter on Public Health and Vital Statistics in Volume I of the Imperial Gazetteer (page 507). Co
tio
tw
cor
bir
fec

Taking the smaller figure, the least number of births should have been 152,709 for each year of the decade from 1901 to 1910; but the average annual number of births according to the Subsidiary Table III is 94,467. The birth-rate as thus returned is therefore impossibly low.

42. Although the Vital Statistics as summarised in Subsidiary Table III, have failed to throw light on the growth of population during the decade, it is desirable to seek for an explanation in the conditions affecting births, deaths and migration. As observed at page 509 (Chapter X, Public Health and Vital Statistics) of Volume I, Imperial Gazetteer, Re
the
tio
the
dec

“Nothing is clearer than the effects of marked abundance of food or the reverse upon the general state of the public health and of both food and health upon the birth-rate. With any marked rise or fall in food prices there is immediately a similar movement in the death-rate and an opposite movement in the birth-rate 9 months later. When famine prevails and subsequently other factors co-operate, marriages are deferred and the able-bodied leave their homes in search of work or relief. With the recurrence of the first bountiful harvest the tide turns, deferred marriages are celebrated, cohabitation is resumed and the sexual instinct, depressed by privation, resumes its sway fortified by rest and by comparatively abundant food. The death-rate now falls rapidly to below the normal owing to the previous elimination of the physically weakest; and nine months later the birth-rate (calculated on the total population which now contains a larger proportion of persons at the reproductive ages) rises with a bound and is maintained above the normal, generally for about a year when the ordinary relations of the rates are resumed.”

The conditions of the decade will, therefore, be described under the following heads:—

- (a₁) Conditions of Season and Agricultural prospects.
- (a₂) State of Public Health.
- (a₃) Extension of Irrigation.
- (a₄) Improvement of Communications and Construction of Civil Buildings.
- (a₅) Development of Agriculture.
- (a₆) Industrial Progress.

43. Average rainfall, 38·56 inches, *i.e.*, 2·36 more than the average for 30 years since 1870. Harvests were good and there was a sufficient supply of water and fodder for cattle. There was an increase in the area under cultivation. The prices of food grains were somewhat easier than during the previous year. (a,
and
cul
pro
190

Rainfall, 42·49 inches. Agricultural conditions were very satisfactory and the prices of food grains declined considerably. There was a large increase both in the area of lands under crops and of lands under occupation. 190

Rainfall, 55·49 inches. The year was memorable owing to the disastrous effects of the torrential rain in the Kolar District, sweeping away nearly the whole of the famous Palar series of tanks. The year was otherwise favourable. 190

- 1904-05.** Average rainfall, 29·16 inches. The year was unfavourable to agricultural operations. There was a drought, particularly in the Kolar District, where cattle suffered more than men, and all possible measures were adopted for the relief of both men and cattle.
- 1905-06.** Rainfall, 26·67 inches. The year was one of considerable anxiety. The crops suffered considerably owing to the general failure of the rains, and there was a rapid rise in the prices of food grains. Cattle also suffered much for want of fodder and water. All possible measures were adopted for the relief of men and cattle.
- 1906-07.** Rainfall, 44·44 inches. The agricultural prospects were favourable and enabled the people to recover from the depressing effects of the previous two lean years.
- 1907-08.** Average rainfall, 38·97 inches. Though above the average for the 37 years, it was not evenly distributed and there was a partial failure of the usual October rains. The outturn of crops during the year perceptibly declined and the prices of food grains rose slightly higher.
- 1908-09.** Rainfall, 35·17 inches. Distress prevailed considerably and the prices of food grains ruled high. Owing to lack of sufficient local employment a larger number of people than usual emigrated from Mysore and Tumkur Districts to Nilgiris, Wynaad and other parts in search of labour.
- 1909-10.** Rainfall, 38·22 inches. Agricultural depression disappeared and the people were generally prosperous. The prices of food grains fell slightly.
- 1910-11.** Rainfall, 48·18 inches. The outturn of crops was good and the prices of food grains fell to some extent.

(a.) State of public health. 44. Plague was virulent during the years from 1901-02 to 1904-05 and in 1907-08 and 1910-11, but was mild during the years 1905-06, 1906-07, 1908-09, and 1909-10. Inoculation against plague was, during the later years of the decennium, popularised as a preventive measure and the disease has lost much of its virulence. Vaccination as a preventive against small-pox was, by Regulation No. I of 1906, made compulsory in Bangalore and Mysore Cities and Kolar Gold Fields. Subsequently, in 1909-10, this system was introduced into several Municipal Towns in the Bangalore, Kolar, Kadur, Shimoga and Chitaldrug Districts.

In August 1907, the Department of Public Health was constituted in the State with a properly equipped staff for successfully combating plague, cholera and other epidemics. The staff consists of a Sanitary Commissioner and other officers. Advisory Sanitary Boards have also been constituted, a Central Sanitary Board for the whole State and District Sanitary Boards for each district.

(a.) Extension of irrigation. 45. The decade is memorable as having seen the completion of big irrigation works in the State. The Marikanave Reservoir which was progressing at the commencement of the decade was practically completed in 1907-08, and the restoration of tanks in the Palar Series in the Kolar District which were swept away by the heavy rains of 1903-04, was also completed in 1905-06.

In January 1902, the members of the Irrigation Commission visited Bangalore and a Conference was held in the Public Offices.

(a.) Civil buildings. 46. The chief among the public buildings undertaken and completed or nearing completion during the decade were the Maharaja's Palace at Mysore, the Victoria Hospital at Bangalore and the buildings in connection with Tata's Indian Institute of Science at Bangalore.

Improvement of communications. The principal works undertaken and completed during the decennium were the widening and extension of the Bababudan Hill roads, the opening out of the Saklespur-Gonibid road, the extension of the Sagar-Malnad roads and the bridging of the difficult river-crossings of the Cauvery at Yedatore, of the Hemavati at Hole-Narsipur, of the Bhadra at Tadasa and of the Lokapavani at Hannakere. In 1907, the Steam Tramway Line was opened from the Shimoga Railway Station to the Manganese Mines at Kumsi. The total length of the roads maintained during the decade was 1,968 miles from Provincial and 3,502 miles from District Funds as against 1,921 miles from Provincial and 3,416 miles from District Funds in the previous decennium.

(a.) Development of agriculture. 47. An Agricultural Chemical Laboratory was established in the State in 1901-02; attention was directed to improve cotton cultivation by the introduction

of the choice foreign varieties of seed, to plant new fruit trees, and to grow coffee in the plains. Considerable attention was also paid to the cultivation of rubber in the State; an Experimental Farm was opened at Hebbal, and a start was given to the imparting of instruction in sericulture at the Tata's Silk Farm at Bangalore.

The Co-operative Societies Regulation (III of 1905) was passed in 1905 and good progress was made during the decennium in regard to co-operative movements. The number of Co-operative Societies working at the close of the decade was 111 with a total membership of 9,043, and a share capital of Rs. 2,31,486.

The holding of several Industrial and Agricultural Exhibitions and of cattle shows in several parts of the State in connection with the jattras or fairs on the occasion of religious festivals, was another noteworthy feature of the decade, these exhibitions and shows having an educative value to the local raiyats in raising different varieties of grains and fruits as also in the breeding of strong agricultural bullocks.

48. An appreciable progress was made in the Industrial movements in the State by the establishment of no less than 20 Industrial and Weaving Schools, both Government and private. Of the aided institutions, the one at Hassan, viz., the Wesleyan Mission Orphanage Industrial School, was mainly for the education of girls. A scheme for working the pottery and the tiles branch at the Government Industrial School, Mysore, was started at the close of the decade thus giving an impetus to the art of pottery and tile making in the State out of choice *terra-cotta*.

(a). Industrial progress

The starting of the Economic Conference at the close of the decade for the furtherance of the Industrial, Agricultural and Educational enterprises and to bring to full development the natural resources of the State marks an epoch in the Economic History of Mysore.

49. A brief account of the principal industries in each district, extracted from page 34 of the Mysore General Administration Report for 1910-11 and the industrial Census schedules, is given below:—

State of the industries in each district.

(1) *Bangalore District*.—The Mysore Spinning and Manufacturing Company and the Bangalore Woollen, Cotton and Silk Mills are in a flourishing condition. The Tata's Silk Filature Company under the management of the Salvation Army continued to work and produced silk worth Rs. 4,587. The Iron and Brass Foundry of Mackenzie & Company and the Ripon Iron Works manufactured articles of the value of Rs. 26,200. The Brick and Tile Works of Bangalore City and the Government Military Dairy Farm in Bangalore Taluk, continued to show steady progress.

The Lakshmi Dye Works and the Mavalli Dye Works turned out Rs. 19,000 worth of goods.

The Cigar Factory, the Mysore Tannery Limited, the Aryan Hosiery Factory and the two tanneries at Thattekere in the Channapatna Taluk were doing good business during the year.

The Sugarcane Mill of Mr. Krishna Iyengar at Urganahalli and the two Sugar Factories at Agaram and Kayamgutta Kundalahalli are working satisfactorily.

(2) *Kolar District*.—The Electric Saw Mills at Bowringpet and the Cigarette Factory at the same place have continued to yield good profit. The Sugar Factory at Goribidnur turned out 800 tons of sugar worth Rs. 1,44,000. The output at the Kolar Gold Mines continued normal, the number of persons employed being 25,303.

Skins to the value of Rs. 15,000 were tanned at the tannery near Chikballapur.

(3) *Tumkur District*.—The Paddy Husking Mill at Tumkur worked for only two months. The Wesleyan Mission Industrial School at Tumkur turned out good work during the year.

(4) *Mysore District*.—The Coffee Curing and Bone Crushing Industries of Hunsur and the Weaving Factory started by Mr. B. S. Krishna Iyengar at Mysore are working satisfactorily.

The Rice Mill at Yedatore did not turn out much work during the latter part of the year. The Government Industrial School at Mysore continued to show good progress in all its branches.

- (5) *Hassan District*.—The well-known Brass and Copper Industry at Sravanabelagola was in a flourishing condition and weaving was largely carried on in Hole-Narsipur.

The Factories for the manufacture of tiles of Mangalore pattern at Saklespur and Harihalli in the Manjarabad Taluk are working satisfactorily. There were 77 coffee and 5 cardamom plantations in the district, the business in most of them being normal.

- (6) *Shimoga District*.—At Yelagalale in the Sagar Taluk, a factory named "Sarada Tile Works" has been started for the manufacture of Mangalore tiles. The tram-way works and the Manganese Mines in the District were not thriving.

The Gudigars of Sagar and Sorab, engaged in sandalwood and ivory carving, are declining owing to insufficient demand for such articles.

- (7) *Kadur District*.—A factory for the manufacture of flooring and roofing tiles after the Mangalore pattern is reported to have been started at Sringeri. The 163 coffee, 4 cardamom and 3 rubber plantations in the district employed 19,127 persons on 10th March 1911.

- (8) *Chitaldrug District*.—The bangle manufactory at Malebannur, which has been in existence for some time, and the several cotton ginning factories at Davangere have become profitable concerns.

Conclusions from the above retrospect.

50. From the above review it will appear that in spite of the failure of harvests in 1904-05, 1905-06 and 1907-08 and of the prevalence of scarcity in 1908-09 in parts of the State and of the recrudescence of plague during the greater part of the decennium, the material condition of the people has improved, the bad seasons having been followed by good seasons and the landed classes profiting by the high prices of food grains, and that the increase of 4·8 per cent over the population of 1901 is a natural one under the circumstances.

Analysis of the growth of population in districts.

51. As the increase of 4·8 per cent in the population during the decade (1901-11) is not uniformly distributed throughout the State and the variation ranges from an increase of 10·4 per cent in the population of Chitaldrug District to a decrease of 5·8 per cent in the population of Kadur District, it is necessary to ascertain the rate of growth in the several districts and taluks. There has been growth of population in all the districts except Kadur and Shimoga, the percentages of increase varying from 2 in Hassan District to 10·4 in Chitaldrug District and the percentages of decrease varying from 2·8 in Shimoga District to 5·8 in Kadur District. The appended maps show the percentage increase and the increase in density in the several districts.

Detailed examination of the results.

52. We shall now proceed to examine the variation of population in each district. In the maps illustrating the percentage increase in taluks, the percentages of variation for such of the taluks as have cities and sub-taluks are consolidated and differ from those given in the Provincial Table I, which gives the variation for sub-taluks and cities separately from the taluks in which the former are situated. It has been considered desirable to adopt this procedure for the maps and for the discussion as the effect of migration between the taluk and city (or sub-taluk) will thereby be eliminated. The population of the Civil and Military Station, Bangalore, has, however, not been included in the population of the Bangalore Taluk or Bangalore District.

- (1) *Bangalore District*.—The percentage of increase during the decade has been 7·4 for the district including city. Of the nine taluks in the district, only one, *i.e.*, Anekal Taluk, has suffered a loss of population to the extent of 3·29 per cent, the increases in the other taluks varying from 3·39 per cent in Nelamangala Taluk to 13·70 per cent in Kankanhalli Taluk. The Deputy Commissioner attributes the decrease of population in Anekal Taluk to the effects of plague. The increase in the occupied area during the decade has been 55,292 acres, but the irrigated area has declined by 4,759 acres. The district has been steadily increasing in prosperity since 1881.

MAP OF MYSORE.

Showing the variation in the Population of the several Districts since 1901.

Scale 80 miles = 1".

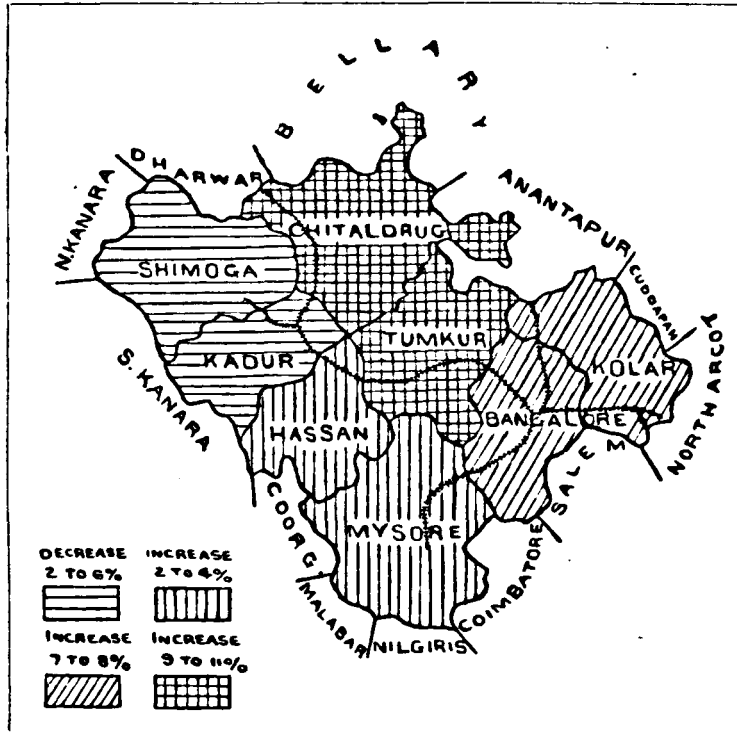

MAP OF MYSORE.

Showing the variation in the number of persons per square mile in the several Districts since 1901.

Scale 80 miles = 1".

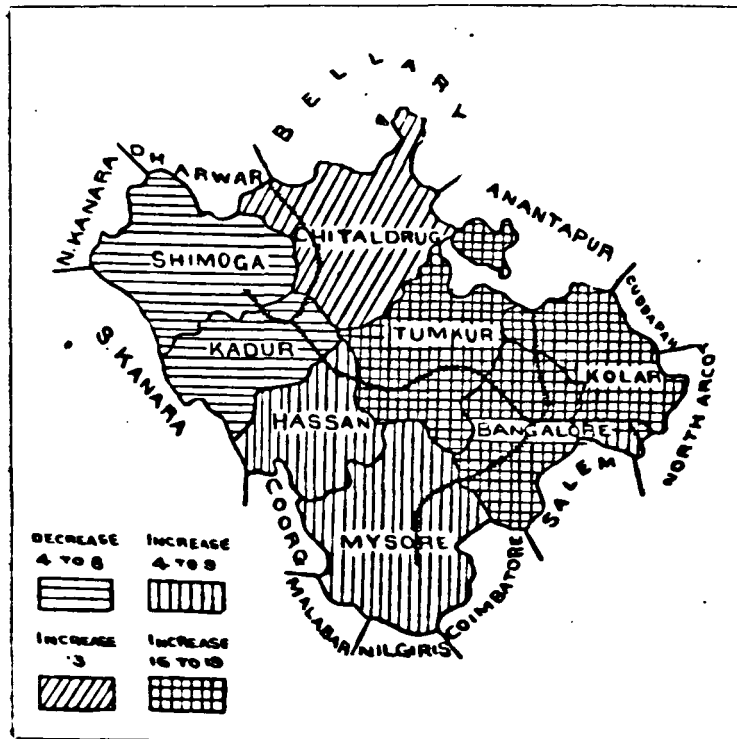

MAP OF MYSORE.

Eastern Division.

Showing the percentage of variation since 1901 of the population of each Taluk.

Scale 40 miles = 1".

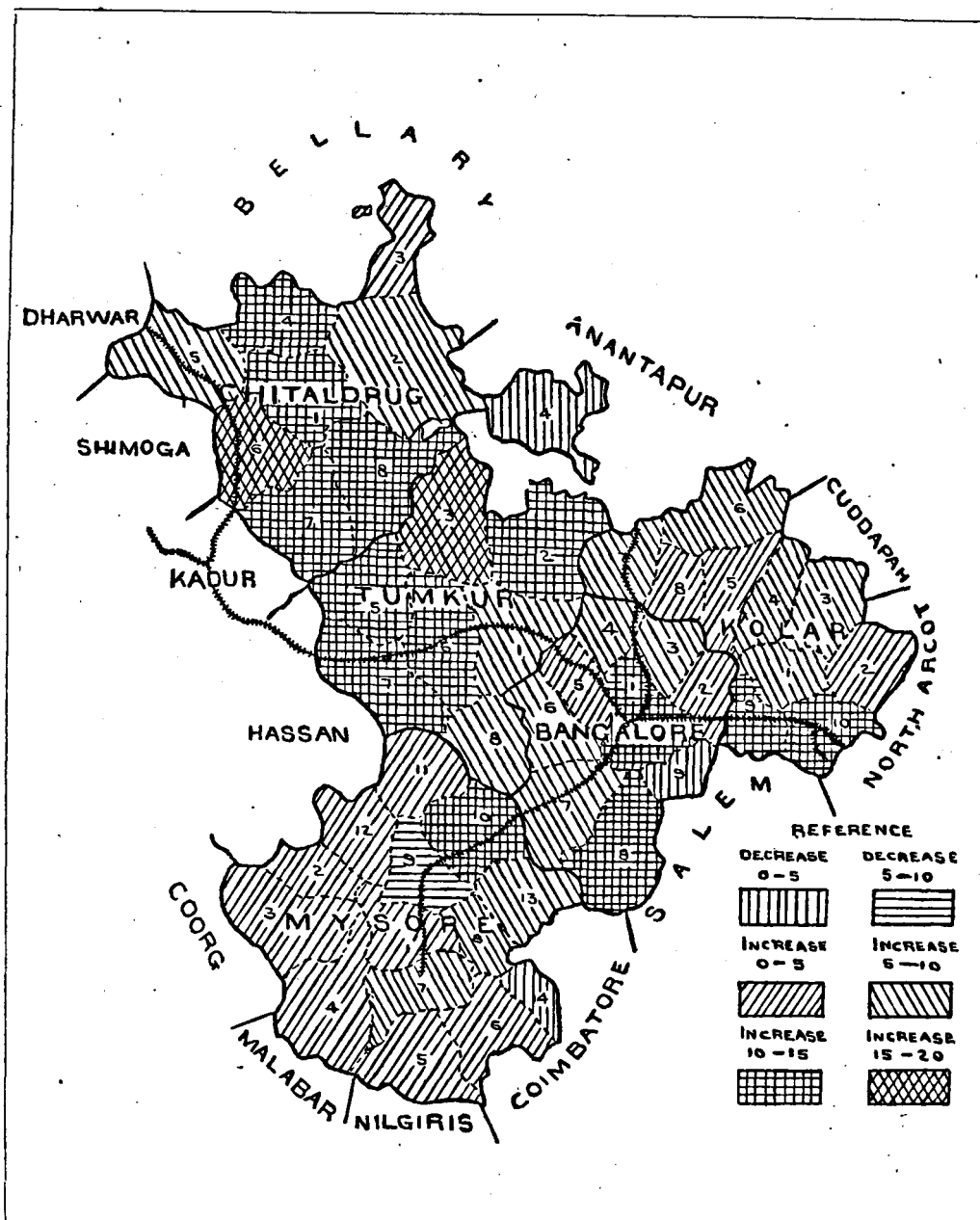

REFERENCES.

B ANGALORE DISTRICT.

1. Bangalore.
2. Hoskote.
3. Devanhalli.
4. Doddballapur.
5. Nelamangala.
6. Magadi.
7. Channapatna and Closepet (Sub).
8. Kankanhalli.
9. Anekal.

KOLAR DISTRICT.

1. Kolar.
2. Mulbagal.
3. Srinivasapur.
4. Chintamani.
5. Sidlaghatta.
6. Bagepalli and Gudibanda (Sub).
7. Goribidnur.
8. Chikballapur.
9. Malur.
10. Bowringpet.

TUMKUR DISTRICT.

1. Tumkur.
2. Maddagiri and Koratagere (Sub).
3. Sira.
4. Pavagada.
5. Chiknayakanhalli.
6. Gubbi.
7. Tiptur and Turuvekere (Sub).
8. Kunigal.

MYSORE DISTRICT.

1. Mysore.
2. Yedatore.
3. Hunsur.
4. Heggaddevankote.
5. Gundlupet.
6. Chamrajnagar.
7. Nanjangud.
8. T.-Narsipur.
9. Seringapatam and French Rocks (Sub).
10. Mandya.
11. Nagamangala.
12. Krishnarajpete.
13. Malvalli.
14. Yelandur Jahgir.

CHITALDRUG DISTRICT.

1. Chitaldrug.
2. Challakere.
3. Molakalmuru.
4. Jagalur.
5. Davangere and Harihar (Sub).
6. Holalkere.
7. Hosdurga.
8. Hiriur.

MAP OF MYSORE.

Western Division.

Showing the percentage of variation since 1901 of the population of each Taluk.

Scale 40 miles = 1".

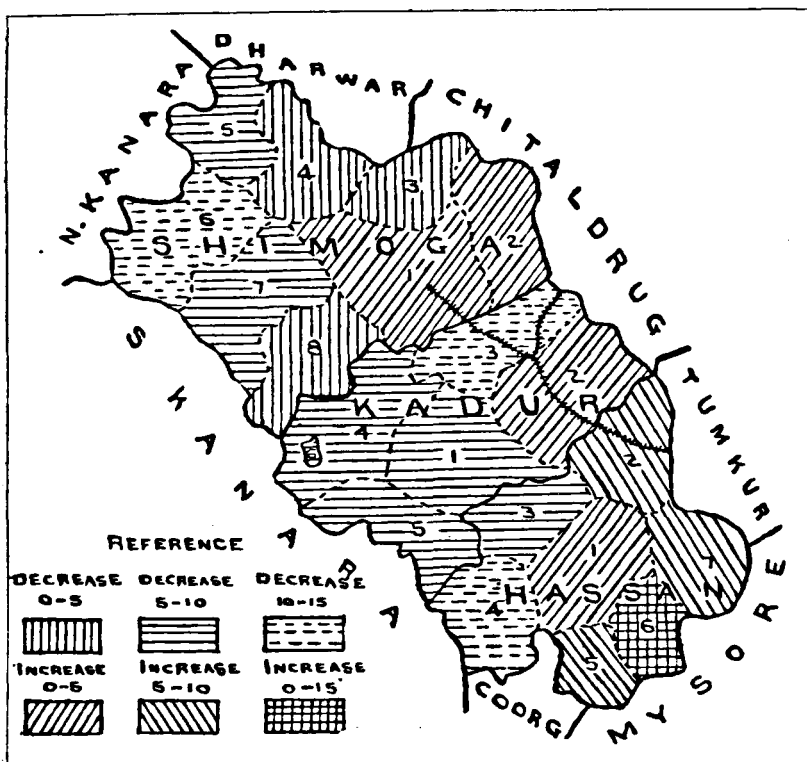

REFERENCES.

HASSAN DISTRICT.

1. Hassan and Alur (Sub).
2. Arsikere.
3. Belur.
4. Manjarabad.
5. Arkalgud.
6. Hole-Narsipur.
7. Channarayapatna.

KADUR DISTRICT.

1. Chikmagalur.
2. Kadur.
3. Tarikere.
4. Koppa & Yedahalli (Sub).
5. Mudgere.
6. Sringeri Jahgir.

SHIMOGA DISTRICT.

1. Shimoga & Kumsi (Sub).
2. Channagiri.
3. Honnali.
4. Shikarपुर.
5. Sorab.
6. Sagar.
7. Nagar.
8. Tirthahalli.

- (2) *Kolar District*.—The population of the district (including Kolar Gold Fields) has grown by 7·8 per cent during the decade and all the taluks have shared in the general growth, the percentages of increase varying from 1·25 per cent in Chikballapur and Sidlaghatta Taluks to 13·67 per cent in Bowringpet Taluk (including Kolar Gold Fields). There has been an increase of 50,940 acres in the occupied area and of 21,116 acres in the irrigated area during the decade.
- (3) *Tumkur District*.—The percentage of increase during the decade has been 9·7. All the taluks, except Pavagada show an increase of population, the percentages of increase varying from 7·64 in Kunigal Taluk to 15·09 in Sira Taluk. The diminution of population in Pavagada Taluk is trifling; but the large decrease of 7,200 acres in the irrigated area and the large increase of 45,545 acres in the occupied area of the taluk during the decade are rather abnormal. During the decade, the occupied area and the irrigated area in the district have risen by 127,683 acres and 16,894 acres respectively.
- (4) *Mysore District*.—The population of the district including the city has risen by 3·6 per cent, during the decade. The growth of population has been general in all the taluks except Seringapatam and Yelandur, the increases varying from 2·16 per cent in Hunsur Taluk to 10·70 per cent in Mandya Taluk. The decadence of Seringapatam Taluk is due to the effects of plague and malaria in reducing the birth-rate and increasing the death-rate. Constant recrudescence of plague in the Yelandur Jahgir accounts for the decrease of population in it during the decade. The increase in the occupied and irrigated areas has been 3,576 and 6,225 acres respectively during the decade.
- (5) *Chitaldrug District*.—The population of the district has increased by 10·4 per cent during the decade, the increases varying from 3·94 per cent in Molakalmuru Taluk to 16·72 per cent in the Holalkere Taluk. Sufficient time has not elapsed for the development in Hiriyur Taluk of the full effects of the Marikanave Project. The occupied and

irrigated areas in the district have increased by 190,269 and 8,358 acres respectively during the decade; but a portion of the increase in the occupied area represents the area transferred in 1902 from the Chiknayakanhalli and Kadur Taluks to Hosdurga Taluk when the latter was constituted into a taluk (*vide* Government Proceedings dated the 20th April 1902, No. R. 4868-4908—R. F. 16-1900).

The Deputy Commissioner of the district makes the following remarks regarding the different rates of increase in the several taluks:—

“The highest increase is in the Holalkeire Taluk. Its nearness to the Railway Station and not being much infected with plague and other epidemics and the successive favourable seasons which this taluk had since last Census have all contributed to the prosperity of the country. Next come in order, the Jagalur, Hosdurga and Chitaldrug Taluks, all of them are nearer the railway communications than any other taluk except perhaps Davangere and Harihar. The comparatively low percentage of increase in the latter two taluks is due to the ravages of plague which had visited these two taluks in almost every year of this decade and which had not yet completely subsided even at the time of this year's Census, and many were found living alone, their families having been sent elsewhere at the outbreak. The increase in Hiriur Taluk is due, in addition to its share of general prosperity of the country, to the throwing open of the lands under the Marikanave channels for cultivation and the consequent influx of some outsiders. The increase in the Challakere Taluk is 2 per cent below the district average, thus confirming the oft-repeated view that this taluk is the driest and the least rain favoured, that it is more deeply affected by the caprices of the seasons, that scarcity makes its appearance here first and most often and that therefore the scope for progress is limited. The very low increase in the Molakalmuru Taluk is singular. It is free from plague. There is also a railway line from Bellary to Raidrug running on the outskirts of the taluk. Perhaps the inaccessibility of the interior parts of the taluk, the want of ample facilities of communication between one village and another on account of the hilly nature of the tract, have much retarded the progress. The Amildar states further that on account of marriages and festivals a large number had temporarily left the taluk.”

- (6) *Hassan District*.—The population of the district as a whole has increased by 2 per cent during the decade, the increases varying from 47 per cent in Hassan (including Alur Sub-Taluk) to 12·63 per cent in Hole-Narsipur Taluk and the decreases varying from 7·01 in Belur Taluk to 14·70 per cent in Manjarabad Taluk. The heavy decreases in Belur and Manjarabad Taluks are ascribed to the decline in the coffee industry and to the deaths exceeding the births owing to the ravages of malaria.

The Deputy Commissioner further states that there is employed on the coffee and cardamom estates of Manjarabad Taluk a large floating population of labourers from South Kanara and other taluks of Hassan District and that this population returned to their homes prior to the date of final Census.

The causes of the decrease of population in this and other *malnad* tracts are being investigated by the Sanitary Commissioner (*vide* Government Proceedings No. 6127-35—San. 92-09-3, dated the 24th April 1910, reviewing the Sanitary report for the calendar year 1908). The occupied area in the district has decreased by 13,894 acres and the irrigated area has increased by 11,861 acres during the decade.

- (7) *Kadur District*.—The population of the district has declined by 5·8 per cent during the decade, *i.e.*, to about the same extent as during the decade 1871-81. The decreases have taken place in all the taluks except Kadur and range from 5·79 per cent in Koppa (including Yedahalli) to 11·29 per cent in Tarikere.

The occupied and irrigated areas have increased by 4,891 and 16,047 acres, respectively, during the decade.

The causes of the decrease of population are similar to those given in the case of Belur and Manjarabad Taluks. The Deputy Commissioner also ascribes the decline in part to plague.

- (8) *Shimoga District*.—The population of the district has declined by 2·8 per cent during the decade and the decrease has affected all the taluks except Shimoga and Channagiri. The decreases vary from 57 per cent

in Honnali to 10·15 per cent in Sagar Taluk. The Deputy Commissioner of the district has made the following remarks regarding the depopulation in the *semi-malnad* and *malnad* taluks:—

“The question of the so-called decimation of the *malnad* population has for some time past been engaging the attention of Government and they have also ordered an investigation into the causes that have brought about a decline in the population of *malnad* tracts. * * * It is interesting to note, however, that the Sub-Division Officer of Sagar has ventured to remark that ‘the depopulating force of insanitation is a thing to be counted. This is a very serious matter and requires to be tackled with earnestness. Effective steps have to be taken to improve sanitation and reduce mortality or otherwise eradicate the causes of depopulation so that a better state of things than what exists at present may be established.’”

* * * * *

“The *maidan* taluks of Channagiri and Honnali show a decided and fairly uniform rate of increase from the Census of 1881; Honnali shows a slight decrease in 1911 probably due to local movements of population. The figures of 1881 show a well-defined fall as the result of the famine of 1877. It is perhaps unnecessary to say more about this group than that it presents the same conditions as prevail in the other *maidan* taluks of the State.”

“Coming now to the *semi-malnad* (Shimoga, Sorab and Shikarpur Taluks), it is evident that the figures relating to the taluks comprised in it disclose conditions entirely different from those of the *maidan*. The first point which strikes the attention is that the famine of 1877 has not had the same depressing effect in the *semi-malnad* as in the *maidan* which would countenance the inference, *ceteris paribus* the *semi-malnad* is better suited to support population in bad seasons than the *maidan*, or in other words that the natural resources of this tract are well in excess of the needs of the population.”

“But looking at the figures as a whole, it is apparent that there are causes at work which tend not only to neutralise the effects of this abundance of resources, but to counteract the natural tendency of population towards increase. These causes, whatever they may be, have kept the population almost stationary; if anything, there is a slight inclination downwards. It need only be said that Sorab, which is more nearly *malnad* in its characteristics than *semi-malnad*, exhibits the conditions which will be noticed when speaking of the *malnad* taluks.”

“Coming now to the most interesting group that of the purely *malnad* taluks (Sagar, Nagar and Tirthahalli), it is at once evident that the famine of 1877 has had the strange effect of bringing about a rise of population. The explanation of this apparent paradox lies in the fact that the *malnad* is by its situation and configuration, no less than by the fertility of its soil less liable to be injuriously affected by drought and adverse seasons; and that its natural capacity is far in advance of the requirements of its population. The result was that the distress elsewhere drove population into this tract, and for a while brought about an increase. If this explanation is correct, it must follow that the increase must have been greatest in those taluks which are most advantageously situated as regards lines of communication. * * * It may then fairly be said that the *malnad* is capable of maintaining a large population without strain on its natural resources even in the most adverse seasons.”

“But it is abundantly manifest that some cause is at work here, more potently than in the *semi-malnad*, which counteracts the fruitfulness of the land and the healthful tendency of population towards growth.” * * *

“Any attempt to assign causes for this decline must, in the absence of facts and scientific investigation, be mere idle guess-work; but it would not be unsafe to say that the invariableness of the result indicates the existence of a constant cause probably to be found in the environment. The fact that the cause which opposes the growth of population as we pass from *semi-malnad* would show that the condition of the climate has something to do with it. How much is attributable to the climate, and how much to such social and hygienic causes as consanguineous marriages in confined communities, and location of village sites with regard rather to agricultural convenience than to sanitary excellence, an inertia of temperament which prevents recourse to medical assistance even where available is a matter to be determined only on patient and exhaustive investigation. Perhaps the day is not far distant when the *malnad* ryot will be as alive to the requirements of sanitation as he now undoubtedly is to his economic interest. A born trader and a wide-awake banker and business-man, he is at present singularly inattentive to the ominous import of low vitality as evinced in a fall of population and the necessity of attempting to improve his environments as the best safeguard of his own permanent prosperity.”

The occupied and irrigated areas in the district have increased by 22,097 and 6,343 acres, respectively, during the decade.

In the India Census Report of 1901, the Census Commissioner has made the following observations regarding this district:—"Shimoga on the Bombay border has only a nominal increase. Very little coffee is grown here; the climate is unhealthy and the population has long been nearly stationary."

Variation by taluks according to density.

53. From Subsidiary Table IV, (a) and (b), it will be observed that the increase of population during the decade has mainly taken place in taluks which had a density of either under 150 or 150 to 300 or in other words in taluks which were thinly or fairly densely populated in 1901.

General summary of results.

54. From the detailed examination, it will be observed that the disquieting feature of the present Census has been the decadence of population in the *malnad* and *semi-malnad* taluks of the Western Division, the decrease of population in a few taluks of the Eastern Division being small. The increase of population in the *maidan* districts of the Eastern Division has proceeded with equal pace with the expansion of cultivation and the extension of irrigation in the tracts where the increases have occurred. At the close of 1910-11, 1,062,729 acres of assessed waste land were available for cultivation in the State and there is still room for further increase of population.

Review of the growth of population for forty years from 1871 to 1911.

55. The appended diagram shows the growth of population in each district from 1871 to 1911. It will be seen therefrom and from Subsidiary Table I that since 1881 when there was a decrease of population owing to the disastrous famine of 1876-78, the population of the State has steadily increased, the percentage of increase being, however, different at each decade. The explanation lies in the distribution of population by age and by race and religion at each Census. In 1881 out of every 10,000 females in the State, the number of females at the reproductive age period 15-50, was 5,272, the number of females at the other two extremes 0-15 and 50 and over being 3,668 and 1,060 respectively. The distribution of males by age periods was also similar (*vide* Subsidiary Table II of Chapter V). The decade 1881-1891 being a healthy and prosperous one, the death-rate at each age-period was low and the birth-rate high. The result was that the population increased by 18·1 per cent in 1891. In 1891, the number of females at the reproductive age-periods 15-50 fell to 5,056, the numbers at the other two extremes of life rising to 3,720 and 1,224 respectively. In 1901, the percentage of increase fell to 12·1 and the distribution of population by age-periods underwent a further change, the number of females at the reproductive age-periods 15-50 falling to 4,698 out of every 10,000 females. In 1911, the percentage of increase in the population is 4·8 but the numbers of females and males at the reproductive age-periods have risen from 4,698 and 4,758 in 1901 to 4,896 and 5,044 respectively.

It will thus be seen that there is no such thing as a normal rate of increase and that, other things such as material and sanitary conditions being the same, the increase at each decade depends primarily on the distribution of population by age periods and secondarily on the distribution by race and religion. The second factor is dealt with below.

Distribution of population by race and religion.

56. From Subsidiary Table I of Chapter IV, it will be observed that out of every 10,000 persons, 9,199 are Hindus, 542 are Musalmans, 124 are Animists and 103 are Christians, the rest being adherents of the minor religions. The percentages of variation given in columns 7-10 of the same table also show that the Hindus both during the decade (1901-1911) and during the thirty years (1881-1911) have increased slower than the Muhammadans and Christians.

The same table shows that while the proportion of Musalmans, Animists, and Christians per 10,000 of population has risen from 479, 117 and 70, respectively, in 1881 to 542, 124 and 103, respectively, in 1911, the proportion in the case of Hindus has fallen from 9,308 in 1881 to 9,199 in 1911. The reasons for this decrease are given as follows in the Imperial Gazetteer (Volume I, page 472):—

"The gains from the ranks of the Animists are probably exceeded by the losses on account of conversions to Muhammadanism and Christianity; and the social customs of the Hindus, especially of the prevalence of infant marriage and the prohibition of the remarriage of widows tend to diminish their reproductive capacity as compared with the adherents of other creeds."

As regards the Musalmans the same writer gives the following reasons for their more rapid increase than the Hindus:—

“Their (Musalman) girls are given in wedlock at a later age and their widows are allowed to remarry so that a larger proportion of their females of the child-bearing ages are married; their dietary is more nourishing; and in the absence of the various marriage difficulties which so often embarrass the Hindu father of a large family of girls, their female children are taken better care of than is often the case with the Hindus. The natural rate of increase is thus relatively high; the loss by conversion to other religions is insignificant; and there is a steady, though small, gain by accessions from the ranks of Hinduism.”

DIAGRAM SHOWING THE POPULATION OF EACH DISTRICT AT EACH OF THE FIVE CENSUSES OF 1871, 1881, 1891, 1901, AND 1911.

EACH DIAMOND REPRESENTS 50,000 PERSONS.

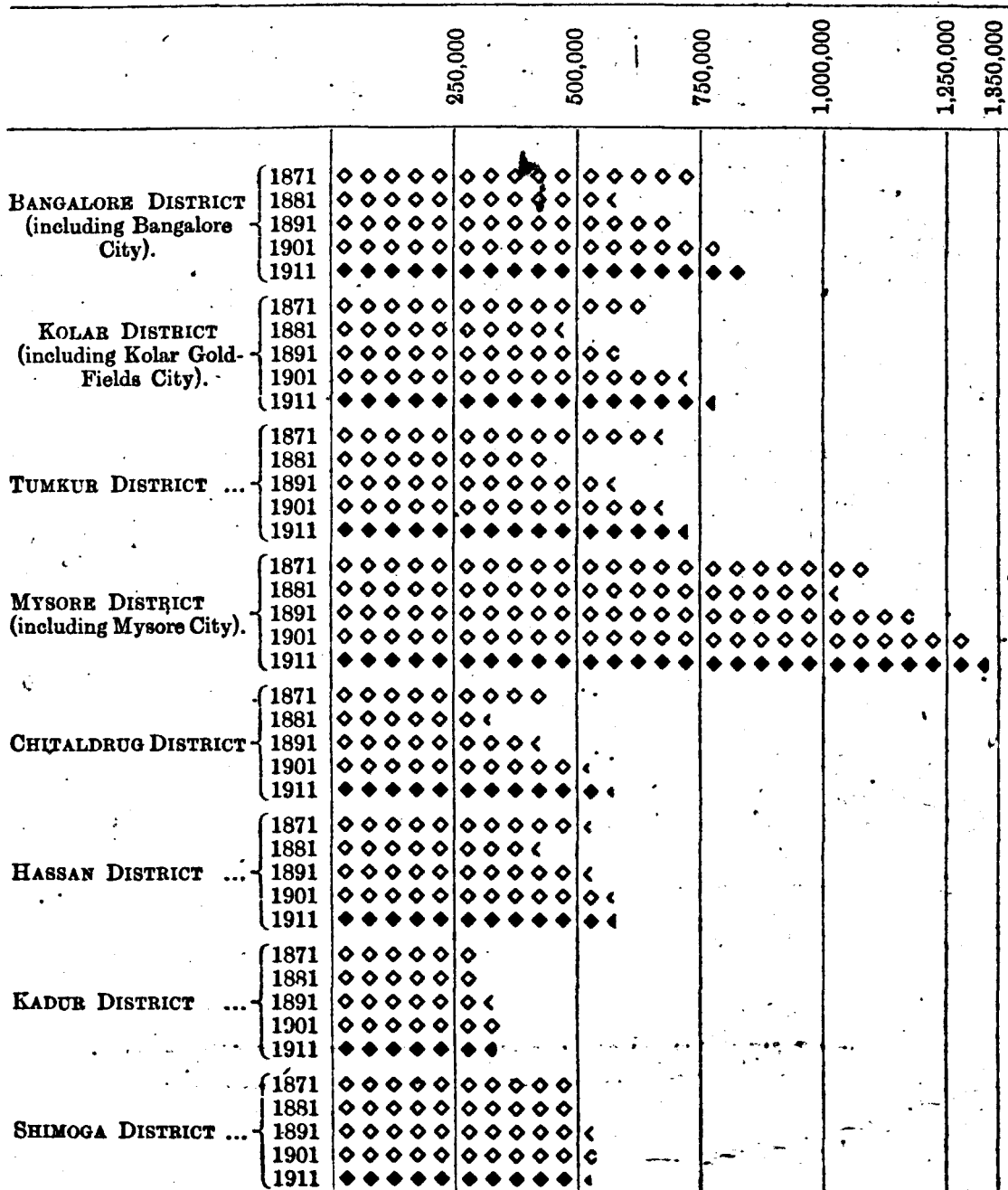

SUBSIDIARY TABLES.

I.—VARIATION IN RELATION TO DENSITY SINCE 1871.

District and Natural Division	Percentage of variation. Increase (+) Decrease (—)				Percentage of net varia- tion in period 1871 to 1911. Increase (+) or Decrease (—)	Mean density per square mile				
	1901 to 1911	1891 to 1901	1881 to 1891	1871 to 1881		1911	1901	1891	1881	1871
	2	3	4	5		7	8	9	10	11
Mysore State, including Civil and Military Station, Bangalore ...	+ 4.8	+12.1	+18.1	-17.2	+14.9	197	188	168	142	172
Mysore State, excluding Civil and Military Station, Bangalore ...	+ 4.7	+12.5	+18.3	-17.7	+14.7	194	185	164	139	169
Eastern Division ...	+ 7.0	+14.9	+21.2	-21.3	+17.3	214	200	174	143	182
Bangalore City ...	+27.7	-13.5	+28.8	+ 2.7	+46.0	9,083	7,115	8,226	6,385	6,220
Bangalore District ...	+ 5.5	+15.7	+18.9	-25.1	+ 8.6	248	235	203	171	228
Kolar Gold Fields (City) ...	+27.3	+439.2	3,968	2,567	476
Kolar District ...	+ 6.7	+17.4	+21.2	-25.6	+13.1	231	217	185	152	204
Tumkur District ...	+ 9.7	+17.0	+22.2	-34.3	+ 8.1	181	165	141	110	168
Mysore City ...	+ 4.7	- 8.0	+22.8	+ 4.3	+23.3	7,170	7,795	7,795	6,347	6,086
Mysore District ...	+ 3.6	+10.8	+13.9	- 7.1	+21.4	232	224	202	177	191
Chitaldrug District ...	+10.4	+20.3	+33.4	-28.8	+26.2	136	123	102	77	107
Western Division ...	- 1.7	+ 6.6	+11.6	- 8.0	+ 7.6	151	154	144	129	141
Hassan District ...	+ 2.0	+11.1	+19.5	-17.5	+11.8	218	213	192	161	195
Kadur District ...	- 5.8	+ 9.2	+12.9	- 5.1	+10.2	121	129	118	104	110
Shimoga District ...	- 2.8	+ 0.5	+ 4.3	- 0.1	+1.7	128	132	131	126	126
Civil and Military Station, Bangalore	+12.5	-10.5	+ 7.0	+14.3	+23.3	7,447	6,617	7,392	6,908	6,042

II.—VARIATION IN NATURAL POPULATION.

District and Natural Division	Population in 1911				Population in 1901				Variation per cent (1901-11) in natural population. Increase (+) Decrease (—)
	Actual popula- tion	Immigrants	Emigrants	Natural popula- tion	Actual popula- tion	Immigrants	Emigrants	Natural popula- tion	
	2	3	4	5	6	7	8	9	
Mysore State, including Civil and Military Station, Bangalore ...	5,806,193	312,908	139,574	5,632,859	5,539,399	306,381	132,342	5,365,360	+5.0
Mysore State, excluding Civil and Military Station, Bangalore ...	5,705,359	282,850	5,449,800	281,526
Eastern Division ...	4,269,966	217,647	3,989,875	221,899
Bangalore City ...	88,651	26,521	69,447	15,544
Bangalore District ...	759,522	50,923	720,217	46,221
Kolar Gold Fields (City) ...	48,635	41,387	36,204	35,764
Kolar District ...	731,518	74,864	685,396	83,534
Tumkur District ...	735,346	49,462	670,377	61,100
Mysore City ...	71,306	9,785	68,111	8,407
Mysore District ...	1,270,765	22,271	1,227,061	25,526
Chitaldrug District ...	564,243	49,990	511,062	54,191
Western Division ...	1,435,373	124,196	1,459,925	120,889
Hassan District ...	580,200	36,037	568,919	37,832
Kadur District ...	338,457	64,674	359,270	60,737
Shimoga District ...	516,716	53,514	531,736	46,691
Civil and Military Station, Bangalore ...	100,834	34,577	89,599	(b) 24,855

(a) Figures are not available by Districts for Columns 4, 5, 8, 9 and 10.

(b) This refers only to the immigrants from outside the Mysore State; figures are not available for immigrants from the several Districts in the State for 1901.

NOTE.—The figures in cols. 3 and 7 for the Mysore State and the two Natural Divisions are not equal to the totals of the figures for the Districts and the Cities concerned, because, for instance, a person born in the Kadur District and enumerated in the Hassan District will be shown as an immigrant against the Hassan District but omitted to be shown as such against the Western Division in which the Hassan District is situated.

III.—COMPARISON WITH VITAL STATISTICS.

District and Natural Division	In 1901-10 Total number of		Number per cent of population of 1901 of		Excess (+) or defici- ency (-) of births over deaths	Increase (+) or decrease (-) of population of 1911 compared with 1901	
	Births	Deaths	Births	Deaths		Natural popu- lation	Actual popu- lation
1	2	3	4	5	6	7	8
Mysore State, including Civil and Military Station, Bangalore	944,667	1,089,186	17.1	19.7	-144,519	+267,499*	+266,794
Mysore State, excluding Civil and Military Station, Bangalore	911,425	1,044,456	16.7	19.2	-133,031	...	+255,559
Eastern Division	680,439	725,692	17.1	18.2	-45,253	...	+280,111
Bangalore City	132,444	167,100	16.8	21.2	-34,656	...	+19,204
Bangalore District	125,391	114,069	17.3	15.8	+11,322	...	+39,805
Kolar Gold Fields (City)	151,545	112,658	22.6	16.8	+38,848	...	+10,431
Kolar District	167,508	246,612	12.9	19.0	-79,104	...	+46,122
Tumkur District	108,630	85,253	20.3	16.7	+18,377	...	+64,969
Mysore City	230,986	318,764	15.8	21.8	-87,778	...	+3,196
Mysore District	92,100	108,460	16.2	19.1	-16,360	...	+43,704
Chitaldrug District	46,131	77,335	12.8	21.5	-31,204	...	+53,161
Shimoga District	92,755	192,969	17.4	25.0	-40,214	...	-24,552
Western Division	33,242	44,730	37.1	49.9	-11,488	...	+11,235
Hasan District							+11,281
Kadur District							-20,818
Shimoga District							-15,020
Civil and Military Station, Bangalore							

* Figures are not available by Districts.

IV.—VARIATION BY TALUKS CLASSIFIED ACCORDING TO DENSITY.

(a) Actual variation.

Natural Division	Decade	Variation in Taluks with a population per square mile at commencement of decade of							
		Under 150	150 to 300	300 to 450	450 to 600	600 to 750	750 to 900	900 to 1050	Over 1050
1	2	3	4	5	6	7	8	9	10
Mysore State, including Civil and Military Station, Bangalore.	1871 to 1881	-215,127	-671,705	-842	+16,191
	1881 to 1891	+348,293	+359,779	+11,448	+84,905
	1891 to 1901	+181,591	+387,718	+22,262	+31,119	-27,257
	1901 to 1911	+45,713	+177,068	-72	+44,055
Mysore State, excluding Civil and Military Station, Bangalore.	1871 to 1881	-215,127	-671,705	-842	+4,461
	1881 to 1891	+348,293	+359,779	+11,448	+29,364
	1891 to 1901	+181,591	+387,718	+22,262	+31,119	-16,775
	1901 to 1911	+45,713	+177,068	-72	+32,830
Eastern Division	1871 to 1881	-208,608	-576,536	-842	+4,461
	1881 to 1891	+277,034	+288,336	+11,448	+29,364
	1891 to 1901	+153,500	+326,121	+22,262	+31,119	-16,775
	1901 to 1911	+77,025	+170,328	-72	+32,830
Western Division	1871 to 1881	-11,519	-95,170
	1881 to 1891	+71,259	+71,443
	1891 to 1901	+24,091	+61,598
	1901 to 1911	-31,313	+6,760

NOTE.—For purposes of this table the cities of Bangalore, Mysore and Kolar Gold Fields and Civil and Military Station, Bangalore, have been each treated as a Taluk.

IV.—VARIATION PER CENT BY TALUKS CLASSIFIED ACCORDING TO DENSITY.

(b) Proportional variation.

Natural Division	Decade	Variation in taluks with a population per square mile at commencement of decade of							
		Under 150	150 to 300	300 to 450	450 to 600	600 to 750	750 to 900	900 to 1050	Over 1050
1	2	3	4	5	6	7	8	9	10
Mysore State, including Civil and Military Station, Bangalore.	1871 to 1881	-14.6	-20.3	-1.2	+8.0
	1881 to 1891	+17.9	+18.5	+16.6	+15.9
	1891 to 1901	+12.1	+13.3	+8.2	+439.2	-10.7
	1901 to 1911	+3.2	+5.3	-0.0	+16.6
Mysore State, excluding Civil and Military Station, Bangalore.	1871 to 1881	-14.6	-20.3	-1.2	+3.7
	1881 to 1891	+17.9	+18.5	+16.6	+22.5
	1891 to 1901	+12.1	+13.3	+8.2	+439.2	-10.9
	1901 to 1911	+3.2	+5.3	-0.0	+18.7
Eastern Division	1871 to 1881	-25.1	-21.9	-1.2	+3.7
	1881 to 1891	+24.9	+18.6	+16.6	+22.5
	1891 to 1901	+17.6	+15.0	+8.2	+439.2	-10.9
	1901 to 1911	+9.7	+6.7	-0.0	+18.7
Western Division	1871 to 1881	-1.7	-14.2
	1881 to 1891	+8.5	+18.2
	1891 to 1901	+4.5	+8.3
	1901 to 1911	-4.9	+0.8

NOTE.—For purposes of this table the Cities of Bangalore, Mysore and Kolar Gold Fields and Civil and Military Station, Bangalore, have been each treated as a Taluk.

CHAPTER III.

MIGRATION.

57. Owing to the necessities of civilization, persons will move out of the tracts where they are born, and for the transaction of their various affairs, people come together "even from distant islands, from the middle of the seas or the ends of the earth." A few there are, who go "to fresh woods and pastures new" simply on pleasure, travel or adventure bent; while many do so, forced thereto by the hard lot at home and the need for seeking livelihood elsewhere, or else allured from their homes by better prospects of successful careers in the new land, while others yet again fluctuating in numbers, have to do so in the ordinary course of business or of visiting their relatives or of paying devotional visits to shrines dear to their heart. The unceasing movement that thus goes on, in the population is taken note of, for the purposes of the Census, synchronously on a particular day by the district of birth (if the country is outside India, the country) being entered against the name of each individual enumerated. The compilation of the information thus collected with regard to the individuals censused enables us firstly to ascertain the natural growth or otherwise of the different districts of the State, and secondly, to note the extent to which the people move from district to district or outside the State. It is the purpose of this chapter to investigate the extent of the movement or migration above referred to, deducible from the statistics of birthplace, the growth of population having been studied in the last chapter (Movement of Population).

Scope of chapter.

58. It has been objected to, that the return of birthplace in the Census schedule is no index of migration, inasmuch as the casual presence of a particular person at a particular place on a particular day, may have been the result of a hundred fortuitous circumstances, all of which, to take an extreme case, may not pertain to the person's ordinary habits of life. It is true that the Census enumeration is more or less a snap-shot; it is confessed too that the snap-shot may not unoften give an illusory view. But it has to be admitted that the 'snap-
ping' process is comprehensive and synchronous all over the country and that as a result of this, and arising out of the fact that most people scarcely ever move out of their birth districts (not birthplaces) the snap-shot is bound to reveal even in the matter of birthplace and Census district, a fairly accurate and faithful picture of the mass of the population. From the point of view of the statesman and the student, the statistician's fact with all its natural shortcomings is preferable to the poet's fancy, the chronicler's legend or the historian's approximation. It only remains for us to distinguish the various kinds of migration that may in the panorama be exhibited to our view, after investigating which, we may point to the permanent, semi-permanent or periodic type of migration which is after all what is very ordinarily taken to be migration proper.

How far enumeration of birth District is an index of migration.

59. Migration has two aspects:—Migration to the State and migration from the State, both of which must be studied in order that the net effect of migration on the population may be estimated. According to its origin it has also been classed as *centrifugal* (directed from a particular area) and *centripetal* (directed towards a particular area).

Statistics for discussion.

(a) *Immigration*.—The statistics of immigration are contained in Imperial Table XI which gives the statistics of the persons enumerated in the divisions, districts and cities of the State by birthplace. It is to be noted that in this table, information by birth districts is available only for the State and the contiguous parts of the adjoining Provinces; in other cases, totals for provinces and countries are given. Cities have been considered as part of the districts in which they are situated when they have to be reckoned as birthplaces. Supplementary statistics regarding birthplace combined with age, caste and occupation,

are given for the cities of Bangalore and the Kolar Gold Fields next after Imperial Table XI. Birthplaces from which there is a noticeable current of migration are dealt with in this table and only the castes returning large numbers are tabulated for.

(b) *Emigration*.—The statistics of emigration from the State are not so complete as one could wish. We have only extracts of Imperial Table XI furnished by the Provincial Superintendents of the several Provinces and States in India. No accurate information is available of persons born in Mysore but who are living in countries outside the Indian Empire with the exception of the Mysore-born enumerated in Ceylon, Hongkong, Rhodesia, the Straits Settlements and the Federated Malay States. In the absence of Census or immigration register figures from those countries and in the non-institution of registration of emigrants from Mysore to those countries, it is impossible to furnish any reliable statistical data. Indian labour has been in great demand for developing new countries in various parts of the world and Mysore must have contributed its mite. As many as 3,615,742 emigrants embarked from the ports of Calcutta and Madras for the various colonies during the year 1900-10 and as many as 3,039,447 persons returned to these ports from the colonies during the decade. Besides this inflow and outflow, there were, as reported by the Protector of Emigrants, Calcutta, 679,464 Indians resident in certain colonies at the end of 1909. We learn that 474 emigrants from Mysore to Natal and Mauritius were registered by the District Magistrate of Bangalore between 1891 and 1898 when further registration was stopped, as against 1,243 emigrants during 1881-1891 to foreign places outside India. In these circumstances it seems clear that emigrants from Mysore have travelled to foreign lands. Again the cause of education has taken a devoted few abroad. To forecast the probable number of emigrants outside India is a useless task; for the rates of the increase of such are not within our ken. For example, the number of emigrants to Ceylon from Mysore in 1911 is more than 12½ times the number for 1901. The figures for emigration so far as they are available are embodied in the Subsidiary Tables.

60. The Subsidiary Tables appended to this chapter exhibit the significance of available absolute figures by arranging them in the form of succinct and comparative statements embodying proportional or abbreviated figures. The first table shows for each division, district and city the figures for the birthplaces of immigrants, the birthplaces being grouped for the sake of easy comprehension, into the unit of enumeration, contiguous and non-contiguous districts, both within and beyond the State in India and countries outside India. The second table shows the figures of emigrants for the same units, the districts of enumeration being grouped as in the first table. It should, however, be remembered that the figures for emigrants given for districts are based only on the data available which again are not complete for the reason that in most Provinces outside the State, the person enumerated might not have returned the birth district of the State. It thus happens that the number of those who are shown as born in Mysore State, district unspecified, is so large that no useful lesson could be learnt from the figures by districts of the State as now given. In the third table, the migration from and to each district is shown for contiguous districts and other places in figures which are worked out proportionately per mille of the total population of the unit concerned, from the data of the first two tables. The number of females proportional to 100 males amongst the immigrants and the emigrants is also shown against each unit so as to assist in deciding about the type of migration denoted by the figures—whether casual, temporary, periodic, semi-permanent, or permanent. The proportion of emigrant females for the districts cannot be taken as exact in view of the fact that the information *re* birth districts of emigrants is not complete (*vide supra*). The fourth table gives the figures of migration between natural divisions compared with 1901. The fifth table is of special interest as it gives in respect of each Province and State in India, the number of immigrants to, and of emigrants from, the Mysore State compared with similar figures for 1901, together with the excess or deficiency of immigration over emigration for the two Censuses. Table V—A, gives similar statistics for migration between Mysore and Ceylon. An additional Subsidiary Table (VI) has been compiled to show the migration between districts within the State during the decade.

61. An illustrative diagram is appended showing the proportional migration Diagram, to districts and cities by sexes and indicating the contiguity or otherwise of the birth district, whether in the State or outside of it in India.

DIAGRAM SHOWING THE PROPORTION OF IMMIGRANTS INTO MYSORE.

(THE PROPORTION THAT THE NUMBER OF IMMIGRANTS BEARS TO THE TOTAL POPULATION IS SHOWN BELOW THE NAME OF DISTRICT.)

EACH ♦ REPRESENTS 2,000 PERSONS BORN IN CONTIGUOUS DISTRICT OF STATE.
 " * " " " OTHER PARTS OF STATE.
 " + " " " CONTIGUOUS PARTS OF OTHER PROVINCES.
 " * " " " NON-CONTIGUOUS PARTS OF OTHER PROVINCES.
 " † " " " OUTSIDE INDIA.

		2,000	4,000	6,000	8,000	10,000	12,000	24,000	36,000	48,000
BANGALORE CITY (299 per mille).	(Males	♦	♦	*	♦	*	*	*		
	Females	♦	♦	♦	*	*	*			
BANGALORE DIS- TRICT (67 per mille).	(Males	♦	♦	♦	♦	♦	♦	♦	♦	*
	Females	♦	♦	♦	♦	♦	♦	♦	♦	*
KOLAR GOLD FIELDS CITY (851 per mille).	(Males	♦	♦	♦	♦	♦	♦	♦	♦	*
	Females	♦	♦	♦	♦	♦	*	*		
KOLAR DISTRICT (102 per mille).	(Males	♦	♦	♦	♦	♦	♦	♦	♦	♦
	Females	♦	♦	♦	♦	♦	♦	♦	♦	♦
TUMKUR DISTRICT (67 per mille).	(Males	♦	♦	♦	♦	♦	♦	♦	*	*
	Females	♦	♦	♦	♦	♦	♦	♦	♦	*
MYSORE CITY (137 per mille).	(Males	♦	*	*						
	Females	♦	*							
MYSORE DISTRICT (18 per mille).	(Males	♦	♦	♦	*	*				
	Females	♦	♦	♦	♦	*				
CHITALDRUG DIS- TRICT (89 per mille).	(Males	♦	♦	♦	♦	♦	♦	♦	♦	*
	Females	♦	♦	♦	♦	♦	♦	♦	♦	*
HASSAN DISTRICT (62 per mille).	(Males	♦	♦	♦	♦	*	*	*	*	
	Females	♦	♦	♦	♦	♦	*	*		
KADUR DISTRICT (162 per mille).	(Males	♦	♦	♦	♦	♦	♦	♦	♦	*
	Females	♦	♦	♦	♦	♦	♦	♦	♦	*
SHIMOGA DISTRICT (104 per mille).	(Males	♦	♦	*	♦	♦	♦	♦	♦	*
	Females	♦	♦	*	♦	♦	♦	*	*	*
CIVIL AND MILI- TARY STATION, BANGALORE (343 per mille).	(Males	♦	*	*	*	*	*	*	†	
	Females	♦	*	*	*	*	*			

General survey of the statistics of Table XI.

62. It will be seen that out of 5,806,193 persons enumerated in the State 312,908 persons or 54 per mille of population have been returned as born outside the Province. Of this number of foreign-born, 308,202 persons or nearly 98 per cent are born in India (outside the State); and 4,263 or more than one per cent born in Europe. For the rest 283 are born in other Asiatic Countries; 46 in Africa; 76 in America; 34 in Australasia; and 4 at sea. Out of the Indian-born, 230,484 persons came from the districts adjoining the State—Dharwar and North Kanara of the Bombay Presidency, Bellary, Anantapur, Cuddapah, North Arcot, Salem, Coimbatore, Nilgiris, Malabar and South Kanara of the Madras Presidency and Coorg. To this number of immigrants must be added fully half of those who were returned as born in Madras and Bombay—district unspecified—for, there can be no doubt that that number does not overstate those who were born in these adjacent districts but did not know the name of the birth district, though they could readily name the Presidency. If this be done, it will be found that 254,110 persons or 82 per cent of the Indian-born (outside the State) are born in districts adjoining the State. The same figures put in another way, show that out of every 1,000 enumerated in the State 946 were born in the State, 40 in the contiguous districts, and 14 in other parts of India and in countries outside India.

A view of the emigration from the State.

63. The information received from the neighbouring Provincial Superintendents discloses the fact that 131,257 persons born in Mysore have left for other parts of India, the chief Provinces of their sojourn and residence being Madras, Coorg, Bombay and Hyderabad. Of these 16,117 persons have been enumerated in Coorg and 74,960 persons in the contiguous districts (Chittoor District excluded) of the Madras Presidency. The figures by districts of the Bombay Presidency are not available, but even thus, 91,077 persons or a little more than two-thirds of the emigrants from the State to other Provinces and States in India are to be found in the districts adjoining the Mysore State. The emigrants to Ceylon number 8,189. The emigrants to Hongkong, Rhodesia and the Straits Settlements and Federated Malay States number 1, 3, 1, and 122 respectively.

Conditions inducing migration—(a) into the State.

64. Before proceeding to draw any inferences from the figures of Immigration and Emigration, we have to take note of the conditions that induce or retard the flow of migration to or from the State. The conditions again may in each case either pertain to the country generally or have come into existence since the last Census (1901) was taken. First, let us consider the circumstances that induce immigration into the State. To begin with, Mysore is an inland Province surrounded by Bombay, Madras and Coorg. The climate is healthy and the soil fertile. The watershed that divides the Tungabhadra basin in the north and west, from the basins of the three rivers—the Palar and the two Pennars—to the east on the one hand, and from the basin of the Cauvery to the south on the other, has divided the table-land into three divisions more or less distinct in physical features, flora and fauna. The present districts of Shimoga, Kadur and Hassan (north) may be taken to be the western portion; Chitaldrug, Tumkur, Kolar and Bangalore Districts may be taken as the eastern portion; and Mysore (and south Hassan) may be taken as the southern part of the State. An excursion on a September day from Shimoga to Sagar; a view westwards in the same month from the top of the Nandi Hills in the Kolar District; a view during the irrigation months across the channels of the Cauvery, say, at Ramanathapur in the Hassan District (south); these give us an idea of the three distinct portions which form the Mysore of the present day. In the Shimoga District one drives for miles and miles through forest glades of bamboo, teak and other timber trees and suddenly as a contrast, comes a stretch of paddy flats, fed by the trickling and moisture of the mountain side, most glorious to look upon; but to commune with a brother-man, one has to arrive at a distant townlet on the roadside or search him out of a lonely far-off homestead. The view from the Nandi Hills shows a perfect mosaic consisting of tank below tank in many cases, full with recent rain, of green fields of unirrigated 'dry' crops, of thickly studded homesteads of villages here and there, of lovely clusters of trees enlivening the landscape in the glorious and mellow sunshine. On either side of the Cauvery channel, one sees smiling and rippling fields of rice as far as the eye can see, with here and there a fringe of dry cultivation, with a peak in the distance which sends in the rainy season a rivulet

down its sides; and one can catch glimpses of the thrifty husbandmen watching the irrigation to, and the crops of, their fields. Of these, the last two divisions being nearer akin in physical features and climate constitute the Eastern Division. Each of these divisions had consequently a history of its own and though consolidated into practically one kingdom at the end of the 17th century A. D., still retains its peculiar features in the matter of climate, style of agriculture, trade and outlets for natural resources, though in the matter of trade, railway communications have made the western and southern parts look more and more to the east and north. From the standpoint of immigration, the western part draws its immigrants from the two Kanara districts on the Malabar Coast. The eastern part looks eastward towards the Madras districts of North Arcot, Bellary, Anantapur and Cuddapah, while the southern part gets the fewest immigrants of all, chiefly from Coimbatore. The moist and slightly malarial climate of the western portion, its abundant rainfall, its woody arecanut gardens rising tier on tier, its numerous coffee and cardamom plantations, its rolling paddy flats in the midst of jungle and hill, its fertile soil and consequently fairly easy life for the scanty population it supports—all these necessitate a big periodic or seasonal inflow of labourers from the western lowlands who generally march in about September of each year and depart in May the next year, before the south-west monsoon bursts on the Western Ghats. The eastern portion, the Tumkur District being typical, on the other hand which depends for a prosperous year on the bountiful showers of both the south-west and north-east monsoons, wants permanent or semi-permanent settlers to derive any benefit from residence there. The neighbouring districts of Bellary, Anantapur and Cuddappah being less favoured in respect of the monsoons than the adjoining districts of Mysore, contribute the main bulk of such. The gold industry of Kolar District perforce commands cosmopolitan attention, but the most numerous immigrants are from the neighbouring North Arcot District. The Civil and Military Station, Bangalore, being the headquarters of the Imperial Military Force stationed in the State and the entrepot for foreign goods, likewise gets immigrants from all parts of India and has most of the European and continental immigrants resident there. Bangalore City, a centre of commerce and an important railway junction, is close to the Civil and Military Station, Bangalore, and has a good climate. Its cotton and woollen mills, and the several extensions give employment to many labourers from outside. The immigrants to Kolar District include many who are labourers, builders and traders, following in the wake of the goldmining industry but have been enumerated outside the area of the Gold Fields. The southern portion which comes a very bad third in immigration, is more or less self-contained, what with its river irrigation and healthy climate, and the immigration into this portion is mainly casual or accidental. Except in the vocations of agriculture and petty trade, foreign influence on the occupations found in the State pervades through outside settlers who are consequently found at work in most of the occupations enumerated in the State, chiefly in industry, trade and Government service.

The mean density for the State per square mile in 1911 is 197 and the highest density amounts to 307 in the case of Bangalore District (including Bangalore City and Civil and Military Station, Bangalore). The density of population of the Madras Presidency is 291 per square mile, the adjacent districts of Malabar, North Arcot, South Kanara, Coimbatore, Salem and Chittore, having each a density more than that of the Mysore State, *viz.*, 520, 399, 297, 294, 280, and 218 respectively. The density of population in Dharwar and North Kanara is 223 and 109 respectively. Very probably the strenuous life at home may have prompted some of the immigrants to go over to the neighbouring Province—Mysore.

65. The domestic and social relations that no artificial restrictions of boundaries of States can bar, are responsible for a good many of the emigrants going into the neighbouring districts of British India. The entrepots for trade and ports being situated outside the State and connected with towns in Mysore by roads and railways, many commercial people have to maintain relations with their *confreres* in Bombay, Madras and elsewhere. The coffee plantations of Coorg draw many labourers from the Mysore District. The density of population per square mile for Coorg is 114 (1901). The Civil and Military Station, Bangalore, attracts the migration thereto, on official and private business, of people from all parts of India, and the children of such sojourners who may be born in Civil and

Condi-
tions in-
ducing mi-
gration
(con-
tinued)—
(b) from
the State.

Military Station, Bangalore, may in course of time be enumerated as emigrants from Mysore. The cause of education, higher and technical, always takes away a few emigrants to centres of light and learning in British India and the United Kingdom.

Condi-
tions of
import-
ance
during
1901-11,
influen-
cing mi-
gration.

66. The general advance in the line of civilization necessitated by existence in the midst of progressive conditions, has had its influence in producing an increase of immigrants and emigrants. The communications, road and railway, remained almost the same as in 1901. The intense desire for developing local industries which was felt during the decade throughout India, showed itself in the increased attempts at mining and prospecting and exploring for economic products in the State. The substitution of electricity as motive power in the Kolar Gold Fields meant a larger output and there was a small increase in the numbers employed in the mines. A few praiseworthy attempts at introducing scientific methods into industries, *e.g.*, Tobacco Factories, Saw Mills, marked a step in the general advance in industries. The large public works on the Marikanave lake (Chitaldrug District) and the new Palace (Mysore City) were completed during the decade. Advantage of the completion of the former has begun to be taken both by subsistence and capitalist farmers.

General
conclu-
sions.

67. (a) The increase of population during the decade 1901-11 is 266,794 persons. The balance between immigration and emigration during the decade has been shown in Chapter II to be approximately 68,916 persons.

(b) Though an inland country, Mysore has a very large population of immigrants (5 per cent) as compared with most provinces in India, *e.g.*, Madras (which has less than 1 per cent) on account of the mining industries (notably gold) and coffee and cardamom plantations, of which it is the home. A study of Subsidiary Table III is very instructive as regards immigration into the several districts. The proportion per mille of immigrants (cities excluded) is only 18 in the Mysore District, while the planting district of Kadur has the highest proportion, *i.e.*, 162, the districts of Shimoga and Kolar coming next with 104 and 102 respectively. Of the cities, the Kolar Gold Fields, which is more or less a semi-permanent camp has as many as 851. The Civil and Military Station, Bangalore, comes next with 343, Bangalore City follows with 299, while Mysore City has only 137 to its credit.

(c) The proportion of emigrants to immigrants is 45 per cent; which shows that Mysore gains more by migration than it loses.

(d) The proportion of females to males, emigrants or immigrants is always, from the nature of the circumstances, greater in the case of contiguous districts than in the case of other places. For the State including Civil and Military Station, Bangalore, the number of females per 100 males is 81 and 73, in the case of immigrants from contiguous districts and other places respectively and 108 and 84 in the emigrants to the tracts described above.

(e) The streams of migration flowing either way are cosmopolitan, no particular caste or creed predominating when the figures are considered with reference to the actual populations of the provinces that give to and take from the Province.

(f) In the case of immigrants to the cities the special return compiled which combines with birthplace, particulars of age, caste and occupation, shows that the few castes of Beda, Brahmin, Holeya, Mudaliar and Vakkaliga alone return nearly 41 per cent of the immigrants into Bangalore City, while in the Kolar Gold Fields, the caste Holeya and the races of Europeans, Anglo-Indians and Indian Christians return as many as 22,401 or more than one half the number of immigrants into the area.

(g) A point worth noting here is the distinction between the character of immigration into the cities and the rural tracts. In the former, the bulk of the immigrants hails from afar, there is not

much inequality* between the numbers of males and females returned and the character of the migration is permanent or semi-permanent, while in the latter, the bulk are from the adjoining districts, there is a disproportion between the sexes immigrating and the immigration is either casual or periodic. The Civil and Military Station, Bangalore, and the Kadar District may be taken as types of the city and district respectively.

68. Next after the general discussion of the subject, we may take up the balance sheet, if the word may be used, of population crossing the border between the State and the other countries. The immigrants from outside India consist chiefly of Europeans from the United Kingdom and Ireland, members of the British Army and Civil Services stationed in the Civil and Military Station, Bangalore. Trade in foreign goods, industry (gold in Kolar and manganese in Shimoga), the evangelistic missions and service under the Local Government all support the majority of the other European immigrants into the State. Travel and sport in this picturesque and historic land have also attracted a few. The Asiatic immigrants are chiefly itinerant traders such as are to be found in any big city in the East congregated mostly in the Civil and Military Station, Bangalore. Regarding emigrants from Mysore outside India complete information is not available. Eight thousand one hundred and eighty-nine persons have gone to Ceylon in search of work in the plantations and a very few have travelled to Europe and America for education.

69. Subsidiary Table V appended to this chapter shows in respect of each province or state, the immigrants therefrom and the emigrants thereto from Mysore. The only provinces from and to which the flow of migration is noticeable are Madras Presidency, Bombay Presidency (including states), Coorg, and Hyderabad. Of the others the most noticeable are (1) Rajaputana which gives to Mysore some of its thrifty money-lenders and brokers and (2) the Punjab which sends its hardy sons to the British Army stationed in Mysore. A few remarks with respect to the first four provinces thus singled out are noted hereunder.

- (1) *Madras Presidency*.—Mysore State is surrounded on all sides (except towards Dharwar and North Kanara) by districts of the Presidency and it is no wonder that the bulk of the Indian immigrants into Mysore, *i.e.*, nearly five-sixths, is from this Presidency. So also the bulk of emigrants from Mysore is to the Madras Presidency. The highways leading to the Madras districts are not so steep and difficult as those leading through the Western Ghats to the Bombay Presidency. Social relations in respect of which political and administrative boundaries afford no let or hindrance, bring about this mighty flow both ways. Besides such casual migration attributable to social relations, the periodic migration into the planting districts of the West and the semi-permanent camp of the Kolar Gold Fields area are responsible for the large excess, *i.e.*, 170,859, of immigrants from Madras over emigrants to the Presidency from the Mysore State.
- (2) *Bombay Presidency*.—The Dharwar and North Kanara districts of the Presidency lie to the north-west of the State. There are no special conditions affecting the flow of migration either way. The outlet for the trade of the Shimoga and Chitaldrug Districts is into the Bombay Presidency. The excess of immigrants to Mysore over emigrants to Bombay comes up to 14,971.
- (3) *Coorg*.—The conditions of migration between the State and the Madras Presidency are reversed in the case of Coorg which takes in 13,046 more than it sends. This is due to the extensive plantations of Coorg for which there is a perennial demand for labour from the neighbouring districts of Mysore and Hassan.
- (4) *Hyderabad*.—The inflow and the outflow are about equal in this case.

* NOTE.—This statement does not hold good in the case of the European rank and file of the British Army stationed at Bangalore.

MAP OF SOUTHERN INDIA.
Showing net results of migration to and from Mysore State.

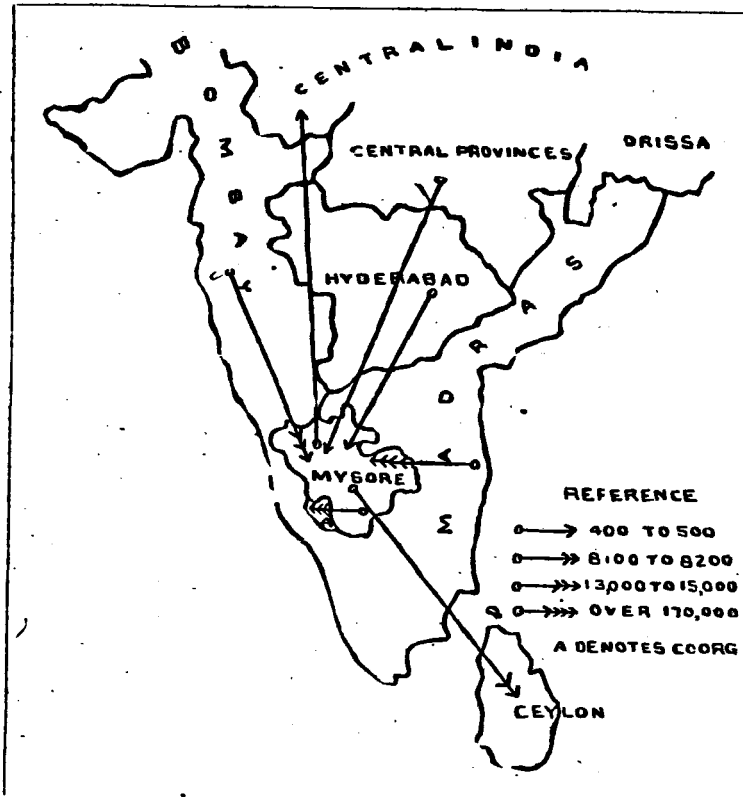

The net results of movements of migration as regards some provinces in India and Ceylon are shown graphically in the map given in the margin by distinctive arrow heads to denote the volume of the currents.

Intra-Provincial migration.

70. For every 1,000 persons enumerated in the Eastern Division (including Civil and Military Station, Bangalore), 943 persons are born in that division and enumerated there, while only 8 persons out of every 1,000 persons enumerated there, who are born there are enumerated in the Western Division while in the Western Division 913 persons are born in that division and enumerated there, while 16 persons born there are enumerated in the Eastern Division. Regarding interchanges between the districts, it is curious to note that migration beyond the districts adjacent to districts of birth is almost a negligible quantity (*vide* Subsidiary Table VI). Bangalore District gives more than 1,000 persons to each of the non-contiguous districts and Mysore District does so to Kolar and Shimoga. This phenomenon may be due firstly to Bangalore District containing the most important towns of the State, Bangalore City and the Civil and Military Station, Bangalore, and secondly to the districts of Bangalore, Mysore, Kolar and Shimoga being traversed by railway, this bringing one another into close communication. The immigrants into the Kolar Gold Fields area from outside the State number more than three-fourths of the entire population of 48,635, while the immigrants from the districts of the State number only 3,598, Bangalore District contributing as many as 3,153. The available statistics are not sufficient to indicate how far most of the general laws* of internal migration enunciated by Ravenstein are applicable in the case of Mysore.

Immigration into cities.

71. The characteristics of centripetal migration into cities have been referred to above (*vide* *para supra*). The special table of immigrants compiled for the cities of Bangalore and Kolar Gold Fields, shows that the number of immigrant

* The general laws of internal migration according to Ravenstein are as follows:—

1. The great body of migrants proceed only a short distance.
2. The process of absorption goes on as follows:—
The inhabitants of the country immediately surrounding a town of rapid growth flock into it; the gaps thus left in the rural population are filled up by migrants from more remote districts, until the attractive force of one of the rapidly growing cities makes its influence felt, step by step, to the most remote corner of the land. Migrants enumerated in a certain centre of absorption will consequently grow less with the distance, proportionately to the native population which furnishes them.
3. The process of dispersion is the inverse of that of absorption, and exhibits similar features.
4. Each main current of migration produces a compensating counter-current.
5. Migrants proceeding long distances generally go by preference to one of the great cities of commerce or industry.
6. The natives of towns are less migratory than those of the rural parts of the country.
7. Females are more migratory than males.

persons aged 15-40 is far greater than those aged 0-15 and 40 and over and also that amongst these the numbers of males between 15-40 invariably exceed the numbers of females far more than the number of males of the other age-periods compare with the number of females of the age-period concerned. This is because the exigencies of life in the cities demand the preponderance of adult immigrants, over infants and aged immigrants, and among the adult immigrants, of males over females. The chief occupations that attract immigrants are, in the case of the Bangalore City, Government service, domestic service, building industries and to a small extent, trade; in the case of Kolar Gold Fields, they are mining, domestic service, building industries and transport.

72. During the decade there was a transfer of an area containing 8,785 persons from Tumkur to Chitaldrug. The figures of migration for 1901 for these two districts not admitting of any alteration to suit the altered actual populations, there is a difficulty in gauging the variation of migration to each of these districts. This should be borne in mind while criticising the available figures for migration from the two districts. There was likewise a transfer of an area containing 3,482 persons from the Kadur District to the Chitaldrug District. The number of immigrants from provinces, states and foreign settlements in India into Mysore in 1911 exceeds the number for 1901 by 4,527 and the number of emigrants from Mysore thither in 1911 is less than the figure for 1901 by 447. The emigrants to Ceylon in 1911 number 8,189 (5,092 males and 3,097 females) whereas in 1901 they numbered only 638 (340 males and 298 females). This very remarkable increase in figures is due to the successful operations of the recruiting Ceylon Labour Commission working in Bangalore City.*

Variation in migration since 1901

Noticeable fluctuations since 1901 in immigration are: Bombay (-7,112), Madras (+8,445) and the Punjab and North-West Frontier Province (+1,567) and Europe (+1,957); remarkable changes in the emigration figures since 1901 are: Bombay (+821), Coorg (-8,596), Madras (+3,073) and Hyderabad (+2,520). The following remarks are made in respect of a few of these countries:—

- (1) *Bombay*.—Going to district figures we see decreases of Bombay immigrants to Kadur, Chitaldrug, Hassan and Mysore. The coffee industry in Kadur and Hassan is not such a paying one now as it was a decade or more ago; in Chitaldrug, the large public works on the Marikanave lake were closed; in Mysore, the skilled artizans, most of them from Bombay, were in 1901 engaged on the new Palace works in Mysore City.
- (2) *Madras*.—The increase is noticeable in Bangalore City, Bangalore District, Kadur and Shimoga. The building industries of the Bangalore City, which town in 1901 was very thinly peopled owing to the prevalence of plague, have attracted about nearly 5,000 more immigrants in 1911. The exploitation of manganese in Shimoga has taken nearly 5,000 more in 1911.
- (3) *The Punjab and North-West Frontier Province*.—The Civil and Military Station, Bangalore, alone accounts for an increase of over 1,000 immigrants. These comprise the ranks of the British Army in Civil and Military Station, Bangalore, the mining watchmen in Kolar Gold Fields and ranks of the detachments of the army on the line of march and in camp in Tumkur and Bangalore Districts.
- (4) *Coorg*.—The work on the plantations in Coorg is slack and there were less emigrants thereto.
- (5) *Europe*.—The increase of 1,957 is chiefly due to increase in the immigrants from the United Kingdom. There has been an increase of nearly 1,200 in the Civil and Military Station, Bangalore. The increases of 319 and 315 in the Bangalore District and Tumkur District respectively are owing to enumeration of units of the British Army on the line of march and in camp on the 10th March 1911.

* NOTE.—Complaints as to the 'modus operandi' of the Ceylon Labour Commission, having come to the notice of Government, the matter was investigated and in order to regulate the recruitment, the 'Mysore Emigration Bill' was introduced in the Legislative Council in February 1912.

Migration since 1871.

73. The statistics for birthplace were compiled for the first time in 1881.

Birthplace	1871	1881	1891	1901	1911
Total Population ...	10,000	8,281	9,779	10,957	11,485
1. Mysore State ...	Details 7,936	7,936	9,369	10,350	10,866
	not available.				
2. Provinces and States in India ...	Do	339	380	601	610
3. Europe ...	Do	5	6	5	8
4. Other countries (including birthplaces unspecified) ...	Do	1	4	1	1

Assuming the whole population of the State in 1871 at 10,000 and working the figures from decade to decade under the following heads of birthplace, (1) Mysore State, (2) Provinces and States in India, (3) Europe and (4) other birthplaces, we have a very instructive statement as per margin. The most interesting

fact disclosed is the expansion, almost unparalleled, of migration from the provinces and states in India to Mysore (chiefly from the Presidencies of Madras and Bombay), during the decade 1891-1901. That period coincided with an era of prosperity for the State which by 1891 had almost recovered from the havoc wrought by the great famine of 1876-77 and was ready for the onward march on the path of progress. The gold industry of Kolar was established as a highly flourishing concern and the Kolar Gold Fields area became thickly peopled. The climax of the boom of high prices in coffee industry was already reached. During the subsequent decade (1901-11) though the gold industry continued to flourish, the slump in the prices for Mysore coffee owing to the titanic competition of Brazil with her practically unlimited natural resources began to tell on the capacity of the brave planters who did so much since the forties of the last century as pioneers and captains of industry in the *Malnad* (Western Division) to support large estates as going concerns. The Koleroga or 'rot,' which eats into the stem of bunches of arecanut pods, has been ruinous to the *Malnad* farmer. The grim spectre of plague, too, made its appearance in the land (in August 1898) and despite all precautions and remedies, inoculation and evacuation and kindred devices, is still stalking, year in year out, in every nook and corner of the State, levying a heavy toll of human life, dislocating trade; disheartening enterprise and discouraging pioneers and settlers from other parts.

Migration into the cities during 1901-11.

74. The statement given in the margin shows per 100 of the population in

City and Birthplace	Number per 100 of population	
	1901	1911
Bangalore City—		
1. Bangalore District ...	78	70
2. Mysore State including Civil and Military Station, Bangalore ...	86	82
3. Provinces and States in India beyond Mysore ...	14	17
Mysore City—		
1. Mysore District ...	88	86
2. Mysore State including Civil and Military Station, Bangalore ...	94	94
3. Provinces and States in India beyond Mysore ...	6	6
Kolar Gold Fields—		
1. Mysore State including Civil and Military Station, Bangalore ...	17	22
2. Provinces and States in India beyond Mysore ...	82	76
Civil and Military Station, Bangalore—		
1. Mysore State including Civil and Military Station, Bangalore ...	72	70
2. Provinces and States in India beyond Mysore ...	26	27
3. Europe ...	2	3

1901-11 in the case of each city, the number born in the birthplaces, the city mostly draws its inhabitants from. The decline during the present Census, of the proportion of people born in the State, in Bangalore City and Civil and Military Station, Bangalore, and their increase in the Kolar Gold Fields City are as remarkable as the increase of those born in India outside the State in Bangalore City, Civil and Military Station, Bangalore, and their decrease in Kolar Gold Fields.

Migration into Kadur and Shimoga Districts.

75. The migration in 1911 into these districts has been specially examined and compared with that in 1901 in order to ascertain how far variation in migration was responsible for the decrease in population of these districts. In the Kadur District, there is a decrease of nearly 18,000 in the number of persons born and enumerated there. Of the immigrants from the districts of the State, the total decrease is nearly 6,000, the decrease being marked in those from Bangalore and Shimoga Districts. There is a further decrease of nearly 2,500 of the immigrants from the Bombay Presidency, against which might be set off the increase in the case of immigrants from the Madras Presidency (notably from the district of North Kanara). An area containing nearly 3,500 persons (1901) was transferred from this district to the Chitaldrug District in the decade (1901-11).

In the Shimoga District, there has been a decrease of 21,000 in those born and enumerated in the district, the fluctuation of the other districts nearly

counterbalancing one another. Against this there is a slight increase in immigrants from the Bombay Presidency and an increase of more than 5,000 in immigrants from the Madras Presidency.

76. From the free nature of the migration to and from the State, its ready growth from decade to decade and the appreciable excess of immigrants over emigrants it is apparent that Mysore has been taking part in the general advancement of the Indian Empire. There was, as we have seen above, during the decade a loss in the indigenous population of the Kadur and Shimoga Districts but immigration stepped a fair way into the breach. Conclusion.

SUBSIDIARY TABLES.

I.—IMMIGRATION (ACTUAL FIGURES).

District and Natural Division where enumerated	Born in (,000's omitted)																	
	District (or Natural Division)			Contiguous Districts in Province			Other parts of Province			Contiguous parts of other Provinces, etc.			Non-contiguous parts of other Provinces, etc.			Outside India		
	Total	Males	Females	Total	Males	Females	Total	Males	Females	Total	Males	Females	Total	Males	Females	Total	Males	Females
1	2	3	4	5	6	7	8	9	10	11	12	13	14	15	16	17	18	19
Mysore State, including Civil and Military Station, Bangalore ...	5,493	2,760	2,733	230	127	103	78	44	34	5	4	1
Mysore State, excluding Civil and Military Station, Bangalore ...	5,423	2,725	2,697	219	121	98	62	35	27	2	2	...
Eastern Division ...	4,053	2,037	2,015	23	11	12	146	75	73	45	25	20	2	2	...
Bangalore City ...	62	31	31	9	5	4	2	1	1	2	1	1	14	6	6
Bangalore District ...	703	359	349	33	14	19	1	1	...	9	4	5	8	4	4	1	1	...
Kolar Gold Fields (City) ...	8	4	4	4	2	2	23	13	10	13	8	5	1	1	...
Kolar District ...	657	333	324	18	8	10	2	1	1	44	21	23	11	6	5
Tumkur District ...	636	350	336	27	12	15	14	6	6	8	4	4
Mysore City ...	62	31	31	4	2	2	1	1	4	2	2
Mysore District ...	1,249	619	630	12	5	7	1	1	...	6	3	3	4	2	2
Chitaldrug District ...	514	262	253	15	7	8	2	1	1	23	14	14	5	3	2
Western Division ...	1,311	660	651	20	14	16	6	3	3	65	42	23	23	14	9
Hassan District ...	544	270	274	21	8	13	4	2	2	6	4	2	5	3	2
Kadur District ...	233	143	140	15	8	7	3	2	1	27	15	9	10	6	4
Shimoga District ...	463	237	226	10	5	5	4	2	2	20	19	11	10	6	4
Civil and Military Station, Bangalore ...	66	33	33	4	2	2	2	1	1	26	14	12	3	3	1

NOTE.—In this table the figures for the Mysore State and the two natural Divisions in columns 2 to 16 will not be the totals of the figures for the districts contained in them. For instance the figures for Kadur District in columns 2 to 4 represent only those born in that district and enumerated there; while the figures for the Kadur District as forming a part of the Western Division include not only those born in the Kadur District and enumerated there but also those born in the other two districts of the said Division, viz., Hassan and Shimoga and enumerated in the Kadur District. The figures for Mysore State and the two natural Divisions have therefore been worked out independently of those for the districts.

II.—EMIGRATION (ACTUAL FIGURES).

District and Natural Division of birth	Enumerated in (,000's omitted)																	
	District (or Natural Division)			Contiguous Districts in Province			Other parts of Province			Contiguous parts of other Provinces, etc.			Non-contiguous parts of other Provinces, etc.			Outside India		
	Total	Males	Females	Total	Males	Females	Total	Males	Females	Total	Males	Females	Total	Males	Females	Total	Males	Females
1	2	3	4	5	6	7	8	9	10	11	12	13	14	15	16	17	18	19
Mysore State, including Civil and Military Station, Bangalore	5,493	2,760	2,733	75	36	39	56	30	26	8	5	3
Mysore State, excluding Civil and Military Station, Bangalore	5,422	2,725	2,697
Eastern Division	4,052	2,037	2,015	36	17	19	20*	11*	9*
Bangalore City	62	31	31	2	1	1	9	5	4
Bangalore District	708	359	349	36	16	20	6	3	3	2	1	1	9	5	4
Kolar Gold Fields (City)	8	4	4
Kolar District	657	333	324	20	9	11	2	1	1	2	1	1
Tumkur District	686	350	336	31	14	17	1	1	...	1	1
Mysore City	62	31	31
Mysore District	1,249	619	630	34	15	19	4	2	2	5†	3†	2†
Chitaldrug District	514	262	252	12	6	6	2	1	1	1	...	1
Western Division	1,311	660	651	20	9	11	3	2	1	1*	0*	1*
Hassan District	544	270	274	15	7	8	3	2	1
Kadur District	283	143	140	12	5	7	1	1
Shimoga District	463	237	226	11	5	6	2	1	1	1	0	1
Civil and Military Station, Bangalore	66	33	33	Vide figures for Bangalore District.								

- NOTE.—1. As the information regarding emigrants to Bombay Presidency and Coorg is not available by districts of enumeration, figures are given in columns 11 to 16 only as far as available.
2. No distinction is made between contiguous and non-contiguous districts of enumeration in the case of emigrants from natural divisions to other Provinces. Such figures are marked with asterisks.
3. In the case of emigrants from Mysore District, the figures for contiguous districts of Madras Presidency include those born in Mysore (district unspecified). Hence figures (marked †) are entered only in columns 14 to 16.
4. The remarks at foot of Table I apply to this table also *mutatis mutandis*.

III.—PROPORTIONAL MIGRATION TO AND FROM EACH DISTRICT.

District and Natural Division	Number per mille of actual population of						Number of females to 100 males amongst			
	Immigrants			Emigrants			Immigrants		Emigrants	
	Total	From contiguous districts	From other places	Total	To contiguous districts	To other places	From contiguous districts	From other places	To contiguous districts	To other places
1	2	3	4	5	6	7	8	9	10	11
Mysore State, including Civil and Military Station, Bangalore	54	40	14	24	13	11	81	73	108	84
Mysore State, excluding Civil and Military Station, Bangalore	50	39	11	23	13	10	81	73	108	84
Eastern Division	51	40	11	13	8	5	99	77	114	84
Bangalore City	299	123	176	56	40	16	87	77	121	88
Bangalore District	67	54	13	31	28	3	127	80	118	80
Kolar Gold Fields (City)	851	546	305	44	43	1	81	54	112	76
Kolar District	102	85	17	32	25	7	114	83	134	72
Tumkur District	67	55	12	27	22	5	132	69	112	76
Mysore City	137	71	66	32	25	7	89	80	134	72
Mysore District	18	14	4	27	22	5	121	70	114	83
Chitaldrug District	89	75	14	27	22	5	108	80	114	83
Western Division	87	66	21	17	14	3	71	65	125	77
Hassan District	62	47	15	31	27	4	123	66	124	67
Kadur District	162	125	37	37	35	2	63	61	129	89
Shimoga District	104	76	28	27	20	7	68	71	112	90
Civil and Military Station, Bangalore	343	59	284	(Vide figures for Bangalore District)			105	77	(Vide figures for Bangalore District)	

IV.—MIGRATION BETWEEN NATURAL DIVISIONS (ACTUAL FIGURES)
COMPARED WITH 1901.

Natural Division in which born	Number enumerated (,000's omitted) in Natural Division	
	Eastern Division	Western Division
1	2	3
Eastern Division 1911	4,123	26
Do 1901	3,829	37
Western Division 1911	23	1,311
Do 1901	24	1,343

NOTE.—1. The figures for Civil and Military Station, Bangalore, have been added to those of the Eastern Division.
2. The entire population of Civil and Military Station, Bangalore, in 1901, shown as enumerated in Mysore State district unspecified), has been added to the Eastern Division figures of 1901.

V.—MIGRATION BETWEEN THE PROVINCE OF MYSORE AND OTHER PARTS OF INDIA.

Province or State	Immigrants to Mysore State, including Civil and Military Station, Bangalore			Emigrants from Mysore State, including Civil and Military Station, Bangalore			Excess (+) or deficiency (-) of Immigration over Emigration	
	1911	1901	Variation	1911	1901	Variation	1911	1901
1	2	3	4	5	6	7	8	9
(A) Provinces in India beyond Mysore ...	300,033	296,606	+3,426	125,711	129,754	-4,043	+174,321	+166,853
Ajmer—Merwara ...	37	11	+26	64	21	+43	-27	-10
Andamans and Nicobars ...	14	14	...	8	150	-142	+6	-136
Baluchistan ...	8	8	...	56	32	+24	-48	-24
Bengal ...	463	416	...	610	623
Eastern Bengal and Assam	22	(Assam) 4	+65	163	(Assam) 170	-20	-289	-374
Bombay (including Aden) ...	29,769	35,874	-7,113	13,791	12,970	+821	+14,971	+22,904
Burma ...	273	184	+89	933	452	+481	-660	-268
Coorg ...	3,071	2,563	+508	16,117	24,713	-8,596	-13,046	-22,160
Central Provinces and Berar ...	1,183	1,541	-358	748	821	-73	+435	+720
Madras (including Laccadives) ...	263,362	254,917	+8,445	92,503	89,430	+3,073	+170,859	+165,487
North West Frontier Province ...	286	45
Punjab ...	1,644	365	+1,567	259	205	+99	+1,628	+160
United Provinces of Agra and Oudh ...	1,933	304
United Provinces of Agra and Oudh ...	906	720	+186	414	167	+247	+492	+553
(B) States and Agencies in India ...	7,373	6,192	+1,181	5,546	1,950	+3,596	+1,227	+4,242
Baluchistan (States) ...	3	...	+3	1	...	+1	+2	...
Baroda ...	46	168	-122	32	23	+10	+14	+146
Bombay States ...	1,009	1,943	-934	431	202	+229	+578	+1,041
Central India Agency ...	85	51	+34	491	...	+491	-406	+51
Eastern Bengal and Assam States ...	1	...	+1	+1	...
Hyderabad ...	4,342	3,552	+790	3,890	1,350	+2,520	+462	+2,192
Kashmir ...	42	11	+31	10	...	+10	+23	+11
Madras States (including Cochin and Travancore) ...	443	361	+82	618	313	+305	-175	+48
Punjab States ...	18	...	+18	14	...	+14	+4	...
Rajputana Agency ...	1,378	802	+576	67	53	+14	+1,811	+749
Sikkim ...	1	1	+1	+1
United Provinces States ...	5	3	+2	2	...	+2	+3	+3
(C) French and Portuguese Settlements ...	738	661	+77
(D) India unspecified ...	50	216	-157

* Information not available.

V (a).—MIGRATION BETWEEN THE PROVINCE OF MYSORE AND CEYLON.

Province or Colony	Immigrants to Mysore State, including Civil and Military Station, Bangalore			Emigrants from Mysore State, including Civil and Military Station, Bangalore			Excess (+) or deficiency (-) of Immigration over Emigration	
	1911	1901	Variation	1911	1901	Variation	1911	1901
1	2	3	4	5	6	7	8	9
Ceylon	140	105	+ 35	8,190*	638	+7,552	-8,050	- 533

* Includes 1 person on vessels arriving at Colombo after the 10th March 1911 who was not enumerated at the Census either in India or in Ceylon or in Great Britain.

VI.—INTER-DISTRICT MIGRATION WITHIN THE MYSORE PROVINCE
(,000'S OMITTED).

Enumerated in District	Born in District								Total immigrants (from districts within the Province) to district in column 1
	Bangalore	Kolar	Tumkur	Mysore	Chitaldrug	Hassan	Kadur	Shimoga	
1	2	3	4	5	6	7	8	9	10
Bangalore District (including Bangalore City and Civil and Military Station, Bangalore)	1911 837 1901 793	16 14	11 9	18 11	1 1	1 1	1 ...	1 1	49 37
Kolar District (including Kolar Gold Fields)	1911 18 1901 21	664 604	3 4	1 1	...	1	23 27
Tumkur District... ..	1911 10 1901 13	4 4	686 618	5 7	4 5	4 4	1 1	1 1	27 35
Mysore District (including Mysore City)	1911 8 1901 8	1 1	3 3	1,310 1,261	...	5 6	18 19
Chitaldrug District	1911 1 1901 1	...	5 4	1 1	514 445	1 1	3 2	6 6	17 15
Hassan District	1911 2 1901 3	...	6 6	11 10	1 1	544 531	5 5	...	25 26
Kadur District	1911 1 1901 2	...	2 2	1 2	2 3	7 6	234 302	5 8	18 23
Shimoga District	1911 2 1901 1	...	1 1	1 1	6 6	1 2	3 3	463 465	14 14
Total Emigrants (from districts within the Province) to districts in columns 2 to 9	1911 42 1901 49	21 19	31 29	38 33	14 16	20 20	12 12	13 18	...

NOTE.—The figures in columns 2 to 10 of this table do not in some cases agree with those given in columns 2, 5 and 8 of Subsidiary Tables I and II of this chapter, the differences in such cases being due to the adjustment of absolute figures under both Immigrants and Emigrants for each district so as to represent the numbers in thousands.

CHAPTER IV.

RELIGION.

PART I.—STATISTICAL.

77. This chapter consists of two parts—(1) statistical and (2) general. In the first part the statistics will be discussed absolutely, relatively to the statistics of the previous Censuses and proportionately to a common figure such as 10,000 or 1,000. So much of the history and conditions of a religion will be given as will suffice to help the reader to comprehend the significance of the discussion. **Introductory remarks.**

78. According to the Slip-system of Abstraction and Tabulation of the information collected in the Census Schedules, adopted in 1901 and 1911, the distinctions of religion and sex are preserved during compilation of all the tables of statistics with reference to any particular unit, for the sake of convenience of tabulation. Thus, though religion may be said, in one sense, to enter into the preparation of all the tables (in the final form of some, the distinction by religion is not shown), yet for the purposes of this chapter, the following tables are those chiefly referred to:— **Statistics**

- (a) Imperial Table VI Religion: giving figures for the population and for each religion by districts and cities.
- (b) Imperial Table V: Towns arranged territorially with population by religion.
- (c) Imperial Table XVII which deals with the territorial distribution of the Christian population by sect and race.
- (d) Provincial Table II giving figures for the chief religions in respect of taluks and cities.

79. The salient features of the statistics are brought together in seven **Subsidiary Tables** appended to this chapter. These are:— **Subsidiary tables.**

- I. General distribution of the population by religion, showing, for the State and Natural Divisions, in respect of each religion, the actual number in 1911, the proportion per 10,000 of the population in each of the last four Censuses, the percentage of variation during each decade, and net variation for 1881-1911.
- II. Distribution by districts of the main religions: giving for each of the last four Censuses, the number per 10,000 of the population who are Hindus, Musalmans, Christians, Jains, Animists and of other religions.
- III. The number and variations of Christians in each district at each of the Censuses in 1911, 1901, 1891 and 1881.
- IV. The actual numbers of the races and sects of Christians.
- V. Distribution of Christians per mille (a) races by sect and (b) sects by race.
- VI. Religions of urban and rural population (for Natural Divisions).
- VI(a). Religions of urban and rural population (for districts and cities).

80. A diagram is given to show the Musalman, Christian, Jain and Animist population in each district and city. Another has been given to show the number of persons in every 10,000 in each district and city who are Hindus, Musalmans, Christians, Jains and Animists. **Diagrams.**

DIAGRAM SHOWING THE NUMBER OF PERSONS IN EVERY 10,000 IN EACH DISTRICT AND CITY WHO ARE HINDUS, MUSALMANS, CHRISTIANS, JAINS, AND ANIMISTS.

(THE NUMBER OF HINDUS, BEING LARGE, IS SHOWN BELOW THE NAME OF DISTRICT.)

MUSALMAN ◆◆◆ CHRISTIAN ✕✕✕ JAIN * * * ANIMIST * * *

EACH MARK REPRESENTS 75 PERSONS.

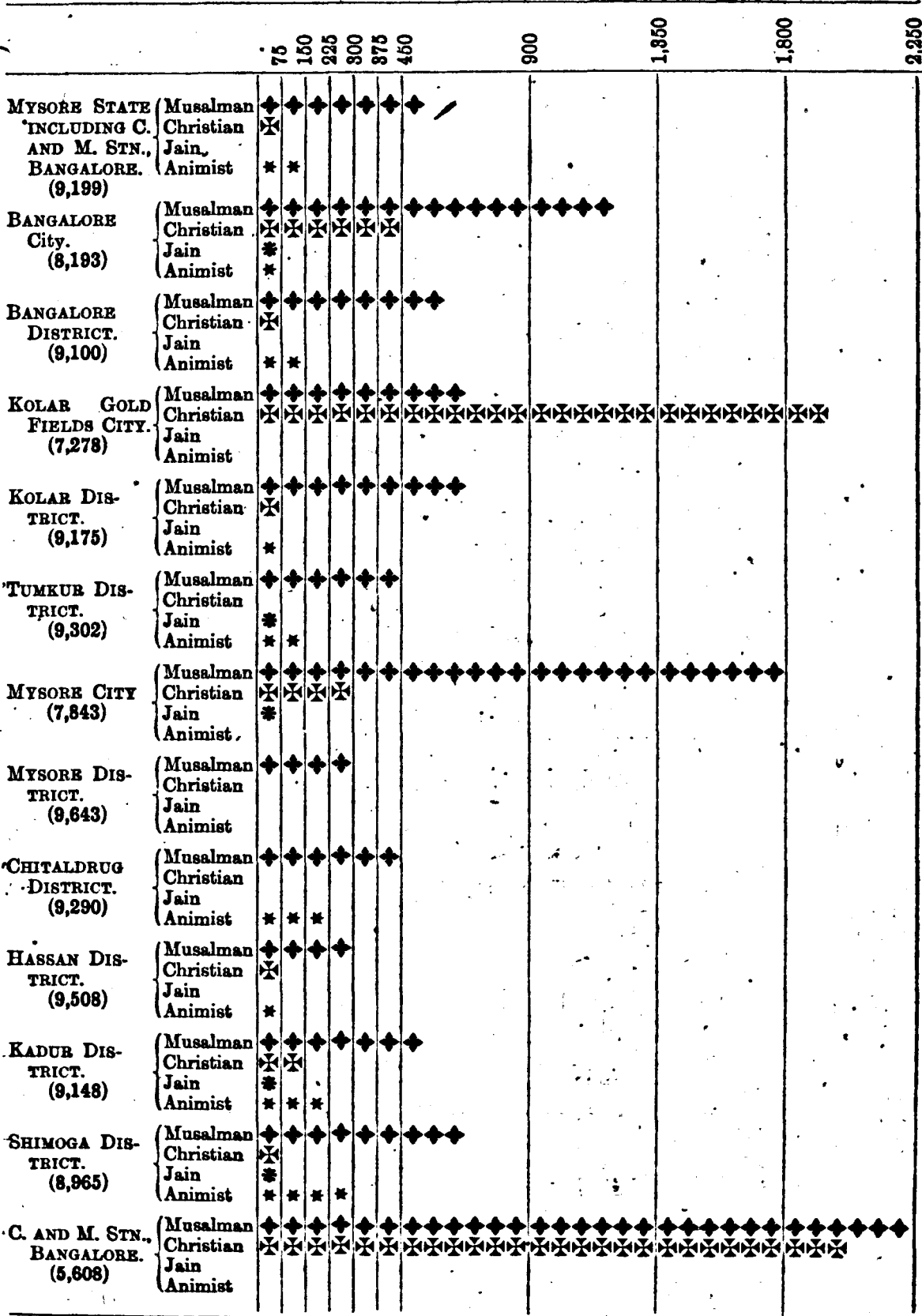

General distribution of the population by religion.

81. The State contains 5,340,908 Hindus, 314,494 Musalmans, 72,196 Animists, 59,844 Christians, 17,630 Jains, 622 Buddhists, 293 Sikhs, 101 Parsis, 65 Brahmos and 40 Jews, making in all 5,806,193 persons. For every 10,000 of the population, 9,199 are Hindus, 542 Musalmans, 124 Animists, 103 Christians, the remainder consisting of adherents of other religions. There has been a steady increase during the decade 1901-11 of the numbers of the Hindus, Musalmans, Christians, and Jains, the variations for these and Animists being +4·7, +8·6, +19·5, +28·9 and -16·7 per cent respectively. The variations in the other religions have no statistical value inasmuch as the followers of those religions are very few numerically and consequently no general inference could be deduced from a study of the figures. As the increase of the total population in 1901-11 is 4·8 per cent, the only notable increases are in the case of Jains, Christians and Musalmans. The decrease under Animists is found to be due to many of the Animist castes (16,491 persons) returning themselves as Hindus in the present Census.

The Civil and Military Station, Bangalore, contains 56,546 Hindus, 22,786 Musalmans, 20,430 Christians, 347 Animists, 320 Jains, 233 Sikhs, 72 Buddhists, 46 Parsis, 34 Jews and 20 Brahmos, making in all 100,834 persons. In other words, out of 10,000 persons 5,608 are Hindus, 2,260 Musalmans, 2,026 Christians, 34 Animists, 32 Jains and 40 of the other religions. The general increase in the decade 1901-11 is 12·5 per cent, the increases in the cases of Hindus, Musalmans and Christians being 11·5, 5·7 and 19·3 per cent, respectively.

The Eastern Division contains 4,269,986 persons, 3,959,805 being Hindus, 223,107 Musalmans, 46,695 Animists, 28,529 Christians, 11,178 Jains, 524 Buddhists, 52 Sikhs, 49 Parsis, 45 Brahmos and 2 Jews. The number per 10,000 of population works up to 9,274 in the case of Hindus, 523 Musalmans, 109 Animists, 67 Christians and 26 Jains. The general increase in population for the division since the Census of 1901 is 7·0 per cent, the variations for Hindus, Musalmans, Animists, Christians and Jains being +6·7, +11·2, +5·7, +22·5 and +68·7 per cent, respectively.

The Western Division which is only about half the area of the Eastern Division and the percentage of cultivable area to the total area of which is only 39·2 as against 48·4 of the Eastern Division, has a population of 1,435,373 persons, 1,324,557 of whom are Hindus, 68,601 Musalmans, 25,154 Animists, 10,885 Christians, 6,132 Jains, 26 Buddhists, 8 Sikhs, 6 Parsis and 4 Jews. Expressed per 10,000 of the population, there are 9,228 Hindus, 478 Musalmans, 175 Animists, 76 Christians and 43 Jains. The variation for the decade is -1·7 per cent, the variations in the case of Hindus, Musalmans, Animists, Christians and Jains being -0·9, +1·8, -40·8, +12·8 and -11·8 per cent, respectively. There was during the decade the transfer of an area containing 3,482 persons from the Western Division (Kadur District) to the Eastern Division (Chitaldrug District).

Features of the distribution of the religions in the districts and the cities. (proportionate figures considered).

82. (a) *Hindu*.—It should be noted that the figures include only those who returned themselves as Hindus in the "Religion" column of the Census Schedule and in whose case an entry being the name of a distinctive religion such as 'Jain,' or 'Sikh' did not occur in the 'Caste' or 'Sub-Caste' column. Animist castes who described themselves as 'Hindu' in the 'Religion' column were classed as 'Hindu' while they were taken as Animists when the caste name was repeated in the column. The Mysore District contains the highest proportion per 10,000, *i.e.*, 9,643, Shimoga District containing the least, *i.e.*, 8,965. Of the cities, Bangalore City has as much as 8,193, while the Civil and Military Station, Bangalore, has only 5,608.
- (b) *Musalman*.—The Shimoga District has the largest number per 10,000 (663) and the Mysore District has the least (298). Among the cities, the Civil and Military Station, Bangalore, has the largest proportion, *i.e.*, 2,260, while Kolar Gold Fields has only 638.
- (c) *Christian*.—The Kadur District has the largest proportion per 10,000, *i.e.*, 134, Chitaldrug District having the least, *i.e.*, 4. Of the cities, the Civil and Military Station, Bangalore, has 2,026, the Kolar Gold Fields 1,986, Bangalore City 478 and Mysore City 302.

- (d) *Jain*.—The Jains number 58 per 10,000 in Shimoga District and only 14 in the Mysore District. The Kolar Gold Fields (City) contains no Jains; Bangalore City, Mysore City and Civil and Military Station, Bangalore, have for every 10,000 persons, 50, 45 and 32 respectively.
- (e) *Animist*.—Shimoga District has the largest proportionate number 264 and Mysore District the least, *i.e.*, 33. Of the cities, Bangalore has 80, while Kolar Gold Fields has only 1.
- (f) *Other Religions*.—It is the cities that have the bulk of the followers of the other religions *i.e.*, Sikh, Brahmo, Parsi, Jew and Buddhist. It is the increase of the adherents of this last mentioned religion that accounts for the high proportionate number of 97 in the Kolar Gold Fields.

83. It is remarkable that Shimoga District has thus the largest proportion per 10,000 of the population among Musalmans, Animists and Jains; Mysore District contains the largest proportion of Hindus, while Kadur District has the largest proportion of Christians. The explanation seems to be due to historical causes in the first three instances and to economic conditions in the last two. **A suggested explanation of the foregoing.**

1. *Shimoga District*.—(a) In the Bijapur Musalman invasion of Mysore in 1637 under Randulhakhan and Shaji, the father of the famous Sivaji, the Bednur and Benkipur country was thoroughly overrun. "By settlement, conquest and conversions there were considerable numbers of Muhammadans employed in the Military and other services of Mysore, Bednur, Chitaldrug and other provinces at the time of Haider's usurpation in 1761,"* so much so that a 'Navayat' Muhammadan is said to have commanded the forces of Bednur in the decisive battle of Mayakonda (Chitaldrug District) in 1748 against Madikere Naik, the Poligar of Chitaldrug.
- (b) In the 18th century, the Mahratta armies swooped down on Mysore through this district time and again. The Lambani camp followers of the armies must have stuck to the country. During the Mahratta and Mysore wars of the century it was that the Lambanis came prominently to notice when "immense numbers of them were employed by the armies of both sides as foragers and transporters of supplies required for the troops."†
- (c) The present village of Humcha (in the Nagar Taluk) was the capital of a Jain principality founded by Jinaditya whose dynasty was flourishing from the 8th to the 12th centuries A. D. and is even now the seat of a Jain monastery.
2. *Mysore District*.—The Muhammadan invasions were all from the north and north-west. This district lying to the south of the country as it does retained its essentially Hindu character despite the "settlement, conquest and conversions" of the new religion.
3. *Kadur District*.—The coffee plantations of Chikmagalur, Koppa and Mudgere Taluks command the immigration of Konkani speaking Indian Christian males and workmen from South Kanara. Hence the proportionate figure has gone up for this district.

In the case of the Civil and Military Station, Bangalore, and the Kolar Gold Fields, it is the nature and economic conditions respectively of these cities that have brought together people of various religions, the number of Musalmans and Christians being prominent in the former and of Christians in the latter.

84. A study of Subsidiary Table VI reveals to us the fact that the Hindus though predominating in both the urban and the rural populations, are very much less so in the former than in the latter. Animists are essentially a rural population, their number per 10,000 of population in the rural area being thrice as much as the number per 10,000 of population in the towns in the Eastern Division (including Civil and Military Station, Bangalore), while in the Western Division, the number is nearly 4½ times as much. Musalmans, Christians and Jains are

Religions of urban and rural population.

* Mysore Gazetteer, 1897, Vol. I, page 460.

† Mysore Gazetteer, 1897, Vol. I, page 231.

mostly an urban population, the ratio between the urban proportional number and the rural proportional figure being approximately in the Eastern Division (including Civil and Military Station, Bangalore) 4 : 1, 28 : 1 and 2 : 1 and in the Western Division 4 : 1, 5 : 1 and 2 : 1 respectively. The disciples of the other religions are mainly found in cities, the urban population of the Eastern Division having as many as 18 to 10,000 of the population, the Western Division having only 4. The obvious explanation seems to be this: the Hindu is in the main an agriculturist, the Animist a labourer, the Musalman an artisan, the Christian an artisan and trader, and the adherents of the other religions, artisans. Looking to the figures for districts, we find the largest proportionate number (per 10,000) in the urban population for Hindus in Mysore (8,528) and for Animists in Chitaldrug (107). In the proportionate figures for rural population (per 10,000) the largest number in the case of Musalmans is for Shimoga (578) of Christians Kadur (125) and of Jains Shimoga (59).

**Hinduism:
a historical
retrospect.**

85. "What is a Hindu?" is a question much debated and seemingly insoluble. To take only the two extreme views on the subject; there are some who say in effect that the term 'Hindu' is as intelligible an expression as the word 'India'; Hindus are merely those who are not the followers of any defined religion such as Muhammadanism, Christianity, etc. There are others who maintain that the creed of Hinduism is as intelligible as the Muhammadan's or the Christian's. A brief historical retrospect would serve better to crystallize our ideas on the subject than any amount of mere ratiocination. When the Aryans poured over the border, and after defeating the indigenous population, settled in the Punjab and the Gangetic valley, they were free to develop their civilization without any thought or anxiety about the people of the soil. It was then as a culminating step that the wonderful Upanishads dwelling on the sublimity of the Almighty but Unknowable were composed. When, however, in course of time, owing to pressure of their own population, they had to strike out in all directions *e.g.*, towards the east and south, they were confronted with the problem of being absorbed by the civilized Dravidians. They seem to have hit upon the happy policy of "live and let live" with regard to the people they subjugated. They in fact seemed to say to the Dravidians, "You will be of our social order, but you have a distinct class therein." The scheme worked very well as an expedient for impressing the mark of Aryan civilization; but in course of time the Aryans saw their thoughts, ideas, beliefs and practices hopelessly mixed up with the thoughts, beliefs and practices of the civilization they thought they had attuned to their own. The result was social chaos and stagnation. It was then that the reformer Buddha arose and said this shall not be. He was so impressed with the force of morality as the supporter of society that he rested his religion on morality. Meantime this reformation produced a counter-reformation among the orthodox whose religious cravings were not satisfied with his exaltation of morality as a religion and who consequently set to work to find a creed and a philosophy to place on the pedestal of morality and to hold this up as a model to which the wavering people should approximate. The efforts were crowned with success, for the innate religious cravings of man were satisfied with the all-embracing creed to which, however, people might take their own time to attain. Thus Buddhism vanished and the Dravido-Aryan religion reappeared with the newly evolved all-embracing creed "*ekam eva adwitiyam Brahma*" which was culled out of the Upanishads and made acceptable to all people by its tolerating the existing kinds of worship as so many different paths leading to the one true goal. There were many aboriginal tribes that stood severely aloof from all contact with the Aryan civilization and even the sections of the community that came into contact with the Aryans, became aryanized in various degrees according to the intimacy or otherwise of the relationship. It is to this Dravido-Aryan community that the over-seas visitors and invaders applied the term "Hindu" and to their religion "Hinduism." But the latitude allowed by the builders of the social and religious structure at the outset of this reclamation of society, involved a drift in ideas about the Godhead and the consequent relation between man and man. Every clan began to have its own traditional worshipfully believing that that was also a number in the series that led ultimately to the realization of the Vedantin's ideal. The result was that society again began to breakup. When race and creed vanished, what was there to hold the society

together but community of occupation? From time to time great thinkers and men of action arose who realised the absurdity of the religious tie being lost sight of and society being hidebound by meaningless customs. These reformers originated so many sects or rather persuasions, which in turn, when the effect of time was to lessen the hold of the reforming dogma on the adherents, reverted to the tie of community of occupation keeping the sections of society together.

86: Western scholarship in the east occupied itself in bringing to light the treasures of the Indian scriptures and was impressed profoundly with the origin and distinction of castes as laid down in well-known sacred books. The scholars took for granted as existing what the text-writers who consistently with the original Aryan policy of assimilation classified and catalogued existing castes and attributed qualities or origins according to their own ideals, thus leaving it to the people to approximate to what was termed best and highest in the opinion of the most cultured of the time, had written concerning society. Very naturally they took the Brahmans who were the representatives of the old text-writers as the social and religious legislators of all Hindus, including in the term even aboriginal tribes who never so much as knew what a Brahman was. Meanwhile the extension of the Indian Empire and the systematic enquiry into the condition of its inhabitants brought to light, just at a time when scholarship thought it had said its last word about Hinduism, when it said that Brahmans were the arch-priests of Hinduism, that Aryan civilization had never so much as made its appearance in some parts of India; that the imprinting of the Aryan impress was very faint in many cases; and that the term 'Hindu' which the foreigners first applied to the usually known 'Hindus,' was quite inapplicable to many sections of society. The word 'Animist' then came into existence to describe those who do not bear any Aryan impress. But then there was this curious phenomenon, as a result of residence in the proximity of a better civilization, that some 'Animists' called themselves 'Hindus' after their more advanced neighbours, all the more readily because the change did not at the same time involve any change in their beliefs, etc. After this review, we may venture to frame a definition of a 'Hindu' somewhat as follows:—

The dis-
quisition
continued
The term
'Hindu'
defined.

"A Hindu is a theist believing in the religious evolution which will some day, but surely through worship of God in His various forms (according to the worshipper's ideal) and through good works in his present life or a series of lives, land him in the Godhead compared to whom nothing is real in this world."

Readers desirous of further information on the subject are referred to para 628 of the India Census Report of 1901, and the articles on "Brahmanism" and "Hinduism" in the Encyclopædia Britannica, 11th Edition.

87. Certain castes and tribes (contributing more than one per mille of total population of the State) returning or classed as Hindus are examined below with reference to certain standards and certain disabilities in order to enable the reader to draw his own conclusion as to whether the members of particular castes or tribes may be regarded as Hindus or not.*

An exami-
nation of
the castes
compris-
ing
Hindus.

- (1) The Lingayats (729,431) '*deny the supremacy of the Brahmans*'; as also the Panchalas (128,098). The aboriginal tribes who have returned themselves as Hindu, Koracha (6,126) and Lambani (9,945) know nothing of Brahmanical supremacy.
- (2) The aboriginal tribes returned as Hindu '*do not receive the mantra*' for Upanayanam '*from a Brahman or other recognised Hindu Guru*.' The time of initiation varies in the case of different castes. The initiation ceremony is denied to castes, such as Holeya (613,248) and Madiga (308,083).
- (3) The Lingayats acknowledge the supremacy of the *Vedas*, but dissent from the performance of the sacrifices and repudiate the efficacy of the *Sraddhas*. (Mysore Census Report, 1901, p. 532.)
- (4) The aboriginal tribes returned as 'Hindu' cannot be said '*to worship the great Hindu Gods*.'

* The standards and disabilities with reference to which the castes are examined were suggested by the Census Commissioner for India in his notes for the Chapter on Religion in the Census Report. The Monographs of the Ethnographic Survey in Mysore have been freely consulted in the preparation of this paragraph.

- (5) Holeyas and Madigas and the aboriginal tribes returned as 'Hindu' cannot be said to be '*served by good Brahman as family priests.*'
- (6) The following castes have '*no Brahman priests*' at all: Jogi (12,881), Madiga, Nayinda (39,414), Neygi (96,466), Tigala (69,233) and Vodda (142,482). The Agasas (97,772) have both Brahman and Jangam priests; the Bedas (268,454) do not have Brahman priests for death ceremonies; the Holeyas merely consult Brahman astrologers and the Kurubas (403,366) have Brahman priests only occasionally. The Komatis (9,813) and Vaisyas (26,497) are gradually displacing Brahman priests who do not minister to them according to the ritual of the Vedas.
- (7) Holeyas and Madigas are '*denied access to the interior of ordinary Hindu temples.*' But at Melkote in the Mysore District, Ramanujacharya, the Srivaishnava reformer, accorded to Holeyas the privilege of entering the temple along with the Brahmans and other higher castes during the annual car-festival for a period of three days. The privilege of entering the temple during the annual car procession is enjoyed by the Holeyas in the Vishnu Temple at Belur, Hassan District. The Medas (6,778) do not enter the inner portions of a temple.
- (8) *Pollution.*—(a) *By touch.*—The Bedas are generally considered as low caste people and therefore the Brahmans and other 'Dwijja' or 'twice born' classes do not touch them. The touch of a Nayinda is supposed to defile a Brahman, a Komati and men of some other similar castes.
- (b) *Within a certain distance.*—The close presence of Holeyas and Madigas is thought to cause pollution.
- (9) The following castes '*bury their dead.*'—
 Agasa, Beda, Golla, Holeyas, Idiga, Jogi, Lingayat, Madiga, Meda, Nayinda, Neygi, Vakkaliga and Vodda. But corpses of lepers and pregnant women are either cremated or buried in heaps of stones, among Agasas; persons suffering from leprosy and other cutaneous diseases are cremated among Bedas; old or esteemed people among Bestas (156,863), old people among Holeyas; those killed by wild animals, pregnant women and lepers are either cremated or buried in heaps of small stones by Voddas.
- (10) Bedas '*eat beef*'; but some do not eat cows and buffaloes. Madigas partake of the carcasses of cattle.

The numbers of Hindus examined.

88. Assuming that the total population in 1871 was 10,000, details for each succeeding Census and for each main religion in all the Censuses have been worked out for the population of the State in the appended statement. The Hindus suffered most in the severe famine of 1876-7. There has been a gradual increase since 1881 but the rate of increase is very slow when compared to the rate of increase of the followers of other religions. Migration from the State or conversions to other religions cannot explain this deficiency. The reason may be owing to a real difference in the rate of increase, due to the social practices among certain Hindu castes, of (1) marriage of girls of tender age, which leads to early maternity and consequently entails greater risks of deaths of mothers and children and (2) prohibition or discountenancing of marriage of widows. As might have been expected, the largest increase was in the decade (next after the famine of 1876-7) 1881-91, *i.e.*, 17.5. Hassan District was the most thickly populated district with Hindus in 1871 (9,695 per 10,000 of population) but in the subsequent decades has given place to the Mysore District (9,643 in 10,000 in 1911). The Eastern Division (including Civil and Military Station, Bangalore) contains more than three-fourths of the number of Hindus, the Western Division containing the remaining one-fourth. Mysore District has 24 per cent, Bangalore 15 per cent, Tumkur and Kolar 13 per cent, each, Hassan and

Chitaldrug 10 per cent, each, Shimoga 9, and Kadur 6 per cent, of the Hindu population of the State.

Religion	1871	1881	1891	1901	1911
Total population	10,000	8,281	9,779	10,957	11,485
Hindu	9,333	7,708	9,045	10,087	10,565
Musalman	414	397	500	573	622
Christian	51	58	75	99	118
Jain	26	21	26	27	35
Animist	176	97	133	171	143
Other religions	2

89. The statement appended gives the figures for each district and city for the two Censuses and the percentage of increase or decrease during the decade. The cities of Bangalore and Civil and Military Station, Bangalore, were thinly populated in 1901 as plague was very prevalent then. So the increases are above the normal for the Hindu population of the State, *i.e.*, 4·7 per cent. It is noteworthy that the increase in Bangalore City is +27·5 per cent. The increase is due both to immigration and to natural growth. The increase in the Kolar Gold Fields is likewise due to immigration and natural growth on account of the expansion of the gold mining industry in the area. Chitaldrug District has received during the decennium an increase of area from the Kadur and Tumkur Districts containing a population (1901) of 12,267 persons and so the increase appears so high as +12·9. The Hindu population of Districts having a percentage of variation lower than that for the State (4·7) will now be examined. It is noticeable that in the Mysore District the decreases in Seringapatam (-6·8), French-rocks (-3·0) and Yelandur (-3·3) account for the small variation of +3·8. In Hassan District the decreases in Manjarabad (-15·4), Belur (-7·2) and Alur (Sub) (-8·1) have brought down the district increase to +1·9. In Kadur District there is a general decrease except in the Kadur Taluk (which was the unit that gave a population of nearly 3,500 to Chitaldrug District). The decrease varies from -9·2 in Chikmagalur Taluk to -2·6 in Koppa. In Shimoga District there is a decrease except in the taluks of Shimoga, Channagiri and Honnali, the decreases varying from -9·9 in the Kumsi Sub-Taluk to -1·9 in Shikarpur. Hinduism has received an accession by some Animist tribes returning themselves as Hindus in this Census, so that in the case of some taluks the natural increase of Hindus would be slightly less and the natural decrease more noticeable than now denoted in Provincial Table II.

District or city	Hindus in		Percentage of variation
	1911	1901	
Bangalore City	72,632	56,975	+27·5
Bangalore District	691,148	659,711	+ 4·8
Kolar Gold Fields (City)	35,395	29,019	+22·0
Kolar District	671,167	634,921	+ 5·7
Tumkur District	683,971	633,847	+ 7·9
Mysore City	55,926	52,495	+ 6·5
Mysore District	1,225,397	1,180,463	+ 3·8
Chitaldrug District	524,169	464,092	+12·9
Hassan District	551,669	541,531	+ 1·9
Kadur District	309,627	326,960	- 5·3
Shimoga District	463,261	468,435	- 1·1
Civil and Military Station, Bangalore	56,546	50,727	+11·5

Musal-
mans.

90. The statement appended in the margin shows taluks with large num-

Taluk	Musalman population	Percentage of Musalman to total population
Bangalore District—		
Bangalore City	10,587	11·9
Closepet (Sub)	3,936	8·7
Hoskote	6,507	8·6
Channapatna	6,229	8·1
Kolar District—		
Kolar Gold Fields (City)	3,103	6·4
Kolar	6,926	8·6
Srinivaspur	5,134	8·0
Chintamani	4,928	7·9
Tumkur District—		
Kunigal	6,964	8·3
Tumkur	7,661	6·6
Sira	4,524	5·0
Mysore District—		
Mysore City	12,825	18·0
Hunsur	5,808	4·9
T.-Narsipur	3,852	4·2
Seringapatam	2,230	4·1
Chitaldrug District—		
Harihar (Sub)	3,435	8·7
Molakalmuru	2,599	6·6
Davangere	4,729	6·2
Hassan District—		
Manjarabad	2,417	4·8
Belur	2,659	3·6
Arsikere	2,565	3·3
Kadur District—		
Yedahalli (Sub)	1,965	3·2
Chikmagalur	5,654	6·9
Tarikere	3,834	5·4
Shimoga District—		
Kumsi (Sub)	2,474	14·4
Shimoga	3,701	11·6
Shikarpur	5,372	8·5
Civil and Military Station, Bangalore	22,786	22·6

bers of Muhammadans in the districts of the State. The urban Muhammadan population forms more than one-third of the total Muhammadan population and consists mostly of artisans and traders. The return of Tribes (Imperial Table XIII), contains such names as Saiyid, Sheikh, Sharif and Hanifi which return 235,378 persons or 75 per cent, of the total population. The foreign tribes such as Awan, Gujar, Jat, Labbai, Mapilla, etc., who are more or less sojourners may be left out of account in tracing the growth of the indigenous population. The Mughals (8,151) and Pathans (44,689) seem to be the only numerous indigenous tribes probably descended from the Dekhani Musalman adventurers who hailed from Bijapur after the disruption of the Vijianagar Kingdom in the 16th Century. The

Mughal occupation towards the end of the 17th Century of Sira meant a good deal and the extensive conversions of Tippu Sultan were responsible for the addition of numbers to Muhammadanism in the 18th Century. It may be herein noted that most of the Muhammadans in the State belong to the sect of Sunnis.

Chris-
tians.

91. Fully seven-tenths of the Christian population are urban. Of this

Taluk	Persons
Bangalore District—	
Bangalore	3,396
Kankanhalli	1,411
Kolar District—	
Kolar	585
Bowringpet	1,588
Tumkur District—	
Tumkur	1,030
Hassan District—	
Hassan	1,758
Manjarabad	1,029
Kadur District—	
Chikmagalur	1,013
Koppa	916
Mudgere	1,758
Shimoga District—	
Shimoga	834
Tirthahalli	678

urban population, nearly one-half are in the Civil and Military Station, Bangalore, and more than six-sevenths reside in the four cities. The taluks that have over 500 Christians are shown in the statement given in the margin. The growth of the Christians during the decade 1901-11 is +19·5 per cent. The increase in the urban Christian population in the period is 20·8 per cent and that in the rural population is 16·7 per cent. The cities alone have an increase of 23·1 per cent, the rest of the State having an increase of 14·4 per cent. The increase in the cities is 70 per cent of the total increase for the State. The increase though favourable when compared with the general increase in population (4·8 per cent) is less than that of the previous decade (+31·3 per cent). Besides being due to natural causes, the increase of +31·9 per

cent in the Bangalore City, of +26·2 per cent in Kolar District and of +37·5 per cent in Kolar Gold Fields is due to migration; of +71·9 per cent in Tumkur on account of the enumeration of the soldiers and followers of two batteries on the line of march on the 10th March 1911; the decrease of 44·7 per cent in Chitaldrug District is due to the closing of the large Public Works on the Marikanave Lake where by a village Chikkanahalli which consisted of 4,544 persons in 1901 (but was unpopulated in 1891) now in 1911 contains only 855 persons.

92. It was only in the case of Christians that the return by sects was prescribed and the information collected showed as follows:—

The sects of Christians.

Sect	1911	1901
Total Population	59,844	50,059
Roman Catholic	42,543	37,616
Anglican Communion	6,656	7,797
Other Protestants	9,050	3,851
Armenian	1	...
Syrian	10	8
Sect not returned and indefinite beliefs...	1,584	787

As the co-operation of the heads of the several missionary bodies was requested by a special circular, there is every reason to believe that the information collected is fairly accurate.

The Roman Catholics form nearly seven-tenths of the Christian population. Among the Roman Catholics the natives form 90 per cent, Anglo-Indians 7 per cent, and Europeans 3 per cent. The Catholic Missions began serious work from the 17th century, to let alone the early labours of the Dominicans in the 14th and of the Franciscans in the 16th centuries. Their efforts, though stemmed during the rule of Tippu Sultan, have been very successful, the largest number of native Christians being in their fold. On the other hand, the Anglican Communion contains the least number of natives in its congregation, i.e., 12 per cent, while Europeans number 59 per cent and Anglo-Indians 29 per cent. Considered by sects, the races stand as follows:—

(1) *Europeans* (7,463) are mostly Anglicans (3,955), Roman Catholics (1,469), Presbyterians (1,030) and Methodists (543).

(2) *Anglo-Indians* (5,827) consist principally of Roman Catholics (3,140), Anglicans (1,910) and Methodists (363).

(3) *Indians* (46,554) are chiefly Roman Catholics (37,934), Methodists (2,919) and other Protestants unspecified (1,671). Comparison with the numbers for sects returned in 1901 is not possible as some of the figures specially for Anglicans in 1901 were inaccurate (*vide* para 14 of Mysore Census Report, 1901, page 88).

93. There is a Roman Catholic Bishop for Mysore and there are nearly 100 places of worship in the State. The first Protestant Mission (London Mission) began working from 1820 and there are now the following Missions engaged in work in different parts of the State:—

Christian Missions and their work.

- (1) London Mission.
- (2) Wesleyan Mission.
- (3) American Methodist Episcopal Church.
- (4) Leipzig Lutheran Mission.
- (5) Church of England Zenana Mission.
- (6) Church Missionary Society.
- (7) Society for the Propagation of the Gospel Mission.
- (8) Ceylon and India General Mission.
- (9) The Salvation Army.

Schools and colleges for boys and girls, orphanages, hospitals and asylums for the aged, are provided by the missionaries. The chief work is among the backward classes of Hindus. The enlightening influence of Christianity is patent in the increased standard of comfort of the converts and their sober, disciplined and busy lives. To take education for instance, we find that among Indian Christians no less than 11,523 persons or 25 per cent of the population are returned as literate while for the total population of the State the percentage is only 6. The natural increase of the existing population, and the influx of outsiders to Bangalore on account of the Civil and Military Station there and to the Kolar Gold Fields on account of the expansion of the gold mining industry, are mainly responsible for the increase during the decade.

94. (i) The convert has better chances of education and start in life as an artisan or agriculturist.

(ii) Even if he be in very humble circumstances he can assert his individuality in the Christian fold, which is sometimes not possible in Hinduism.

Conversion to Christianity.

- (iii) He can be represented by the 'Padre' in his temporal dealings if need be and his case put clearly before Government officials.

The success in gaining converts is not now so marked as the spread of a knowledge of Christian tenets and standards of morality not only in the classes among whom they work but also among the people in general. Converts now-a-days are many of them isolated individuals or members of families some inmates of whom have already been converted. The age statistics (Imperial Table VII) have been examined in order to find out the ages at which converts are chiefly gained. The Civil and Military Station, Bangalore, may be excluded for this purpose as its conditions in this respect are so peculiar, and fluctuations owing to migration are very frequent. So, for the State excluding Civil and Military Station, Bangalore, comparing the number of Christians at the age periods 10-15, 15-20, 20-40, 40-60 and 60 and over, of the Census of 1911 with the numbers of Christians of the age periods 0-5, 5-10, 10-30, 30-50, and 50 and over respectively of 1901 Census, we find that the increases over the numbers of 1901 are in the age periods 10-15, and 20-40 of 1911. For the age period 10-15 we have the increase of 242. For the other age period 20-40 we have to deduct the increases in the Kolar Gold Fields, numbers in which are chiefly augmented by immigration, and in Tumkur District, where British troops on the line of march on the 10th March 1911 have been enumerated. We thus get 63 net increase for this age period. Thus we may roughly say that $242 + 63 = 305$ persons of age periods 10-15, and 20-40 have been converted during the decade. The ideal of a Nationalist Indian Protestant Church is in the minds of a few Indian Christians from Madras but no definite movement seems to have taken place in the State.

**Euro-
peans and
Anglo-
Indians in
1901 and
1911.**

95. The marginal statement shows the number of Europeans and Anglo-Indians in 1901 and 1911.

	Europeans		Anglo-Indians	
	1911	1901	1911	1901
Mysore State	7,463	4,753	5,827	5,721
Civil and Military Station, Bangalore	5,042	2,961	3,035	3,271
Bangalore City	337	246	485	268
Bangalore District	412	166	138	330
Kolar Gold Fields	893	762	1,520	1,178
Kolar District	57	57	133	122
Tumkur District	340	11	15	26
Mysore City	122	143	198	197
Mysore District	46	43	33	44
Chitaldrug District	4	12	10	45
Hassan District	70	147	106	94
Kadur District	109	166	91	116
Shimoga District	31	40	63	30

Analysed by districts, it is seen that there is a decrease in Hassan and Kadur owing to the emigration of planters and agents consequent on the low prices of coffee; the decrease in Chitaldrug is due to the closing of the works on the Marikanave lake; in Tumkur the increase in Europeans is due to the enumeration of soldiers of two batteries of Royal Field Artillery, on the line of march; in Kolar Gold Fields the increase is due chiefly to migration; the increase in Europeans and the decrease in Anglo-Indians in the Bangalore City, Civil and Military Station, Bangalore, and Bangalore District, is due to (a) some Anglo-Indians having returned themselves as Europeans and (b) migration. In the Bangalore District at the time of Census enumeration, there was an European regiment in camp.

Animists.

96. The Animists form one per cent of the total population and are mostly found in the Bangalore, Tumkur, Chitaldrug and Shimoga Districts. Some of the Animist castes have returned themselves as Hindu in the present Census and hence the apparent decrease of 16·7 per cent during the decade. The number of persons belonging to Animist tribes but enumerated as Hindus is 16,491. If this number is added to the number of Animists returned, *i.e.*; 72,196, the total will be 88,687 persons, which compares well with the number of 86,627 of 1901. Therefore, the conclusion seems to be that the loss in the number of Animists in the decade 1901-11 is due almost entirely to an accession to Hinduism of a good many of their number chiefly in Mysore, Hassan, Kadur and Shimoga Districts. But it must be remembered that no conscious effort was made by Hinduism to enlist these in the religion. The result is due more to the progressive life they lead in the neighbourhood of the Hindus. The taluks that contain more than 2,000 Animists each are Kankanhalli (Bangalore District), Goribidnur (Kolar District), Sira (Tumkur District), Chitaldrug and Davangere (Chitaldrug District), Arsikere (Hassan District), Kadur (Kadur District) and Shimoga, Channagiri and Shikarpur (Shimoga District).

97. The increase in numbers among Jains is remarkable (28·9 per cent). **Jains.** The community has a history of its own and dates in Mysore from the time of the migration of their great teacher Bhadrabahu southwards and sojourn near Sravana Belgola in the Hassan District. The Jains have left an indelible mark on Kanarese literature. At the present day, the majority of Jains (who are Digambaras) are mostly traders and landlords. The increase is due to natural growth and also to many Sadas (Vakkaligās) in the Bangalore and Tumkur Districts returning themselves as "Jains."* The immigrant Jains (chiefly Svetambaras) are mostly from the Rajputana States and are engaged in trade and money lending. The taluks returning more than 500 Jains in each district are:—Nelamangala and Magadi (Bangalore District), Goribidnur (Kolar District), Tumkur, Maddagiri and Koratagere (Sub) (Tumkur District), Heggaddevankote (Mysore District), Hassan and Channarayapatna (Hassan District), Mudgere (Kadur District) and Sagar (Shimoga District).

98. The adherents of the Parsi, Sikh, Brahma and Jew religions are numerically very few. The Buddhists number 622 in 1911 while they numbered 10 in 1901. As the increase is remarkable, a few facts regarding the same may not be out of place here. The increase is most marked in the Civil and Military Station, Bangalore, and the Kolar Gold Fields. The expansion is not due to natural growth or immigration, but to proselytism. There are two branches of the South India Sakya Buddhist Society working at Bangalore (Civil and Military Station) and Kolar Gold Fields respectively. Mission work seems to have begun at the latter place in the year 1906 and at the former in 1909. The disciples belong to the Indian Church of Buddhists which is akin to the Buddhist Church of Burma and Ceylon. The lofty principles and beautifully simple life enunciated by the founder of the religion seem to appeal with peculiar force to the Tamil-speaking artisans and middle classes in the localities mentioned above. In fact, it is learnt that but for the unavoidable absence of the Buddhist priests (who are naturally at this infant stage of their mission, required to be touring to all the branch societies in Mysore and elsewhere in Southern India), many more persons would have received the "Tri Saranam" (three refuges) and the "Pancha Sila" (five precepts) which ceremonial is necessary for admission into the fold of the Buddhist Church. This initiation consists in the disciple asking and receiving the vows (*i.e.*, Tri Saranam and Pancha Sila) at the hands of a Buddhist priest. These vows are (as translated into English):—

(i) Tri Saranam (three refuges)—

(a) To the Buddha I go for refuge.

(b) To the Law I go for refuge.

(c) To the Order I go for refuge.

(ii) Pancha Sila (five precepts)—

(a) I promise to abstain from taking or destroying the breath, the energy or the life of any human being.

(b) I promise to abstain from taking anything that belongs to another with thievish intention.

(c) I promise to abstain from unlawful indulgence of the bodily passion.

(d) I promise to abstain from uttering (even) a word of falsehood.

(e) I promise to abstain from partaking of anything which will tend to produce drunkenness.

Conversion does not seem to necessitate any change either in the social life or in the civil law followed by the disciple. This renaissance of the Buddhist movement is full of interest and future promise. The usual thorny questions incidental to proselytism, *viz.*, those relating to inheritance and marriage have not yet disturbed the peace of the young community.

There has been an increase of Brahmans in the Bangalore City and Civil and Military Station, Bangalore. The Samaj here belongs to the 'Sadharan' section. The numbers include local converts as well.

99. For every 1,000 males there are 986 females among Hindus, 897 among Muhammadans, 879 among Christians, 877 among Jains and 951 among Animists.

Proportion of females to males in the main religions.

* NOTE.—The following note occurs against the caste in the Mysore Census Report, 1871 :—'The whole tribe appear originally to have been Jains but are now divided into three classes according to the religion they follow. They are worshippers of Vishnu, Siva and Jaineswara. All of them eat together and intermarry; the wife, as usual in such cases, adopts the religion of her husband.'

PART II.—GENERAL.

The actual religious beliefs of the Hindu villager.

100. As Hinduism is a religion which gives scope for a variety of beliefs, the ordinary Hindu villager's religious beliefs, what with the usually precarious nature of the yearly monsoons, consist mainly of notions which suggest to him the necessity of placating unseen potent influences which on the whole seem to work against him. Unlike the Duke in Shakespeare's 'As You Like It,' he does *not* find

"Books in the running brooks,
Sermons in stones, and good in everything."

Whether it be the permanent village deity (Gramma Devata) or the visiting Maramma of plague, cholera, drought or famine, the idea is clear, *viz.*, that of appeasing her wrath by general feeding and sacrifices. Buffaloes, sheep and goats are generally sacrificed in public celebrations and sheep or fowls in family celebrations. The important occasions connected with agriculture, *e.g.*, the beginning of the ploughing season and the harvest home, are celebrated with feasts, sacrifices being offered in the usual way to keep the wrathful gods at peace. Resort to astrologers who generally advise a shift from the dwelling or a local pilgrimage or feeding and sacrifice, or reference to one versed in incantations to drive out the evil, is invariably had in emergencies such as the obsession of a devil or a predeceased co-wife or death on an unlucky day. It is only when these placative resources are exhausted that the ordinary villager becomes resigned to his lot.—"Whatever will be, will be." Anything grand or imposing or awe-inspiring or out of the way, *e.g.*, a mansion, a big tree, a lonely cave, a natural spring, is at once thought of as having a spirit which must be placated in order to keep it from crossing one's path. Coigns of vantage in natural scenery are almost always found capped with rough mantaps within which are Gods consecrated to the spot. This pessimistic temperament is softened by the two ideas of contentment and charity that run through the villager's whole nature. These grand qualities may be said to be the legacy of the Aryan civilization.

Forms of worship among Hindus.

101. (a) The Brahmans and the other high castes, resemble one another in ritual observances. A Brahman must bathe and offer his prayers to the Sun thrice a day. If he is a householder, he must worship his Gods Ganapathi, the Siva Linga, Saligram, Nag and the *pada* of Vishnu according to the sectarian views of the worshipper, every day himself or by a member of the same family or by a paid Brahman. A Brahman has to do five things daily according to the orthodox rule—study the Vedas, offer libations to Gods, welcome guests, offer water to departed ancestors and give food to animals. The study is gone through by repeating the important texts of the scriptures. The chief Gods, preceptors and teachers (and also the ancestors in the case of persons who have lost their fathers) are remembered, oblations of water being offered the while. Periodically the feasts come round to commemorate some incident in the life of the great Gods, *e.g.*, Gouri, Ganesha, Krishna Jayanti, the anniversary of departed teachers or the remembrance of the primeval life led by the Brahmans, *e.g.*, Sravani or the national festival, *viz.*, the Dasara, when the monsoons are closing for the year. Special ceremonies are performed when he is anxious for a special favour, *e.g.*, cure of a disease or success in a particular undertaking or when a calamity is impending. Such ceremonies take the form of pilgrimages and special prayers to Gods, *e.g.*, the Sun or the nine planets (Grahas). Tending the 'Tulasi' plant is a religious observance specially looked to by the women of the household. The rearing of the 'ficus religiosa' and *neem* tree with a platform round them is considered a pious act by all castes. This is so very common that almost every village has two or three platforms in the midst of which the stately ficus and the gnarled *neem* rear their rustling foliage.

(b) The lower Hindu castes. Periodical and special worship is resorted to by these, daily worship being the privilege, so to say, of the cultured and leisurly classes. The periodical worship varies more or less with the profession of the devotee and special worship with the object sought to be attained. At the ceremonies of the domestic occurrences the Gods, family Gods and ancestors are invoked and propitiated and there is a general feeding. The degree and comprehensiveness of the invocation are often determined by the social rank of the head of the family and the nature of the occasion.

(c) The ideas and practices regarding household worship and pollution (*vide* para 87 *supra*) are slowly disintegrating owing to the growth of scientific knowledge, the conditions of modern travel, and the stress of competition in all walks of life.

102. In domestic and daily ceremonial many of the higher castes desire the presence of the Brahman or set apart his share of gifts before they begin. In communal or special worship, *e.g.*, to Maramma or Grama Devata, the officiator is most often not a Brahman. On such occasions Brahmans contribute to the general worship even though a Brahman is not the officiator. For most temples in villages the priest is a Satani or Vaishnava who does not wear the sacred thread. To certain 'Grama Devatas' and 'Marammas' the priest or spokesman is of other castes and sometimes a Madiga or Holeya.

103. With the exception of the Mughals and Pathans who may be regarded as descended from the Dekhani Musalman immigrants from Bijapur in the 17th century, of Dayares from Hyderabad and the immigrant tribes of Labbai and Mapilla on the one hand and Arab, Gujar, Jat, Meman, etc., on the other, the rest seem to be the descendants of the local converts. There are not many conversions now-a-days; the Hindu customs, etc., do not survive among the converts; but the idea of the Hindu Joint Family seems still to prevail in the minds of the Muhammadans in the rural tracts.

I.—GENERAL DISTRIBUTION OF THE POPULATION BY RELIGION—concl'd.

Religion and locality	Actual number in 1911	Proportion per 10,000 of population in				Variation per cent increase (+) decrease (-)			Net variation 1891-1911
		1911	1901	1891	1881	1901-1911	1891-1901	1881-1891	
1	2	3	4	5	6	7	8	9	10
PARSI.									
1. Mysore State, including Civil and Military Station, Bangalore ...	101	0	+128.6	-25.5	+114.9
2. Mysore State, excluding Civil and Military Station, Bangalore ...	55	Details not available	+19.6	+58.6	Details avail for 1881	not able 1881
3. Eastern Division ...	49	Do	+8.9	+55.3	Do	Do
4. Western Division ...	6	+500.0
BRAHMO.									
1. Mysore State, including Civil and Military Station, Bangalore ...	65	Details not available	+6,400.0	-95.7	Details avail for 1881	not able 1881
2. Mysore State, excluding Civil and Military Station, Bangalore ...	45	Do	+4,400.0	...	Do	Do
3. Eastern Division ...	45	Do	+4,400.0	...	Do	Do
4. Western Division	Do	Do	Do
JEW.									
1. Mysore State, including Civil and Military Station, Bangalore ...	40	+17.6	+61.9	+2,000.0	+3,900.0
2. Mysore State, excluding Civil and Military Station, Bangalore ...	6	Details not available	-71.4	+4.8	Details avail for 1881	not able 1881
3. Eastern Division ...	2	Do	-60.0	...	Do	Do
4. Western Division ...	4	-75.0	+6.7	+1,400.0	+300.0

1. In the case of Civil and Military Station, Bangalore, details are not available for 1881, separately for Jains and Animists. So, figures cannot be given for these religions for 1881 in the case of (1) Mysore State, excluding Civil and Military Station, Bangalore, and (2) Eastern Division.
2. Brahmors have not been shown separately in 1891.
3. In Subsidiary Table I, Chapter III, Mysore Census Report, 1901, figures for religions other than Hindu, Musalman, Christian, Jain, and Animist, have been added together for purposes of proportional representation, whereas in this table, such figures have been shown separately.

II.—DISTRIBUTION BY DISTRICTS OF THE MAIN RELIGIONS.

District and Natural Division	Number per 10,000 of the population who are—											
	Hindus				Musalmans				Christians			
	1911	1901	1891	1881	1911	1901	1891	1881	1911	1901	1891	1881
1	2	3	4	5	6	7	8	9	10	11	12	13
Mysore State, including C. and M. Stn., Bangalore ...	9,199	9,206	9,248	9,308	542	523	512	479	108	90	77	70
Mysore State, excluding C. and M. Stn., Bangalore ...	9,262	9,264	9,321	Not available	511	492	473	430	60	60	41	31
Eastern Division ...	9,274	9,310	9,358	Do	522	508	489	466	67	59	28	28
Bangalore City ...	8,193	8,204	8,366	8,456	1,194	1,235	1,304	1,394	478	463	302	150
Bangalore District ...	9,100	9,160	9,228	9,444	637	608	560	508	76	74	59	48
Kolar Gold Fields (City) ...	7,278	7,596	7,912	8,456	638	561	548	...	1,262	1,889	51	19
Kolar District ...	9,175	9,263	9,312	9,456	656	598	548	449	44	36	18	14
Tamkur District ...	9,302	9,333	9,399	9,510	479	468	434	415	23	14	13	14
Mysore City ...	7,843	7,707	7,674	7,574	1,799	1,928	2,067	2,204	303	393	221	214
Mysore District ...	9,643	9,620	9,623	9,579	298	296	300	323	12	12	12	16
Chitaldrug District ...	9,280	9,304	9,360	9,510	462	460	439	363	4	9	7	4
Western Division ...	9,228	9,126	9,226	9,216	478	461	433	385	76	66	22	28
Haasan District ...	9,508	9,519	9,561	9,695	306	298	265	206	66	67	64	45
Kadur District ...	9,146	9,013	9,093	9,123	490	500	471	420	134	107	67	36
Shimoga District ...	6,965	6,810	6,961	7,028	663	618	572	562	49	37	31	29
C. & M. Stn., Bangalore ...	5,608	5,662	5,769	6,008	2,269	2,407	2,287	2,227	2,026	1,911	1,789	1,764

II.—DISTRIBUTION BY DISTRICTS OF THE MAIN RELIGIONS—*concl'd.*

District and Natural Division	Number per 10,000 of the population who are—											
	Jains				Animists				Others			
	1911	1901	1891	1881	1911	1901	1891	1881	1911	1901	1891	1881
	14	15	16	17	18	19	20	21	22	23	24	25
Mysore State, including C. and M. Stn., Bangalore	30	25	27	26	124	156	136	117	3
Mysore State, excluding C. and M. Stn., Bangalore	31	25	27	Not available	126	159	138	Not available	1	Not available
Eastern Division	26	17	20	Do	109	111	95	Do	1	Do
Bangalore City	50	16	23	•	80	81	•	•	5	1
Bangalore District	34	9	19	•	152	149	134	•	1
Kolar Gold Fields (City)	15	11	1	2	73	64	97	2
Kolar District	25	13	•	•	100	86	•	•
Tumkur District	45	32	34	30	152	153	120	31
Mysore City	45	20	32	17	2	8	48	60	9	4	6	8
Mysore District	14	15	17	17	33	57	•	•
Chitaldrug District	16	16	16	17	208	191	158	106
Western Division	43	47	44	47	175	290	246	214
Hassan District	31	33	26	27	89	66	64	24	1
Kadur District	39	43	40	37	189	337	329	333
Shimoga District	53	66	65	74	264	474	351	307	1
C. & M. Stn., Bangalore	32	12	13	•	24	...	42	•	40	8	4	1

NOTE.—The figures for 1881 for Jains and Animists are included in those for Hindus in the case of the cities of Bangalore, Mysore and Civil and Military Station, Bangalore; while the figures for 1891 for Animists are merged in those for Hindus in the case of the cities of Bangalore and Mysore.

III.—CHRISTIANS. NUMBER AND VARIATIONS.

District and Natural Division	Actual number of Christians in				Variation per cent			
	1911	1901	1891	1881	1901—1911	1891—1901	1881—1891	1881—1911
1	2	3	4	5	6	7	8	9
Mysore State, including Civil and Military Station, Bangalore	59,944	50,059	28,135	29,249	+19.5	+31.3	+30.4	+104.6
Mysore State, excluding Civil and Military Station, Bangalore	39,414	32,933	20,233	12,751	+19.7	+62.8	+58.7	+209.1
Eastern Division	28,529	23,283	13,077	7,657	+22.5	+73.0	+71.2	+273.6
Bangalore City	4,938	3,212	2,425	932	+31.9	+32.5	+160.2	+354.7
Bangalore District	5,807	5,367	3,682	2,497	+8.2	+45.8	+48.0	+133.5
Kolar Gold Fields (City)	9,660	7,027	2,996	869	+37.5	Not available
Kolar District	3,253	2,578	+26.2	+220.6	+244.8	+274.3
Tumkur District	1,631	949	743	603	+71.9	+27.7	+23.2	+170.5
Mysore City	2,152	2,366	1,640	2,603	-5.0	+38.2	+13.2	+29.0
Mysore District	1,543	1,441	1,307	1,433	+7.1	+10.3
Chitaldrug District	245	443	294	143	-44.7	+56.0	+98.6	+71.3
Western Division	10,886	9,650	7,156	5,114	+12.8	+34.9	+39.9	+112.8
Hassan District	3,028	3,795	3,296	2,393	+0.9	+15.1	+37.7	+60.0
Kadur District	4,542	3,898	2,309	1,245	+16.8	+76.0	+77.4	+264.8
Shimoga District	3,315	1,967	1,551	1,476	+97.9	+19.1	+11.9	+70.4
Civil and Military Station, Bangalore	20,530	17,126	17,908	16,498	+19.3	-4.3	+8.5	+23.8

IV.—RACES AND SECTS OF CHRISTIANS. (ACTUAL NUMBERS.)

Sect.	European		Anglo-Indian		Native		Total.		Variation In- crease(+) or De- crease(-)
	Male	Female	Male	Female	Male	Female	1911	1901	
1	2	3	4	5	6	7	8	9	10
Total	4,908	2,561	2,673	2,154	24,278	22,276	59,844	50,059	+9,785
Anglican Communion	2,471	1,284	909	1,001	346	445	6,656	7,737	-1,141
Armenian	1	1	...	+1
Baptist	49	37	34	56	626	467	1,969	279	+990
Congregationalist	9	6	2	14	166	177	374	116	+258
Greek	+4
Lutheran	6	2	1	2	80	70	160	336	-176
Methodist	269	174	157	206	1,362	1,537	3,925	2,644	+1,281
Minor Protestant denominations	7	8	2	4	72	46	139	76	+63
Presbyterian	927	108	11	23	25	52	1,141	400	+741
Protestant (unsectarian or sect not specified)	157	117	96	97	919	752	2,138
Roman Catholic	274	595	1,449	1,691	19,217	18,017	42,543	37,616	+4,927
Syrian (Chaldean)	7	1	8	3	+5
Syrian (Jacobite)	1	1	2	5	+3
Sect not returned	17	31	12	60	732	708	1,560	722	+776
Indefinite beliefs	16	4	2	2	24	6	-19

V.—DISTRIBUTION OF CHRISTIANS PER MILLE (a) RACES BY SECT AND (b) SECTS BY RACE.

Sect	Races distributed by sect				Sects distributed by race			
	European	Anglo-Indian	Native	Total	European	Anglo-Indian	Native	Total
1	2	3	4	5	6	7	8	9
Anglican Communion	530	328	17	111	594	287	119	1,000
Armenian	1,000	1,000
Baptist	11	15	23	21	68	71	861	1,000
Congregationalist	2	3	7	6	40	43	917	1,000
Greek	1,000	1,000
Lutheran	1	1	2	3	44	19	927	1,000
Methodist	73	62	63	64	142	95	768	1,000
Minor Protestant denominations	2	1	2	2	108	43	849	1,000
Presbyterian	138	6	2	19	903	30	67	1,000
Protestant (unsectarian or sect not specified)	37	33	36	26	126	20	792	1,000
Roman Catholic	197	539	616	711	24	74	892	1,000
Syrian (Chaldean)	1,000	1,000
Syrian (Jacobite)	1,000	1,000
Sect not returned	6	12	31	26	81	45	923	1,000
Indefinite beliefs	2	1	633	...	167	1,000
	1,000	1,000	1,000	1,000	126	97	776	1,000

VI.—RELIGIONS OF URBAN AND RURAL POPULATION (FOR NATURAL DIVISIONS).

Natural Division	Number per 10,000 of urban population who are						Number per 10,000 of rural population who are					
	Hindu	Musalman	Animist	Christian	Jain	Others	Hindu	Musalman	Animist	Christian	Jain	Others
1	2	3	4	5	6	7	8	9	10	11	12	13
Eastern Division, including Civil and Military Station, Bangalore ...	7,537	1,658	39	700	48	18	9,432	402	118	25	23	...
Western Division ...	7,945	1,641	41	285	94	4	9,322	392	185	61	40	...

VI (a).—RELIGIONS OF URBAN AND RURAL POPULATION (FOR DISTRICTS AND CITIES).

District or City	Number per 10,000 of urban population who are						Number per 10,000 of rural population who are					
	Hindu	Musalman	Animist	Christian	Jain	Others	Hindu	Musalman	Animist	Christian	Jain	Others
1	2	3	4	5	6	7	8	9	10	11	12	13
Bangalore City ...	8,193	1,194	80	478	50	5
Bangalore District ...	7,891	1,991	56	60	1	1	9,191	535	160	78	36	...
Kolar Gold Fields (City) ...	7,378	638	1	1,986	...	97
Kolar District ...	7,480	2,246	40	205	29	...	9,237	551	108	34	25	...
Tumkur District ...	8,078	1,547	49	199	126	1	9,366	422	158	18	41	...
Mysore City ...	7,843	1,798	2	302	45	10
Mysore District ...	8,528	1,318	...	75	79	0	9,713	234	35	8	10	...
Chitaldrug District ...	7,941	1,798	107	51	107	1	9,393	382	216	1	6	...
Hassan District ...	8,094	1,407	69	273	155	2	9,587	245	90	54	24	...
Kadur District ...	7,955	1,748	15	225	57	...	9,266	366	205	125	38	...
Shimoga District ...	7,816	1,743	38	345	49	9	9,055	578	282	26	59	...
Civil and Military Station, Bangalore ...	5,608	2,260	34	2,026	32	40

CHAPTER V.

AGE.

104. Although statistics of classification by age are to be found in Imperial Tables VII, VIII, XII, XIV and XVIII, they are confined to the literate in Table VIII, to the infirm in Table XII, and to Christians in Table XVIII; and as such these will be discussed elsewhere in the chapters specially devoted to the respective subjects. In Table VII, the entire population is distributed by religion, age, sex and civil condition, while Table XIV exhibits a similar classification by age, sex and civil condition for each caste with, however, a different scheme of age-grouping from that adopted in Table VII. The figures in these two tables, so far as they relate to sex and civil condition, will be chiefly dealt with in the next two chapters. The scope of the present chapter will thus be confined to a discussion of the statistics of age-distribution contained in Tables VII and XIV supplemented by vital statistics furnished elsewhere in annual departmental reports, with a view to draw therefrom useful or interesting inferences regarding the longevity and fecundity of the people, as well as changes, if any, that might occur in their age-distribution from time to time.

Reference
to statis-
tics.

There are 19 age-groups exhibited in Imperial Table VII, *viz.*, one for each year of life up to 5, and one for each quinquennial period thereafter up to 70, with a single head for persons aged 70 and over. The same scheme of age-grouping was also adopted in Table VII of the Census of 1901 except that the quinquennial periods then went up only to 60, leaving a single final age-group '60 and over.' In Imperial Table XIV, the ages are shown in six groups as in the Census of 1901 and they are 0-5, 5-12, 12-15, 15-20, 20-40 and 40 and over. The main features of the statistics contained in these tables and of the vital statistics referred to above are exhibited in the following Subsidiary Tables appended to this chapter:—

- (i) Age distribution of 100,000 of each sex by annual periods.
- (ii) Age distribution of 10,000 of each sex in the Province and each Natural Division.
- (iii) Age distribution of 10,000 of each sex in the Province in each main religion.
- (iv) Age distribution of 1,000 of each sex in certain castes.
- (v) Proportion of children under 10 and of persons over 60 to those aged 15-40; also of married females aged 15-40 per 100 females.
- (vi) Variation in population at certain age periods.
- (vii) Reported birth-rate by sex and Natural Divisions.
- (viii) Reported death-rate by sex and Natural Divisions.
- (ix) Reported death-rate by sex and age in decade and in selected years per mille living at same age according to the Census of 1901.
- (x) Reported deaths from certain diseases per mille of each sex.
- (xa) Reported deaths from plague per mille.

105. The instructions issued to enumerators for filling up the age column in the general schedule were the same as in 1901 and were as follows:—

"Enter the age on last birth-day, *i.e.*, the number of years each person has completed. For infants less than one year old, enter the word "Infant." If a person cannot state his or her age exactly you should ask the relations or refer to some well-known event of local importance, or if the person be present, make a guess at the age from the appearance."

Age sta-
tistics
how far
reliable.
Their uti-
lity.

It cannot be denied that the enumerators who were mostly Government officials exercised all possible care and diligence in ascertaining and recording the ages of the people. Still there are certain inevitable features detracting from the accuracy of the age return. For one thing, it is rare for an average person to be able to give out his *exact* age off-hand, for the simple reason that for the masses the annual variant of a numeral denoting age does not figure prominently or frequently in the daily transactions of life so that it matters little for them to be ignorant of their exact age to the niceties of a few months or even years. Horoscopes and similar records of birth are maintained only among an extremely small minority of the population, and even in such cases, people do not surely think of referring to them when they are asked to state their age. The annual celebration of birth-days would, no doubt, tend to keep alive one's exact age in one's memory, but such observances are rare indeed. Under these circumstances, the age entered in the Census schedule is very often the result of a guess which betrays, naturally enough, a preference for round numbers or multiples of five. Further, there is the tendency to give out the *current* year instead of the *completed* year of age, to understate the age in the case of grown-up unmarried females and to exaggerate it in the case of old persons and of young married women with children. Subsidiary Table I appended to this chapter will afford interesting study in this connection. The table exhibits the distribution by age (as actually returned in the schedule) of 100,000 persons of each sex among Hindus taken at random in a few typical localities in the State. If the ages had all been correctly returned, one might naturally expect, in a stationary or growing population, the number at each age to go on steadily decreasing as the age advances. But the actual figures in the table disclose some capricious irregularities which may be briefly noticed here.

There is no sharp fluctuation from figure to figure as we pass from age 0 to 10 except for a marked depression against age 1 and a more striking elevation observed in the case of age 8. From 10 onwards, the general rule seems to be that multiples of 5 and 10 are more favoured than their neighbours on either side, while at the same time *even* ages are preferred to *odd* ones, subject, however, to the above rule. The lumping of figures against ages 12 and 16 also deserves special notice. Age 30 claims the largest number in the case of both males and females. All these features are graphically exhibited in the following diagram.

Diagram showing the actual number of males returned at each age per 100,000.

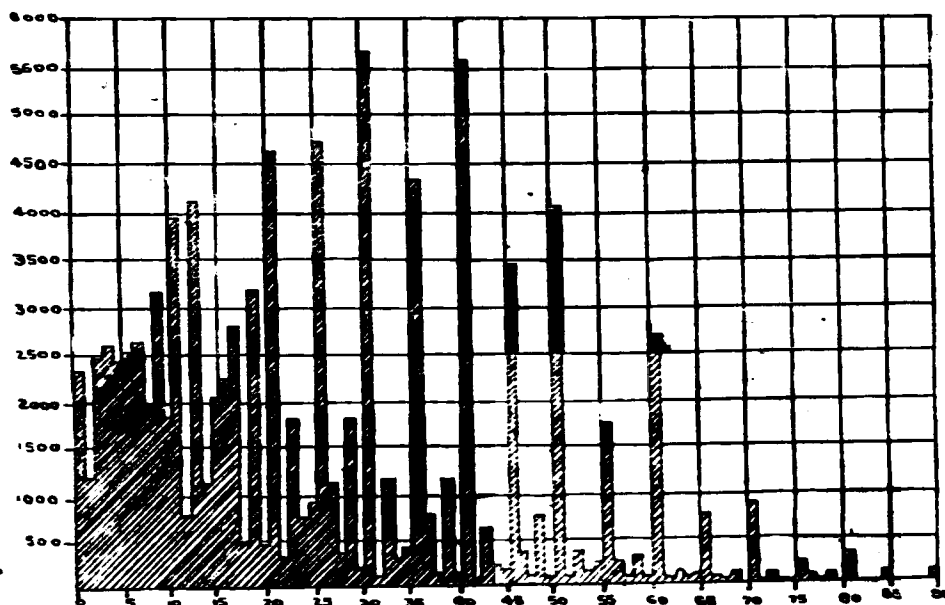

NOTE.—The figures at the bottom indicate the age and those at the side the number of persons returned at it.

The defects noticed above in the age return would appear to be so flagrant that at first sight one wonders what useful purpose can be served by such crude statistics. But in a large population the defects of over- and under-statement of age tend to counteract each other, and as for the tendency to pitch on round

numbers or multiples of 5, this can be partially corrected by suitable methods of 'smoothing' of age figures. Even then, it is doubtful if a high standard of accuracy is attainable; but in any case, in the present imperfect state of our vital statistics, these age returns afford the only means of check and verification and thus constitute an indispensable auxiliary to vital statistics for the purpose of drawing fairly reliable inferences regarding birth- and death-rates, the expectation of life at different ages and the effects of famine or other public calamities that might be traced in variations in the age-distribution of the population from time to time.

106. Although the age-distribution of the population is mainly determined by the normal birth-and death-rates, there are also other disturbing factors such as famine and migration that have to be taken into account. Not only does famine swell the death-rate for the time being, but it also leads to far-reaching fluctuations in the age-distribution of the people in the succeeding decades, as will be clear from the following extract taken from the India Census Report of 1901 (para 752, pages 474-5):—

"When a tract is afflicted by famine . . . all sections of the population, however, are not equally affected; the very old and the very young suffer most while those in the prime of life sustain only a comparatively small diminution in their numbers. . . . Consequently at the close of a famine, the population consists of an unusually small proportion of children and old persons and of a very large proportion of persons in the prime of life *i.e.*, at the reproductive ages. For some years, therefore, in the absence of any fresh calamity, the growth of the population is very rapid. The number of persons capable of adding to the population not having been much affected, the actual number of births is very little less than before the famine, but the proportion calculated on the diminished population is much greater, and so too is the excess of births over deaths, as the latter are much below the average in a population consisting of an unusually large proportion of healthy persons in their prime, and of a comparatively small proportion of persons who by reason of youth, old age, or infirmity have a relatively short expectation of life. This more rapid rate of growth continues for some years, but then as the persons who at the time of the famine were in their prime pass into old age and their place is taken by the generation born shortly before the famine with its numbers greatly reduced by the mortality which then occurred, the birth-rate falls, not only below that of the years following the famine, but also below the average. The disturbance of the normal conditions is still not ended, and the pendulum continues to swing backwards and forwards between periods of high and low birth-rate, but its oscillations gradually become fainter until they cease from natural causes to be apparent or, as more often happens, until some fresh calamity obliterates them."

The above remarks will find illustration later on in para 108 where the figures of past Censuses are discussed and reference is made to the famine of 1876-77.

107. Then there is the disturbing effect of migration. As people who leave their homes for distant lands will mostly consist of adults, their departure will tend, if their number is sufficiently large, to reduce the proportion of the middle-aged and raise that of children and old persons in the population of the tracts from which they go, and produce an opposite effect in the age-distribution of the population of the country that receives them. Immigration and emigration have thus counteracting tendencies, and it is therefore the actual difference between the number of immigrants and of emigrants that may be roughly considered as determining the disturbing factor. Taking the Mysore State as a whole, the total number of immigrants (*i.e.*, those born outside Mysore and enumerated in Mysore) is 312,908, while the emigrants from Mysore who have gone to other parts of India and Ceylon number 139,446. Although we have no information regarding the number of those who have left Mysore for other parts of the world, we may estimate this at a comparatively low figure. In any case, it will be a safe approximation if we take the excess of immigrants over emigrants as 170,000. This comes to nearly 3 per cent of the total population of Mysore and as such its influence over the age-distribution of the population cannot be altogether ignored. It must, at the same time, be admitted that in the absence of statistics to show the age-distribution of immigrants, it is not possible to frame any accurate measure of the disturbing influence of migration. But as a special table was compiled as regards birthplace, caste, age* and occupation of immigrants in

* Only three age-periods were distinguished, *viz.*, 0-15, 15-40, and 40 and over.

.....
affecting
age-distribution.

(i) Famine.

(ii) Migration.

a limited area (*viz.*, Bangalore City and Kolar Gold Fields) a fair idea of the subject can be formed from the marginally noted comparative statement showing the age-distribution of (a) the total population of the Mysore State, (b) the total population of Bangalore City and Kolar Gold Fields and (c) the immigrants only in these two cities.

	Number per mille aged		
	0-15	15-40	40 and over
1. Population of the whole State ...	374	392	234
2. Do Bangalore City and Kolar Gold Fields (City) ...	332	474	194
3. Do Bangalore City and Kolar Gold Fields, excluding immigrants ...	492	365	203
4. Immigrants in Bangalore City and Kolar Gold Fields (City) ...	220	585	185

Age-distribution.

108. Subsidiary Table II exhibits the age-distribution of the population in 1911 as well as in the three previous Censuses. Let us first take up the figures relating to the Census of 1911. It is curious to find that, contrary to the natural law of age-distribution obtaining in a progressive or stationary population, persons aged 5-10 in each sex outnumber those aged 0-5. This must have been due to the inaccuracy in the age return owing to the circumstance that persons who have completed their 4th year of age but not the 5th are often erroneously shown as aged 5. Another remarkable feature is the excess of females aged 20-25 over those aged 15-20, which is observable in all the Censuses. This has to be explained on the one hand by the tendency to mention young (aged 15-20) married women with children as older than they really are, and on the other by the disposition to understate age in the case of unmarried females aged 15-20, so that the number returned for the age-group 15-20 suffers a decrease in both ways. A tendency to exaggerate age in the case of old persons is likewise traceable in the excess of males aged 60-65 over those aged 55-60 and of females aged 50-55 over those aged 45-50. It is rather difficult to account for the fact that the age-group 40-45 claims more people in each sex than the earlier period 35-40. Perhaps one has to be content with the observation that, ordinarily beyond 25 or 30, the older the individual the greater is the margin of error in the age as returned in the schedule. It may, however, be pointed out that in 1881 also the number of males aged 10-15 exceeded those aged 5-10 and their survivors in 1911 would be comprised in the above age-groups 40-45 and 35-40 respectively.

A comparison of the figures for the last four Censuses reveals unmistakable traces of the famine of 1876-77. Taking only the case of males as their ages are likely to be more accurately returned than those of females, it will be noted that in 1881, close after the famine, the proportion of children aged 0-5 was considerably reduced, with a similar shrinkage in the age-groups comprising their survivors in the next three Censuses, *viz.*, 10-15 in 1891, 20-25 in 1901 and 30-35 in 1911. So also is the rebound after famine visible in the large proportion of

Year	Number per 10,000 males aged			
	0-5	10-15	20-25	30-35
1881 ...	915 (b)	1,396	848	902
1891 ...	1,384 (a)	921 (b)	850	829
1901 ...	1,282	1,326 (a)	664 (b)	762
1911 ...	1,156	1,256	665 (a)	710 (b)

children aged 0-5 in 1891 and a perceptible increase due to the inclusion of their survivors in the age-group 10-15 in 1901 and in 20-25 in 1911. The statistics relevant to the subject are exhibited in the marginal statement where the inflated and reduced figures are shown in italics and marked (a) and (b) respectively.

It will also be seen from the above statement that the disparity in the italicised figures as compared with those against the same age-groups in other Censuses becomes less and less marked as we recede farther and farther from the famine period 1876-77. The inflated figures for 1881 under the age-groups 10-15, 20-25 and 30-35 must be due to the circumstance that the majority of victims in the famine of 1876-77 were either children or aged persons. All this is in entire consonance with the observations contained in the India Census Report of 1901, which have already been quoted in para 106 above.

Mean age.

109. The mean age of the population at each of the last four Censuses, calculated for each Natural Division and main religion, is shown in Subsidiary Tables II and III. By 'mean age' is meant the average age of the living, *i.e.*, the arithmetical sum of the ages of all the persons living at a particular time divided by the total number of such persons. It is not therefore necessarily identical with the mean duration of life or the expectation of life at birth. It is

a mere mathematical abstraction determined by the nature of age-distribution in the population. A high mean age may be due to general longevity of the people or a low birth-rate or high death-rate among children. Similarly, a low figure may indicate either that the people are comparatively short-lived or that they are very prolific and multiplying rapidly. The mean age, as shown in Subsidiary Tables II and III, has been calculated from the figures of Imperial Table VII according to the following formula:—

Where ages have been tabulated by five-year periods only (as in Imperial Table VII) find out the total number of persons living at the close of each age-period. The sum of these totals, multiplied by five and raised by two and a half times the actual number of persons comprised in the population, should be divided by the last-mentioned number of persons.

110. In discussing the variations in the mean age of the population in the past Censuses, it will be sufficient to confine our consideration to the male sex inasmuch as the age return for males is likely to be less inaccurate than in the case of females. Taking, then, the entire male population of the Mysore State including the Civil and Military Station of Bangalore, the mean age has steadily risen from 1881 to 1911 as may be seen from the marginally noted figures. This is due, on the one hand, to the continued decline in the proportion of children under 10 years from 1891 to 1911, and on the other, to the uninterrupted growth in the proportion of old persons aged 60 and over ever since 1881 onwards. The low proportion of children in 1881 may at first sight lead one to expect a relatively high mean age in that Census, but this factor is more than counterbalanced by the abnormally small proportion of old persons in the same Census, both being the result of the severe famine of 1876-77 already referred to in a previous paragraph.

Year	Mean age
1881 ...	24.5
1891 ...	24.9
1901 ...	25.0
1911 ...	25.9

111. The mean age in the Eastern Division stands higher than in the Western. It will be seen from Subsidiary Table II that the proportion of children under 10 years, as also of persons aged 40 and over is greater in the former Division. This may be attributed to the higher birth-rate and lower death-rate in that Division as evidenced by Subsidiary Tables VII and VIII. People are apparently more favoured with longevity in the Eastern than in the Western Division.

112. To bring out the salient features of variation in the age-distribution of the population in different districts and cities, the marginal tabular statement has been prepared to show the number of persons per mille aged 0-15, 15-50 and 50 and over respectively.

Division, District or City	Number per mille aged		
	0-15	15-50	50 and over
MYSORE STATE, INCLUDING CIVIL AND MILITARY STATION, BANGALORE.	374	497	129
MYSORE STATE, EXCLUDING CIVIL AND MILITARY STATION, BANGALORE.	374	497	129
EASTERN DIVISION	375	488	137
Bangalore City ...	339	540	121
Bangalore District ...	374	481	145
Kolar Gold Fields (City) ...	319	624	57
Kolar District ...	355	487	158
Tumkur District ...	380	480	140
Mysore City ...	352	520	128
Mysore District ...	380	490	130
Chitaldrug District ...	394	483	123
WESTERN DIVISION	373	521	106
Hasan District ...	392	500	118
Kadur District ...	361	545	94
Shimoga District ...	371	630	99
Civil and Military Station, Bangalore ...	366	526	108

the cities themselves, the lowest proportion is found in the Mysore City and the highest in Kolar Gold Fields where the so-called 'onerous' population, *i.e.*, the young and the old, may naturally be expected to stand at a very low figure owing to the exigencies of the local mining industry.

Among districts, Kadur stands first with 545 and Tumkur last with 480. The high proportions in Kadur and Shimoga Districts are mainly due to the comparatively short duration of life obtaining generally in the case of people in the *malnad*.

In this connection it may be observed that M. Sundborg, Deputy Director of the Central Statistical Bureau, Stockholm, pointed out in an address delivered by him before the International Statistical Institute at Christiana that in almost all countries the proportion of persons aged 15-50 to the total population is uniformly about half. This was supported by statistics for almost all the countries of Europe and also United States, Australia and Japan, the proportion ranging from 492 to 509 per mille in these countries. It is evident that this standard cannot be expected to be always conformed to in a country like India where the age-distribution of the population is liable to rude disturbances from periodical visitations of famine which carries away a large number of victims at the extreme ages of life, *i.e.*, of very young and old persons. For instance in the Mysore State which suffered severely from the famine of 1876-77 the proportion of persons aged 15-50 was so high as 535 per mille in 1881, *i.e.*, soon after this famine. It went down to 515 in 1891 and fell still further to 473 in 1901, but more or less recovered its normal position in 1911 when it stood at 497. It may perhaps be expected that, in the absence of disturbances caused in age-distribution by famine, the age-period 15-50 would ordinarily comprise about one-half of the total population.

Taking up next the age-period 0-15, the proportion is naturally lowest in the Kolar Gold Fields, as already explained, and highest in the Chitaldrug District which likewise exhibits the largest percentage of increase in population from 1901 to 1911 (*vide* Subsidiary Table I of Chapter II). The number of old persons aged 50 and over is proportionately least in Kadur District and greatest in Kolar District.

Religions.

113. Among the different main religions, the mean age is highest for 'Jain' and lowest for 'Christian.' The other three religions, *viz.*, Hindu, Animistic and Musalman come between these two in the order named. This was almost the same order as in 1901 except that the 'Musalman' and the 'Animistic' have changed places in 1911 owing to the larger proportion of persons aged 40 and over among the Animists in 1911. Taking the entire population, *i.e.*, of all religions together, the mean age in 1911 works out to 25·9 for males and 25·3 for females. The mean age for 'Hindu' and 'Jain' is higher than the above average while that for the other three main religions falls below the same (*vide* marginal statement). In discussing the relative age-distribution of the population as among the adherents of different religions, we may, as in para

Religion	Mean age in 1911		Mean age in 1901	
	Male	Female	Male	Female
Hindu ...	26·0	25·4	25·0	25·6
Musalman ...	25·1	23·8	24·3	24·1
Christian ...	24·7	23·5	23·6	23·4
Jain ...	26·6	26·2	26·4	25·8
Animistic ...	25·2	23·9	23·9	23·4
All religions ...	25·9	25·3	25·0	25·5

110 above, confine ourselves to the case of males. Taking first the proportion of children aged 0-10, it is highest among the Animists. Next come the Musalmans, Hindus and Christians in order, and last the Jains. It may as well be remarked that the relative fecundity as among the different communities does not necessarily follow the same order. Taking the ratio of children aged 0-10 to married women aged 15-40 as a rough and ready measure of relative fecundity, the above five religions stand as in the margin.

Religion	Number of children under 10 years per 100 married females aged 15-40
Hindu ...	162
Musalman ...	182
Christian ...	182
Jain ...	156
Animistic ...	175

As regards old persons aged 60 and over, the Animists again claim the highest proportion, Hindus, Musalmans, Jains and Christians following in the order named. It is remarkable that the Animists who had only 441 per 10,000 males aged 60 and over in 1901 have gone up to 597 over the heads of other communities in 1911. In fact, they possess the largest proportion of persons at both the extreme periods of life, *viz.*, at the age-periods 0-10 and 60 and over. Their ranks are thus considerably thinned in the middle of life and this is not evidently favourable to a large rate of increase among them in the next decennium. It is strange that the figures of the recent Census should point to them as the most favoured from the standpoint of longevity, although they were considered as comparatively shortlived in 1901. It may perhaps be suggested that the age

return would have been distorted by the usual tendency of exaggerating the age of old persons in a specially marked degree among this backward section of the population. But this explanation is not adequate to bridge the wide gulf that exists between the proportion of persons aged 60 and over among the Animists in 1901 and that in 1911. It is at the same time not prudent to infer merely from these figures that the Animists have considerably improved in longevity in the course of the last decade. As between the Hindus and the Musalmans although the former can boast of a higher proportion of persons aged 60 and over, the Musalmans cannot be said to be inferior to them in regard to longevity; for,

Religion	Number of males aged 60 and over per 1,000 aged 10 and over
Hindu	78
Musalman	79

proportion of persons aged 60 and over, it cannot be inferred that they are short-lived as compared with other religionists. They form a young and rapidly

Religion	Number per mille of males who are aged		
	0-15	15-50	50 and over
Hindu	866	504	180
Musalman	888	496	121
Christian	841	571	68
Jain	821	553	126
Animistic	899	473	129

growing community and their ranks are being recruited by immigrants and converts on the right side of life so that the age-distribution of the Christian population presents a special feature.

The distribution of males of each religion under the three age-periods 0-15, 15-50 and 50 and over is exhibited in the margin as it may be of some interest in connection with the remarks contained in para 112 above.

114. Subsidiary Table IV exhibits the age-distribution of the population belonging to a few selected castes, tribes or races. It will be seen therefrom that the proportion of children aged 0-5 is highest among the Lambanis, while the Indian Christians take easily the first place as regards the age-period 15-40. Examining the proportion of persons aged 40 and over among the several castes, it will be found that the first six places as regards males are taken up by Golla, Banajiga, Nayinda, Beda, Brahman and Ganiga, and, as regards females, by Brahman, Banajiga, Golla, Ganiga, Kshattriya and Nayinda, so that, considering both the sexes, it may be said that the Banajiga, Brahman, Golla, Ganiga and Nayinda are comparatively long-lived. The low proportion of persons aged 40 and over among the Animistic Lambanis points to their relatively short duration of life. But a similar inference with regard to Indian Christians who possess in fact the lowest proportion of old persons, is not permissible in the light of the remarks made in the previous para concerning the special nature of age-distribution among the Christians in general, of whom Indian Christians form nearly 78 per cent.

115. The mean age for the entire population comprising both sexes, calculated as in para 109 above from the figures contained in Imperial Table VII, comes to 25.6. This would roughly represent the mean duration of life if the population had been stationary for some time. But as it is actually progressive, the mean duration of life should be pitched somewhat higher. Let us then take it hypothetically as 27. The average death-rate will then be $\frac{1000}{27}$ or 37 per mille per annum, and assuming the normal annual rate of increase of population as 6 per mille, the birth-rate comes to 43. A perusal of Subsidiary Tables VII and VIII will show, however, that the recorded birth- and death-rates average only 17 and 20 respectively. This would indicate that the registration of vital statistics is very imperfect and that omissions occur more largely in the case of births than of deaths. A comparison of the total number of recorded births in 1910 with the number of children under one year found in Imperial Table VII reveals likewise considerable omissions in the registration of births, the two figures being respectively 97,481 and 143,543. Even if we compare the total recorded births in the five years 1906-10 with the number of children aged 0-5 according to Imperial

Total number of births in the five years 1906-10 ... 497,830
Number of children aged 0-5 according to Imperial Table VII 699,174

Table VII (*vide* margin), the latter is found to exceed the

former although it should in fact be considerably less on account of the high mortality among children.

Castes.

Birth-and
death-
rates.

The registration of vital statistics being thus admittedly imperfect, it is not profitable to discuss at any length the figures contained in Subsidiary Tables VII to X. It may be remarked, however, that so far as these figures go, they point to a higher birth-rate and a lower death-rate in the Eastern than in the Western Division. Also on a comparison of the figures for the ten years ending with 1910, it will be observed that the birth-rate was highest in 1908 which followed a year of agricultural prosperity while the maximum death-rate occurred in 1904 when plague claimed a large number of victims and the country was also suffering from deficient rainfall and, in parts, from severe drought. As regards the death-rates prevailing at different ages, it will be seen from Subsidiary Table IX that the period of least risk in the case of males is 10-15, the death-rate rising steadily on either side of this age-period. For females, mortality is at the lowest ebb in the age-period 5-10 although this distinction is almost equally shared by the next period 10-15. It is noteworthy that in the case of females, the death-rate at the age-period 15-20 is higher than at '20-30' which again is exposed to greater risks than the next higher age-period 30-40. These features which are peculiar to the fair sex are presumably attributable to pregnancy and parturition.

**Urban-
birth-rate.**

116. The recorded birth- and death-rates are found to be much higher in urban than in rural areas. It is not easy to make out how far this corresponds to actual facts and how far the apparent disparity is due to more satisfactory registration of vital statistics in towns. The only available Census figures that can throw any light on this subject are those relating to children and married women of child-bearing age in the four cities for which statistics are separately given in Imperial Table VII. It will be seen from column 14 of Subsidiary Table V that the proportion of married females aged 15-40 is comparatively higher in the cities so that the birth-rate calculated on the basis of total population may also be expected to be higher in cities. It does not follow, however, that the fecundity of women in cities is necessarily greater than in rural parts. In fact, column 5 of the same Subsidiary Table shows that fecundity as indicated by the proportion of children to married women of child-bearing age is relatively low in the three cities of Bangalore, Kolar Gold Fields and Mysore, while the higher figure for the Civil and Military Station, Bangalore, is attributable to its specially large proportion of Musalmans and Christians who are presumably more prolific than Hindus (*vide* para 113 above).

**Married
women of
child-
bearing
age.**

117. The proportion of married women of child-bearing age also comes up for consideration in several other ways. For instance, leaving alone the imperfect nature of registration of births, the higher birth-rate (17.6) recorded in 1910 as compared with 1901 (15.5) corresponds in a way to a similar rise in the proportion of married women aged 15-40, the number of such women per 100 females of all ages being 31 in 1911 as against 29 in 1901. Let us next see how far the proportion of fertile women among the different religionists corresponds to the rate of growth in their numbers during the last decade. From the

Religion	Number of married females aged 15-40 per 100 females of all ages (1901)	Percentage of increase in 1901-1911
Hindu	29	+4.7
Jain	29	+28.9
Animistic	30	-16.7
Hindu, Jain and Animistic	29	+2.4
Musalman	30	+8.6
Christian	27	+19.5

marginal statement, it will be seen that, except perhaps in the case of Musalmans, there is no apparent correspondence between the figures in columns 2 and 3. The abnormal figures for Jains and Animists in column 3 can only be accounted for by the shifting and elusive nature of classification as between them and the Hindus, so that figures have also been calculated for all these

three allied religions put together and are shown in italics in the statement. In the case of Christians, the explanation for disparity in the figures in columns 2 and 3 will be found, as already referred to in para 113, in the fact that, besides births, immigration and conversion from other faiths are responsible for a considerable portion of increase in their numbers.

A similar attempt to correlate the rate of growth with the proportion of married women of child-bearing age among the different castes has not yielded any useful results and it is therefore considered unnecessary to reproduce the long array of figures here.

118. It has already been mentioned that the recorded birth- and death-rates are impossibly low on account of defective registration of births and deaths. It is therefore necessary, in comparing Mysore with European countries in this respect, to take the probable true rates as arrived at in para 115 from the mean age of the population in Mysore. The birth- and death-rates were thus estimated at 43 and 37 per mille respectively. It will be seen from the marginally noted statistics that these are much higher than the birth-and death-rates obtaining in European countries, while the excess of birth-rate over death-rate in all those countries except France and perhaps Ireland, is considerably greater than in Mysore. Thus while we have here a more rapid succession of generations than in European countries, the population in those countries is increasing at a higher rate. Their mean duration of life, too, is considerably longer. The explanation for these differences has to be sought in the varying nature of physical and social environments. It is generally urged that the system of early marriages is not conducive to a high degree of fecundity of women in India. Taking the crude birth-rate in Mysore as 43, the number of births per 100 married women aged 15-45 will come to 252. From similar proportions for European countries exhibited in the margin, it will be seen that in spite of a lower birth-rate in those countries, their women are more fertile except in the case of England and France. Even within India itself, the greater fecundity of Musalman and Christian women as compared with their Hindu sisters is partly accounted for by the fact that early marriages are not so common among the former as among the latter.

Compared with European countries.

Country	Birth-rate in 1908	Death-rate in 1908
Sweden ...	25.7	14.9
Norway ...	26.2	14.3
Denmark ...	28.7	14.7
Holland ...	29.7	15.0
Belgium ...	24.9	16.6
Germany ...	32.0	18.0
Switzerland ...	27.1	16.2
England ...	26.6	14.7
Scotland ...	27.2	16.1
Italy ...	33.4	22.6
Spain ...	34.2	24.0
France ...	20.2	19.0
Ireland ...	23.8	17.6

differences has to be sought in the varying nature of physical and social environments. It is generally urged that the system of early marriages is not conducive to a high degree of fecundity of women in India. Taking the crude birth-rate in Mysore as 43, the number of births per 100 married women aged 15-45 will come to 252. From similar proportions for European countries exhibited in the margin, it will be seen that in spite of a lower birth-rate in those countries, their women are more fertile except in the case of England and France. Even within India itself, the greater fecundity of Musalman and Christian women as compared with their Hindu sisters is partly accounted for by the fact that early marriages are not so common among the former as among the latter.

Country	Number of births per mille of married women of age 15-45
Sweden ...	268
Norway ...	301
Denmark ...	259
Holland ...	321
Belgium ...	252
Germany ...	285
Switzerland ...	266
England ...	235
Scotland ...	271
Italy ...	269
Spain ...	259
France ...	159
Ireland ...	288

119. An examination of the monthly figures regarding births during the past four or five years shows that the largest average number of births has occurred in October and that the five months from July to November claim a relatively higher average than the other seven months of the year. The corresponding period of conception may be roughly taken as from October to February; and the reproductive instinct may naturally be expected to be most active during this season when harvests are gathered and the agriculturists who comprise the bulk of the population have a plentiful time of it.

Monthly variation in birth-rate.

SUBSIDIARY TABLES.

I.—AGE DISTRIBUTION OF 100,000 OF EACH SEX (HINDUS) BY ANNUAL PERIODS.

Age	Male	Female	Age	Male	Female	Age	Male	Female	Age	Male	Female
1	2	3	1	2	3	1	2	3	1	2	3
0	2,333	2,589	27	925	257	54	190	152	81	4	3
1	1,176	1,255	28	1,796	1,735	55	1,703	1,475	82	14	13
2	2,432	2,932	29	235	209	56	275	237	83	3	6
3	2,599	3,015	30	5,743	5,923	57	64	45	84	7	5
4	2,391	2,648	31	137	103	58	312	272	85	71	56
5	2,549	2,609	32	1,110	909	59	60	55	86	11	12
6	2,613	2,926	33	293	206	60	2,675	2,920	87	3	1
7	1,940	2,355	34	388	303	61	44	23	88	3	6
8	3,219	3,363	35	4,373	3,867	62	161	143	89	2	6
9	1,803	1,922	36	600	553	63	62	43	90	71	110
10	3,920	4,089	37	192	124	64	72	48	91	1	...
11	741	1,027	38	1,153	910	65	810	802	92	2	4
12	4,164	3,668	39	189	175	66	61	78	93	5	3
13	1,051	1,059	40	5,623	5,376	67	20	18	94	3	2
14	2,072	1,767	41	99	85	68	111	104	95	10	24
15	2,227	1,841	42	624	568	69	12	14	96	1	5
16	2,814	2,355	43	245	187	70	923	1,118	97	1	...
17	459	521	44	213	148	71	9	6	98	3	2
18	3,188	3,443	45	3,474	2,863	72	40	50	99	...	5
19	477	495	46	402	333	73	14	15	100	9	5
20	4,535	5,697	47	63	71	74	18	26	101
21	297	248	48	737	553	75	291	266	102	2	...
22	1,817	1,842	49	97	98	76	31	19	103	1	...
23	724	602	50	4,027	4,109	77	5	9	104
24	973	932	51	57	69	78	30	34	105	1	...
25	4,776	5,092	52	824	265	79	6	13	Total ...	100,000	100,000
26	1,121	954	53	123	94	80	385	460			

II.—AGE DISTRIBUTION OF 10,000 OF EACH SEX IN THE PROVINCE AND EACH NATURAL DIVISION.

Age	1911		1901		1891		1881	
	Male	Female	Male	Female	Male	Female	Male	Female
1	2	3	4	5	6	7	8	9
Mysore State, including Civil and Military Station, Bangalore.								
0-5	1,156	1,255	1,268	1,325	1,364	1,471	915	978
0-1	239	256	255	265	239	255	233	206
1-2	131	144	169	169	191	207	141	145
2-3	265	299	271	280	316	336	139	137
3-4	267	295	276	293	329	351	153	177
4-5	256	271	311	318	309	320	204	316
5-10	1,254	1,338	1,421	1,455	1,364	1,414	1,371	1,415
10-15	1,256	1,223	1,326	1,173	921	835	1,395	1,375
15-20	930	884	791	687	867	793	973	868
20-25	865	931	664	728	850	943	844	973
25-30	811	797	754	779	901	904	955	1,012
30-35	710	735	762	794	829	825	902	886
35-40	625	542	688	638	700	618	735	593
40-45	637	618	623	620	656	601	631	606
45-50	465	390	476	452	439	378	377	337
50-55	459	466	436	469	417	442	351	437
55-60	239	202	277	275	219	213	169	177
60-65	298	309
65-70	108	98	500	604	451	557	357	446
70 and over	191	213
Age not stated	2	2
Mean age	25.9	25.3	25.0	25.5	24.9	24.9	24.5	24.3
Mysore State, excluding Civil and Military Station, Bangalore.								
0-5	1,154	1,253	1,268	1,324	1,365	1,473		
0-1	237	254	255	264	237	255		
1-2	131	144	169	169	192	209		
2-3	263	299	271	280	316	336		
3-4	267	295	276	292	330	352		
4-5	256	271	312	319	310	321		
5-10	1,254	1,333	1,422	1,457	1,364	1,415		
10-15	1,260	1,225	1,323	1,175	919	832		
15-20	931	883	789	688	867	789		
20-25	859	929	660	724	845	942		
25-30	808	795	751	777	901	905		
30-35	708	735	762	794	830	825		
35-40	625	543	689	641	703	615		
40-45	638	617	624	620	657	600		
45-50	467	391	479	454	442	379		
50-55	461	467	436	469	417	442		
55-60	240	202	279	278	221	214		
60-65	299	310		
65-70	108	98	498	604	447	555		
70 and over	192	213		
Age not stated	2	2		
Mean age	25.9	25.3	25.0	25.5	24.9	24.9		
Eastern Division.								
0-5	1,173	1,255	1,334	1,345	1,429	1,499		
5-10	1,275	1,347	1,435	1,431	1,377	1,398		
10-15	1,238	1,192	1,334	1,135	863	764		
15-20	912	862	752	645	834	764		
20-40	2,889	2,952	2,745	2,897	2,235	2,204		
40-60	1,863	1,717	1,674	1,908	1,774	1,664		
60 and over	650	665	525	639	485	605		
Age not stated	2	2		
Mean age	25.2	25.6	25.1	25.9	25.1	25.2		
Western Division.								
0-5	1,094	1,216	1,145	1,255	1,374	1,404	968	1,053
5-10	1,194	1,308	1,389	1,529	1,334	1,462	1,440	1,515
10-15	1,326	1,324	1,313	1,256	1,056	1,009	1,397	1,391
15-20	968	941	898	788	949	855	955	868
20-40	2,335	2,158	2,175	2,044	2,330	2,250	2,509	2,415
40-60	1,634	1,551	1,555	1,582	1,644	1,555	1,425	1,447
60 and over	428	423	425	505	352	453	305	391
Age not stated	1	1		
Mean age	25.0	24.5	24.7	24.2	24.4	24.1	23.8	23.9

III.—AGE DISTRIBUTION OF 10,000 OF EACH SEX IN EACH MAIN RELIGION.

Age	1911		1901		1891		1881	
	Male	Female	Male	Female	Male	Female	Male	Female
1	2	3	4	5	6	7	8	9
Hindu.								
0-5	1,148	1,242	1,274	1,311	1,386	1,466	987	969
5-10	1,250	1,326	1,418	1,448	1,362	1,411	1,373	1,416
10-15	1,258	1,225	1,328	1,169	917	832	1,400	1,280
15-20	931	880	789	681	870	791	978	869
20-40	3,008	3,011	2,863	2,945	3,278	3,294	3,451	3,473
40-60	1,816	1,690	1,826	1,837	1,737	1,639	1,539	1,554
60 and over	594	626	502	609	448	565	352	439
Age not stated	2	2
Mean age	26.0	25.4	25.0	25.6	24.9	24.9	24.5	24.8
Musalman.								
0-5	1,239	1,443	1,388	1,516	1,377	1,579	1,042	1,196
5-10	1,343	1,517	1,441	1,520	1,430	1,502	1,334	1,392
10-15	1,252	1,174	1,234	1,202	992	867	1,332	1,150
15-20	929	920	823	763	815	772	888	696
20-40	3,040	2,905	2,902	2,818	3,191	3,111	3,398	3,336
40-60	1,607	1,477	1,643	1,597	1,683	1,544	1,545	1,569
60 and over	590	564	509	584	511	623	461	581
Age not stated	1	2
Mean age	25.1	23.8	24.3	24.1	24.8	24.3	24.8	25.0
Christian.								
0-5	1,171	1,355	1,258	1,327	1,267	1,462	1,059	1,229
5-10	1,137	1,348	1,418	1,572	1,224	1,364	1,289	1,423
10-15	1,100	1,193	1,274	1,250	958	1,063	1,337	1,344
15-20	930	1,078	850	845	849	1,030	866	1,029
20-40	3,784	3,216	3,427	3,141	3,988	3,193	3,847	3,071
40-60	1,507	1,397	1,462	1,491	1,392	1,381	1,374	1,421
60 and over	371	413	311	374	368	500	334	477
Age not stated	4	7
Mean age	24.7	23.5	23.6	23.4	24.1	23.5	23.6	23.6
Jain.								
0-5	992	1,114	972	1,253	1,046	1,321	Figures not available	Figures not available
5-10	1,038	1,227	1,128	1,233	1,166	1,292	Figures not available	Figures not available
10-15	1,178	1,216	1,217	1,262	951	974	Figures not available	Figures not available
15-20	1,033	963	1,045	825	950	839	Figures not available	Figures not available
20-40	3,390	3,014	3,271	2,935	3,544	3,137	Figures not available	Figures not available
40-60	1,811	1,798	1,818	1,759	1,844	1,777	Figures not available	Figures not available
60 and over	558	668	549	633	433	660	Figures not available	Figures not available
Age not stated	6	...	Figures not available	Figures not available
Mean age	26.6	26.2	26.4	25.8	26.4	25.9	Figures not available	Figures not available
Animistic.								
0-5	1,258	1,409	1,480	1,516	Figures not available	Figures not available	Figures not available	Figures not available
5-10	1,388	1,467	1,559	1,598	Figures not available	Figures not available	Figures not available	Figures not available
10-15	1,344	1,249	1,345	1,284	Figures not available	Figures not available	Figures not available	Figures not available
15-20	856	871	740	674	Figures not available	Figures not available	Figures not available	Figures not available
20-40	2,799	2,944	2,659	2,905	Figures not available	Figures not available	Figures not available	Figures not available
40-60	1,758	1,590	1,776	1,548	Figures not available	Figures not available	Figures not available	Figures not available
60 and over	597	530	441	475	Figures not available	Figures not available	Figures not available	Figures not available
Age not stated	Figures not available	Figures not available	Figures not available	Figures not available
Mean age	25.2	23.9	23.9	23.4	Figures not available	Figures not available	Figures not available	Figures not available

IV.—AGE DISTRIBUTION OF 1,000 OF EACH SEX IN CERTAIN CASTES.

Caste	Males—Number per mille aged					Females—Number per mille aged				
	0-5	5-12	12-15	15-40	40 and over	0-5	5-12	12-15	15-40	40 and over
1	2	3	4	5	6	7	8	9	10	11
Agass ...	118	176	79	343	299	129	196	65	396	224
Banajiga ...	108	165	72	326	260	117	176	64	396	244
Beda ...	118	178	74	344	261	129	199	66	394	244
Besta ...	118	180	79	348	240	124	188	69	396	220
Brahman ...	114	168	69	408	248	127	170	61	398	254
Ganiga ...	114	174	79	346	247	122	188	65	398	245
Golla ...	112	172	73	376	268	126	186	66	373	248
Holeys ...	115	170	75	407	283	125	188	67	411	217
Idiga ...	108	174	86	400	282	120	187	70	408	220
Kahatriya ...	112	169	75	404	238	121	184	66	390	239
Kumbara ...	112	174	75	405	294	121	191	75	398	217
Kuruba ...	116	176	81	344	248	129	184	69	397	237
Lingayat ...	111	168	86	398	237	118	185	74	398	236
Madiga ...	127	184	74	379	236	141	196	64	398	211
Mahratta ...	112	170	70	417	231	129	187	64	396	225
Navinda ...	116	172	71	364	257	126	186	68	391	246
Neygi ...	118	172	79	348	248	126	186	69	390	227
Panchala ...	111	168	79	408	239	124	190	69	396	221
Tigala ...	128	183	70	380	239	129	194	64	396	218
Uppara ...	114	178	88	396	229	123	192	71	395	219
Vaiya ...	119	155	77	391	258	127	179	66	390	229
Vakkaliga ...	112	178	81	358	241	120	187	78	381	239
Vodda ...	126	181	74	376	248	128	196	63	397	216
Pathan ...	131	194	76	342	218	146	212	66	375	208
Saiyid ...	124	192	76	397	221	146	207	65	376	206
Sheikh ...	127	187	76	369	221	142	206	60	388	204
Indian Christian ...	126	187	78	448	191	140	191	71	423	173
Lambani ...	122	208	87	364	214	150	215	75	371	189

V.—PROPORTION OF CHILDREN UNDER 10 AND OF PERSONS OVER 60 TO THOSE AGED 15-40; ALSO OF MARRIED FEMALES AGED 15-40 PER 100 FEMALES.

District and Natural Division	Proportion of children (both sexes) per 100						Proportion of persons over 60 per 100 aged 15-40						Number of married females aged 15-40 per 100 females of all ages		
	Persons aged 15-40			Married females aged 15-40			1911		1901		1891				
	1911	1901	1891	1911	1901	1891	Male	Female	Male	Female	Male	Female	1911	1901	1891
1	2	3	4	5	6	7	8	9	10	11	12	13	14	15	16
Mysore State, including Civil and Military Station, Bangalore ...	64	75	68	163	198	175	15	16	14	17	11	14	21	26	28
Mysore State, excluding Civil and Military Station, Bangalore ...	64	75	68	163	194	176	15	16	14	17	11	14	21	26	28
Eastern Division ...	66	79	70	163	196	173	17	17	16	18	12	15	21	26	28
Bangalore City ...	62	68	70	199	172	166	12	14	14	16	14	17	24	26	24
Bangalore District ...	69	66	70	164	218	166	19	19	14	19	14	17	22	26	24
Kolar Gold Fields (City) ...	46	59	66	136	226	166	3	4	2	8	14	17	48	27	25
Kolar District ...	66	77	66	156	192	166	21	20	16	21	14	17	22	26	25
Tumkur District ...	69	79	68	170	198	179	16	17	15	16	10	12	21	26	23
Mysore City ...	63	64	70	152	169	170	14	16	16	21	11	15	22	20	28
Mysore District ...	66	79	70	160	185	170	15	16	15	16	11	15	21	20	28
Chitaldrug District ...	69	78	75	178	209	197	15	14	12	14	10	11	20	27	23
Western Division ...	67	67	65	164	187	181	19	12	19	12	8	11	20	26	21
Hassan District ...	62	74	70	164	190	180	12	16	12	16	9	12	20	26	23
Kadur District ...	51	65	61	157	185	182	8	10	9	11	7	10	21	20	21
Shimoga District ...	64	63	62	169	184	182	9	11	10	12	8	11	20	26	20
Civil and Military Station, Bangalore	60	64	67	166	176	174	11	12	14	14	15	16	22	26	21

VI.—VARIATION IN POPULATION AT CERTAIN AGE-PERIODS.

District and Natural Division	Period	Variation per cent in population: increase (+) decrease (-)					
		All ages (c)	0-10	10-15	15-40	40-60	60 and over
1	2	3	4	5	6	7	8
Mysore State, including Civil and Military Station, Bangalore.	1881-1891 ...	+ 18.1	+ 42.1	- 22.3	+ 10.9	+ 28.6	+ 49.6
	1891-1901 ...	+ 12.1	+ 9.1	+ 59.5	- 0.7	+ 20.8	+ 21.3
	1901-1911 ...	+ 4.8	- 4.4	+ 3.9	+ 12.7	+ 0.4	+ 15.2
Mysore State, excluding Civil and Military Station, Bangalore.	1881-1891 ...	+ 18.3	(a)	(a)	(a)	(a)	(a)
	1891-1901 ...	+ 12.5	+ 9.5	+ 60.9	- 0.5	+ 21.4	+ 22.4
	1901-1911 ...	+ 4.7	- 4.6	+ 3.9	+ 12.6	+ 0.2	+ 15.5
Eastern Division	1881-1891 ...	+ 21.2	(a)	(a)	(a)	(a)	(a)
	1891-1901 ...	+ 14.9	+ 11.7	+ 74.4	- 0.6	+ 26.4	+ 22.5
	1901-1911 ...	+ 7.0	- 2.3	+ 5.4	+ 15.9	+ 1.4	+ 21.0
Bangalore District (including Bangalore City).	1881-1891 ...	+ 19.9	(a)	(a)	(a)	(a)	(a)
	1891-1901 ...	+ 12.4	+ 12.0	+ 71.9	- 4.8	+ 29.5	- 0.0
	1901-1911 ...	+ 7.1	+ 2.8	+ 4.3	+ 20.1	- 5.2	+ 35.4
Kolar District (including Kolar Gold Fields).	1881-1891 ...	+ 22.8	+ 65.6	- 27.9	+ 18.5	+ 36.5	+ 70.8
	1891-1901 ...	+ 22.4	+ 19.9	+ 72.1	+ 5.2	+ 45.1	+ 25.0
	1901-1911 ...	+ 7.8	- 1.1	+ 14.9	+ 17.2	- 4.2	+ 22.3
Tumkur District	1881-1891 ...	+ 26.2	+ 91.9	- 32.5	+ 29.3	+ 57.0	+ 102.5
	1891-1901 ...	+ 17.0	+ 10.0	+ 128.0	- 4.9	+ 34.6	+ 32.7
	1901-1911 ...	+ 9.7	+ 1.6	+ 0.5	+ 16.7	+ 2.5	+ 26.9
Mysore District (including Mysore City).	1881-1891 ...	+ 14.4	+ 46.9	- 5.7	+ 28.0	+ 37.0	+ 55.3
	1891-1901 ...	+ 9.6	+ 10.0	+ 41.6	- 0.8	+ 9.4	+ 29.1
	1901-1911 ...	+ 3.6	- 8.1	+ 7.5	+ 10.3	+ 5.1	+ 6.5
Chitaldrug District	1881-1891 ...	+ 33.4	+ 62.2	- 41.3	- 4.2	+ 22.7	+ 47.9
	1891-1901 ...	+ 20.3	+ 7.4	+ 132.1	+ 4.6	+ 30.7	+ 32.7
	1901-1911 ...	+ 10.4	+ 7.3	- 1.2	+ 21.3	+ 13.0	+ 30.0
Western Division	1881-1891 ...	+ 11.6	+ 10.4	- 22.4	- 3.0	+ 12.3	+ 17.5
	1891-1901 ...	+ 6.6	+ 3.8	+ 34.1	- 0.3	+ 8.0	+ 21.9
	1901-1911 ...	- 1.7	- 11.4	- 0.0	+ 4.6	- 3.5	- 3.1
Hassan District	1881-1891 ...	+ 19.5	+ 10.4	- 35.1	- 6.5	+ 3.6	+ 23.2
	1891-1901 ...	+ 11.1	+ 5.6	+ 54.0	+ 0.1	+ 14.6	+ 26.6
	1901-1911 ...	+ 2.0	- 9.1	+ 1.5	+ 9.4	+ 2.9	+ 6.5
Kadur District	1881-1891 ...	+ 12.9	+ 12.9	- 24.6	- 4.6	+ 16.0	+ 23.3
	1891-1901 ...	+ 9.2	+ 7.8	+ 40.2	+ 2.0	+ 13.3	+ 26.2
	1901-1911 ...	- 5.8	- 19.6	- 1.9	+ 1.4	- 8.5	- 11.8
Shimoga District	1881-1891 ...	+ 4.3	+ 8.9	- 4.5	+ 1.7	+ 19.7	+ 8.9
	1891-1901 ...	+ 0.5	- 0.7	+ 13.5	- 2.2	- 1.3	+ 14.3
	1901-1911 ...	- 2.8	- 8.3	- 0.4	+ 2.3	- 7.1	- 9.6
Civil and Military Station, Bangalore	1881-1891 ...	+ 7.0	(b)	(b)	(b)	(b)	(b)
	1891-1901 ...	- 10.5	- 13.8	- 0.2	- 9.6	- 10.3	- 18.2
	1901-1911 ...	+ 12.5	+ 11.3	+ 6.7	+ 18.1	+ 10.3	- 3.8

(a) Figures not available as apart from Civil and Military Station, Bangalore.

(b) Figures not available as apart from Bangalore City.

(c) For purposes of column 3, figures adjusted for inter-territorial changes in area prior to 1911 have been used.

VII.—REPORTED BIRTH-RATE BY SEX AND NATURAL DIVISION.

Year	Number of births per 1,000 of total population (Census of 1901)							
	Mysore State, including Civil and Military Station, Bangalore		Mysore State, excluding Civil and Military Station, Bangalore		Eastern Division		Western Division	
	Male	Female	Male	Female	Male	Female	Male	Female
1	2	3	4	5	6	7	8	9
1901	7.8	7.7	7.7	7.6	7.5	7.4	8.2	8.1
1902	8.4	8.2	8.3	8.0	8.4	8.3	7.9	7.3
1903	8.7	8.6	8.6	8.4	8.8	8.6	8.1	8.0
1904	7.3	7.1	7.1	6.9	7.2	7.1	6.8	6.5
1905	8.5	8.3	8.3	8.1	8.4	8.3	8.1	7.8
1906	9.1	8.8	8.9	8.6	8.9	8.6	8.8	8.5
1907	8.2	7.9	8.0	7.7	8.3	8.0	7.3	6.9
1908	10.0	9.6	9.6	9.4	10.2	10.0	8.7	8.0
1909	9.6	9.1	9.4	9.0	9.5	9.1	9.1	8.6
1910	9.0	8.6	8.9	8.4	9.2	8.8	7.8	7.3

VIII.—REPORTED DEATH-RATE BY SEX AND NATURAL DIVISION.

Year	Number of deaths per 1,000 of total population (Census of 1901)							
	Mysore State, including Civil and Military Station, Bangalore		Mysore State, excluding Civil and Military Station, Bangalore		Eastern Division		Western Division	
	Male	Female	Male	Female	Male	Female	Male	Female
i	2	3	4	5	6	7	8	9
1901	10.7	9.8	10.4	9.5	9.7	9.0	12.6	11.1
1902	10.7	10.2	10.3	9.7	9.5	9.3	12.3	10.9
1903	10.9	10.4	10.6	10.1	9.9	9.5	12.7	11.6
1904	11.6	10.7	11.3	10.5	10.7	10.1	12.2	11.5
1905	8.5	7.9	8.2	7.5	8.1	7.5	8.7	7.7
1906	9.6	8.9	9.4	8.7	8.9	8.3	11.0	9.9
1907	11.2	10.1	11.0	9.9	10.1	9.2	12.5	11.7
1908	8.8	8.1	8.6	7.9	7.9	7.4	10.6	9.3
1909	9.3	8.6	9.2	8.4	9.0	8.4	9.5	8.2
1910	10.6	9.8	10.6	9.6	10.2	9.4	11.6	10.1

IX.—REPORTED DEATH-RATE BY SEX AND AGE IN DECADE AND IN SELECTED YEARS PER MILLE LIVING AT SAME AGE ACCORDING TO THE CENSUS OF 1901.

Age	Average of decade		1906		1905		1907		1909	
	Male	Female	Male	Female	Male	Female	Male	Female	Male	Female
i	2	3	4	5	6	7	8	9	10	11
All ages	20.2	19.1	21.5	21.0	16.9	15.9	22.2	20.4	18.5	17.3
Under 1 year	60.2	68.6	94.0	80.8	70.5	60.1	77.8	64.7	80.7	67.3
1-5	18.8	17.4	17.9	16.9	15.3	13.4	21.1	19.6	22.0	20.2
5-10	10.4	10.3	10.1	10.8	7.4	6.9	11.9	11.4	9.3	8.8
10-15	9.3	10.3	9.9	11.3	6.6	7.6	11.3	11.5	7.5	8.0
15-20	15.7	18.8	17.3	20.9	10.7	13.8	21.2	24.0	13.1	16.8
20-30	16.1	16.9	19.2	20.1	12.4	13.8	16.7	18.1	13.0	14.7
30-40	17.4	15.8	19.3	17.8	16.8	15.2	16.9	15.4	14.5	12.4
40-50	22.1	17.9	23.7	19.7	19.5	15.2	23.7	18.8	18.6	15.3
50-60	29.4	21.1	30.3	25.7	25.9	21.3	33.7	27.6	26.1	20.6
60 and over	59.3	49.4	60.0	54.0	51.6	42.6	67.4	58.4	59.1	47.3

CHAPTER VI

THE PROPORTION OF THE SEXES.

120. Although the distinction by sex is kept up in all the Imperial Census Tables, the scope of the present chapter is mainly confined to a discussion of the proportion of the sexes in the entire population with regard to locality, age-period, religion or caste, and we are here concerned only with the statistics contained in Imperial Tables VII and XIV. The salient features of these and also of extra Census vital statistics relevant to the subject are brought out in the following Subsidiary Tables to be found at the end of this chapter:—

- (i) General proportions of the sexes by Natural Divisions and Districts.
- (ii) Number of females per 1,000 males at different age-periods by religions at each of the last three Censuses.
- (iii) Number of females per 1,000 males at different age-periods by religions and Natural Divisions.
- (iv) Number of females per 1,000 males for certain selected castes.
- (v) Annual number of births and deaths reported for each sex during the decades 1891-00 and 1901-10.
- (vi) Number of deaths of each sex at different ages.

121. Taking the population of the whole State, males outnumber females, there being only 979 of the latter for every 1,000 of the former. Similar proportions for a few other Provinces, States and Countries are set forth in the margin as likely to be of interest for purposes of comparison.

Province, State or Country	Number of females per 1,000 males
Madras Presidency ...	1,031
Bombay Presidency ...	920
Hyderabad ...	968
Baroda ...	925
India ...	959
Japan ...	979
England and Wales ...	1,068
Scotland ...	1,063
United States of America	948

122. Within the State itself, the proportion of females is higher in the Eastern than in the Western Division, their number per 1,000 males being 986 and 958 in the two divisions respectively. It is only in the Mysore and Hassan Districts that females exceed males, while the other six districts show a deficiency of the fair sex. The lowest proportion of females is to be found in the Kadur District. The relative proportion of the sexes in the several districts is graphically shown in the marginal map.

MAP OF MYSORE.

Showing the number of females to 1,000 males in each district.

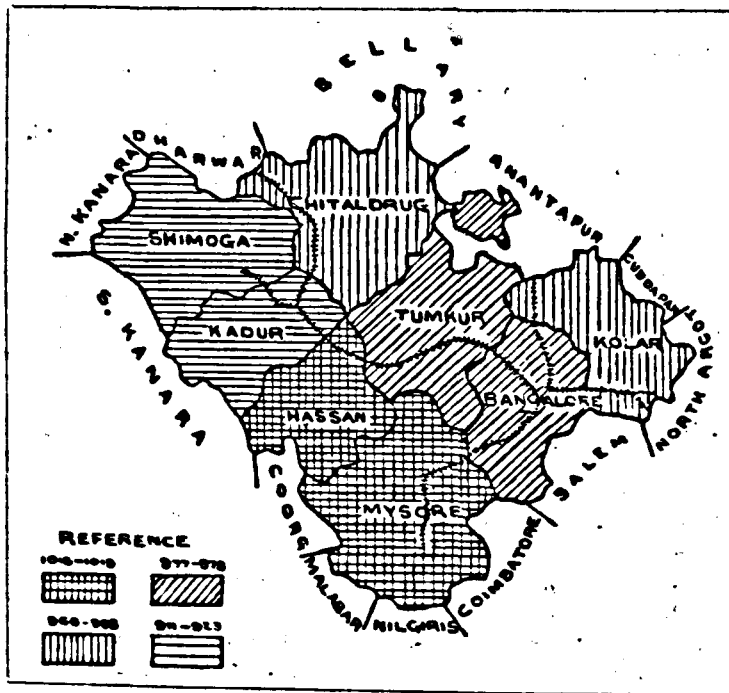

(iii) Cities. 123. Taking the four cities, the proportion of females in every one of them is less than the average for the whole State. It is so low as 739 per 1,000 males in Kolar Gold Fields, the marked deficiency of females being accounted for by the greater demand for male labour in mining operations.

(iv) Taluks. 124. An analysis of the figures indicating the proportion of females in each taluk reveals considerable variations therein, ranging from 744 (females per 1,000 males) in the Koppa Taluk of the Kadur District to 1,108 in the Nagamangala Taluk of the Mysore District. In the districts of Mysore and Hassan, the only taluks with a deficiency of females are Mysore and Malvalli in the former, and Belur and Manjarabad in the latter. All the taluks in the districts of Chitaldrug and Kadur share in the general excess of males over females. So also is the case in the Tumkur and Shimoga Districts except for the Kunigal Taluk in the former and the Channagiri Taluk in the latter where the fair sex preponderates. In the remaining districts of Bangalore and Kolar, all the taluks except Magadi, Channapatna and Anekal in the former, and all except Kolar, Mulbagal, Srinivaspur, Chintamani and Malur in the latter share in the general preponderance of males.

Urban and rural.

125. Taking the rural population of the whole State, it contains 983 females for every 1,000 males, while the proportion of females in the urban population is only 942. Viewed also by Natural Divisions and districts, there is a similar disparity in the sex proportions of urban and rural tracts except in the districts of Bangalore and Shimoga, as will be clear from the marginal tabular statement.

Division, District or City	Number of females per 1,000 males	
	Urban	Rural
Mysore State, including Civil and Military Station, Bangalore ...	942	983
Mysore State, excluding Civil and Military Station, Bangalore ...	941	983
Eastern Division ...	941	992
Bangalore City ...	927	...
Bangalore District ...	1,001	963
Kolar Gold Fields (City)...	739	...
Kolar District ...	965	986
Tumkur District ...	960	977
Mysore City ...	975	...
Mysore District ...	998	1,020
Chitaldrug District ...	941	968
Western Division ...	939	959
Hassan District ...	964	1,021
Kadur District ...	881	914
Shimoga District ...	951	931
Civil and Military Station, Bangalore ...	948	...

Even in the case of Bangalore District, the exception is only apparent; for if the population of Bangalore City is included in the urban population of the district, the proportion of females then falls below that in the rural population. Owing to various kinds of industrial occupations pursued in towns and the large number of immigrants who go there in quest of livelihood leaving their families behind, females will not, as a general rule, figure as largely in urban as in rural tracts. But as most of the towns in Mysore are small and situated in the midst of agricultural tracts without any important industries apart from that of the rural popu-

lation surrounding them, they cannot be strictly considered as urban in their characteristics, so that it is unnecessary to discuss the relative proportion of females in the so-called urban and rural population of each district. The four cities may be really considered as urban tracts, and these have, as observed in para 123 above, a decidedly lower proportion of females than the average for the whole State, thus conforming to the general law.

Migration allowed for.

126. We have hitherto been discussing the proportion of the sexes in the 'actual population,' i.e., persons enumerated in Mysore irrespective of where they were born. Let us now consider the 'natural population' of Mysore, or in other words, those born in Mysore whether enumerated within or beyond Mysore. Although the exact number of persons of either sex born beyond the limits of Mysore and enumerated in Mysore is known from Imperial Table XI, figures regarding emigrants or those born in Mysore and found in other parts of the world are necessarily incomplete. But as the number of Mysore-born persons enumerated in other parts of India is known from the Census statistics of those places and as figures have also been procured by the Census Commissioner in regard to emigrants to Ceylon and a few other likely places beyond India, the omission of those who have emigrated from Mysore to other parts of the world will be of too trifling a nature to affect our present discussion. Allowing, then, for immigration and also for emigration as far as available figures permit, the

proportion of females in the natural population of the State works up to 990 per 1,000 males, as against only 979 in the actual population. There is an excess of males over females among both immigrants and emigrants, the proportion of females to males being considerably lower among the former than among the latter; and as immigrants are more than twice as numerous as emigrants, females are proportionately more deficient in the actual than in the natural population.

It is not possible to calculate the proportion of the sexes in the natural population of each Natural Division or district, as figures received from Provincial Census Superintendents regarding emigrants from Mysore to other parts of India do not make any distinction as regards the different districts of the State where such emigrants may have been born.

127. Arranged according to the proportion of females to males in the enumerated population, the main religions in the State stand in the following order:—Hindu, Animistic, Musalman, Christian and Jain. Religions.

Religion	Number of females to 1,000 males
Hindu ...	936
Musalman ...	697
Christian ...	679
Jain ...	677
Animistic ...	951

From the marginal figures, it will be seen that for every 1,000 males there are 35 females less among Animists than among Hindus, while in the case of Musalmans, Christians and Jains, the disparity as compared with Hindus is considerably greater. The low proportion of females among Musalmans and Jains is partly due to the large preponderance of the male sex in the immigrant population, and the same remark applies with even greater force to Christians

among whom immigrants with a proportion of only 687 females per 1,000 males constitute nearly one half of the entire enumerated population.

The discussion of the relative proportion of the sexes among Hindus and Musalmans may next be taken up in detail. The proportion of females to males is lower among Musalmans than among Hindus whether in the actual or in the natural population. In both the religions, females are more deficient in the actual than in the natural population. The gain in the proportion of females in the natural as compared with the actual population is, however, very much greater among Musalmans than among Hindus, amounting to 50 and 8 females per 1,000 males respectively. On comparing the proportion of females in the enumerated population at different age-periods, it will be found that the Musalmans

Age-period	Number of females per 1,000 males	
	Hindus	Musal- mans
0-30 ...	1,009	936
30 and over ...	947	824
Difference ...	62	112

possess, in the early years of life, a slightly lower proportion of females than Hindus and that the difference shows an abrupt increase in the age-period 10-15, this marked disparity continuing practically undiminished throughout the later years of life. Considering only the two age-periods 0-30 and 30 and over, the marginal figures will show that, as compared with Hindus, Musalmans suffer from a much greater decline in the proportion of females in the later period.

128. The proportion of the sexes among the main castes, tribes and races is shown in Subsidiary Table IV. It will be seen from the figures in column 2 of this table that it is only among Bestas that females exceed males. Castes.

It is significant that more than two-thirds of the population of this caste is to be found in the Mysore District where the general proportion of females is so high as 1,019 per 1,000 males. If the several castes are arranged in order according to the proportion of females, the first six places are taken by Besta, Vakkaliga, Lingayat, Kuruba, Ganiga and Agasa, while the last six are held by Sheikh, Vaisya, Mah-ratta, Indian Christian, Pathan and Saiyid.

Caste	Number of females per 1,000 males in		Number of persons in Mysore District per 1,000 in the whole State
	Mysore District, including Mysore City	Mysore State, as a whole	
Besta ...	1,024	1,005	677
Brahman ...	1,016	973	229

So far as the statistics go, they do not seem to suggest any interdependence between the proportion of the sexes and the relative social status of different castes. On the other hand, a comparison of the marginal figures relating to Bestas and Brahmans in the Mysore District as well as in the whole State would point to locality rather than

caste or race as the main factor to be reckoned with. In fact, the same view receives additional support from the marginal tabular statement which shows

Caste	Number of females per 1,000 males in	
	Mysore* and Hassan Districts	Other parts of the State
Agasa ...	1,098	968
Banajiga ...	1,024	969
Beda ...	1,008	979
Besta ...	1,024	956
Brahman ...	1,016	954
Golla ...	1,023	965
Holeya ...	1,015	951
Kuruba ...	1,012	966
Lingayat ...	1,029	980
Madiga ...	1,029	973
Panchala ...	993	912
Uppara ...	1,026	938
Vakkaliga ...	1,035	977
Vodda ...	985	961

* Including Mysore City.

that almost all the numerically important castes generally possess a higher proportion of females in Mysore and Hassan Districts than in other parts of the State:—

It is remarkable that nearly all the castes mentioned in Subsidiary Table IV exhibit a higher proportion of females to males in the age-period 15-20 than in the earlier period 12-15. This must be mainly attributed to inaccuracies in the age return, as unmarried females aged 12-15 are often returned as younger than they really are. A similar tendency of exaggerating the age in the case of married females between 12-15 may be reflected in the abnormally high proportion of females in the age-period 15-20 among Brahmans and Vaisyas.

Age-periods.

129. On examining the figures in column 4 of Subsidiary Table II, it will be seen that, during the first five years of life, females exceed males in number and that this numerical superiority is kept up, though in a somewhat lower proportion, in the next quinquennial age-period 5-10. There is a sudden drop in the proportion of females in the next two periods 10-15 and 15-20, which is to be mainly attributed to greater mortality among females at the time of puberty and first delivery. There may have been also inaccuracies in the age return of females belonging to the period 10-15 owing to the tendency of understating age in the case of unmarried girls, thus unduly lowering the visible proportion of females at this period. But such defects in the age return must have been considerably eliminated in the present Census enumeration, as evidenced by the

Age	Number of females to 1,000 males	
	1901	1911
5-10 ...	1,004	1,043
10-15 ...	868	951

relatively easy fall in the proportion of females in passing from the age-period 5-10 to the next higher period 10-15, as compared with the previous Census (*vide* marginal figures). From 20 to 30 years of age, females seem to have a firmer hold on life than males owing probably to the impulsive and reckless nature of the latter at this period of life,

although the *jerky* preponderance of females in the age-period 20-25 is to be really ascribed to the defective nature of the age return (*vide* para 108 of Chapter V). From 30 onwards up to 50, males fare better than females, while above 50, the latter, having passed the stage of child-bearing, gain once more an advantage over the former, although the rise in the proportion of females may also be partly due to inaccuracies in the age return resulting from the tendency of exaggerating age in the case of old women.

Census figures and vital statistics.

130. In correlating the Census proportion of the sexes at different age-periods with the results of vital statistics, the first subject for consideration concerns the proportion of the sexes at birth. The numerical superiority of females over males at each of the first five years of life, kept up at a steadily high ratio of more than 1,050 females per 1,000 males according to Census figures, naturally leads to the presumption that more females are born than males. But as the reported vital statistics for the decade 1901-10 point only to 966 female births for every 1,000 male births and as males are also said to exceed females at birth generally in all parts of India and in Europe as well, the figures must be carefully examined before coming to a definite conclusion on the point. It is generally held that although vital statistics suffer from defects of omission in the registration of births and deaths, it cannot be said that such omissions occur more largely with regard to female births and deaths than similar occurrences relating to males. Granting this, let us see what follows. From Subsidiary Table V, it will be seen that 966 females were born for every 1,000 males during the decade 1901-10. The death-rate in the first year of life is shown in Subsidiary Table IX of Chapter V as 80·2 per mille among males and 68·6 among females. But owing to omissions in the registration of deaths, the real death-rate among infants must be taken at a very much higher figure. Let us pitch

it so high as 200 per mille for male infants. Then, out of 1,000 male births, there will be 800 surviving at the end of the first year of life. Corresponding to 200 deaths among male infants, there can be only 173 female deaths according to the proportion shown in column 14 of Subsidiary Table VI, so that out of 966 female births the survivors at the end of the first year will number only 793. Thus the proportion of males to females at the end of the first year will be as 800 to 793, whereas the Census proportion of male and female infants under one year is as 1,000 to 1,051. In fact it is difficult to arrive at the latter proportion on any basis other than an excess of females over males at birth, unless we adopt the apparently inconsistent course of accepting the proportion of the sexes at birth according to vital statistics and at the same time questioning the accuracy of the proportion regarding infantile mortality worked out from the same statistics. At any rate, there is reason to suspect that, in the registration of births and deaths, omissions occur more largely with regard to females than males.

Viewed in the light of the conclusions arrived at from the Census proportion of females to males at different age-periods, the figures indicating the proportion of female to male deaths in column 14 of Subsidiary Table VI suggest that the same tendencies of over- and under-stating age in certain circumstances which vitiate the accuracy of the Census age return must have also operated in the registration of vital statistics so as to unduly reduce the proportion of female to male deaths in the age-period 10-15 and exaggerate similar proportions in regard to the age-periods 20-30 and 60 and over.

131. The proportion of females to males, whether in the actual or natural population of the State, shows a slight decline as compared with the previous Census of 1901; or in other words, there has been a more rapid increase in the male than in the female population during the past decade. As between the two Natural Divisions in the State, it is only in the Eastern Division that a similar result is seen, whereas in the Western Division the proportion of females has actually increased since 1901. It is not profitable to attempt to correlate the above features with the results of vital statistics, for, neither the excess of male over female births nor the excess of deaths over births during the past decade, as indicated by recorded vital statistics, is borne out by the Census figures, as explained in the previous para and in paras 40 and 41 of Chapter II respectively. In fact according to vital statistics the excess of deaths over births during the past decade numbers 85,127 among males and 59,392 among females so that the proportion of females to males should have really increased during the decade, whereas the Census figures indicate just the reverse.

Comparison with previous Censuses.

Let us next examine the variation in the proportion of the sexes from the earliest Census of 1871 onwards. In that year there were 994 females for every 1,000 males in the enumerated population. This proportion went up to 1,007 in 1881 owing chiefly to greater mortality among males during the severe famine of 1876-7. From 1881 to 1891 the figure went down to 991, all the districts showing a uniform decline from the more or less abnormal proportion of the sexes reached in 1881. Taking the figures for the State as a whole, there has been a further steady decline in the proportion of females from 1891 onwards. Viewed, however, by divisions and districts, there have been a few exceptions to this general downward trend. In the Western Division, as well as in two of its component districts, *viz.*, Kadur and Shimoga, the female element has steadily increased since 1891 while in the remaining district of Hassan also the proportion of females has risen since 1901. Again, in two of the districts of the Eastern Division, *viz.*, Kolar and Chitaldrug, the proportion of females has practically remained stationary since 1901 while there has been a steady increase in the City of Kolar Gold Fields from 1891 onwards.

The above fluctuations in the proportion of the sexes in the population of the State have to be accounted for by variations in the proportions of the sexes as regards births, deaths and migration. But it is not easy to apportion the relative operative influences of these three factors in each particular case.

132. The question has often been raised as to why males should generally preponderate over females in the population of India whereas the case is just the reverse in the greater part of Europe. It is suggested by a few European *statisticians* that the difference is to be partly explained by the omission of females in countries.

Contrast with European countries.

the Census enumeration in India. This view seems to be untenable, at any rate as regards Mysore where people have not manifested any tendency of fighting shy of the Census and there is no reason to believe that there have been any such omissions in enumeration. On the other hand, a comparative study of the figures showing the proportion of the sexes at different age-periods in India as well as in European countries where females are in excess of males, points to relatively greater mortality among females in India as an adequate explanation for the deficiency of females which is peculiar to this country. Various causes are said to contribute towards this result and they will be examined in the following serial order, with special reference to conditions in Mysore:—

(i) *Female infanticide*.—This does not seem to have prevailed in Mysore at any time in the near past, and is at any rate unheard of at the present day.

(ii) *Neglect of female life*.—In Hindu households, a son is looked upon as a necessity not only for the support of his parents in old age, but also for saving their souls after death by the performance of religious ceremonies. A daughter, on the other hand, is after all a temporary member of the household of her parents and after marriage she joins a different family. It is no surprise therefore to find that sons are generally preferred to daughters. Added to this, the difficulty, and expenditure of money involved in marrying a girl to a suitable husband lead to a comparative neglect of female children on the part of parents; or to put it in a milder form, girls are not as carefully and anxiously tended as boys.

(iii) *Infant marriage and premature child-bearing*.—The prevalent system of early marriage and consummation within a short interval after the married girl attains puberty is responsible for the early breakdown of the girl's constitution owing to the severe strain of maternity imposed on her while still very young.

(iv) *A very high birth-rate*.—Although the average fecundity of women in India is lower than in Europe (*vide* para 118 of Chapter V), the *crude* birth-rate is considerably higher in India owing to the universality of marriage. Taking the sum total of the female population, the aggregate number of births being a proper measure of the strain they are put to, the higher birth-rate in India will conduce towards a relatively higher female mortality in this country as compared with Europe; or in other words, the number of unmarried females being proportionately greater in Europe, more women escape the ordeals of childbirth and are therefore exposed to less risks in life than in India.

(v) (a) *Unskilful midwifery*, (b) *Confinement and bad feeding of women at puberty and during their menstrual period and after childbirth*, (c) *the hard life of widows* and (d) *the hard labour which women of the lower classes have to perform*, these are all mentioned as peculiar conditions of Indian life, conducive to greater mortality among Indian women as compared with their sisters in Europe. All these conditions obtain also in Mysore and there can be no doubt that female life is to some extent prejudicially affected thereby.

Excess of females in Mysore and Hassan Districts.

133. Turning once more to the subject of variation in the proportion of the sexes within the State itself, the excess of females over males which is a peculiar feature of Mysore and Hassan Districts deserves more than a passing mention. The proportion of females has been highest in these two districts from the earliest Census. We have also seen (*vide* para 128) that all the main castes

Age	Number of females per 1,000 males in the		
	Whole State	Mysore District*	Hassan District
0-5 ...	1,064	1,060	1,052
5-10 ...	1,043	1,028	1,059
10-15 ...	951	940	999
15-20 ...	930	903	935
20-25 ...	1,005	1,124	1,091
25-30 ...	961	1,079	1,007
30-40 ...	936	1,040	976
40-50 ...	894	939	938
50-60 ...	937	1,009	1,066
60 and over ...	1,025	1,192	1,166

* Excluding Mysore City.

have generally a higher proportion of females in these districts than in other parts of the State. The question then arises as to how this peculiar local phenomenon is to be accounted for. Neither recorded vital statistics nor the Census figures point to any strikingly higher proportion of females to males at birth in these districts as compared with other districts in the State. On the other hand, a comparative study of the proportion of the sexes at different age-periods (*vide* margin) leads to the inference that the death-rate among females aged 20 and above must be

comparatively low in these two districts. It is not easy to say how this result is brought about; nor is it possible to lay stress on any peculiarities of soil, elevation, climate, etc., which obtain in these tracts, but not in any of the remaining six districts. Perhaps in Mysore and Hassan Districts the standard of comfort among females may be somewhat higher and they probably enjoy more of outdoor life; and this may partially account for the lower death-rate among women of these districts than in other parts of the State.

134. Although it will be very interesting and useful to know the causes that determine the sex of the offspring, biology has yet to furnish a satisfactory solution of the problem. Various theories have, however, been advanced by European writers on the subject and a few of these theories that have gained widespread currency refer either to the relative age of the parents or to their relative superiority or to the state of nourishment of the organisms at the time of conception as affecting the sex of the child. According to this last-mentioned theory, organisms in a high state of nourishment tend to produce more female offspring than male and in the opposite case more male. This theory is perhaps the most widely accepted one at present and it also claims some degree of accord with the findings of biology as it points to the female as the outcome and expression of relatively preponderant *anabolism* and the male of relatively preponderant *katabolism*. It seems also to receive further support from the results of vital statistics; for an examination of the monthly variations in the proportion of the sexes at birth in Mysore during the last five years reveals a relatively larger proportion of female births during the latter half of the year (*i.e.*, July to December) as compared with the first six months (January to June); and the period of conception corresponding to births occurring from July to December ranges from October to March which is the season of plentiful harvests for the agricultural population.

Theories regarding causation of sex.

The prevalent Indian theory as regards the causation of sex emphasises the importance of the period (*i.e.*, number of days) that elapses between menstruation and conception. If conception takes place on *odd* days reckoned from the commencement of menstruation, a female child will be born and if on *even* days, a male child. As presupposing an excess of blood in the female organism on *even* days reckoned from the appearance of menses, and a relative diminution of blood on *odd* days, the above theory is akin to the other one already referred to, which attributes the determination of sex to the state of nourishment of the organism at the time of conception.

135. We may now conclude this chapter with a brief reference to ceremonies which are performed with a view to make a married woman conceive or to secure a male offspring. The object of the ceremony called "*Garbhádána*" is to bring about conception and it is performed at the time of consummation. Another ceremony known as "*Pumsavana*" is intended to secure the birth of a male child, and although, according to Shastras, it should be performed in the third or fourth month of pregnancy, it is rarely so done and is often combined with "*Símanthónayana*" which is a purificatory ceremony done in the sixth or eighth month of pregnancy.

Ceremonies for begetting children.

Besides the above observances which are obligatory and confined only to the "*twice-born*" classes, there are a few others which are occasionally resorted to among the Hindus generally with a view to begetting children, and they are as follows:—

- (i) "*Asvatthapradakshina*" which consists in the woman worshipping the *Asvattha ficus religiosa* tree and walking daily round it 108 times for a period of 48 days.
- (ii) "*Asvattha Vivaha*" which is a symbolical marriage of an *Asvattha* plant with a *Margosa* plant, in which both the husband and wife take part.
- (iii) "*Nágaprathishta*" or worship of the "*Cobra*" deity in the form of an image carved in stone.
- (iv) "*Nágabali*" or performing the obsequies of a dead cobra with all the formalities observed in ordinary funeral ceremonies.

SUBSIDIARY TABLES.

I.—GENERAL PROPORTIONS OF THE SEXES BY NATURAL DIVISIONS AND DISTRICTS.

Districts and Natural Divisions	Number of females to 1,000 males					
	1911		1901		1891	
	Actual population	Natural population	Actual population	Natural population	Actual population	Natural population
1	2	3	4	5	6	7
Mysore State, including Civil and Military Station, Bangalore ...	979	990	980	994	991	1,001
Mysore State, excluding Civil and Military Station, Bangalore ...	979	...	980	...	991	...
Eastern Division ...	986	...	992	...	1,008	...
Bangalore City ...	927	...	931	...	964	...
Bangalore District ...	985	...	996	...	1,019	...
Kolar Gold Fields (City) ...	739	...	699	...	507	...
Kolar District ...	986	...	986	...	993	...
Tumkur District ...	977	...	986	...	996	...
Mysore City ...	975	...	994	...	1,018	...
Mysore District ...	1,019	...	1,022	...	1,036	...
Chitaldrug District ...	966	...	966	...	974	...
Western Division ...	958	...	950	...	948	...
Hassan District ...	1,019	...	1,010	...	1,019	...
Kadur District ...	911	...	907	...	898	...
Shimoga District ...	923	...	918	...	914	...
Civil and Military Station, Bangalore ...	948	...	986	...	994	...

N.B.—Figures by districts are not available for columns 3, 5 and 7.

II.—NUMBER OF FEMALES PER 1,000 MALES AT DIFFERENT AGE-PERIODS BY RELIGIONS AT EACH OF THE LAST THREE CENSUSES.

Age	All religions			Hindus			Musalmans		
	1891	1901	1911	1891	1901	1911	1891	1901	1911
1	2	3	4	5	6	7	8	9	10
0-1 ...	1,057	1,018	1,051	1,057	1,022	1,052	1,045	959	1,024
1-2 ...	1,074	982	1,076	1,076	966	1,078	1,018	921	1,085
2-3 ...	1,061	1,012	1,074	1,062	1,013	1,080	1,055	1,018	1,032
3-4 ...	1,058	1,039	1,084	1,054	1,041	1,085	1,131	1,020	1,087
4-5 ...	1,026	1,002	1,037	1,026	1,006	1,037	1,082	991	1,039
Total—0-5 ...	1,053	1,012	1,064	1,053	1,016	1,066	1,060	966	1,044
5-10 ...	1,027	1,004	1,043	1,031	1,008	1,045	971	952	1,012
10-15 ...	898	868	951	903	869	959	806	838	841
15-20 ...	906	852	930	906	853	932	876	837	888
20-25 ...	1,098	1,074	1,054	1,113	1,066	1,067	982	943	942
25-30 ...	994	1,013	961	1,002	1,023	974	926	879	840
Total—0-30 ...	1,002	966	1,003	1,007	970	1,009	948	912	936
30-40 ...	932	963	936	938	979	947	840	840	809
40-50 ...	885	957	894	889	966	901	806	849	802
50-60 ...	1,019	1,025	997	1,027	1,036	943	911	916	859
60 and over ...	1,246	1,184	1,025	1,254	1,197	1,039	1,126	1,036	857
Total 30 and over ...	971	1,004	938	977	1,015	947	883	885	824
Total all ages (actual population) ...	991	980	979	996	987	986	924	908	897
Total all ages (natural population) ...	1,001	994	990	Not available	Not available	994*	Not available	Not available	947*

* These figures are only rough approximations as the figures relating to emigrants classified by religion were available only for two Provinces, viz., Bombay and United Provinces of Agra and Oudh.

III.—NUMBER OF FEMALES PER 1,000 MALES AT DIFFERENT AGE-PERIODS BY RELIGIONS AND NATURAL DIVISIONS. (CENSUS OF 1911.)

Age	EASTERN DIVISION			WESTERN DIVISION		
	All religions	Hindus	Musalmans	All religions	Hindus	Musalmans
1	2	3	4	5	6	7
0-1	1,054	1,055	1,010	1,099	1,096	1,029
1-2	1,075	1,077	1,031	1,076	1,079	1,069
2-3	1,074	1,060	1,019	1,078	1,084	1,088
3-4	1,084	1,086	1,079	1,083	1,088	1,186
4-5	1,088	1,084	1,024	1,047	1,048	1,084
Total 0-5	1,063	1,068	1,030	1,084	1,065	1,062
5-10	1,049	1,045	1,008	1,049	1,050	1,049
10-15	949	956	849	957	966	816
15-20	933	934	898	913	919	824
20-25	1,077	1,085	975	1,008	1,021	851
25-30	968	999	858	904	916	791
Total 6-30	1,010	1,014	942	965	992	907
30-40	975	964	851	846	858	781
40-50	904	910	834	863	876	735
50-60	916	921	853	1,010	1,022	910
60 and over	1,009	1,031	846	1,100	1,117	924
Total 30 and over	948	956	846	908	921	786
Total all ages (actual population)	966	962	909	958	967	865
Total all ages (natural population)						

Figures not available.

IV.—NUMBER OF FEMALES PER 1,000 MALES FOR CERTAIN SELECTED CASTES.

Caste	Number of females per 1,000 males						
	All ages	0-5	5-12	12-15	15-20	20-40	40 and over
1	2	3	4	5	6	7	8
Agas ✓	991	1,062	1,049	819	972	1,022	928
Banajiga ✓	978	1,061	1,046	869	956	941	934
Beda ✓	980	1,072	1,062	867	946	992	913
Besta ✓	1,005	1,061	1,023	884	964	1,050	958
Brahman ✓	973	1,079	1,016	863	1,023	902	998
Ganiga ✓	992	1,067	1,042	819	883	1,025	992
Golla ✓	969	1,091	1,057	854	923	979	897
Holey ✓	961	1,065	1,052	840	974	949	913
Idiga ✓	954	1,059	1,025	779	910	975	906
Kahattria ✓	966	1,033	1,052	840	908	916	970
Kumbara ✓	961	1,126	1,055	925	915	924	890
Kuruba ✓	997	1,057	1,043	852	905	1,034	975
Lingayat ✓	998	1,052	1,100	860	900	999	968
Madiga ✓	980	1,066	1,043	829	1,007	1,007	877
Mahratta ✓	920	1,060	1,011	846	927	857	894
Nayinda ✓	973	1,044	1,045	867	939	1,003	893
Neygi ✓	986	1,053	1,062	861	962	1,001	918
Panchala ✓	947	1,058	1,105	823	931	916	877
Tigala ✓	954	1,039	1,012	874	956	970	870
Uppara ✓	963	1,064	1,061	843	964	946	940
Vaisya ✓	923	1,059	1,069	790	1,053	881	815
Vakkaliga ✓	999	1,067	1,078	902	890	998	958
Vodda ✓	963	1,053	1,044	825	903	992	854
Pathan ✓	904	1,008	986	797	903	892	839
Saryid ✓	903	1,068	971	767	858	829	840
Sheikh ✓	929	1,044	1,022	735	956	916	857
Indian Christian	918	1,019	1,050	847	978	852	843
Lambani ✓	930	1,058	985	738	864	968	823

V.—ACTUAL NUMBER OF BIRTHS AND DEATHS REPORTED FOR EACH SEX DURING THE DECADES 1891-1900 AND 1901-1910.

Year	Number of births			Number of deaths			Difference between columns 2 and 3. Excess of latter over former (+) Defect (-)	Difference between columns 5 and 6. Excess of latter over former (+) Defect (-)	Difference between columns 4 and 7. Excess of former over latter (+) Defect (-)	Number of female births per 1,000 male births	Number of female deaths per 1,000 male deaths
	Male	Female	Total	Male	Female	Total					
1	2	3	4	5	6	7	8	9	10	11	12
Total 1891-1900*	410,667	392,902	803,569	370,048	341,506	711,549	-17,765	-28,537	+92,020	957	923
1891 ...	49,815	47,793	97,608	35,958	33,870	69,828	-2,022	-2,088	+27,760	959	942
1892 ...	45,170	42,836	88,006	43,491	39,063	82,574	-2,334	-4,408	+5,432	948	899
1893-1894 ...	46,223	43,517	89,740	35,137	31,843	66,980	-2,706	-3,294	+22,760	941	906
1894-1895 ...	50,334	47,620	97,954	34,694	31,228	65,922	-2,714	-3,466	+32,032	946	900
1895-1896 ...	46,327	44,148	90,475	34,880	32,616	67,496	-2,179	-2,264	+22,979	953	935
1896-1897 ...	45,412	43,437	88,849	38,756	36,445	75,201	-1,975	-2,311	+13,648	957	940
1897-1898 ...	39,388	38,813	78,201	52,244	47,951	100,195	-575	-4,293	-21,994	985	918
1898-1899 ...	40,170	38,869	79,039	51,882	48,280	100,162	-1,301	-3,602	-21,123	968	931
1899-1900 ...	47,828	45,869	93,697	43,001	40,190	83,191	-1,959	-2,811	+10,506	959	935
Total 1901-1910...	480,383	464,284	944,667	565,510	523,676	1,089,186	-16,099	-41,834	-144,519	966	926
1901 ...	43,439	42,588	86,027	59,153	54,285	113,438	-851	-4,868	-27,411	960	918
1902 ...	46,774	45,218	91,992	59,265	56,453	115,718	-1,556	-2,812	-23,726	967	953
1903 ...	48,460	47,450	95,910	60,479	57,592	118,071	-1,010	-2,887	-22,161	979	952
1904 ...	40,483	39,319	79,802	64,119	59,485	123,604	-1,164	-4,634	-43,802	971	928
1905 ...	47,124	45,984	93,106	47,251	43,615	90,866	-1,138	-3,636	+2,240	976	923
1906 ...	50,136	48,575	98,711	53,305	49,409	102,714	-1,561	-3,896	-4,008	969	927
1907 ...	45,643	43,924	89,567	62,098	55,906	118,004	-1,719	-6,192	-28,437	962	900
1908 ...	55,286	53,227	108,513	48,605	45,067	93,672	-2,059	-3,538	+14,841	963	927
1909 ...	52,935	50,623	103,558	51,685	47,472	99,157	-2,312	-4,213	+4,401	956	918
1910 ...	50,105	47,376	97,481	59,550	54,392	113,942	-2,729	-5,158	-16,461	946	913

* The total covers only nine years instead of ten, as the first six months of 1893 and the last six months of 1900 have been left out of account in changing from calendar to official year in the departmental reports.

VI.—NUMBER OF DEATHS OF EACH SEX AT DIFFERENT AGES.

Age	1905		1906		1907		1908		1909		Total		Average number of female deaths per 1,000 male deaths
	Male	Female	Male	Female	Male	Female	Male	Female	Male	Female	Male	Female	
1	2	3	4	5	6	7	8	9	10	11	12	13	14
0-1 ...	5,095	4,367	5,955	5,253	5,516	4,700	6,031	5,278	5,761	4,889	28,298	24,487	865
1-5 ...	4,398	3,883	5,526	5,271	6,058	5,706	4,565	4,239	6,332	5,882	26,879	24,981	929
5-10 ...	2,935	2,771	4,052	3,900	4,743	4,557	3,237	3,150	3,711	3,493	18,678	17,871	957
10-15 ...	2,431	2,456	3,433	3,286	4,209	3,702	2,800	2,529	2,781	2,577	15,654	14,550	929
15-20 ...	2,375	2,591	3,389	3,442	4,685	4,515	2,903	2,928	2,897	3,172	16,249	16,648	1,025
20-30 ...	4,923	5,708	5,537	6,402	6,627	6,647	5,157	5,555	5,148	6,089	27,392	30,396	1,110
30-40 ...	6,797	5,961	6,245	5,386	6,063	6,063	5,508	4,945	5,869	4,859	31,274	27,214	870
40-50 ...	5,963	4,483	6,121	4,508	7,281	5,522	5,565	4,620	5,728	4,492	30,678	23,620	770
50-60 ...	5,169	4,355	5,404	4,328	6,710	5,650	5,305	4,620	5,200	4,202	27,798	23,155	833
60 and over	7,205	7,045	7,643	7,638	9,414	8,844	7,534	7,203	8,258	7,817	40,054	38,547	962

CHAPTER VII.

CIVIL CONDITION.

136. The heading of this chapter is meant to refer to the state of an individual from the point of view of marriage, *i.e.*, whether the person is unmarried, married or widowed. Statistics regarding civil condition by age and sex are contained for each religion in Imperial Table VII, and for each caste, tribe or race in Imperial Table XIV. The salient features of these statistics are brought out in the following Subsidiary Tables appended to this chapter:—

- (i) Distribution by civil condition of 1,000 of each sex, religion and main age-period at each of the last four Censuses.
- (ii) Distribution by civil condition of 1,000 of each sex at certain ages in each religion and Natural Division.
- (iii) Distribution by main age-periods and civil condition of 10,000 of each sex and religion.
- (iv) Proportion of the sexes by civil condition at certain ages for religions and Natural Divisions.
- (v) Distribution by civil condition of 1,000 of each sex at certain ages for selected castes.

137. It is a trite observation, but none the less true, that the married state is much more common in India than in Europe. Among Hindus who constitute the bulk of the Indian population, marriage is considered as a religious duty and it is performed at a very early age and as a rule before the girl attains puberty. Accordingly we find that among every 1,000 males in India, only 492 were unmarried according to the Census of 1901 as against 608 in England in the same year, while in the case of females the disparity is even more striking, the corresponding figures for India and England being 344 and 586 respectively.

138. In Mysore, according to the recent Census, out of every 11 males, 6 are unmarried; and of the latter more than two-thirds are less than 15 years of age. Among those aged from 15 to 40, only 9 out of every 20 are bachelors, while among those aged 40 and over it is only 1 in 30. The proportion of the unmarried is much lower still in the case of females. Among them 4 out of every 11 are unmarried; and more than five-eighths of the total number of spinsters are less than 10 years old and ten-elevenths under 15. Among females aged from 15 to 40, only 1 in every 14 is unmarried while among older women it is even less than 1 in 70.

There are practically no married males less than 15 years old. At '15-20,' 1 in every 12 males has a wife; and the proportion rises steadily to 2 in 5 at '20-25,' to 7 in 10 at '25-30,' 17 in 20 at '30-35' and 18 in 20 at '35-40,' after which there is a gradual decline corresponding to a complementary increase in the proportion of widowers. Females enter on matrimony much earlier in life; and between the ages of 5 and 10, 8 per mille are already married. At '10-15' more than 1 in 5 is wedded, and the proportion goes up to 3 in 4 at '15-20' and culminates at '20-25' with more than 17 married out of every 20. Beyond the age of 25, the proportion of married females suffers a steady decline owing to mortality among husbands and increase in the ranks of widows. It is interesting to note that the highest proportion of the married among males is claimed by the age-period 35-40, while it is '20-25' for females.

139. The above remarks apply to the entire population of the State. Let us next consider the salient features of the statistics of marriage relating to each of the religions in turn. First, as regards Hindus, they constitute 92 per cent of the total population, so that the proportional figures indicative of their distribution by age, sex and civil condition do not show any appreciable variation from those relating to the entire population of all religions taken together. A close comparison of the two sets of figures reveals, however, a slight excess in the proportion of the married at '15-20' in the case of Hindu males, and at '10-15'

and '15-20' in the case of Hindu females. This must be due to the prevalence of early marriage among this community.

(ii) Musal-
mans.

140. As compared with Hindus, there are, in every 200 Musalman males, 5 more unmarried, 2 less married and 3 less widowed. The higher proportion of bachelors is due to Musalmans marrying at a comparatively later age than Hindus. On the other hand, the decrease in the proportion of Musalman widowers may be attributed to the existence of greater facilities for their remarriage owing to the availability of widows for such marriage and to the absence of any costly and elaborate religious formalities that are characteristic of a Hindu wedding. Among Musalman females, although the proportion of wives of all ages is the same as among Hindus, it is only half of that among the latter between the ages 5 and 10 and two-thirds of the same at '10-15.' This deficiency is made up at later age-periods where the ranks of the married must have been augmented by the remarriage of Musalman widows. This accounts also for the lower proportion of widows as compared with Hindus.

(iii) Ani-
mists.

141. Among Animists, the proportion of married males is the same as among Musalmans, although from age 10 to 20 marriage appears to be more frequent among Animist boys. The proportion of widowers is higher than among Musalmans but lower than among Hindus. As regards females, the Animists have proportionately the largest number of married women and the smallest number of widows. With them, marriage in the earlier ages prior to 20 seems to be less common than among Hindus, Musalmans or Jains.

(iv) Jains.

142. The Jains possess a smaller proportion of the married of either sex than Hindus, Musalmans or Animists. A detailed examination of the figures for the several age-periods shows that early marriage is most prevalent among them. They also hold the unenviable position of possessing the highest proportion of widowers and of widows and especially those of the latter under 20 years of age.

(v) Chris-
tians.

143. Lastly, the Christian population holds a unique place in certain respects. Among them, the married state is least common in either sex, and early marriage of boys and girls is least in evidence. They possess also a very low proportion of widowers and of widows, the Animists alone showing a still smaller figure as regards widows.

Varia-
tions by
Natural
Divisions.

144. On examining the figures contained in Subsidiary Table II for the two Natural Divisions, it will be found that in the case of both sexes the married condition is more prevalent in the Eastern than in the Western Division, the latter possessing a larger proportion of the unmarried and the widowed. The same local variation is also to be observed in the figures for each of the main religions except in the case of Christians. Christian bachelors are proportionately more numerous in the Eastern Division, and married females in the Western Division. It is a fact that Roman Catholics bulk much more largely in the Christian population of the Western Division than in the Eastern; but in the absence of definite statistics of marriage for the different sects of Christians it is not safe to ascribe the above result to any variation in the relative proportion of such sects in the two divisions. In the case of Christian bachelors, it is curious to note that while the proportion for "all ages" as shown in Subsidiary Table II is considerably higher in the Eastern Division, similar proportions for each of the several age-periods are not favourable to that division. This will perhaps puzzle a lay reader, who may, however, be assured that there has been no mistake in these figures and that they do not rebel against any fundamental axioms* of the mathematical theory of proportions.

Returning to the figures for the entire population of all religions in the two Divisions, it may be pointed out that the higher proportion of bachelors and spinsters in the Western Division obtains in all the age-periods and that the proportion of girl-wives aged from 10 to 20 is only three-fourths of that in the Eastern Division. As for the excess of widows and widowers in the Western Division, this must be mainly due to its inferiority to the other division as regards the general longevity of the population (*vide* para 108 of Chapter V).

145. If the figures for individual districts are examined, it will be found that in the case of both sexes the proportion of the married is lowest and that of the widowed is highest in the Shimoga District, while Kolar District holds the first place as regards the married and the last place as regards the unmarried. It is remarkable that the latter district also contains by far the largest proportion of the Telugu-speaking population of the State and it is generally held that the practice of early marriage is especially in vogue in this linguistic division of the community. This may perhaps partly account for the abovementioned unique position held by this district.

Variations
by dis-
tricts.

Proportional figures indicating the distribution of the population by civil condition in the several districts and cities are given below:—

District and City	Number per 1,000 males			Number per 1,000 females		
	Unmar- ried	Married	Widow- ed	Unmar- ried	Married	Widow- ed
Bangalore City	504	442	54	347	447	206
Bangalore District	521	429	50	366	445	189
Kolar Gold Fields (City)	477	505	18	405	498	97
Kolar District	516	430	54	355	449	196
Tumkur District	549	403	48	389	424	187
Mysore City	520	419	61	349	423	228
Mysore District	541	423	36	373	428	199
Chitaldrug District	562	388	50	420	410	170
Hassan District	573	382	45	416	386	198
Kadur District	565	381	54	413	379	208
Shimoga District	567	372	61	398	379	223
Civil and Military Station, Bangalore	565	392	43	417	404	179

146. The subject of infant marriage cannot be dealt with in this report as fully as its importance demands. The evil effects of this system are admittedly grave and still it prevails in India while the Western nations have none of it. There have been various conjectures as to the cause of its peculiar origin and persistence in India. Some of the Hindu social reformers hold that, in the earliest period of Aryan occupation of India, 'adult' marriage was the rule as evidenced by the spirit of the Vedic 'mantras' of the marriage ritual and that in later times of turbulence and wars and foreign Musalman invasions, the practice of pre-puberty marriage of girls was enjoined as a practical measure of safeguarding the chastity of Hindu girls from violation at the hands of the foreigners that dominated the country. They argue further that, in modern times of peace and enlightened Government, the practice should be thoroughly condemned and put a stop to, whatever doubtful justification it might have had in the past. Finally they deny that there can be any religious sanction for early marriages.

Child
marriage.
(i) Intro-
ductory.

147. Turning to the actual state of things in Mysore, as far as can be judged from the Census figures of Imperial Table VII, we find that, in a total population of nearly six millions, the number of married children under five years is 26—9 male and 17 female—besides a single child-widow of the same tender age. Among boys between the ages of 5 and 10 numbering in all nearly 370,000 in the State,

(ii) Gene-
ral review.

Sex and Age	Number per mille unmarried in			
	Mysore	Madras	Bombay	Baroda
Male— 0-5...	1,000	928	922	959
5-10...	1,000	991	965	863
Female— 0-5...	1,000	994	966	915
5-10...	992	846	836	807

90 have wives and 2 are widowers, while among girls of the same ages, one in every 128 is married, and the actual number of widows is 55 which comes to about 1 in 7,000. The marginally noted figures indicate that infant marriage in Mysore is much less common than in either of the adjacent British Provinces or in a Native State like Baroda.

148. In judging of the varying degrees of prevalence of infant marriage among the adherents of different religions as far as Census figures permit, we may as well confine ourselves to a discussion of the civil condition of girls between the ages of 5 and 10: for, as we have already seen, married boys of less than

(iii) By
religion.

10 years as well as child-wives under 5 are too few in numbers to form an adequate basis of comparative study in statistics. Even as regards girls aged from 5 to 10, the total number as well as the number of married ones among Christians, Jains and Animists is so small when compared with the same among Hindus and Musalmans that any inferences based on a comparison of mere proportional figures must be received with some caution. The proportion of unmarried girls aged from 5 to 10 is highest among Christians and lowest among Jains, while Musalmans, Animists and Hindus come between the above two in the order named (*vide* marginal figures). The figures for the next higher age-period

Religion	Number of unmarried girls per mille aged	
	5-10	10-15
Hindu	992	771
Musalman	996	858
Christian	999	933
Jain	991	682
Animistic	995	859

'10-15' are also interesting, as reflecting, however roughly, the varying tendencies of early marriage among the different communities. Arranged according to the magnitude of the proportion of unmarried girls aged from 10 to 15, the different religions stand as follows:—Christian, Animistic, Musalman, Hindu and Jain, *i. e.*, in the same order as was observed in the case of the earlier age-period '5-10' except for an interchange of places between the Animists and Musalmans. The conclusion then seems to be that

early marriage is most common among Jains and least so among Christians, while Animists and Musalmans marry somewhat later in life than Hindus.

(iv) By
Natural
Divisions.

149. The proportion of unmarried girls in each of the age-periods 5-10 and 10-15 is higher in the Western than in the Eastern Division. Viewed by religions also, the same local difference is observed in the case of Hindus, Musalmans and Animists, but among Christians and Jains, girl-wives of the above ages are more common in the Western Division. It is not easy to say how far the greater prevalence of early marriage in the Eastern Division may be due to the earlier age at which girls may attain puberty in the warmer climate of these parts as compared with the hilly tracts of the Western Division.

(v) By
districts.

150. Descending to figures for districts and cities, it will be seen from the following tabular statement that the proportion of unmarried girls, whether in the age-period 5-10 or 10-15 is highest in the Hassan District with Kadur coming next after it.

District or City	Number of unmarried girls per mille aged	
	5-10	10-15
Bangalore City	993	710
Bangalore District	991	731
Kolar Gold Fields (City)	990	817
Kolar District	991	742
Tumkur District	994	772
Mysore City	995	703
Mysore District	990	741
Chitaldrug District.	992	810
Hassan District	996	894
Kadur District	995	869
Shimoga District	990	747
Civil and Military Station, Bangalore	995	841

(vi) Compared
with past
Censuses.

151. On comparing the figures indicating the proportion of unmarried children of less than 10 years of age for the past three Censuses (*vide* margin), it will be found that there has been a steady improvement since 1891 in the discontinuance of infant marriage. Although this satisfactory result reflects a corresponding gradual growth of enlightened ideas among the people during the past two decades, it cannot be denied that the Mysore Infant Marriage Prevention Regulation has been

largely responsible for educating the masses in this respect and bringing about the present improved state of things. A brief summary of the results of the working of this Regulation cannot therefore fail to be of interest in this connection.

Year	Number unmarried per 10,000 aged 0-10	
	Male	Female
1891	9,969	9,740
1901	9,996	9,904
1911	9,999	9,959

152. The Mysore Infant Marriage Prevention Regulation was passed in October 1894 and came into force 6 months later. It applies only to marriages among Hindus. It prohibits not only the marriage of girls under 8 years of age but also the marriage of men who have completed their 50th year of life with girls who have not completed the 14th year. During the past 16 years, *i.e.*, from 1895-96 to 1910-11, the total number of cases prosecuted under the Regulation was 202, of which 175 resulted in the conviction of 475 persons. This works out to an average of 11 cases with 30 persons convicted per year. Such cases were relatively more numerous during the first three years from the commencement of the Regulation and also later on from 1901-02 to 1905-06; but, of late, during the past five years there have been only five or six cases with about 15 persons convicted on an average per year.

(vii) Mysore Infant Marriage Prevention Regulation.

153. It may be interesting to note that a similar piece of legislation was enacted in Baroda in 1904, *i.e.*, 10 years after the passing of the corresponding Regulation in Mysore. The age limit of girls was, however, fixed at 12 in Baroda as against 8 in Mysore. But as there was a clause in the Baroda Act authorising the marriage of girls under 12 but over 9 years after obtaining exemptions which were to be granted under certain circumstances, and as such permission is reported to have been accorded in 95 per cent of the cases wherein the same was applied for, we may practically consider 9 as the effective age limit prescribed by legislation. Even then it is a little higher than what is laid down in the Mysore Regulation. We are, however, told that, during a period of 7 years from 1904 to 1910, so many as 23,388 persons were convicted under the Baroda Act while the corresponding figure for Mysore is relatively insignificant. This appears to show that the present piece of legislation in Baroda is much more advanced than in Mysore, and much farther ahead of current notions and practices among the people at large. It has already been pointed out that, as regards early marriage, the recent Census figures are more favourable to Mysore than to Baroda.

(viii) Legislation in Baroda.

154. Let us next consider the statistics of widows. It is notorious that the proportion of widows in India is abnormally large when compared with that obtaining in European countries. The peculiar social conditions of India that are responsible for this result are to be found in the universality of marriage, the prevalence of early marriage and the prohibition of widow marriage. We may confine our present discussion, for the sake of simplicity, to figures relating to widows in the reproductive period of life, *i.e.*, from 15 to 40 years of age; for, not only will these figures faithfully reflect the influence of the above three social factors but they will also be significant as regards economic waste in the community from the standpoint of increase of population.

Prevalence of widowhood.

(i) Introductory.

155. In Mysore, out of every 1,000 females aged from 15 to 40 years, 130 have been returned as widows. Viewed by religions, the proportion of widows at this age-period is lowest among Animists, being only 71 per mille. The figure rises to 91 for Christians, 96 for Musalmans and 133 for Hindus, and finally shoots up to 204 for Jains, among whom widowhood is most common. The above differences, so far as they are determined by social causes, must be due not only to the varying prevalence of infant marriage and enforced widowhood in the different communities, but also to variations in the difference between the ages of husband and wife. Judging by the statistics of unmarried girls between 5 and 10 years of age, we have already seen that the main religions stand in the following order with regard to the prevalence of child marriage:—Jain, Hindu, Animistic, Musalman and Christian. As for ascertaining the average difference in the ages

(ii) By religion.

Religion	Mean age of married		Difference
	Males	Females	
Hindu ...	40.4	29.7	10.7
Musalman ...	40.8	29.9	10.9
Christian ...	39.4	30.4	9.0
Jain ...	39.3	28.0	11.3
Animistic ...	41.1	30.6	10.5

of husband and wife, the only practical method of statistics seems to be to calculate the 'mean age' of husbands and of wives in each religion according to the working rule quoted in para 106 of Chapter V and to take the difference as the average excess of the husband's age over the wife's. The figures thus worked out are shown in the margin and they indicate the greatest disparity in the ages of the married couple among Jains and the least among Christians. Finally as regards enforced widowhood, the recent Census does not afford any materials to determine, even roughly, the relative prevalence of widow marriage in different communities.

It is, however, a matter of common knowledge that such marriages are prohibited among Jains and the 'higher' castes of Hindus. Although the latter constitute but a small portion of the total Hindu population, their example in this respect has also spread among the 'lower' castes, prohibition of widow marriage being commonly viewed by them as a badge of respectability in the social scale. Among Musalmans, Animists and Christians, there is no such prohibition, and the prevalence of polygamy among the first two would naturally result in widow marriage being more frequent than among Christians who are strict monogamists. As between Musalmans and Animists, the ease and facility with which marriages are performed as well as economy of expenditure seem to be on the side of the latter, so that in all likelihood their widows re-enter the portals of matrimony much more freely than their Musalman sisters in similar plight. We may accordingly arrange the different religions as regards the varying degrees of prevalence of widow marriage in the following order:—Animistic, Musalman, Christian, Hindu and Jain. Actual statistics of widow marriage compiled in the Census of 1901 pointed also to the same relative position of these religions in this respect.

(iii) By
Natural
Divisions.

156. A comparison of figures for the two Natural Divisions shows that widows of child-bearing age are more common in the Western Division although infant marriage is more freely resorted to in the other division. The high proportion of widows in the '*malnad*' tracts must be due to the relatively shorter span of life generally enjoyed by people in those parts.

(iv) Com-
pared with
past Cen-
suses.

157. It is satisfactory to note that the proportion of widows of child-bearing age has been steadily declining ever since 1881. In that year, it was so high as 234 per mille owing to the great havoc caused by the disastrous famine of 1876-77. It fell to 152 per mille in 1891 to 139 in 1901 and finally to 130 in 1911. A similar gratifying improvement is also observable in the steady decline of girl-widows (of less than 15 years of age) from 1881 onwards.

Polygamy.

158. It is not safe to base any conclusions regarding the prevalence of polygamy on the mere ratios of married men and women in different localities or communities. For, besides the temporary absence of husbands or wives in other lands which tends to disturb the proportion of the sexes among the married in the enumerated population, the chances of such separation of the married couple are relatively greater in a country like India where girls are as a rule married before they attain puberty and do not immediately join their husbands, but continue to remain with their parents for a few more years till they reach womanhood. Bearing this in mind, let us examine the figures contained in Subsidiary Table IV. In the total population of the State, we find that for every 1,000 married males, there are 1,007 married females. If there were no married pair separated from each other by the boundary line of the State on the Census night and if no husband had more than two wives, the above figures would indicate that the proportion of married men indulging in a double dose of matrimony is 7 per mille. But as the proviso is merely theoretical, the conclusion is likewise of no practical interest. If we examine the figures for the main religions, we find the proportion of wives to husbands to be highest among Animists who possess 1,042 married females for every 1,000 married males. The proportion among Hindus is considerably lower, being only 1,012 per mille. While there is thus an excess of wives over husbands in the enumerated population among Hindus and Animists, there is an actual shortage of wives among Musalmans, Christians and Jains. The latter result is to be attributed to migration which, as already mentioned in para 126 of Chapter VI, has considerably lowered the general proportion of females in these three communities.

It is refreshing, after a discussion of nebulous figures like the above, to turn

Religion	Number of married females per 1,000 married males.	Number of polygamists per 1,000 married males
ALL RELIGIONS ...	1,031	18
Hindu ...	1,036	18
Musalman ...	964	20
Christian ...	823	2
Jain ...	980	11
Animistic ...	1,037	29

to actual statistics of polygamy which, like those relating to the marriage of widows, were specially compiled in the State at the previous Census and which should prove of great value and interest to the student of sociology. The marginal figures which speak for themselves have been reproduced

from the tabular statement printed on page 231 of the Mysore Census Report of 1901, while the following extract is also from the same report:—

“ there is no denying that polygamy exists in India. It is allowed in all classes except the Christians, but under restrictions which render it rare. Among the higher castes of the Hindus, a second wife is permitted, not as a luxury, at the mere caprice of the husband, but only when the existing wife, proves barren or is afflicted with some loathsome incurable disease or is guilty of immoral conduct.

How much polygamy is discouraged though sanctioned among the Brahmans may be judged from the fact that the first wife alone, except when cast off for immoral conduct, is entitled to join the husband in religious ceremonies and that the second or subsequent wife has no status here unless with the acquiescence and consent of the first wife.”

159. Polyandry is unknown in Mysore.

Polyandry

160. Let us next examine the statistics of civil condition with regard to different castes. The figures are given in Subsidiary Table V for 28 selected castes. The proportion of married girls between the ages of 5 and 12 is so high as 95 per mille among Brahmans who are closely followed by Vaisyas with 85 per mille. In both these castes girls are, as a rule, married before attaining maturity. The Mahrattas, Kumbaras, Nayindas and Ganigas have also a considerable proportion of young married girls, although they come a long way behind the Brahmans and Vaisyas. Early marriage seems to be least common among the Indian Christians who have only 6 married girls out of every 1,000 in the age-period 5-12.

Marriage by caste.

If the proportion of widows between the ages of 20 and 40 be considered, the Brahmans again top the list with the Vaisyas closely competing with them for the first place. The prohibition of widow marriage is mainly responsible for the large proportion of widows in both these castes. On the other hand, widows are not half so numerous among the Madigas, Voddas and Lambanis owing to the fact that widow marriage is very freely practised in these castes.

161. Before concluding this chapter, a brief reference may be made to some of the interesting marriage customs in vogue among the different castes in this part of the country.

Marriage customs.

(a) The woman who remains unmarried in life is usually viewed askance in Hindu society. She cannot take any prominent part in domestic or social functions. At her death, funeral ceremonies are not gone through with the usual formality among a few castes, *e.g.*, Agasa and Meda, while the Beda caste does not in such a case perform any obsequies at all, the dead body being simply carried without the usual bier and interred with the face downwards.

Unmarried women.

(b) The practice of dedicating girls to temples or as public women (styled as *Basavi*) obtains in a few of the 'lower' castes, but it is gradually getting into disfavour. Among Kurubas when there are no sons in a family, the eldest girl is occasionally so dedicated. In the Beda caste, the ceremony of dedication as 'Basavi' resembles that of a regular marriage. The girl is taken in procession to a temple and is there seated by the side of a dagger, the 'tali' being tied to her by the 'purohit' or by a maternal uncle's son. Her children are considered legitimate. Among Voddas, if an adult female cannot get any one to marry her, she may be dedicated to a free life in the name of Yellamma who is their patron deity.

Public women.

(c) Although the bride must, as a rule, be younger than the bridegroom, exceptions are allowed in Tigala, Kadugolla and Koracha castes. In the last caste, there is a special obligation for a man marrying his sister's daughter, even though older than himself. Among Holeyas and Mondaru, the bride may be older if she is already a widow.

Relative ages of bride and bridegroom.

(d) It is only among Brahmans and rarely in a few other castes that the practice of paying for the bridegroom prevails in varying degrees. Of late, the price of the bridegroom has gone up considerably, the amount varying with the property or the University qualifications of the boy. Barring this practice which is of comparatively recent growth and which exists only among a small fraction of the total

Bride-price.

population, the general rule is for the bride to be paid for. The bride-price varies from a nominal amount of a rupee or two as among Tigalas to 50 or even 100 rupees as in the Dombar or Koracha castes. The practice is, however, modified under rare circumstances, *e.g.*, among Idigas if two families exchange brides, when the bride-price is paid by neither, or in the Meda caste if a girl is married to her maternal uncle, when the amount is either reduced or excused altogether. Again, as a general rule, a widow is paid only half the amount that would go to a virgin bride. So also a widower has to pay more than a bachelor except in a few castes like Koracha and Nayinda.

- Polygamy. (e) Among Bestas, the first wife's sister is generally preferred as a second wife.
- Endogamy. (f) Endogamous groups of the 'functional' or 'occupational' type are found in a few castes like Sannyasi and Besta. Among Bestas, there will be no intermarriage between families engaged in different occupations, *viz.*, agriculture, fishing and palanquin-bearing.
- Hypergamy. (g) Instances of hypergamous divisions are very rare in Mysore. In the Madiga caste, the 'Jambavas' who form the priestly division of the caste do not allow their women to be married into other divisions.
- Exogamy and prohibited degrees. (h) Exogamous divisions occur in most of the Hindu castes. The 'gotra' of Brahmans belongs to the *eponymous* type of such divisions. The *totemistic* type is met with among several castes, *e.g.*, Madiga, Banajiga, Kumbara, etc.
- A man is generally prohibited from marrying his mother's sister's daughter or his younger sister's daughter. Among Korachas, however, a widower is allowed to marry his younger sister's daughter. In Koracha, Komati and Nayinda castes, one cannot marry in the section to which one's maternal grandmother belongs. Among Komatis, the 'gotras' of the maternal uncles of the bride and of the bridegroom should not be the same.
- Cousin marriage. (i) In the Komati (Vaisya) caste, there is a moral obligation for a boy being married to his maternal uncle's daughter.
- Marriage by capture. (j) Among Lambanis, the women weep on marriage occasions, which is perhaps a relic of 'marriage by capture.'
- Interval between marriage and consummation. (k) In the case of marriage of a young girl, she continues to stay with her parents till she attains puberty. Afterwards, she is formally taken to the husband's house where they live together. In case the girl has already attained womanhood at the time of marriage, consummation also takes place generally at the same time. In the Agasa caste there must, however, be an interval of 15 days between marriage and consummation, while the Kurubas go further and insist on an interval of three months as they consider it inauspicious that a child should be born within a year of the marriage.
- Marriage of widows. (l) The marriage of widows is prohibited only among Brahmans and in a very few other castes. Among the rest, such marriages are allowed. In a few castes like Besta and Uppara, a fine has to be paid for the benefit of the caste people if a man marries a widow. A widow is not generally allowed to marry any of her late husband's brothers. But among Bestas, she is permitted to marry her late husband's elder brother on payment of an additional fine. Sometimes the restriction extends to all the agnatic relations of the late husband as in the Uppara caste, and even to all belonging to her father's division as in the Bilimagga and Sannyasi castes. Among Madigas and Idigas, a bachelor cannot marry a widow, while in a few other castes he can do so only after undergoing the formality of a first marriage with an 'ekka' (*calotropis gigantea*) plant.

Terms of relationship. 162. A list of Kanarese terms of relationship with their English equivalents is printed after Subsidiary Table V of this chapter.

SUBSIDIARY TABLES.

I.—DISTRIBUTION BY CIVIL CONDITION OF 1,000 OF EACH SEX, RELIGION AND MAIN AGE-PERIOD AT EACH OF THE LAST FOUR CENSUSES.

Religion, sex and age		UNMARRIED				MARRIED				WIDOWED				
		1911	1901	1891	1881	1911	1901	1891	1881	1911	1901	1891	1881	
1		2	3	4	5	6	7	8	9	10	11	12	13	
All religions	Males.													
	0-5	1,000	1,000	1,000	997	8	
	5-10	1,000	999	998	997	...	1	2	3	
	10-15	935	931	976	971	5	19	24	28	1	
	15-20	914	865	848	866	85	132	150	128	1	2	2	6	
	20-40	282	271	284	290	690	692	685	646	28	37	31	64	
	40-60	38	40	40	35	642	816	829	796	120	142	131	170	
	60 and over	24	21	23	23	679	677	664	629	297	302	313	349	
	Females.													
	0-5	1,000	929	999	975	...	1	1	24	1	
	5-10	992	938	948	975	6	17	51	1	...	
	10-15	777	750	664	721	218	243	328	260	5	7	8	19	
	15-20	223	224	159	232	746	742	810	694	31	34	31	74	
	20-40	30	37	33	35	811	600	786	690	159	163	181	274	
40-60	15	14	18	15	450	475	373	299	535	511	609	686		
60 and over	11	13	11	9	117	161	118	75	871	826	872	916		
Hindu	Males.													
	0-5	1,000	1,000	1,000	997	8	
	5-10	1,000	999	995	997	...	1	2	3	
	10-15	935	931	976	970	5	19	24	29	1	
	15-20	911	862	844	868	88	136	154	131	1	2	2	6	
	20-40	279	269	260	266	693	693	688	649	28	33	32	65	
	40-60	39	40	40	35	839	815	827	792	122	145	133	173	
	60 and over	25	21	22	21	674	673	659	623	301	306	319	356	
	Females.													
	0-5	1,000	999	999	974	...	1	1	25	1	
	5-10	992	932	946	974	8	18	53	1	...	
	10-15	771	744	657	716	224	249	335	265	5	7	8	19	
	15-20	230	219	157	231	748	746	811	693	32	35	32	76	
	20-40	30	37	32	35	808	797	784	666	162	166	184	273	
40-60	16	14	18	15	445	473	370	296	539	513	612	669		
60 and over	11	13	11	9	115	161	117	74	874	826	872	917		
Muselman	Males.													
	0-5	1,000	1,000	1,000	998	3	
	5-10	1,000	999	997	998	...	1	3	3	
	10-15	996	934	965	984	4	15	15	15	...	1	...	1	
	15-20	942	914	899	926	57	84	99	71	1	2	2	3	
	20-40	302	287	313	322	675	681	656	630	23	32	22	38	
	40-60	23	33	41	39	895	972	876	854	82	95	83	107	
	60 and over	17	22	36	28	746	738	748	711	237	240	216	258	
	Females.													
	0-5	1,000	999	999	991	...	1	1	9	
	5-10	936	938	930	991	4	8	19	1	...	
	10-15	653	808	753	805	140	185	244	188	2	7	4	7	
	15-20	212	221	143	200	766	752	837	737	22	24	20	43	
	20-40	20	25	25	21	861	654	847	773	119	121	128	207	
40-60	7	7	11	9	502	509	435	338	421	484	554	653		
60 and over	7	8	6	6	144	161	132	86	849	831	862	908		

I.—DISTRIBUTION BY CIVIL CONDITION OF 1,000 OF EACH SEX, ETC.—*concl'd.*

Religion, sex and age		UNMARRIED				MARRIED				WIDOWED				
		1911	1901	1891	1881	1911	1901	1891	1881	1911	1901	1891	1881	
1		2	3	4	5	6	7	8	9	10	11	12	13	
Christian	Malea.													
	0-5	1,000	1,000	999	999	1	1	...	
	5-10	999	999	998	998	1	1	1	1	1	...	
	10-15	995	996	990	993	5	4	10	7	
	15-20	969	967	967	963	30	41	58	45	1	2	5	2	
	20-40	439	359	467	466	543	611	512	491	18	30	21	24	
	40-60	46	58	65	54	864	842	841	846	90	100	94	100	
	60 and over	46	43	39	12	673	694	706	709	281	263	255	279	
	Femalen.													
	0-5	1,000	999	997	998	...	1	2	2	1	...	
	5-10	999	993	996	996	1	6	5	2	...	1	
	10-15	933	923	909	941	66	75	90	57	1	2	1	2	
	15-20	489	545	459	510	493	432	519	464	18	23	22	26	
	20-40	138	123	137	102	747	747	735	732	115	130	128	166	
40-60	64	52	45	24	459	496	445	383	477	452	510	598		
60 and over	31	48	21	15	145	137	165	107	824	815	814	878		
Jain	Malea.													
	0-5	1,000	1,000	1,000	
	5-10	1,000	990	995	...	10	4	1	...		
	10-15	966	981	976	...	14	19	24		
	15-20	919	887	888	...	80	108	108	1	5	4	...		
	20-40	353	369	396	...	600	577	556	47	54	48	...		
	40-60	87	93	65	...	730	701	713	183	206	202	...		
	60 and over	52	54	66	...	576	553	529	372	393	405	...		
	Femalen.													
	0-5	1,000	1,000	999	1	
	5-10	991	957	964	...	9	42	43	...	1	3	...		
	10-15	682	635	638	...	311	343	347	7	22	15	...		
	15-20	132	131	137	...	804	809	820	64	60	43	...		
	20-40	15	16	12	...	786	733	726	249	251	262	...		
40-60	3	3	9	...	344	344	302	653	653	689	...			
60 and over	2	2	7	...	93	94	74	205	204	219	...			
Animistic	Malea.													
	0-5	1,000	1,000	
	5-10	999	999	1	1		
	10-15	992	985	8	15		
	15-20	930	860	69	117	...	1	3	...			
	20-40	274	261	699	704	...	27	35	...			
	40-60	24	26	874	848	...	102	126	...			
	60 and over	14	13	714	705	...	272	264	...			
	Femalen.													
	0-5	1,000	998	2		
	5-10	995	980	5	19	1	...			
	10-15	859	844	137	154	...	4	2	...			
	15-20	287	306	701	577	...	12	17	...			
	20-40	24	23	868	876	...	88	101	...			
40-60	9	10	571	572	...	420	418	...				
60 and over	10	5	171	192	...	819	803	...				

NOTE.—Figures are not available for 1881 in the case of Jain and for 1881 and 1891 in the case of Animistic religion.

II.—DISTRIBUTION BY CIVIL CONDITION OF 1,000 OF EACH SEX AT CERTAIN AGES IN EACH RELIGION AND NATURAL DIVISION.

Religion and Natural Division	MALES																	
	All ages			0-5			5-10			10-15			15-20			20 and over		
	Unmarried	Married	Widowed	Unmarried	Married	Widowed	Unmarried	Married	Widowed	Unmarried	Married	Widowed	Unmarried	Married	Widowed	Unmarried	Married	Widowed
1	2	3	4	5	6	7	8	9	10	11	12	13	14	15	16	17	18	19
Mysore State, including Civil and Military Station, Bangalore—																		
All religions	844	409	48	1,000	1,000	995	5	...	491	547	22	94	803	164
Hindu	542	409	49	1,000	1,000	995	5	...	498	550	22	95	799	166
Musalman	567	399	34	1,000	1,000	996	4	...	462	530	18	22	855	123
Christian	605	364	31	1,000	999	1	...	996	5	...	544	449	14	48	926	138
Jain	553	377	70	1,000	1,000	996	14	...	496	478	36	79	693	228
Animistic	559	399	42	1,000	999	1	...	993	8	...	423	551	21	22	833	145
Mysore State, excluding Civil and Military Station, Bangalore—																		
All religions	544	408	48	1,000	1,000	995	5	...	481	547	22	94	803	164
Hindu	542	409	49	1,000	1,000	995	5	...	429	549	22	25	799	166
Musalman	569	397	34	1,000	1,000	995	4	...	452	531	17	23	855	123
Christian	568	401	31	1,000	999	1	...	993	7	...	448	496	16	37	841	132
Jain	553	377	70	1,000	1,000	997	15	...	488	478	35	78	694	228
Animistic	560	398	42	1,000	999	1	...	993	7	...	429	550	21	22	833	146
Eastern Division—																		
All religions	595	419	46	1,000	1,000	995	5	...	420	562	18	22	813	155
Hindu	538	420	47	1,000	1,000	995	5	...	417	554	19	23	811	157
Musalman	565	402	33	1,000	999	1	...	997	3	...	442	543	15	19	862	119
Christian	582	387	31	1,000	999	1	...	992	8	...	445	500	15	31	841	138
Jain	540	392	66	1,000	1,000	997	15	...	479	495	25	75	710	215
Animistic	543	417	40	1,000	999	1	...	991	9	...	416	566	18	23	843	134
Western Division—																		
All religions	569	378	53	1,000	1,000	995	5	...	460	510	20	44	793	194
Hindu	568	378	54	1,000	1,000	995	5	...	458	511	31	45	757	198
Musalman	578	384	37	1,000	1,000	995	5	...	452	495	22	29	837	194
Christian	585	434	31	1,000	1,000	993	7	...	494	468	18	49	844	107
Jain	573	352	75	1,000	1,000	998	12	...	496	454	50	26	655	299
Animistic	590	365	45	1,000	1,000	994	6	...	458	522	25	20	809	171
FEMALES																		
Religion and Natural Division	FEMALES																	
	All ages			0-5			5-10			10-15			15-20			20 and over		
	Unmarried	Married	Widowed	Unmarried	Married	Widowed	Unmarried	Married	Widowed	Unmarried	Married	Widowed	Unmarried	Married	Widowed	Unmarried	Married	Widowed
20	21	22	23	24	25	26	27	28	29	30	31	32	33	34	35	36	37	
Mysore State, including Civil and Military Station, Bangalore—																		
All religions	385	420	195	1,000	993	8	...	777	218	5	74	796	130	14	890	625
Hindu	382	420	198	1,000	993	8	...	771	224	5	73	794	133	14	857	629
Musalman	423	420	157	1,000	996	4	...	858	140	2	66	838	96	7	403	841
Christian	469	371	140	1,000	999	1	...	935	66	1	227	648	91	56	346	556
Jain	334	406	260	1,000	991	9	...	842	311	7	44	752	204	3	276	722
Animistic	428	437	145	1,000	985	6	...	859	137	4	84	845	71	9	469	522
Mysore State, excluding Civil and Military Station, Bangalore—																		
All religions	385	420	195	1,000	992	8	...	777	218	5	73	797	130	14	890	626
Hindu	382	420	198	1,000	992	8	...	771	224	5	73	794	133	14	857	629
Musalman	425	418	157	1,000	995	4	...	853	139	2	65	836	96	7	405	847
Christian	474	397	129	1,000	998	2	...	920	79	1	171	741	88	34	408	558
Jain	333	405	262	1,000	991	9	...	842	311	7	43	751	205	3	276	723
Animistic	428	437	145	1,000	985	6	...	859	136	4	84	845	71	9	469	522
Eastern Division—																		
All religions	377	433	190	1,000	992	8	...	754	241	5	63	820	117	13	379	609
Hindu	373	434	193	1,000	991	8	...	747	248	5	62	818	120	13	375	613
Musalman	424	425	151	1,000	995	4	...	852	145	2	62	851	95	7	428	567
Christian	477	400	123	1,000	998	2	...	924	71	1	163	752	66	28	422	542
Jain	329	420	251	1,000	992	8	...	894	295	6	34	796	171	3	304	693
Animistic	409	454	136	1,000	994	6	...	828	179	3	74	859	67	9	461	540
Western Division—																		
All religions	408	392	209	1,000	994	6	...	836	157	5	108	730	167	21	395	648
Hindu	407	391	213	1,000	993	7	...	834	160	5	108	727	170	22	295	656
Musalman	425	397	178	1,000	995	4	...	879	119	2	75	796	130	9	345	606
Christian	468	387	145	1,000	996	4	...	899	99	2	199	705	97	26	354	606
Jain	341	378	291	1,000	999	11	...	660	325	5	58	677	255	3	308	735
Animistic	465	402	138	1,000	997	3	...	849	64	6	108	819	73	9	419	572

III.—DISTRIBUTION BY MAIN AGE-PERIODS AND CIVIL CONDITION OF 10,000 OF EACH SEX AND RELIGION.

Religion and age	Males			Females		
	Unmarried	Married	Widowed	Unmarried	Married	Widowed
1	2	3	4	5	6	7
All religions.						
All ages	5,443	4,060	477	3,853	4,199	1,948
0-10	2,410	2,592	10
10-15	1,951	6	951	266	6
15-40	1,700	2,157	85	289	3,097	506
40 and over	68	1,917	392	32	826	1,436
Hindu.						
0-10	2,399	2,556	11
10-15	1,952	6	944	274	6
15-40	1,684	2,162	86	283	3,092	517
40 and over	85	1,925	401	33	826	1,458
Musalman.						
0-10	2,591	1	2,953	7
10-15	1,947	5	1,007	164	3
15-40	1,792	2,105	72	252	3,207	367
40 and over	48	1,878	271	15	821	1,204
Christian.						
0-10	2,307	1	2,701	2
10-15	1,094	6	1,114	78	1
15-40	2,565	2,092	67	973	2,990	390
40 and over	86	1,551	241	102	702	1,007
Jain.						
0-10	2,080	2,331	11
10-15	1,162	16	829	379	8
15-40	2,146	2,116	161	174	2,990	812
40 and over	186	1,643	540	6	680	1,780
Animistic.						
0-10	2,646	1	2,869	8
10-15	1,334	10	1,073	171	5
15-40	1,563	2,016	76	320	3,224	271
40 and over	51	1,961	342	19	965	1,076

IV.—PROPORTION OF THE SEXES BY CIVIL CONDITION AT CERTAIN AGES FOR RELIGIONS AND NATURAL DIVISIONS.

Natural Division and religion	Number of females per 1,000 males														
	All ages			0-10			10-15			15-40			40 and over		
	Unmarried	Married	Widowed	Unmarried	Married	Widowed	Unmarried	Married	Widowed	Unmarried	Married	Widowed	Unmarried	Married	Widowed
1	2	3	4	5	6	7	8	9	10	11	12	13	14	15	16
Mysore State, including C. & M. Station, Bangalore—															
All religions	693	1,007	3,995	1,049	30,343	28,000	744	43,107	59,643	166	1,405	5,794	382	422	3,589
Hindu	694	1,012	4,005	1,051	34,458	54,000	743	44,942	61,769	166	1,409	5,899	381	423	3,582
Musalman	669	944	4,119	1,025	11,333	724	30,500	19,000	126	1,365	4,599	282	392	3,966
Christian	710	896	3,990	1,029	1,667	894	11,522	333	1,237	5,107	1,040	397	3,674
Jain	530	944	3,255	1,807	626	20,800	71	1,240	4,430	29	363	2,992
Animistic	728	1,042	3,070	1,031	7,000	765	15,868	195	1,522	3,391	349	468	2,968
Mysore State, excluding C. & M. Station, Bangalore—															
All religions	691	1,007	3,996	1,049	30,347	28,000	743	43,160	58,964	164	1,407	5,817	377	422	3,587
Hindu	694	1,012	4,006	1,051	34,193	54,000	743	44,935	61,269	166	1,411	5,912	382	423	3,583
Musalman	670	946	4,177	1,025	10,444	725	29,947	16,500	126	1,367	4,794	275	398	4,014
Christian	690	816	3,394	1,036	2,500	904	10,294	263	1,118	4,147	636	333	3,150
Jain	534	949	3,286	1,009	631	22,071	70	1,257	4,597	29	362	2,897
Animistic	728	1,043	3,063	1,031	7,000	765	16,135	195	1,525	3,405	349	468	2,977
Eastern Division—															
All religions	694	1,020	4,081	1,048	32,699	19,000	730	46,965	64,278	148	1,444	6,316	350	435	3,668
Hindu	695	1,024	4,091	1,050	39,345	38,000	718	48,628	65,706	148	1,447	6,424	351	436	3,665
Musalman	681	962	4,183	1,014	8,333	726	36,160	27,000	127	1,399	4,946	286	417	4,010
Christian	732	923	3,520	1,045	1,540	896	8,769	288	1,293	5,000	846	372	3,129
Jain	538	978	3,400	1,029	644	20,667	59	1,361	5,492	34	397	2,948
Animistic	724	1,050	3,256	1,033	5,500	747	19,000	180	1,529	3,792	346	491	3,148
Western Division—															
All religions	689	967	3,780	1,053	23,480	806	32,232	49,400	209	1,300	5,032	448	371	3,356
Hindu	693	975	3,791	1,054	22,240	810	34,022	52,339	208	1,305	5,109	451	374	3,348
Musalman	637	892	4,160	1,062	732	18,000	6,000	124	1,271	4,507	256	328	4,086
Christian	694	995	3,103	1,007	927	15,250	217	780	2,862	333	247	3,209
Jain	495	894	3,107	971	610	24,640	86	1,091	3,901	18	275	2,723
Animistic	734	1,028	2,750	1,026	796	9,364	220	1,517	2,928	358	415	2,683

V.—DISTRIBUTION BY CIVIL CONDITION OF 1,000 OF EACH SEX AT CERTAIN AGES FOR SELECTED CASTES.

Caste	Distribution of 1,000 males of each age by civil condition																	
	All ages			0-5			5-12			12-20			20-40			40 and over		
	Unmarried	Married	Widowed	Unmarried	Married	Widowed	Unmarried	Married	Widowed	Unmarried	Married	Widowed	Unmarried	Married	Widowed	Unmarried	Married	Widowed
1	2	3	4	5	6	7	8	9	10	11	12	13	14	15	16	17	18	19
Agasa	535	417	48	1,000	999	1	...	941	58	1	951	719	80	95	810	165
Banajiga	528	414	58	1,000	1,000	955	44	1	929	677	31	48	770	187
Beda	559	397	54	1,000	999	1	...	956	43	1	931	642	27	52	763	185
Besta	537	419	44	1,000	999	1	...	948	56	1	947	725	27	29	821	150
Brahman	469	442	69	1,000	999	1	...	891	117	2	174	737	29	51	720	229
Ganiga	629	426	45	1,000	1,000	941	59	...	943	733	24	27	819	154
Golla	551	396	53	1,000	1,000	957	42	1	954	620	25	41	789	170
Holeya	551	405	44	1,000	999	1	...	958	41	1	908	664	28	26	814	150
Idiga	565	392	43	1,000	999	1	...	948	51	1	925	645	29	29	815	146
Kshatriya	542	406	52	1,000	999	1	...	950	49	1	928	680	32	41	781	178
Kumbara	518	428	44	1,000	999	1	...	919	80	1	921	740	29	25	826	147
Kuruba	635	418	47	1,000	999	1	...	942	57	1	950	723	27	25	816	159
Lingayat	552	391	57	1,000	1,000	959	40	1	924	675	31	44	758	198
Madiga	559	402	39	1,000	999	1	...	946	51	1	921	692	21	26	822	140
Mahratta	533	414	58	1,000	999	1	...	943	55	2	921	682	37	40	784	176
Nayinda	511	428	51	1,000	1,000	931	69	...	928	742	30	27	809	164
Neygi	524	415	61	1,000	999	1	...	937	62	1	922	744	34	31	761	208
Panchala	536	412	51	1,000	999	1	...	952	47	1	920	658	32	28	790	172
Tigala	546	409	45	1,000	999	1	...	959	40	1	973	704	24	24	820	156
Uppara	554	400	46	1,000	999	1	...	950	49	1	926	695	28	25	811	163
Vaiya	495	424	71	1,000	999	1	...	876	123	1	902	765	28	55	708	226
Vakkaliga	540	416	44	1,000	999	1	...	951	48	1	970	704	26	27	825	148
Vodda	542	415	43	1,000	999	1	...	949	50	1	959	703	28	24	824	142
Pathan	574	391	35	1,000	1,000	959	31	...	925	692	22	20	851	129
Saiyd	573	392	36	1,000	999	1	...	955	34	1	902	671	27	24	854	122
Sheikh	567	394	35	1,000	1,000	966	33	1	921	695	24	21	754	125
Indian Christian	574	393	33	1,000	999	1	...	977	23	...	909	668	23	25	843	131
Lambani	589	374	37	1,000	999	1	...	957	33	...	928	687	25	22	837	141

Caste	Distribution of 1,000 females of each age by civil condition																	
	All ages			0-5			5-12			12-20			20-40			40 and over		
	Unmarried	Married	Widowed	Unmarried	Married	Widowed	Unmarried	Married	Widowed	Unmarried	Married	Widowed	Unmarried	Married	Widowed	Unmarried	Married	Widowed
20	21	22	23	24	25	26	27	28	29	30	31	32	33	34	35	36	37	
Agasa	375	423	122	1,000	999	1	...	399	561	20	15	829	155	5	355	620
Banajiga	362	420	218	1,000	959	40	1	373	595	27	28	787	175	25	831	644
Beda	411	409	180	1,000	956	33	1	441	543	16	70	779	141	25	855	650
Besta	387	425	188	1,000	961	33	2	425	554	21	44	805	151	25	866	606
Brahman	290	447	263	1,000	908	26	2	54	822	64	3	745	253	...	926	707
Ganiga	360	421	209	1,000	956	45	1	370	607	23	20	817	163	5	357	626
Golla	384	412	204	1,000	969	21	...	453	518	19	20	829	151	8	858	634
Holeya	407	416	177	1,000	975	25	...	516	458	16	55	608	142	22	822	595
Idiga	390	408	202	1,000	965	24	1	466	506	28	22	794	174	11	826	658
Kshatriya	364	412	224	1,000	960	22	1	362	608	30	20	780	200	9	822	659
Kumbara	380	448	177	1,000	950	49	1	378	602	20	17	841	142	4	390	606
Kuruba	371	420	199	1,000	959	40	1	411	571	18	20	820	150	9	354	637
Lingayat	373	398	229	1,000	967	22	1	434	548	22	17	773	211	7	204	629
Madiga	424	418	149	1,000	964	25	1	458	525	17	79	807	114	45	425	522
Mahratta	361	422	211	1,000	945	54	...	316	651	31	20	794	165	5	838	622
Nayinda	358	457	165	1,000	954	45	1	342	630	28	17	845	127	5	405	599
Neygi	373	422	198	1,000	966	24	...	369	604	27	13	805	161	6	375	618
Panchala	371	423	201	1,000	961	28	1	360	612	26	17	804	179	6	351	643
Tigala	400	423	168	1,000	976	24	1	430	552	18	17	857	125	7	405	545
Uppara	405	405	168	1,000	973	25	1	508	473	18	22	805	152	9	370	621
Vaiya	317	457	225	1,000	915	25	...	38	860	57	3	772	225	3	329	662
Vakkaliga	375	422	202	1,000	961	23	1	439	544	17	17	827	155	5	357	638
Vodda	403	447	150	1,000	974	25	1	448	545	14	20	873	108	7	459	534
Pathan	430	416	154	1,000	977	13	...	450	535	15	18	873	110	9	398	593
Saiyd	426	416	158	1,000	926	14	...	455	533	13	21	859	120	5	405	559
Sheikh	419	422	159	1,000	945	15	...	429	555	15	20	858	122	3	402	590
Indian Christian	467	328	150	1,000	924	6	...	545	400	14	22	790	181	23	352	615
Lambani	466	418	119	1,000	928	11	1	600	395	5	24	802	74	9	450	511

LIST OF TERMS OF RELATIONSHIP.

English terms	Kanarese equivalents	English terms	Kanarese equivalents
1	2	1	2
Father	Thande	Wife's brother	Bhávamaida
Mother	Tháyí	Wife's sister	Ná dini
Elder brother	Anna	Husband's brother	Maida
Elder sister	Akka	Husband's sister	Atthige
Father's brother (younger)	Chikkappa	Wife's sister's husband	Shaddaka
Do (elder)	Doddappa	Husband's brother's wife	Váragitthi
Father's younger brother's wife	Chikkamma	Son's wife's parents ...	Bígaru
Father's elder brother's wife	Doddamma	Daughter's husband's parents	Bígaru
Father's brother's son	[Same as for 'brother']	Son	Maga
Do daughter	[Same as for 'sister']	Daughter	Magalu
Father's sister	Sódaratthe	Younger brother	Thamma
Father's sister's husband	Sódaramáva	Younger sister	Thangi
Do son	Bhávamaida	Brother's son (M. S.)	[Same as for 'son']
Do daughter	Ná dini	Do daughter (M. S.)	[Same as for 'daughter']
Mother's brother	Sódaramáva	Husband's brother's son	[Same as for 'son']
Mother's brother's wife	Sódaratthe	Do daughter	[Same as for 'daughter']
Do son	Bhávamaida	Brother's son (W. S.)	Sodaraliya
Do daughter	Ná dini	Brother's daughter (W. S.)	Sódarasose
Mother's sister (younger)	Chikkamma	Sister's son (M. S.) ...	Sódaraliya
Do (elder)	Doddamma	Sister's daughter (M. S.)	Sódarasose
Mother's younger sister's husband	Chikkappa	Sister's son (W. S.) ...	[Same as for 'son']
Mother's elder sister's husband	Doddappa	Sister's daughter (W. S.)	[Same as for 'daughter']
Mother's sister's son	[Same as for 'brother']	Wife's sister's son ...	[Same as for 'son']
Do daughter	[Same as for 'sister']	Do daughter	[Same as for 'daughter']
Father's father	Thátha	Son's son	Mominaga
Father's mother	Avva, ajji or hetthamma	Daughter's son	Mommaga
Mother's father	Thátha	Wife	Hendathi
Mother's mother	Avva, ajji or hetthamma	Daughter's husband ...	Aliya
Husband	Ganda	Son's wife	Soe
Wife's father	Máva	Elder sister's husband	Bhá va
Wife's mother	Atthe	Younger sister's husband	Bhávamaida
Husband's father	Máva	Brother's wife	Atthige
Husband's mother	Atthe		

M. S. stands for 'man speaking,' and W. S. for 'woman speaking.'

CHAPTER VIII.

EDUCATION.

163. The scope of this chapter is much more limited than what the general reader may naturally expect from the comprehensive nature of its heading. The information recorded on the Census Schedule as regards a person's educational attainments was merely confined to literacy, *i.e.*, ability both to read and write. If a person was literate in one or more languages, the names of these languages were also recorded. The statistics compiled from such entries are contained in Imperial Tables VIII and IX. In the former, the literate population is distributed by age, sex and religion, while the latter exhibits similar details for the several castes, tribes and races. Besides the figures to be found in these two tables which will form the main basis of discussion in the course of this chapter, a passing reference will also be made to such departmental statistics as may throw light on the progress of education in general. The salient features of all the abovementioned statistics have been brought out in the following Subsidiary Tables printed at the end of the chapter:—

Reference to statistics.

- (i) Education by age, sex and religion.
- (ii) Education by age, sex and locality.
- (iii) Education by religion, sex and locality.
- (iv) English education by age, sex and locality.
- (v) Progress of education since 1881.
- (vi) Education by caste.
- (vii) Number of institutions and pupils according to the returns of the Education Department.
- (viii) Main results of University examinations.
- (ix) Number and circulation of newspapers and periodicals.
- (x) Number of books published in each language.

164. Taking the whole population of the State, only 1 in every 16 persons can read and write. Among males, 1 in every 9 is literate, while among females it is only 1 in 77. The proportion of the literate among males less than 10 years of age is 19 per mille; and it increases to 103 per mille at the age-period '10-15', to 137 at '15-20' and finally to 152 at '20 and over.' There is a similar rise in the proportion of literate females from 5 per mille at '0-10' to 20 at '10-15' and to 24 at '15-20', but it drops down to 13 per mille for higher ages. The varying proportions at different age-periods will be discussed later on.

General review.

165. Of the two Natural Divisions, the Western Division is more advanced

Diagram showing the number of literate persons per 1,000 of each sex in each Natural Division.

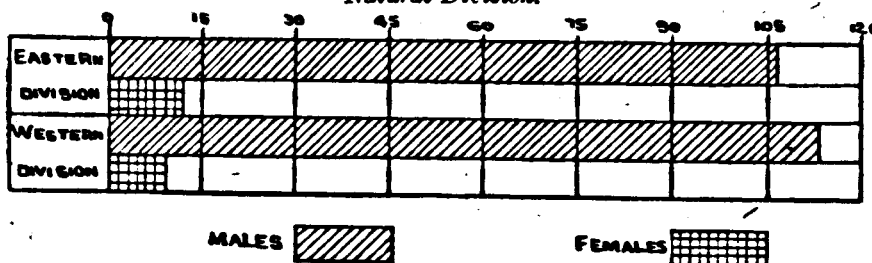

in respect of literacy, containing 62 literate persons in every thousand as against 59 in the other division. On examining the figures for

by locality. (i) Natural Divisions.

each sex, however, it is found that the superiority of the Western Division is maintained only in the case of males, and that as regards females it is more backward than the Eastern Division. The relative position of the two divisions is graphically indicated in the above diagram.

166. In discussing the relative prevalence of literacy in the several districts, we may as well exclude the cities for the present and consider the figures for districts as shown in Subsidiary Table II. Of the eight districts, Kadur easily holds the first place with a proportion of 70 literate persons per mille. Then comes Shimoga followed in order by Tumkur, Chitaldrug, Kolar (excluding Kolar

(ii) Districts.

Gold Fields), Hassan and Bangalore (excluding Bangalore City) with proportions varying from 64 to 53 per mille, while, a long way behind, Mysore comes last with not even 4 persons literate in every 100. It is not easy to determine the exact nature of the causes which account for the above variations by district. A brief reference may, however, be made to a few of the more important features affecting the result. Owing to the greater prevalence of literacy among Christians as compared with Hindus or Musalmans, the varying proportions of Christian population in different districts will affect their relative position in the scale of literacy. So also a high or low proportion of immigrants in a district will tend to raise or lower its position as the proportion of literate persons is generally larger among immigrants than in the rest of the population. Again, the nature of the occupations pursued by the people is also a factor to be reckoned with. The capacity to read and write is not in equal demand in occupations of all kinds and agriculture in its present state is comparatively in little need of such a qualification, so that a high percentage of agricultural population in a district tends to lower its position in respect of literacy. Finally, there is

District	Number per 10,000 of Christians	Number per mille of immigrants	Number per mille of persons supported by agriculture	Percentage of villages provided with schools
Bangalore ...	76	67	762	17.9
Kolar ...	44	102	729	12.4
Tumkur ...	22	67	769	22.3
Mysore ...	12	18	800	24.1
Chitaldrug ...	4	89	715	27.1
Hassan ...	66	62	801	20.3
Kadur ...	134	162	717	23.8
Shimoga ...	49	104	740	19.4

the spread of primary education to be taken into account. The varying facilities for such education in different districts may be roughly gauged by the proportion of villages equipped with schools in each district. The tabular statement in the margin will elucidate the relative position of the several districts with reference to each of the four aspects mentioned above. It is not possible to go into a minute discussion of all the figures contained in the statement or

to determine the relative influence of each of the four factors referred to therein.

As regards literacy among males, Kadur District once more stands first with

MAP OF MYSORE.

Showing the number of literate males per mille in each district.

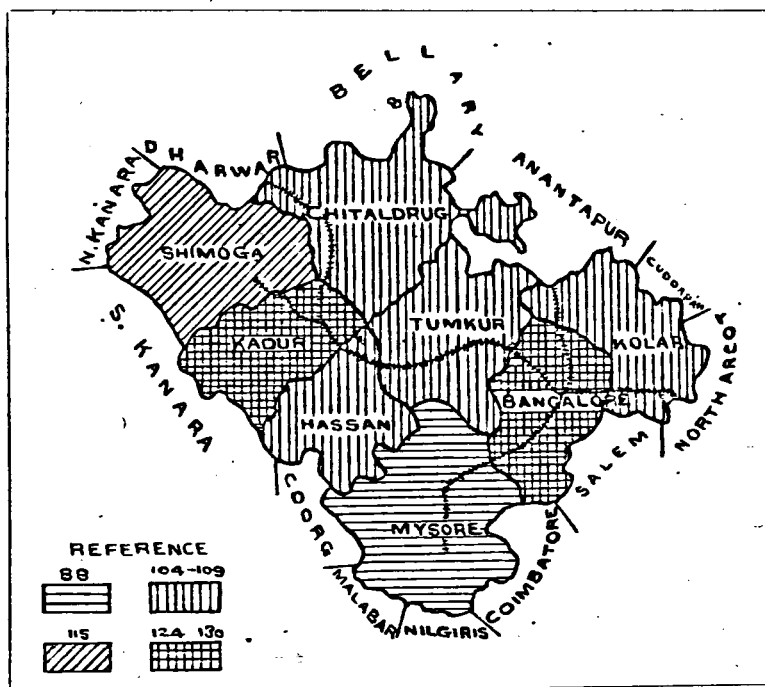

1 literate male in every 8 and Mysore District (excluding Mysore City) comes last with only 1 in 14. The varying degrees of literacy in the several districts are indicated in the marginal map with the cities of Bangalore, Kolar Gold Fields and Mysore included in the respective districts. On comparing this map with the one showing the density of population in each district (*vide* page 5), it is clear that, except for Bangalore District, there is no connection between literacy and density, or if at all, it looks as if

the prevalence of literacy generally varies inversely as the density of population.

The prevalence of literacy among females is very poor when compared with that among males. Even the highest proportion of literate females in any district comes up only to 11 per mille, and this occurs in the Kadur District, while at the other end of the scale Mysore District (excluding Mysore City) exhibits the very meagre proportion of 5 per mille.

167. The inhabitants of cities are, for obvious reasons, far more educated (iii) Cities. than those of rural parts, and we accordingly find that, in the total population of the four cities in the State, 352 males and 101 females per mille can read and write as against 112 males and 13 females in the State as a whole. Of the four cities, Bangalore City contains the highest proportion of literate males, while the lowest is found in Kolar Gold Fields which has none of the advantages of being a seat of learning or of Government or the headquarters of an administrative division. As regards literacy among females, the Civil and Military Station, Bangalore, takes the first place mainly owing to the strength of the Christian element in its population. Considering both sexes together, the relative position of the cities remains the same as for literacy among males, i.e., they stand in the following order:— Bangalore City, Mysore City, Civil and Military Station of Bangalore and Kolar Gold fields.

168. Turning to the statistics of education by religion, we may at the outset Literacy by religion. dispose of Parsis, Jews, Brahmos, Sikhs and Buddhists with the remark that the numerical strength of none of these communities exceeds 650 in the State and that, as regards spread of literacy among them, they stand in the above-mentioned order with 80 literate persons among 101 Parsis and 172 among 622 Buddhists at either end of the scale. Considering the main religions of the State, literacy among males is most widespread in the Christian population among whom 4 in every 9 can read and write. The Jains come next with 2 literate males in every 5 and the proportion drops down to 1 in 5 for Musalmans and still lower to 1 in 10 for Hindus while the Animists come a long way behind with the lowest proportion of 1 in 91.

The disparity in the figures for different religions is still more marked in respect of females. Here again, the Christians take the lead with 7 literate females in every 25; next come Musalmans with 1 in 24, followed by Jains with only 1 in 26, although the latter are really more advanced than the former as regards literacy among males. The proportion of literate females among Hindus is so low as 8 per mille while it is even so negligible as 1 per mille among Animists.

169. The varying degrees of diffusion of education among the several numerically important castes in the State will be manifest from Subsidiary Table VI. It is remarkable that the proportion of literate males among the different Hindu castes ranges so wide as from 707 to 5 per mille, the Brahman and the Madiga being the most advanced and the most backward respectively. Next to the Brahman comes the Vaisya with 581 literate males per mille, followed in order by the Kshattriya, Panchala, Neygi, Lingayat, Banajiga, Mahratta and Ganiga, all of whom exhibit a higher proportion of literate males than the average for Hindus as a whole. Just above the Madiga at the bottom of the list, stand the Vodda and the Holeya with a proportion of only 9 and 17 per mille respectively. As regards female education, the Brahman again takes the lead with 119 literate females per mille. A long way behind comes the Kshattriya with a proportion of only 30 per mille, followed by the Vaisya, Banajiga and Mahratta with 22, 20 and 12 per mille respectively. At the lowest rung of the ladder, the Madiga and the Vodda can boast of very few literate females while the Holeya is only slightly less backward with a proportion of 1 per mille. Literacy by caste.

Among Christians, Europeans and Anglo-Indians are far ahead of Indian

Race	Number literate per 100	
	Males	Females
Europeans ...	91	85
Anglo-Indians ...	65	67
Indian Christians	23	16

Christians (*vide* marginal figures). It is, however, remarkable that the proportion of literate persons among Protestant Indian Christians is nearly as high as among Anglo-Indians, while the Roman Catholic section of Indian Christians lags a long way behind with only 28 males and 9 females literate in every 100 of each sex.

170. Let us next turn to the languages of literacy. Taking up English first, Literacy by language: (i) English. we find that in the total population of the State, 12 males and 2 females in every 1,000 of each sex can read and write this language. Knowledge of English is naturally most prevalent in cities and especially in the Civil and Military Station of Bangalore with its large European and Anglo-Indian population. Among the several districts, Kadur which contains the largest proportion of

Christians is likewise the most advanced in respect of literacy in English, while Mysore District (excluding Mysore City) stands at the bottom of the list. If, on the other hand, the statistics be examined by religion, it will be found that Christians are considerably in advance of Hindus, Musalmans, Jains or Animists. Among Christians, the proportion of English-knowing persons is 284 per mille in the case of males and 194 per mille for females. The proportions are naturally even higher among Europeans and Anglo-Indians as English is generally their mother-tongue, while the figures for Indian Christians are much lower, *viz.*, 123 and 55 per mille as regards males and females respectively. Here again, among the Indian Christians themselves, English-knowing persons are proportionately thrice as numerous among Protestants as among Roman Catholics. The Jains come a very long way behind Christians, with a proportion of only 13 per mille for males and 1 per mille for females, closely followed by Musalmans and Hindus. But in a few of the Hindu castes, *viz.*, Brahman, Kshatriya, Vaisya and Banajiga, the proportion of English-knowing males is comparatively high ranging from 156 to 17 per mille. In fact, the Brahmans claim a higher proportion of males literate in English than even Indian Christians, although Brahman females lag considerably behind their Christian sisters. In the whole female population of Hindus numbering more than 2½ millions, there are only 662 who can read and write English, while 50 can do so in a population of nearly 150,000 Musalman females. The entire Animistic female population of more than 35,000 is absolutely ignorant of English, while, among Animistic males, the number returned as literate in English is actually 4.

We have hitherto been discussing the proportion which the number of persons literate in English bears to the total strength of the population pertaining to a particular religion or caste. It will, however, be interesting to know how far the literate population takes to English in different communities. The marginally noted figures will be suitable for this purpose. It may be pointed out that English is more widely known among the literate Hindus than among literate Musalmans, although the proportion of English-knowing persons in the total population is really higher in the case of Musalmans.

Religion or Caste	Number literate in English per 1,000 literate persons
Hindu ...	80
(i) Brahman ...	195
(ii) Kshatriya ...	115
(iii) Vaisya ...	37
Musalman ...	51
Christian ...	656
Indian Christian	364
Jain ...	32

(ii) Other languages.

171. Besides statistics of literacy in English, the number of persons literate in each of six other languages, *viz.*, Kanarese, Telugu, Tamil, Hindustani, Marathi and Sanskrit, is shown in Imperial Table VIII and corresponding proportional figures are contained in Subsidiary Table I. In reading these figures, it must be remembered that a person knowing two or more languages is included in the number shown as literate under each of those languages. Among the above mentioned 7 languages including English, Kanarese is cultivated by the largest proportion of the population in the State, *viz.*, 49 per mille. Then comes English, a long way behind, with 7 per mille, followed by Tamil and Hindustani with 5 per mille each, while only 4 per mille can read and write Telugu and 1 per mille can do so in Marathi and Sanskrit. Turning to the statistics by religion, we find that, among Hindus as well as Jains and Animists, Kanarese is the most widespread language of literacy. Its place is taken by Hindustani in the case of Musalmans and by English in the case of Christians. Among the latter, literacy in Tamil and Kanarese is also fairly well diffused, *viz.*, to the extent of 111 and 71 per mille, respectively.

Literacy by age-periods.

172. On examining the proportion of the literate at each of the four age periods '0-10,' '10-15,' '15-20' and '20 and over' (*vide margin*), it will be seen that as regards males, there is a steady increase from 19 per mille at '0-10' to 152 at '20 and over.' In the case of females, the proportion reaches the maximum of 24 per mille at '15-20' and then falls to 13 at '20 and over.' Considering that it is very rare for a person to first learn to read and write after attaining 15 years and that the younger generation aged

Age	Number literate per 1,000	
	Males	Females
0-10 ...	19	5
10-15 ...	103	20
15-20 ...	137	24
20 and over ...	152	13

from 15 to 20 years must have had at least equal, if not greater, educational facilities than what older persons had formerly enjoyed in their boyhood, it is natural to expect a higher proportion of literate persons at '15-20' than at later ages. The contrary result in the case of males stands therefore in need of some

Religion	Number literate per 1,000 males aged	
	15-20	20 & over
Hindu ...	127	134
Musalman ...	229	234
Christian ...	460	595
Jain ...	522	503
Animistic ...	12	15

explanation. On analysing the figures by religion (*vide margin*), we find the same feature repeated except in the case of Jains. Leaving aside the Animists as too insignificant from the standpoint of literacy, we may point out that the proportion of immigrants among Musalmans and Christians is relatively large and that, not only will literacy be more widespread among immigrants than in the rest of the population, but immigrants will also be proportionately more numerous at the age-period '20 and over' than at '15-20.' In the case of Christians there is an additional factor operating in the same direction in favour of the age-period '20 and over,' as the Europeans who form the most educated section of Christians are proportionately more numerous at the above age-period than at '15-20.' Similarly also is the case with regard to Brahmans, Kshattriyas and Vaisyas who are the most advanced communities among Hindus in respect of diffusion of literacy. It is doubtful, after all, whether the above circumstances can more than partially explain the case. Let us next try to find out, if possible, how far increased facilities of education are really availed of by the younger generation in increasing numbers. For the sake of simplicity, we may consider the

Year	Primary Schools for boys	
	No. of Schools	No. of pupils
1901-02 ...	1,725	53,868
1902-03 ...	1,709	53,529
1903-04 ...	1,689	50,858
1904-05 ...	1,711	52,589
1905-06 ...	1,704	55,293
1906-07 ...	1,707	53,434
1907-08 ...	1,777	56,851
1908-09 ...	1,801	63,898
1909-10 ...	1,845	64,920
1910-11 ...	1,866	64,956

marginal figures showing, for the past 10 years, the number of boys educated in departmental primary schools. It is curious to observe that the number of pupils in 1906-07 was actually less than in 1901-02, *i.e.*, 5 years earlier. The low figures for 1903-04 and a few other years must be mainly attributable to the ravages of plague, but whatever the cause may be, there is no denying the fact that, judged by these figures, the period of 6 years from 1901-02 to 1906-07 had nothing to record for progress in primary education. This must have also contributed towards the low proportion of literate males of 15 to 20 years of age at the recent Census. It is remarkable that in a few other Provinces also, *e.g.*, Madras and Burma, there is a similar excess in the proportion of literate males at the age-period '20 and over' as compared with '15-20.'

173. There has been a steady advance since 1891 in the diffusion of literacy in the State. The progress made by females has, however, been more rapid than in the case of males owing to the vast field for improvement among the former and the increasing attention bestowed on female education. On comparing the figures of 1911 with those of 1901 for the several age-periods, a general progress is noticeable all around except in the case of males between the ages of 15 and 20. On a further analysis of the figures by districts, the above decline in the literacy of males at '15-20' is found to occur only in the districts of Bangalore, Kolar and Tumkur. It is not easy to account for the peculiar result in these three districts. It seems, however, somewhat strange that the proportion of literate males at '15-20' in the Tumkur District should have been so high as 221 per mille in 1901.

Compared with previous Censuses.

174. As regards the spread of English education, there has been a steady improvement since 1891 when the proportion of males and of females literate in English stood at 51 and 11 per mille respectively. The figures rose to 83 and 16 in 1901 and have further gone up to 117 and 21 respectively at the present Census. It will thus be seen that females are progressing at a slower rate than males. On examining the figures for the several districts and cities, the same uniform progress is observed everywhere as regards males, but English education among females has practically remained stationary since 1901 in the districts of Tumkur, Chitaldrug, Hassan and Mysore (excluding Mysore City), while there has been

Progress of literacy in English.

an actual decline in the proportion of English-knowing females in Bangalore District (excluding Bangalore City).

Depart-
mental
statist-
ics.

175. We have hitherto confined our discussion to Census statistics of literacy. We may now conclude this chapter with a brief review of the figures compiled from departmental returns and throwing light on the progress of education. The number of educational institutions and of scholars in the State is shown in Subsidiary Table VII for each of the years 1911, 1901 and 1891. The figures indicate a general improvement during the past two decades. The fact that several industrial and a few commercial schools have sprung up during the last decade is

Year	Amount spent on primary education from Provincial and Local Funds	Expenditure per 1,000	
		Of total population	Pupils (Primary) in Public Institutions
	Rs.	Rs.	Rs.
1900-01 ...	2,44,622	45	3.735
1910-11 ...	3,18,441	56	4.257

a distinct and gratifying sign of appreciation of the importance of industry and trade. The expenditure incurred from Provincial and Local Funds on primary education in the State (excluding the Civil and Military Station, Bangalore) in 1910-11 as well as 1900-01 is shown in the margin. It will be seen that the amount spent in 1910-11 shows an

increase of about 30 per cent over the corresponding figure for 1900-01.

Let us next see whether there is any correspondence between the number of literate persons between the ages of 15 and 20 according to Imperial Table VIII and the number of scholars in educational institutions in 1911. Excluding pupils of primary and elementary schools as too young for the age-period under consideration, we have 34,031 scholars as against 43,359 literate persons. The difference between these two figures is mainly attributable to the fact that many of the latter would have already discontinued their scholastic studies, more especially among females. It may also be noted that occasionally girls are taught the three R's at home without attending any regular school.

News-
papers
and
books.

176. The number of newspapers and periodicals published in the State in 1911 was 47 with a total circulation of 35,898, against 24 and 18,082 respectively in 1901. Journalistic activity has thus nearly doubled during the decade and may be taken as indicating a corresponding increase in the thirst for general information and knowledge on the part of the literate public. The progress in journalistic output has been greater in Kanarese than in English publications. The former also enjoy a larger circulation in the aggregate, although it must be said that the latter are taken to more largely by the English-knowing classes.

The total number of books published during the past decade was only 733 as compared with 1,327 in the previous decade (1891-1900), although the output in the English language in particular shows a remarkable increase. Literary activity has, however, set in with renewed vigour since 1909, as will be seen from the figures of Subsidiary Table X.

SUBSIDIARY TABLES.

L—EDUCATION BY AGE, SEX AND RELIGION.

Religion	Number per mille who are literate											Number per mille who are illiterate			
	All ages			0—10		10—15		15—20		20 and over		Total	Male	Female	
	Total	Male	Female	Male	Female	Male	Female	Male	Female	Male	Female				
1	2	3	4	5	6	7	8	9	10	11	12	13	14	15	
All religions ...	63	112	12	19	5	103	20	137	24	152	13	937	928	927	
Hindu ...	66	108	8	18	4	97	15	127	16	136	7	944	897	922	
Musalman ...	125	200	41	24	12	150	65	229	73	294	47	875	800	952	
Christian ...	368	445	280	92	93	407	345	460	399	595	340	632	555	720	
Indian Christian	248	228	150	Figures not available.									722	672	641
(i) Roman Catholic ...	189	279	90	Figures not available.									811	721	910
(ii) Protestant ...	568	613	522	Figures not available.									432	327	478
Jain ...	229	398	38	49	16	373	82	522	58	503	34	771	602	622	
Parai ...	792	909	652	429	192	1,000	875	1,000	714	972	600	208	91	348	
Sikh ...	892	446	137	200	100	...	250	314	...	492	167	608	554	862	
Brahmo ...	554	742	282	266	71	1,000	400	1,000	1,000	842	642	446	258	618	
Animistic ...	6	11	1	3	...	11	1	12	3	15	1	924	929	929	
Jew ...	700	650	550	...	1,000	1,000	500	1,000	1,000	909	865	300	150	450	
Buddhist ...	277	384	134	42	45	300	250	525	292	538	116	728	616	662	

Number per mille who are literate in

Religion	English			Kanarese			Telugu			Tamil		
	Total	Male	Female	Total	Male	Female	Total	Male	Female	Total	Male	Female
	16	17	18	19	20	21	22	23	24	25	26	27
All religions ...	7	12	2	49	89	7	4	3	1	5	3	2
Hindu ...	4	9	...	50	92	7	4	3	1	3	5	1
Musalman ...	6	12	...	29	53	2	1	3	...	11	20	1
Christian ...	242	294	194	71	87	52	8	11	5	111	152	65
Indian Christian	90	122	55	Figures not available.								
(i) Roman Catholic ...	69	100	37	Figures not available.								
(ii) Protestant ...	202	254	150	Figures not available.								
Jain ...	7	13	1	177	303	33	1	1	...	2	4	...
Parai ...	604	745	435	109	200	30	55	...
Sikh ...	24	21	39	24	29	...	3	4
Brahmo ...	354	613	118	246	419	68	108	225	...	277	355	206
Animistic	6	10	1	...	1
Jew ...	625	700	350	60	100
Buddhist ...	77	121	19	11	14	7	5	8	...	248	342	128

Number per mille who are literate in

Religion	Hindustani			Marathi			Sanskrit			Others		
	Total	Male	Female	Total	Male	Female	Total	Male	Female	Total	Male	Female
	28	29	30	31	32	33	34	35	36	37	38	39
All religions ...	5	8	2	1	1	...	1	1	...	1	2	...
Hindu	1	1	...	1	2	1	...
Musalman ...	86	136	35	14	20	7
Christian ...	3	8	2	1	1	12	16	8
Indian Christian	Figures not available.											
(i) Roman Catholic ...	Figures not available.											
(ii) Protestant ...	Figures not available.											
Jain ...	2	2	...	2	5	...	6	12	...	44	20	4
Parai ...	139	163	67	30	55	658	727	652
Sikh ...	75	83	39	2	4	217	254	99
Brahmo ...	62	97	29	46	66	29
Animistic
Jew	175	200	150	225	250	200
Buddhist ...	2	...	4	21	34	4

II.—EDUCATION BY AGE, SEX AND LOCALITY.

District and Natural Division	NUMBER PER MILLE WHO ARE LITERATE										
	All ages			0—10		10—15		15—20		20 and over	
	Total	Male	Female	Male	Female	Male	Female	Male	Female	Male	Female
1	2	3	4	5	6	7	8	9	10	11	12
Mysore State, including Civil and Military Station, Bangalore ...	63	112	13	19	5	103	20	137	24	152	13
Mysore State, excluding Civil and Military Station, Bangalore ...	60	108	11	18	5	100	18	132	21	145	10
Eastern Division ...	59	106	11	18	5	100	19	131	22	143	11
Bangalore City ...	264	410	107	96	49	409	183	512	184	511	103
Bangalore District ...	53	97	8	18	4	97	15	115	15	130	8
Kolar Gold Fields (City) ...	149	215	60	36	22	230	89	226	79	269	74
Kolar District ...	56	101	10	20	5	108	21	123	21	130	8
Tumkur District ...	58	107	8	15	4	99	16	135	16	147	8
Mysore City ...	241	383	95	82	47	382	178	517	163	488	89
Mysore District ...	38	71	5	11	2	64	9	81	10	99	5
Chitaldrug District ...	56	105	6	15	3	101	10	134	11	144	6
Western Division ...	62	113	9	19	4	100	15	136	18	152	9
Hassan District ...	56	104	8	18	4	93	13	131	17	142	8
Kadur District ...	70	124	11	22	4	109	15	143	21	163	10
Shimoga District ...	64	115	10	18	4	102	16	136	17	154	10
Civil and Military Station, Bangalore ...	239	354	118	45	32	276	165	416	183	497	140
Cities (all the four taken together) ...	232	352	101	66	38	338	165	439	163	455	108

III.—EDUCATION BY RELIGION, SEX AND LOCALITY.

District and Natural Division	Number per mille who are literate									
	Hindu		Jain		Musalman		Christian		Animistic	
	Male	Female	Male	Female	Male	Female	Male	Female	Male	Female
1	2	3	4	5	6	7	8	9	10	11
Mysore State, including Civil and Military Station, Bangalore ...	103	3	338	38	200	41	445	280	11	1
Mysore State, excluding Civil and Military Station, Bangalore ...	101	3	330	38	190	40	377	217	11	1
Eastern Division ...	99	8	425	45	190	42	419	238	12	1
Bangalore City ...	414	92	823	273	357	94	508	381	77	...
Bangalore District ...	91	6	255	13	163	37	271	85	12	...
Kolar Gold Fields (City) ...	133	11	(a)	(a)	365	100	458	218
Kolar District ...	96	7	404	32	161	38	374	256	17	1
Tumkur District ...	103	7	340	25	171	34	529	363	12	1
Mysore City ...	389	83	717	201	329	93	486	370	167	...
Mysore District ...	66	4	568	57	188	41	361	146	7	...
Chitaldrug District ...	103	5	636	62	156	23	458	351	7	1
Western Division ...	108	7	330	24	190	35	281	153	8	2
Hassan District ...	98	6	571	46	221	52	236	151	12	1
Kadur District ...	114	8	342	27	255	45	311	146	4	...
Shimoga District ...	114	9	191	8	140	21	279	167	9	3
Civil and Military Station, Bangalore ...	280	43	720	44	322	54	589	390	122	...
Cities (all the four taken together) ...	325	65	759	193	335	75	538	345	91	...

(a) There are no Jains in Kolar Gold Fields.

IV.—ENGLISH EDUCATION BY AGE, SEX AND LOCALITY.

District and Natural Division	LITERATE IN ENGLISH PER 10,000													
	1911										1901		1891	
	0-10		10-15		15-20		20 and over		All ages		All ages		All ages	
	Male	Female	Male	Female	Male	Female	Male	Female	Male	Female	Male	Female	Male	Female
1	2	3	4	5	6	7	8	9	10	11	12	13	14	15
Mysore State, including Civil and Military Station, Bangalore ...	11	7	91	25	183	37	100	25	117	21	83	15	51	11
Mysore State, excluding Civil and Military Station, Bangalore ...	7	3	72	13	153	19	122	11	91	10	64	7	31	3
Eastern Division ...	7	4	85	17	173	24	137	13	103	12	71	8	23	3
Bangalore City ...	150	61	1,563	409	2,420	394	1,724	194	1,436	206	1,146	135	69	9
Bangalore District ...	2	1	38	2	69	6	63	6	58	4	38	5	6	0
Kolar Gold Fields (City) ...	117	142	663	525	568	408	838	453	654	361	526	304	84	4
Kolar District ...	6	1	67	5	124	13	86	5	68	5	42	2	12	1
Tumkur District ...	2	...	30	2	63	3	77	2	58	2	37	2	12	1
Mysore City ...	73	55	1,187	249	2,274	245	1,175	110	1,016	124	752	62	27	2
Mysore District ...	1	...	22	1	42	2	50	1	34	1	22	1	27	2
Chitaldrug District ...	1	...	22	2	64	4	53	2	40	1	35	1	17	1
Western Division ...	4	1	37	2	86	5	62	5	50	4	42	2	26	2
Hassan District ...	4	2	35	2	62	3	73	4	52	2	36	2	19	2
Kadur District ...	5	2	42	4	104	11	117	10	82	7	66	5	40	5
Shimoga District ...	3	1	37	1	79	3	66	2	51	2	32	1	24	2
Civil and Military Station, Bangalore ...	234	191	1,353	351	1,907	340	2,152	260	1,566	222	1,250	152	1,042	407

V.—PROGRESS OF EDUCATION SINCE 1881.

District and Natural Division	Number literate per mille							
	All ages							
	Male				Female			
	1911	1901	1891	1881	1911	1901	1891	1881
1	2	3	4	5	6	7	8	9
Mysore State, including Civil and Military Station, Bangalore	112	93	84	85 (a)	13	8	5	(a) 3
Mysore State, excluding Civil and Military Station, Bangalore	108	89	79	...	11	6	3	...
Eastern Division	106	88	81	...	11	7	4	...
Bangalore City	410	341	104	...	107	59	6	...
Bangalore District	97	81	8	5
Kolar Gold Fields (City)	215	168	60	55
Kolar District	101	88	81	...	10	5	3	...
Tumkur District	107	91	87	...	8	6	3	...
Mysore City	383	341	67	...	95	58	3	...
Mysore District	71	59	5	3
Chitaldrug District	105	86	73	...	6	4	1	...
Western Division	113	92	75	...	9	5	3	...
Hassan District	104	78	66	...	8	5	2	...
Kadur District	124	106	84	...	11	7	7	...
Shimoga District	115	96	77	...	10	5	2	...
Civil and Military Station, Bangalore	354	315	312	...	118	91	79	...

District and Natural Division	Number literate per mille											
	10-15				15-20				20 and over			
	Male		Female		Male		Female		Male		Female	
	1911	1901	1911	1901	1911	1901	1911	1901	1911	1901	1911	1901
10	11	12	13	14	15	16	17	18	19	20	21	
Mysore State, including Civil and Military Station, Bangalore	108	82	20	12	137	144	24	18	152	129	13	8
Mysore State, excluding Civil and Military Station, Bangalore	100	79	18	10	132	139	21	16	145	123	10	6
Eastern Division	100	79	19	10	131	147	22	17	143	121	11	7
Bangalore City	409	175	183	65	512	422	184	101	511	497	108	68
Bangalore District	97	71	15	8	115	155	15	18	130	117	8	4
Kolar Gold Fields (City)	230	104	89	46	226	166	79	257	269	240	74	65
Kolar District	108	82	21	11	128	136	21	15	130	130	8	5
Tumkur District	99	112	16	9	135	221	16	16	147	100	8	6
Mysore City	382	308	178	105	517	458	168	114	488	455	89	56
Mysore District	64	52	9	6	81	78	10	7	99	85	5	3
Chitaldrug District	101	68	10	5	134	128	11	8	144	128	6	5
Western Division	100	78	15	8	136	121	18	12	152	123	9	5
Hassan District	93	64	13	8	131	112	17	11	142	112	8	4
Kadur District	109	95	15	11	143	132	21	16	163	146	10	6
Shimoga District	102	82	16	7	136	121	17	11	154	132	10	5
Civil and Military Station, Bangalore	276	269	165	126	416	404	183	138	497	441	140	107

(a) In columns 4, 5, 8 and 9, persons over 15 years of age who were returned as 'learning' in 1881 and 1891 have been included among the 'literate.' But figures for the districts are not given in columns 5 and 9 as no information is available regarding the 'learning' distinguished by age-periods in 1881.

VI.—EDUCATION BY CASTE.

Caste	Number per 1,000 who are literate						Number per 10,000 who are literate in English					
	1911			1901			1911			1901		
	Persons	Males	Females	Persons	Males	Females	Persons	Males	Females	Persons	Males	Females
1.	2.	3.	4.	5.	6.	7.	8.	9.	10.	11.	12.	13.
Agas	12	23	1	6	11	...	2	3
Banajiga	96	173	20	73	145	11	91	173	7	43	65	1
Beda	14	27	2	10	18	1	2	4	...	2	4	...
Besta	14	26	1	10	20	1	2	3	...	1	2	...
Brahman	417	707	119	376	621	64	612	1,556	48	535	1,022	24
Ganiga	66	108	4	47	91	2	7	14	1	1
Golla	18	33	1	13	24	1	10	20	...	4	8	...
Holeya	9	17	1	5	9	1	10	20	...	3	6	...
Idiga	32	60	2	18	34	1	3	6	1	1	1	...
Kahattriya	168	301	30	128	220	21	194	365	16	130	238	16
Kumbara	27	51	2	24	45	1	2	4	...	4	7	...
Kuruba	15	30	1	11	21	1	3	6	...	1	3	...
Lingayat	92	177	6	73	142	4	11	22	1	7	13	...
Madiga	3	6	...	1	2	1
Mahratta	79	141	12	55	101	6	69	132	1	26	46	2
Nayinda	32	63	2	21	40	1	9	18	...	1	3	...
Neygi	97	187	7	76	147	3	22	43	2	16	31	...
Panchala	123	232	7	93	177	4	10	20	...	9	17	...
Tigala	21	36	2	12	23	...	16	32	...	4	7	...
Uppara	13	22	1	6	15	...	2	4	...	1	2	...
Vaisya	312	561	28	(a)	(a)	(a)	116	223	...	(a)	(a)	(a)
Vakkaliga	32	62	2	21	41	1	6	12	...	4	7	...
Vodda	5	9	...	2	4	1	1	1
Pathan	119	179	38	63	142	19	62	117	7	26	52	2
Saiyid	126	196	49	115	186	35	71	129	7	51	97	1
Sheikh	118	191	39	66	145	21	66	105	3	36	68	1
Indian Christian	248	323	159	126	264	113	202	1,227	545	475	722	131
Lambani	8	6	1	1	1	1

(a) The 'Vaisya' caste does not appear in the Census Tables of 1901.

VII.—NUMBER OF INSTITUTIONS AND PUPILS ACCORDING TO THE RETURNS OF THE EDUCATION DEPARTMENT.

Class of Institution	1911		1901		1891	
	Number of		Number of		Number of	
	Institutions	Scholars	Institutions	Scholars	Institutions	Scholars
1.	2.	3.	4.	5.	6.	7.
Institutions—Public and Private	4,375	146,198	4,115	122,962	2,226	102,438
(A) Public Institutions	2,548	122,294	2,259	101,675	1,711	73,968
(a) University education—Colleges	10	650	9	547	7	520
(b) School education—General	257	21,593	224	25,365	225	22,162
Secondary Schools for Boys	90	8,562	86	2,568	29	2,457
Secondary Schools for Girls	1,927	68,031	1,804	58,168	1,300	45,458
Primary Schools for Boys	250	11,390	223	11,119	93	5,428
Primary Schools for Girls
(c) School education—Special	3	177	4	158
Training School for Masters	3	33	1	6	1	43
Training School for Mistresses	41	1,371	41	1,056	49	1,545
Sanskrit Schools	20	1,234	7	423	2	26
Industrial Schools	2	101
Commercial Schools	2	115	1	47
Engineering Schools	1	15
Kindergarten Schools	3	22
Schools for deaf, dumb and blind boys
(B) Private Institutions	1,827	22,904	1,785	21,677	1,815	22,470
Advanced	9	158	12	243	65	1,226
Elementary	1,738	22,746	1,753	21,939	1,750	22,176

VIII.—MAIN RESULTS OF UNIVERSITY EXAMINATIONS.

Examination	1911		1901		1891	
	Candidates	Passed	Candidates	Passed	Candidates	Passed
1	2	3	4	5	6	7
Matriculation (Entrance) ...	479	104	436	124	455	150
F. A. or Intermediate Examination ...	101	46	137	56	142	54
Degrees in Arts—						
B. A. Examination—						
(1) English Language Branch ...	78	39	69	25	25	15
(2) Second do do ...	67	58	48	38		
(3) Science Branches ...	69	55	55	28		
(a) Mathematics ...	12	5	15	5		
(b) Physics ...	26	24	21	13		
(c) Geology ...	14	12	9	4		
(d) History ...	17	14	10	9		
Degrees in Medicine ...						
Do Law ...			Nil			
Do Civil Engineering ...						

IX.—NUMBER AND CIRCULATION OF NEWSPAPERS AND PERIODICALS.

Language	Class of newspaper (Daily, Weekly, etc.)	1911		1901	
		Number	Circulation	Number	Circulation
1	2	3	4	5	6
Kanarese ...	(a) Weekly ...	3	10,910	4	6,700
	(b) Fortnightly ...	1	1,000
	(c) Monthly ...	16	8,482	4	4,766
	Total ...	20	20,392	8	11,466
English ...	(a) Daily ...	2	1,000	1	400
	(b) Bi-weekly ...	1	300	1	350
	(c) Tri-weekly	2	218
	(d) Weekly ...	4	2,990	3	900
	(e) Monthly ...	3	1,191	2	1,810
	(f) Bi-monthly ...	1	250
	(g) Quarterly ...	2	1,550	1	450
	Total ...	13	7,281	10	4,128
Sanskrit ...	Monthly ...	2	400	1	500
Urdu ...	(a) Weekly	1	250
	(b) Fortnightly ...	1	200
	(c) Monthly ...	2	1,050
Total ...	3	1,250	1	250	
Telugu ...	Monthly ...	1	750
Tamil ...	Bi-weekly	1	200
	Bi-monthly ...	1	575	1	575
	Fortnightly ...	1	600	2	963
	Monthly ...	6	4,650
Total ...	8	5,825	3	1,538	
Grand Total ...		47	35,898	24	18,082

X.—NUMBER OF BOOKS PUBLISHED IN EACH LANGUAGE.

Language	Number of books published in											Total of decade		
	1901	1902	1903	1904	1905	1906	1907	1908	1909	1910	1901-1910	1891-1900	1881-1890	
	2	3	4	5	6	7	8	9	10	11	12	13	14	
English ...	4	2	2	9	1	6	8	7	24	31	94	47	36	
Vernaculars spoken in the State ...	33	26	42	38	51	49	46	39	85	92	501	367	729	
Kanarese ...	33	23	41	37	47	44	38	35	83	89	470	318	672	
Tamil	1	1	1	2	1	...	1	7	13	10	
Telugu	1	3	1	4	3	1	2	15	27	28	
Hindustani	1	1	1	...	3	2	...	1	...	9	9	18	
Kodagu	1	
The Indian classical languages	10	1	1	4	3	2	4	8	10	43	155	241	
More than one language (Polyglot) ...	7	4	6	9	8	13	9	13	8	18	95	258	153	

N.B.—The figures for Civil and Military Station, Bangalore, included in those of col. 14 relate only to the period from 1885 to 1890.

CHAPTER IX.

LANGUAGE.

177. "Enter the language which each person ordinarily uses in conversation, with his mother or other near relation. In the case of infants and deaf-mutes, the language of the mother should be entered." These were the instructions issued to enumerators with regard to the entries in the 'Language' column of the Census Schedule. A variety of names for each language and dialect, *e.g.*, Arava for Tamil, Are for Marathi, Andhra for Telugu was returned in a few cases but in the case of obvious synonyms (*vide* remarks contained in para 188 *infra*) the ordinary name was retained for the statistics of Imperial Table X (Language). The grouping of languages and dialects according to the results of the Linguistic Survey of India has been prepared and the results exhibited in Subsidiary Table I (b) appended to this chapter. The entries in the Schedules were generally found to be accurate. Scope of the chapter.

178. Imperial Table X contains statistics of Mother-tongue according to the Census Returns. The following Subsidiary Tables are given at the end of this chapter:— Statistics of language.

- (i) Subsidiary Table I (a), showing distribution of total population by language according to Census. The table indicates the number of speakers of a language per mille of population of the State and mentions the localities where each tongue is chiefly spoken.
- (ii) Subsidiary Table I (b), showing distribution of total population by language according to Linguistic Survey. The arrangement of the table is similar to that of I (a).
- (iii) Subsidiary Table II, showing distribution by language of the population of each District and City. Besides the vernaculars of the State, the following languages are included in the Table—Lambani, Tulu and English; the other languages are grouped under a common heading 'others.'
- (iv) Subsidiary Table III, showing comparison of Caste and Language tables. Koracha, Korama and Lambani are the Castes dealt with.
- (v) An additional Subsidiary Table III-A has been given to show side by side language, birthplace and caste figures with regard to a few selected languages.

179. A diagram is given at the end of this chapter to show the distribution of vernaculars of the State in the districts and cities. Diagram.

180. For the State including Civil and Military Station, Bangalore, the number of persons speaking the vernaculars of the State is 5,691,625; those speaking the vernaculars of India foreign to the State number 99,323; 1,706 persons speak vernaculars of Asiatic Countries beyond India, while 13,539 individuals speak European Languages. The marginal statement gives similar details for (1) the State excluding Civil and Military Station, Bangalore, (2) the Eastern Division, (3) the Western Division, and (4) Civil and Military Station, Bangalore. It will be noticed that the Civil and Military Station, Bangalore, has more than half the total number of those who speak European General linguistic distribution.

Division	Vernaculars of the State	Vernaculars of India foreign to the State	Vernaculars of Asiatic Countries beyond India	European languages
1. Mysore State, excluding Civil and Military Station, Bangalore ...	5,600,405	98,076	1,589	5,389
2. Eastern Division ...	4,338,573	25,611	1,054	4,748
3. Western Division ...	1,361,833	72,465	535	541
4. Civil and Military Station, Bangalore ...	91,220	1,247	117	8,250

(2) the Eastern Division, (3) the Western Division, and (4) Civil and Military Station, Bangalore. It will be noticed that the Civil and Military Station, Bangalore, has more than half the total number of those who speak European

Languages (mostly English) and that the Western Division has nearly three-fourths of the number speaking vernaculars of India foreign to the State (chiefly Tulu, Lambani and Konkani). The same figures expressed proportionally per mille of population are shown in the following statement:—

District	Number per mille of population speaking			
	Vernaculars of the State	Vernaculars of India foreign to the State	Vernaculars of Asiatic countries beyond India	European languages
1 Mysore State, excluding Civil and Military Station, Bangalore ...	982	17	1
2 Eastern Division ...	993	6	1
3 Western Division ...	949	51
4 Civil and Military Station, Bangalore	905	12	1	82

A comparison of this with a similar statement (given below) prepared for the figures of the Census of 1901 is instructive.

District	Number per mille of population speaking			
	Vernaculars of the State	Vernaculars of India foreign to the State	Vernaculars of Asiatic countries beyond India	European languages
1 Mysore State, excluding Civil and Military Station, Bangalore ...	985	14	1
2 Eastern Division ...	993	5	1	1
3 Western Division ...	963	37
4 Civil and Military Station, Bangalore	911	18	1	70

Distribution by districts and cities.

181. The statement given in the margin shows for 1901 and 1911 proportionally per 10,000 speakers of each District and City, the number speaking (a) vernaculars of the State, (b) vernaculars of India foreign to the State, (c) vernaculars of Asiatic countries beyond India and (d) European languages. The decrease among those speaking the vernaculars of the State is very noticeable in Kadur and Shimoga Districts and the Kolar Gold Fields while there is a slight increase in the Mysore District and Mysore City. Of persons speaking vernaculars of India foreign to the State, there has been a marked increase in the Kolar Gold Fields, Kadur District and Shimoga District. Among speakers of European languages, there is an increase in Bangalore City and decreases are seen in the Kolar Gold Fields and Mysore City.

District or City		Number per mille of population speaking			
		(a) Vernaculars of the State	(b) Vernaculars of India foreign to the State	(c) Asiatic Vernaculars (not of India)	(d) European languages
Bangalore City ...	1901	986	7	...	7
	1911	984	7	...	9
Bangalore District	1901	992	6	1	1
	1911	992	6	1	1
Kolar Gold Fields (City) ...	1901	926	21	..	53
	1911	906	45	...	49
Kolar District ...	1901	996	8	1	...
	1911	996	4
Tumkur District ...	1901	994	6
	1911	994	6
Mysore City ...	1901	985	8	2	5
	1911	988	8	...	4
Mysore District ...	1901	998	1	1	...
	1911	999	1
Chitaldrug District	1901	986	14
	1911	988	17
Hassan District ...	1901	987	13
	1911	984	16
Kadur District ...	1901	929	70	...	1
	1911	897	102	...	1
Shimoga District...	1901	960	40
	1911	945	55

182. The statement here given shows the details of speakers of the vernacu-

Language	1871	1881	1891	1901	1911
Total Population ...	10,000	8,261	9,779	10,957	11,486
Vernaculars of the State.		6,234	9,623	10,765	11,259
Kanarese ...		4,123	7,232	8,000	8,205
Hindustani ...		456	465	532*	604
Marathi ...		134	129	154	155
Tamil ...		259	316	448	477
Telugu ...		1,260	1,477	1,652	1,619
English ...		16	20	20	26

* Calculated after including in the number those returned as speaking Hindi and Urdu.

lars of the State and English at the several censuses assuming the population of the State to have been 10,000 in 1871. The increase of persons speaking Kanarese and Telugu is marked in the decennium 1881-1891; the increase of persons speaking Tamil and Marathi is noticeable in 1891-1901; and the increase of English speakers is conspicuous in 1881-91 and 1901-11.

183. The number of speakers of the principal families, branches and groups of

Language	Persons
Total number of speakers ...	5,806,193
Dravidian family ...	5,348,959
Dravida Group ...	4,429,449
Andhra Group ...	919,410
Indo-European Family ...	413,266
Indian Branch ...	396,336
Eranian ...	1,890
European ...	13,536
Armenian and Singalese ...	5
Semitic Family ...	303
Mongolian Family ...	17
Tibeto-Chinese Family ...	15
Unclassified Languages ...	43,738

languages returned for the State are shown in the subjoined statement. From this it will be seen that the Dravidian family of languages accounts for 92 per cent of speakers, the Indo-European family for 7 per cent and the unclassified languages for nearly one per cent.

(a) *Dravidian Family*.—The languages of the Dravida group are Kanarese (4,147,765), Tamil (244,947), Tulu (31,995), Malayalam (4,692) and Coorgi (50). Of these, the first two are the vernaculars of the State and Tulu is the chief language spoken by the periodic immigrants to the Western Division from South Kanara. Mysore is the home of the Kanarese language, the 'Karnata' of the Hindu geographers and historians. Telugu (919,410) comprises the Andhra group and is next to Kanarese, the most widely spoken language in the State. It is markedly prevalent in the Kolar, Bangalore and Tumkur Districts in the order mentioned; and in fact in the first-named District (Kolar) the Telugu speakers number more than twice the speakers of the Kanarese language.

(b) *Indo-European Family*.—The chief languages of the Indian branch are Western Hindi or Hindustani (305,182) and Marathi (87,472) which are both of them the vernaculars of the State. The chief language of the Eranian group is Persian (1,384). English is the principal language of the European branch and is spoken by 13,120 persons.

(c) *Unclassified Languages*.—The only other widely spoken language is Lambani which is spoken by 43,667 persons.

184. (1) *Kanarese*.—This language is spoken by 714 per mille of the population in the State. The accompanying statement shows the numbers speaking the same in each district and the percentage they bear to the population of the unit concerned. Mysore, Hassan, Kadur and Shimoga Districts return more than four-fifths of their populations as Kanarese speakers. In the Kolar District, Telugu displaces Kanarese as the principal mother-tongue. The proportion of

District or City	Number returning Kanarese as mother tongue	Percentage to population
Bangalore City ...	37,786	31
Bangalore District ...	456,198	64
Kolar Gold Fields (City) ...	856	1
Kolar District ...	166,526	26
Tumkur District ...	577,762	79
Mysore City ...	87,266	52
Mysore District ...	1,194,956	94
Chitaldrug District ...	411,732	73
Hassan District ...	527,575	91
Kadur District ...	269,441	60
Shimoga District ...	420,342	61
Civil and Military Station, Bangalore.	5,326	6

per cent each, Kadur District 6 per cent and Kolar District (including Kolar Gold Fields) 5 per cent.

Kanarese speakers is very low in the cities, being most marked in Kolar Gold Fields and the Civil and Military Station, Bangalore. Mysore District (including Mysore City) contains 29 per cent of the Kanarese speakers in the State, Tumkur District 14 per cent, Bangalore District (including Bangalore City and Civil and Military Station) and Hassan District 13 per cent each, Chitaldrug and Shimoga Districts 10

The numbers speaking the vernaculars of the State and English at each of the Censuses 1881-1911.

Language distribution according to linguistic survey.

Vernaculars of the State; their distribution.

(2) *Hindustani*.—Hindustani “is not only a local vernacular, but is also spoken over the whole of the north and west of continental India as a second language, a *lingua franca* employed alike in the court and in the market-place by every one with any claim to education.”* The modern Indo-Aryan vernacular of the old Midland or the Gangetic Doab and its country to the north, is the Western Hindi, the principal dialect of which is Hindustani. This dialect was in general use in Delhi and from there it was carried everywhere in India by the lieutenants of the Mughal Empire. The Musalmans employed the Persian character for recording it and enriched its vocabulary with a large stock of Persian and Arabic words. This Persianised form of Hindustani is known as Urdu. The Hindu form of Hindustani is more or less Hindustani for the use of Hindus and was derived from Urdu by ejecting all words of Arabic and Persian birth and substituting in their place words borrowed or derived from the indigenous Sanskrit. Hindi is generally written like Sanskrit in the Devanagari character. While Urdu is enlisted into the service of both prose and poetry, Hindi is employed only for prose. The name ‘Hindustani’ when connoting any particular form of speech is properly reserved for a language whose vocabulary is neither excessively Persianised nor excessively Sanskritised. The speakers of Hindustani number 53

District	Number of Hindustani speakers	Percentage to total Hindustani speaking population
Bangalore District	48,767	16
Bangalore City	10,986	4
Bangalore Civil and Military Station...	23,101	8
Kolar District	47,856	16
Kolar Gold Fields (City)	2,309	1
Tumkur District	84,899	11
Mysore District	33,710	11
Mysore City	13,098	5
Chitaldrug District	24,289	8
Hassan District	16,587	5
Kadur District	15,004	5
Shimoga District	33,676	11

per mille of the population of the State. The marginal statement shows the number of speakers in each District and City and gives the percentage that the number bears to the total of Hindustani speakers in the State. Among the Districts, Kolar and Shimoga have each a little more than 6 per cent of their populations speaking Hindustani, while Mysore has only about 3 per cent. Of the Cities, Civil and Military Station, Bangalore, has nearly 23 per cent of its population speaking Hindustani, Mysore City 20 per cent, Bangalore City 12 per cent, and Kolar Gold Fields only 5 per cent.

(3) *Marathi*.—The marginal statement shows for Districts and Cities the percentage of Marathi speakers of the unit concerned to the speakers of Marathi in the State. It is noticeable that Bangalore District (including the City and the Civil and Military Station) and Shimoga District contain 50 per cent of the number of Marathi speakers in the State, who themselves form a little more than one per cent of the whole population.

District or City	Percentage to population of District or City of Marathi speakers
Bangalore City	11
Bangalore District	14
Kolar Gold Fields (City)	...
Kolar District	10
Tumkur District	8
Mysore City	6
Mysore District	9
Chitaldrug District	8
Hassan District	4
Kadur District	5
Shimoga District	20
C. & M. Stn. Bangalore	5

(4) *Tamil*.—This “the oldest, richest and most highly organised of the Dravidian languages, plentiful in vocabulary, and cultivated from a remote period”† is spoken by 4 per cent of the population of the State. The distribution of the speakers is as in the margin. Of the cities, 77 per cent of the population of the Kolar Gold Fields speak Tamil; the Civil and Military Station, Bangalore, has 42 per cent of its inhabitants Tamil speakers and 22 and 11 per cent of the populations of the Cities of Bangalore and Mysore have returned Tamil as their mother-tongue. Of the Districts, Bangalore and Kolar are the only Districts having more than 6 per cent of their populations speaking Tamil; on the other hand, Shimoga and Chitaldrug return less than one per cent Tamil speakers.

* Imperial Gazetteer of India, Vol. I, p. 365.

† Imperial Gazetteer of India, Vol. I, p. 360.

(5) *Telugu*.—Next to Kanarese, Telugu is the most widely spoken language in the State; nearly 16 per cent of the population speak it. Of the Telugu speakers, as many as 93 per cent live in the following four districts, Kolar (including Kolar Gold Fields) (48), Bangalore (including Bangalore City and Civil and Military Station, Bangalore) (21), Tumkur and Chitaldrug (12 per cent each). Telugu “the only important Andhra language, * * * has an extensive literature written in a character of its own, * * * which owes its numerous curves to the fact that it has been written on palm leaves.”*

185. Of the other languages it will be sufficient if the local distribution of those which have in each case more than 1,000 speakers for the State be considered. Other languages.

(1) *Gujarati* (2,679).—This language is spoken in all the Districts. Of the Cities, the Civil and Military Station, Bangalore, has 301 speakers, Mysore City 278 and Bangalore City 179.

(2) *Konkani* (9,358).—This dialect of Marathi is spoken chiefly by the immigrants from the Konkan who are mostly found in Kadur (3,736) and Shimoga (4,971) Districts.

(3) *Koracha* (2,739) is spoken by Korachas, chiefly in Chitaldrug, Kolar and Bangalore Districts.

(4) *Korama* (1,049) is spoken mostly in Kolar, Kadur and Bangalore Districts.

(5) *Lambani* (43,667).—The Lambani speakers are chiefly found in Shimoga (16,239), Chitaldrug (7,620), Kadur (7,531) and Bangalore (4,243) Districts.

(6) *Malayalam* (4,692).—Nearly one half of the speakers are on the Kolar Gold Fields Area (2,138). The districts having above 500 speakers are Kadur (692) and Hassan (610).

(7) *Marwari* (1,247).—Marwari is chiefly spoken in Shimoga District (256), Kolar District (217), Civil and Military Station, Bangalore (209), Chitaldrug (154) and Kadur (146) Districts.

(8) *Tulu* (31,995).—The speakers are mostly immigrants from South Kanara. Kadur District has as many as 21,976 speakers, Shimoga District 5,265 and Hassan 4,518.

(9) *Persian* (1,384) is spoken chiefly in the Bangalore District (450), Hassan District (251) and Kolar District (210). The tongue may have been in most instances a Persianised form of Hindustani but styled Persian.

Trade or travel accounts for most of the other languages returned in Imperial Table X.

186.	This language has been returned as mother-tongue by 13,120 persons in the State. On a reference to Imperial Table XIII, (caste, tribe or race) we find the number of Anglo-Indians, Armenians and Europeans to be 13,290. Deducting from this figure, the number of speakers of European languages (who it is presumed belong to the races mentioned above) other than English (except Turkish) we get the number of Anglo-Indians, Armenians and Europeans, who may be expected to have returned themselves as speaking English. The working is as in the margin. The difference between those returned in Imperial Table X as speaking English and this figure is 13,120—	The English language.
Danish	...	9
French	...	130
Gaelic	...	1
German	...	40
Greek	...	1
Hungarian	...	2
Irish	...	1
Italian	...	102
Portuguese	...	125
Welsh	...	7
	13,290—418=	12,872

12,872=248. This number is scarcely 2 per cent of the number of English speakers. A reference to Imperial Table IX shows that 10,264 Anglo-Indians, Armenians and Europeans are literate in English. The total number of persons literate in English for the State is 40,641. Therefore as many as 40,641—10,264=30,377 persons not belonging to these races and more than twice as many as those who returned the language as mother-tongue are found literate in English. English is not only the official language, it is the language of science and literature, of scholarship and art, of commerce and business and that is why—because

* Imperial Gazetteer of India, Vol. I. p. 281.

it is the key to all knowledge—it has the unique distinction of commanding the literacy of more than thrice the number of persons who use it as their mother-tongue.

Dialects.

187. The following are the principal dialects returned in the present Census.
- | | | |
|------------------------|---|---|
| (1) Koracha. | { | are dialects of Tamil spoken by the Animist tribes of the same name. |
| (2) Korama. | | |
| (3) Multani (7). | { | dialect of Western Panjabi or Lahnda spoken in Bangalore City. |
| (4) Goanese (5). | | |
| (5) Konkani. | { | dialects of Marathi. Konkani is said to differ so widely from standard Marathi that some of its speakers claim for it the dignity of a separate language. <u>The Kanarese alphabet is generally employed for recording Konkani.</u> |
| (6) Rajputani (1). | | |
| (7) Marwari. | { | dialects of Rajasthani. Marwari is the western dialect of Rajasthani and its speakers who are enterprising merchants and bankers, have carried it all over India. It "has a copious literature, written in a peculiar character, the aspect of which is familiar to every Indian official who has had occasion to inspect the accounts of native bankers."* |
| (8) Memani (2). | | |
| (9) Nagari (43). | { | dialects of Gujarati. |
| (10) Patnuli (52). | | |
| (11) Ladar (66). | { | are included under Gipsy languages. These Gipsy languages have nothing to do with European Romani. "Some are mere thieves' jargons, others are hybrids, developed in journeys from place to place, and some are real dialects of well known languages."† |
| (12) Lambani (43,667.) | | |

**Dialects—
continued.**

188. Most of the dialects mentioned in the foregoing paragraph are dialects of languages spoken more or less by immigrants and concern vernaculars foreign to the State. Resort is had generally to the language from which the dialects are derived when these are not intelligible. Dialect does not seem to be a question of sex. So also it cannot be said that caste differences have produced true linguistic differences. It is true that residence in a place where a different language is widely spoken, tends to produce, in respect of a language, loss of its proper accentuation, of its inflectional suffixes and also in a few cases of its idioms, *e.g.*, the spoken Tamil of the Vaishnavas in Mysore is hardly the Tamil of Madura; and the spoken Hindustani of Bangalore may not be considered elegant in the Court of Hyderabad. It is true also that there are sure to be little differences in style and accent when the same language is spoken in different districts, *e.g.*, the Kanarese of Mangalore is not considered orthodox by the Kanarese speakers of Mysore. The pronunciation of the low caste man may sound queer to the high caste speaker of the same language. In colloquial language, strict grammar is considered *a purism* and women and children do not generally correctly articulate the gutturals, nasals, sibilants and the aspirants. But these peculiarities of a language engendered by (1) the speakers' domicile in the midst of speakers of other languages, (2) by the same language giving way to local predilection in point of intonation and style, (3) by the articulation of the same language by different castemen and (4) by use in ordinary colloquy specially by females and children, surely do not amount to differences which alone mark one dialect from another and both from the principal language. The Kanarese and Urdu newspapers in the State adopt the style and idioms of the languages as prevalent here. Kanarese and Urdu are being taught in public schools. The school books of the Primary classes are written in intelligible Mysore Kanarese and in easy Urdu. The State being compact in size, there are no great local differences in the form of speech.

**Tribal
languages.**

189. Koracha, Korama and Lambani are the three tribal languages returned in the present Census. These are spoken by the tribes of the Sanie names. As regards the names Koracha and Korama, the Officer in charge of Ethnographic Survey opines in his monograph on the Koracha caste that "there is strong reason

* Imperial Gazetteer of India, Vol. I, p. 368.

† Imperial Gazetteer of India, Vol. I, p. 389.

to hold that the names (Koracha and Korama) are mere local variations for one and the same caste. The exogamous divisions among them and family names wherever they are found * * * * are all common to both the branches, who moreover speak the same language." These tribes "speak a language which appears to be a dialect of Tamil or a medley of Tamil, Telugu and Kannada, the first element preponderating." In the light of these remarks it seems best to take the two names together, whether in the case of the tribe or the language and combine the figures of 1901 for Koracha and Korama (and Korava) for the purposes of comparison. Doing this, we find as follows:—

Tribe	Strength of tribe	Number speaking tribal language
Koracha or Korama	1901 ...	24,228
	1911 ...	26,988

Many members of the tribe return their language as Tamil.

Similar information for Lambanis is embodied in the statement given below:—

Tribe	Strength of tribe	Number speaking tribal language
Lambani	1901 ...	45,579
	1911 ...	51,168

The reason why such a large number speaking the tribal language is returned among Lambanis as distinguished from Korachas, seems to be that the Lambanis cannot very easily designate their language with the name of any well-known Vernacular whereas the Korachas can easily do so, *i.e.*, call their language Tamil, Telugu or Kanarese.

190. "The superior power of resistance of Tamil, Telugu and Kanarese to the advance of the Sanskritic languages is probably due mainly to the fact that they have their own written character and religious and secular literature and that all sections of the community, including the great majority of the Brahmans, are of local origin."* The Kannada character is the same as the Telugu, and Karnataka seems to have been a generic term which formerly included both. There is an extensive literature in the Kannada language going back to great antiquity. Down to about A. D. 1300 the language was cultivated entirely by the Jains; from that period to A. D. 1500, the Lingayats continued its use in literature and thenceforward Brahmans and other sects took part in its cultivation. The importation of Sanskrit terms latterly found great favour and there is a natural reaction against the same. Many English terms notably relating to Revenue and Civil Law, are being daily used by Kanarese speakers most ignorant of English Language. In the domain of Science, Kanarese translations of English terms are sometimes unintelligible and probably will have to yield to adaptations of the terms themselves. The script and language of correspondence of English-knowing Indians is most often English, so that thinking in the vernacular and vernacular composition are almost the monopoly of scholars. The public taste is not very favourable to the flourishing of real Kanarese composition. Apart from school books, easy stories from old works or songs written in colloquial Kannada are most in demand. The reading public, who go in for reading as a necessity, care more for English novels and periodicals if they chance to know English. Adaptations from favourite English authors are attempted very frequently; but even these, though successful from a literary point of view, rarely bring encouragement to the authors, because to the English-knowing public, though the ideas are

The Kanarese language.

* Census Commissioner's notes for Chapter IX of Report, page 3.

familiar, the vehicle of thought seems unusual whereas to the non-English-knowing public, the ideas are foreign though the diction is fairly acceptable. So original work may be said to be more or less comparatively rare. Laudable efforts are being made in parts of the country (1) to standardize and regulate the influx of foreign words into the vocabulary and (2) to give an encouragement to authors. In this lull of public demand, it remains to be seen how far these efforts will be successful. A study of Sanskrit, the language of the Vedas and sacred books, claims the attention of many students and this again reacts on the taste for the vernacular.

Proportion of female speakers to male speakers of the vernaculars of the State.

191. The following statement shows the number per 1,000 males, of female speakers of each vernacular :—

No.	Language	Number of female speakers to 1,000 male speakers
1	Kanarese	995
2	Hindustani	918
3	Marathi	928
4	Tamil	927
5	Telugu	986

Similar information for the Civil and Military Station, Bangalore, Eastern and Western Divisions, is given below:—

No.	Language	Number of female speakers to 1,000 male speakers in		
		Civil and Military Station, Bangalore	Eastern Division	Western Division
1	Kanarese	1,015	1,000	985
2	Hindustani	870	923	919
3	Marathi	886	935	920
4	Tamil	1,026	914	855
5	Telugu	995	987	954

Correlation of figures for language, birth-place, and caste, tribe or race.

192. It has been remarked in the Mysore Census Report of 1901, while controverting an opinion expressed in the report for 1891, that mother-tongue is more dependent on racial and tribal characteristics than on birthplace. Let us examine this statement with reference to a typical language Hindustani. Taking the tribes that are generally presumed to speak the language Hindustani—the tribes of Musalmans—we find the following discrepancy :—

	Persons	Males	Females
Hindustani speakers	305,182	159,136	146,046
Musalmans (presumed to be Hindustani speakers)	314,494	165,824	148,670
∴ Excess of Musalmans over Hindustani speakers	9,312	6,688	2,624

Even deducting from this the number of Musalmans who may be presumed to speak Memani, Pashto, Arabic, Persian and Turkish, *i.e.*, 1,686 persons (929 males and 757 females), we have an excess of 7,626 persons (5,759 males and 1,867 females). It may be said that the tribes of Mapilla, 2,257 persons (1,989 males and 268 females) and Labbai 7,995 persons (5,200 males and 2,795 females) include some who are speakers of Malayalam and Tamil as they come mostly from Malabar and North Arcot respectively. But here we are going back on the argument of birthplace to support that of racial and tribal characteristics. Again

how many of these may be Hindustani speakers? It is simply impossible to make a general statement. We find as a fact that some Pinjaris (Musalmans) have returned themselves as speaking Kanarese in Chitaldrug District. Here the racial characteristic does not indicate a language. The fact is that the evolution of language, is too subtle to be gauged by such considerations as racial and tribal characteristics or birthplace. One or more of these may co-exist with any other and sometimes a startling coincidence may ensue, for example the existence in the present census figures of four Japanese speakers, one male and three females (Imperial Table X), of four persons born in Japan (Imperial Table XI) and of four Japanese Buddhists (Imperial Table XIII). Such coincidences are not at all of value sufficient to enable general inferences being drawn as to the relations of causation and effect of the three attributes—language, caste, tribe or race, and birthplace.

193. Language is the expression of human thought, and as such grows with the progress of human thought, in proportion as the latter progresses, either by cultivation or by contact with better culture. During such an expansion, human thought must, in some instances at least, overcome the predilections of racial and tribal characteristics and of birthplace and may take for its expression a convenient language adapted to its needs. It depends on the circumstances of each case—the tie of nationality, tribe or caste, the superiority of language to hand, the drawbacks of the original language, the purpose sought to be attained, the better adaptability of the local language to subserve the material and moral condition of progress of the race, etc., concerned, how far the language of the birthplace, the language of the tribe or race, or the language of the locality will prevail. The time has gone by when it was the fashion to trace a common origin to races the languages of which showed remarkable affinities. Just as language is a human necessity, so also similarities in the structure of languages must result from men working out their civilization in parallel lines. We see in many Marathi, Tamil and Telugu speaking households the younger generation more familiar with Kanarese than with the mother-tongue. When these grow up to be men and women, who knows but they may not use Kanarese as their tongue? This paragraph may be aptly concluded with a few quotations bearing on the matter from the Imperial Gazetteer of India, Chapter VII, (Language). “The Dravidian race is widely spread over India but all the members of it do not speak Dravidian languages. In the North many of them . . . have adopted the language of their conquerors while they have retained their ethnic characteristics. . . . Dravidians are almost the only speakers of two other important families of speech, the Munda and the Dravidian proper . . . Whether we consider the phonetic systems, the methods of inflexion or the vocabularies, the Dravidian have no connection with the Munda languages.” In fact language seems to be beyond the pale of any conscious human policy. We may take as an example, the case of Sanskrit which may be said to be the polished form of the archaic dialect of the upper Doab, the language of the Rig Veda. “It received literary culture from the most ancient times and became fixed by the labours of grammarians which may be said to have culminated in the work of Panini about the year 300 B.C.” “Just as the spoken dialects of Italy existed side by side with Latin, and while the evolution of Latin was arrested by its great writers, ultimately developed into the modern Romance languages, so the ancient Vedic form of speech developed first into that stage of language known as Prakrit and then into one or more modern Indo-Aryan vernaculars.”

The Evolution of language.

SUBSIDIARY TABLES.

I.—DISTRIBUTION OF TOTAL POPULATION BY LANGUAGE.

(a) According to Census.

Language	Total number of speakers	Number per mille of population of Province	Where chiefly spoken
1	2	3	4
Mysore State, including Civil and Military Station, Bangalore—			
A (i) Vernaculars of the State	5,691,625	981	
Kanarese	4,147,765	714	
Hindustani	305,182	53	
Marathi	78,109	14	
Tamil	241,159	42	
Telugu	919,410	158	Kolar and Bangalore Districts.
A (ii) Vernaculars of India foreign to the State ..	99,323	17	
Gujarati	2,679	...	Chitaldrug and Shimoga Districts and Civil and Military Station, Bangalore.
Konkani	9,358	2	Kadur and Shimoga Districts.
Koracha	2,739	...	
Korama	1,049	...	
Lambani (a Gipsy language)... ..	43,667	8	
Malayalam	4,692	1	Kolar Gold Fields (City).
Marwari	1,247	...	
Tulu	31,995	6	Hassan, Kadur and Shimoga Districts.
Others	1,897	...	
B. Vernaculars of Asiatic countries beyond India	1,706	...	
Persian	1,384	...	Bangalore and Hassan Districts.
Others	322	...	
C. European Languages	13,539	2	
English	13,120	2	Kolar Gold Fields (City) and Civil and Military Station, Bangalore.
Others	419	...	

I.—DISTRIBUTION OF TOTAL POPULATION BY LANGUAGE.

(b) According to Linguistic Survey.

Family, Sub-family, Branch and Sub-Branch	Group and Sub-Group	Language	Total number of speakers	Number per mille of population of Province	Where chiefly spoken
1	2	3	4	5	6
Tibeto-Chinese Family ...					
Tibeto-Burman Sub-Family	Tibetan Group ...	Tibetan ...	1	...	
Tibeto-Himalayan Branch	Burma Group ...	Burmese ...	14	...	Civil and Military Station, Bangalore.
Assam-Burmese Branch ...					
Dravidian Family ...	Dravida Group ...	Tamil ...	244,947	42	Kolar Gold Fields (City).
		Malayalam ...	4,692	1	
		Kanarese ...	4,147,765	714	Mysore City and Mysore District.
		Coorgi ...	50	...	
		Tulu ...	31,995	6	Kadur, Hassan and Shimoga Districts.
	Andhra Group ...	Telugu ...	919,410	158	Kolar and Bangalore Districts.
Indo-European Family—					
Aryan Sub-Family—					
Erastian Branch ...	Eastern Group ...	Pashto ...	6	...	Civil and Military Station, Bangalore.
Indian Branch—					
Sanskritic Sub-Branch ...	North-Western Group.	Lahnda or Western Punjabi.	7	...	Bangalore City.
		Sindhi ...	59	...	Cities of Bangalore, Mysore and Civil and Military Station, Bangalore.
		Kachohhi ...	150	...	Bangalore City and Civil and Military Station, Bangalore.
	Southern Group ...	Marathi ...	87,472	15	Kolar, Chitaldrug and Hassan Districts.
	Eastern Group ...	Oriya ...	976	...	Civil and Military Station, Bangalore.
		Bengali ...	58	...	

(b) According to Linguistic Survey—concl'd.

Family, Sub-family, Branch and Sub-Branch	Group and Sub-Group	Language	Total number of Speakers	Number per mille of population of Province	Where chiefly spoken		
1	2	3	4	5	6		
Unclassified Languages ... Indo-European Family ...	Western Group ...	Western Hindi or Hindustani ...	305,168	53	Kolar and Shimoga Districts and Civil and Military Station, Bangalore.		
		Rajasthani ...	1,948	...			
		Gujarati ...	2,776	1		Chitaldrug and Shimoga Districts and Civil and Military Station, Bangalore.	
	Celtic Group ...	Gaelic ...	Gaelic ...	1	...	Kolar Gold Fields (City).	
			Irish ...	1	...		
			Welsh ...	7	...		
		Greek Group ...	Greek ...	1	...		
			Romanic Group ...	French ...	130		...
				Italian ...	103		...
				Portuguese ...	125		...
		Teutonic Group ...	Danish ...	Danish ...	9		...
				English ...	13,120		2
		German ...	German ...	40	...		Civil and Military Station, Bangalore.
			Eranian Group ...	Persian ...	1,364		...
		Armenian Group		Armenian ...	1		...
	Singhalese ...		4	...			
Semitic Family	Arabic ...	293	...	Kadur and Shimoga Districts.		
Semitic Family—Northern Branch.	...	Hebrew ...	10	...	Civil and Military Station, Bangalore.		
Mongolian Family ...	Monosyllabic Group	Chinese ...	10	...	Mysore City and Bangalore District.		
		Japanese Group ...	Japanese ...	4	...	Civil and Military Station, Bangalore.	
	Ural-Altaic Group	Hungarian ...	2	...			
		Turkish ...	1	...			

II.—DISTRIBUTION BY LANGUAGE OF THE POPULATION OF EACH DISTRICT.

District and Natural Division	Number per 10,000 of population speaking								
	Kanarese	Hindustani	Marathi	Tamil	Telugu	Lambani (a Gipsy language)	Tulu	English	Others
1	2	3	4	5	6	7	8	9	10
Mysore State, including Civil and Military Station, Bangalore ...	7,144	826	126	415	1,533	75	55	23	44
Mysore State, excluding Civil and Military Station, Bangalore ...	7,269	494	131	349	1,532	77	56	9	43
Eastern Division ...	6,949	508	121	439	2,029	38	...	11	24
Bangalore City ...	2,134	1,239	963	2,157	2,348	3	2	62	72
Bangalore District ...	6,401	643	147	625	2,104	56	...	7	17
Kolar Gold Fields (City) ...	73	475	59	7,720	738	460	491
Kolar District ...	2,577	654	106	617	6,001	18	...	4	23
Tankur District ...	7,857	475	68	60	1,458	41	...	5	18
Mysore City ...	5,226	1,263	632	1,026	956	...	18	40	75
Mysore District ...	2,404	265	54	129	146	2	...	1	5
Chitaldrug District ...	7,297	431	110	37	1,267	125	1	...	33
Western Division ...	8,461	455	158	139	255	199	221	3	96
Hassan District ...	9,098	295	57	179	215	60	78	3	29
Kadur District ...	7,961	443	117	166	378	222	649	6	159
Shimoga District ...	8,126	652	299	77	294	214	102	2	125
Civil and Military Station, Bangalore ...	378	2,291	399	4,179	1,947	...	1	205	147

III.—COMPARISON OF CASTE AND LANGUAGE TABLES.

Tribe	Strength of Tribe. (Table XIII)	Number speaking Tribal language. (Table X)
1	2	3
Koracha	20,705	2,739
Returned as Hindu	6,126	
Do Animist	14,579	
Total	20,705	
Korama	6,283	1,049
Returned as Hindu	165	
Do Animist	6,118	
Total	6,283	
Lambani	51,168	43,667
Returned as Hindu	9,945	
Do Animist	41,223	
Total	51,168	

III-A.—TABLE SHOWING LANGUAGE, BIRTHPLACE, AND CASTE, ETC., FIGURES
IN RESPECT OF CERTAIN LANGUAGES.

Language	Table X	Table XI.	Table XIII
Bengali	58	486	7
Burmese	14	273	(Buddhists)
Coorgi	50	3,071	45,898
Marathi	78,109		731
Marwari	1,247	1,378	61+165 (H) 58+259 (J) 188 (Gujarati)
Tibetan	1		
Tulu	31,995	48,958 (South Kanara)	
Pashto	6	24	
Arabic	274	23	
Armenian	1	2	1
Chinese	10	18	8 (Buddhists)
Hebrew	10		40 (Jews)
Japanese	4	4	4
Danish	9	5	
English	13,120	2,642	13,290
French	130	90	
German	40	52	
Greek	1	1	
Hungary	2	2	
Italian	102	127	
Portuguese	125	2	
Turkish	1	6	

CHAPTER X.

INFIRMITIES.

194. The infirmities regarding which information was collected during the present Census, were, as in 1901, (1) Insanity, (2) Deaf-mutism (from birth), (3) Blindness (total) and (4) Corrosive leprosy. The instructions issued to enumerators on this occasion were also similar to those issued on the previous occasions and were as follows:— General.

“If any person be blind of both eyes, or deaf and dumb from birth, or insane or suffering from corrosive leprosy, enter the name of the infirmity in this column. Do not enter those who are blind of one eye only, or who have become deaf and dumb after birth or who are suffering from white leprosy only.”

There is every reason to believe that the instructions were carefully followed in the districts during the enumeration. The abstraction of the information concerning these infirms was effected in the present Census (1911) by having special slips written for such individuals and by getting these sorted for Imperial Tables XII and XII-A. The result is that the information collected by the enumerators has been accurately tabulated. With all this, it must be admitted that there are certain considerations, arising from the nature of the case, which apply with peculiar force to the accuracy of the statistics of the infirmities with which we are now dealing and the chief of these are:—(1) The information demanded of householders regarding the column of infirmities in the Census Schedule, involves, in cases where the specified infirmities exist, the admission, which one will not willingly make, of the existence of serious and loathsome diseases. Again “Hope rises eternal in the human breast” and if there is the slightest chance of recovery, the existence of the disease is denied. This consideration weighs least in the case of blindness. The reticence is more in the case of afflicted females than in the case of males and more in the case of the young and adolescent than in the case of the old. (2) The diagnosis of the householder or of the householder aided by the enumerator may be wrong. Just as fever is in the language of the ignorant the usual name for general bodily distempers, so in common parlance, any continued mental or nervous affection may be styled ‘insanity’ *e.g.*, hysteria may be confounded with insanity. Just as there is a tendency to return the ages of elderly women as at least a score of years more than their proper age, so dimness of sight in old people may be described as blindness. A retarded development of speech in a weak-headed urchin may not unfrequently be regarded as dumbness while very few non-medical men know that deaf-mutism is the consequence of congenital deafness or complete deafness arising in very early infancy and that the affliction cannot result in after life. Syphilis, scrofula or erisypelas may be taken for leprosy. For instance, “the leprosy commission found that of the persons produced before them as lepers by police inspectors and other non-medical men, about 10 per cent were suffering from diseases other than true leprosy. The error must be still greater when the diagnosis is made by the simple villagers from whose ranks most of our enumerators were drawn.”*

195. After this preliminary caution, so essential for a true criticism of the figures, we shall point out where the statistics are to be found. Statistics.

- (1) Imperial Table XII, Part I, gives for (a) the State including, and (b) the State excluding, the Civil and Military Station, Bangalore, the distribution by age-periods of the infirms. Part II gives the distribution by divisions, districts and cities. A few unfortunate persons

* India Census Report 1901, page 131.

have been found to be afflicted with two or more infirmities. Information regarding these individuals is given in a separate statement at the foot of the table, in which, it may be added, such persons have been shown under each of the infirmities but have been reckoned singly for the purposes of the total afflicted.

- (2) Imperial Table XII-A gives details of the infirms according to caste, tribe or race for (a) the State including, and (b) the State excluding, Civil and Military Station, Bangalore. The population of the caste, etc., is given in a separate column so as to assist in forming an opinion about the significance of the figures.

Proportional figures.

196. The proportional figures worked out from the absolute figures are exhibited in the following Subsidiary Tables:—

- (i) Table I, showing the numbers afflicted per 100,000 of the population at each of the last four Censuses, for the State, divisions, districts and cities.
(ii) Table II, showing the distribution of the infirm by age-periods per 10,000 of each sex.
(iii) Table III, showing the number of afflicted persons per 100,000 of each age-period and also the number of females afflicted per 1,000 males.
(iv) Table IV, showing the number afflicted per 100,000 persons of certain castes, etc., and the number of females afflicted per 1,000 males.

The number of infirms at each Census.

197. The statement A given below shows the number of infirms in the State at each of the Censuses 1871, 1881, 1891, 1901 and 1911. The total population at each period is also given. The proportion per 100,000 at each of the Censuses can be seen from the following statement B. (The figures for 1901 are adjusted by including cases of combined infirmities under each of the infirmities concerned.)

A

Infirmity	Number in				
	1871	1881	1891	1901	1911
Total population ...	5,055,402	4,186,188	4,943,604	5,539,399	5,806,193
Insanity ...	2,980	767	1,089	1,032	1,334
Deaf-mutism ...	6,070	2,610	3,466	3,055	4,472
Blindness ...	7,933	3,926	5,250	4,049	5,749
Leprosy ...	1,497	533	814	672	767

B

Proportion per 100,000 in	Insane		Deaf-mute		Blind		Lepers	
	Males	Females	Males	Females	Males	Females	Males	Females
1871 ...	61	57	123	117	155	159	36	23
1881 ...	22	14	68	56	89	98	16	9
1891 ...	25	19	78	62	108	105	22	11
1901 ...	21	16	62	48	79	67	17	8
1911 ...	26	20	86	68	104	94	18	8

It will be noticed that there has been a sudden fall in the numbers of the infirms in the Census of 1881, a rise in 1891, a fall in 1901 and a rise again in 1911. Examining the material conditions of each decade, we find that the famine of 1876-7 carried off nearly a million of human lives and accounted for a reduction of the infirms from 18,480 persons in 1871 to 7,836 persons in 1881. In the next Census (1891) there was a general increase in every infirmity as compared with the preceding Census. In 1901 there is a decrease again; the reason for this decrease which is marked is not apparent. The large decrease in India generally in 1901 was attributed in many Provinces to the two great famines

(1896-97; 1899-1900) which naturally bore most heavily on persons dependent on charity, as most of the infirm are. (*Vide* the summary given in the Imperial Gazetteer of India, Volume III, pages 501-2, of the famine and scarcity conditions in India since 1769.) None of these extreme conditions affected the Mysore State during the decade, but still there has been a fall in the numbers. Perhaps the figures of 1901 have to be taken with some modification inasmuch as the process of abstraction in 1901 was not uniform in the case of all districts in the State, *e.g.*, in the case of Bangalore, Kolar, Tunkur and Chitaldrug Districts, the infirmity tables were—

“all got up simultaneously by the tick-system. A section consisting of 7 men was formed, one of whom was the Supervisor and the rest tickers. Four of these were asked to note down the various particulars relating to the infirms required for the above tables (XII, XII-A, XII-B, religion and civil condition of the infirm and XII-C literacy and occupation of the infirms), while the fifth read and the sixth simply noted the number of the entry. The results as tested afterwards by sorting have also proved the correctness of the result obtained under the tick-system.” (Mysore Census Administrative Report, 1901, page 276.)

In the case of Mysore, Hassan, Kadur and Shimoga Districts, “The slips relating to the infirms were sorted; but * * * it was found that the infirm slips (were much fewer in number than the afflicted population counted at the examination of the schedules. * * * By the frequent stitchings which the schedule books had undergone in the course of the examination of the returns and the serial numbering thereof, several of the short infirmity entries had got hidden into the stitch and escaped the notice both of the slip-writer and of the checker. Thereupon the schedule books were opened out and a separate set of slips was copied out, in respect of the whole of the infirm population.” (Mysore Census Administrative Report 1901, page 299.)

198. Thus, in the absence of any reason being assigned for the fall in 1901 and owing to want of uniformity in the methods of abstraction adopted then, it must be said that the figures of the present Census have, in order to convey a correct idea, to be compared not only with the figures for 1901 but with the figures of other Censuses as well. Improvement in the material condition of the people, better sanitation and (especially in the case of blindness) cures effected with the aid of modern medical and surgical science, have brought down the rate of increase very considerably, as compared with the figures of 1871. The operation of these causes has had so far a negative effect because in India the institution of marriage is as open to afflicted persons as to ordinary people. The use of a special infirmity slip was resorted to on the present occasion (*vide* para 195 *supra*) and to the greater accuracy of tabulation resulting therefrom may also be ascribed a slight increase.

The number of infirms at each Census (contd.)

INSANITY.

199. Taking the case of insanity, we have the numbers comparing as follows:—

Statistics of insanity examined.

Insane	1871	1881	1891	1901	1911
Persons	2,980	767	1,089	1,092	1,334
Males	1,546	466	628	601	764
Females	1,434	301	461	431	570

The proportion of females to 1,000 afflicted males in each Census is given below.

Insane	1871	1881	1891	1901	1911
Proportion of females to 1,000 males afflicted	928	646	734	717	746

According to the figures furnished for the Lunatic Asylum, Bangalore, there were 270 lunatics there on 31st December 1901 against 180 on 31st December

1911, the numbers of criminal lunatics on the same dates being 42 and 24 respectively. The excess number in 1901 is due to observation cases of alleged insane persons being included as insane as was in vogue prior to 1904. An analysis of admissions according to localities in the State is embodied below.

District	Number of insanes (Imperial Table XII)	Admissions in 1911	Remarks
Bangalore District, including City ...	345	30	179 who were under treatment at the Asylum are included in the figures for Bangalore District.
Kolar District, including Kolar Gold Fields (City) ...	198	6	
Tumkur District ...	121	4	
Mysore District, including City ...	234	6	
Chitaldrug District ...	171	1	
Hassan District ...	79	3	
Kadur District ...	44	1	
Shimoga District ...	130	1	
Civil and Military Station; Bangalore ...	12	14	

Regarding the causes of insanity, the following remarks are taken from the report on the working of the Lunatic Asylum during the year 1911:—

“Taking the admissions of the last decade (1901-10) there were altogether 596 admissions, of whom the cause of insanity was known in 283 cases, 56 being due to moral causes and 227 to physical. Out of the latter, intoxicants, *e.g.*, alcohol and *ganja*—contributed 83 or 36·56 per cent, epilepsy 38, congenital or hereditary 17, masturbation 14, child-birth 11, overstudy 7 and other physical causes 57.” “It may be noted from the figures of the ‘remaining’ column under *ganja* and spirit in Statement VII, that there are more under ‘*ganja*’ than under ‘spirit,’ showing that the different types of insanity due to ‘*ganja*’ tend to become chronic and are not easily curable whereas those due to ‘spirit’ get well and the persons so affected will become useful members of society.”

Distribution of the insane by locality.

200. The accompanying inset map shows the proportion of the afflicted to the total population of each district in the present Census. It will be seen that the proportion is the highest in Bangalore District (including Bangalore City and the Civil and Military Station, Bangalore), and lowest in Kadur District. The proportion in Bangalore City even after deducting the number of lunatics born outside Bangalore District and enumerated in the Lunatic Asylum, works up to 152 males and 117 females per 100,000 of the population. (*Vide* note to Subsidiary Table I). This may be due to the ignorance on the part of the guardians of alleged lunatics, of the rule that on an order being passed by the District Magistrate, the District Surgeon may detain and observe the person, before the person is admitted into the Lunatic Asylum at Bangalore, in consequence of which alleged insane people are brought in numbers to Bangalore City for observation. The following statement indicates the order of districts in each Census,

MAP OF MYSORE.

Showing the proportion of the insane to the total population of each District.

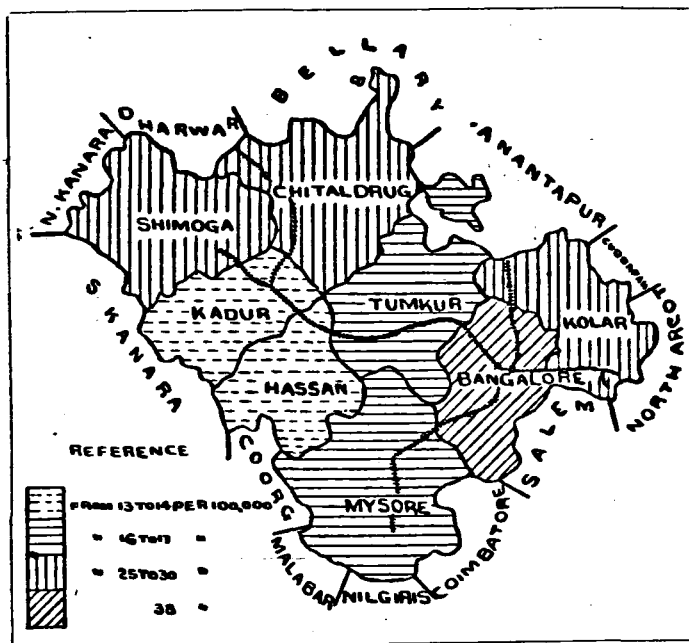

the District Surgeon may detain and observe the person, before the person is admitted into the Lunatic Asylum at Bangalore, in consequence of which alleged insane people are brought in numbers to Bangalore City for observation. The following statement indicates the order of districts in each Census,

beginning with the lowest according to the proportion of the insane per 100,000 of population.

District	Number indicating order beginning with the lowest according to proportion of insane per 100,000 of population in				
	1871	1881	1891	1901	1911
Kadur District	1	4	3	1	1
Hassan District	2	1	2	2	2
Mysore District including City	3	2	4	4	4
Bangalore District including Civil and Military Station	4	8	8	8	8
Shimoga District	5	7	7	7	5
Tumkur District	6	6	1	3	3
Chitaldrug District	7	5	6	6	7
Kolar District including Kolar Gold Fields (City)	8	3	5	5	6

201. The diagram given in the margin shows the number of persons afflicted per 100,000 persons of decennial age-periods. Separate curves are drawn for males and females at the present and 1901 enumerations. The excess of males over females is most noticeable between the ages of 20 and 50. The numbers of the insane between the ages 10 and 40 form a little more than 60 per cent of the total insane. Comparing the numbers at age-periods 10-15 onwards of the insane at the present Census with the numbers at age-periods 0-5 onwards of 1901, we find that the increases are all between the ages of 10 and 40 of the present Census.

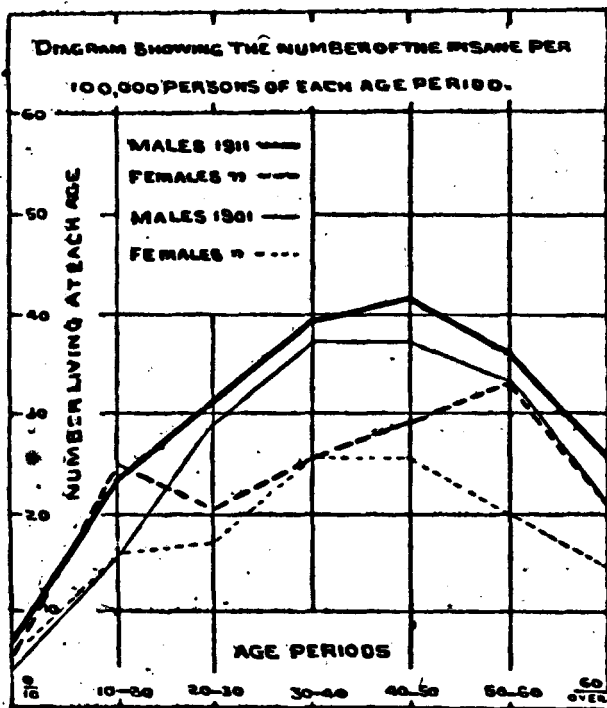

202. The proportionate figure for 100,000 for males only is taken for purposes of comparison as the figures for females may not be so much relied on owing to the chances of concealment of information during enumeration. The highest figure is in the case of tribe of Sheikhs (57) in Musalmans; next come in order Neygi (51), Brahman (48), Kshatriya (47), Indian Christian (45), Pathan (Musalman) (43), and Mahratta (38). The great cultivating caste of Vokkaliga has 22. The custom of marrying in and in perhaps accounts for the high figure in respect of certain castes, tribes and races. The low proportion of the insane in India as compared with the number of such in European countries is attributed to "the very different conditions of life in the East. In Europe the competition between man and man is severe and is yearly becoming more so. The mental wear and tear is very great and the strain on the nervous system deranges many feeble intellects which in the calm and placid East would escape the storms to which they succumb."*

* India Census Report, 1901, page 134.

DEAF-MUTISM.

An examination of the statistics of deaf-mutism.

203. The numbers for the several Censuses compare as follows:—

Deaf-mute				1871	1881	1891	1901	1911
Persons	6,070	2,610	3,466	3,055	4,472
Males	3,124	1,426	1,937	1,735	2,513
Females	2,946	1,184	1,529	1,320	1,959

The proportion of females per 1,000 afflicted males in each Census is indicated hereunder:—

Deaf-mute		1871	1881	1891	1901	1911
Proportion of females to 1,000 males afflicted	...	943	830	789	761	780

“As in the case of other forms of congenital malformation, so also, with deaf-mutes, males in all countries suffer more than females.”† The figures of the statement above given illustrate this dictum. That insanity is found to co-exist with deaf-mutism seems probable from the fact that 40 such cases have been found in the present Census.

Relief for the deaf-mute and the blind.

204. To brighten the cheerless lot of these unfortunates as well as the blind, a school was started in Mysore City in October 1901 which has been doing philanthropic work ever since. In 1904 a hostel was attached to the school wherein inmates are lodged, fed and clothed free of cost. The American method of oral teaching is adopted for teaching the deaf-mutes, and drawing, weaving, sewing, knitting and mat-making are the industries taught them. The blind are taught the three R's by the Braille Method. Music, vocal and instrumental, rattan-work and tape-weaving form part of the curriculum for the training of these. The school is considered as a model institution and in 1908 teachers from Baroda State were deputed to study the methods of instruction imparted here. The handicraft of the pupils has won medals and certificates of merit in the local exhibitions and the Nagpur Exhibition of 1908. The Head Master in charge is a graduate who has made a study of the systems of teaching adopted in the Deaf and Dumb Schools of Calcutta and Bombay. It is interesting to note that in the class for the deaf-mute there were during the official year 1909-10, 14 boys and in the class for the blind 17.

Local distribution of the deaf-mutes.

205. The distribution per 100,000 of the population in each district is illustrated in the following inset map, the proportionate figure ranging from 70 in Kolar District to 87 in Kadur District.

MAP OF MYSORE.

Showing the proportion of the deaf-mute to the total population of each district.

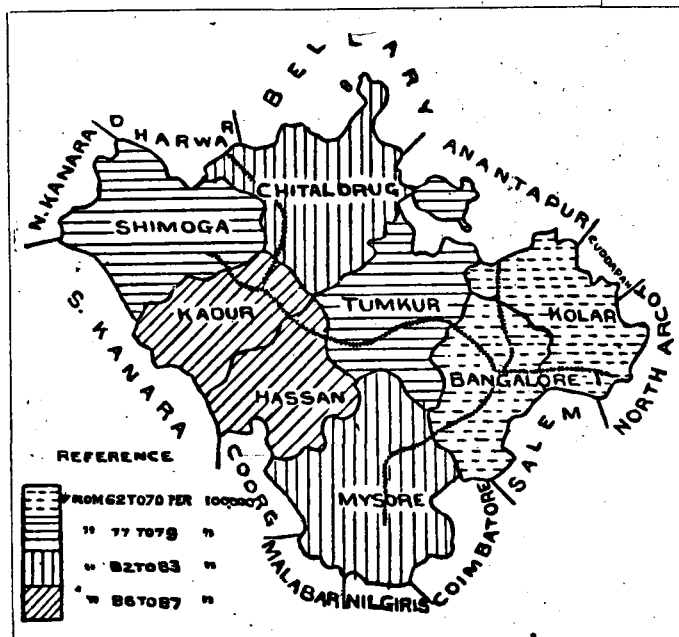

It is noteworthy that the variation in this number is not so marked between district and district as in the case of the other infirmities. This points to a general prevalence of the infirmity in all parts of the State.

† India Census Report, 1901, Chapter IV, page 149.

206. The diagram inserted in the margin shows the curves for both sexes in 1901 and 1911 for persons per 100,000 of population, living at the decennial age-periods. The deaf-mutes are generally short-lived as is seen by the rapid fall of the curve from age-period 20-30 onward.

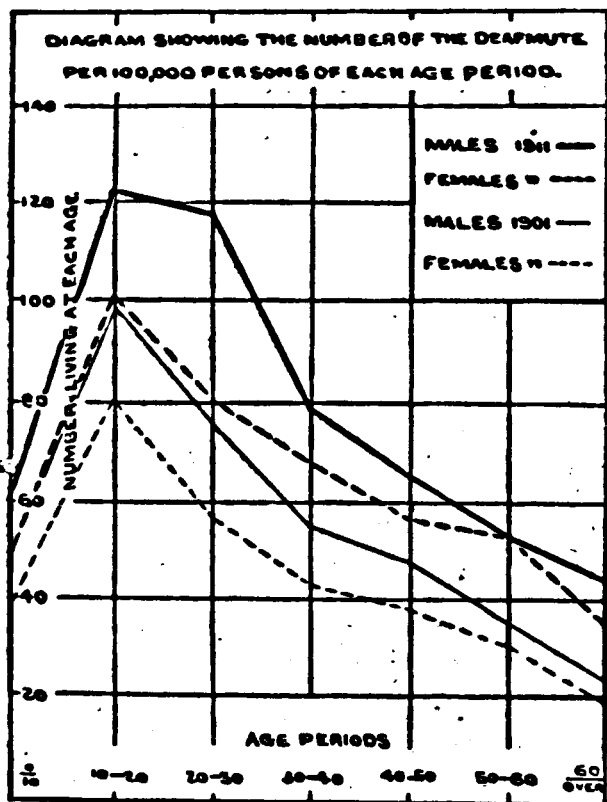

207. Deaf-mutism seems to be more prevalent among Hindus than among the followers of other religions. Among the Hindus, the following castes have the proportionate figure (for 100,000 of population) in the case of males higher than the average (86) for the State:—

District	Number indicating order showing prevalence of deaf-mutism beginning with the lowest in				
	1871	1881	1891	1901	1911
Kadur District	1	5	2	3	8
Shimoga District	2	2	1	2	4
Mysore District, including City	3	1	6	4	5
Hassan District	4	4	8	5	7
Chitaldrug District	5	8	5	7	6
Bangalore District, including City and Civil and Military Station	6	3	4	1	1
Tumkur District	7	7	3	8	3
Kolar District, including Kolar Gold Fields (City)	8	6	7	6	2

Prevalence of deaf-mutism in religion and caste. Panchala (123), Brahman (111), Vodda (107), Agasa (94), Ganiga (94), Vakkaliga (89), Lingayat (88), Madiga (88) and Tigala (88). Consanguineous marriages which are usually favoured by custom among certain Hindu castes may be responsible in some degree for the occurrence of this infirmity among the progeny. The marginal statement gives the order, beginning with the lowest, in which deaf-mutism was prevalent in districts in the several Censuses.

BLINDNESS.

208. The numbers returned at the several Censuses are given in the following statement:—

Blind	1871	1881	1891	1901	1911
Persons	7,933	3,926	5,250	4,049	5,749
Males	3,923	1,866	2,673	2,216	3,055
Females	4,010	2,060	2,577	1,833	2,694

Significance of the figures

The next statement gives the proportion of females to 1,000 afflicted males at each Census:—

Blind	1871	1881	1891	1901	1911
Proportion of females to 1,000 males afflicted...	1,022	1,104	964	827	882

Curiously enough, the figure for 1881 is the highest, coming as the enumeration does next after the famine of 1876-7. The reason* for this phenomenon seems to be that females are better able than males to resist the ill effects of famine.

"The most potent reason seems to be that after reaching maturity women are constitutionally stronger than men, and have, besides, more fat and less muscle in their composition so that they not only need a smaller quantity of food to support their frames but are also better able to endure the wasting process."*

Distribution by districts of the blind.

209. It will be seen from the inset map given here that the proportion of

MAP OF MYSORE.

Showing the proportion of the blind to the total population of each district.

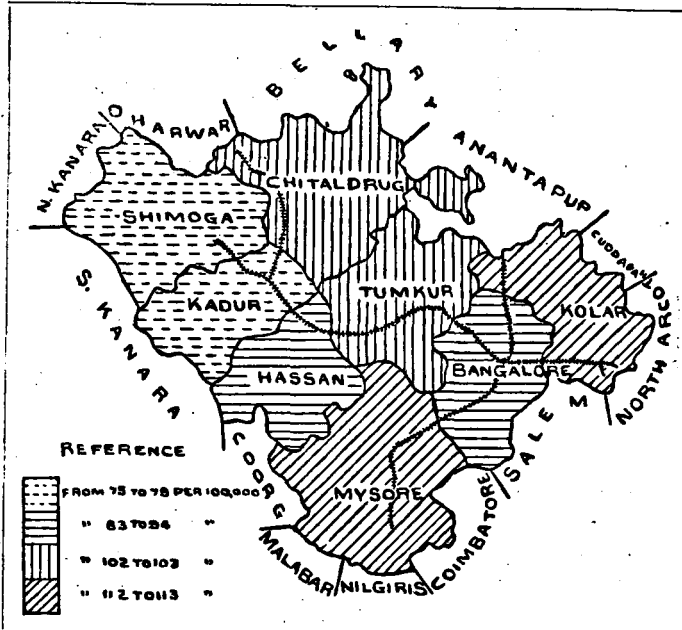

the blind per 100,000 of the population varies from 75 in the Shimoga District to 112 in the Kolar District and 113 in the Mysore District. Blindness depends more than the other infirmities, on (i) occupation, (ii) habitation and (iii) locality. So far as the statistics of locality are concerned (*vide* the following table which gives the order of districts showing the prevalence of blindness at each Census), they do not admit of any definite deduction being drawn. The proverbially ill-ventilated and ill-lit habitations of rural tracts would naturally be expected to have a very unwholesome effect on the eye-sight of the dwellers but for the

fact that most of these, being agriculturists, spend their time in the open. Continuous and frequent exposure to the glare of the sun and to dust too has its

District	Number indicating order beginning with the lowest, showing prevalence of blindness in—				
	1871	1881	1891	1901	1911
Kadur District	1	3	1	1	2
Bangalore District (including Civil and Military Station and Bangalore City)	2	5	6	5	4
Hassan District	3	2	3	3	3
Mysore District (including City)	4	1	5	7	8
Shimoga District	5	4	2	2	1
Chitaldrug District	6	8	4	4	6
Kolar District (including Kolar Gold Fields City.)	7	7	8	8	7
Tumkur District	8	6	7	6	5

evil effects as is seen by the excessive proportion per 100,000 borne to the average (104) by males of such castes as Uppara (127), Kuruba (126), Agasa (120), Vakkaliga (116), Lingayat (115) and Tigala (113). Sedentary occupations have their effects also, *e.g.*, in the case of males, Neygi (132) and Brahmans (126). Loss of sight owing to small-pox is very rare nowadays considering the extent to which vaccination has been rendered popular

and accessible even in remote parts. Much has been done by the State in recent years to alleviate the sufferings of the eye. An Eye Infirmary, equipped with the

Decade	Cataract operations
1881-1891	72
1891-1901	545
1901-1911	3,008

most up-to-date appliances and directed by a Specialist, has been located at Bangalore and has been doing excellent work. The figures in the appended table show the number of successful cataract operations in the decades 1881-

1891, 1891-1901 and 1901-1911, in the several hospitals and dispensaries in the State.

One fruitful source of loss of vision is the neglect of the common disease Ophthalmia, which comes in every year with the mango season and the 'eye-fly.'

* India Census Report, 1901, Chapter III, page 120.

Neglect develops granules and granules impair, in course of time, the vision. Cataract in advancing years is another frequent cause of eye-sight being impaired.

210. The blind after the age of 50 form very nearly one-third of the total

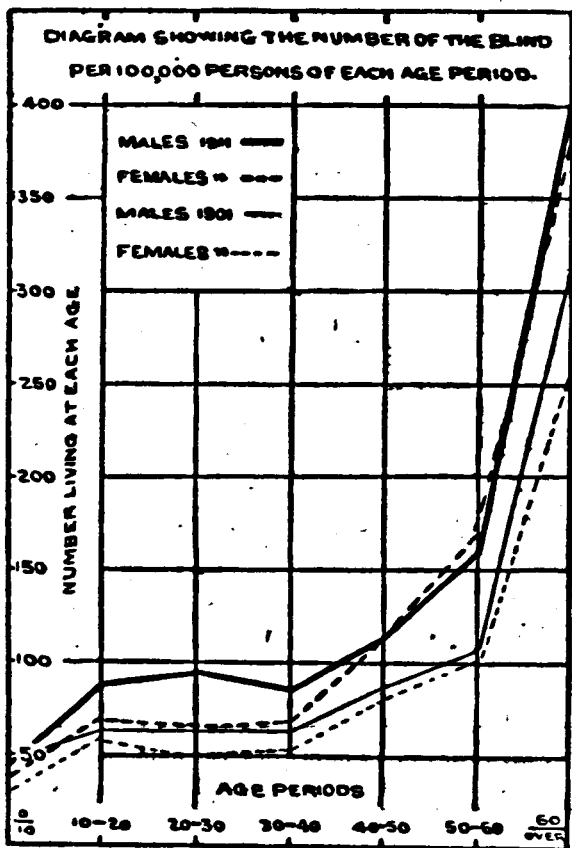

number of blind persons returned. In fact the diagram given shows that the proportionate number (per 100,000) of the blind in age-period '60 and over' is more than twice the number in the preceding age-period. In the actual figures we find that though, for all ages, there are 3,055 males and 2,694 females, after the age 50 there are only 1,011 males and 1,024 females.

Distribution by age and sex of the blind.

"The larger proportion of females at the higher ages seems to be due partly to the fact that females are less ready to seek medical aid and partly to the circumstance that with them congenital blindness is more rare, and there is thus a larger proportion of cases where it is due to external conditions, such as glare, dust and smoke which operate gradually and do not finally destroy the sight until people are well advanced in life. It is also just possible that a certain amount of blindness amongst young girls may have escaped registration."†

LEPROSY.

211. The numbers of lepers at each Census are given in the following statement:—

Lepers	1871	1881	1891	1901	1911
Persons	1,497	539	814	672	767
Males	912	340	544	463	528
Females	585	193	270	209	239

The proportion of females to 1,000 males afflicted is shown in the margin.

Lepers	1871	1881	1891	1901	1911
Proportion of females to 1,000 males afflicted.	641	568	496	451	458

There is a Leper Asylum located in Bangalore City into which any one who seeks admission for treatment is taken. The treatment is regulated according to the necessities of the case.

Nastin treatment is not adopted; the Senior Surgeon to Government remarked in his Report on the working of the Asylum for 1909:—"After careful enquiry, I find Nastin treatment highly unsatisfactory." The number actually in residence at the beginning of the year 1901 was 17 and at the end of the year 1911, 25.

† India Census Report, 1901, page 142.

Local distribution of leprosy.

212. A reference to the inset map given here shows that the proportion of lepers to 100,000 of population varies from 5 in Hassan District to 23 in Bangalore and Kolar Districts. The relative place of each district from the point of view of the prevalence of the infirmity at the several Censuses is indicated below :—

MAP OF MYSORE.

Showing the proportion of the lepers to the total population of each district.

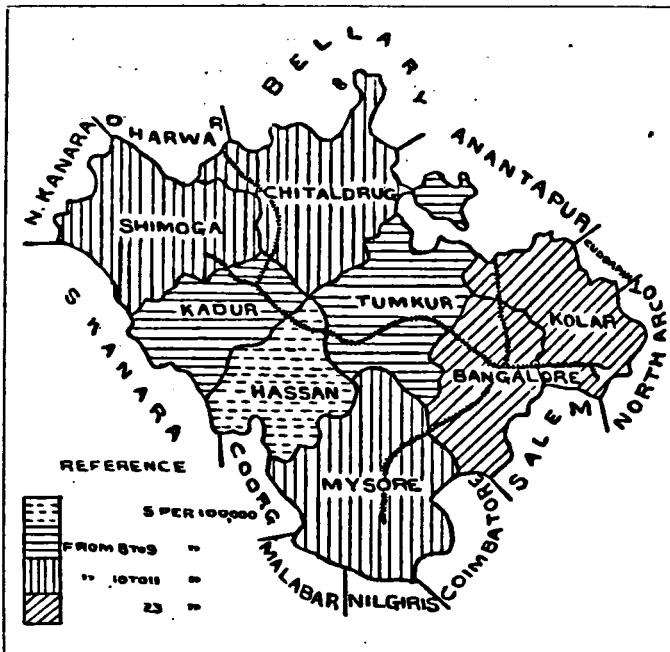

District	Number indicating order of district, beginning with the lowest showing prevalence of leprosy in				
	1871	1881	1891	1901	1911
Mysore District, including City ...	1	6	5	6	4
Hassan District ...	2	5	6	3	1
Kadur District ...	3	3	1	1	3
Chitaldrug District ...	4	1	4	2	6
Tumkur District ...	5	2	2	4	2
Shimoga District ...	6	4	3	5	5
Bangalore District, including City and Civil and Military Station, Bangalore ...	7	8	7	7	7
Kolar District, including Kolar Gold Fields (City) ...	8	7	8	8	8

From this statement it is seen that the proportion of lepers is highest in the two districts of Kolar and Bangalore at all the Censuses. The chief taluks that show large numbers in these two districts are :—Hoskote (45), Devanhalli (39) and Bangalore (36), in the Bangalore District; and Kolar (29), Malur (27), Sidlaghatta (26) and Chintamani (21) in the Kolar District. No data are available as regards the prevalence of the infirmity in taluks at the Census of 1881, 1891 and 1901, and the figures by taluks of 1871 do not stand comparison with the present figures for the reason, *inter alia*, that the boundaries of taluks have undergone great changes since then. An examination of the slips and compilation registers shows the disease to be rife in the country between the upper waters of the Southern Pennar and the Palar, chiefly in the tracts mentioned in the margin.

Taluk	Hobli (Revenue Circle)
Bangalore Taluk ...	Vartur. Yeswantapur. Uttarahalli. Begur. Hessarghatta.
Hoskote Taluk ...	Bidarahalli. Sulibele. Jadigenahalli.
Devanhalli Taluk ...	Vadigenhalli. Channarayapatna. Jala.
Kolar Taluk ...	Vakkaleri. Vemgal. Holur.
Malur Taluk ...	Narasapura. Lakkuru.
Chintamani Taluk ...	Kaivara. Ambajidurga.
Sidlaghatta Taluk ...	Sidlaghatta. Jangankote.

The proportion of the lepers in the two districts to the total population of the districts is 24 per 100,000 (the figure for the whole State being 13), whereas in the seven taluks named above the proportion to the population of the tract is 41 per 100,000. The marginal statement shows the population, number of lepers and the proportion of afflicted males and females to 100,000 of population.

Taluk	Population	Lepers	Proportion of afflicted to 100,000 of population	
			Males	Females
Bangalore	119,836	36	23	6
Hoskote	75,690	45	47	11
Devanahalli	62,692	39	41	27
Kolar	60,691	29	23	12
Malur	68,931	27	29	10
Chintamani	62,077	21	22	11
Sidlaghatta	70,895	26	26	9

213. The following diagram shows the number of the lepers per 100,000 of the population living at each decennial age-period. Comparing the numbers of lepers in age-periods 10-15, etc., of this Census, with the numbers of age-periods 0-5, etc., of 1901, we find an increase in the numbers of 1911 in all the age-periods up to the age of 55.

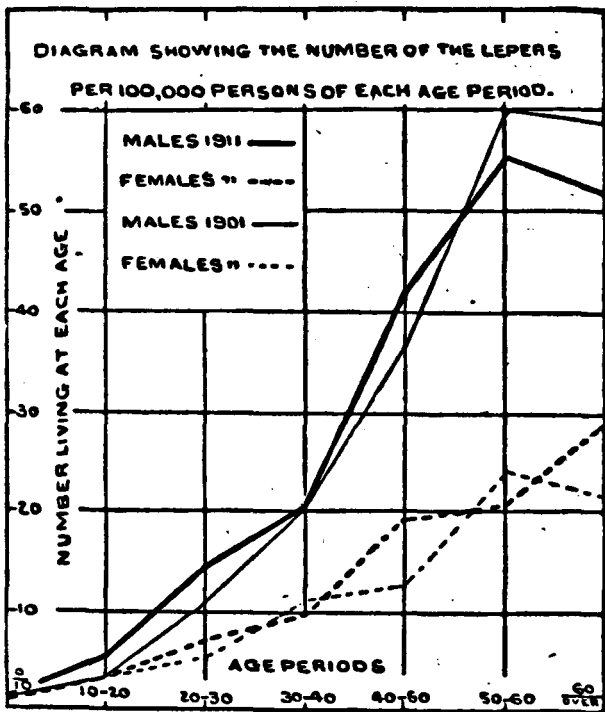

214. An examination of Subsidiary Table IV shows that leprosy is fairly prevalent in all castes. As the increase is found spread among persons of such different castes as Agasa, Beda, Golla, Holeya, Madiga, Vakkaliga, etc., in the area mentioned as specially affected in the foregoing paragraph, no inference can be drawn of the prevalence of the infirmity in particular castes. Above all, it must be remembered that the disease is seldom owned to by people who can, owing to their easy circumstances in life, help doing so.

215. The proportion of infirms to 100,000 of population is in the Mysore State 211; in Bombay it is 273; and in Madras 218. In Bombay there seems to be a greater proportion of the insane, blind and lepers than in Mysore, while in Madras there is a greater proportion of deaf-mutes and lepers than in Mysore. Judged by the figures of the preceding Censuses, the numbers afflicted are not increasing to what they were prior to the famine of 1876-7. Locality has almost nothing in particular to do with the prevalence or spread of these diseases; nor can the castes or peoples of Mysore be said to observe any particular customs or social practices tending to the same, apart from what are involved in the caste *jus cunnubii*, common to castes all over India.

SUBSIDIARY TABLES.

I.—NUMBER AFFLICTED PER 100,000 OF THE POPULATION AT EACH OF THE LAST FOUR CENSUSES.

District and Natural Division	Insane								Deaf-Mute							
	Male				Female				Male				Female			
	1911	1901	1891	1881	1911	1901	1891	1881	1911	1901	1891	1881	1911	1901	1891	1881
1	2	3	4	5	6	7	8	9	10	11	12	13	14	15	16	17
Mysore State, including Civil and Military Station, Bangalore.	26	21	25	22	20	16	19	14	26	62	78	68	53	48	62	56
Mysore State, excluding Civil and Military Station, Bangalore.	26	22	25	Not available	20	16	19	Not available	27	63	78	Not available	69	49	63	Not available
Eastern Division ...	29	25	28	Do	21	17	20	Do	25	64	81	Do	66	49	64	Do
Bangalore City ...	235*	534	65	...	157*	203	83	...	83	56	76	...	40	60	64	...
Bangalore District ...	21	14	...	50	18	14	...	26	78	49	...	72	57	43	...	52
Kolar Gold Fields (City)	11	4	25	27	10	13
Kolar District ...	28	20	24	16	25	19	17	7	80	65	87	70	66	50	65	63
Tumkur District ...	19	13	13	24	14	11	10	20	83	78	71	73	70	59	57	64
Mysore City ...	19	26	18	...	26	33	18	...	94	52	85	...	26	24	68	...
Mysore District ...	19	14	...	13	15	10	...	9	94	66	...	53	73	42	64	47
Chitaldrug District ...	36	21	23	19	25	18	18	14	91	70	87	84	75	58	64	79
Western Division ...	19	12	18	18	16	12	13	13	91	68	71	70	77	47	59	54
Hassan District ...	15	7	13	10	12	9	15	7	96	66	96	75	76	47	74	52
Kadur District ...	13	9	17	16	13	4	17	11	93	69	58	78	80	46	51	50
Shimoga District ...	28	20	24	27	23	21	20	21	83	60	55	60	75	48	47	58
Civil and Military Station, Bangalore.	10	11	20	Not available	14	13	3	Not available	27	20	58	Not available	20	13	38	Not available

District and Natural Division	Blind								Lepers							
	Male				Female				Male				Female			
	1911	1901	1891	1881	1911	1901	1891	1881	1911	1901	1891	1881	1911	1901	1891	1881
	18	19	20	21	22	23	24	25	26	27	28	29	30	31	32	33
Mysore State, including Civil and Military Station, Bangalore.	104	79	108	89	94	67	105	98	18	17	22	16	8	8	11	9
Mysore State, excluding Civil and Military Station, Bangalore.	105	80	109	Not available	95	67	106	Not available	18	16	22	Not available	8	8	11	Not available
Eastern Division ...	115	88	120	Do	99	74	117	Do	21	20	26	Do	9	9	12	Do
Bangalore City ...	70	61	124	...	40	33	119	...	28*	42	19*	33	21	...
Bangalore District ...	113	81	...	104	101	73	...	104	96	95	47	88	12	13	...	15
Kolar Gold Fields (City)	18	27	34	13	4	5
Kolar District ...	135	110	143	121	101	84	141	123	35	37	44	22	13	16	18	12
Tumkur District ...	107	64	110	87	97	77	123	135	8	9	7	6	8	4	8	6
Mysore City ...	125	79	117	...	77	68	103	...	11	9	17	...	3	6	8	...
Mysore District ...	119	88	...	72	107	78	...	63	15	12	...	13	5	6	...	12
Chitaldrug District ...	111	82	106	118	98	56	108	145	16	4	16	6	6	4	5	5
Western Division ...	76	59	80	76	82	49	78	84	10	8	13	12	7	4	7	6
Hassan District ...	77	65	105	83	89	57	95	72	5	8	19	16	5	5	8	6
Kadur District ...	76	50	55	59	84	46	69	101	11	3	8	11	7	1	2	3
Shimoga District ...	76	58	74	81	74	42	65	87	13	11	10	9	8	6	11	7
Civil and Military Station, Bangalore.	33	42	58	Not available	37	49	54	Not available	14	29	16	Not available	8	4	8	Not available

* Note.—The corrected proportions for Bangalore City after deducting the number of lunatics and lepers born outside Bangalore District and enumerated in the Asylums of the Bangalore city are for 1911 (vide columns 2, 6, 26 and 30) 152, 117, 22 and 7 respectively. The uncorrected proportional figures are marked with asterisks.

II.—DISTRIBUTION OF THE INFIRM BY AGE PER 10,000 OF EACH SEX.

Age	Insane								Deaf-Mute							
	Male				Female				Male				Female			
	1911	1901	1891	1881	1911	1901	1891	1881	1911	1901	1891	1881	1911	1901	1891	1881
	2	3	4	5	6	7	8	9	10	11	12	13	14	15	16	17
All ages	10,000	10,000	10,000	10,000	10,000	10,000	10,000	10,000	10,000	10,000	10,000	10,000	10,000	10,000	10,000	10,000
0-5	65	50	143	64	159	255	195	38	247	363	459	276	267	294	543	379
5-10	537	499	637	647	491	577	369	532	1,446	1,752	1,415	1,431	1,460	1,871	1,341	1,613
10-15	1,113	649	557	773	1,333	1,044	624	797	1,771	2,115	929	1,795	1,766	2,030	1,073	1,621
15-20	929	699	780	730	1,299	869	759	1,063	1,269	1,269	1,043	1,031	1,263	1,061	963	1,157
20-25	1,066	649	924	2,253	1,223	629	824	2,369	1,254	916	1,023	2,012	1,129	694	850	1,633
25-30	916	1,291	1,178	2,596	579	789	954	2,492	1,047	690	800	1,267	863	677	644	1,031
30-35	1,004	1,291	1,063	2,596	912	1,246	1,245	2,492	649	778	673	1,267	765	765	696	1,031
35-40	995	1,215	1,210	2,596	737	928	953	2,492	577	519	573	1,267	531	523	556	1,031
40-45	1,034	1,015	1,226	1,717	947	1,114	1,026	963	449	549	609	954	546	523	755	836
45-50	746	652	644	1,717	544	626	673	963	362	311	372	954	296	290	356	836
50-55	655	616	557	751	660	672	803	697	299	306	490	519	309	309	490	697
55-60	314	466	319	751	245	255	222	697	143	93	274	519	139	174	229	697
60 and over	602	499	542	429	667	560	954	854	306	196	1,141	603	227	235	1,164	752

Age	Blind								Lepers							
	Male				Female				Male				Female			
	1911	1901	1891	1881	1911	1901	1891	1881	1911	1901	1891	1881	1911	1901	1891	1881
	18	19	20	21	22	23	24	25	26	27	28	29	30	31	32	33
All ages	10,000	10,000	10,000	10,000	10,000	10,000	10,000	10,000	10,000	10,000	10,000	10,000	10,000	10,000	10,000	10,000
0-5	292	422	524	295	390	366	369	199	76	86	73	...	167	...	296	103
5-10	707	1,151	670	622	642	911	667	556	76	43	129	206	167	191	222	62
10-15	907	1,133	693	841	857	993	555	600	246	173	331	358	293	144	332	311
15-20	953	663	602	606	790	666	516	573	417	194	515	568	602	479	630	623
20-25	631	562	561	1,527	720	556	543	1,374	625	369	478	1,412	670	526	406	1,658
25-30	730	623	658	1,527	546	573	594	1,374	662	516	625	1,412	711	479	652	1,658
30-35	609	722	673	1,334	546	622	601	1,306	644	621	717	2,294	962	1,059	1,186	2,299
35-40	494	496	602	1,334	466	465	536	1,306	633	972	1,268	2,294	502	1,053	615	2,299
40-45	664	666	700	1,404	746	791	839	1,456	1,307	1,015	1,305	2,353	1,339	957	1,370	1,917
45-50	514	510	629	1,404	494	502	574	1,456	1,250	1,404	1,011	2,353	921	1,059	1,111	1,917
50-55	700	650	609	1,126	639	720	795	1,466	1,362	1,577	1,140	1,647	1,172	1,575	869	1,299
55-60	344	325	531	1,126	360	415	646	1,466	739	1,015	609	1,647	502	670	779	1,299
60 and over	2,265	2,017	2,447	2,246	2,602	2,400	2,324	2,379	1,723	1,793	1,599	1,147	2,052	1,722	1,111	1,710

N. B.—Figures under "age not stated" for 1891 have been included in 60 and over.

III.—NUMBER AFFLICTED PER 100,000 PERSONS OF EACH AGE PERIOD AND NUMBER OF FEMALES AFFLICTED PER 1,000 MALES.

Age	Number afflicted per 100,000								Number of females afflicted per 1,000 males			
	Insane		Deaf-Mute		Blind		Lepers		Insane	Deaf-Mute	Blind	Lepers
	Male	Female	Male	Female	Male	Female	Male	Female				
	2	3	4	5	6	7	8	9	10	11	12	13
All ages	26	29	26	68	184	94	12	8	746	739	882	463
0-5	1	2	16	20	24	29	1	1	1,000	1,161	1,213	1,000
5-10	11	7	102	74	59	46	1	1	604	765	601	1,000
10-15	23	22	121	99	73	66	4	2	694	778	634	528
15-20	26	29	126	104	107	84	6	5	1,042	770	732	546
20-25	33	26	124	69	100	73	12	6	643	746	764	426
25-30	29	14	110	74	94	64	15	7	471	648	659	472
30-35	37	25	78	71	69	70	16	11	675	920	790	676
35-40	41	27	79	67	68	61	24	6	558	717	634	373
40-45	42	31	66	61	112	114	37	10	604	670	962	464
45-50	42	26	67	58	115	119	46	20	544	627	647	328
50-55	37	37	56	57	129	169	54	21	940	1,013	1,056	394
55-60	34	24	51	47	150	167	66	21	502	750	924	305
60 and over	26	21	44	26	260	294	52	28	625	681	1,013	529

IV.—NUMBER AFFLICTED PER 100,000 PERSONS OF EACH CASTE AND NUMBER OF FEMALES AFFLICTED PER 1,000 MALES.

Caste	Number afflicted per 100,000								Number of females afflicted per 1,000 males			
	Insane		Deaf-Mute		Blind		Lepers		Insane	Deaf-Mute	Blind	Lepers
	Male	Female	Male	Female	Male	Female	Male	Female				
1	2	3	4	5	6	7	8	9	10	11	12	13
Hindu.												
Agasa	22	29	94	74	120	83	14	6	1,273	783	678	429
Banajiga	27	21	91	76	100	106	30	12	778	820	1,045	400
Beda	29	24	83	68	111	96	24	12	800	805	848	485
Beata	23	13	66	52	92	98	13	5	588	738	1,069	400
Brahman	48	25	111	76	126	107	13	10	511	670	631	769
Ganiga	39	20	94	55	123	89	15	...	500	579	720	...
Golla	23	24	85	57	112	98	22	11	1,000	646	849	471
Holeya	16	13	63	66	76	89	25	8	776	779	1,140	321
Idiga	25	26	76	106	60	90	10	...	1,000	1,333	1,417	...
Kahattriya	47	21	78	64	109	81	5	16	444	800	714	3,000
Kumbara	19	29	80	49	84	200	9	15	1,500	588	2,278	1,500
Kuruba	14	13	65	66	126	103	14	7	964	779	616	500
Lingayat	26	17	88	75	115	119	15	9	649	851	1,031	607
Madiga	21	20	88	75	91	79	28	12	909	839	645	433
Mahratta	38	18	71	68	117	64	13	9	444	862	500	667
Nayinda	15	15	65	51	110	77	20	5	1,000	769	682	250
Neygi	51	31	78	63	132	104	23	8	600	749	781	364
Panchala	24	14	123	88	103	96	14	3	563	679	882	223
Tigala	26	24	88	68	113	38	11	12	849	742	325	1,000
Uppara	24	15	77	63	127	103	11	4	615	810	797	333
Vaisya	15	16	7	16	7	1,000	2,000	...
Vodda	25	23	107	87	80	67	14	3	489	782	810	200
Vakkaliga	22	19	89	74	116	98	15	8	644	836	841	495
Musalman.												
Saiyid	20	29	69	22	59	47	23	11	1,333	286	722	429
Sheikh	57	33	63	34	64	49	22	4	522	500	712	150
Pathan	43	14	64	47	98	47	26	5	300	667	435	111
Christian.												
Indian Christian.	45	63	62	27	62	58	8	31	1,273	400	867	3,500
Animist.												
Lambani	28	15	75	35	84	76	14	...	500	438	533	...

Note.—The proportional figures relate to each sex of each caste, etc.

CHAPTER XI.

CASTE.

216. Religion and caste are so intertwined in the economy of the social organisation in India that it is difficult to say with respect to any division of the Hindu community, where religious ordinance ends and caste control begins. Therefore, in order to comprehend, the "population and breed of men" of India, it is essential to understand the caste system of the Hindus and to gain thus an insight into the working beliefs, practices and observances, social and religious, of the millions of people comprised under the common designation 'Hindu.' Considered in this light, the present chapter is but a complement of the chapter on Religion (Chapter IV), and the one will have to be read with the other to get a clear idea of the matter dealt with in either. An attempt will be made in this chapter to study the caste system as it is found in the State, a study, which, it is frankly confessed, considering the vastness and the importance of the subject and the occasion of a report such as this is, must necessarily be cursory and subject to the qualifications insisted on by M. Senart that no statement that can be made on the subject of caste can be considered as absolutely true and that the apparent relations of facts admit of numerous shades of distinction.

Preliminary remarks and the accuracy of the caste return.

The first step to be taken is to have a correct appreciation of the statistics of caste as contained in Imperial Table XIII, of what it contains and of what it does not contain. One of the most difficult tasks in a Census is to obtain a correct enumeration of the entries of the 'Caste' column and thereafter to compile the information thus collected. The magnitude of the task must be the apology for any shortcomings in the list of castes, etc., as published in the table. Column 7 of the schedule was in the present Census divided into two sub-columns, so that the caste and sub-caste entries might be recorded separately. The instructions regarding the 'Caste' sub-column were:—'Enter the main caste of Hindus and Jains; and the main race or tribe of others.' Regarding the sub-column of 'Sub-caste,' they were:—'Enter the sub-division of the caste or tribe, if any such be returned.' The question that was to be put to the householder regarding caste entries ran thus: '(In the case of Hindus and Jains) mention the name of the caste and the sub-caste by which you are commonly known. (For other than Hindus and Jains) mention the name of the tribe or race to which you belong.' As a guide to the enumerator the names of the castes and chief sub-castes of castes returned in the Census of 1901, were printed below the specimen schedule on the cover, with the injunction that 'if any new castes are now returned, they should be entered.' In regard to this matter, representations were made (1) that in the case of some castes information regarding the sect, caste and sub-caste, could not be adequately conveyed through the columns as prescribed and (2) that, regarding the names of castes and sub-castes as made known to the Census staff, certain caste names and sub-caste names were inaccurate and the list not complete; and therefore instructions might be issued for the return of specified castes in the manner pointed out in each case. The reply given was to the effect that it was not the object of the Census to go into the merits or superiority *inter se* of castes; that the list given on the cover of the Census schedule was not exhaustive; and that if individuals really and truly thought, in the light of the obligation that rested on them in virtue of the Census Regulation, the caste name to be the particular one urged in the representation, they were welcome to return the same. The result seems to be that the caste return is mainly the return of the people according to their own description, modified by the exigencies of grouping together for purposes of comparison with the caste names of the previous Censuses.

Part I consists of a general discussion of the subject; Part II deals with the distribution of castes; and in Part III is given an ethnographic glossary of castes, etc., occurring in Imperial Table XIII.

PART I.—GENERAL.

**Classifi-
cation of
castes in
the sever-
al cen-
suses.**

217. The system followed in the first population Census of the State in 1871 was the arrangement of the Castes under (1) Brahman or priestly class; (2) Kshattriya or military class; (3) Vaisya class composed of husbandmen and merchants; (4) Sudra class comprising artisans, labourers and agriculturists; and (5) other castes, "unrecognised by the four grand divisions" (referring by this term to the classical four "*Varnas*" enunciated by Manu and other text writers) and "whose manners and customs are governed by laws of their own," Jains and Animist castes as being included in this category. The term 'Sudra' was omitted in 1881, when the classification was into (1) Brahmans; (2) Kshattriyas; (3) Other Hindu castes, sub-divided into Jains, trading classes, miscellaneous, agricultural, artisan, wandering tribe and out-caste groups; and (4) Non-Hindu aboriginal castes and tribes, only Iruligas, Soligas and Bettada Kurubas coming under this head. In the Census of 1891, however, the castes were grouped according to the traditional occupations (without the classical functional terms, Vaisya and Sudra, appended) and were classed under (1) Agricultural; (2) Professional; (3) Commercial; (4) Artisan and Village Menial; and (5) Vagrant Minor Artisans, Performers, etc., the particular traditional occupation being mentioned against the name of each caste. Forest and Hill tribes, who would now usually come under Animists were included under the 'Agricultural' group and the Jains under 'Professional.' The castes were grouped in 1901, not by social position as was the case in some British Provinces but were arranged in English alphabetical order, the traditional occupation being given against the caste name to indicate the position of the caste in the tables of 1891. The castes of Jains and Animists were shown separately. This time the arrangement of 1901 has been adopted, modified as follows:—(1) The grouping according to traditional occupations, which was the main basis of the classification adopted in 1891, has been done in a subsidiary Table (I) at the end of the chapter; and (2) where more than one religion is returned by the members of the caste, separate figures are given for each.

**The caste
system in
general.**

218. In Sir Herbert Risley's classical work on the 'People of India,' the results of the ethnological investigations as to the origin of the peoples of India are summarised on page 266 of the book. Those conclusions that refer to *physical types* are contained in the following three statements: (1) There are seven main physical types in India, of which the *Dravidian* (extending from Ceylon to the Ganges) alone is, or may be, indigenous. The *Indo-Aryan* (occupying the Punjab, Rajputana and Kashmir), the *Mongoloid* (of the Himalayas, Nepal, Assam and Burma) and the *Turko-Iranian* (represented by the Baloch, Brahui, and Afghans of the Baluchistan Agency and the North-West Frontier Province) types are, in the main, of foreign origin; the *Aryo-Dravidian* (found in the United Provinces of Agra and Oudh, in parts of Rajputana, in Behar and Ceylon), the *Mongolo-Dravidian* (of Lower Bengal and Orissa) and the *Scytho-Dravidian* (of Western India) are composite types formed by crossing with the Dravidians. (2) The dominant influence in the formation of three types, was the physical seclusion of India, involving the consequence that the various invaders brought few women with them and took the women of the country to wife. (3) To this rule the first wave of Indo-Aryans formed the sole exception, because, before the advent of the succeeding waves of invaders, the country on the marches of India, Baluchistan and Southern Afghanistan became, owing to physical causes, bleak and desolate and hence quite unfit to support caravans of settlers travelling with women and children on their journeys to India. Then follow statements regarding the subsequent development of the social organization of the peoples. (4) The social grouping of the Indian people comprises both tribes and castes. The three types of tribe are *Dravidian* (e.g., Khonds of Orissa), *Mongoloid* (e.g., the tribes of the Naga Hills in Assam) and *Turko-Iranian* (e.g., the Pathan Afghans and the Balochs). There are seven types of castes, i.e., (a) the *tribal type*, where a tribe has insensibly been converted into a caste (e.g., Vellalas and Paraiyans in Madras); (b) the *functional or occupational type*, which is so numerous and the characteristics of which are so prominent that community of function is ordinarily regarded as the chief factor in the

evolution of caste (*e.g.*, Agasa, Kumbara, Kuruba); (c) the *sectarian type*, which comprises a small number of castes which commenced life as religious sects, but which reverted to the normal type of Hindu society, *i.e.*, caste, (*e.g.*, Lingayats, etc.), (d) *Castes formed by crossing*; (e) *Castes of the national type* (*e.g.*, Mahrattas and the Newars of Nepal); (f) *Castes formed by migration* (*e.g.*, Nambudri Brahmans of Malabar); and (g) *Castes formed by changes of custom* (*e.g.*, Pandaram in Madras). (5) Both tribes and castes are sub-divided into endogamous (marrying in the division), exogamous (marrying out of the division) and hypergamous (marrying above the division) groups. (6) Of the exogamous groups, a large number are totemistic. The same writer defines caste as "a collection of families or groups of families bearing a common name; claiming common descent from a mythical ancestor, human or divine; professing to follow the same hereditary calling and regarded by those who are competent to give an opinion as forming a single homogeneous community. The name generally denotes or is associated with a special occupation. A caste is almost invariably endogamous in the sense that a member of the large circle denoted by the common name may not marry outside that circle, but within the circle there are usually a number of smaller circles each of which is also endogamous" (Page 67.)

219. On a perusal of this very brief outline of the origin and development of caste, especially the portion dealing with the types of caste, we get an idea of the phenomena by which, collections of families became transformed from tribes into castes. But one is tempted to exclaim, "Why should the Aryan tribe in India alone develop into caste and not, as in Europe, lose its individuality by becoming merged in nationality?" The physical seclusion of India alone cannot furnish the answer; for it is said that when tribes are left to themselves, they exhibit no inborn tendency to crystallise into castes. This extremely fascinating subject has engaged the attention of scholars for a long time and has been "an insoluble problem." We do not think that any useful purpose would be served by attempting a solution in this Report and therefore we shall proceed to notice some features of the caste system as it exists in the State.

Some features of the caste system in the Mysore State.

(a) In compiling Imperial Table XIII (Caste, Tribe, Race or Nationality) for the State, it has been found necessary to *group together endogamous groups* wherever, for purposes of comparison with the figures of the preceding censuses, such a procedure was required. Endogamous divisions even though based on linguistic or provincial (*e.g.*, Agasa, Sakala, Vannan), territorial or local (*e.g.*, Vakkaliga, Kapu, Reddi), considerations have not been kept distinct. For instance, there would have been no meaning had all the entries of sects returned by Christians not been grouped under a few broad heads in Imperial Table XVII; the wood could not have been seen for the trees.

(b) Going over the list of the names of the castes, etc., (Hindu, Jain and Animist of the Table) we find *tribes of only one type, viz.*, the Dravidian type (Iruliga, Soliga, Paniya, etc.) and castes of all the types mentioned by Risley.

(c) The crucial test of a caste, *the existence of endogamy and exogamy* is found in each of the organisations.

(d) Ideas of pollution by touch or proximity of other castes, of performing *Sraddhas*, of early marriage of girls before maturity, of taking the *mantra* from a Guru, of prohibition of widow marriage are prevalent or non-existent according as the caste is found to have come under or kept away from *the influence of the Brahmans*.

(e) '*Hypergamy*' in the sense that a woman of a particular group in the caste is not at liberty to marry a man of group lower than her own in social standing does not prevail to any extent in the castes of the State. Of course, the natural desire of every parent to see his daughter married to a young man of an affluent house of good standing is as inherent in every caste as the desire to see the son marry a bride from a richer family and start life well.

(f) There are three well-marked *sectarian influences* visible in the constitution of the castes, which in some instances, were not able to produce a fission in the caste concerned. These are in historical sequence, (1) of the Jains, (2) of the Vaishnavas (followers of Ramanujacharya), and (3) of the Lingayats. Of these, the first seems to have had its day centuries ago and given way to the

other two which are in operation, serving to minister to the religious and ceremonial cravings of the members of castes, to whom the orthodox Brahman priest has not been accessible from time immemorial.

(g) The rules about *eating at the hands of other castes* slightly differ here from those of Northern India. For example, here Brahmans do not take water or articles of food baked, boiled or fried in ghee, from persons of other castes. But the amenities of civilized life are satisfied by each caste taking food prepared by persons of certain specified castes, most castes taking food prepared in the houses of Brahmans or Lingayats. Generally all the endogamous divisions, except such as are based on linguistic or territorial distinctions, of a caste observe commensality.

(h) The tendency to *consecrate men and women to God's service* (as Dasas and Basavis) is prevalent in certain castes.

(i) The practice of *adopting a son-in-law* into the household whether there is a son or not prevails in some castes (*e.g.*, Beda, Besta, Golla, Morasu Vakkaliga, Vodda) and the practice of recognising the issue as legitimate, of the daughter of a sonless house, left on purpose unmarried, is found in a few castes (*e.g.*, Beda, Holeyas, Madiga).

(j) *Polyandry* and the levirate are unknown.

(k) The custom by which a person can *claim his maternal uncle's daughter in marriage* and is often accepted, is observed in many castes.

(l) The traditional division of the trader, artisan and cultivator castes into two grand divisions, *18 phanas and 9 phanas*, is peculiar to Southern India.

(m) There are no sections of the *Brahmans* in Mysore who are held to be *degraded* on account of their ministering to the low castes as priests (*e.g.*, the Barna Brahmans of Northern India). Some Brahman functionaries connected with great public shrines and some who accept forbidden gifts during the obsequies after cremation are not allowed to take food with other Brahmans.

(n) The castes at the lowest strata of society are the Holeyas and the Madigas. Unlike the purely forest and hill tribes, they do not fight shy of the settled life among other castes. We cannot surmise that the castes are simply primitive tribes come into contact with the Hindu civilisation, for two important reasons, *viz.*, (1) there are other primitive tribes within the reach of Hindu civilisation and so there seems to be no particular reason why Holeyas and Madigas alone should have merited particular attention at the hands of the Hindus; and (2) each of these two castes numbers more than 300,000 and the very numbers point to the voluntary entrance of the castes into the fold of Hindu civilisation. The lot of Holeyas was of old more or less that of agrestic serfs and that of Madigas, almost akin to that of unpaid general labourers. All these circumstances together with the existence of such sub-caste names among Kannada speaking Holeyas as Gangadikara and Morasu, seem to warrant the inference that these castes—*Holeyas and Madigas*—were the earliest settlers.

(o) The custom of observing the *Mahalaya* (new-moon day) in memory of deceased ancestors, prevails also in castes among whom annual *sraddhas* are not performed.

(p) The institution of '*tera*' or *bride-price* exists generally in castes with the exception of the Brahman and a few others.

(q) The *custom of admitting outsiders* prevails in some castes (*e.g.*, Agasa, Beda, Holeyas, Madiga, Nayinda). The individual is admitted in the presence of the elders of the caste and after purification. The admissions are of persons regarded by the caste in question as higher than their own in social standing.

Caste rules and restrictions. 220. It is proposed to consider in the course of this paragraph the nature and extent of restrictions, social and industrial, which the caste system involves. A Hindu caste is essentially a collection of families having a caste organisation, *viz.*, endogamy and exogamy, and owing no allegiance to any well-known personal religion (*i.e.*, having a Founder) and hence coming under the Hindu doctrine of religious evolution (*vide* Chapter IV, para 85, *supra*). Therefore *restrictions of sorts, very often in parallel lines exist with varying degrees of rigour in different castes.* The general change in the condition of the people has no doubt had its effects

on caste rules and restrictions but it is necessary to properly gauge the nature of effects without undervaluing or overrating the same. The movement, though very gradual, of society from status to contract; the minute specialisation of labour characteristic of modern times, necessitating closer interdependence of all sections of society; the sense of individualism (as contrasted with the communism of the joint family) which is permeating all classes with the spread of education; the equal opportunities in life now made available to persons of all castes whatsoever since the establishment of the Pax Britannica; those useful institutions in which no social distinction is known or can be possibly recognised, the railway train, the school or college and the dispensary;—the influences of all these emancipating tendencies have surely been borne upon caste restrictions; but for all that, it must be said, endogamy is endogamy and caste is caste. Rules regarding the adoption of a profession, the observance of pollution by touch or mere proximity of persons of other castes, restriction of competition or underselling (by members of the same caste) have fast been dying out, no one being anxious to enforce the same.

221. By the system of caste government is meant the manner in which the caste rules and restrictions regarding commensality, marriage, occupation and the like are enforced. As has been hinted above, the venue of occupation is almost deleted from the jurisdiction of caste tribunals. Questions of inheritance are settled (in cases where the aid of the Civil Courts is not invoked) by the village wise men including often the Shanbhog (Accountant) and the Patel (Head man) who are consulted along with, or independently of, the caste headman. Questions of food, of marriage, of the important domestic ceremonies, of admission of outsiders into the caste (where such a custom obtains) and of domestic or family dissensions come up before the caste council. Broadly speaking there are two kinds of such councils: (1) the religious authority has its agents scattered over the tracts where the castemen live; the agent is recognised on such ceremonial occasions as marriage; he makes his reports and transmits the decisions of the chief (*e.g.*, among Brahmans and Lingayata); (2) each caste in a village has its own chief who settles all matters of dispute as they arise, the chief headman being referred to only on important occasions (*e.g.*, Kuruba, Beda, Morasu Vakkaliga, Golla). This latter type prevails in the case of castes who are not yet impatient of caste control; and the authority exercised by such a headman goes far beyond the power wielded by the chief of the first type which has to be circumscribed by the considerations due to the delinquent's influential position in life or his inclination to test the efficiency of the fiat in a Court of Law. The succession to the headman's place is mainly hereditary, that to a 'mutt' being by nomination or ordination. The headmen of the castes who belong to the 'phanas' make use of the phana beadle also in convening assemblies in his jurisdiction or *kattemanne*. The Gauda, Setti, Yajamana or headman is often assisted by his deputies (*e.g.*, Besta) or by assessors—*buddhiwantas*—in his work (*e.g.*, Vodda). The parties are summoned and heard, sometimes under oaths special to the caste (*e.g.*, swearing by a lump of *vibhuti* or sacred ashes after placing it on a *kumbli* and making *puja* to it, prevails among Kurubas; and swearing by *Junjappa* or sacred sheep is peculiar to Kadugollas). Then evidence is heard and sentence pronounced. The sentence usually consists of a fine.

222. As a working hypothesis we may assume that the group of families which first adopted the principle of endogamy (and exogamy) from the existing Indo-Aryan (or Hindu) system in its ranks, adopted the caste organisation and remained a self-sufficient social unit to begin with. Contemporaneous observers saw and picked out traits of uniformity in the beliefs, practices, origin and manners of similar endogamic groups and gave the groups a distinctive name which has come down to posterity as the caste name of the groups concerned and treated the endogamic groups as so many sub-castes with as many different names. Such a distinctive name very often denotes the traditional occupation of the caste and is nothing more or less than a functional name (*e.g.*, Baniya, Vakkaliga). Thus from the point of view of development, the sub-caste is the earlier unit. Of course, it may so happen in a few cases that a caste may not have more than one endogamic group in it, in which case, the caste name and the sub-caste name are identical, or the original sub-caste may have split up into two or more endogamous groups owing to residence in different parts of the country, etc. It is very common to

**System of
caste
govern-
ment.**

**Function
caste and
sub-caste.**

find the members of a caste (and its sub-caste) referring to themselves by the sub-caste names, the caste name being almost never mentioned; the caste name is usually the one referred to by persons of other castes while speaking of the members of the caste. There are also instances of castes existing in different parts of India, of corresponding social status and similar traditional occupation and with similar names (*e.g.*, Goalas of Bengal and Gollas of Mysore). The similarity of the function does not do away with the need of distinguishing the castes concerned, as they are so different in origin and development. In these circumstances, it is but reasonable to preserve in ethnographic literature the caste names as well as the sub-caste names. Discarding the caste name would be to miss the points of resemblance, ethnic, eponymous, functional or otherwise, that have been observed for years (almost centuries) by neighbours, themselves in many cases accustomed to live under similar social organisation, among the several endogamic groups comprising the caste; and overlooking the sub-caste name would mean not to recognise the members of the caste as they recognise themselves.

To demonstrate the value of these remarks, the constitution of a few sub-castes of certain castes (Agasa, Beda, Holeya, Kuruba, Madiga, Nayinda, Vakkaliga, Vodda) are examined with reference to their origin, rigidity of rules of endogamy and commensality, caste councils and penalties on breach of the rules which differentiate different sub-castes of the same caste.

(a) *Origin*:—*Agasa*.—The main endogamous divisions, *Kannada* and *Telugu*, are based on the languages they speak. Two endogamous divisions of the Telugu section *Murikinati* and *Pasupanati*, are indicative of the country of origin.

Beda.—The endogamic divisions of *Uru*, *Gudlu* and *Monda* are due to their original habits. (*Uru*, dwellers in villages; *Gudlu*, living in temporary huts; and *Monda*, begging); that of *Myasa* is probably owing to the peculiar customs which they observe, *e.g.*, circumcision, abstaining from eating fowls and pigs.

Holeya.—There are divisions comprising endogamous groups based on the language they speak, Kanarese, Telugu and Tamil. Of the Kanarese-speaking division, the groups of *Gangadikara* and *Morasu* probably point to the Vakkaligas of those names under whom the sub-castes took refuge when they were first dispossessed of the lordship of the soil; the groups *Dasa* (servant), *Hagga* (rope) and *Magga* (weaver) had their origin in the different occupations followed.

Kuruba.—There are three chief endogamous divisions: (1) *Halu* (milk) or *Sada* (pure), as they abstain from liquor; (2) *Ande*, because they used to catch the milk of their sheep in a bamboo cylinder or *ande*; (3) *Kambali* (blanket), as they weave coarse blankets and their women dress themselves with aprons of the same material.

Madiga.—The two main divisions are based on the language they speak, Kanarese and Telugu. Each language division has three endogamous groups which are named after the manner in which the bride and bridegroom eat the common marital meal or *Buvva* in a *Tanige* (dish), a *Hedige* (basket) or a *Mora* (winnow).

Nayinda.—The caste has, according to the language spoken by the members, two main divisions each of which has further sub-divisions. All these divisions and sub-divisions are said to be endogamous. Among the Kanarese-speaking division are *Morasu* which indicates the country of origin (*e.g.*, *Morasu Vakkaliga*) and *Silavanta* (one of good character) which is probably from their being strict vegetarians and abstaining from liquor. Among the Telugu-speaking division, are *Nadigaru* which means people of the country, *Raddibhumi*, which denotes that they originally came from the tracts of the Raddis, *e.g.*, Bellary, Cuddapah, and other Telugu tracts, and *Kudipaita* in which group women wear their garment in a peculiar way.

Vakkaliga.—The sub-castes, *Reddi*, *Morasu*, *Gangadikara*, *Nonaba*, point to the territories they lived in formerly. *Hallikara* points to the profession, *i.e.*, that of breeding cattle. Each of these, *e.g.*, *Morasu* contains endogamic groups. Some endogamic groups, *e.g.*, *Raddi*, *Palyadasime*, speak Telugu.

Vodda.—The names of the endogamous divisions *Kallu* (stone), *Mannu* (earth), and *Uppu* (salt) point to the traditional occupation.

Some sub-caste names among Brahmans point to the original homes of the people named; and some sub-caste names among Lingayats point to the occupation or caste from which these were converted.

(b) *Rigidity of the rules of endogamy and commensality*:—*Agasa*.—The groups of endogamous divisions do not eat together or intermarry.

Beda.—Intermarriage is not allowed; commensality probably is in vogue.

Holeya.—Tamil Holeyas take food in the houses of Kannada and Telugu sections, while the latter do not return the compliment, regarding the Tamil Holeyas as inferior in origin. The Gangadikar Holeyas, however, do not eat in the houses of even other Kannada Holeyas. Endogamy is strictly observed.

Kuruba.—The divisions are strictly endogamous. Male members may dine together.

Madiga.—The Kannada Madigas do not intermarry with the Telugu-speaking Madigas.

Nayinda.—Endogamy is strictly observed.

Vakkaliga.—Endogamy is strictly observed. Commensality is in vogue.

Vodda.—By changing the occupation to a stone worker, a Mannu-Vodda may marry a girl of the Kallu-Vodda section. These two sections do not eat with Uppu-Voddas, who are sweepers in towns. Kallu-Voddas are acknowledged to be superior to other classes and do not eat with them.

(c) *Caste Councils*.—Sufficient information is not available as to whether sub-caste councils are affiliated to a common caste council. The jurisdiction seems to be territorial over the caste or connected group of endogamous groups, rather than over the endogamous group only. The Morasu Vakkaligas, for instance, are divided into *Kattemanes*, each of them being presided over by a *Yajaman* or *Gauda*. Several *Kattemanes* form a *Nadu* (division of country) and at the head of each *Nadu* is a *Nadu Gauda*. Several such *Nadus* form a *Desa* (or country) presided over by a *Desayi Gauda* or *Bhumi Gauda*. There are two such, one at the head of the Telugu section and another at the head of the Kannada section of this caste. The goldsmiths are recognised by the other Panchalas as the head of their clan and are given caste jurisdiction.

(d) *Nature of penalties on breach of rules which differentiate the sub-castes of the caste*.—Breach of rule of endogamy is severely punished. As regards offences against rules of food, the caste *panchayats* are disposed to be lenient.

223. The question of the extent to which caste prejudices and restrictions have survived amongst or extended to, the Muhammadans, is one on which there is little to be said. Social prejudices and restrictions such as are noticeable in all nationalities do exist among Muhammadans also; but the social prejudices and restrictions that are peculiar to the Hindu institution of caste may be said to be non-existent. Some tribes (*e.g.*, Dayare, Navayat, Pinjari and probably Meman) do not marry out of the tribe.

224. A short account is here given of the description of the characteristics of castes as they are found in proverbs and popular sayings (chiefly of the Kanarese language). A proverb has been described 'as the wisdom of many and the wit of one' and again 'a proverb is to speech what salt is to food.' Without attaching undue importance to proverbs which are sometimes half truths and caricatures, we may say that a study of them gives us an insight into the thoughts and feelings of the people and that the study of sayings relating to caste shows us how people describe themselves.

Proverbs may be grouped as (i) general, where a caste name is taken to illustrate a common characteristic; or as (ii) particular, where the characteristics of the caste are held out to view.

(i) The meaning of 'To ride a willing horse to death' is expressed in 'If an elephant is tame, the Agasa has a clothes load ready to put on its back.' 'Every man to his trade' has its parallel in the following: 'A Brahman unaccustomed, singed his beard and whiskers in making a *homa*'; 'A carpenter planes and a bricklayer builds'; 'An Agasa's prowess can be shown on the clothes of others'; and 'Like searching for a brass pot in a potter's kiln.' That the example of men is catching is funnily expressed in 'Jogi and Jogi jostle and the pots (slung on their shoulders) rattle.' 'All that glitters is not gold' finds parallels in 'If the

dhotra (cloth) is gaudy, is he of a big *gotra*?' and 'Never trust a black Brahman or a white Holeyā.' Worldly wisdom is expressed in the saying 'A Konkani's buffalo and a stout club.' Imprudence and want of sense of proportion are censured in 'The setti's toilet went merrily on while the town was taken,' and 'The enemy is at the gate (of the village): 'Oh! Help me to don my dress' said the Gauda's grandam.' The difficulty of original work is referred to in 'It takes a year for Kumbara (potter) but a minute for a stick.'

(ii) The description of castes is not always to the credit of the caste concerned. Still, 'To see ourselves as others see us' is an advantage. Taking the castes that ordinarily constitute a village, we find the description running on, somewhat as follows: the Brahman's helplessness is remarked in "The coward said 'I cannot fight an elephant or a horse or a soldier; what shall I do?' 'Go,' said his friend, 'and fight a bald Brahman'"; and 'On mounting a jaded horse that all had ridden, the astrologer slipped and fell down.' 'Never stand before a Brahman or behind a horse' refers to his tendency to beg and trouble one. 'Never be a Brahman's servant or Ganiga's bull' refers to the habit of dining late, after performing ceremonies (and the consequential late feeding of the servant) usual among Brahmans. The usual item of expenditure is pointed out in 'The Brahman earns for *sraddhas*, the Holeyā for drink and the *Vakkaliga* for the fine.' One sees a cynicism worthy of Dean Swift in 'A Brahman's presence destroys a village as that of a crab does a tank.' An equally cynical proverb exists regarding a *Baliija* (Telugu trader): 'A *Baliija* as small as a garlic tuber, and the village is ruined.' The *Shanbhog*, the principal village functionary, is twitted in 'Forget where you find the *Shanbhog*'s buffalo as soon as you see it'; 'A *Shanbhog* when hungry looks to his old accounts'; 'There may be levied one hundred (pagodas) from the village; but never a cash from the *Shanbhog*'; and 'Never ask a *Shanbhog* if he had his dues and never enquire if your wife's relatives have dined.' 'Agriculture not done by a *Vakkaliga* is no agriculture,' but 'He pawns jewels for a feast'; 'He is generally friendless.' The trader's businesslike habits are referred to in the following: 'The town is where the *setty* builds'; 'The *setty* never enters a flood unless there be a profit for the trouble'; 'The *Komati* may fall but he will never fail in his accounts'; 'He will not be deceived but if unfortunately he is, he will never tell'; 'A *setty*'s affairs will come out only after his death'; and 'You can stand a Brahman's anger but never a *setty*'s smile.' The artisans come in for their share of these wordy squibs thrown at them. 'A goldsmith knows whose ornaments are made of gold just as an *Agasa* knows the poor (as is evident by their not having changes of clothes) of the village.' 'The *Akkasale* (goldsmith) cannot help taking from the gold given to him to work by his sisters or brothers'; 'An *Agasa*'s courtyard is dirty and so is a barber's house'; 'One can dine out of an *Agasa*'s hand but never in a barber's courtyard'; 'The washerman is bedecked with his master's finery.' A *Ganiga*'s (oilman's) bull is as lean as the church mouse and hence the adage, 'Never take a bull from a *Ganiga*.' 'The weaver was ruined by separating from his partner (and the *chetty* by having one).' The mendicant classes are naively described. 'Jogi and Jogi clasp and both are smeared with ashes'; 'A Jogi's knapsack is on his shoulder the moment he gets up'; 'The house is on fire but the *Jangama*'s bag and bowl are with him'; 'A king is satisfied with half a kingdom (his neighbour's) but the beggar wants a full one.' Temple servants are referred to in the following: "Infants and temple servants do not suffer from hunger"; 'Never (take in marriage) a *pujari*'s daughter (for she is accustomed to the toothsome dainties offered to the god worshipped by her father and so off and on keeps going to the parental home).' The habits of *Holeyas* are thus described: 'Never engage in agriculture depending on the word of a *Holeyā*'; 'Though seventy years old, he will not work unless he is prompted.' The future of a *Madiga* seems preordained, if we are to believe the saying, 'No untruth in *Vedas* and no *Madiga* in heaven.'

PART II.—STATISTICS.

Statistics of castes. 225. Imperial Table XIII comprises the statements relating to the division of the population into caste, tribe, race or nationality. Apart from this general

table, there are other tables specially devoted to bring out certain attributes by caste, *i.e.*, Imperial Table IX deals with literacy; Imperial Table XII-A gives figures for infirms; Imperial Table XIV exhibits figures for civil condition; and in Imperial Table XVI are found the statistics of occupation. In Imperial Table XV-E—Statistics of Industries—information as to the castes, etc., of owners and workmen is given. It may be noted here that the Imperial Tables IX, XII-A, XIV and XVI were compiled for all castes, tribes and races in the State. The characteristics of these tables are dwelt upon in the special chapters allotted to them. In this chapter, it is only the general distribution of the population into caste, tribe, race or nationality that is discussed.

The Subsidiary Tables appended to this chapter are:—

(i) I, giving a statement of castes classified according to their traditional occupations;

(ii) II, showing variation in caste, tribe, etc., returning not less than two per mille of population since 1871. It may be added that no special statistics were collected with regard to castes as in 1901, when the special caste Tables related to (1) Gotras, Sakhas and Sects of Brahmans; (2) the Gotras of non-Brahmans and (3) Phanas.

226. The local distribution by districts (including cities) of the following castes, Vakkaliga, Lingayat, Holeya, Kuruba, Madiga, Brahman, has been illustrated by means of rectangles in the appended inset maps; the base of the rectangle indicating the population of the district, the height, the proportion that the caste bears to the district population, and the rectangle consequently indicating the strength of the caste in the district. **Maps.**

227. (a) *Hindu*.—There is only one caste, *i.e.*, Vakkaliga, numbering over 1,000,000. The numbers (1,331,029) represent 24·9 per cent of the Hindu population of the State. There are two castes Lingayat (729,431), Holeya (613,248), of over 500,000 and under 1,000,000 forming 25·1 per cent; the castes, 10 in number, Banajiga (132,955), Beda (268,454), Besta (156,863), Brahman (194,570), Golla (150,842), Kuruba (403,366), Madiga (308,083), Panchala (128,098), Uppara (108,131) and Vodda (142,482) aggregating between 100,000, and 500,000 come up to 37·3 per cent; three castes between 50,000 and 100,000, Agasa, (97,772), Neygi (96,466), Tigala (69,233) form 4·9 per cent. The remaining castes below 50,000, 57 in number total up to 409,885* and comprise the remaining 7·7 per cent of the total Hindu population. **Groups of castes and tribes according to the numbers returned.**

(b) *Musalman*.—The only tribe returning over 100,000 is that of Sheikh (176,482) forming 56·1 per cent of the total number of Muhamadans in the State. There are two tribes between 10,000 and 100,000, Pathan (44,689) and Saiyid (57,671) which comprise 32·5 per cent; the Mughal (8,151) is the only tribe between 8,000 and 10,000 making up 2·6 per cent; the remaining 24 tribes return 27,501* and form 8·7 per cent of the total Musalman population.

228. The appended inset maps and rectangles inserted in them are designed to show the local distribution of a few numerically important Hindu castes. The following statement gives, as regards Hindu castes of over 100,000, percentages of the caste population to the total population of the State and of each district. **Distribution of castes by districts.**

* NOTE.—The numbers under 'unclassified and unspecified' are reckoned, however, for the sake of the total.

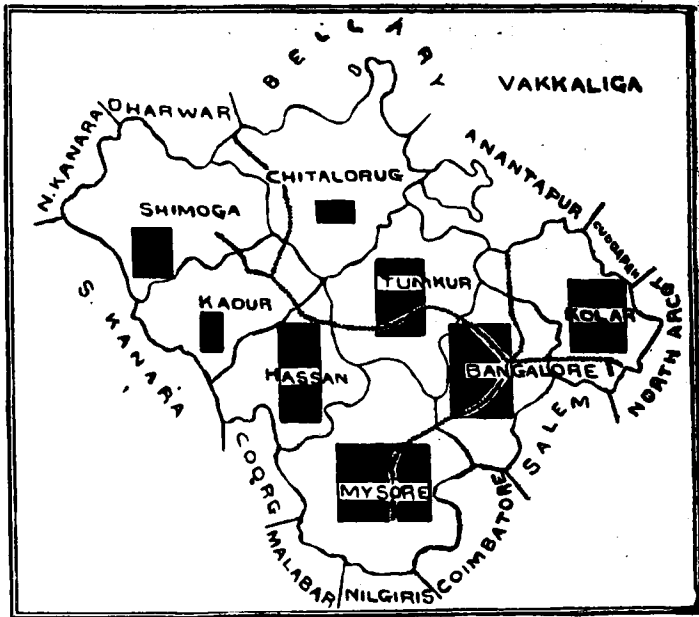

2

REFERENCE.

The base of each rectangle indicates the population of the district.

Scale 1" = 2,700,000 persons.

The height shows the proportion which the caste bears to the population of the district.

Scale 1" = 60 per cent.

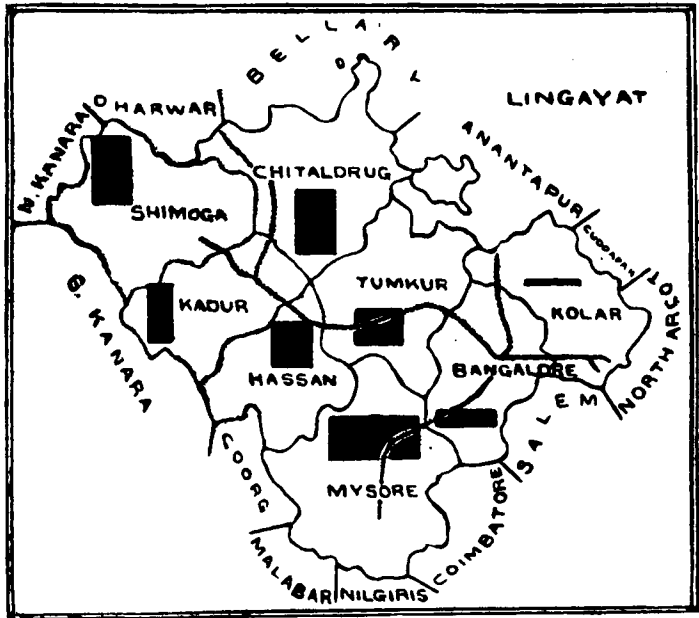

3

The area of the rectangle shows the strength of the caste in each district.

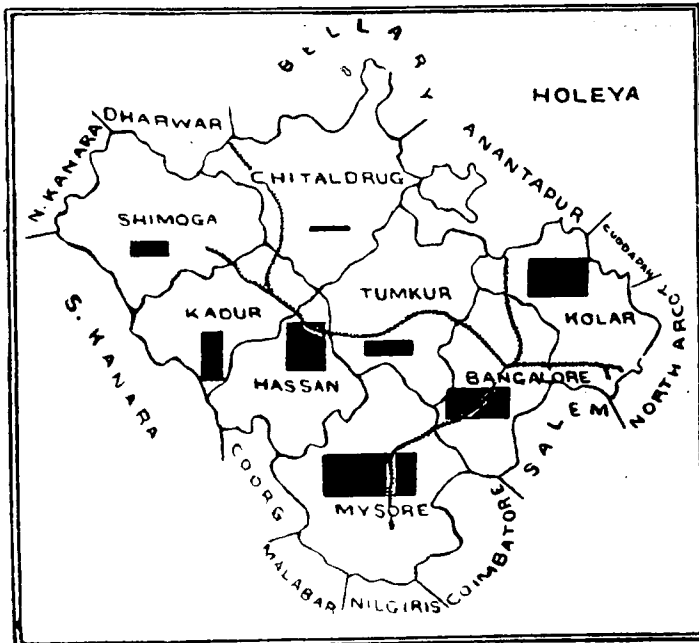

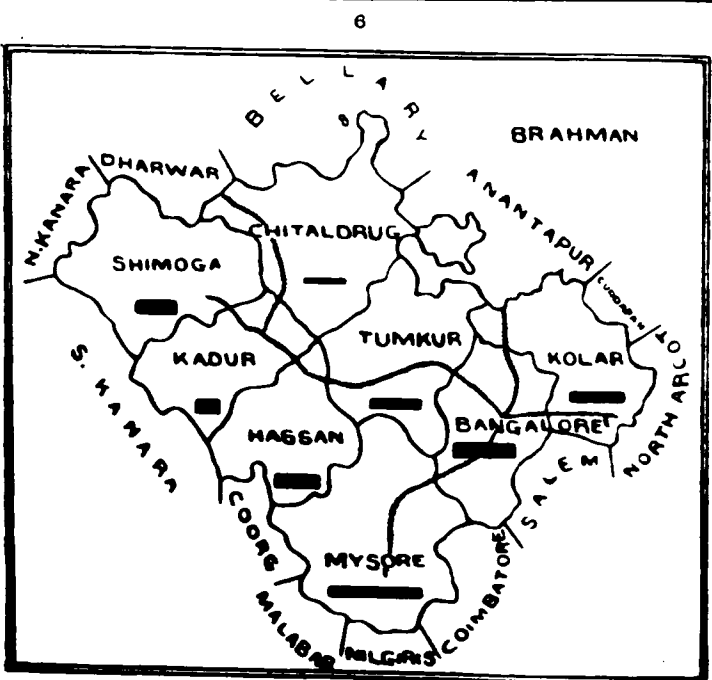
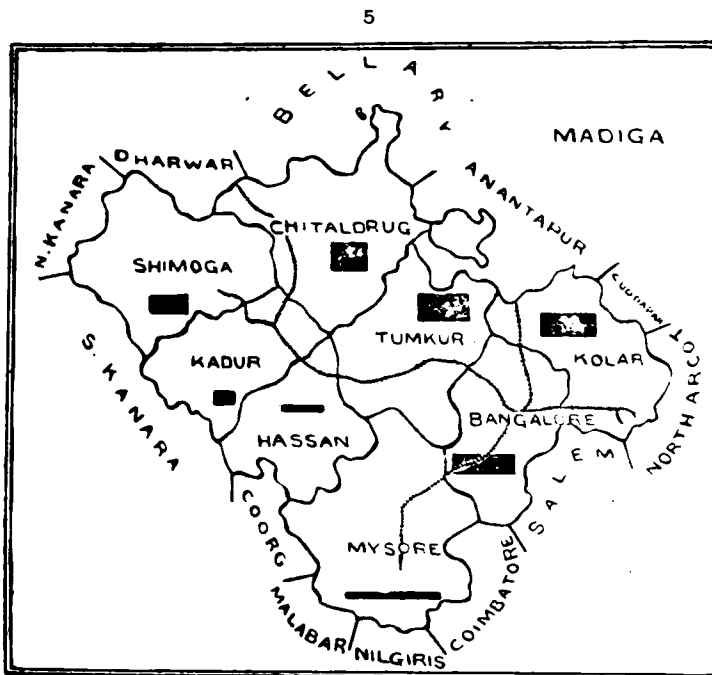
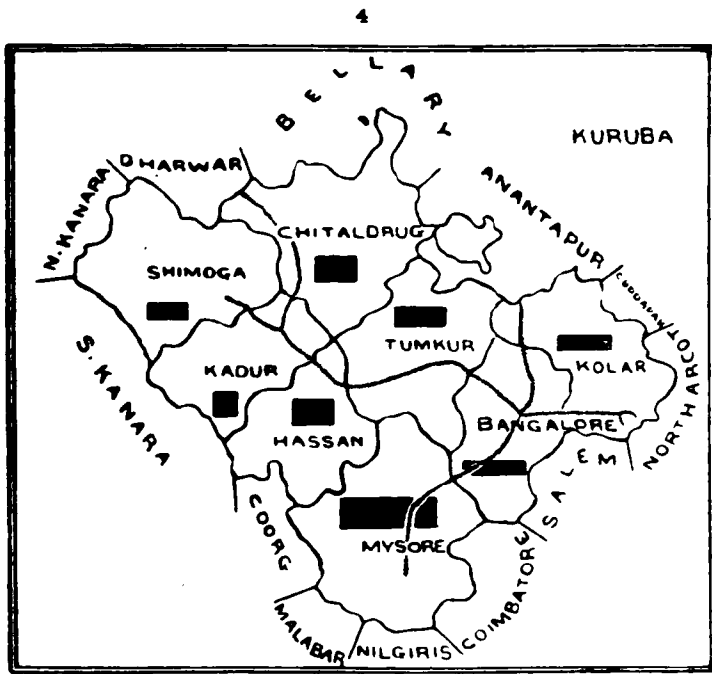

REFERENCE.

The base of each rectangle indicates the population of the district.

Scale 1" = 2,700,000 persons.

The height shows the proportion which the caste bears to the population of the district.

Scale 1" = 60 per cent.

∴ The area of the rectangle shows the strength of the caste in each district.

Caste	Percentage of caste population to total population in								
	Mysore State, including Civil and Military Station, Bangalore	Bangalore District, including Bangalore City	Kolar District, including Kolar Gold Fields	Tumkur District	Mysore District, including Mysore City	Chitaldrug District	Hasan District	Kadur District	Shimoga District
1	2	3	4	5	6	7	8	9	10
Total Hindus ...	92	90	91	93	95	93	95	91	90
Vakkaliga ...	23	30	24	25	26	8	32	14	17
Lingayat ...	13	5	2	12	14	23	15	20	22
Holeya ...	11	10	13	4	15	2	16	16	5
Kuruba ...	7	5	5	6	10	8	8	8	5
Madiga ...	5	7	7	9	2	9	2	4	5
Beda ...	5	2	3	7	...	17	1	1	5
Brahman ...	3	4	3	3	3	1	3	5	2
Besta ...	3	1	1	1	6	1	2	1	2
Golla ...	3	2	3	6	...	8	1	1	1
Vodda ...	2	3	4	2	1	5	1	2	3
Banajiga ...	2	3	6	2	1	1	1	2	1
Panchala ...	2	2	1	2	3	2	3	2	3
Uppara ...	2	2	3	2	2	3	2

To give an idea of the relative distribution of castes in the two Natural Divisions, the statement given below has been compiled as regards castes returning more than two per mille of the population of the State.

Caste	Place, beginning with the most numerous, in		Caste	Place, beginning with the most numerous, in	
	Eastern Division	Western Division		Eastern Division	Western Division
Vakkaliga ...	1	1	Agasa ...	14	12
Lingayat ...	2	2	Neygi ...	15	9
Holeya ...	3	3	Tigala ...	16	26
Kuruba ...	4	4	Ganiga ...	17	23
Madiga ...	5	6	Nayinda ...	18	21
Beda ...	6	8	Kumbara ...	19	18
Golla ...	7	16	Kshattriya ...	20	19
Besta ...	8	13	Idiga ...	21	17
Brahman ...	9	5	Mahratta ...	22	14
Banajiga ...	10	15	Vaisya ...	23	22
Vodda ...	11	11	Satani ...	24	20
Panchala ...	12	7	Mudali ...	25	25
Uppara ...	13	10	Jogi ...	26	24

Variation since 1901.

229. It has been found that the variation in the numbers of Hindus in the State since 1901 has been +4·7 per cent. (Chapter IV, Subsidiary Table I.) Noticeable increases are found in the case of Kshattriya (+49·1), and Mudali (+52·2); and marked decreases are evident in the case of Idiga (-19·6), Kumbara (-4·0) and Mahratta (-14·0).

- (a) *Kshattriya*.—Comparison by districts shows that there have been notable increases in Chitaldrug, Bangalore and Kolar (including the cities situated therein) districts. The original functional name may have been freely returned.
- (b) *Mudali*.—The increase is due to the figures of the Civil and Military Station, Bangalore, for 1911 exceeding those for 1901 by nearly 6,000.
- (c) *Idiga*.—This caste has shown a marked decrease in the Western Division.
- (d) *Kumbara*.—The decrease is general in the Western Division and the Chitaldrug District.

(e) *Mahratta*.—The decrease is noticeable in the Mysore, Chitaldrug and Kolar Districts; the reason in the case of the first two districts being due to the closure during the decade of the large public works on the New Palace and the Marikanve lake respectively.

230. The percentage of net variation since 1871 in the case of Hindus has been +13·2 exclusive of 89,049, persons shown as wild and wandering tribes under Hindus in 1871. Marked increases above this standard are found in Lingayats (+74·5) and Mudali (+99·2) and notable decreases in Idiga (−52·0), Kshattriya (−31·1), Nayinda (−0·6), Neygi (+1·0) and Vakkaliga (+1·6). Variation since 1871.

(a) *Lingayat and Vakkaliga*.—At first sight it is very astonishing to find that these two castes, which are found distributed throughout the State, should vary so widely in the percentage of increase during 1871-1911, one of them, Vakkaliga, showing an increase of only 1·6 while the other, Lingayat, shows an increase of 74·5. The reason for the apparent difference is to be traced to the inclusion, in the Censuses of 1871, 1881 and 1891, under Vakkaliga, of Nonabas and Sadas who are Lingayat cultivators. (*Vide* also the remarks contained in pages 495-6, Mysore Census Report of 1901.) A glance at column 10 of Subsidiary Table II of this chapter shows that 'Lingayat' is the single caste numbering more than 100,000, that is shown to have had an increase and that too a good one of +12·5 per cent, in the decade 1871-81, during which occurred the terrible Southern Indian famine of 1876-7. Now agriculturists are the first (next after the labouring classes) to suffer from famine. As in the computation in 1881, Nonabas and Sadas were placed under Vakkaligas (*vide* page 66, Mysore Census Report of 1881), the vast decreases that must have occurred in the ranks of these people, were not included in the figures under 'Lingayat'; hence the real decrease has not been shown against the caste in the decade 1871-1881. Trying to reconstruct the figures of the two castes for 1891, 1881 and 1871, by including Nonabas and Sadas under 'Lingayat' (by means of actual figures of 1881 and 1891, and estimates of the numbers of Nonabas only of 1871) and placing these side by side with those for 1901 and 1911, we have the following result:—

Caste	Persons (000's omitted) in					Percentage of variation increase (+), decrease (-)				Percentage of net variation 1871-1911
	1911	1901	1891	1881	1871	1901-1911	1891-1901	1881-1891	1871-1881	
<i>Lingayat.</i>										
(a) Figures as in Subsidiary Table II.	730	671	483+64 (Nonabas (105) (Sadas)	470+35 (Nonabas (+96 (Sadas)	418+70 estimated (Nonabas (+119 (Sadas) 607	+8·7	+38·9	+2·7	+12·5	+74·5
(b) as reconstructed ...	730	671	652	601		+8·7	+2·9	+8·5	-1·0	+20·8
<i>Vakkaliga.</i>										
(a) Figures as in Subsidiary Table II.	1,331	1,287	1,342 -169	1,060 -131	1,310 -189	+3·4	-4·0	+26·6	-19·1	+1·6
(b) as reconstructed ...	1,331	1,287	1,173	929	1,121	+3·4	+9·7	+26·8	-17·1	+18·7

(b) The increase in 'Mudali' is chiefly due to the increase of nearly 6,000 returned as such in the Civil and Military Station, Bangalore, in the decade 1901-11.

(c) As regards 'Idiga,' the class 'Halepaika' which is numerous in the Western Division was included under 'Idiga' in the Census of 1871 (*vide* page 66, Mysore Census Report, 1871) but has since then been included under 'Vakkaliga' to which it properly belongs. In 1881, 'Halepaika' was shown separately (*vide* pp. 65,67, Mysore Census Report, 1881, and Tables) and in the subsequent Censuses has been omitted under 'Idiga' (*vide* p. 256 of Imperial Tables

Volume, Mysore Census Report, 1891; Caste Glossary, Mysore Census Report, 1901). This view, which is concurred in by the Officer in charge of the Ethnographic Survey in the State, suggests a probable explanation as to the apparent decrease in the numbers of the caste in 1871-1911.

(d) Under 'Kshattriya' in 1871, were included Mahrattas who formed nearly $\frac{1}{4}$ ths of the numbers returned; the decrease is thus apparent and not real.

(e) 'Nayinda' and 'Neygi.' The almost stationary populations of these castes are accounted for by the varying nature of variation from decade to decade in the Natural Divisions:—

Caste and Division	Percentage of variation; increase (+) or decrease (-) in				Percentage of net variation 1871-1911
	1901-11	1891-1901	1881-91	1871-81	
<i>Nayinda.</i>					
Eastern Division ...	+ 4	+10	+30	-28	+ 8
Western Division ...	-20	-12	-14	- 7	-44
<i>Neygi.</i>					
Eastern Division ...	+ 1	+13	+23	-24	+ 8
Western Division ...	- 4	+ 9	- 2	-13	-11

Variation since 1901 in the Kadur and Shimoga Districts.

231. To begin with, in order to have a comparative view of the rate of variation in the Western Division and these two districts as regards Hindus, Musalmans, Christians, Jains and Animists, the following statement has been prepared. During the decade 1901-11, an area containing 3,482 persons was transferred from Kadur District (Western Division) to Chitaldrug District (Eastern Division). The numbers of the followers of various religions for the total population of 3,482, have been calculated by the rule of proportion on the proportion per 10,000 existing in 1901 in Kadur District. The numbers of Animist tribes returned as Hindus have been included in the former and excluded from the latter for the purposes of the calculations of this statement.

Religion	Percentage of variation 1901-11, in		
	Western Division	Kadur District	Shimoga District
Total population ...	-1·7	-5·8	-2·8
Hindus ...	- 1·7	- 5·5	- 3·1
Musalmans ...	+ 2·3	- 7·7	+ 5·1
Christians ...	+13·2	+17·9	+27·9
Jains ...	-11·6	-13·5	-14·6
Animists ...	- 1·7	-16·8	- 8·2

Below are given statements (1) for Kadur District and (2) for Shimoga District, to show the variation of each Hindu caste numbering not less than 4 per mille of the total population of the district concerned. It should be noted that the Animist tribes returned as Hindu have not been mentioned in the statements,

the numbers of these having been included under Animist in the foregoing statement:—

(1) KADUR DISTRICT

Caste	Numbers in		Difference	Percentage of variation
	1911	1901		
Agasa	4,337	4,614	-277	-6.0
Banajiga	7,524	8,256	-732	-8.9
Beda	4,895	4,983	-88	-1.8
Besta	3,624	4,902	-1,278	-26.1
Brahman	16,776	18,253	-1,477	-8.1
Golla	3,787	3,704	+83	+2.2
Holeya	54,272	56,136	-1,864	-3.3
Idiga	2,853	6,320	-3,467	-54.9
Kshattriya	2,353	1,794	+559	+31.2
Kumbara	2,869	3,289	-420	-12.8
Kuruba	28,134	29,108	-974	-3.3
Lingayat	67,173	70,457	-3,284	-4.7
Madiga	14,314	12,633	+1,681	+13.3
Mahratta	2,352	3,493	-1,141	-32.7
Neygi	9,045	10,263	-1,218	-11.9
Panchala	8,118	9,249	-1,131	-12.2
Uppara	11,143	11,489	-346	-3.0
Vakkaliga	46,992	50,260	-3,268	-6.5
Vodda	6,255	6,318	-63	-1.0

(2) SHIMOGA DISTRICT.

Caste	Numbers in		Difference	Percentage of variation
	1911	1901		
Agasa	12,262	12,723	-461	-3.6
Banajiga	4,692	5,430	-738	-13.6
Beda	23,531	22,716	+815	+3.6
Besta	12,257	13,740	-1,483	-10.8
Brahman	25,656	26,098	-442	-1.7
Darzi	2,491	2,816	-325	-11.5
Golla	3,126	3,600	-474	-13.2
Holeya	27,711	30,796	-3,085	-10.0
Idiga	5,323	9,618	-4,295	-44.7
Kshattriya	4,141	3,665	+476	+13.0
Kumbara	2,501	3,593	-1,092	-30.4
Kuruba	27,414	24,249	+3,165	+13.1
Lingayat	115,327	119,312	-3,985	-3.3
Madiga	23,544	21,967	+1,577	+7.2
Neygi	7,348	7,477	-129	-1.7
Panchala	14,338	14,875	-537	-3.6
Uppara	9,972	10,699	-727	-6.8
Vakkaliga	88,183	90,446	-2,263	-2.5
Vodda	17,768	16,339	+1,429	+8.7

PART III.—ETHNOGRAPHIC GLOSSARY.

**Ethno-
graphic
glossary.**

232. An ethnographic glossary containing a brief note on the traditional occupations, customs, etc., of the various castes, tribes or races, will be a fitting conclusion to this chapter. It should be remembered that the glossary is intended merely to serve as an introduction to the fuller study of the subject in standard books like the volumes of Ethnographic Survey in Mysore or Thurston's *Castes and Tribes in Southern India*. The names of castes, etc. (printed in the glossary in clarendon type) are those the distribution of which is given by Districts in Imperial Table XIII. The figures entered after them show the total strength of the caste. Among Musalmans, Jains, and Animists, are found returned the names of some castes which find a place among Hindus also. In such cases, the numbers of such entries are brought together under the name where it first occurs, with a letter to indicate the religion returned (*e.g.*, H-Hindu; M-Musalmán; J-Jain; A-Animist). The books referred to are the Mysore Census Reports of the several Censuses (C. R. 1871, *etc.*), the Monographs of the Ethnographic Survey in Mysore (Mys. Eth. Mon.), Bhattacharya's *Hindu Castes and Sects* (B. H. C.) and Thurston's *Castes and Tribes of Southern India* (C. T. S. I.).

GLOSSARY.

HINDU.

AGASA (97.772).—A caste of Kanarese washermen. Out of 30,141 actual workers, 13,944 follow the traditional occupation. The other chief occupation of the caste is agriculture. The caste has two main endogamous divisions based upon the language they speak, Kanada Agasa and Telugu Agasa. (It should be noted that the Mahatta and Hindustani-speaking washermen have nothing to do with the Agasa, but are immigrants of a recent date.) These main divisions do not intermarry or dine together. Among the Telugu sections, there seem to be other endogamous sub-divisions. Polygamy is not prohibited but is rarely practised. Both infant and adult marriages are allowed and practised. A girl may even remain without marriage all her lifetime. The bridegroom or his party has to pay a price for the bride, the amount varying in different localities, between Rs. 13 and 24. Widow marriage is allowed and practised; but the husband must always be a widower. Adultery or loss of caste enables the husband to divorce the wife; for loss of caste only can the wife break the marriage tie with the husband. They do not perform *śradhās*. The Agasa are found all over the State. They form part of the village corporation.

In most cases, their priests are *Jangamas* or their own headmen; but a few are in the habit of calling in Brahmans as *parohits*. Their *gurus* is a Lingayat to whom they give periodical presents. They are employed as torch-bearers on festive occasions and to show respect or fight the way to persons of rank. They are also worshippers at some of the shrines of the humble order. They do not wash the clothes of Holayras and Madiga. Agasa are Saivites and Vaishnavites also. They however, show reverence at all recognised shrines. Their goddess is Lakshmi Devi, the consort of Vishnu. Their tribal god is 'Bhumiderrara' (Earth God) which they worship during the Ganu feast (August-September), after which they perform Uthe-puja (worship of the washing tub) They belong to the 18-Phanas section. They have a ceremony for taking into their caste persons from higher castes such as Vakkiliga, Kuruba and others. After ascertaining that the original caste has no objection to one of their men being taken into their fold, they invite their own caste-men from several divisions to a meeting at which all the Yajmans of the several divisions and others are present. The candidate has to get shaved and bathe in a tank or river and worship Ganga (Water Goddess). After being given *tirtha*, he is made to pass successively through seven huts which are burnt soon after he leaves each. He bathes again and is given a paste of soap-nut and turmeric which he swallow. Then he makes puja to the spoon and bell, the symbol of the 18-phanas, with which are placed some *śubhāti* balls. The *kolār*, applies some of the *śubhāti* ashes to his forehead. After this, there is a dinner at which the recruit eats along with others and is treated as one of the caste. (*My. Eth. Mon.*)

Bairagi (267).—An immigrant caste. The Bairagi are the followers of Ramanand. Most of them are mendicants, who pass through Mysore in the course of their immigration to places of pilgrimage in Southern India. They are also known as Sadhus. The Bairagi are not very strict about the caste rules and they will usually eat cooked food given to them by a clean Sudra of any caste. They are all Vaishnavites and worship *śaigramā*. (C. R. 1901; B. H. C.)

Banajiga (132,955).—Kanarese tradesmen. Of the actual workers, 7,301 follow the traditional occupation, while 19,658 are agriculturists. The other principal occupation is labour. This caste is divided into numerous sects, the principal of which are Telugu, Dasa, Yale and Gopeṭi Banajiga. The Telugu Banajiga originally came from Madras and Northern Orissa. Many Banajiga are Lingayats also by faith. The Banajiga are divided into a number of sub-castes none of whom eat together or intermarry. One of the sub-castes called Babegara (makers of bangles), Dendiga or Bannagara does not indulge in either animal food or spirits. The Telugu Banajiga are either Saivites or Vaishnavites. They do not wear the sacred thread or follow the Vedic ritual. Widows are prohibited from remarrying and the dead are buried. The *gurus* of the Vaishnavite Telugu Banajiga is the *guru* of the Sri Vaishnava Brahmans. These belong to the 18-phanas section of the community of which they are the foremen (C. R. 1871, 1901).

Baniya (64).—These are immigrant traders and money-lenders from Northern India. The word Baniya is a corruption of the Sanskrit word 'banī' which means 'merchant'. The subdivisions among the Baniyas are said to be as numerous as those amongst the Brahmans. (B. H. C.)

Bavaji (35).—'Bavaji' is very probably another form of 'Babaji' which is the usual title of male mendicants of the Vaishnavite sect founded in Bengal by Chaitanya. These are immigrants. **Boda** (368,454).—The name Boda is a corruption of the Sanskrit word 'Yodha' meaning a hunter and shows what the original occupation of the caste was. This traditional occupation is not nowadays followed as principal occupation (only 50 actual workers being returned in this Census as doing so). The chief occupations followed are agriculture, village service (as watchmen), ordinary labour and service as peons in Government departments. The Boda, from their hardy out-door life, were largely employed in the rank and file of the armies of the Vijayanagar Empire; later on Hyder Ali employed them extensively as soldiers. They seem to have been originally a Telugu-speaking people but after long settlement, those of the Kanada districts, have adopted that language as their mother-tongue. The following are the endogamous divisions of the caste:—Ura, Mysara, Gadlu, Marama, Hala and Mondā. Ura Boda are by far the largest division of the caste, and are so called because of their residence in towns and villages, unlike for example, Mondā Boda, a

wandering tribe, who are beggars by profession. Myasa Bedas are found mostly in the Chitaldrug District. They form an interesting division and have some peculiar customs such as circumcision, and abstaining from eating fowls and pigs. They lived mostly in jungles till recently; many have since taken to living in towns and villages. It deserves to be ascertained how far their customs have been moulded by the influence of Musalmans. These seem to be the same as the forest tribe known as Chenchu who are a Telugu-speaking jungle tribe inhabiting the hills of the Kurnool and Nellore Districts. Gudlu Bedas live in temporary huts and form an inferior division. Monda Bedas never enter the houses of the other Bedas. They live by begging. The caste is divided into a number of exogamous divisions and their integrity is kept up with the utmost scrupulousness. Polygamy is allowed. Marriage is generally of adults. A woman may remain without marriage all through her life. The bride's price is Rs. 12. Widow marriage is allowed and generally practised but the form differs considerably from the regular marriage and is styled union or 'kudlike' or the giving of a cloth to wear or the tying of a 'tali.' Loss of caste and adultery are good grounds for divorce. The practice of making Basavis of women obtains in this caste. When there are no male children, the eldest daughter may be converted to a Basavi, when she remains permanently in her father's house, inherits the property and in all possible respects, takes the place of a son. A girl afflicted with a dangerous illness, is often made a Basavi in pursuance of a vow to the effect. The dedication of Basavi is made by a ceremony which as far as possible resembles a marriage. After the ceremony the girl is free to associate with any man who is not of a lower caste than her own. Her issue become legitimate and are entitled to a share of their grandfather's property. A widow or a divorced woman may become a public woman with the consent of the castemen, when she has the same license as a Basavi but her issue, though legitimate, rank only as the issue of a *kudike* marriage. No *sraddhas* are performed. Outsiders from any recognised higher castes are admitted to the Beda caste, the headmen and castemen being assembled for the ceremony. *Illatom* (*nanevalatana* in Kannada) or affiliation of a son-in-law is practised and such son-in-law gets a share equal to that of a son. The Bedas belong to the 9-Phana section. They are Vaishnavites, but some are Saivites also. Their Guru is a Srivaishnava Brahman who pays occasional visits, gives them *chakrankitam* (branding) and holy water and receives his fees. The goddesses worshipped by Bedas are Gangamma, Maramma, Kavellamma, Lakkamma, Payamma, Odisilamma, Mariamma, Durgamma and Chellapuramma. Muniswara, who is said to be the soul of a saint who lived at a time beyond memory and to reside in trees, is worshipped by the Bedas in common with the other lower castes. (Mys. Eth. Mon.; C. T. S. I.)

Besta (156,863).—In the Eastern Districts, they are called Besta (fishermen); in the Southern, Toraya, Ambiga and Parivara (boatmen); while in the Western parts, their names are Kabyara and Gangemakkalu. Their main occupations have been fishing, lime-burning, palanquin-bearing and cultivation. Of late, fishing as an occupation is deprecated. Most of the actual workers are cultivators and labourers, a small number only being returned as fishermen and traders. The Bestas belong to the 18-phanas and do not dine with any of the 9-Phanas who are their rivals. The following are the exogamous divisions or 'Kulas':—Chinna (gold), Belli (silver), Surya (sun), Chandra (moon), Devi (goddess), Suta (charioteer), Mugilu (cloud), Bhashinga (marriage chaplet), Muttu (pearl), Ratna (precious stone), Kasturi (musk), Havala (coral bead) and Mallige (jasmine). It is said that silver ornaments are not worn by those of the Belli Kula except during marriages. This caste admits persons of superior castes in the social scale, after a ceremony. A Besta girl may remain unmarried. The practice of dedicating Basavis, though it exists, is getting into disfavour. Both infant and adult marriages are allowed to take place. The brideprice is Rs. 12. Divorce is allowed on the ground of unchastity on the part of the wife. The remarriage of a widow is permitted if she and her husband pay to the caste a fine of Rs. 6 and 8 respectively. Polygamy is practised. A son-in-law remaining with his father-in-law is stated to be entitled to inherit the property of his father-in-law, provided he performs the latter's obsequies. Ceremonies for deceased individuals are not performed periodically. For the propitiation of the ancestors in general, a *yadé* consisting of all the articles of food and plantain leaves and coin, is presented to a *purohit* on Mahalaya day. Religious mendicants such as Dasayyas are fed. Among the Bestas are both Saivas and Vaishnavas. There are two religious mendicant orders in this caste, the Saivite Jogis who worship Bairedvaru of Chunchangiri and the Vaishnavite Dasaris who worship Ranganatha of Biligiri Rangan hills. Tolasamma, Maramma, Uttanhalliyamma, Patalamma, Kalamma, and Yellamma are also worshipped. Pujaris of this caste worship daily in the temples built for these. (Mys. Eth. Mon.; C. R., 1901; C. T. S. I.)

Bhatraju (905).—These speak Telugu and are supposed to have come from the Northern Circars. Probably these were bards in the Court of Vijayanagar and as the empire split in the 16th century, they passed to the courts of minor chiefs and viceroys further south. Nowadays they are mostly mendicants. They employ Brahman priests for their marriages but Jangamas or Satanis for funerals. They are principally worshippers of Vishnu and correspond to the Bhats of Northern India. (C. R., 1901.)

Brahman (194,570).—The tenets and customs of the Brahmans are so well known that they need not be described here in detail. It is remarkable that the traditional occupation of priest is followed by a very small minority of actual workers. Income from rent of land, public administration and the learned professions are the chief occupations that support the majority. The Brahmans are divided into Pancha Gauda and Pancha Dravida sections, those living north and south of the Vindhya, respectively. The Pancha Gauda comprise Saraswata, Kanyakubja, Gauda, Utkala and Maithila classes; the Pancha Dravida consists of Maharashtra, Andhra, Dravida, Carnata, and Gujarati classes. The names of these classes originated from the tracts where they lived in centuries gone by. The Brahman population in any district is almost never of the same class. The divisions and sub-divisions of the several classes are so numerous that it is exceedingly difficult

if not impossible, to frame an exhaustive and accurate list thereof. We shall only give here details of the classes who are found in numbers in Mysore; there are—

- (1) Canarese or Karnataka—the Tulu-speaking Shivalli Brahmans are included in this class;
- (2) Telugu or Andhra;
- (3) Tamil or Dravida; and
- (4) Marathi or Desastha.

THE KARNATAKA BRAHMANS.—The chief endogamous divisions are:—Aruvaththu Vokkalu, Badaganadu, Hoisanige or Vaishanige, Kamme (Bobburu, Karna and Ulcha), Prathamasaake and Sirnadu. Here again, the names are in most instances indicative of the original domicile of the division. The Havika Brahmans of the western parts of the Shimoga District, are the descendants of settlers in the Haiga, which comprised the southern part of North Kanara and the extreme northern part of South Kanara. Unlike Shivalli Brahmans who speak Tulu and are the followers of Madhvacharya, the Havikas are followers of Sankaracharya and are speakers of Kanarese. They are for the most part engaged in the cultivation of areca palm gardens, in which they are very expert.

THE ANDHRA BRAHMANS.—The chief divisions are Murikinadu, Telaganyam, Velnadu, Kasalnadu, Prathamasaake and Karnakammalu. The divisions that do not follow the priestly profession are called Niyogis and their divisions are Aruvelu, Nandavarikulu, Kammalu, etc.

THE DRAVIDA BRAHMANS.—The chief divisions of the class are, in the case of Smarthas, Vadama, Brahatcharanam, Ashtasahasra and Sankethi and in the case of Sri Vaishnavas, Vaikhanaasa, Pancharatra, Hebbar and Mandya.

✓ **THE MAHRATTA BRAHMANS.**—The chief divisions are Desastha, Konkanastha, White Yajurvedi, Karhade and Shenvi.

The Sectarian divisions run in almost parallel lines through the endogamous divisions. Brahmans are either *Dwaitis*, *Adwaitis* or *Visishtadwaitis* whatever be their patron deity, whether they are votaries of Durga, Vishnu, Surya or Shiva. The Dwaitis are the Madhvas who say that Soul and God are separate. The Adwaitis are the Smarthas who say that soul (Jivatma) and God (Paramatma) are one, and the Visishtadwaitis are the Srivaishnavas who are a compromise between the two. The Dwaitis are known as Madhvas from Madhvacharya who was the founder of this sect. The founder of the Smartha sect was Sankaracharya, while the Sri Vaishnava sect was founded by Ramanujacharya. Among the Madhvas, there are two sub-sects Vyasakuta and Dasakuta; amongst the Smarthas, there are the Smartha proper and the Bhagavatsampradaya people; while amongst the Srivaishnavas (who are found among the Tamil-speaking Brahmans) there are two mutually exclusive sects, the Tangale and Vadagale. Sectarian distinction is often no bar to marriage. Under the influence of education, the endogamous distinctions too are giving gradual way. The *gotra* or descent from a remote ancestor is the exogamous unit. (C. R., 1901; B. H. C; C. T. S. I.)

Budubudike (1,327).—Most of these are wandering beggars; only some are cultivators. They are gipsy beggars and fortune-tellers from the Mahratta country, who pretend to consult birds and reptiles to predict future events. The name is derived from the sound made by the hour-glass-shaped drum when it is struck by a knotted string tied to its middle as the drum is turned right and left deftly in the hands of the fortune-teller. The burden of the chant is invariably stereotyped and purports to have been gleaned from the warble of the feathered songsters of the forest. It prognosticates peace, plenty and prosperity to the house, the birth of a son to the fair, lotus-eyed house wife, and worldly advancement to the master whose virtues are countless as the stars and have the power to annihilate his enemies. It also holds out a tempting prospect of coming joy in an unknown shape from an unknown quarter and concludes with an appeal for a cloth. Amba Bhavani is their tribal deity. Hanumanta is also worshipped. (C. R., 1901; C. T. S. I.)

Darzi (11,564).—This caste is found in all the districts, the Shimoga District containing a fairly large number (2,491). Nearly five-sixths of the actual workers follow the traditional occupation of tailors and dyers. These are immigrants from the Mahratta country and worship Vitthoba or Krishna. The section Namdev of the caste are professional tailors while the section Rangare are also dyers and calico printers. In these modern days, when sewing is done entirely by machinery, it is not unusual to find the representatives of almost every caste and tribe in the profession of tailoring. (C. R., 1891, 1901.)

Dasari (4,565).—These are fairly numerous in the Kolar, Tumkur and Chitaldrug Districts. They are priests or rather functionaries in certain domestic ceremonies in some castes. They live mostly by begging and agriculture. These are mendicants who originally belonged to different classes. Telugu Banajigas, Holeyas, Tigalas and Vakkaligas are the castes, from which the Dasari ranks are usually filled. Such as become Dasaris, do so in pursuance of a vow to the God Venkataramana at Tirupati, made either by themselves or their relatives, at some moment of anxiety or danger, and live by begging in His name. Dasaris are Vaishnavites. Dasaris are invited by the Sudras on ceremonial days and feasted. Admission to the community is obtained by being branded by some Vaishnavite *guru*. The five insignia of a Dasari are the conch shell which he blows to announce his arrival; the gong which he strikes as he goes his rounds; the tall iron lamp (with a cocoonut to hold the oil for replenishing it) which he keeps lighted as he begs; the brass or copper vessel (sometimes painted with the *namam*) suspended from his shoulder, in which he places the alms received; and the small metal image of Hanuman, which he hangs round his neck. Every Saturday after bathing and praying for some hours, a Dasari must cook his own food in a clean pot. Towards the evening he goes about begging. Some Dasaris are servants under Vaishnava Brahmans who act as *gurus* to various castes. For councils, settlement of marriage and the decision of the social matters, the Dasaris meet, at times of festivals, at well-known places such as Tirupati. The Gangeddus are Dasaris who exhibit young bulls which perform tricks. Quite

different from these Dasaris are the Donga Dasaris of the Bellary District, who pretend that they are Dasaris, and thus mix with the villagers, in order to steal from them later on as opportunity offers. (C. R., 1901; C. T. S. I.)

Dogra (3).—The name is said to be derived from the Sanskrit words *Dvaṁ Gartaṁ* which mean 'two valleys.' These are immigrants in the Civil and Military Station, Bangalore.

Dombar (3,390).—These are found chiefly in the Tumkur and Kolar Districts. They are tumblers and acrobats by profession. Some follow agriculture also. The settled portion of the caste are found in Tumkur, Matchenhalli in Goribidnur Taluk and Chiknayakanhalli Taluk and are almost all engaged in agricultural pursuits, the proceeds of which they supplement by comb-making and pig breeding. Their *guru* is a Sri Vaishnava Brahman. The wandering section, owing to their nomadic life, is broken into a number of groups, each having its own Yajaman. The common head of this section is said to be a man of the *matli* sub-division and is styled *matli nayada*. The Dombars are a Telugu caste, having migrated from the Kurnool and Nellore Districts, and have nothing to do with the Doms of Northern India. Polygamy is common. Girls are trained to play on poles and such as become skilled in that art are not married and lead a life of prostitution. The *tera* or brideprice, is as high as Rs. 52. The practice of dedicating Basavis is common specially with the wandering section of the caste. No *sraddhas* are performed. The chief deities worshipped are Yellamma, Sunkalamma, Gurumurti and Maramma. The Dombars freely admit recruits, both male and female, from any caste, not lower than their own, as fixed by the test of commensality. The wandering Dombars breed pigs on a large scale; men engage themselves as day labourers in the villages near or about which they encamp, their women going about begging also. They are expert bird-catchers which they secure either by spreading snares or applying bird-lime on their roosts. The wandering section generally live in huts made of bent bamboos covered over with date mats, in the form and size of the tops of country carts; and they carry baggage from place to place on donkeys or oxen. (Mys. Eth. Mon.)

Ganiga (40,469).—The caste is chiefly found in the Mysore, Bangalore and Kolar Districts. The traditional occupation is oil-pressing. Nearly one-fourth of the number of actual workers follow it as their principal means of livelihood. Cultivation of land is the chief occupation. The Ganigas are known by different names according to locality and special customs such as Hegganigas, those who yoke pairs of oxen to their stone oil mills; Kiru-Ganigas those who work with wooden mills; Vontiyettu Ganigas who yoke only one bull to the mill, etc., none of whom eat together or intermarry. The main caste of the Ganigas is also known collectively as Jotiphana or Jotinagara, or the tribe of light. These belong to the 9-Phanas section of which they along with the Nagartas form the leading communities. The Ganigas are both Vaishnavites and Saivites. There is a small division of the oil-mongers who wear the *linga*, known as Sājjana. These Sājjanas hold no social intercourse of any kind with the other sub-divisions. The Saivite Ganigas own the Jangamas and Linga Banajigas as their *guru*. Widows are not permitted to marry. If a young man dies a bachelior, the corpse is married to an arka plant (*calotropis gigantea*), and decorated with a wreath made of the flowers thereof.

The oil mill of the Ganigas has been described thus:—

"The oil mill is a sort of large wooden mortar, usually formed out of the heart of a tamarind tree and firmly imbedded in the ground. A wooden cylinder, shod with iron, fits roughly into the cavity. A cross beam is lashed to this in such a way that one end is close to the ground and to this a pair of bullocks or buffaloes is fastened. By an arrangement of pulleys the pressure of the cylinder can be increased at pleasure. As the bullocks go round the trough, the seeds are crushed by the action of the cylinder, so that the expressed oil falls to the bottom, while the residuum as oil cake, adheres to the side of the mortar." (C. R., 1891, 1901; C. T. S. I.)

Garadiga (325).—These are found chiefly in the Kolar and Bangalore Districts. The traditional occupation is that of jugglers, snake charmers and animal exhibitors; in fact, begging is usually combined with the same. They are mendicants from the Telugu country who also practise sleight-of-hand tricks.

Golla (150,842).—These are found chiefly in Tumkur, Chitaldrug, and Kolar Districts. The main occupation is agriculture. Only a small number follow the traditional occupation of cowherds. Many earn their livelihood as labourers. The caste consists of Uru Gollas and Kadu Gollas who differ widely in their customs.

The Uru Gollas or Gollas proper have the following endogamous divisions, members of whom, however, eat together:—Onti Chapparamuvallu, Rendu-Chapparamuvallu, Yerra or Kilari, Punagu or Kudi Paitala, Karani, Puni or Puje, Bigamudre or Bokkasa, Kanchu, Racha and Mushti. Yerra or Kilari Gollas appear to be superior to the other divisions and put on the sacred thread during marriages. Bigamudre or Bokkasa Gollas (Gollas of the lock and seal section) are so called because they were the guards of the treasury in former times. Gollas have a large number of exogamous divisions named after some animal, plant or other material, and the members belonging to a particular division are prohibited from eating, cutting or otherwise interfering with the object representing their division. The original language of the Gollas seems to have been Telugu. But those that are living in the purely Kannada parts of the State use only that language. *Illatom* is common in the Telugu parts of the State and an *illatom* son-in-law gets a share in the property equal to that of a son, and in the absence of any sons, becomes sole heir to his father-in-law. Marriage is generally between adults but as in other similar castes there is a feeling that infant marriages are more respectable. Polygamy is rare. A person whether male or female may remain unmarried without incurring any social odium. The bride price is Rs. 15. Widows are not allowed to marry. The husband may give up his wife for her unchastity or loss of caste and the wife may also separate herself from her husband for habitual ill-treatment or his loss of caste. The divorced woman may not remarry. There is no practice of dedicating Basavis. Gollas are Vaishnavas and worship Krishna under various names. Some worship Siva also. Other deities whom they worship are Maramma, Yellamma and Gangamma. Persons dying as bachelors are

deified as Iragararu and their figures are cut on stone slabs as riding on horseback and set up in fields with female figures on either side. The most important feast observed by Gollas is the Sankranti. The presence of Dasayyas is necessary on all occasions of religious ceremonies. The dedicating of men for the service of God as Dasayyas is very common among Gollas. Gollas belong to the 9-Phanas group.

The Kadu Gollas say that they are immigrants from the North. They speak Kannada as they have long been domiciled here. The three primary exogamous septs of the Kadu Gollas are known as Chitta Muttur or Karadi Gollaru, Chandinoru and Rama Gandana Kuladavaru. A pregnant woman in labour is lodged far off from a village and only a Beda midwife is allowed near her. After three months, the mother and the child are brought in. Marriage among them is generally adult but infant marriage may take place. A woman should not die unmarried. The bride price is Rs. 14. A girl first attaining her age has to stop out for 21 days far off from the village. Widows are not permitted to marry. In each hamlet they have a Yajaman who wields extensive powers. In fact, in times of epidemics or calamity, he orders the removal of the settlement *ex bloc* to a new site. The hamlets are usually kept very tidy. They worship Vishnu under the names of Krishna, Venkatramana, Rama, Ranga and Vishnu. Their tribal deities are Junjappa, Chikkannaswami, Kyatedevaru, Chitradevaru and Bhutappa. Junjappa, the chief deity, is a glorified shepherd. Before the tribal council the parties swear by Junjappa or by the sacred sheep (*Jenuige Kari*—the sheep is marked by three longitudinal cuts in its ears and is considered sacred). Generally each hamlet has one or more such sheep. (Mys. Eth. Mon.)

Gondaliga (71).—More than half are in the Kolar District. These are mendicants of Mahratta origin like the *Budubudikes* and may perhaps be a sub-division of them. They are worshippers of *Durga*. Their occupation, as the name indicates, is to perform *gondala* or a kind of torchlight dance, usually performed in honour of *Amba Bhanani*, especially after marriages in Desastha Brahmans' houses, or at other times in fulfilment of any vow. (C. R., 1901.)

Goniga (998).—These are mostly found in Bangalore and Tumkur Districts. The chief occupations are weaving and agriculture. The Gonigas are sack weavers and makers of gunny bags. The known sub-divisions of the caste are the *Janapas* and the *Sadkaramasthas*. Some of the latter are agriculturists, while many of the grain porters in Bangalore City are of this sub-caste. They do not wear the sacred thread. Widow marriage is not permitted; girls are married after puberty. The Telugu *Janapas* seem to have twenty-four *gotras*. Some of these are totemistic in their character. (C. R., 1901; C. T. S. I.)

Gosayi (367).—The chief occupations are trade and begging. This is an immigrant caste. The *gosayi* is no caste; commonly any devotee is called a *gosayi*, whether he lives a life of celibacy or not, whether he roams about the country collecting alms, or resides in a house like the rest of the people, whether he leads an idle existence or employs himself in trade. The *Gosayis* although by profession belonging to the religious class, apply themselves nevertheless to commerce and trade. They never marry. Any casteman can become a *gosayi* and unite with the members of this fraternity in eating and drinking; but if this is done, the person is not admitted to his original caste. (C. R., 1901.)

Gujar (H.—156; M.—36).—They are enumerated in the Civil and Military Station, Bangalore. The actual workers of this caste are mostly soldiers in the British army. The *Gujars* are a pastoral tribe, the majority of whom have in recent times espoused the Muhammadan faith. With the *Jats* they form the backbone of the rural population of the Punjab though inferior to them in civilization, industry and agricultural skill.

Gurkha (11).—They have been enumerated in Mysore City. The actual workers are Military pensioners employed as Palace bandsmen. The caste has immigrated into the country from the North.

Gujarati (188).—These are found chiefly in the Mysore City and the Civil and Military Station, Bangalore. Their chief occupation is trade. These are immigrants from Gujarat and are followers of Vallabhacharya.

Holeya (613,248).—These are found everywhere, but they are not so numerous in Chitaling and Tumkur Districts. The traditional occupation is that of either a village watchman or an agricultural labourer. Nearly one-fifth of the number of actual workers follow the traditional occupation. They furnish the bulk of the ordinary and mining labourers. The word '*Holeya*' is, literally speaking, a person of the land and probably points to the origin of the caste. The *Holeyas* may have been the original dwellers of the country, who were subjugated and made to be labourers attached to the land, by in-coming settlers in times beyond memory. The derivation of the word from '*hole*' or pollution does not seem to be correct for we are not positive whether the uncleanly habits were the resulting effects or the causing factors of the degraded condition of the caste. The *Holeyas* form the bulk of agricultural labourers in the State. In Mysore they generally speak Kanarese, Tamil, Telugu and Marathi being used by small sections of them according to the place of their origin. The *Holeya* belongs to the 18-Phanas section of the community, of the meetings of which he is the convener when he goes forth carrying a brass cup and chain as insignia, the cup having on it engraved the badges of different castes composing this section, such as the plough of the Vakkaliga, the scales of the Banajiga, the shears of a Kuruba, the spade of a Vodda, the razor of a barber, the washing stone slab and pot of an Agasa and the wheel of a Kumbara. The caste *Holeya* has a number of sub-divisions, the principle of division being language, profession or place of residence or two or more combined; and these groups are all said to be endogamous. Kannada-speaking divisions are *Gangadikara*, *Morasa*, *Dasa*, *Mayya* (*wescer*), and *Hagya* (*rope-maker*). The Telugu groups are *Pakinati*, *Chintala*, *Gundlajapati*, *Rampala*, *Pasupasere* and *Seru*. *Konga*, *Dyarel*, *Mastikaru*, *Goyla*, and *Kudaru* are of Tamil origin. A small number of Marathi-speaking

Holeyas are found scattered over the country on the borders of the Bombay Presidency. Tamil Holeyas take food in the houses of Kannada and Telugu sections, while the latter do not return the compliment, regarding the Tamil Holeyas as inferior in origin. The *Gangadikara* Holeyas are regarded as the highest in rank. The Holeyas have a number of exogamous divisions or *Kulas*. Those who perform the worship of their gods are known as *Devaraguddas* the relation of these to others of the caste being hypergamous. Holeyas girls are married either before or after puberty. If a girl remains unmarried from the absence of suitors, she is married to trees, Honge (*Pongamia glabra*), Bevu (*Margosa*), Yekke (*Calotropis gigantea*), and dedicated to shrines like those of *Biligiri Ranga* or *Siddappaji*. She may then live with any man of the caste without losing status. She inherits then the rights and privileges of a son. Her children belong to her father and are legitimate. A father may also dedicate his daughter to the patron deity having made a vow during the child's illness. This system is not in vogue among the *Gangadikara* and *Morasu* Holeyas but is general among the rest. The bride price is stated to be Rs. 12-13-4 at Channapatna, Rs. 25 at Koppa and Rs. 15 at Nanjangud. The marriage of widows is permitted. Divorce is permitted at the desire of either party, for infidelity on the part of the wife or even without such a ground if they agree to part, provided she pays a fine to the caste. Holeyas do not perform *Shraddhas*. The Holeyas live in a hamlet separate from the village called *Holageri*. Though very rarely, recruits from other castes are taken into the fold after a ceremony. Sons divide the father's property equally, the youngest son having a right of selecting the first share. A son-in-law who resides with his father-in-law receives an equal share with his brothers-in-law. Holeyas cannot use the village well and the village barber and washerman do not render services to them. Holeyas are either *Saivas* or *Vaishnavas*. They pay homage chiefly to the images which personify the malignant powers and bloodthirsty qualities, e. g., *Mariamamma*, *Sangamma*, *Mastamma*, *Baire Devaru*, *Manigamma*, *Hindamma*, *Mutyalamma*, *Patalamma* etc. The religious itinerant mendicants among them are known as *Dasa*, *Jogi*, *Devaragudda*, *Bidimanushya*, or *Nilagararu*. Satanis are generally the priests of Holeyas. Sometimes a man of Lingayat caste and a *Tirukala Dasa* of the Vishnu cult also sometimes serve as priests.

The Holeyas manufacture coarse cotton cloth; some are engaged in betel vine gardening. The *Aleman* sub-division furnishes recruits to the local infantry as sepoy. In purely *Malnad* Taluks, some Holeyas on estates were considered *serfs* either as *Huttalu* or going with the family of the landlord or as *Mannalu* or going with land when it changes hands. (*Mys. Eth. Mon.*)

Idiga (38,758).—The caste is found in all the districts especially in Mysore, Tumkur and Shimoga Districts. The traditional occupation is that of toddy drawer, and it is followed by one-sixth of the number of actual workers of the caste as the principal occupation. The chief occupations are cultivation, labour and trade. Their language is Telugu, and except in the Western districts where they have forgotten their original language and adopted Kannada, they speak it at home. The Idigas are immigrants from the Telugu country. The two main endogamous divisions are (1) *Maddi* or *Sada* or *Uru Idigas* and (2) *Bellada* or *Eni* or *Kadu Idigas*. The two exogamous divisions of the caste are styled *Sasmeyavaru* and *Bodeyaravaru*. Polygamy is allowed. Marriage of adults is the rule. The bride price is Rs. 15. Widow marriage styled *Kudike* or union is generally allowed though it does not find favour. A man cannot divorce his wife for any other reason than that of adultery or loss of caste and the wife can separate herself from her husband only if the latter is thrown out of caste. Idigas do not dedicate *Basavis*. They make offerings to the ancestors generally on the Mahalaya new-moon day and on the New-year's day but they do not perform any anniversary *Shraddhas* for the dead. The Idigas are of the 18-*Phanas* section. They consider bullocks sacred and never use them for carrying toddy. Brahmans are allowed to minister to them as priests and are employed on marriage and other festive occasions. They are also called in to purify houses after pollution of death. They have a *Sri Vaishnava* Brahman known as *Tatacharya* of Tirumale as their *guru* and some have *Satani gurus* likewise. Outsiders belonging to any recognised higher castes such as *Vakkaligas* may be admitted into their caste, though such admissions occur very rarely. Idigas worship *Siva* and *Vishnu*. They pay homage to *Munisvara*, *Mariamamma* and *Durgi*. Their special gods are known as *Katamadevaru* and *Yellamma*. Idigas have a class of beggars known as *Enutivallu* who visit them periodically and receive some presents.

Iruliga (H.—154; A.—1,889).—These are found mostly in the Bangalore District. The chief occupations are cultivation and labour, specially in collecting forest produce. (The figures for castes of Iruligas and Soligas were combined together in the Census Report of 1901.) The language of these people is Tamil mixed with Kanarese and Telugu words spoken in a strange tone. They are found chiefly in the hilly tracts of Kankanhalli, Closepet (Sub) and Magadi Taluks. They live on roots, herbs, fruits and ragi. They say they are settlers from the Anamalai forests below the ghats. (C. R., 1901.)

Jat (H.—38; M.—23).—These people are immigrants from the North. The Hindu Jats are found in the Kolar Gold Fields engaged in mining, while the Muhammadans are found in the Civil and Military Station, Bangalore, employed in the army.

Jogi (12,881).—These are found chiefly in the districts of Bangalore, Kolar and Shimoga. Cultivation and begging are the occupations followed. These are a caste of Telugu beggars. Besides begging, they employ themselves in snake-charming and pig-breeding.

The *Jogis* are composed of devotees recruited from all castes. They are also called *Sillekyata*, *Helava*, *Jangaliga* and *Pakanati*. The two latter deal in medicinal drugs and wander about calling out the particular diseases which they profess to cure by means of their medicaments. (C. R., 1901, 1891.)

Kahar (73).—These are found in the Civil and Military Station, Bangalore, Mysore City, and Mysore District. The chief occupation is transport. The caste is the important domestic

servant class of Northern India. It is said that in every well-to-do family there is at least one *Rawani* (member of a sub-caste of Kahars), to serve as 'maid-of-all-work.' (B. H. C.)

Kanakkan (186).—This caste is found mostly in the Kolar Gold Fields, Kolar District and Civil and Military Station, Bangalore. The chief occupations are mining and trade. Kanakkan is a *Tamil accountant caste*, found chiefly in North Arcot, South Arcot and Chingleput. They are generally *Saivites* and their title is *Pillai*.

Kayastha (17).—This caste is found mostly in the Bangalore City and Civil and Military Station, Bangalore. The Kayasthas are the great writing caste of Bengal.

Komati (9,813).—This caste is found all over the State. They are the well-known caste of traders, four-fifths of the number of actual workers following the traditional occupation. The language of the caste is Telugu. They have a number of *gotras* or exogamous divisions. The girls are married before puberty and polygamy is allowed though rarely practised. In the matter of religious ceremonial, they closely follow the practices of the Brahman caste.

Koracha (H.—6,126; A.—14,579).—This caste is found all over the State, specially in Kolar and Shimoga Districts. The Korachas are a wandering tribe. They are known as *Erukulas* in the Telugu country, as *Koravas* in the Tamil tracts, *Koramas* or *Korachas* in the Kannada tracts and as *Koravis* or *Kaikaris* in the Mahratta country. There are four endogamous divisions—*Uru* or *Dabbe*, *Uppu* or *Ghattada* or *Ettina*, *Kunchiga* and *Sonai*. *Uru* Korachas are so called because they have settled down within towns and villages. They are agriculturists but also make baskets and their women practise tattooing and fortune-telling. *Uppu* Korachas trade in salt. *Kunchiga* Korachas are those who manufacture *Kunchige* or the brush used by weavers for starching their yarn. *Sonai* Korachas get their name from a wind instrument on which they play and are snake charmers generally. They have four exogamous divisions—*Satpadi*, *Kavadi*, *Menpadi* and *Mendragutti*. The Korachas seem to have traces of the custom called *Cowade*, according to which, when a wife is delivered of a child, the husband is confined to bed and treated as a delicate patient. The practice seems to be dying out and exists only in remote parts in Shimoga District and elsewhere (*vide* also Madras Museum Bulletin, Vol. IV, No. 2, pp. 115-6). Marriage is generally celebrated after puberty. Polygamy is allowed. The bride price is Rs. 72. Widow marriage is freely allowed. Divorce is allowed on account of the wife's adultery. They do not perform *sraddhas*. *Uru* and *Sonai* Korachas are more or less a settled people. They have no objection to take into their fold persons of other castes who are higher in the social scale, except, it is said, a Brahman. Korachas belong to the 18-Phanas section. For an account of tattooing see Census Report of 1901, Chapter VIII, p. 556 *et. seq.* Korachas worship God Venkataramana of Tirupati. The chief female deities worshipped by them are *Durgamma*, *Halagamma*, *Mathangamma*, *Gangamma*, *Madduramma*, and *Yellamma*. (Mys. Eth. Mon.)

Korama (H.—165; A.—6,118).—These are found chiefly in Bangalore District. (*Vide* notes on Koracha caste.)

Kshattriya (37,927).—They are found in all districts, the Mysore District (including Mysore City) returning a little more than one-fourth the number. The traditional occupation of Military service is followed as principal means of livelihood by one-seventeenth of the number of actual workers; nearly half the number are either rent receivers or rent payers, the rest being engaged in industry, trade, Government service, etc. Among the castes grouped under 'Kshattriya' are the *Arasus*, of whom are the ruling dynasty of Mysore, *Rajputs*, *Coorgs*.

Kumbara (41,810).—Two-fifths of their number are to be found in the Mysore District. The traditional occupation is that of potters, fully half the number of actual workers following the same as principal means of livelihood. Cultivation is the other chief occupation of the caste. There are three main divisions among the Kumbaras: (1) *Telugu* Kumbaras otherwise known as *Sajjana* Kumbaras, (2) *Kannada* Kumbaras and (3) *Lingayat* Kumbaras. There are said to be two more divisions, *Kudipaitala* and *Tamil* Kumbaras, the latter being very few in number. These divisions are endogamous and sometimes do not eat together. The *Lingayat* Kumbaras follow the rites and ceremonies peculiar to that sect and have *Jangamas* for their priests. There are a number of exogamous sub-divisions in each division. Marriage may be infant or adult, the bride price varying from Rs. 25 to Rs. 50. Polygamy is permitted. Widow marriage is allowed. Divorce is not popular and takes place only among the more backward portion of the caste living in villages. They do not observe *sraddhas* but on the Mahalaya new-moon day, they offer rice doles and money to Brahmans to propitiate all the deceased ancestors. Kumbaras worship both *Siva* and *Vishnu* as well as local deities. (Mys. Eth. Mon.)

Kuruba (403,366).—This caste is found in all districts, two-fifths of the number returned being in the Mysore District. The traditional occupation is that of shepherds and wool weavers, the same being followed, as principal means of livelihood, only by about one-fifteenth the number of actual workers returned for the caste. More than two-thirds are agriculturists, rent payers, and rent receivers. The Kurubas form an important portion of the population of the country. *Gauls* and *Heggade* are the titles used by them. The Kurubas are said to be the modern representatives of the ancient *Kurumbas* or *Pallavas*, who were once so powerful throughout Southern India. Their language is Kannada but some who are living in the taluks bordering on the Telugu districts, as Mulbagal for instance, have adopted Telugu as their home speech. The three main endogamous divisions are *Hals* Kurubas, *Ande* and *Kambli* Kurubas. The *Hals* Kurubas form by far the largest and most important division, who abstain from liquor. The *Kambli* Kuruba division is said to indulge in drink. The caste contains a large number of exogamous divisions, many of the names of these *Kulas* being totemistic in their origin. There are no hypergamous divisions, but the *Samanai* Kula (exogamous division) is considered superior to others, and the *gurus* or the *pujaris* of the caste are drawn from this sept. These do not eat flesh or drink liquor: wear a

linga round their necks, and do not eat with others. They can take wives only from the 'Ane' and *Gali* septes. Marriages are generally adult but infant marriages are also common. It is not compulsory that a woman must be married. The Kurubas have their own *Pujari* to officiate at marriages and do not generally invite Brahmans as priests except where their casteman called *Revanyya* is not available. The bride price is Rs. 12. Widow marriage is permitted. A husband may divorce his wife on account of her unfaithfulness. The practice of dedicating girls as Basavis exists in some places. Generally the eldest girl is so dedicated, either when there are no sons to continue the line or in pursuance of a vow. The Basavi is considered as entitled to inherit her father's property as a son. Kurubas do not perform *sraddhas* but they worship all the ancestors generally on the Mahalaya new-moon day and on the *New-year's day*. They do not admit outsiders to the caste. Questions affecting inheritance, etc., if they are not of a complicated nature, are inquired into and settled by the village panchayat, including the patel and shanbhog. The Kurubas are a well-organised community. The whole caste is divided into a number of territorial divisions, at the head of each is a *gauda* or *headman*. There is a *Nadu* *gauda* who has jurisdiction over several *gaudas*. Some Kurubas call in Lingayat and Brahman priests to assist at auspicious ceremonies. The Kurubas are *Saivas* but worship all Hindu gods. Their tribal deity is *Bira* or *Vira* a name of Siva. The other deities are *Mailara*, *Batyappa*, *Irachikkappa*, *Budalappa*, *Yellamma*, *Lakshmidēvi*, *Karakurappa* etc. The chief place of pilgrimage is Mailara in the Bellary District. (Mys. Eth. Mon.)

Ladar (1,038).—More than one-third have been returned in the Mysore District (including Mysore City). The traditional occupation, *viz.*, trade, is followed as principal means of livelihood by one half the number of actual workers returned for the caste. The Ladars are a class of general merchants, found chiefly in cities. They are said to have come from Benares to Mysore under pressure of famine 700 years ago. There is a division of *Baniyas* in Gujarat known as '*Lad*.' The Ladars wear the sacred thread and they have *gotras* like the Brahmans. They claim to be Kshattriyas. Girls must be married before the tenth year. Their goddess is *Bharani*. They abstain from meat and liquor.

Lingayat (729,431).—The community is found all over the State, Mysore, Chitaldrug, Shimoga and Tumkur Districts returning the largest numbers. They are found engaged in all occupations—agriculture, commerce, public administration and the professions, nearly the four-fifths of the number of actual workers being rent-receivers and rent-payers.

The term 'Lingayat' is properly not a caste but a religious designation combining several castes. It is a popular designation but the caste people call themselves Virasaivas, Sivabhaktas, or Sivachars. For an excellent account of the Lingayats the reader is referred to pages 529-35 of the Mysore Census Report, 1901. A note on the Lingayat mutts is given below.

There are five great religious centres of the Lingayats and these are situated in different parts of India as follows:—(1) Ujjani, Kudligi Taluk, Bellary District. (2) Balehonnur, Koppa Taluk, Kadur District, Mysore State. (3) Benares or Kasi. (4) Himavatketara in the Garhwal District and (5) Srisaia *alias* Parvata in the Cuddapah District.

The famous teachers who established these seats were Marulacharya, Renukacharya, Viswacharya, Ekoramacharya and Punditacharya, respectively. The seat of Srisaia has now been removed to a place called Harahalli, Hospet Taluk in the Bellary District. Kollipaki is another mutt of some reputation established by Renukacharya of Balehonnur and is considered to be a branch of the latter mutt. Kollipaki, however, has branches of its own and there is one such branch even now in the Mysore City. Ballepalli in the Hosur Taluk and Rajapuram near Anekal are branch mutts of Balehonnur. Vibhutipuram, Gummalapuram, Bellarai and Tiruvannamalai are all branch mutts belonging to one or other of the five great centres referred to above.

Each of the five principal mutts is called a '*Simhasana*' (throne) and has sub-mutts in important popular centres under the management of *Pattadaswamis* (who are *Brahmacharis*). Each sub-mutt has a number of branch mutts called *Gurusthala* (*Grihastha*) mutts and these latter are to be found wherever a community of Lingayats exists. The rights and duties of the *Swamis* (*heads*) of these mutts are to preside in all religious functions, to receive their dues, to impart religious instruction, to settle all religious and caste disputes and to exercise a general control over all matters affecting the religious interests of the community at large.

Another order of priests exists called *Viraktas* also known as *Shatsthala Nirabharis* who hold the highest position in the ecclesiastical order and therefore command the highest respect from laymen as well as from the abovementioned mutts. There are three chief *Virakta* mutts and these are (i) the *Muragi* mutt in Chitaldrug, Mysore State, (ii) the *Dombal* mutt in Gadag, Dharwar District, and (iii) the *Moorusavirada* mutt in Hubli, Dharwar District. These mutts have also their respective sub-mutts and branch mutts all over India and exercise jurisdiction over all the *Viraktas* and the general body of the Lingayats. Every Lingayat centre has a *Virakta* mutt built outside the town in which the Swami leads a simple and spiritual life. Unlike other priests, the *Viraktaswami* is prohibited from presiding on ceremonial occasions and from receiving unnecessary alms. He should devote his life partly to spiritual meditation and partly to the spreading of spiritual knowledge among his disciples, so that he would be the fountain head, to whom all laymen and all priests must resort for spiritual enlightenment; in short, his position is that of a pure *sannyasi* or *yati*, of the most exalted order. (Memorandum by Rajasabhabhushana Dewan Bahadur K. P. Puttanna Chetty, Esq., late Senior Member of Council, Mysore State.)

Lambani (H.—9,945; A.—41,223).—A little less than one-third of the total number are to be found in the Shimoga District; the rest are found distributed among the other districts, Kolar and Mysore Districts returning the fewest numbers. About one-ninth of the number of actual workers are engaged in cultivation. Labour (agricultural and other) and petty trade are the other occupations chiefly followed. The Lambanis are locally known as *Sukalis*, *Sukaligas* and *Binjaras* or

Binjaris. The women wear a peculiar dress and ornament themselves with cowries and bangles made of metal and bone. The Lambanis own the *Gosais* as their priests or *gurus*. The Lambani outcastes comprise a sub-division called '*Thalya*' who like the Holeyas are drumbeaters and live in detached habitations. The Lambanis live in clusters of huts called '*Thandas*.' There is a *Naik* or headman of a *Thanda* and he has extensive powers over his fold. Females are married after puberty. The bride price is Rs. 21 or Rs. 41 with 4 bullocks. Widow marriage and polygamy freely prevail among these people. The Lambanis are Vaishnavites and their principal object of worship is *Krishna*. *Banasankari*, the goddess of forests, and *Basava* are also worshipped. During the marriages, the women weep; probably this is a relic of marriage by capture of bride and the officiating priest is jocularly handled by the women; milk is poured by the bride and the bridegroom, into an ant-hill where a snake is said to live. The Lambanis were the noted carriers by packbullocks following the armies in the wars of the 18th and 19th centuries. With the restoration of peace and order, their occupation was well-nigh gone and some took to robbing. The habit of drinking prevails among persons of both sexes. (C. R., 1901, 1891.)

Madiga (308,083).—The caste is most numerous in Tumkur, Bangalore, Kolar and Chitaldrug Districts. They are, by tradition, workers in leather but hardly one in twenty of the actual workers returned follows the occupation now. A little less than one-third are cultivators while four-ninths subsist by labour (agricultural and other). Madigas belong to the 9-Phanas group of castes. They speak Kannada or Telugu according to the locality they live in. There are some immigrants into the State from the southern parts of the Madras Presidency and these speak Tamil; but their number is insignificant. Among the Kannada and Telugu Madigas (who do not intermarry) there are three endogamous divisions:

- (1) *Tanige Buvvadavaru* or *Tala Buvvanavallu*;
- (2) *Hedige Buvvadavaru* or *Gampa Buvvanavallu*; and
- (3) *Mora Buvvadavaru*.

There are two other divisions known as *Jambavas* and *Dakkaloru*. The *Jambavas* are the *gurus* of the Madigas and consider *Panchalas* as their patrons. The *Jambavas* talk Telugu and among them hypergamy prevails, their women not being allowed to marry into the other divisions. *Dakkaloru* are considered to be the *Halemakkalu* (hereditary bondsmen) of the Madigas and are treated by them as outcastes. Madigas have a number of exogamous divisions known as *kulas* named after trees and animals. There is no limit of age for marriage in either sex. Polygamy is allowed. The bride price is Rs. 12. Widow marriage is allowed and freely practised. Divorce is granted for adultery. Dedication of girls as *Basavis* is common in this caste. Some families have the custom of devoting the eldest girls to this life; while in many cases, a girl is so dedicated in pursuance of some vow taken at a time of illness or other distress. They do not perform *Sradhas*. Madigas reside in quarters outside the main village and apart from *holegeri*. They are not allowed to use the common village well. Madigas freely take in recruits from all castes except Holeyas. The Madigas worship *Marianamma*, *Masanamma*, *Matangi*, *Pujamma*, *Akkayamma*, *Kalamma*, *Choudamma*, *Durgamma*, *Ganyamma* and *Yellamma*. Their patron saint is *Aralappa*. A section among them known as *Desabhayadavaru* are Vaishnavas, having as their *gurus* *Satanis* or *Srivaishnava* Brahmans. It is stated that a Western Chalukya king, *Mangalesa* (567-610 A. D.) conquered the *Matangas*. Who these were has not been definitely settled and it is conjectured that they were hill tribes and that Madigas are their descendants. (Mys. Eth. Mon.)

Mahratta (45,898).—Nearly one-third of the number reside in Shimoga District. Three-fifths of the remaining numbers live in Bangalore (including Bangalore City and Civil and Military Station, Bangalore), Mysore (including Mysore City), and Tumkur Districts. More than a third of the actual workers are engaged in cultivation of land. The other occupations chiefly followed are service in the Military and Police forces, industry and trade. The Mahrattas are called *Are* by the people in Mysore. They are the military caste of the Mahratta country. The lower classes of Mahrattas do not go through the ceremony of *Upanayana* or investiture with the sacred thread; but they take it at the time of their marriage. Brahmans minister to them as their priests. The Mahrattas have two main divisions among them. The branch called the 'seven families' has a superior status. The great *Sivaji* belonged to this division. The other division is called that of the 'Ninety-six families.' Some Mahratta families are connected by marriage with Rajput clans. (B. H. C.)

Malayali (1,448).—A little more than half the number are found in the Kolar Gold Fields and Kolar District. Nearly half the number of actual workers returned are engaged in mining on the Kolar Gold Fields. The name is given to persons belonging to immigrant castes from Malabar who are not Nayars.

Maleru (H—1,756, A-1).—These are found mostly in the *Malnad* districts of Kadur and Shimoga. The chief occupations are returned as cultivation and labour. The traditional occupation is that of temple servants. In some temples of the *Malnad* there exists a set of females who though not belonging to the *Natuva* class are yet temple servants like them and these are known by the name of *Maleru*. Any woman who eats the sacrificial rice strewn on the *Balipitam*, at once loses caste and becomes a member of this caste. The children of *Maleru*s by Brahmans are termed *Golakas*. (C. R., 1901; O. T. S. I.)

Maravan (15).—The members of this caste are enumerated in the Civil and Military Station, Bangalore. The actual workers are engaged in the public forces. The Maravans are chiefly found in Madura and Tinnavelly Districts of the Madras Presidency.

Marwadi (H.—226; J. 317).—These traders and bankers from the North are found mostly in the towns. The Jain Marwadis are all *Swetambaras* and the local Jains, who are *Digambaras*, do

not mix with them. 'Marwadi' means a native of Marwar in Rajputana; but it should be noted the designation as commonly used is not strictly confined to the meaning.

Meda (6,778).—Medas are found in all districts of the State, specially in Mysore and Shimoga Districts. These persons are mat-makers and cane-splitters by traditional occupation, more than three-fifths of the actual workers returning the same as their principal means of livelihood. The Medas are divided into two linguistic divisions, Kannada Medas and Telugu Medas. The endogamous divisions are:—(1) Gavarigas, found only in the Mysore District, (2) Palli Medas and (3) Bandikara Medas. The exogamous sects are in the case of Gavarigas, *Bellikula* and *Nagarakula* in the case of Palli Medas who probably originally immigrated from the Tamil Country, *Alukula*, *Sampigekula*, *Karekula* etc. Among the Bandikaras, *Nayakan Bidu*, *Masakanni Bidu*, *Gandana Bidu*, *Pattara Bidu*. Polygamy is allowed but is not generally practised. Girls may be married before or after puberty. Widow marriage is allowed and freely practised. The bride price varies from Rs. 12 to Rs. 24. Divorce is permitted on account of the wife's adultery or the husband's loss of caste and sometimes on account of continued disagreement. Medas do not dedicate girls as Basavis. They do not observe *sraddhas*. There are both Saivas and Vaishnavas among the Medas. Saivas sometimes become Devaraguddas (religious mendicants) and Vaishnavas, Dasaris. The tribal deity is known as *Durgamma*, *Kukkaradagamma*, *Malamma* and *Chaudamma*. They belong to the 18-Phanas section. Each of the endogamous divisions has a tribal constitution independent of other divisions. (Mys. Eth. Mon.)

Mochi (1,287).—The Mochis are found chiefly in Mysore (including Mysore City) and Shimoga Districts. The traditional occupation is that of leather workers and five-eighths of the number of actual workers of the caste follow the same as principal means of livelihood. They are immigrant Mahrattas, who, it is said, came to Mysore with Khasim Khan, the General of Aurangzib. They are shoemakers and saddlers by trade and are Saivas by faith. The Mochi is not a tanner and as a leather worker only engaged in the higher branches of the trade. (C. R., 1901; C. T. S. I.)

Mudali (17,896).—More than a third have been enumerated in the Civil and Military Station, Bangalore; Bangalore and Kolar Districts (including the cities situated there) contain a similar number. Nearly a fifth of the number of actual workers are engaged in industries as artisans and workmen; the other chief occupations are trade, Government service and mining. Most of these are immigrants. Mudali is the title of the great farmer caste of the Tamil country. The Vellalas of the Madras Presidency are described as "a peace-loving, frugal and industrious people, and in the cultivation of rice, betel, tobacco, etc., have perhaps no equals in the world. Some are well educated and employed in Government service and as clerks, merchants, shopkeepers, etc., but the greater part of them are the peasant proprietors of the soil and confine their attention to cultivation." (C. T. S. I.)

Multani (28).—These were enumerated in the Cities of Bangalore and Mysore. These are immigrant traders from the North. The name denotes that they are from Multan in the Punjab.

Nagarta (7,782).—Four-fifths of the number reside in the Bangalore and Kolar Districts (including the cities situated therein). The traditional occupation is trade and is followed by one-half of the number of actual workers returned at this Census. Nagartas are principally found in towns and large trade centres. Some are worshippers of Vishnu, others of Siva. Of the latter, some wear the *linga*. They are dealers in bullion, cloth, cotton, drugs and grain. Marriage must be performed before a girl reaches puberty and widows are not allowed to marry. Polygamy is allowed and divorce can be for adultery alone. It is said that Nagartas are co-emigrants with Ganigas to Bangalore where one Mallaraj Ars made headmen of the principal members of the two castes and exempted them from the house tax. It is recorded that the Nagartas originally hailed from Kanchipuram (Conjeeveram) where, it is said, a thousand families of this caste formerly lived. Their name (Nagaram a city) refers to their original home. They wear the sacred thread. They closely imitate the Brahmanical ceremonies of marriage and death. (C. R., 1901, 1891; C. T. S. I.)

Natuva (1,745).—The members of this caste are found chiefly in Bangalore and Kolar Districts (including the cities situated therein). The traditional occupation is that of singing and dancing, about one-fifth of the number of actual workers returned following the same as their principal means of livelihood. At nautch parties, the women dance, the males playing the accompaniment on the drum, the bagpipe, flute, clarinet, cymbals, etc. The Natuva comprises the sub-divisions of Natuvas, and Kaikolas (a caste of Tamil weavers, among whom it seems there is a rule that in every family, at least one girl should be set apart for and dedicated to temple service. So long as this girl or her descendants, born or adopted, continued to live, the family concerned does not dedicate another girl). The Natuva is strictly speaking not a caste, the individuals in the category being in many cases, either affiliated to or born in it. The Natuvas who speak Telugu belong to the Telugu Banajiga caste, while the Kannada-speaking Kaikolas are said to be a sub-division of the Lingayats. The Natuvas have, however, at the present day a distinct caste organisation of their own. (C. R., 1901; C. T. S. I.)

Nayar (785).—Nearly three-fifths of this number have been enumerated in the Kolar Gold Fields and Kolar District. The mining industry engages more than half the number of the actual workers of the caste. The Nayars are the well-known middle class community of Travancore. The Nayars found in Mysore are mostly immigrants.

Nayinda (39,414).—The caste is found in all districts, the Kolar and the Mysore Districts (including the cities situated therein) containing each more than one-fourth of the total number. The traditional occupation is that of barbers, nearly one-half of the actual workers returning the same as their principal means of livelihood. The other chief occupation is cultivation of land. Nayindas belong to the 18-Phanas section of the community. The main divisions of the caste are Kannada and Telugu (according to the languages they speak). The endogamous divisions

of the Kannada section are *Morasa*, *Uppina* and *Silavanta*. (The Silavantas are Lingayets in faith and are strict vegetarians and do not touch liquor.) The Telugu section has the following endogamous divisions—*Nadigaru*, *Raddibhumi*, *Gundlajagata* and *Kudipaita*. The exogamous divisions of the Telugu section are named after plants, flowers, animals and other objects, with the usual prohibition against killing, cutting or using them. There are some *gotras* in the Kannada section. Polygamy is allowed but seldom indulged in. A woman may be married at any age or may remain unmarried altogether. Remarriage of woman is prohibited in some sections of the caste, while the majority allow it. There is no dedication of Basavis. The Silavantas have Jangamas as their priests. Some invite Satani priests. The Nayindas do not perform annual *Sraddhas*. They do not shave the Holeyas and Madigas and do not play the musical instruments at the marriages of these castes and also of Agasas, Korachas and Voddas. Nayindas are professional musicians. They were formerly village surgeons, but this occupation has fallen into desuetude. Women of this caste were employed as midwives and even now in remote villages, many have still that vocation. The Nayindas worship both Siva and Vishnu. The other deities worshipped are *Muniscara*, *Akkagaru* (the sisters—who are regarded as spirits of the woods and trees), *Gangamma*, and *Gramadevata* as *Maramma* or *Sidriramma*. (Mys. Eth. Mon.)

Neygi (96,466).—These are found all over the State, the Bangalore District (including Bangalore City) containing nearly one-fourth of the total number returned for the State. The traditional occupation is that of weavers, calenderers and dyers, a little more than one-half of the number of actual workers returned following the same as their principal means of livelihood. The other chief occupations are agriculture and trade. 'Neyige' is occupational name of the silk and cotton handloom weavers of the State and includes the following well-known divisions: *Bilimagga*, *Devanga*, *Khatri*, *Patvegar*, *Sale*, *Sourashtra* (*Patmulkaran*), *Seniga* and *Togata*. These divisions are quite distinct, there being no intermarriage or no social intercourse.

(a) **BILIMAGGA**.—Otherwise called *Kuruvina Banajiga*. They speak Kannada. There are two endogamous divisions—Lingayats and those that are not Lingayats. There are sixty-six exogamous divisions. There is no age restriction in marriages. The bride price is Rs. 25. Marriage of widows is permitted. Adultery on the part of the woman is the only ground for divorce. They do not admit outsiders into the caste. The Lingayat section do not eat flesh or drink liquor. They worship *Nilkantesvara* and *Narasimhaswami*. *Sangamesvara* is their patron God. Those that are not Lingayats employ Brahmans for religious and ceremonial purposes. The name 'Bilimagga' comes from the white cloth that is worn.

(b) **DEVANGA**.—The main divisions are *Kanarese* and *Telugu* based on the language they speak. The Kanarese section have adopted Brahmanical ceremonials to a greater extent than the Telugu, who are more conservative. Those who wear the sacred thread, seem to preponderate over those that do not wear the thread, in the Kanarese section. The Telugu section has many exogamous sects. The majority of Devangas are Saivites and some wear the *lingam*. The Kanarese section worship Siva, Parvati and Ganesha, who is considered as a special patron of their looms. They do not eat animal food or drink spirituous liquors. Among the Telugu sections some worship Vishnu and the others Siva. The difference in belief is no bar for intermarriage, the wife always adopting the religion of the husband. The tribal goddess of the Devangas is *Chaudesvari*, a form of *Kali* or *Durga*, in whose honour there is an annual festival, in which the entire community takes part either at the temple or at a house or grove specially prepared for the occasion.

(c) **KHATRI**.—The Khatri are the silk weavers and in manners, customs and languages, are akin to the Patvegars but do not intermarry with them, though the two castes eat together. They are Saivites. They speak a dialect of Marathi. The caste title is *Sa*.

(d) **PATVEGAR**.—The Patvegars are the silk weavers. They worship all the Hindu deities, especially *Sakti*. They speak a corrupt conglomerate of Gujarati and Hindi.

(e) **SALE**.—The Sales comprise the clans of *Padmasala* and *Pathasala*, who are worshippers of Vishnu and the *Sakunasala* who are worshippers of Siva and wear the *Lingam*. The two sects do not intermarry. They are of Telugu origin. *Padmasala* speak Telugu and the other two Kannada.

(f) **SOURASHTRA**.—These are commonly known as *Patnuli* or *Jamkhanwala*. These people were originally immigrants from Northern India. With silk they manufacture a fabric called *kutni* which no other weavers are said to be able to prepare. They manufacture superior kinds of cotton and woollen carpets and an imitation shawl of cotton and silk mixture and of green colour called *khes*. They are Vaishnavites. Their hereditary *gurus* are Sri Vaishnava Brahmans. Marriage of girls before the age of puberty is obligatory among them and marriage of widows is not permitted.

(g) **SENIGA**.—The Senigas are a wealthy caste of weavers. They are immigrants from the lower Carnatic and specially manufacture cloths for female wear, of superior kind and high value. They are Lingayats by religion.

(h) **TOGATA**.—The Togatas are of Telugu origin (being most numerous in the Cuddapah District of Madras) and worshippers of Siva in the form of his consort *Chaudesvari*. They manufacture coarse kinds of cloths that are worn only by the poorer classes. They are generally Vaishnavites and have for their priests Sri Vaishnava Brahmans or Satania. (Mys. Eth. Mon.; C. R., 1901, 1891; C. T. S. I.)

Panchala (128,098).—One-fourth of the number are found in the Mysore District (including Mysore City); the districts of Bangalore (including Bangalore City), Hassan and Shimoga return nearly half the remaining number. The traditional occupations are those of goldsmiths, carpenters, blacksmiths, brass and coppersmiths, masons and goldwashers. More than five-ninths of the number of actual workers returned for the caste follow the traditional occupations. The other chief occupation is agriculture. The word 'Panchala' refers to persons following the five professions or

handicrafts, *viz.*, work in (1) Gold and Silver, (2) Brass and Copper, (3) Iron, (4) Carpentry and (5) Sculpture. These artisans are all of the same race known under the general name of Panchala, although there are shades of difference between them according to locality and spoken language. They wear the sacred thread and have their own priests. They do not take animal food and do not drink liquors. The marriage of girls should be before puberty and widows are not allowed to marry. The caste is a highly organised one. The five sections of the caste intermarry but the goldsmiths have, specially in towns ceased to intermarry with the blacksmiths. The Panchalas have adopted Brahmanical *gotras*. It is usual to pay the bride price in marriages in the community. Many are Saivas and worship Ganesa. The tribal goddess is *Kamakshi Amma*. The Panchalas belong to the 9-Phanas section of the community. The goldsmiths or *Akkasales* are recognised by the other Panchalas as the head of their clan and are given caste jurisdiction. The five specified different crafts are not confined to particular divisions of the caste. Difference of sect is no bar to intermarriage or social intercourse. (C. R., 1901; C. T. S. I.)

Pandaram (659).—These are found chiefly in Kolar (including Kolar Gold Fields) and Katur Districts. Most of the actual workers returned are mining and other labourers. The Pandaram caste is composed of respectable people who have settled down as land-holders, and of *sannyasis* of certain *matams* (in the Madras Presidency). The mendicant Pandarams are recruited from various classes and wear the *lingam*. The Pandarams are immigrants. (C. T. S. I.)

Paniya (188).—The caste has been enumerated in the Heggaddevankote and Gundlupet Taluks of the Mysore District. The main occupation is labour (agricultural and other). The Paniyans are described as a dark-skinned tribe, short in stature, with broad noses and curly or wavy hair, inhabiting Wynad and parts of Malabar and Nilgiri Districts. They are coolies on estates and fishermen. (C. T. S. I.)

Pille (1,251).—These are found in all parts of the State, but chiefly in the Bangalore and Kolar Districts (including the cities situated therein). The chief occupations followed are trade and labour (mining and other). 'Pille' is the title generally assumed by Vellalas in the Southern Districts of the Madras Presidency. These are immigrants. There are both Saivites and Vaishnavites among them. Brahmans are said to officiate at ceremonies. (C. T. S. I.; C. R., 1901.)

Pinjari (H-25; M-5,861).—These are found chiefly in Chitaldrug, Kolar and Tumkur Districts. These are cotton cleaners, agriculturists and labourers. "This caste may be said to be almost indigenous, and though Musalmans, they are little better than circumcised Hindus."

The Pinjaris as their name indicates, are cotton ginners and cleaners. They do not intermarry with other Musalmans, who, as a rule, have no intercourse with them. (C. R. 1901). "Though Muhammadans, they have adopted or retained many of the customs of the Hindus around them, tying a *tali* to the bride at marriage, being very ignorant of the Muhammadan religion and even joining in Hindu worship as far as allowable." (Madras C. R., 1891.) They generally speak either Kanarese or Telugu but some speak Hindustani also.

Rachewar (3,179).—The Rachewars are found specially in Bangalore and Mysore Districts (including the cities situated therein). Mostly they are cultivators and artisans. Some are employed in the public forces. There are two main exclusive divisions of Kannada and Telugu Rachewars. One section *Ranagara* are Military and are most of them employed in the Palace Military Force in Mysore City; another section consisting of *Chitragars* make good paintings, decorations and lacquered ware and toys. There is a third section called *Sarige* or gold lace makers. The Saivite and Vaishnavite Rachewars intermarry. Brahmans are their priests. (C. R., 1901.)

Rawat (123).—These persons have been enumerated in the Civil and Military Station, Bangalore. The actual workers are all officers and soldiers in the British army. These are immigrants from the Punjab.

Saniyar (46).—These are found chiefly in the Bangalore and Kolar Districts (including the cities). The actual workers are labourers. The Saniyars are immigrants.

Sannyasi (1,479).—The Sannyasis are found chiefly in the Kolar and Tumkur Districts. The actual workers are mostly mendicants. They are itinerant beggars of the Saiva order and have nothing to do with the Brahman ascetic *sannyasis*. Their language is Telugu, though in places they speak Kannada. There are five endogamous divisions and also a few exogamous divisions. They are initiated to the profession by a Lingayat priest. Marriage of a girl may take place at any time. The bride price is Rs. 12. Polygamy is rare. Widow marriage is permitted. Divorce is allowed. Annual *sraddhas* are not performed. They worship *Venkataramana*, *Akkammadevaru*, *Gangamma*, *Veerabhadra*, *Bhairava* and *Rudra*. It seems that they are not permitted to practise any manual occupation. (Mys. Eth. Mon.)

Satani (23,038).—Members of this caste are found all over the State, notably in the Mysore (including Mysore City), Tumkur, Bangalore (including Bangalore City), and Hassan Districts. The traditional occupation is that of priests, a little less than one-third of the number of the actual workers returned following the same as their principal means of livelihood. The other chief occupation is agriculture. The word 'Satani' is a corrupt form of *Sattadavan* which literally means one who does not wear (the sacred thread and tuft of hair). For temple services, Ramanuja classed Vaishnavites into *Sattinavan* and *Sattadavan*. Hence Satani is the professional name given to a group of the Vaishnava creed. The Satanis are *Tengalai* Vaishnavas. The sub-divisions of the Satanis are *Khadri Vaishnavas*, *Natacharamurti*, *Prathama Vaishnava*, *Sameraya* or *Samoji*, *Sankara*, *Suri*, *Sattadhava*, *Telugu Satani* and *Venkatapurada*. The Satanis are also called *Dasa Nambis*. Marriage of girls after puberty and widow marriage are entirely prohibited. They attach no importance to the Sanskrit Vedas or to the ritual sanctioned therein, but revere the sacred hymns of the twelve Vaishnava saints or *Alvars* called 'Nalayira Prabandam' (book of the four

thousand songs) which is in Tamil. In their social and religious customs, all the sub-divisions closely imitate the Tengalai Vaishnava Brahmans. (C. R., 1901; C. T. S. I.)

Sillekyāta (982).—The members of the caste are found mostly in the Chitaldrug and Shimoga Districts. Some of the actual workers are fishermen and others are strolling players. They are Mahrattas by origin and speak that language. One section of these who fish in rivers are known as *Burude Bestas* on account of their using dry gourds to swim in water while fishing. The other section are a wandering tribe of picture showmen known as *Bombe Atadavaru*. They worship *Mahadeva* and *Durgamma*. They have a strong caste constitution, the head of the caste being styled *Ganachari*. (Mys. Eth. Mon.)

Soligaru (H—101; A. 1,796).—They are mostly in the Mysore District. The actual workers of the caste are engaged in cultivation and ordinary labour. These inhabit the depths of the forests clothing the foot and slopes of the Biligiri Rangan hills. They cultivate with the hoe small patches of jungle clearings. Their chief God is *Biligiri Rangaswami*, but they also worship *Karaiyya*, their tribal tutelary deity. They speak a patois allied to old Kanarese. They are perfect trackers of wild animals. Polygamy is freely practised. Widows are permitted to marry. They live in huts built of bamboos and thatched over with plantain leaves. Each settlement has its own headman who exercises very wide powers. (C. R., 1901; C. T. S. I.)

Sudugadusidda (1,198).—These are found mostly in the districts of the Western Division and Mysore. The chief occupations are begging and cultivation. They are itinerant mendicants. These are considered as allied to the Jogis or Sillekyatas. The name literally means 'lords of the burning ground'; the *Kularadi* who took the cloth of the deceased and a fee for every dead body burned, formerly paid the members of this caste something as acknowledging their overlordship. (C. R., 1901.)

Tigala (69,233).—Nearly four-fifths of the members of this caste reside in Bangalore (including the Bangalore City and Civil and Military Station, Bangalore) and Tumkur Districts. These are cultivators by profession, market gardening being their speciality. Seven-tenths of the actual workers returned, follow the traditional occupations. The other principal means of livelihood is labour (mining and other). They talk either Kannada or Tamil. Those that talk Kannada are the earliest immigrants among them into the State, and they are found in Tumkur. The two main endogamous divisions are known as *Ulli* or Kannada Tigala and *Arava* Tigala or *Dharmarayana Vakkalu*. The latter includes the sub-divisions *Tondiamallaru*, *Aganudiyavaru*, *Kanjavara*, *Vannigaru* and *Yele Tigala*. The exogamous divisions are named after deities or founders. A girl is married generally not later than twelve. A woman may remain unmarried. Polygamy is allowed. The bride need not necessarily be younger than the bridegroom. Divorce is allowed. The bride price is a rupee and a half. Marriage of widows is permitted. During the first year of a person's death they perform monthly ceremonies to propitiate the dead. In succeeding years, the whole body of the deceased ancestors are worshipped on the *New-year's day* and the *Mahalaya* new-moon day. The Tigalas have divided themselves into sections by the tracts of country inhabited by them, each section called a *Kattmane* being under the jurisdiction of a headman or *Gauda* with a council of elders. Persons from any higher castes may be admitted into the Tigala caste. There are both Saivas and Vaishnavas in the caste. They worship all the Hindu gods; other deities worshipped are:—*Maramma*, *Marigamma*, *Muniswara*, *Yellamma*, *Siddedevuru*, *Kollapuramma*. During marriage they do puja in the name of *Agni Vanhi Raya*, their progenitor, burning frankincense. The tribal festival is that of *Karaga*, which is celebrated with great zeal and ceremony once every year in the month of *Chaitra* and lasts nine days. *Dharmaraya* is the special deity worshipped. (Mys. Eth. Mon.)

Uppara (108,131).—Nearly four-ninths of the total number are found in the Mysore District (including Mysore City). The traditional occupation is that of salt workers but now-a-days hardly one in fifty of the actual workers follows the same. The chief occupations are agriculture and labour. In Kolar and Bangalore and parts of Tumkur Districts they talk Telugu and in the rest of the State, Kannada. Some of the Upparas or Uppaligas who live in the Tamil country are called Uppaligas and speak Tamil. Upparas are either Telugu or Kannada and there is no intermarriage between the sections. Some call themselves according to their profession, *Gare-upparas*, *Sunna-upparas*, *Kallukutiya-upparas*, *Mole-upparas* and *Dombur-upparas*. The exogamous divisions are known as *Kula* or *Beduga* named after some plant, animal or other material object, which the members of that division refrain from cutting, eating or otherwise utilising. Marriage before puberty is not obligatory. Women may remain unmarried if they choose. The bride price varies in different localities between Rs. 12 and 30. Widow marriage is permitted. Divorce is permitted. They do not perform *Sradhas*; but once a year on the *Mahalaya Amavasya* day they do *puja* to a *Kalasa* in the names of all the deceased ancestors and distribute raw rice and other things to Brahmans, Jangamas and Satanis. Upparas are mostly Vaishnavas, their tribal god being *Chennakesava*. They make pilgrimages to Tirupati, Kadari and Nanjangud. They worship all village goddesses, such as *Yellamma*, *Duryamma*, *Sunnakallamma*, *Maramma*. As the manufacture of earthsalt is prohibited in Mysore within five miles of the British frontier and as sea-salt is comparatively cheap the industry is languishing and all but extinct. As a consequence, the Upparas have taken to agriculture. Those that live in large towns are bricklayers, artisans in the building trade, etc. The Upparas belong to the 18-Phanas section. (Mys. Eth. Mon.)

Vakkaliga (1,331,029).—This caste is the great farmer class of the Kanarese country and is found in all parts of the State, specially in the Mysore, Bangalore, Hassan, Kolar and Tumkur Districts. They are found represented in all occupations, but the chief occupation returned is agriculture, nearly five-sixths of the actual workers following the same as principal means of livelihood. The *Raddis* or the Telugu Vakkaligas are found in parts of the Kolar, Tumkur and Chitaldrug

Districts, the *Morasu* Vakkaligas in parts of the Kolar and Bangalore Districts, the *Gangadikars* in the Mysore, Hassan and parts of the Bangalore Districts, the *Nonabas* in the Tumkur and Chitaldrug Districts and the *Namadhari* Vakkaligas in the Shimoga and Kadur Districts. Interspersed with these are other Vakkaligas called *Kunchitigas*, *Hallikars*, *Sadas*, *Halu Vakkalu* and other sub-divisions. There is reason to believe that all or most of these divisions formerly formed one homogeneous caste which from various causes separated themselves into different groups. Many of these divisions have become Lingayats and their affinity with the main division is still recognised by the practice of intermarrying with most Lingayat families of their division, which, however, is now becoming rare.

(a) The *Gangadikara* are the most numerous of the Vakkaligas and are purely Kannada. They represent the subjects of the ancient province of *Gangavadi* which formed an important part of the kingdom of the *Gangas* (a line of kings who ruled over the greater part of the Mysore country and of the Cauvery River basin from early in the Christian Era till about 1,004). The *Gangadikars* are some of them followers of Siva and others of Vishnu.

(b) The *Morasu* Vakkaligas appear to have been originally immigrants from a district near the modern Conjeeveram, called *Morasumad* to the east of Mysore, whose chiefs formed settlements in the neighbourhood of Nandidroog. The Palyegars of Devanhalli, Dodballapur, Yelahanka, Magadi, Hoskote, Kolar, Anekal and Koratagere belonged to this division. Kempe Gauda of the Magadi family was the founder of the City of Bangalore. The endogamous divisions are *Musaka Reddi*, *Palyadasime*, and *Morasu proper* (including *Kamsalu*, *Nerlegattasalu* and *Kuterassalu*). There are many exogamous divisions called *bedagu* or *gotra*. The practice of bringing up a son-in-law as heir is common, chiefly among the Telugu-speaking families. Such a son-in-law succeeds to the whole property of the father-in-law who has no sons, or shares the patrimony equally with the sons. Polygamy is rare. Marriages are generally between adults. Women may remain unmarried. The bride price is between Rs. 6 and 12. Widow marriage is not allowed. Divorce is permitted. They do not perform *sraddhas*. They, however, honour their ancestors on the Mahalaya, the New-year's day and the Gauri feast. They worship Siva under the appellation of *Bhairidevaru* or *Bhandidevaru*. They generally employ Brahmans as *purohitis* and some also respect Lingayat priests or Jangamas. Those of the Morasu who are *Tirunamadharis* call Satanis to conduct funeral ceremonies, the Brahmans being required only to purify the house by *punyaha*. They also invite *Dasayyas*. (Mys. Eth. Mon.)

(c) The *Nonabas* are the relics of the ancient province of *Nonambavadi* (which was ruled up to the 10th century by the Pallava kings who called themselves indiscriminately *Pallavadhiraja* and *Nolambadhiraja*). They are by faith Lingayats.

(d) The *Reddis* are of Telugu origin and have been supposed to represent the subjects of the *Rattas* or *Rashtrakutas*.

(e) The *Hallikara* are largely engaged in raising cattle and the breed of that name is the best in the Amrut Mahal Cattle.

(f) The *Sadas* abound mostly in the north and west. In the old days, many of them acted in the *Kandachara* or *Native Militia*. They are not only cultivators but sometimes trade in grain. They include Jains and Lingayats, Vaishnavas and Saivas. Not improbably, they all belonged to the Jains originally.

(g) The *Halu* Vakkaligas are most numerous in Kadur and Hassan Districts.

The customs of the *Morasu* Vakkaligas (the division of the caste dealt with up to date by the Ethnographic Survey) may be taken as typical of the caste. Drink is tabooed. (C. R., 1901.)

Vaisya (26,497).—About half the total number are found in the Kolar and Tumkur Districts. Four-fifths of the number of the actual workers returned are engaged in trade, 'Vaisya' is the third of the traditional castes of *Manu*, 'Brahmana' and 'Kshattriya' being the first and second respectively.

Vodda (142,482).—The Voddas are found all over the State but chiefly in the Kolar, Chitaldrug and Bangalore Districts. The traditional occupation is that of earth-workers and stone-dressers, the same being followed as principal means of livelihood by nearly one-fourth of the number of actual workers returned. The other chief occupations are agriculture and general labour. Their home language is Telugu. They are said to have originally emigrated from Orissa or 'Odradesa.' The three endogamous divisions are (1) *Kallu*, *Uru* or *Bandi*, (2) *Mannu*, *Bailu*, or *Desada* and (3) *Uppu*. *Kallu* Voddas who quarry stone, are acknowledged to be superior to the other classes and do not eat with them. *Mannu* Voddas follow the profession of doing earthwork to tanks or digging in gardens or elsewhere for wages. *Uppu* Voddas are persons who are employed as sweepers in Municipal towns. There are many exogamous divisions. Polygamy is allowed. Marriages before puberty are not compulsory. A woman can remain unmarried. The bride price is Rs. 7 and sometimes varies up to Rs. 15 according to family custom. Marriage of widows is allowed. Divorce is permitted. An unmarried woman may become a *Basavi*. The Vaishnavite Voddas invite Satanis to officiate at funerals. They do not perform *sraddhas*. They take into their caste any member of a caste higher than their own. *Venkataramana* of Tirupati is their God. Other deities worshipped are *Yallamma*, *Kariyamma*, *Gangamma* and *Chaudamma*. Among the peculiar customs of the Voddas are these:—(1) The Voddas never eat a tortoise, (2) The bridegroom grows his beard until he is married and removes it at the time, (3) During the pregnancy of the wife, a Vodda does not breach a tank or carry a corpse. (Mys. Eth. Mon.)

MUSALMAN.

ARAB (39).—These are itinerant tradesmen from Arabia.

AWAN (1).—'Awan' is a Musalman tribe of the Punjab.

- BALUCHI (3).**—An immigrant tribe.
- DAYARE (422).**—These are found chiefly in the Bangalore District. They differ from the general body of Musalmans in that they believe that the *Imam Mahdi* has visited this earth and departed. They do not intermarry with the other Musalmans. They carry on a brisk trade in silk.
- DHOBI (1).**—An immigrant tribe.
- GUJAR.**—See *supra* under Hindu castes.
- HANIFI (188).**—A Musalman sect.
- JAM (125).**—An Asiatic tribe of reputed foreign origin.
- JANJUA (17).**—A Musalman tribe of the Punjab.
- JAT.**—See *supra* under Hindu castes.
- KHABRAL (2).**—A tribe of the Punjab, which counts among its members Hindus, Sikhs and Muhammadans.
- KHADRI (5).**—An Asiatic tribe of reputed foreign origin.
- KHAKAR (520).**—Found chiefly in Mysore City and Shimoga District. These are allied to the Pindaris.
- KHANDARI (40).**—A Musalman territorial name meaning a person from Kandahar.
- LABBAI (7,995).**—An immigrant tribe of traders and money-lenders. The Labbais are descendants of Arab and Persian traders who landed on the Coromandel Coast in the 8th Century A. D., owing to persecutions at home. These are found chiefly in the Mysore District. Many speak Tamil.
- MAPILLA (2,257).**—These are found chiefly in the Kolar Gold Fields and the districts of the Western Division. They are labourers and traders. These come from Malabar. Malayalam is spoken by many among them.
- MEMAN (661).**—This tribe is found chiefly in the Civil and Military Station, Bangalore, and Mysore City. They are mostly traders.
- MUGHAL (8,151).**—This is an immigrant tribe from the North and settled in the State for good. They are descendants from Tartar chiefs who followed Tamerlane into India and who came later to take service under Mughal Emperors. They are engaged in service under the Local Government and also in trade and agriculture.
- NAVAYAT (9).**—A Musalman tribe which appears to have originally settled at Bhatkal in North Canara. This tribe does not intermarry with other tribes.
- PANJABI (65).**—A territorial name meaning a native of the Panjab.
- PATHAN (44,689).**—These are found all over the State. They are Musalmans of Afghan descent and long settled in Mysore. The actual workers are found engaged in all the chief occupations returned for the State.
- PERSIAN (63).**—A territorial name meaning a native of Persia.
- PINDARI (2,047).**—These are found chiefly in the Kolar and Tumkur Districts and Mysore City. They are the descendants of the disbanded soldiers of the Mughal Empire, who in the beginning of the last century, ravaged Central India. They are now settled in peaceful avocations.
- PINJARI.**—See *supra* under Hindu castes.
- SAIYID (57,671).**—The Saiyids are the lineal descendants of the Prophet, being descended from Ali, the son-in-law, and Fatima, the favourite daughter of Mahomet. These claim the first place among the Musalmans by virtue of their pedigree.
- SHEIKH (176,482).**—The majority of the Musalman population of the State has been returned under this head. 'Sheikh' properly connotes Musalmans of foreign descent who are the descendants of the first three Khalifas or successors of the Prophet.
- SHARIF (1,037).**—A tribal name among Musalmans.
- TURK (4).**—A Musalman territorial name.

CHRISTIAN.

- ANGLO-INDIAN (5,827).**—This term is applied to those who used to be formerly termed Eurasians.
- ARMENIAN (1).**—A racial designation.
- EUROPEAN AND ALLIED RACES (7,462).**—The distinction has been made between British subjects (7,123) and others (339). All Europeans, etc., whose birthplace is Great Britain or a British Colony or Dependency have been treated (in accordance with the instructions of the Census Commissioner for India) as British subjects unless the contrary was expressly stated.
- INDIAN CHRISTIAN (46,554).**—Christian Natives of India.

JAIN.

- BANIYA (6).**—Immigrant traders from the North.
- BORA (2).**— Do do do
- BRAHMAN (6).**—Jain Brahman.
- CHATRALAKSHATRI (112).**—A division among the Jains who are devotees and traders.
- DIGAMBARA (9,665).**—A sectarian name. The Jains indigenous to the State are Digambaras. These are generally engaged in trade, selling mostly brass and copper vessels, and are scattered all over the country, the largest number of them being found in Shimoga, Mysore and Hassan Districts. Agriculture is the chief occupation. Sravanbelagula in the Hassan District is the chief seat of the Jains in the State. Marriage takes place before or after puberty. Widows are not allowed to marry. The dead are buried.

- GADIYA (2).—A Jain caste who are by traditional occupation weavers, calenderers and dyers.
 MARWADI.—See *supra* under Hindu castes.
 PANCHAMAKSHATRI (147).—A division among the Jains who are by traditional occupation devotees and traders.
 PITAMBARA (18).—Jain priests.
 SADA (5,153).—These were originally Vakkaligas by caste who are now Jains by religion.
 SRAVAKA (12).—Jain traders.
 SVETAMBARA (786).—These are immigrants from the north and are traders mostly found in cities.
 TIRTHANKARA (97).—Jain priests.

ANIMIST.

- HASALARU (114).—These live by cultivation and begging. This tribe is met with in the north-west frontier of the Mysore District. These resemble the Soligaru.
 IRULIGA.—See *supra* under Hindu castes.
 KORACHA.— Do do
 KORAMA.— Do do
 KURUBA (6,476).—The Kadukurubas of Mysore are divided into *Betta* or *Hill Kurubas* (with sub-divisions *Ane*, *Bevina* and *Kolli*) and *Jenu* or *Honey Kurubas*. Their villages or clusters of huts, are called *hadi*. A separate hut is set apart for the unmarried females to sleep in at night and another one at the opposite end of the settlement as the dormitory of the unmarried males. They are experts in tracking wild animals. Polygamy prevails. Girls are married after puberty. The dead are, if adult, cremated; if children, buried. The *Betta Kurubas* worship *Norale* or *Mastamma*. (C. R., 1901.)
 LAMBANI.— See *supra* under Hindu castes.
 SOLIGA.— Do do

SUBSIDIARY TABLES.

I. CASTES CLASSIFIED ACCORDING TO THEIR TRADITIONAL OCCUPATIONS.

Group and caste	Strength (000's omitted)	Proportion per mille of population	Group and caste	Strength (000's omitted)	Proportion per mille of population
1	2	3	1	2	3
1 Landholders for cultivating landholders, <i>vide</i> 2 below	17 Carpenters (Masons, Blacksmiths; Gold and Silver-smiths and Brass and Copper-smiths) ...	128	22
2 Cultivators (including growers of special products) ...	1,400	241	Panchala ...	128	...
Vakkaliga ...	1,331	...	18 Potters ...	42	7
Tigala ...	69	...	Kumbara ...	42	...
3 Labourers ...	613	106	19 Oil-pressers ...	40	7
Holeya (also village watchmen)	613	...	Ganiga ...	40	...
4 Forest and hill tribes ...	89	15	20 Toddy-drawers and distillers	39	7
Koracha ...	21	...	Idiga ...	39	...
Lambani ...	51	...	21 Leather-workers ...	308	54
Others ...	17	...	Madiga ...	308	...
5 Graziers and Dairymen ...	151	26	Others ...	1	...
Golla ...	151	...	22 Basket workers and mat-makers ...	7	1
6 Fishermen, Boatmen, and Palki Bearers ...	157	27	23 Earth, salt, etc., workers and quarriers ...	251	43
Beata ...	157	...	Uppara ...	108	...
7 Hunters and Fowlers ...	268	46	Vodda ...	143	...
Beda ...	268	...	24 Others—
8 Priests and Devotees ...	223	38	(a) Hindu ...	243	42
Brahman ...	195	...	Lingayat ...	730	...
Sataui ...	23	...	Maharatta ...	46	...
Others ...	4	...	Kshattriya ...	28	...
9 Temple Servants ...	2	...	Jogi ...	13	...
10 Bards and Astrologers ...	1	...	Others ...	16	...
11 Musicians, Singers, Dancers, Mimes and Jugglers ...	5	1	(b) Musalman ...	314	54
12 Traders and Pedlars ...	196	34	Pathan ...	45	...
Banajiga ...	153	...	Saiyid ...	69	...
Mudali ...	18	...	Sheikh ...	176	...
Vaisya ...	26	...	Others ...	26	...
Others ...	19	...	(c) Christian ...	60	11
13 Barbers ...	82	7	Indian or Native Christian ...	47	...
Nayinda ...	39	...	Others ...	13	...
14 Washermen ...	98	17	(d) Jain ...	12	2
Agasa ...	98	...	(e) Others—	1	...
15 Weavers, Carders and Dyers ...	501	86	Parai
Kuruba ...	403	...	Sikh
Neygi ...	97	...	Brambo
Others ...	1	...	Jew
16 Tailors ...	12	2	Buddhist—	1	...
			(i) Burmese
			(ii) Chinese
			(iii) Indian
			(iv) Japanese

NOTE.—The figures for Animistic castes returned as Hindus have been included in group 4.

II.—VARIATION IN CASTE, TRIBE, ETC., SINCE 1871.

Caste, Tribe or Race	Persons (000's omitted)					Percentage of variation increase + decrease (-)				Percentage of net variation 1871-1911
	1911	1901	1891	1881	1871	1901-11	1891-1901	1881-91	1871-81	
1	2	3	4	5	6	7	8	9	10	11
HINDU.										
1 Agasa ...	98	92	86	70	87	+ 6.3	+ 7.3	+ 22.5	-19.6	+12.4
2 Banajiga ...	133	133	115	94	122	+ 0.3	+ 15.5	+ 22.1	-23.0	+ 9.0
3 Beda ...	268	245	217	171	262	+ 9.6	+ 12.8	+ 26.8	-34.7	+ 2.4
4 Besta ...	157	153	100	129	134	+ 2.3	+ 53.5	- 22.8	- 3.6	+16.8
5 Brahman ...	195	190	184	163	174	+ 2.4	+ 3.5	+ 12.8	- 6.5	+11.9
6 Ganiga ...	40	41	36	29	35	- 0.7	+ 13.8	+ 21.6	-16.0	+15.3
7 Golla ...	151	143	129	103	160	+ 5.3	+ 11.1	+ 25.7	-35.9	- 5.7
8 Holey ...	613	596	520	447	Not available	+ 2.9	+ 14.5	+ 16.3
9 Idiga ...	39	48	40	21	81	-19.6	+ 20.8	+ 88.7	-73.8	-52.0
10 Jogi ...	13	13	9	6	Not available	+ 0.0	+ 36.8	+ 61.5
11 Kshatriya ...	38	25	22	13	55	+49.1	+ 16.7	+ 64.5	-75.9	-31.1
12 Kumbara ...	42	44	41	31	35	- 4.0	+ 6.7	+ 30.5	- 9.5	+21.0
13 Kuruba ...	403	378	347	292	371	+ 6.8	+ 8.9	+ 18.8	-21.4	+ 8.6
14 Lingayat ...	730	671	483	470	418	+ 8.7	+ 88.9	+ 2.7	+12.5	+74.5
15 Madiga ...	308	280	240	241	Not available	+10.2	+ 16.7	- 0.7
16 Mahatta ...	46	53	44	41	Do	-14.0	+ 20.1	+ 7.9
17 Mudali ...	18	12	5	10	9	+52.2	+116.2	- 45.6	+11.3	+99.2
18 Nayinda ...	39	39	37	30	40	+ 0.8	+ 4.8	+ 22.8	-23.4	- 0.6
19 Neygi ...	97	97	87	77	96	- 0.6	+ 11.5	+ 13.3	-19.6	+ 1.0
20 Panchala ...	128	126	114	99	104	+ 2.0	+ 10.4	+ 14.8	- 4.6	+23.3
21 Satani ...	23	22	20	17	Not available	+ 2.9	+ 12.0	+ 18.5
22 Tigala ...	69	65	57	44	55	+ 6.8	+ 14.3	+ 23.1	-19.5	+25.8
23 Uppara ...	108	106	89	85	92	+ 1.8	+ 19.2	+ 5.4	- 8.1	+17.5
24 Vodda ...	143	135	107	76	116	+ 5.8	+ 25.6	+ 41.4	-34.5	+23.1
25 Vaisya ...	26	36	33	29	26	+11.1	+ 12.5	+ 11.8	- 8.3	+23.1
25 Komati ...	10									
26 Vakkaliga ...	1,331	1,287	1,342	1,060	1,310	+ 3.4	- 4.0	+ 26.6	-19.1	+ 1.6
MUSALMAN.										
27 Pathan ...	45	41	39	Not available	...	+ 8.6	+ 6.7
28 Saiyid ...	58	42	39	Do	...	+35.8	+ 9.8
29 Sheikh ...	176	179	155	179	...	- 1.2	+ 15.2	- 13.5
CHRISTIAN.										
30 Indian Christians	47	40	28	21	...	+17.6	+ 41.5	+ 33.1
ANIMISTIC.										
31 Koracha ...	21	10	11	12	37	+11.4	- 1.0	+106.5	-67.6	-26.4
31 Korama ...	6	15	14							
32 Lambani ...	51	46	39	31	Not available	+12.3	+ 16.5	+ 24.5

NOTE.—The figures for Komati and Vaisya have been added together for the present Census to compare with the figures for Komati of the previous Censuses. Koracha and Korama being allied castes, the figures for these are added together for purposes of comparison with similar figures since 1871. The figures for Animistic castes returned as Hindus in this Census have been added to the figures for the castes as given in this table.

CHAPTER XII.

OCCUPATIONS.

PART I.—GENERAL.

233. This chapter deals with the occupations of the people of Mysore, distinguishing *Actual Workers* from *Dependants*. **Scope of chapter.**

234. The statistics of occupations are contained in Table XV, Parts A, B, C and E, and Table XVI; and an explanatory memo as to the nature of information contained in the former is given on the title page of Table XV-A and is extracted below, with modifications, for ready reference. **Reference to statistics.**

(i) XV-A. In this, the occupations have been arranged in 4 *classes*, 12 *sub-classes*, 55 *orders* and 169 *groups*. For the purpose of this Table, an actual worker is classified according to his principal occupation, and a dependant, by the principal occupation of the actual worker on whom he depends. Thus the same person is not counted twice for purposes of grouping and the population is distributed exhaustively into 169 groups.

(ii) XV-B. In this are given the subsidiary occupations of the agriculturists (actual workers only); and the Table is divided into three parts:—

- (1) Rent-receivers (landlords),
- (2) Rent-payers (actual cultivators) and
- (3) Farm servants and field labourers.

In each part, figures are given separately for some of the most numerous subsidiary occupations followed.

(iii) XV-C. This Table shows for certain mixed occupations the number of persons who returned each as their (a) *principal* and (b) *subsidiary* means of livelihood. Four pairs of occupations have been selected for the purpose, *viz.*, (a) agriculture and government service, (b) village watchman and agricultural labourer, (c) grain dealer and money-lender and (d) landholder and money-lender.

(iv) XV-E. This Table gives the particulars of statistics relating to industrial undertakings in the State, employing not less than 20 persons on the date of the Census. The Table is divided into four parts as follows:—

- I. This gives for the Province as a whole the number of persons employed in each kind of industry dealt with;
- II. This part deals with the details for each district; and
- III. and (4) furnish statistics of the *races* and *castes* of owners and managers of factories, etc.

(N. B.—Table XV-D showing the distribution of occupations by religion was not compiled for the State, the preparation thereof having been left to the option of local Governments.)

In addition to the above, nine Subsidiary Tables compiled for the purpose of presenting in a condensed form the salient features of the statistical details contained in the main Tables and in certain departmental returns are appended to the chapter and their headings are shown below:—

- I. General distribution of the population by occupation;
- II. Distribution by occupation in the two Natural Divisions;
- III. Distribution of the agricultural, industrial, commercial and professional population in Natural Divisions and districts;
- IV. Occupations combined with agriculture (where agriculture is the *subsidiary* occupation);
- V. Occupations combined with agriculture (where agriculture is the *principal* occupation);
- VI. Occupations of females by sub-classes, and selected orders and groups;
- VII. Selected occupations and a comparative view of the figures of 1911 and those of 1901;
- VIII. Occupations of selected castes.
- IX. Apart from the above, a special Table (Subsidiary Table IX) to show the number of employes in the Railway, Post Office, Telegraph and Irrigation Departments, has been also appended.

System of enumeration and nature of information collected.

235. In 1881, the occupations of only such of those as were *actually* engaged in some calling or other were shown in detail, while all the juveniles *under 15 years* of age and all dependants were grouped under one single head 'Unoccupied.'

In 1891, all males and females who earned their living by their work or lived on private property such as house rent, pension, etc., were enumerated as 'actual workers' and in the case of children and women doing no work, the occupation of the head of the family or of the person supporting them was recorded, the word 'dependant' being added against them. In the case of persons following dual occupations, only the principal occupation was entered against them except when the subsidiary occupation was agriculture, in which case the latter was also shown.

In 1901, in addition to such of those as were shown as 'actual workers' in 1891, those also who got work done by others were shown under that head and a record was made of the subsidiary occupations also *in all cases* whether or not connected with land.

On the present occasion, the system of enumeration remained almost the same as in 1901 and three columns were provided in the schedule for recording the occupations of a person as shown in the margin.

Occupation or means of subsistence of actual workers		If dependant, principal occupation or means of livelihood of actual worker on whom dependant
Principal	Subsidiary	
8	9	10

Columns 8 and 9 were intended for the entry of *principal* and *subsidiary* occupations of actual workers, while in column 10 entries were recorded regarding the

occupation or means of subsistence of *actual workers supporting the dependants*.

Instructions to enumerators.

236. The following instructions were issued to enumerators for filling in the above columns:—

"Before filling up these columns, you should first of all determine by suitable enquiry whether the person about whose particulars you are writing should be treated as *independent* and entered in columns 8 and 9 or as *dependant* and entered in column 10. For example, children who actually do work and earn wages, and women who earn money by occupations in which the husbands do not take part, such as selling firewood, butter-milk, cowdung cakes, or grass or rice pounding, weaving or doing house work for wages, should be shown under those occupations in columns 8 and 9. But women and children who do not carry on any such occupation should be entered in column 10 as *dependants*. Servants are not to be shown as dependant on the occupation of their master.

"In filling up columns 8 and 9, the occupations of *actual workers* should be clearly entered distinguishing carefully the *principal* from the *subsidiary*.

"If a person who has more than one occupation or means of livelihood should express a doubt as to what he should consider as his principal occupation, he should be asked which of the occupations he relies upon most for his livelihood or considers to be the most indispensable, and that should be regarded as his principal occupation and entered in column 8. The rest should be regarded as subsidiary occupations; and of the latter again, that on which he relies the most should be entered in column 9. It is not necessary to enter more than one subsidiary occupation.

"The entries should be made clearly and exactly. Do not use vague terms such as 'service,' 'government service,' 'shop-keeping,' 'trade,' 'writing,' 'labour,' etc., but state the exact service, the goods sold in the shop, the class of articles the person is trading in, the class of writing or labour and so forth. For example, in the case of clerks, domestic servants and the like, the kind of service rendered should be precisely stated and also the occupation of the person to whom it is rendered, as for instance, jahgirdar's cook, schoolmaster's water carrier, lawyer's typist, rice merchant's accountant, etc.

"When a person is in the service of a public body, enter the name of that body before service, thus railway guard, municipal sweeper, etc.

"A seller who makes the articles he sells should be entered as 'maker and seller' of them.

"In the case of agriculture, persons should be entered as—

- | | |
|----------------------------------|------------------------------------|
| (i) Non-cultivating landholders, | } corresponding to rent-receivers. |
| (ii) Non-cultivating tenants, | |
| (iii) Cultivating landholders, | } corresponding to rent-payers. |
| (iv) Cultivating tenants, | |

and (v) Field labourers—those *generally* employed being clearly distinguished from those who work *by the day or by the job*.

"In the case of labourers who are not agricultural labourers, they should be entered as *earth-workers, labourers in mines* (stating the substance mined such as stone, gold, etc.) and *operatives in mills, workshops, factories, etc.*, specifying the kind of mill or factory such as cotton mills, rice mills, lac factories, oil-presses, etc.

"Gardeners and growers of special products such as coffee, cardamom, pepper, betel, etc., should be shown as such separately.

"In the case of one or more members of a joint family who earn money, they should all be regarded as actual workers and their *principal* and *subsidiary* occupations should be entered in the respective columns. They are not to be shown as dependants."

237. The entries of occupations in schedules were generally clear and owing to the simplification of the scheme of occupations (to be described below) and with the use of alphabetical indexes of occupations in English and Kanarese, the mistakes in slip-sorting and compilation were few and unimportant and were promptly corrected on discovery. **Accuracy and limitations of the return.**

Apart from certain mistakes in schedules and in tabulation, the returns of occupations are affected by the facts that the Census is taken on a date when certain occupations like agricultural field labour are at a low ebb and that all the subsidiary occupations of an actual worker are not recorded, only the principal one being taken to account.

238. The scheme of classification of occupations adopted in 1901 divided all occupations returned in the schedules into 8 classes, 24 orders, 79 sub-orders and 520 groups. This classification was open to criticism in several ways. In the first place, it was far too elaborate for Census work in India and involved an excessive amount of labour in compilation. Secondly, the results obtained were in some cases defective. Accordingly the Census Commissioner for India drew up a scheme based on that of Monsieur Bertillon, an eminent European statistician, by which the number of detailed heads in the grouping of occupations was greatly reduced. **Revision of the scheme of occupations.**

239. M. Bertillon's scheme, the great merit of which is its elasticity and applicability to all countries at all stages of economic progress and industrial development and which was commended by the International Statistical Institute for general adoption with a view to rendering possible the comparison of the occupation statistics of different countries, divides all occupations into 4 main classes and 12 sub-classes with 3 series of minor sub-divisions, *viz.*, 61 orders, 206 sub-orders and 499 groups. The 4 main classes and 12 sub-classes are the following:— **M. Bertillon's scheme and the principles underlying it.**

A. Production of raw materials:

- (i) Agriculture.
- (ii) Extraction of minerals.

B. Transformation and employment of raw material:

- (iii) Manufacture.
- (iv) Transportation.
- (v) Trade.

C. Public administration and liberal arts:

- (vi) Public force.
- (vii) Public administration.
- (viii) Liberal professions.
- (ix) Persons living on their income.

D. Miscellaneous:

- (x) Domestic service.
- (xi) Insufficiently described occupations.
- (xii) Unproductive and not returned.

The rationale of the scheme is explained by M. Bertillon thus:—

"These divisions are so logical that there is scarcely need to justify them.

A. Man procures raw materials necessary for every occupation either by working upon the soil (I. Agriculture) or by working under the soil (II. Extraction of minerals).

B. These materials are then changed by the arts and manufactures (III. Manufactures), carried to the place where they are needed (IV. Transportation), and distributed among consumers by trade (V. Trade).

C. To keep good order and guard the welfare of the preceding occupations, every country has an army and a police force (VI. Public force) and a public administration (VII. Public administration). The liberal professions (VIII) and persons living on their income (IX) naturally follow the occupations just reviewed.

D. Finally, it is expedient to establish a division for domestic service (X), insufficiently described occupations (XI) and unproductive (XII)."

The new classification as adopted at the present Census.

240. The scheme adopted on the present occasion maintains unchanged the classes, sub-classes and orders of M. Bertillon's scheme, but the sub-division of the orders into groups has been carried out with reference to local conditions. This classification as further simplified by the Census Commissioner divides all occupations into 4 main classes, 12 sub-classes, 55 orders and 169 groups as against 8 classes, 24 orders, 79 sub-orders and 520 groups in 1901. The distribution of population by classes, sub-classes and orders is given in subsidiary Table I, and the classified scheme of occupations (including groups) is printed as appendix A.

Re-arrangement of the occupation groups of 1901.

241. An English alphabetical index of occupations and a classified list of occupations in Kanarese with their English translations were prepared and referred to in the course of tabulation. By means of these and with the help of appendix II to the Census Commissioner's letter No. 240, dated 17th February 1911, the groups of the last Census were brought under the corresponding groups of the present classification and a comparison has been made possible of the present statistics with those of 1901 as will be seen from Subsidiary Table VII and elsewhere in this chapter. The result thus arrived at is in many cases but a fair approximation and not an absolute accuracy. The fluctuations are in some cases very great, and a comparison of the present figures with those of the previous Census often fails to throw light on the changed condition of the people during the decade 1901-11. But this will be more than compensated by the fact that the Census statistics as now compiled admit of international comparison.

PART II.—URBAN AND RURAL OCCUPATIONS.

Introductory.

242. Before discussing the statistics in detail by different sub-classes, orders and groups, it will be well to pause here for a while and take a general survey of the whole field of occupations under two main heads (i) *Urban* and (ii) *Rural*. Certain occupations are urban in their nature and practically foreign to rural economy, such as mining and other large industrial concerns, public force, public administration, domestic service and the like while others such as agriculture, trade in articles of ordinary home consumption etc., are essentially rural.

Distribution of population by occupation.

243. Subsidiary Table I of this chapter exhibits the general distribution of entire population of the State by classes, sub-classes and orders of occupations. The distribution by sub-classes is graphically illustrated in the following diagram :—

Diagram showing the percentage distribution of the total population of the Mysore State (including Civil and Military Station, Bangalore) by sub-classes of the occupation scheme.

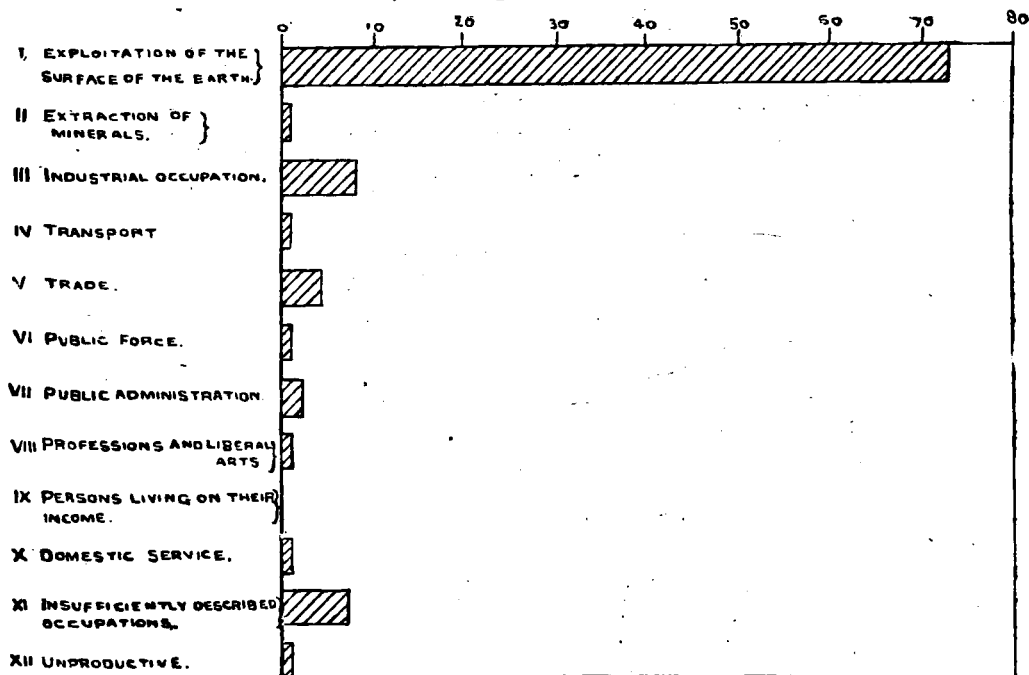

From this diagram, it will be seen that 73.1 per cent of the entire population of the State (including Civil and Military Station, Bangalore), *i.e.*, 4,245,644 persons come under sub-class I—Exploitation of the surface of the earth—and are engaged in different pursuits for the production of raw materials. Of these again, *cultivation* (groups 1 to 6) claims the largest proportion, being 72.4; next comes *pasture* (groups 9 to 12) supporting 0.5 per cent. Under *fishing* and *hunting* the proportion is extremely small being only 0.04, while the rest, *viz.*, 0.2 per cent, belong to groups 7, 8 and 13 and follow either the order of *forestry* or of *raising of small animals*. Next in the order of relative strength come those who follow *industrial pursuits*. Their proportion to the total population of the State is 7.6 per cent. Of them again 1.8 come under industries of dress and toilet; and textile, metal, and food industries claim 1.7, 0.4 and 0.4 per cent respectively, while the rest of the orders in this class count 3.3 per cent on the entire population.

Sub-class V—Trade—counts 236,104 persons, being 4.1 per cent of the total population. Most of them, *viz.*, 2.5 per cent trade in food stuffs, while a comparatively small number of them, *viz.*, 0.4 per cent, deal in textiles. Next in the order of importance comes sub-class II (Extraction of minerals) supporting 52,987 persons or 0.9 per cent of the total population as against 14,358 or 0.3 per cent in 1901. The large increase under this head is mainly due to the increased prosperity of gold mining and manganese industries in the State during the decennium 1901-11. This subject will be discussed at length later on.

Of the other sub-classes, Transport (IV) supports 0.5 per cent Public force (VI) and Public administration (VII) show 1.2 and 2.3 respectively and Professions and Liberal Arts (VIII) claim 1.4 per cent, and sub-class IX—Persons living on their income—supports 0.4 per cent. Under the remaining three heads, *viz.*, sub-classes X to XII, the percentage on total population is 8.5. Viewed by main classes of the occupation scheme, 74.0 per cent of the entire population are engaged in the Production of raw materials, 12.2 per cent in the Preparation and supply of material substances, 5.3 in Public administration and Professions and liberal arts, the remaining 8.5 being supported by other occupations.

Among the population of the four cities of Bangalore, Mysore, Kolar Gold Fields and Civil and Military Station, Bangalore, Industrial pursuits with 21.5 per cent on the entire population of the four cities, take precedence over all other occupations, as will be seen from the following diagram, Trade, Mining, Domestic service, Exploitation of the surface of the earth, Public force, Professions

Diagram showing the percentage distribution of the population of the four cities of Bangalore, Mysore, Kolar Gold Fields and Civil and Military Station, Bangalore, by sub-classes of the occupation scheme.

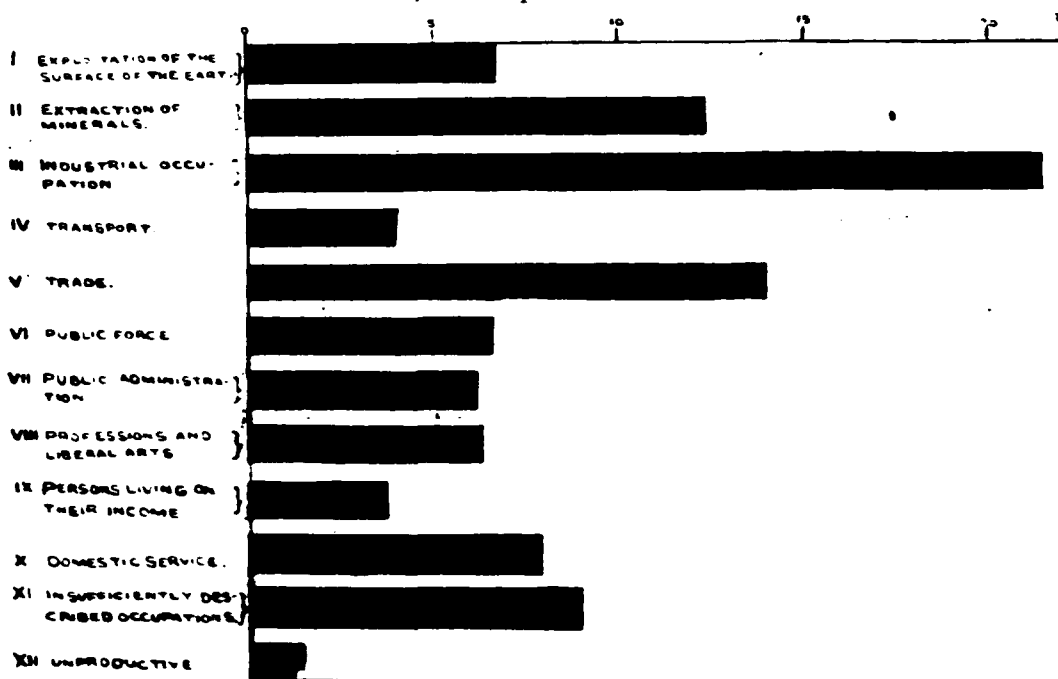

and Public administration coming next in order with proportions of 14·1, 12·4, 7·9, 6·7, 6·7, 6·4 and 6·2 respectively. Taking the Province as a whole, it will be seen that agricultural pursuits are mostly rural while in towns the industrial, trading, and mining pursuits preponderate to a considerable extent.

Relative strength of districts and cities in respect of certain groups of occupations.

244. The following diagram illustrates the percentage distribution of population of each District and City supported by 5 groups, *viz.*, (i) Agriculture, (ii) Industry (including mines), (iii) Commerce, (iv) Professions and (v) Other pursuits (including Public force and Public administration). On examining the

Diagram showing the percentage distribution of population of each district and city supported by (a) Agriculture, (b) Industry (including mines), (c) Commerce, (d) Profession and (e) 'Other' pursuits including Public force and Public administration.

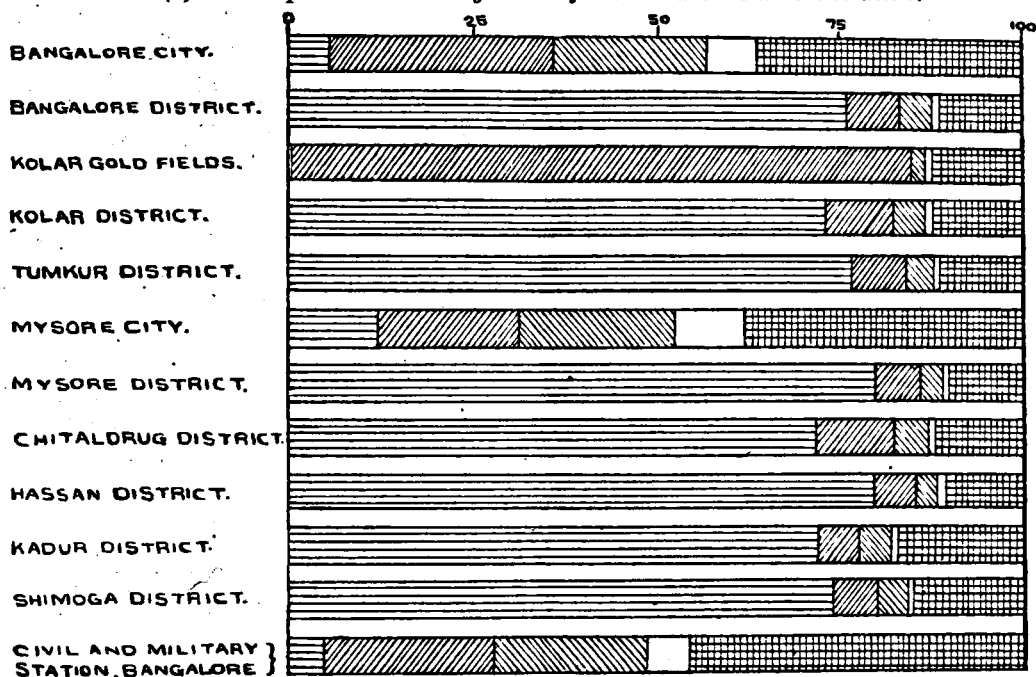

figures by districts, it will be seen that the percentage of agricultural population is highest in the Mysore and Hassan Districts, being 80·0 per cent in each, and lowest in Kadur and Chitaldrug (71·7) and (71·6) respectively. The splendid system of river irrigation in the former two districts contributes mainly to this high percentage, while an extensive forest and unculturable area in Kadur, and insufficiency and uneven distribution of rain in Chitaldrug are responsible for the small percentages in those districts. As regards industry, Chitaldrug stands first with a percentage of 11·0 due to the existence of cotton ginning and pressing mills at Davangere and the extensive weaving of woollen blankets carried on in the district. This is followed in the order of precedence by Kolar with 9·0 per cent, Tumkur (7·3), Bangalore (6·9), Mysore (6·1) and Shimoga, Kadur and Hassan with (5·7), (5·5) and (5·4) per cent respectively.

In regard to commerce, Kolar, Bangalore and Chitaldrug take precedence over other districts with a percentage of (4·7), (4·5) and (4·5) respectively, Hassan coming last with only 2·8 per cent.

Professional pursuits claim the highest percentage in the Shimoga District, being 1·3 on the district population while in each of the Bangalore, Kolar, Hassan and Kadur Districts the percentage is 1·2, the smallest percentage being 0·9 in the Mysore District. Under "other pursuits" (including Public force and Public administration) Kadur District occupies the highest place with a percentage of 17·7, Mysore district coming last with only 10·0 per cent.

Turning to the four cities of Bangalore, Mysore, Kolar Gold Fields and Civil and Military Station, Bangalore, the diagram shows that in them the agricultural pursuits are almost eclipsed by the preponderance of industrial and mining occupations, and that next to industry come the orders of Public force and Public administration included under 'others.' Industry (including mines) supports the highest percentage, viz., 84·7 in the Kolar Gold Fields, the percentages in the other cities being 30·4 in Bangalore City, 22·9 in Civil and Military Station, Bangalore, and 18·9 in Mysore City.

The commercial population is lowest in the Kolar Gold Fields, viz., 2·2 per cent and highest in the Mysore City (21·2) per cent, while Civil and Military Station, Bangalore, and Bangalore City show 21·1 and 20·8 per cent respectively.

Under combined group (V)—'others,' comprising Public force, Public administration, Domestic service and other orders—Civil and Military Station, Bangalore, comes first with a percentage of (45·3), next comes Mysore City (37·7), then Bangalore City (36·1), and last of all, Kolar Gold Fields (11·8).

The professional population preponderates mostly in the two capital cities of Bangalore and Mysore, being 7·0 and 9·9 per cent respectively, while Kolar Gold Fields City claims only 0·9 per cent.

245. Comparing the occupations in the districts with those followed in the four cities, it will be seen that the occupations in the cities alone have certain urban characteristics in them while those in districts (including minor municipal towns which are at best but overgrown villages) are practically rural in their nature. Agriculture prevails most in the districts and least in cities, while 'industry,' 'commerce,' 'profession,' 'public force,' 'public administration,' and 'domestic service' preponderate in cities. The large percentage of industrial population in Kolar Gold Fields City is an indication of the increased prosperity of the gold mining industry which has in the decennium 1901-10 received an enormous impetus by the introduction of electricity as motive power in place of steam. In the two capital cities of Bangalore and Mysore, which are the seats of administration, reside most of the Government Officers; and this accounts for a large percentage under 'public force,' 'public administration' and 'domestic service' included in combined group V 'others.'

Occupations in cities and in districts compared.

Civil and Military Station, Bangalore, is more a military cantonment than a civil station. It has a large percentage of 45·3 of population supported by military and other services of Government, while 'industry' and 'commerce' with comparatively small percentages under each group take a secondary place.

246. For a correct appreciation of the present agricultural and industrial situation of the people of Mysore, it is necessary to have a clear idea of the rural conditions as they prevail in an average village in the State the population of which we have seen in Chapter I to be 303.

A description of village life in Mysore.

Descriptions, more or less detailed from an administrative point of view, of an ordinary Mysore village, will be found in the History of Mysore by Col. Wilkes, in the General Memorandum of 1854 on Mysore by Sir Mark Cubbon and in the Selections from the records of the Commissioner's Office, Mysore, published in 1864.

Conditions have, however, rapidly changed in the interval and the following description is therefore adapted from recent descriptions from an economic point of view such as those given in Mr. P. Banerjea's "A Study of Indian Economics," in the "Economics of British India" by Professor J. Sarkar and in Sir T. Morison's "Industrial Organisation of an Indian Province" and "Economic Transition in India."

(a) "In each of the villages, there is the usual set of village officers, the *patel*, the *shambhog*, the *talari* and one or two more other officials whose duties are laid down by Government. Each village constitutes an industrial unit of which the chief feature is its self-sufficiency. It is, to a large extent, independent of relations with the outside world, so far as its internal economy is concerned; for within its own boundaries the village possesses all the factors which are requisite for the supply of its few wants. The great bulk of the people is agricultural. The cultivators take lease of small plots of the village land either directly from Government or from a landlord to whom they pay rent. They work the land themselves with the aid of their family members and sometimes also of hired servants. They supply the small capital from their own savings or borrow from the

Village economy.

village landlord or the money-lender. They are also themselves the managers, organisers, and experts of their petty farms; and they carry their produce to the market—which is held once in the week—to exchange it for other commodities.

Classes in the village.

(b) "Besides the two classes of landlords and cultivators, there is a third class of inhabitants in the village composed of the artisans. The weaver, the blacksmith, the carpenter, the oilman and the goldsmith supply the needs of the small society, and are recognised members of the village community. The washerman, the barber and the potter are the other artisans of the village. The blacksmith and the carpenter follow industries which are directly subsidiary to agriculture; they make and repair the carts, ploughs and other simple implements of Indian husbandry; the potter supplies domestic utensils; and the barber and washerman perform services for the rural population which Indian social habits have delegated to a particular class of the community. Their services are often paid for in kind. The petty shopkeeper performs the important function of exchanging the different products. The money-lender who also usually combines other functions, especially that of a grain merchant, is by virtue of his position, a very important member. The villagers also have their travelling traders who come to their doors in a definite season every year. The *purohit* and the doctor complete the village organisation.

The economic condition of the village.

(c) "In the village economy, there is very little competition with the outside world though within the village the motive of self-interest prompts everybody to find the best advantage for himself. Wages and profits are to a large extent governed by custom and are comparatively fixed and inelastic. Division of labour is carried to some extent, but as division depends on the extent of the market it cannot be carried very far. Labour is immobile; and what little capital there is in the village is locked up in the land. In short, the village system compels production on a small scale and deepens the effect of custom. Money is rarely used, grain being used for exchange.

Life in the village.

(d) "The different classes in the village are conscious that each is dependant on the others and that the interests of each class are bound up with those of the rest. The villager lives a simple, and in years of good harvest, a contented life. There is little wealth in the village, but the evils of capitalism are also absent. The cultivator or artisan knows little of the comforts and luxuries of urban life and does not miss them.

Change.

(e) "The village system as above described is slowly changing, and the impact of Western civilisation is working a change in the ideas and ideals of the villager. Villages which supply big cities in their neighbourhood or stand on important railway lines are more subject to rapid changes of prices and wages."

Village occupations.

247. The statistics of occupations as ordinarily followed in the rural areas will now be discussed. The subjoined statement gives the proportion per 10,000 of the total population of the State under different kinds of occupations as ordinarily followed in the villages and as distinguished from those pursued in the four cities of the State.

No.	Occupations	Total number of persons supported	Number per 10,000 of population
1	Landlords and tenants	4,028,656	6,939
2	Labourers:—(a) Agricultural	177,372	305
	(b) Labourers unspecified	391,427	674
3	Fishermen and boatmen	3,263	6
4	Stock-owners, milkmen and herdsmen	27,754	48
5	Oil-pressers	6,791	12
6	Toddy drawers and sellers	16,301	28
7	Grain parohers	191	...
8	Leather workers	8,697	15
9	Basket-makers, scavengers and drummers	29,357	50
10	Grocers and confectioners	67,823	117
11	Grain dealers and money-lenders	26,654	46
12	Vegetable and fruit sellers	25,354	44
13	Makers and sellers of bangles	7,668	13
14	Silkworm rearers and silk weavers	2,986	5
15	Cotton workers (not in mills)	32,663	56
16	Goldsmiths and blacksmiths	70,317	121
17	Brass, copper and bell-metal workers	1,591	3
18	Carpenters, wood cutters, etc.	32,149	55
19	Potters	27,060	47
20	Tailors	16,841	29
21	Other shop-keepers	12,314	21
22	Barbers	21,238	37
23	Washermen	44,150	76
24	Priests, acrobats, etc.	35,122	60
25	Village doctors and midwives	2,876	5
26	Mendicants, etc.	51,979	90
	Total ...	5,168,594	8,902

It will be seen from the above that in every 10,000 persons in the State 8,902 are supported by these village occupations, agriculture claiming 7,244 or 7 in every 10. The other rural occupations all put together support 1,658 persons or 2 in every 10 persons in the State.

The following diagram illustrates graphically the occupations ordinarily followed in a village of the description given in paras 246 and 247. Assuming

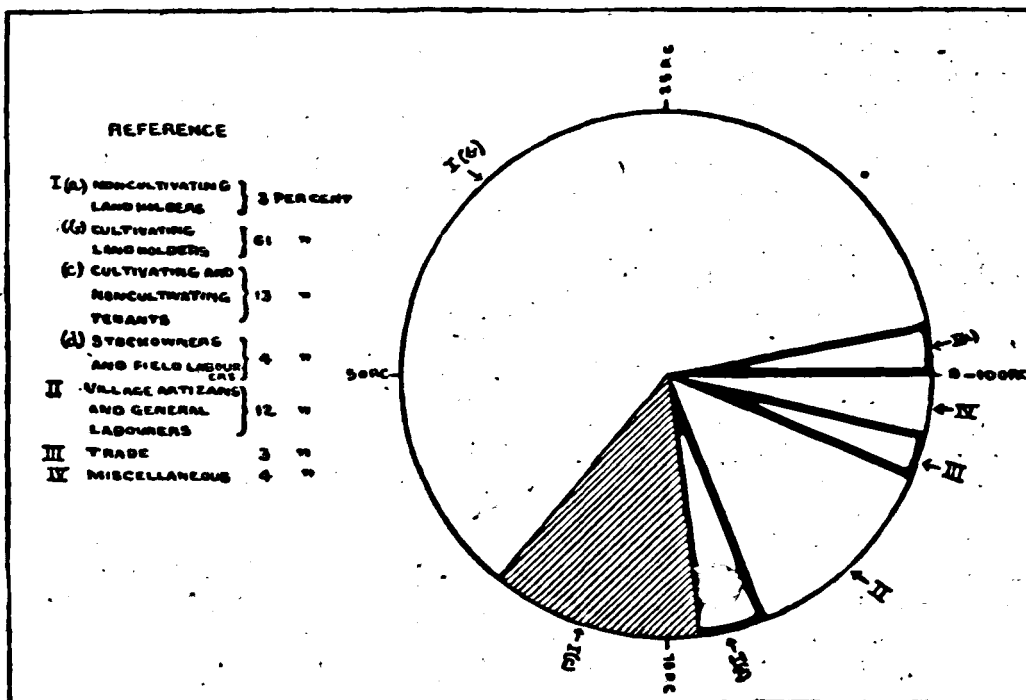

that there are 100 persons in the village, it will be seen that 81 of them subsist mainly by cultivation, field labour and stock-owning; 12 are village artisans and general labourers; 3 are traders and 4 follow miscellaneous pursuits. On further analysing these main occupational groups, it is found that the first division contains 3 non-cultivating landholders, 61 cultivating landholders, 13 land tenants and 4 stock-owners and field labourers. The artisan group which forms 12 per cent of the village population comprises goldsmiths, blacksmiths, carpenters, potters, barbers, washermen and oilpressers; and it also includes a handful of general labourers who assist in one or other of the above handicrafts, and are remunerated in kind or cash according to custom. The third group of traders is made up of grain dealers and money-lenders, shop-keepers, dealers in bangles, etc., vegetable and fruit sellers and the like. The miscellaneous or the last group comprises priests, cotton workers (not in mills), fishermen and boatmen, toddy drawers, grain parchers, basket-makers, leather workers and the village scavengers and drummers. Thus from an economic point of view it may be remarked that the inhabitants of a large village form within themselves a compact, organised and self-sufficient community.

248. The marginal statement worked out from Subsidiary Table I shows the

Sub-class	Proportion per cent	
	Workers	Dependants
I. Exploitation of the surface of the earth...	27	73
II. Extraction of minerals ...	40	60
III. Industrial occupation ...	35	65
IV. Transport ...	39	61
V. Trade ...	37	63
VI. Public force ...	39	61
VII. Public administration ...	24	76
VIII. Professions and liberal arts ...	33	67
IX. Persons living on their income ...	33	67
X. Domestic service ...	53	47
XI. Insufficiently described occupations ...	57	43
XII. Unproductive ...	57	43
All occupations ...	69	31

Actual workers and dependants. The proportion per cent of actual workers to dependants under each sub-class of the occupation scheme. The percentage of dependants to workers is highest in sub-class VII—Public administration—being 76 per cent, and least in sub-class XI—Insufficiently described occupations—and XII—Unproductive—(43 per cent in each). Next to sub-class VII come in the order of precedence sub-class I—Exploitation of the surface of the earth—

(73 per cent), sub-class VIII—Professions and liberal arts—(68 per cent), IX—Persons living on their income—(68 per cent), III—Industrial occupations—(65 per cent), V—Trade (63 per cent), VI—Public force—(61 per cent), IV—Transport—(61 per cent), and II—Extraction of minerals—with a percentage of 60.

Proportion of female to male actual workers.

249. The marginal map represents the percentage proportion of female to male actual workers in the several districts of the Province (the cities being included in the respective districts in which they are situated). The highest percentage is in the Kadur District (31.5); next come Chitaldrug and Shimoga with (27.9) and (27.7) respectively; and these are followed by Mysore (25.4), Tumkur (23.6) and Hassan (23.2), Bangalore and Kolar Districts coming last with (19.7) and (18.6) per cent respectively. The comparatively small percentage of female labour employed on the Gold Fields of Kolar accounts to some extent for the small percentage of female workers in the Kolar District.

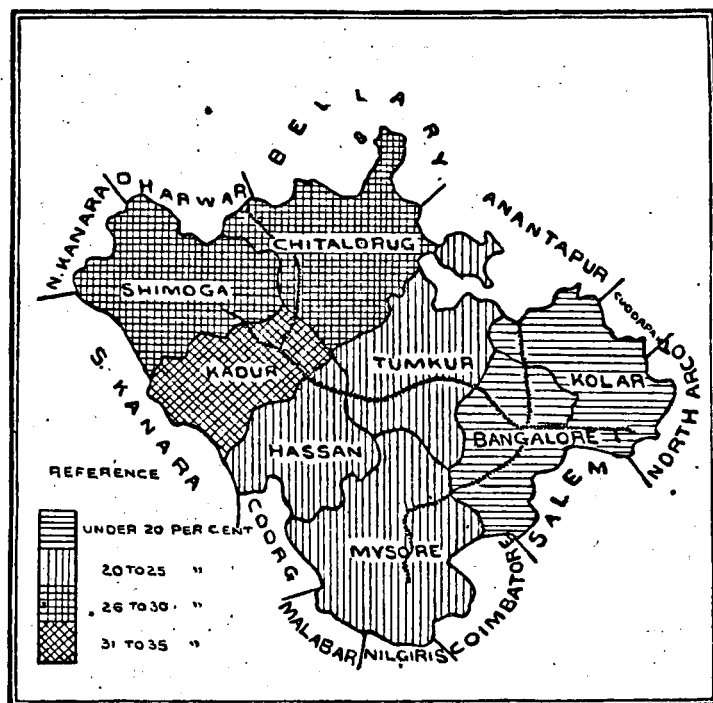

Taking the two sexes separately, 49.4 per cent of males and 12.2 per cent of females are actual workers in the State. The variation per cent by districts and cities is given in the statement below:—

District and City	Percentage of actual workers to total population of		
	Both sexes	Males	Females
Total Mysore State ...	31.0	49.4	12.2
Bangalore City ...	38.0	59.3	14.9
Bangalore District ...	27.3	25.9	8.4
Kolar Gold Fields (City) ...	42.0	66.1	9.3
Kolar District ...	24.4	40.5	8.1
Tumkur District ...	32.8	52.5	12.7
Mysore City ...	37.6	56.0	18.8
Mysore District ...	30.4	49.1	12.0
Chitaldrug District ...	26.2	40.3	11.6
Hassan District ...	30.8	50.4	11.5
Kadur District ...	42.0	61.1	21.1
Shimoga District ...	37.8	57.0	17.1
Civil and Military Station, Bangalore.	38.9	59.9	16.8

Viewed by the sub-classes of the Occupation Scheme the number of female workers in every 1,000 males is highest (even higher than the males) in sub-class—XI—Insufficiently described occupations—being 1,044; sub-class XII—Unproductive (849) comes next; then follow sub-classes V—Trade (419), III—Industry (225) and I—Exploitation of the surface of the earth (151). (*Vide* Subsidiary Table VI.) It is interesting to note that most of the occupations in which the number of female workers to 1,000 males exceeds 500 such as selling firewood and cowdung cakes, silk spinning, rice-pounding and husking,

flour-grinding, the selling of milk, butter, ghee, poultry and eggs, selling hay, grass and fodder and trade in refuse matter, involve a comparatively small amount of physical labour, the more difficult pursuits being left to the male workers.

PART III—A REVIEW OF THE STATISTICS BY PRINCIPAL ORDERS AND GROUPS.

250. The figures as presented by the general occupation Tables will next be examined for the principal orders and groups.

The marginal table shows the general distribution, per 1,000 of total population, of the agriculturists supported by groups 1 to 6. In the whole State agriculture is the mainstay of 724 persons per mille of total population. Viewed by districts as given in Subsidiary Table III, the proportion of agricultural population per 1,000 of the district population is highest in the Hassan and Mysore Districts, being 801 and 800 respectively ; next comes Tumkur (769). This is followed by Bangalore District (762), Shimoga District (740), Kolar District (729), Kadur District (717) and lastly Chitaldrug (715). The distribution of the agricultural population per 1,000 of the total population in the two Natural Divisions gives 759 for the Western Division and 729 for the Eastern Division.

Group No.	Occupation	Number supported per 1,000 of total population
1	Income from rent of agricultural land ...	30
2	Ordinary cultivators ...	656
3	Agents, Managers, of landed estates (not Planters), clerks, rent collectors, etc.
4	Farm servants and field labourers ...	30
5	Tea, coffee, etc., plantations ...	4
6	Fruit, flowers, vegetables, betel, vine, areca-nut, etc., growers.	4
	Total ...	724

Agriculture: Sub class I. Order 1 (a) and (b) groups 1 to 6.

251. This large milage of the agricultural on the total population of the State is mainly due to the inclusion in that category of persons who while following also other occupations such as Government service, etc., as their subsidiary pursuits depend *principally* on agriculture (*vide* para 253 below analysing Imperial Table XV-B).

Occupations combined with agriculture.

252. From the marginal statement and from Subsidiary Table IV, it will be

Sub-class	Number per mille who are partially agriculturists
VII. Public administration ...	437
VIII. Professions ...	187
VI. Public force ...	145
III. Industrial occupation ...	125
IX. Persons living on their income ...	114
V. Trade ...	81
II. Extraction of minerals ...	69
IV. Transport ...	67
XII. Unproductive ...	23
X. Domestic service ...	12
XI. Insufficiently described occupations ...	8

(a) *Where agriculture is the subsidiary occupation*
 seen that the milage of partial agriculturists is highest in sub-class VII "Public administration" and least in sub-classes X and XI "Domestic service" and "Insufficiently described occupations" with a milage of only 12 and 8 respectively.

An examination of the figures by Natural Divisions as given in Subsidiary Table III to this chapter shows that the agriculturists preponderate in the Western Division. The reason is not far to seek. Nature is more bountiful with copious rainfall in the Western Division and consequently the districts comprising this division are more agricultural ; while the fitful and uneven distribution of rain and constant relinquishments of land in the districts comprising the Eastern Division are mainly answerable for the smaller proportions noticed in that division.

253. The statistics of persons following agriculture as their principal means of livelihood are contained in Table XV-B. The main features of these statistics are brought out in Subsidiary Table II appended to this chapter under three distinct categories of (1) landlords (rent-receivers), (2) cultivators (rent-payers) and (3) farm servants and field labourers. Of the landlords or rent-receivers, 1,841 in every 10,000 follow Government service as their subsidiary occupation and 1,534 subsist partly by trade. They are seen in the least proportion as lawyers.

(b) *Where agriculture is the principal occupation.*

Next, of the cultivating agriculturists (rent-payers), 1,306 in 10,000 live partly by trade, and next to trade, village service (as watchmen), general labour and Government service partially support 1,107, 1,020 and 908 respectively. Thus these Tables (Imperial Table XV-B and Subsidiary Table II) illustrate by figures the significance of the statement in para 246(c) regarding the rural economy in Mysore that "division of labour cannot be carried very far" and the truth of the statement in the Mysore Census Report of 1901 (para 7 of Chapter IX) that "the rural inhabitants combine in themselves the artisan, the raiyat, the labourer and sometimes the trader too." Agriculture is combined in least proportion with fishing and boating.

Among farm servants and field labourers, general labour is the Subsidiary occupation of 2,005 persons, while village service (as watchmen) partly supports 1,350 in every 10,000. Only 3 in 10,000 are both agriculturists and oil-pressers.

Variation of agricultural population in decennium 1901-11.

Group No.	Occupation	No. supported per 1,000 of total population	
		1911	1901
1	Income from rent of agricultural land	90	488
2	Ordinary cultivators ...	656	94
3	Agents, managers of landed estates (not planters), clerks, rent collectors, etc.
4	Farm servants and field labourers ...	30	64
5	Tea, coffee, cinchons and indigo plantations ...	4	5
6	Fruit, flower, vegetable, betel, vine, arecanut, etc., growers ...	4	8
	Total ...	724	659

254. There were 4,206,095 persons returned as agriculturists at the present Census as against 3,653,840 in 1901, the number per mille of total population being 724 and 659 respectively. The variation under the different groups is given in the marginal statement. There is a net increase of 15·1 per cent in the total agricultural population during the decennium; and this is partly attributable to the increase in the area of occupied land in 1911 over that of 1901, being 42·9 as against 40·5 per cent of the net provincial area.

Comparing the statistics of the agricultural population of 1911 with those of 1901 by groups, we find that there is a large increase of 562 per mille in group 2—ordinary cultivators,—while there is a corresponding decrease of 458 per mille in group 1 of 1911, *income from rent of agricultural land*. These variations are due to the present system of classification by which the old groups of 1901 had to be either split up or combined so as to fit them in to the new groups of 1911. An analysis of the figures in group 36 of 1901 shows that this group included the non-cultivating as well as the cultivating landholders numbering in all 2,705,208 persons returned as *landholders* and *rent receivers*. Among these 342,231 were non-cultivating landholders (landholders 329,909, inamdars 1,891, and jodidars 10,431) and the rest, *viz.*, 2,362,977, were simple landholders who both held and cultivated their lands. On the present occasion the non-cultivating landholders alone are retained in group 1, the cultivating landholders being brought under group 2, thus swelling the number in that group. Again, group 37 of 1901—*rent payers*—comprised mostly the tenants only, both cultivating and non-cultivating, and showed a return of 520,213 persons; while group 2 of 1911, which corresponds to group 37 of 1901, has 3,811,562 persons, 3,148,294 of whom are cultivating landholders and the rest, *viz.*, 663,268 are cultivating tenants. The large addition to group 2 of 1911 is thus due to the fact that most of the cultivating landholders who were included in group 36 of 1901 have come to be included in new group 2 of 1911. For purposes of comparison the groups may be arranged thus, the equivalence of the groups for the two Censuses being approximate:—

1911.	1901.
Group 1 (a) Non-cultivating land holders 159,103.	Group 36 (b), Landholders, inamdars, and jodidars, 342,231.
Group 1 (b) and 2 (b) Cultivating and Non-cultivating tenants, 675,714.	Group 37 (a), (b) and (c) Rent payers, 520,213.
Group 2 (a) Cultivating landholders 3,148,294.	Group 36 (a), Hiduvalidars, pattadars, khatadars, vargadars, 2,362,977.

From this it will be seen that the increase in the number of persons in each of the groups "landholders" and "tenants" is proportional to the increase in the

area of occupied land noticed already and to the general growth of population during the decennium 1901-11.

There is also a marked decrease of 34 per mille in group 4—Farm servants and field labourers. There were 353,436 persons who returned themselves as farm servants and field labourers in 1901 (groups 38 and 39 of 1901); but this number consisted of 78,096 *Kumki Zirayatdars* and 131,340 cultivators, some of whom require to be properly classed as cultivating landholders inasmuch as most of them have shares in land and assist in the cultivation of it. Excluding these for purposes of comparison, there will remain in groups 38 and 39 of 1901, 419 farm servants, 113,849 *saguvalidars* and 29,732 field labourers receiving annual payment in kind or money as remuneration for their labour, making a total of 144,000 agricultural labourers as against 177,372 in 1911.

From the above review of the statistics of agricultural population in the State, it may be remarked that the fluctuations by groups are but apparent and not real. As remarked in para 100 of Chapter IX of the Mysore Census Report of 1901, "the expressions recorded in the Schedules of 1901 to denote the agricultural occupations were so vague that it was hard to make out whether a person returning himself as an agriculturist was a cultivating occupant or a non-cultivating occupant, a rent-payer or a rent-receiver and if both, which more and which less or whether he was merely a labourer working in the fields." On the present occasion these distinctions were carefully brought out in the schedules and the fluctuations in the figures of 1911 as compared with those of 1901 are mostly due to the present system of enumeration. They are not to be taken as indicating any material change in the conditions of the agricultural section of the population of the State. Taking all the groups together, it is satisfactory to note that agriculture has made a steady progress during the decennium 1901-11.

255. We have in paragraphs 250 to 254 discussed the statistics relating to the agricultural population of the State who depend mainly and *directly* on the cultivation of land for their subsistence. In addition to these, there is another section

of the population who subsist *indirectly* on land and who require to be dealt with here as a quasi-agricultural class. They are by occupation Keepers and breeders of cattle, sheep, goats, etc., and live by pasturage. Their number per 10,000 of the total population is 48 and are distributed among the different groups of the occupation scheme as shown in the margin,

Quasi-agricultural occupations: pasture, sub-class (I), Order 1(d), Groups 9-12.

Group No.	Occupation	Actual No.	No. supported per 10,000 of population
9	Cattle and buffalo breeders and keepers ...	875	3
10	Sheep, goat and pig breeders ...	1,081	2
11	Breeders of other animals such as horses, mules, camels, asses, etc.	223	...
12	Herdsmen, shepherds, goatherds, etc.	25,575	44
	Total ..	27,754	48

256. At the Census of 1901 no distinction was kept up between stock-breeding and dealing, and consequently all persons returning themselves as either breeders or dealers of cattle, buffalo, etc., or in any way connected with stock-owning were shown in one or other of the eleven groups provided at that Census under sub-orders 'Stock-breeding and dealing' and 'Training and care of animals.' Such persons as kept cattle and subsisted by selling milk, butter, etc., were not included among the above but were relegated to a different group provided under 'Provision of animal food.' On the present occasion the *stock-breeders* are well differentiated from *dealers*; and for purposes of instituting a comparison of the present figures with those of 1901 some of the old groups have been broken up with reference to local conditions on the assumption that the proportions in each part of the group were the same in 1901 as on the present occasion. The result thus obtained is but a rough approximation. In this way most of the groups of 1901 corresponding to groups 9 to 12 of 1911 and comprising the order 'Raising of farmstock' have been split up and the population distributed proportionally, the new groups 9 to 12 receiving some, the rest being added to groups 118, 123, or 129 according as the proportion for splitting the figures in the old groups demanded. For instance, group 78 of 1901 comprising 14,240 persons was made up of 'cow and buffalo keepers' and 'milk and butter sellers.' This number has been broken up in the ratio of the present absolute figures in groups

Comparison of present figures with those of 1901.

9 and 118, viz., 875 and 8,265, which gives 1,365 for group 9 'cattle and buffalo breeders and keepers,' and the rest 12,875 to an altogether different group 118 'sellers of milk, butter, ghee, etc.' Thus, the total number of breeders and keepers of cattle, buffalo, sheep, goat, etc., including all the herdsmen, shepherds and goatherds, supported by order 1 (d) of 1911 'Raising of farmstock' is 27,754 in 1911 according to the new grouping as against 77,431 in 1901. The net decrease of 64·2 per cent is merely due to the somewhat arbitrary adjustment of figures as explained above necessitated for purposes of maintaining a clear distinction between a dealer and a breeder in stock and as such the variation is no indication of any material change which might have taken place in the condition of stock-owners since 1901.

Fishing and hunting: sub-class I, Order ii, groups 14 and 15.

257. Fishing and hunting are mainly rural occupations supporting 2,209 persons or 4 in every 10,000 of the total population as against 5 in 1901. Only 5 per cent of actual workers among fishermen and huntsmen live in cities (Subsidiary Table I).

Extraction of minerals: sub-class II, Orders iii to v, groups 16 to 20.

258. Sub-class II—Extraction of minerals, supports 52,987 persons, or 9 per mille of total population who are distributed among groups 16 to 20 of Orders 3 to 5 of the Occupation Scheme. There are only 3 persons returned under coal-mines and petroleum wells (group 16); and they are all dependants found in Civil and Military Station, Bangalore; group 20—Extraction of saltpetre, etc., has none at all returned under it. Group 18—Other minerals, is a minor group of Order 4, Quarries of hard rocks, and only 28 persons have returned themselves under it. Group 19—Extraction of earth or marsh-salt, is the means of support of 2,136 persons in the State which gives 4 persons in every 10,000 of the population. Of these, 1,657 persons are concentrated in the Chitaldrug District. In 1901, 7 per 10,000 of the total population were supported by this occupation as against 4 on the present occasion. The decline in the number of professional salt workers is chiefly due to the fact that the country earth-salt has failed to find the demand which it did formerly, the cheap sea-salt having taken its place and diverted 98 per cent of the Uppara caste to other walks of life.

Mining industry.

259. Mining is an important industry in the State which yielded a revenue to Government of about 18 lakhs in 1910-11; and before proceeding to discuss the Census statistics relating to this branch of occupation, it will be convenient to take here a general view of the Mining industry in the State as it stood in 1910-11 and as it was at the commencement of the decade.

Gold mines.

260. In 1901, the Kolar Gold Fields City was the chief mining centre. There were 14 mines at work, 5 of which were paying dividends to shareholders. The value of gold produced was £1,921,570 and the royalty paid to Government amounted to £93,912. In 1910-11, the number of gold mines at work was 10. The total value of gold produced in 1910-11 was £2,098,916 and the royalty paid to Government amounted to £118,685, being an increase of £177,346 and £24,773 in the value of gold and royalty respectively over those of 1901.

Manganese and Chromium.

261. Till 1903, gold was the only metal mined in the State. In 1904, Russia which enjoyed with Brazil the complete monopoly of manganese trade was involved in a war with Japan, with the result that Russia had to stop for some time her supply of manganese to the markets of Europe. The supply of the ore having thus become unequal to meet the growing demand, there was a sudden rise in the price of this ore. In some parts of India, operations were commenced for the collection of the ore. Mysore also shared in this and some companies started work in that year. Several promising outcrops of manganese ores were located in the jungles on the Shankargudda Range, south of Ayanur in the Shimoga District, in addition to the discovery of such deposits near Kumsi. In 1905-06, some attention was paid to the collection of chromium also.

The manganese trade continued to prosper till the end of 1906. On the close of the Russo-Japanese war in August 1905, Russia recommenced its operations in manganese with the result that there was a heavy fall in the price of this mineral. Since 1907-08, the Mysore manganese industries began to show

a gradual decline and at the close of 1910 the three manganese companies of Shimoga continued their work in a rather depressed condition while trade in chrome was at a complete standstill.

262. It is, however, noteworthy that several mica deposits in the Sringeri Mica Jahgir were opened up in 1910-11 and a quantity of 60,000 lbs. of muscovite mica of a fairly good quality was unearthed.

263. We will now proceed to review the Census statistics relating to group 17 of the Occupation scheme—mines and metallic minerals. **Census statistics of mining occupation in Mysore.**

According to Table XV-A, there were 50,820 persons on the 10th March 1911 supported by mining, being 87 per 10,000 of the total population of the State. 75 per cent of these are chiefly centred in the Kolar Gold Fields City, and of the remaining 25 per cent Kolar District contains 23 per cent and Shimoga District 2 per cent. Both in the Kolar Gold Fields and in the Kolar District 40 per cent are actual workers, 38 per cent being males and 2 per cent females. In Shimoga the proportion of actual workers employed on the manganese mines to the total mining population of the district is 54 per cent, 37 per cent being males and 17 per cent females.

Of the 10 gold mines noticed in para 260, 6 mines employed more than 20 persons each on the date of the Census. In 4 of them the work was reported to be normal, the operations in the other two being slacker than usual. From the statistics relating to these mines which were collected on a separate special industrial schedule and exhibited in Table XV-E, it will be seen that the 6 mines referred to above employed in all 25,303 persons. Of these, 661 persons were employed on direction, supervision and clerical work, 521 of whom were Europeans and Anglo-Indians and 140 Indians. The number of skilled workmen employed was 5,982 and unskilled labourers 18,660. Among the skilled workmen 350 were Europeans and Anglo-Indians and 5,632 Indians; and of the unskilled labourers 17,896 were over 14 years of age and 764 under 14. In every 100 persons employed, 94 are males and the rest females. Out of 38,229 persons forming the mining population of the Kolar Gold Fields 66 per cent, were employed by 6 of the mines referred to above, 5 using steam and electricity as motive power and steam alone being employed in the sixth. In the department of direction and supervision, out of 100 employes, 79 were Europeans and Anglo-Indians and 21 Indians. Among skilled workmen, 94 per cent were Indians, the rest being Europeans and Anglo-Indians.

264. The number supported by sub-class II—Extraction of minerals, per 10,000 of the total population is 91 in 1911 as against 26 in 1901. This increase has already been explained in para 245 above. **Comparison with 1901.**

265. The statistics relating to the industrial occupations were collected on two schedules on the date of the Census—one, the general population schedule (columns 8 to 10) and the other, the special industrial schedule altogether unconnected with the former and relating only to the big industrial undertakings in the State employing not less than 20 persons on the date of the Census. In explanation of the adoption of the latter schedule in addition to the former, it may be stated that while the former would indicate the main functional distribution of the people, distinguishing workers from dependants and would also furnish statistics of occupations combined with agriculture and of occupation by caste, it does not give any clue regarding the recent industrial developments in the State, distinguishing *workers in factories* from those engaged in home industries. It also fails to furnish the data for distinguishing between "owners, managers and superior staff" and "operatives in mills." Hence the adoption of this special industrial schedule. **Industrial occupation: sub-class III.**

As a preliminary step, a register of all factories, etc., employing not less than the prescribed number of persons was compiled for the several districts; and on the date of the Census the industrial schedules were filled in by the owners or managers of the several institutions to whom instructions were issued previously in the matter of correctly filling them up. A list of industries to which alone this special Census would extend was also published in sufficient time for the guidance of the district census officers. The special statistics thus collected have been exhibited in four parts of Table XV-E as already referred to

in para 234 of this chapter. It will be therefore convenient to discuss the statistics of industrial occupations under two separate and distinct heads (1) statistics *general* and (2) statistics *special*.

Statistics
general:
Popula-
tion Cen-
sus.

266. As already noticed in para 243 of this chapter, sub-class III—Industrial

Order No.	Occupation	Number supported per 10,000 of total population
	Total ...	764
6	Textiles ...	175
7	Hides, skins, etc. ...	7
8	Wood ...	70
9	Metals ...	40
10	Ceramics ...	46
11	Chemical products ...	12
12	Food industries ...	40
13	Industries of dress and toilet ...	177
14	Furniture industries ...	1
15	Building industries ...	84
16	Construction of means of transport ...	2
17	Production and transmission of physical forces ...	2
18	Industries of luxury ...	92
19	Industries concerned with refuse matter ...	16

Occupation, comes next to sub-class I—Agriculture, in the order of numerical strength as well as in importance, supporting 764 persons in every 10,000 of the total population. Their distribution by orders is given in the marginal statement. Of the 764 persons, 177 are supported by the dress and the toilet industries. Textiles, industries of luxury, building industries, wood and ceramics come next in the order of numerical strength, employing 175, 92, 84, 70 and 46 respectively, the remaining orders, all put together, claiming the rest 120.

The number per mille of total population in the State supported by the

District and City	Percentage of industrial population to total population of the district or city	Percentage of actual workers on total industrial population of the district or city	Percentage of male and female workers to 100 workers of both sexes	
			Males	Females
Bangalore District ...	7	31	85	15
Kolar District ...	7	30	87	13
Tumkur District ...	7	35	84	16
Mysore District ...	6	36	78	22
Chitaldrug District ...	11	30	85	15
Hassan District ...	5	35	81	19
Kadur District ...	5	46	76	24
Shimoga District ...	6	42	81	19
Bangalore City ...	30	39	83	17
Kolar Gold Fields ...	6	52	83	17
Mysore City ...	19	41	68	32
Civil and Military Station, Bangalore ...	23	40	80	20
Mysore State including Civil and Military Station, Bangalore	8	35	82	18

industrial occupations is 80 in the Eastern Division and 55 in the Western Division (Subsidiary Table II). The high mille age in the former is due to the inclusion in it of the four cities which are the chief industrial centres in the State. Viewed by cities and districts, their proportion per cent on the total district and city population is highest in the Bangalore City, being 30 per cent, as

will be seen from the marginal statement. Civil and Military Station, Bangalore, has 23 per cent. It is in these two cities that most of the big industrial factories are located. Next comes Mysore City with 19 per cent. Of the districts, Chitaldrug scores 11 per cent, due to the location of cotton ginning and pressing mills at Davangere, while Hassan and Kadur Districts have the least percentages.

Among persons supported by the Industrial occupations in the State, 35 per cent are actual workers and the rest dependants. Kolar Gold Fields City has the highest percentage of actual workers (52) and the districts of Kolar and Chitaldrug, the least (30 each). In the State as a whole in every 100 workers, 82 are males and the rest females.

Variation
in period
1901-11.

267. On the present occasion, 443,132 have returned themselves under sub-class III—Industries, as against 489,511 in 1901 (Subsidiary Table VII). The decrease, which comes to 9.5 per cent, is partly due to the new method of classification of occupations and partly to the displacement of manual labour by the labour-saving machinery driven by water, oil, steam or electric power, particularly in occupations such as ginning, sizing, carding, spinning and weaving of cotton, wool and silk, brick and tile-making, sawing and carpentry and such like industries, which largely employed manual labour in the previous decennium but which now employ machinery worked by one or other of the physical forces enumerated above.

Statistics
special:
Industrial
Census.

268. We have so far discussed the statistics of industrial occupations as collected on the general population schedules. Let us now examine those collected on the special industrial schedules. These special industrial statistics are

contained in parts I to IV of Table XV-E. Part I is the Provincial Summary which shows for the Province as a whole the number of persons employed in each kind of industry dealt with, distinguishing between those factories, etc., in which mechanical power is used and those in which it is not, and classifying them according to the number of persons employed. Part II gives for each district the number of persons employed in each industry, without the above details. Parts III and IV are intended to throw light on the extent to which the different races and castes have taken part in the establishment or management of the various industrial undertakings. They are compiled only for certain selected industries.

According to the Provincial Summary the total number of persons employed in factories, mills, works, etc., including gold and manganese mines and coffee, cardamom and rubber plantations is 58,613, of whom 45,382 or 77 per cent are males and 13,231 or 23 per cent females. All the workers are divided into three groups. The first group consists of the superior staff employed in direction, supervision and clerical work. The second is made up of skilled workmen, and the third group consists of unskilled labourers, the latter being again subdivided into two sub-groups—(a) those whose age is 14 and over and (b) those under 14 years. The distribution per cent of the employes in each group is graphically illustrated in the following diagram, from which it will be seen that the percentage on the industrial population of persons employed in direction, supervision and clerical work is 3·7. The skilled and unskilled labourers number 17·1 per

Diagram showing the proportion per cent of the different classes of workmen employed in the various industrial undertakings (employing not less than 20 persons) in the Mysore State including Civil and Military Station, Bangalore.

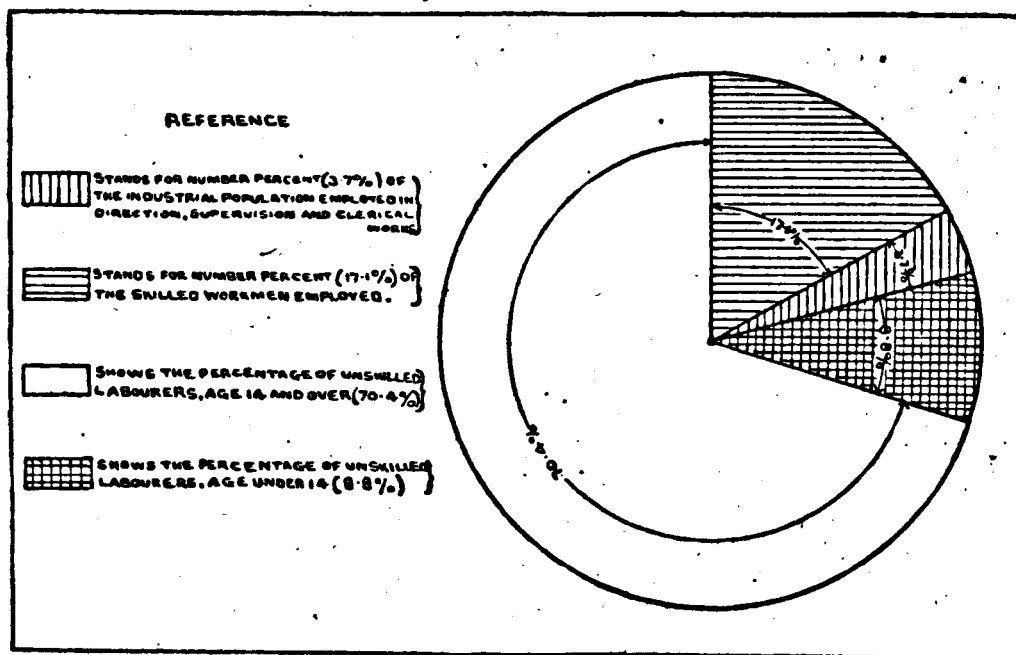

cent and 79·2 per cent respectively and among the latter 70·4 per cent are of age 14 and over, the rest 8·8 per cent being under 14. The proportion per cent of Europeans and Anglo-Indians to Indians employed in the superior staff of direction and supervision is 33·6. Among the skilled workmen 5 in every 100 are Europeans and Anglo-Indians and the remaining 95 Indians. Of the unskilled workmen 11·1 per cent are juveniles under 14 years of age, the rest being above that age.

The distribution per mille of the labour force employed on the different kinds

Sub-class	Order No.	Occupation	Number supported per 1,000 of the factory population
I	1 (b)	Growing of special products (222 coffee, 9 cardamom, and 3 rubber plantations).	446
II	2	Mines (6 gold and 2 manganese mines).	441
III	3 to 19	Industrial occupation	118

of factory, etc., works in the State (including Civil and Military Station, Bangalore) by sub-classes of the Occupation scheme is given in the marginal statement. It will be seen from it that the big industrial works

included in sub-class III support 113 per mille of the factory employees, the rest being employed by the coffee plantations of Kadur and Hassan Districts and by the gold mines of Kolar and manganese mines of Shimoga. Among the factory works, those connected with the textiles take precedence over the rest and employ 39 per mille.

Power employed and state of business.

269. Of the 327 factory works in the State, mechanical power is used in 80 works, water being employed in 19, oil in 14, steam in 29, electricity in 12 and steam and electricity in 6. As regards the state of business on the 10th March 1911, it was much brisker than usual in 4, brisker than usual in 30, somewhat brisker than usual in 29, normal in 178, somewhat slacker than usual in 18, slacker than usual in 38 and much slacker than usual in 30.

Kolar is the only gold-producing district. The woollen and cotton spinning and weaving mills are located in the City of Bangalore, the former using electricity and the latter steam. The cotton ginning and pressing mills which use steam power are located at Davangere in the only cotton-growing district of Chitaldrug. The hydro-electric plant is installed in the Mysore District at the Cauvery Falls in Sivasamudram. Kadur and Hassan are coffee-growing districts, the former containing 163 coffee plantations employing 18,002 labourers and the latter 77 plantations with 6,433 workmen. In Shimoga District, there are 3 manganese mines giving employment to 538 persons.

Ownership of factories.

270. For purposes of Parts III and IV of Table XV-E, 315 factories have been selected. 58 of these are owned by companies and the remaining 257 by private persons. Of the former 40 employ European or Anglo-Indian directors and 17 Indians, while in 1 they are of both races. Of the 257 private factories, etc., Europeans and Anglo-Indians own 138, Hindus 67, Musalmans 28, Indian Christians 21, Jain 1, Parsi 1 and Jew 1. Again, of the Hindus, 16 are Brahmans, 1 Devanga, 9 Komatis, 20 Lingayats, 20 Vakkaligas, and 1 Mudali.

Caste or race of managers.

271. Of the above 315 works and factories, 186 are managed by Europeans or Anglo-Indians and 129 by Indians. Of the Indians, 75 are Hindus, 27 Musalmans, 23 Indian Christians, 2 Jains, 1 Parsi, and 1 Jew; and among the Hindu managers, again, 25 are Brahmans, 20 Lingayats, 19 Vakkaligas, 8 Komatis, 2 Mudalis and 1 Devanga.

A comparison of the special industrial figures with those of the general Census under sub-class III of the Occupation Scheme shows that 15 in every 1,000 persons are factory employes.

The statistics reviewed till now have a peculiar value as throwing light on the industrial expansion of the State in recent times.

Hydro-Electric Works or 'the Cauvery Power Scheme.'

272. Before closing the section on the industries in Mysore, a short description may be given of the Cauvery Electrical Power Scheme which supplies power to the mining industry and has begun to affect the internal structure of other industries in the State. The works connected with the Electrical Department in the Province have been grouped under the head "Production and transmission of physical forces." These are of recent origin and did not exist in the previous decade. The main power station is located at Sivasamudram, where, the river Cauvery, as it passes out of Mysore, branches into two streams, each making a descent of about 200 feet in a succession of picturesque rapids and waterfalls. Here at the western falls which present a scene of grandeur and beauty are installed the Hydro-electric Works, better known as the Cauvery Power Scheme, which has been designed to generate electricity for the supply of power to the Gold Fields of Kolar as also to the three chief cities in the Province for lighting purposes.

Its history.

(a) In June 1899, it was decided to utilise the falls for generating electricity and to work with it the gold mines of Kolar. Accordingly, a special division known as the Cauvery Power Scheme Division was formed and the headquarters were established on the 'Bluff,' immediately above the site of the Fore-bay and Power Station. Steady progress in the construction work was made both at Sivasamudram and at Kolar Gold Fields; and in June 1902, the operations were in readiness for a final test. On the 30th June of that year, the electric power

was for the first time successfully transmitted to the Gold Fields, and since then the transmission has been steadily kept up uninterrupted.

The whole scheme was completed on the eve of the Installation on the 8th August 1902, of His Highness Sri Krishnarajendra Wodeyar Bahadur when he was invested with the administration of the State. The main power station has been named after Sir Sheshadri Iyer.

A second installation for an additional 2,000 H.P. was completed in January 1905 at a cost of 13 lakhs, and a third was started in 1906 and completed in 1908.

(b) The Electric Works as they stood in 1910-11 consisted of 5 electric power and light works and 1 hydro-electric plant, the former for the supply of power to the Cities of Bangalore, Mysore, and Civil and Military Station, Bangalore, for lighting purposes, and the latter for the supply of power to the Kolar Gold Fields. The total number of persons employed on these works was 391 on the date of the Census. The number of street lights at the close of 1910-11 was 2,832. Of these, 1,325 were in the Bangalore City, 598 in the Mysore City and 909 in the Civil and Military Station, Bangalore. In addition to these, there were 603 interior lighting installations and 20 power installations (11 in Bangalore City, 4 in Mysore City, 4 in Civil and Military Station, Bangalore and 1 in Kolar Gold Fields). The total quantity of power generated in 1910-11 amounted to 74,776,308 units. Of these, 69,795,028 units were sold to the Kolar Gold Fields; and of the remaining power 2,868,809 units were supplied to Bangalore City, 1,353,280 to Mysore City and 759,191 to Civil and Military Station, Bangalore, for lighting purposes.

The revenue actually collected during the year 1910-11 amounted to Rs. 1,599,179, leaving an arrear at the end of the year of Rs. 281,249.

The total capital outlay invested on the scheme since its commencement up to the end of June 1911 amounted to Rs. 8,261,696 and the gross earnings from the scheme amounted to Rs. 14,378,051. Deducting the working expenses, the net profit on the whole scheme till the close of 1910-11 amounted to Rs. 7,368,876, which represents 89.19 per cent of the capital outlay.

273. Now turning to sub-class IV—Transport, we see that on the present occasion 31,096 persons or 53 in every 10,000 of the total population of the State are supported by this sub-class, as against 33,515 or 60 per 10,000 in 1901, the decrease being due to the proportional splitting up of the figures in the old groups of 1901 to correspond with the figures in the new groups of 1911.

Their distribution among the four orders of the Occupation Scheme gives for every 10,000 of the total population 1 to order 20—Transport by Water, 30 to order 21—Transport by road, 16 to order 22—Transport by Rail and 6 to order 23—Post Office, Telegraph and Telephone Services.

39 per cent of the population maintained by this sub-class are actual workers and the rest dependants (Subsidiary Table I).

274. This order comprises 594 persons employed on the maintenance of streams, rivers, and canals (including construction) and of boat-owners and 2 persons included in groups 94 and 95—Harbour works and Ship employés, who are found in the Civil and Military Station, Bangalore, as dependants. The former are found chiefly in the river districts of Mysore (including Mysore City) and Hassan. In every 100 persons in the State, 52 are in the Mysore District, 16 in Hassan, 9 in Kadur, 7 in each of the districts of Chitaldrug and Tumkur and 4 in each of the districts of Shimoga and Kolar. Bangalore comes last with the least percentage of 1.

275. The number supported by this order in the State including Civil and Military Station, Bangalore, is 17,547 in 1911 as against 21,394 in 1901. The difference is due to the adjustment of figures according to the new classification. The number supported by this order per 10,000 of the total population is 30, of whom 13 are actual workers. They are spread over groups 98 to 102 of the Occupation scheme and consist of persons employed on the construction and maintenance of roads and bridges, cart-owners and drivers, jutka drivers and owners, coachmen and stable-boys, owners and drivers of pack animals such as mules, bullocks, etc.,

and porters and messengers, etc. Their distribution per cent by district and

City and District	No. per cent
Civil and Military Station, Bangalore ...	17
Bangalore City	10
Mysore City	9
Kolar Gold Fields	2
Mysore District	10
Kolar District	10
Chitaldrug District	9
Shimoga District	9
Bangalore District	8
Kadur District	8
Tumkur District	4
Hassan District	4
Total	100

city in the order of numerical strength is noted in the margin. Among the four cities, Civil and Military Station, Bangalore, comes first with a percentage of 17 followed by Bangalore City with 10 per cent. The high percentage in these two cities is due to the large number of cart-owners, drivers, coachmen, etc., who reside in them, a feature which one may readily notice at the Railway stations in these places. Perhaps, the very first thing to arrest the atten-

tion of a stranger alighting here is the presence of a large number of private and hackney coaches and the long line of jutkas and bullock carts the drivers of which flock close to the platform. Incidental to the heavy transport is the maintenance of a number of roads, and this gives employment to several persons who have been included in group 98 of this sub-class.

**Transport
by Rail:
Order 32.**

276. The total number supported by this order is 9,395 or 16 per 10,000 of the

District and City	Percentage
Total	100
Bangalore District	12
Kolar District	8
Tumkur District	5
Mysore District	4
Chitaldrug District	8
Hassan District	7
Kadur District	5
Shimoga District	2
Bangalore City	27
Mysore City	4
Kolar Gold Fields	5
Civil and Military Station, Bangalore ...	13

total population, of whom 6 are actual workers and the rest dependants.

Their percentage distribution by districts and cities is given in the margin. Among the districts the percentage is highest in Bangalore (12) and least in Shimoga (2); while among cities, the Bangalore City contains the largest percentage of 27 and Mysore City the least (4).

**Post office,
etc.,
services
Order 23.
Trade:
sub-class
v.**

277. Six per 10,000 of the total population are supported by this order, 2, of whom are actual workers. Viewed by districts, their proportion is highest in the Mysore District (12 per cent) and least in the Hassan and Tumkur Districts (7 per cent in each). Among cities, Civil and Military Station, Bangalore, has the largest proportion of 20 per cent, and Kolar Gold Fields least (1 per cent).

278. This sub-class comes next to sub-class III—Industrial Occupation, in

Order No.	Occupation	Number supported per 10,000 of population
	Trade	406
24	Banks, establishments of credit, exchange and insurance	12
25	Brokerage, commission and export	3
26	Trade in textiles	40
27	Trade in skins, leather and furs	8
28	Trade in wood	5
29	Trade in metals	2
30	Trade in pottery	1
31	Trade in chemical products	3
32	Hotels, cafés, restaurants, etc.	20
33	Other trade in food stuffs	225
34	Trade in clothing and toilet articles	7
35	Trade in furniture	4
36	Trade in building materials	7
37	Trade in means of transport	2
38	Trade in fuel	12
39	Trade in articles of luxury and those pertaining to letters and the arts and sciences	16
40	Trade in refuse matter
41	Trade of other sorts	39

the order of numerical strength as well as in importance, the number supported by it being 236,104 or 406 per 10,000 of the total population. They are spread over 18 orders of the Occupation Scheme as shown in the marginal statement, which shows that trade in food-stuffs (Orders 32 and 33) supports 245 per 10,000. This is followed by trade in textiles (40), trade in articles of luxury, etc. (16), trade in fuel (12) and exchange trades (12). The remaining orders all put together count 81 per 10,000.

From Subsidiary Table VI, it will be seen that the number of female workers per 1,000 males is

419—a fact which indicates that among the trading classes, the females assist the males largely as actual workers and substantially add to the earnings of the family.

The distribution by districts of the trading population is given in the marginal map. It will be seen from it that Bangalore District has the highest milleage of 65.

MAP OF MYSORE.

Showing the milleage distribution of the trading population in the several districts.

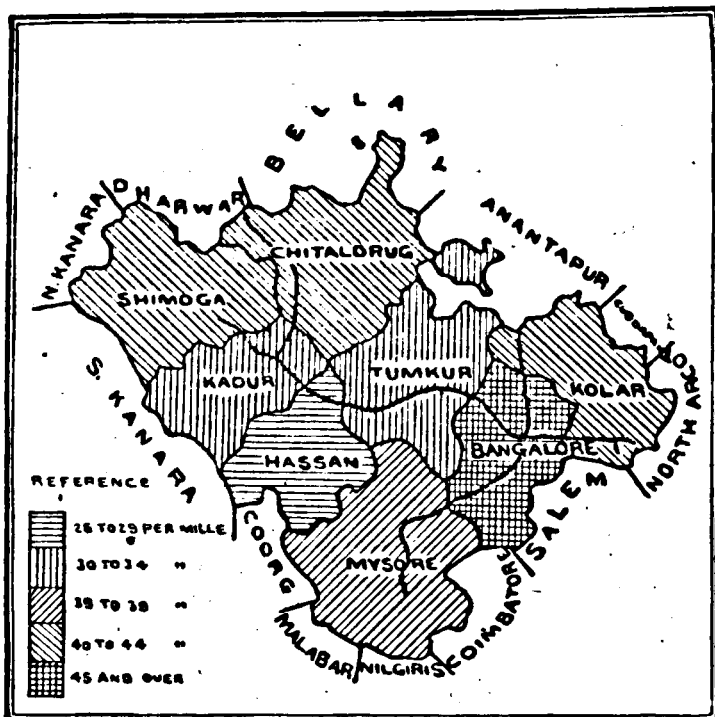

Next come in order, the districts of Kolar, Chitaldrug and Shimoga with milleages of 41, 41 and 40 respectively. These are followed by Mysore District (36), Tumkur (34) and Kadur (33). Hassan District is the least commercial, the trading population in it being 25 per mille. The high milleage in the Bangalore District is due to the inclusion in it of Bangalore City and Civil and Military Station, Bangalore, which are the chief trading centres in the Province.

279. In 1901 there were 278,772 persons or 50 per mille returned under trade as against 236,104 or 41 per mille in 1911. In 1901 the distinction between "makers" and "sellers" was not uniformly kept up. But on the present occasion, this distinction between a *maker* and a *seller* has been clearly kept up. Persons who *make* are in all cases classed under "Industry" whether they sell the articles to middlemen or direct to the consumer, while persons who *sell* only and do not *make* are classed under "Trade." This distinction accounts for the variations in some of the groups included under trade. For instance, in villages, the potter sells the articles he makes, the fisherman deals in the fish he catches and the blacksmith trades in the articles he prepares. These are brought under industry, while those only who are engaged exclusively in selling are classed as traders.

280. The total number supported by this sub-class in the Province is 71,729 or 12 per mille of the total population. Their distribution by principal orders of the Occupation scheme is noted in the margin. In every 100 persons supported by this sub-class, 39 are actual workers and the rest dependants; and again, the distribution of actual workers by cities and rural areas gives 31 per cent for the former and 69 per cent for the latter. Viewed by Natural Divisions, the Eastern Division contains a milleage of 12, while in the Western Division it is 7. The high milleage in the Eastern Division is due to the inclusion in it of the four cities, and more particularly of the Civil and Military Station, Bangalore, which contains a large proportion of this population.

Order No.	Occupation	Number supported per 1,000 of total population
42	Army ...	4
44	Police ...	8

281. A comparison of the statistics of 1911 with those of 1901 as given in Subsidiary Table VII shows that there is a net increase of 102.6 per cent, under sub-class VI—Public force. Under "Army—Native States" the increase is 585,350 per cent while under "Police" it is 2,962 per cent. The fluctuations are due to the regrouping of the figures of 1901 according to the new system of classification on the present occasion.

282. The number of persons in the Province supported by this sub-class is 132,867 or 2.29 per 10,000. They consist of persons employed in the service of

Public force: sub-class vi. Orders 42 to 44.

Public administration: sub-class vii.

the State as well as in the Municipal, Muzrai, Palace and other Local Service (not village service), and include all village officials other than the village watchmen. Among them 55 in every 10,000 are actual workers. Their general distribution by districts and cities is shown in the marginally noted statement. It will appear

District and City	Number supported per 10,000 of total population
Bangalore City	13
Bangalore District	30
Kolar Gold Fields	37
Kolar District	25
Tumkur District	14
Mysore City	31
Mysore District	19
Chitaldrug District	31
Hassan District	9
Kadur District	15
Shimoga District	5
Civil and Military Station, Bangalore	229
Total	229

from it that in every 10,000 persons in the Province, Kolar District has the highest proportion of (37). Among cities, Mysore takes the lead with a proportion of (14) and next to it comes Bangalore (13). The high proportion in Mysore is due to the presence in it of a large number of Palace servants, while the location in the Bangalore City of the Principal Public Offices of

the State accounts for the large proportion noticed there.

Variation in 1901-11. 283. On the present occasion 132,867 or 23 per mille have returned themselves under this sub-class as against 174,181 or 31 per mille in 1901.

Professions and liberal arts: sub-class viii. 284. All persons supported by the five orders of (a) Religion, (b) Law, (c) Medicine, (d) Instruction and (e) Letters, Arts and Sciences have been included in this sub-class. They are spread over groups 148 to 160 of the Occupation scheme. The total number supported is 81,077 or 140 per 10,000. Their distribution among the several orders is given in the marginal statement. Among them 45 in every 10,000 are workers and the rest dependants. Of the 45 actual workers,

Order No.	Occupation	Number supported per 10,000 of total population
46	Religion	60
47	Law	5
48	Medicine	13
49	Instruction	38
50	Letters, Arts and Sciences...	24
	Total	140

19 follow Religion, 1 Law, 4 Medicine, 14 Instruction and 7 Letters, Arts and Sciences. Among the workers, the proportion of female to 1,000 males is 118 (Subsidiary Table VI); and viewed by orders, the proportion per 1,000 is 94 under Religion, 325 in Medicine, 765 in Midwifery, etc., 104 under Instruction, 131 in Letters, Arts and Sciences and 282 under Music, etc. The percentage distribution by districts and cities is given in the marginally noted statement. Mysore District has the highest percentage of 14, Bangalore and Kolar come next in the order of numerical

District and City	Percentage distribution
Bangalore City	8
Bangalore District	11
Kolar Gold Fields	1
Kolar District	11
Tumkur District	10
Mysore City	9
Mysore District	14
Chitaldrug District	7
Hassan District	9
Kadur District	5
Shimoga District	8
Civil and Military Station, Bangalore	7
Total	100

strength. Kadur District has the least percentage of 5. Among the cities, Mysore has the largest percentage of 9; Bangalore City comes next (8) and Kolar Gold Fields (City) has the least (1).

Variation in 1901-11. 285. The number supported by this sub-class is 81,077 in 1911, as against 77,179 in 1901. The increase is but slight (5.1 per cent) and is commensurate with the general growth of population noticed in Chapter I.

Persons living on their income: sub-class ix. 286. On the present occasion 20,935 persons have returned themselves under this sub-class as against almost the same number in 1901, *viz.*, 20,943. It comprises all kinds of proprietors (other than of agricultural land), fund and scholarship holders and pensioners. Twelve are actual workers among them in every 10,000 of the total population; and the number of female actual workers per 1,000 males is 376.

Their milleage distribution gives 63 for Civil and Military Station, Bangalore, 34 to Mysore City, 31 to Bangalore City and 2 to Kolar Gold Fields. In the

districts, it is 3 in Kolar; Bangalore, Tumkur, Shimoga and Hassan have 2 each; and in each of the districts of Mysore, Chitaldrug and Kadur it is 1.

287. The number returning *domestic service* as their occupation is 38,308. Domestic

City and District	Number per mille
Civil and Military Station, Bangalore	150
Kolar Gold Fields	61
Mysore City	41
Bangalore City	39
Kolar District	2
Bangalore District	2
Shimoga District	4
Hassan District	2
Tumkur District	2
Mysore District	2
Chitaldrug District	1
Kadur District	6

They include cooks, water-carriers, private grooms, coachmen, etc., who find employment in domestic service for their principal means of subsistence. They form 66 per 10,000 of the total population, 35 of whom are actual workers; the number of female workers per 1,000 males is 453. Their distribution per mille of population in cities and districts is given in the margin. The proportion is highest in Civil and Military Station, Bangalore, it being also high in the

other cities. Thus it will be seen that this occupation is essentially urban in its nature, the persons supported by it finding it easy to get employment as either coachmen, stable boys or cooks in towns and cities.

288. From Subsidiary Table VII it will be seen that there is a decrease of 58.3 per cent in this sub-class in the period under review due to the system of classification on the present occasion.

289. All persons who returned their occupations in general terms which did

District and City	Number per 1,000 of population
Bangalore City	132
Bangalore District	59
Kolar Gold Fields	38
Kolar District	57
Tumkur District	55
Mysore City	66
Mysore District	66
Chitaldrug District	63
Hassan District	58
Kadur District	132
Shimoga District	93
Civil and Military Station, Bangalore	62
Mysore Province	60

not indicate a definite occupation have been included in this sub-class, and such persons number 400,349, forming 69 per 1,000 of the total population. The marginal statement gives their milage distribution by districts and cities. The proportions are highest in the Kadur District and in the Bangalore City, being 132 and 130 respectively. Kolar Gold Fields has the least proportion of 38 per mille.

As compared with the figures of 1901, there is a decrease of 17.2 per cent in 1911. The decrease, which is partly

due to adjustment of the figures of 1901 reflects the extent to which instructions regarding the return of occupations were understood by the people and by the enumerators. The number of female workers per 1,000 males in this sub-class is 1,044.

290. In this sub-class are included the inmates of jails, asylums and hospitals, and beggars, etc. They number in all 51,965 or 89 per 10,000 of the total population. Taking them by orders, it will be found that 2 in every 10,000 are inmates of Jails, etc., while the remaining 87 subsist either as beggars and vagrants or as prostitutes.

291. The total number of inmates of jails, etc., in the Province is 1,434 and

Bangalore City	67
Bangalore District	...
Kolar Gold Fields	...
Kolar District	1
Tumkur District	2
Mysore City	16
Mysore District	...
Chitaldrug District	5
Hassan District	1
Kadur District	1
Shimoga District	2
Civil and Military Station, Bangalore	5
Total	100

their percentage distribution among cities and districts is shown in the margin. The highest percentage is in the Bangalore City which contains 67, due to the location in it of the Bangalore Central Jail, where all the long-term convicts are confined. Next to Bangalore comes Mysore City with a percentage of 16. Chitaldrug and Shimoga also show a small percentage of 5 in each, due to the presence of a number of under-trial prisoners and convicts in the district headquarters where the Sessions Court holds its sittings once a quarter and in which persons charged with heinous criminal offences take their trial.

In this connection, it is necessary to say a few words about the convict population of the Central Jail of Bangalore. In this jail, several industrial works are undertaken by Government, principally those relating to carpet manufacture, weaving of cotton and wool, rope-making, carpentry, wood-carving, etc., and the

prisoners who before their conviction were following one or other of these occupations are employed on these works. There were in the Bangalore Central Jail 223 convicts thus employed on the date of the Census. Of these, 127 were skilled workmen, 119 being males and the rest females. The unskilled convict labourers numbered 96, all of whom were males over 14 years of age.

**Beggars,
vagrants
and
prosti-
tutes
Order 55.**

292. This order comprises beggars, vagrants, prostitutes, etc., who make up the bulk of the proletariat class in the Province. They are most often houseless and penniless, and are obviously driven to seek their livelihood either by begging or by other means. They are chiefly found in large numbers at annual fairs or

District and City	Number per cent
Bangalore City	2
Bangalore District	14
Kolar Gold Fields	18
Kolar District	18
Tumkur District	14
Mysore City	3
Mysore District	11
Chitaldrug District	19
Haasan District	6
Kadur District	4
Shimoga District	13
Civil and Military Station, Bangalore	2
Total	100

jatras, seeking public charity for subsistence. They number in all 50,531 or 87 per 10,000; and are distributed among cities and districts as shown in the margin. The largest proportion is in the Kolar District, and this is accounted for by the Sri Ramalingeswaraswami Jatra at Avani in the Mulbagal Taluk, lasting from 28th February to 12th March, and the Bhoga Nandeswaraswami Jatra and cattle show at Nandi in the Chikballapur Taluk, lasting from 27th February to

8th March. At each of these annual festivals more than 20,000 persons assemble, attracting a large number of beggars. In Bangalore and Tumkur Districts the proportions are also high and are due to the same cause. It may be remarked here that in some parts of the State, particularly in Chitaldrug District, a peculiar custom obtains among certain castes, of dedicating the eldest-born daughter for the service of the goddess of the place as *Basavi* (*vide* Chapters VII & XI). This has, however, begun to disappear under the influence of education, as from Census figures it will be seen that the proletariat population which in 1901 formed 17 per mille has considerably declined at the present Census, being only 9 per mille.

Taking the whole sub-class, it will be seen that in the period under review there is an increase of 108·1 per cent in the jail population, while beggars and prostitutes have decreased by 45·6 per cent.

**A retros-
pect.**

293. In the foregoing paragraphs the occupation statistics have been discussed in their various aspects. We have shown how agriculture dominates over all other occupations, forming a little over 73 per cent, and how indigenous handicrafts have come to be affected by the introduction of the power-driven machinery. During the decade under review, manual labour has been largely displaced by the labour-saving appliances, and a perceptible progress has been made in agriculture and industry as already reviewed in paragraphs 38 to 49 of Chapter II. Though there is an increase in the occupied area during the decade 1901-11, there has been no appreciable fall in the prices of staple food-grains which remain almost the same as in the previous decennium. This is chiefly due to the surplus produce finding a ready market outside the State by means of rail-borne trade.

The most satisfactory feature in the present industrial condition of the people of the Province is the impulse which is noticed in the attraction of capital for the formation of several Joint Stock Companies and Co-operative Societies for promoting scientific agriculture, trade and other industries.

PART IV.—OCCUPATION BY CASTE.

**Review of
occupa-
tions by
castes.**

294. We will close this chapter with a brief review of the occupation statistics by caste. These are contained in Table XVI, and their salient features have been brought out in Subsidiary Table VIII. It is therefore unnecessary to enter into a detailed discussion of them here. It will be enough to examine how some castes have adhered tenaciously to their traditional occupations and how others have seceded from them and taken to other calls in life for their principal means of subsistence.

The different castes in the Province, as in other parts of India, have each a distinctive occupation of its own which finds its origin in the religious scriptures and has been fostered by long usage. Originally, Brahmans were the priests; Kshatriyas were the dominant military class and rulers of the country; Vaisyas or Komatis were engaged exclusively in trade; and Sudras comprising most of the artisan castes were the servants of the above three classes. As admitted on all hands, these different classes indicate the conditions of an old order of things when people had to defend their country against their foreign enemies and to depend on their own resources. In course of time, sub-divisions of these original castes were made, and many new ones came into existence.

The limitations imposed by caste rules on occupation have now lost much of their rigour and a person can follow whatever occupation he might choose as his principal means of livelihood consistent with his convenience and adaptability.

From Table XVI, it will be seen that the Vakkaligas are faithful to their traditional occupation as cultivators, no less than 80 per cent of actual workers clinging to agriculture. Of the remaining 20, 9 follow other non-agricultural pursuits included in sub-class I, 1 has taken to mining and industry, 2 are engaged in transport or trade, 1 is in the service of the State and 7 follow other occupations. Next to them come Tigalas in their adherence to cultivation. 67 in 100 persons are cultivators, 9 traders, 6 non-agriculturists, 5 are engaged in mining and industry, 2 are in public service and the rest follow other pursuits. Of the priestly class of Brahmans, 48 per cent depend on agriculture, 30 are employed in public service and only 6 are priests. Among Komatis (Vaisyas) 56 per cent are traders, 10 per cent follow agriculture and the rest have taken to other callings. In every 100 Kshatriyas 6 follow their traditional occupation; and of the rest 48 are cultivators, 15 follow mining and other industries, 10 are engaged in transport and trade, 9 are in the public service of the State constituting the public force and public administration and 12 have taken to other pursuits. Among Kumbaras, 51 per cent are potters, 38 follow agriculture and the rest other occupations. In the Agasa or washerman caste 46 per cent are washermen, another 46 per cent cultivators, and the remaining 8 are engaged either in trade, industry or other business. The traditional occupation has almost disappeared among Bestas, Gollas and Upparas, not more than 2 per cent in each following it. Of the rest, many castes have taken to agriculture while a few others pursue other calls in life. The Beda caste has almost completely given up its time-honoured occupation of hunting, most of the Bedas having taken to agriculture.

Turning to non-Hindu tribes and races, we see from a reference to Subsidiary Table VIII, that among Musalmans, Pathans are most agricultural and Saiyids the least, the number per 1,000 workers engaged in cultivation being 335 and 295 respectively. The Musalmans figure largely as traders and general labourers also. In every 1,000, 71 among Pathans, 49 among Saiyids and 47 among Sheikhs are in the public force.

Among European Christians, 569 in every 1,000 are in the State service constituting the public force, 128 are engaged in the extraction of minerals and 102 follow arts and professions. Of the 1,000 workers among Anglo-Indian Christians, 227 are employed in the extraction of minerals, 144 in transport, and the rest follow other occupations. Among the Indian Christians, 192 in 1,000 are in the domestic service, other occupations also evenly engaging them.

Among the Animists, 427 in 1,000 are cultivators, 390 labourers, 102 follow trade and the rest 81 have taken to other pursuits.

295. It would appear, further, that in Civil and Military Station, Bangalore, where alone the Income Tax Act of 1886 is in force within the territories of Mysore, there were 333 persons assessed to such tax during 1910-11, of whom 215 were traders, 73 owners of property, 37 belonged to professions, 4 were manufacturers and the remaining 4 were returned under other occupations. On examining the figures by races or castes, it is found that the Europeans form 15 per cent, Jains 11 per cent, Kachi Memans 9 per cent, Labbais 9 per cent, Vellalas and Vaisyas 7 per cent, each, Sheikhs 5 per cent, Brahmans 4 per cent and Anglo-Indians 4 per cent, the other castes, all put together, claiming 29 per cent.

Persons assessed to Income Tax.
Part IV of the Income-Tax Act of 1886.

SUBSIDIARY TABLES.
I.—GENERAL DISTRIBUTION BY OCCUPATION.

Class, Sub-class and Order	Number per 10,000 of total population		Percentage in each Class, Sub-class and Order of		Percentage of actual workers employed		Percentage of dependants to actual workers	
	Persons supported	Actual workers	Actual workers	Dependants	In cities	In rural areas	In cities	In rural areas
1	2	3	4	5	6	7	8	9
Class A.—Production of raw materials ...	7,403	2,021	27	73	2	98	148	269
<i>Sub-class I.—Exploitation of the surface of the earth</i> ...	7,312	1,985	27	73	1	99	148	269
Order 1. Pasture and Agriculture ...	7,306	1,984	27	73	1	99	147	269
(a) Ordinary cultivation ...	7,165	1,895	26	74	1	99	165	279
(b) Growers of special products and market gardening ...	78	46	58	42	5	95	135	69
(c) Forestry ...	16	7	45	55	22	78	77	137
(d) Raising of farm stock ...	48	36	74	26	1	99	68	34
(e) Raising of small animals ...	1	...	39	61	2	98	175	159
" 2. Fishing and hunting ...	4	1	39	61	5	95	213	153
<i>Sub-class II.—Extraction of minerals</i> ...	91	36	40	60	73	27	148	157
Order 3. Mines ...	87	35	40	60	75	25	148	148
" 4. Quarries of hard rocks	71	29	...	100	...	40
" 5. Salt, etc. ...	4	1	31	69	...	100	...	228
Class B.—Preparation and supply of material substances ...	1,223	437	36	64	18	82	163	184
<i>Sub-class III.—Industrial occupation</i> ...	764	267	35	65	17	83	148	194
Order 6. Textiles ...	175	60	34	66	16	84	146	202
" 7. Hides, skins and hard materials from the animal kingdom ...	7	2	29	71	27	73	85	299
" 8. Wood ...	70	28	40	60	17	83	163	151
" 9. Metals ...	40	12	29	71	18	82	180	254
" 10. Ceramics ...	46	14	31	69	3	97	148	221
" 11. Chemical products properly so called, and analogous ...	12	4	31	69	10	90	183	226
" 12. Food industries ...	40	19	48	52	24	76	131	103
" 13. Industries of dress and the toilet ...	177	58	33	67	14	86	162	210
" 14. Furniture industries ...	1	...	38	62	31	69	212	143
" 15. Building industries ...	84	32	39	61	19	81	147	162
" 16. Construction of means of transport... ..	2	1	37	63	40	60	182	165
" 17. Production and transmission of physical forces (heat, light, electricity, motive power, etc.) ...	2	1	39	61	76	24	155	165
" 18. Industries of luxury and those pertaining to literature and the arts and sciences ...	92	26	30	70	14	86	188	235
" 19. Industries concerned with refuse matter ...	16	8	52	48	54	46	74	115
<i>Sub-class IV.—Transport</i> ...	53	21	39	61	35	65	194	132
Order 20. Transport by water ...	1	...	30	70	3	97	317	236
" 21. Transport by road ...	30	13	44	56	31	69	177	104
" 22. Transport by rail ...	16	6	34	66	45	55	218	182
" 23. Post Office, Telegraph and Telephone services. ...	6	2	34	66	32	68	213	190
<i>Sub-class V.—Trade</i> ...	406	149	37	63	18	82	182	172
Order 24. Banks, establishments of credit, exchange and insurance ...	12	4	30	70	26	74	210	235
" 25. Brokerage, commission and export ...	3	1	25	75	51	49	230	372
" 26. Trade in textiles ...	40	12	30	70	17	83	231	238
" 27. Trade in skins, leather and furs ...	8	3	33	67	18	82	224	203
" 28. Trade in wood ...	5	2	42	58	11	89	354	113
" 29. Trade in metals ...	2	1	28	72	45	55	261	259
" 30. Trade in pottery ...	1	...	42	58	5	95	125	137
" 31. Trade in chemical products ...	3	1	32	68	24	76	316	184
" 32. Hotels, cafés, restaurants, etc. ...	20	6	31	69	15	85	245	217
" 33. Other trade in food stuffs... ..	225	86	38	62	19	81	152	166
" 34. Trade in clothing and toilet articles... ..	7	2	31	69	28	72	338	178
" 35. Trade in furniture ...	4	1	35	65	27	73	222	170
" 36. Trade in building materials ...	7	2	32	68	8	92	173	212
" 37. Trade in means of transport ...	2	1	42	58	7	93	266	130
" 38. Trade in fuel ...	12	7	63	37	10	90	175	47
" 39. Trade in articles of luxury and those pertaining to letters and the arts and sciences ...	16	6	37	63	22	78	160	176
" 40. Trade in refuse matter	50	50	80	20	113	46
" 41. Trade of other sorts ...	39	14	35	65	12	88	243	174

I.—GENERAL DISTRIBUTION BY OCCUPATION—concl'd.

Class, Sub-class and Order	Number per 10,000 of total population		Percentage in each Class, Sub-class and Order of		Percentage of actual workers employed		Percentage of dependants to actual workers	
	Persons supported	Actual workers	Actual workers	Dependants	In cities	In rural areas	In cities	In rural areas
1	2	3	4	5	6	7	8	9
Class C.—Public administration and liberal arts ...	829	169	39	79	26	75	291	241
<i>Sub-class VI.—Public force</i> ...	194	46	39	61	31	69	136	167
Order 42. Army ...	36	17	45	55	71	29	118	138
" 43. Navy	50	50	100	...	100	...
" 44. Police ...	86	31	36	64	9	91	216	173
<i>Sub-class VII.—Public Administration</i> ...	229	55	24	76	17	63	250	332
Order 45. Public Administration ...	229	55	24	76	17	63	250	332
<i>Sub-class VIII.—Professions and liberal arts</i> ...	140	45	32	69	22	78	243	200
Order 46. Religion ...	60	19	32	68	11	89	235	206
" 47. Law ...	5	1	19	81	43	57	477	413
" 48. Medicine ...	13	4	31	69	42	58	225	230
" 49. Instruction ...	33	14	36	64	22	78	223	167
" 50. Letters and arts and sciences ...	24	7	30	70	37	63	250	225
<i>Sub-class IX.—Persons living on their income</i> ...	36	12	33	66	54	46	218	198
Order 51. Persons living principally on their income ...	36	12	33	66	54	46	218	198
Class D.—Miscellaneous ...	945	479	57	43	9	91	117	72
<i>Sub-class X.—Domestic service</i> ...	66	35	53	47	53	47	127	43
Order 52. Domestic service ...	66	35	53	47	53	47	127	43
<i>Sub-class XI.—Insufficiently described occupations</i> ...	690	398	57	43	5	95	124	73
Order 53. General terms which do not indicate a definite occupation ...	690	398	57	43	5	95	124	73
<i>Sub-class XII.—Unproductive</i> ...	69	51	57	43	10	90	43	78
Order 54. Inmates of jails, asylums and hospitals ...	2	2	100	...	86	14
" 55. Beggars, vagrants, prostitutes ...	67	49	56	44	6	94	63	79

II.—DISTRIBUTION BY OCCUPATION IN NATURAL DIVISIONS.

Occupation	Number per mille of total population supported in		Occupation	Number per mille total population supported in	
	Eastern Division	Western Division		Eastern Division	Western Division
1	2	3	1	2	3
Class A.—Production of raw materials ...	748	767	Order 10. Ceramics ...	6	6
<i>Sub-class I.—Exploitation of the surface of the earth</i> ...	736	768	" 11. Chemical products properly so called, and analogous ...	2	...
Order 1. Pasture and Agriculture ...	736	765	" 12. Food industries ...	3	...
(a) Ordinary cultivation ...	725	739	" 13. Industries of dress and the toilet ...	18	12
(b) Growers of special products and market gardening ...	4	20	" 14. Furniture industries
(c) Forestry ...	2	1	" 15. Building industries ...	9	5
(d) Raising of farm stock ...	5	5	" 16. Construction of means of transport
(e) Raising of small animals	" 17. Production and transmission of physical forces (heat, light, electricity, motive power, etc.)
" 2. Fishing and hunting	1	" 18. Industries of luxury and those pertaining to literature and the arts and sciences ...	9	9
<i>Sub-class II.—Extraction of minerals</i> ...	12	1	" 19. Industries concerned with refuse matter ...	1	1
Order 3. Mines ...	12	1	<i>Sub-class IV.—Transport</i> ...	6	4
" 4. Quarries of hard rocks	Order 20. Transport by water
" 5. Salt, etc.	" 21. Transport by road ...	3	2
Class B.—Preparation and supply of material substances ...	125	91	" 22. Transport by rail ...	2	1
<i>Sub-class III.—Industrial occupation</i> ...	60	55	Order 23. Post Office, Telegraph and Telephone services
Order 6. Textiles ...	21	6	<i>Sub-class V.—Trade</i> ...	40	32
" 7. Hides, skins and hard materials from the animal kingdom ...	1	...	Order 24. Banks, establishments of credit, exchange and insurance ...	1	1
" 8. Wood ...	7	7	" 25. Brokerage, commission and export...
" 9. Metals ...	4	4			

II.—DISTRIBUTION BY OCCUPATION IN NATURAL DIVISIONS—*concl'd.*

Occupation	Number per mille of total population supported in		Occupation	Number per mille of total population supported in		
	Eastern Division	Western Division		Eastern Division	Western Division	
1	2	3	1	2	3	
Order 26. Trade in textiles ...	4	2	<i>Sub-class VIII.—Professions and liberal arts</i>	13	13	
" 27. Trade in skins, leather and furs ...	1	1		Order 46. Religion ...	6	6
" 28. Trade in wood ...	1	...		" 47. Law ...	1	1
" 29. Trade in metals		" 48. Medicine ...	4	3
" 30. Trade in pottery		" 49. Instruction ...	2	3
" 31. Trade in chemical products		" 50. Letters and arts and sciences...	3	2
" 32. Hotels, cafés, restaurants, etc.	2	2		<i>Sub-class IX.—Persons living on their income</i>	3	2
" 33. Other trade in food stuffs ...	22	18		Order 51. Persons living principally on their income ...	3	2
" 34. Trade in clothing and toilet articles ...	1	1		Class D.—Miscellaneous ...	76	98
" 35. Trade in furniture		<i>Sub-class X.—Domestic service</i> ...	4	4
" 36. Trade in building materials ...	1	1		Order 52. Domestic service ...	4	4
" 37. Trade in means of transport ...	1	1		<i>Sub-class XI.—Insufficiently described occupations</i> ...	63	86
" 38. Trade in fuel		Order 53. General terms which do not indicate a definite occupation	63	86
" 39. Trade in articles of luxury and those pertaining to letters and the arts and sciences ...	2	1		<i>Sub-class XII.—Unproductive</i> ...	9	8
" 40. Trade in refuse matter	Order 54. Inmates of jails, asylums and hospitals	
" 41. Trade of other sorts ...	4	4	" 55. Beggars, vagrants, prostitutes	9	8	
Class C.—Public administration and liberal arts ...	51	44				
<i>Sub-class VI.—Public force</i> ...	12	7				
Order 42. Army ...	3	1				
" 43. Navy				
" 44. Police ...	9	6				
<i>Sub-class VII.—Public Administration</i> ...	23	22				
Order 45. Public Administration ...	23	22				

III.—DISTRIBUTION OF THE AGRICULTURAL, INDUSTRIAL, COMMERCIAL AND PROFESSIONAL POPULATION IN NATURAL DIVISIONS AND DISTRICTS.

District and Natural Division	Agriculture				Industry (including mines)				Commerce				Professions			
	Population supported by agriculture	Proportion of agricultural population per 1,000 of district population	Percentage on agricultural population of		Population supported by industry	Proportion of industrial population per 1,000 of district population	Percentage on industrial population of		Population supported by commerce	Proportion of commercial population per 1,000 of district population	Percentage on commercial population of		Population supported by profession	Proportion of professional population per 1,000 of district population	Percentage on professional population of	
			Actual workers	Dependants			Actual workers	Dependants			Actual workers	Dependants			Actual workers	Dependants
1	2	3	4	5	6	7	8	9	10	11	12	13	14	15	16	17
Mysore State, including Civil and Military Station, Bangalore ...	4,206,095	724	27	73	496,119	85	36	64	267,200	46	37	63	81,077	14	32	68
Mysore State, excluding Civil and Military Station, Bangalore ...	4,201,475	736	27	73	473,060	83	35	65	245,883	43	37	63	74,922	13	33	67
Eastern Division ...	3,111,801	729	25	75	393,455	92	34	66	193,726	45	36	64	56,503	13	32	68
Bangalore City ...	5,082	57	40	60	26,975	304	99	61	18,471	208	34	66	6,235	70	30	70
Bangalore District ...	578,424	762	24	76	52,574	69	31	69	34,376	45	35	65	8,762	12	32	68
Kolar Gold Fields City ...	196	4	57	43	41,204	847	41	59	1,060	22	47	53	436	9	37	63
Kolar District ...	533,206	729	20	80	65,723	90	32	68	34,603	47	33	67	8,733	12	29	71
Tumkur District ...	565,593	769	29	71	54,031	73	35	65	26,253	36	38	62	8,431	11	33	67
Mysore City ...	8,736	123	37	63	13,497	189	41	59	15,136	212	37	63	7,057	99	28	72
Mysore District ...	1,017,094	800	27	73	77,489	61	36	64	38,174	30	42	58	11,534	9	34	66
Chitaldrug District ...	403,470	715	22	78	61,962	110	30	70	25,653	45	31	69	5,315	9	34	66
Western Division ...	1,089,674	759	32	68	79,605	55	40	60	52,157	36	41	59	18,419	13	36	64
Hassan District ...	464,584	801	28	72	31,453	54	35	65	15,964	28	37	63	7,437	13	32	68
Kadur District ...	242,754	717	36	64	18,585	55	46	54	13,519	40	46	54	4,145	12	39	61
Shimoga District ...	382,336	740	34	66	29,567	57	43	57	22,674	44	41	59	6,837	13	38	62
Civil and Military Station, Bangalore ...	4,620	46	40	60	23,059	229	40	60	21,317	211	34	66	6,155	61	29	71

IV.—OCCUPATIONS COMBINED WITH AGRICULTURE (WHERE AGRICULTURE IS THE SUBSIDIARY OCCUPATION).

Occupation	Number per mille who are partially agriculturists			
	Mysore State, including Civil and Military Station, Bangalore	Mysore State, excluding Civil and Military Station, Bangalore	Eastern Division	Western Division
1	2	3	4	5
Class A.—Production of raw materials	2	2	2	1
<i>Sub-class I.—Exploitation of the surface of the earth</i>	—	—	1	1
Order 1. Pasture and agriculture	1	1	1	1
(a) Ordinary cultivation	—	—	—	—
(b) Growers of special products and market gardening	19	19	54	11
(c) Forestry	51	59	50	100
(d) Raising of farm stock	14	14	15	94
(e) Raising of small animals	46	47	47	—
" 2. Fishing and hunting	98	99	126	58
<i>Sub-class II.—Extraction of minerals</i>	59	59	60	25
Order 3. Mines	55	55	55	2
" 4. Quarries of hard rocks	—	—	—	—
" 5. Salt, etc.	186	186	177	379
Class B.—Preparation and supply of material substances	108	113	113	113
<i>Sub-class III.—Industrial occupation</i>	125	132	131	136
Order 6. Textiles	99	99	90	173
" 7. Hides, skins and hard materials from the animal kingdom	67	116	125	60
" 8. Wood	95	99	109	91
" 9. Metals	150	160	153	179
" 10. Ceramics	202	208	212	176
" 11. Chemical products properly so called, and analogous... ..	262	290	291	260
" 12. Food industries	28	41	33	56
" 13. Industries of dress and the toilet	161	174	173	177
" 14. Furniture industries	87	87	41	—
" 15. Building industries	95	104	116	59
" 16. Construction of means of transport	143	197	215	129
" 17. Production and transmission of physical forces (heat, light, electricity, motive power, etc.)	13	19	19	—
" 18. Industries of luxury and those pertaining to literature and the arts and sciences	198	202	196	216
" 19. Industries concerned with refuse matters... ..	13	17	16	25
<i>Sub-class IV.—Transport</i>	57	65	66	61
Order 20. Transport by water	170	173	168	167
" 21. Transport by road	42	47	51	37
" 22. Transport by rail	64	72	69	65
" 23. Post Office, Telegraph and Telephone services	123	147	131	167
<i>Sub-class V.—Trade</i>	81	86	88	81
Order 24. Banks, establishments of credit, exchange and insurance	153	173	171	178
" 25. Brokerage, commission and export	65	90	78	126
" 26. Trade in textiles	109	115	114	119
" 27. Trade in skins, leather and furs	56	65	65	65
" 28. Trade in wood	53	56	52	105
" 29. Trade in metals	109	130	135	106
" 30. Trade in pottery	137	144	178	61
" 31. Trade in chemical products	71	78	77	88
" 32. Hotels, cafés, restaurants, etc.	65	69	101	54
" 33. Other trade in food stuffs	76	61	62	79
" 34. Trade in clothing and toilet articles	96	101	109	91
" 35. Trade in furniture	114	140	135	150
" 36. Trade in building materials	118	118	134	46
" 37. Trade in means of transport	39	40	47	22
" 38. Trade in fuel	22	23	27	10
" 39. Trade in articles of luxury and those pertaining to letters and the arts and sciences	94	100	109	66
" 40. Trade in refuse matter	30	154	—	233
" 41. Trade of other sorts	90	93	94	91
Class C.—Public administration and liberal arts	256	277	212	266
<i>Sub-class VI.—Public force</i>	145	152	156	137
Order 42. Army	98	64	66	51
" 43. Navy	—	—	—	—
" 44. Police	171	174	168	146

IV.—OCCUPATIONS COMBINED WITH AGRICULTURE (WHERE AGRICULTURE IS THE
SUBSIDIARY OCCUPATION)—*concl'd.*

Occupation	Number per mille who are partially agriculturists			
	Mysore State, including Civil and Military Station, Ban- galore	Mysore State, excluding Civil and Military Station, Ban- galore	Eastern Division	Western Division
1	2	3	4	5
<i>Sub-class VII.—Public Administration</i>	437	448	428	506
Order 45. Public Administration	437	448	428	506
<i>Sub-class VIII.—Professions and liberal arts</i>	187	199	192	218
Order 46. Religion	252	258	263	267
„ 47. Law	279	295	266	425
„ 48. Medicine	60	70	67	81
„ 49. Instruction	153	162	156	183
„ 50. Letters and arts and sciences	136	154	133	212
<i>Sub-class IX.—Persons living on their income</i>	114	155	153	170
Order 51. Persons living principally on their income	114	155	153	170
<i>Class D.—Miscellaneous</i>	10	11	10	11
<i>Sub-class X.—Domestic service</i>	12	16	18	13
Order 52. Domestic service	12	16	18	13
<i>Sub-class XI.—Insufficiently described occupations</i>	8	9	9	8
Order 53. General terms which do not indicate a definite occupation	8	9	9	8
<i>Sub-class XII.—Unproductive</i>	23	24	16	51
Order 54. Inmates of jails, asylums and hospitals
„ 55. Beggars, vagrants, prostitutes	24	25	17	51

V.—OCCUPATIONS COMBINED WITH AGRICULTURE (WHERE AGRICULTURE IS THE
PRINCIPAL OCCUPATION).

Land lords. (Rent receivers.)		Cultivators. (Rent payers.)		Farm servants and field labourers	
Subsidiary occupation	Number per 10,000 who follow it	Subsidiary occupation	Number per 10,000 who follow it	Subsidiary occupation	Number per 10,000 who follow it
1	2	3	4	5	6
Total ...	10,000	Total ...	10,000	Total ...	10,000
Rent payers	110	Rent receivers	67	Rent receivers	965
Agricultural labourers	174	Agricultural labourers	196	Rent payers	1,084
Government employes of all kinds	1,841	General labourers	1,020	General labourers	2,005
Money lenders and grain dealers	873	Government employes of all kinds	908	Village watchmen	1,350
Other traders of all kinds	1,534	Money lenders and grain dealers... ..	427	Cattle breeders and milkmen	156
Priests	924	Other traders of all kinds	1,906	Mill hands	11
Clerks of all kinds (not Government)	89	Fishermen and boatmen	19	Fishermen and boatmen	18
Schoolmasters... ..	206	Cattle breeders and milkmen	67	Rice pounders	170
Lawyers	10	Village watchmen	1,107	Shopkeepers and pedlars	312
Estate agents and managers	12	Weavers	659	Oil-pressers	3
Medical practitioners	70	Barbers	225	Weavers	258
Artisans (weavers, carpenters, pot- ters, etc.)	699	Oil-pressers	100	Potters	88
		Washermen	461	Leather workers... ..	858
		Potters	197	Washermen	216
		Blacksmiths and carpenters	316	Blacksmiths and carpenters	117
Other occupations	3,458	Other occupations	2,925	Other occupations	3,489

VI.—OCCUPATIONS OF FEMALES BY SUB-CLASSES, AND SELECTED ORDERS AND GROUPS.

Group No.	Occupation	Number of actual workers		Number of females per 1,000 males
		Males	Females	
1	2	3	4	5
	Class A.—Production of raw materials	1,021,469	132,180	149
	<i>Sub-class I.—Exploitation of the surface of the earth...</i>	1,001,581	150,921	151
	Order 1. Pasture and agriculture	1,000,830	150,809	151
	(a) Ordinary cultivation	963,004	137,261	143
1	Income from rent of agricultural land	84,295	20,718	604
2	Ordinary cultivators... ..	845,056	82,855	98
4	Farm servants and field labourers	63,532	63,687	403
	(b) Growers of special products and market gardening	18,084	8,354	463
5	Tea, coffee, cinchona and indigo plantations	11,923	7,158	600
6	Fruit, flower, vegetable, betel, vana, arecanut, etc., growers	6,161	7,206	196
	(c) Forestry	2,516	1,543	613
8	Wood-cutters; firewood, lac, catechu, rubber, etc., collectors and charcoal burners... ..	1,169	1,543	1,320
	(d) Raising of farm stock	17,056	3,615	213
12	Herdsmen, shepherds, goatherds, etc.	16,181	3,447	214
	(e) Raising of small animals	170	26	153
13	Birds, bees, silkworms, etc.	170	26	153
	3. Fishing and hunting	751	112	149
	<i>Sub-class II.—Extraction of minerals</i>	19,898	1,259	63
	Order 3. Mines	19,313	1,163	60
16	Coalmines and petroleum wells
	5. Salt, etc.	569	58	146
20	Extraction of saltpetre, alum and other substances soluble in water
	Class B.—Preparation and supply of material substances	199,228	54,416	273
	<i>Sub-class III.—Industrial occupation</i>	126,543	28,469	225
	Order 6. Textiles	29,461	5,094	173
21	Cotton ginning, cleaning and pressing	47	9	191
22	Cotton spinning, sizing and weaving	11,750	1,563	183
24	Rope, twines and string	323	159	492
25	Other fibres (cocoanut, aloes, flax, hemp, straw, etc.)	57
26	Wool carders and spinners, weavers of woollen blankets, carpets, etc.	4,565	947	207
27	Silk spinners and weavers	639	637	993
	7. Hides, skins and hard materials from the animal kingdom	922	195	197
	8. Wood	13,455	2,627	195
37	Basket makers and other industries of woody material, including leaves	3,411	2,469	721
	9. Metals	6,822	221	33
	10. Ceramics	6,686	1,639	245
47	Potters and earthen pipe and bowl makers	6,624	1,829	246
	11. Chemical products properly so called, and analogous	1,662	26	207
	12. Food industries	4,938	6,102	1,223
56	Rice pounders and huskers and flour grinders... ..	716	5,757	6,018
59	Grain parchers, etc.	57	24	596
63	Sweetmeat makers, preparers of jam and condiments, etc.	70	54	629
65	Toddy drawers	2,257	53	23
	13. Industries of dress and the toilet	27,662	6,126	221
68	Tailors, milliners, dress makers and darners, embroiderers on linen	4,699	1,732	373
71	Washing, cleaning and dyeing	11,056	2,839	247
73	Other industries connected with the toilet (tattooers, shampooers, bath houses, etc.)	6	107	21,400
	14. Furniture industries	123	12	36
	15. Building industries	15,228	2,569	234

VI.—OCCUPATIONS OF FEMALES BY SUB-CLASSES, AND SELECTED ORDERS AND GROUPS—*contd.*

Group No.	Occupation	Number of actual workers		Number of females per 1,000 males
		Males	Females	
1	2	3	4	5
	Order 16. Construction of means of transport	395	4	10
	„ 17. Production and transmission of physical forces (heat, light, electricity, motive power, etc.)	497	1	2
	„ 18. Industries of luxury and those pertaining to literature and the arts and sciences	15,831	476	30
90	„ Makers of bangles, rosaries, bead and other necklaces, spangles, lingams and sacred threads	30	29	967
	„ 19. Industries concerned with refuse matter	2,740	2,017	736
93	„ Sweepers, scavengers, dust and sweeping contractors	2,740	2,017	736
	<i>Sub-class IV.—Transport</i>	11,833	432	37
	Order 20. Transport by water	165	11	67
	„ 21. Transport by road	7,363	383	52
98	„ Persons employed on the construction and maintenance of roads and bridges	1,069	329	308
	„ 22. Transport by rail	3,114	34	11
104	„ Labourers employed on railway construction	273	34	125
	„ 23. Post Office, Telegraph and Telephone services	1,191	4	3
	<i>Sub-class V.—Trade</i>	60,852	25,515	419
	Order 24. Banks, establishments of credit, exchange and insurance	1,759	441	251
	„ 25. Brokerage, commission and export	411	14	34
	„ 26. Trade in textiles	6,540	311	48
	„ 27. Trade in skins, leather and furs	1,470	59	40
	„ 28. Trade in wood	552	537	973
	„ 29. Trade in metals	277	8	29
	„ 30. Trade in pottery	169	64	379
112	„ Trade in pottery	169	64	379
	„ 31. Trade in chemical products	466	119	245
	„ 32. Hotels, cafés, restaurants, etc.	3,125	492	157
114	„ Vendors of wine, liquors and aerated waters	2,728	358	131
	„ 33. Other trade in food stuffs	32,284	17,317	536
116	„ Fish dealers	322	110	342
117	„ Grocers and sellers of vegetable oil, salt and other condiments	16,194	4,507	278
118	„ Sellers of milk, butter, ghee, poultry, eggs, etc.	1,276	2,955	2,316
119	„ Sellers of sweetmeats, sugar, gur and molasses	1,123	1,151	1,025
120	„ Cardamom, betel-leaf, vegetables, fruit and arecanut sellers	5,903	5,167	875
121	„ Grain and pulse dealers	5,433	1,019	188
122	„ Tobacco, opium, ganja, etc., sellers	1,327	228	172
124	„ Dealers in hay, grass and fodder	233	2,143	9,197
	„ 34. Trade in clothing and toilet articles	1,053	126	120
	„ 35. Trade in furniture	807	43	53
	„ 36. Trade in building materials	894	478	535
	„ 37. Trade in means of transport	576	15	26
	„ 38. Trade in fuel	1,254	3,058	2,439
130	„ Dealers in firewood, charcoal, coal, cowdung, etc.	1,254	3,058	2,439
	„ 39. Trade in articles of luxury and those pertaining to letters and the arts and sciences	2,577	917	356
	„ 40. Trade in refuse matter	27	39	1,444
	„ 41. Trade of other sorts	6,591	1,477	224
136	„ Itinerant traders, pedlars, hawkers, etc.	203	144	709
137	„ Conjurers, acrobats, fortune tellers, reciters, exhibitors of curiosities and wild animals	639	135	211

SUBSIDIARY TABLES.

213

VL.—OCCUPATIONS OF FEMALES BY SUB-CLASSES, AND SELECTED ORDERS AND GROUPS.—concl'd.

Group No.	Occupation	Number of actual workers		Number of females per 1,000 males
		Males	Females	
1	2	3	4	5
	Class C.—Public administration and liberal arts	86,144	6,460	75
	<i>Sub-class VI.—Public force</i>	27,262	596	21
	Order 42. Army	9,899
	" 43. Navy	4
	" 44. Police	17,359	586	34
	<i>Sub-class VII.—Public Administration</i>	30,524	1,251	41
	Order 45. Public Administration	30,524	1,251	41
	<i>Sub-class VIII.—Professions and liberal arts</i>	23,430	2,771	118
	Order 46. Religion	10,254	968	94
	" 47. Law	513
	" 48. Medicine	1,753	570	325
155	Midwives, vaccinators, compounders, nurses, masseurs, etc.	591	452	765
	" 49. Instruction	7,146	740	104
	Order 50. Letters and arts and sciences	3,764	493	131
160	Music composers and masters, players on all kinds of musical instruments (not military), singers, actors and dancers	1,636	461	282
	<i>Sub-class IX.—Persons living on their income</i>	4,928	1,862	376
	Order 51. Persons living principally on their income	4,928	1,862	376
	Class D.—Miscellaneous	141,575	136,384	963
	<i>Sub-class X.—Domestic service</i>	14,078	6,382	453
	Order 52. Domestic service	14,078	6,382	453
162	Cooks, water carriers, doorkeepers, watchmen and other indoor servants	11,879	6,382	537
	<i>Sub-class XI.—Insufficiently described occupations</i>	111,445	116,381	1,044
	Order 53. General terms which do not indicate a definite occupation	111,445	116,381	1,044
167	Labourers and workmen otherwise unspecified	107,976	116,123	1,075
	<i>Sub-class XII.—Unproductive</i>	16,052	13,621	849
	Order 54. Inmates of jails, asylums and hospitals	1,237	197	159
	" 55. Beggars, vagrants, prostitutes	14,815	13,424	906
169	Beggars, vagrants, procurers, prostitutes, receivers of stolen goods, cattle poisoners	14,815	13,424	906

VII.—SELECTED OCCUPATIONS, 1911 AND 1901.

Group No.	Occupation	Population supported in 1911	Population supported in 1901,	Percentage of variation
1	2	3	4	5
	Class A.—Production of raw materials	4,298,631	3,761,041	+14.3
	<i>Sub-class I.—Exploitation of the surface of the earth...</i>	4,245,644	3,746,683	+13.3
	Order 1. Pasture and agriculture	4,243,435	3,743,813	+13.3
	(a) Ordinary cultivation	4,160,550	3,579,101	+16.2
1	Income from rent of agricultural land	171,549	2,705,208	-93.7
	(a) Non-cultivating landholder	159,103	Not available	...
	(b) Non-cultivating tenant	12,446	Not available	...
2	Ordinary cultivators	3,811,562	520,213	+692.7
	(a) Cultivating landholder	3,148,294	Not available	...
	(b) Cultivating tenant	663,268	Not available	...
3	Agents, managers of landed estates (not planters), clerks, rent collectors, etc.	67	244	-72.6
4	Farm servants and field labourers	177,372	353,436	-49.8
	(b) Growers of special products and market gardening	45,545	74,739	-39.1
5	Tea, coffee, cinchona and indigo plantations	24,695	28,536	-13.5
6	Fruit, flower, vegetable, betel, vine, arecanut, etc., growers	20,850	46,203	-54.9
	(c) Forestry	9,078	12,424	-26.9
8	Wood cutters; firewood, lac, catechu, rubber, etc., col- lectors and charcoal burners	4,867	8,806	-44.7
	(d) Raising of farm stock	27,754	77,431	-64.2
9	Cattle and buffalo breeders and keepers	875	2,838	-69.2
10	Sheep, goat and pig breeders	1,081	37,903	-97.1
11	Breeders of other animals (horses, mules, camels, asses, etc.)	223	169	+32.0
12	Herdsmen, shepherds, goatherds, etc.	25,575	36,521	-30.0
	(e) Raising of small animals... ..	508	118	+330.5
	2. Fishing and hunting	2,209	2,870	-23.0
14	Fishing	1,993	2,966	-15.8
15	Hunting	216	504	-57.1
	<i>Sub-class II.—Extraction of minerals</i>	52,967	14,358	+269.0
	Order 3. Mines	50,823	10,596	+379.5
	4. Quarries of hard rocks	28
	5. Salt, etc.	2,136	3,760	-43.2
	Class B.—Preparation and supply of material substances	710,332	801,798	-11.4
	<i>Sub-class III.—Industrial Occupation</i>	443,132	489,511	-9.5
	Order 6. Textiles	101,407	106,035	-4.4
21	Cotton ginning, cleaning and pressing	163	1,157	-85.9
22	Cotton spinning, sizing and weaving	33,673	83,489	-59.7
23	Jute spinning, pressing and weaving	118	8	+3,833.3
24	Rope, twine and string	1,370	1,646	-16.8
26	Wool carders and spinners, weavers of woollen blankets, carpets, etc.	18,999	15,145	+21.5
27	Silk spinners and weavers	2,478	4,308	-42.5
28	Hair, camel and horse hair, bristles work, brush makers, etc.	71	194	-63.4
29	Persons occupied with feathers
30	Dyeing, bleaching, printing, preparation and sponging of textiles	126	54	+133.3
	7. Hides, skins and hard materials from the animal kingdom	4,055	8,889	-54.4
32	Tanners, curriers, leather dressers, dyers, etc.	1,066	2,975	-64.2
33	Makers of leather articles, such as trunks, water bags, etc.	2,945	5,762	-48.9
34	Furriers	44	162	-71.1
35	Bone, ivory, horn, shell, etc., workers	44	162	-71.1
	8. Wood	40,659	46,299	-12.2
36	Sawyers, carpenters, turners and joiners, etc.	27,282	30,682	-11.1
37	Basket makers and other industries of woody material, including leaves	13,377	15,617	-14.3
	9. Metals	23,315	25,593	-8.9
39	Plough and agricultural implement makers	7	15	-53.3
41	Other workers in iron and makers of implements and tools, principally or exclusively of iron	19,730	20,505	-3.8
42	Workers in brass, copper and bell metal	1,591	2,461	-35.4

VII.—SELECTED OCCUPATIONS, 1911 AND 1901—*contd.*

Group No.	Occupation	Population supported in 1911	Population supported in 1901	Percentage of variation
1	2	3	4	5
	Order 10. Ceramics	26,515	25,265	+4.9
47	Potters and earthen pipe and bowl makers	26,229	24,192	+8.5
	11. Chemical products properly so called, and analogous	7,238	3,987	+81.5
53	Manufacture and refining of vegetable and mineral oils	6,791	3,236	+106.7
	12. Food industries	23,213	33,853	-31.4
56	Rice pounders and huskers and flour grinders	9,972	11,645	-14.4
53	Grain parchers, etc.	191	3,164	-94.0
59	Butchers	4,610	4,248	+8.5
60	Fish carers	11	14	-21.4
62	Makers of sugar, molasses and gur	482	124	+288.7
63	Sweetmeat makers, preparers of jam and condiments, etc.	289	249	+16.1
64	Brewers and distillers	64	1,925	-96.7
65	Toddy drawers	6,200	9,979	-87.9
	13. Industries of dress and the toilet	102,557	111,145	-7.7
68	Tailors, milliners, dressmakers and darners, embroiderers on linen	16,841	14,465	+16.4
69	Shoe, boot and sandal makers	19,537	24,058	-18.8
71	Washing, cleaning and dyeing	44,150	52,702	-16.2
73	Barbers, hair-dressers and wig makers	21,238	19,333	+9.9
	14. Furniture industries	857	96	+971.9
	15. Building industries	43,714	54,571	-10.7
77	Excavators, plinth builders and well-sinkers... ..	16,203	7,996	+102.6
78	Stone and marble workers, masons and bricklayers	27,708	43,930	-36.9
	16. Construction of means of transport	1,063	1,264	-14.3
	17. Production and transmission of physical forces (heat, light, electricity, motive power, etc.)	1,281	3	+42,600.0
	18. Industries of luxury and those pertaining to literature and the arts and sciences	53,558	52,054	+2.9
89	Workers in precious stones and metals, enamellers, imitation jewellery makers, gilders, etc.	50,587	44,002	+15.0
90	Makers of bangles, rosaries, bead and other necklaces, spangles, lingams and sacred threads	109	1,095	-90.1
	19. Industries concerned with refuse matter	9,180	20,457	-55.1
93	Sweepers, scavengers, dust and sweeping contractors	9,180	20,457	-55.1
	<i>Sub-class IV.—Transport</i>	31,096	33,515	-7.2
	Order 20. Transport by water	596	624	-27.7
95	Shipowners and their employes, ship brokers, ships' officers, engineers, mariners and firemen	1	5	-80.0
96	Persons employed on the maintenance of streams, rivers and canals (including construction)	369	511	-27.8
97	Boat owners, boat men and tow men	225	308	-26.9
	21. Transport by road	17,517	21,394	-18.0
98	Persons employed on the construction and maintenance of roads and bridges	3,343	4,590	-27.2
99	Cart owners and drivers, coachmen, stable boys, transport, mail carriage, etc., managers and employes (excluding private servants)	18,070	15,901	-17.6
100	Palki, etc., bearers and owners	335	267	+44.2
101	Pack elephant, camel, mule, ass and bullock owners and drivers	58	403	-99.0
102	Porters and messengers	691	153	+851.6
	22. Transport by rail	9,395	8,738	+7.5
103	Railway employes of all kinds other than construction coolies	8,652	7,718	+12.1
104	Labourers employed on railway construction	743	1,020	-27.2
	23. Post Office, Telegraph and Telephone services	3,558	2,579	+39.0
105	Post Office, Telegraph and Telephone services	3,558	2,558	+39.0
	<i>Sub-class V.—Trade</i>	236,104	278,772	-15.3
	Order 24. Banks, establishments of credit, exchange and insurance	7,217	6,527	+10.6
106	Bank managers, money lenders, exchange and insurance agents, money changers and brokers and their employes	7,217	6,527	+10.6
	25. Brokerage, commission and export	1,698	3,846	-55.9
107	Brokers, commission agents, commercial travellers, warehouse owners and employes	1,698	3,846	-55.9

VII.—SELECTED OCCUPATIONS, 1911 AND 1901—*contd.*

Group No.	Occupation	Population supported in 1911	Population supported in 1901	Percentage of variation
1	2	3	4	5
	Order 26. Trade in textiles	23,060	27,455	-16.0
108	Trade in piece goods, wool, cotton, silk, hair and other textiles	23,060	27,455	-16.0
	„ 27. Trade in skins, leather and furs	4,686	2,883	+96.6
109	Trade in skins, leather, furs, feathers, horn, etc.	4,686	2,883	+96.6
	„ 28. Trade in wood	2,615	2,421	+8.0
110	Trade in wood (not firewood), cork, bark, etc.	2,615	2,421	+8.0
	„ 29. Trade in metals	1,027	508	+104.2
	„ 30. Trade in pottery	551	3,605	-84.7
112	Trade in pottery	551	3,605	-84.7
	„ 31. Trade in chemical products	1,913	7,017	-72.7
113	Trade in chemical products (drugs, dyes, paints, petroleum, explosives, etc.)	1,913	7,017	-72.7
	„ 32. Hotels, cafés, restaurants, etc.	11,624	12,123	-4.1
114	Vendors of wine, liquors, aerated waters, etc.	10,101	10,314	-2.1
115	Owners and managers of hotels, cookshops, sarais, etc., and their employés	1,523	1,809	-15.6
	„ 33. Other trade in food stuffs	130,518	90,916	+43.6
116	Fish dealers	1,034	2,092	-50.6
117	Grocers and sellers of vegetable oil, salt and other condiments	61,518	14,957	+311.3
118	Sellers of milk, butter, ghee, poultry, eggs, etc.	8,255	14,101	-41.6
119	Sellers of sweetmeats, sugar, gur and molasses	5,046	1,485	+239.6
120	Cardamom, betel-leaf, vegetables, fruit and arecanut sellers	25,354	25,812	-1.8
121	Grain and pulse dealers	19,437	14,694	+32.3
122	Tobacco, opium, ganja, etc., sellers	4,894	4,723	+3.6
123	Dealers in sheep, goats and pigs	1,601	3,583	-55.3
124	Dealers in hay, grass and fodder	3,379	2,469	-64.3
	„ 34. Trade in clothing and toilet articles	3,803	2,207	+72.3
125	Trade in ready-made clothing and other articles of dress and the toilet (hats, umbrellas, socks, ready-made shoes, perfumes, etc.)	3,803	2,207	+72.3
	„ 35. Trade in furniture	2,417	8,453	-71.4
127	Hardware, cooking utensils, porcelain, crockery, glass-ware, bottles, articles for gardening, the cellar, etc.	1,940	8,234	-76.4
	„ 36. Trade in building materials	4,234	4,563	-7.2
128	Trade in building materials (stones, bricks, plaster, cement, sand, tiles, thatch, etc.)	4,234	4,563	-7.2
	„ 37. Trade in means of transport	1,421	3,253	-56.3
129	Dealers and hirers of elephants, camels, horses, cattle, asses, mules, etc., sellers (not makers) of carriages, saddlery, etc.	1,421	3,253	-56.3
	„ 38. Trade in fuel	6,880	2,215	+210.6
130	Dealers in firewood, charcoal, coal, cowdung, etc.	6,880	2,215	+210.6
	„ 39. Trade in articles of luxury and those pertaining to letters and the arts and sciences	9,531	12,612	-24.4
131	Dealers in precious stones, jewellery (real and imitation), clocks, optical instruments, etc.	1,572	2,676	-41.3
132	Dealers in common bangles, bead, necklaces, fans, small articles, toys, hunting and fishing tackle, flowers, etc.	7,560	9,429	-19.8
	„ 40. Trade in refuse matter	132
	„ 41. Trade of other sorts	22,777	86,673	-74.3
135	Shopkeepers otherwise unspecified	12,314	77,399	-84.1
136	Other trades (including farmers of pounds, tolls and markets).	6,915	6,879	+0.5
	Class C.—Public administration and liberal arts	306,608	307,712	-0.4
	<i>Sub-class VI.—Public force</i>	71,729	35,409	+102.6
	Order 42. Army	21,986	16,448	+33.7
139	Army (Imperial)	10,277	16,446	-37.5
140	Army (Native States)	11,709	2	+586,350.0

VII.—SELECTED OCCUPATIONS, 1911 AND 1901—concl'd.

Group No.	Occupation	Population supported in 1911	Population supported in 1901	Percentage of variation
1	2	3	4	5
	Order 43. Navy	8
	„ 44. Police	4,736	18,961	+162.3
142	Police	1,188	594	+2,969.0
143	Village watchmen	3,547	18,367	+71.8
	<i>Sub-class VII.—Public Administration</i>	13,867	174,181	-23.7
	Order 45. Public Administration	13,867	174,181	-23.7
144	Service of the State (Imperial Government)	928	1,652	-43.8
145	Service of Native and Foreign States	3,841	81,370	-68.4
146	Municipal and other local (not village) and Muzrai service	3,374	6,466	-9.2
146(a)	Palace service	4854
147	Village officials and servants other than watchmen	87,370	84,698	+3.2
	<i>Sub-class VIII.—Professions and liberal arts</i>	81,377	77,179	+5.1
	Order 46. Religion	34,364	33,819	+2.2
148	Priests, ministers, etc.	12,312	12,016	+1.6
149	Religious mendicants, inmates of monasteries, etc.	1,448	1,478	-2.0
150	Catechists, readers, church and mission service	629	1,337	-53.0
151	Temple, burial or burning ground service, pilgrim conductors, circumcisers	20,375	18,988	+6.8
	„ 47. Law	2,537	2,560	+5.0
152	Lawyers of all kinds including Kasis, law agents and mukhtars	2,330	2,199	+2.4
153	Lawyers' clerks, petition writers, touts, etc.	207	362	+20.7
	„ 48. Medicine	7,77	6,431	+16.3
154	Medical practitioners of all kinds, including dentists, oculists and veterinary surgeons	4,011	3,861	+19.2
155	Midwives, vaccinators, compounders, nurses, masseurs, etc.	2,878	2,570	+11.9
	„ 49. Instruction	22,110	16,101	+37.3
156	Professors and teachers of all kinds (except law, medicine, music, dancing and drawing) and clerks and servants connected with education	22,110	16,101	+37.3
	„ 50. Letters and arts and sciences	14,239	18,268	-22.1
159	Others (authors, photographers, artists, sculptors, astronomers, meteorologists, botanists, astrologers, etc.)	2,433	3,767	-35.3
160	Music composers and masters, players on all kinds of musical instruments (not military), singers, actors and dancers	6,801	11,121	-38.9
	<i>Sub-class IX.—Persons living on their income</i>	20,935	20,943	-0.0
	Order 51. Persons living principally on their income	20,935	20,943	-0.0
161	Proprietors (others than of agricultural land), fund and scholarship holders and pensioners	20,935	20,943	-0.0
	<i>Class D.—Miscellaneous</i>	490,622	668,848	-26.6
	<i>Sub-class X.—Domestic service</i>	38,308	91,774	-56.3
	Order 52. Domestic service	38,308	91,774	-56.3
162	Cooks, water carriers, doorkeepers, watchmen and other indoor servants	32,584	79,014	-69.6
163	Private grooms, coachmen, dogboys, etc.	5,724	12,760	-55.1
	<i>Sub-class XI.—Insufficiently described occupations</i>	400,349	463,496	-17.2
	Order 53. General terms which do not indicate a definite occupation	400,349	463,496	-17.2
164	Manufacturers, business-men and contractors otherwise unspecified	4,031	6,529	-39.3
165	Cashiers, accountants, book-keepers, clerks and other employes in unspecified offices, warehouses and shops	8,900	13,166	-32.4
167	Labourers and workmen otherwise unspecified	297,341	463,633	-16.6
	<i>Sub-class XII.—Unproductive</i>	51,965	92,573	-44.5
	Order 54. Inmates of jails, asylums and hospitals	1,434	689	+108.1
168	Inmates of jails, asylums and hospitals	1,434	689	+108.1
	„ 55. Beggars, vagrants, prostitutes	50,531	92,890	-45.6
169	Beggars, vagrants, procurers, prostitutes, receivers of stolen goods, cattle poisoners	50,531	92,890	-45.6

VIII.—OCCUPATIONS OF SELECTED CASTES.

Caste and occupation	Number per 1,000 workers engaged on each occupation	Number of female workers per 100 males	Caste and occupation	Number per 1,000 workers engaged on each occupation	Number of female workers per 100 males
HINDU.					
1. Agasa.			14. Madiga.		
Industries ...	468	35	Cultivators of all kinds ...	393	8
Cultivators of all kinds ...	403	9	Field labourers ...	169	34
Others ...	129	67	Labourers, unspecified ...	265	116
			Others ...	233	26
2. Banajiga.			15. Mahratta.		
Traders ...	173	46	Cultivators of all kinds ...	379	10
Cultivators of all kinds ...	428	9	Public force ...	56	2
Labourers, unspecified ...	108	91	Labourers, unspecified ...	126	70
Others ...	292	30	Others ...	439	29
3. Beda.			16. Nayinda.		
Cultivators of all kinds ...	549	10	Industries ...	455	1
Field labourers, etc. ...	139	54	Cultivators of all kinds ...	344	11
Labourers, unspecified ...	160	130	Others ...	201	76
Others ...	152	45			
4. Besta.			17. Neygi.		
Cultivators of all kinds ...	557	9	Industries ...	546	17
Labourers, unspecified ...	178	124	Cultivators of all kinds ...	241	9
Others ...	265	60	Others ...	213	70
5. Brahman.			18. Panchala.		
Income from rent of lands ...	305	19	Industries ...	594	3
Cultivators of all kinds ...	167	12	Cultivators of all kinds ...	257	13
Public administration ...	181	1	Others ...	149	97
Others ...	347	12			
6. Ganiga.			19. Satani.		
Industries ...	276	31	Religion ...	315	7
Cultivators of all kinds ...	390	8	Cultivators of all kinds ...	418	8
Trade ...	116	42	Others ...	267	53
Others ...	218	52			
7. Golla.			20. Tigala.		
Cultivators of all kinds ...	654	10	Cultivators of all kinds ...	670	8
Labourers, unspecified ...	105	144	Others ...	330	63
Others ...	241	43			
8. Holeya.			21. Uppara.		
Agricultural labourers (includes village watchmen) ...	197	99	Cultivators of all kinds ...	585	9
Cultivators of all kinds ...	339	9	Labourers, unspecified ...	204	109
Labourers, unspecified ...	256	116	Others ...	211	54
Others ...	208	37			
9. Idiga.			22. Vakkaliga.		
Industries ...	190	11	Cultivators of all kinds ...	806	12
Cultivators of all kinds ...	391	14	Others ...	194	69
Trade ...	100	23			
Labourers, unspecified ...	158	93	23. Vaisya.		
Others ...	161	43	Trade ...	805	8
			Others ...	195	24
10. Kshatriya.			24. Vodda.		
Cultivators of all kinds ...	410	10	Industries ...	262	34
Industries ...	137	19	Cultivators of all kinds ...	348	6
Public force ...	79	...	Labourers, unspecified ...	243	86
Others ...	374	35	Others ...	147	44
11. Kumbara.			MUSALMAN.		
Industries ...	519	26	1. Pathan.		
Cultivators of all kinds ...	321	12	Cultivators of all kinds ...	335	4
Others ...	160	54	Trade ...	133	9
			Public force ...	71	...
12. Kuruba.			Labourers, unspecified ...	123	28
Cultivators of all kinds ...	668	9	Others ...	333	19
Labourers, unspecified ...	110	138			
Others ...	227	40	2. Saiyid.		
			Cultivators of all kinds ...	295	5
13. Lingayat.			Industries ...	105	31
Cultivators of all kinds ...	746	9	Trade ...	154	9
Trade ...	66	30	Public force ...	49	...
Others ...	183	59	Labourers, unspecified ...	142	33
			Others ...	255	14

VIII.—OCCUPATIONS OF SELECTED CASTES—*concl.*

Caste and occupation	Number per 1,000 workers engaged on each occupation	Number of female workers per 100 males	Caste and occupation	Number per 1,000 workers engaged on each occupation	Number of female workers per 100 males
1	2	3	1	2	3
3. Sheikh.			Public force 569		
Cultivators of all kinds	305	4	Arts and professions	103	26
Industries	115	25	Others	179	84
Trade	168	9	3. Indian Christian.		
Public force	47	...	Cultivators of all kinds	107	10
Labourers, unspecified	184	33	Extraction of minerals	107	4
Others	231	15	Industries	123	16
CHRISTIAN.			Domestic servants	193	57
1. Anglo-Indian.			Labourers, unspecified	137	53
Extraction of minerals	227	...	Others	334	29
Industries	132	81	ANIMIST.		
Transport	144	1	1. Lambani.		
Persons living on their income	121	51	Cultivators of all kinds	427	6
Others	376	76	Field labourers, wood cutters, etc.	301	88
2. European.			Trade	102	294
Agents, managers of landed estates	23	2	Labourers, unspecified	189	90
Extraction of minerals	128	...	Others	61	8

IX.—NUMBER OF PERSONS EMPLOYED ON THE 10TH MARCH 1911 ON RAILWAYS AND IN THE IRRIGATION, POST OFFICE AND TELEGRAPH DEPARTMENTS.

Class of persons employed	Euro-peans and Anglo-Indians	Indians	Remarks	Class of persons employed	Euro-peans and Anglo-Indians	Indians	Remarks
RAILWAYS.				COOLIES 8,150			
Total persons employed	171*	4,219*	* Excluding those employed in the Railway Police Department.	POSTAL DEPARTMENT.			
Persons directly employed	171	3,974		Total	23	1,033	
Officers		Supervising Officers	4	7	
Subordinates drawing more than Rs. 75 per mensem	73	18		Post Masters	3	129	
Subordinates drawing from Rs. 20 to 75 per mensem	85	467		Miscellaneous Agents	293	
Subordinates drawing under Rs. 20 per mensem	13	3,494		Clerks	6	134	
Persons indirectly employed	245		Postmen, etc.	638	
Contractors	7		Road Establishment	308	
Contractors' regular employes	13		Railway Mail Service.			
Coolies	235		Supervising officers	5	4	
IRRIGATION DEPARTMENT.				Clerks and Sorters	6	60	
Total persons employed	7	11,335	Mail guards, etc.	37		
Persons directly employed	7	264	Combined offices.				
Officers	2	15	Signallers	2	90		
Upper subordinates	2	24	Messengers, etc.	43		
Lower do	2	273	TELEGRAPH DEPARTMENT.				
Clerks	Total	26	173		
Peons and other servants	356	Administrative Establishment	2	...		
Coolies	227	Signalling do	25	...		
Persons indirectly employed	10,371	Clerks		
Contractors	848	Skilled labour	46		
Contractors' regular employes	1,573	Unskilled labour	86		
			Messengers, etc.	29		

APPENDIX A.—1.

CLASSIFIED SCHEME OF OCCUPATIONS RELATING TO THE MYSORE CENSUS OF 1911.

Class	Sub-class	Order	Group	
A.—Production of raw materials.	I.—Exploitation of the surface of the earth.	1. Pasture and agriculture.	1. Income from rent of agricultural land.	
		(a) Ordinary cultivation.	(a) Non-cultivating landholder. (b) Non-cultivating tenant.	
			2. Ordinary cultivators.	
			(a) Cultivating landholder. (b) Cultivating tenant.	
			3. Agents, managers of landed estates (not planters), clerks, rent collectors, etc.	
			4. Farm servants and field labourers.	
			(b) Growers of special products and market gardening.	5. Tea, coffee, cinchona and indigo plantations.
				6. Fruit, flower, vegetable, betel, vine, arecanut, etc., growers.
			(c) Forestry ...	7. Forest officers, rangers, guards, etc.
				8. Wood-cutters; firewood, lac, catechu, rubber, etc., collectors and charcoal burners.
			(d) Raising of farm stock.	9. Cattle and buffalo breeders and keepers.
				10. Sheep, goat and pig breeders.
			(e) Raising of small animals.	11. Breeders of other animals (horses, mules, camels, asses, etc.).
			2. Fishing and hunting.	12. Herdsmen, shepherds, goatherds, etc.
		B.—Preparation and supply of material substances.	II.—Extraction of minerals.	3. Mines ...
	14. Fishing.			
	15. Hunting.			
4. Quarries of hard rocks	16. Coal mines and petroleum wells.			
	17. Mines and metallic minerals (gold, iron, manganese, etc.)			
	5. Salt, etc. ...		18. Other minerals (jade, diamonds, limestone, etc.)	
III.—Industrial occupation.			6. Textiles ...	19. Rock, sea and marsh salt.
				20. Extraction of saltpetre, alum and other substances soluble in water.
				21. Cotton ginning, cleaning and pressing.
				22. Cotton spinning, sizing and weaving.
			23. Jute spinning, pressing and weaving.	
			24. Rope, twine and string.	
		25. Other fibres (cocoanut, aloes, palm leaf, flax, hemp, straw, etc.).		
		26. Wool carders and spinners, weavers of woollen blankets, carpets, etc.		
		27. Silk spinners and weavers.		
		28. Hair, camel and horse hair, bristles work, brush makers, etc.		
		29. Persons occupied with feathers.		
		30. Dyeing, bleaching, printing, preparation and sponging of textiles.		
		31. Other (lace, crêpe, embroideries, fringes, etc.) and insufficiently described textile industries.		

CLASSIFIED SCHEME OF OCCUPATIONS, ETC.—contd.

Class	Sub-class	Order	Group
B.—Preparation and supply of material substances—contd.	III.—Industry—contd.	7. Hides, skins and hard materials from the animal kingdom.	32. Tanners, curriers, leather dressers, leather dyers, etc. 33. Makers of leather articles such as trunks, water bags, etc. 34. Furriers. 35. Bone, ivory, horn, shell, etc., workers.
		8. Wood	36. Sawyers, carpenters, turners and joiners, etc. 37. Basket makers and other industries of woody material, including leaves.
		9. Metals	38. Forging and rolling of iron and other metals. 39. Plough and agricultural implement makers. 40. Makers of arms, guns, etc. 41. Other workers in iron and makers of implements and tools, principally or exclusively of iron. 42. Workers in brass, copper and bell metal. 43. Workers in other metals (tin, zinc, lead, quicksilver, etc.) 44. Workers in mints, die-sinkers, etc.
		10. Ceramics	45. Makers of glass and crystal ware. 46. Makers of porcelain and crockery. 47. Potters and earthen pipe and bowl makers. 48. Brick and tile makers. 49. Others (mosaic, talc, mica, alabaster, etc., workers.)
		11. Chemical products properly so called, and analogous.	50. Manufacture of matches and explosive materials. 51. Manufacture of aerated and mineral waters. 52. Manufacture of dyes, paint and ink. 53. Manufacture and refining of vegetable and mineral oils. 54. Manufacture of paper, cardboard and papier maché. 55. Others (soap, candles, lac, cutch, perfumes and miscellaneous drugs).
		12. Food Industries	56. Rice pounders and huskers and flour grinders. 57. Bakers and biscuit makers. 58. Grain parchers, etc. 59. Butchers. 60. Fish curers. 61. Butter, cheese and ghee makers. 62. Makers of sugar, molasses and gur. 63. Sweetmeat makers, preparers of jam and condiments, etc. 64. Brewers and distillers. 65. Toddy drawers. 66. Manufacturers of tobacco, opium and ganja.
			67. Hat, cap and turban makers. 68. Tailors, milliners, dress makers and darters, embroiderers on linen. 69. Shoe, boot and sandal makers.

CLASSIFIED SCHEME OF OCCUPATIONS, ETC.—*contd.*

Class	Sub-class	Order	Group
B.—Preparation and supply of material substances— <i>contd.</i>	III.—Industry— <i>conold.</i>	13. Industries of dress and the toilet.	70. Other industries pertaining to dress—gloves, socks, gaiters, belts, buttons, umbrellas, canes, etc. 71. Washing, cleaning and dyeing. 72. Barbers, hairdressers and wig makers. 73. Other industries connected with the toilet (tattooers, shampooers, bath houses, etc.)
		14. Furniture industries.	74. Cabinet makers, carriage painters, etc. 75. Upholsterers, tent makers, etc.
		15. Building industries.	76. Lime burner, cement workers. 77. Excavators and well-sinkers. 78. Stone and marble workers and masons. 79. Others (thatthers, building contractors, house painters, tilers, plumbers, locksmiths, etc.).
		16. Construction of means of transport.	80. Cart, carriage palki, etc., makers and wheelwrights. 81. Saddlers, harness makers, whip and lash makers. 82. Ship and boat builders.
		17. Production and transmission of physical forces (heat, light, electricity, motive power, etc.).	83. Gas works, electric light and ice factories.
		18. Industries of luxury and those pertaining to literature and the arts and sciences.	84. Printers, lithographers, engravers, etc. 85. Newspaper and magazine managers and editors, journalists, etc. 86. Bookbinders and stitchers, envelope makers, etc. 87. Makers of musical instruments. 88. Makers of watches and clocks and optical, photographic and surgical instruments. 89. Workers in precious stones and metals, enamellers, imitation jewellery makers, gilders, etc. 90. Makers of bangles (material unspecified), rosaries, bead and other necklaces, spangles, lingams and sacred threads. 91. Toy, kite, cage, fishingtackle, etc., makers, taxidermists, etc. 92. Others, including managers, persons other than performers employed in theatres and other places of public entertainment, race-course service, huntsmen, etc.
		19. Industries concerned with refuse matter.	93. Sweepers, scavengers, dust and sweeping contractors.
		20. Transport by water.	94. Harbour works, dockyards and pilots. 95. Ship owners and their employes, ship brokers, ships' officers, engineers, mariners and firemen.

CLASSIFIED SCHEME OF OCCUPATIONS, ETC.—*contd.*

Class	Sub-class	Order	Group						
B.—Preparation and supply of material substances— <i>contd.</i>	IV. Transport (<i>concl'd.</i>)	21. Transport by road.	96. Persons employed on the maintenance of streams, rivers and canals (including construction).						
			97. Boat owners, boat men and tow men.						
			98. Persons employed on the construction and maintenance of roads and bridges.						
			99. Cart owners and drivers, coachmen, stable boys, tramway, mail carriage, livery stable, etc., managers, and employes (excluding private servants).						
			100. Palki, etc., bearers and owners.						
			101. Pack elephant, camel, mule and bullock owners and drivers.						
			102. Porters and messengers.						
			103. Railway employes of all kinds other than ordinary labourers.						
			104. Labourers employed on railway construction.						
			105. Post Office, Telegraph and Telephone services.						
	V.—Trade	22. Transport by rail.	106. Bank managers, money lenders, exchange and insurance agents, money changers and brokers and commission agents and their employes.						
			107. Brokers, commercial travellers, warehouse owners and employes.						
			108. Trade in piece goods, wool, cotton, silk, hair and other textiles.						
			109. Trade in skins, leather, furs, feathers, horn, etc.						
			110. Trade in wood (not firewood), cork, bark, etc.						
			111. Trade in metals, machinery, knife, tool, etc., sellers.						
			112. Trade in pottery.						
			113. Trade in chemical products (drugs, dyes, paints, petroleum, explosives, etc.)						
			114. Vendors of wine, liquors and aerated waters.						
			115. Owners and managers of hotels, cookshops, sarais, etc., and their employes.						
			116. Fish dealers.						
117. Grocers and general condiment dealers and sellers of salt and vegetable oil.									
23. Post Office, Telegraph and Telephone services.	24. Banks, establishments of credit, exchange and insurance.	25. Brokerage, commission and export	26. Trade in textiles.						
				27. Trade in skins, leather and furs.					
					28. Trade in wood ...				
						29. Trade in metals ...			
							30. Trade in pottery ...		
								31. Trade in chemical products.	
									32. Hotels, cafés, restaurants, etc.

CLASSIFIED SCHEME OF OCCUPATIONS, ETC.—*contd.*

Class	Sub-class	Order	Group
B.—Preparation and supply of material substances— <i>concl'd.</i>	V.—Trade— <i>concl'd.</i>	33. Other trade in food-stuffs.	118. Sellers of milk, butter, ghee, poultry, eggs, etc.
			119. Sellers of sweetmeats, sugar, gur and molasses.
			120. Cardamom, betel-leaf, vegetables, fruit and arecanut sellers.
			121. Grain and pulse dealers.
		34. Trade in clothing and toilet articles.	122. Tobacco, opium, ganja, etc., sellers.
			123. Dealers in sheep, goats and pigs.
		35. Trade in furniture	124. Dealers in hay, grass and fodder.
			125. Trade in ready-made clothing and other articles of dress and the toilet (hats, umbrellas, socks, ready-made shoes, perfumes, etc.)
		36. Trade in building materials.	126. Trade in furniture, carpets, curtains and bedding.
			127. Hardware, cooking utensils, porcelain, crockery, glassware, bottles, articles for gardening, the cellar, etc.
		37. Trade in means of transport.	128. Trade in building materials (stones, bricks, plaster, cement sand, tiles, thatch, etc.).
			129. Dealers and hirers of elephants, camels, horses, cattle, asses, mules, etc.; sellers (not makers) of carriages, saddlery, etc.
		38. Trade in fuel ...	130. Dealers in firewood, charcoal, coal, cowdung, etc.
			131. Dealers in jewellery (real and imitation), clocks, optical instruments, etc.
39. Trade in articles of luxury and those pertaining to letters and the arts and sciences.	132. Dealers in common bangles, bead, necklaces, fans, small articles, toys, hunting and fishing tackle, flowers, etc.		
	133. Publishers, booksellers, stationers, dealers in music, pictures, musical instruments and curiosities.		
40. Trade in refuse matter.	134. Dealers in rags, stable refuse, etc.		
	135. Shopkeepers otherwise unspecified.		
41. Trade of other sorts.	136. Itinerant traders, pedlars, hawkers, etc.		
	137. Conjurers, acrobats, fortune tellers, reciters, exhibitors of curiosities and wild animals.		
42. Army ...	VI.—Public force.	138. Other trades (including farmers of pounds, tolls and markets).	
		139. Army (Imperial).	
		140. Army (Native States).	
43. Navy ...	141. Navy.		

CLASSIFIED SCHEME OF OCCUPATIONS, ETC.—*contd.*

Class	Sub-class	Order	Group
C.—Public administration and liberal arts— <i>concl'd.</i>	VII.—Public Administration.	44. Police ...	142. Police. 143. Village watchmen.
		45. Public Administration.	144. Service of the State. (Imperial Government). 145. Service of Native and Foreign States. (a) Tabulating State. (b) Other States.
			146. Municipal and other local (not village) and Muzrai service. 146 (a). Palace service. 147. Village officials and servants other than watchmen.
		46. Religion ...	148. Priests, ministers, etc. 149. Religious mendicants, inmates of monasteries, etc.
			150. Catechists, readers, church and mission service. 151. Temple, burial or burning ground service, pilgrim conductors, circumcisers.
		47. Law	152. Lawyers of all kinds, including Kazis, law agents and mukhtars.
			153. Lawyers' clerks, petition writers, touts, etc.
	VIII.—Professions and liberal arts.	48. Medicine ...	154. Medical practitioners of all kinds, including dentists, oculists and veterinary surgeons. 155. Midwives, vaccinators, compounders, nurses, masseurs, etc.
		49. Instruction ...	156. Professors and teachers of all kinds and clerks and servants connected with education. 157. Public scribes, copyists, stenographers, etc.
			158. Architects, surveyors, engineers and their employes.
	IX.—Persons living on their income.	50. Letters and arts and sciences.	159. Others (authors, photographers, artists, sculptors, astronomers, meteorologists, botanists, astrologers, etc.) 160. Music composers and masters, players on all kinds of musical instruments (not military), singers, actors and dancers.
		X.—Domestic service.	51. Persons living principally on their income.
	52. Domestic service ...		162. Cooks, water carriers, doorkeepers, watchmen and other indoor servants. 163. Private grooms, coachmen, dog boys, etc.

