



**REPORT  
OF THE  
SELECTED BUILDINGS PROJECTS TEAM  
ON  
GRAIN STORAGE STRUCTURES**

**COMMITTEE ON PLAN PROJECTS  
NEW DELHI**

*November, 1957.*

*Composition of the Committee on Plan Projects for Public Works and Buildings Sector  
of the Second Five Year Plan :*

*Chairman.*

Shri Govind Ballabh Pant, Union Minister for Home Affairs.

*Members.*

Shri V. T. Krishnamachari, Deputy  
Chairman, Planning Commission.

Shri T. T. Krishnamachari,  
Union Minister for Finance.

Shri Gulzarilal Nanda, Union  
Minister for Planning, Labour  
and Employment.

Shri K. C. Reddy,  
Union Minister for Works,  
Housing & Supply.

Shri N. Sinjiva Reddy, Chief Minister,  
Andhra.

Dr. B. C. Roy, Chief Minister,  
West Bengal.

*Secretary.*

Shri Inderjit Singh, Jt. Secretary, Economy,  
Union Ministry of Finance.

*Composition of the Team for Selected Buildings Projects.*

*Leader.*

Shri S. K. Patil, Minister for Irrigation and Power.

*Members.*

Shri Sarup Singh, I.S.E. (Retd.),  
formerly Director, National Buildings  
Organisation.

Dr. Eng. A. Carbone, M.I.A.B.S.E.,  
Consulting Engineer, Calcutta.

Shri C. P. Malik, Director,  
National Buildings Organisation. (Ex-Officio).

General H. Williams, Director, Central Building Research Institute, Roorkee, has also kindly agreed to attend meetings of the Team and the Panels as and when he can spare time. He has, however, placed the facilities of the C.B.R.I., at the disposal of the Team.

*Secretary.*

Shri T. S. Vedagiri.

MINISTER FOR IRRIGATION & POWER.

INDIA.

NEW DELHI,

*December 2nd, 1957. .*

My Dear Pantji,

As Leader of the Selected Buildings Projects Team, I forward herewith the report of the panel of the Team relating to Grain Storage Structures. I am very glad to inform you that the Union Ministers of Food and Agriculture and Works, Housing and Supply, have accepted the suggestions made in this report. Action on implementing the suggestions has already begun. The Ministry of Works, Housing and Supply have initiated at the Central Building Research Institute, Roorkee, a course of lectures on shell design and construction. This will enable the necessary machinery to be built up for undertaking construction and supervising the new building technique that has been suggested in the report.

We are circulating copies of the report to the State Governments for their comments and to solicit information regarding the type and extent of storage structures required by them. We are also informing them that the Team will be ready to assist them with designs suited to their special requirements.

Yours sincerely,  
S. K. PATIL.

Shri Govind Ballabh Pant,  
Chairman, Committee on  
Plan Projects, &  
Minister for Home Affairs,  
NEW DELHI.

# REPORT ON GRAIN STORAGE STRUCTURES

## CONTENTS

	PAGE
1. Background . . . . .	I
2. Existing Design . . . . .	1
3. Observations & Recommendations . . . . .	2
Alternative proposals	
Shell Type Design	
Design Features	
Other Items of Work :—	
(i) Foundations	
(ii) Plinth Height	
(iii) Height of Walls	
(iv) Thickness of Walls	
(v) Concrete Mix for Shell	
(vi) Flooring	
(vii) Finish of Walls	
(viii) Ventilation	
(ix) Lighting	
(x) Platform Protection	
4. Cost and Material Analysis . . . . .	6
5. Administrative and other arrangements for implementation . . . . .	7

### *Appendices*

- I. Calculations of Shell Design
- II. Abstract of Cost of Conventional Type Grain Godown
- III. Abstract of Cost of Shell Type Grain Godown

### *Plates*

- I. Conventional Type Grain Godown:—  
Drawings of Shell Type Godown.
- II. Stress Diagram for Shells.
- III. Details of End, & Intermediate Frame.
- IV. Geometry of Shell.
- V. Developed Plan for Shell.
- VI. Plan, Elevation & Section.

## REPORT OF THE SELECTED BUILDINGS PROJECTS TEAM ON PROPOSED CONSTRUCTION OF GRAIN STORAGE STRUCTURES

---

### 1. BACKGROUND

1.1. In pursuance of its Terms of Reference, the Selected Buildings Projects Team, in its meeting on the 29th March, 1957, decided to set up a Panel of Engineers for carrying out a study of the existing designs and specifications for the building of the grain godowns, with a view to evolving improved designs, which, while fulfilling the functions of efficient storage, would be more economical in cost and consumption of scarce materials, *viz.*, steel and cement.

The panel comprises the following:—

1. Dr. Eng. A. Carbone, Engineer, Calcutta.—*Chairman.*
2. Shri C. P. Malik, Superintending Engineer, Central Public Works Department, New Delhi.—*Member.*
3. Prof. G. S. Ramaswamy, Assistant Director, Structural Division, Central Building Research Institute, Roorkee.—*Member.*
4. Shri K. L. Revri, Executive Engineer, Ministry of Food, New Delhi.—*Member.*
5. Shri T. S. Vedagiri, Secretary of the Team.—*Member-Secretary.*

1.2. The Panel held a preliminary meeting in Calcutta on the 22nd, 23rd and 24th of April, 1957 and further meetings were held on the 22nd, 23rd, 29th and 30th of May, 1957.

1.3. The Members inspected the conventional P.W.D. type of grain godowns at Jingrapole and the shell type godown recently put up at Vizag. While in Calcutta the Panel visited some of the shell structures at Behala to acquaint themselves with the behaviour of such structures, their resistance to weather and their suitability as roof over large areas.

1.4. The third meeting of the Panel was held at Roorkee and Dehra Dun on the 6th, 7th and 8th June, 1957. This and subsequent meetings of the Panels were also attended by Shri Sarup Singh, Member/Chief Engineer of the Team while Shri A. Balakrishnan, a former Member of the Team attended the third meeting.

1.5. The Panel also held extensive discussions with General Sir Henry Williams, Director of the Central Building Research Institute at Roorkee as well as with the President and officers of the Forest Research Institute at Dehra Dun, with a view to acquaint themselves with the latest advances on the subject of economic roofing of large areas with specially designed timber trusses.

1.6. The last two meetings of the Panel were held at Delhi. When the members were in Delhi for the last meeting they met the Minister for W. H. & S. and explained to him the salient features of this report.

### 2. EXISTING DESIGN

2.1. Plate No. I. attached to this report gives the details of the structure adopted by the C.P.W.D. for constructing grain godowns for the Food Ministry. The godown is 90 feet wide and 300–345 feet long with covered platforms of 8 feet width on one side and of 10 feet width on the other. The structure of the godown consists of R.C.C. columns spaced 45 feet apart laterally and 15 feet apart longitudinally with brick Masonry walls  $13\frac{1}{2}$  inches thick. The roofing is of steel trusses of the Fink type 45 feet span supported on R.C.C. columns with G. I. sheet covering. The roofing of the plat-

forms is also of G.I. sheeting over cantilevered mild steel brackets at 15 feet centre to centre. The height of godowns from plinth level to the tie level of trusses is 17 feet 6 inches.

2.2. The quantity of structural steel used per 100 sq. ft. of godown space comes to about 592 lbs. apart from 419 lbs. for G. I. sheeting and accessories and M. S. reinforcement bars. The main disadvantage of this type of structure is its consumption of structural steel which is in serious short supply in the country. Another disadvantage in the design from the functional point of view is the lack of flexibility of arrangement of stacks due to close spacing of columns and the interference from the tie of the trusses at short intervals. The presence of trusses at close intervals and the horizontal bracings make the space above the tie level useless for storage purposes. In fact, the stacks have to be kept 3 feet or so lower than the tie level for ensuring effective and easy handling of bags. The only advantage, however, in this type is the simplicity of design and construction.

### 3. OBSERVATIONS & RECOMMENDATIONS

As a result of their observations and study, the panel makes the following recommendations:

3.1. The grain godowns constructed by other agencies also follow the same design with slight modifications in the span of trusses and spacing of columns. Some States have constructed godowns of small capacity with masonry walls and vaulted roofing. Timber trusses have also been adopted for godowns of small width. Only in Punjab bulk storage of grain has been resorted to in a restricted way. Batteries of bunkers of the hexagonal pattern have been constructed at Sonapat, Ambala and a few other places.

3.2. *Alternative proposals.*—The Panel considered silos as one of the alternate means of efficient storage. But as the question of bulk storage was not acceptable to the Ministry of Food, the panel did not consider this in detail. However, some technical information on the problems of overhead and underground storage in silos has been obtained from our Ambassador in Argentina and more information is awaited. The Panel will be considering these in detail and make recommendations in due course regarding their adaptability in this country.

3.3. There are many other alternatives to the existing type design for grain godowns but taking a practical view of the question the following three appear to be the feasible solutions:—

- (a) Specialised forms of timber trusses using secondary grades of timber.
- (b) Prestressed concrete girders and rafters.
- (c) Shell type of roofing.

3.4. The question of utilising timber trusses for the roofing of grain godowns was discussed by the Panel in detail with the officers of the Forest Research Institute at Dehra Dun. The design envisages the use of small scantlings of secondary grades of timber as members of the truss with nailed joints. The timber used is properly seasoned and treated. Special connectors have been adopted for main joints in some cases. Trusses of spans upto 70 feet have been designed and a few have been erected at the Institute. The efficacy and life of the nailed joints when subject to varying weather conditions are some of the important factors on which further experimental research is necessary. This apart, the Panel understands that the shortage of timber for structural purposes is almost as great, if not greater, than that of steel.

3.5. Considering all these and the immediate necessity of putting up a large number of godowns for grain storage, the Panel is not inclined to recommend the adoption of timber trusses for grain godowns at this juncture. It must, however, be added that the development of different varieties of structural timber is an utmost necessity as it can be one of the major substitutes for steel in building construction.

3.6. The next alternative was the adoption of prestressed concrete girders, R.C.C. rafters and asbestos cement sheets for roofing. From the functional point of view it is desirable to space the columns as far apart as possible consistent with structural requirements. The elimination of the central row of columns was also suggested in this connection to improve the manoeuvrability inside the godown. This gives rise to the problem of roofing over large spans with a meagre superimposed load.

3.7. Prestressed construction in this context was not found to be economical as the proportion of self weight of the structure to the super load will be too high for an economical design. Apart from this, there is the difficulty of getting the high tensile steel which will be required in large quantities for this purpose. Considering these factors the Panel ruled out the idea of prestressed constructions in this case.

3.8. The third alternative was the adoption of shell roofing. The development of shell structure is one of the outstanding achievements of the day resulting in wider and more economical use of reinforced concrete in large span construction. Its structural soundness is already well established. The amazing reduction of self weight achieved by the use of thin shells 2 to 3 inches in thickness assists also in reducing structural dimensions throughout the building resulting in all round saving of both space and material. Experience has shown that shell structures have great resistance to damage by bombs or fire owing to their monolithic construction. Engineering studies made after the recent earthquake at Mexico City have also revealed the resistance of thin membrane roofs to seismic forces. In Europe and other advanced countries this type of construction has gained great currency since the close of the Second World War. Shell roofing is not new to India. Many industrial and factory buildings with shell roof have been constructed recently. The performance of such roofs is also found to be very satisfactory.

3.9. *Shell type design:* After having decided that shell construction would be the suitable solution for the problems on hand, the Panel tried several types of shell and came to the conclusion that the barrel shell was the best. The details of shell structure as finally evolved by the Panel are given in plates II to VI. During the working of the Panel several modifications and refinements were suggested and all these have been incorporated in the final plan.

3.10. The present plan envisages a unit of godown of 90 feet width and 70 feet length. One row of godown may consist of 4 or 5 such units. The shell roof for the godown is a continuous one with a double span of 35 feet each and a chord of 90 feet. The platform roofs are cantilevered from the main shell itself. This arrangement has a number of advantages:

- (a) *Greater flexibility:* The unrestricted floor space gives ample scope for easy arranging and rearranging of the stacks.
- (b) *Better lighting:* Better standard of lighting inside the godown can be obtained with lesser area of glazing in the roof.
- (c) *Possibility of reducing the godown space required per ton of storage:* The absence of any horizontal obstruction and the greater rise of the shell roof make more space available for stacking inside the godown. It may be possible to rearrange the stacks in such a way as to reduce the area of valuable godown space required per ton of storage.
- (d) *Saving in structural steel:* The shell structure requires no structural steel. This is a significant advantage particularly with the present acute shortage of structural steel.

3.11. The Panel also suggests that further saving in steel can be obtained if the end frames of 90 feet span are prestressed. Modified designs for this are under way and it may be possible to utilise this refinement also, if high tensile wire is available.

3.12. *Design features:* A complete set of drawings of the recommended design with shell type roofing is attached *vide* plates II to VI in the report.



3.13. The cylindrical shell has chord width of 90 feet and is supported by traverses at 35 feet intervals. In addition there are two cantilever slabs on either side, 10 feet and 8 feet which are integrally connected to the shell.

3.14. The analysis of the cylindrical shell can conveniently be divided into two stages. The first part consists in treating the structure as statically determinate and calculating what are known as "Membrane Stresses". These stresses are tabulated in tables given in Appendix I. From the membrane analysis edge stresses in the nature of Normal stresses, Shear stresses and Bending moments will be found to occur along the edges. But the stresses occurring along the edges found from the membrane analysis will not satisfy the actual boundary conditions that are known to exist along the edges. This means that a subsidiary system of stresses usually known as "Line Loads" will have to be applied along the edges so that the actual boundary conditions may be satisfied. These Line Loads in turn produce stresses which are shown in tables given in Appendix I.

3.15. In accordance with usual practices secondary stresses of an insignificant character have been discarded in the analysis. The next step consists in superimposing the stresses by line loads on the membrane stresses. The resultant stresses thus arrived at can be found on tables given in Appendix I.

3.16. The present design does not make any provision for the earth-quake factor, but there is no difficulty in designing shell type roofs for safety in seismic areas. The nomenclature employed in the tables and the coefficients used in calculations generally follow the approach indicated in "VOLTE SECONDO SUPERFICI DI TRANSLAZIONE (1938)—Krall." Similar tables are also to be found in the "American Society of Civil Engineers manual No. 31".

3.17. *Other Items of Work:* Important items of work involved in the construction of grain godowns were considered in detail and the conclusions arrived at in respect of each are detailed below:

(i) *Foundation.*—The existing design shows that the foundations of the filler walls have been carried down to the same depth as the foundations of columns. This is difficult to justify. It appears that the foundation designs are not determined by detailed investigations of the site conditions and the applications of the latest principles of soil mechanics. Perhaps, the rule of thumb has been applied. It is very desirable that in future site investigations are carried out in advance and the designs drawn up accordingly. It will not only result in economy but there will also be greater confidence in the soundness of the structure.

(ii) *Plinth height.*—The present practice is to build the plinth upto the floor level of the wagons. With a formation depth of 1.5 feet this involves earth-filling to the extent of 5 feet. The earth has, in the majority of the cases, to be imported. The design therefore ordinarily proves expensive.

Examination has shown that it is unnecessary to keep the platform level at the floor level of the wagons. The platform height should therefore be kept as low as possible subject to a minimum of  $1\frac{1}{2}$  feet above the proposed formation level with a view to secure damp proofness of the floor. Each case must, however, be decided in relation to the site conditions.

To secure the maximum economy the user department should devise suitable portable sloping gangways for the loading and unloading of the bags by manual workers. It is considered that this should not present any unsurmountable difficulty.

(iii) *Height of walls.*—The shell type of roofing being free from any obstruction, the height of the external walls can be profitably lowered. A minimum clearance of 17.5 feet is required by the user. This, however, need not be provided at the extreme end of the godown and it should suffice if it is available at a distance of 2.5 feet from the inner face of the wall. This is agreed to by the Ministry of Food.

(iv) *Thickness of walls.*—The present practice is to keep the walls a brick-and-a-half thick, or  $13\frac{1}{2}$  inches in the case of standard 9 inches bricks. In the case of shell roof construction the walls have two functions to perform:—

(a) to provide rigidity against wind pressure and rolling grain bags, and  
 (b) protection against weather conditions. The question of reduction of the thickness has been considered, but in spite of the reduction in the height of the wall, as mentioned in (iii) above a thickness of 9 inches would not be safe against wind load, and therefore, the present practice of keeping the wall  $13\frac{1}{2}$  inches thick would have to be continued. Wherever, however, it can prove cheaper, the walls may be built in stone masonry 1.25 feet thick.

(v) *Concrete mix for shell.*—The concrete for the shell structure is of nominal mix 1 : 2 : 4 but the present practice is to specify concrete by strength and not by mix. For work of this type of shell the ultimate cube strength of 3,500 lbs. per sq. inch at 28 days is required. By proper grading of aggregates both fine and coarse and careful design of mix, it is possible to attain this strength with less cement. Adoption of discontinuous grading is suggested. It is also emphasised that the mix must be designed on the basis of aggregate size available and the nature of sand.

(vi) *Flooring.*—The floor has to perform three functions:

- (a) damp proofness,
- (b) rigidity, and
- (c) durability.

It is considered that 9 inches thick layer of pure sand, free from all deleterious materials, especially clay, or cinder, whichever is cheaper should be provided under the rigid part of the floors. Prior to sand or cinder filling, the earth filling under the floor must be properly stabilised in accordance with the modern practice; otherwise, there would be danger of settlement and cracks.

The top layer of the floor may consist of 4 inches lime or lean cement concrete 1 : 5 : 10 with 2 inches wearing surface of rich concrete 1 : 2 : 4 mixed with ironite or rockite.

This type of construction, it is considered, will meet the requirements of Fork Lift trucks of half-ton capacity—the usual size.

Where the sub-soil water level is within 5 feet of the prevailing ground level or conditions otherwise demand, a membrane of tar-felt or alkathene sheets, may be introduced between the sand and the top layer.

If it is difficult or expensive to obtain clean sand, two-coat treatment of Bitumen at 50 lbs. per 100 sft. should be given above the lean concrete course. In such cases, the thickness of the sand layer can be reduced to 6 inches.

(vii) *Finish of walls.*—For cleanliness it was considered necessary that the inside of the walls may be plastered and white-washed. The outside need only be pointed. Plastering is not necessary as the walls are fully protected by Chhajjas which form part of the shell roof.

(viii) *Ventilation.*—Entry of fresh air is needed to keep grain in good condition, but during the monsoon period, it is necessary to shut out moisture, and therefore ventilators must be provided with shutters. The top ventilators should have wire gauze protection on the external side, and top hung shutters. The lower ventilators should have expanded metal protection outside and sliding shutters and wire gauze, on the inside.

- (ix) *Lighting*.—The proposed plan is considered satisfactory from the point of view of obtaining the required day-light. It is estimated that the intensity of lighting at 3 feet above the floor level within the godown will be 20 lumens per sft. which is very nearly the same as obtained in the conventional type godown. The internal covering should consist of reinforced glass.
- (x) *Platform protection*.—To prevent damage to the platform by the backing of the transport vehicles, it should be provided with wooden fenders throughout backed by hard rubber packing at intervals.

#### 4. COST AND MATERIAL ANALYSIS

4.1. Detailed estimates of cost and material requirements have been worked out both for the existing type of godown and the proposed type with concrete shell roofing. Abstract of cost of each is given in appendix II and III respectively. The rates are based on the Delhi Schedule of Rates (1955) and the effect of the recent increase in the prices of cement and steel has also been taken into account.

4.2. Following is a comparative statement of Cost and Material analysis:—

Item	Existing Type	Shell Type
Area . . . . .	26,226 sft.	24,785 sft.
1. Cost of FRAME WORK per sft. of godown space . . . . .	Rs. 5.82	Rs. 5.24
2. Cost of FILLER WORK per sft. of godown space . . . . .	Rs. 5.18	Rs. 4.95
3. TOTAL COST per sft of godown space . . . . .	Rs. 11.00	Rs. 10.19
4. STEEL required per 100 sft. of godown space—		
(a) Structural steel . . . . .	5.29 cwts.	Nil
(b) M.S. bars . . . . .	1.26 cwts.	4.10 cwts.
(c) G.I. sheets & accessories . . . . .	2.48 cwts.	Nil
TOTAL . . . . .	9.03 cwts.	4.10 cwts.
5. CEMENT required per 100 sft. of godown space . . . . .	17.04 cwts.	22.93 cwts.

4.3. It will be observed from the above statement that the shell type construction,

- (i) costs Rs. 0.80 less per sft. of godown space as compared to the existing type, and
- (ii) there is a gross saving in steel to the extent of about 52%.

4.4. However cement requirement shows an increase of 35%. This is inevitable since the steel type of roofing has been converted into reinforced concrete type. But the team is of the opinion that in the interest of economy of materials in short supply, it is more important to effect saving in steel than in cement. Therefore, the implications of the design appear to be in the right direction.

4.5. The Food Ministry's programme is to construct godowns for storage of 15 lakh tons of grain. A few godowns have already been constructed and some are in the process of construction. Obviously, it is not possible to effect any change in the completed works. A change in the work in progress may also be impossible. Storage space for 12 lakh tons of grain is, however, still to be provided. Obviously, the new designs can very easily be adopted for what remains to be constructed.

4.6. Further there is a provision in the Plan for setting up warehousing corporations and societies. The amount earmarked for these items is quite considerable and the quantity of grain for which storage facilities are to be made available by these bodies is 30 lakh tons. Out of this, 18 to 20 lakh tons are for large godowns. The total tonnage of grain requiring storage accommodation therefore comes to 30 to 32 lakh tons.

4.7. It is estimated that about 7.25 sft. of space is needed per ton of storage. In terms of storage capacity, the saving in cost per ton of storage by adopting the shell type design would be Rs. 0.80 X 7.25 equal to Rs. 5.80.

4.8. By adopting the modified design for the storage accommodation of 30 to 32 lakh tons, the saving in

(i) overall cost will be of the order of Rs. 180 lakhs, and

(ii) the saving in structural steel will be to the extent of 56,000 tons, apart from the saving of 26,000 tons of G.I. sheets and accessories. The latter, however, will be counter-balanced by 31,000 tons of extra mild steel which will be needed in the construction of the shell.

## 5. ADMINISTRATIVE & OTHER ARRANGEMENTS FOR IMPLEMENTATION

5.1. The Union Ministries of Food and W. H. & S., have accepted the report subject to a few minor remarks of the C.P.W.D., which are being examined by the Team.

5.2. The designing of shell structures is comparatively new to India. It is therefore necessary that arrangements should be made for introducing this technique among the Engineers who are likely to undertake tasks of this kind in the near future. The Team has suggested and the Ministries of W.H. & S., and Finance at the Centre, have agreed that training should be imparted to adequately qualified officers for this technique at the Central Building Research Institute. The Director, N.B.O. has agreed to sponsor the course and the Ministry of Education & Scientific Research has agreed to meet the reasonable expenses necessary for conducting such a course. As the first batch of Engineers is to be trained from the C.P.W.D., the Chief Engineer, C.P.W.D. has kindly offered to meet the expenses of the course from the budget of the C.P.W.D.

5.3. The arrangements for the course and the planning of instruction have been entrusted to Prof. Ramaswamy in consultation with Dr. Carbone and Chief Engineer, C.P.W.D. The course is likely to begin in the first week of December, 1957. Subsequent courses may also be held if the State Governments, who are being approached in the matter, express their agreement to send their Engineers for this purpose. The details of the course would be worked out by the Director, N.B.O. who will get in touch with the State Governments in due course.

5.4. The question of the agency of construction is also important in this connection. There are very few construction firms that have experience of putting up shell structures. Two courses are therefore open namely either to invite the few firms that have experience in this matter to tender on a restricted basis or to explore avenues of construction through the department or semi-government institution such as National Projects Construction Corporation. The Chief Engineer, C.P.W.D. has expressed the view that he would not be able to undertake responsibility for departmental construction especially under existing conditions relating to powers of appointment, to sanction advances to labour etc. The question is being further discussed with the Ministries of W. H. & S. and Finance for arriving at a suitable arrangement in this respect.

Summarised Auxiliary Calculations.

	Values of $(\phi_k - \phi)$								
	7.25°	22.52°	30.16°	33.98°	35.90°	36.87°	37.80°		
1 $3/\pi \cos(\phi_k - \phi) \sin(\phi_k - \phi)$	0.1196	0.3378	0.4148	0.4425	0.4336	0.4332	0.4625	$S_2 = 4/\pi p R \frac{L}{t} \times 3/\pi \cos(\phi_k - \phi) \sin(\phi_k - \phi)$	
2 $2/\pi \sin(\phi_k - \phi)$	0.0803	0.2438	0.3198	0.3358	0.3220	0.3220	0.3302	$S_1 = 4/\pi p R \frac{L}{t} \times 2/\pi \sin(\phi_k - \phi)$	
3 $3/4 [\cos^2(\phi_k - \phi) - \sin^2(\phi_k - \phi)]$	0.29427	0.21876	0.15096	0.11405	0.09491	0.08496	0.07562	$T_x = 4/\pi p R \frac{L}{t} \times 3/4 [\cos^2(\phi_k - \phi) - \sin^2(\phi_k - \phi)]$	
4 $2/\pi^2 \cos(\phi_k - \phi)$	0.20102	0.18718	0.17520	0.16803	0.16414	0.16205	0.16018	$T_x = 4/\pi p R \frac{L}{t} \times 2/\pi^2 \cos(\phi_k - \phi)$	

$$1. V_u = -p R \frac{L}{t} \left(\frac{L}{R}\right)^2 \times \frac{6}{\pi^2} \cos(\phi_k - \phi) \times \sin(\phi_k - \phi) \left[2 + \left(\frac{\pi R}{L}\right)^2\right] \sin \frac{\pi x}{L}$$

$$2. V_d = -p R \frac{L}{t} \left(\frac{L}{R}\right)^2 \times \frac{2}{\pi^2} \left[1 + 2 \left(\frac{\pi R}{L}\right)^2\right] \sin(\phi_k - \phi) \sin \frac{\pi x}{L}$$

$$3. W_u = -p R \frac{L}{t} \left(\frac{L}{R}\right)^2 \times 6 \left\{ [\cos^2(\phi_k - \phi) - \sin^2(\phi_k - \phi)] \times \left[2 + \left(\frac{\pi R}{L}\right)^2\right] + \frac{1}{6} \left(\frac{\pi R}{L}\right)^4 \cos^2(\phi_k - \phi) \right\} \sin \frac{\pi x}{L}$$

$$4. W_d = -p R \frac{L}{t} \left(\frac{L}{R}\right)^2 \times 2 \left[1 + 2 \left(\frac{\pi R}{L}\right)^2 + \left(\frac{\pi R}{L}\right)^4 \times 0.5\right] \cos(\phi_k - \phi) \sin \frac{\pi x}{L}$$

5.  $V = V_u + V_d$       6.  $W = W_u + W_d$

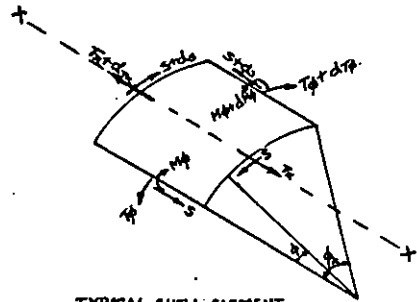

TYPICAL SHELL ELEMENT.

Notes:-

- $\phi_k = 37.48^\circ = 37.80^\circ = 0.6577R$
- $\sin 37.80^\circ = 0.6129, \sin^2 37.80^\circ = 0.37564$
- $\cos 37.80^\circ = 0.7902, \cos^2 37.80^\circ = 0.62441$
- $\sin 37.80^\circ \times \cos 37.80^\circ = 0.4843$
- $\cos^2 37.80^\circ - \sin^2 37.80^\circ = 0.2487$
- $R/\pi R = 0.15158, (L/\pi R)^2 = 0.02297$
- $(L/\pi R)^4 = 0.0005276$
- $\pi^2/L = 6.597, (\pi R/L)^2 = 43.52$
- $(\pi R/L)^4 = 1894$
- CHORD WIDTH = 90°.

$$\therefore V_u = -2339 \times \frac{L}{t} \times 6 \times 0.0005276 \times 0.4843 [2 + 43.52] \sin \frac{\pi x}{L}$$

$$= -\frac{L}{t} 163 \sin \frac{\pi x}{L}$$

$$V_d = -3360 \times \frac{L}{t} \times 2 \times 0.0005276 \times [1 + 2 \times 43.52] \sin \frac{\pi x}{L} \times 0.6129$$

$$= -\frac{L}{t} 192 \sin \frac{\pi x}{L}$$

$$V = -\frac{L}{t} 355 \sin \frac{\pi x}{L}$$

$$W_u = -2339 \frac{L}{t} \times 6 \times 0.0005276 \times [0.24877 \times 43.52 + 0.1667 \times 1894 \times 0.6244] \sin \frac{\pi x}{L}$$

$$= \frac{L}{t} \times 1542 \sin \frac{\pi x}{L}$$

$$W_d = -3360 \frac{L}{t} \times 2 \times 0.0005276 \times [1 + 2 \times 43.52 + 0.5 \times 1894] \times 0.7902 \times \sin \frac{\pi x}{L}$$

$$= -\frac{L}{t} 2906 \sin \frac{\pi x}{L}$$

$$W = -\frac{L}{t} 4448 \sin \frac{\pi x}{L}$$

Sheet No. 2.

$$1. \Delta_H = V \cos(\phi_k - \phi) - W \sin(\phi_k - \phi)$$

$$= \frac{L}{t} \left\{ \left[ -\frac{V \times 2}{t} - K_1 (T_\phi + T_L) - K_7 (S + S_L) + \frac{L}{t} R_L K_4 + K_{10} \frac{M_L}{t} \right] \cos(\phi_k - \phi) \right.$$

$$\left. - \left[ \frac{W \times 2}{t} - (T_\phi + T_L) K_2 - K_8 (S + S_L) + K_5 \frac{L}{t} R_L + K_{11} \frac{M_L}{t} \right] \times \frac{L}{t} \sin(\phi_k - \phi) \right\} \sin \frac{\pi x}{L}$$

$$2. T_x = \left[ T_x + K_{a1} (T_\phi + T_L) + K_{a9} (S + S_L) - K_{a5} \frac{L}{t} R_L - K_{a13} \frac{M_L}{t} \right] \sin \frac{\pi x}{L}$$

The moment applied to the shell must be equal to the moment developed by Chajja.

$$\therefore M_L = -\frac{4}{\pi} \times 61 \times \frac{10^2}{12} = -647 \text{ ft-lbs.}$$

The vertical component of the applied live load must be equal to the half the load due to horizontal slab.

$$\sin(\phi_k - \phi) \times T_L - \cos(\phi_k - \phi) R_L = \frac{4}{\pi} \times 61 \times \frac{10^2}{2} = 388$$

$$\therefore T_L = \frac{388 + 0.7902 R_L}{0.6129} = 1.289 R_L + 633$$

Substituting the values for  $T_L$  and  $M_L$  in-to equations 1 & 2 and collecting similar terms :-

$$\Delta_H = \frac{L}{t} (442418 + 14.93 S_L - 1035 R_L) \sin \frac{\pi x}{L}$$

$$\frac{T_x}{t} = \frac{1}{t} (5968 + 4.811 S_L - 76.534 R_L) \sin \frac{\pi x}{L}$$

In order to evaluate four unknowns  $\Delta_H, T_x, S_L$  and  $R_L$  two additional equations based on the displacement and fibre stress in the horizontal slab must be established. Designating the loads applied to the horizontal slab as  $H_b$  &  $S_b$  we have:-

$$\Delta_H = \frac{L}{t} \left[ \left(\frac{35}{10}\right)^2 \times 0.12319 H_b + 0.19351 \left(\frac{35}{10}\right)^2 S_b \right] \sin \frac{\pi x}{L}$$

$$\frac{T_x}{t} = \frac{1}{t} \left[ 0.60793 \left(\frac{35}{10}\right)^2 H_b + 1.2732 \left(\frac{35}{10}\right)^2 S_b \right] \sin \frac{\pi x}{L}$$

$$\text{Hence } \Delta_H = \frac{L}{t} (2640 + 8.61 R_L - 8.37 S_L) \sin \frac{\pi x}{L}$$

$$\frac{T_x}{t} = \frac{1}{t} (3725 + 12.15 R_L - 4.456 S_L) \sin \frac{\pi x}{L}$$

Notes

- $K_1 = -13.18$
- $K_7 = -3.452$
- $K_4 = +1.00$
- $K_{10} = +2.293$
- $K_2 = -1.00$
- $K_8 = -0.2058$
- $K_5 = +0.1036$
- $K_{11} = +0.358$
- $K_{a1} = +10.83$
- $K_{a9} = +4.811$
- $K_{a5} = -0.6465$
- $K_{a13} = -1.0849$
- $H_b = \cos(\phi_k - \phi) T_x + \sin(\phi_k - \phi) R_L$
- $= 1.63 R_L + 800$
- and  $S_b = -S_L$

Equating the horizontal displacement and longitudinal stress in the beam to those of the shell :-

$$442418 + 14.93 S_L - 1035 R_L = 2640 + 8.61 R_L - 2.37 S_L$$

$$59686 + 4.811 S_L - 76.534 R_L = 3725 + 12.15 R_L - 4.46 S_L$$

Solving,  $S_L = 2385$ ,  $R_L = 382$ ,  $\therefore T_L = 1.289 \times 382 + 633 = 492 + 633 = 1125$  lbs per ft.

Correction for Continuity.

- (a) Column (4) = Column (1+2+3)
- (b) Column (5) = Column (1)  $\times \frac{6}{\pi^2 [2+3(\frac{3}{2})^2]} = \frac{Cl(1) \times 6}{\pi^2 [2+3(\frac{3}{2})^2]} = 0.04 \times \text{Column (1)}$
- (c) Column (6) = Column (2)  $\times \frac{3}{\pi^2 [1+6(\frac{3}{2})^2]} = \text{Column (2)} \times 0.011$
- (d) Column (7) = Column (3)  $\times \frac{3}{\pi^2}$
- (e) Column (8) represent the value of Hyperbolic function  $e^{-k\phi} - k\phi W$
- (f) The coefficients of Col (8) are multiplied by A where  $A = \frac{2R_L \cos \phi \sin \phi + \frac{4P}{L} \sin \phi}{2+3(\frac{3}{2})^2 - 1+6(\frac{3}{2})^2} = 1045$
- (g) Column (9) =  $-A \times \text{Column (8)}$
- (h) Column (10) = Column (5+6+7+9)
- (i) Column (15) =  $-\frac{6}{\pi^2 [2+3(\frac{3}{2})^2]} \times \text{Column (11)} = -0.1254 \times \text{Column (11)}$
- (l) Column (16) =  $-\frac{3}{\pi^2 [1+6(\frac{3}{2})^2]} \times \text{Column (12)} = -0.0347 \times \text{Column (12)}$
- (m) Column (17) =  $\text{Column (13)} \times \frac{3}{\pi^2} = -0.955 \times \text{Column (13)}$
- (n) Column (18) =  $e^{-k\phi} + e^{-k\psi}$
- (o) Column (19) =  $A \times \sqrt{L} \times \text{Column (18)} = 2560 \times \text{Column (18)}$
- (p) Column (20) = Column (15+16+17+19)
- (q) Column (21) gives transverse moment at  $x = \frac{L}{2}$ .
- (r) Column (22) =  $\frac{2T}{L} \times \text{Column (21)} = 1.57$
- (s) Final values of  $S$  = Column (4) + Correction, i.e. Col (4)  $\times \cos \frac{\pi x}{L} + \text{Col (10)}$
- (t) Final values of  $T_x$  = Column (16)  $\times \sin \frac{\pi x}{L} + \text{Col (20)} (\frac{1-x}{L})$
- (u) Final values of  $M_\phi$  = Column (21)  $\times \sin \frac{\pi x}{L} - \text{Column (22)} \left[ \left(\frac{x}{L}\right)^3 - 3\left(\frac{x}{L}\right) + 2 \left(\frac{x}{L}\right) \right]$

Notes:  
 $K_1 \frac{3}{L} \sqrt{6} = \frac{7.5}{5} \times 2 + 4.93 = 5.144$   
 $W = (2\phi - \psi)$   
 values of  $\phi$   
 $30.55^\circ = 0.533198$   
 $15.28^\circ = 0.266744$   
 $7.64^\circ = 0.133223$   
 $3.82^\circ = 0.066613$   
 $1.90^\circ = 0.033161$   
 $0.95^\circ = 0.016580$   
 $0^\circ = 0$

$\therefore$  Value of  $W$  :-  $(2\phi - \psi)$   
 $45.05^\circ = 0.786271$   
 $60.32^\circ = 1.052724$   
 $67.96^\circ = 1.186242$   
 $71.78^\circ = 1.252855$   
 $73.70^\circ = 1.286307$   
 $74.65^\circ = 1.302888$   
 $75.6^\circ = 1.319468$   
 $\frac{3}{L} = \frac{7.5}{5} = 2.1, \left(\frac{3}{L}\right)^2 = 4.41$

$5.144 \times 0.533198 = 2.744$	$- e^{-5.144 \times 0.786271} = 0.06678$
$-5.144 \times 0.266744 = -1.374$	$- e^{-5.144 \times 1.052724} = 0.24912$
$-5.144 \times 0.133223 = -0.685$	$- e^{-5.144 \times 1.186242} = 0.50184$
$-5.144 \times 0.066613 = -0.342$	$- e^{-5.144 \times 1.252855} = 0.70915$
$-5.144 \times 0.033161 = -0.171$	$- e^{-5.144 \times 1.286307} = 0.84149$
$-5.144 \times 0.016580 = -0.085$	$- e^{-5.144 \times 1.302888} = 0.91728$
$-5.144 \times 0 = 0$	$- e^{-5.144 \times 1.319468} = 0.99887$

Table 1

	$\eta L/2 = 0.015$							$\phi_x = 37.48^\circ = 37.80^\circ$							$4/\eta = 0.476$							$(4/\eta)^2 = 0.2266$							
$\frac{x}{L}$	3.2	1.6	0.8	0.4	0.2	0.1	0	3.2	1.6	0.8	0.4	0.2	0.1	0	3.2	1.6	0.8	0.4	0.2	0.1	0	3.2	1.6	0.8	0.4	0.2	0.1	0	Sheet. No 3
$S$	39.20'	19.60'	9.80'	4.90'	2.45'	1.225'	0	39.20'	19.60'	9.80'	4.90'	2.45'	1.225'	0	39.20'	19.60'	9.80'	4.90'	2.45'	1.225'	0	39.20'	19.60'	9.80'	4.90'	2.45'	1.225'	0	
$\phi$	30.55°	15.28°	7.64°	3.82°	1.90°	0.95°	0°	30.55°	15.28°	7.64°	3.82°	1.90°	0.95°	0°	30.55°	15.28°	7.64°	3.82°	1.90°	0.95°	0°	30.55°	15.28°	7.64°	3.82°	1.90°	0.95°	0°	
$\phi_x - \phi$	7.25°	22.52°	30.16°	33.98°	35.90°	36.87°	37.80°	7.25°	22.52°	30.16°	33.98°	35.90°	36.87°	37.80°	7.25°	22.52°	30.16°	33.98°	35.90°	36.87°	37.80°	7.25°	22.52°	30.16°	33.98°	35.90°	36.87°	37.80°	
LOAD	COEFFICIENTS							Multipliers							FORCES														
								$T_\phi @ x = 1/2$ (lbs. per ft.)																					
1. Uniform	0.7841	0.8532	0.7473	0.6876	0.6561	0.6398	0.6243	-2359	$\sin \frac{\pi x}{L}$						-2301	-1995	-1748	-1608	-1535	-1496	-1460								
2. Dead	0.9120	0.9237	0.8646	0.8202	0.8000	0.7999	0.7901	-3369	$\sin \frac{\pi x}{L}$						-3342	-3112	-2913	-2763	-2728	-2695	-2662								
3. Z																													
4. $T_L$	+0.055	-0.255	-0.236	+0.418	+0.803	+0.943	+1.00	5247							+288	-1337	-1238	+2182	+4213	+4997	+5247								
5. $R_L$	-0.00205	+0.00882	+0.04639	+0.02902	+0.01080	+0.00336	0	53480							-109	+971	+2491	+1352	+577	+179	0								
6. $S_L$	+0.0146	-0.0657	+0.0112	+0.1242	+0.1242	+0.0836	0	3525							+57	-231	+39	+437	+437	+294	0								
7. $M_L$	+0.00453	-0.03674	+0.03121	+0.03537	+0.0374	+0.00511	0	-2588							-11	+95	-80	-92	-40	-13	0								
8. Z																													
9. $S+B$																													

$S @ x = 0$  (lbs. per ft.)

1. Uniform	0.1195	0.5378	0.4148	0.4425	0.4536	0.4582	0.4625	-1114	$\cos \frac{\pi x}{L}$						-133	-376	-462	-493	-505	-510	-515							
2. Dead	0.0805	0.2438	0.3198	0.3558	0.3720	0.3820	0.3902	1604	$\cos \frac{\pi x}{L}$						-129	-391	-513	-570	-596	-612	-625							
3. Z																												
4. $T_L$	-0.115	+0.504	-0.952	-1.845	-1.529	-0.961	0	5247							-603	+2644	-4795	-9575	-8022	-5042	0							
5. $R_L$	+0.01080	-0.04966	-0.00114	+0.0772	+0.07946	+0.06385	0	53480							+566	-2655	-61	+4128	+4249	+2820	0							
6. $S_L$	-0.016	+0.059	-0.280	-0.160	+0.214	+0.544	+1.00	3525							-56	+207	-916	-564	+754	+1917	+3525							
7. $M_L$	+0.0119	-0.0325	-0.0708	+0.0626	+0.1047	+0.0811	0	-2588							-30	+84	+188	-162	-270	-210	0							
8. Z																												
9. $S+B$																												

Table 2.

$\frac{x}{L}$	3.2	1.6	0.8	0.4	0.2	0.1	0	3.2	1.6	0.8	0.4	0.2	0.1	0	3.2	1.6	0.8	0.4	0.2	0.1	0	3.2	1.6	0.8	0.4	0.2	0.1	0
$S$	39.20'	19.60'	9.80'	4.90'	2.45'	1.225'	0	39.20'	19.60'	9.80'	4.90'	2.45'	1.225'	0	39.20'	19.60'	9.80'	4.90'	2.45'	1.225'	0	39.20'	19.60'	9.80'	4.90'	2.45'	1.225'	0
$\phi$	30.55°	15.28°	7.64°	3.82°	1.90°	0.95°	0°	30.55°	15.28°	7.64°	3.82°	1.90°	0.95°	0°	30.55°	15.28°	7.64°	3.82°	1.90°	0.95°	0°	30.55°	15.28°	7.64°	3.82°	1.90°	0.95°	0°
$\phi_x - \phi$	7.25°	22.52°	30.16°	33.98°	35.90°	36.87°	37.80°	7.25°	22.52°	30.16°	33.98°	35.90°	36.87°	37.80°	7.25°	22.52°	30.16°	33.98°	35.90°	36.87°	37.80°	7.25°	22.52°	30.16°	33.98°	35.90°	36.87°	37.80°



APPENDIX II  
ABSTRACT OF COST—CONVENTIONAL TYPE

Item	Quantity or No.	Rate Rs.	Per	Amount Rs.
A. FRAME WORK				
1. Earth work . . . . .	5,800 cft.	33 0 0	1000 cft.	191
2. Lean concrete under foundation . . . . .	360 cft.	93 0 0	100 cft.	335
3. RCC in columns etc. . . . .	2,712 cft.	2 8 0	cft.	6,780
4. RCC in foundation . . . . .	1,450 cft.	2 3 0	cft.	3,172
5. M.S. Reinforcement . . . . .	29,033 lbs.	0 6 0	lb.	10,887
6. Structural steel work . . . . .	13,867 cwts.	0 7 0	cwt.	65,142
7. G.I. Roofing . . . . .	34,376 sft.	93 0 0	100 sft.	31,970
8. Ridges etc. . . . .	609 rft.	1 9 0	rft.	952
9. Eaves gutters etc. . . . .	609 rft.	2 14 0	rft.	1,751
10. Valley gutters . . . . .	305 rft.	7 11 0	rft.	22,345
11. Holding down bolts . . . . .	152 Nos.	6 6 0	each	969
12. Small sets of holding down bolts . . . . .	42 Sets.	16 0 0	set	672
13. Painting steel work . . . . .	9,200 sft.	18 8 0	100 sft.	1,702
14. Perspex sheets . . . . .	2,490 sft.	6 14 0	sft.	17,119
			TOTAL	1,43,987

B. FILLER WORK				
1. Earth work . . . . .	14,200 cft.	33 0 0	1000 cft.	469
2. Refilling with earth . . . . .	59,997 cft.	85 0 0	1000 cft.	2,147
3. Filling with river sand . . . . .	22,900 cft.	17 0 0	100 cft.	3,893
4. 1:5:10 concrete under walls & floors . . . . .	13,000 cft.	93 0 0	100 cft.	12,090
5. D.P.C. with Pudlo . . . . .	802 sft.	65 0 0	100 sft.	521
6. Hot bitumen with 50 lbs/100 sft. . . . .	31,435 sft.	15 0 0	100 sft.	4,715
7. RCC in beams & lintels . . . . .	990 cft.	2 8 0	cft.	2,475
8. M.S. reinforcement . . . . .	7,035 lbs.	0 6 0	lb.	2,638
9. Brick work in foundations & plinth . . . . .	10,429 cft.	97 0 0	100 cft.	10,116
10. Brick work in superstructure . . . . .	11,520 cft.	116 0 0	100 cft.	13,363
11. Type V ventilator . . . . .	160 sft.	6 2 0	sft.	980
12. Type VI ventilator . . . . .	800 sft.	5 11 0	sft.	4,550
13. Type V2 ventilator . . . . .	80 sft.	6 2 0	sft.	490
14. Grill of required pattern . . . . .	80 sft.	3 2 0	sft.	250
15. Rolling shutters . . . . .	1280 sft.	6 12 0	sft.	8,640
16. Iron hold fasts . . . . .	232 Nos.	0 13 0	each	188
17. 1½" cement concrete flooring with ½" ironite . . . . .	30,633 sft.	123 0 0	100 sft.	37,679
18. ½" cement plaster 1:6 . . . . .	13,255 sft.	12 8 0	100 sft.	1,657
19. Pointing . . . . .	13,796 sft.	10 0 0	100 sft.	1,379
20. White washing . . . . .	15,000 sft.	1 3 0	100 sft.	178
21. Painting wood work . . . . .	1,300 sft.	17 12 0	100 sft.	231



**APPENDIX II—concl'd.**

1	2	3	4	5
22. Painting steel work . . . . .	2,610 sft.	18 8 0	100 sft.	482
23. Plaster bands . . . . .	190 rft.	0 3 0	rft.	36
24. 6" diameter waterpipe . . . . .	671 rft.	4 10 0	rft.	3,104
25. C.I. heads . . . . .	33 Nos.	6 8 0	each	215
26. C.I. bends . . . . .	11 Nos.	6 8 0	each	72
27. C.I. Tee 6" . . . . .	22 Nos.	6 8 0	each	143
28. 6" S & S pipe . . . . .	500 rft.	5 4 0	rft.	2,625
29. Lead caulked joints for S & S Pipe. . . . .	56 Nos.	9 8 0	each	532
30. 9" S & S pipe . . . . .	920 rft.	8 12 0	rft.	8,050
31. Joints for 9" S & S pipe . . . . .	103 Nos.	15 0 0	each	1,545
32. Brick masonry in chamber . . . . .	11 Nos.	120 9 0	each	1,326
33. 9" open surface drain . . . . .	605 rft.	2 3 0	rft.	1,323
34. Bird proof netting . . . . .	800 sft.	1 3 0	sft.	950
35. Reducers . . . . .	11 Nos.	6 8 0	each	72
36. Plinth protection flat bricks 3" in cement mortar 1 : 6 including a bed of 4" dry brick ballast round etc. . . . .	648 sft.	57 8 0	100 sft.	372
37. Wooden fenders with hard rubber packing . . . . .	316 rft	2 0 0	rft.	632
<b>TOTAL</b>				<b>1,33,081</b>

(a) Total plinth area =  $301' - 1\frac{1}{2}" \times 108' - 0" = 32,521$  sq. ft.

(b) Godown area =  $298' - 10\frac{1}{2}" \times 87' - 3" = 26,226$  sq. ft.

**TOTAL COST**

A. Cost of frame work . . . . .	Rs.
B. Cost of filler work . . . . .	1,43,987
	1,33,081
<b>TOTAL</b>	<b>2,77,068</b>

(A) Cost of frame work :—

Add extra for cost of steel $\frac{2,298 \times 70}{20}$	1,43,987
	8,043
Add extra for cost of cement $\frac{816.58 \times 15}{20}$	613

**TOTAL** **1,52,643**

∴ Rate per sq ft. of godown space  $\frac{1,52,643}{26,226}$  . . . . . 5.82

(B) Cost of filler work

Add extra for cost of steel $\frac{69.91 \times 70}{20}$	1,33,081
	245
Add extra for cost of cement $\frac{3,439 \times 15}{20}$	2,579

**TOTAL** **1,35,905**

∴ Rate per sq. ft. of godown space =  $\frac{1,35,905}{26,226}$  . . . . . 5.12

APPENDIX III

ABSTRACT OF COST—SHELL TYPE (35' × 90')

Item	Quantity	Rate Rs.	Unit	Amount Rs.
<i>A. Frame work</i>				
1. Excavation . . . . .	4,232 cft	33 0 0	1000 cft.	140
2. Lean concrete mix. 1:5:10 . . . . .	265 cft	93 0 0	100 cft.	246
3. Concrete in foundation mix 1:2:4 . . . . .	1,208 cft	2 3 0	cft.	2,643
4. RCC in columns mix 1:2:4 . . . . .	653 cft	2 8 0	cft.	1,633
5. RCC in beams of frames mix 1:2½:5 . . . . .	2,490 cft	2 8 0	cft.	6,225
6. RCC in shell roof mix 1:2½:5 . . . . .	6,530 cft	2 5 0	cft.	15,101
7. RCC in projected slab portion mix 1:2½:5 . . . . .	1,105 cft	2 0 0	cft.	2,812
8. Centring and shuttering for shell roof. . . . .	25,618 sqft	1 4 0	sft	32,023
9. -D3- for projected slab portion. . . . .	6,747 sqft	0 7 0	sft	2,952
10. M.S. Bars. . . . .	996 cwts	42 0 0	cwt.	41,823
11. Copper cradle for expansion joints in roof & columns . . . . .	1,108 lbs	2 2 0	lb.	2,355
12. Tarfelt in two courses . . . . .	32,330 sqft	45 0 0	100 sft.	14,549
13. Ordinary wired glass . . . . .	1,152 sqft	1 14 0	sft.	2,160
			TOTAL	<u>1,24,671</u>

*B. Filler Work*

1. Earth work in excavation . . . . .	9,957 cft	33 0 0	1000 cft	329
2. Earth work in filling . . . . .	57,450 cft	85 0 0	1000 cft	4,883
3. River sand under floors . . . . .	21,626 cft	17 0 0	100 cft	3,676
4. Lean concrete 1:5:10 . . . . .	12,650 cft	93 0 0	100 cft	11,765
5. D.P.C. with pudlo . . . . .	802 sqft	65 0 0	100 sft	531
6. Hot bitumen painting (water proofing) . . . . .	30,332 sqft	15 0 0	100 sft	4,550
7. Lintels and beams . . . . .	650 cft	2 8 0	cft	1,625
8. M.S. Reinforcement . . . . .	3,312 lbs	0 6 0	lb.	1,242
9. B.W. in foundations and plinth . . . . .	10,351 cft	97 0 0	100 cft.	10,040
10. B.W. in superstructure . . . . .	11,460 cft	116 0 0	100 cft	13,294
11. Type V ventilator . . . . .	160 sft	6 2 0	sft	980
12. Type VI ventilator . . . . .	320 sft	5 11 0	sft	1,820
13. Type V2 ventilator . . . . .	128 sft	6 2 0	sft	784
14. Grills . . . . .	128 sft	3 2 0	sft	390
15. Rolling shutters . . . . .	1,024 sft	6 12 0	sft	6,912
16. Hold fasts . . . . .	160 Nos.	0 13 0	each	130
17. 1½" C.C. flooring & ½" ironite . . . . .	28,800 sft	123 0 0	100 sft	35,424
18. ½" thick plaster . . . . .	12,350 sft	12 8 0	100 sft	1,545
19. Pointing . . . . .	13,730 sft	10 0 0	100 sft	1,373
20. White washing . . . . .	47,790 sft	1 3 0	100 sft	543
21. Painting wood work . . . . .	750 sft	17 12 0	100 sft	133
22. Painting steel work . . . . .	2,048 sft	18 8 0	100 sft	379
23. Plaster Band . . . . .	288 rft	0 3 0	rft	54
24. 6" C.I. pipe . . . . .	324 rft	4 10 0	rft	1,499

**APPENDIX III—concl.**

1	2	3	4	5
25. 6" heads . . . . .	18 Nos.	6 8 0	each	117
26. 6" bends . . . . .	18 Nos.	6 8 0	each	118
27. 6" Tee . . . . .	9 Nos.	6 8 0	each	59
28. 6" S. Pipe . . . . .	810 rft	5 4 0	rft	4,253
29. Joints of 6" S.S. pipe . . . . .	91 Nos.	9 8 0	each	865
30. 9" S. pipe . . . . .	362 ft.	8 12 0	rft	3,168
31. Joints of 9" S & S pipe . . . . .	41 Nos.	15 0 0	each	615
32. Brick masonry chamber . . . . .	9 Nos.	120 9 0	each	1,085
33. 9" open surface drain . . . . .	560 rft	2 3 0	rft	1,225
34. Reducers . . . . .	9 Nos.	6 8 0	each	59
35. Plinth protection . . . . .	648 sft	57 8 0	100 sft	373
36. Wooden fenders . . . . .	296 rft	2 0 0	rft	592
37. Making connection of drains . . . . .	9 Nos.	5 8 0	each	50
<b>TOTAL</b>				<u>1,16,480</u>

(a) Total Plinth Area =  $281' - 1\frac{1}{2}" \times 108' - 0" = 30,361$  Sq. ft.

(b) Godown Area =  $278' - 10\frac{1}{2}" \times 88' - 10\frac{1}{2}" = 24,785$  Sq. ft.

Total Cost.

A. Cost of Frame Work = Rs. 1,24,671

B. Cost of Filler Work = Rs. 1,16,480

**TOTAL** Rs. 2,41,151

(A) Cost of frame work . . . . .		Rs.
Add extra for cost of steel	$\frac{996 \times 70}{20}$	1,24,671 3,486
Add extra for cost of cement	$\frac{2,098 \cdot 68 \times 15}{20}$	1,574
<b>TOTAL</b>		<b>Rs. 1,29,731</b>
∴ Rate per sq. ft. of godown space =	$\frac{1,29,731}{24,785}$	5.24

(B). Cost of filler work . . . . .		Rs.
Add extra for cost of steel	$\frac{39 \times 70}{20}$	1,16,480 137
Add extra for cost of cement	$\frac{3,242 \cdot 10 \times 15}{20}$	2,432
<b>TOTAL</b>		<b>Rs. 1,19,049</b>
∴ Rate per sq. ft. of godown space	$\frac{1,19,049}{24,785}$	4.80

NOTE :—Making allowance for some filler work between expansion joints of columns etc. the rate per sq. ft. of Godown space may be taken as Rs. 4.95.

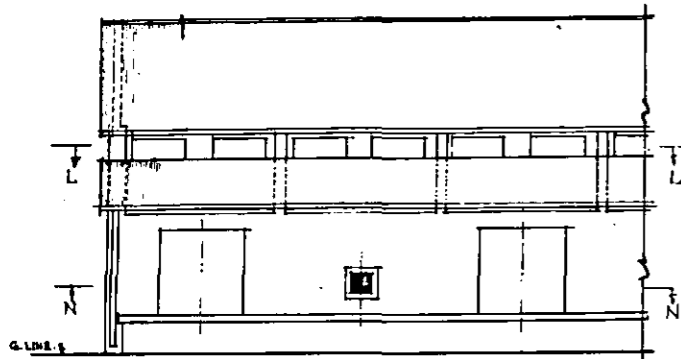

PART ELEVATION.

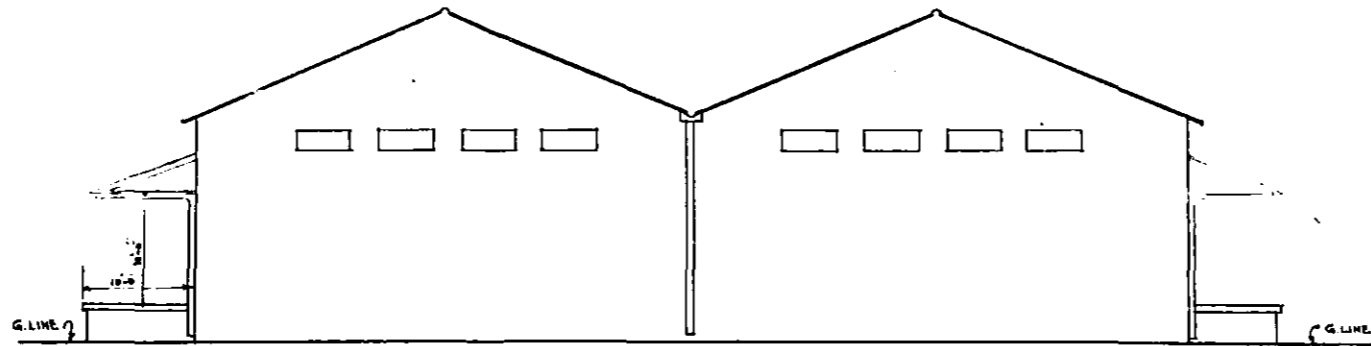

SIDE ELEVATION.

SCHEDULE OF DOORS & WINDOWS.			
TYPE	DESCRIPTION.	SIZE	REF. G/311/23
D	OPENING WITH ROLLING SHUTTERS.	8'-0" 8'-0"	G/109/1.
V	OPENING WITH FIXED GLAZING AND R.C. FABRIC.	5'-0" 2'-0"	n
V <sup>1</sup>	OPENING WITH WIRE MESH ONLY.	5'-0" 2'-0"	n
V <sup>2</sup>	OPENING WITH GLASS LOUVERS, GRILLWORK AND - WIRE MESH.	2'-0" 2'-0"	n

PLATE NO I.

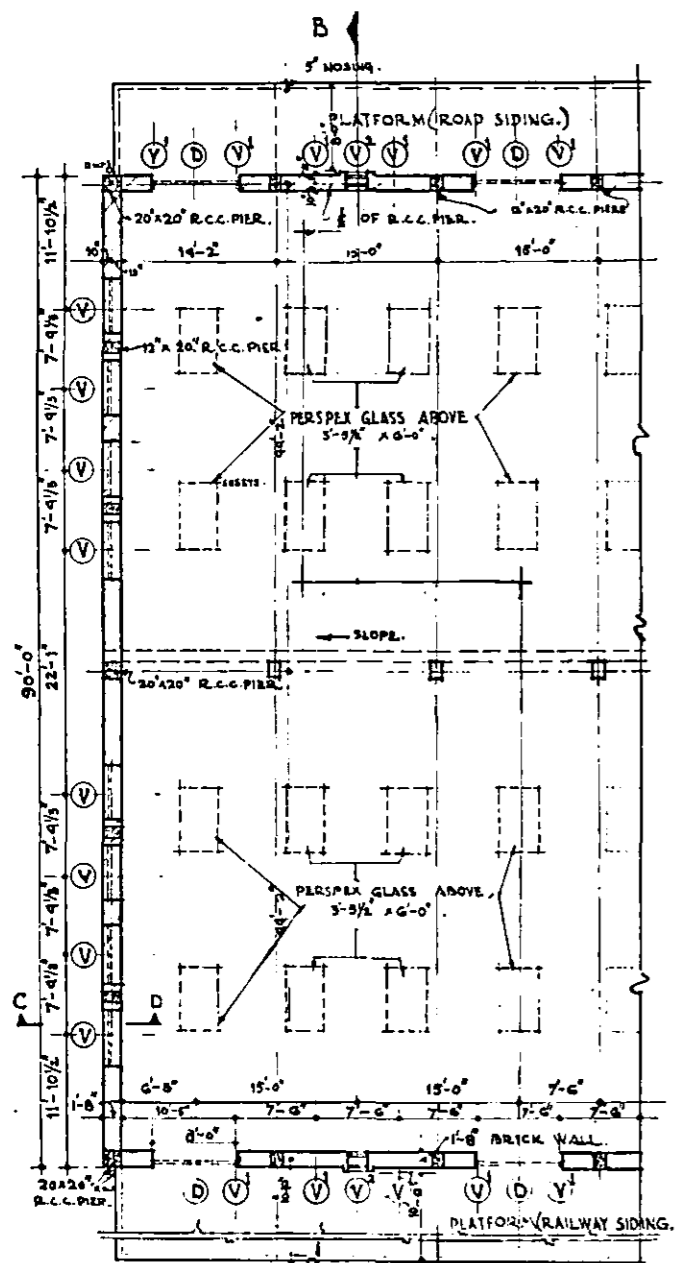

PART PLAN.

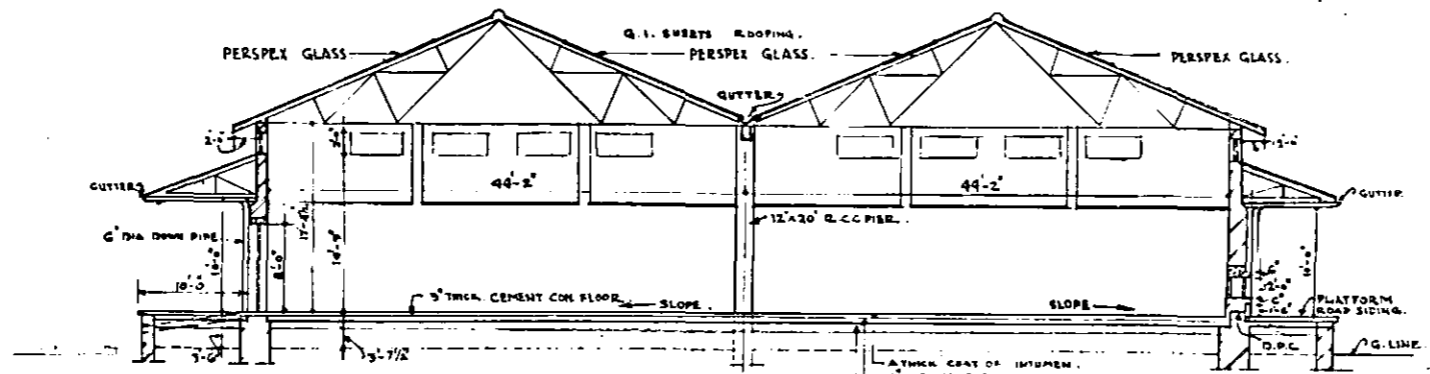

SECTION ON AB.

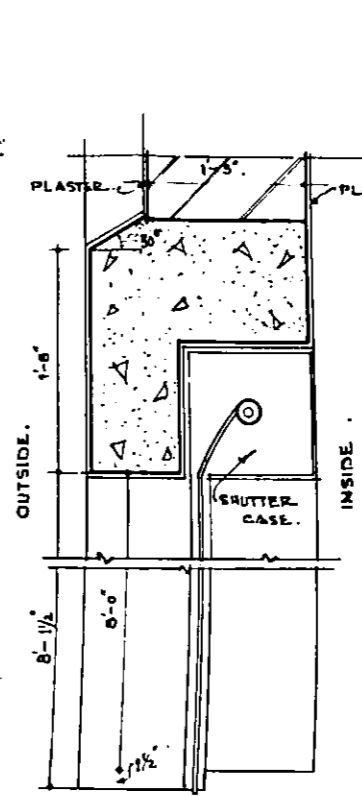

1/8 F.S. SECTION.

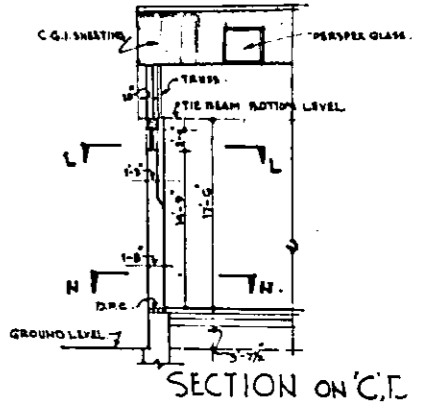

SECTION ON C,C.

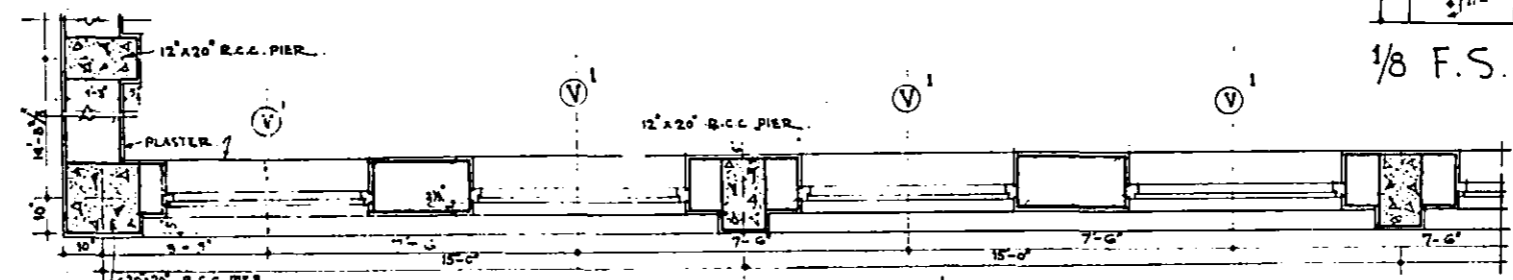

1/2 SCALE DETAIL PLAN AT 'L,L'.

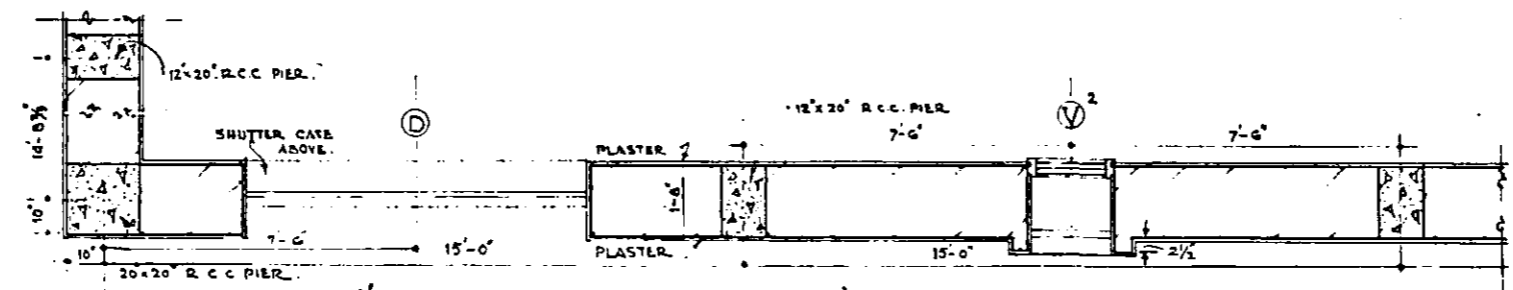

1/2 SCALE DETAIL PLAN AT 'N,N'.

PLATFORM.

FOOD GRAIN STORAGE GODOWN.

TYPE DESIGN.

PLAN, ELEVATIONS, SECTION & HALF INCH DETAILS.

SCALE:- 1/8", 1/2" & 1/8" FULL SIZE.

ADDITIONS & ALTERATIONS:-  
 G/311/1. DATED 27/1/55.  
 IN EVERY ALTERNATE BAY EXTRA PERSPEX GLASSES ADDED.  
 G/311/2. DATED 22.3.56.  
 CERTAIN DIMENSIONS CORRECTED  
 G/311/3 DATED 5-12-56  
 PLATFORM INCREASED FROM RAILWAY SIDING.

DRAWN BY: *Jan A. R.*  
 TRACED BY: *Jan A. R.*

CHECKED BY:

*Jan A. R.*  
 25/1/55  
 ASST. ARCHITECT.

*T. J. Hancock*  
 20/1/55  
 B.E., B. ARCH. (L. POOL)  
 F.R.I.B.A., A.M.T.P.I.  
 SENIOR ARCHITECT.  
 C.P.W.D. NEW DELHI.

G/311/23

NOTE:- THE DIMENSIONS AS REGARD TO THE THICKNESS OF WALLS ARE BASED ON 4" x 13" BRICK. WHERE THE DIMENSIONS OF A BRICK IS 2 1/4" x 3". THE THICKNESS OF WALLS SHALL BE 9.13" IS IN PLACE OF 10.15. 20" RESPECTIVE..Y.

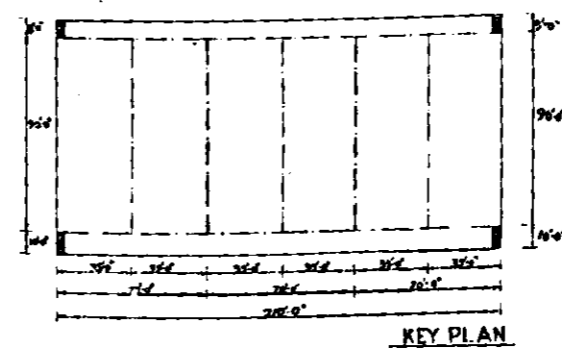
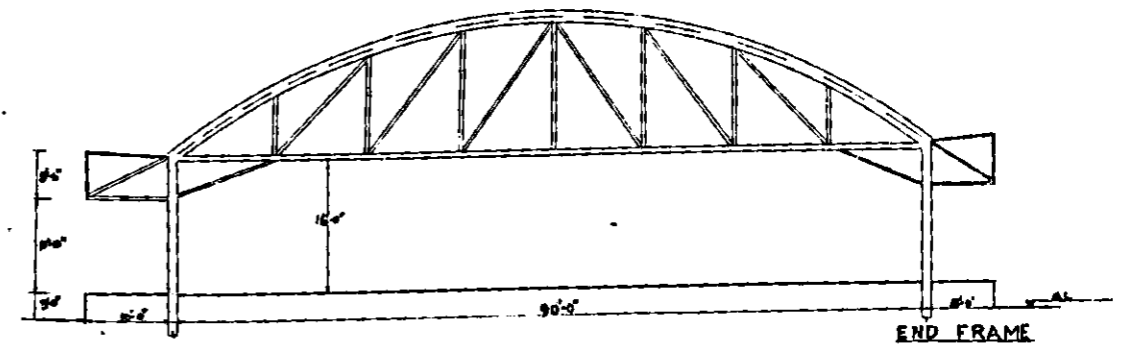
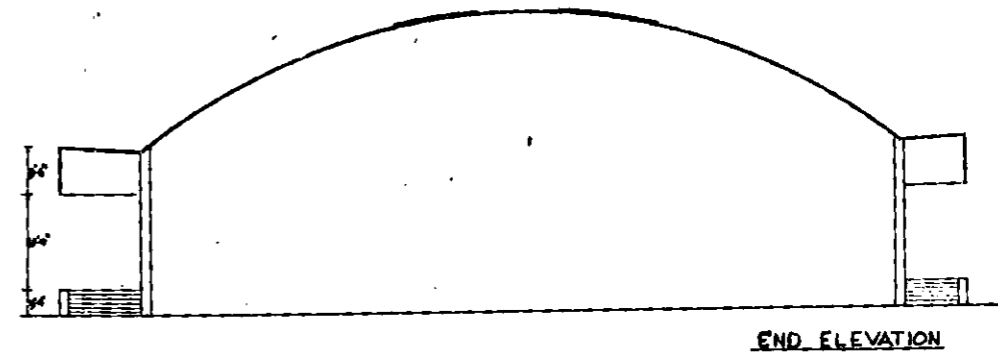
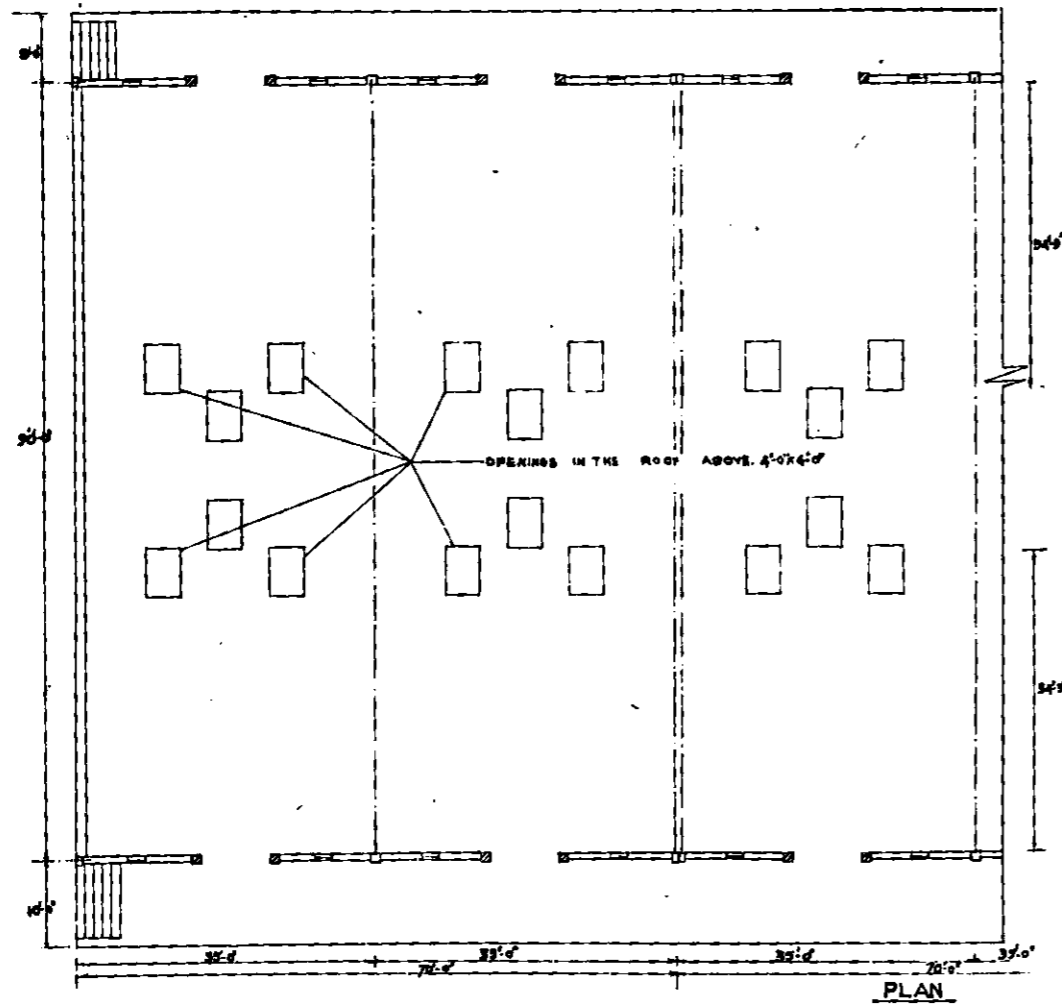
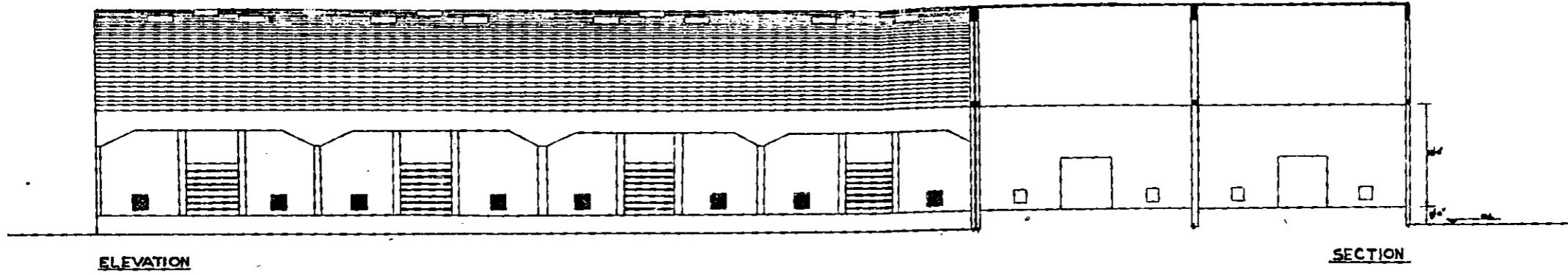

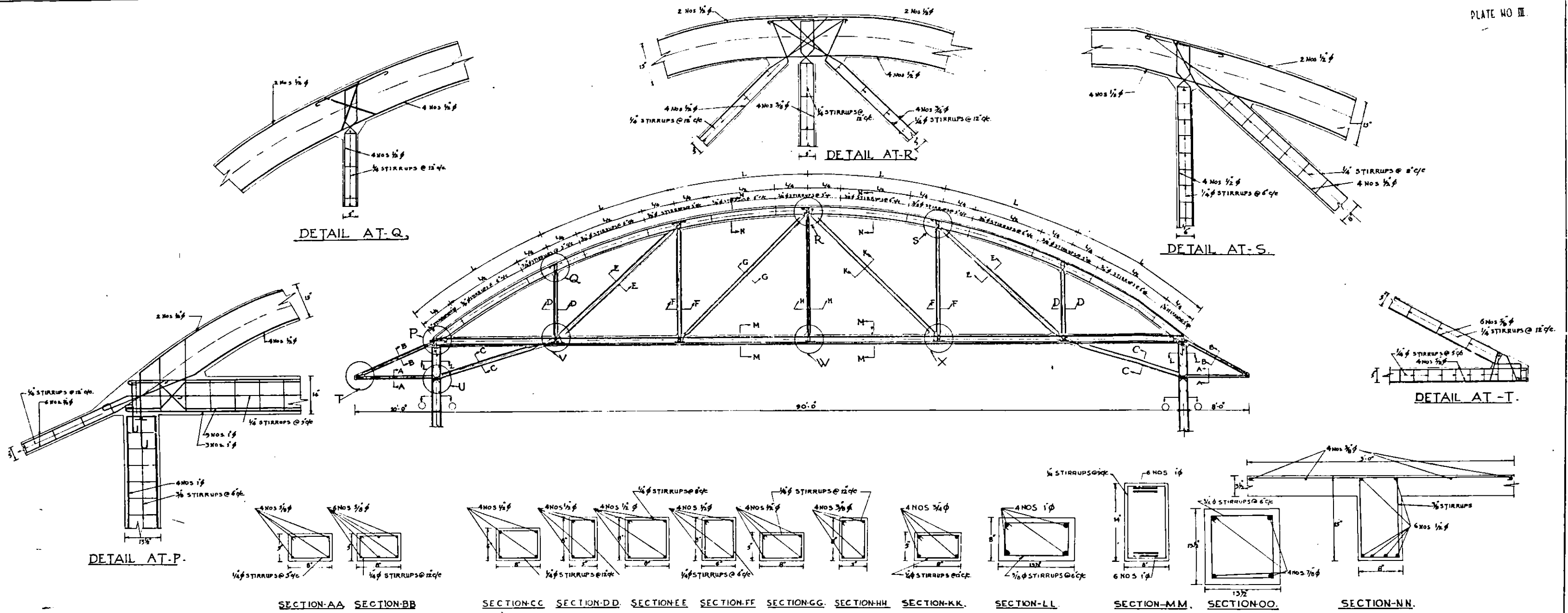

INTERMEDIATE FRAME

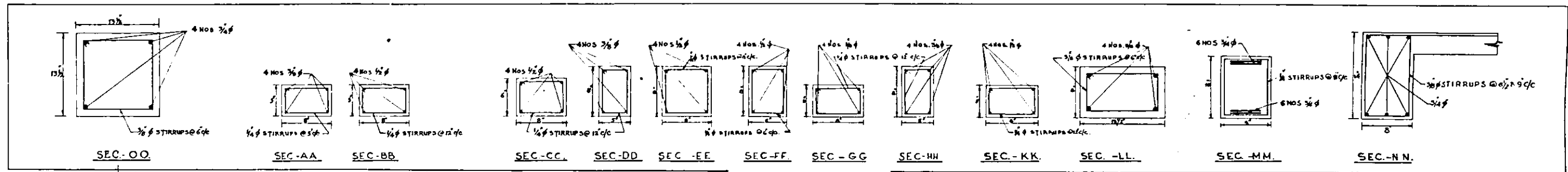

END FRAME

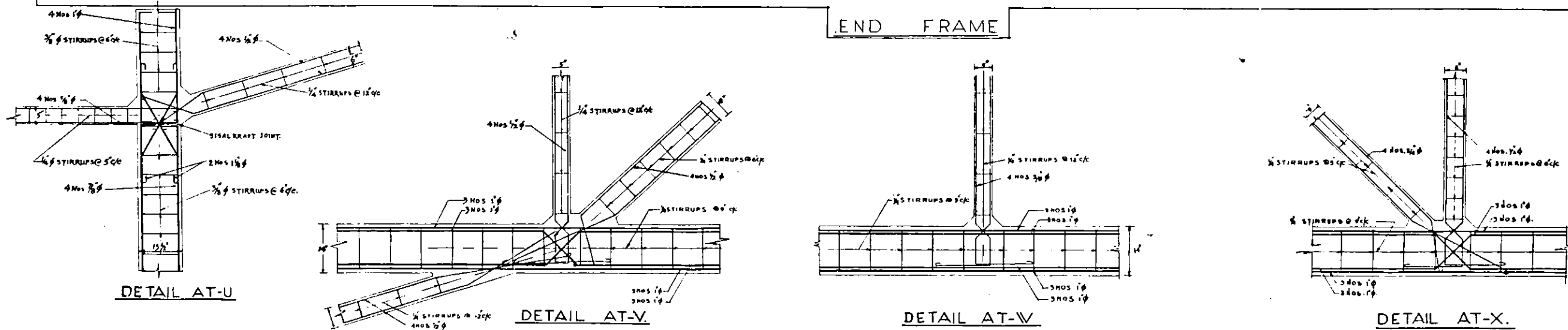

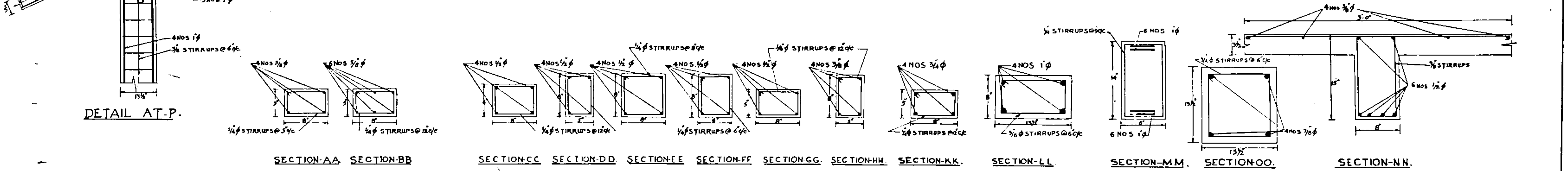
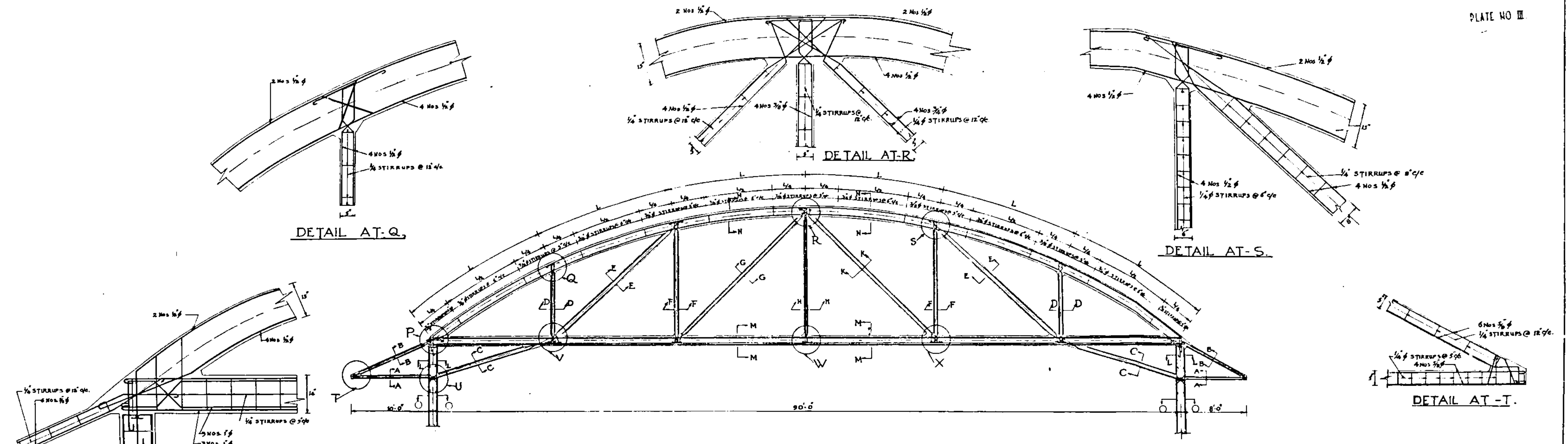

INTERMEDIATE FRAME

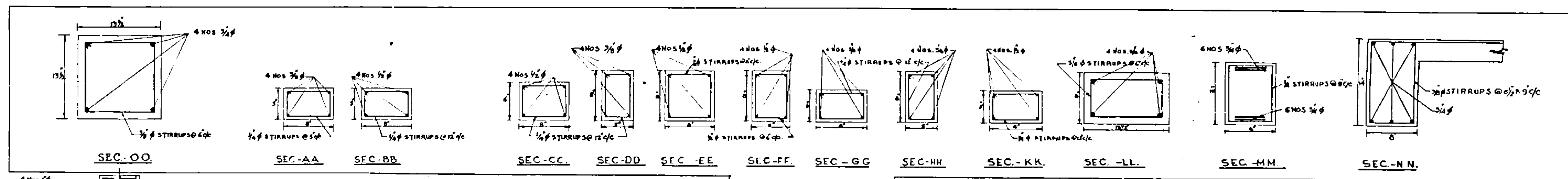

END FRAME

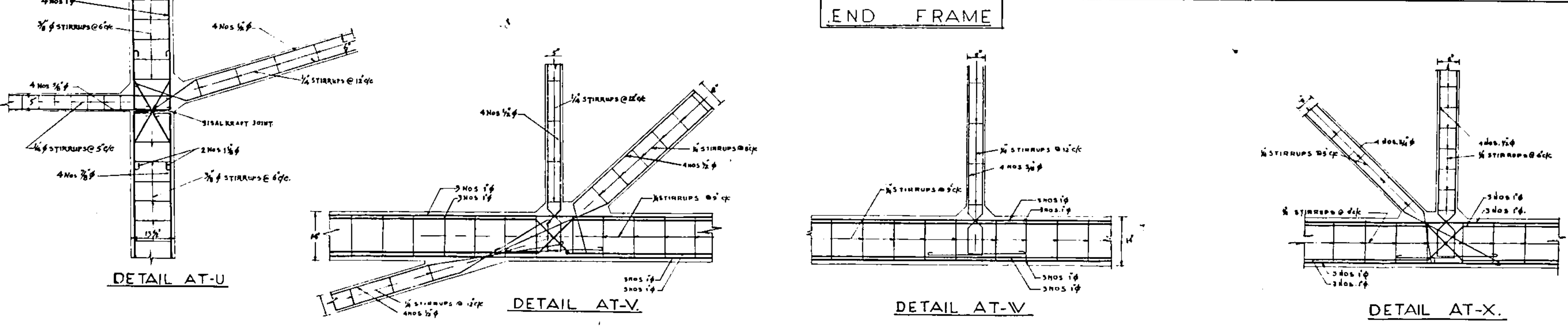

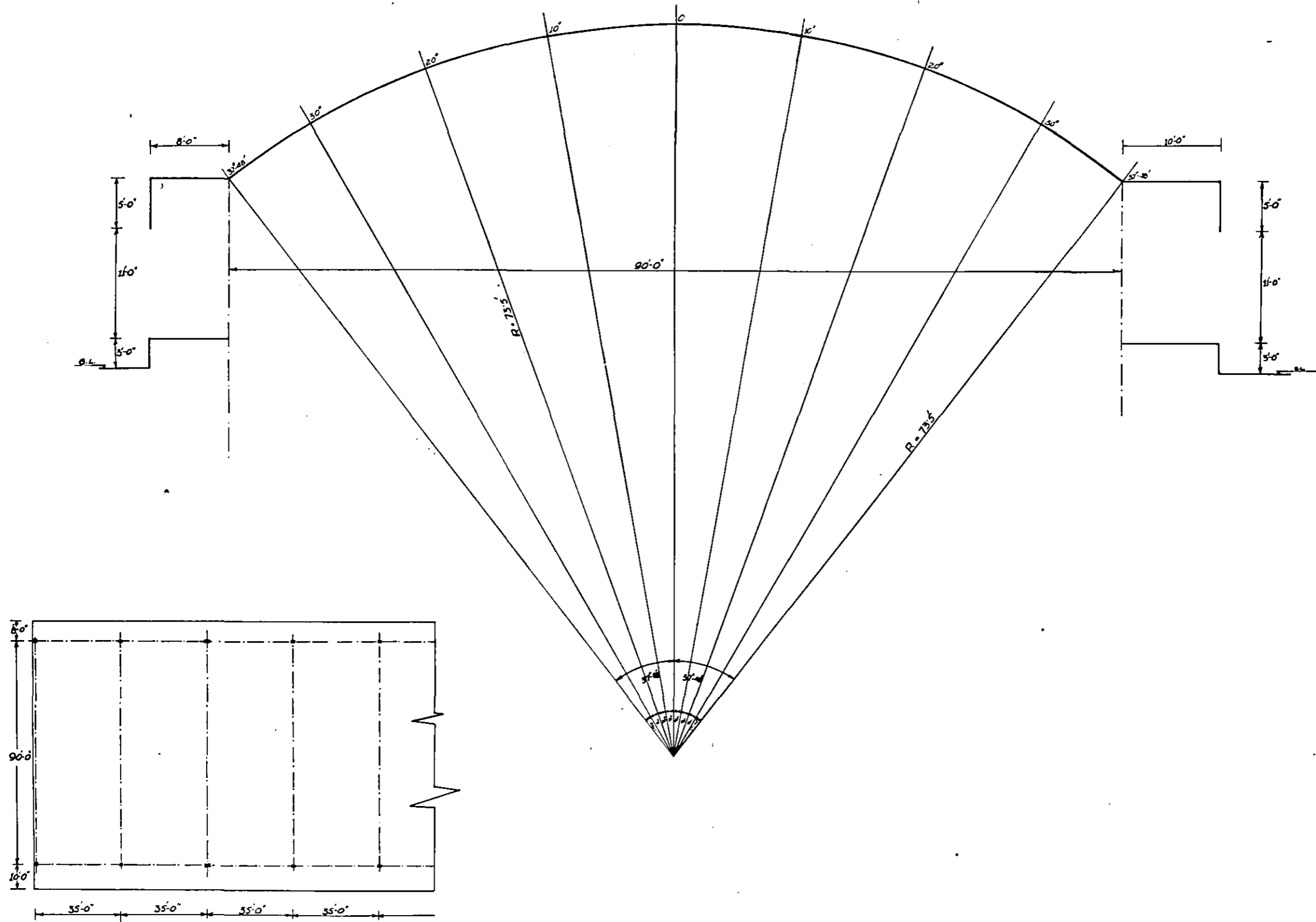





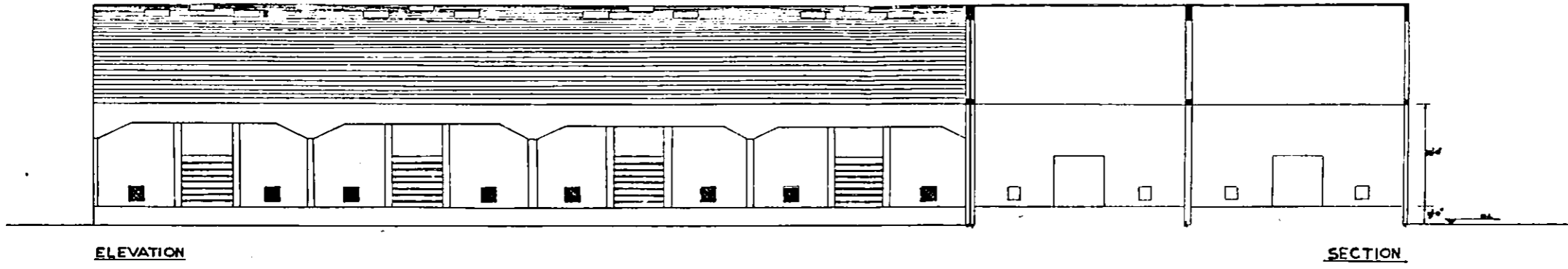

ELEVATION

SECTION

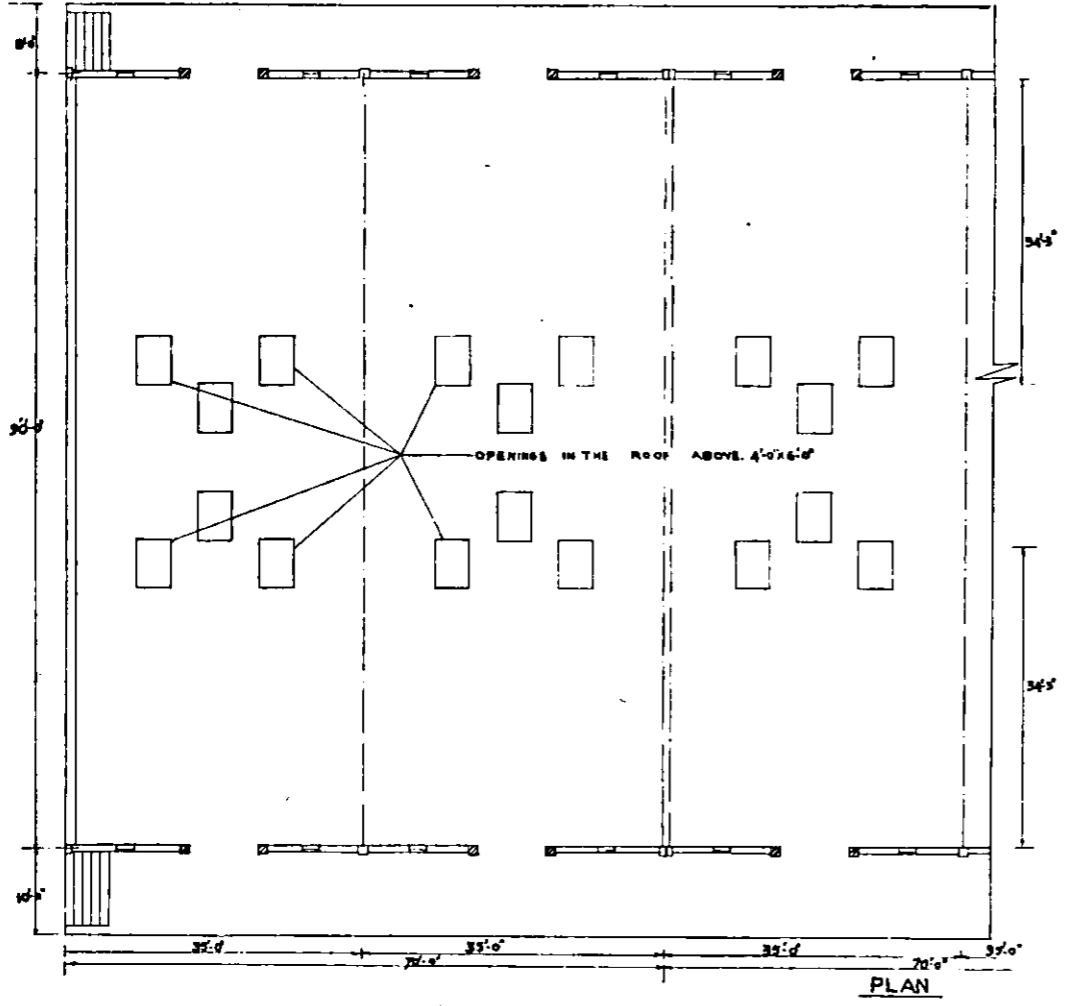

PLAN

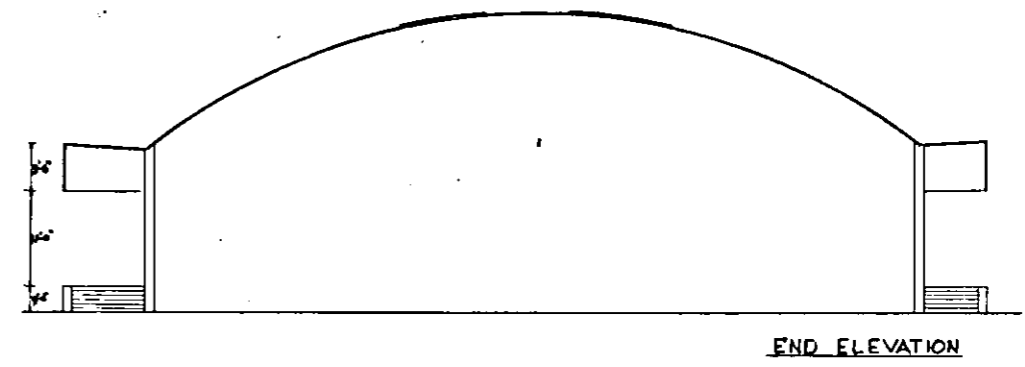

END ELEVATION

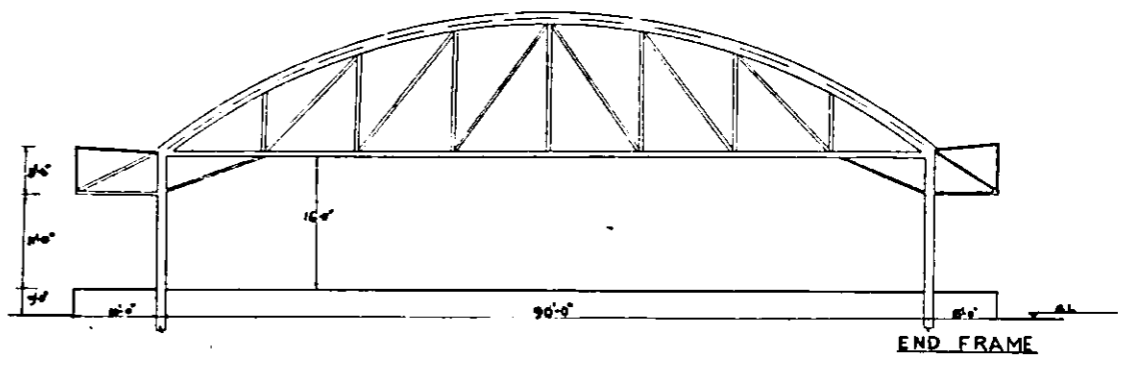

END FRAME

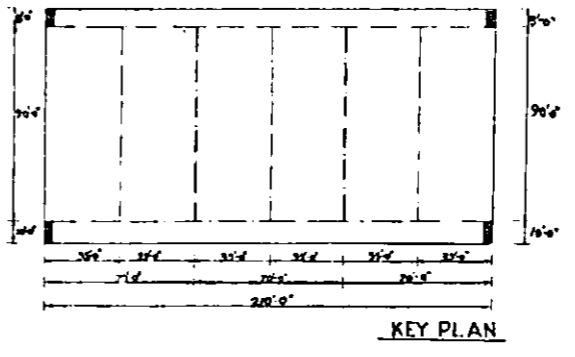

KEY PLAN

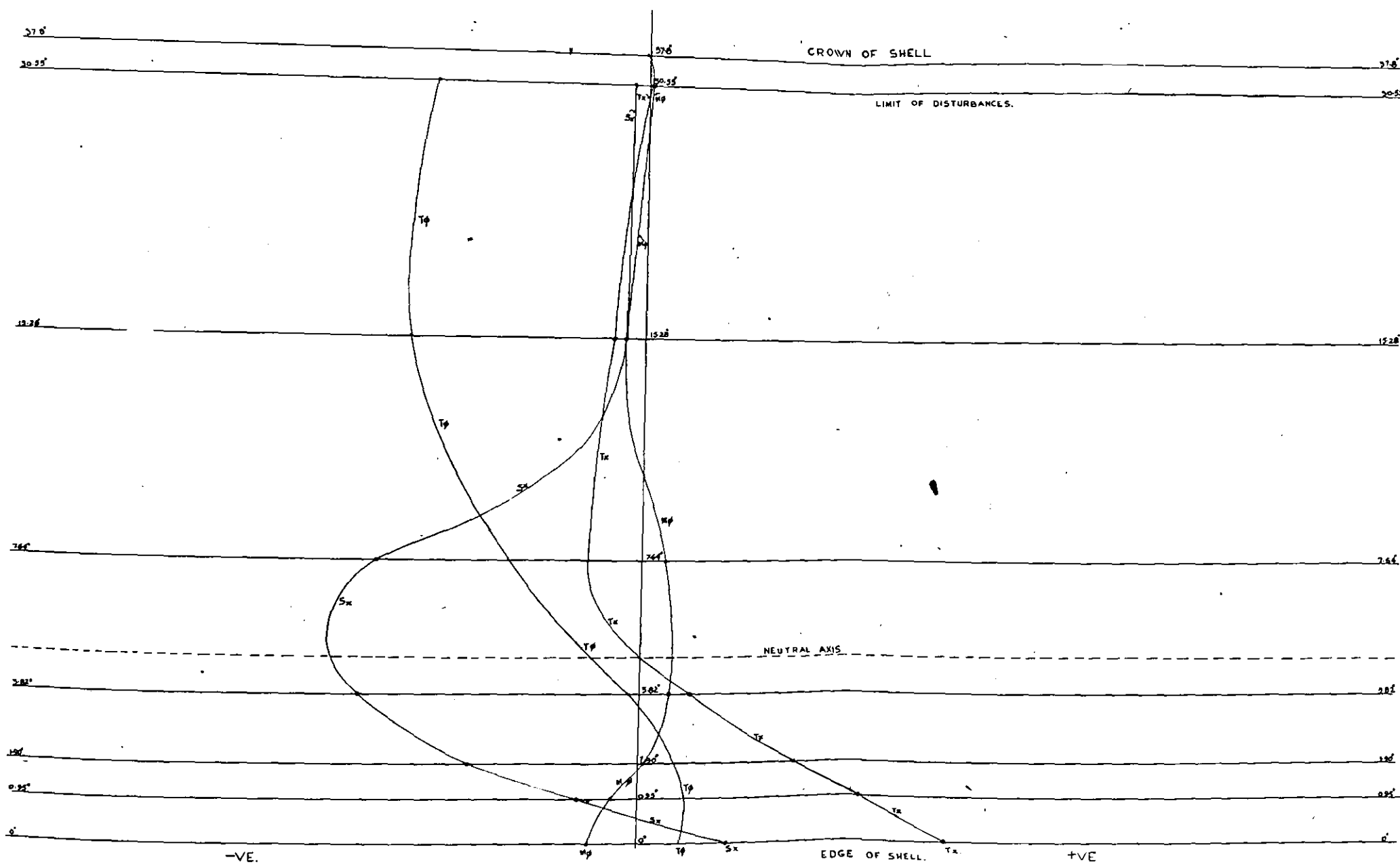

SCALE FOR DIFFERENT CURVES

- $T_x$ , 1cm. = 2500 lbs/FT.
- $T_\phi$ , 1cm. = 500 lbs/FT.
- $S_x$ , 1cm. = 500 lbs/FT.
- $M_\phi$ , 1cm. = 250 FT.lbs/FT.