

Fundamentals of POWER PLANT ENGINEERING

by

GEORGE E. REMP, B.S.M.E., M.S.E., M.E.

*Assistant Professor of Mechanical Engineering
University of Florida*

Member, The American Society of Mechanical Engineers

Member, The National Society of Professional Engineers

THE NATIONAL PRESS

MILLBRAE, CALIFORNIA

COPYRIGHT 1949
by
George E. Remp

Printed in the United States of America
from the
Author's Typescript
by
THE NATIONAL PRESS
Millbrae, Cal.

Dedicated to my wife
Carolyn Perkins Remp
and to my son
George E. Remp, Jr.

ERRATA AND REVISIONS
FUNDAMENTALS OF POWER PLANT ENGINEERING

by
GEORGE E. REMP

Page 9, first line after Table I: "load" should read "demand."

Page 10, second line in solution of Example 1: "load" should read "demand."

Page 11, equation in 3rd line from bottom of page: "5.3" should read "5.9."

Page 37, last paragraph on page should read:

Make a block meter rate which will recover the fixed element in the first 8 kwh per customer per month; the customer element in the next 15 kwh per customer per month; and the energy and profit elements from the excess over 23 kwh per customer per month.

Page 39, load table in Example 4: "11.2" in hours from 6 - 7 and 7 - 8 AM should read "12.2."

Page 39, 15th line from bottom of page: Annual fuel cost "\$363" should read "\$3630."

Page 39, 10th line from bottom of page: Total annual energy element "\$10803" should read "\$14070."

Page 40, section E of Example 4 should read:

E. Block meter rate:

First block:

$$\text{rate} = \frac{\$18730}{12(8000)} = \$0.195/\text{kwh for first 8 kwh}$$

Second block:

$$\text{rate} = \frac{\$27855}{12(15000)} = \$0.155/\text{kwh for next 15 kwh}$$

(continued next page)

Third block:

$$\text{rate} = \frac{\$14070 + \$15750}{12\left[\frac{365(1653)}{12} - 23000\right]} = \$0.091/\text{kwh for excess over 23 kwh}$$

Page 41, section B of Example 5: Total annual energy element "\$10803" should read "\$14070."

Page 41, section E of Example 5 should read:

E. Block meter rate:

First block:

$$\text{rate} = \frac{\$19148}{12(8000)} = \$0.199/\text{kwh for first 8 kwh}$$

Second block:

$$\text{rate} = \frac{\$28235}{12(15000)} = \$0.157/\text{kwh for next 15 kwh}$$

Third block:

$$\text{rate} = \frac{\$14070 + \$15750}{12(27300)} = \$0.091/\text{kwh for excess over 23 kwh}$$

Page 43, 10th line from bottom of page: Machine shops "7 AM to 5 PM" should read "8 AM to 5 PM."

Page 44, last paragraph should read:

(e) Set up a block meter rate which will recover the fixed element in the first 30, the customer element in the next 40 and the energy and profit elements in the excess over 70 kwh per customer per month.

Page 46, Figure IV-2: Designations of points 5_a and 5_b should be reversed.

Page 98, solution of Example 9: Last term in denominator of expression for U, " $\frac{0.75}{0.652}\left[\frac{1}{3000}\right]$ " should read " $\frac{C.75}{C.652}\left[\frac{1}{1615}\right]$ "

Page 115, 5th line from bottom of page: "on of the" should read "one of the."

Page 136, solution of Example 18: Last term in equation for M_{gd} , "0.025" should read "0.038."

Page 150, solution of Example 20: Numerator of equation for SH, "497" should read "407" and "0.24[535 - 70]" should read "0.24[535 - 70][14.82]." Add the following note: See Example 24 for determination of $M_{gs} = 14.82$.

Page 161, 5th line from bottom of page: "~~29(12)~~/4.5" should read "20(12)/4.5."

Page 162, solution of Example 22-A beginning at the third line from the top of the page should read:

If the superheater is disposed in two of three boiler passes, each pass will be 20 ft wide by 6.67 ft deep. Then the area for gas flow between the superheater tubes will be $(53 - 1)(4.5 - 2)(6.67)/12 = 72.3$ sq ft.

The mass flow of gas between the tubes will be:

$$v_g = \frac{291000}{3600(72.3)} = 1.12 \text{ lbs/sec/sq ft}$$

$$\text{and, } h_g = \frac{0.41(1.12)^{0.855} (2048)^{0.315}}{(2.0/12)^{0.415}} = 10.12$$

Then, the overall coefficient of heat transfer is:

$$U = (0.90) \frac{1}{\frac{1}{10.12} + \frac{4.0}{2.0 + 1.67 \left[\frac{0.165}{12(20)} \right]} + \frac{2.0}{1.67 \left[\frac{1}{236} \right]}} = 8.65$$

Superheater area is:

$$A = \frac{50,600,000}{8.65(260)} = 6800 \text{ sq ft}$$

Each foot of superheater tube has an area of $2\pi/12 = 0.523$ sq ft. There will be $6800/0.523 = 13000$ linear feet of tube, and the length of each element will be $13000/53 = 246$ feet.

Page 186, solution of Example 26-A: Viscosity " $\mu = 0.025$ " should read " $\mu = 0.022$ " and Reynolds' number " $r = 1,485,000$ " should read " $r = 1,690,000$."

Page 188, solution of Example 26-B, add at top of page:

$$\Delta h = 0.745 \frac{(0.041)(682)(2.91)^3}{3.548} = 49.5 \text{ ft of oil}$$

Page 207, Example 30, add the following:

Note: The above method of expressing entrance and exit losses is often used. Another method would be to express the entrance and exit losses as equivalent lengths of straight pipe added to the fittings, etc., when calculating the friction losses.

Page 239, 12th line from bottom of page: "states in" should read "stated in."

Page 246, equation for draft produced by a stack should read:

$$h = 0.254 B H \left(\frac{1}{T_a} - \frac{1}{T_g} \right) - 1.49 \times 10^{-5} \frac{f H W_g^2}{\rho D_i^5}$$

where: W_g = weight of flue gas, lb per hr

"f = 0.0013" for steel stacks should read "f = 0.013"

"f = 0.0018" for brick lined stacks should read

"f = 0.018."

Page 248, last part of solution of Example 34 should read:

Then, by trial in the equation for stacks:

$$0.6 = 0.00384 H - 43.4 \frac{H}{D_i^5}$$

H	160	170	180	190	200	210
D_i	13.60	10.70	9.68	9.11	8.76	8.50
HD_i	2180	1810	1740	1730	1750	1785
D_i/H	0.085	0.063	0.054	0.048	0.044	0.041

It can be seen that the product HD_i has reached a minimum at a stack height of 190 ft. This stack height by chance produces a diameter which falls within the stability range for the parameter D_i/H .

PREFACE

This book is the outgrowth of the author's experience in operating power plants and in teaching power plant engineering to students in mechanical, electrical and chemical engineering. The principal portion of the material is confined to steam power plants and is presented in what the author has found to be a logical sequence, beginning with a study of load curves and power plant economics and progressing through vapor cycles and a detailed examination of the fundamental principles of the various plant components. Chapters are added, as a matter of interest, on the subjects of the economics of load division and Diesel-electric, hydro-electric and gas turbine power plants. No attempt is made to treat the subject of power plant wiring, as this subject properly belongs to the field of the electrical engineer.

The presentation of the material in this book is based on the assumption that it will be presented as a one-semester course, and that the student is familiar with the fundamentals of engineering thermodynamics. The author prefers the project method of presentation of problems to the student because he has found that the method has the advantage of making it possible to integrate the problems into a whole which has meaning to the student. Examples are given in the text in sufficient quantity and detail to guide the student in the execution of the projects. Only one series of projects is given in the text as an aid to the instructor in preparing additional projects from materials out of his own experience.

In order to hew to the line of fundamentals, it has been found necessary to say little about the minor details of design and operation, because these only serve to obscure the job at hand, which is to give a broad picture of power plant engineering in a limited time. It is expected that the instructor will make free use of visual aids, such as motion pictures and plant inspection trips, to supplement and clarify the presentation in the text. A bibliography of selected references is given at the end of each chapter for the benefit of those students who would delve more deeply into this extremely important and intensely interesting subject.

It is a pleasure for the author to acknowledge with thanks the encouragement and assistance of Professors Newton C. Ebaugh, John A. Dent and Paul C. Hoffman of the Mechanical Engineering Department of the College of Engineering of the University of Florida; Mr. Robert B. Cowan, Engineer-Manager of the Utilities Department of the City of Jacksonville, Florida; and Mr. J. H. White, Vice-President of the Florida Power and Light Company of Miami, Florida. Thanks are also due to Mr. L. N. Rowley, Executive Editor of *Power* for permission to use many of the illustrations which originally appeared in that excellent magazine, and to Mr. L. K. Gaventa for his capable aid in making the many drawings necessary in a work of this type.

The author wishes to thank the many manufacturers and engineers who have contributed illustrations and information. An effort has been made to see that proper credit lines are attached.

George E. Remp

Gainesville, Florida
July, 1949

CONTENTS

	page
<i>Preface</i>	v
CHAPTER I	
Introduction.....	1
Growth of Power Generation in the United States. Improvement in Thermal Efficiency of Steam Power Plants. Progress in Hydro and Internal Combustion Power. Power Systems. Public Utility Organization.	
CHAPTER II	
Load Curves.....	8
Demand and Diversity. Load Curves. Factors Used in Operation Analysis. Determination of Size of Equipment.	
CHAPTER III	
Economics of Power Production.....	25
Power Plant Income. Public Utilities as Monopolies. Rates. The Fixed Element. The Energy Element. The Variable Load Element. The Customer Element. The Investor's Profit. Types of Rates. Project I.	
CHAPTER IV	
Vapor Power Cycles.....	45
Carnot Cycle. Rankine Cycle. Engine Efficiency. Reheating Cycle. Regenerative Cycle. Reheating-Regenerative Cycle. Field Cycle. Superposed Cycle. Binary Cycles.	
CHAPTER V	
Prime Movers.....	67
Steam Engines. Estimation of Steam Engine Dimensions. Steam Turbines. Engine Efficiencies and Willans' Line for Steam Turbines.	
CHAPTER VI	
Condensers, Feed-Water Heaters and Evaporators.....	89
Condensers. Mixing Condensers. Surface Condensers. Heat Transfer in Surface Condensers. Commercial Heat Transfer Standards for Surface Condensers. Feed-Water Heaters. Open Heaters. Closed Heaters. Vacuum Pumps.	

Water Cooling Equipment. Evaporators. Project II.	
CHAPTER VII	
Fuels and Combustion.....	117
Coal. Fuel Oil. Natural Gas. Combustion. Heating Value of Fuels. Flue Gas Analysis.	
CHAPTER VIII	
Steam Generators.....	130
Steam Generator Efficiency. Fire-Tube Boilers. Water-Tube Boilers. Heat Transfer in Boilers. Water-Cooled Furnaces. Furnace Refractories and Insulation.	
CHAPTER IX	
Superheaters, Reheaters, Economizers and Air Heaters.....	156
Superheaters. Heat Transfer in Superheaters. Reheaters. Economizers. Heat Transfer in Economizers. Air Heaters. Heat Transfer in Air Heaters. Apportionment of Heating Surface.	
CHAPTER X	
Piping and Duct-Work.....	175
Piping. Friction in Condensers and Feed-Water Heaters. Duct-Work. Pipe and Duct Insulation. Project III.	
CHAPTER XI	
Water Handling Equipment.....	200
Types of Pumps. Head and Work Relations in Pumps. Pump Efficiencies. Laws of Similarity for Centrifugal Pumps. Water Treatment. Precipitation Softening. Base Exchange Softening. Boiler Water Treatment.	
CHAPTER XII	
Fuel Handling Equipment.....	221
Gas Burning Equipment. Fuel Oil Burning Equipment. Coal Burning Equipment. Stokers. Pulverizers. Pulverized Coal Burners. Horizontal Cyclone Burner. Furnace Bottoms. Multiple Fuel Burning Installations. Ash Removal Systems. Dust Collectors.	
CHAPTER XIII	
Draft Equipment.....	236
Fans. Head and Work Relations in Fans. Fan Speeds. Draft Losses. Stacks.	
CHAPTER XIV	
Supervisory and Control Equipment.....	249
Temperature. Pressure. Speed. Fluid Level. Combustion. Chemical Characteristics. Fluid Flow.	

CONTENTS

ix

CHAPTER XV

The Complete Power Plant.....265
Details of Design. Power Plant Buildings. Project IV.

CHAPTER XVI

Economics of Load Division.....280
The Incremental Rate Theory. Division of Load. Load-
ing Schedules. Applications of the Incremental Rate
Method.

CHAPTER XVII

Diesel-Electric Power Plants.....286
Two-Stroke Diesel Cycle. Four-Stroke Diesel Cycle.
The Ideal Diesel Cycle. Supercharging. Diesel Engine
Efficiencies. Diesel Engine Auxiliaries.

CHAPTER XVIII

Hydro-Electric Power Plants.....295
Impoundment Methods. Water Storage. Hydraulic Tur-
bines.

CHAPTER XIX

Gas Turbine Power Plants.....:...303
Gas Turbine Cycles. Gas Turbine Plants.

Appendix.....307

Index.....339

LIST OF TABLES

Table	Page
I. Demand and Diversity Factors.....	9
II. Approximate Power Plant Capital Costs.....	29
III. Probable Life of Power Plant Components.....	31
IV. Design Data for Steam Engines.....	71
V. AIEE-ASME Standardized Turbine Generator Units.....	76
VI. Thermal Conductivity of Metals.....	95
VII. Standard Condenser Tube Data.....	96
VIII. Analyses of Typical American Coals.....	118
IX. Analyses of Typical Fuel Oils.....	119
X. Analyses of Typical Natural Gases.....	119
XI. Heating Value of Coal Based on Proximate Analysis.....	127
XII. Furnace Heat Release.....	147
XIII. Radiation Coefficients.....	152
XIV. Gas Mass Flows and Coefficients of Heat Transfer for Steam Generator Components.....	172
XV. Pipe Line Velocities.....	175
XVI. Dimensions of Pipe.....	176
XVII. Pipe Fittings.....	183
XVIII. Duct Velocities.....	190
XIX. Equivalent Lengths of Duct Bends.....	192
XX. Centrifugal Pump Data.....	205
XXI. Fuel Burning Rates for Stokers.....	225
XXII. Pulverizer Power Requirements.....	229
XXIII. Power Plant Fan Data.....	241
XXIV. Water Conditioning Chemistry Data.....	320
XXV. Steam Tables.....	323

FUNDAMENTALS OF POWER PLANT ENGINEERING

CHAPTER I

INTRODUCTION

1. It is the function of the power plant engineer to specify the equipment for the production of power at the lowest possible cost per unit. This function requires the understanding of the fundamentals of power plant engineering from the standpoint of mechanical design as well as from the standpoint of economics. The word *specify* should be carefully noted. It is the function of the specialist in equipment design to supply machinery which will fit the specifications of the power plant engineer. Obviously, if the power plant engineer does not have a thorough knowledge of the possibilities and limitations of the machinery with which he is dealing, he cannot make workable recommendations.

2. Growth of Power Generation in the United States--Until Thomas A. Edison built the Pearl Street Station for the New York Edison Company in 1880, very little power was produced in the form of electricity. Most of the installed power machinery was in the form of steam engines of various specialized types in mills and mines. Some hydro power was utilized in mills located at the sites of the water wheels.

Before the turn of the century, the largest and most efficient steam power plants were found on ships. At about this time, however, the large central steam-electric station became a necessity and it was not long before these stations surpassed the marine power plant in both size and efficiency.

The growth of the power industry in the United States has been phenomenal. A study by the Twentieth Century Fund has shown conclusively that the rise in our standard of living has paralleled the rise in the utilization of power. Figures I-1 through I-3 show some important data on the growth of the power industry in the United States and the increase in our standard of living during the same period, with an extension of the electric production and installed capacity curves to 1960 to correspond with the Twentieth Century Fund's predictions.

3. Improvement in Thermal Efficiency of Steam Power Plants--Examination of the data on growth of the power industry is not sufficient to show the contributions of the engineer. The engineer's contribution has been the continual improvement in thermal efficiency of the power plant. Figure I-4 shows this improvement in terms of British thermal units

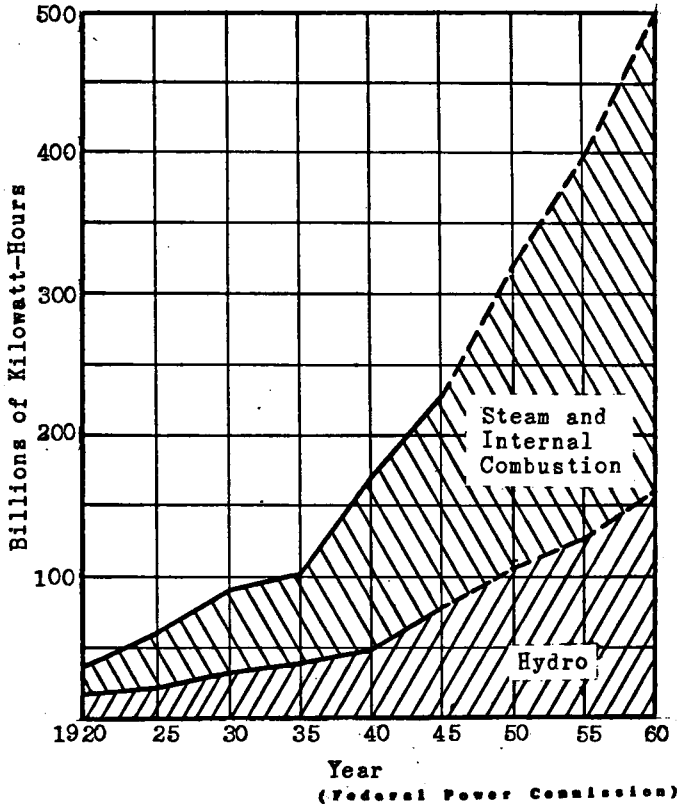

Fig. 1-1. Production of electric energy by type of prime mover. 1920 - 1960.

per kilowatt-hour for plants in the United States. It will be seen that the rate of improvement has apparently reached a minimum, and truly it seems that it is impossible to further improve our steam power cycles. The end of the engineer's contribution is not yet in sight, however. Binary vapor cycles have been proven practicable and thermal efficiency improvements up to 50 per cent will be seen in the not-too-distant future. Power from nuclear fission may someday become economical when cheaper sources of energy become exhausted or so scarce as to be more valuable as raw materials for chemical syntheses.

4. Progress in Hydro and Internal Combustion Power--Fig-

ure I-1 showed that the larger part of the nation's power production has been obtained from steam power plants, and it is likely that such a relation will continue so long as fuels are easily obtainable. Hydro plants at present provide slightly more than half as much power as steam plants, and they are not likely to improve their relative position very much in the future due to the decreasing availability of suitable dam sites. A good example of maximum utilization of hydro power possibilities is to be seen in the installations of the Tennessee Valley Authority which has 26 dams in the more than 1000 miles of the Tennessee River and its tributaries. The TVA, as well as any other well designed hydro system, makes use of steam power plants as auxiliary power sources during the annual dry season.

In Figure I-1, internal combustion engine plants have been included with steam plants because the power produced by the internal combustion engine plants is somewhat less than one per cent of the total production. It must not be concluded, however, that the internal combustion engine plant

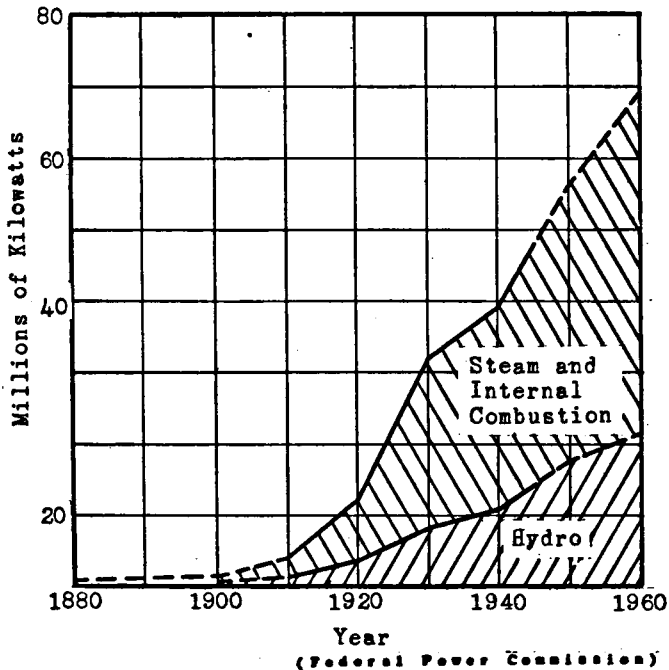

Fig. I-2. Installed capacity of generating plants. 1889 - 1960.

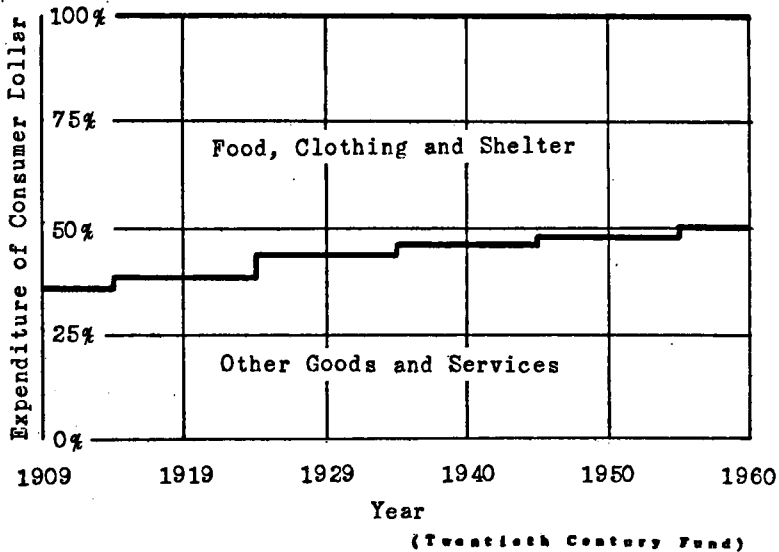

Fig. 1-2. Standard of living in the United States. 1909 - 1960.

is insignificant, because there are locations where conditions are such that steam power plants would be impractical. As a general rule, where the total load is less than about 7,500 kilowatts the Diesel-generator plant will be found to be most economical.

5. Power Systems--Due to the fact that larger power plants can produce power more cheaply than small plants, we have the central station rather than individual power plants for each consumer. The problem of supplying power to the consumer from the central station gives rise to a rather complicated system of transmission and distribution lines. Figure I-5 shows the elements of a power system which includes a power plant and a primary and secondary distribution system. The secondary distribution system is always existent in any power system, but the primary distribution (sometimes called transmission) system may or may not be present depending upon the distance between the power plant and the area which it is to serve. The complexity of the secondary distribution system depends upon the types and sizes of the loads served. Figure I-6 shows a schematic wiring diagram for a typical power system with the various voltages used in present practice. The voltages selected for a particular system will depend largely on the distances

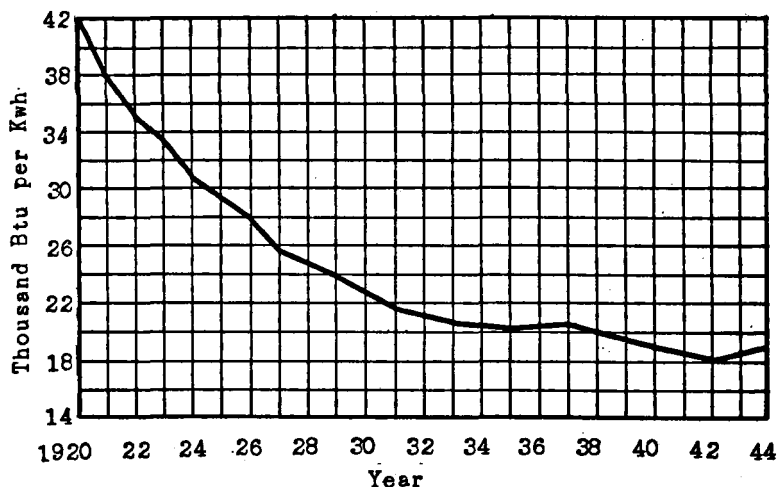

Fig. I-4. Plant heat rate, Btu per kWh, for plants in the United States, 1920 - 1944.

to be covered and the type of load to be supplied.

6. Public Utility Organization¹--At the present time in the United States there are three classes of utility businesses:

1. Private utilities.
2. Municipal utilities.
3. Federal utilities.

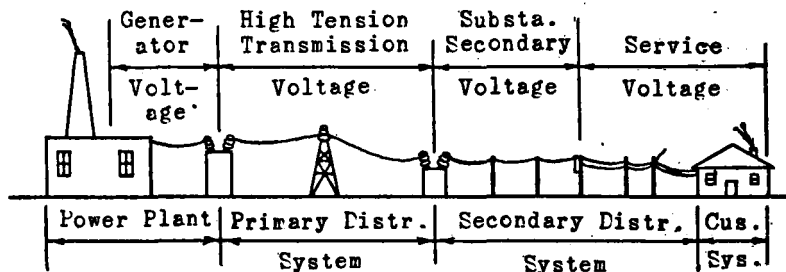

Fig. I-5. A typical power system.

¹ "Public utility" is the generic term for utilities of all classes.

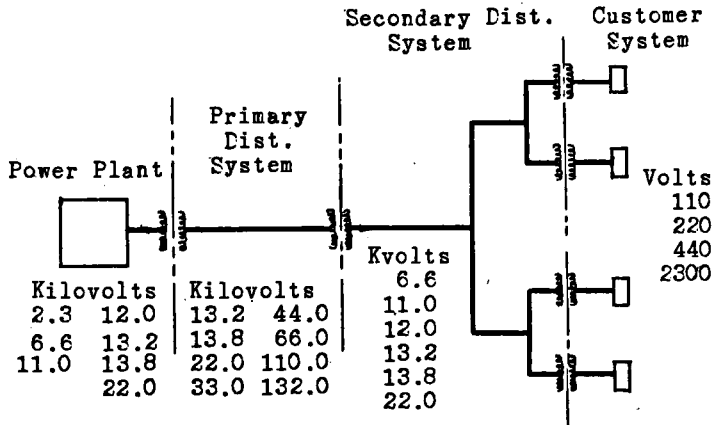

Fig. I-6. Wiring diagram for a typical power system.

Private utilities are almost always incorporated and are usually a part of a very complex organization called a holding company. Briefly, the holding company owns all or a majority of the common stock of a number of subsidiary power companies, known as operating companies. The common stock of the holding company is usually held by the public, but a few individuals may hold sufficient of the common stock to exert effective control of the whole holding company system. Ordinarily the common stock in any corporation amounts to only 40 to 50 per cent of the capitalization, therefore it is possible by pyramiding through sub-holding companies for a few individuals to control huge enterprises. This is not to say that the holding company system is undesirable from the theoretical point of view, because it is possible to effect great economies in equipment purchasing and in the furnishing of engineering services with an organization of this type. The Public Utilities Holding Company Act of 1934 was intended to break up these large aggregations of power companies, and it has had some success to date with several which had been in particularly vulnerable positions due to mismanagement.

Municipal utilities are operated by municipal governing bodies for the benefit of the citizens of the municipality. Financing is obtained by the sale of either bonds or revenue certificates. Revenue certificates encumber only the future income of the system and usually do not require a property owners referendum for their authorization. Municipal utility financing lately has been largely accomplished with revenue certificates.

Federal utilities do not usually sell power directly to the consumers but wholesale it to municipalities, private utilities and rural electrification cooperatives. State governments are compensated for loss of tax revenues by payments in lieu of taxes which would have been collected from the former owners of lands which have been permanently flooded by storage reservoirs which are necessary for most hydroelectric plants. These payments are sometimes claimed to be inadequate by the States which receive them.

BIBLIOGRAPHY

Anon., "Interconnection of Electric Systems," *Power Plant Engineering*, May, 1926.

Annual Statistical Numbers, *Electrical World*.

Benton, Harry W., "Power Use and Human Progress," *Power Plant Engineering*, January, 1931.

Frank, Glenn, "Power, the Background of Our Present-day Civilization," *Mechanical Engineering*, April, 1928.

Vowles, H. P., and Vowles, M. W., *The Quest for Power from Prehistoric Times to the Present Day*, Chapman and Hall, London, 1932.

CHAPTER II

LOAD CURVES

7. Before an attempt is made to design any type of power plant, whether a new installation (quite rare) or an extension to existing facilities, it is necessary to make an exhaustive analysis of the load which the plant is to serve. This analysis must take into account the various types of loads, their probable maximum demands and their geographic location in relation to the plant. Other items for consideration would include a decision as to the relative priority for maintenance of service during an emergency and provision for future growth of load.

8. **Demand and Diversity**--Consideration of the problem of providing adequate plant capacity for a given situation will show that in very few cases will it be necessary to provide capacity to serve every electrical device in the system at the same time. Engineers have developed two statistical factors to deal with this fact: the demand factor and the diversity factor.

Demand factor expresses as a fraction the probability that any one customer will require full rated power for any particular class of service at any given moment, or during any given period of time. The periods of time are not standardized, but usually are taken as fifteen or thirty minutes. Expressed as an equation, the demand factor is the maximum load demand in kilowatts during a given period for a particular class of service divided by the total rated load in kilowatts for the same class of service, or

$$f_d = \frac{\text{actual maximum demand in kw}}{\text{total connected load in kw}}$$

Diversity factor expresses as a fraction the probability that any number of customers will require the maximum demand for a particular class of service at the same moment. Expressed as an equation, the diversity factor is the ratio of the maximum demand in kilowatts for a class of service, measured at the point of supply, to the sum of the individual customers' maximum demands in kilowatts for the same class of service, or

$$f'_d = \frac{\text{maximum demand in kw at point of supply}}{\Sigma \text{ individual maximum demands in kw}}$$

Table I gives the generally accepted demand and diversity factors for a number of classes of service.

TABLE I

DEMAND FACTORS

Residence Lighting	0.50
Commercial Lighting	
General commercial lighting	0.60
Restaurants, stores, offices	0.70
Theaters	0.60
Schools and churches	0.55
Hotels	0.50
Hospitals	0.45
Warehouses	0.40
General Power Service	
Less than 10 hp	0.75
10 to 20 hp	0.65
20 to 100 hp	0.55
Over 100 hp	0.50

DIVERSITY FACTORS

	Between Cust.	Between Trans.	Between Fdrs.	Between Substa.
Residence Lighting	0.30	0.75	0.85	0.90
Commercial Lighting	0.70	0.75	0.85	0.90
General Power	0.70	0.75	0.85	0.90

Example 1 shows the use of demand and diversity factors in the determination of the capacity of the various components of an elementary power system such as is shown in Figure II-1.

Example 1.

A power plant supplies energy to a town through a primary distribution system consisting of a transmission line and three substations. Substation A serves a residential district through two feeders and five transformers; Substation B serves a commercial district through two feeders and five transformers; and substation C serves an industrial district through three feeders and four transformers. In-

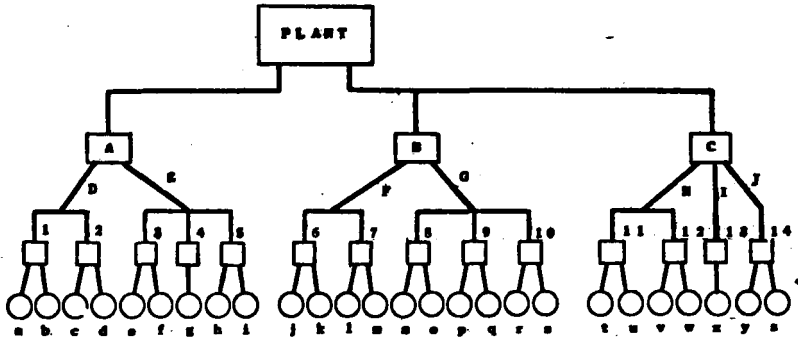

Fig. II-1. Elementary power system.

dividual customer connected loads are as follows (Refer to Figure II-1):

a. 3 kw	j. 15 kw (theater)	t. 10 hp
b. 2 kw	k. 20 kw (restaurant)	u. 50 hp
c. 5 kw	l. 17 kw (store)	v. 35 hp
d. 4 kw	m. 25 kw (warehouse)	w. 2 hp
e. 6 kw	n. 30 kw (school)	x. 100 hp
f. 7 kw	o. 26 kw (hospital)	y. 40 hp
g. 5 kw	p. 15 kw (office)	z. 60 hp
h. 10 kw	q. 18 kw (store)	
i. 8 kw	r. 35 kw (store)	
	s. 40 kw (hotel)	

Determine the rating of each transformer, feeder, sub-station, transmission line section; and the probable maximum demand on the power plant.

Solution:

1. Determine the probable maximum kilowatt demand for each customer by applying the demand factor appropriate for each case, as follows:

a. $3(0.5)=1.5$ kw	j. $15(0.60)=9.0$ kw	t. $10(0.65)(0.746)$ $+ 0.80 = 6.1$ kw
b. $2(0.5)=1.0$ kw	k. $20(0.70)=14.0$ kw	u. $50(0.55)(0.746)$ $+ 0.80 = 25.7$ kw
c. $5(0.5)=2.5$ kw	l. $17(0.70)=11.9$ kw	v. $35(0.55)(0.746)$ $+ 0.80 = 25.7$ kw
d. $4(0.5)=2.0$ kw	m. $25(0.40)=10.0$ kw	w. $2(0.75)(0.746)$ $+ 0.80 = 1.4$ kw

LOAD CURVES

11

- | | | |
|---------------------|-----------------------|--|
| e. $6(0.5)=3.0$ kw | n. $30(0.55)=16.5$ kw | x. $100(0.55)(0.746)$
$+ 0.80 = 51.3$ kw |
| f. $7(0.5)=3.5$ kw | o. $26(0.45)=11.7$ kw | y. $40(0.55)(0.746)$
$+ 0.80 = 20.5$ kw |
| g. $5(0.5)=2.5$ kw | p. $15(0.70)=10.5$ kw | z. $60(0.55)(0.746)$
$+ 0.80 = 20.8$ kw |
| h. $10(0.5)=5.0$ kw | q. $18(0.70)=12.6$ kw | |
| i. $8(0.5)=4.0$ kw | r. $25(0.70)=24.5$ kw | Note: Motor efficiency estimated at 80 per cent. |
| | s. $40(0.50)=20.0$ kw | |

2. Determine the kilowatt rating of each transformer by applying the appropriate diversity factor for consumers, as follows:

- | | |
|--------------------------------------|--|
| 1. $(1.5 + 1.0)(0.30)=0.75$ kw | 8. $(16.5+11.7)(0.70)=19.8$ kw |
| 2. $(2.5 + 2.0)(0.30)=1.35$ kw | 9. $(10.5+12.6)(0.70)=16.2$ kw |
| 3. $(3.0 + 3.5)(0.30)=1.95$ kw | 10. $(24.5+20.0)(0.70)=31.2$ kw |
| 4. $(2.5)(\text{no div.}) = 2.50$ kw | 11. $(6.1 + 25.7)(0.70)=22.2$ kw |
| 5. $(5.0 + 4.0)(0.20)=2.70$ kw | 12. $(18.0 + 1.4)(0.70)=12.8$ kw |
| 6. $(9.0 + 14.0)(0.70)=16.1$ kw | 13. $(51.3)(\text{no div.}) = 51.3$ kw |
| 7. $(11.9+10.0)(0.70)=15.3$ kw | 14. $(20.5+20.8)(0.70)=25.9$ kw |

3. Determine the kilowatt rating of each feeder by applying the diversity factor for transformers, as follows:

- | | |
|---------------------------------|-----------|
| D. $(0.75 + 1.35)(0.75)$ | = 1.58 kw |
| E. $(1.95 + 2.50 + 2.70)(0.75)$ | = 5.36 kw |
| F. $(16.1 + 15.2)(0.75)$ | = 23.6 kw |
| G. $(19.8 + 16.2 + 21.2)(0.75)$ | = 50.4 kw |
| H. $(22.2 + 13.6)(0.75)$ | = 26.8 kw |
| I. $(51.3)(\text{no div.})$ | = 51.3 kw |
| J. $(25.9)(\text{no div.})$ | = 35.9 kw |

4. Determine the kilowatt rating of each substation by applying the diversity factor for feeders, as follows:

- | | |
|---------------------------------|----------|
| A. $(1.58 + 5.36)(0.85)$ | = 5.9 kw |
| B. $(23.6 + 50.4)(0.85)$ | = 63 kw |
| C. $(26.8 + 51.3 + 25.9)(0.85)$ | = 97 kw |

5. Determine the probable maximum demand on the power plant by applying the diversity factor for substations, as follows:

$$(5.9 + 63 + 97)(0.90) = 149 \text{ kw}$$

It will be obvious from the preceding analysis that the rating of any component of the system will never be less

than the probable maximum demand of the largest component served by it. For example, transformer 1 would of necessity have a rating of 1.5 kw in spite of the mathematics which indicates that the rating is 0.75 kw. However, as the size of the system increases, the behavior of the system approaches the statistical ideal and these irrationalities disappear.

9. Load Curves--The foregoing discussion of demand and diversity factors indicates that a constant load cannot be expected for any actual power plant. This indication is found to be true, and furthermore, it has also been found to be true that systems serving approximately the same classes of loads anywhere will have approximately the same type of load curves. For example, industrial plant load will show flat-topped curves with sharp drops at the time of shift changes and at meal times. Utility plant loads will show a minimum during the night; a minor and somewhat flat-topped peak during the morning; a sharp drop at noon; and a sharp peak in the early evening. These characteristics are shown

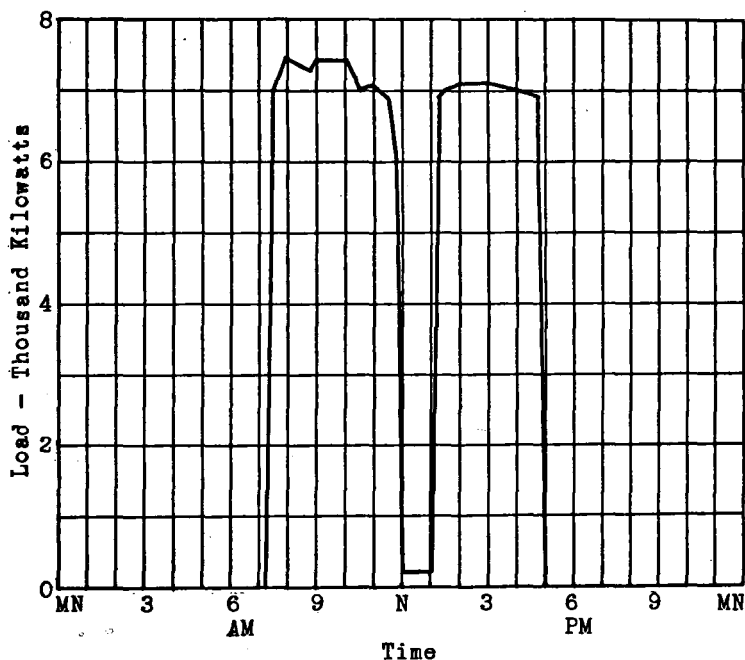

Fig. II-2. Typical daily load curve for industrial plant.

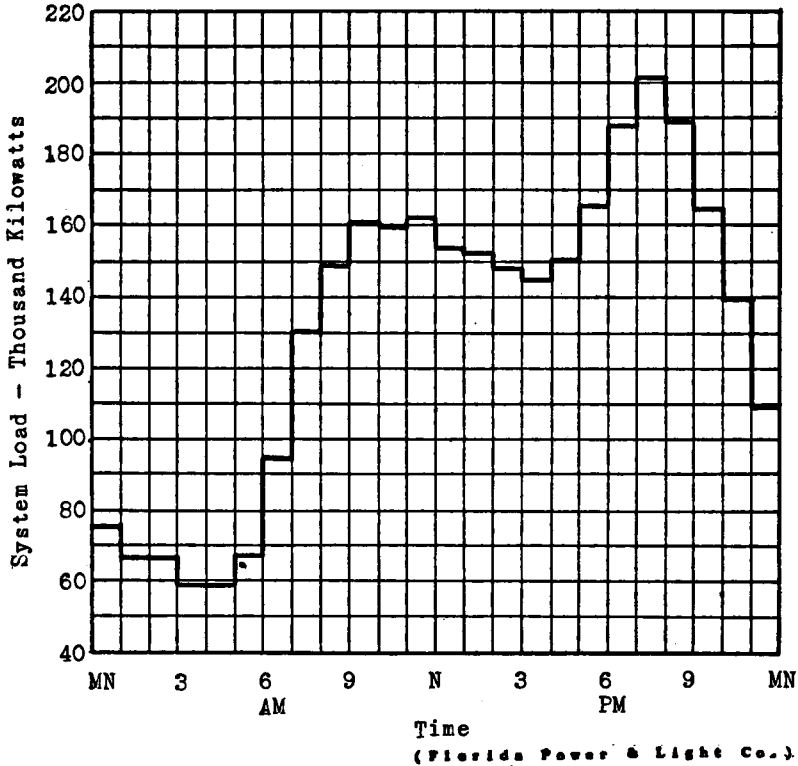

Fig. II-3. Typical daily load curve for public utility.

in Figures II-2 and II-3. Load curves of these types can easily be synthesized if the character and size of the loads of various classes along with the time of their demands are known.

Other types of load curves can be drawn in addition to the daily load curves. For example, the daily maximum loads may be plotted to give an annual peak load curve. This type of curve is useful in deciding upon the best time during the year for scheduling major plant maintenance operations. The yearly maximum loads may be plotted to give a load growth curve. This type of curve will give information as to when it will be necessary to increase plant capacity. These two types of curves are used most frequently with the public utility plant because electric power is the primary product. The industrial plant will make use of similar curves with units of production, such as tons of steel, for ordinates

rather than kilowatts of load. In the ordinary industrial plant power is not a salable commodity. There are cases, however, where industrial plants have arranged to sell power to public utilities, and vice versa, when the peaks in the two types of operations do not coincide. Figures II-4 and II-5 show typical annual peak and load growth curves for a public utility.

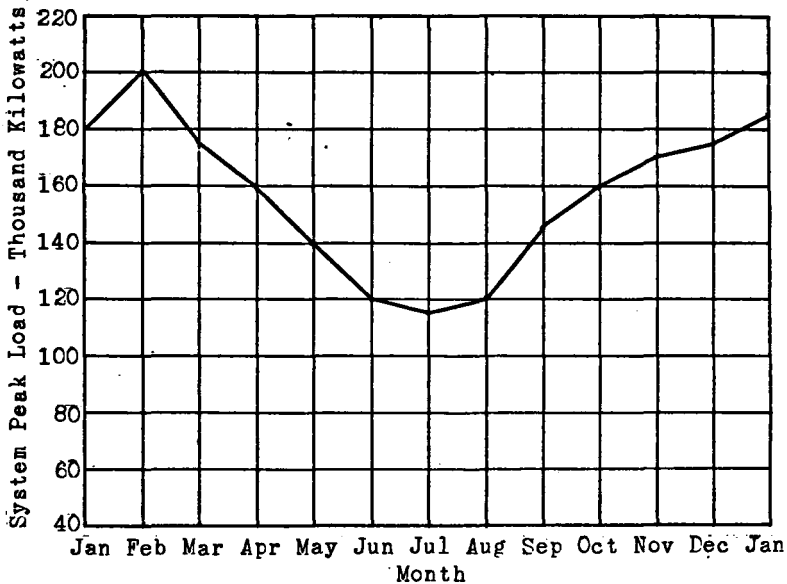

Fig. II-4. Annual peak load curve for public utility.

The daily load curve or the annual peak load curve may be plotted in a form known as the load duration curve. This curve is plotted with time units as abscissa and load as ordinate, such that any point on the curve gives the total time for which the particular load was in demand. Figure II-6 shows a typical daily load duration curve for a public utility. It will be noted that since power output is the product of load and time, the area under the load duration curve is the same as under the load curve.

Example 2 shows the method of synthesis of a daily load curve for the elementary power system of Example 1.

LOAD CURVES

15

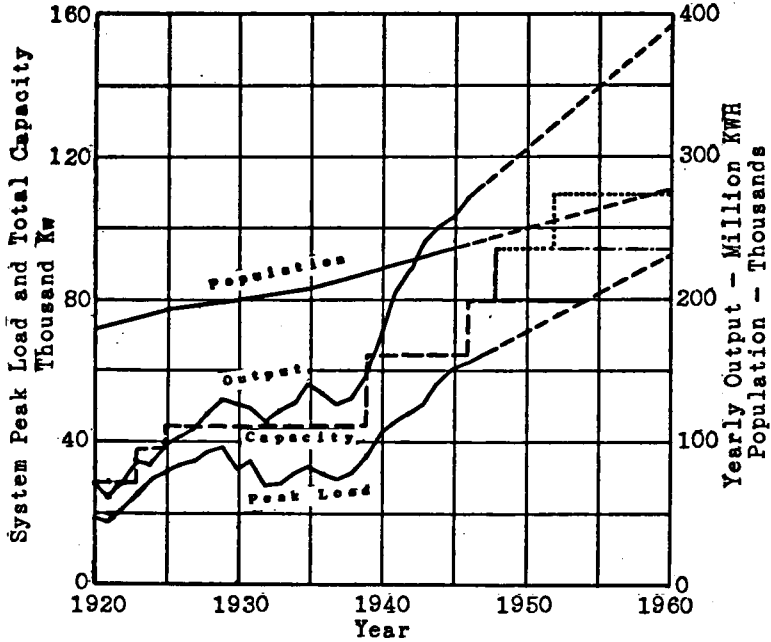

Fig. II-5. Load growth curve for public utility.

Example 2.

The various loads in the town of Example 1 are to be expected at the following times:

Residential load:

10 o/o
100 o/o

all day
6 AM to 9 AM
4 PM to 8 PM

Commercial load:

Theater, j
Restaurant, k

11 AM to 11 PM
6 AM to 9 AM
11 AM to 2 PM
5 PM to 9 PM

Stores, l, q, r
Offices, p

9 AM to 6 PM
9 AM to 12 N

Schools, n

1 PM to 5 PM
9 AM to 12 N
1 PM to 4 PM

FUNDAMENTALS OF POWER PLANT ENGINEERING

Hospitals, o	
10 o/o	all day
100 o/o	9 AM to 5 PM
Warehouses, m	6 AM to 6 PM
Hotels, s	
10 o/o	all day
100 o/o	7 AM to 10 PM
Industrial load:	
25 o/o	all day
100 o/o	8 AM to 12 P
	1 PM to 5 PM

Using the demand and diversity data from Example 1, set up a load table and plot an expected daily load curve.

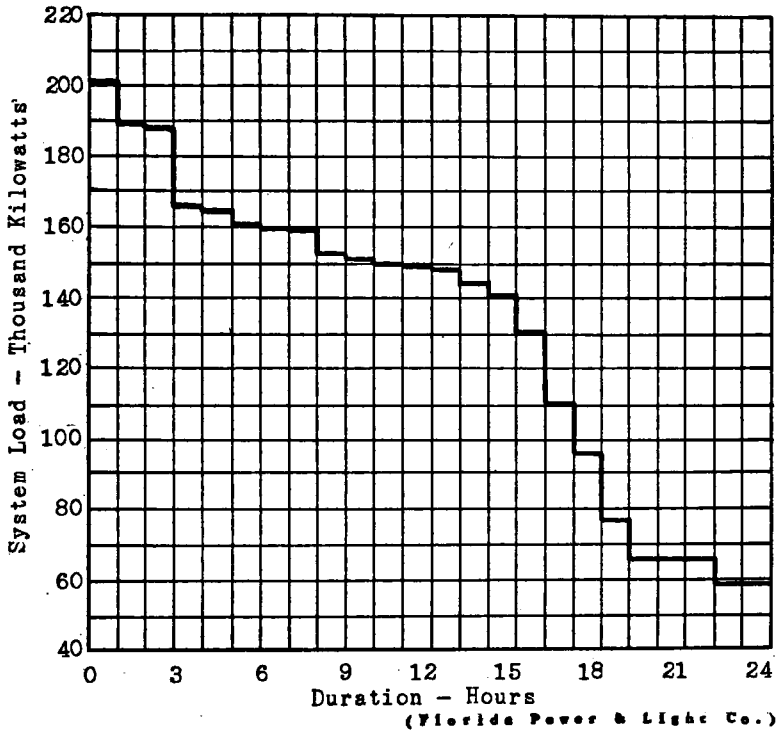

Fig. II-6. Daily load duration curve for public utility.

FUNDAMENTALS OF POWER PLANT ENGINEERING

Serv.	6-7AM	7-8AM	8-9AM	9-10AM	10-11AM	11-12N
Res.	5.31	5.31	5.31	0.53	0.53	0.53
j						3.61
k	5.62	5.62	5.62			5.62
l,q,r				19.69	19.69	19.69
m				4.21	4.21	4.21
n				6.63	6.63	6.63
o	0.47	0.47	0.47	4.70	4.70	4.70
p	4.01	4.01	4.01	4.01	4.01	4.01
s	0.80	8.04	8.04	8.04	8.04	8.04
Ind.	21.70	21.70	86.78	86.78	86.78	86.78
Total	37.91	37.91	110.23	134.59	134.59	143.82
Serv.	12-1PM	1-2PM	2-3PM	3-4PM	4-5PM	5-6PM
Res.	0.53	0.53	0.53	0.53	5.31	5.31
j	3.61	3.61	3.61	3.61	3.61	3.61
k	5.62	5.62				5.62
l,q,r	19.69	19.69	19.69	19.69	19.69	19.69
m	4.21	4.21	4.21	4.21	4.21	4.21
n		6.63	6.63	6.63		
o	4.70	4.70	4.70	4.70	4.70	0.47
p		4.01	4.01	4.01	4.01	4.01
s	8.04	8.04	8.04	8.04	8.04	8.04
Ind.	21.70	86.78	86.78	86.78	86.78	21.70
Total	68.20	143.82	138.20	138.20	136.35	72.66
Serv.	6-7PM	7-8PM	8-9PM	9-10PM	10-11PM	11-MN
Res.	5.31	5.31	0.53	0.53	0.53	0.53
j	3.61	3.61	3.61	3.61	3.61	
k	5.62	5.62	5.62			
l,q,r						
m						
n						
o	0.47	0.47	0.47	0.47	0.47	0.47
p						
s	8.04	8.04	8.04	8.04	0.80	0.80
Ind.	21.70	21.70	21.70	21.70	21.70	21.70
Total	44.75	44.75	44.75	34.35	27.11	23.50

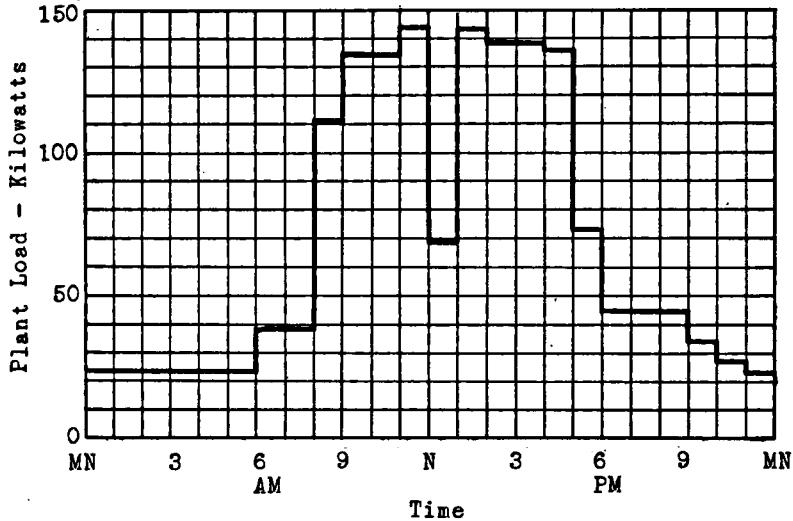

Fig. 11-7. Load curve for elementary power system.

10. Factors Used in Operation Analysis--Due to the variability of the load on power systems, it is seldom that a plant operates at its ultimate capacity continuously. In order to express the power output of a plant in terms that are easily analyzed, several factors have come into use.

Load factor is the average load during any specified time divided by the peak load of any specified duration. The average load may be taken over a day, month or year, and the peak load duration may be taken as fifteen or thirty minutes or one hour. For the most common case of daily load factor:

$$f_l = \frac{\text{total generation for day in kwh}}{24[\text{maximum demand in kw sustained for one hour}]}$$

Capacity factor is the total power production for any specified time divided by the product of the installed capacity times the length of the specified period. For the most common case of daily capacity factor:

$$f_c = \frac{\text{total generation for day in kwh}}{24[\text{installed capacity in kw}]}$$

Use factor is the total power production for any given

time divided by the summation of the products of the hours operated times the installed capacity for each machine. For the most common case of daily use factor:

$$f_u = \frac{\text{total generation for day in kwh}}{\Sigma[(\text{hours operated})(\text{capacity of machine in kw})]}$$

11. Determination of Size of Equipment--The problem of variable load and the necessity for insuring continuity of service are the two factors which have the greatest influence in the selection of equipment for a power plant. It has been seen that the plant must have a capacity sufficient to carry the maximum demand, but it is almost never the case where only one generating unit is selected to meet this demand. It is much more usual to select two or more units for the installation. Examination of Figure II-8 will show why

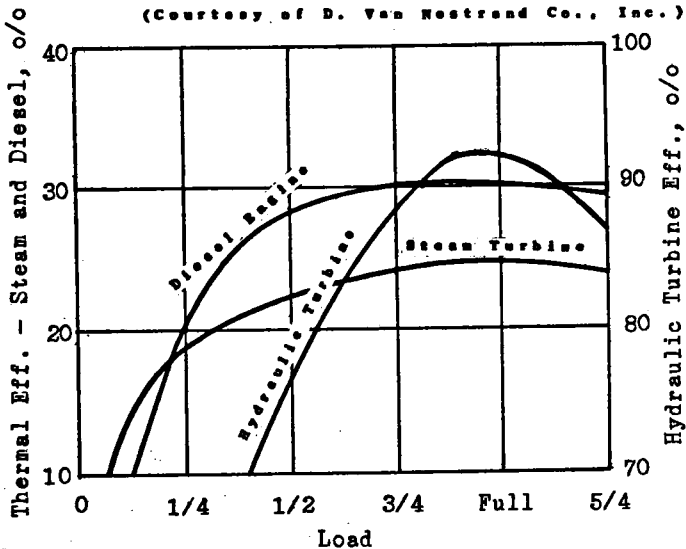

Fig. II-8. Efficiency vs. load, engines and turbines.

this is the case. Power generating equipment design involves many compromises, especially when the equipment is expected to operate with variable load, and the usual result is that the thermal efficiency of the machine is at its maximum between three-fourths load and full load, with the efficiency falling as the load increases or decreases beyond this range.

It can be seen, then, that for maximum operating efficiency the machine should operate at or near its rated load. This means that the usual plant will have more than one machine, and they may very well be of different sizes so that maximum efficiency could be approached at all loads. Such an ideal case is never the most economical, however, when the complete picture is considered. It is a fact that as the size of the machine increases the thermal efficiency at full load increases and the cost per kilowatt of installed capacity decreases. Economies in investment can also be made by installing duplicate machines wherever possible.

Continuity of service and ability to meet unusual conditions require that:

1. In order to insure against breakdown in equipment, reserve idle capacity must be provided equal to the capacity of the largest machine in the plant or system.
2. In order to insure against inability to meet sudden unusual demands, spinning or active reserve capacity must be provided, usually to the extent of about 25 per cent of the demand at any time.

The following criteria are useful in the examination of a proposed design, or will be of help in selecting equipment to fit a particular situation:

1. The total plant investment per kilowatt of capacity must be at the minimum, or it must be demonstrated that the sum of the operating costs and fixed charges are at the minimum.
2. Capacity and use factors for the plant must be at the maximum consistent with adequate idle and spinning reserves and with leeway for growth of load.

Similar considerations apply to the selection of boiler and other equipment in the plant. Each major item of equipment should be subjected to a critical analysis in order to determine the most economical combination.

Example 3-A shows the method of selection of machines for the installation considered in the elementary power system of Example 1 and Example 3-B shows the method of selection of machine sizes to fit an extension of a load growth curve.

Example 3-A.

The town of Examples 1 and 2 is to be served by a Diesel-electric plant. Available generator sizes are: 25 kw, 50 kw, 75 kw and 100 kw. Select a unit or units which will give the maximum use and capacity factors consistent with required reserves. Set up an operating schedule for the plant.

Solution:-----

Since the peak load is almost 150 kw, provision for adequate spinning reserve would dictate an assured plant capacity of at least 185 kw to care for present needs. This capacity would necessitate the use of at least two machines in addition to a spare machine for assuring plant capacity. Possible combinations are: (a) 3 - 100 kw (one spare); (b) 5 - 50 kw (one spare); (c) 1 - 25 kw, 1 - 50 kw and 2 - 100 kw (one spare); and (d) 2 - 50 kw and 2- 75 kw (one spare). Capacity factors for these combinations would be:

$$(a) \quad f_c = \frac{1652.7}{24(300)} = 0.229$$

$$(b) \text{ and } (d) \quad f_c = \frac{1652.7}{24(250)} = 0.275$$

$$(c) \quad f_c = \frac{1652.7}{24(275)} = 0.250$$

On the basis of capacity factors alone, (a) could be eliminated from further consideration, although some leeway would be provided for future growth of load. However, (b) offers the same leeway with a higher capacity factor, and (c) and (d) offer high capacity factors with no leeway for growth. From this analysis, then, (c) and (d) are eliminated and the next step is to investigate the use factors. Load factors are determined after setting up operating schedules as in Figure II-9. These schedules with use factors are:

- (a) 1 - 100 kw on 24 hours
 1 - 100 kw on 7:30 AM, off 6:30 PM, 11 hours

$$f_u = \frac{1652.7}{24(100) + 11(100)} = 0.472$$

- (b) 1 - 50 kw on 24 hours
 1 - 50 kw on 7:30 AM, off 6:30 PM, 11 hours
 2 - 50 kw on 7:30 AM, off 5:30 PM, 20 hours

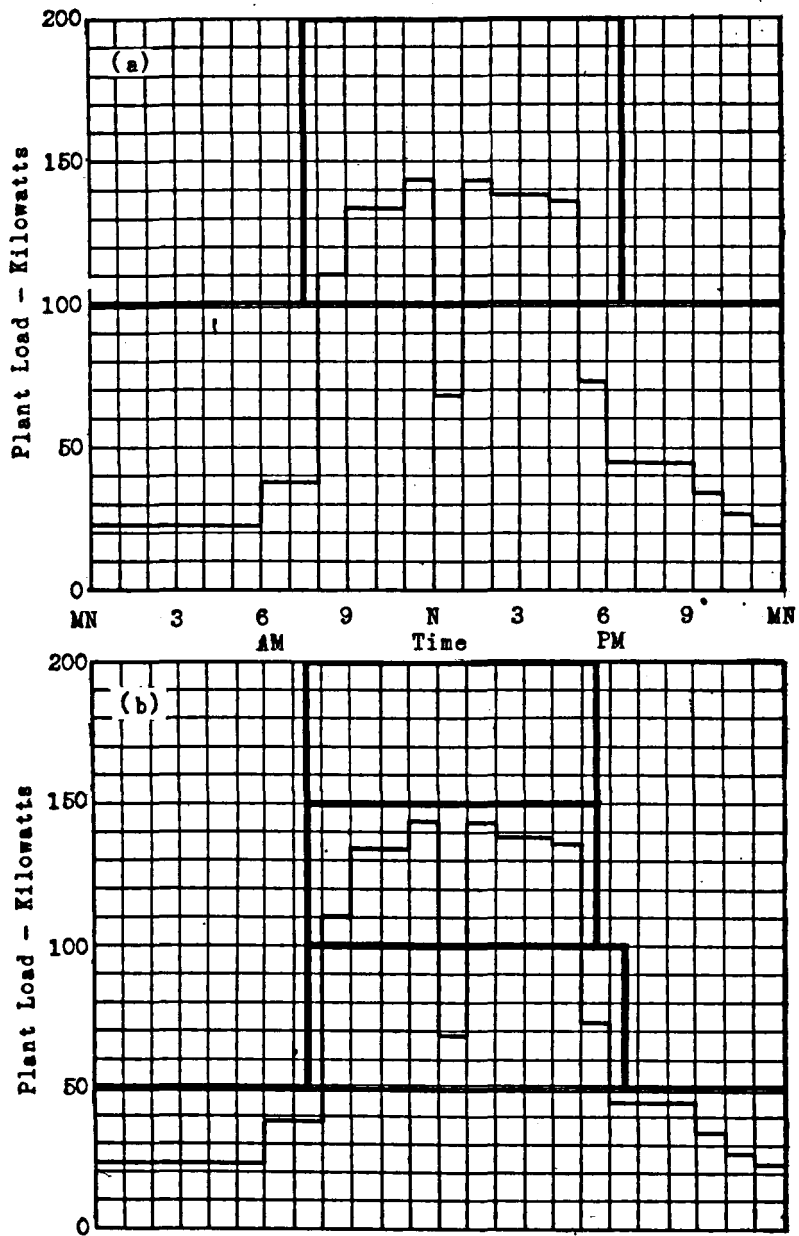

Fig. II-9. Selection of generating units.

$$f_u = \frac{1652.7}{24(50) + 11(50) + 20(50)} = 0.602$$

Then, from the standpoints of maximum use and capacity factors and leeway for growth, combination (b) consisting of 5 - 50 kw machines would be selected. Additional advantages would be realized in the purchase and maintenance of identical units.

Example 3-B.

The power plant whose load growth curve is shown in Figure II-5 had a net assured capacity (total plant capacity less the capacity of the largest machine in the plant) of 49,000 kw in 1945. At this time the peak load was 60,000 kw which necessitated operation with practically no reserve capacity. An order for a 15,000 kw machine had been placed in 1942, but, due to wartime conditions, the plant extension was not placed into operation until 1946. Another 15,000 kw machine was ordered in 1945 and was scheduled for operation before the 1948 peak load. In 1948 the net assured capacity of the plant was 79,000 kw and the peak load was 66,000 kw. At this time it was decided to plan for future load growth. The load growth curve was projected and it appeared that the peak load would equal the plant net assured capacity in 1954. It was decided to order another 15,000 kw unit to operate initially in 1952, and indications were that the plant net assured capacity would then be sufficient until about 1960. It was also decided that the situation would be re-surveyed in 1955 with the view of retiring some of the older machines which had been operating since 1920.

BIBLIOGRAPHY

- Anon., "Load Curve Studies," *Electrical World*, December, 1927
- Anon., "Peak Load Problems of Central Stations," *Mechanical Engineering*, December, 1928.
- Allner, F. A., "The Parallel Operation of Hydro and Steam Plants," *Transactions A.S.M.E.*, Volume 47.
- Cook, H. M., "Methods of Obtaining Economical System Operation," *Mechanical Engineering*, April, 1927.
- Gear, H. B., "Application of Diversity Factor," *Proceedings N.E.L.A.*, 1915.

CHAPTER III

ECONOMICS OF POWER PRODUCTION

12. **Power Plant Income**--The public utility derives its income directly from the customers it serves, while the industrial power plant usually receives its operating funds from the revenues of the company of which it is a part.

It can be seen, after some thought, that the public utility company's charge, or rate, for electrical service to its customers must include an element to pay for the labor, materials and fuel, an element to pay for the cost of the necessary machinery, and an element which represents the investors' profit. Furthermore, since industrial customers usually supply a higher type of load than domestic customers, the industrial customers are usually accorded a more favorable rate than the domestic customers. These considerations, when coupled with the inevitability of daily and seasonal demand fluctuations, result in a somewhat complex rate structure for a public utility.

The industrial power plant is not usually faced with the problem of setting a rate for its power. The present method of cost accounting in industry takes only the average annual cost of power per unit of production for the determination of the power element in the cost of the manufactured product. This may not be a fair method of accounting if the industry suffers from seasonal peaks, but, on the other hand, it is only the net annual profit for the industry which is significant.

In spite of the tremendous growth of the manufacturing industries in this country, the domestic customer supplies the greater part of the public utilities' revenue. Figure III-1 shows the growth of load and decrease in cost per kilowatt-hour for domestic customers. The engineer's contribution can be seen clearly in these curves. Increasing efficiency, as seen in Figure I-4, has made lower rates possible, which in turn has made it possible for customers to increase their use of electricity. It should be noted that the trend of rates has been continually downward in spite of the fact of creeping inflation which has been reducing the real value of money.

13. **Public Utilities as Monopolies**--It does not take careful consideration to arrive at the conclusion that a service such as electric power can be supplied most economic-

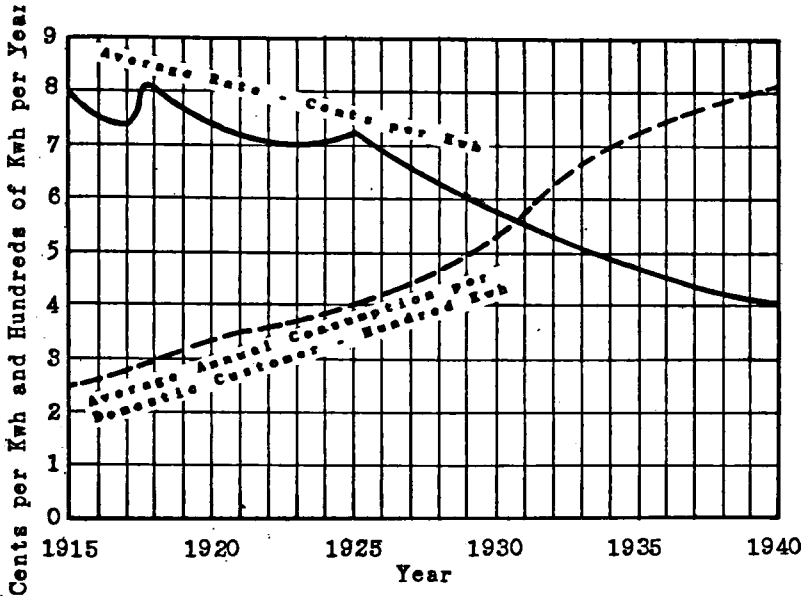

(Courtesy of D. Van Nostrand Co., Inc.)

Fig. III-1. Cost and use of domestic electric service.

ally by only one company operating within a given area. Any other arrangement would be wasteful and even inconvenient. Consider, for example, the case of a large city which has two telephone companies competing in the same area. Obviously, the customer is being made to pay for two systems where one would be sufficient. The public utility, then, takes on the character of a monopoly, but abuses are prevented, in the case of private ownership, by the necessity of obtaining a renewal of its permit to do business (or *franchise*) at intervals of time. Franchise granting agencies always reserve the right to purchase the utility at the end of the franchise period, or to grant a new franchise. Further insurance against abuses is provided by regulation by various public utility commissions, local, State or Federal.

The municipal utility has no such restrictions upon it, and the rates charged may or may not include an element of profit. Most cities which own and operate their own power systems do include an element of profit which is intended to make it possible to charge lower ad valorem property taxes. This method of collecting taxes for municipal operating expenses is based on the theory that taxes will receive

the least opposition from the public when they are spread out in small payments attached to some widely used commodity.

14. Rates--Any rate for power should be examined with the following criteria in mind:

1. Fairness--Rates should distribute costs in accordance with the variability of the customer's demand.
2. Simplicity--Rates, especially domestic, should be as simple as possible in order to avoid antagonism from the public.
3. Cost--The outlay for metering equipment and accounting machinery should not be so great as to increase costs to a greater amount than can be paid for out of increased revenues from more complicated rate structures.

Every rate charged the consumer of electrical energy contains the following elements:

1. *Fixed element* is the element of cost which is present in the system operation whether or not energy is produced.
2. *Energy element* is the element of cost which is proportional to the amount of energy produced.
3. *Variable load element* is the element of cost which is due to the character of the load served.
4. *Customer element* is the element of cost which is proportional to the number of customers.
5. *Investors' profit* is the element of cost which goes to reimburse the investor for the use of his capital.

15. The Fixed Element--The fixed element of the cost of producing power is the sum of the following factors:

1. Capital cost of the power plant.
 - a. Real estate.
 - b. Building and machinery.
 - c. Cost of construction.
 - d. Engineering fees.
2. Capital cost of primary distribution or transmission system.

FUNDAMENTALS OF POWER PLANT ENGINEERING

- a. Cost of easements or right-of-way.
 - b. Cost of line and substation equipment.
 - c. Cost of construction.
 - d. Engineering fees.
3. Interest, taxes and insurance.
 4. Depreciation of buildings and equipment.²
 5. Sinking fund contributions for bond retirement.²
 6. Cost of management.
 7. Capitalized maintenance, or the cost of general maintenance required whether or not power is produced.

Estimating the capital cost of a power plant is a rather difficult problem due to variations in such factors as location, availability of labor and materials and size of plant. Table II in connection with Figure III-2 may be useful in making a first approximation. The lower figures in Table II apply to larger plants.

In the final analysis, the only way to prepare an accurate cost estimate is from manufacturers' and contractors' bids after the general layout of the plant has been determined.

If the plant is not situated within very close proximity to the area which it is to serve, a primary distribution system will be necessary. This system should be laid out to carry the expected load of the plant, therefore its cost will be proportional to the capacity of the plant and to the distance over which the lines extend. It is almost impossible to give any figures as to cost per mile for transmission systems because of the many factors, such as type of terrain and size of conductors and carrying capacity, that enter into the cost. However, for purposes of estimating very

² Municipal utilities are required by State laws to include a sinking fund for bond retirement in the fixed element of the cost. Sometimes a depreciation reserve is also included to provide for replacement of equipment when it becomes obsolete, but more often a small reserve is maintained for minor replacements only, and when major improvements are required bonds or revenue certificates are sold.

The private utility always includes a depreciation reserve in the fixed element of the cost, but it is expected to provide a sinking fund for bond retirement out of the profit element. This is usually explained as preventing the practice of making the customer pay for the capital required to provide him with service."

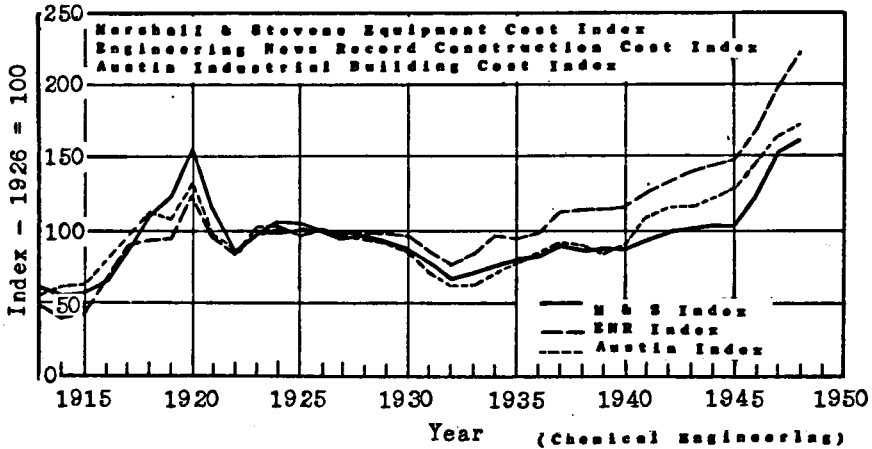

Fig. III-2. Building and equipment cost index.

TABLE II

APPROXIMATE POWER PLANT CAPITAL COSTS
dollars per kilowatt capacity
(base year 1932)

Turbo-generator plants	80 to 150
Engine-generator plants	70 to 150
Diesel-generator plants	130 to 250
Hydro-generator plants	100 to 300

roughly, the cost of the primary distribution system may be taken as ranging between \$1500 and \$5000 per mile (based on 1928), the lower figure applying to low voltages and light loads in relatively flat and open country.

Since it is usual to finance part or all of the cost of construction by the issuance of bonds or revenue certificates, interest on these securities is part of the cost of operation. Interest rates vary according to the money policies of the Federal Government. At the present time, interest rates are low, usually around three per cent, but in the past they have been as high as six per cent.

If the utility is privately owned, ad valorem property taxes and occupational licence fees must be paid. These

usually amount to from two to three per cent of the investment annually. In some States municipally owned utilities must pay the State occupational licence fee.

All utilities maintain insurance on their equipment and liability insurance for protection against claims for damages. The cost of insurance amounts to from one to two per cent of the investment annually.

In order to provide a fund for eventual replacement of worn-out or obsolete equipment, a retirement reserve is accumulated over a period of years. The length of time for the accumulation of the reserve depends upon the estimated life of the equipment. Table III shows the legally approved retirement periods for various types of equipment. The reserve may be accumulated in two different ways: by the sinking fund method or by the straight line method, although the straight line method is most usual. In either case, the sum accumulated will be equal to the original cost of the equipment less a salvage value. For a number of years business organizations have been attempting to have income tax laws amended to allow retirement reserves to be accumulated on the basis of present replacement cost, but they have had no success up to the time of this writing. Inadequate retirement reserves have necessitated the sale of additional stocks and bonds to obtain capital for needed modernization.

The sinking fund for retirement of bonds or obsolete equipment is similar to an annuity, and, as a matter of fact, annuity tables can be used for computing the annual payment. The sinking fund is accumulated by making an annual payment to an account in a bank, which draws interest at the current rate, or by purchasing negotiable securities which draw interest. The total of the payments plus the interest earned over the retirement period will equal the total sinking fund reserve. The annual payment can be calculated from the following equation:

$$\text{annual payment} = \{P - S\} \{r + [(1 + r)^n - 1]\}$$

where: P = original cost

S = salvage value

r = rate of interest earned
(compounded annually)

n = number of years

Since the accumulation of the plant retirement reserve is not a very accurate process at best, it is more usual to use the straight line method of depreciation and to treat

TABLE III
PROBABLE LIFE OF POWER PLANT COMPONENTS

Component	Years
Boilers, fire-tube	10 to 15
Boilers, water-tube	20
Breechings and ducts	10 to 30
Buildings	20 to 30
Cables and feeders	15 to 25
Coal and ash machinery	10 to 20
Condensers	20
Cranes	30
Economizers and air heaters	15
Electric generators	20
Electric motors	20
Engines, steam	15 to 35
Engines, Diesel	15
Feed-water heaters	20
Fuel oil handling equipment	20
Pipe and pipe covering	15 to 25
Pumps	15 to 20
Stacks, brick or concrete	30
Stacks, steel	12 to 15
Stokers and other coal burning equipment	20
Superheaters	20
Switchboards and equipment	20
Transformers	15
Turbines, steam	15 to 20
Turbines, hydro	30

any interest earned as income. The annual payment can be calculated from the following equation, with symbols as above:

$$\text{annual payment} = \frac{(P - S)}{n}$$

Unlike the plant retirement reserve, the amount necessary for bond retirement is known exactly. For this reason, the sinking fund is universally used for bond retirement.

The annual payment can be calculated from the previous sinking fund equation (leaving out the salvage item). It is necessary to recalculate the annual payment from time to time as interest rates change.

The cost of management is included in the fixed charges, and usually management is taken to include all administrative officers down to and including the plant superintendent.

Usually about ten per cent of the total maintenance for the system is included in the fixed charges. This so-called capitalized maintenance is assumed to be the portion of the maintenance which is independent of the amount of power produced.

16. The Energy Element--The energy element of the cost of producing power is the sum of the following factors:

1. Cost of fuel.
2. Cost of labor.
3. Cost of water.
 - a. Boiler feed makeup water.
 - b. Condensing water.
 - c. Service water.
4. Lubricating oil and operating supplies.
5. Maintenance.

The greatest portion of the energy element is due to the cost of fuel, and for this reason it will be found that highly skilled labor in the power plant will always operate the plant in such a way as to save more than enough fuel to pay the difference in salary over unskilled labor. Due to the fact that the labor force required is proportional to the capacity of the plant rather than to plant output, employment in the public utility business is very stable and attractive to those who would make a career in the business.

Since the steam power plant operates best with pure water, and natural waters are very seldom pure enough, the cost of preparation of the water for use as well as the cost of the water itself, in cases where it must be purchased or pumped, must be considered.

A not inconsiderable item in operating costs is that of supplies of various sorts. These would include forms and charts for record keeping, cleaning and wiping sundries, and

all other expendable items which might be needed. Lubricating oil is not a large item of expense in the well operated turbo-generator plant, since with proper care a lubricating oil charge will last almost indefinitely and requires only a small amount of makeup at infrequent intervals.

Maintenance costs include the cost of repair and of replacement of parts which wear out. Properly supervised plants have a schedule of continuous maintenance designed to keep the machinery in the best possible condition at all times. All but the smallest plants employ a maintenance force in addition to the plant operators. The cost of maintenance is usually estimated at about one per cent of the investment annually.

17. The Variable Load Element--This element of the cost of production of power is usually included with the energy element because of the difficulty in assessing its effect. Consideration would have to be made of the reserve capacity required and the status of the plants in the system with respect to the type of loading, that is, base load, standby or swinging.

18. The Customer Element--The customer element in the cost of producing power is the sum of the following factors:

1. Capital cost of the secondary distribution system.
 - a. Cost of easements or right-of-way.
 - b. Cost of line and substation equipment.
 - c. Cost of construction.
 - d. Engineering fees.
2. Interest, taxes and insurance.
3. Depreciation of equipment.
4. Sinking fund contributions for bond retirement.
5. Cost of franchise.
6. Publicity.
 - a. Public relations.
 - b. Advertising.
7. Cost of collecting revenue.
 - a. Meter reading.
 - b. Billing and collecting.
 - c. Accounting.
8. Maintenance.

Most of the factors appearing in the customer element have been discussed under the fixed element. In the matter of depreciation and sinking fund, the remarks in the footnote on page 28 also apply.

Investment in the secondary distribution system is roughly proportional to the number of customers served, and for purposes of estimation may be taken as approximately \$50 per customer (based on 1928).

The cost of publicity is usually lumped together with the cost of the franchise and may be taken as between one and two dollars per year per customer, depending upon the amount of advertising considered necessary. The cost of the franchise itself is usually nominal, and is usually considered to be in the nature of an occupational licence tax.

The cost of collecting revenue may vary between \$1.50 and \$3 per customer per year (based on 1932), the smaller figure applying to the larger systems.

19. Investors' Profit--The profit element in the cost of producing power may or may not be present, according to the type of utility operation. It is inherently present in the private utility system, and it may be present in the municipal utility operation, as previously pointed out, when it is desired to reduce property taxes. It is usually absent in the Federal utility system, and, as a matter of fact, the Federal utility may suffer a deficit without danger of bankruptcy.

The profit on electric utility operations is usually estimated at about ten per cent of the investment annually before income taxes and bond sinking fund deductions are made.

20. Types of Rates--There have been a great number of methods of calculating rates for electrical power used in the past, but of them only the following remain to any considerable extent:

Block Meter Rate--In this type of rate a certain specified price per unit is charged for all or part of a block of units, and reduced prices per unit are charged for succeeding blocks. Figure III-3 shows a rate schedule based on this system. The block meter rate has the advantage of encouraging the use of electricity, providing the initial blocks are not too large, and is almost universally used for residential service,

Rate Schedule RS-1**RESIDENTIAL SERVICE—ELECTRIC****APPLICATION:**

For service for all domestic purposes in private residences and individually metered apartment units.

LIMITATION OF SERVICE:

All residential service required on the premises by Customer shall be supplied through one meter. Stand-by or resale service not permitted hereunder.

CHARACTER OF SERVICE:

Single phase, 115/230 volts, 3 wire or 115 volts, 2 wire depending upon Customer's requirements. Three phase, 230 volt service may be furnished but only under special arrangements.

MONTHLY RATE:

\$1.00 which entitles Customer to use 14 kwh,
4.5¢ per kwh for the next 36 kwh,
2.5¢ per kwh for the next 130 kwh,
1.5¢ per kwh for all additional kwh.

Tax Adjustment.—Plus the applicable proportionate part of any taxes and assessments imposed by any governmental authority in excess of those in effect January 1, 1937, which are assessed on the basis of meters or customers or the price of or revenues from electric energy or service sold or the volume of energy generated or purchased for sale or sold.

Inflation Adjustment.—In order to take care of extreme increases in costs in the event of inflation there shall be added to the above rate $\frac{1}{2}$ of 1% for each 1% increase in cost of oil over \$2.00 a barrel (or \$2.00 per 6,300,000 Btu, if fuel used is other than oil) based on the average cost of fuel used in Company's plants during the next preceding month.

Excess Capacity Charge: For each kw of Demand in excess of 10, add \$1.75. The kw of Demand is the average kw supplied during the 15-minute period of maximum use during the current month.

RULES AND REGULATIONS:

Service under this schedule is subject to orders of governmental bodies having jurisdiction and to the currently effective "General Rules and Regulations for Electric Service" on file in Company's office, which are hereby made a part hereof. A copy of the present effective "General Rules and Regulations for Electric Service" is attached hereto. In case of conflict between any provision of this schedule and said "General Rules and Regulations for Electric Service" the provision of this schedule shall apply.

FLORIDA POWER & LIGHT COMPANY

Effective June 1, 1946

Fig. III-3. Residential rate schedule.

Block Hopkinson Demand Rate—In this type of rate a demand charge based on the maximum demand during any stated period is added to a block meter rate. Figure III-4 shows a rate schedule based on this system. It is named after Dr. John Hopkinson, an Englishman who did much to develop the theory of rate making. This rate has the advantage of encouraging commercial and industrial customers to develop a high load factor. It is almost never used for residential service because of the necessity for demand meters.

Room Rate—In this type of rate the block meter rate is modified to include the number of rooms in the residence. For example: 9¢ per kwh for the first three kwh per room; 6-1/2¢ per kwh for the next three kwh per room; and 3-1/2¢ per kwh for the excess over six kwh per room.

Rate Schedule IR

INDUSTRIAL SERVICE—ELECTRIC

APPLICATION:

For power service for industrial, manufacturing or processing purposes. The use of energy for lighting purposes within and about the buildings, structures and premises housing or enclosing the power driven and operated machinery and equipment used in or in connection with such industrial, manufacturing or processing purposes and incidental to the use of power supplied hereunder for such purposes is permissible under this Schedule. For such lighting use, Customer will provide and maintain all transformers and auxiliary appurtenances.

CHARACTER OF SERVICE:

Single or three phase, 60 cycles and at any available standard voltage.

LIMITATION OF SERVICE:

All service required on premises by Customer shall be furnished through one meter. Not applicable to service in stores, hotels, office buildings, theatres, apartment houses, restaurants, clubs, or in any other commercial establishments, nor to stand-by or resale service.

MONTHLY RATE:

\$1.50 per kw for the first 400 kw of Demand,
 \$1.00 per kw for all additional kw of Demand.
 2.6¢ per kwh for the first 1,700 kwh,
 1.3¢ per kwh for the next 4,300 kwh,
 1.0¢ per kwh for the next 34,000 kwh,
 0.8¢ per kwh for the next 40,000 kwh,
 0.6¢ per kwh for all additional kwh.

For each kw of the highest Excess On-Peak Demand established during the 12 months ending with the current month, add to the 2.6¢ block: 100 kwh per kw for the first 50 kw, 80 kwh per kw for the next 100 kw, and 70 kwh per kw for all additional kw.

Adjustments:

First,—Minus or plus .0183¢ per kwh used for each 1¢ below 12¢ or above 18¢, respectively, in Company's cost per million British Thermal Units of fuel. For this purpose there shall be employed the weighted average delivered cost (including freight, storage and handling costs) as shown by Company's books, of all fuel used during the next preceding month in the generating stations interconnected with Company's main transmission system.

Second,—Plus the applicable proportionate part of any taxes and assessments imposed by any governmental authority in excess of those in effect January 1, 1937, which are assessed on the basis of meters or customers or the price of or revenues from electric energy or services sold or the volume of energy generated or purchased for sale or sold.

Minimums \$1.50 per kw of the highest Demand established during the 12 months ending with the current month, but not more than an amount sufficient to make the total charges for such 12 months equal to \$20.00 per kw of such Demand, and not less than the charge for the currently effective Demand.

The foregoing rate is net and not subject to any municipal, county or other discount.

DEMAND:

The kw as determined from Company's demand meter for the 15-minute period of Customer's greatest use during the month, adjusted for power factor, but not less than 15 kw.

ON-PEAK DEMAND:

The kw as determined from Company's demand meter for the 15-minute period of Customer's greatest use during the On-Peak Hours of the current month, adjusted for power factor.

The On-Peak Hours shall be from 5 to 9 p.m. each day, excluding Sundays, Christmas and New Year's, from December 1 to March 31 inclusive. Company reserves the right to change the monthly and hourly periods after giving 30 days' notice, but the On-Peak Hours of each day shall always be consecutive.

EXCESS ON-PEAK DEMAND:

The number of kw by which the On-Peak Demand exceeds 20% of the average of the three highest Demands determined during the next preceding calendar months of April to November, inclusive.

The Excess On-Peak Demand effective for each month of the first contract year will be mutually agreed upon by Company and Customer, and used until actual operating data are available.

POWER FACTOR:

If Customer's power factor shall average less than 85% lagging during any month, then Company may adjust the readings taken to determine the Demand by multiplying the kw obtained through such readings by 85 and by dividing the result by the average power factor actually established during the current month. Such adjusted readings shall be used in determining the Demand.

TERM OF SERVICE:

Not less than one year. In the event this schedule is a part of an agreement for a term of less than 5 years, 5% shall be added to the amount computed under the above Monthly Rate, before Adjustments, and to the above Minimum.

RULES AND REGULATIONS:

Service under this schedule is subject to orders of governmental bodies having jurisdiction and to the currently effective "General Rules and Regulations for Electric Service" on file in Company's office, which are hereby made a part hereof. A copy of the present effective "General Rules and Regulations for Electric Service" is attached hereto. In case of conflict between any provision of this schedule and said "General Rules and Regulations for Electric Service" the provision of this schedule shall apply.

FLORIDA POWER & LIGHT COMPANY

Effective May 1, 1946

The computations involved are somewhat cumbersome, but the rate is used to a great extent in large cities where the majority of the population lives in apartments.

Example 4 shows the method of computing rates for the elementary power system of Example 1, based on the assumption that the system is privately owned, and Example 5 shows the calculations for rate making for the same power system based on the assumption that the system is owned by a municipality.

Example 4.

The power plant of Examples 1, 2 and 3-A contains five 50 kw Diesel-generators which cost \$250 per kw, installed, and have a salvage value of 10 o/o at the end of 15 years. The primary distribution system cost \$20000 and has a salvage value of 20 o/o at the end of 12 years. Management cost is \$6000 per year and taxes and insurance together are 7 o/o. Depreciation of the investment is on the straight line basis. Sixty per cent of the investment is raised by the sale of bonds which mature in 20 years and bear interest at 3.5 o/o. The bonds are to be retired out of profits and the remaining 40 o/o of the investment is raised by the sale of common stocks.

The engine heat rates (Btu/kwh net output) are: full load, 11800; 0.75 load, 12000; 0.5 load, 12900; 0.25 load, 14850. Fuel oil having 6,300,000 Btu/bbl and costing \$3.00 per bbl is used; maintenance \$600 per year; labor \$800 per month; supplies \$200 per year; and cost of water \$100 per year.

The system has 1000 customers and the cost of collection is \$3.00 per customer per year. The secondary distribution system cost \$75000 and has a salvage value of 15 o/o at the end of 12 years; labor \$1000 per month; maintenance \$800 per year; and taxes and insurance together are 7 o/o. The depreciation and financing are managed in the same way as for the plant and primary distribution system.

The annual profit is expected to be 10 o/o of the total investment, before income taxes are deducted. The income tax rate is 30 o/o. Find the amount of money available for common stock dividends after setting up a sinking fund for bond retirement. The sinking fund earns interest at 2 o/o.

Make a block meter rate which will recover the fixed element in the first 8 kwh per customer per month; the customer element in the next 15 kwh per customer per month; and

the energy and profit elements from the excess over 30 kwh per customer per month.

Solution:

A. Fixed element:

Investment in plant = 250(\$250)	\$ 62500
Investment in primary distribution system	20000
Annual depreciation of plant = $0.90 \frac{62500}{15}$	\$ 3750
Ann. depr. of pri. dist. sys. = $0.80 \frac{20000}{12}$	1333
Taxes and insurance = 0.07(82500)	5775
Interest = 0.035(0.60)(82500)	1732
Capitalized maintenance = (0.10)(1400)	140
Management	6000
 Total annual fixed element	 \$ 18730

B. Energy element:

In Figure III-5 a the engine heat rates are plotted vs kw output. Since all units are identical, the load will be divided equally among the units operating at any particular time. Figure III-5 b shows the plant heat rate vs plant load in kw. The following table can then be calculated:

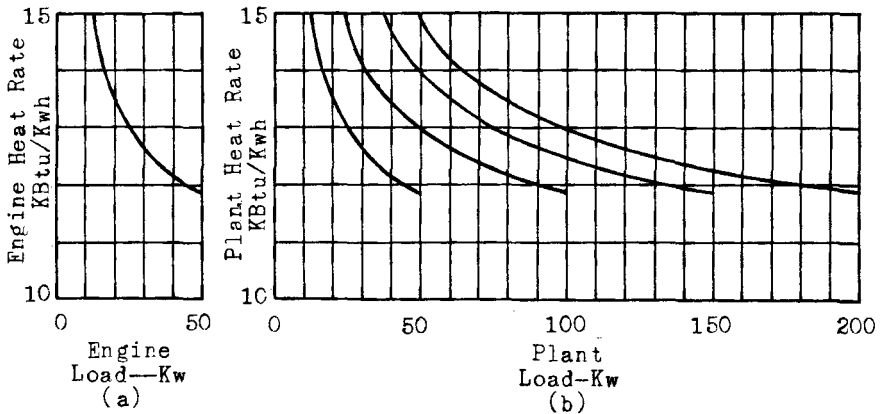

Fig. III-5. Engine heat rates for elementary power system.

ECONOMICS OF POWER PRODUCTION

39

Time AM	kwh	HR K	Heat KBtu	Time PM	kwh	HR K	Heat KBtu
MN- 1	23.5	13.1	308	N - 1	68.2	13.7	935
1 - 2	23.5	13.1	308	1 - 2	143.8	12.3	1770
2 - 3	23.5	13.1	308	2 - 3	138.2	12.4	1715
3 - 4	23.5	13.1	308	3 - 4	138.2	12.4	1715
4 - 5	23.5	13.1	308	4 - 5	136.4	12.4	1690
5 - 6	23.5	13.1	308	5 - 6	72.7	{ 13.6 13.0 13.2 }	968
6 - 7	37.9	12.2	425	6 - 7	44.8	{ 12.0 }	565
7 - 8	37.9	{ 12.2 20.0 }	591	7 - 8	44.8	12.0	538
8 - 9	110.2	12.8	1410	8 - 9	44.8	12.0	538
9 -10	134.6	12.4	1670	9 -10	34.4	12.3	424
10-11	134.6	12.4	1670	10-11	27.1	12.8	347
11- N	143.8	12.3	1770	11-MN	23.5	13.1	308

Total Btu/day = 20,887,000

Cost of fuel/day = $\frac{20,887,000}{6,300,000} (\$3.00) = \$9.95$

Annual fuel cost = 365(\$9.95)	\$3630
Labor = 12(\$800)	9600
Water	100
Supplies	200
Maintenance = 0.90(\$600)	540

Total annual energy element. \$14970

C. Customer element:

Investment in sec. dist. sys. = \$75000

Depr. of sec. dist. sys. = $0.85 \frac{75000}{12}$ \$ 5310

Taxes and insurance = 0.07(75000) 5250

Interest = 0.035(0.60)(75000) 1575

Maintenance = 0.90(800) 720

Labor = 12(1000) 12000

Cost of collection = 1000(\$3.00) 3000

Total annual customer element \$27855

D. Profit element:

Total investment		\$157500
Profit = 0.10(157500)		\$15750
Less income tax = 0.30(15750)		4725
Profit after taxes		\$11025
Less sinking fund cont. =		
	$0.60(157500) \frac{0.02}{(1 + 0.02)^{20} - 1}$	3880
Available for dividends		\$ 7145
Dividend rate = $\frac{7145(100)}{0.40(157500)}$		11.3 o/o

E. Block meter rate:

First block:

$$\text{rate} = \frac{\$18730}{12(10000)} = \$0.156/\text{kwh for first 10 kwh}$$

Second block:

$$\text{rate} = \frac{\$27855}{12(20000)} = \$0.116/\text{kwh for next 20 kwh}$$

Third block:

$$\text{rate} = \frac{\$10803 + \$15750}{12\left[\frac{365(1653)}{12} - 30000\right]} = \$0.109/\text{kwh for excess over 30 kwh}$$

Example 5.

This example is the same as Example 4 except for the method of financing, which is typical of municipal practice. All of the capital is raised by the sale of revenue certificates which mature in 20 years and bear interest at 3.5 o/o and the sinking fund earns interest at 2 o/o. Profit of 10 o/o on the investment goes to defray town operating expenses. No taxes are paid, and insurance is 2 o/o.

Solution:

A. Fixed element:

ECONOMICS OF POWER PRODUCTION

41

Investment in plant = 250(\$250)	\$ 62500
Investment in primary distribution system	20000
Annual depreciation of plant	\$ 3750
Annual depr. of pri. dist. sys.	1333
Insurance = 0.02(82500)	1650
Interest = 0.035(82500)	2885
Capitalized maintenance	140
Management	6000
Sinking fund cont. = 0.0411(82500)	3390
Total annual fixed element	\$19148

B. Energy element:

Total annual energy element	\$10803
-----------------------------	---------

C. Customer element:

Investment in secondary distribution system	\$75000
Depreciation of sec. dist. sys.	5310
Insurance = 0.02(75000)	1500
Interest = 0.035(75000)	2625
Maintenance	720
Labor	12000
Cost of collection	3000
Sinking fund cont. = 0.0411(75000)	3080
Total annual customer element	\$28235

D. Profit element:

Profit = 0.10(157500)	\$15750
-----------------------	---------

E. Block meter rate:

First block:

$$\text{rate} = \frac{\$19148}{12(10000)} = \$0.159/\text{kwh for first 10 kwh}$$

Second Block:

$$\text{rate} = \frac{\$28235}{12(20000)} = \$0.118/\text{kwh for next 20 kwh}$$

Third block:

$$\text{rate} = \frac{\$10803 + \$15750}{12(20300)} = \$0.109/\text{kwh for excess over 30 kwh}$$

BIBLIOGRAPHY

- Anon., "Public Control of Power," *Electrical World*, April, 1930.
- Anon., "Building and Equipment Cost Indexes," *Chemical Engineering*, February, 1949.
- Brydon, H. B., "Some Economic Factors of Power Station Design," *Transactions A.S.M.E.*, Volume 5C.
- Committee of Edison Electric Institute, "Power Station Building Costs," *Power Plant Engineering*, July, 1934.
- Elliot, Louis, "Semi-outdoor Plants Save Dollars," *Combustion*, July, 1942.
- Knowlton, A. E., "Cost of Power, Survey, 1938," *Electrical World*, December, 1939.
- Nash, L. R., *Economics of Public Utilities*, McGraw-Hill, New York, 1932.
- Raymond, W. G., *The Public and Its Utilities*, Wiley, New York, 1925.

PROJECT I

1. A certain town of 20,000 population is served by a private utility and has the equivalent of 6,000 customers, divided among three substations. Substation A serves a residential district; substation B serves a commercial district; and substation C serves an industrial district. Street lighting is supplied from substation D. The system (incomplete) is shown in Figure III-6. Connected loads and hours of use are as follows:

Class of Service	Connected Load kilowatts	Hours of Use
Substation A:		
Residences	7500	6 to 8 AM 5 to 11 PM
Apartments	2500	6 to 8 AM 5 to 11 PM
Substation B:		
Public buildings	250	9 AM to 5 PM
Churches	140	10 AM to 1 PM 6 to 9 PM
Hospitals	450	all day
Theaters	250	2 to 11 PM
Laundries	100	7 AM to 5 PM
Retail stores	450	9 AM to 6 PM
Offices	300	9 AM to 5 PM
Newspapers	150	9 AM to 8 PM
Substation C:		
Factories	3000	7 AM to 5 PM
Machine shops	500	8 AM to 5 PM
Substation D:		
Street lighting	500	6 PM to 6 AM

(a) Find the probable maximum demand for each class of service.

(b) Find the probable maximum demand on each substation.

(c) Find the probable maximum demand on the power plant and plot a typical daily load curve for the plant.

(d) Turbo-generator sizes available are: 500 kw, 750 kw, 1000 kw, 1500 kw, 2000 kw, 2500 kw and 3000 kw. Choose a unit or units which will give the maximum use and capacity factors

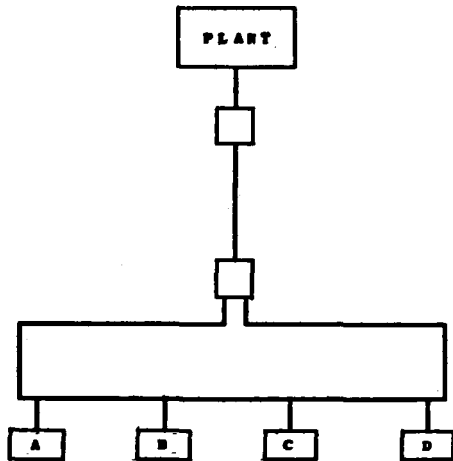

Fig. III-6. Elementary power system, Project I.

consistent with required reserves and leeway for growth, and set up an operating schedule for the plant.

2. (a) Estimate the cost of the plant and transmission system, assuming that the transmission system consists of approximately five miles of 13.2 kv line in flat country. Management cost is \$10000 per year and taxes and insurance together are 7 o/o. Depreciation of the investment is on the straight line basis. Sixty per cent of the investment is financed

by the sale of bonds which mature in twenty years and bear interest at 3 o/o. The remainder of the investment is financed by the sale of common stock. What is the annual fixed cost?

(b) If the turbo-generator heat rates (Btu per kwh net output) are estimated as: full load, 17500; 3/4 load, 17850; 1/2 load, 18650; and 1/4 load, 20500; fuel oil having 6,325,000 Btu per bbl, costing \$1.50 per bbl is used; labor, \$2,000 per month; supplies, \$3,000 per year; and cost of water, \$1,000 per year, what is the annual energy element? (Assume that the typical day in part one is the average day.)

(c) Estimate the cost of the secondary distribution system and the annual customer element if labor costs \$5,000 per month and taxes and insurance together are 7 o/o. The depreciation and financing of the investment is in the same manner as with the plant and primary distribution system.

(d) If the annual gross profit is to be ten per cent of the investment, how much will be left for common stock dividends after setting up a sinking fund for bond retirement and paying income taxes? The sinking fund earns interest at two per cent and the income tax rate is 38 o/o.

(e) Set up a block meter rate which will recover the fixed element in the first ten, the customer element in the next 25 and the energy and profit elements in the excess over 35 kwh per customer per month.

CHAPTER IV
VAPOR POWER CYCLES

21. Carnot Cycle--A cycle composed of completely reversible processes was proposed by Sadi Carnot, a French engineer, in 1824. The Carnot cycle is accepted as being the most efficient between any two temperature limits. The efficiency of the Carnot cycle can only be approached, however, because all real processes are irreversible. Figure IV-1 shows the Carnot cycle on the T-S and H-S planes for saturated steam and for superheated steam, both produced from saturated water.¹

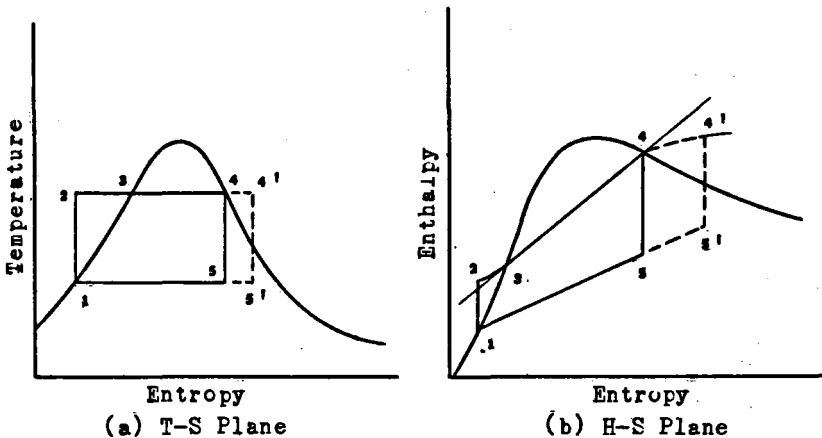

Fig. IV-1. Carnot cycle.

It will be noted that the Carnot cycle consists of two reversible isothermal and two reversible adiabatic processes. Examination of the cycle on the H-S plane will show that the characteristics of real vapors, such as steam, will not allow a practical realization of the Carnot cycle for the reason that the isothermal additions of heat from 2 to 3 and from 4 to 4' require that the pressure must decrease as the heat is being added.

¹ Since these figures are not to scale, considerable distortion exists, especially in the liquid region.

22. Rankine Cycle--The simplest vapor power cycle which has been proposed was conceived by Prof. W. J. M. Rankine, of the University of Glasgow, in 1849. This cycle is shown on the T-S and H-S planes in Figure IV-2, and will be seen to be a modification of the Carnot cycle to meet the requirements of real vapors. The expansion and compression lines

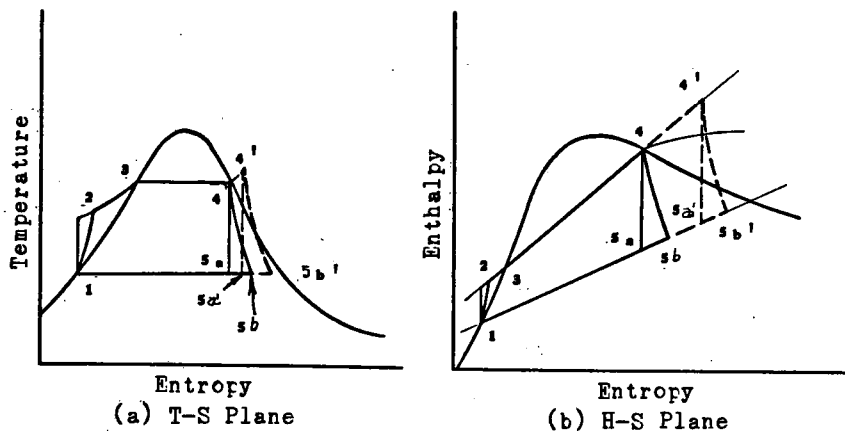

Fig. IV-2. Rankine cycle.

are shown to follow paths of increasing entropy because of the irreversibility of real processes. The ideal Rankine cycle would have these two processes follow paths of constant entropy.

A schematic diagram of the Rankine cycle is shown in Figure IV-3. The process 1-2 takes place in the pump and is one of subcooling in which the pressure is increased to that prevailing in the boiler. The process 2-3 takes place in the boiler and represents the constant pressure heating of water to the saturation temperature. The process 3-4 takes place in the boiler, also, and represents the production of steam from water at constant pressure. The steam at state 4 may be either wet or superheated. The process 4-5 represents the expansion in the engine, during which process work is done. The process 5-1 takes place in the condenser and is a constant pressure rejection of heat. It should be remembered that within the region of vapor mixtures (under the saturation line) a constant pressure process is identical with a constant temperature process.

The cycle represented in Figure IV-3 is closed, in that the same working fluid is used over and over. Often in

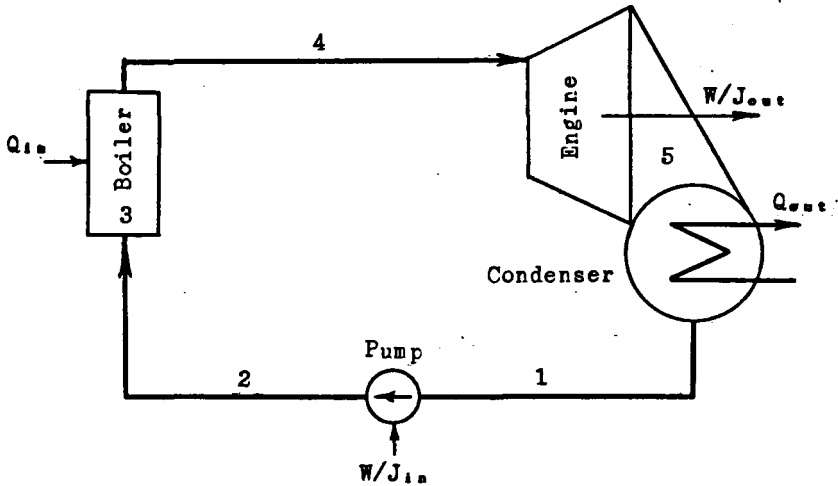

Fig. IV-3. Rankine cycle.

simple plants the cycle is open, that is, the condenser is absent and the steam is exhausted to the atmosphere at state 5. Sometimes part of the steam exhausted at state 5 in an open cycle is used to heat the feed-water going to the pump. This arrangement is shown in Figure IV-4.

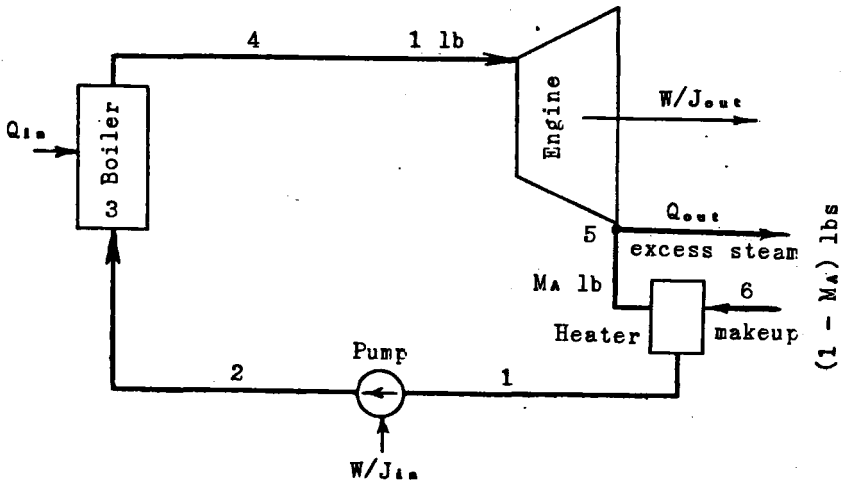

Fig. IV-4. Open Rankine cycle with feed-water heating.

The general energy equation of steady flow can be applied to each piece of equipment in the cycle and the various heat and work quantities determined, most conveniently on the basis of one pound of steam to the throttle of the engine.

For the closed Rankine cycle:

$$\text{Pump:}^1 \quad W/J_{in} = H_2 - H_1$$

$$\text{Boiler:} \quad Q_{in} = H_4 - H_2 = H_4 - H_1 - (H_2 - H_1)$$

$$\text{Engine:} \quad W/J_{out} = H_4 - H_{s_b}$$

$$\text{Condenser:} \quad Q_{out} = H_{s_b} - H_1$$

The efficiency of the cycle will be the net output divided by the input, or

$$e_{tc} = \frac{H_4 - H_{s_b} - (H_2 - H_1)}{H_4 - H_1 - (H_2 - H_1)}$$

For the open Rankine cycle with feed-water heating:

$$\text{Pump:} \quad W/J_{in} = H_2 - H_1$$

$$\text{Boiler:} \quad Q_{in} = H_4 - H_1 - (H_2 - H_1)$$

$$\text{Engine:} \quad W/J_{out} = H_4 - H_{s_b}$$

The preceding relations are the same as for the closed Rankine cycle, but the fact that part of the exhaust steam is used for feed-water heating makes it necessary to introduce a weight term, M_A , to represent the amount of steam used for feed-water heating and to make an energy balance for the feed-water heater, as follows:

$$M_A (H_{s_b} - H_1) = (1 - M_A)(H_1 - H_0)$$

¹ For pressure rises in the pump of less than 300 lbs per sq in. the pump work terms may be neglected without appreciable error. For pressure rises greater than 300 lbs per sq in. the pump work can be determined from Table 4 of Thermodynamic Properties of Steam, by Keenan and Keyes.

$$M_A = \frac{H_2 - H_4}{H_{s,b} - H_4}$$

H_4 would ordinarily be unknown, but, from the conditions under which the cycle operates, it can be no greater than the enthalpy of saturated water at the exhaust pressure (atmospheric usually). Then as before,

$$e_{t,c} = \frac{H_4 - H_{s,b} - (H_2 - H_1)}{H_4 - H_1 - (H_2 - H_1)}$$

This same sort of analysis could be applied to the open Rankine cycle without feed-water heating. The advantage of using part of the exhaust steam for feed-water heating can be seen if the expression for thermal efficiency is examined. With feed-water heating H_1 will be greater, thereby causing a decrease in the value of the denominator with a resulting increase in efficiency. In addition, less makeup water would be required.

23. Engine Efficiency--The ratio of the actual work energy removed from a pound of steam in the engine to the amount that could be removed in an adiabatic expansion is known by several names: *engine efficiency*, *Rankine cycle efficiency ratio*, and *Rankine cycle ratio*. The preferred name, however, is engine efficiency. The mathematical relation (referring to Figure IV-2) is:

$$e_e = \frac{H_4 - H_{s,b}}{H_4 - H_{s,a}}$$

The engine efficiency can be determined directly for steam engines because it is possible to follow the path of the steam expansion with an engine indicator and to determine the power delivered to the piston. In this case,

$$e_e = \frac{2545}{S_i(H_4 - H_{s,a})}$$

where: S_i = steam rate, lbs/indicated hp-hr

In the case of the steam turbine, it is difficult to determine the engine efficiency because the path of the expansion cannot be followed completely and the mechanical efficiency cannot be determined easily. Therefore, the term

overall engine efficiency, which is the product of engine efficiency and mechanical efficiency (and generator efficiency, if electrical output is measured) is employed. In this case,

$$e_{e_o} = \frac{2545}{S_s(H_4 - H_{5_a})}$$

where: S_s = steam rate, lbs/shaft hp-hr

It should be pointed out here that the steam rate has significance in the above equations only for engines or turbines operating on the Rankine cycle where all of the steam passes completely through the engine or turbine. In other cases the steam rate is of value only in comparing similar cycles or for checking day to day performance of a particular machine.

24. Reheating Cycle--This cycle was proposed by Ferranti as a means of improving the efficiency of the Rankine cycle for real engines. It is a characteristic of real engines and turbines that the engine efficiency is greater in the region of superheat than in the region of mixtures. The ideal reheating cycle is intended to cause a greater portion of the expansion to take place in the region of superheat where the enthalpy drop between any two pressures is greater than the enthalpy drop in the region of mixtures between the same two pressures. This difference is slight, however, and results in very insignificant gains in thermal efficiency for the ideal cycle. The opposite is true for the real reheating cycle, and very significant gains are made as a result of the improved engine efficiency. Figure IV-5 shows the reheating cycle on the T-S and H-S planes, and Figure IV-6 shows a schematic diagram of the cycle.

The reheating of the steam may be done in one of three ways: (a) Using steam from the boiler in a heat exchanger; (b) using a separate reheating furnace; or (c) using a reheater built into the boiler gas passages. The reheating cycle utilizing the first method of reheating has very little advantage, if any, over the Rankine cycle due to thermal losses in the reheating system. The second method has thermodynamic advantages over the first method, but requires considerable additional investment in fuel burning equipment, etc. The third method has both thermodynamic and economic advantages over the first method.

The cycle can be analyzed as follows:

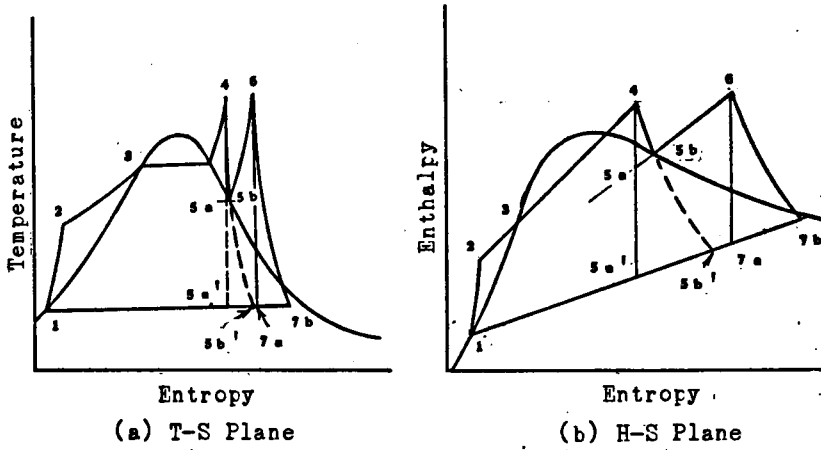

Fig. IV-5. Reheating cycle.

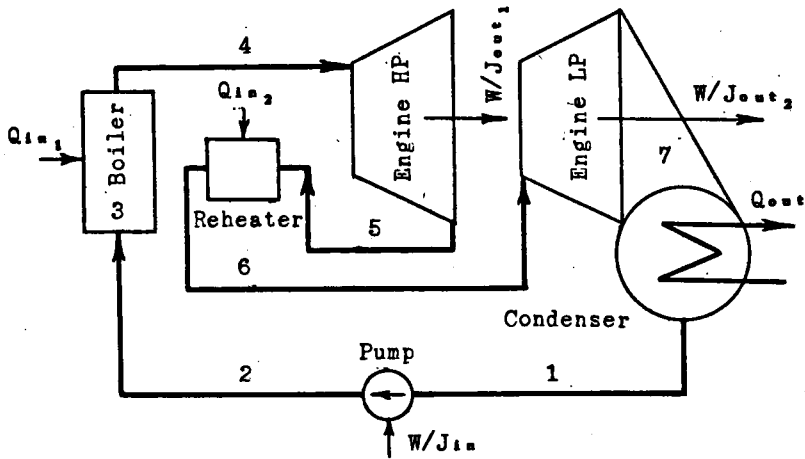

Fig. IV-6. Reheating cycle.

Pump: $W/J_{in} = P_2 - H_1$

Boiler: $Q_{in_1} = H_4 - H_1 - (H_2 - H_1)$

Engine H.P.: $W/J_{out_1} = H_4 - H_{5b}$

Reheater: $Q_{in_2} = H_6 - H_{5b}$

$$\text{Engine L.P.: } W/J_{out,2} = H_6 - H_7$$

$$\text{Condenser: } Q_{out} = H_7 - H_1$$

$$e_{t_c} = \frac{H_A - H_{5b} + H_6 - H_7 - (E_2 - H_1)}{H_A - H_1 + H_6 - H_{5b} - (E_2 - H_1)}$$

25. Regenerative Cycle--This cycle was proposed by Prof. J. H. Cotterill in 1890, and depends for its improvement in thermal efficiency over the Rankine cycle upon the use of part of the steam from the engine, after it has done some work, to heat feed-water going to the boiler. The regenerative cycle is similar to the open Rankine cycle with feed-water heating except for the addition of the condenser to carry the expansion down to lower temperatures and to close the cycle. Figure IV-7 shows the regenerative cycle on the T-S and H-S planes, and Figure IV-8 (a) shows a schematic diagram of the cycle with two mixing (or open) heaters to correspond with Figure IV-7. Figure IV-8 (b) shows the modification of the schematic diagram and the lower part of the H-S plane that is necessary when the low pressure open heater is replaced by a closed (or surface) heater.

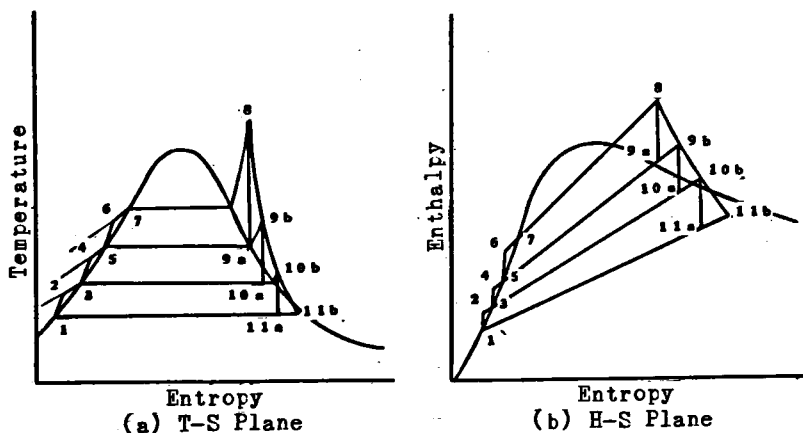

Fig. IV-7. Regenerative cycle.

R. L. Reynolds has given considerable data on the performance of regenerative cycles with various numbers of feed-water heaters, and Figure IV-9 shows some of his data which are used for the determination of the best final feed-water temperature. It will be noted that the curves in Figure IV-9 (a) are drawn for a standard throttle temperature of

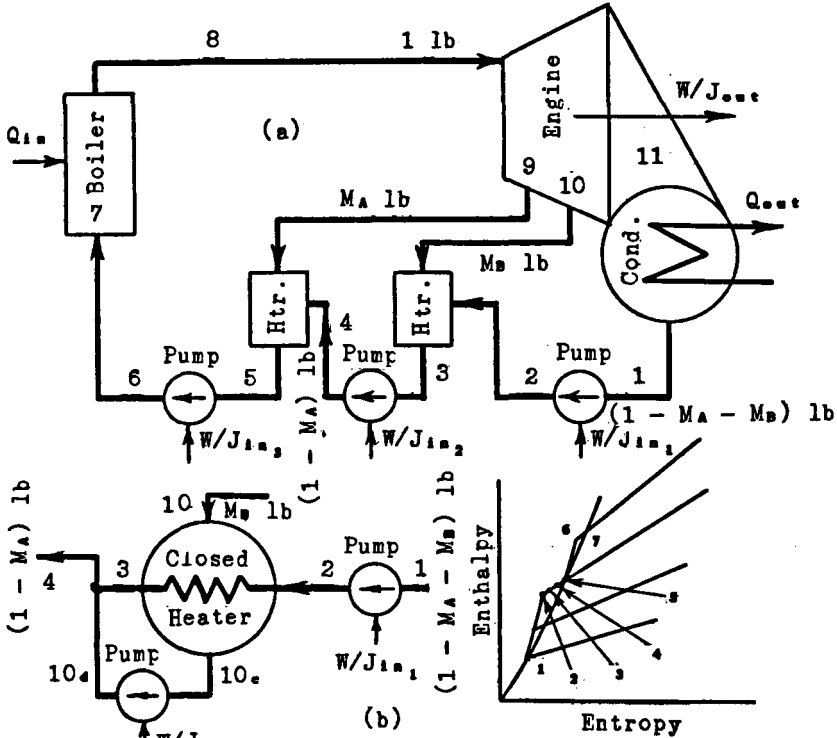

Fig. IV-8. Regenerative cycle.

750 F and a standard condenser vacuum of 29 inches of mercury. The effect of departure from these standards can be computed with the aid of the correction curves in Figures IV-9 (b) and IV-9 (c). It is customary to select the extraction pressures for feed-water heating so that the temperature rises in each heater are approximately equal. Ordinarily only one open heater is used in the modern regenerative cycle, so placed that the pressure in the heater is slightly above atmospheric at the minimum normal load.

The cycle can be analyzed as follows:

A. For two open heaters:

Pumps:
$$W/J_{in,1} = (H_2 - H_1)(1 - M_A - M_B)$$

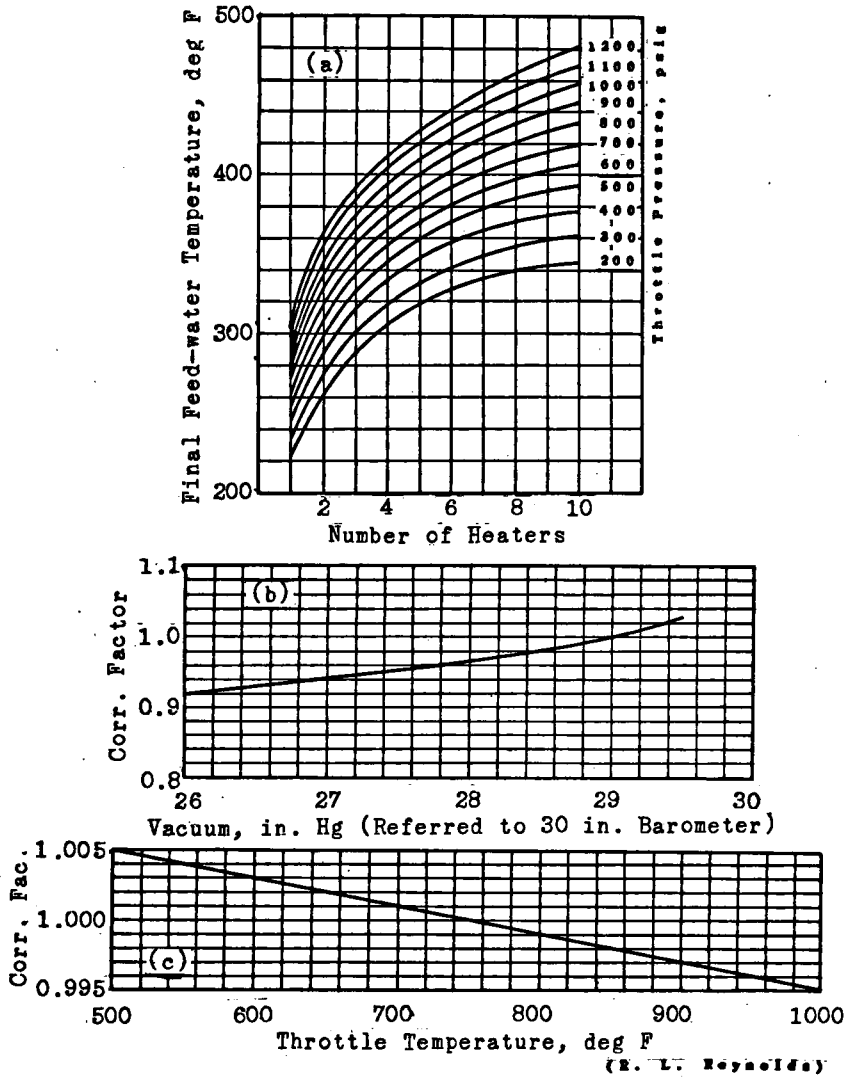

Fig. IV-9. Regenerative cycle feed-water temperatures.

$$W/J\dot{m}_2 = (H_4 - H_3)(1 - M_A)$$

$$W/J\dot{m}_3 = (H_6 - H_5)$$

Boiler: $Q_{in} = H_6 - H_5 - (H_6 - H_5)$

Engine: $W/J_{out} = H_6 - H_{6b} + (1 - M_A)(H_{6b} - H_{10b})$
 $+ (1 - M_A - M_B)(H_{10b} - H_{11b})$

Condenser: $Q_{out} = (1 - M_A - M_B)(H_{11b} - H_1)$

The extraction quantities can be determined by the use of energy balances for each feed-water heater, as follows:

$$M_A[H_{6b} - H_5] = [1 - M_A][H_5 - H_3 - (H_4 - H_3)]$$

$$M_B[H_{10b} - H_3] = [1 - M_A - M_B][H_3 - H_1 - (H_2 - H_1)]$$

The thermal efficiency is:

$$e_{tc} = \frac{W/J_{out} - W/J_{in_1} - W/J_{in_2} - W/J_{in_3}}{Q_{in}}$$

B. For one high pressure open heater and one low pressure closed heater:

Pumps: $W/J_{in_1} = (H_2 - H_1)(1 - M_A - M_B)$
 $W/J_{in_2} = (H_{10c} - H_{10b})(M_B)$
 $W/J_{in_3} = (H_6 - H_5)$

Boiler: $Q_{in} = H_6 - H_5 - (H_6 - H_5)$

Engine: $W/J_{out} = H_6 - H_{6b} + (1 - M_A)(H_{6b} - H_{10b})$
 $+ (1 - M_A - M_B)(H_{10b} - H_{11b})$

Condenser: $Q_{out} = (1 - M_A - M_B)(H_{11b} - H_1)$

Extraction quantities:

$$M_A[H_{6b} - H_5] = [1 - M_A][H_5 - H_4]$$

$$H_A = \frac{[1 - M_A - M_B][H_3] + [M_B][H_{10c} + (H_{10d} - H_{10c})]}{[1 - M_A]}$$

$$M_B[H_{10b} - H_{10c}] = [1 - M_A - M_B][H_3 - H_1 - (H_2 - H_1)]$$

The addition of more stages of feed-water heating merely makes the mathematics more complicated. An energy balance for each feed-water heater and for each junction point where closed heater drip pumps discharge into the main condensate line will give sufficient equations to solve for all of the unknowns.

Modifications of the cycle are sometimes made in the minor details, such as disposal of the closed heater drips. Where closed heaters are placed in series, the drips may be cascaded counterflow to the condensate with a slight loss in thermodynamic efficiency, but with saving in installation and maintenance costs due to the elimination of several pumps. It is usual, however, to have at least one heater drip pump, located at the closed heater nearest to the condenser. Figure IV-10 shows the heat balance diagram for a modern high pressure regenerative cycle.

26. Reheating-Regenerative Cycle--The simple reheating cycle is no longer used in central station practice because greater efficiency gains can be realized by combining it with the regenerative cycle. In the last few years there have been several large stations built on this cycle using flue gas reheating. The reheating-regenerative cycle is generally considered to provide the ultimate improvement in efficiency over the Rankine cycle where only a single working fluid is concerned. The cycle analysis is made in the same manner as given for the two separate cycles. Figure IV-11 shows the heat balance diagram for a modern high pressure reheating-regenerative cycle.

27. Field Cycle--This cycle was proposed by J. F. Field, of the British Electric Authority, in 1948. The cycle eliminates the boiler and depends upon vapor compression to bring the steam back to the saturation condition before superheating. The cycle is shown on the T-S and H-S planes in Figure IV-12, and a schematic diagram is shown in Figure IV-13. The unavailable energy is rejected in a small condenser called a "calorifier," and the condensate is returned to the system through a spray nozzle. Field has also shown modifications of the cycle which include reheating and regeneration.

The simple cycle can be analyzed as follows:

$$\text{Pump:} \quad W/J_{i_n_1} = -(M)(H_6 - H_5)$$

$$\text{Compressor:} \quad W/J_{i_n_2} = H_2 - H_{1p}$$

$$\text{Superheater:} \quad Q_{i_n} = H_3 - H_2$$

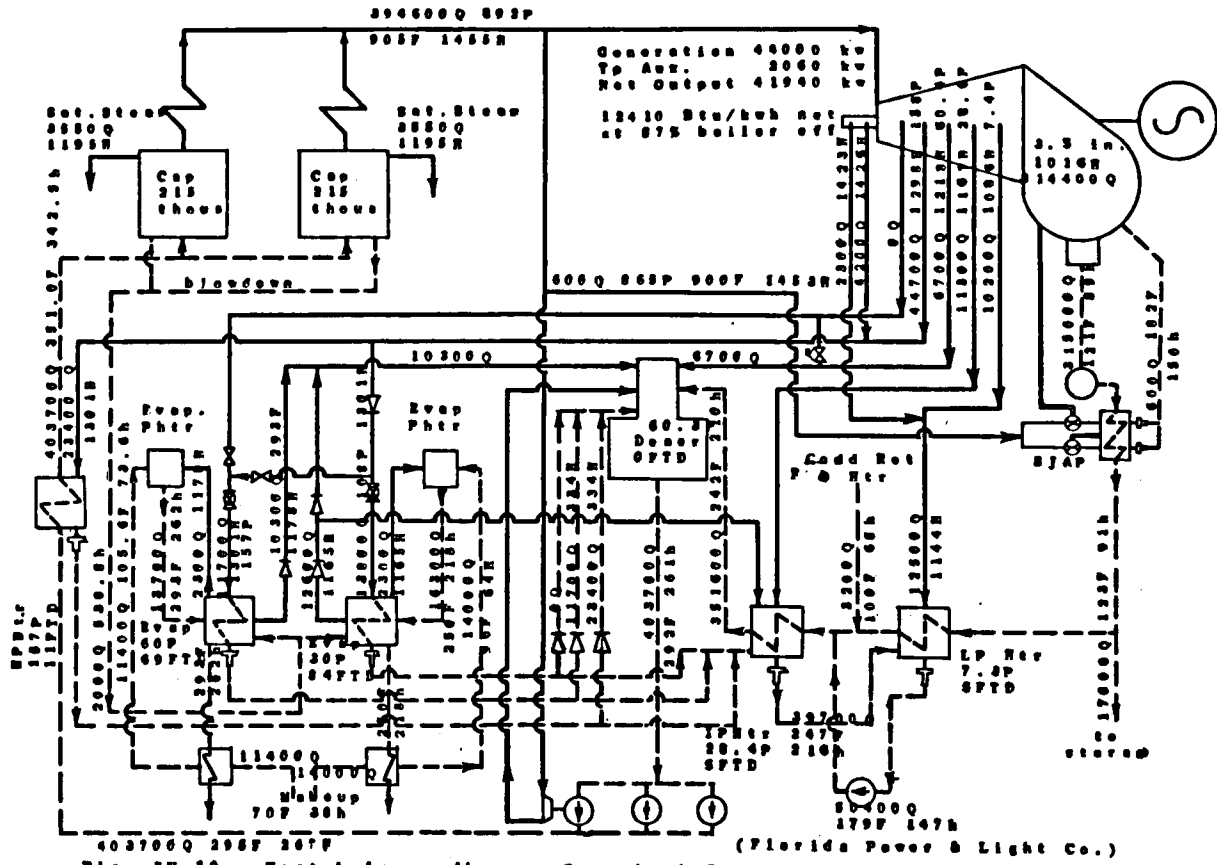

Fig. IV-10. Heat balance diagram for Miami Steam Electric Station.

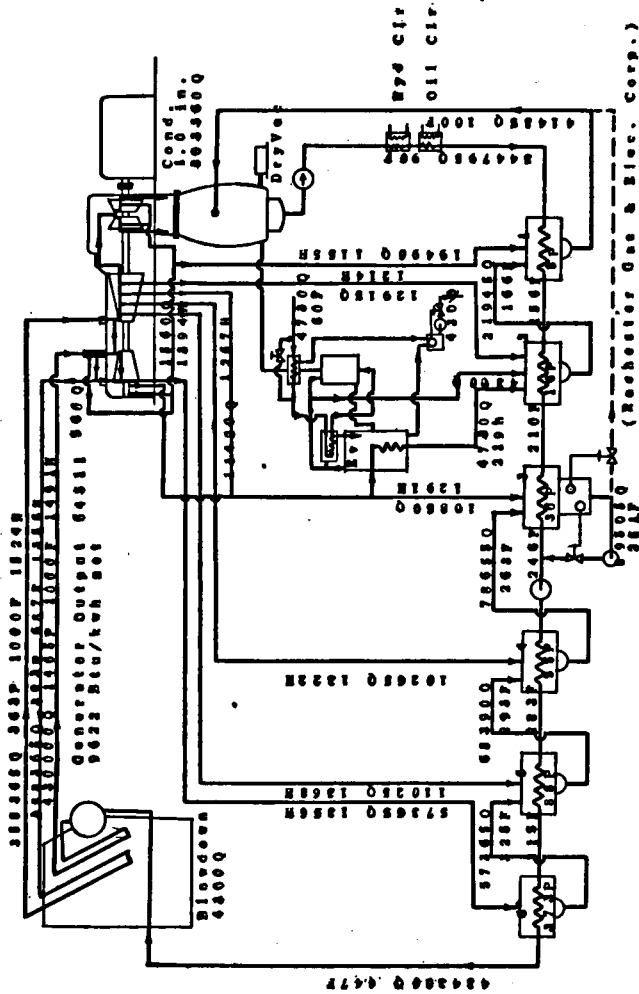

Fig. IV-11. Heat balance diagram for Russell Station.

Engine: $W/J_{out} = H_3 - H_{4b}$

Calorifier flow:

$$[1 - M][H_{4b} - H_{1b}] = M[H_{1b} - H_5 - (H_6 - H_5)]$$

$$e_{tc} = \frac{H_3 - H_{4b} - E_2 - H_{1b} - M(H_6 - H_5)}{H_3 - H_2}$$

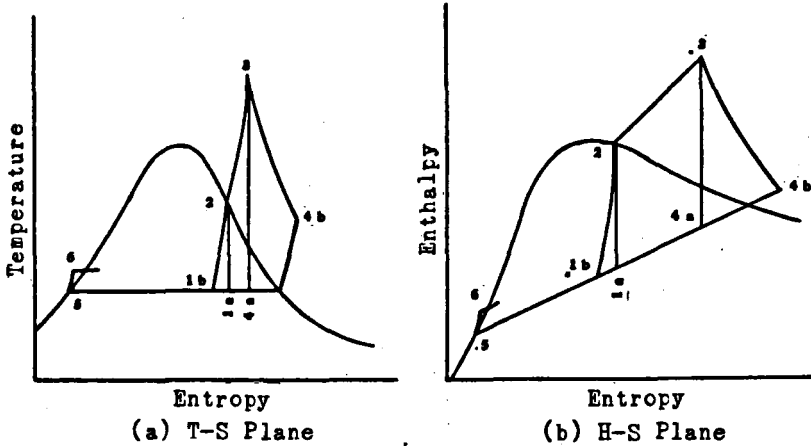

Fig. IV-12. Fluid cycle.

The theoretical advantages of this cycle are such as to make the efficiency much greater than that of the reheating-regenerative cycle because only a small portion of the steam flowing is condensed to water. The practical disadvantage, however, is the large amount of the output of the engine which is returned to the compressor. The cycle is similar to the gas turbine cycle in this respect. (see Chapter XIX), and for all practical purposes is a closed gas turbine cycle using steam instead of air as the working fluid.

28. Superposed Cycle--The superposed (sometimes called "topping") cycle was developed during the depression of the 1930's to allow the addition of capacity without the necessity for building complete new plants. The cycle is a compound arrangement in which new high pressure boilers, replacing obsolete low pressure boilers, supply steam to a new high pressure turbo-generator which exhausts to the existing low pressure turbo-generators. The low pressure turbo-generators are rehabilitated to give additional useful life. This type of additional capacity can be installed for about one-half the cost of a complete new plant of the same capacity. The upper portion of the cycle is shown on the H-S plane in Figure IV-14, and a schematic diagram is shown in Figure IV-15. To date, superposition has been practiced only on regenerative cycles.

The cycle can be analyzed in the usual manner, remembering that the condition of the steam at state 10_1 (the exhaust of the high pressure turbine) must be identical with

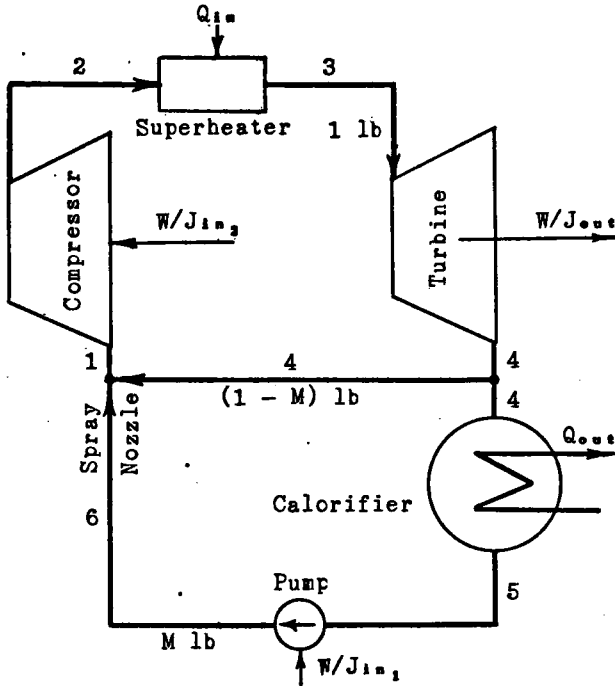

Fig. IV-13. Field cycle.

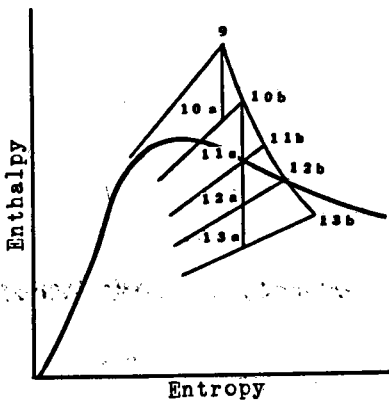

Fig. IV-14. Superposed cycle.

the specified conditions for the throttle of the old low pressure turbines. It will be seen that the high pressure turbine must pass large weights of steam, but the initial and final specific volumes are small enough to make the actual physical size of the high pressure turbine rather small in comparison with that of the low pressure turbines.

Perhaps the most important calculations in the superposed cycle have to do with the determination of the additional power produced by the

high pressure turbine. The heat balance of the regenerative cycle upon which the high pressure system is superimposed is already known, and it is only necessary to consider the effect of the superposition upon the complete system, as follows:

Additional pump work:

$$W/J_{in_{add}} = (H_8 - H_5)P_9 - (H_8 - H_5)P_{10}$$

Additional engine work:

$$W/J_{out_1} = H_9 - H_{10}$$

State 10_b is known, but in order to determine state 9 the engine efficiency of the superposed turbine and the approximate amount of power required from it must be known. In general, a superposed turbine produces about one-third as much power as the low pressure turbines which it supplies with steam. Then, if M is the total steam flow in pounds per hour required for the low pressure turbines, and kw is the output of the low pressure turbines,

$$e_s = \frac{H_9 - H_{10b}}{H_9 - H_{10a}} = \frac{3413(kw)}{3M(H_9 - H_{10a})}$$

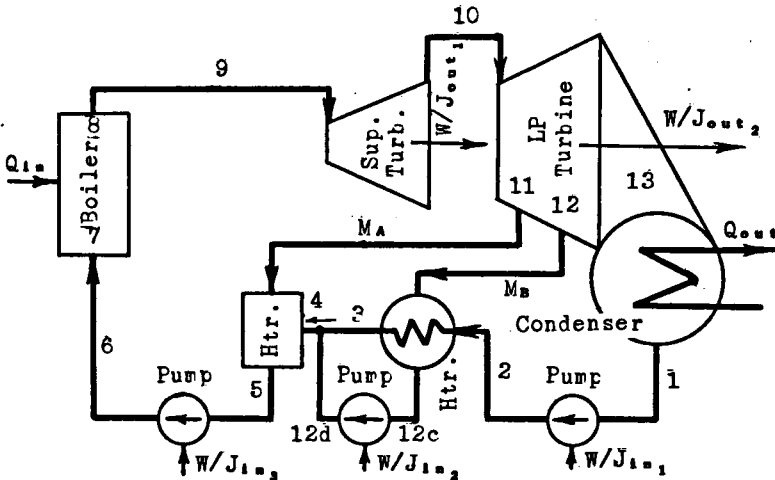

Fig. IV-15. Superposed cycle.

are further adjusted. Figure IV-16 shows the heat balance diagram for a modern superposed installation.

29. Binary Cycles--Some years ago it was realized that progress in increasing the efficiency of vapor power cycles was being retarded by the thermodynamic disadvantages of steam in the higher temperature ranges. That is, extremely high pressures are required for high initial temperatures so that the condition of the steam at the end of expansion in the engine will be within a range that can be economically handled. This limitation led to the development of the mercury-steam binary cycle. Mercury has the advantage of requiring much lower pressures for higher temperatures than does steam.

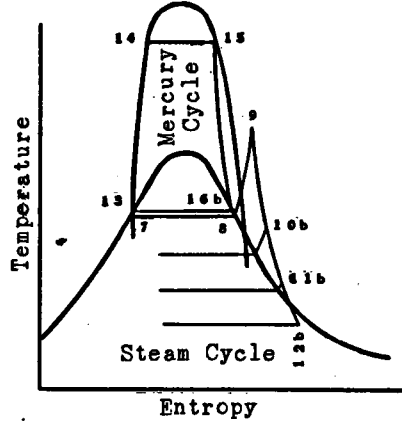

Fig. IV-17. Mercury-steam binary cycle.

The mercury-steam binary cycle utilizes the latent heat of condensation of the mercury to generate steam. Figure IV-17 shows the cycle on the T-S plane, and Figure IV-18 shows a schematic diagram of the cycle. Figure IV-19 is a Mollier diagram for mercury vapor.

The cycle can be analyzed in two parts on the basis of one pound of each fluid, and then combined into the binary cycle, as follows:

$$\frac{[\text{lbs Hg}]}{[\text{lbs H}_2\text{O}]} = \frac{H_8 - H_5 - (H_9 - H_5)}{H_{10b} - H_{13}}$$

$$W/J_{netc} = W/J_{H_2O_{net}} + W/J_{Hg} \frac{[\text{lbs Hg}]}{[\text{lbs H}_2\text{O}]}$$

$$Q_{inc.} = Q_{in_1} + Q_{in_2} \frac{[\text{lbs Hg}]}{[\text{lbs H}_2\text{O}]}$$

$$e_{tc} = \frac{W/J_{netc}}{Q_{inc}}$$

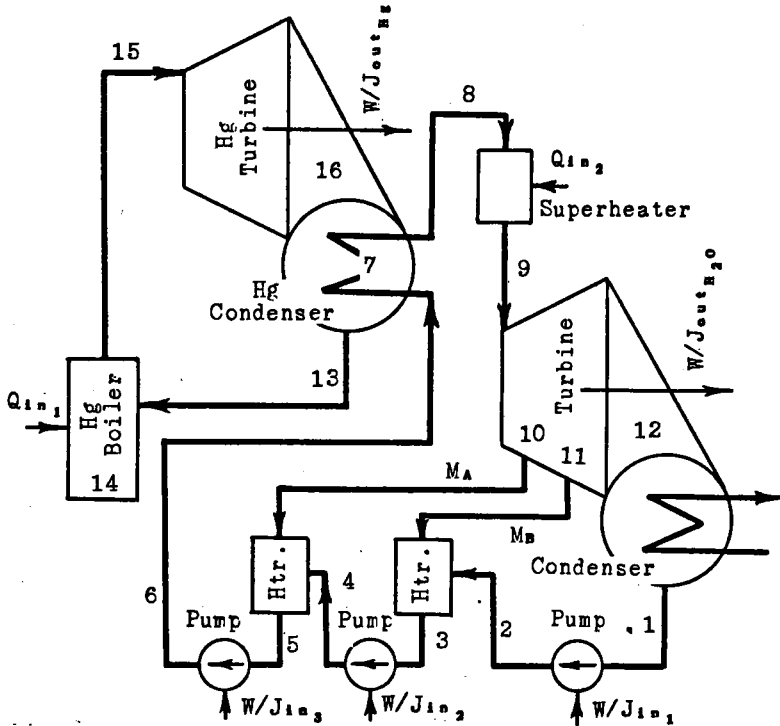

Fig. IV-18. Mercury-steam binary cycle.

An interesting feature of the mercury cycle is the absence of a mercury pump. The mercury turbine and condenser is placed on an elevation above the mercury boiler, and the difference in density between liquid and vapor is sufficient to feed the boiler. One problem that has slowed down the acceptance of the mercury-steam binary cycle is that of sealing in the highly toxic mercury vapors. However, this difficulty has been overcome satisfactorily and a complete plant is presently being built in New England.

Other binary cycles have been proposed which use steam as the upper fluid followed by sulphur dioxide, petroleum ether, butane or propane. The disadvantages of these cycles lie in the undesirable properties of steam at higher temperatures and in the toxicity and inflammability of some of the secondary fluids proposed. The advantage, however, is in the fact that both engines exhaust at pressures above atmospheric, thus eliminating the necessity for a vacuum pump

on the condenser. There is little, if any, gain in thermal efficiency over the straight steam cycle.

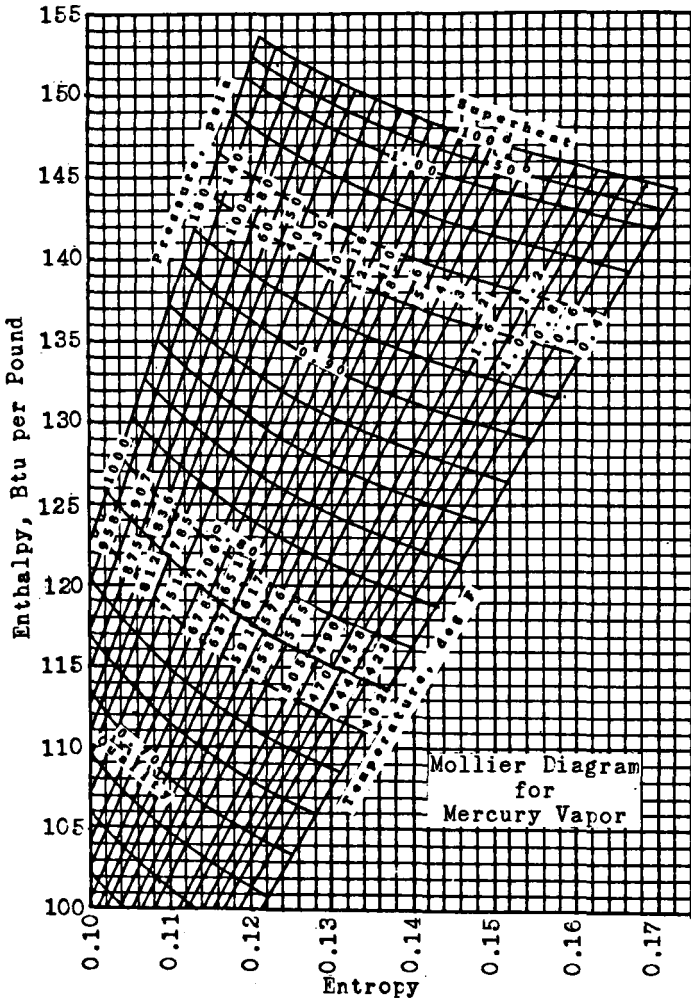

Fig. IV-19. Mollier diagram for mercury vapor.

BIBLIOGRAPHY

- Ebaugh, Newton C., *Engineering Thermodynamics*, Van Nostrand, New York, 1937.
- Field, J. F., "New Steam Cycle Proposed," *Combustion*, August, 1948.
- Gaffert, G. A., "High Pressure Steam and Binary Cycles as a Means of Improving Power Station Efficiency," *Transactions A.S.M.E.*, October, 1934.
- Salisbury, J. K., "The Steam Turbine Regenerative Cycle--An Analytical Approach," *Transactions A.S.M.E.*, April, 1942.
- Zetterquist, E., "Burlington Station Modernized by High Pressure Top," *Power*, 1933.

CHAPTER V

PRIME MOVERS

30. The only prime movers used in vapor power cycles are engines or turbines. The engine is a reciprocating device which utilizes both pressure and expansion energy of the steam, while the turbine is a rotating machine which utilizes only the expansion energy of the steam.

Steam engines in sizes below 500 hp are more efficient than steam turbines and find their greatest application where variable speed and exhaust steam for process use is required. Steam turbines have replaced steam engines in sizes over 500 hp, principally because of their compactness and higher efficiency.

31. Steam Engines--The steam engine became a practical reality in the 1600's, and after improvements by Newcomen and Watt, and many others, reached the peak of its growth and use in the early 1900's. Engine sizes reached 25,000 hp on a single shaft with four cylinder triple expansion machines for driving battleships. As previously mentioned, however, the steam engine is finding its field limited to small sizes. It appears that the steam engine on the railroads is also doomed to obsolescence. The American Locomotive Company, which built steam locomotives for 100 years, recently announced that its entire production in the future would be confined to Diesel-electric equipment.

The principal types of engine remaining in use today are divided into two general classifications, counterflow and uniflow, depending upon the location of the main exhaust ports with relation to the stroke of the piston. The classifications are further subdivided as to valve types, whether slide, rotary or poppet. It can be said, in general, that the uniflow engine is more efficient than the counterflow engine because of reduced thermal losses resulting from the avoidance of alternate heating and cooling of the cylinder. Rotary and poppet valve engines are more efficient than slide valve engines. The rotary and poppet valves reduce losses by avoiding the throttling of steam at the intake and exhaust. Figures V-1 and V-2 show two common types of steam engine.

The mechanical efficiency of a steam engine can be determined directly if the output horsepower (usually called brake horsepower because some form of brake or dynamometer is used for its measurement) and input horsepower (called indicated horsepower because an engine indicator is used

for its determination) are known. Figure V-3 shows one type of brake used to determine engine output, and Figure V-4 shows an engine indicator with a diagram (or card) drawn by it. If the constants of the brake, engine and indicator are known, the following equations will give the required information:

$$Bhp = \frac{2\pi FLN}{33000}$$

where: F = net force exerted by brake, lbs.
 L = length of brake arm, ft.
 N = speed of engine, rpm.

$$Ihp = \frac{P_{m_h} LA_h N}{33000} + \frac{P_{m_c} LA_c N}{33000}$$

where: P_{m_h} and P_{m_c} = mean effective pressures exerted on the head and crank ends of the piston, lbs/sq in.
 L = length of piston stroke, ft.
 A_h and A_c = effective piston area of head and crank ends, sq in.
 N = speed of engine, rpm.

$$P_m = \frac{A_d S}{L_d}$$

where: A_d = area of indicator diagram, sq in.
 L_d = length of indicator diagram, in.
 S = scale of indicator spring, lbs/sq in./in.

$$e_m = \frac{Bhp}{Ihp}$$

The mechanical efficiency of steam engines is high, and the shape of the efficiency vs load curve depends primarily upon the valve type, as can be seen in Figure V-5. Engine efficiencies are moderately high and depend primarily upon the flow direction within the cylinder, as shown in Figure V-6.

32. Estimation of Steam Engine Dimensions--
 In preliminary calculations for engine plants it is necessary to estimate the dimensions of the engine. This estimation is based on empirical data as to piston speeds and departure from the ideal expansion in the engine.

The approximate work obtained from the engine can be obtained from consideration of the ideal indicator diagram with the application of a diagram factor to allow for the effects of compression and the departure of the expansion from the adiabatic.² Figure V-7 shows the ideal indicator diagram with a realized diagram superimposed. From the ideal diagram:

$$\begin{aligned} \text{Net area} &= \text{net work} \\ &= P_1 V_1 + P_1 V_1 \log_e \frac{V_2}{V_1} - P_2 V_2 \end{aligned}$$

V_2/V_1 is called the expansion ratio, R . It can be seen from the diagram that the larger the value of R , the larger the proportion of the total work done by the expansion of the steam. One method of governing the output of a steam engine is to vary the expansion ratio. For purposes of estimation for full load, R is usually taken as being between three and four. Making the substitution for R ,

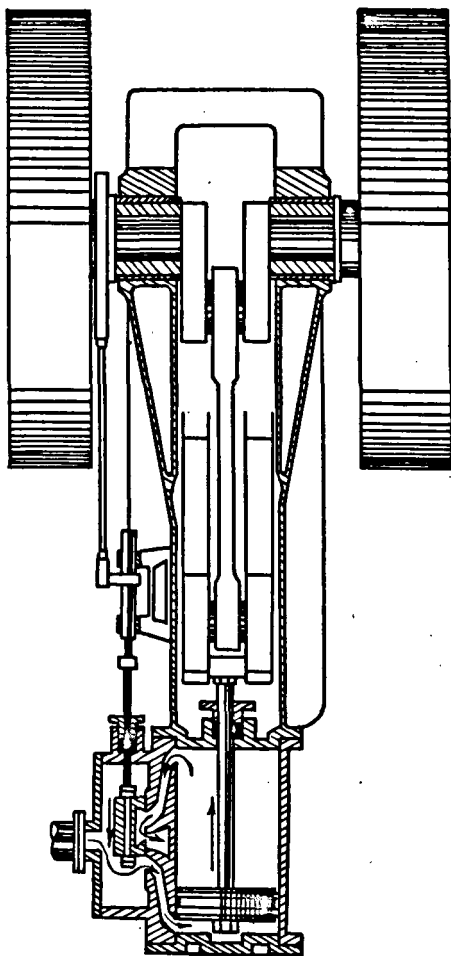

Fig. V-1. Counterflow steam engine with D slide valve.

² For simplicity, the derivation of the ideal diagram area assumes that the expansion is isothermal.

$$\frac{\text{Net work}}{V_2} = P_m = [(P_1/R)(1 + \log_e R) - P_2]F_d$$

where: P_m = mean effective pressure, lbs/sq in.
 P_1 and P_2 = throttle and exhaust pressure,
 respectively, lbs/sq in abs.
 R = expansion ratio
 F_d = a diagram factor depending on the
 type of engine (Table IV)

The engine dimensions are affected by the rotational speed and the allowable piston speed, as shown in Table IV.

Example 6 shows the method of estimating steam engine dimensions by use of the preceding information.

Example 6.

Determine the approximate dimensions of a single cylinder double-acting uniflow steam engine to develop 250 bhp at 200 rpm.

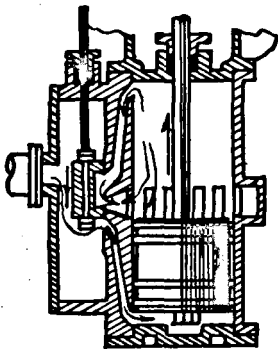

Fig. V-2. Uniflow steam engine cylinder with D slide valve.

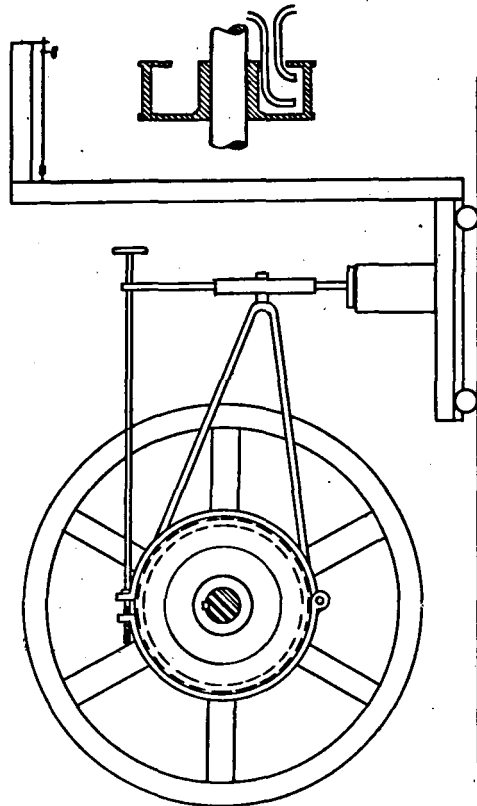

Fig. V-3. Proxy brake.

Steam to the throttle is at 150 psig and saturated. Exhaust is at 3 in. Hg abs.

Solution:

From Figure V-5, the mechanical efficiency is found to be about 90 o/o, and from Table IV, the piston speed and diagram factor are estimated to be 750 fpm and 0.80 respectively. Taking the expansion ratio as 4,

$$P_m = \left[\frac{164.7}{4} (1 + \log_e 4) - 1.47 \right] [0.80] = 77.5 \text{ psi}$$

$$\text{Length of stroke} = \frac{750}{2(200)} = 1.875 \text{ ft} = 22.5 \text{ in.}$$

$$I_{hp} = \frac{250}{0.90} = 278 = \frac{77.5(1.875)(200)(2)A}{33000}$$

from which, $A = 158 \text{ sq in.}$ and $d = 14.2 \text{ in.}$

The required engine dimensions are $22\frac{1}{2} \text{ in.} \times 14\frac{1}{2} \text{ in.} \times 200 \text{ rpm.}$

TABLE IV

DESIGN DATA FOR STEAM ENGINES

ROTATIONAL SPEEDS

Counterflow engines	200 to 350 rpm
Uniflow engines	100 to 300 rpm

PISTON SPEEDS

Counterflow engines	600 to 450 fpm
Uniflow engines	900 to 600 fpm

DIAGRAM FACTORS

Counterflow engines	0.70 to 0.85
Uniflow engines	
Condensing	0.75 to 0.85
Non-condensing	0.70 to 0.80

Figure V-8 shows the approximate cost (based on 1936) of modern steam engine-generator sets.

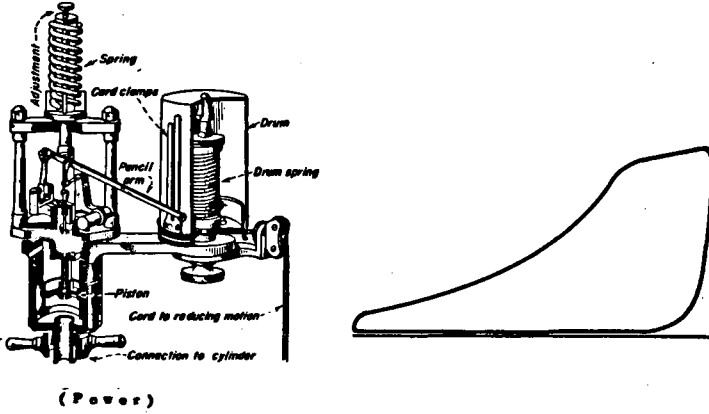
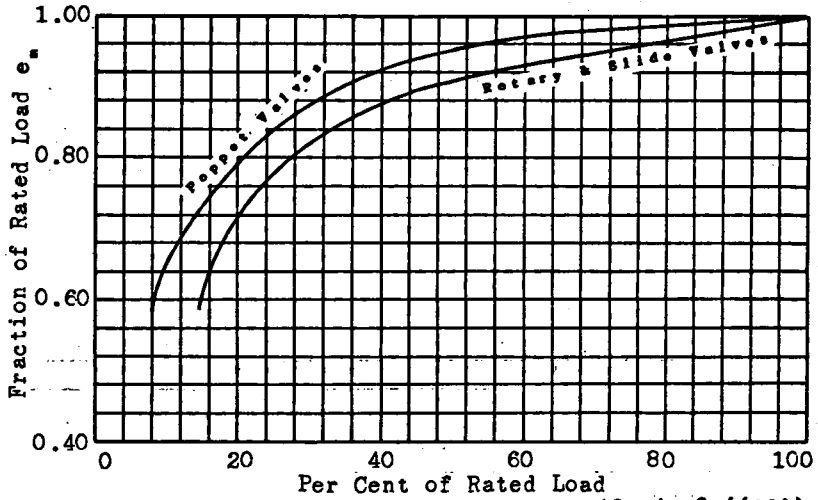

Fig. V-4. Engine indicator with diagram.



Type of engine	Full load e_m per cent
Four rotary valves	90 to 92
Uniflow	90 to 91
Slide valves (D or piston)	88 to 90

Fig. V-5. Mechanical efficiency of steam engines.

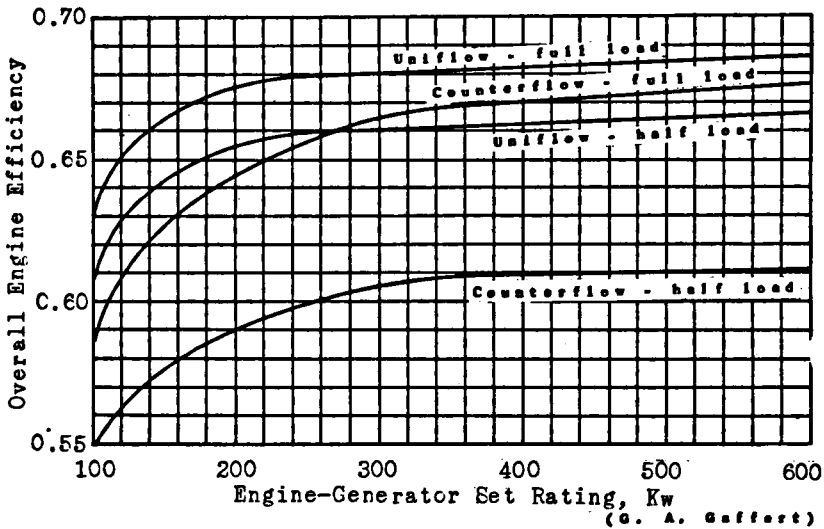

Fig. V-6. Engine efficiency of steam engines.

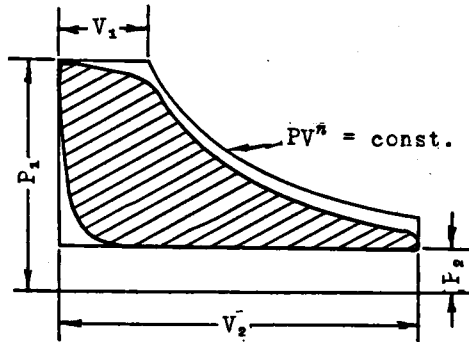

Fig. V-7. Ideal indicator diagram.

33. Steam Turbines--The steam turbine as we know it today has been developed from the machine invented by DeLaval in 1882 to run his cream separator. DeLaval's machine was of the single stage impulse type having an extremely high rotational speed. C. A. Parsons, an Englishman, invented the multistage reaction turbine; Rateau, a Frenchman, the pressure compounded impulse turbine; and C. G. Curtis, an American, the velocity compounded impulse turbine, all of which make it possible to reduce rotational speeds to reasonable levels.

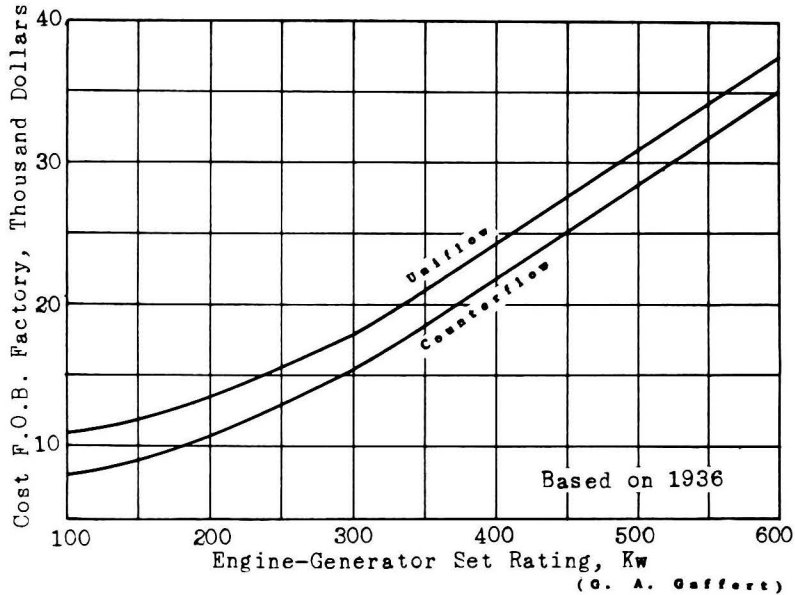

Fig. V-8. Cost of steam engine-generator sets.

The first commercial turbo-generator installations appeared around 1900, and were of the vertical type to conserve floor space. The largest vertical turbine, a 20,000 kw unit, was built in 1914, but shortly after its initial operation the horizontal turbine was introduced in order to eliminate troubles which had been experienced with thrust bearings in the vertical machines. By 1930 50,000 kw single cylinder machines had been built, but further increases in size required multi-cylinder cross or tandem compound arrangements. The largest cross compound unit in existence is a three cylinder 1800 rpm machine at State Line Station at Hammond, Indiana. This machine has a rated capacity of 208,000 kw, and consists of one high pressure and two low pressure cylinders with separate generators and steam reheating between high and low pressure cylinders. Manufacturers now are confining their production of compound machines to the tandem



(Power)
Fig. V-9. DeLaval impulse stage.

type in capacities of from 40,000 to 100,000 kw and with speeds of 3600 rpm. The 3600 rpm machines are attractive because of their saving in space over the 1800 rpm machines.

All of the basic types of turbine are built in this country, and are more or less characteristic for the various manufacturers. Allis-Chalmers produces the Parsons reaction turbine; Westinghouse produces a combination machine, usually with one Curtis velocity compounded stage followed by Parsons stages; and General Electric makes what they call the Curtis turbine, but which at present is really a Rateau pressure compounded turbine, sometimes with an initial Curtis stage. DeLaval still builds the single impulse stage machine with reduction gearing. Figures V-9 through V-13 show the various types of staging, with pressure and velocity relations for the steam.

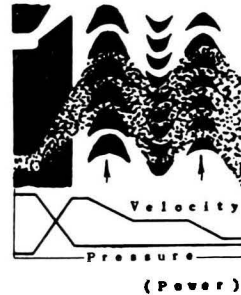

Fig. V-10. Curtis velocity compounded staging.

34. Engine Efficiencies and Willans' Line for Steam Turbines--Steam turbines for power plants are divided into two classifications: auxiliary or mechanical drive turbines, and turbines for generator drive.

Mechanical drive turbines are made in sizes from five to 2,000 hp and are used for driving fans, pumps, etc. They have from one to three velocity compounded stages and exhaust at a back pressure, ordinarily to the open heater in the feed-water system. They are not very efficient due to the small ratio of blade speed to jet velocity, but where process steam or steam for feed-water heating is required they can often be justified for continuous service. In other cases they are used for emergency service. Figure V-14 shows the variation in overall engine efficiency (including mechanical efficiency) for typical mechanical drive turbines.



Fig. V-11. Parsons reaction staging.

Turbines for generator drive are made in sizes from 500 kw capacity upwards to a maximum of about 100,000 kw. All major manufacturers have adopted the A.S.M.E.-A.I.E.E. Standards for Turbo-Generators which are shown in Table V.

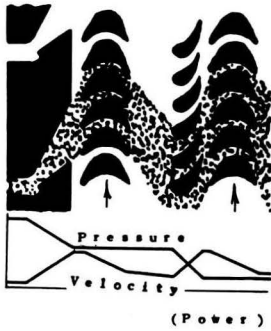

Fig. V-12. Rateau pressure compounded staging.

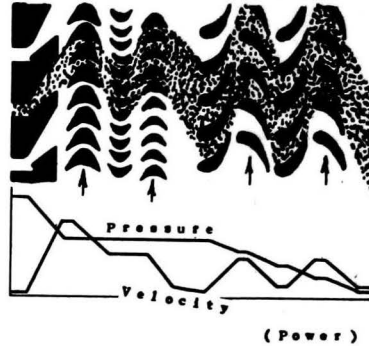

Fig. V-13. Curtis-Parsons staging.

TABLE V

AIFE-ASME STANDARDIZED TURBINE GENERATOR UNITS

3600 rpm, 60 cycles, 3 phase

	Single-casing, Single-flow Turbine				Tandem-compound, Double-flow Turbine			
	Air-cooled Generator	Hydrogen-cooled Generator						
		11,500 Kw	15,000 Kw	20,000 Kw	30,000 Kw	40,000 Kw	60,000 Kw	
Throttle pressure, lb gage	600	850	850	850	850	1250	850	1250
Throttle temperature, deg F	825	900	900	900	900	950	900	950
Exhaust pressure, in. Hg. abs.	1.5	1.5	1.5	1.5	1.5	1.5	1.5	1.5
Turbine capability, kw	12,650	16,500	22,000	33,000	44,000	66,000		
Number of extraction openings	4	4	4	5	5	5		
Saturation temperature at								
1st	175	175	175	175	175	175		
2nd	235	235	235	235	235	235		
3rd	285	285	285	285	285	285		
4th	350	350	350	350	350	350		
5th	—	—	—	410	410	410		
Generator kva								
Air-cooled generator	13,529	—	—	—	—	—		
Hydrogen-cooled generator								
0.5 lb hydrogen pressure	—	17,647	23,529	35,294	47,058	70,588		
15.0 lb hydrogen pressure	—	20,294	27,028	40,588	54,117	81,176		
Power factor	0.85	0.85	0.85	0.85	0.85	0.85		0.85
Short-circuit ratio	0.8	0.8	0.8	0.8	0.8	0.8		0.8

Figures V-15 and V-16 show the approximate overall engine efficiencies (including mechanical and generator efficiencies) to be expected from small turbo-generators, both condensing and non-condensing.

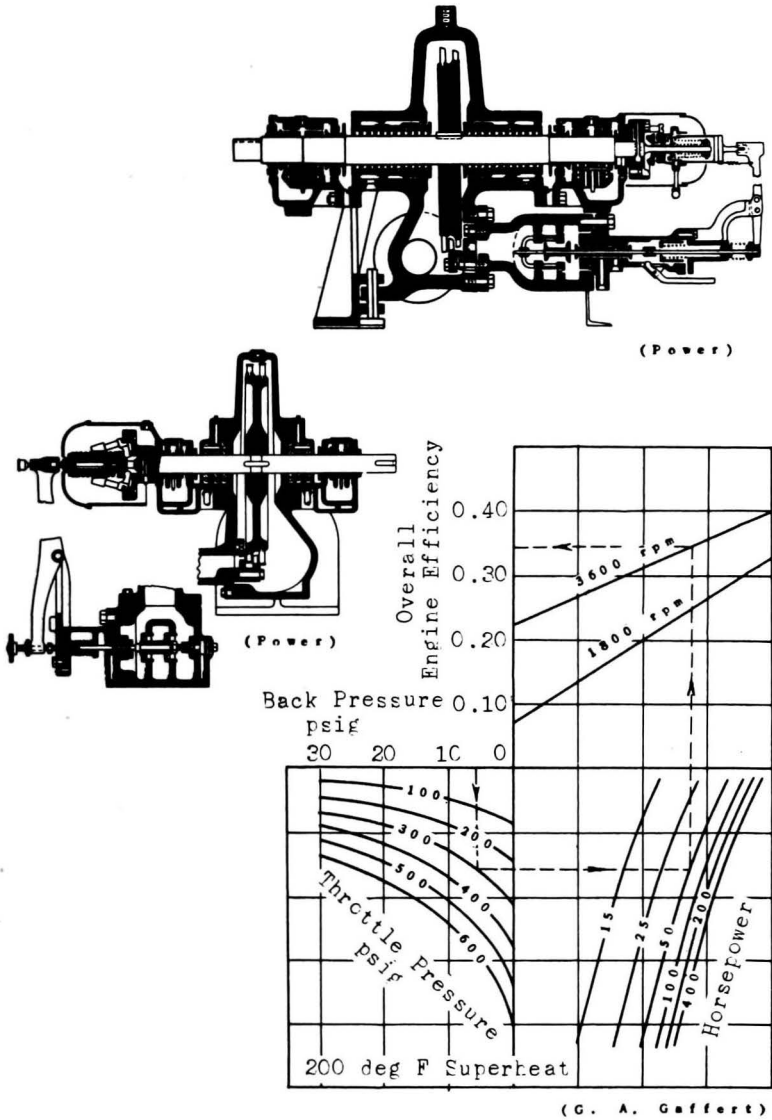

Fig. V-14. Mechanical drive turbines.

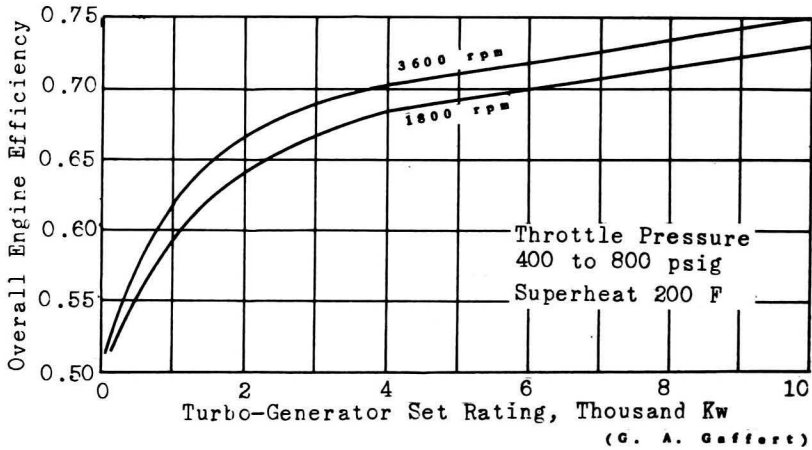
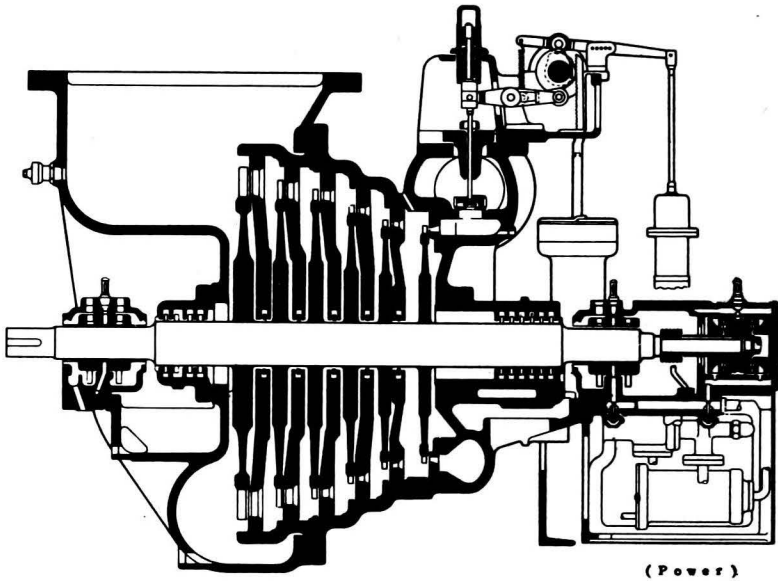

Fig. V-15. Small condensing turbo-generators.

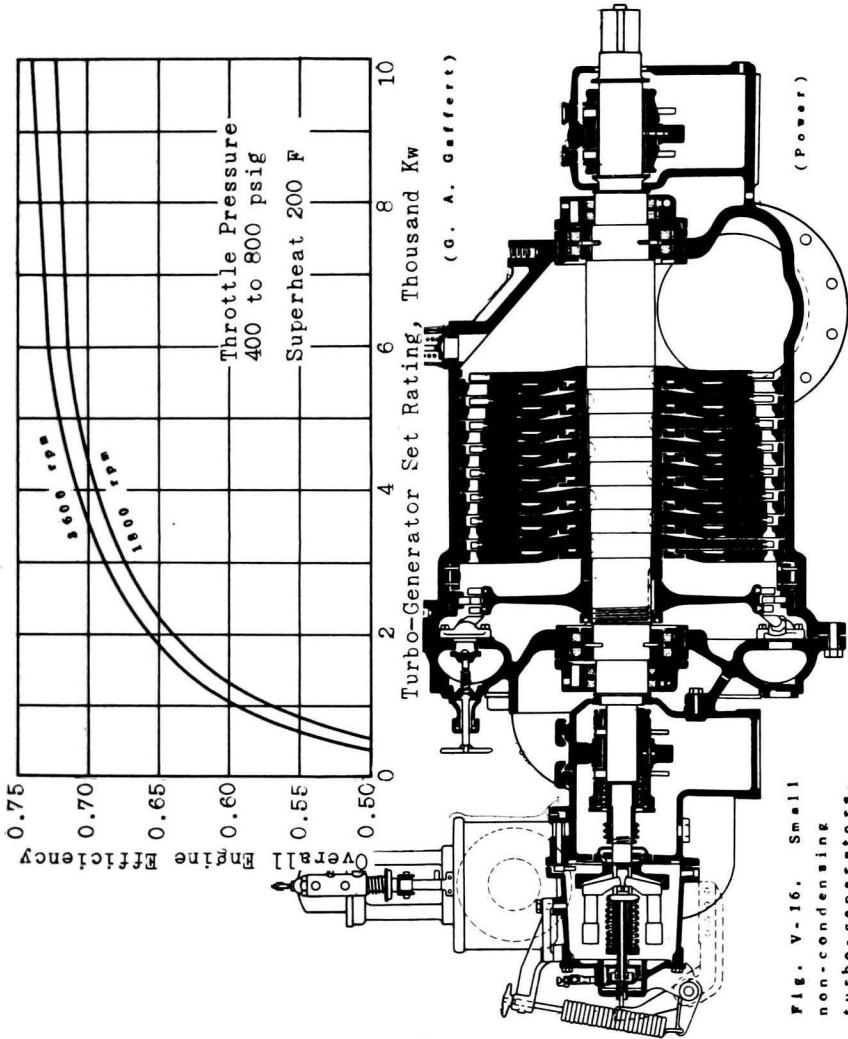

Fig. V-16. Small non-condensing turbo-generators.

Figure V-17 shows overall engine efficiency data for large condensing turbo-generators; Figure V-18 shows data for correcting engine efficiencies for part load operation; and Figure V-19 shows some turbo-generator cost data (based on 1945).

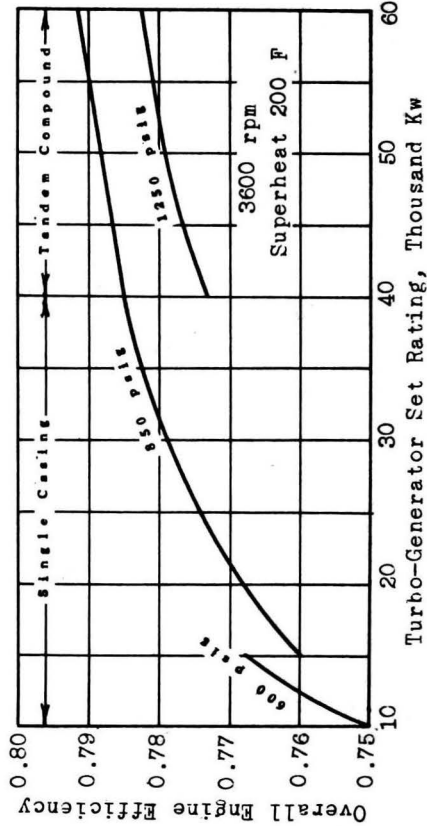
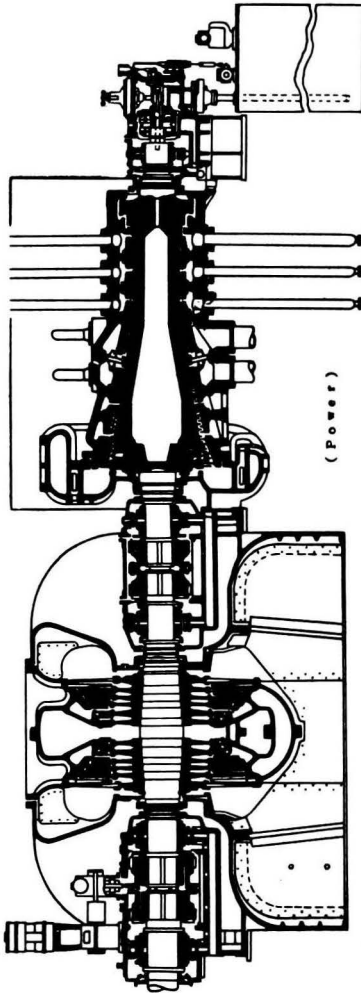

Fig. V-17. Large condensing turbo-generators.

following empirical formulae will be useful:

For 1800 rpm machines:
$$e_m = 1.00 - \frac{0.026(\text{Rating})}{\sqrt{\text{Rated kw}/1000 (\text{Load})}}$$

$$e_g = 0.9885 - \frac{0.0685(\text{Rating})}{\sqrt{\text{Rated kw}/1000 (\text{Load})}}$$

Where it is necessary to estimate mechanical and generator efficiencies in order to predict the turbine expansion line, the

For 3600 rpm machines:
$$e_m = 1.00 - \frac{0.04(\text{Rating})}{\sqrt{\text{Rated kw}/1000} (\text{Load})}$$

$$e_g = 0.96 - \frac{0.019(\text{Rating})}{\sqrt{\text{Rated kw}/1000} (\text{Load})}$$

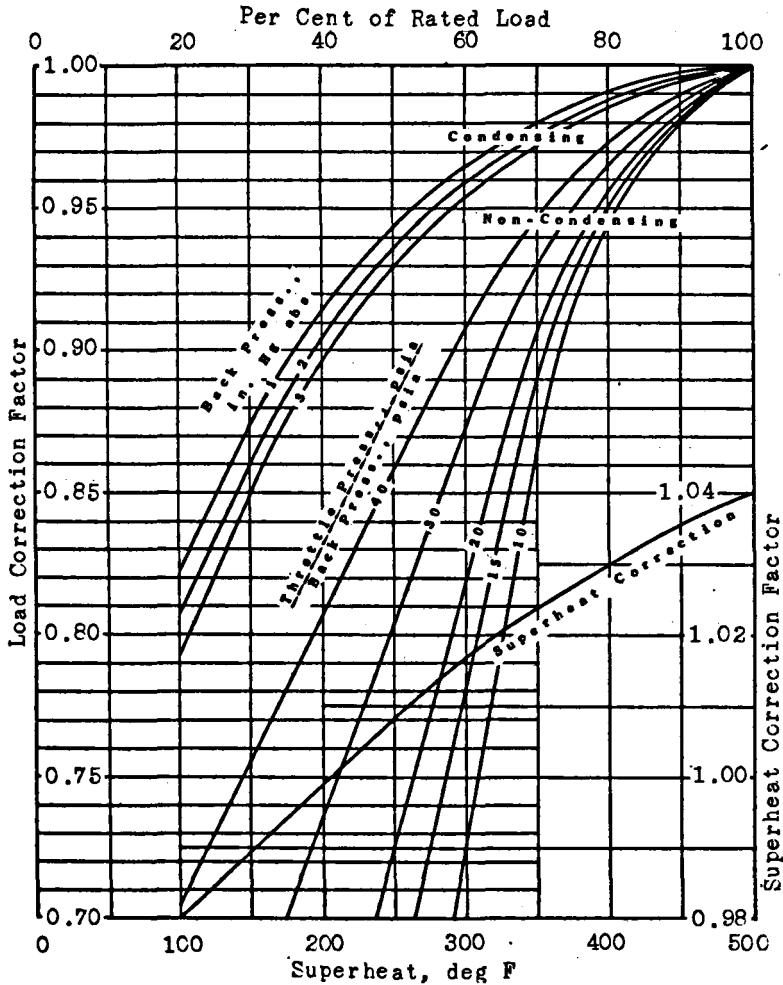

Fig. V-18. Engine efficiency correction factors for turbines.

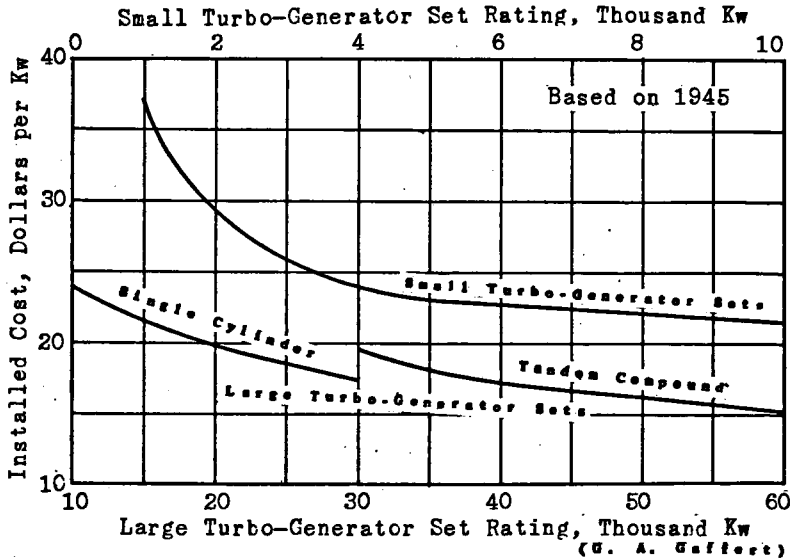

Fig. V-19. Turbo-generator cost data.

The likeness of a throttle-governed turbine to an orifice having the back pressure less than the critical makes it possible to predict extraction pressures at any partial load if they are known for any one load. It can be assumed, with very slight error, that the back pressure remains constant, and that the first stage and extraction absolute pressures will vary directly with load. With this relation it is possible to estimate part-load performance of a turbine, providing the expansion lines are known. The full load expansion line can be estimated quite closely, if the initial and final conditions are known, by referring to Figure V-20. Connect the initial and final steam conditions on the Mollier diagram by a straight line; move along the saturation line to point B which is 20 Btu per pound greater than point A, the intersection of the straight line with the saturation line. Connect the initial and final conditions with a smooth curve through point B so that the slope decreases gradually from the initial to the final conditions. The extraction conditions can then be located at the intersections of the pressure lines with the expansion lines. For part-load expansion lines, the curve will be of the same shape from the initial condition but with point X displaced to the right. A ship curve is excellent for drawing expansion lines.

The curve of total steam flow vs output for a turbine is a straight line (called *Willans' line*), and can be estimated from engine, mechanical and generator efficiency data. The slope of the line is constant only so long as a single throttle valve is employed. As additional valves open the slope becomes steeper. Example 7 shows the method of estimating Willans' line and the expansion lines for a single valve turbine.

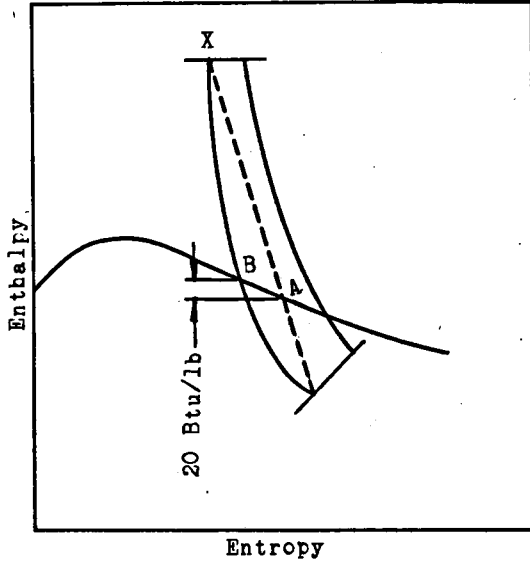

Fig. V-20. Estimating turbine expansion lines.

Example 7.

A 2500 kw turbo-generator operates at 3600 rpm with steam to the throttle at 400 psig and 750 F and exhausts at 2 in. Hg abs. Estimate the non-extraction Willans' line.

Solution:

From Figure V-15, the full load overall engine efficiency is estimated to be 0.68. From Figure V-18, the superheat correction factor is found to be 1.017 (superheat 305F) and the following table is made:

Load	Eng. eff. full load	supht. corr.	load corr.	corr. eng. eff.
Full	0.68	1.017	1.000	0.69
0.75	0.68	1.017	0.975	0.67
0.50	0.68	1.017	0.940	0.65
0.25	0.68	1.017	0.820	0.57

The expansion lines are drawn as in Figure V-21, and from these lines the work output per pound of steam can be determined as: full load, 320 Btu; 0.75 load, 298 Btu; 0.50 load, 274 Btu; and 0.25 load, 216 Btu. From these work out-

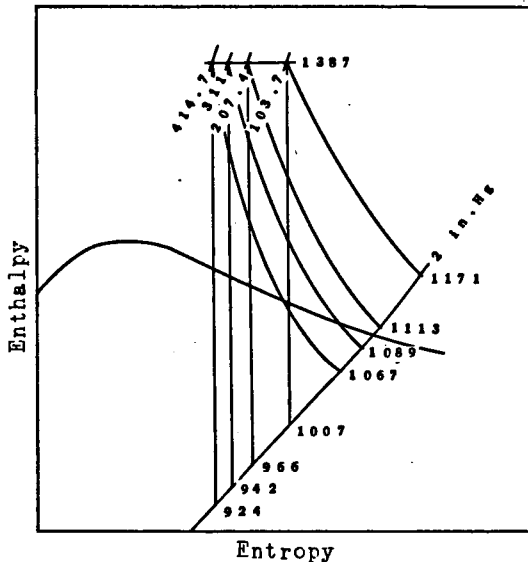

Fig. V-21. Turbine expansion lines for Example 7.

puts, the steam flows to the throttle at the various loads can be computed from the relation:

$$\text{Throttle flow, lbs/hr} = \frac{3413(2500)(\text{load frac.})}{\text{Work, Btu/lb}}$$

Flows from this relation are: Full load, 26700 lbs/hr; 0.75 load, 21450 lbs/hr; 0.50 load, 15600 lbs/hr; and 0.25 load, 9880 lbs/hr. Willans' line is plotted in Figure V-22.

Note: The expansion lines in Figure V-21 are "apparent" or based on the overall engine efficiencies. For the true expansion lines which give the actual enthalpies of the steam to the condenser, see Example 8.

Example 8 shows the method of calculating the approximate heat balance for a regenerative cycle using the steam turbine of Example 7.

Example 8.

The turbo-generator of Example 7 is placed in a regenerative cycle. One closed heater is used with the extraction point in the turbine located so that the extraction pressure

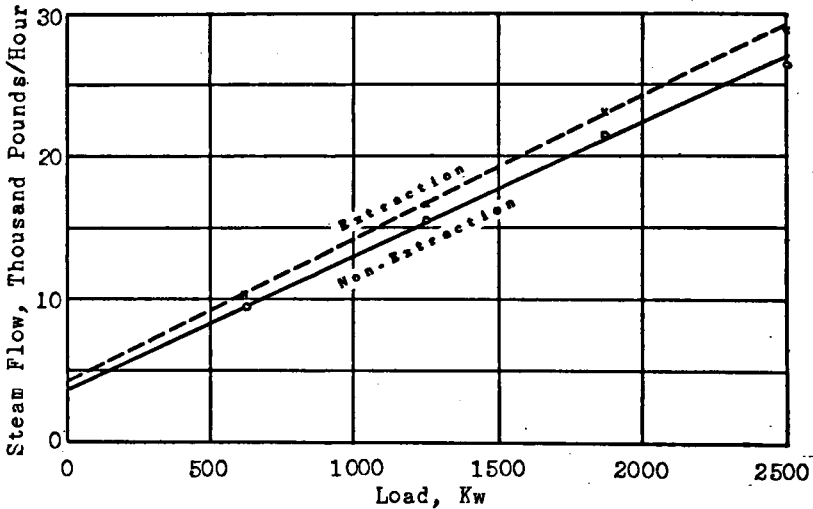

Fig. V-22. Willans' lines for Examples 7 and 8.

is 5 psia at 0.25 load. One open heater is placed in the cycle so that the extraction pressure is 16 psia at 0.25 load. The arrangement is similar to that in Figure IV-8(b). Neglect pump work. Make a heat balance and estimate the extraction Willans' line.

Solution:

The expansion lines and engine efficiencies of Example 7 were on the overall basis. In order to estimate the extraction performance it is necessary to estimate the mechanical and generator efficiencies and to replot the expansion lines.

$$e_m = 1.00 - \left[\frac{0.04(\text{rating})}{\sqrt{2500/1000} (\text{load})} \right]$$

$$e_g = 0.96 - \left[\frac{0.019(\text{rating})}{\sqrt{2500/1000} (\text{load})} \right]$$

Load	overall eng. eff.	mech. eff.	gen. eff.	internal eng. eff.
Full	0.69	0.975	0.946	0.749
0.75	0.67	0.966	0.941	0.737

Load	overall eng. eff.	mech. eff.	gen. eff.	internal eng. eff.
0.50	0.65	0.949	0.932	0.735
0.25	0.57	0.899	0.904	0.702

The expansion lines are plotted in Figure V-23 and the extraction enthalpies determined, remembering that the extraction pressures are directly proportional to load. The following table is set up to aid in the calculation of extraction quantities:

Load	H_1	H_{10c}	H_3	H_5	H_8	H_{9b}	H_{10b}	H_{11b}
Full	69.0	196.2	190.2	266.4	1387	1224	1150	1040
0.75	69.0	181.1	175.1	247.5	1387	1240	1169	1059
0.50	69.0	161.2	155.2	222.6	1387	1245	1175	1077
0.25	69.0	130.1	124.1	184.4	1387	1262	1195	1120

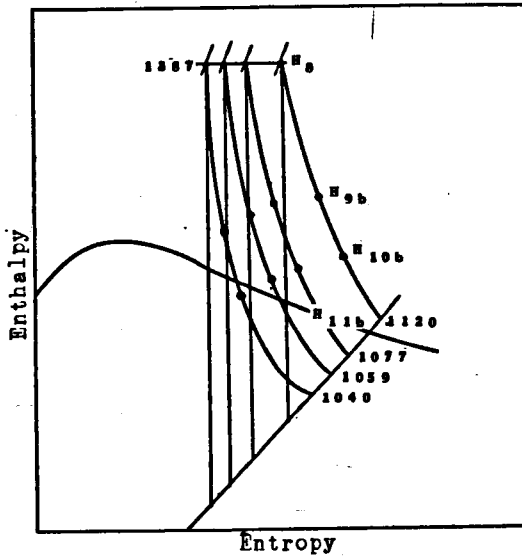

Fig. V-23. Turbine expansion lines for Example 8.

It should be noted that it was assumed in setting up the preceding table that H_9 is 6 Btu/lb less than H_{10c} due to the use of a closed feed-water heater. Also, in order to

avoid the necessity of solving for H_2 , the drip from the closed heater is assumed to be pumped directly to the open heater.

The extraction quantities, M_A and M_B , can be found by use of the equations in Section 25, as follows:

Full load:

$$M_A(1224 - 266.4) = (1 - M_A - M_B)(266.4 - 190.2) + M_B(266.4 - 196.2)$$

$$M_B(1150 - 196.2) = (1 - M_A - M_B)(190.2 - 69.0)$$

	$M_A = 0.073$	$M_B = 0.104$ lb/lb to throt.
0.75 load	0.068	0.099
0.50 load	0.062	0.074
0.25 load	0.053	0.047

Work output to the turbine shaft per pound of steam to the throttle is then calculated, as follows:

Full load:

$$W/J = (1387 - 1224) + 0.927(1224 - 1150) + 0.823(1150 - 1040)$$

	$W/J = 322.0$ Btu/lb to throttle
0.75 load	304.8
0.50 load	292.3
0.25 load	256.0

Throttle flows are:

Full load:	$\frac{3413(2500)}{322.0(0.975)(0.946)} = 28750$ lbs/hr
0.75 load	23100
0.50 load	16500
0.25 load	10260

Extraction and condenser flows are:

Load	open htr. lbs/hr	closed htr. lbs/hr	conden- ser lbs/hr
Full	2100	3000	23700
0.75	1570	2290	19240

Load	open htr. lbs/hr	closed htr. lbs/hr	conden- ser lbs/hr
0.50	1027	1225	14298
0.25	545	481	9234

The Willans' line for extraction operation is plotted in Figure V-22.

BIBLIOGRAPHY

- Alden, V. E., and Balcke, W. H., "Steam Turbine Practice in the United States," *Transactions A.S.M.E.*, March, 1933.
- Church, E. F., Jr., *Steam Turbines*, McGraw-Hill, New York, 1935.
- Gaffert, G. A., *Steam Power Stations*, McGraw-Hill, New York, 1946.
- Gardner, F. W., "British Practice in Steam Turbine Design," *Transactions A.S.M.E.*, March, 1933.
- Newman, L. E., and Associates, *Modern Turbines*, Wiley, New York, 1944.
- Warren, G. B., and Knowlton, F. H., "Relative Engine Efficiencies Realizable from Large Modern Steam Turbine Generator Units," *Transactions A.S.M.E.*, Volume 63, 1941.

CHAPTER VI

CONDENSERS, FEED-WATER HEATERS AND EVAPORATORS

35. Condensers--The purpose of the condenser in a vapor cycle is primarily to lower the temperature of the prime mover exhaust so that the thermal efficiency of the cycle can be increased. Due to the nature of steam, operation of the condenser at a temperature less than 212 F requires that the pressure within the condenser be less than atmospheric. Operation of condensers at sub-atmospheric pressures requires the use of vacuum pumps to remove the air which unavoidably leaks into the condenser and which, if not removed, would make it impossible to maintain the low exhaust temperature.

Condensers may be divided into two general classes: mixing condensers and surface condensers. The most important type is the surface condenser which allows the reduction of exhaust temperature while at the same time allowing the recovery of the condensate. The mixing condenser is able only to lower the exhaust temperature without recovering the condensate.

36. Mixing Condensers--Mixing condensers may be either of the jet type or of the barometric type. The jet type depends upon the aspirating action of a jet of water to condense the steam and to remove the air from the condenser. A typical jet condenser is shown in Figure VI-1. The use of the jet for aspirating air requires more pump power for a given vacuum, but a separate vacuum pump is not required. The barometric condenser utilizes a leg of water to provide the seal for the condenser rather than power from a pump as in the jet condenser. The barometric condenser is always provided with a vacuum pump for air removal. A typical barometric condenser is shown in Figure VI-2. With 70 F cooling water, about the best vacuum which can be maintained with a mixing condenser is 28 inches of mercury. Due to the fact that the volume of the condenser is small in relation to the amount of steam and water handled, the mixing process does not reach equilibrium and the temperature of the mixture leaving the condenser will be about 5 F less than the saturation temperature corresponding to the pressure in the condenser. The following equations can be written for the mixing type condenser, considering it a steady flow device with no shaft work:

$$M_x(H_m - H_x) = M_v(H_v - H_m)$$

where: M_x = weight of condensing water, lbs/hr.

M_v = weight of steam, lbs/hr.

H_m = enthalpy of mixture leaving the condenser, Btu/lb.

H_v = enthalpy of steam entering the condenser, Btu/lb.

H_x = enthalpy of cooling water, Btu/lb.

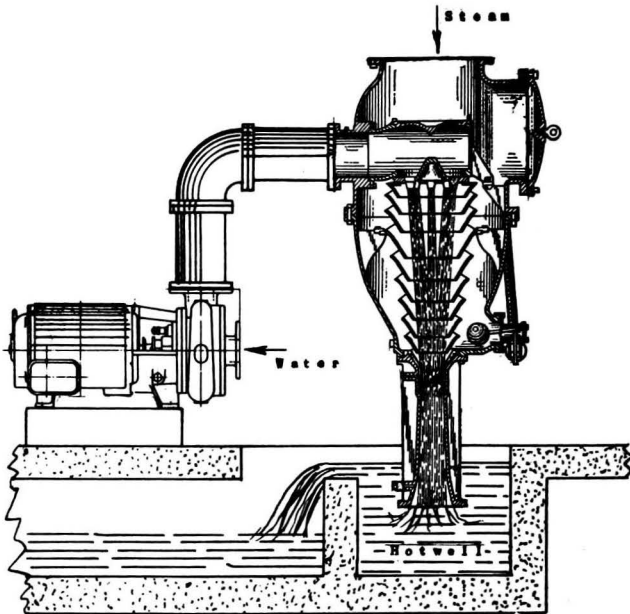

Fig. VI-1. Jet condenser.

37. Surface Condensers--The surface condenser has the advantage of making it possible to save the condensed steam for use as boiler feed, but keeping the condensing steam separate from the cooling water requires that the heat be transferred through a dividing wall. This necessity complicates the design of condensers by making it necessary to take into account the resistance of the dividing wall to heat flow. Two methods of calculating condenser size are available: calculating from the known and estimated resistances to heat flow

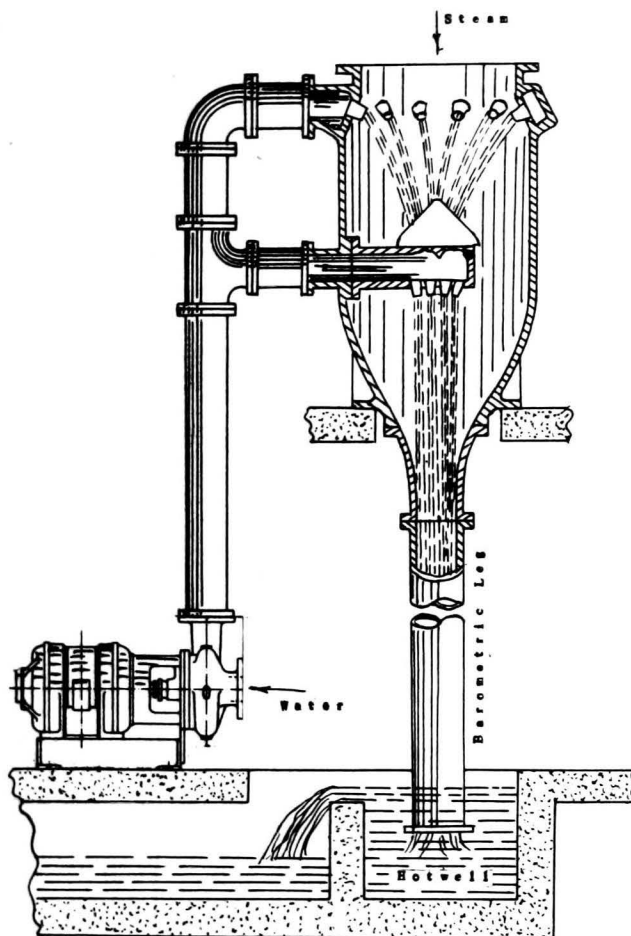

Fig. VI-2. Barometric condenser.

of the various elements in the heat flow path; and estimating from empirical data of the Heat Exchange Institute.

Surface condensers will be made in as many shapes and designs as there are manufacturers, the only similarity being in the existence of water boxes, tubes, a shell and a hotwell. Figure VI-3 shows a typical surface condenser with its various parts.

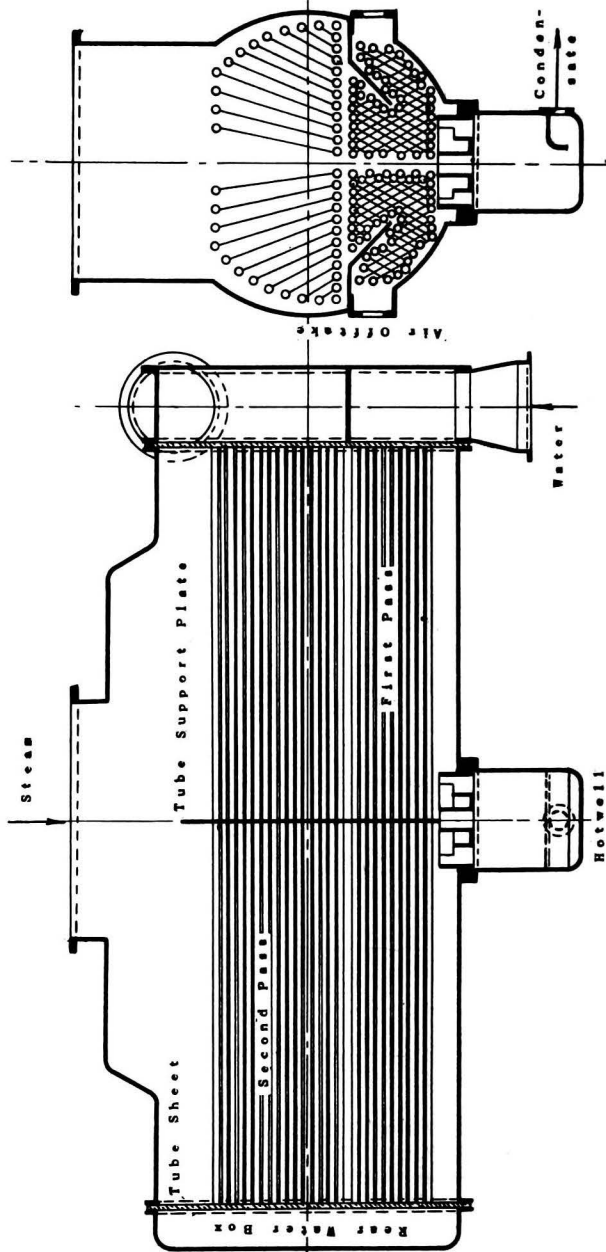

Fig. VI-3. Surface condenser.

38. Heat Transfer in Surface Condensers--Heat transfer in surface condensers is accomplished entirely by conduction, and consideration of the process will reveal that the heat must pass first through a film of water formed by the condensing steam, then in succession through the tube, scale from compounds and dirt deposited by the cooling water and finally through the boundary water film on the cooling water side of the tube. Figure VI-4 shows the heat paths in relation to a conventional condenser tube in which the tube conveys the cooling water and is surrounded by the steam.

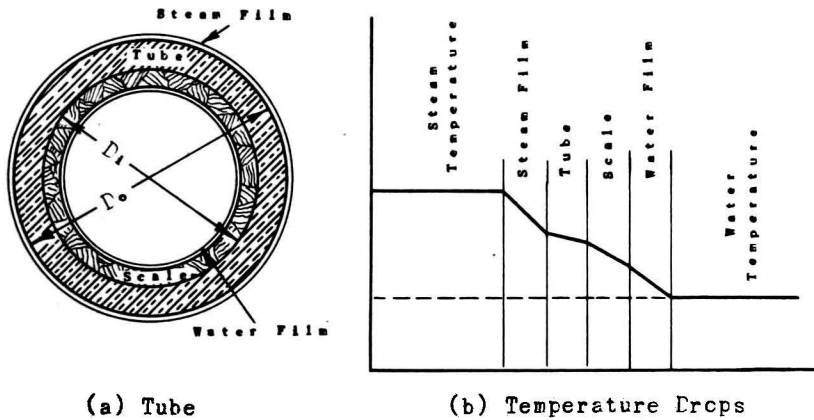

Fig. VI-4. Temperature relations in heat transfer through condenser tube.

The outside and inside diameters of the tube are the only definitely measurable distances in the heat path. It can be seen that the heat flow path is similar to series resistances in an electrical circuit, that is:

$$R = R_v + R_t + R_s + R_w$$

where: R = total resistance to heat flow

R_v = resistance of steam film

R_t = resistance of tube

R_w = resistance of water film

R_s = resistance of scale

If the individual resistances to heat flow are defined in terms of the thickness and area of each element,

$$R_t = \frac{l}{K_t S_t}, \text{ etc.}$$

where: R = resistance, (hr)(deg F)(sq ft)/Btu
 l = thickness in feet
 K = thermal conductivity,
 Btu/(hr)(sq ft)(deg F)(ft)
 S = area, sq ft

and if $1/R$ is called the overall heat transfer coefficient U, and S allowed to be one square foot,

$$U = \frac{1}{\frac{1}{K_v} + \frac{1}{K_t} + \frac{1}{K_s} + \frac{1}{K_w}}$$

As previously mentioned, the only readily determined dimensions are the inside and outside diameters of the tube. Furthermore, the area of condensing surface is always measured on the outside diameter of the tube. For these reasons all areas are corrected to the outside area of the tube, so that if all elements in the heat flow path except the tube are considered to have no thickness,

$$U = \frac{1}{\frac{1}{K_v} + \frac{(2D_o)}{D_o + D_i} \frac{(l_t)}{(K_t)} + \frac{D_o}{D_i} \frac{1}{K_s} + \frac{D_o}{D_i} \frac{1}{K_w}}$$

where: D_o and D_i are the outside and inside diameters of the tube

It is not possible to determine $1/K$ for any resistance except the tube wall, so empirical formulae based on rational concepts of heat flow are employed. Substitution of $1/h$ is made for the vapor film, scale and water film, so that,

$$U = \frac{1}{\frac{1}{h_v} + \frac{2D_o}{D_o + D_i} \frac{(l_t)}{(K_t)} + \frac{D_o}{D_i} \frac{1}{h_s} + \frac{D_o}{D_i} \frac{1}{h_w}}$$

The value of h for the vapor film is dependent principally on the amount of air dissolved in the film. Nusselt and others have found that this value varies between 1500 and 3000, and in the absence of better data a value of 2000

may be used.

Table VI shows approximate values of K for several materials which are commonly used for heat transfer surfaces.

TABLE VI

THERMAL CONDUCTIVITY OF METALS

	Btu per hr(sq ft)(deg F)(ft)
Pure copper	220
Aluminum	118
Brasses (Admiralty, Muntz, etc.)	58
Steel	30

The amount of scale present in tubes is highly variable, depending upon the type of water and the season of the year, among other factors. For purposes of estimation, h for the scale may be taken as ranging between 4000 for favorable conditions and 2000 for unfavorable conditions, with an average of about 3000.

The value of h for the water film may be calculated from Nusselt's equation, with water velocity between 6 and 9 feet per second, as follows:

$$h_m = \frac{93.6(1 + 0.01 t)V^{0.8}}{D_i^{0.2}}$$

where: t = arithmetic mean water temperature, deg F
 V = water velocity, ft/sec
 D_i = inside diameter of tube, ft

Table VII gives the most useful size constants for tubes of various thicknesses and diameters.

After having found the value of U for the condenser, the total surface required may be found from the relation,

$$A = \frac{Q}{Ut_m}$$

where: A = total area, sq ft
 Q = heat transferred, Btu/hr

U = overall heat transfer
coefficient

t_m = mean temperature difference
between steam and water, deg F

TABLE VII

STANDARD CONDENSER TUBE DATA

OD in.	Thickness BWG	in.	ID in.	Outside surface sq ft/ft	Inside sectional area sq ft
5/8	16	0.065	0.495	0.1626	0.00134
	18	0.049	0.527	0.1636	0.00152
	20	0.035	0.555	0.1626	0.00168
3/4	14	0.083	0.584	0.1963	0.00186
	16	0.065	0.620	0.1962	0.00210
	18	0.049	0.652	0.1963	0.00232
7/8	14	0.083	0.709	0.2291	0.00274
	16	0.065	0.745	0.2291	0.00303
	18	0.049	0.777	0.2291	0.00329
1	14	0.083	0.824	0.2618	0.00379
	16	0.065	0.870	0.2618	0.00413
	18	0.049	0.902	0.2618	0.00444

The value of the mean temperature difference is somewhat different from the arithmetic mean temperature difference due to the fact that the temperature rise of the water is not a straight line function of the distance traversed by it. Figure VI-5 illustrates this point. It can be shown that

$$t_m = \frac{t_{w_o} - t_{w_i}}{\log_e \frac{t_v - t_{w_i}}{t_v - t_{w_o}}}$$

where: t_m = mean temperature difference
between steam and water, deg F

t_v = temperature of steam, deg F
 t_{w_i} and t_{w_o} = inlet and outlet cooling
 water temperatures, deg F

It is necessary to have a temperature difference between the steam and the outlet cooling water in order to maintain heat flow. This difference in temperature is called the terminal difference, and is usually from 5 to 10 F for surface condensers, the smaller applying to two pass and the larger to single pass designs. Refrigeration or reheating (according to the design of the condenser) is encountered with the water leaving the hotwell. This action will have to be taken into account in the computation of the heat transferred, but it must be ignored in the computation of the mean temperature difference because of the smallness of the effect of removal of sensible heat in the condenser. In well designed condensers refrigeration will not exceed 5 F, and some designs will actually reheat as much as 2 F.

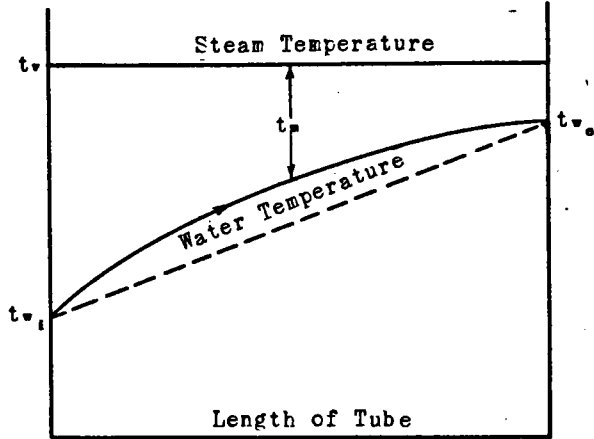

Fig. VI-5. Temperature relations in heat transfer through condenser tube.

Example 9 shows the method of calculating the principal dimensions of a surface condenser for the regenerative cycle of Example 8.

Example 9.

Estimate the principal dimensions of a surface condenser to serve the turbine of Example 8. Inlet cooling water temperature 72 F, terminal difference 8 F. Use 3/4" X 18 BWG aluminum brass tubes with a water velocity of 8 fps. Assume $h_s = 3000$.

Solution:

From Example 8, the condenser flow at full load is 23700 lbs per hour, and the heat removed in the condenser is $(1040 - 69) = 971$ Btu/lb. The temperature of the steam in the condenser is 101 F.

$$Q = 23700(971) = 23,000,000 \text{ Btu/hr}$$

$$t_m = \frac{(101 - 8) - 72}{\log_e \frac{101 - 72}{101 - (101 - 8)}} = \frac{21}{\log_e \frac{29}{8}} = 16.3 \text{ F}$$

$$h_m = \frac{93.6[1 + 0.01(82.5)][8]^{0.8}}{[0.652/12]^{0.2}} = 1615$$

$$U = \frac{1}{\frac{1}{2000} + \left[\frac{1.5}{0.75+0.652} \right] \left[\frac{0.049}{12(58)} \right] + \frac{0.75}{0.652} \left[\frac{1}{3000} \right] + \frac{0.75}{0.652} \left[\frac{1}{1615} \right]}$$

$$U = \frac{1}{0.00167} = 599$$

$$A = \frac{23,000,000}{599(16.3)} = 2360 \text{ sq ft}$$

$$\text{Water required} = \frac{23,000,000}{21(60)(8.33)} = 2190 \text{ gal/min} = 4.88 \text{ cu ft/sec}$$

$$\text{Flow area} = \frac{4.88}{8} = 0.61 \text{ sq ft}$$

$$\text{Number of tubes} = \frac{0.61}{0.00232} = 264$$

$$\text{Length of tubes} = \frac{2360}{264(0.1963)} = 45.5 \text{ ft}$$

The condenser would be too long for a single pass, so two passes, each 22'-9" long, are specified.

The principal dimensions of the condenser are:

Area	2360 sq ft
Tube material	3/4" X 18 BWG Alum. brass
Number of passes	2
Active tube length	22'-9"
Heat duty	23 million Btu/hr

39. Commercial Heat Transfer Standards for Surface Condensers--Several of the large manufacturers of heat transfer equipment have cooperated in setting up the Heat Exchange Institute with the purpose of standardizing design data for this type of equipment. Figure VI-6 shows the curves in use for surface condensers. These curves are drawn for tubes

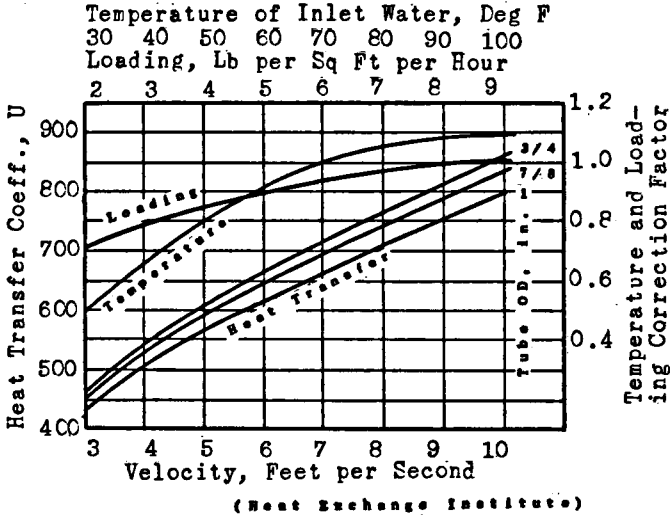

Fig. VI-6. Heat Exchange Institute design data for surface condensers.

with no scale on the water side. In use, the overall heat transfer coefficient from the curves is reduced by a so-called "cleanliness factor," which is usually taken as about 0.80. Two other correction factors, for loading and inlet water temperature, are used in addition to the cleanliness factor. In commercial practice loading ranges from 7 to 10 pounds of steam per square foot per hour. Example 10 shows the method of application of the Heat Exchange Institute data to the determination of the dimensions of a surface condenser for the same duty as in Example 9.

Example 10.

Estimate the principal dimensions of the condenser of Example 9 by means of the Heat Exchange Institute data. Take the cleanliness factor as 0.85.

Solution:

From Figure VI-6, $U = 765$, temperature corr. = 1.01, loading corr. = 1.0.

$$\text{Corrected } U = 765(1.01)(1.0)(0.85) = 657$$

$$A = \frac{23,000,000}{657(16.3)} = 2150 \text{ sq ft}$$

Cooling water flow and number of tubes would be the same as in Example 9.

$$\text{Length of tubes} = \frac{2150}{264(0.1963)(2)} = 20.7 \text{ ft}$$

The principal dimensions of the condenser are:

Area	2150 sq ft.
Tube material	3/4" X 18 BWG Alum. brass
Number of passes	2
Active tube length	20'-9"
Heat duty	23 million Btu/hr

These calculations show that the method of Example 9 is more conservative than the method of the Heat Exchange Institute.

40. Feed-Water Heaters--The primary function of feed-water heaters is to utilize extracted or exhaust steam from prime movers to increase the temperature of water before feeding it to boilers. Feed-water heaters may be divided into two general classes: open (or mixing) and closed (or surface) heaters. Feed-water heaters are counterparts of condensers, the difference being in their smaller size and higher operating temperature.

41. Open Heaters--The name "open heater" often leads to a misconception of the operation of this type of heater. Actually, an open heater can operate at any pressure, not necessarily atmospheric. All modern regenerative cycles include one open heater in the feed-water circuit, so designed as to act as a scrubber for deaerating the feed-water before it enters the boiler. Deaeration is necessary to remove oxygen and other gases which are harmful to boilers and piping, and which have entered the system by leaking into the condenser. There are a number of types of deaerating open heaters in use, but the most common is the tray type shown in Figure VI-7. It is quite common to provide integral or connected

storage for deaerated feed-water, as shown in Figure VI-8. This storage is usually about a two or three minute supply at full load. Often additional surge tanks are connected through overflows and surge pumps with the water storage section of the deaerating heater to provide additional emergency storage for unusual conditions.

The same considerations of heat balance apply to open heaters as to mixing condensers. Well proportioned deaerating heaters will produce water with almost immeasurable quantities of dissolved gases and with practically zero terminal difference.

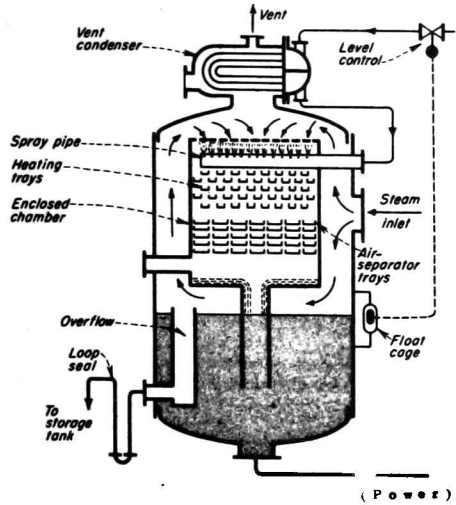
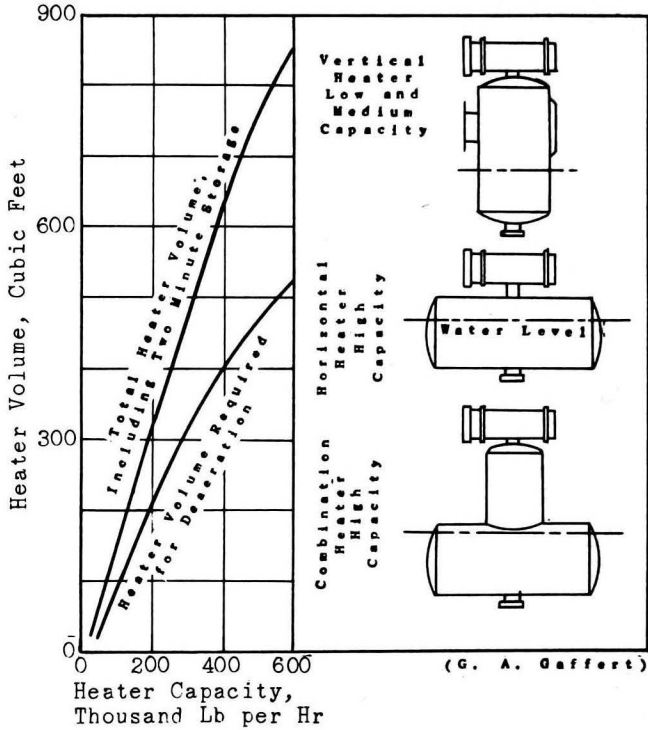

Fig. VI-7. Tray type deaerating feed-water heater.

42. Closed Heaters--Due to the fact that the water is separated from the steam in a closed heater, it is possible to operate them at high water pressures in relation to the steam pressure. Figure VI-9 shows a section of a typical closed feed-water heater.

The same considerations of heat transfer apply to closed feed-water heaters as to surface condensers. Because feed-water heaters operate with relatively clean tubes, the value of h for scale can be taken to be about 6000. Following are the terminal differences to be expected in good heater designs:

Temperature of exit feed-water deg F	Terminal difference deg F
86 - 230	5
230 - 300	10
300 - 400	15
400 - 525	20



(G. A. Gaffert)

Fig. VI-8. Design data for deaerating feed-water heaters.

Refrigeration in the hotwell of horizontal heaters will be of about the same magnitude as for surface condensers, but will be from 10 to 15 F for vertical heaters. Water velocities are somewhat smaller than for surface condensers,

ranging from 3 to 8 feet per second. The drainage from closed heaters is usually flashed to the next lower heater in the circuit, while the drainage from the first closed heater may be either pumped to the condensate line before the

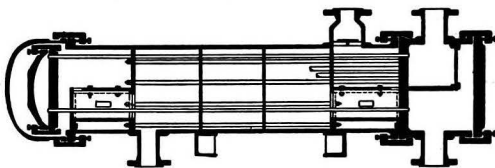

(Alico Products Corp.)

Fig. VI-9. Closed feed-water heater.

deaerating heater or flashed to the hotwell of the condenser. The heater air offtakes are connected to the condenser through flow limiting orifices.

Commercial closed heaters are designed using Kittredge's data from Figure VI-10.

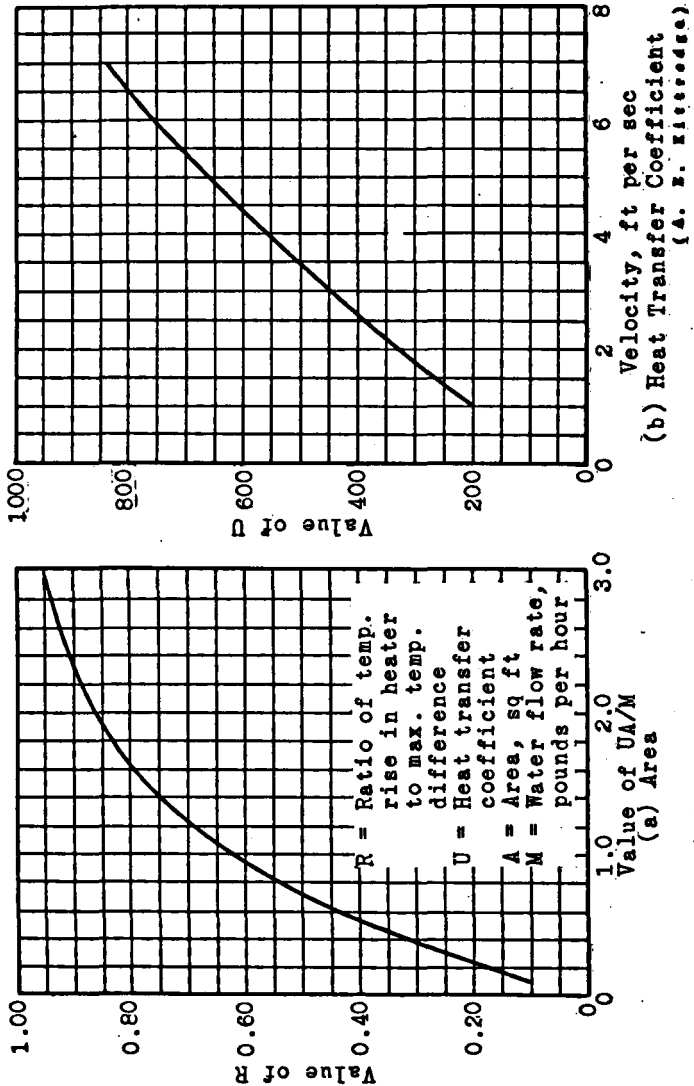

Fig. VI-10. Commercial design data for closed feed-water heaters.

Examples 11 and 12 show the method of computing the principal dimensions of a closed feed-water for the regenerative cycle of Example 8.

Example 11.

Specify the principal dimensions of a six-pass closed feed-water heater to serve the regenerative cycle of Example 8. Terminal difference 6 F. Use 5/8" X 16 BWG Admiralty brass tubes. Water velocity 6 ft/sec and $h_g = 6000$.

Solution:

From Example 8, the extracted steam to the closed heater at full load is 3000 lbs/hr and the heat given up by the steam is (1150 - 196.2) = 953.8 Btu/lb. The temperature of the steam in the heater is 228 F; water temperature to the heater 101 F and from the heater 222 F.

$$Q = 3000(953.8) = 2,860,000 \text{ Btu/hr}$$

$$t_m = \frac{222 - 101}{\log_e \frac{228 - 101}{228 - 222}} = \frac{121}{\log_e \frac{127}{6}} = 39.7 \text{ F}$$

$$h_* = \frac{93.6[1 + 0.01(161.5)][6]^{0.8}}{[0.495/12]^{0.2}} = 1945$$

$$U = \frac{1}{\frac{1}{2000} + \left[\frac{1.25}{0.625 + 0.495} \right] \left[\frac{0.065}{12(58)} \right] + \frac{0.625}{0.495} \left[\frac{1}{6000} \right] + \frac{0.625}{0.495} \left[\frac{1}{1945} \right]}$$

$$U = 684$$

$$A = \frac{2,860,000}{684(39.7)} = 105.5 \text{ sq ft}$$

$$\begin{aligned} \text{Water flow} &= \text{condenser flow} = 23700 \text{ lbs/hr} \\ &= \frac{23700}{3600}(0.0164) = 0.108 \text{ cu ft/sec} \end{aligned}$$

$$\text{Flow area} = \frac{0.108}{6} = 0.018 \text{ sq ft}$$

$$\text{Number of tubes} = \frac{0.018}{0.00134} = 14 \text{ per pass}$$

$$\text{Length of tubes} = \frac{105.5}{14(0.1636)(6)} = 7.68 \text{ ft}$$

The principal dimensions of the feed-water heater are:

Area	105.5 sq ft
Tube material	5/8" X 16 BWG. Adm. brass
Number of passes	6
Active tube length	7'-8"
Heat duty	2.86 million Btu/hr

Example 12.

Estimate the area required for the closed feed-water heater of Example 11 by means of the Kittredge data.

Solution:

Using Figure VI-10, $R = \frac{222 - 101}{228 - 101} = 0.953$, $\frac{UA}{M} = 3.0$
 and $U = 760$. From Example 10, $M = 23700$ lbs/hr, then,

$$A = \frac{23700(3.0)}{760} = 107 \text{ sq ft.}$$

This area is quite close to the area determined by the method of Example 11.

43. Vacuum Pumps--As previously mentioned, a condenser must be supplied with some sort of air removal apparatus. The usual equipment consists of steam ejectors with suitable coolers, although some plants make use of mechanical air pumps.

Figures VI-11 and VI-12 show some details of the steam ejector type of vacuum pump, and Figure VI-13 shows some operating characteristics. The size of the vacuum equipment will depend upon the air leakage to be expected,

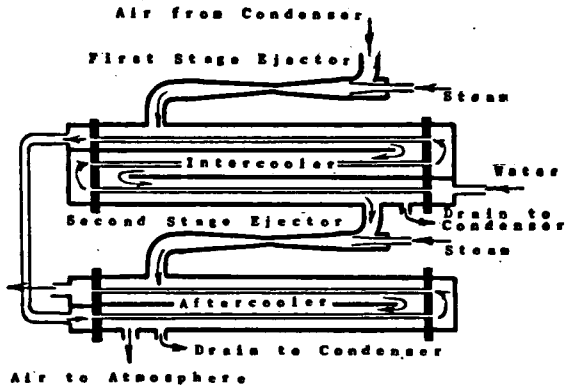
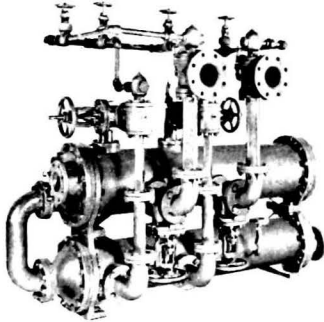

Fig. VI-11. Steam jet vacuum pump.



(Allis-Chalmers Co.)

Fig. VI-12. Steam jet vacuum pump.

which in turn depends upon the size and type of condenser. Figure VI-14 shows the approximate maximum air leakage to be expected.

44. Water Cooling Equipment

--Plants must often be located where an abundant source of condenser cooling water is not available. In these cases it is necessary to provide a spray pond or cooling tower and to use a closed circuit for the cooling water. Both spray ponds and cooling towers depend upon the evaporation into the air of a part of the water to be cooled.

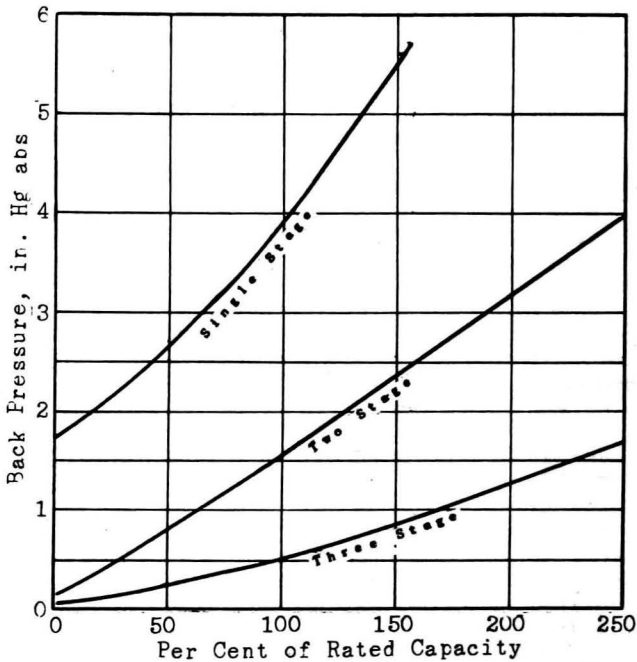

Fig. VI-13. Ejector operating characteristics.

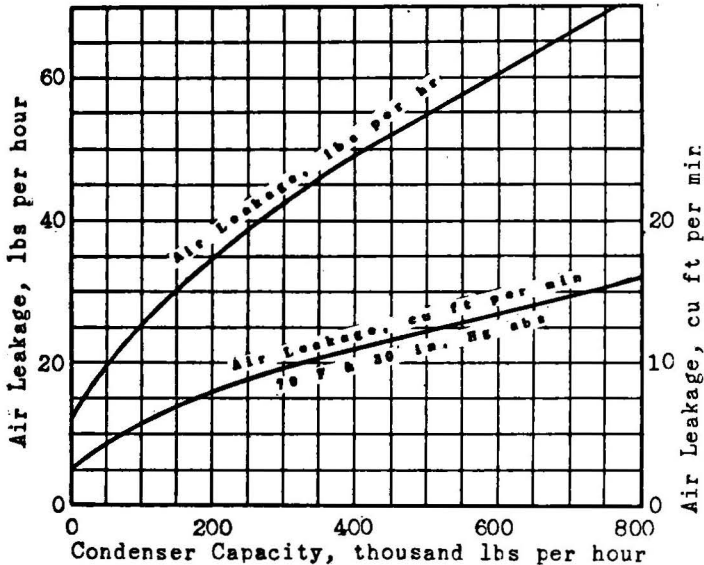
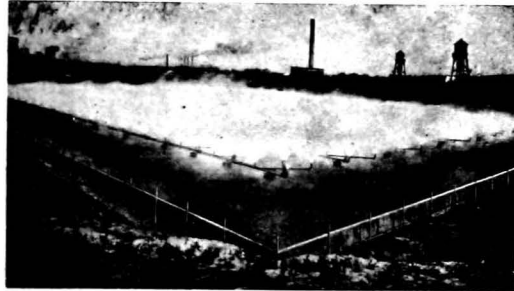

Fig. VI-14. Maximum expected condenser air leakage.

Spray ponds are wasteful of ground space because they depend upon natural air motion for their effective operation. On the other hand, they are relatively inexpensive to operate because they only require enough power to produce a pressure of about 10 pounds per square inch at the spray nozzles. Figure VI-15 shows a spray pond with the nozzles arranged in clusters, each cluster having a capacity of about 200 gallons per minute. It can be estimated that a spray pond will require about one square foot of ground area for each 250 pounds per hour of water to be cooled. The depth of the pond need not be greater than three feet. Figure



(Binks Mfg. Co.)

Fig. VI-15. Spray pond.

VI-16 shows some typical spray pond performance data.

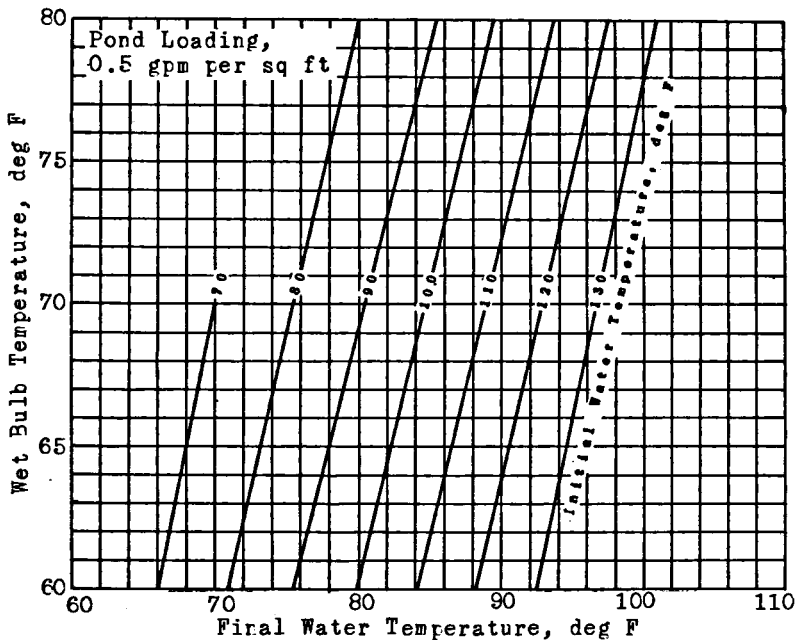
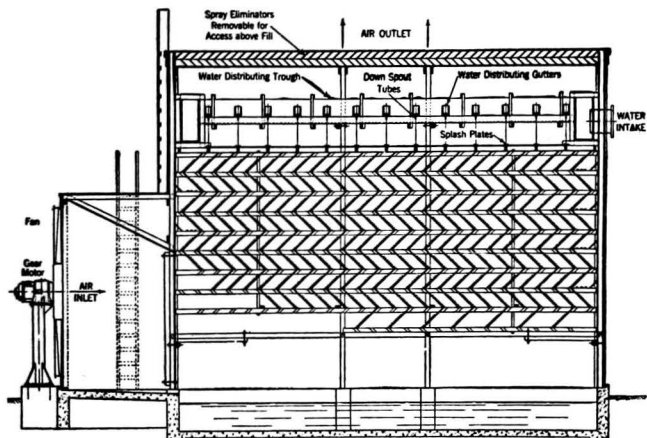

Fig. VI-16. Spray pond performance.

Cooling towers of the forced or induced draft types are much more economical of ground space than the spray pond because they do not depend upon natural air motion for their cooling effectiveness. In either type the water is broken into drops by being allowed to impinge upon wooden packing in the tower. The air flows through the falling water drops. The tower requires sufficient pump power to raise the water to the distributing troughs at the top, and sufficient fan power to move the required amount of air. Figures VI-17 and VI-18 show forced and induced draft towers, and Figure VI-19 shows some typical performance data.

45. *Evaporators*--Since regenerative cycles operate with the same water continuously and leakage is slight, it has been found advantageous to use evaporators to produce distilled water for the small amount of makeup required. Makeup requirements vary from about two to five per cent, depending upon a number of factors such as the amount of boiler blowdown and auxiliary steam unrecovered. The makeup water might be introduced directly to the boiler as raw or treated



(Foster-Wheeler Corp.)

Fig. VI-17. Forced draft cooling tower.

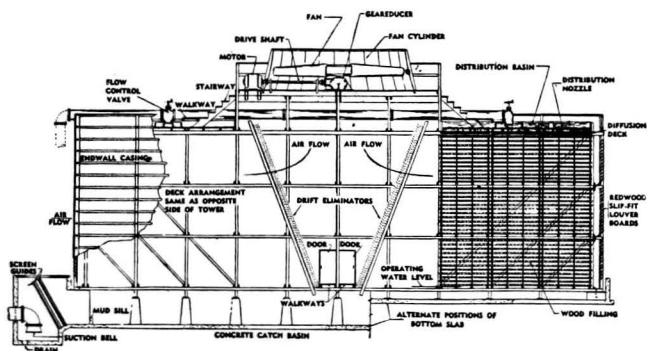

(The Marley Co.)

Fig. VI-18. Induced draft cooling tower.

water, but it has been found to be much easier to clean a small evaporator than to clean a large boiler.

Evaporators are most often fitted into the feed-water and steam cycle so that they use steam from one of the high pressure extraction nozzles in the turbine and use condensate to condense the vapor produced. Figure VI-20 shows one of the methods of arrangement of an evaporator set in a regen-

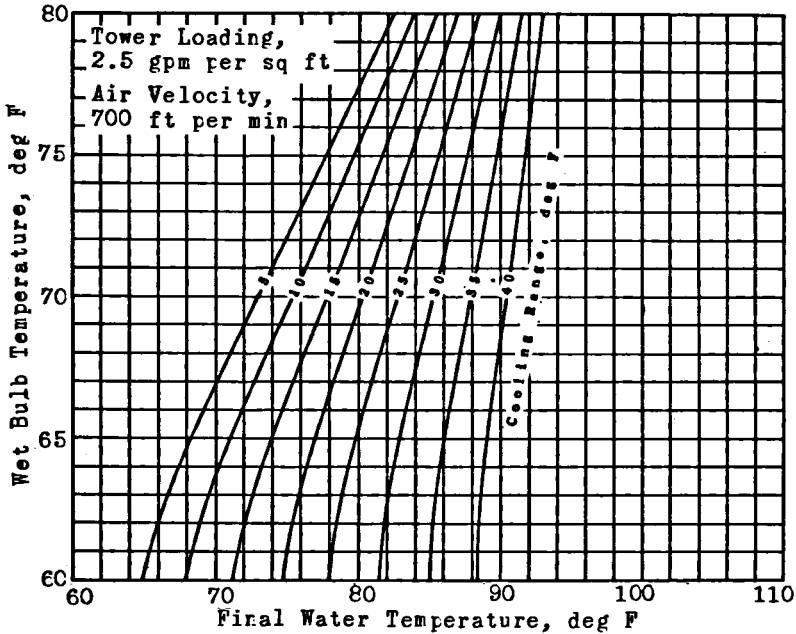

Fig. VI-19. Forced and induced draft tower performance.

erative cycle. It will be noted that the only heat loss from the system is due to the necessary blowdown from the evaporator shell. Figure VI-21 shows one of the usual types of evaporator.

In process industries which perform evaporation on a product, multiple effect evaporator systems are used because of their economy of operation. Figure VI-22 shows a typical quadruple effect system with a finishing pan for the production of citrus molasses. It will be noted that the vapor from a preceding effect is used as a source of heat for successive evaporations. The evaporators are of the long tube type with vapor separating heads. In this type of evaporator the liquid flows inside the tubes. In the first four effects the circulation is natural, and in the finishing pan a pump forces circulation. Figure VI-23 shows long tube types of evaporator.

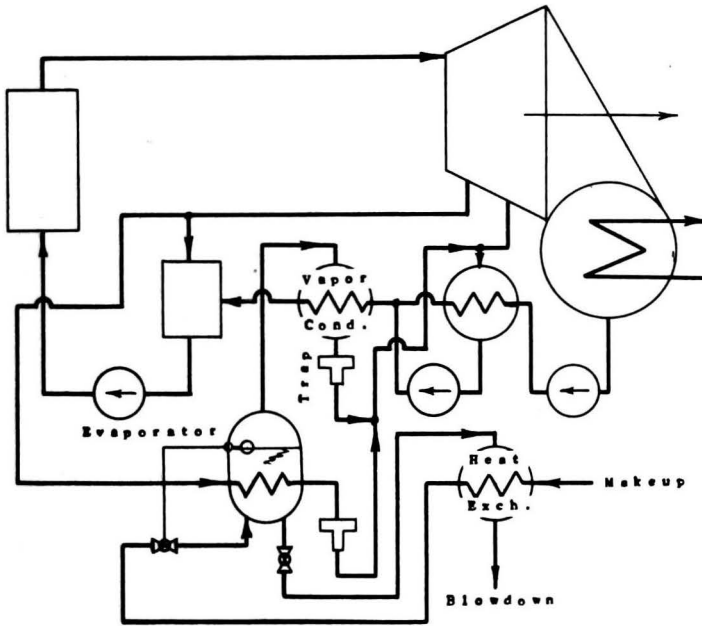
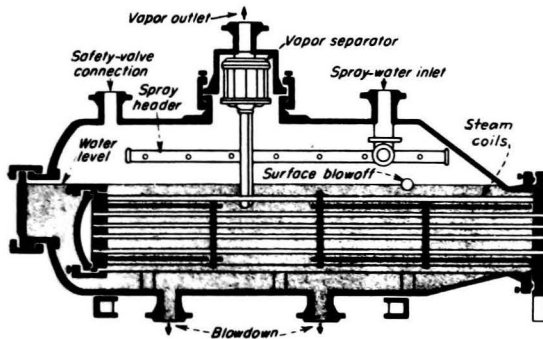

Fig. VI-20. Evaporator in regenerative cycle.



(Power)

Fig. VI-21. Shell and tube evaporator.

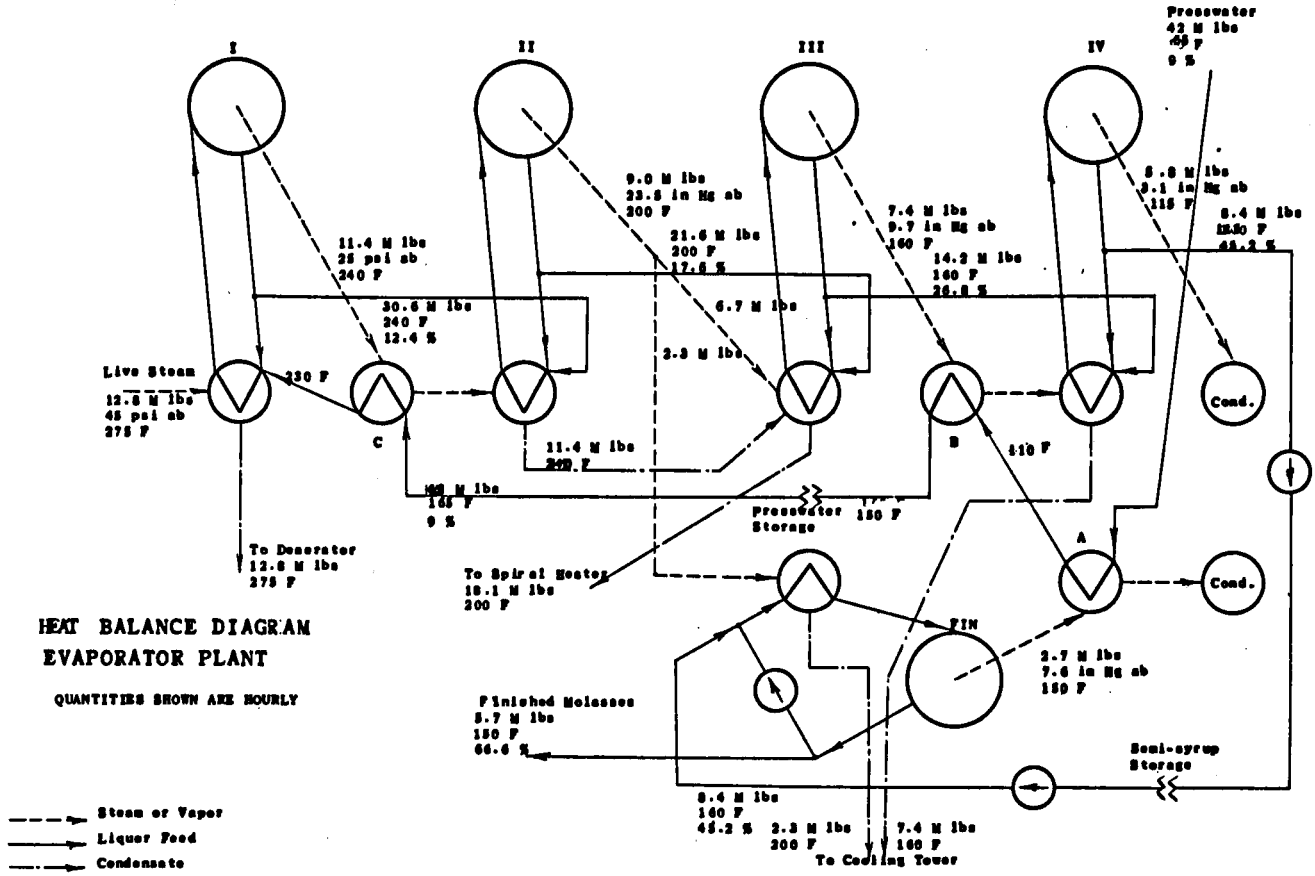
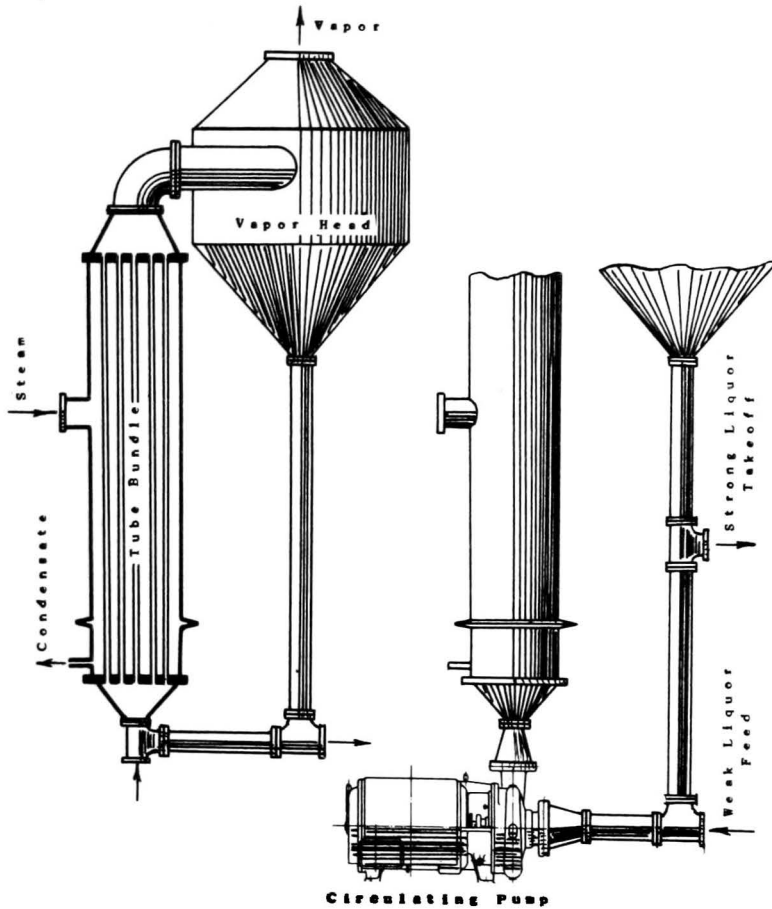

Fig. VI-22. Quadruple effect evaporator system with finishing pan for production of citrus molasses.



(a) Natural Circulation (b) Forced Circulation

Fig. VI-23. Long tube evaporators.

BIBLIOGRAPHY

- Badger, W. L., "Evaporators for Boiler Feed Makeup Water,"
Transactions A.S.M.E., Volumes 49-50, 1927.
- Chatel, F. J., "Steam Condenser Performance and Practice,"
Mechanical Engineering, March, 1927.

- Gaffert, G. A., "Extraction Heaters in the Fower Plant," *Power Plant Engineering*, April, August, 1933.
- Iira, D. O., "Fond Cooling by Surface Evaporation," *Power*, March, 1936.
- McAdams, W. H., *Heat Transmission*, McGraw-Hill, New York, 1933.
- Nance, G. R., "Fundamental Relationships in the Design of Cooling Towers," *Transactions A. S. M. E.*, November, 1939.
- Wheeler, F. R., "Closed Feed-water Heater Design," *Power Plant Engineering*, July, 1933.

PROJECT II

1. The power plant of Project I is to be designed around three turbo-generator units. One of the units will operate continuously, one unit will be operated to handle peak loads and the remaining unit will be a spare. The plant will operate on the regenerative cycle with one closed feed-water heater and one evaporator vapor condenser per machine. There will be one evaporator and one deaerating feed-water heater common to all machines. Boiler blowdown is fed to the evaporator shell. The flow diagram is shown in Figure VI-24.

It is expected that boiler and evaporator blowdown will each be five per cent and makeup will be two per cent. The open heater and evaporator will be supplied with steam from extraction points in the turbines so located that at full load the water temperature leaving the open heater will be at the most economical value. The closed heaters will be supplied with steam from extraction points in the turbines so located that at full load half of the feed-water temperature rise will be supplied by the open heater. Throttle conditions are: 350 psig, 725 F. Back pressure is 2.5 in. Hg abs. Refrigeration in the condenser hotwell is 2 F and terminal difference in the open heater is zero. Make heat balances for the plant at full and half load (two machines operating).

2. Specify the principal dimensions for a surface condenser to serve one of the turbines of part one. The average temperature of the inlet cooling water is 85 F. Use 3/4" OD X 18 BWG Admiralty metal tubes with a water velocity of 7 ft per sec.

3. Specify the area of an induced draft cooling tower to serve the condenser of part two. Design wet bulb temperature is 78 F.

4. Specify the principal dimensions of a closed feed-water heater to serve one of the turbines of part one. Use 5/8" OD X 18 BWG Admiralty metal tubes with a water velocity of 5 ft per sec. Maximum tube length is six feet.

5. Specify the principal dimensions of the deaerating feed-water heater for the regenerative cycle of part one.

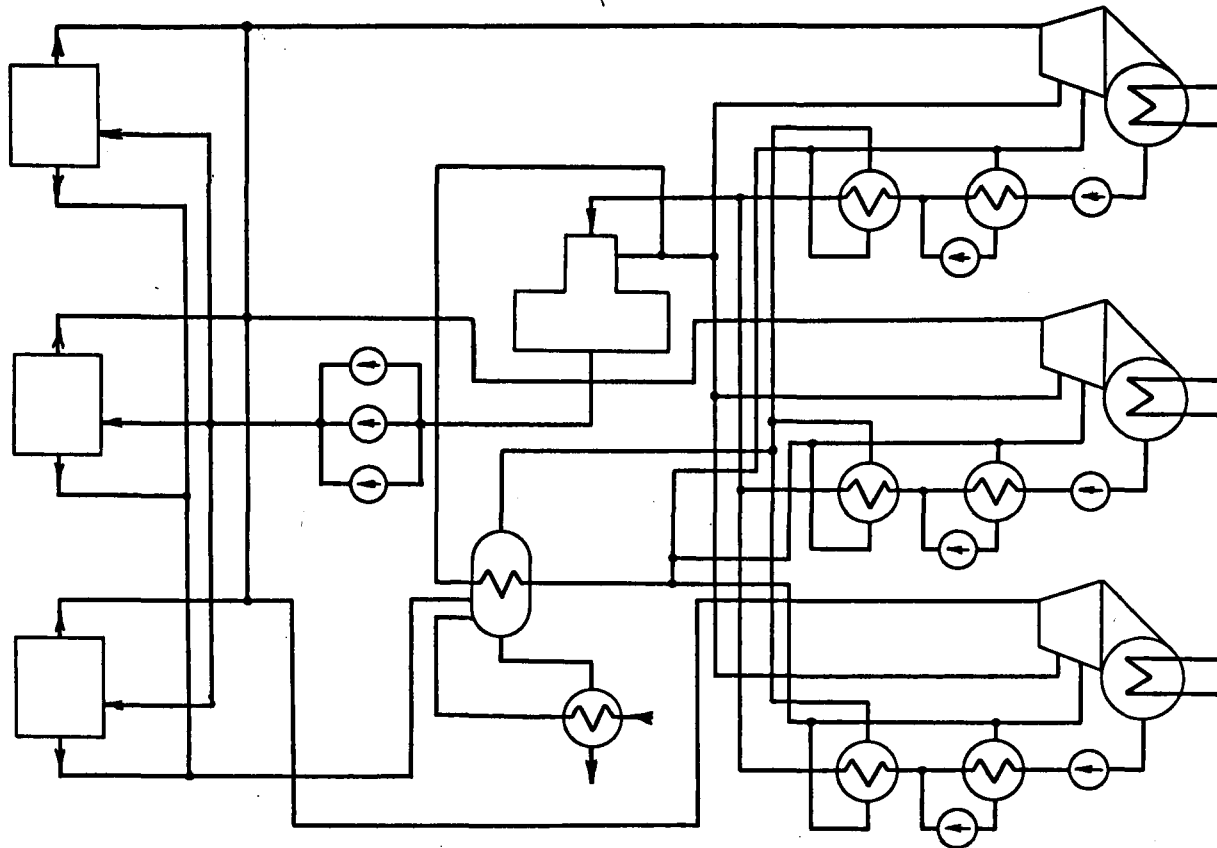

Fig. VI-24. Flow diagram for power plant of elementary power system, Project II.

CHAPTER VII
FUELS AND COMBUSTION

46. The variety of fuels used for the production of power is large, and the type used in any particular locality is always dependent upon economic factors. The most important fuels for commercial power production, in order of importance, are: coal, natural gas and fuel oil. Process industries often make use of cellulosic wastes as fuel.

47. Coal--Coal is a product of fermentation of vegetable matter laid down in prehistoric times. In this country, coal is found in almost every State in various phases of the evolutionary process. The most important coals for power production are the bituminous and semi-bituminous types, but some use is made of lignite and anthracite which are respectively younger and older than bituminous coal.

Coal is made up of moisture, volatile matter, fixed carbon and ash. The proportions of moisture and volatile matter decrease as the age of the coal deposit increases. Volatile matter consists of hydrocarbons which have a greater heating value than carbon on a weight basis, but which are more difficult to burn in small furnace volumes. Table VIII shows the analysis of some of the more important coals, both in the proximate form (fixed carbon, volatile, ash and moisture) and in the ultimate form.

48. Fuel Oil--The fuel oil ordinarily used in the production of electrical power is residuum from petroleum refining operations. Petroleum is found in large areas throughout the United States and South America, and is also a product of the fermentation of vegetable matter laid down in past ages. Its principal difference from coal is the almost complete absence of fixed carbon and ash. Table IX shows some analyses of typical fuel oils. The most important sources of fuel oil for the United States are the Pacific and Gulf coasts and Venezuela.

49. Natural Gas--Natural gas is principally a by-product from petroleum wells, although much gas is removed from the earth's crust through wells which are not connected with petroleum operations. Natural gas is a product of the fermentation of vegetable matter to produce coal and petroleum. Table X shows some analyses for natural gas.

TABLE VIII
ANALYSES OF TYPICAL AMERICAN COALS

	H ₂ O	Proximate		Ash	Ultimate - mois. incl.					HHV
		Vol.	FC		S	H	C	N	O	
Ark. Semi-anth.	1.28	12.84	73.69	12.21	2.01	3.74	77.29	1.39	3.36	13408
Penna. Anth.	2.19	5.67	86.24	5.90	0.57	2.70	86.37	0.91	3.55	13828
Penna. Semi-bit.	2.95	21.29	66.92	8.84	1.35	4.74	78.51	1.19	5.37	13901
W. Va. Semi-bit.	3.10	17.91	75.26	3.73	0.55	4.50	84.02	1.17	6.03	14724
Penna. Bit.	2.44	28.44	60.68	8.44	1.32	5.07	76.91	1.31	6.95	13732
Ala. Bit.	2.53	26.94	59.48	11.05	0.79	4.80	74.44	1.59	7.32	13286
Ill. Bit.	13.31	33.62	41.34	11.73	3.75	5.19	59.07	0.95	19.31	10548
Ind. Bit.	9.69	38.59	41.04	10.68	4.79	5.39	62.36	1.28	15.50	11412
N. Dak. Lig.	36.18	29.77	25.35	8.70	0.68	6.76	39.45	0.59	43.82	6700
Texas Br. Lig.	13.04	42.75	29.00	14.85	1.04	5.51	52.06	0.95	25.33	9358

(U. S. Bureau of Mines)

TABLE IX
ANALYSES OF TYPICAL FUEL OILS.

	Ultimate - mois. incl.				O	API ^o 60 F	HHV
	C	H	S	N			
Mexican	84.02	10.06	4.93	0.09	0.00	11.9	18510
Mid-cont.	85.62	11.98	0.35	0.50	0.60	27.1	19378
Calif.	84.67	12.36	1.16	0.90	0.91	16.7	18835
Texas	83.26	12.41	1.80	1.50	1.03	21.2	19654

TABLE X
ANALYSES OF TYPICAL NATURAL GASES

	Volumetric - std. cond. 60 F, 30 in. Hg							CO ₂	HHV
	CH ₄	C ₂ H ₄	C ₂ H ₆	CO	H ₂	O ₂	N ₂		
Marion, Ind.	93.56	0.16	0.00	0.60	1.20	0.55	3.42	0.30	1000
Pittsburgh, Pa.	72.18	3.00	0.00	1.00	20.00	0.80	0.00	0.80	920
Findlay, O.	93.35	0.35	0.00	0.41	1.64	0.39	3.41	0.25	1010
Monroe, La.	78.80	0.00	9.50	0.00	0.00	0.34	11.30	0.06	960

(Various sources)

50. **Combustion**--The process of combustion of fuels is one of rapid oxidation of the carbon, hydrogen and sulphur which it contains. In order to calculate the amount of air, which is the source of oxygen, for combustion, it is necessary to know the ultimate analysis of the fuel. Since the combustion process takes place too rapidly to reach equilibrium, it is always necessary to supply more than the theoretical amount of air. The air supplied in relation to the theoretical air is known as the total air, while that supplied above the theoretical air is called the excess air. Both total air and excess air are expressed as percentages by weight of the theoretical air. Examples 13 and 14 show the method of making combustion calculations for each of the principal types of fuels.

Example 13.

Determine the weight of air required for theoretically perfect combustion and the flue gas analysis for a fuel with the following analysis by weight: C = 0.8339; H = 0.0428; O = 0.0283; N = 0.0103; S = 0.0064; moisture = 0.025; and ash = 0.0533. Also, determine the weight of air required and the flue gas analysis for combustion with 30 o/o excess air.

Solution:

The combustion reactions are:

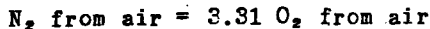
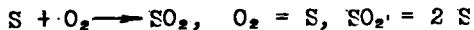
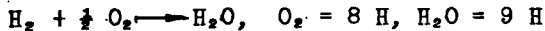
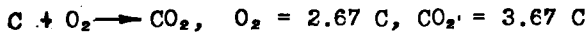

Theoretically perfect combustion: Basis, one lb fuel.

Const. weight	O ₂ req.	prod. wght.	wght. prod.	mol. wt.	mols.	anal. by vol. o/o	anal. by vol. dry o/o
C	0.8339	2.230 CO ₂	3.060	44	0.0696	17.70	18.78
H	0.0428	0.342 H ₂ O	0.385	18	0.0214	5.80	
O	0.0283	-0.028					
N	0.0103	N ₂	0.010	28	0.0004	76.50	81.22
S	0.0064	0.006 SO ₂	0.012	64	0.0002		
moist.	0.0250	H ₂ O	0.025	18	0.0014		
ash	0.0533						

FUELS AND COMBUSTION

121

	weight	O ₂ req.	wght. prod.	mols,
	1.0000	2.550	3.492	0.0930
N ₂ air		8.440	8.440	0.3010
Totals/lb		10.990	11.922	
		air	gas	

For theoretically perfect combustion, 10.99 lbs of air are required and 11.932 lbs of gas are produced per lb of fuel burned. The dry (Orsat) analysis of the flue gas would be: CO₂ = 18.78 o/o and N₂ = 81.22 o/o.

Combustion with 30 o/o excess air: Basis, one lb fuel.

O ₂ req.	2.550	Gas prod., theo.	11.932
O ₂ suppl.	3.320	Excess O ₂	0.770
N ₂ air	11.000	N ₂ with exc. O ₂	2.560
Air suppl.	14.320	Gas produced	15.262

Prod.	wght. prod.	mol. wt.	mols.	anal. by vol. o/o	anal. by vol. dry o/o
CO ₂	3.060	44	0.0696	13.70	14.30
H ₂ O	0.410	18	0.0228	4.48	
O ₂	0.770	32	0.0240	4.71	4.93
N ₂	11.010	28	0.3930	77.21	80.72
SO ₂	0.012	64	0.0002		
	15.262		0.5096		
	gas				

For combustion with 30 o/o excess air, 14.32 lbs of air are required and 15.262 lbs of gas are produced per lb of fuel burned. The dry (Orsat) analysis of the flue gas would be: CO₂ = 14.30 o/o, O₂ = 4.93 o/o and N₂ = 80.72 o/o.

Example 14.

Determine the weight of air required for theoretically perfect combustion and the flue gas analysis for a gaseous fuel with the following analysis by volume: CO₂ = 0.004; CH₄ = 0.921; C₂H₆ = 0.041; and N₂ = 0.034. Also, determine the amount of air required and the flue gas analysis for

combustion with 20 o/o excess air.

Solution:

Combustion reactions are:

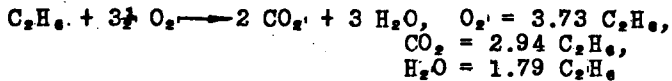
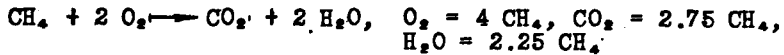

N_2 from air = 3.31 O_2 from air

Theoretically perfect combustion: Basis, one lb fuel.

Const.	anal.	mol.	lbs.	anal.	O_2	Products			
	by vol.	wt.		by wt.	req.	CO_2	H_2O	N_2	
CO_2	0.004	44	0.176	0.0103		0.01			
CH_4	0.921	16	14.750	0.8630	3.45	2.37	1.94		
C_2H_6	0.041	30	1.230	0.0720	0.27	0.21	0.13		
N_2	0.034	28	0.953	0.0557				0.06	
	1.000		17.109	1.0010	3.72	2.59	2.07	0.06	
N_2 from air					12.30			12.30	
Total				air	16.02	2.59	2.07	12.36	17.02
				Mol. wt.		44	18	28	gas
				mols.		0.06	0.12	0.44	0.62
				Anal. by vol. wet. o/o		9.60	18.7	71.70	
				Anal. by vol. dry o/o		11.80		88.20	

From the preceding analysis it is seen that one pound of this particular fuel gas requires 16.02 lbs of air for theoretically perfect combustion and produces 17.02 lbs of wet flue gas. The dry (Orsat) analysis of the flue gas would be: $\text{CO}_2 = 11.80$ o/o and $\text{N}_2 = 88.20$ o/o.

Combustion with 20 o/o excess air: Basis, one lb fuel.

O_2 req.	3.72	Gas prod., theo.	17.02
O_2 suppl.	4.46	Excess O_2	0.74
N_2 from air	14.76	N_2 with exc. O_2	2.46
Air supplied	19.22	Gas produced	20.22

Prod.	wght. prod.	mol. wt.	mols	anal. by vol. wet o/o	anal. by vol. dry o/o
CO ₂	2.59	44	0.0589	8.10	9.63
H ₂ O	2.07	18	0.1150	15.82	
O ₂	0.74	32	0.0231	3.08	3.78
N ₂	14.82	28	0.5300	73.00	86.59
	20.22		0.7270		
	gas				

For combustion with 20 o/o excess air, 19.22 lbs of air are required and 20.22 lbs of flue gas are produced per lb of fuel. The dry (Orsat) analysis of the flue gas would be: CO₂ = 9.63 o/o, O₂ = 3.78 o/o and N₂ = 86.59 o/o.

Often it is necessary to determine combustion conditions from a fuel analysis and an analysis of the flue gas. Examples 15 and 16 show the method followed for each of the types of fuels.

Example 15.

Fuel with an ultimate analysis of: C = 0.83; H = 0.127; O = 0.012; N = 0.016; S = 0.004; moisture = 0.01; and ash = 0.001 is burned in a boiler furnace. The flue gas has the following volumetric analysis on the dry basis: CO₂ = 13.7 o/o; O₂ = 2.6 o/o; CO = 0.4 o/o; and N₂ = 83.3 o/o. Find the theoretical air, actual air and flue gas produced in lbs per lb of fuel fired.

Solution:

- The theoretical air can be found from the formula:

$$M_{at} = 11.53 C_{burned} + 34.36 \left[H - \frac{O}{8} \right] + 4.32 S \text{ lbs/lb fuel}$$

$$M_{at} = 11.53(0.83) + 34.36 \left[0.127 - \frac{0.012}{8} \right] + 4.32(0.004)$$

$$M_{at} = 13.91 \text{ lbs/lb fuel}$$

- The dry flue gas produced can be determined with the aid of a carbon balance, as follows:

$$M_{gd} = \frac{44 \text{ CO}_2 + 32 \text{ O}_2 + 28(\text{N}_2 + \text{CO})}{12(\text{CO}_2 + \text{CO})} [C_{burned} + \frac{1}{8}S] + \frac{1}{8}S \text{ lbs/lb}$$

$$M_{gd} = \frac{44(13.7) + 32(2.6) + 28(83.3 + 0.4)}{12(13.7 + C.4)} [0.83 + (0.375)0.004] + 40.625(0.004)$$

$$M_{gd} = 19.93 \text{ lbs/lb fuel}$$

Note: Sulphur dioxide in the flue gas is analyzed as carbon dioxide by the Orsat apparatus. If all of carbon in the fuel is not burned a correction is made (see Example 17).

3. The wet flue gas produced can be found from a weight balance, as follows:

$$M_{gn} = M_{gd} + 9H + \text{moisture lbs/lb fuel}$$

$$M_{gn} = 19.93 + 9(0.127) + 0.01 = 21.08 \text{ lbs/lb fuel}$$

4. The actual air supplied can be found from a weight balance, as follows:

$$M_{aa} = M_{gd} + 8\left[H - \frac{O}{8}\right] - C_{burned} - S - N \text{ lbs/lb fuel}$$

$$M_{aa} = 19.93 + 8\left[C.127 - \frac{0.012}{8}\right] - 0.83 - 0.004 - 0.016$$

$$M_{aa} = 20.08 \text{ lbs/lb fuel}$$

5. Excess air can be found from the relation:

$$\text{Excess air o/o} = \frac{M_{aa} - M_{at}}{M_{at}}(100)$$

$$\text{Excess air o/o} = \frac{20.08 - 13.91}{13.91}(100) = 44.3 \text{ o/o}$$

Example 16.

A fuel gas having an analysis of $\text{CH}_4 = 77.5 \text{ o/o}$, $\text{C}_2\text{H}_6 = 16.0 \text{ o/o}$, $\text{CO}_2 = 6.3 \text{ o/o}$, $\text{N}_2 = 0.2 \text{ o/o}$ is burned in a boiler furnace. The flue gas has the following analysis on the dry basis: $\text{CO}_2 = 9.0 \text{ o/o}$, $\text{O}_2 = 3.0 \text{ o/o}$, $\text{CO} = 0.2 \text{ o/o}$, $\text{N}_2 = 87.8 \text{ o/o}$. Find the theoretical air, actual air and flue gas in lbs per lb of fuel fired and the percentage of excess air supplied.

Solution:

The first step in the solution is the conversion of the volumetric analysis to a gravimetric analysis.

Const.	anal. by vol.	mol. wt.	lbs.	anal. by wt.
CH ₄	0.775	16	12.40	0.619
C ₂ H ₆	0.160	30	4.80	0.239
CO ₂	0.063	44	2.77	0.138
N ₂	0.002	28	0.06	0.004
	1.000		20.03	1.000

1. Theoretical air:

$$M_{at} = 17.25 \text{ CH}_4 + 16.10 \text{ C}_2\text{H}_6 + 14.8 \text{ C}_2\text{H}_4 + 34.5 \text{ H}_2 \text{ lbs/lb}$$

$$M_{at} = 17.25(0.619) + 16.10(0.239) = 14.53 \text{ lbs/lb fuel}$$

2. Dry flue gas:

$$M_{gd} = \frac{44 \text{ CO}_2 + 32 \text{ O}_2 + 28(\text{N}_2 + \text{CO})}{12(\text{CO}_2 + \text{CO})} [0.75 \text{ CH}_4 + 0.8 \text{ C}_2\text{H}_6 + 0.857 \text{ C}_2\text{H}_4] + \text{CO}_{2f} + \text{N}_{2f}$$

$$M_{gd} = \frac{44(9.0) + 32(3.0) + 28(87.8 + 0.2)}{12(9.0 + 0.2)} [0.75(0.619) + 0.8(0.239) + 0.138 + 0.004]$$

$$M_{gd} = 17.64 \text{ lbs/lb fuel}$$

3. Wet flue gas:

$$M_{gw} = M_{gd} + 2.25 \text{ CH}_4 + 1.8 \text{ C}_2\text{H}_6 + 1.29 \text{ C}_2\text{H}_4 + 9 \text{ H}_2$$

$$M_{gw} = 17.64 + 2.25(0.619) + 1.8(0.239) = 19.46 \text{ lbs/lb fuel}$$

4. Actual air supplied:

$$M_{aa} = M_{gd} + 1.25 \text{ CH}_4 + 0.80 \text{ C}_2\text{H}_6 + 0.29 \text{ C}_2\text{H}_4 + 8 \text{ H}_2 - \text{N}_2 - \text{CO}_2$$

$$M_{aa} = 17.64 + 1.25(0.619) + 0.80(0.239) - 0.002 - 0.138$$

$$M_{aa} = 18.47 \text{ lbs/lb fuel}$$

5. Excess air:

$$\text{Excess air} = \frac{18.47 - 14.53}{14.53} (100) = 27.1 \text{ o/o}$$

51. Heating Value of Fuels--One of the most important properties of any fuel is its heating value per unit of weight or volume. The higher heating value (HHV) is the value which would be obtained if the products of combustion were cooled to the temperature of the original fuel and air. The lower heating value (LHV) is the higher heating value less the latent heat of vaporization of the moisture formed in the combustion process and present in the fuel originally. It is customary to base efficiencies on the higher heating values, although efficiencies would appear to be higher if they were based on the lower heating value.

The heating values of fuels can be determined approximately by calculation if the ultimate analysis, proximate analysis (for coal) or specific gravity (for fuel oil) is known.

For solid or liquid fuels with the ultimate analysis known:

$$\text{HHV} = 14600 C + 62000\left(H - \frac{O}{8}\right) + 4050 S$$

where: HHV = higher heating value, Btu/lb
 C, H, O and S = carbon, hydrogen,
 oxygen and sulphur, lbs/lb fuel

For coals with the proximate analysis known, the heating value can be determined from Table XI. It will be noted that the proximate analysis must be converted to the combustible basis before the table is used, and the result converted to the as fired basis. These conversions may be made as follows:

Converting proximate analysis as fired to
 combustible basis, lbs/lb fuel:

$$\text{Volatile matter} = \frac{\text{Volatile matter as fired}}{1 - \text{moisture as fired} - \text{ash as fired}}$$

$$\text{Fixed carbon} = \frac{\text{Fixed carbon as fired}}{1 - \text{moisture as fired} - \text{ash as fired}}$$

Converting heating value on combustible basis
 to as fired basis, Btu/lb:

$$\text{HHV} = (\text{HV on comb. basis})(1 - \text{mois. as fired} - \text{ash as fired})$$

TABLE XI

HEATING VALUE OF COAL BASED ON PROXIMATE ANALYSIS

States	Per cent Volatile on Combustible Basis	Btu/lb on Combustible Basis
Pa., Ohio, W.Va., Md., Va., Ky., Ga., Tenn., Ala., Ind., Iowa, Neb., Kan., Mo., Okla., Ark., and Texas	0 - 16 16 - 36 36 - up	HHV = 14550 + 7810 V HHV = 16160 - 2250 V HHV = 18750 - 9440 V
Ill. and Mich.	all	HHV = 16062 - 3830 V

where: HHV = higher heating value
 V = decimal fraction volatile
 on combustible basis

(F. C. Evans)

For heavy fuel oils with the specific gravity known:

$$\Delta HV = 18650 + 40(\text{A.P.I.}^\circ - 10)$$

where: A.P.I.[°] = specific gravity
 on the American Petroleum
 Institute scale, or
 $\text{A.P.I.}^\circ = 141.5 - (131.5/\text{sp.gr.})$

For gaseous fuels with the volumetric analysis known:

$$\text{HHV} = 323 \text{ CO} + 328 \text{ H}_2 + 1012 \text{ CH}_4 + 1762 \text{ C}_2\text{H}_6 + 1641 \text{ C}_2\text{H}_4$$

where: HHV = higher heating value, Btu/cu ft
 at 60 F and 30 in. Hg

CO, H₂, CH₄, C₂H₆ and C₂H₄ = carbon
 monoxide, hydrogen, methane, ethane
 and ethylene, volume fractions
 as fired.

The preceding equations are only approximate, and for the most precise determination of heating value it will be necessary to employ a calorimeter of a suitable type.



(Parr Instrument Co.)

Fig. VII-1. Parr bomb calorimeter.
tance wire.

For heating value determinations on gaseous or light liquid fuels, the steady flow calorimeter is used. The Sargent calorimeter shown in Figure VII-2 is of this type and consists of a water jacket with flues for absorbing heat from the products of combustion of the fuel. If the products of combustion leave the calorimeter at the same temperature as the incoming fuel and air, the higher heating value will be determined. The heating value is calculated from the known weight of water heated through a known temperature rise by a known volume or weight of fuel.

52. Flue Gas Analysis--
Analysis of the products of combustion is most conveniently made with an Orsat type

For heating value determinations on solid or heavy liquid fuels, it is customary to employ one of the constant volume "bomb" types of calorimeter. The Parr bomb calorimeter is shown in Figure VII-1, and consists of a heavy steel container into which the fuel sample is placed with sufficient pure oxygen to insure complete combustion. The bomb is immersed in a known weight of water whose temperature rise is determined after igniting the fuel sample with an electric resis-

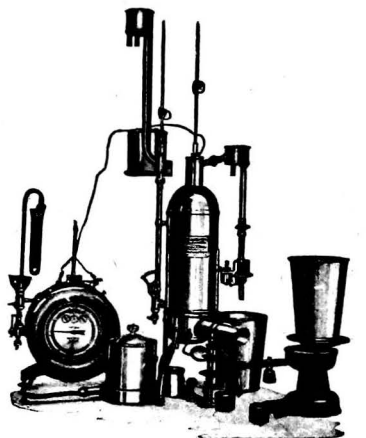

(Precision Scientific Co.)

Fig. VII-2. Sargent calorimeter.

of apparatus which absorbs the various flue gas constituents, one at a time, by means of chemical solutions. Figure VII-3 shows a common portable form of the apparatus.

The Orsat analysis is given on the dry basis because the sample remains saturated with moisture throughout the test procedure. The ordinary form of the apparatus measures volumetric or mol fractions of carbon dioxide, oxygen and carbon monoxide. It is assumed that the remaining gas is nitrogen. Due to the fact that the reagent for carbon dioxide will absorb all acid gases, the sulphurous gases in the products of combustion will be analyzed as carbon dioxide, but the error is slight for ordinary fuels.

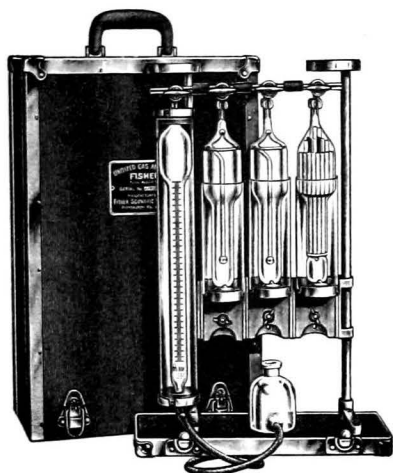

(Fisher Scientific Co.)

Fig. VII-3. Orsat gas analysis apparatus.

BIBLIOGRAPHY

- Fieldner, A. C., "Constitution and Classification of Coals," *Transactions A. S. M. E.*, September-December, 1928.
- Kreisinger, H., and Cross, B. F., "Burning Characteristics of Different Coals," *Transactions A. S. M. E.*, September-December, 1928.
- Peabody, E. H., "The Burning of Liquid Fuel," *Transactions A. S. M. E.*, Volumes 49-50, 1927-28.
- Philo, F. G., "Boiler Plant Performance with Natural Gas Firing," *Transactions A. S. M. E.*, November, 1939.

CHAPTER VIII

STEAM GENERATORS

53. *Steam generator* is the preferred name for equipment which produces steam from water by means of fuel. Steam generators are divided into two general classifications: fire-tube and water-tube, depending upon whether the water surrounds the tubes or is contained within the tubes. It might be said here that the term *boiler* is used somewhat flexibly, but strictly speaking should only be applied to the convection steam generating surface in a steam generator, while the term *steam generator* includes the boiler and all auxiliary heat recovery apparatus.

Steam generators in small sizes are rated in terms of boiler horsepower, which amounts to a heat absorption of 33,480 Btu per hour per boiler horsepower, or 34.5 pounds of steam per hour per boiler horsepower from and at 212 F. One boiler horsepower is also approximately equal to ten square feet of convection heating surface. Large steam generators are rated in terms of the actual weight of steam produced per hour at definite outlet conditions with feed-water at a definite temperature.

54. *Steam Generator Efficiency*--Steam generator efficiency is the quotient of the heat output of the steam generator divided by the heat input from the fuel. That is:

$$e_{sg} = \frac{M_v(H_v - h_{f_1}) + M_b(h_{f_2} - h_{f_1})}{M_f(\text{HHV})}$$

where: M_v = steam flow, lbs/hr
 M_b = blowdown rate, lbs/hr
 M_f = fuel feed rate, lbs/hr or cu ft/hr
 H_v = enthalpy of steam at boiler outlet, Btu/lb
 h_{f_2} = enthalpy of boiler feed, Btu/lb
 h_{f_1} = enthalpy of saturated water at boiler pressure, Btu/lb
HHV = higher heating value of fuel, Btu/lb or Btu/cu ft

Quite often it is impossible to measure accurately the quantities of fuel, steam and blowdown, making it necessary

to determine the steam generator efficiency by the method of losses. This method requires that the flue gas analysis and ultimate analysis of the fuel, as well as combustion air temperature, fuel temperature and flue gas temperature be known. The various losses per pound of fuel can then be calculated and the difference between the heating value of the fuel and the losses considered as the heat absorbed by the steam generator. The losses are:

- (a) Due to sensible heat in the dry flue gases..
- (b) Due to sensible and latent heat in the vapor formed from the moisture in the fuel.
- (c) Due to sensible and latent heat in the vapor formed from the combustion of hydrogen in the fuel.
- (d) Due to carbon monoxide resulting from the incomplete combustion of carbon.
- (e) Due to unburned carbon in the ash pit refuse and in fly ash.
- (f) Due to radiation from the boiler setting..
- (g) Due to unaccounted for losses, such as sensible heat in the ash pit refuse, unburned hydrocarbons, and moisture in the air used for combustion. (This item can be estimated at from 0.1 to 0.2 per cent.)

The above losses might be regrouped into two general classifications, as follows:

- A. Combustion losses due to failure to develop the full heating value of the fuel. These items would include items (d) and (e) and part of (g).
- B. Conversion losses due to failure to transmit all of the heat developed to the steam. These losses would include items (a), (b), (c) and (f) and part of (g).

Example 17 shows the method of determination of steam generator efficiency by the direct method and by the method of losses for solid or liquid fuels, and Example 18 shows the same procedure for gaseous fuels.

Example 17.

The following data were recorded for a test on a boiler

rated at 200,000 lbs per hour and equipped with a completely water-cooled furnace:

Average steam temperature	900 F
Average steam pressure	910 psig
Steam generated in 8 hours	1,600,000 lbs
Average feed-water temperature	300 F
Heating value of coal as fired	14,400 Btu/lb
Fuel fired in 8 hours	74 tons
Heating value of refuse	5,100 Btu/lb
Refuse collected in 8 hours	5.9 tons
Average flue gas temperature	250 F
Average combustion air temperature	110 F
Average fuel temperature	70 F

Flue gas analysis
by volume

CO ₂ = 12.8 o/o
O ₂ = 6.4 o/o
CO = 0.2 o/o
N ₂ = 80.6 o/o

Fuel analysis
lb/lb as fired

C = 0.8152
H = 0.0447
O = 0.0495
N = 0.0100
S = 0.0063
ash = 0.0521
mois. = 0.0222

Make a heat balance for the boiler:

Solution:

A. Carbon burned:

$$C_{burned} = C - \left[\frac{\text{wt. of refuse(heating value of refuse)}}{14600(\text{wt. of fuel})} \right]$$

$$C_{burned} = 0.8152 - \left[\frac{5.9(5100)}{14600(74)} \right] = 0.7873 \text{ lb/lb fuel}$$

B. Dry gas: (See Example 15)

$$M_{gd} = \frac{44(12.8)+32(6.4)+28(80.6+0.2)}{12(12.8+0.2)} [0.7873+0.375(0.0063)] + 0.625(0.0063)$$

$$= 15.30 \text{ lbs/lb fuel}$$

C. Heat absorbed by boiler:

$$Q_1 = \frac{\text{Wt. of water evaporated(heat added to water)}}{\text{Wt. of fuel fired}} \text{ Btu/lb}$$

$$Q_1 = \frac{1,600,000(1450.9 - 269.6)}{74(2000)} = 12,780 \text{ Btu/lb fuel}$$

D. Heat loss due to dry flue gas:

$$Q_2 = 0.24(M_{gd})(\text{temp. of flue gas} - \text{temp. of comb. air})$$

$$Q_2 = 0.24(15.30)(250 - 110) = 515 \text{ Btu/lb fuel}$$

E. Heat loss due to moisture in fuel:

When temperature of flue gas < 575 F:

$$Q_3 = [\text{mois. in fuel}][1089 - \text{temp. of fuel} + 0.46(\text{temp. of flue gas})]$$

When temperature of flue gas > 575 F:

$$Q_3 = [\text{mois. in fuel}][1066 - \text{temp. of fuel} + 0.50(\text{temp. of flue gas})]$$

$$Q_3 = 0.0222[1089 - 70 + 0.46(250)] = 25 \text{ Btu/lb fuel}$$

F. Heat loss due to moisture from combustion of H:

When temperature of flue gas < 575 F:

$$Q_4 = [9 H][1089 - \text{temp. of fuel} + 0.46(\text{temp. of flue gas})]$$

When temperature of flue gas > 575 F:

$$Q_4 = [9 H][1066 - \text{temp. of fuel} + 0.50(\text{temp. of flue gas})]$$

$$Q_4 = 9[0.0447][1089 - 70 + 0.46(250)] = 456 \text{ Btu/lb fuel}$$

G. Heat loss due to carbon monoxide in flue gas:

$$Q_5 = \frac{\text{CO}}{\text{CO}_2 + \text{CO}}(10160)(C_{\text{burned}})$$

$$Q_5 = \frac{0.2}{12.8 + 0.2}(10160)(0.7873) = 123 \text{ Btu/lb fuel}$$

H. Heat loss due to combustible in refuse:

$$Q_6 = \frac{\text{Wt. of refuse}}{\text{Wt. of fuel}}(\text{heating value of refuse})$$

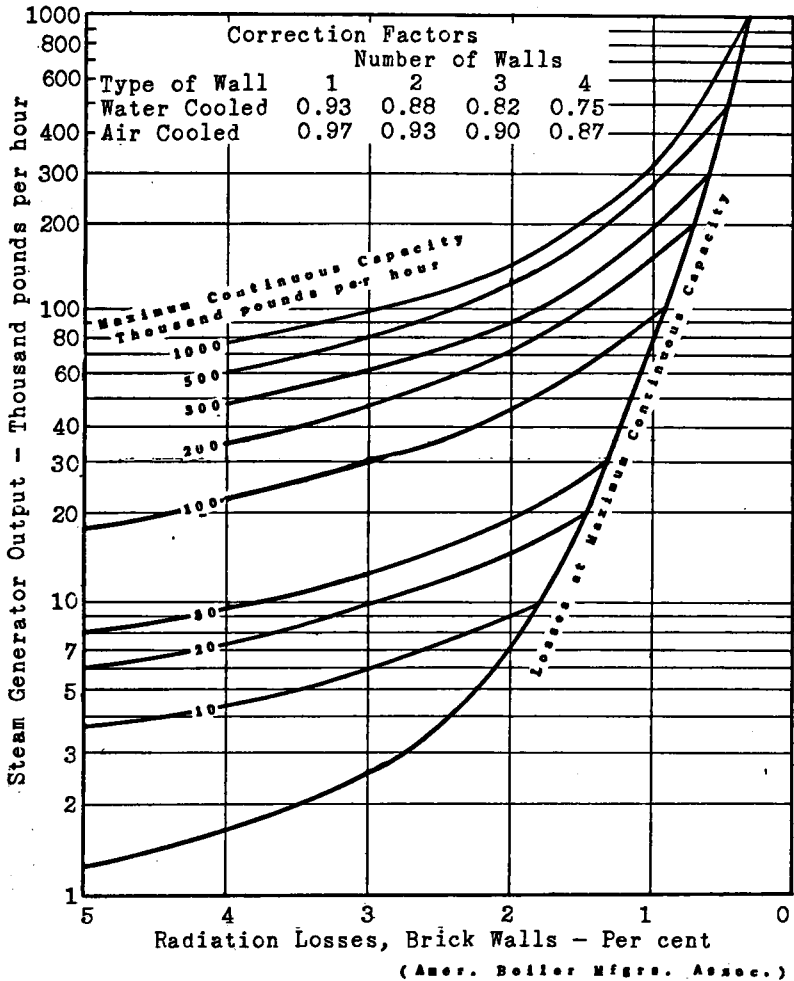

Fig. VIII-1. A.B.M.A. boiler radiation loss chart.

$$Q_r = \frac{5.9}{74}(5100) = 407 \text{ Btu/lb fuel}$$

I. Radiation losses from boiler setting:

From Figure VIII-1, radiation losses for a 200,000 lb/hr boiler at full load are 0.75 o/o for brick walls, with a

correction factor of 0.75 for four water-cooled walls.

$$Q_7 = 0.0075(0.75)(14400) = 81 \text{ Btu/lb fuel}$$

J. Unaccounted for losses:

$$Q_8 = \text{Heating value of fuel} - [Q_1 + Q_2 + Q_3 + Q_4 + Q_5 + Q_6 + Q_7]$$

$$Q_8 = 14400 - [12780 + 515 + 25 + 456 + 123 + 407 + 81] = 13 \text{ Btu/lb fuel}$$

Recapitulation: Basis, one lb fuel as fired.

Heat absorbed by boiler	12780 Btu/lb	88.7 o/o
Heat loss due to dry flue gas	515	3.6
Heat loss due to moisture in fuel	25	0.2
Heat loss due to mois. from comb. of H	456	3.2
Heat loss due to carbon monoxide	123	0.8
Heat loss due to comb. in refuse	407	2.8
Heat loss due to radiation	81	0.6
Unaccounted for losses	13	0.1
Heating value of fuel	14400 Btu/lb	100.0 o/o

Example 18.

The following data were recorded for a test on a boiler rated at 25,000 lbs per hour and equipped with plain brick furnace walls:

Average steam pressure	215 psig
Average steam temperature	540 F
Steam generated in 4 hours	86,000 lbs
Average feed-water temperature	260 F
Heating value of gas (std.cond.)	1,060 Btu/cu ft
Fuel fired in 4 hours, at 70 F and 3 psig	89,400 cu ft
Average flue gas temperature	350 F
Average combustion air temp.	100 F

Flue gas analysis
by volume

CO ₂	= 9.3 o/o
O ₂	= 2.5 o/o
CO	= 0.3 o/o
N ₂	= 87.9 o/o

Fuel analysis
by volume

CH ₄	= 0.840
C ₂ H ₆	= 0.120
N ₂	= 0.025

Make a heat balance for the boiler.

Solution:

The volumetric fuel analysis is first changed to a gravimetric analysis:

Const.	anal. by vol.	mol. wt.	lbs.	anal. by wt.
CH ₄	0.840	16	13.45	0.759
C ₂ H ₆	0.120	30	3.60	0.203
N ₂	0.025	28	0.70	0.038
	1.000		17.75	1.000

A. Dry gas: (See Example 16)

$$M_{gd} = \frac{44(9.3) + 32(2.5) + 28(87.9 + 0.3)}{12(9.3 + 0.3)} [0.75(0.759) + 0.8(0.203) + 0.038]$$

$$M_{gd} = 18.82 \text{ lbs/lb fuel}$$

B. Heat absorbed by boiler: (See Example 17)

From the calculations converting the fuel analysis to the gravimetric basis, the apparent molecular weight is 17.75, from which $R = 1544/17.75 = 87.0$. The weight of fuel fired is:

$$M_f = \frac{(3 + 14.7)(144)(89400)}{87(530)} = 4950 \text{ lbs}$$

The weight of one cubic foot of fuel at standard conditions is:

$$\rho = \frac{30(0.491)(144)}{87(520)} = 0.0469 \text{ lb/cu ft}$$

from which the heating value of the fuel is:

$$\text{HHV} = \frac{1060}{0.0469} = 22600 \text{ Btu/lb}$$

$$Q_1 = \frac{86,000(1287.8 - 228.6)}{4950} = 18400 \text{ Btu/lb fuel}$$

C. Heat loss due to dry flue gas: (See Example 17)

$$Q_2 = 0.24(18.82)(350 - 100) = 1130 \text{ Btu/lb fuel}$$

D. Heat loss due to moisture from combustion of H:

When temperature of flue gas < 575 F:

$$Q_4 = [2.25 \text{ CH}_4 + 1.8 \text{ C}_2\text{H}_6 + 1.29 \text{ C}_2\text{H}_4 + 9 \text{ H}_2][1089 - \text{temp. of fuel} + 0.46(\text{temp. of flue gas})]$$

When temperature of flue gas > 575 F:

$$Q_4 = [2.25 \text{ CH}_4 + 1.8 \text{ C}_2\text{H}_6 + 1.29 \text{ C}_2\text{H}_4 + 9 \text{ H}_2][1066 - \text{temp. of fuel} + 0.50(\text{temp. of flue gas})]$$

$$Q_4 = [2.25(0.759) + 1.8(0.203)][1089 - 70 + 0.46(350)]$$

$$Q_4 = 2440 \text{ Btu/lb fuel}$$

E. Heat loss due to carbon monoxide in flue gas:

$$Q_5 = \frac{\text{CO}}{\text{CO}_2 + \text{CO}}(10160)(0.75 \text{ CH}_4 + 0.8 \text{ C}_2\text{H}_6 + 0.857 \text{ C}_2\text{H}_4)$$

$$Q_5 = \frac{0.3}{9.3 + 0.3}(10160)(0.75[0.759] + 0.8[0.203]) = 232 \text{ Btu/lb}$$

F. Radiation losses from boiler setting:

From Figure VIII-1, radiation losses for a 25,000 lb/hr boiler operating at 21,500 lbs/hr are 1.5 o/o.

$$Q_7 = 0.015(22600) = 339 \text{ Btu/lb fuel}$$

G. Unaccounted for losses:

$$Q_8 = 22600 - [18400 + 1130 + 2440 + 232 + 339] = 59 \text{ Btu/lb fuel}$$

Recapitulation: Basis, one lb fuel as fired.

Heat absorbed by boiler	18400 Btu/lb	81.5 o/o
Heat loss due to dry flue gas	1130	5.0
Heat loss due to mois. from comb. of H	2440	10.8
Heat loss due to carbon monoxide	232	1.0
Heat loss due to radiation	339	1.5

Unaccounted for losses	59	0.2
Heating value of fuel	22600 Btu/lb	100.0 o/o

55. Fire-Tube Boilers--Fire-tube boilers (or steam generators) are built in sizes up to about 500 horsepower and for pressures up to about 200 psig. The principal types are: horizontal return tubular; Scotch marine; vertical tubular; and firebox tubular.

Horizontal return tubular boilers consist of a drum with longitudinal flues set over a brick firebox, as shown in Figure VIII-2. They are moderately efficient and are suitable for use with any kind of fuel.

Scotch marine boilers are so named because they were first used in steam powered ships built in Scotland. They have been adapted to stationary power plants and are most popular for packaged units because the furnace is internal to the boiler. Figure VIII-3 shows a modern Scotch marine package unit.

Vertical tubular boilers are built in small sizes up to about 50 boiler horsepower and are popular for laundries and small food processing plants because of the small floor space requirement. Due to the fact that part of the flues are above the water line, the steam is delivered with a small amount of superheat. Figure VIII-4 shows a boiler of this type.

Firebox tubular boilers are made in a number of different designs, one of which is shown in Figure VIII-5. Their advantage is the ability to put more heating surface in a given total boiler volume than the other fire-tube types.

Fire-tube boilers are not made for high pressures because of the difficulty of staying the flat tube sheets against bulging, and because tubes are relatively less resistant to collapse from external pressure than they are to rupture from internal pressure.

56. Water-Tube Boilers--Water-tube boilers are built in capacities from about 100 boiler horsepower to more than one million pounds of steam per hour, with pressures ranging from 15 to 3500 psig. The variety of water-tube boilers is very large, but the general types are: straight tube and bent tube.

Straight tube boilers require the use of headers for the tube ends. The main disadvantage is that the many hand-

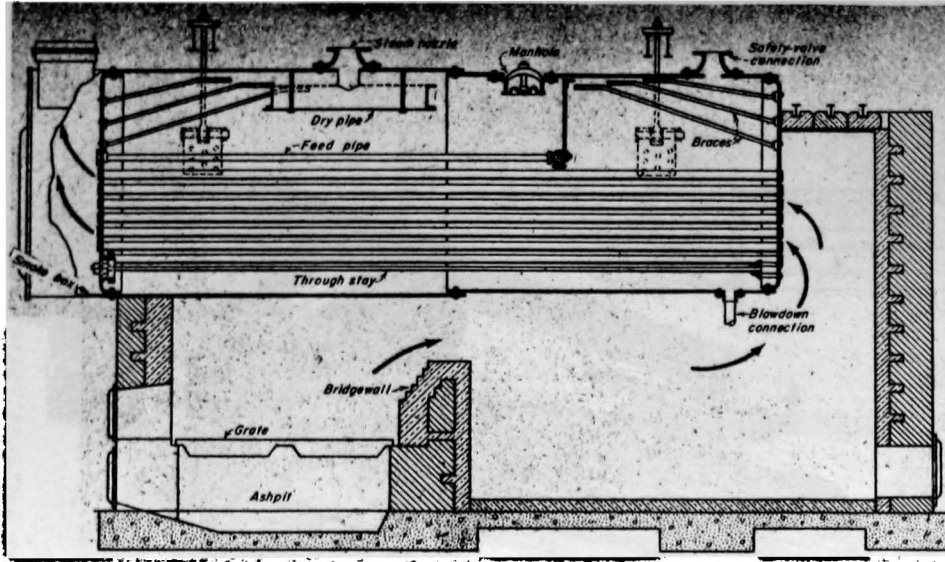

Fig. VIII-2. Horizontal return tubular boiler.

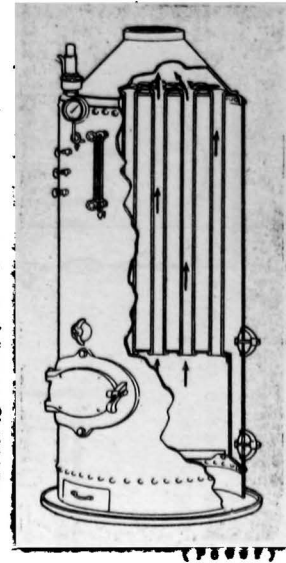

Fig. VIII-4. Vertical tubular boiler.

(Cleaver-Brooks Co.)

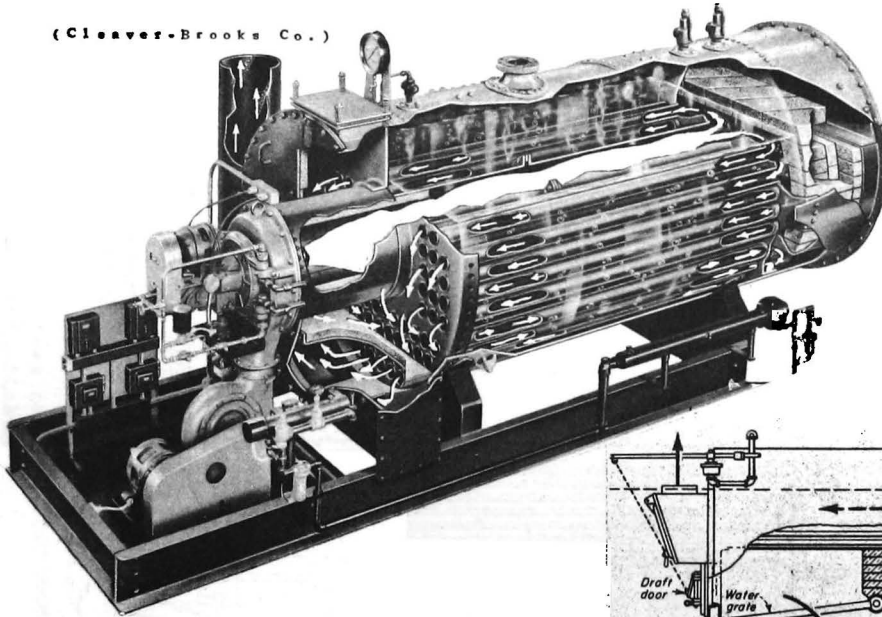
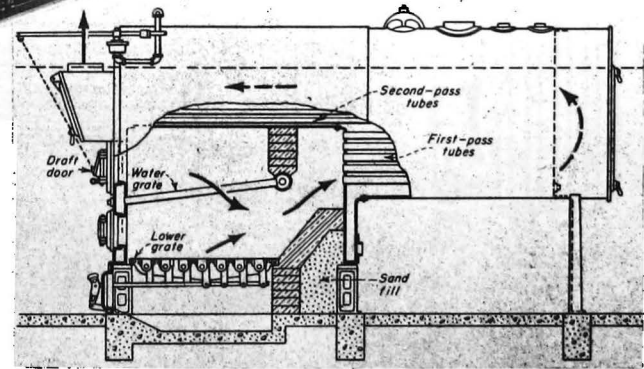

Fig. VIII-3. Package Scotch marine type boiler.



(Power)

Fig. VIII-5. Firebox tubular boiler.

hole covers which are necessary have a tendency to leak. The main advantages are that all of the steam generating tubes are alike and they are easy to clean, when necessary. Figures VIII-6 and VIII-7 show two types of straight tube boilers.

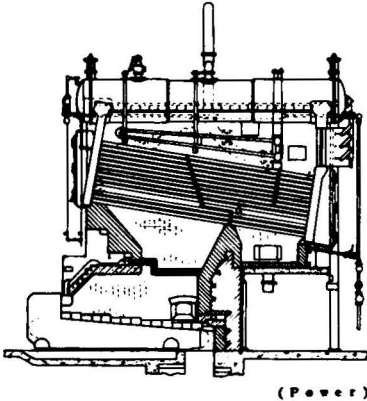

Fig. VIII-6. Longitudinal drum straight tube boiler.

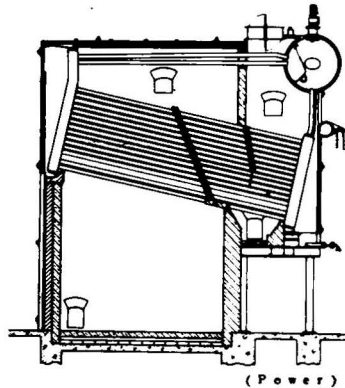

Fig. VIII-7. Cross drum straight tube boiler.

Bent tube boilers were designed to eliminate the tube headers and handhole covers which gave trouble in the straight tube boilers in the higher pressure ranges. Figures VIII-8 through VIII-11 show some modern bent tube boilers of various sizes and arrangements and Figure VIII-12 shows boiler cost data (based on 1946).

57. Heat Transfer in Boilers--The major portion of the heat transfer in boilers takes place by convection from the flue gases and by conduction through the tubes. Consideration of the mechanisms of heat transfer in boilers will show that, while they are similar to those in surface condensers, some of the factors are not easily determined. For instance, in most boilers the circulation of water is by natural forces set up by the difference in density between steam and water, and as a consequence it is not easy to determine the velocity of the water passing over the boiler surface. In a similar manner to the effect of velocity on water film coefficients, the velocity of the flue gas over the surface of the tubes affects the gas film coefficient. For these reasons, manufacturers of boilers employ empirical formulae to a great extent in calculating the heating surface required.

One of the best known empirical formulae for estimation

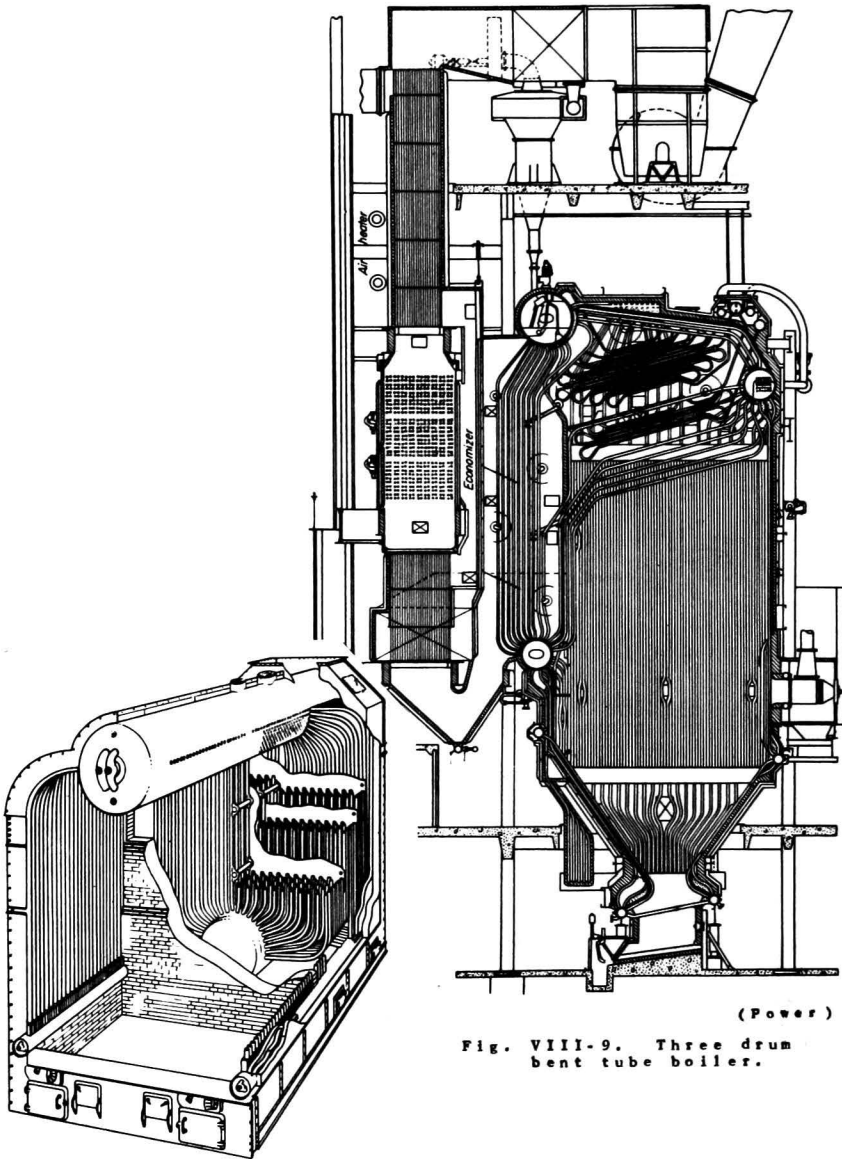
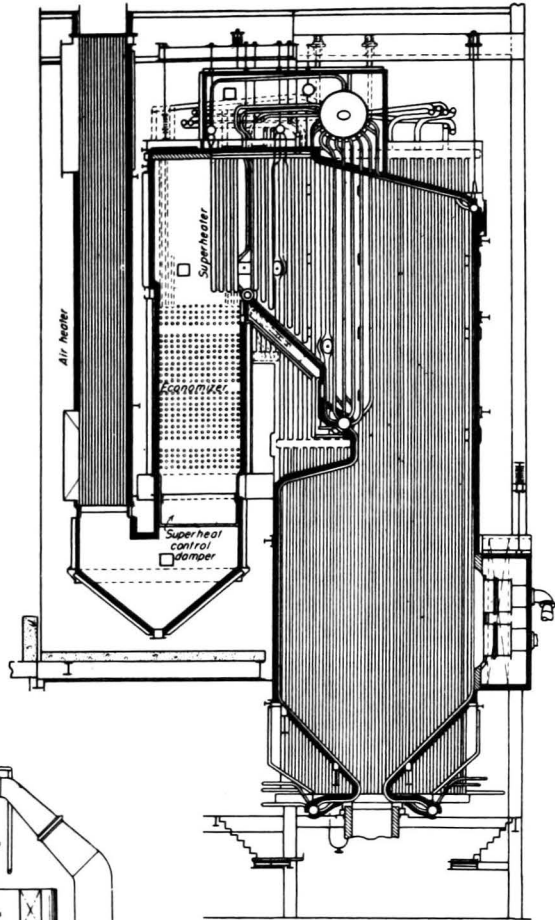

Fig. VIII-8. Longitudinal drum bent tube boiler.

Fig. VIII-9. Three drum bent tube boiler.



(Power)

Fig. VIII-10. Radiant boiler.

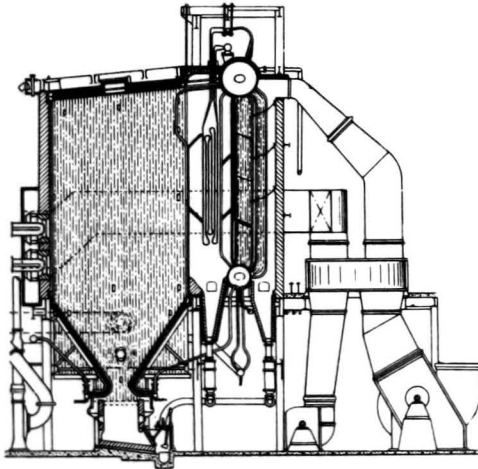

(Power)

Fig. VIII-11. Two drum bent drum boiler.

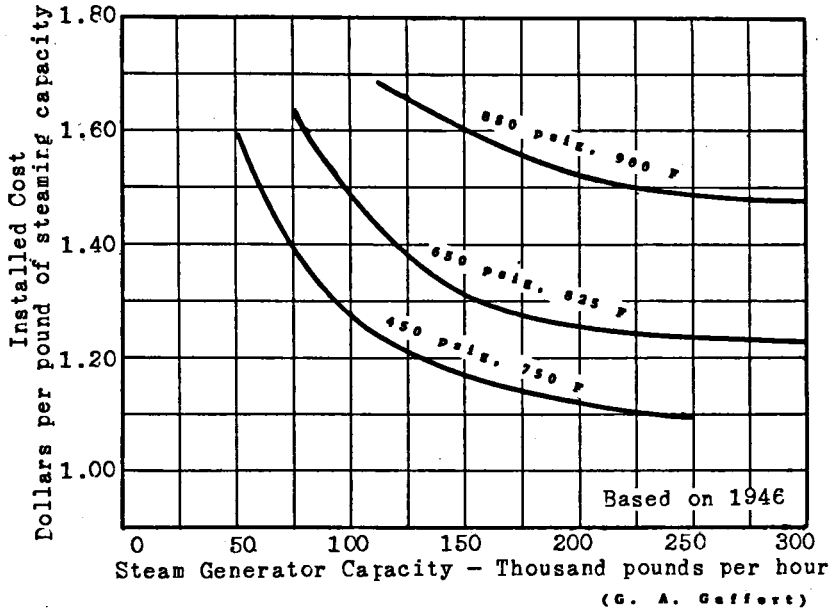

Fig. VIII-12. Boiler cost data.

of overall heat transfer coefficients in water-tube boilers is the Babcock and Wilcox equation:

$$U = 2.00 + 0.0014 G$$

where: G = mass flow of gas, lbs/hr per sq ft
of projected flow area transverse
to the tubes.

Example 19 shows the method of estimating the surface required for a water-tube boiler.

Example 19.

A boiler using fuel oil of the analysis of Example 15 with a heating value of 18500 Btu/lb and with the same flue gas analysis is to produce 20,000 pounds of steam per hour at 150 psig and saturated from feed-water at 212 F. Temperature of flue gas 500 F, temperature of combustion air 80 F, temperature of combustion 2500 F, and temperature of fuel 180 F. The boiler is to be of the three-pass straight

tube sectional header type with 3 in. OD tubes spaced 5 in. on centers. There will be 24 tubes per bank, and the tubes will be 12 ft long. Determine the number of banks required, neglecting the area of the sectional headers and the boiler drum. The furnace has plain brick walls. Assume that no refuse is formed.

Solution:

The heat absorbed by the boiler per pound of fuel fired, can be determined by the method of losses, allowing about 1 o/o for unaccounted for.

$$\begin{aligned}
 Q_2 &= 0.24(19.93)(500 - 80) = && 2010 \text{ Btu/lb} \\
 Q_3 &= 0.01(1089 - 180 + 0.46[500]) = && 11 \\
 Q_4 &= 9(0.1270)(1089 - 180 + 0.46[500]) = && 1300 \\
 Q_5 &= \frac{0.4}{13.7 + 0.4}(10160)(0.83) = && 239 \\
 Q_7 &= 0.015(18500) = && 278 \\
 Q_8 &= 0.01(18500) = && 185 \\
 \text{Total losses} &&& 4023 \\
 Q_1 &= 18500 - 4023 = && 14477 \text{ Btu/lb}
 \end{aligned}$$

The weight of fuel fired per hour is:

$$M_f = \frac{20,000(1195.6 - 180.1)}{14477} = 1405 \text{ lbs/hr}$$

The heat transferred is:

$$Q = 20,000(1195.6 - 180.1) = 20,300,000 \text{ Btu/hr}$$

The gas flow is:

$$M_{g^*} = 21.08(1405) = 29600 \text{ lbs/hr}$$

The transverse gas flow area between tubes is:

$$A_j = \frac{(24 - 1)(5 - 3)12}{3(12)} = 15.35 \text{ sq ft}$$

$$\text{from which, } G = \frac{29600}{15.35} = 1930 \text{ lbs/hr/sq ft}$$

and from the Babcock and Wilcox equation,

$$U = 2.00 + 0.0014(1930) = 4.70$$

The mean temperature difference is:

$$t_m = \frac{2500 - 500}{\log \frac{366 - 2500}{366 - 500}} = 724 \text{ F}$$

and the boiler area required is:

$$A = \frac{20,300,000}{4.70(724)} = 5970 \text{ sq ft}$$

Each bank of tubes contains $12\left(\frac{3\pi}{12}\right)(24) = 226 \text{ sq ft}$

therefore, the number of banks of tubes required is:

$$\frac{5970}{226} = 26 \text{ banks of tubes.}$$

58. Water-Cooled Furnaces--The water-cooled furnace was introduced as a means of reducing maintenance on furnace refractories. Acceptance was slow because of difficulties with water circulation, but a modern steam generator is almost all water-cooled furnace with only enough boiler surface to reduce the gas temperature to an economical point for use in economizers or air heaters. Reference to the illustrations of water-tube boilers will show the application of furnace cooling.

Heat transfer to furnace cooling surface is almost entirely by radiation and the heat transfer coefficients are extremely high. The amount of radiant heating surface required in a furnace is a function of several variables, such as the volume of the furnace, the temperature of the flue gas leaving the furnace, the sensible heat in the flue gas and the arrangement of the cooling surface.

Table XII gives some generally accepted data on values of heat release per unit of furnace volume.

The temperature of the flue gas leaving the furnace should always be at least 200 F and preferably 250 F less than the ash fusion temperature of the fuel used in order to avoid tightly adhering deposits in the convection sections of the steam generator. The result is that with fuels with very low

ash fusion temperatures (fuel oil has an ash fusion temperature of about 1600 F) the steam generator would necessarily be mostly furnace.

The sensible heat in the flue gas can be calculated from the following relation:

$$\text{Sensible heat/lb fuel} = \text{LHV} - h' - h'' + h'''$$

where: LHV = lower heating value of fuel

h' = heat lost by radiation and convection from the boiler setting

h'' = heat lost due to incomplete combustion and due to combustible in refuse

h''' = heat gained by use of pre-heated air

TABLE XII

FURNACE HEAT RELEASE

Kbtu per cubic foot per hour

Fuel	All refractory	Air cooled	Water cooled
Coal			
Pulverized	12 - 18	15 - 20	18 - 25
Stokers	15 - 25	25 - 40	30 - 45
Grates	25 - 40	35 - 45	40 - 50
Gas and Oil	20 - 25	25 - 40	30 - 50

Lower values in a range are for smaller boilers.

The arrangement of the cooling surface affects the effective area as shown in Figure VIII-13. The effective area is related to the projected area on the furnace envelope by the equation:

$$S_r = s\delta S_p$$

where: S_r = effective radiant cooling surface, sq ft

s = a slagging factor (0.90 to 0.95)

S_p = projected tube area, sq ft

δ = an arrangement factor

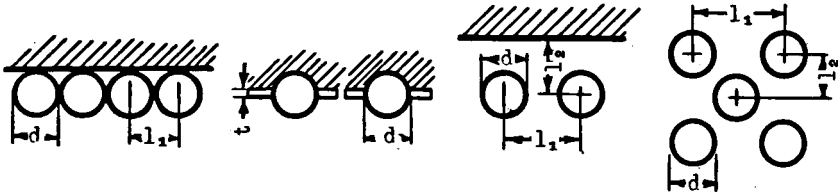

$$\delta = [\pi/2][l_1/d] \quad \text{up to } l_1/d = 1.5$$

$$\delta = \pi/2 + 6t$$

$$\delta = [\pi/2][l_1/d] \quad \text{up to } l_1/d = 1.5$$

$$\delta = 2$$

(Courtesy of D. Van Nostrand Co., Inc.)

Fig. VIII-13. Arrangement of radiant heat transfer surface.

Figure VIII-14 shows some empirical data which ties together the preceding factors in the estimation of furnace cooling area and Example 20 shows the method of estimation of the principal dimensions of a water-cooled furnace.

Example 20.

Determine for the boiler of Example 17:

1. The furnace volume required for full load operation using pulverized coal.
2. The amount of effective radiant furnace cooling surface required for a gas temperature of 1950 F entering the superheater (250 F less than the ash fusion temperature). Assume that the preheated air temperature is 535 F.
3. The number and length of 2½ in. OD furnace tubes, spaced on three inch centers. The boiler screen consists of three banks of 2½ in. OD tubes spaced on nine inch centers. The plan dimensions of the furnace are 20 ft X 20 ft.

Solution:

1. From Table XII, a heat release value of 22,000 Btu per cubic foot per hour is selected. The total heat re-

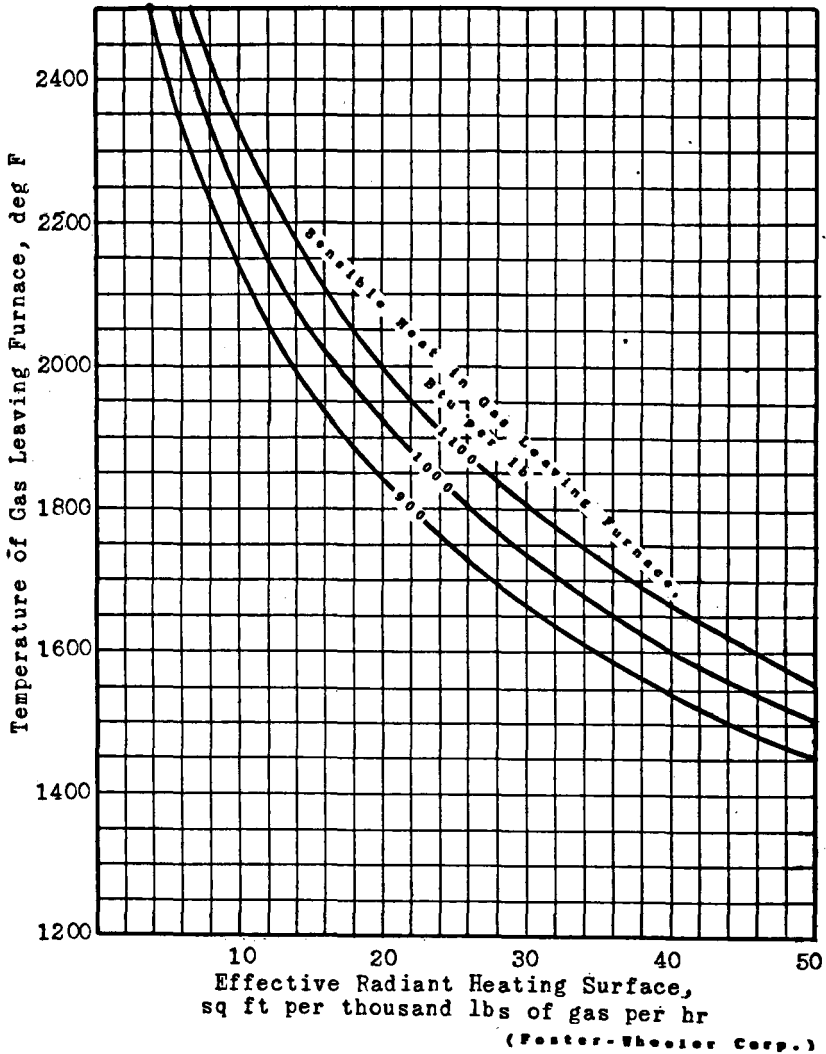

Fig. VIII-14. Furnace cooling surface design curves.

leased in the furnace is:

$$Q = \frac{74}{8}(2000)(14400) = 266,000,000 \text{ Btu/hr}$$

from which the furnace volume is:

$$V_f = \frac{266,000,000}{22000} = 12100 \text{ cu ft}$$

2. The sensible heat per pound of flue gas is:

$$\text{SH} = \frac{\text{LHV} - h' - h'' + h'''}{M_{g^*}} + 0.24[535 - 70]$$

$$\text{SH} = \frac{14400 - [9(0.0447) + 0.0222][1066] - 81 - [123 + 497]}{15.30 + 9(0.0447) + 0.0222}$$

$$\text{SH} = 856 \text{ Btu/lb flue gas}$$

Then, from Figure VIII-14, the area of effective radiant surface per thousand pounds of gas per hour is 14 sq ft. The total area is:

$$S_r = \frac{14(15.72)(2000)(74/8)}{1000} = 4070 \text{ sq ft}$$

3. The boiler screen will have 20 ft tubes, and there will be $20(12)/9 = 26$ tubes per bank. Assuming a slagging factor of 0.90 and $\delta = 2$, the effective radiant area of the boiler screen will be:

$$S_r = 0.90(2)(2.25/12)(20)(26)(3) = 525 \text{ sq ft}$$

The furnace walls will have an effective radiant surface of $4070 - 525 = 3545$ sq ft. The length of the furnace wall tubes will be approximately the same as the height of the furnace, or 30.2 ft. Assuming a slagging factor of 0.90 and $\delta = (\pi/2)(3/2.25) = 2.09$, the projected area of the furnace wall tubes will be:

$$S_p = \frac{3545}{0.90(2.09)} = 1885 \text{ sq ft}$$

The furnace walls can each have $20(12)/3 = 80$ tubes, each 30.2 ft long, for a total of:

$$S_{p_{\text{walls}}} = 4(80)(30.2)(2.25/12) = 1810 \text{ sq ft}$$

This leaves 75 sq ft of projected area for the furnace floor, and since each floor tube would have a projected area of $20(2.25)/12 = 3.75$ sq ft, there would be $75/3.75 = 20$ floor tubes.

59. Furnace Refractories and Insulation--In order to minimize heat losses from furnaces, it is necessary to supply some sort of insulating material, and in order to prevent fire damage to insulation it is necessary to supply refractory.

Refractories are made from materials which have good resistance to damage from direct flame impingement. They are usually supplied in brick form, although plastic refractories are available. The standard refractory brick is $2\frac{1}{2}$ " X $4\frac{1}{2}$ " X 9", and other sizes are available in multiples and submultiples of these dimensions as well as in special shapes. Figure VIII-15 shows some heat conductivity data for various refractory materials.

Insulation is made of material which has good resistance to heat flow but which is not necessarily resistant to direct flame impingement. Several companies make insulating refractories which are very useful. Figure VIII-16 shows some heat conductivity data for various insulating materials.

Heat flows through the furnace wall by conduction and leaves the outer wall by radiation and convection. It is usually assumed that the heat lost by convection is about 50 per cent of that lost by radiation, so that:

$$Q = 1.5 CA(T_1^4 - T_2^4)$$

where: Q = heat loss, Btu/hr

C = a radiation coefficient

A = area of radiating surface, sq ft

T_1 = temperature of radiating surface, deg R

T_2 = ambient temperature, deg R

The preceding expression will be recognized as a modification of the Stefan-Boltzman relation, and values of the radiation coefficient can be found from Table XIII.

It is obvious that the heat lost from the wall surface must be equal to the heat flowing through the wall, so that the determination of the thickness of insulation required resolves itself into a trial and error process. Ordinarily it will be known how much structural brick is necessary on the outside of the furnace wall and how much refractory is used inside the furnace (from $2\frac{1}{2}$ " to $4\frac{1}{2}$ " for backing water walls and from 9" to $13\frac{1}{2}$ " for plain walls). Example 21

shows the method of procedure.

TABLE XIII

RADIATION COEFFICIENTS

Bare brick work	16.3×10^{-10}
Unpainted steel	16.3×10^{-10}
Asbestos cloth	16.0×10^{-10}
Aluminum paint	11.0×10^{-10}
Flat black paint	16.4×10^{-10}
Glossy black paint	14.0×10^{-10}

Example 21.

Determine the thickness of insulation required for a furnace wall which consists of Armstrong insulation sandwiched between eight inches of hard burned red brick and nine inches of kaolin refractory brick. The furnace temperature is 2300 F and ambient temperature is 95 F. Desirable outside wall temperature is 175 F.

Solution:

The heat transferred through the wall is:

$$Q = 1.5[16.3 \times 10^{-10}] [(635)^4 - (555)^4]$$

$$Q = 164 \text{ Btu/hr/sq ft}$$

Temperature drop through the wall is $2300 - 175 = 2125\text{F}$. Temperature drops through the individual sections of the wall will be determined by trial.

Assume mean temperature of red brick = 300 F and mean temperature of kaolin brick = 2150 F. From Figure VIII-15, the values of k at these temperatures will be 6.5 for red brick and 15.0 for kaolin brick.

Then, for red brick, $\Delta t = Qd/k = 164(8)/6.5 = 202\text{ F}$, and for kaolin brick, $\Delta t = 164(9)/15.0 = 98.5\text{ F}$.

Recalculation of mean temperatures gives for red brick, $0.5[175 + (175 + 202)] = 276\text{ F}$, and for kaolin brick, $0.5[2300 + (2300 - 98.5)] = 2251\text{ F}$. At these mean temperatures, k for red brick is 6.4 and for kaolin brick is 15.5.

Then, for red brick, $\Delta t = 164(8)/6.4 = 205\text{ F}$, and for kaolin brick, $\Delta t = 164(9)/15.5 = 95.3\text{ F}$.

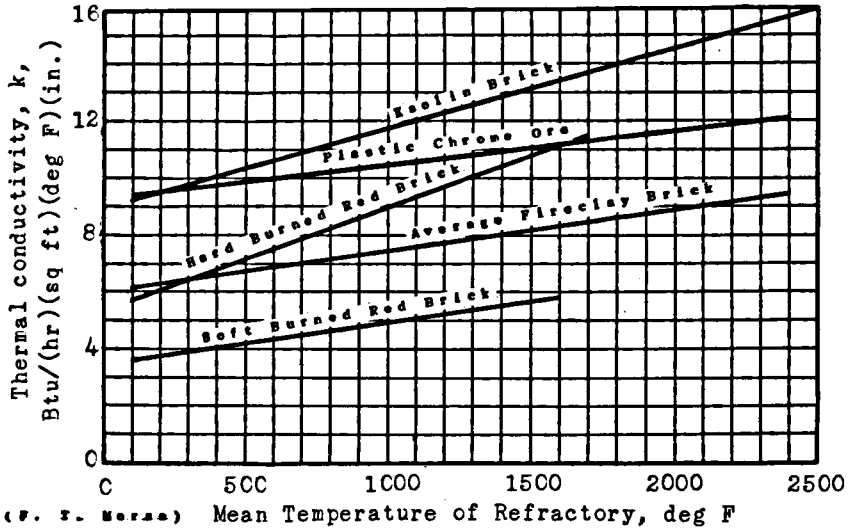

Fig. VIII-15. Thermal conductivity of refractory materials.

Recalculation of mean temperatures gives for red brick, $0.5[175 + (175 + 205)] = 278$ F, and for kaolin brick, $0.5[2300 + (2300 - 95.3)] = 2257$ F. These mean temperatures are reasonably close to the previous calculations so that further trials are not considered necessary.

The temperature drop for the insulation will be $\Delta t = (2300 - 95.3) - (175 + 205) = 1825$ F, and the mean temperature is $0.5(2205 + 380) = 1292$ F. At this mean temperature, k for the insulation is 1.7, and the insulation thickness is $d = k\Delta t/Q = 1.7(1825)/164 = 18.9$ inches.

Example 21 shows clearly why insulated refractory and brick furnaces are seldom used in modern boiler installations. Better arrangements are water-cooled or air-cooled walls.

In the water-cooled wall the inside wall temperature is reduced almost to the saturation temperature of the steam in the boiler, thus necessitating less refractory and insulation. As previously mentioned, water walls are backed with up to $4\frac{1}{2}$ " of refractory, and in addition a layer of Superex block and 3" of rockwool (conductivities of these materials can be found from Figure X-13) with an outside casing of sheet metal are usually used to complete the wall. The effect of the metal casing can be ignored with respect to the

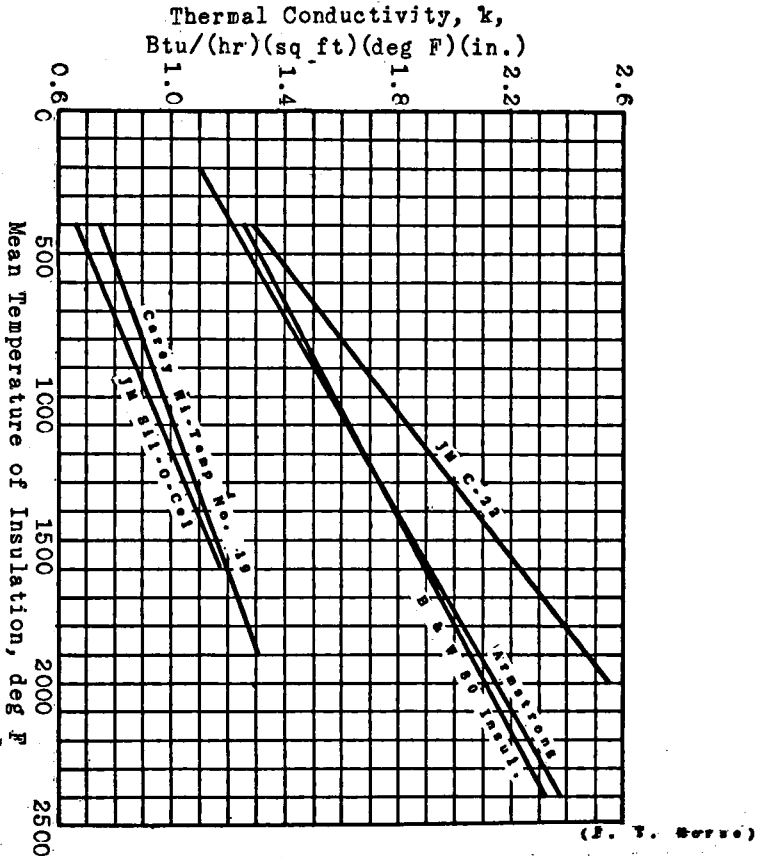

Fig. VIII-16. Thermal conductivity of insulating materials.

amount of insulation required, but the exterior finish (color of paint) must be considered in determination of the heat loss from the surface.

In the air-cooled wall the refractory and structural brick are separated by an air space which serves as a conduit for combustion air. Thus, most of the heat passing through the refractory is salvaged and returned to the furnace.

BIBLIOGRAPHY

Bailey, E. G., "Modern Boiler Furnaces," *Transactions A.S.M.E.*, October, 1939.

- Caldwell, W. E., "Characteristics of Large Hell Gate Direct Fired Boiler Units," *Transactions A.S.M.E.*, Volume 56, 1934.
- deLorenzi, O., "Furnace Design," *Combustion*, February, 1937.
- McMillan, L. B., "Heat Insulation Practice in Modern Steam Generating Plants," *Transactions A.S.M.E.*, Volume 51, 1929.
- Morse, F. T., *Power Plant Engineering and Design*, Van Nostrand, New York, 1942.
- Orrok, G. A., and Artsay, N. C., "Furnaces, Radiant Heat Exchange," *Combustion*, April, 1938.
- Van Brunt, J., "Design of High Capacity Boilers," *Transactions A.S.M.E.*, August, 1938.

CHAPTER IX

SUPERHEATERS, REHEATERS, ECONOMIZERS AND AIR HEATERS

60. Superheaters--The economies to be realized with superheated steam in a vapor power cycle have been set forth previously under the discussion of the various cycles. Superheaters are always made up of tubular elements and they are classified as to their arrangement in the boiler, that is, pendant or drainable, convection or radiant.

Pendant superheaters are hung from headers which are located at the top of the boiler. This is the simplest arrangement, but they are difficult to clean. Figure IX-1 shows a pendant superheater in a bent tube boiler.

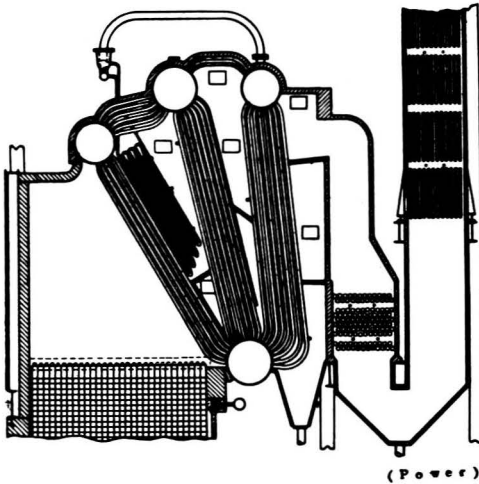

Fig. IX-1. Pendant superheater in bent tube boiler.

heat by convection from the flue gas. They have a rising temperature characteristic because of increase in heat transfer coefficients with increasing gas velocities. For this reason, modern boilers which contain convection superheaters alone have some means of bypassing part of the flue gas around part of the superheater to effect temperature control in the steam from the superheater. The temperature control damper can be seen in Figure VIII-10.

Drainable superheaters are mounted in such a way that condensation in the elements can drain back to the headers. This type of superheater is more difficult to place in the boiler because it requires that all of the element slope toward the headers, but they are easy to clean. Figure IX-2 shows a drainable superheater in a straight tube boiler.

Convection superheaters are so named because they receive all or a major portion of their

Radiant superheaters receive all or most of their heat through radiation because they are mounted where they can "see" the fire in the furnace. They have a drooping temperature characteristic because the temperature of the fire in the furnace remains essentially constant throughout the load range. Radiant superheaters are often placed in series with convection superheaters, and proper proportioning of the areas in each will result in a nearly constant steam temperature characteristic over the normal boiler operating range. Figure IX-3 shows a radiant superheater mounted in series with a convection superheater, and Figure IX-4 shows the temperature characteristics.

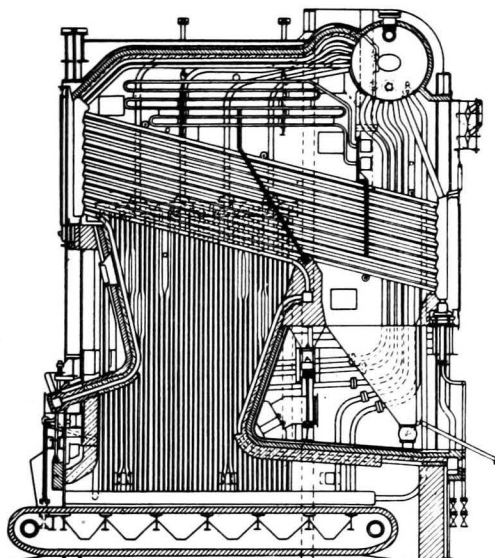

(Power)

Fig. IX-2. Drainable superheater in straight tube boiler.

61. Heat Transfer in Superheaters--Heat transfer in a convection superheater involves a decreasing flue gas temperature and an increasing steam temperature. Wherever possible the surfaces are arranged so that the gases enter the superheater at the same end at which the steam leaves. This counterflow principle results in more uniform temperature differences and higher steam outlet temperatures in comparison with parallel flow arrangements. Figure IX-5 shows a comparison of the temperatures existing in the two arrangements.

The logarithmic mean temperature difference for the counterflow case can be found from the relation:

$$t_m = \frac{(t_{g_i} - t_{v_o}) - (t_{g_o} - t_{v_i})}{\log_{st} \frac{t_{g_i} - t_{v_o}}{t_{g_o} - t_{v_i}}}$$

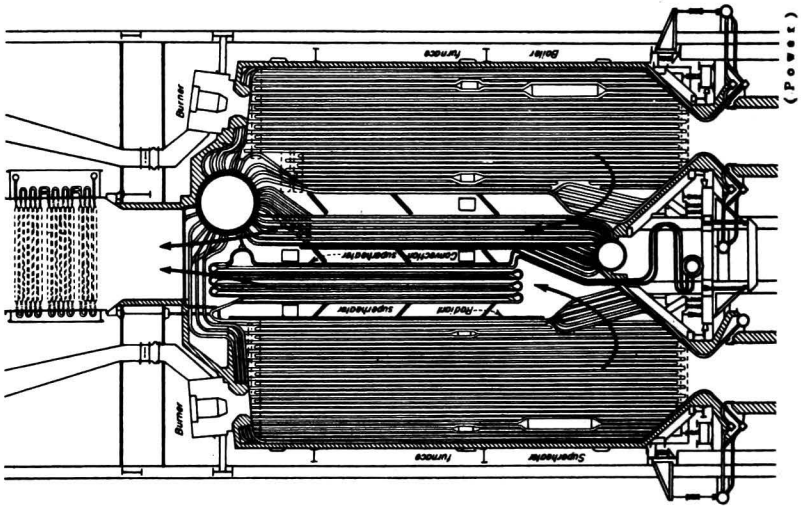

Fig. IX-3. Radiant superheater.

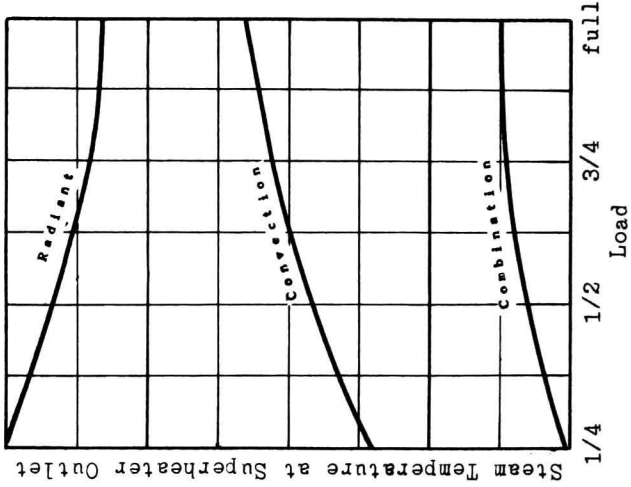

Fig. IX-4. Superheater characteristics.

SUPERHEATERS, REHEATERS, ECONOMIZERS AND AIR HEATERS 159

where: t_m = log mean temperature difference, deg F

t_{g_i} and t_{g_o} = inlet and outlet
flue gas temperatures, deg F

t_{v_i} and t_{v_o} = inlet and outlet
steam temperatures, deg F

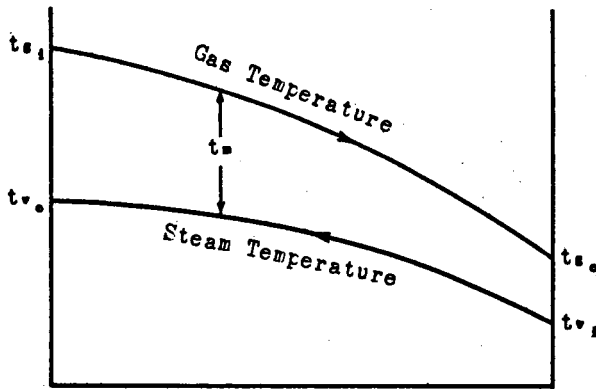

(a) Counterflow

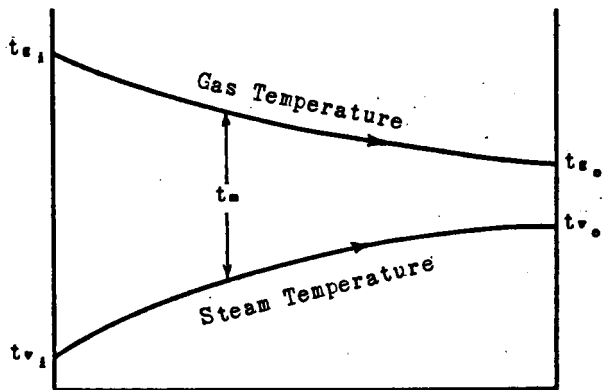

(b) Parallel flow

Fig. IX-5. Temperature relations in heat transfer.

and for the parallel flow case from the relation:

$$t_m = \frac{(t_{g_i} - t_{v_i}) - (t_{g_o} - t_{v_o})}{\log_e \frac{t_{g_i} - t_{v_o}}{t_{g_o} - t_{v_i}}}$$

The overall heat transfer coefficient for a convection superheater is calculated in a manner similar to that for other heat transfer apparatus. There is no reliable empirical equation for the overall heat transfer coefficient as there is for boilers, so that it is necessary to estimate film coefficients and combine them according to the usual manner with the addition of a slagging factor, as follows:

$$U = s \frac{1}{\frac{1}{h_g} + \frac{2F_o}{D_o} + \frac{1}{D_i} \frac{1}{K_t} + \frac{D_o}{D_i} \frac{1}{h_v}}$$

The gas film coefficient can be estimated from the equation:

$$h_g = \frac{0.41 v_g^{0.585} T^{0.315}}{D_o^{0.415}}$$

where: v_g = mass flow of gas, lbs/sec
per sq ft of gas flow area

T = arithmetic mean gas temperature, deg R

D_o = outside diameter of tube, ft

The steam film coefficient can be approximated from the following equation:

$$h_v = 8.0 v_v^{0.8}$$

where: v_v = mass flow of steam, lbs/sec
per sq ft of steam flow area

The Nusselt equation for radiant superheaters is used for the determination of the overall heat transfer coefficient, as follows:

$$U = \frac{0.0333 k^{0.214} (G c_p)^{0.786}}{D_i^{0.214}}$$

SUPERHEATERS, REHEATERS, ECONOMIZERS AND AIR HEATERS 161

where: k = steam conductivity,
 $= 0.0131 + 0.000029 t$
 t = arithmetic mean steam
temperature, deg F
 G = mass flow of steam, lbs/hr
per sq ft of steam flow area
 c_p = arithmetic mean specific
heat of steam
 D = inside diameter of tube, ft

Example 22-A shows the method of calculating the dimensions of a convection superheater and Example 22-B shows the procedure for a radiant superheater.

Example 22-A.

Determine the number and length of tubes required for a convection superheater for the boiler of Examples 17 and 20. The tubes are 2 in. OD X 8 BWG and are spaced on $4\frac{1}{2}$ in. centers. Assume counterflow and a slagging factor of 0.90. Dispose of the superheater in two of the three boiler passes.

Solution:

$$M_{gs} = (74/8)(2000)(15.72) = 291,000 \text{ lbs/hr}$$

$$Q = 200,000(1450.9 - 1197.8) = 50,600,000 \text{ Btu/hr}$$

$$\Delta t_{flue\ gas} = \frac{50,600,000}{291000(0.24)} = 725 \text{ F}$$

Temperature of gas at superheater inlet	1950 F
Temperature of gas at superheater outlet	1225 F
Temperature of steam at superheater inlet	535 F
Temperature of steam at superheater outlet	900 F

$$t_m = \frac{(1950 - 900) - (1225 - 535)}{\log \frac{1950 - 900}{1225 - 535}} = 860 \text{ F}$$

Since the boiler is 20 ft wide, there will be $20(12)/4.5 = 53$ tubes in the superheater. Each tube has a flow area of $[\pi/4][2.0 - 2(0.165)]^2/144 = 0.0152$ sq ft, and the total steam flow area is $53(0.0152) = 0.806$ sq ft.

The mass flow of steam through the tubes will be:

$$v_v = \frac{200000}{3600(0.806)} = 69.0 \text{ lbs/sec/sq ft}$$

and, $h_v = 8.0(69.0)^{0.8} = 236$

If the superheater is disposed in two of three boiler passes, each pass will be 20 ft wide by 6.67 ft deep. Then the area for gas flow between the superheater tubes will be $(53 - 1)(4.5 - 2)(6.67)/12 = 23 \text{ sq ft}$.

The mass flow of gas between the tubes will be:

$$v_g = \frac{291000}{3600(23)} = 3.52 \text{ lbs/sec/sq ft}$$

and, $h_g = \frac{0.41(3.52)^{0.855} (2048)^{0.315}}{(2.0/12)^{0.415}} = 19.8$

Then: the overall heat transfer coefficient is:

$$U = (0.90) \frac{1}{\frac{1}{19.8} + \frac{4.0}{2.0 + 1.67 \left[\frac{0.165}{12(30)} \right] + \frac{2.0}{1.67 \left[\frac{1}{236} \right]}} = 16.1$$

Superheater area is:

$$A = \frac{50,600,000}{16.1(860)} = 3666 \text{ sq ft}$$

Each foot of superheater tube has an area of $2\pi/12 = 0.523 \text{ sq ft}$. There will be $3666/0.523 = 7000$ linear feet of tube, and the length of each element will be $7000/53 = 132$ feet.

Example 22-B.

The boiler of Examples 17 and 20 is to be fitted with a combination convection-radiant superheater. Half of the temperature rise in the superheated steam is to be supplied by the radiant section which is in series with and follows the convection section. The radiant superheater is to replace part of the rear furnace wall cooling surface. The tubes will be $2\frac{1}{2}$ in. OD X 8 BWG spaced on 3 in. centers with a length of 5 feet. Find the number of tubes in the radiant superheater.

SUPERHEATERS, REHEATERS, ECONOMIZERS AND AIR HEATERS 163

Solution:

Steam temperature at rad. suphtr. inlet	718 F
Steam temperature at rad. suphtr. outlet	900 F
Temperature in furnace	1950 F

$$t_m = \frac{900 - 718}{\log_e \frac{1950 - 718}{1950 - 900}} = 1134 \text{ F}$$

The heat transferred in the radiant superheater is:

$$Q = 200,000(1450.9 - 1342.1) = 21,800,000 \text{ Btu/hr}$$

Assume, as a first approximation, that $U = 400$ based on effective radiant surface. Then the effective radiant surface required would be $21800000 / [(400)(1134)] = 48 \text{ sq ft}$. One linear foot of 2.25 in. OD tube, in this particular wall arrangement, has an effective radiant surface of $0.90(\pi/2)(3.0/2.25)(2.25/12) = 0.354 \text{ sq ft}$. Then the linear length of tube required would be $48/0.354 = 136 \text{ ft}$. If each tube is 5 ft long, there would be $136/5 = 27$ tubes in the radiant superheater.

It is necessary to check the assumed value of U by use of the Nusselt equation, as follows:

The steam flow area per tube is $[\pi/4][2.25^2 - 2(0.165)^2]/144 = 0.02 \text{ sq ft}$, and the total steam flow area is $27(0.02) = 0.54 \text{ sq ft}$. The mass flow of steam is $G = 200000/0.54 = 370000 \text{ lbs/hr/sq ft}$. The conductivity of the steam is $k = 0.0131 + 0.000029(809) = 0.0365$ and the mean specific heat is 0.62 , then the overall heat transfer coefficient is:

$$U = 0.0332 \left[\frac{0.0365}{1.92/12} \right]^{0.214} [370000(0.62)]^{0.786} = 404$$

This value of U checks very closely with the assumed value.

62. Reheaters--All reheaters which are presently being built use flue gas as the heat source. For this reason, the reheater may be considered to be the same as a superheater. Figure IX-6 shows a modern reheating steam generator.

63. Economizers--An economizer is essentially a feed-water heater employing flue gas as the heat source. Its primary purpose is to lower the temperature of the flue gas leaving the steam generator in order to increase the efficiency. Economizers are made in several styles, some of

which are shown in Figure IX-7.

64. Heat Transfer in Economizers--Heat transfer in an economizer is from flue gas at decreasing temperature to water at increasing temperature. The overall heat transfer coefficient may be approximated from the same Babcock and Wilcox equation used for boilers.

Example 23 shows the method of estimating economizer surface.

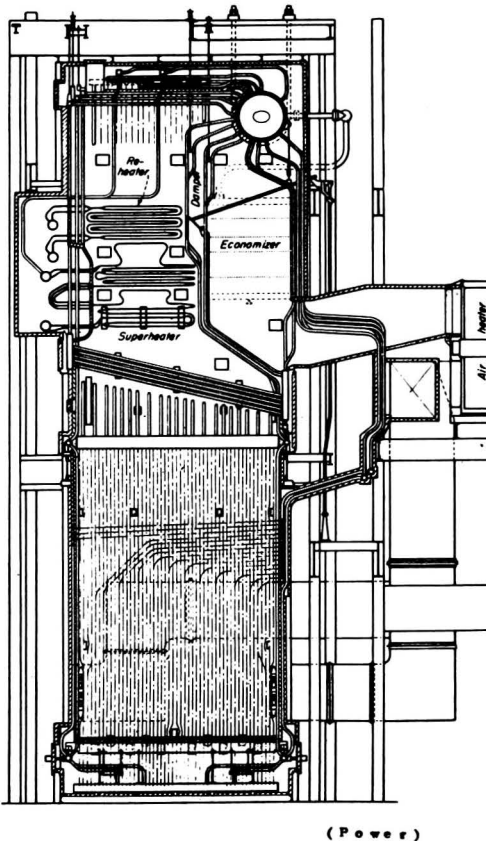
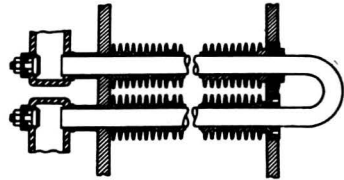

Fig. IX-6. Reheating steam generator.



A straight-tube economizer of extended-surface type. Each pair of tubes makes up in a header that acts as a manifold to connect successive passes together. Tubes, being straight, are readily replaced



U-bend or return-bend economizer contains a forged-steel header into which tubes are rolled and handhole plugs installed for tube maintenance

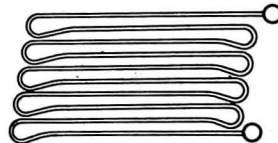

As its name implies, continuous-tube economizer is constructed of a leaped tube between two connections

(Power)

Fig. IX-7. Economizers.

SUPERHEATERS, REHEATERS, ECONOMIZERS AND AIR HEATERS 165

Example 23.

Determine the number and length of tubes required for an economizer for the boiler of Examples 17 and 20. The tubes are 2 in. OD X 8 BWG and are spaced on 3 in. centers. Tubes run lengthwise in the economizer casing whose plan dimensions are 12 ft X 18 ft. The water flows counterflow to the gas. Gas inlet temperature is 1225 F, water inlet temperature is 300 F and water outlet temperature 485 F.

Solution:

The heat transferred in the economizer is:

$$Q = 200000(470.2 - 269.6) = 40,100,000 \text{ Btu/hr}$$

The weight of wet flue gas is 291000 lbs/hr, so that the flue gas temperature drop is $40100000/[291000(0.24)] = 575$ F. Then the flue gas temperature leaving the economizer is $1225 - 575 = 650$ F.

$$t_m = \frac{(1225 - 485) - (650 - 300)}{\log_e \frac{1225 - 485}{650 - 300}} = 520 \text{ F}$$

Since the economizer casing is 12 ft wide, there will be $12(12)/3 = 48$ tubes giving a gas flow area of $(48 - 1)(3 - 2)(18)/12 = 70.5$ sq ft and a gas mass flow $G = 291000/70.5 = 4130$ lbs/hr/sq ft.

Then, the overall heat transfer coefficient is:

$$U = 2.0 + 0.0014(4130) = 7.78$$

and,
$$A = \frac{40,100,000}{7.78(520)} = 9900 \text{ sq ft}$$

Each linear foot of economizer tube has a surface area of 0.523 sq ft, so that there will be $9900/0.523 = 18950$ linear feet of tube. Then, the length of each tube will be $18950/48 = 395$ feet.

65. Air Heaters--Air heaters are also devices for salvaging heat from the flue gas in order to improve overall steam generator efficiency. They are of two general types: recuperative, either tubular or plate; and regenerative.

Recuperative air heaters depend upon the flow of heat from the flue gas through a dividing wall to the air. Ord-

inarily, in the tubular type the air flows around the outside of the tubes and the flue gas passes through the tubes. In the plate type the gas and air flow through alternate passages. Figure IX-8 shows the tubular and plate types of air heater.

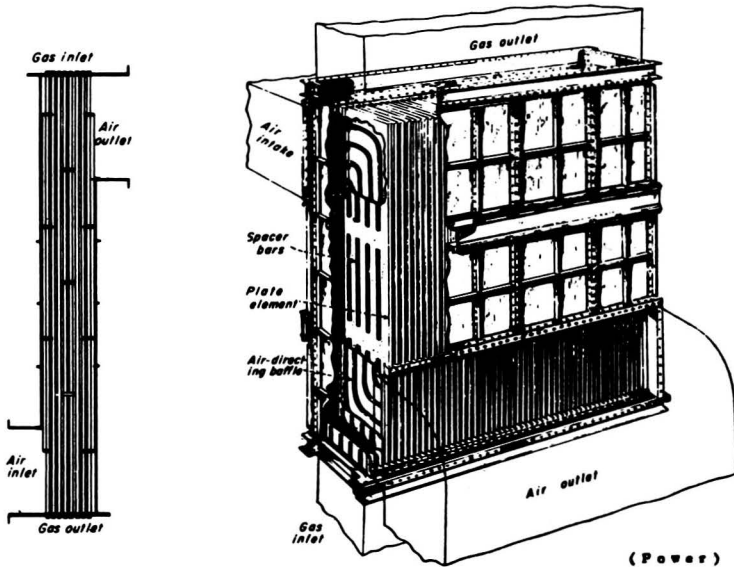

(a) Tubular Type

(b) Plate Type

Fig. IX-8. Recuperative air heaters.

Regenerative air heaters depend upon the transfer of heat from gas to air by the alternate heating and cooling of a mass of metal or other heat storing material. Figure IX-9 shows the principal type of regenerative air heater in use at the present time. This type uses corrugated steel sheets for the heat storage material.

66. Heat Transfer in Air Heaters--Heat transfer in air heaters is a similar mechanism to those previously discussed. For tubular air heaters where the gas flows through the tubes and the air flows across the tubes, the overall heat transfer coefficient can be estimated from the equation:

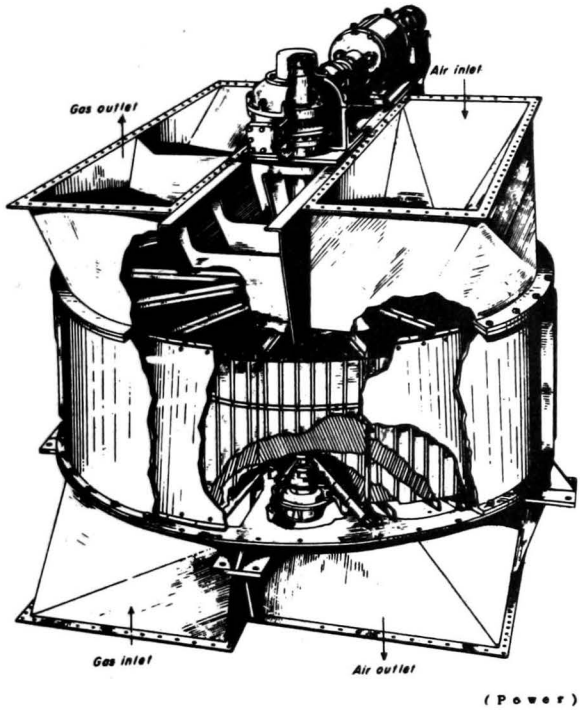

Fig. IX-9. Regenerative air heater.

$$U = 0.45 + 0.00045 G$$

where: G = arithmetic mean mass flow
of air and gas, lbs/hr/sq ft

For plate type air heaters the overall coefficient of heat transfer can be approximated from the following equation:

$$U = 0.28 V^{0.75}$$

where: V = arithmetic mean velocity
of gas and air, ft/sec

Regenerative air heaters do not depend upon the transfer of heat through a dividing wall for their action. The temperature relations are somewhat complicated, but, for purposes of estimation, it can be assumed that (with the rotor turning at the usual speed of three revolutions per minute) the weight of metal in the rotor will be:

$$W_m = \frac{M_g}{93.8}$$

where: W_m = weight of metal, lbs

M_g = gas flow, lbs/hr

and, if 20 USG steel sheets are used, the area would be (one side of the sheet):

$$A = \frac{M}{140.7}$$

where: A = area (one side) of
20 U.S. gage steel sheets,
square feet

Example 24 shows the method of estimation of the dimensions of a tubular air heater.

Example 24.

Determine the number and length of tubes and number of passes on the air side required for a tubular air heater for the boiler of Examples 17 and 20. The tubes are $1\frac{1}{2}$ in. OD X 14 BWG and are spaced on $2\frac{1}{2}$ in. centers. The gas flows through the tubes in a single pass and the air flows across the tubes. Plan dimensions of the air heater casing are 12 ft X 18 ft and the tubes run vertically. The air inlet is 6 ft X 12 ft and placed so that counterflow is obtained.

Solution:

From previous examples:

Air temperature entering air heater	110 F
Gas temperature entering air heater	650 F
Gas temperature leaving air heater	250 F

Heat transferred in the air heater:

$$Q = 291,000(0.24)(650 - 250) = 28,000,000 \text{ Btu/hr}$$

SUPERHEATERS, REHEATERS, ECONOMIZERS AND AIR HEATERS 169

Weight of air heated:

$$M_{aa} = [74/8][2000][15.30 + 8(0.0447 - \frac{0.0495}{8}) - 0.7873 - 0.0063 - 0.01]$$

$$M_{aa} = 274,000 \text{ lbs/hr}$$

Temperature rise in the air is $28000000/[274000(0.24)] = 425$ F and the temperature of the air leaving the air heater is $110 + 425 = 535$ F.

$$t_m = \frac{(650 - 425) - (250 - 110)}{\log_e \frac{650 - 425}{250 - 110}} = 179 \text{ F}$$

Since the air heater tube sheet is 12 ft X 18 ft, there will be $[12(12)/2.5][18(12)/2.5] = 5000$ tubes in the air heater. The gas flow area is $5000[\pi/4][1.5 - 2(0.083)]^2/144 = 48.5$ sq ft, and the mass flow of gas is $G_g = 291000/48.5 = 6000$ lbs/hr/sq ft.

Since the air enters the short side of the air heater, the air passes between 58 tubes in the first row. The air flow area per pass is $(58 - 1)(2.5 - 1.5)(6)/12 = 28.5$ sq ft, and the mass flow of air is $G_a = 274000/28.5 = 9600$ lbs/hr per sq ft.

The overall coefficient of heat transfer is:

$$U = 0.45 + 0.00045\left(\frac{9600 + 6000}{2}\right) = 3.96$$

and, $A = \frac{28,000,000}{3.96(179)} = 39,500 \text{ sq ft.}$

Each $1\frac{1}{2}$ in. OD tube has an area of $1.5\pi/12 = 0.393$ sq ft per linear foot, so the total length of tube required would be $39500/0.393 = 100,500$ ft, and since there are 5000 tubes, the tubes would be $100500/5000 = 20.1$ feet long. Each air pass is 6 feet high, so there would be 3 passes on the air side.

67. Apportionment of Heating Surface--The relative amounts of heating surface provided in a complete steam generator installation is a compromise between the economic factors and the practical necessities. For example, air heater surface is the cheapest, but combustion considerations limit air temperatures to about 600 F for pulverized coal, oil or gas, and to about 350 F for stokers. In order to avoid corrosion

difficulties, the minimum gas outlet temperature for air heaters should be about 250 F. It is usual to limit the water temperature leaving the economizer to about 50 F less than the saturation temperature in the boiler in order to avoid steaming in the economizer.

Equations can be set up to give the most economical temperatures at the various locations after the superheater in the steam generator. The temperature of the gas leaving the furnace is fixed by the characteristics of the fuel; the temperature of the water entering the economizer is fixed by the most efficient operation of the regenerative cycle; the temperatures of the gas and air leaving the air heater are fixed as previously mentioned; and the temperature of the air entering the air heater is fixed by ambient conditions. The boiler screen is ordinarily two or three rows deep and receives the major portion of its heat by radiation, so that it may be included as part of the furnace cooling surface. Then, the temperature of the gas entering the superheater will be fixed as the temperature of the gas leaving the furnace. The temperature of the gas leaving the superheater will be determined by the necessities of heat transfer in the superheater. The boiler, economizer and air heater are then subject to economic analysis as follows (according to Helander):

Let: C = annual charges per square foot of additional surface, dollars

U = heat transfer coefficient for surface

C_f = annual saving per Btu of heat recovered per hour, dollars

= value of Btu X hours service per year
 ÷ overall steam generator efficiency

M_a , M_g and M_w = air, gas and water flows, lbs/hr

t_g = gas temperatures, deg F

t_a = air temperatures, deg F

t_w = water temperatures, deg F

t_b = saturation temperature in boiler, deg F

a , b , e , i and o are subscripts referring to

air heater, boiler, economizer, in and out

To determine the most economical temperature of the outlet gas from an economizer when the inlet gas and inlet water temperatures are fixed:

SUPERHEATERS, REHEATERS, ECONOMIZERS AND AIR HEATERS 171

$$\frac{C_e}{U_e C_f} = \frac{(t_{goe} - t_{wie})(t_{gie} - t_{woe})}{(t_{gie} - t_{wie})}$$

$$\frac{0.24 M_g}{c_p M_w} = \frac{(t_{woe} - t_{wie})}{(t_{gie} - t_{goe})} = e$$

To determine the most economical temperature of the outlet gas from an air heater when the inlet gas and inlet air temperatures are fixed:

$$\frac{C_a}{U_a C_f} = \frac{(t_{goa} - t_{aia})(t_{gia} - t_{aoa})}{(t_{gia} - t_{aia})}$$

$$\frac{M_g}{M_a} = \frac{(t_{aoa} - t_{aia})}{(t_{gia} - t_{goa})} = a$$

To determine the most economical boiler outlet gas temperature and water temperature leaving the economizer in the case of a boiler-economizer combination when the economizer gas outlet temperature and inlet water temperature are fixed:

$$\frac{C_e U_b}{U_e C_b} = \frac{(t_{gie} - t_{woe})}{(t_{gie} - t_v)}$$

To determine the most economical boiler outlet gas temperature and air temperature leaving the air heater in the case of a boiler-air heater combination when the air heater gas outlet temperature and entering air temperature are fixed:

$$\frac{C_a U_b}{U_a C_b} = \frac{(t_{gia} - t_{aoa})}{(t_{gia} - t_v)}$$

To determine the most economical boiler and economizer outlet gas temperatures, water temperature leaving the economizer and air temperature leaving the air heater in the case of a boiler-economizer-air heater combination when the air heater gas outlet temperature, entering air temperature and water inlet temperature are fixed:

$$\frac{C_b U_e}{C_e U_b} = \frac{(t_{gie} - t_v)}{(t_{gie} - t_{woe})}$$

$$\frac{U_e C_a}{C_e U_a} = \frac{(t_{gie} - t_{wie})(t_{gia} - t_{aoa})}{(t_{gie} - t_{woe})(t_{gia} - t_{wie})}$$

The following notes will be helpful in coming to a decision as to the proper combination of boiler and heat recovery apparatus:

1. If the water outlet temperature in a boiler-economizer combination is not at least 50 F less than the saturation temperature in the boiler, try adding an air heater to the combination.
2. If the air outlet temperature from the air heater in a boiler-air heater combination is greater than 600 F for pulverized coal, oil or gas, or 350 F for stokers, try adding an economizer to the combination.

Table XIV gives some mass flows and heat transfer coefficients to be expected in commercial practice. After making an estimate from the table, the final values of economical temperatures can be arrived at by successive approximations.

TABLE XIV
GAS MASS FLOWS AND COEFFICIENTS OF HEAT TRANSFER
FOR
STEAM GENERATOR COMPONENTS

	G	U
	Lbs/hr/sq ft	Btu/hr/sq ft/deg
Boiler	1000 to 5000	3 to 8
Superheater	2000 to 9000	10 to 25
Economizer	2000 to 9000	6.5 to 9
Air Heater	2000 to 9000	2.5 to 4

Example 25 shows the method of application of the preceding equations to the determination of the most economical division of heat transfer surface.

Example 25.

Determine the most economical temperatures for the boil-

SUPERHEATERS, REHEATERS, ECONOMIZERS AND AIR HEATERS 173

er of Examples 17 and 20, given the following additional data:

Annual fixed charges	15 o/o
Cost of additional boiler surface	\$10.00 /sq ft
Cost of additional econ. surface	\$ 4.00 / sq ft
Cost of additional air htr. surface	\$ 1.00 /sq ft
Boiler heat transfer coefficient	4.7
Econ. heat transfer coefficient	7.8
Air htr. heat transfer coefficient	4.0
Cost of fuel	\$ 8.00 /ton
Hours operated per year	8000

Solution:

$$C_f = \frac{\$8.00(8000)}{2000(14400)(0.887)} = 0.00251$$

$$C_b = 10(0.15) = 1.50$$

$$C_e = 4(0.15) = 0.60$$

$$C_a = 1(0.15) = 0.15$$

1. Assuming a boiler-economizer combination:

The temperature of the water entering the economizer is greater than the temperature specified for the flue gas outlet temperature, therefore this combination would be impossible.

2. Assuming a boiler-air heater combination:

$$t_{g oa} = 250 \text{ F} \quad t_{a ia} = 110 \text{ F} \quad t_v = 535 \text{ F}$$

$$\frac{0.15(4.7)}{4.0(1.50)} = 0.1175 = \frac{(t_{gia} - t_{a oa})}{(t_{gia} - 535)}$$

$$a = \frac{291000}{274000} = 1.06 = \frac{(t_{a oa} - 110)}{(t_{gia} - 250)}$$

from which, $t_{gia} = 1230 \text{ F}$ and $t_{a oa} = 1145 \text{ F}$.

These temperatures indicate that no boiler surface could be justified, but the temperature of the air leaving the air heater is too high for satisfactory operation.

3. Assuming an economizer-air heater combination:

$$\frac{7.8(0.15)}{0.60(4.0)} = 0.488 = \frac{(1225 - 300)(t_{gia} - t_{soa})}{(1225 - t_{nos})(t_{gia} - 300)} \quad [A]$$

$$\frac{t_{nos} - 300}{1225 - t_{gia}} = 0.322 \qquad \frac{t_{soa} - 110}{t_{gia} - 250} = 1.06$$

Assume for a first approximation that $t_{nos} = 485$ F, then, $t_{gia} = 650$ F and $t_{soa} = 535$ F. Substitution of these temperatures in equation [A] gives a ratio of 0.414 instead of the required value of 0.488.

Assume for a second approximation that $t_{nos} = 500$ F, then, $t_{gia} = 602$ F and $t_{soa} = 483$ F. Substitution of these temperatures in equation [A] gives a ratio of 0.503.

Interpolation gives $t_{nos} = 498$ F, however, this temperature is too close to the saturation temperature in the boiler so the first approximation will be taken as most satisfactory.

BIBLIOGRAPHY

- Anon., "Selection of Economizers and Air Heaters," *Combustion*, July, 1938.
- Darling, C. S., "Economic Aspects of Air Heating," *Power Plant Engineering*, September, 1931.
- Drewry, M. K., "Radiant Superheater Developments," *Transactions A.S.M.E.*, Volume 54, 1932.
- Frisch, M., "Superheat Control," *Mechanical Engineering*, September, 1941.
- Helander, L., "Dividing Heating Surface among Boiler, Economizer and Air Heater," *Power*, March, 1930.
- Kreisinger, H., "Heat Transfer in Air Heaters and Economizers," *Combustion*, December, 1933.
- Rieder, E. V., "Regulation of Steam Temperature by Controlled Gas Flow," *Combustion*, November-December, 1934.
- Van Deventer, F. M., "Economics of Air Heater Applications," *Transactions A.S.M.E.*, Volumes 50-51, 1927-28.

CHAPTER X
PIPING AND DUCT-WORK

68. Power plants require conduit for the transportation of fuel, air, gas, water and steam. Conduit for air and gas are called ducts, and for other materials are called pipe. The variety of conduit is large, but the laws of fluid flow apply to all.

69. Piping--Calculations for piping involve the determination of pipe size, pressure class and pressure drop.

Pipe size is determined from the fluid velocity which will produce a pressure drop which is not excessive. Table XV gives practical velocities for various fluids and vapors.

TABLE XV
PIPE LINE VELOCITIES

	ft per sec
Low press. sat. steam	65 - 100
High press. sat. steam	100 - 170
High press. suphtd. steam	170 - 250
Atmos. exhaust steam	130 - 200
Low press. exhaust steam	330 - 400
Boiler feed-water	8 - 12
Pump suction, water	4 - 7
General service water	5 - 10
Fuel oil	1 - 4

Application of the continuity equation will give the solution for pipe size, as follows:

$$A = \frac{Mv}{3600 V} \quad d_i = 0.4 \sqrt{Mv/\pi V}$$

where: M = flow, lbs/hr

v = specific volume, cu ft/lb

V = velocity, ft/sec

d_i = inside diameter of pipe, in.

A = flow area, sq ft

Pressure class (or schedule number) is determined from the relation:

$$SN = \frac{1000 P}{S}$$

where: SN = pipe schedule number

P = working pressure in pipe,

lbs/sq in. gage

TABLE XVI

(Crane Co.)

Dimensions of Welded and Seamless Steel Pipe

Nominal Pipe Size	Out-side Diam.	Nominal Wall Thicknesses for Schedule Numbers									
		Schedule 10	Schedule 20	Schedule 30	Schedule 40	Schedule 60	Schedule 80	Schedule 100	Schedule 120	Schedule 140	Schedule 160
$\frac{1}{8}$.405068095
$\frac{1}{4}$.540088119
$\frac{3}{8}$.675091126
$\frac{1}{2}$.840109147187
$\frac{3}{4}$	1.050113154218
1	1.315133179250
1 $\frac{1}{4}$	1.660140191250
1 $\frac{1}{2}$	1.900145200281
2	2.375154218343
2 $\frac{1}{2}$	2.875203276375
3	3.500216300437
3 $\frac{1}{2}$	4.000226318
4	4.500237337437531
5	5.563258375500625
6	6.625280432562718
8	8.625250	.277	.322	.406	.500	.593	.718	.812	.906
10	10.75250	.307	.365	.500	.593	.718	.843	1.000	1.125
12	12.75250	.330	.406	.562	.687	.843	1.000	1.125	1.312
14 O.D.	14.00	.250	.312	.375	.437	.593	.750	.937	1.062	1.250	1.406
16 O.D.	16.00	.250	.312	.375	.500	.656	.843	1.031	1.218	1.437	1.562
18 O.D.	18.00	.250	.312	.437	.562	.718	.937	1.156	1.343	1.562	1.750
20 O.D.	20.00	.250	.375	.500	.593	.812	1.031	1.250	1.500	1.750
24 O.D.	24.00	.250	.375	.562	.687	.937	1.218	1.500	1.750

Dimensions of Welded Wrought-Iron Pipe

Nominal Pipe Size	Outside Diameter	Nominal Wall Thicknesses for Schedule Numbers					
		Schedule 10	Schedule 20	Schedule 30	Schedule 40	Schedule 60	Schedule 80
$\frac{1}{8}$.405070098
$\frac{1}{4}$.540090122
$\frac{3}{8}$.675093129
$\frac{1}{2}$.840111151
$\frac{3}{4}$	1.050115157
1	1.315136183
1 $\frac{1}{4}$	1.660143195
1 $\frac{1}{2}$	1.900148204

s = allowable working stress,
 lbs/sq in. (10 to 15 per cent
 of ultimate tensile strength)

Table XVI gives pertinent data for the various pipe schedules made at the present time, along with minimum tensile strengths for the various grades of steel and wrought iron piping materials.

TABLE XVI
 continued

2	2.375158223
2½	2.875208282
3	3.500221306
3½	4.000231325
4	4.500242344
5	5.563263383
6	6.625286441
8	8.625283	.329510
10	10.75313	.372	.510	
12	12.75336			

Note: Bold face numbers in Schedules 40 and 80 correspond to standard and extra strong weights respectively.

A.P.I. and A.S.T.M. Specifications for Pipe, With Tensile Strengths Called for and the Corresponding Uses for Which Each Material Is Intended

Title	Tensile Strength Lbs. per Sq. In.	Scope
Line Pipe Specifications (A.P.I. 5-L)	Furnace welded: Bessemer, 50,000 min Open-hearth, Class I, 45,000 min Open-hearth, Class II, 48,000 min Wrought iron, 42,000 min Seamless or electric welded: Open-hearth, Grade A, 48,000 min Open-hearth, Grade B, 60,000 min Open-hearth, Grade C, 75,000 min Seamless or furnace welded: Open-hearth iron, 42,000 min	Pipe for line pipe purposes, to convey gas, water, or oil. Sizes covered, ½ inch nominal size to 24-inch outside diameter. Couplings for threaded line pipe are of special design. Threads on pipe and in couplings are subject to official gage limits.
Seamless Carbon-Molybdenum Alloy-Steel Pipe for Service at Temperatures from 750 to 1000 F. (A.S.T.M. A206)	55,000 min	Seamless carbon—½ per cent molybdenum alloy steel pipe intended for service at metal temperatures from 750 to 1000 F. Suitable for bending, flanging, and similar forming operations, and for fusion welding.
Seamless Alloy-Steel Pipe for Service at Temperatures From 750 to 1100 F (A.S.T.M. A158)	Ferritic, 60,000 min Austenitic, 75,000 min	Seamless alloy-steel pipe intended for service at metal temperatures from 750 to 1100 F. Several classes of materials that have been rather extensively used are included. Choice from the respective steels should be made on the basis of requirements of design, service conditions, and the physical properties.

Pressure drop is determined by the application of the pipe friction formula, as follows:

$$\Delta P = 0.00518 \frac{f L V^2}{v d_i} \qquad \Delta h = 0.745 \frac{f L V^2}{d_i}$$

where: ΔP = pressure drop, lbs/sq in.

Δh = pressure drop, ft of fluid

f = a friction factor

L = equivalent length of pipe, ft

V = average fluid velocity, ft/sec

v = specific volume of fluid, cu ft/lb

d_i = inside diameter of pipe, in.

The equivalent length of pipe is equal to the sum of the length of straight pipe plus an allowance for valves and fittings. Figure X-1 gives the equivalent pipe length allowances.

The friction factor is a function of Reynolds' number, which is in turn a function of the size of the pipe, and the velocity, density and viscosity of the fluid. That is,

$$r = 122.5 \frac{d_i V}{z v}$$

where: r = Reynolds' number

z = viscosity of fluid, centipoises

Figures X-2 and X-3 show curves of viscosity for water, steam and oils, and specific gravity for oils. Figure X-4 shows the relation of friction factor to Reynolds' number.

Pipe fittings are specified by pressure class and material. Figures X-5 and X-6 and Table XVII show some piping details and standard types of fittings. Figure X-7 shows some of the various types of valves used in power plants.

Examples 26-A and 26-B show the method of calculation of pipe data based on the preceding information.

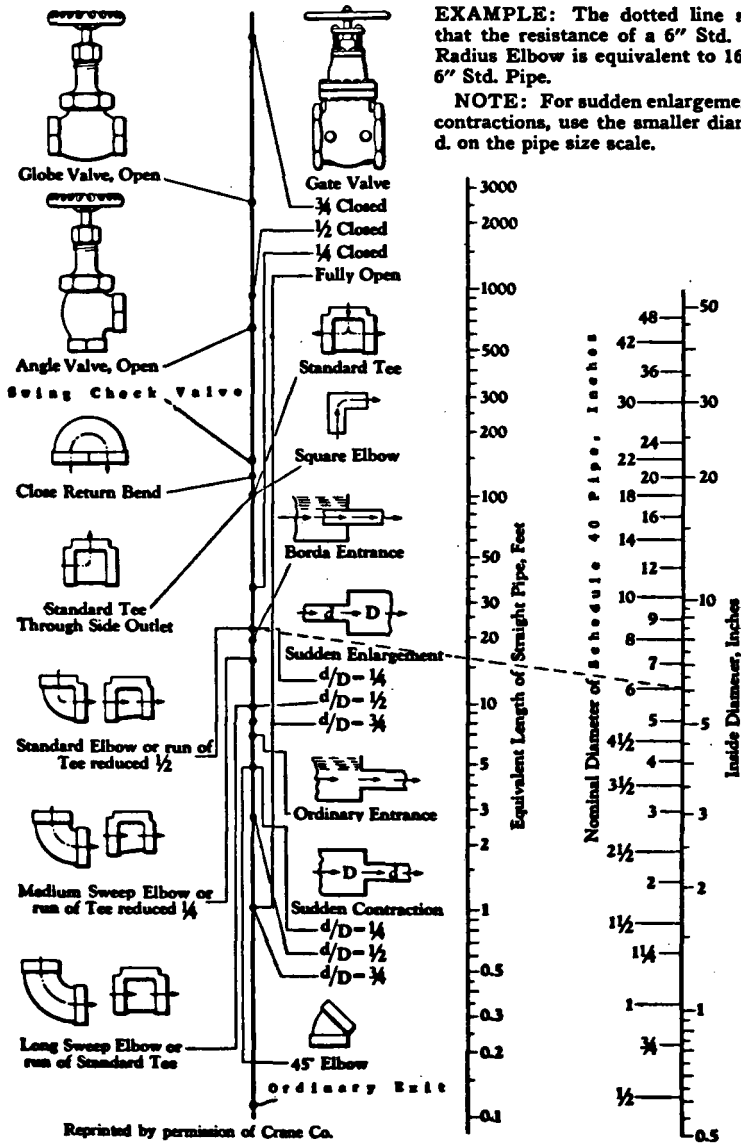

Fig. X-1. Equivalent straight pipe length for valves and pipe fittings.

Reprinted by permission of Crane Co.

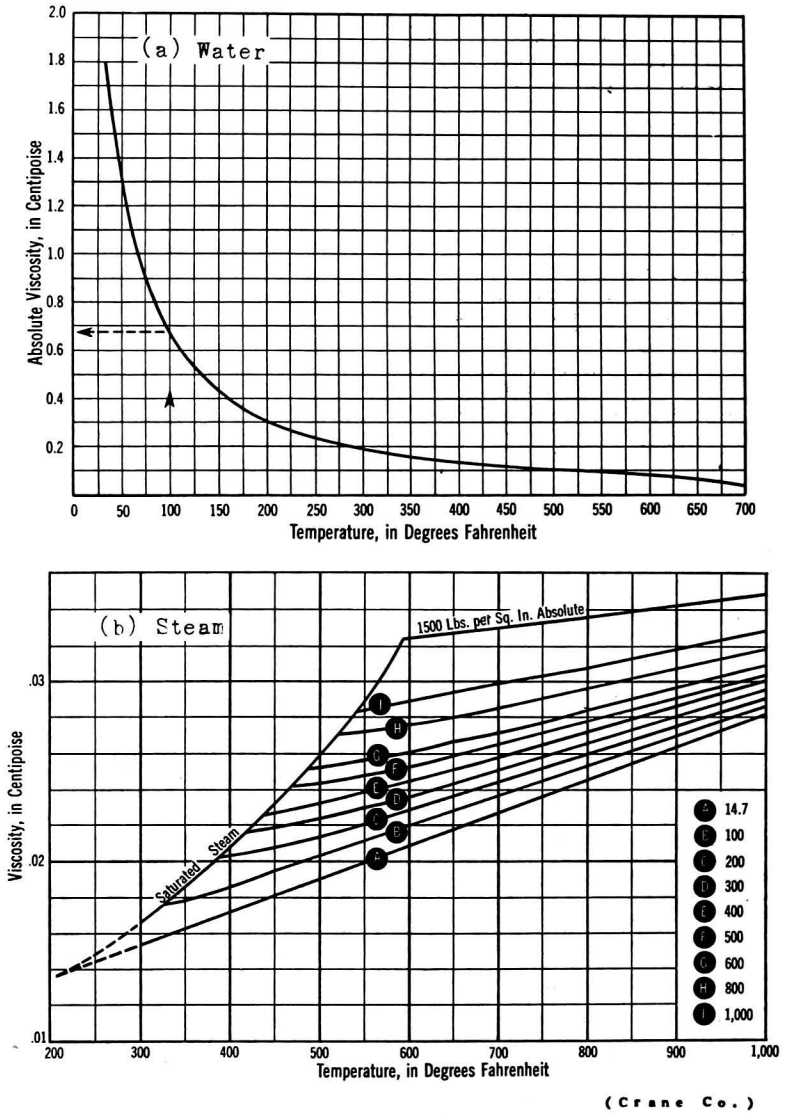
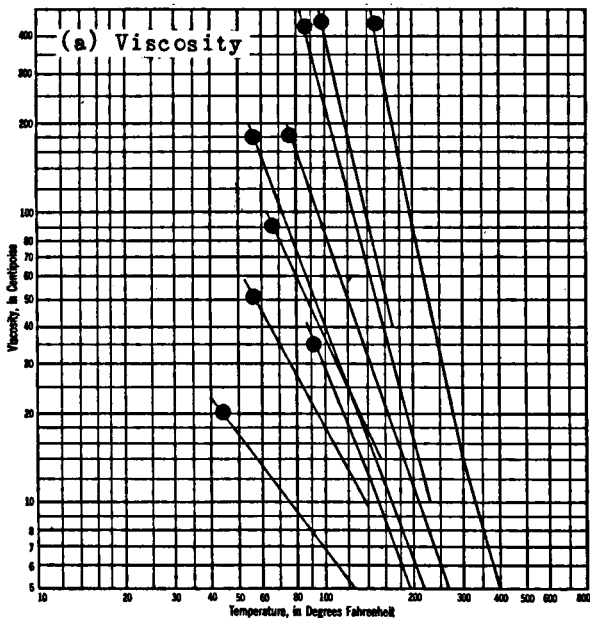
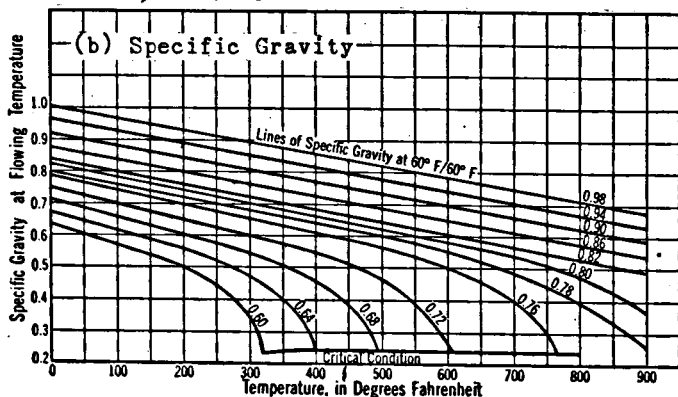

Fig. X-2. Viscosity of water and steam.



- (1) Midcontinent residuum, $S=0.97$; (2) California heavy crude, $S=0.976$; (3) Residuum, $S=0.94$; (4) Eastern light lubricating oil, SAE 30; (5) Midcontinent light lubricating oil, $S=0.90$; (6) Olive oil; (7) Eastern light lubricating oil, SAE 10; (8) California light crude, $S=0.91$; (9) Midcontinent crude, $S=0.85$.



(Crane Co.)

Fig. X-3. Characteristics of petroleum oils.

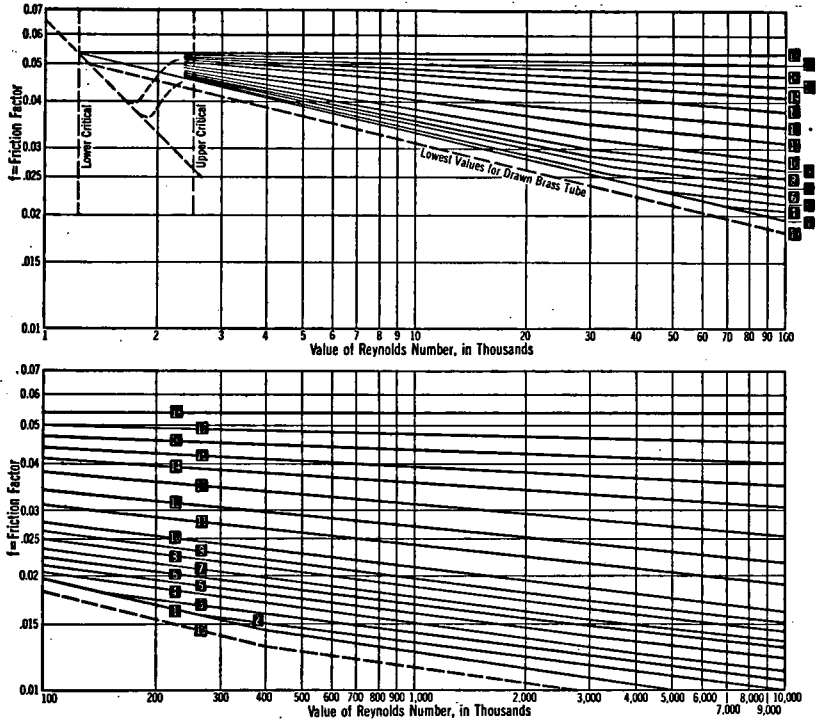

Curve No.	Roughness %	Diameter of Pipe, in Inches					
		Type A	Type B	Type C	Type D	Type E	Type F
1	0.2	0.35 up	72
2	0.45	48 to 66
3	0.81	14 to 42	30	48 to 96	96	220
4	1.35	6 to 12	10 to 24	20 to 48	42 to 96	84 to 204
5	2.1	4 to 5	6 to 8	12 to 16	24 to 36	48 to 72
6	3.0	2 to 3	3 to 5	5 to 10	10 to 20	20 to 42
7	3.8	1½	2½	3 to 4	6 to 8	16 to 18
8	4.8	1 to 1¼	1½ to 2	2 to 2½	4 to 5	10 to 14
9	6.0	¾	1½	1½	3	8
10	7.2	½	1	1½	5
11	10.5	¾	¾	1	4
12	14.5	¼	½	3
13	19.0	¾
14	24.0	0.125	¾
15	28.0
16	31.5	¼
17	34.0	¾
18	37.5	0.0625	¾

Type A: Drawn tubing, and brass tin, lead, and glass pipe.

Type B: Clean steel and wrought iron pipe.

Type C: Clean galvanized pipe.

Type D: Best cast iron pipe, cement, and light riveted sheet ducts.

Type E: Average cast iron pipe and rough formed concrete ducts.

Type F: First class brick, heavy riveted, and spiral riveted ducts.

In drawn tubing, the actual inside diameter is given.

In pipe, the nominal size of standard weight is given.

(Crane Co.)

Fig. X-4. Friction factor with relation to Reynolds' number.

TABLE XVII

(Crane Co.)

Standard Malleable Iron Fittings

WORKING PRESSURES, BANDED FITTINGS

150 pounds steam

300 pounds cold water, oil, or gas, non-shock

Dimensions, in Inches

TABLE XVII continued in APPENDIX

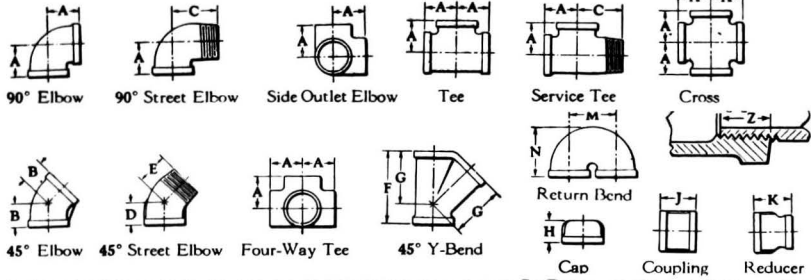

Size	A	B	C	D	E	F	G	H	J	K	Z	Return Bends		
												Size	M	N
1/8	11/16	1/2	1	11/16	13/16			9/16	15/16		1/4			
1/4	13/16	3/4	1 1/16	1 1/16	1 1/16			5/8	1 1/16	1	3/4			
3/8	15/16	13/16	1 7/16	1 1/16	1 1/16	2 1/8	1 7/16	3/4	1 3/16	1 1/8	3/8	1/2	1	1 3/4
1/2	1 1/8	7/8	1 5/8	1 3/16	1 3/16	2 7/16	1 11/16	7/8	1 5/8	1 1/4	1/2	3/4	1 1/4	2 3/4
3/4	1 5/16	1	1 7/8	1 5/16	1 5/16	2 13/16	2 1/16	1 1/16	1 1/2	1 7/16	9/16	1	1 1/2	2 1/2
1	1 1/2	1 1/8	2 1/8	1 1/16	1 1/2	3 3/8	2 7/16	1 3/16	1 11/16	1 11/16	1 1/16	1 1/4	1 3/4	2 13/16
1 1/4	1 3/4	1 5/16	2 7/16	1 1/4	1 11/16	4 1/16	2 15/16	1 1/4	1 15/16	2 1/16	1 1/16	1 1/2	2 3/16	3 3/16
1 1/2	1 15/16	1 7/16	2 11/16	1 3/8	1 7/8	4 1/2	3 5/16	1 5/16	2 1/8	2 5/16	1 1/16	2	2 5/8	3 3/8
2	2 1/4	1 11/16	3 1/4	1 11/16	2 1/4	5 7/16	4	1 7/16	2 1/2	2 13/16	3/4	2 1/2	3 1/2	4 1/2
2 1/2	2 11/16	1 15/16	3 13/16	1 3/8	2 3/8	6 1/4	4 11/16	1 11/16	2 7/8	3 1/4	1 5/16	3 1/2	4 1/2	5 1/2
3	3 1/8	2 3/16	4 1/2	2 1/8	3	7 1/4	5 9/16	1 13/16	3 3/16	3 11/16	1	4	5 1/2	6 1/2
3 1/2	3 7/16	2 3/8	5 1/2	2 3/8	3 3/4			1 5/16	3 7/16	4	1 1/16	4 1/2	5 1/2	6 11/16
4	3 3/4	2 5/8	5 11/16	2 3/8	3 3/4	8 7/8	6 1 5/16	2 1/16	3 11/16	4 3/8	1 1/8	5 1/2	6 1/2	7 1/2
5	4 1/2	3 1/16	6 1/8					2 5/16	4 1/4	5 1/8	1 1/4	6 1/2	7 1/2	8 1/2
6	5 1/8	3 7/16	8					2 9/16	4 3/4	5 3/8	1 5/16	7 1/2	8 1/2	9 1/2

FIG. X-5. Pipe fitting types.

(Crane Co.)

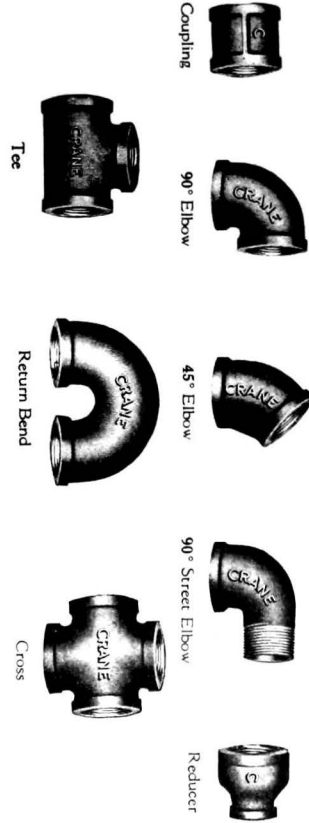

PIPING AND DUCT-WORK

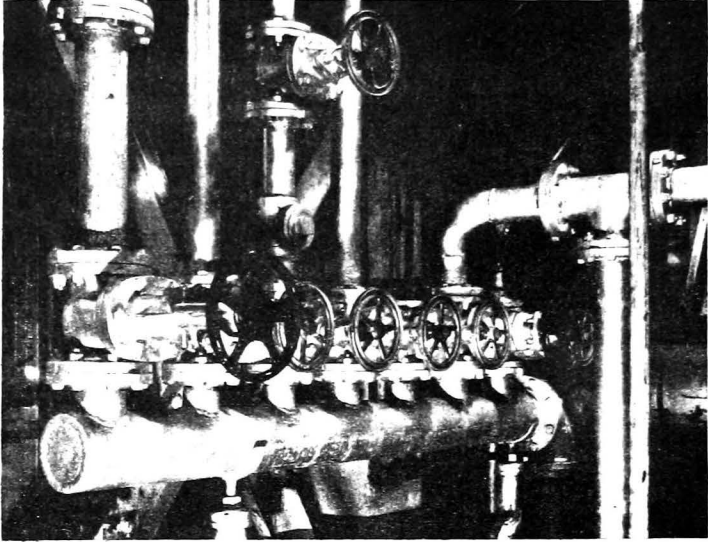

(Crane Co.)

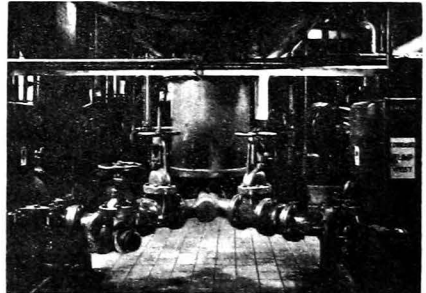
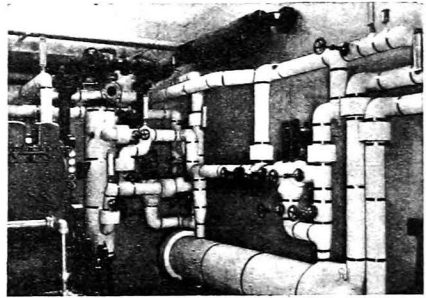

Fig. X-6. Piping details.

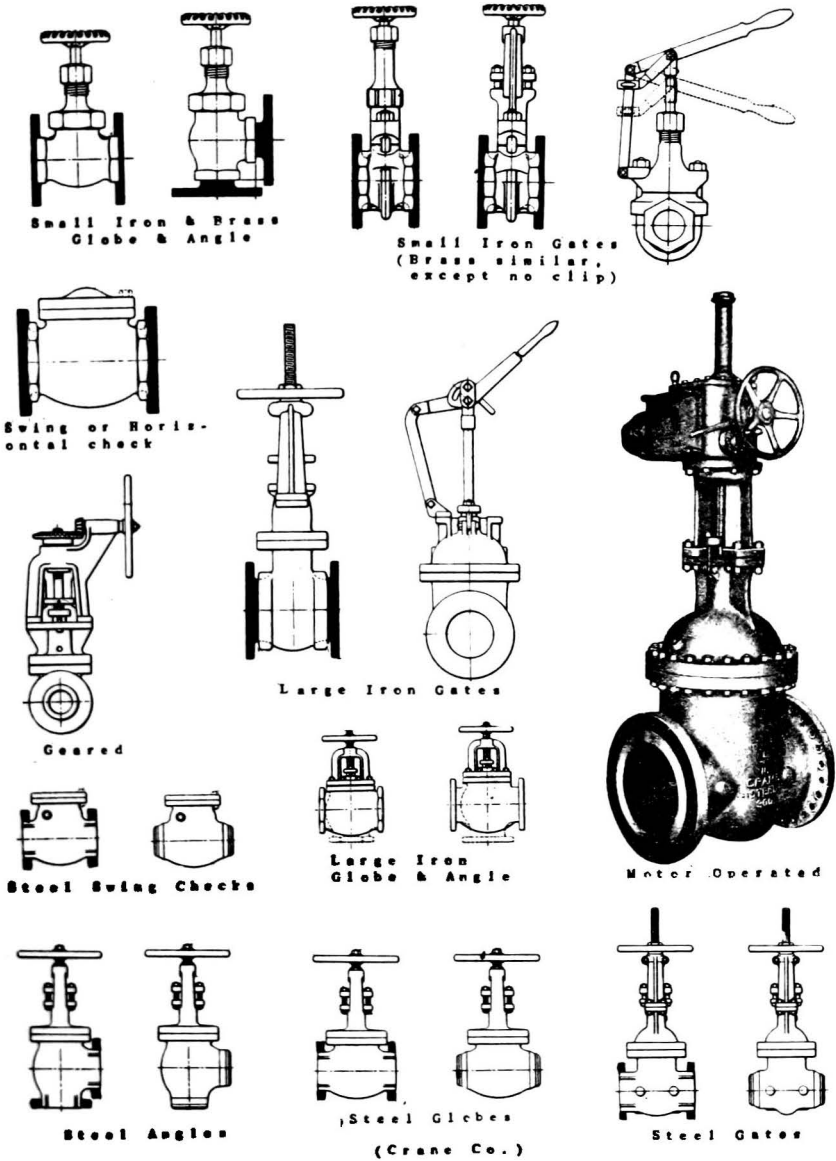

Fig. X-7 Power plant valve types.

Example 26-A.

Determine the nearest standard pipe size and pressure drop for a steam line (seamless Grade A steel pipe) carrying 30,000 lbs/hr at 215 psig and 560 F. The line contains 100 ft of straight pipe, 2 gate valves, 1 globe valve, 1 swing check valve and 3-90° elbows.

Solution:

The steam is at a moderately high pressure and is superheated, so a velocity of 180 ft/sec is selected. The required inside diameter is:

$$d_i = 0.4 \left[\frac{30000(2.531)}{180 \pi} \right]^{0.5} = 4.65 \text{ in.}$$

The pipe schedule number (allowing a factor of safety of about 10) is:

$$SN = \frac{1000(215)}{4800} = 45$$

Schedule 40 pipe would be safe enough. The inside diameter of 5 in. Schedule 40 pipe is 5.05 in. which is close enough to the required 4.65 in. The true velocity of the steam is:

$$V = \frac{0.16(30000)(2.531)}{\pi(5.05)^2} = 152 \text{ ft/sec}$$

In order to determine the friction factor, Reynolds' number is calculated (finding the viscosity, μ , from Figure X-2) as follows:

$$r = \frac{122.5(5.05)(152)}{0.025(2.531)} = 1,485,000$$

From Figure X-4, the friction factor is 0.016.

The total equivalent length of pipe is found with the aid of Figure X-1, as follows:

Straight pipe		100 ft
2 Gate valves	2(2.8) =	5.6 ft
1 Globe valve		140 ft
1 Swing check valve		31 ft
3 90° Elbows	3(14)	42 ft
Total equivalent length		318.6 ft

The pressure drop is:

$$\Delta P = 0.00512 \frac{(0.016)(318.6)(152)^2}{2.521(5.05)} = 47.7 \text{ psi}$$

Example 26-6.

Determine the nearest standard pipe size and pressure drop for a seamless Grade A steel pipe carrying 40,000 lbs/hr of residual fuel oil at a pressure of 200 psig and a temperature of 200 F. The specific gravity of the oil at 60°/60° is 0.89. The pipe line contains 500 ft of straight pipe, 6-90° elbows, 2 gate valves, 1 swing check valve, and 1 globe valve.

Solution:

From Figure X-3 b, the specific gravity of the oil at 200°/60° is 0.89, from which the specific volume v is $1/[62.4(0.89)] = 0.018$ cu ft/lb, and taking $V = 3$ ft/sec,

$$d_i = 0.4 \left[\frac{40000(0.018)}{2 \pi} \right]^{0.5} = 3.5 \text{ in.}$$

3½ in. Schedule 40 pipe has an inside diameter of 3.548 in. The actual velocity would be:

$$V = \frac{0.16(40000)(0.018)}{\pi(3.548)^2} = 2.91 \text{ ft/sec}$$

Reynolds' number is calculated using the viscosity, z , from Figure X-3 a, as follows:

$$r = \frac{122.5(3.548)(2.91)}{17(0.018)} = 4130$$

From Figure X-4, the friction factor is 0.041.

The total equivalent length of pipe is:

Straight pipe	500	ft
6 90° Elbows 6(9.5)	57	
2 Gate valves 2(2.0)	4	
1 Swing check valve	21	
1 Globe valve	100	
Total equivalent length	682	ft

The pressure drop is:

$$\Delta h = 0.745 \frac{(0.041)(682)(2.91)^2}{3.548} = 49.5 \text{ ft. of oil}$$

70. Friction in Condensers and Feed-Water Heaters--Friction losses in condensers and feed-water heaters may be calculated from the pipe friction formula, but it is more usual to use the curves shown in Figure X-8 for the losses in the tubes and Figure X-9 for the losses in the water boxes.

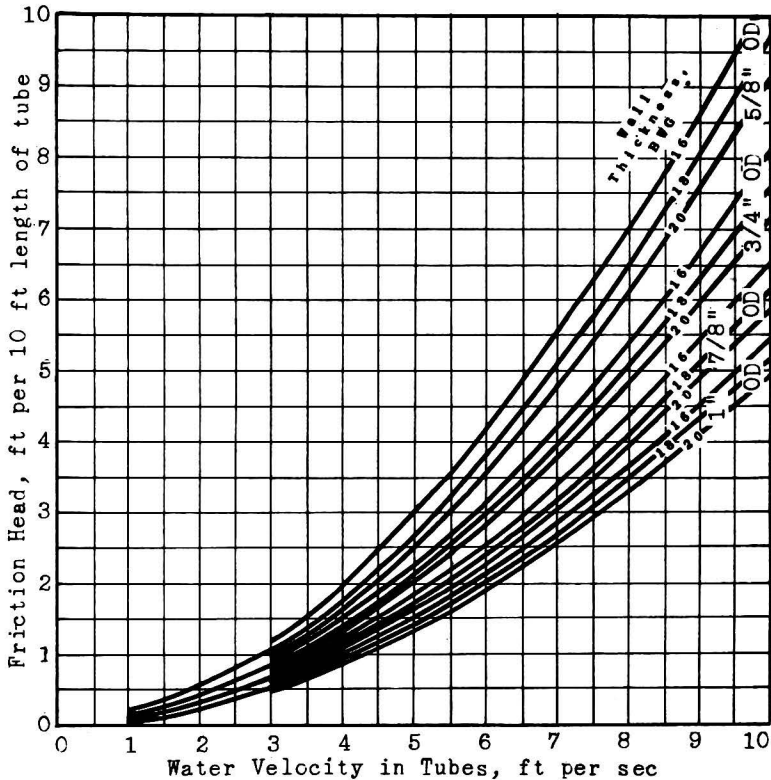

Fig. X-8. Head loss in condenser and feed-water heater tubes

Examples 27-A and 27-B show the method of calculation of head losses in the condenser and feed-water heater of Examples 9 and 11.

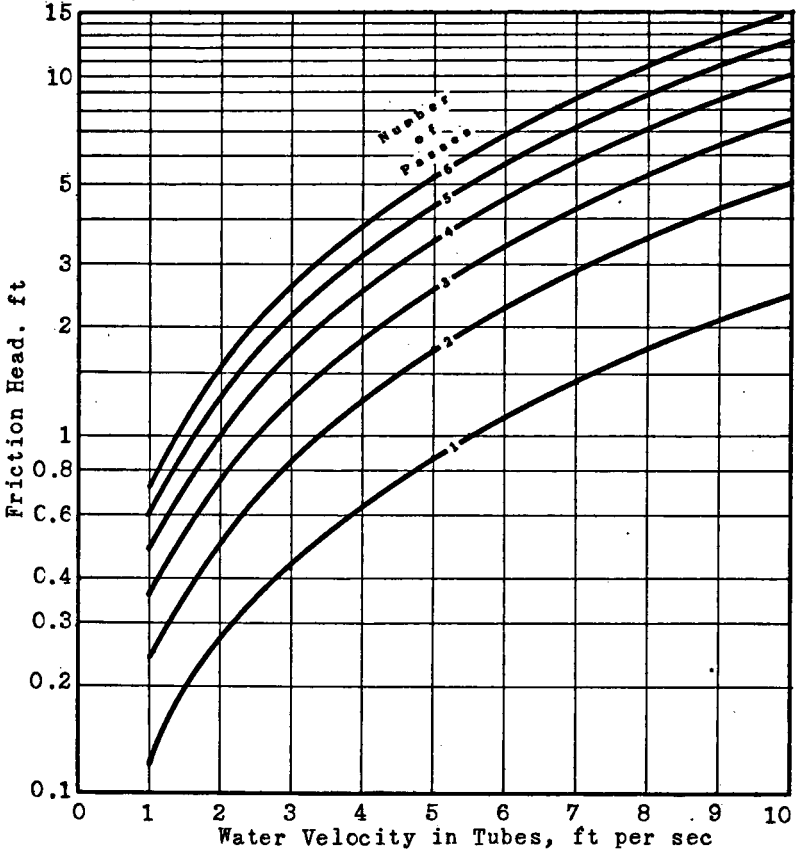

Fig. X-9. Head loss in condenser and feed-water heater water boxes.

Example 27-A.

Determine the head loss in the tubes and water boxes of the condenser of Example 9.

Solution:

From Figure X-8, the head loss in 3/4 in. X 18 BWG tubes at a velocity of 8 ft/sec is 5.1 ft per 10 ft length of tube. The water box head loss for a two-pass condenser at a velocity of 8 ft/sec, from Figure X-9, is 3.6 ft. Then the total head loss is:

Tubes	5.1(45.5/10)	23.3 ft
Water boxes		3.6
Total head loss		26.9 ft

Example 27-B.

Determine the head loss in the tubes and water boxes of the feed-water heater of Example 11.

Solution:

From Figure X-8, the head loss in 5/8 in. X 16 BWG tubes at a velocity of 6 ft/sec is 4.2 ft per 10 ft length of tube. The water box head loss for a six-pass heater at a velocity of 6 ft/sec, from Figure X-9, is 6.9 ft. Then the total head loss is:

Tubes	4.2[7.68(6)/10]	19.4 ft
Water boxes		6.9
Total head loss		26.3 ft

71. Duct-Work--The method of calculating the dimensions of ducts for gas or air are very similar to those employed for piping. Ducts usually operate at maximum pressures of the order of several inches of water, so that ordinarily if the duct is strong enough to support itself without buckling, it will be strong enough to withstand the pressure.

Duct size is determined by substituting the allowable velocity in the continuity equation, as for piping. Ducts, however, are usually rectangular in cross section rather than round. Table XVIII gives reasonable velocities in ducts. The higher velocities apply to higher static pressures.

TABLE XVIII

DUCT VELOCITIES

	ft per sec
Air ducts	20 - 50
Gas ducts	20 - 40
Stacks	20 - 40

Pressure drop (or draft loss) is usually measured in inches of water, and is given by the equation:

$$\Delta p = 0.00298 \frac{\rho f L V^2}{R}$$

where: Δp = draft loss, in. water
 ρ = density of gas, lbs/cu ft
 R = hydraulic radius of duct, ft
 = area/perimeter

Reynolds' number is as for piping, except that the smallest dimension of the duct (if rectangular) is substituted for the inside diameter of the pipe. Viscosity in centipoises for various gases can be found from the following equations:

$$\text{Flue gas: } z = 0.0153 + 2.5 \times 10^{-5} t$$

$$\text{Air: } z = 0.0165 + 2.5 \times 10^{-5} t$$

where: t = temperature, deg F

Figure X-1C shows densities for air and flue gas.

Length allowances for bends may be found from Table XIX after converting rectangular duct sizes to equivalent round duct diameter by the equation:

$$d_e = 1.35 \frac{(a b)^{0.627}}{(a + b)^{0.255}}$$

where: d_e = equivalent round duct diameter, in.
 a and b = rectangular duct dimensions, in.

Figure X-11 shows some typical ducts, and Example 28 shows some sample duct calculations.

Example 28.

Determine the draft loss in the flue gas duct between the economizer and air heater for the boiler of Example 17. The duct has a straight length of 20 ft and has 2-90° bends with a radius of 8 ft. The maximum width of duct is 12 ft and the maximum gas velocity is 20 ft/sec.

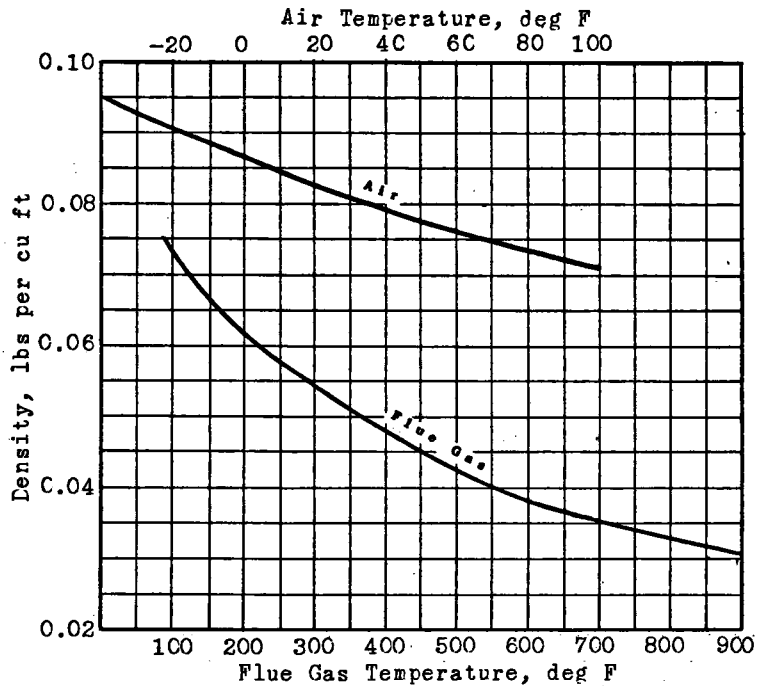

Fig. X-10. Densities of air and flue gas.

TABLE XIX

EQUIVALENT LENGTHS OF DUCT BENDS

Diameters of Straight Duct

Right angle bends

Center line radius 2 to 8 dia. 10

Center line radius 1 dia. 20

Mitred right angle elbow 50

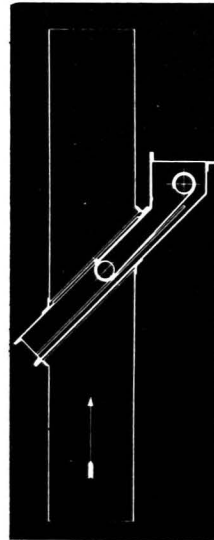
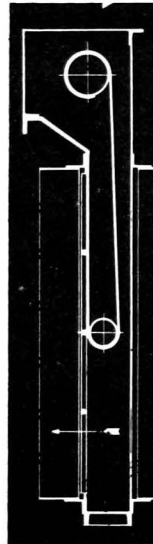
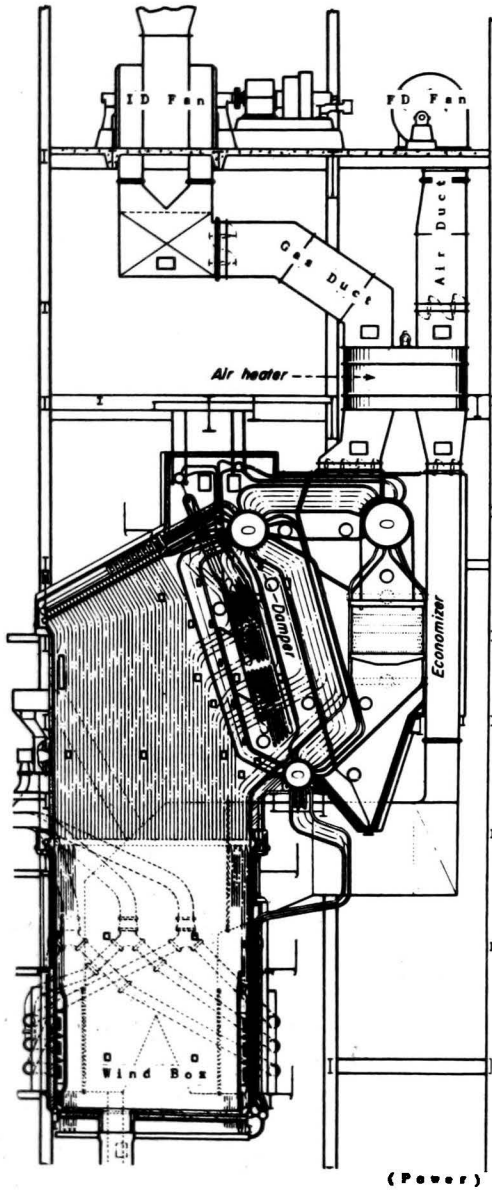

(Thermix
Engg. Co.)
Curtain
Dampers

Fig. X-11. Duct-work.

Solution:

From Example 23, the gas temperature is 650 F, and from Figure X-10, the density of the gas is 0.0375 lbs/cu ft, which is equivalent to a specific volume of 26.7 cu ft/lb. The required area of duct is:

$$A = \frac{291000(26.7)}{3600(20)} = 108 \text{ sq ft}$$

The duct dimensions are then 9 ft X 12 ft.

The viscosity of the gas is $\mu = 0.0153 + 2.5 \times 10^{-5}(650) = 0.03155$ centipoises. Reynolds' number is:

$$r = \frac{122.5(9)(12)(20)}{0.03155(26.7)} = 314,000$$

and the friction factor is found to be 0.0152 (Curve 1, Figure X-4).

The equivalent duct diameter is:

$$d_e = 1.35 \left[\frac{(108)(144)^{0.627}}{(108 + 144)^{0.255}} \right] = 83 \text{ in.}$$

and the radius of the bends is $8(12)/83 = 1.15$ dia., for which the allowance is 20 diameters of duct each. The total equivalent duct length is:

Straight duct	20 ft
2-90° bends $\frac{2(20)(83)}{12}$	277

Total equiv. length	297 ft
---------------------	--------

The draft loss in the duct is:

$$\Delta p = 0.00298 \frac{(0.0375)(0.0152)(297)(20)^2}{108/[2(12) + 2(9)]} = 0.078 \text{ in. water}$$

72. Pipe and Duct Insulation--Most pipes and ducts which carry liquids or gases whose temperature is very much different from the ambient temperature require insulation of some kind to prevent heat transfer to or from the surroundings. The most common insulation materials for pipe and ducts are asbestos, magnesia, mineral wool and diatomite. These materials are made in the form of blocks, moulded circular sections, blankets or plastic for application with a

trowel. Figure X-12 shows some of the various forms of insulation and Figure X-13 gives thermal conductivities for a variety of materials with the approximate temperature ranges for best utilization.

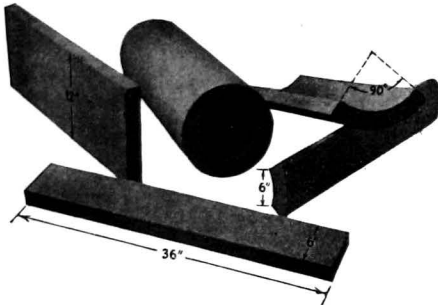

Standard Moulded Shapes
Magnesia or Diatomite



Pipe Covering
Magnesia or Diatomite



Pipe Covering
Asbestos Paper

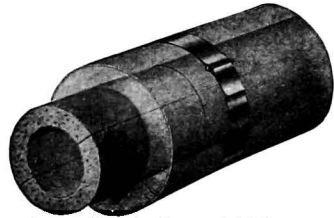

Pipe Covering
Diatomite Inner Layer
Magnesia Outer Layer.

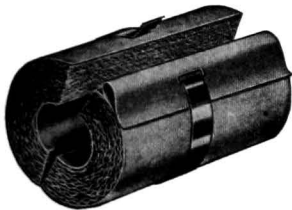

Pipe Covering
Corrugated
Asbestos Paper

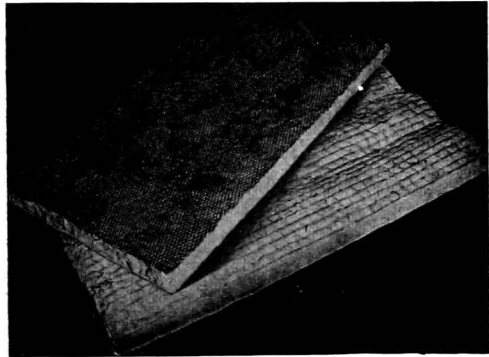

Mineral Wool Blankets
Wire Reinforced
(Philip Carey Co.)

Fig. X-12. Insulating materials.

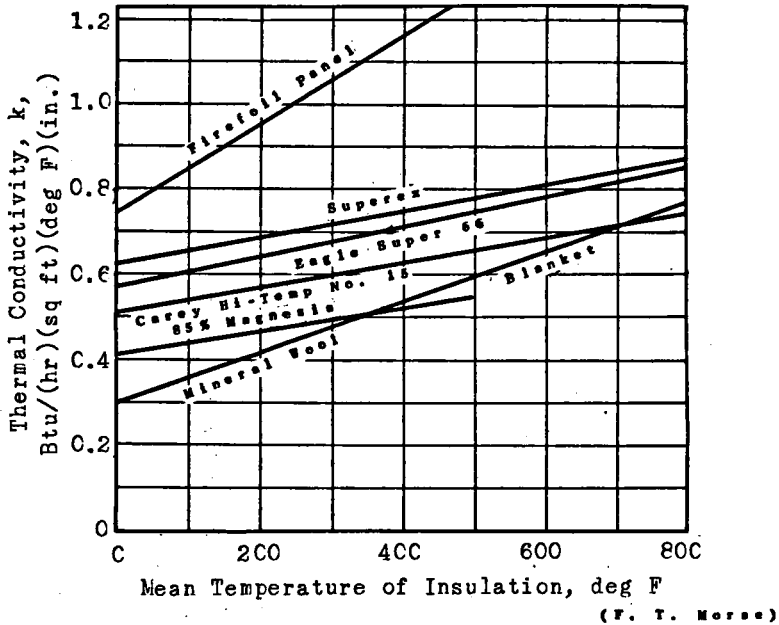

Fig. X-13. Thermal conductivities of insulating materials.

Heat transfer through insulation follows the same laws as previously discussed. It is not usual, however, to make an exhaustive analysis of the economic factors involved, but to use an economic selection chart such as is shown in Figure X-14. Example 29 shows the use of the chart.

Example 29.

Find the most economical thickness of 85 o/o magnesia pipe covering for the steam line of Example 26-A. Ambient temperature is 90 F; cost of insulation 24 cents/bd ft; fixed charges 20 o/o; used 8000 hrs/yr; fuel costs \$2.00 per bbl of 6,300,000 Btu.

Solution:

From Figure X-13, the conductivity of 85 o/o magnesia at a mean temperature of 325 F is 0.53. The value of the heat in the fuel is \$0.318 per million Btu. Entering Figure X-14 at 8000 hours and following the dotted lines, the most economical thickness of 85 o/o magnesia insulation for a 5 in. pipe is determined as 2 in.

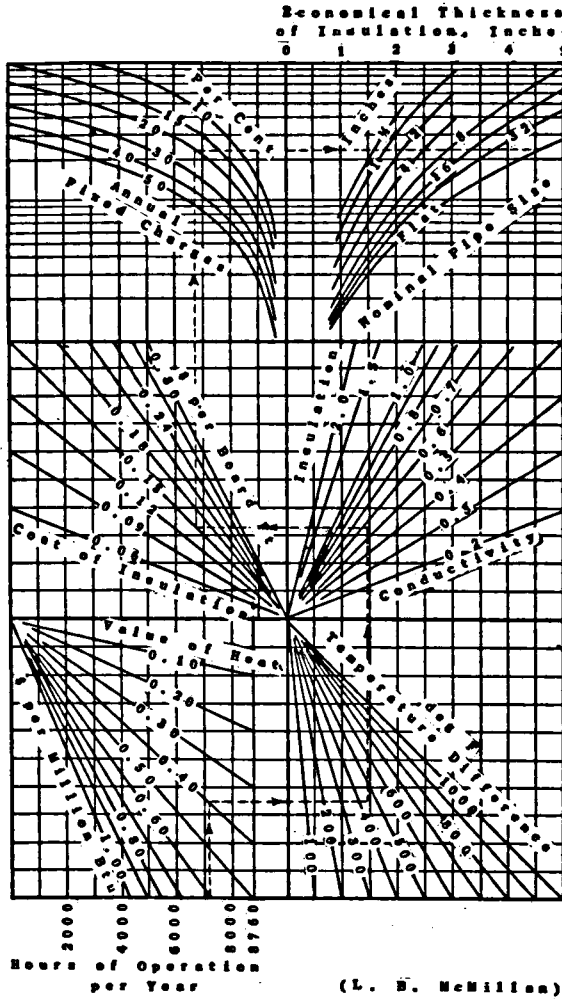

Fig. X-14. Selection chart for insulation thickness.

BIBLIOGRAPHY

- Code for Pressure Piping*, American Society of Mechanical Engineers, New York, 1942.
- Walker, J. H., and Crocker, S., *Piping Handbook*, McGraw-Hill, New York, 1939.

PROJECT III

1. The power plant of Projects I and II is to contain three steam generators. One will be operated continuously, one will be operated to handle peak loads and one will be a spare. Each steam generator will have a capacity sufficient to handle one turbo-generator at full load. The fuel oil has a higher heating value of 18,500 Btu per lb as fired and the analysis is as follows: Carbon = 0.851, hydrogen = 0.11, oxygen = 0.022, nitrogen = 0.002, sulphur = 0.013, and moisture = 0.002. The expected flue gas analysis is: Carbon dioxide = 14.0 o/o, carbon monoxide = 0 o/o, and oxygen = 3.0 o/o. Expected steam generator efficiency is 86.5 o/o. Temperatures expected are: Combustion air, 100 F; flue gas to stack, 300 F; fuel oil at burners, 175 F; and gas entering superheater, 1500 F.

(a) Make a heat balance for the steam generator and calculate the weight of fuel fired per hour.

(b) Estimate the furnace volume required and specify the furnace dimensions.

(c) Estimate the effective radiant surface in the furnace and the number of linear feet of $2\frac{1}{2}$ " OD tubes spaced on four inch centers in the furnace walls and boiler screen (assume that the boiler screen consists of three staggered rows).

(d) Estimate the superheater surface required and calculate the number and length of 2" OD X 12 BWG tubes required (assume that the superheater is placed in one boiler pass).

(e) Estimate the most economical temperatures for the remainder of the steam generator. Assume that boiler surface costs \$8.00, economizer surface \$3.50 and air heater surface \$C.90 per incremental square foot with annual fixed charges of 12 o/o.

(f) If boiler surface is justified, estimate the amount necessary and the number of rows and banks of $2\frac{1}{2}$ " OD X 12 BWG tubes required.

(g) If economizer surface is justified, estimate the amount necessary and the number and length of $1\frac{1}{2}$ " X 12 BWG tubes required.

(h) If air heater surface is justified, estimate the amount necessary and the number and length of $1\frac{1}{2}$ " OD X 16 BWG tubes required for one of the recuperative type with the gas

through the tubes. Calculate the number of gas passes necessary if the maximum tube length is 20 ft.

2. Specify the pipe sizes and calculate the pressure drops for the following lines in the power plant of Projects I and II:

(a) Circulating water: Suction line, 50 ft with three 90° elbows. Pump to condenser, 6 ft with one 90° elbow and one gate valve. Condenser discharge, 100 ft with four 90° elbows.

(b) Condensate: Suction line, 10 ft with two 90° elbows and one gate valve. Discharge line, 50 ft with eight 90° elbows, six gate valves and one swing check valve. Assume vapor condenser tube velocity is 5 ft per sec through two 6 ft passes.

(c) Boiler feed: Suction line, 40 ft with three 90° elbows and one gate valve. Discharge line, 75 ft with eight 90° elbows, two gate valves, two swing check valves and one globe valve.

(d) Main turbine lead (manifold to throttle): Length, 50 ft with the equivalent of 3-90° elbows and one gate valve.

(e) Extraction to closed heater: Length, 15 ft with two 90° elbows, one gate valve and one swing check valve.

3. Specify the size and estimate the draft loss for the following ducts for one of the steam generators of part one:

(a) Air heater to windbox (if necessary): Length, 50 ft with two 90° bends.

(b) Economizer to air heater (if necessary): Length, 20 ft with two 90° bends.

(c) Air heater, economizer or boiler to induced draft fan: Two ducts in parallel, each with length of 20 ft with one 90° bend and one 45° bend.

4. Specify the insulation thickness to be used in the following locations in the power plant of Projects I and II (fixed charges 15 o/o and ambient temperature 90 F):

(a) Main turbine lead: 85 o/o magnesia at \$C.21 per bd ft.

(b) Preheated air duct: Mineral wool at \$C.05 per bd ft.

CHAPTER XI
WATER HANDLING EQUIPMENT

73. Water handling equipment consists of pumps and water softeners. Pumps may be either reciprocating or rotating; and water softeners may be either precipitating or base exchanging.

74. Types of Pumps--Pumps are used to move liquids, usually through pipe lines, and at the same time to increase the pressure (head) of the liquid.

Reciprocating pumps may be simplex or multiplex; steam driven or motor driven; or of the plunger or piston type. Figures X-1 and X-2 show two of the various types of reciprocating pumps. Reciprocating pumps have the advantage of being able to operate at extremely high discharge heads or extremely low suction (inlet) heads; and to operate at variable delivery with good efficiency.

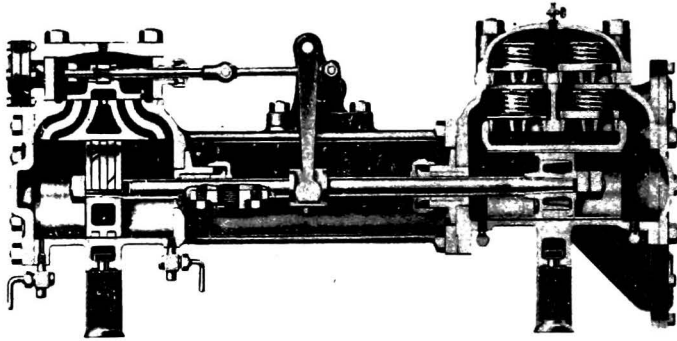

(Warren Steam Pump Co.)

Fig. XI-1. Duplex steam driven pump.

Rotating pumps may be centrifugal, turbine, screw or gear; steam driven or motor driven; single stage or multi-stage. Figures XI-3 through XI-7 show a number of rotating pumps of various types. Rotating pumps have the advantage of simplicity and being adapted to direct drive by high speed turbines or motors. They have the disadvantage of being unable to start pumping at negative suction pressures without being primed. This disadvantage is not serious, however, because it is always possible to find a type of pump which can be installed with a flooded suction.

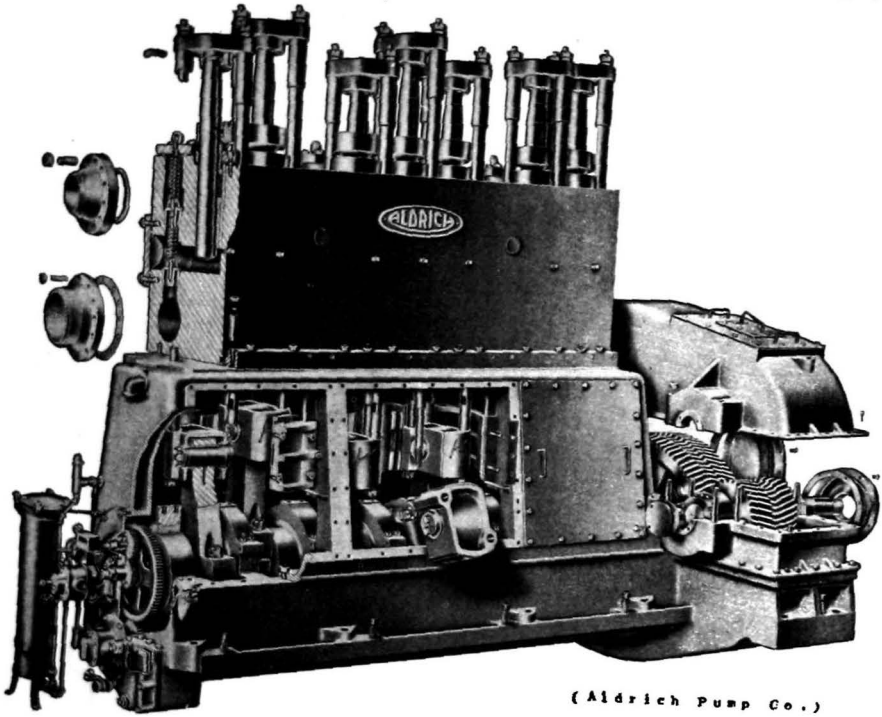

(Aldrich Pump Co.)

Fig. XI-2. Multiplex motor driven plunger pump.

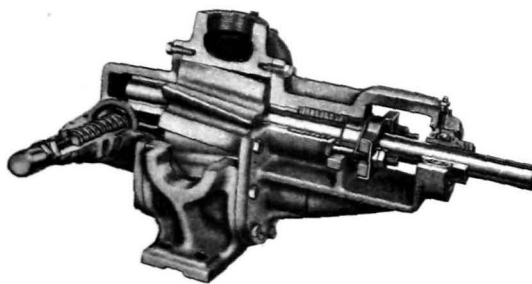

(Geo. D. Roper Corp.)

Fig. XI-3. Gear pump.

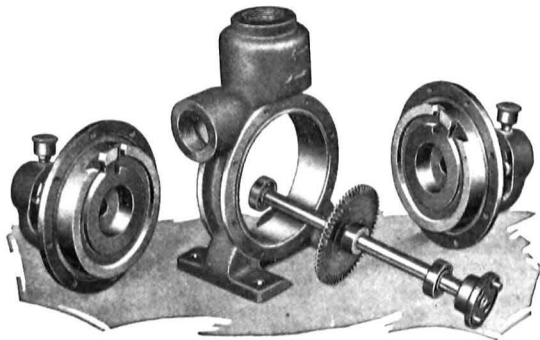

(Aurora Pump Co.)
 Fig. XI-4. Turbine pump.

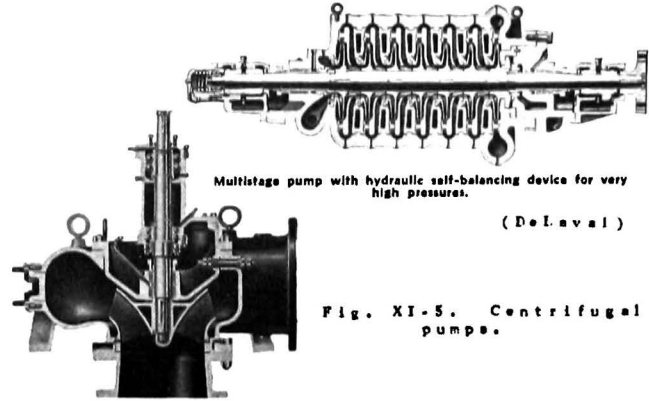

Multistage pump with hydraulic self-balancing device for very high pressures.
 (DeLaval)
 Fig. XI-5. Centrifugal pumps.
 Mixed flow pump for large capacity against low heads at high speed.

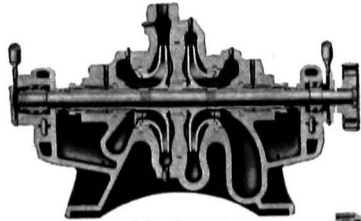

Opposed impeller series pump.
 Fig. XI-6. Centrifugal pumps.

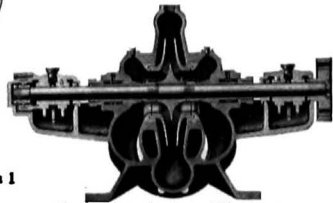

Single-stage, double-suction pump.
 (Sleeve or Ball Bearing)
 (DeLaval)

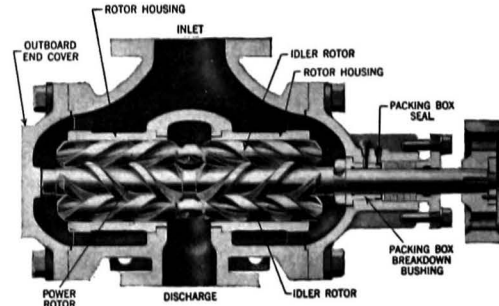

(DeLaval Steam Turbine Co.)
 Fig. XI-7. Screw pump.

75. Head and Work Relations in Pumps--Consideration of a pump as a work transferring device will show that the work input to the pump is equal to the work output plus the losses, or:

$$\text{whp} = e_p(\text{shp})$$

where: whp and shp = water horsepower
and shaft horsepower

e_p = pump efficiency

Water horsepower is the power required to move the water, or:

$$\text{whp} = \frac{M_w H_t}{60 \times 33000}$$

where: M_w = water flow, lbs/hr
 H_t = total head on pump,
ft of fluid

The total head on the pump is the sum of the friction losses in the pipe, the increase in velocity head through the pump, the entry losses and leaving losses for the system, the difference in pressure between inlet and discharge and the difference in static heads, or:

$$H_t = H_f + \frac{V_d^2 - V_i^2}{2g} + H_{s_d} - H_{s_i} + H_{p_d} - H_{p_i} + H_{e_d} + H_{e_i}$$

where: H_f = friction in piping, ft

V = velocity, ft/sec

H_s = static head, ft

H_p = pressure head, ft

H_e = entry and exit losses, ft

Figure XI-8 shows pump and pipe systems with the various heads in relation to the above equation. It should be noted that the static head on the inlet side of hot water pumps should always be great enough to prevent boiling in the eye of the pump impeller due to pressure reduction below the saturation pressure corresponding to the temperature of the water. An empirical equation which gives the static head at the pump suction is as follows:

$$h = 0.32 \times 10^{-7} t^{3.6}$$

where: h = static head on pump suction, ft.

t = water temperature, deg F.

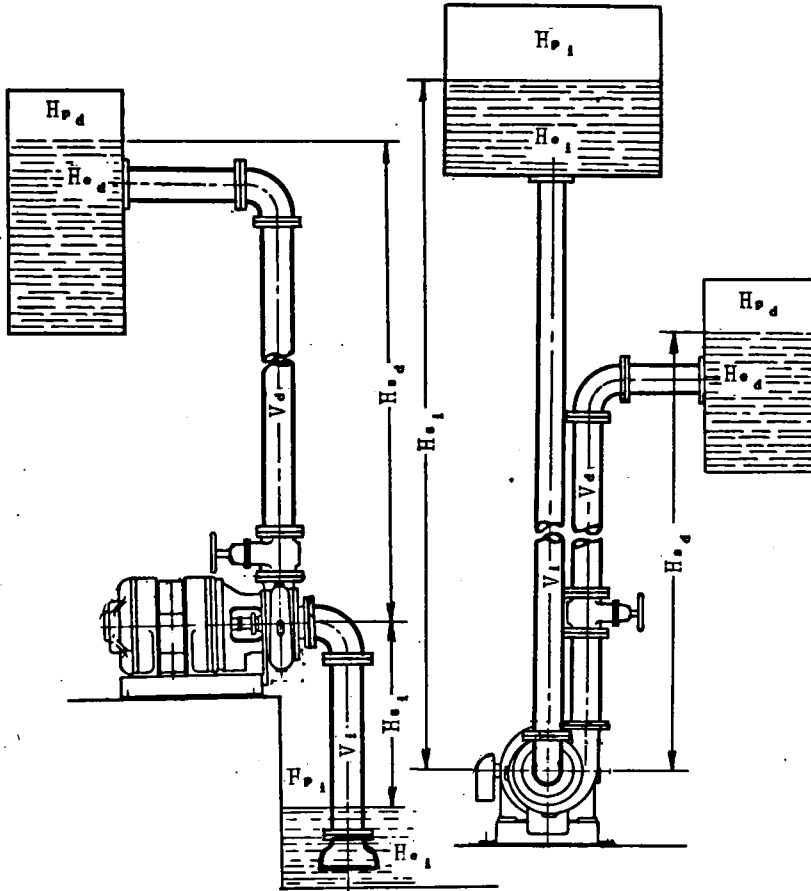

(a) Negative suction head (b) Positive suction head

Fig. XI-8. Head relations in pump systems.

76. Pump Efficiencies--In general, large slow speed pumps have higher efficiencies than small high speed pumps. Table XX shows the ranges of speed and efficiency to be

expected for various types of pumps for power plant service.

TABLE XX

CENTRIFUGAL PUMP DATA

	Cap., gpm	Head, ft	Speed, rpm	Eff., o/o
Boiler feed	10 to 400	300 to 6000	1200 to 3600	70
Condensate	10 to 400	50 to 300	1200 to 3600	70
Condenser	200 to 50000	10 to 50	120 to 450	80
General	5 to 100	10 to 300	1200 to 3600	75

77. Laws of Similarity for Centrifugal Pumps--The performance of centrifugal pumps follows certain definite patterns and laws. Figure XI-9 shows typical performance curves for two types of centrifugal pump. It will be noted that the head capacity curve has a falling characteristic and the horsepower curve reaches a maximum and then falls. The "self-limiting" power characteristic is of value in preventing the overloading of the driver in case the pump should operate against zero head.

The following equation expresses the laws of similarity for centrifugal pumps.

$$\frac{A_1}{A_2} = \frac{[B_1]^X [\rho_1]^Y}{[B_2]^X [\rho_2]^Y}$$

	X				Y				
A =	Q	M	P	H	Q	M	P	H	= A
B = N	1	1	3	2	0	1	1	1	D const
B = D	2	2	5	2	0	1	1	1	N const

where: Q = capacity, volume N = speed P = power
M = capacity, weight ρ = density H = head
D = diameter

It will be seen that, for any given pump, the quantity of water delivered varies directly with the speed, the head with the square of the speed and the power with the cube of the speed. The equation will be valuable in predicting the effect of changes of speed or impeller diameter for a particular pump.

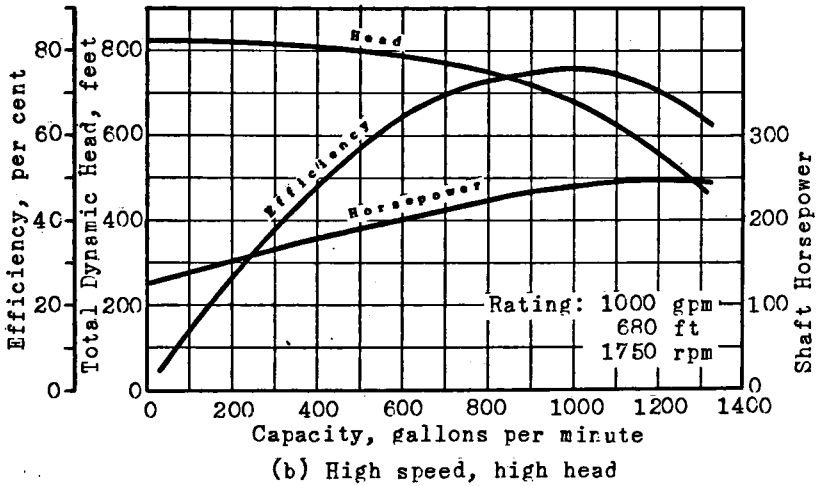
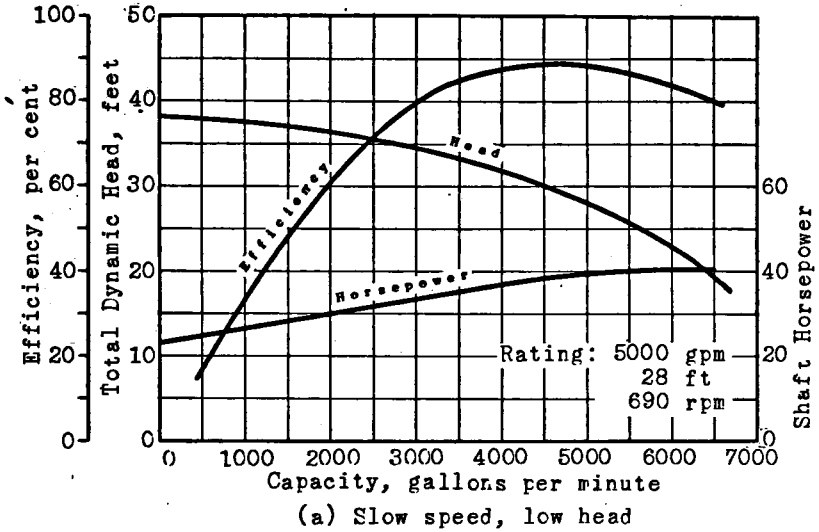

Fig. XI-9. Centrifugal pump performance curves.

Example 30 shows the method of computing the specifications for a centrifugal pump, and Example 31 shows the method of estimating the effect of changes in pump speed or impeller diameter.

Example 30.

Specify the capacity in gallons per minute and total dynamic head in feet for a centrifugal boiler feed pump to operate under the following conditions: Flow 28800 lbs/hr at 297 F; static lift 20 ft; friction losses 2 ft in suction line and 20 ft in discharge line; inlet velocity 5 ft/sec and outlet velocity 10 ft/sec; entrance and exit losses one-half of the velocity head; pressure in boiler 400 psia and in open heater 64 psia.

Solution:

The capacity of the pump is:

$$\text{Cap.} = 28800(0.01742)(7.48)/60 = 62.5 \text{ gpm}$$

The total dynamic head is:

Static lift	20 ft
Friction losses	22
Velocity head $[10^2 - 5^2]/2g$	1.2
Entrance and exit losses	0.6
Press. head $(400 - 64)(144)(0.01742)$	= 843 ft
Total dynamic head	886.8 ft

Example 31-A.

A centrifugal pump with an impeller diameter of 12 in. operates at 3600 rpm and delivers 100 gpm at 300 ft head. What would be the capacity and head if (a) the impeller diameter were reduced to 10 inches, or (b) the speed were reduced to 1800 rpm?

Solution:

(a) At constant speed, the capacity and head are proportional to the square of the diameter.

$$\frac{100}{Q_2} = \frac{(12)^2}{(10)^2}$$

$$Q_2 = 69.5 \text{ gpm}$$

$$\frac{300}{H_2} = \frac{(12)^2}{(10)^2}$$

$$H_2 = 208 \text{ ft}$$

(b) At constant diameter, the capacity is proportional to the speed and the head is proportional to the square of the speed.

$$\frac{100}{Q_2} = \frac{3600}{1800}$$

$$Q_2 = 50 \text{ gpm}$$

$$\frac{300}{H_2} = \frac{(3600)^2}{(1800)^2}$$

$$H_2 = 75 \text{ ft}$$

Example 31-B.

A three stage boiler feed pump with 17 inch diameter impellers is rated at 1000 gpm at 675 ft TDH with a motor speed of 1750 rpm. The characteristic curves are shown as solid lines in Figure XI-10. It was found when the pump was placed into operation that the boiler feed system head loss had been overestimated, and instead of being 675 ft at 1000 gpm was actually 600 ft. It was proposed to correct the pump characteristics by turning down the outside diameter of the impeller. Calculate the required impeller diameter and plot the new characteristic curves for the pump.

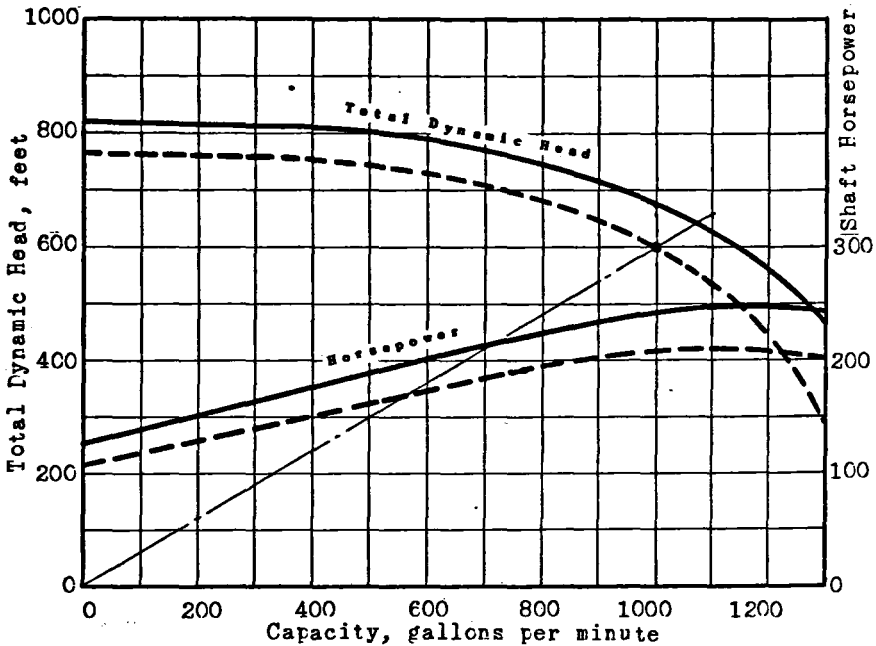

Fig. XI-10. Effect of reduced impeller diameter on centrifugal pump characteristics.

Solution:

An empirical method for determination of the new impeller diameter is as follows:

1. Draw a line from the origin through the new specification point to intersect the original head-capacity curve.
2. Read the head and capacity at the point of intersection and solve for the impeller diameter from both head and capacity relations in the pump equation.
3. Obtain the root mean square of the two solutions for impeller diameter.

This method can be illustrated, as follows:

1. The line from the origin through the new specification point intersects the original head-capacity curve at 640 ft and 1070 gpm.

2. Solving for impeller diameter,

$$\frac{1070}{1000} = \frac{(17)^2}{(D_2)^2} \qquad \frac{640}{600} = \frac{(17)^2}{(D_2)^2}$$

$$D_2 = 16.40 \text{ in.}$$

$$D_2 = 16.45 \text{ in.}$$

3. The root mean square of these two solutions is:

$$D_2 = \sqrt{\left[\frac{(16.40)^2 + (16.45)^2}{2} \right]} = 16.425 \text{ in.}$$

The new head curve can be plotted by applying the pump equation at several points on the original curve, as follows:

$$\frac{1200}{Q_2} = \frac{555}{P_2} = \frac{(17.000)^2}{(16.425)^2} = 1.07 \qquad Q_2 = 1120 \text{ gpm}$$

$$H_2 = 519 \text{ ft}$$

$$\frac{800}{Q_2} = \frac{745}{H_2} = 1.07 \qquad Q_2 = 748 \text{ gpm}$$

$$H_2 = 696 \text{ ft}$$

etc.

The new power curve can be plotted in a similar manner, as follows:

$$\begin{aligned} Q_1 &= 1200 \text{ gpm} & \frac{248}{P_2} &= \frac{(17.000)^5}{(16.425)^5} = 1.182 & P_2 &= 210 \text{ hp} \\ Q_2 &= 1120 \text{ gpm} & & & & \end{aligned}$$

$$\begin{aligned} Q_1 &= 800 \text{ gpm} & \frac{224}{P_2} &= 1.182 & P_2 &= 190 \text{ hp} \\ Q_2 &= 748 \text{ gpm} & & & & \end{aligned}$$

etc.

The new characteristic curves are shown as dotted lines on Figure XI-10.

78. Water Treatment--All natural waters contain quantities of dissolved salts which make the water undesirable for use in steam generators. Calcium and magnesium salts precipitate in the boiler to form scales or sludges which adversely affect the heat transfer coefficients. Sodium salts are soluble at all temperatures, but excessive concentrations of dissolved sodium salts lead to foaming which has the bad effect of causing deposits in superheaters and turbines. It is the purpose of water treatment to either remove the undesirable salts before they reach the boiler or to produce conditions within the boiler which are such as to cause precipitation of the undesirable salts in forms which will not produce scale and which can be easily removed from the boiler by blowdown.

Calcium and magnesium bicarbonates are soluble at ordinary temperatures, but when water containing them is boiled the bicarbonates decompose to carbonates and precipitate. The fact that bicarbonates can be removed by boiling gives them the name *temporary hardness* (hardness is a measure of the soap destroying power of water). Non-carbonate salts of calcium and magnesium produce what is termed *permanent hardness*, that is, boiling has no effect as with temporary hardness.

Hardness can be removed from water in two general ways (in addition to boiling to remove temporary hardness, which has no extensive commercial application): by precipitation or by base exchange.

79. Precipitation Softening--Precipitation softeners may operate either by the cold process or by the hot process. Due to the fact that most of the slightly soluble calcium and magnesium salts exhibit a decreasing solubility with increasing temperature, the hot process of softening is more efficient than the cold process. There are cases, however, where the cold process must be used (such as softening of municipal water supplies). Following are detailed explan-

ations of the various processes.

The cold lime and alum process uses either quicklime or hydrated lime for the precipitation of temporary hardness and filter alum for the production of a floc which aids in the coagulation of the precipitate and in the removal of bacteria and dirt. Figure XI-11 shows a typical softener operating with this process. The reactions are:

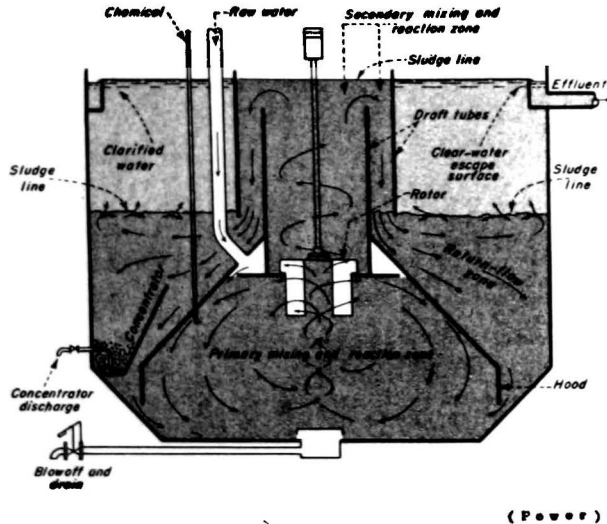
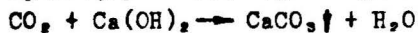
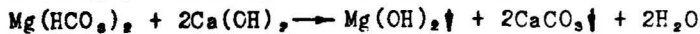
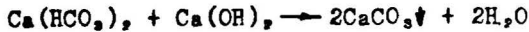
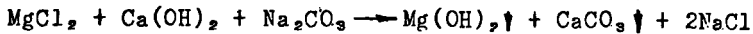

Fig. XI-11. Cold process softener.

The lowest hardness which can be produced by this process is about 70 parts per million, which is the solubility of calcium carbonate at ordinary temperatures.

The cold lime-soda and alum process uses lime and alum, as in the previous process, plus soda ash to precipitate non-carbonate hardness. The apparatus employed is identical with that used for the lime and alum process. The additional reactions are:



In this process it is customary to use excess soda ash in order to depress the solubility of calcium carbonate by common ion effect. Figure XI-12 shows the hardness attainable by the use of excess soda ash.

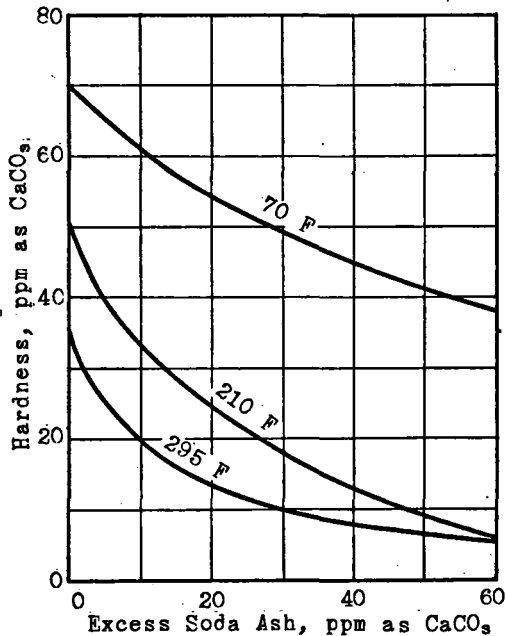

Fig. XI-12. Residual hardness resulting from use of excess soda ash.

The hot lime-soda process is similar to the cold lime-soda and alum process, except that the alum is not used because at elevated temperatures magnesium hydroxide forms a floc. The reactions are the same as previously given, and the residual hardness can be estimated from Figure XI-12. Figure XI-13 shows a typical hot process softener with its auxiliaries.

Example 32 shows the method of calculation of quantities of chemicals required for softening by the various

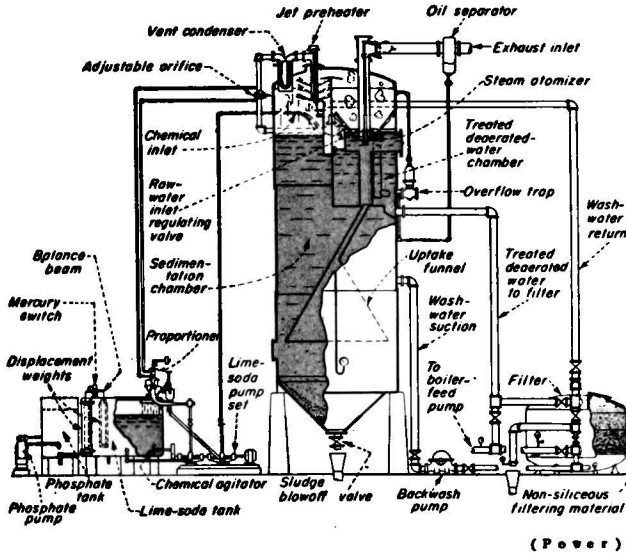

Fig. XI-13. Hot process softener.

precipitation methods. Useful chemical tables will be found in the Appendix.

Example 32-A.

A water of the following analysis is to be softened with lime and coagulated with 10 ppm of aluminum sulphate (filter alum): Ca = 62 ppm; Mg = 31 ppm; Na = 38 ppm; HCO₃ = 250 ppm; SO₄ = 139 ppm; Cl = 11 ppm; CO₂ = 16 ppm. Determine the weight of 90 o/o hydrated lime and 95 o/o crystalline filter alum required per thousand gallons of water.

Solution:

The first step in the solution is the conversion of the ionic analysis to the hypothetically combined form, as follows:

Ions	ppm	+epm	-epm	Combinations	epm	ppm
Ca	62	3.10		Ca(HCO ₃) ₂	3.10	251.5
Mg	31	2.55		Mg(HCO ₃) ₂	1.00	73.2
Na	38	1.65		MgSO ₄	1.55	93.5

Ions	ppm	+epm	-epm	Combinations	epm	ppm
HCO ₃	250		4.10	Na ₂ SO ₄	1.34	95.1
SO ₄	139		2.89	NaCl	0.31	18.2
Cl	11		0.31			
Sub.tot	531	7.30	7.30		7.30	531.5
CO ₂	16					16
Total	547					547.5

It will be noted that the hypothetical combinations are made in a definite order, as follows:

Positive ions	Negative ions
Ca	HCO ₃
Mg	SO ₄
Na	Cl

Next, the reactions are written with molecular weights and parts per million, as follows:

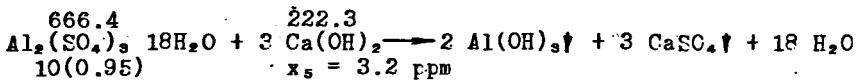
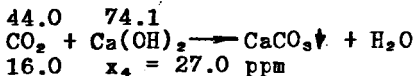
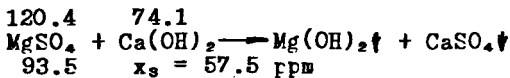
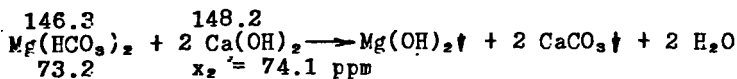
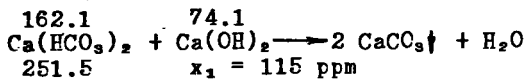

Total 90 o/o hydrated lime required = $276.8/0.90 = 308$ ppm
 Total 95 o/o filter alum required = 10 ppm

The final water analysis would be: NaCl = 18 ppm;
 Na₂SO₄ = 95 ppm; hardness about 70 ppm as CaCO₃.

One thousand gallons of water = 8.33×10^{-3} million lbs.
 Therefore, the lime required is 2.56 lbs per thousand gallons
 and the alum required is 0.083 lbs per thousand gallons.

Example 32-B.

The water of Example 32-A is to be softened by the lime soda and alum process. In order to depress the solubility of calcium carbonate, 25 ppm of excess soda ash is added. Determine the weight of 95 o/o soda ash required in addition to the lime and alum.

Solution:

The reactions with molecular weights and parts per million are:

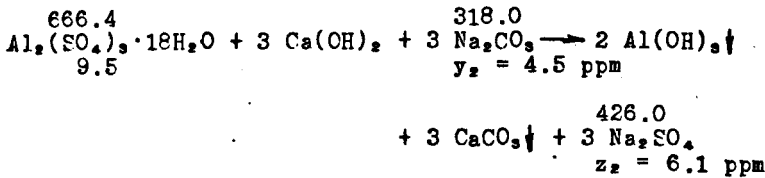
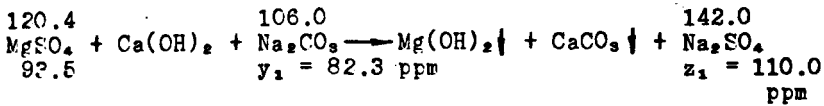

The total 95 o/o soda ash required (including excess) is $111.8/0.95 = 118 \text{ ppm}$.

The final water analysis would be: $\text{NaCl} = 18 \text{ ppm}$; $\text{Na}_2\text{SO}_4 = 211 \text{ ppm}$; $\text{Na}_2\text{CO}_3 = 25 \text{ ppm}$; hardness about 50 ppm as CaCO_3 .

The soda ash required would be 0.98 lbs per thousand gallons.

If this water were to be softened by the hot lime soda process (atmospheric pressure), the alum would be omitted and the final water analysis would be: $\text{NaCl} = 18 \text{ ppm}$; $\text{Na}_2\text{SO}_4 = 205 \text{ ppm}$; $\text{Na}_2\text{CO}_3 = 25 \text{ ppm}$; hardness about 22 ppm as CaCO_3 . Slightly less lime would be used because of the omission of the alum.

80. Base Exchange Softening--Several natural minerals called *zeolites* (complex sodium aluminum silicates) have the property of base exchange, that is, they will exchange their sodium for calcium or magnesium, or vice versa, depending upon which is present in the greatest concentration in the solution passing over them. Synthetic zeolites of various types have been made which have greater exchange capacity

than the natural materials as well as the ability to operate with acids or bases.

The sodium cycle exchanges sodium for calcium or magnesium in the softening run, and vice versa in the regenerating run. Regeneration is accomplished with strong brine (ordinary salt) solution. Some of the reactions are:

Softening:

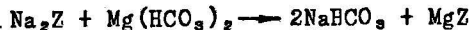
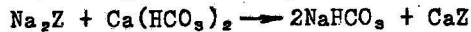

Regeneration:



Both magnesium and calcium chlorides are extremely soluble and are washed out, with the excess brine, with raw water. When the wash water becomes soft the washing is stopped and the zeolite is ready for another softening run. Figure XI-14 shows a typical zeolite softener which operates on the sodium cycle.

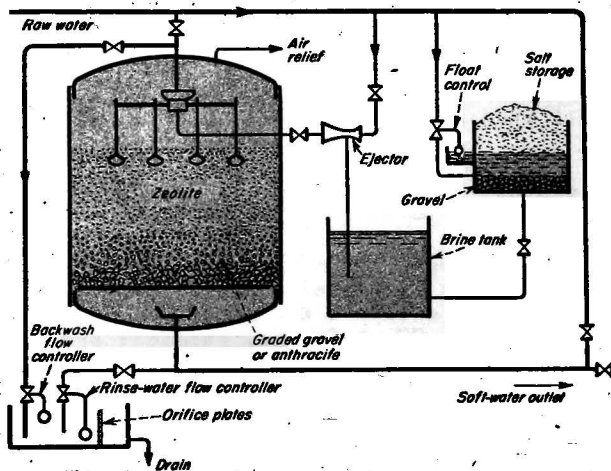

(Power)

Fig. XI-14. Zeolite softener, sodium cycle.

The hydrogen cycle exchanges hydrogen for all metals, and the regeneration is accomplished with acid. Some of the reactions are:

Softening:



Regeneration:

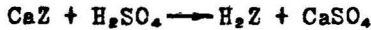

The carbonic acid can be removed from the water by aeration. The other acids produced in this cycle are extremely corrosive, so the water is blended with effluent from a sodium cycle softener before aeration to produce essentially neutral water by the reaction of sodium bicarbonate with the acids. Figure XI-15 shows a typical zeolite softener which operates on the dual cycle.

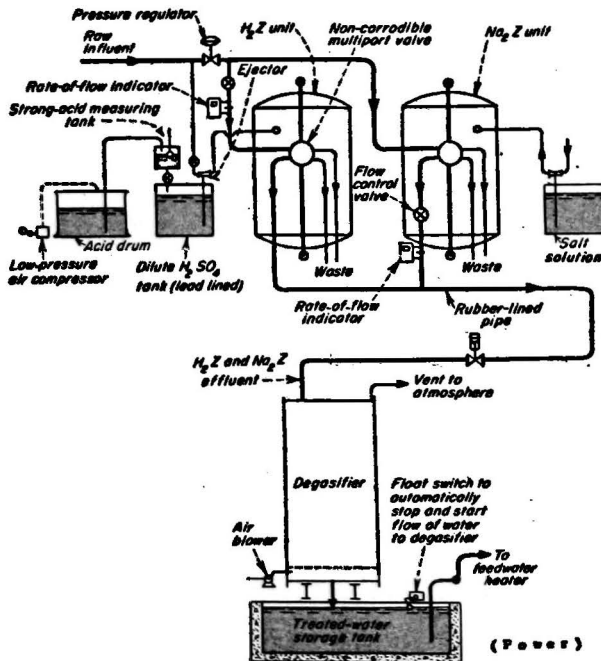
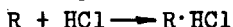

Fig. XI-15. Zeolite softener, dual cycle.

The acid adsorbing cycle employs a synthetic resin which has the property of being able to adsorb acids from solution and of being regenerated by alkali, as follows:

Adsorption:



Regeneration:



When the acid adsorbing cycle follows a hydrogen zeolite cycle and a deaerator water of almost as good quality as commercially distilled water is produced. The process is quite economical and requires much less investment than a distillation plant where pure water is required for industrial use. It does not appear, however, that the process has any advantages over the evaporator in a regenerative power cycle.

81. Boiler Water Treatment--Even in cycles which use evaporators for makeup water it is necessary to use some form of boiler water treatment because contamination of the boiler water results from even a small amount of condenser leakage or carryover from evaporators. It is even more necessary to treat boiler water in cycles where makeup is raw or softened water. Boiler water treatment has four objectives:

1. To prevent corrosion of the boiler or power piping.
2. To prevent embrittlement of boiler metal.
3. To prevent formation of scale in the boiler.
4. To prevent the formation of deposits in superheaters or turbines.

The methods of accomplishing these objectives are as follows:

Corrosion is prevented by maintaining the boiler water within a narrow alkaline range as indicated by the pH (which should be between 10 and 11) and by removing as much as possible of the dissolved gases in the condensate or boiler feed before it reaches the boiler.

The alkalinity is maintained by the use of caustic soda, soda ash or one or more of the polybasic phosphates. The phosphates have the advantage of helping to prevent scale; caustic soda has the disadvantage of inconvenience in hand-

ling as well as the ability to cause boiler embrittlement when not closely controlled; and soda ash has the disadvantage of decomposing to caustic soda and releasing carbon dioxide which, when in solution, is corrosive to piping.

The removal of dissolved gases was discussed under feed-water heaters. The best deaerating feed-water heaters will not remove all of the dissolved oxygen from the boiler feed, so it is customary to maintain a residual of about 10 ppm of sodium sulphite in the boiler water to act as an oxygen scavenger, according to the reaction:

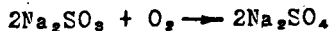

The sodium sulphate produced has the advantage of helping to inhibit boiler embrittlement.

Boiler embrittlement, which is caused by caustic attack on intergranular cementite, is prevented primarily by avoiding riveted boiler drums, and inhibited in all cases by maintaining concentrations of certain materials in the boiler water. The best known inhibitor is sodium sulphate which is maintained at a ratio of about three to one with relation to the concentration of sodium carbonate in the boiler water. Trisodium phosphate has an embrittlement inhibiting property, and will replace an equal weight of sodium sulphate for this purpose. Organic inhibitors, such as sodium lignin sulphate (from sulphite paper mill wastes) and quebracho extract (a tannin) are also used to some extent.

Scales formation is usually prevented or minimized by maintaining a residual of phosphate ion (about 50 ppm) in the boiler water. Calcium phosphate is less soluble than calcium carbonate or calcium sulphate, which are the principal constituents of boiler scale, but it precipitates as a sludge which is much less adherent than the other calcium precipitates. Sludge conditioners, such as sodium alginate (from certain seaweeds) and starches, are sometimes used to improve the fluidity of the sludge, thus making it easier to remove by boiler blowdown.

Deposits in superheaters and turbines are the result of carryover of solids from the boiler with the steam. These deposits can be prevented or minimized by careful attention to the maintenance of a practical minimum of dissolved solids in the boiler water by proper blowdown, and by the installation of efficient steam purifiers inside the boiler. Figure XI-16 shows several types of steam purifiers which are used in modern steam generators.

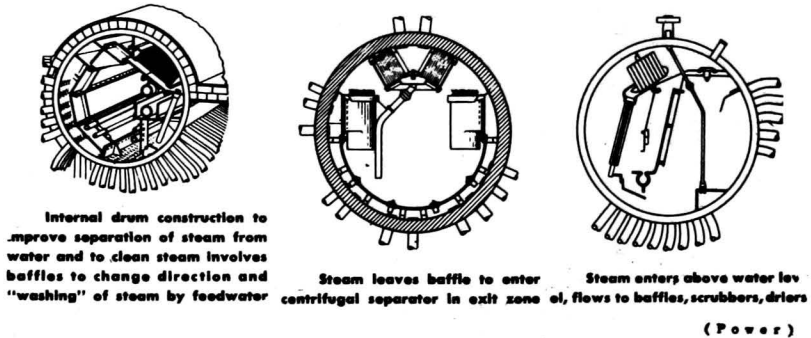

Fig. XI-16. Steam purifiers.

BIBLIOGRAPHY

- Baker, M. D., "Mechanical Purification of Steam within the Boiler Drum," *Transactions A.S.M.E.*, November, 1939.
- Dawson, L. J., "High Pressure Boiler Feed Pump Practice," *Combustion*, November, 1942.
- Joos, C. E., "Hot Process Treatment of Feedwater for High Pressure Boilers," *Combustion*, July, 1930.
- Ryan, W. J., *Water Treatment and Purification*, McGraw-Hill, New York, 1937.
- Spannhake, W., "Problems of Modern Pump and Turbine Design," *Transactions A.S.M.E.*, April, 1934.
- Tiger, H. L., "Carbonaceous Zeolites—An Advance in Boiler Feedwater Conditioning," *Transactions A.S.M.E.*, May, 1938.
- Yoder, J. D., "Hot Process Softener vs Evaporator," *Power*, October, 1931.

CHAPTER XII

FUEL HANDLING EQUIPMENT

82. The simplest fuel handling equipment will be found in the plant which burns gas. The complexity of the system increases when fuel oil is used, and becomes a large part of the plant investment when coal is burned.

83. Gas Burning Equipment--The fuel handling equipment for a gas burning plant would consist of a pipe line bringing the gas to the plant, a gas holder (when the supply is subject to fluctuation), gas meters, control valves and burners. Figure XII-1 shows the elements of a gas fuel system and figure XII-2 shows a typical gas burner.

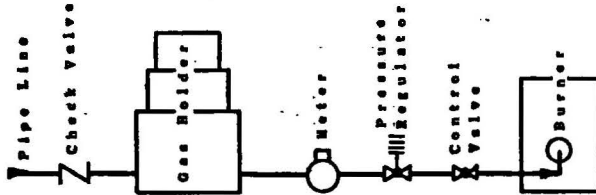

Fig. XII-1. Gas fuel system.

84. Fuel Oil Burning Equipment--The fuel handling equipment for a fuel oil burning plant would consist of unloading facilities (docks or railroad sidings), tanks (for about a 30 day supply), pumps, strainers, heaters, control valves and burners. Figure XII-3 shows the elements of a fuel oil burning system and Figure XII-4 shows a typical oil burner with mechanical atomizing and steam atomizing burner tip details. Figure XII-5 shows a so-called rotary cup oil burner which embodies a forced draft primary air fan, fuel oil pump and controls. This type of burner is well adapted to small



(Parney Engineering Co.)

Fig. XII-2. Gas burner.

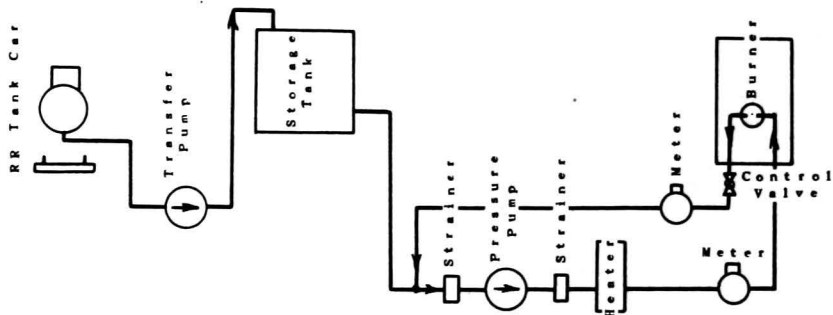

Fig. XII-3. Fuel oil system.

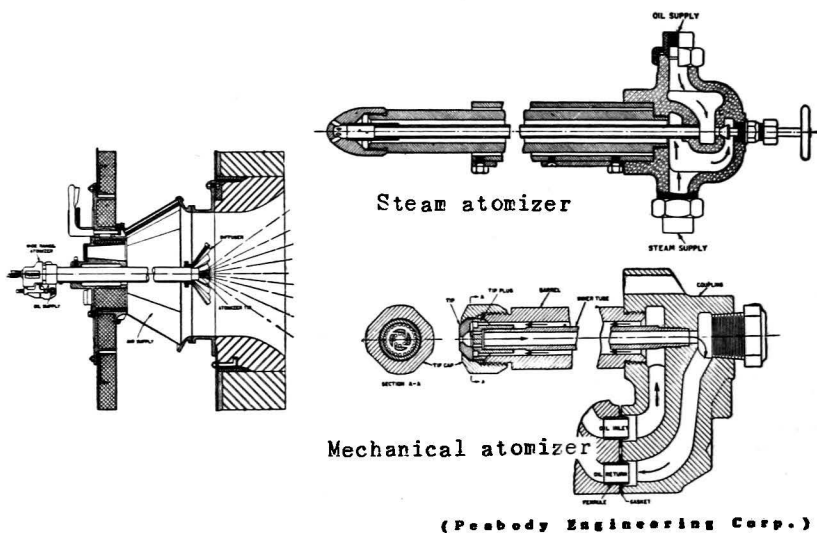
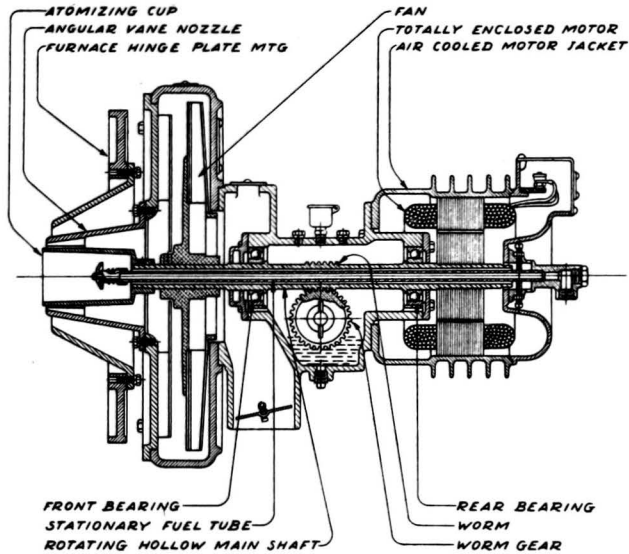

Fig. XII-4. Oil burner.

boilers, since burners of this type are available in sizes to handle up to about 200 boiler horsepower.

85. Coal Burning Equipment--The variety of fuel handling equipment for a coal burning plant is quite large. Whether the plant burns lump coal or pulverized coal, a storage yard of sufficient size for about a 30 day supply of



(Ray Oil Burner Co.)

Fig. XII-5. Rotary cup oil burner.

coal is necessary; as well as conveying equipment for storing and reclaiming the coal, bringing the coal to sizing crushers and then to the plant bunkers. If the plant operates with lump coal it will be fed from the bunkers to the stokers through weighing devices. Then, after the fuel is burned, the ash must be disposed of in some way (some companies sell it for road surfacing or for concrete block aggregate). Figure XII-6 shows a typical lump coal (stoker) burning system, and Figure XII-7 shows a pulverized coal system of the direct firing type..

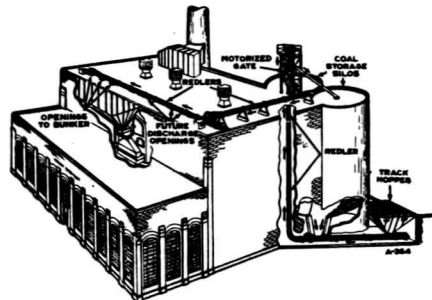

(Stephens-Adanson Mfg. Co.)

Fig. XII-6. Coal stoker system.

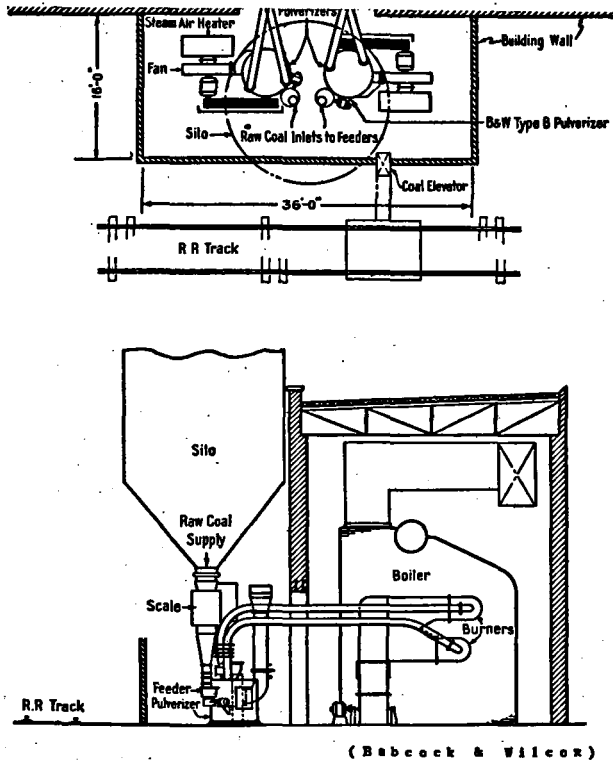

Fig. XII-7. Coal pulveriser system, direct firing.

Sometimes the pulverizers are operated to store pulverized coal in bunkers from which it is fed to the burners. The storage system requires smaller pulverizers than the direct firing system, but the storage of pulverized coal is hazardous and more plant space is taken up by the extra set of bunkers. Figure XII-8 shows a coal storage yard with the coal handling machinery.

86. Stokers--The equipment used for burning lump coal in a boiler furnace is known as a stoker, and it may be either underfeed or overfeed, depending upon whether the coal comes in under or over the air supply.

Overfeed stokers may be of the travelling grate type

(suitable for free burning coals), the chain grate type (suitable for caking coals), or the spreader type with dumping or travelling grates (suitable for a wide variety of coals). Figure XII-9 shows some of the various overfeed stokers in use at the present time.

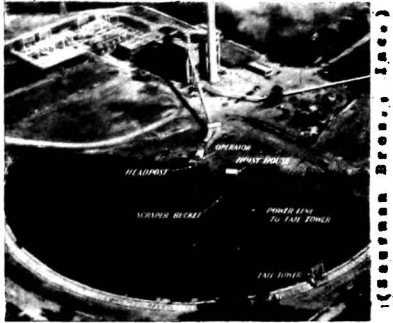

Underfeed stokers are of the retort type and are suitable for high volatile coals. There may be one or more retorts, depending upon the amount of fuel to be burned. Figure XII-10 shows typical single and multiple retort stokers presently in use.

(Link Belt Co.)

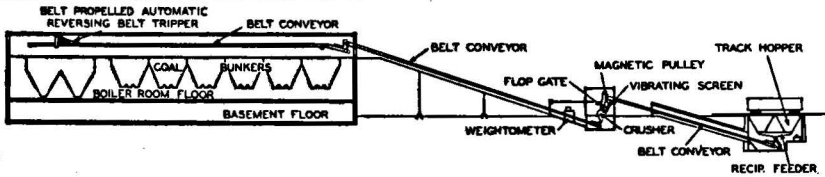

Fig. XII-8. Coal storage system.

Table XXI shows some approximate data for fuel burning rates per square foot of area for the various types of stokers.

TABLE XXI

FUEL BURNING RATES FOR STOKERS

Pounds per hour per square foot

Overfeed	
Spreader	25 - 40
Travelling and chain grates	
Anthracite	35
Bituminous	60
Underfeed	
Single retort	40
Multiple retort	50 - 60

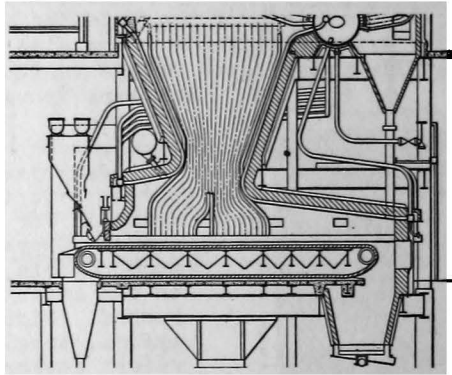

General arrangement

Travelling grate details

Chain grate details

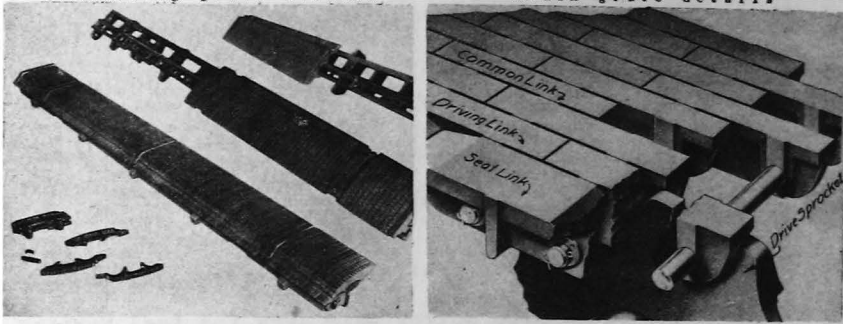

(a) Travelling grate or chain grate

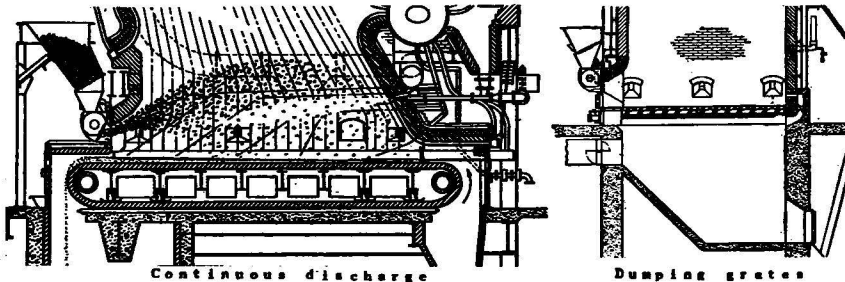

Continuous discharge

Dumping grates

(b) Spreader

(Comb. Engrg.-Suphte., Inc.)

Fig. XII-9. Overfeed stokers.

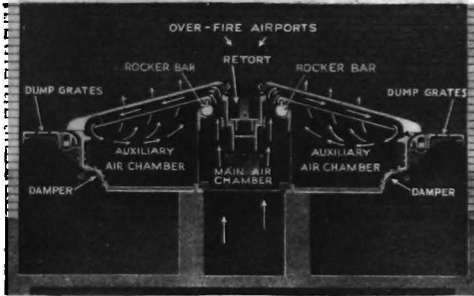
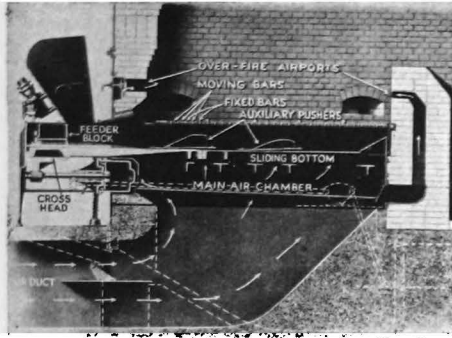

(Comb. Engrg. - Supptr., Inc.)

(a) Single retort.

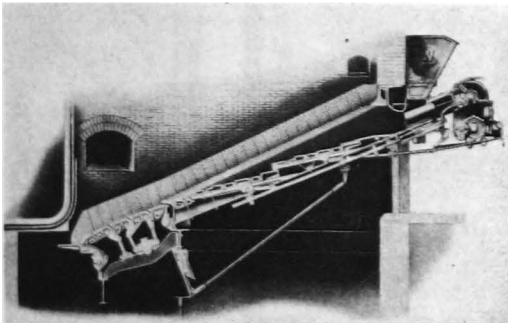

(Westinghouse Elec. Corp.)

(b) Multiple retort

Fig. XII-10. Underfeed stokers.

87. **Pulverizers**--The function of a pulverizer is to grind previously crushed coal to a fine powder (about 90 per cent through a 200 mesh screen) so that it will burn in a manner similar to gas or oil. The pulverizer may be of the types shown in Figure XII-11. Mill exhauster fans may be built into the pulverizer, as with the attrition mill, or they may be separate. Mill feeders may also be built in or separate. About twenty per cent of the total combustion air is used as primary air (always preheated) for conveying the coal from the pulverizers to the burners. Pulverizers require powerful motors, and Table XXII shows approximate power requirements for the various types of mill.

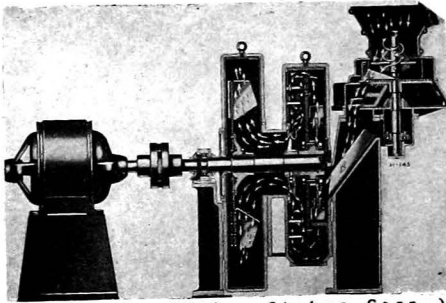

(Riley Stoker Corp.)

(a) Attrition mill

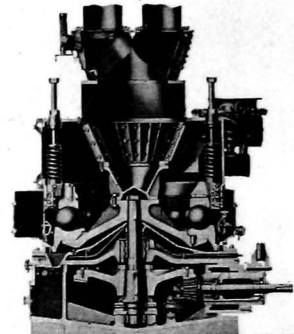

(Babcock & Wilcox)

(b) Ball mill

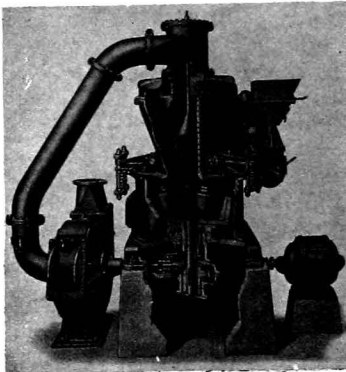

(Comb. Engrg.-Supptr., Inc.)

(c) Bowl mill

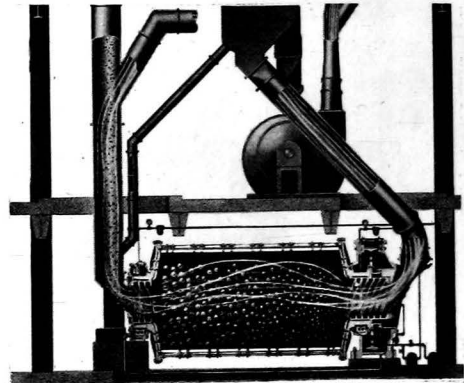

(Kennedy-Van Saun Mfg. Corp.)

(d) Tube mill

Fig. XII-11. Pulverizers.

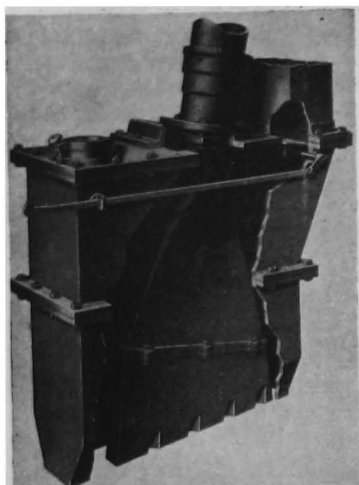

(a) Vertical

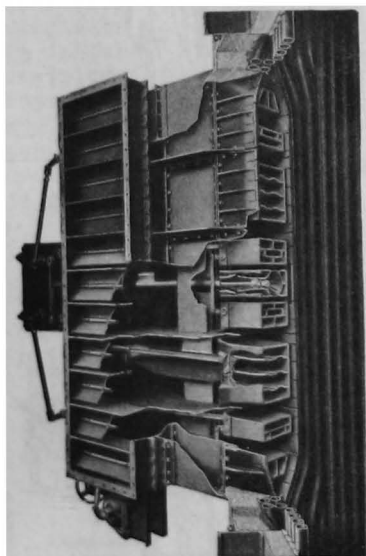

(b) Tangential

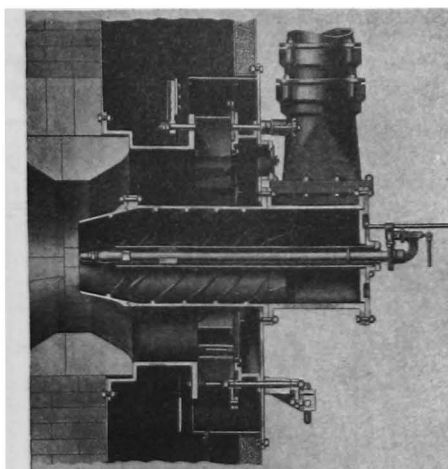

(c) Horizontal

(Comb. Engrg. - Suphtr., Inc.)

TABLE XXII
PULVERIZER POWER REQUIREMENTS

	KWH per ton
Ball and race mill	8 - 12
Bowl mill	11 - 16
Tube mill	11 - 17
Attrition mill	11 - 17

88. **Pulverized Coal Burners**--A pulverized coal burner is designed to mix the coal and primary air with secondary air as it is blown into the furnace. A few of the many types of pulverized coal burners are shown in Figure XII-12.

89. **Horizontal Cyclone Burner**--A recent development

Fig. XII-12. Pulverized coal burners.

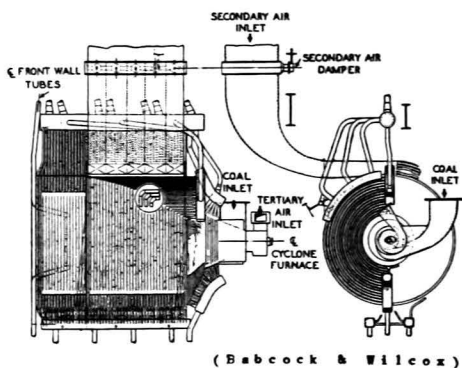
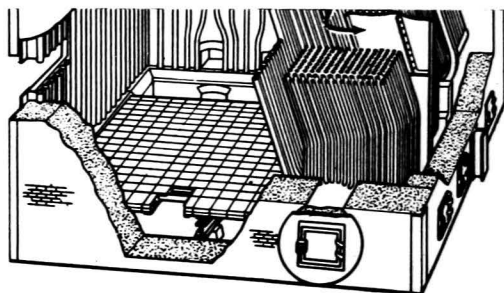
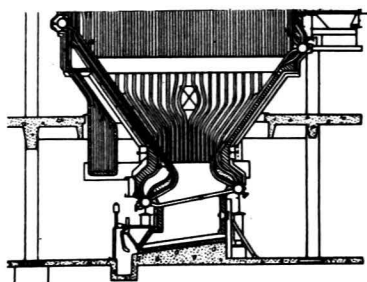

Fig. XII-13. Horizontal cyclone burner.

in coal burning equipment is the horizontal cyclone burner which is designed to burn low grades of coal at high rates without the necessity for pulverizing it. Figure XII-13 shows the burner which would be attached to the side of a furnace and connected into the waterwall circulation. The furnace is smaller than is usual with other



(a) Oil or gas



Dry bottom

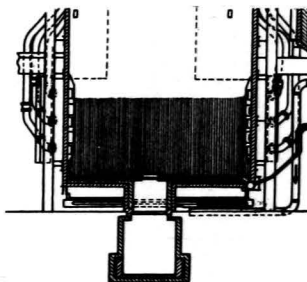

Wet bottom

(b) Pulverized coal

(Power)

Fig. XII-14. Furnace bottoms.

types of fuel burning equipment because most of the combustion takes place in the cyclone. Coal, crushed to about four mesh size, is fed with primary air at high velocity into the rear end of the burner where it is met by a high velocity tangential stream of secondary air. The coal sticks into a layer of molten slag and burns as the air blows across it. The slag is continuously moving toward a drain hole at the bottom of the burner front from which it drips into the main furnace.

90. Furnace Bottoms--Furnace bottoms vary in design depending upon the type of fuel to be burned. Some of the various types of furnace bottoms are shown in Figure XII-14. Furnaces for gas or oil usually have sloping flat water cooled bottoms. Furnaces for stokers, naturally, have the bottom made up of grates or retorts. Furnaces for pulverized coal may be of the wet or dry bottom types. The wet bottom type has little or no cooling surface on the furnace bottom, so that the ash which falls on it remains in the molten condition in a pool, from which it is tapped, either continuously or intermittently. The dry bottom furnace has a completely cooled hopper bottom, so that the ash which falls to the bottom is cooled sufficiently to be removed in granular form.

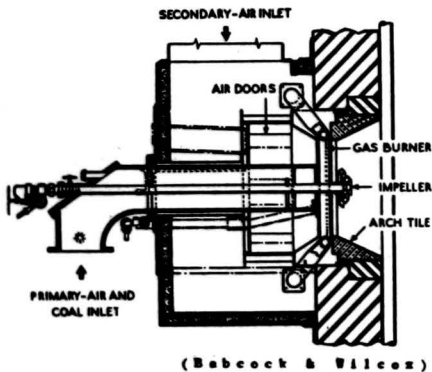

Fig. XII-15. Three-fuel burner.

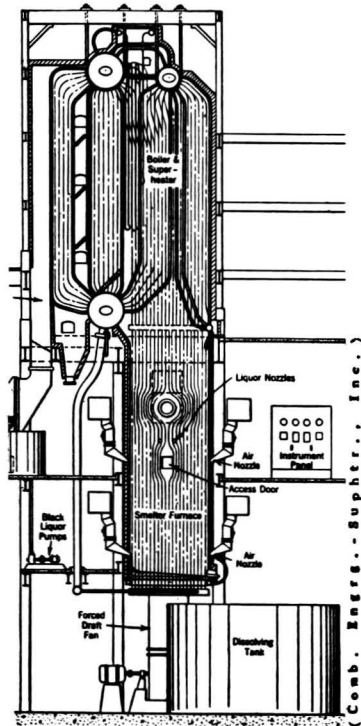

Fig. XII-16. Sulphate paper mill chemical recovery boiler.

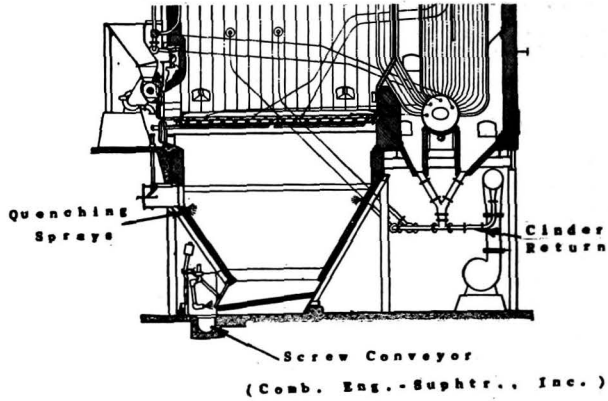

Fig. XII-17. Stoker ash disposal system.

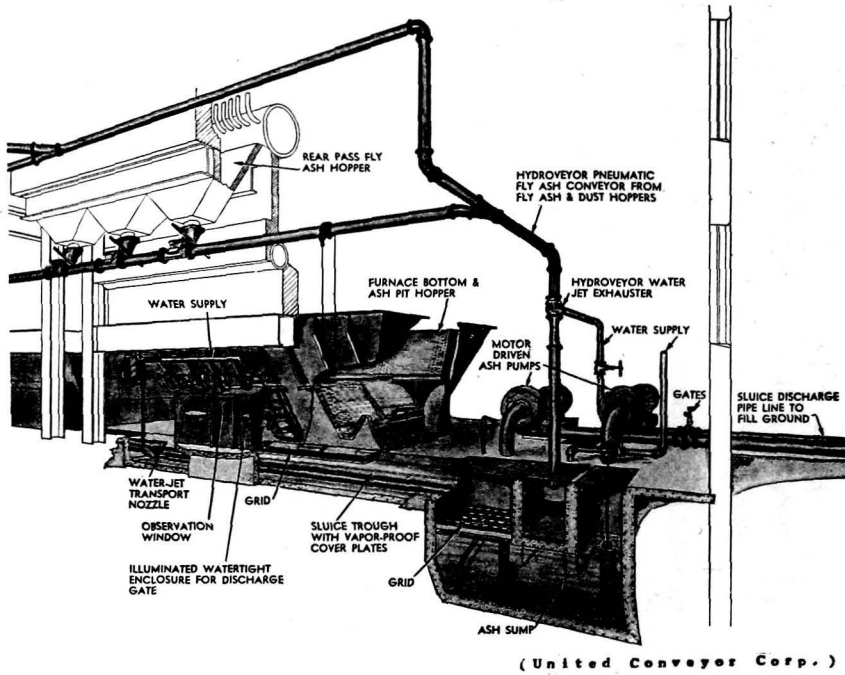

Fig. XII-18. Pulverized coal ash disposal system.

91. Multiple Fuel Burning Installations--In some localities more than one fuel may be available, and plants have been designed to burn two or three fuels separately or in combination. Figure XII-15 shows a three-fuel burner for pulverized coal, oil or gas. Other plants have been designed to burn industrial wastes in combination with some other fuel. Figure XII-16 shows a sulphate paper mill chemical recovery boiler which burns black liquor (containing lignin) in combination with fuel oil.

92. Ash Removal Systems--Coal burning plants must have some means of ash removal. Stoker firing produces a large cinder which can be dropped into a hopper car in an air lock under the boiler, or removed by a screw conveyor, as shown in Figure XII-17. Pulverized coal ash can be tapped from wet bottom furnaces into quench pits from which it can be transferred to any desired location by sludge pumps. Dry bottom furnaces may discharge into a conveyor or a quench pit as with the wet bottom furnace. One of these systems is shown in Figure XII-18.

93. Dust Collectors--Coal burning plants which are located close to population centers must be furnished with some sort of apparatus to remove dust and cinders from the flue gas in order to avoid the creation of a nuisance. Pulverized coal plants produce an extremely fine ash (called flyash), and at least half of the ash in the fuel goes along with the flue gas. Stoker fired plants do not produce significant amounts of flyash but some small cinders do travel through the steam generator. It is often thought that fuel oil produces no flyash, but some Florida cities have ordinances requiring dust collectors on fuel oil burning power plants within their municipal limits.

Cinder catchers operate on the principle of changing the direction of gas flow so that heavy particles will drop out of the gas stream. Figure XII-19 shows a cinder trap of this type.

Dust collectors may be of the centrifugal type, which operate in a manner somewhat similar to the cinder trap except that the gas velocity is higher; the electrostatic type which uses a high direct current potential to charge the

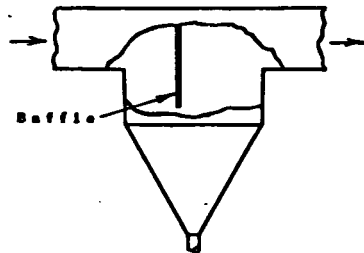
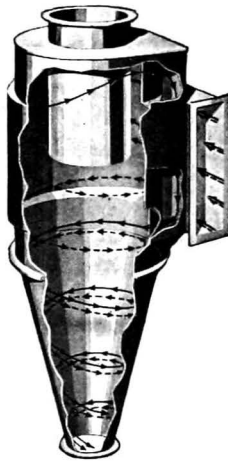
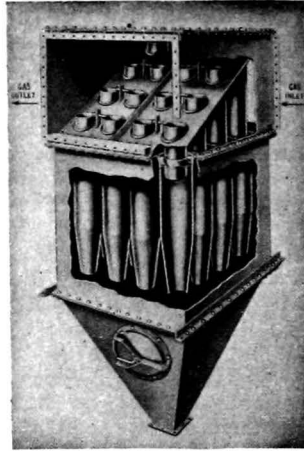

Fig. XII-19. Cinder trap.



(Buell Engrs. Co.)

(a) Single



(Western Precip. Co.)

(b) Multiple

Fig. XII-20. Cyclone dust collectors.

the dust particles so that they may be collected on electrodes; the bag type which employs fabric bags to filter the gas; and the wet scrubber which uses water for washing the gas. Figures XII-2C through XII-23 show these various types of dust collector.

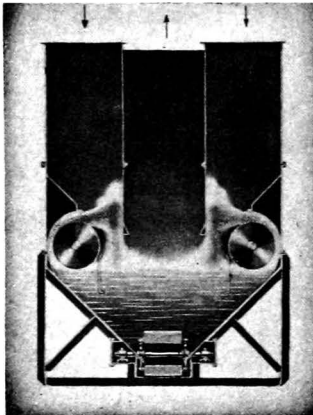

(Schweg Industries)

Fig. XII-21. Flue gas scrubber.

BIBLIOGRAPHY

- Grunert, A. E., Skog, L., and Wilcoxson, L. S., "The Horizontal Cyclone Burner," *Transactions A.S.M.E.*, August, 1947.
- Heinrich, K., "Dust Collector Comparison," *Combustion*, February, 1937.
- Kreisinger, H., "Combustion of Pulverized Coal," *Transactions A.S.M.E.*, May, 1938.
- Worker, J. G., and Bennett, J. S., "Development and Recent Design of Stoker-fired Equipment for Steam Generation," *Transactions A.S.M.E.*, Volume 50, 1927-28.

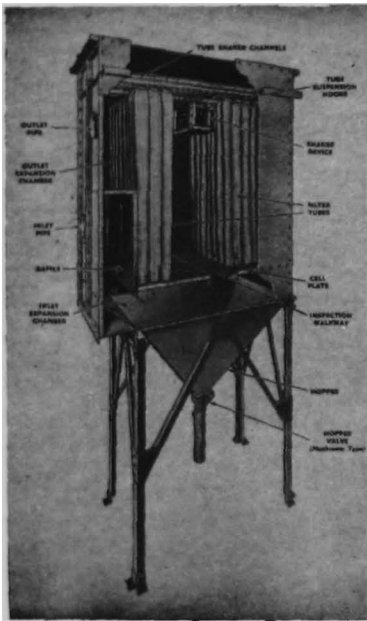

(Amer. Foundry Equip. Co.)

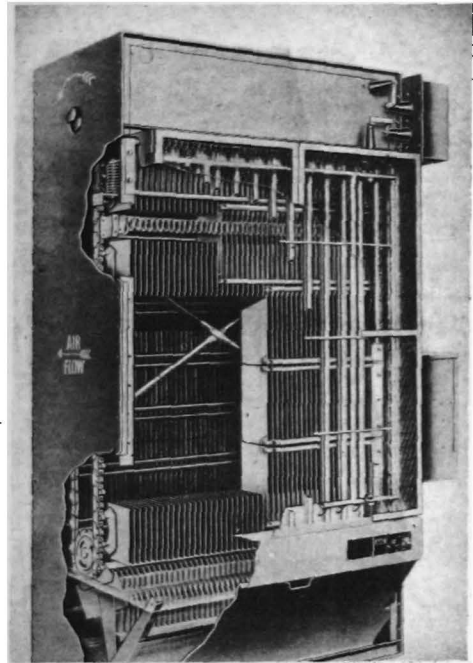

(American Air Filter Co.)

Fig. XII-22. Bag type dust collector.

Fig. XII-23. Electrostatic dust collector.

CHAPTER XIII
DRAFT EQUIPMENT

94. Draft equipment consists of fans and stacks (or chimneys) whose purpose is to supply air for the combustion of fuel and to remove the products of combustion from the steam generator for disposal to the surrounding air.

95. Fans--Fans in use for the production of draft are almost always of the centrifugal type, although some small installations use axial flow fans and the new horizontal burners use axial flow blowers.

Axial flow fans follow the same laws of similarity as centrifugal pumps, but the shapes of the characteristic curves are considerably different. It will be noted from

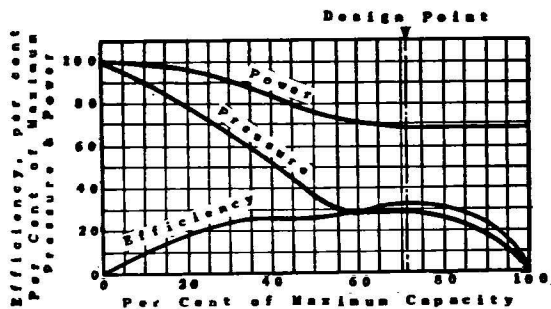
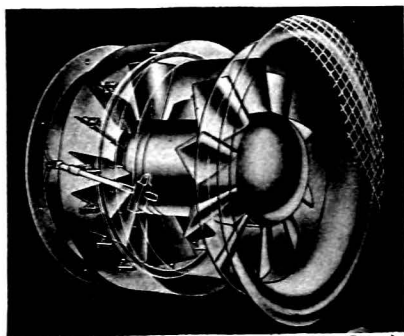

Figure XIII-1 that the pressure curve has an unstable region which makes it impossible to parallel two axial flow fans within the region of best operating efficiency.



(L. J. Wing Co.)

Fig. XIII-1. Axial flow fan characteristics.

Centrifugal fans follow the same laws of similarity as centrifugal pumps, but their characteristic curves will have somewhat different shapes due to the use of several different types of blade arrangement. Blade arrangements, as shown in Figures XIII-2 through XIII-5, may be either forward curved, backward curved, radial or combination.

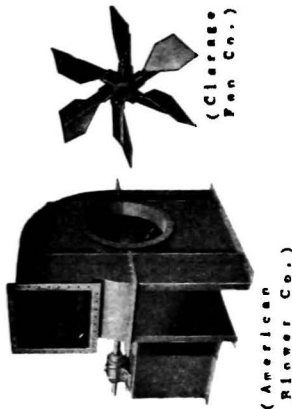
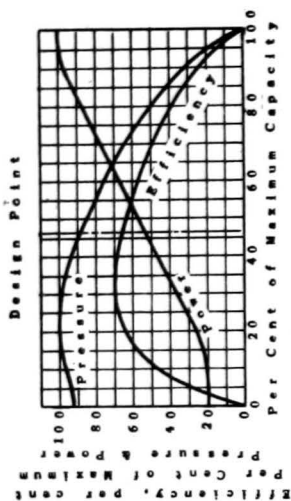

FIG. XIII-3. Radial blade fan characteristics.

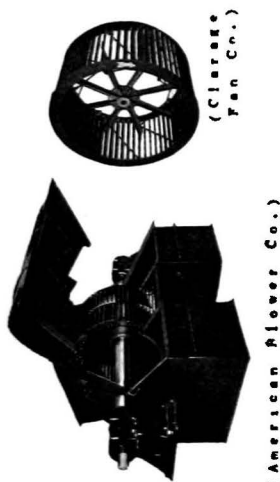
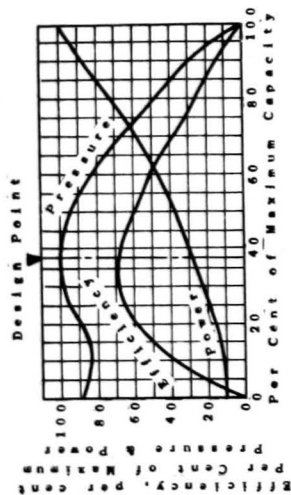

FIG. XIII-2. Forward curved blade fan characteristics.

The forward curved blade fan has a limited application in power plants because it is possible to overload the motor at zero head. In addition, it is impossible to operate these fans in parallel because of the existence of more than one point on the head-capacity curve which has the same ordinate. Such a characteristic leads to hunting (instability) in the system.

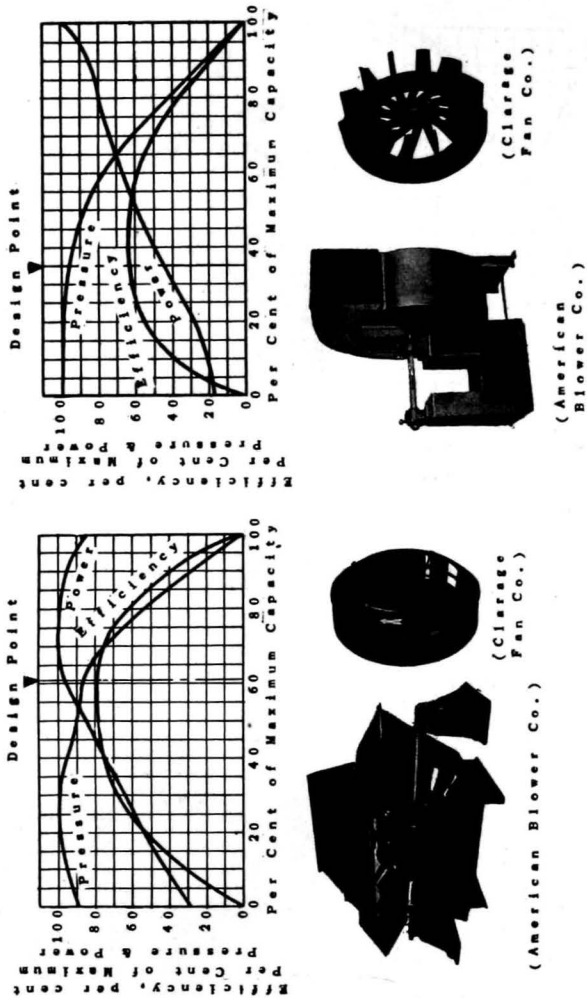

Fig. XIII-4. Backward curved blade fan characteristics.

Fig. XIII-5. Combination blade fan characteristics.

The radial blade fan is extensively used in pulverizer exhausters because it is difficult for the blades to become fouled. Otherwise, the power characteristic is unfavorable as with the forward curved blade fan.

The backward curved blade fan is the most popular type in use in power plants because, like the centrifugal pump,

it has a self-limiting power characteristic, and, due to the continually falling head-capacity characteristic, two or more fans can be operated in parallel without hunting.

The combination blade fan has characteristics intermediate between those of the radial and backward curved blade fans.

96. Head and Work Relations in Fans--As previously mentioned, centrifugal fans are similar to centrifugal pumps, the only difference being in the fluid pumped and the magnitude of the pressure rise. It can be seen that:

$$\text{ahp} = e_f (\text{shp})$$

where: ahp and shp = air horsepower
and shaft horsepower
 e_f = fan efficiency

Air horsepower is the power required to move the air, or

$$\text{ahp} = \frac{M_a H_t}{60 \times 33000}$$

where: M_a = flow, lbs/hr
 H_t = total head on fan
ft of fluid.

Since pressures in the steam generator combustion air and flue gas circuits are stated in terms of inches of water and fan capacities are stated in cubic feet per minute, air horsepower is also

$$\text{ahp} = \frac{62.4 Q h_t}{12 \times 33000}$$

where: Q = fan capacity, cu ft/min
 h_t = total pressure rise
through fan, in. water

The total pressure rise through the fan is the sum of the friction losses in the ducts and apparatus; the increase in velocity head through the fan; the losses at the entrance and exit of the system; the difference in pressure between the inlet and discharge; and the static head (or chimney effect), or

$$h_t = h_f + \frac{V_d^2 - V_i^2}{2g} + h_{s_d} - h_{s_i} + h_{p_d} - h_{p_i} + h_{e_d} + h_{a_i}$$

Figure XIII-6 shows a steam generator with its fan and duct system and the location of the various positive and negative pressures:

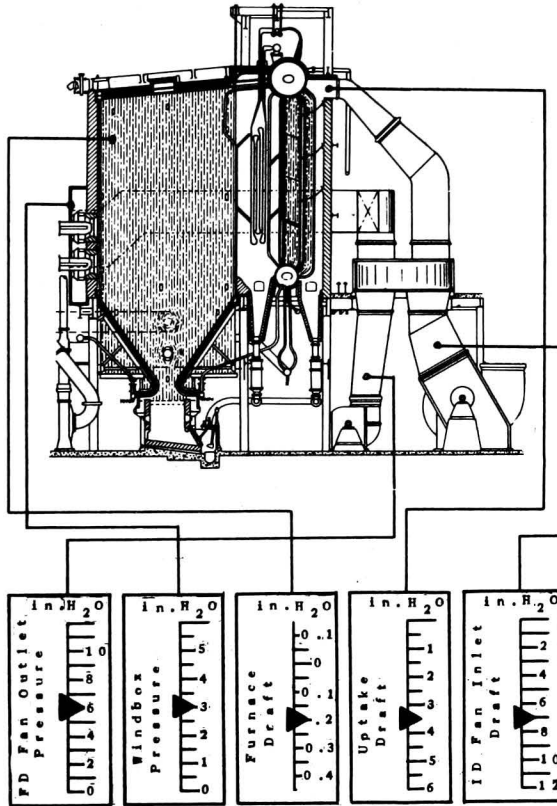

Fig. XIII-6. Steam generator fan and duct system.

97. Fan Speeds--The maximum efficiency of fans is approximately the same regardless of type or size. Larger fans will operate at slower speeds than smaller ones for the same head. Table XXIII shows the ranges of speeds and sizes to be expected for fans in use in power plants.

DRAFT EQUIPMENT

TABLE XXIII

ABBREVIATED PERFORMANCE—IMPROVED EXHAUSTERS—RIM OR L.H. WHEEL

Fan Size No.		11	13	15	17	19	21	23	25	29	33	37	41
Wheel Diam.		16"	20"	23"	26"	30"	33"	36"	40"	44"	50"	57"	66"
2' S.P. 2000 O.V.	CFM	1172	1398	1710	2170	3326	4312	5178	6120	6248	10640	13396	16464
	RPM	1303	1040	905	800	694	631	579	520	452	391	348	315
	BHP	.66	.90	1.23	1.98	2.00	2.43	2.92	3.46	4.96	6.03	7.96	9.30
3' S.P. 2800 O.V.	CFM	1463	1982	2712	3492	4407	5390	6470	7650	10310	13300	16748	20860
	RPM	1600	1285	1110	964	850	776	710	640	558	483	428	388
	BHP	1.25	1.66	2.31	2.97	3.75	4.58	5.50	6.50	8.90	11.50	14.20	17.50
4' S.P. 3000 O.V.	CFM	1758	2379	3285	4191	5289	6468	7764	9180	12372	15960	20094	24686
	RPM	1868	1490	1295	1140	990	908	830	745	647	562	498	450
	BHP	2.02	2.73	3.74	4.80	6.06	7.40	8.90	10.50	14.20	18.30	23.00	28.40
5' S.P. 3280 O.V.	CFM	1904	2577	3528	4540	5730	7007	8411	9947	13403	17290	21768	26754
	RPM	2065	1650	1430	1266	1100	1000	918	825	718	623	550	500
	BHP	2.70	3.66	5.00	6.48	8.14	9.91	11.90	14.10	19.00	24.50	30.90	38.00
6' S.P. 3800 O.V.	CFM	2051	2778	3797	4889	6170	7548	9098	10710	14434	18620	23443	28812
	RPM	2260	1808	1570	1390	1205	1098	1005	900	784	683	600	548
	BHP	3.48	4.72	6.48	8.30	10.80	12.80	15.40	18.40	24.58	31.70	39.80	49.00
7' S.P. 3780 O.V.	CFM	2197	2974	4068	5239	6610	8088	9708	11475	15468	19950	25117	30870
	RPM	2440	1950	1698	1495	1300	1180	1080	978	848	738	650	590
	BHP	4.34	5.98	8.08	10.38	13.05	15.98	19.15	22.60	30.50	39.40	49.90	61.00
8' S.P. 4000 O.V.	CFM	2344	3172	4340	5588	7052	8624	10352	12240	16496	21280	26792	32928
	RPM	2608	2090	1805	1600	1385	1268	1159	1040	903	782	692	630
	BHP	3.30	4.72	6.80	9.80	13.95	19.45	23.35	27.60	37.20	48.00	60.50	74.40
10' S.P. 4800 O.V.	CFM	2637	3568	4882	6288	7933	9702	11646	13770	18558	23940	30141	37044
	RPM	2920	2330	2028	1790	1580	1415	1298	1165	1010	880	778	708
	BHP	7.50	10.18	13.90	17.85	22.60	27.60	33.20	39.10	52.90	68.20	85.90	108.90
12' S.P. 5000 O.V.	CFM	2930	3968	5428	6985	8815	10780	12940	15300	20620	26800	33490	41180
	RPM	3218	2660	2228	1970	1710	1585	1428	1285	1110	968	858	778
	BHP	10.00	13.50	18.50	23.80	30.10	36.70	44.10	52.20	70.30	90.78	114.00	140.80

ABBREVIATED PERFORMANCE—TYPE HV FANS, SINGLE WIDTH, SINGLE INLET

Fan Size No.		1	1 1/4	1 1/2	1 3/4	2	2 1/4	2 1/2	2 3/4	3	3 1/4	3 1/2	4	4 1/4	5
Wheel Dia.		13"	16 1/4"	19 1/4"	22 3/4"	26"	29 1/4"	33 1/4"	38 1/4"	44 1/4"	50 1/4"	57 1/4"	62"	68 1/4"	80"
1/2' S.P. 1200 O.V.	CFM	1038	1613	2322	3156	4128	5220	6444	7782	9288	10990	12660	15524	20880	25800
	RPM	809	407	327	281	245	217	197	178	164	146	136	120	106	96
	HP	.12	.18	.22	.29	.38	.48	.59	.75	.85	1.04	1.22	1.59	2.00	2.47
1/2' S.P. 1300 O.V.	CFM	1127	1748	2516	3419	4472	5658	6981	8430	10062	11798	13715	17510	22620	27950
	RPM	637	510	412	353	308	273	247	224	206	188	174	152	135	122
	HP	.19	.29	.36	.49	.64	.81	1.00	1.20	1.44	1.64	1.90	2.48	3.13	3.87
1/2' S.P. 1400 O.V.	CFM	1208	1882	2709	3682	4816	6090	7518	9078	10836	12705	14770	17920	24360	30100
	RPM	748	598	490	420	367	325	294	264	245	222	206	180	160	144
	HP	.28	.44	.54	.73	.95	1.20	1.48	1.76	2.13	2.48	2.85	3.72	4.70	5.80
1' S.P. 1800 O.V.	CFM	1294	2016	2903	3945	5160	6525	8058	9727	11610	13613	15825	20655	26100	32250
	RPM	851	680	557	478	417	369	335	302	279	252	233	204	181	163
	HP	.39	.61	.72	.98	1.28	1.61	1.99	2.38	2.87	3.28	3.80	4.97	6.26	7.75
1 1/4' S.P. 1800 O.V.	CFM	1380	2150	3096	4208	5504	6960	8592	10375	12384	14520	16890	22032	27840	34400
	RPM	944	754	618	530	463	410	371	336	309	280	261	228	203	182
	HP	.52	.80	.93	1.26	1.66	2.09	2.58	3.13	3.72	4.33	5.02	6.55	8.27	10.2
1 1/4' S.P. 1800 O.V.	CFM	1552	2420	3482	4734	6192	7830	9666	11672	13932	16335	18990	24786	31320	38700
	RPM	1039	830	683	585	512	453	410	369	341	308	286	250	222	200
	HP	.70	1.09	1.30	1.77	2.31	2.92	3.61	4.29	5.20	6.27	7.62	9.82	12.6	15.8

NOTE: For performance of double width, double inlet HV Fans (available in sizes No. 1 1/4 and larger) multiply CFM x 2, RPM x 1.01, BHP x 2.1 and CV x 1.11.

ABBREVIATED PERFORMANCE—TYPE W FANS, SINGLE WIDTH, SINGLE INLET

Fan Size No.		1 1/4	1 1/2	1 3/4	1 3/4	2	2 1/4	2 1/2	2 3/4	3	3 1/4	3 1/2	3 3/4	4 1/4	4 1/4
Wheel Dia.		16 1/4"	17 3/4"	19 1/4"	22 3/4"	26"	29 1/4"	33 1/4"	38 1/4"	44 1/4"	50 1/4"	57 1/4"	64 1/4"	72 1/4"	80"
1/2' S.P. 1000 O.V.	CFM	1344	1627	1935	2630	3440	4350	5370	6485	7740	9075	10650	12900	15919	19390
	RPM	829	735	620	532	464	412	371	336	312	286	258	231	218	196
	HP	.11	.13	.14	.19	.25	.32	.39	.48	.57	.66	.77	.94	1.13	1.41
1/2' S.P. 1200 O.V.	CFM	1613	1952	2322	3156	4128	5220	6444	7782	9288	10990	12660	15480	18623	23268
	RPM	1038	840	732	699	594	528	468	422	396	366	336	306	276	252
	HP	.24	.29	.29	.40	.52	.66	.81	.98	1.17	1.37	1.59	1.94	2.34	2.92
1/2' S.P. 1300 O.V.	CFM	1747	2115	2516	3419	4472	5658	6981	8430	10062	11798	13715	16770	20175	25207
	RPM	1188	1078	928	778	682	604	544	494	454	418	389	351	320	286
	HP	.37	.45	.45	.59	.77	.98	1.20	1.46	1.73	2.04	2.36	2.89	3.48	4.35
1' S.P. 1400 O.V.	CFM	1882	2278	2709	3682	4816	6090	7518	9078	10836	12705	14770	18060	21777	27140
	RPM	1225	1203	1012	868	760	676	600	552	508	468	434	392	358	320
	HP	.51	.62	.60	.83	1.08	1.36	1.68	2.04	2.41	2.84	3.30	4.02	4.85	6.05
1 1/4' S.P. 1800 O.V.	CFM	2016	2441	2903	3945	5160	6525	8058	9727	11610	13613	15825	19350	23279	28688
	RPM	1469	1317	1108	948	830	736	664	604	554	511	474	428	390	349
	HP	.68	.82	.80	1.09	1.42	1.79	2.21	2.68	3.19	3.75	4.35	5.32	6.40	8.00
1 1/4' S.P. 1800 O.V.	CFM	2150	2603	3096	4208	5504	6960	8592	10375	12384	14520	16890	20640	24830	31024
	RPM	1567	1423	1204	1032	902	800	722	656	602	552	518	465	424	380
	HP	.86	1.04	1.01	1.37	1.80	2.25	2.81	3.41	4.03	4.76	5.48	6.75	8.13	10.15

NOTE: For performance of double width, double inlet W Fans (available in sizes No. 1 1/4 and larger) multiply CFM x 2, RPM x 1.01, BHP x 2.08 and CV x 1.11.

98. Draft Losses--Since a steam generator installation may include both forced and induced draft fans, the draft losses may be divided into two classifications, as follows:

1. Forced draft (pressure) losses (air system).
 - a. Loss in duct between fan and air heater.
 - b. Loss in air heater.
 - c. Loss in duct between air heater and windbox.
 - d. Loss through fuel bed or burner.
2. Induced draft losses (flue gas system).
 - a. Loss between furnace and boiler outlet.
 - b. Loss in duct between boiler and economizer.
 - c. Loss in economizer.
 - d. Loss in duct between economizer and air heater.
 - e. Loss in air heater.
 - f. Loss in duct between air heater and fan.
 - g. Loss in duct between fan and stack.

All of the draft losses, except those for the ducts, are usually taken from data supplied by the manufacturers, but the methods of estimating the losses are of interest.

Duct draft losses have been discussed in Chapter X.

Air heater draft losses vary according to the arrangement of the surfaces. The draft loss on the gas side of tubular air heaters can be estimated by treating the air heater tubes as round ducts in parallel and using the average gas velocity; considering the inlet and outlet boxes as part of the main ducts; and adding 0.05 inches of water draft loss for each right angle turn. The draft loss on the air side of tubular air heaters may be estimated by using the empirical formula (adding 0.05 in. H₂O for each right angle turn):

$$\Delta p = 0.0002307 \frac{f N (G/1000)^2}{\rho}$$

where: Δp = draft loss, in. water
 f = a friction factor
 = 0.06 for in-line tubes
 = 0.09 for staggered tubes
 N = number of restrictions
 ρ = arithmetic mean gas density, lbs/cu ft
 G = mass flow of gas, lbs/hr per sq ft of flow area

Fuel bed or burner draft losses can be estimated from Figures XIII-7 and XIII-8.

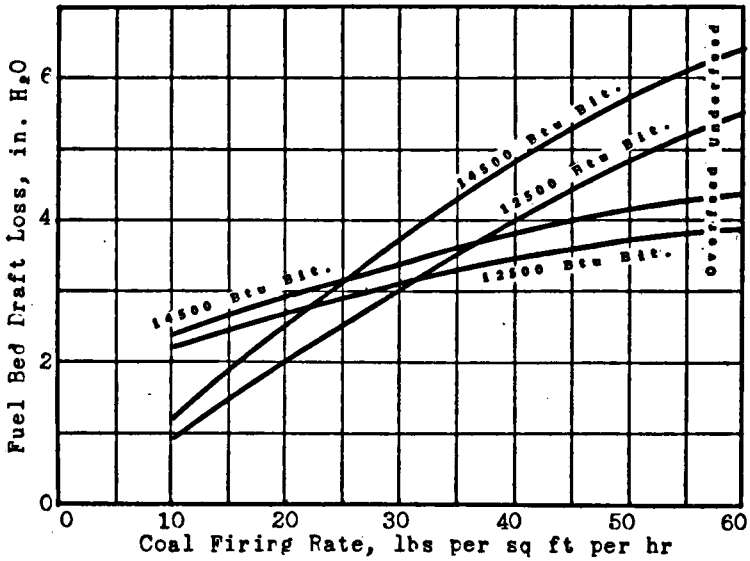

Fig. XIII-7. Fuel bed draft losses.

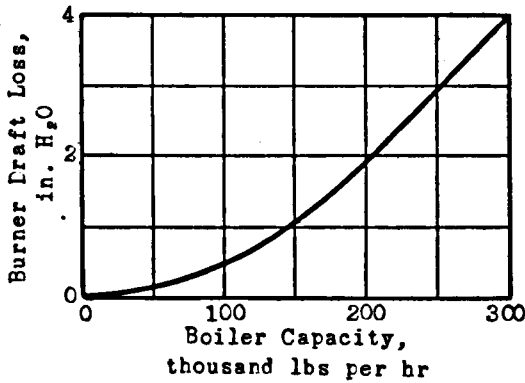

Fig. XIII-8. Burner draft losses.

Boiler, superheater and economizer draft losses depend upon the arrangement of the surfaces and the mass flow of the gas. Draft losses for fire-tube boilers can be estimated in the same manner as for the gas side of tubular air heaters. Draft losses for water-tube boilers, superheaters and economizers can be estimated in the same way as for the air side of tubular air heaters.

Due to the fact that ducts and boiler settings are never gas tight, an allowance of ten per cent on the gas volume and air volume should be made when specifying fan sizes. The normal practice is to control the furnace draft at between 0.1 and 0.2 inches of water to allow the opening of inspection doors without danger to the operators. Some modern steam generators, however, especially marine types and those utilizing the horizontal cyclone burner, dispense with the induced draft fan and operate entirely with forced draft. Figure XIII-9 shows some draft loss curves for a typical steam generator. It will be seen that, as in all devices involving fluid flow, the draft loss is proportional to the square of the quantity flowing.

Example 33 shows the method of making fan specifications

Example 33.

Determine the fan specifications for an oil fired boiler producing 300,000 lbs per hour of steam at 925 psia and 900 F from feed-water at 300 F. The fuel is that of Example 15 with a heating value of 18500 Btu/lb, and it is burned with 15 o/o excess air to produce a boiler efficiency of 89 o/o. Air temperature is 100 F and flue gas temperature is 300 F. The boiler draft losses are shown in Figure XIII-9.

Solution:

Heat added to steam = (1450.9 - 269.6) =	1180.3 Btu/lb
Oil fired = $\frac{300000(1180.3)}{0.89(18500)}$ =	21500 lbs/hr
Theoretical air	13.9 lbs/lb
Actual air = 13.9(1.15)	16.0 lbs/lb
Weight of air per hr. (incl. 10 o/o leakage)	378000 lbs/hr
Density of air at 100 F	0.07 lbs/ft ³
Volume of air at 100 F	88800 cfm

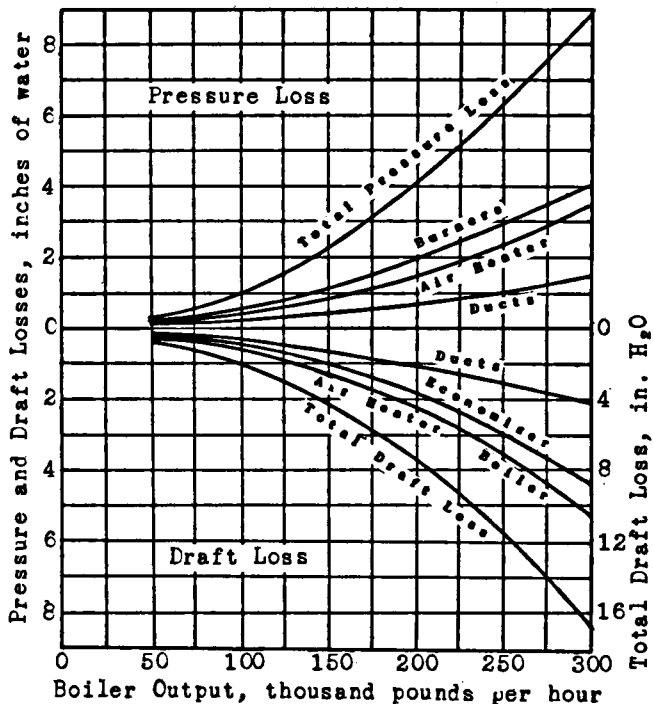

Fig. XIII-9. Steam generator draft losses.

Wet gas produced	17.0 lbs/lb
Weight of gas per hr. (incl. 10 o/o leakage)	402000 lbs/hr
Density of gas at 300 F	0.055 lbs/ft ³
Volume of gas at 300 F	122000 cfm

From Figure XIII-9, the forced draft loss is 8.8 in. of water, and the induced draft loss is 16.7 in. of water at a steam flow of 300,000 lbs/hr.

The fan specifications would be:

Forced draft fan: 89,000 cfm air at 100 F, 9 in. water.

Induced draft fan: 122,000 cfm gas at 300 F, 17 in. water.

99. Stacks--Small boilers may depend entirely upon stacks for the production of the necessary draft for operation, while large steam generators use stacks mainly for flue gas disposal, with draft production for emergency operation without the fans a secondary consideration. As a matter of fact, most large steam generators are completely incapable of being operated without the induced draft fan.

A stack produces draft because the hot gas inside is less dense than the air outside. The draft produced by a stack is proportional to the height of the stack and to the difference in density between the outside air and the flue gas, or (allowing for friction in the stack)

$$h = 0.254 B H \left(\frac{1}{T_a} - \frac{1}{T_g} \right) - 0.77 \frac{\rho f H^2}{D_i} \left(\frac{T_g}{T_a} - 1 \right)$$

where: h = draft produced by stack, in. water

B = barometric pressure, in. Hg

H = height of stack above duct inlet, ft

T_a = outside air temp, deg R

T_g = arithmetic mean gas temperature, deg R

ρ = density of gas, lbs/cu ft

D_i = inside diameter of stack, ft

f = a friction factor

= 0.0013 for steel stacks

= 0.0018 for brick-lined stacks

It will be seen that, if given a certain draft to be produced, both stack height and diameter will be unknown, but if the first term on the right hand side of the equation is solved the minimum stack height will be obtained. Then the dimensions can be determined by trial with due consideration to stability of self-supporting stacks and to economy of construction. As a general rule, a guyed stack can be designed for maximum economy, a condition that is obtained when the product of the height and diameter is at the minimum. Self-supporting stacks must be designed to give maximum economy within the range of stability, a condition which will be met when the ratio of diameter to height is between 0.03 and 0.08 and the product of diameter and height is nearest to that for maximum economy. Figures XIII-10 and XIII-11 show two common types of power plant stacks, and Example 34 shows the method of calculating stack dimensions.

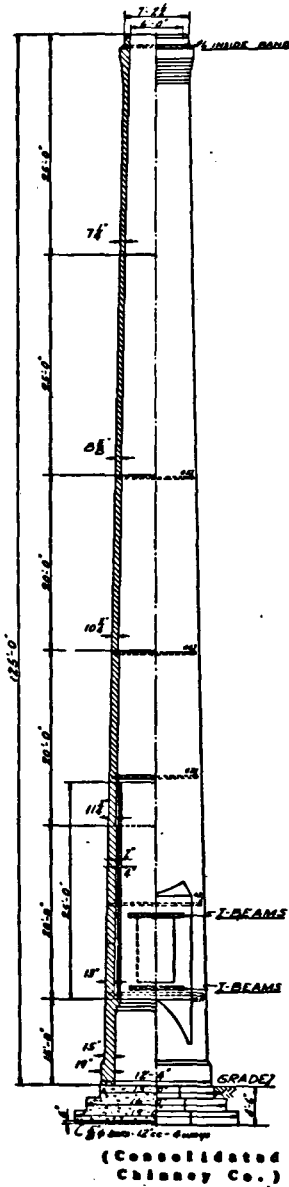

Fig. XIII-10. Radial brick stack.

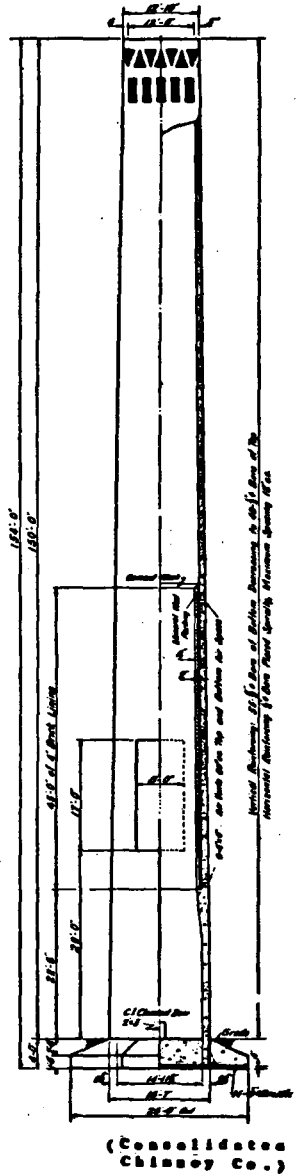

Fig. XIII-11. Reinforced concrete stack.

Example 34.

Determine the most economical dimensions for a brick stack to produce a draft of 0.6 inches of water for the boiler of Example 33. Barometric pressure is 30 inches of mercury and ambient temperature is 90 F.

Solution:

For a first approximation of the height,

$$0.6 = 0.254(30) H \left(\frac{1}{550} - \frac{1}{760} \right)$$

$$H_{min} = 156 \text{ ft}$$

Then, by trial in the equation for stacks:

$$0.6 = 0.00384 H - 0.0000226 \frac{H^2}{D_i}$$

H	160	170	180	190	200
D_i	38.6	12.3	8.0	6.3	5.4
HD_i	6180	2090	1448	1192	1070
D_i/H	0.241	0.072	0.045	0.033	0.027

It is apparent that the product HD_i is still decreasing at a stack height of 200 ft. From the standpoints of economy and stability, the best choice would be the 6.3 ft diameter by 190 ft tall stack.

BIBLIOGRAPHY

- Criqui, A. A., "What Type Fan for Forced and Induced Draft?" *Power*, May, 1934.
- Hagen, H. F., "Farallel Operation of Fans," *Combustion*, April, 1936.
- Marks, L. S., *Mechanical Engineers' Handbook*, McGraw-Hill, New York, 1941.
- Patterson, W. S., "Selection of Mechanical Draft Fans," *Combustion*, August, 1938.

CHAPTER XIV
SUPERVISORY AND CONTROL EQUIPMENT

100. Every power plant contains a great variety of instruments and equipment for indicating, recording and controlling the performance of the plant in many details. The various instruments and controls may be divided into classifications as to the variable, such as temperature, pressure, speed, fluid level, combustion conditions, chemical characteristics and fluid flow.

101. Temperature--Temperature may be indicated by mercury thermometers, bourdon tube thermometers, thermocouples or electric resistance thermometers. In addition, all of these devices, except the mercury thermometer, may be made to control temperature by means of secondary devices such as valves or switches and may be made to record the temperature with relation to time. Figures XIV-1 through XIV-5 show some of the many temperature devices which are used in power plants.

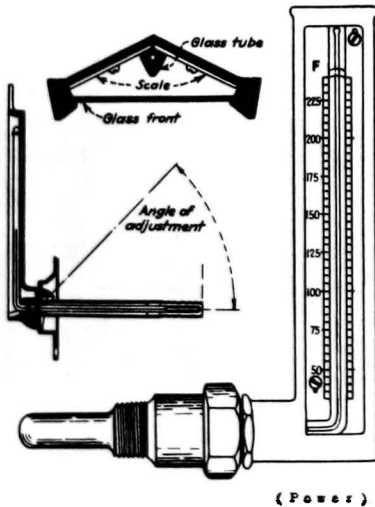

Fig. XIV-1. Industrial mercury thermometer.

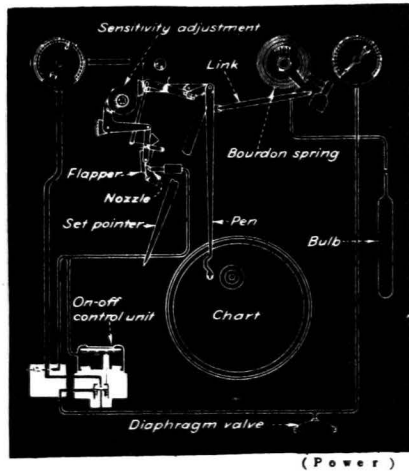

Fig. XIV-2. Air operated temperature controller.

102. Pressure--Pressures may be indicated by manometers using various fluids, bourdon gages or diaphragm gages, depending upon the pressure range to be covered. The ranges

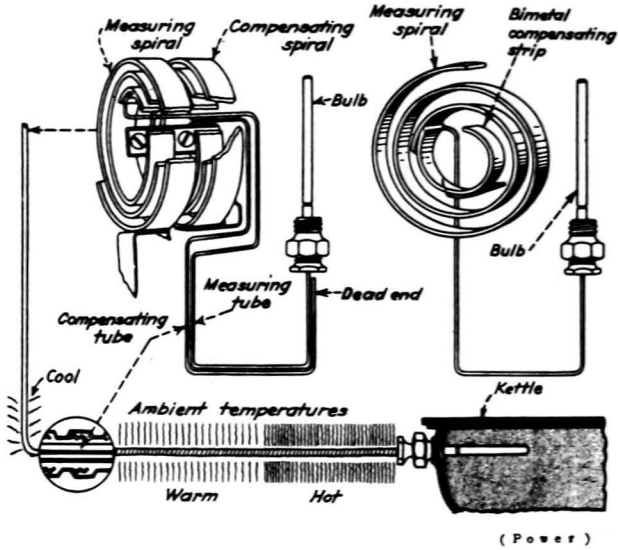

Fig. XIV-3. Bourdon tube thermometers.

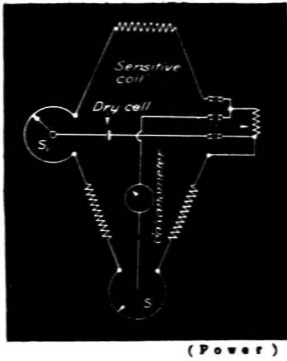

Fig. XIV-4. Electric resistance temperature bridge.

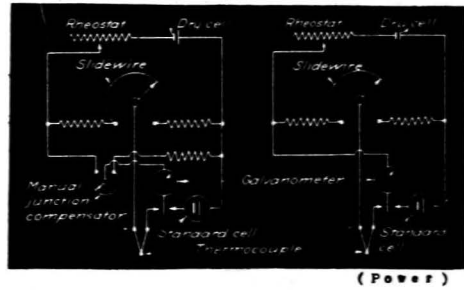

Fig. XIV-5. Thermocouple temperature potentiometers.

of usefulness of these various types overlap somewhat, but in general, manometers are used for indicating pressures in the range from 0.001 inch of water to 100 inches of mercury; diaphragm gages for indicating, recording or controlling pressures in the range from 0.01 inch of water to 10 pounds per square inch; and bourdon gages for indicating, recording or controlling pressures in the range from one pound per

square inch to the maximum obtainable. Figures XIV-6 through XIV-10 show some of the instruments of this class.

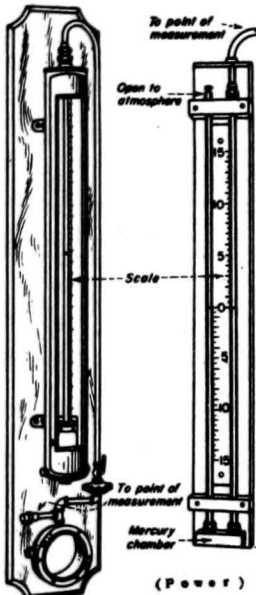

Fig. XIV-6. Mercury manometers.

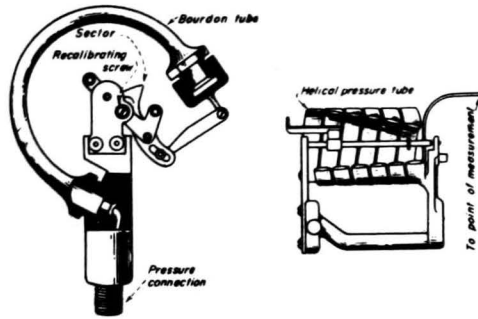

Fig. XIV-7. Bourdon tube pressure gages.

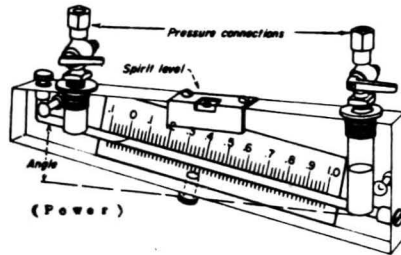

Fig. XIV-9. Inclined draft gage.

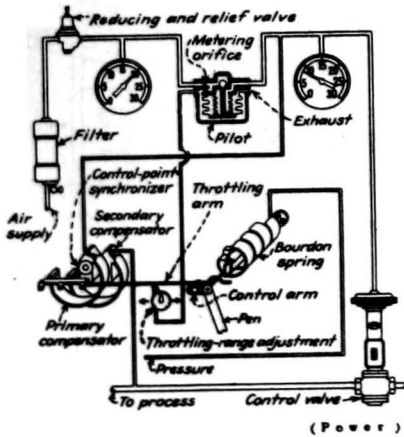

Fig. XIV-8. Air operated pressure controller.

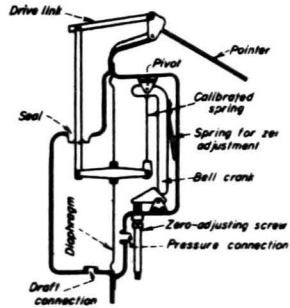
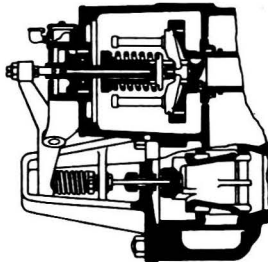

Fig. XIV-10. Diaphragm draft gage.

103. Speed--The most common speed controlling device is the centrifugal flyball resisted by a spring, as shown in Figure XIV-11. The radial motion of the flyballs may be transferred to a throttle valve for controlling the speed of a turbine or engine within predetermined limits. A change in speed is always necessary to actuate the controlling device, therefore flyball governors have regulation characteristics as shown in Figure XIV-12. Since turbo-generators or engine-generators are constant speed apparatus, it is necessary to provide a device for readjusting the flyballs to a new load position. This device is arranged to adjust the governor spring tension or the throttle valve position, either locally or remotely by manual or automatic means.



(Power)

Fig. XIV-11. Flyball governor, direct acting.

The hydraulic governor is found on certain makes of steam turbines and consists essentially of an oil pump on the turbine shaft which produces a pressure which is proportional to speed in the same relation as with a flyball device. The pressure produced by the pump is resisted by a spring which has a load adjustment as in the flyball type of governor. A governor of this type is shown in Figure XIV-13.

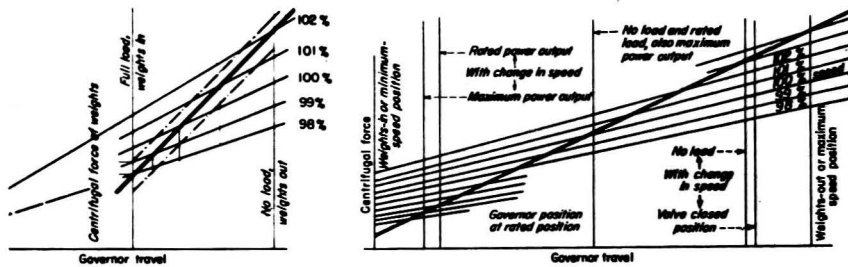

(Power)

Fig. XIV-12. Governor characteristics.

The direct acting flyball or hydraulic governors are satisfactory for small turbines or engines of not more than a few hundred kilowatts capacity, but in larger sizes the governing forces are not sufficient to operate the heavy valve gear. To overcome this difficulty, hydraulic relays of various kinds are used to amplify the governor forces. Figures XIV-14 and XIV-15 show two of these relay systems.

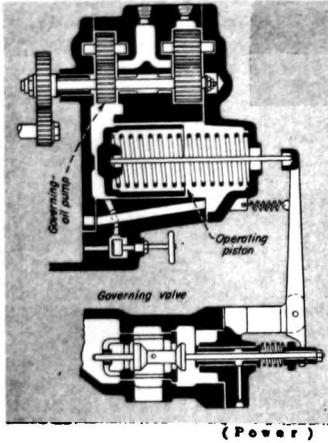

Fig. XIV-13. Hydraulic governor, direct acting.

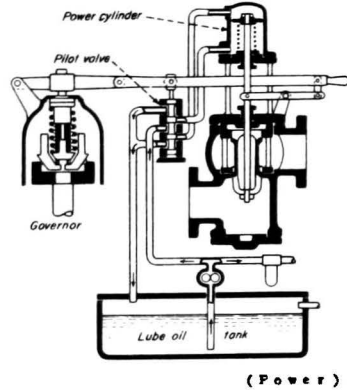

Fig. XIV-14. Flyball governor, relayed.

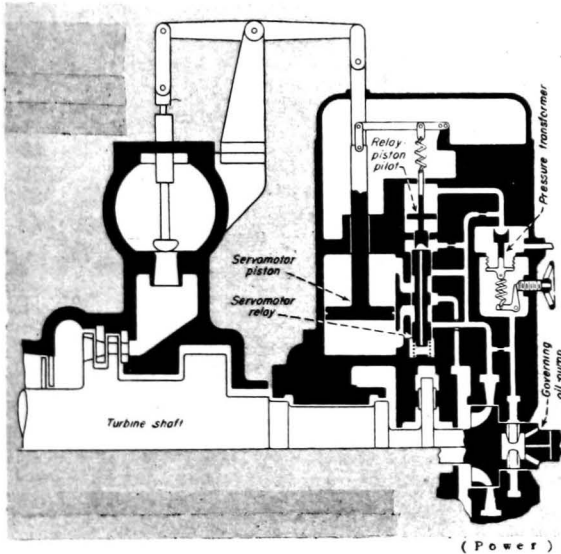
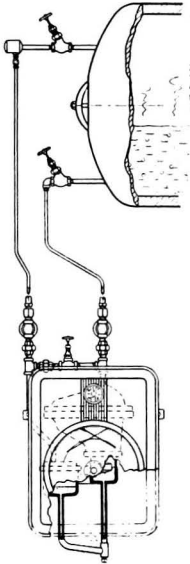

Fig. XIV-15. Hydraulic governor, relayed.

104. Fluid Level--Fluid level instruments very frequently contain floats whose motion is transmitted to indicating, recording or controlling devices. The float type of instru-

ment is applicable to any pressure or level range for which a suitable float system can be devised. Figures XIV-16 through XIV-20 show several of the float type of fluid level instruments.



(Bailey
Meter Co.)

Fig. XIV-16.
Boiler water
level
recorder.



(Mason-Nielan
Reg. Co.)

Fig. XIV-17. Float
controlled feeder.

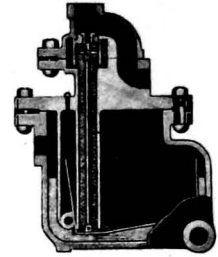

(Strong, Carlisle
& Hammond Co.)

Fig. XIV-19.
Open
bucket trap.

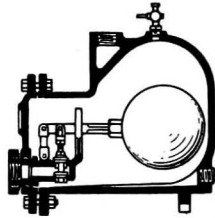

(Power)

Fig. XIV-18.
Float controlled
drainer.

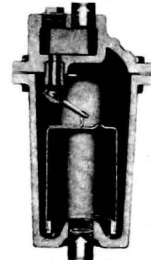

(Armstrong
Machine
Works)

Fig. XIV-20.
Inverted
bucket trap.

Fluid level in boilers may be controlled by float types of instruments, but it is much more usual to employ a thermostatic device or a thermohydraulic regulator. The first, shown in Figure XIV-21, utilizes a long inclined polished metal tube connected at the bottom end to the water space and at the top end to the steam space of the boiler. The tube is arranged with a bell crank and lever so that any change in length of the tube will be reflected as a change in water control valve position. As the water level in the boiler falls the tube lengthens, because the steam in the upper part of the tube has a higher temperature than the water in the lower part of the tube. This lengthening of the tube is employed to open the water control valve. A rise in water

level causes a reverse action. These regulators have a falling water level characteristic with relation to boiler load, and the operating limits may be too wide for modern steam generators which are extremely sensitive to water level variations (with respect to steam quality). In these cases a second element which contains a

spring loaded diaphragm is connected to the regulator in such a way that the pressure drop across the superheater is used to modify the thermostatic tube characteristics to maintain the water level within closer limits over the load range. This modification is shown in Figure XIV-22, and a hydraulic or air relay may be used to operate large valves.

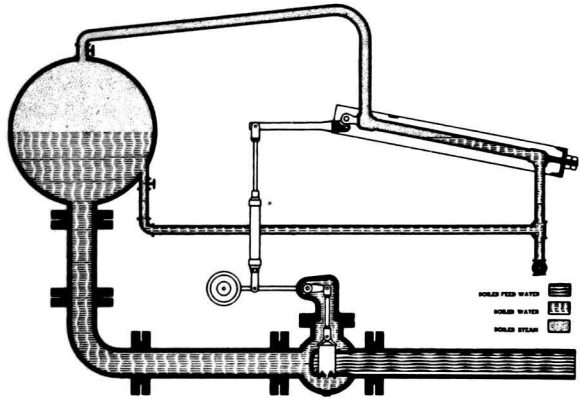

(Northern Equipment Co.)

Fig. XIV-21. Thermostatic feed-water regulator.

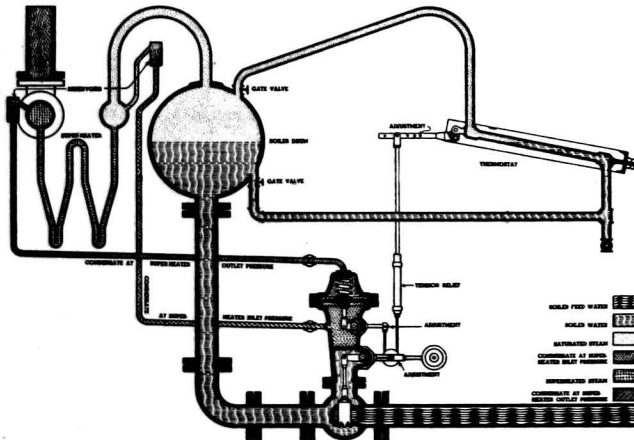

(Northern Equipment Co.)

Fig. XIV-22. Two-element thermostatic feed-water regulator.

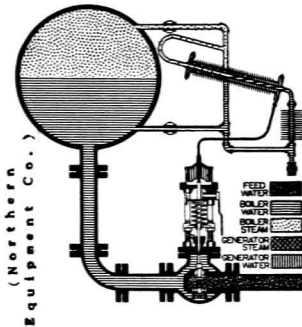

Fig. XIV-23. Thermo-hydraulic feed-water regulator.

characteristics are similar to those of the thermostatic type.

The thermo-hydraulic boiler water level control employs an inclined tube similar to the thermostatic regulator except that it is surrounded by a jacket with heat radiating fins. The jacket is connected by tubing to a diaphragm type water control valve. The generator jacket, connecting tubing and diaphragm chamber are completely filled with water so that any decrease in water level in the boiler will result in an increase in pressure in the generator jacket and an opening action in the water control valve. This type of regulator is shown in Figure XIV-23. Its characteristics are similar to those of the thermostatic type.

A third element, sensitive to water flow, may be added to the two-element regulator to coordinate water flow with steam flow and water level for smoother operation on rapid load changes, as shown in Figure XIV-24.

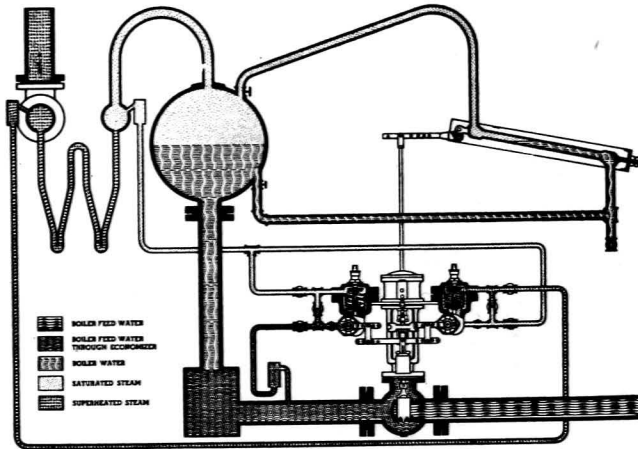

Fig. XIV-24. Three-element thermostatic feed-water regulator.

105. Combustion--Some of the most valuable instruments in modern power plants are automatic combustion controls

which relieve the fireman from the necessity of manually controlling fuel and air flow, and which, incidentally, do a much better job than any human fireman could possibly do. Combustion controls are available for the smallest boiler as well as for the largest steam generator, and they will pay for themselves from fuel savings in a relatively short time.

All combustion controls for boilers or steam generators operate to maintain a constant pressure at the turbine throttle by varying the fuel and air supplied to the furnace. In addition, some controls have an element which maintains a constant draft in the furnace. Figures XIV-25 through XIV-27 show simple modulating or positioning electric controls for application to various fuels in small boilers. Large steam generators employ elaborate controls which meter fuel and air flows in exact relation to each other and to load. Some

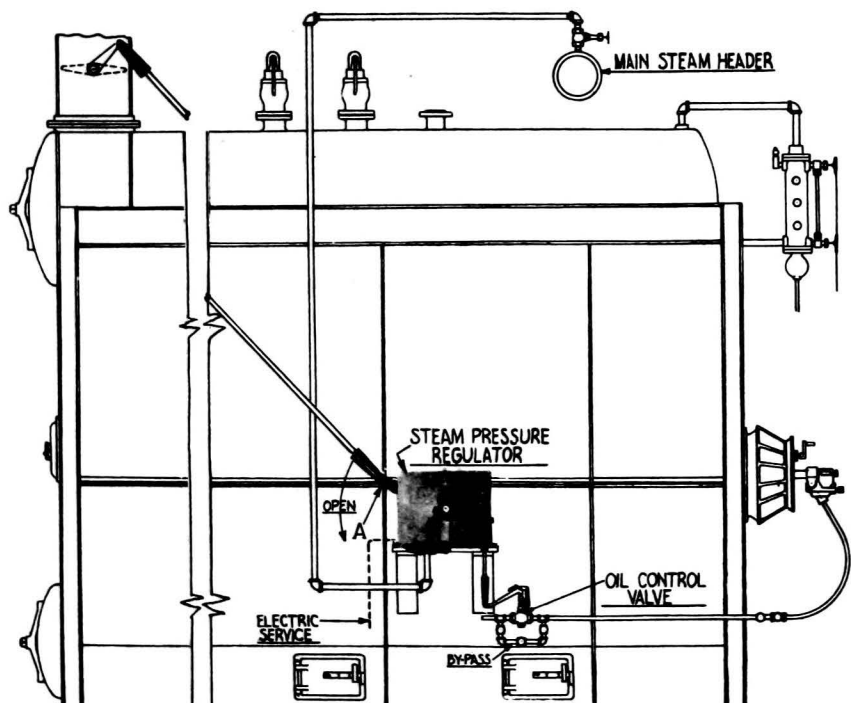
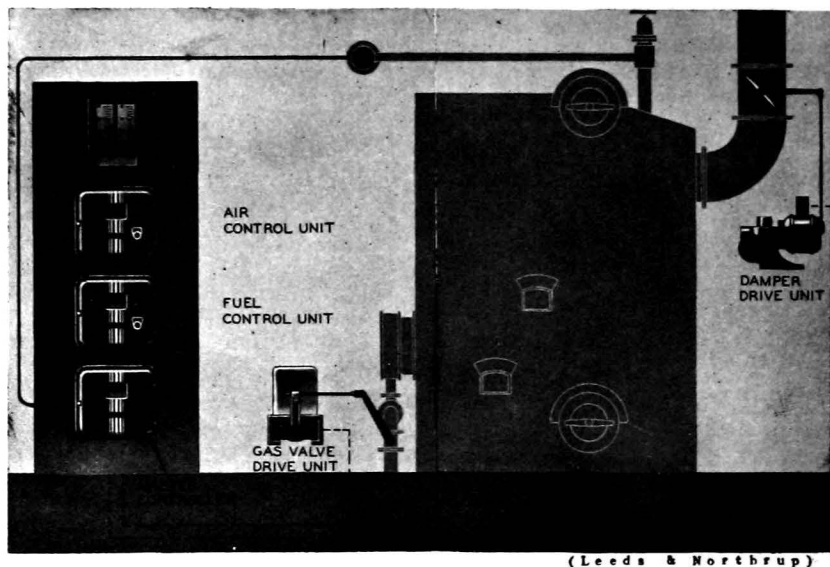

Fig. XIV-25. Modulating oil burner control.

of these control systems are shown in Figures XIV-28 through XIV-31.



(Leeds & Northrup)

Fig. XIV-26. Modulating gas burner control.

106. Chemical Characteristics--Chemical characteristics of water in power plants are often controlled or supervised by electrical instruments. The chemical characteristics which are useful as control variables are pH and electrolytic conductivity. pH can be controlled in precipitation water softening because the pH of the water is affected by the softening chemicals. Electrolytic conductivity is most often used as a variable for operating alarm devices for signalling contamination of condensate by condenser leakage or faulty evaporator operation. Figures XIV-32 through XIV-34 show some of the instruments used for these purposes.

107. Fluid Flow--The most common fluid flow measuring devices utilized in power plants are nozzles and orifices with various types of secondary elements for measuring and recording the pressure differential produced by the primary element in terms of flow units. Figures XIV-35 through XIV-39 show some of the more common primary and secondary head type flow measuring devices.

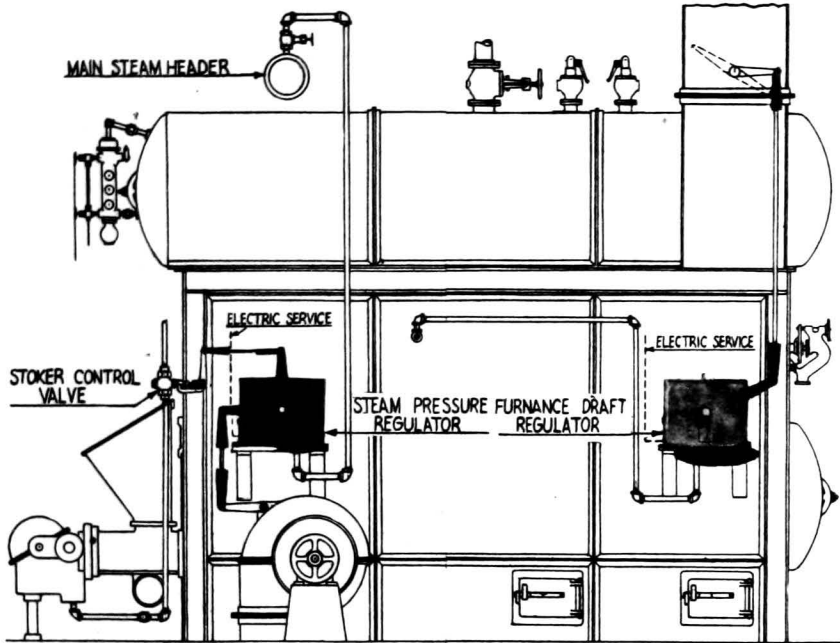

(Brooke Engineering Co.)

Fig. XIV-27. Modulating stoker control.

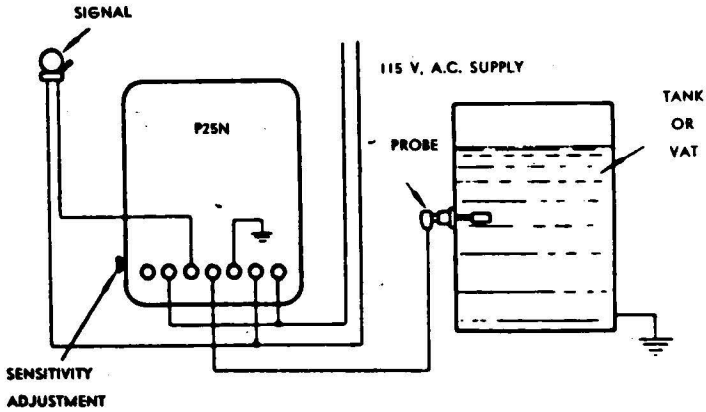

(Photoswitch, Inc.)

Fig. XIV-34. Conductivity alarm.

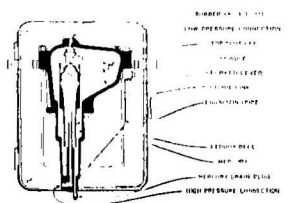

(Bailey Meter Co.)

Fig. XIV-35. Ledoux bell secondary flow measuring device.

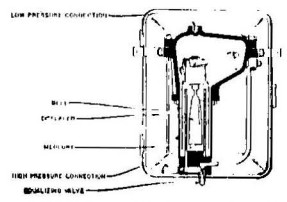

(Bailey Meter Co.)

Fig. XIV-36. Shaped displacer secondary flow measuring device.

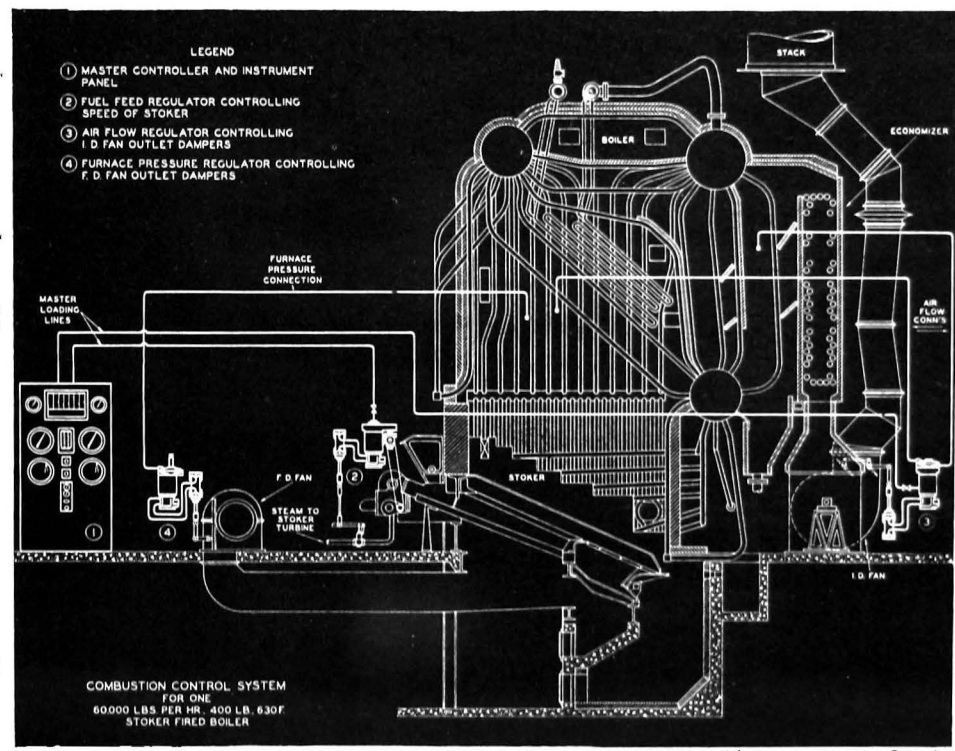

(Republic Flow Meters Co.)

Fig. XIV-28. Air-hydraulic combustion control for stokers, metering.



(Bailey Meter Co.)

Fig. XIV-37. Venturi.

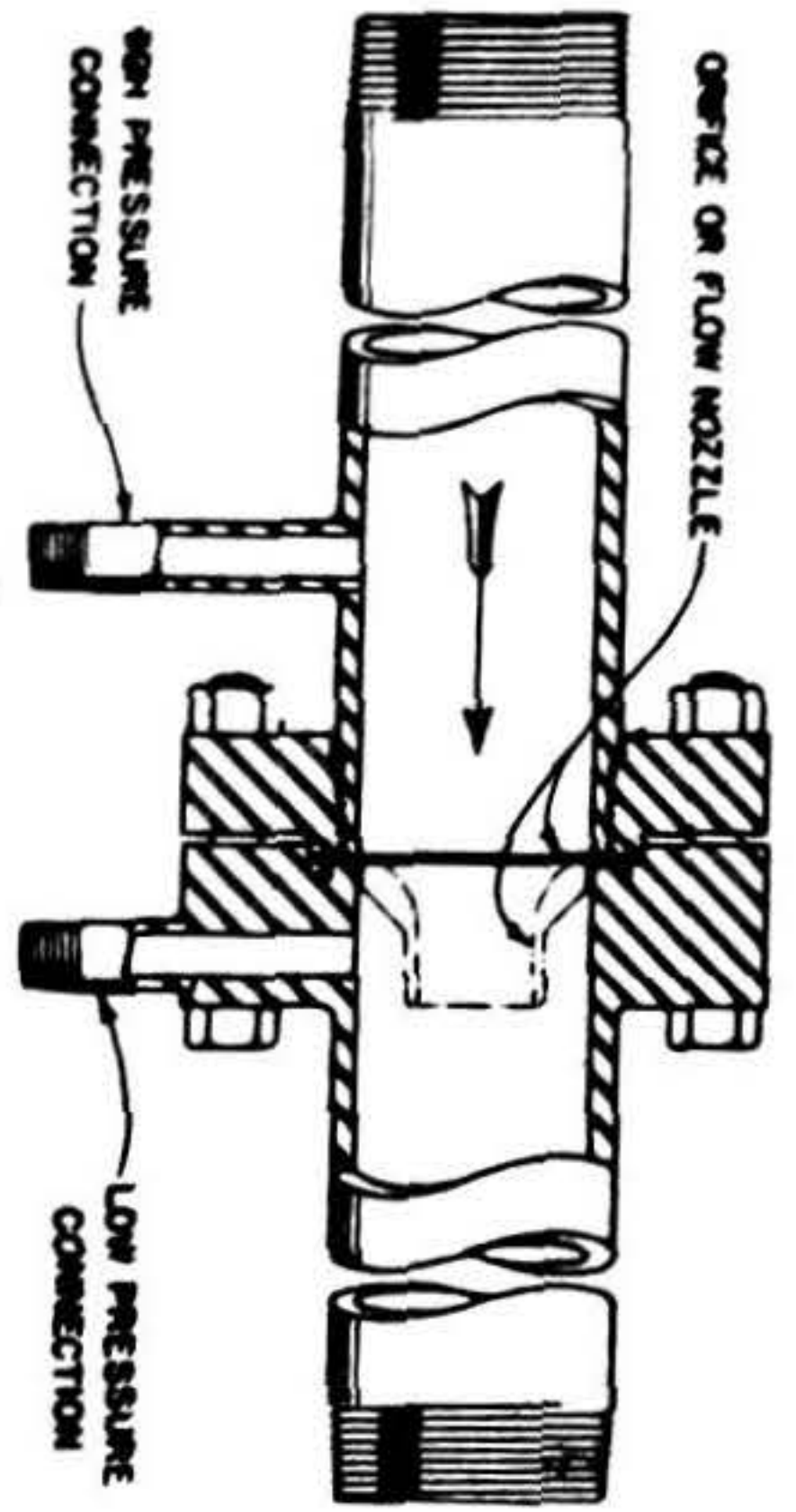

(Bailey Meter Co.)

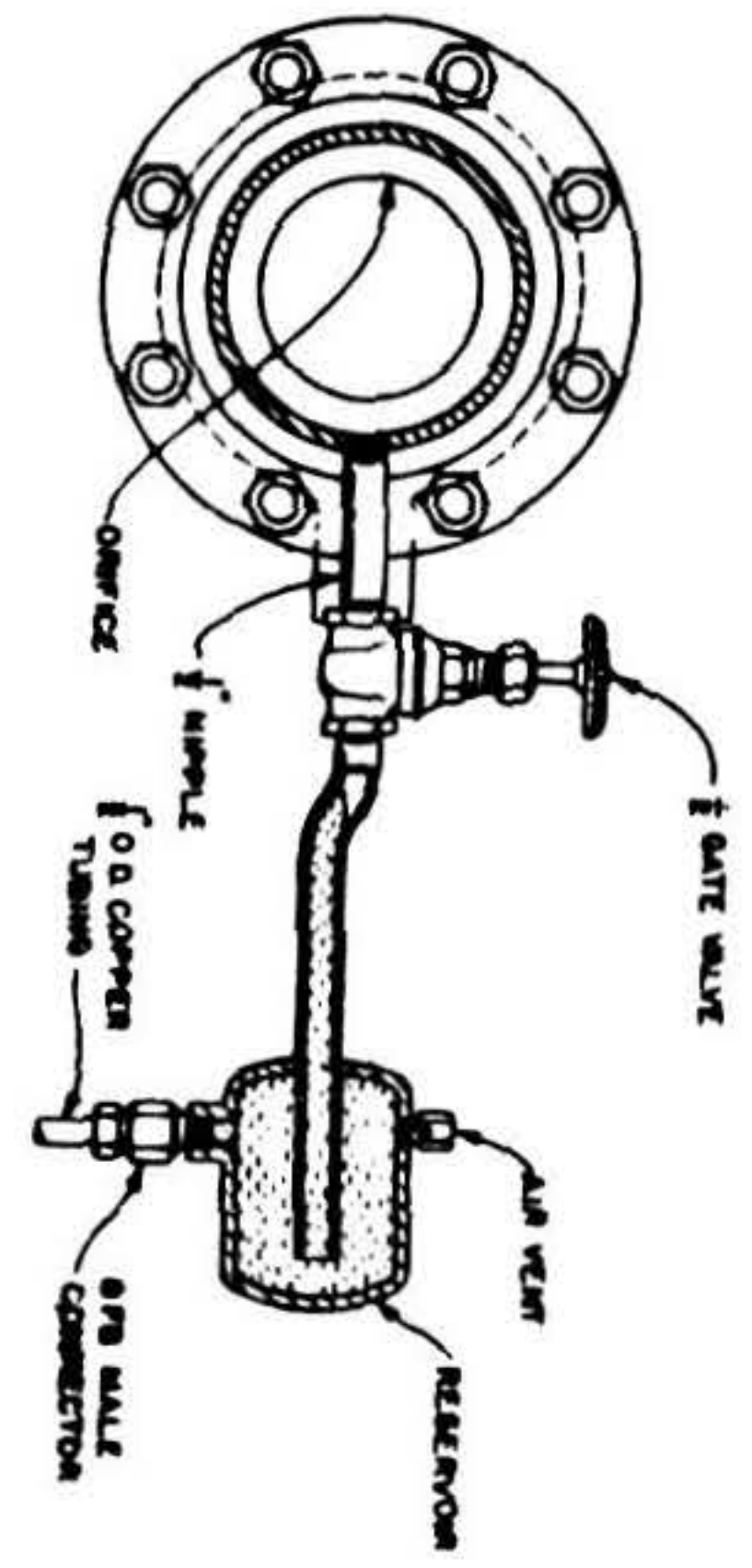

(Bailey Meter Co.)

Fig. XIV-38. Primary flow measuring device in steam line.

Fig. XIV-39.

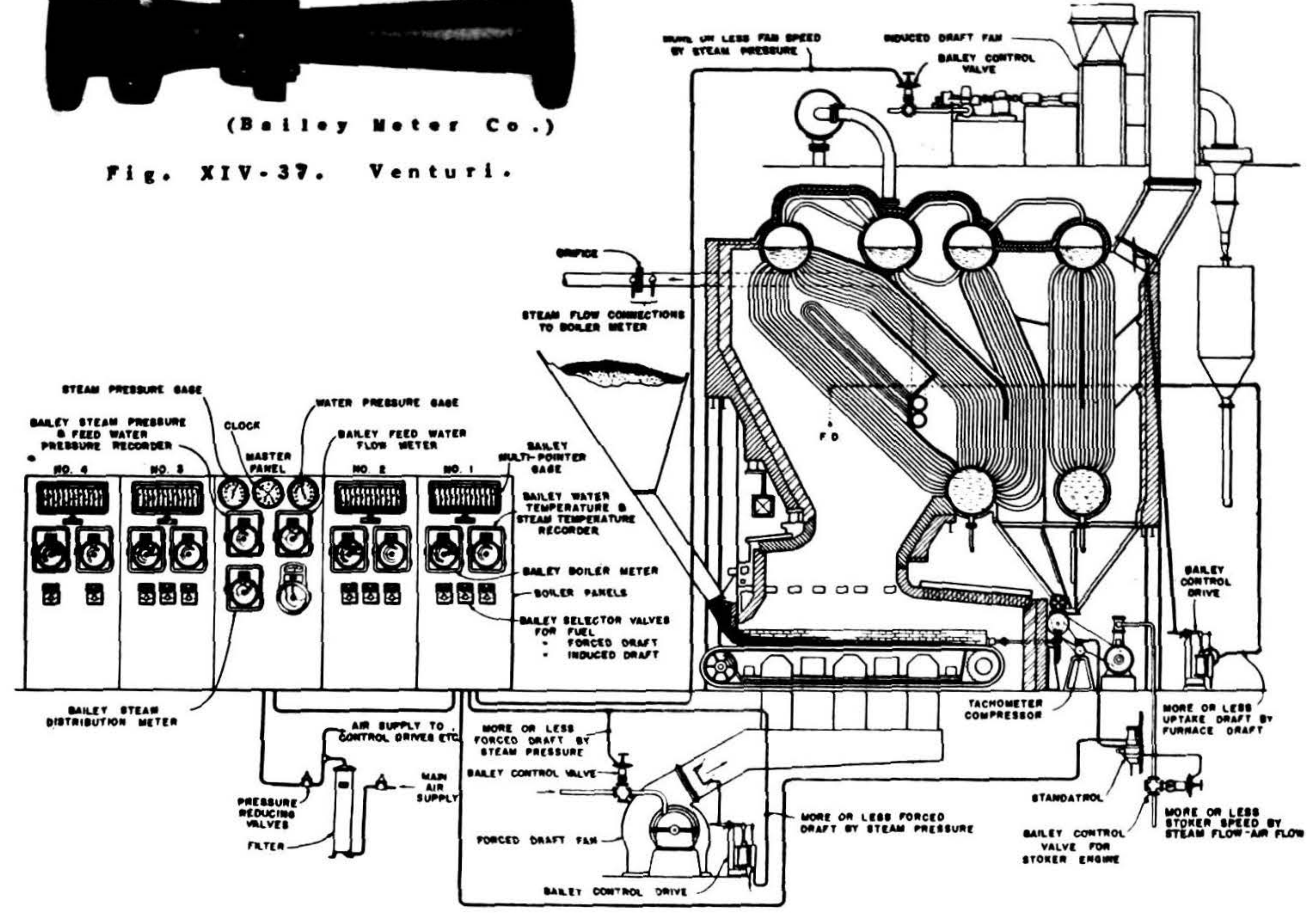

(Bailey Meter Co.)

Fig. XIV-29. Air combustion control for stokers, metering.

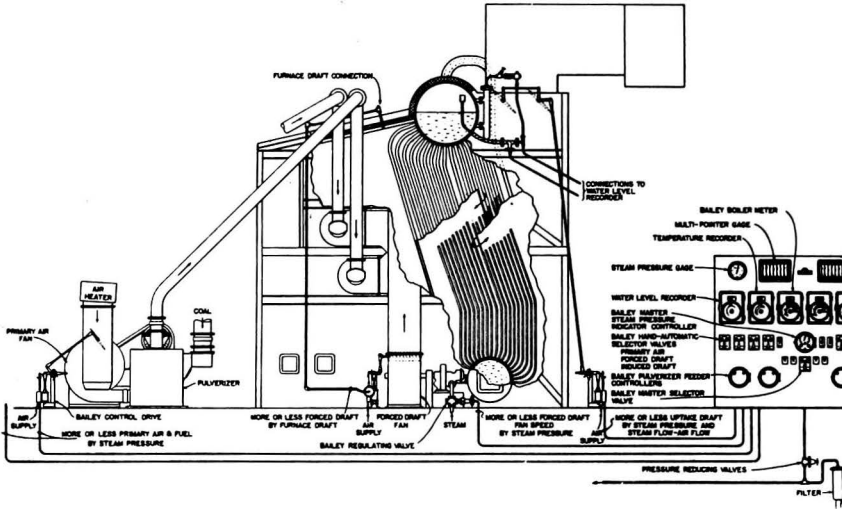

(Bailey Meter Co.)

Fig. XIV-30. Air combustion control for pulverizers, metering.

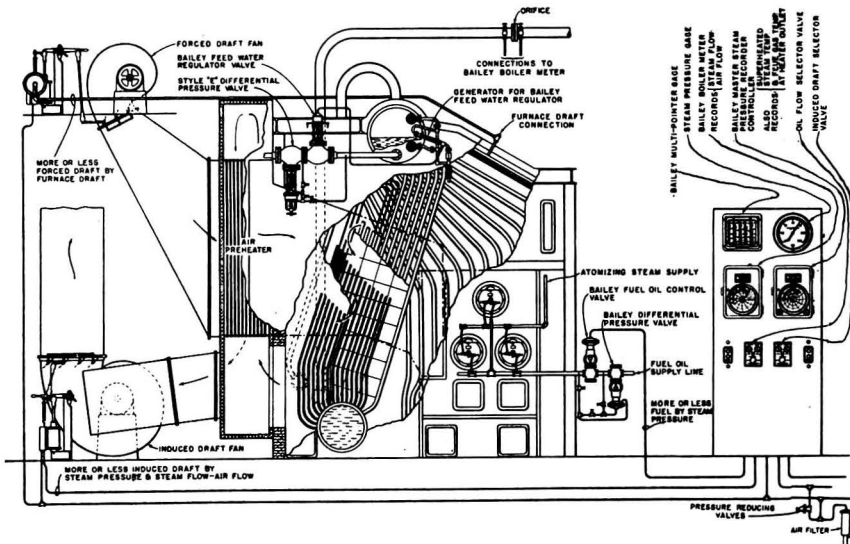

(Bailey Meter Co.)

Fig. XIV-31. Air combustion control for fuel oil, metering.

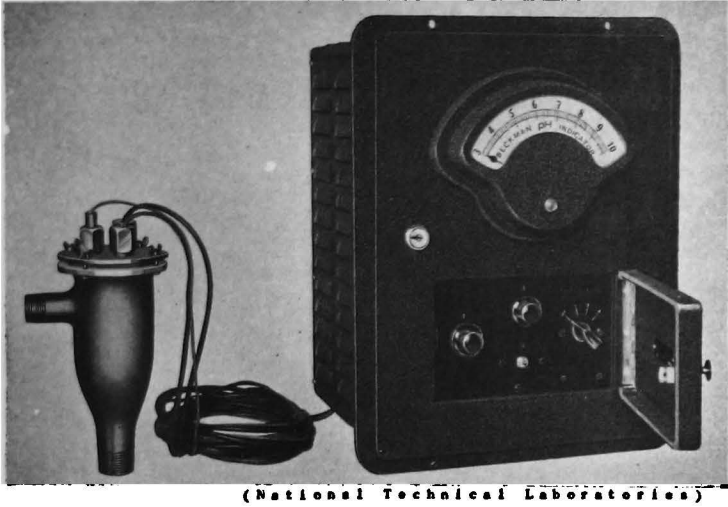

(National Technical Laboratories)
 Fig. XIV-32. pH indicator and controller.

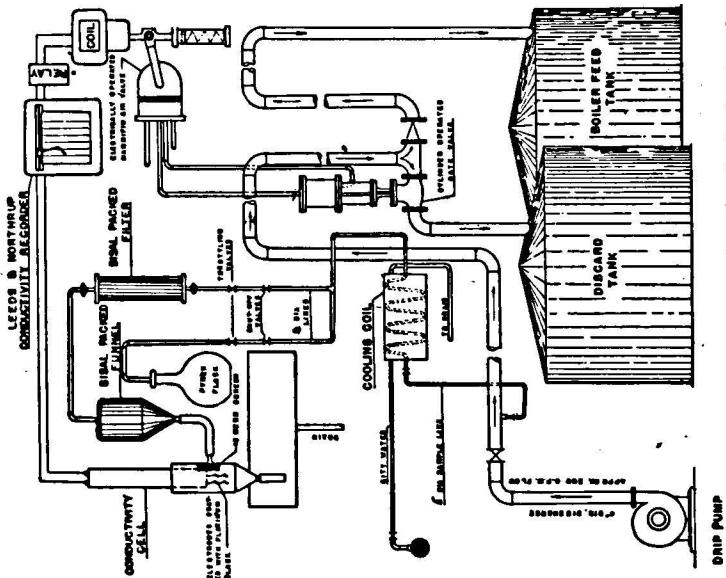

(Southern Power & Industry)
 Fig. XIV-33. Conductivity recorder and alarm.

Some special flow measuring applications make use of fluid meters of the disc or vortex types, as shown in Figures XIV-40 and XIV-41. Rotameters, one of which is shown in Figure XIV-42, have a float which rises inside a tapered tube in proportion to the flow.

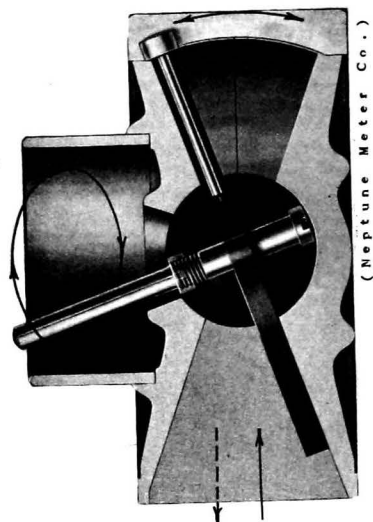

(Neptune Meter Co.)

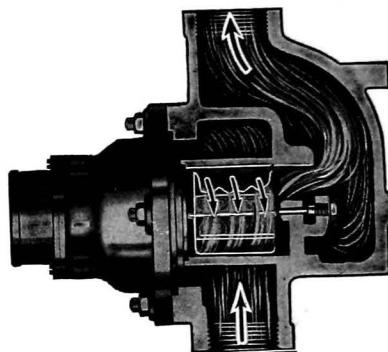

(Henssey Co.)

Fig. XIV-40.
(above) Disc
fluid meter.

Fig. XIV-41.
(right) Vor-
tex fluid
meter.

Fig. XIV-42.
(left) Rota-
meter.

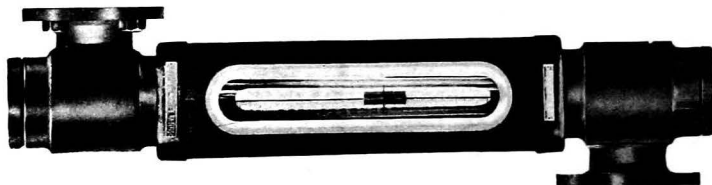

(Fischer &
Porter Co.)

BIBLIOGRAPHY

Various Manufacturers' Catalogues.

Diederichs, H., and Andrae, W. C., *Experimental Mechanical Engineering*, Wiley, New York, 1930.

Moyer, J. A., *Power Plant Testing*, McGraw-Hill, New York, 1934.

CHAPTER XV

THE COMPLETE POWER PLANT

108. The design of a power plant, it has been seen, involves the integration of many pieces of equipment into a whole system which must meet exacting economic requirements as well as requirements for reliability and ease of operation. The steps in the design of a power plant are essentially as follows:

1. A study of present and future load requirements.
2. A study to determine the best possible location for a new plant or for an extension to an existing plant in a system.
3. A study of cycle types and arrangements to reveal the most economical solution for the operating conditions.
4. Selection of the major equipment to fit the cycle decided upon.
5. Making a preliminary layout of the plant and analyzing it from the standpoint of ease of operation and economy of floor space and building volume.
6. Making a final layout of the plant and writing specifications for the minor equipment.

Some of these steps may be transposed, or several may be carried on simultaneously. It is always true that subsequent discoveries may invalidate some of the conclusions drawn in earlier steps, thus requiring modifications. The final design should be the result of exhaustive analysis and detailed study from all standpoints.

After the consulting engineers have completed the design of the plant their function is limited to aiding in the analysis of bids for equipment and supervising the construction and initial operation of the plant. In some cases, especially with municipal projects, they will aid in securing the financing of the project.

109. Details of Design--The actual details of the design of a power plant are so voluminous that it is impossible to deal with even a small part of them in a text on fundamentals. Probably the best way for a student to gain some

insight into the process of power plant design is to examine very carefully the design of actual plants, both in the field and from drawings, trying to determine the reason for each detail in the light of his knowledge of the fundamentals.

In order to show some of the multitude of design details, a portion of a set of power plant drawings is given in Figures XV-1 through XV-6.

It will be seen, from an examination of the complete power plant, that the mechanical equipment falls into several major groups, corresponding somewhat to the chapter headings in this book, as follows:

1. Prime movers.
2. Condensers, feed-water heaters and evaporators.
3. Steam generators and auxiliaries.
4. Piping and duct-work.
5. Water handling equipment.
6. Fuel handling equipment.
7. Draft equipment.
8. Supervisory and control equipment.

Another method of grouping the equipment would be as follows:

1. Prime movers.
 - a. Lubricating oil system.
 - b. Generator cooling system.
 - c. Shaft gland sealing system.
2. Condensers.
 - a. Condensate pumps.
 - b. Circulating water pumps.
 - c. Vacuum pumps.
3. Feed-water heaters and evaporators
 - a. Drip pumps.
 - b. Evaporator feed pumps.
4. Boiler feed system.
 - a. Boiler feed pumps.

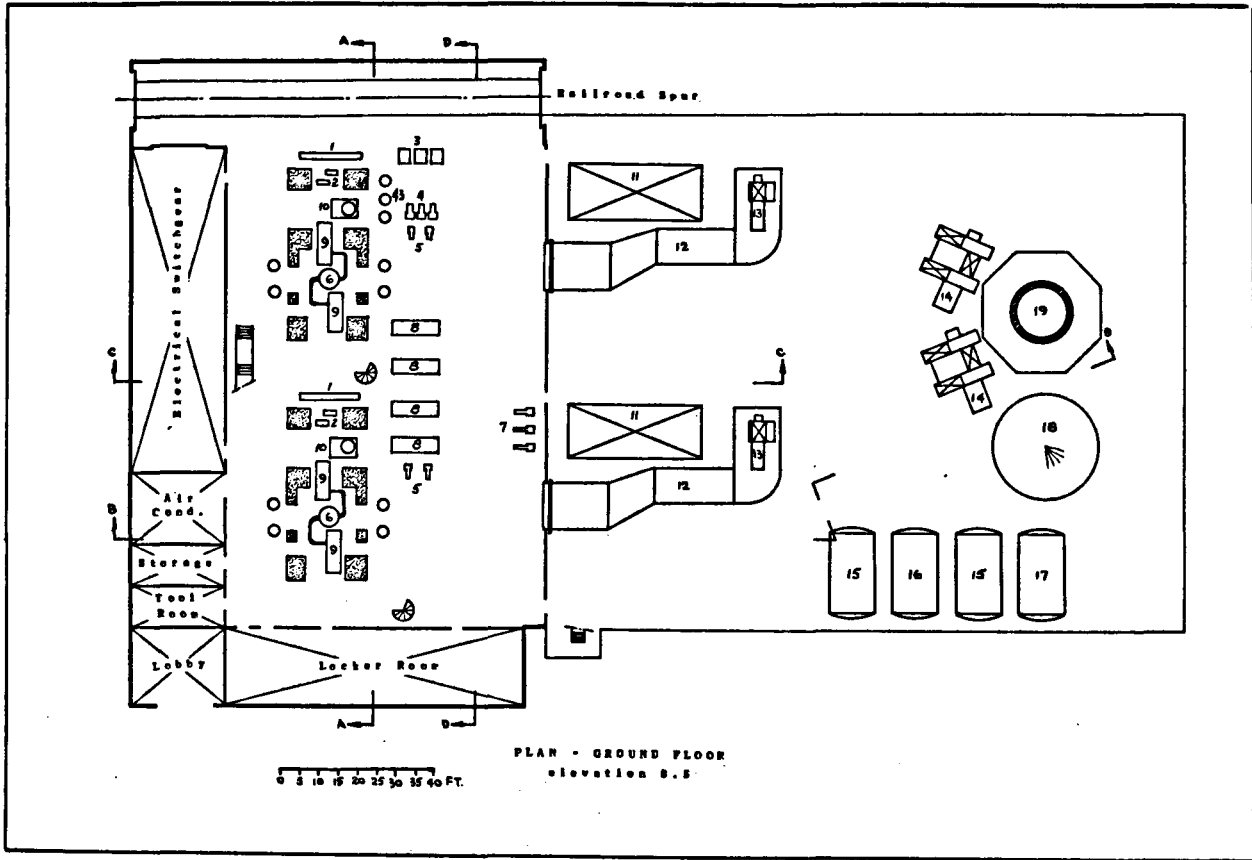

Fig. XV-1. City of Jacksonville, Florida, Power Plant No. 2.

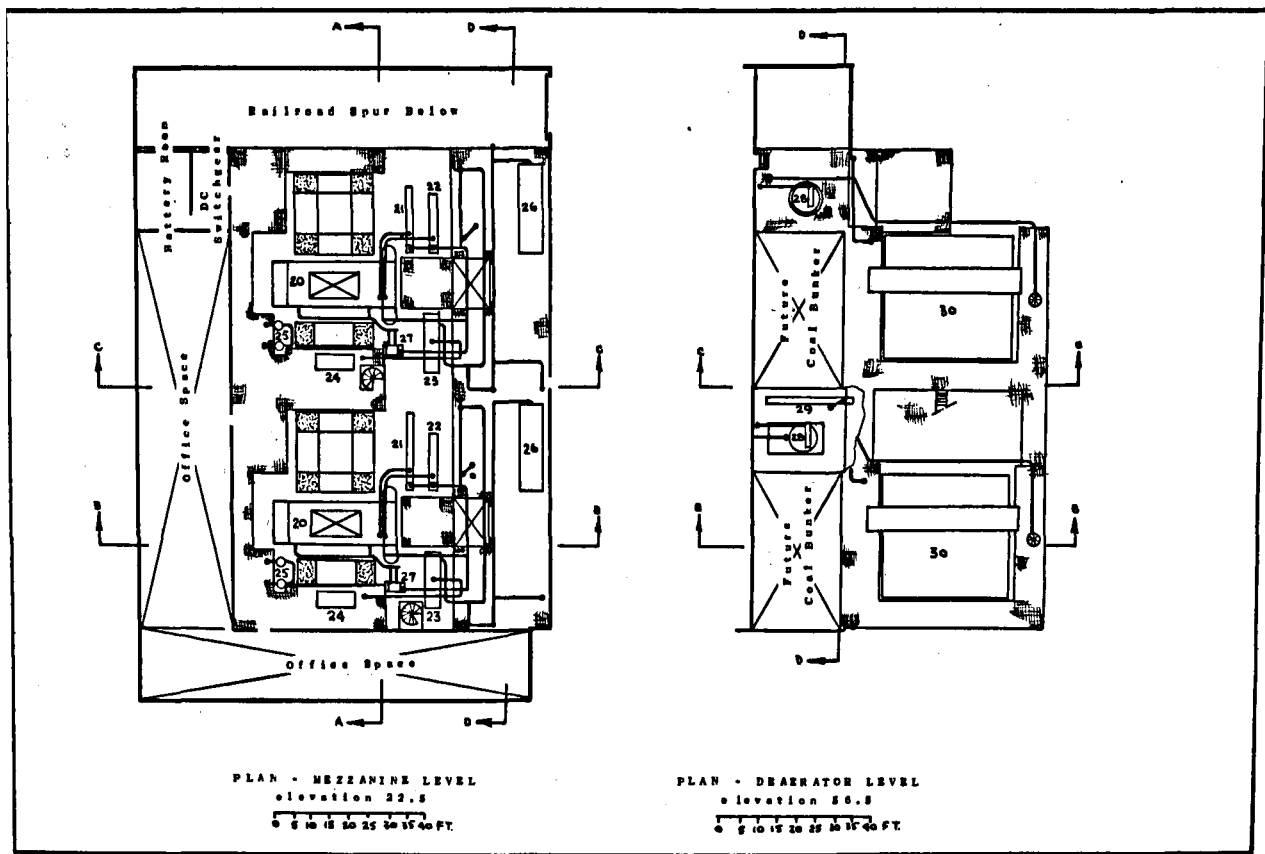

Fig. XV-2. City of Jacksonville, Florida, Power Plant No. 2.

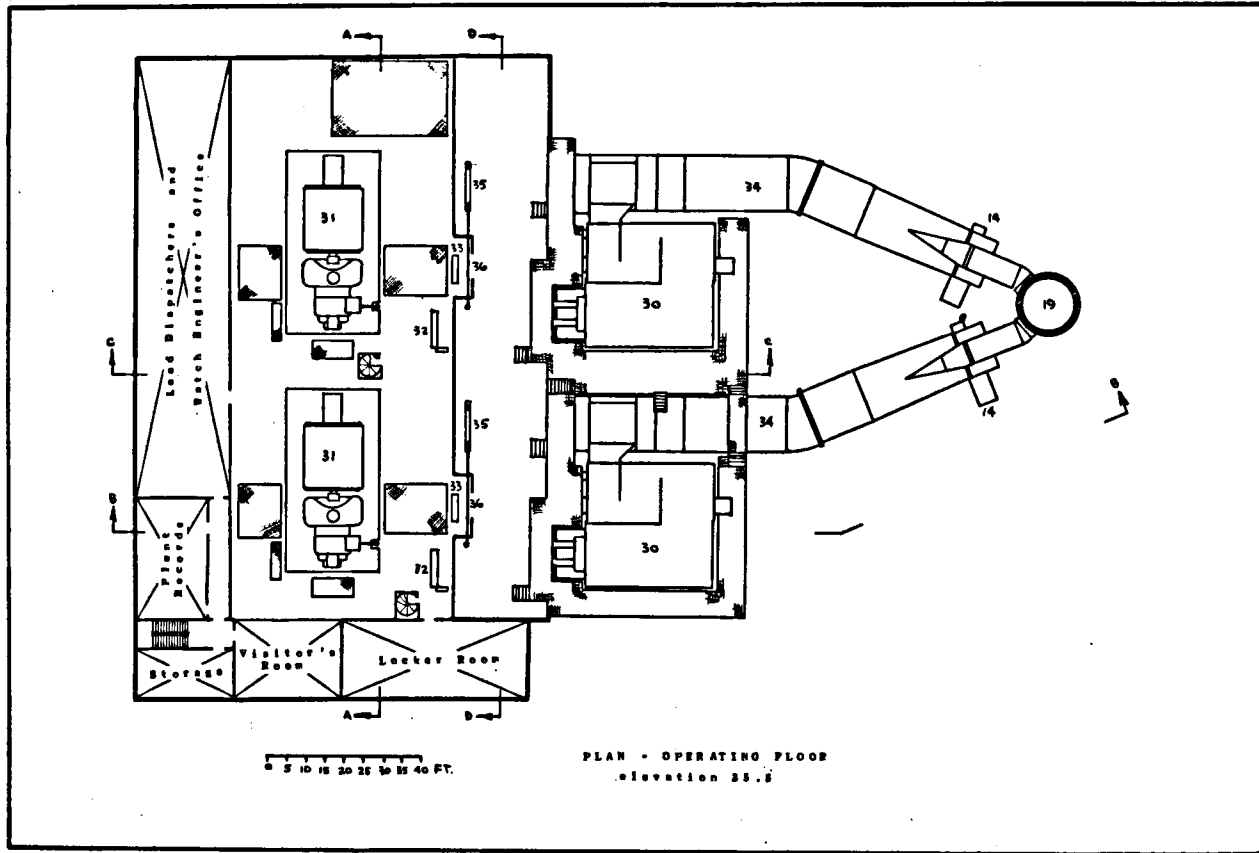

Fig. XV-3. City of Jacksonville, Florida, Power Plant No. 2.

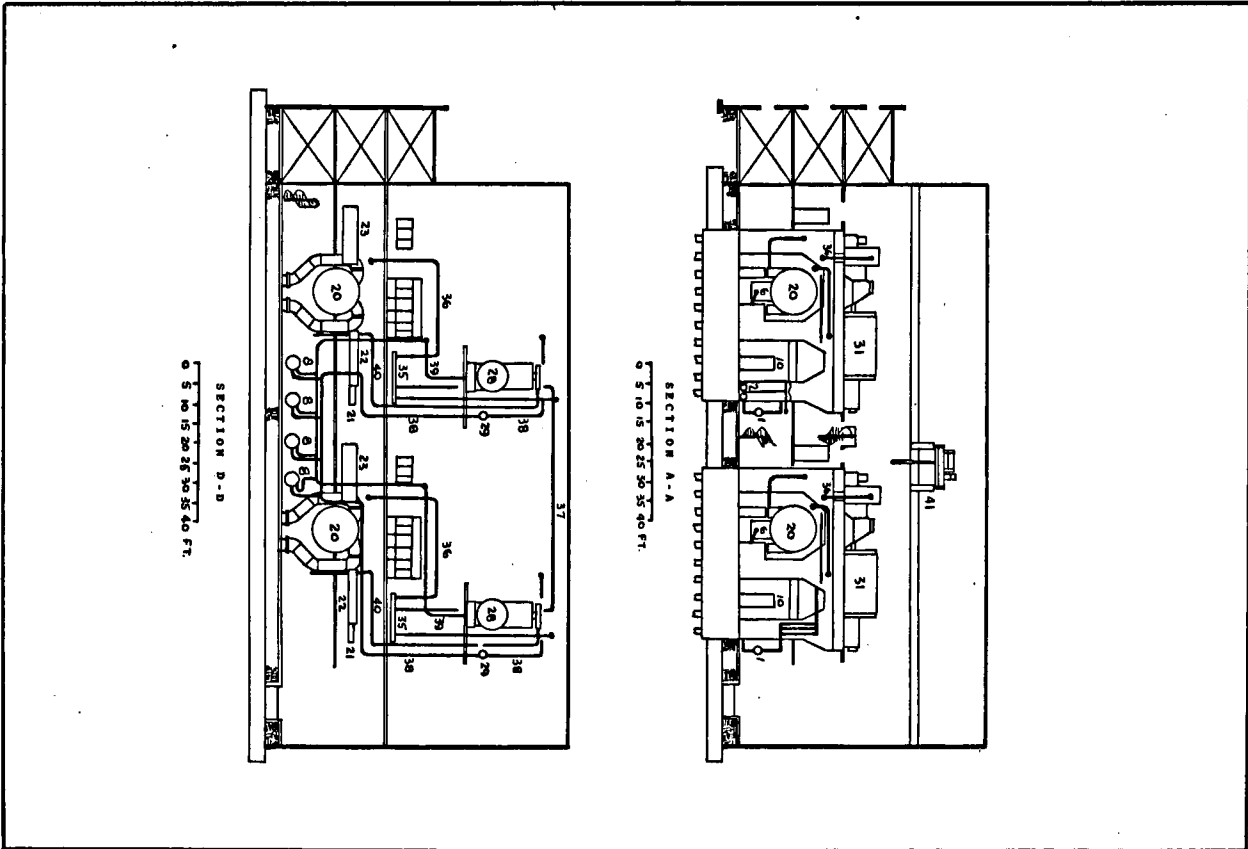

Fig. XV-4. City of Jacksonville, Florida, Power Plant No. 2.

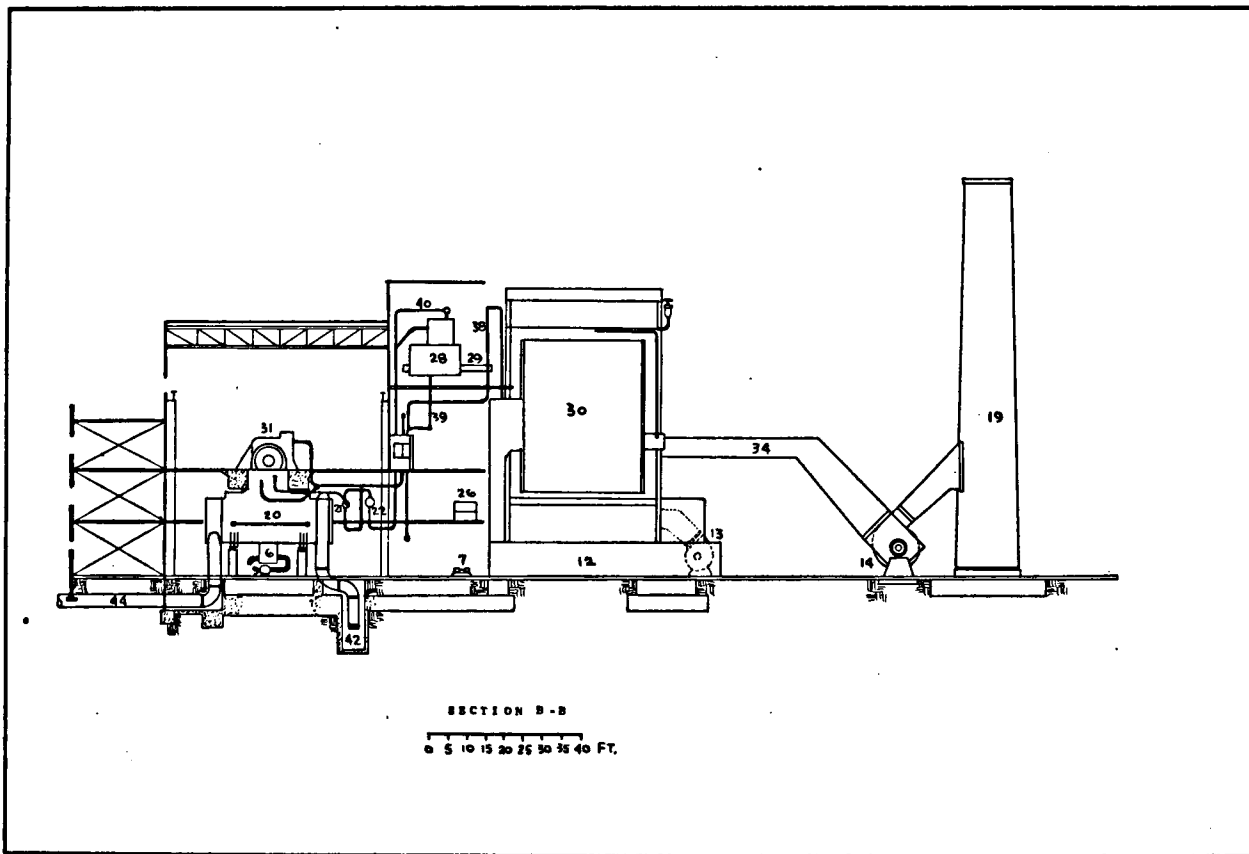

Fig. XV-5. City of Jacksonville, Florida, Power Plant No. 2.

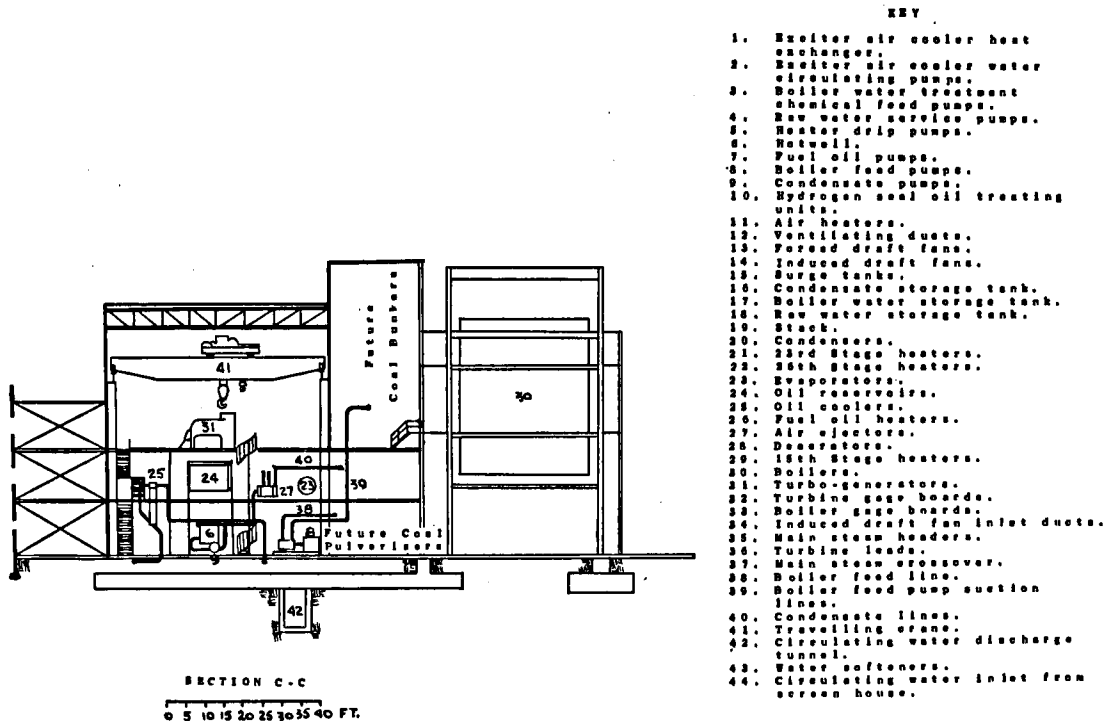

Fig. XV-6. City of Jacksonville, Florida, Power Plant No. 2.

- b. Surge tanks and pumps.
 - c. Feed-water regulators.
5. Steam generator.
- a. Boiler and furnace.
 - b. Superheater.
 - c. Economizer.
 - d. Air heater.
 - e. Fans and stack.
6. Fuel system.
- a. Fuel oil pumps or coal conveyors.
 - b. Fuel oil heaters or coal pulverizers.
 - c. Burners.
 - d. Ash disposal.
7. Piping and duct-work.
- a. Circulating water system.
 - b. Condensate system.
 - c. Boiler feed system.
 - d. Steam system.
 - e. Service and fire protection water system.
 - f. Lubricating oil system.
 - g. Fuel oil, fuel gas or coal system.
 - h. Air ducts.
 - i. Gas ducts.
 - j. Compressed air system.
8. Water supply.
- a. Condenser cooling system.
 - b. Boiler feed makeup.
 - c. Service and fire protection water.
9. Fuel supply.
- a. Unloading facilities.
 - b. Storage facilities.

110. Power Plant Buildings--In past years the aim of power plant architecture was to give the impression of power and stability. This aim resulted in buildings that were much too expensive for their primary purpose of sheltering the power generating equipment. The last ten years has proven the ascendancy of functional power plant architecture in the acceptance of the semi-outdoor and outdoor plant.

In the semi-outdoor plant more or less of the steam generating equipment is left exposed to the weather (with weatherproof casings) and the turbine equipment and boiler operating stations are completely sheltered. The outdoor power plant is just what the name implies, except that a

shelter is provided for the boiler and turbine operating stations.

At present, with few exceptions, in plants which are designed for complete shelter, as well as for semi-outdoor installations, the buildings are made as inexpensively as possible in order to reduce the capital outlay to the minimum. Probably the cheapest type of power plant building construction (but not unattractive with proper treatment) makes use of corrugated asbestos-cement sheeting fastened to a structural steel frame. This construction is fire resistant and weatherproof, and has the additional advantage of being easily modified for expansion in any direction.

Figures XV-7 through XV-15 show some views of power plants of the various types of construction.

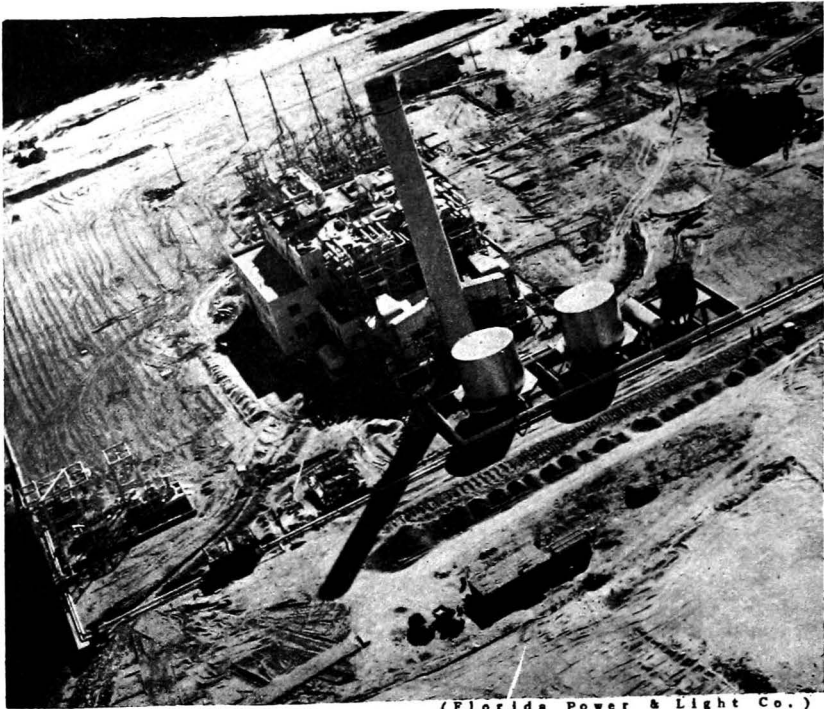

(Florida Power & Light Co.)

Fig. XV-7. Semi-outdoor plant, exterior.

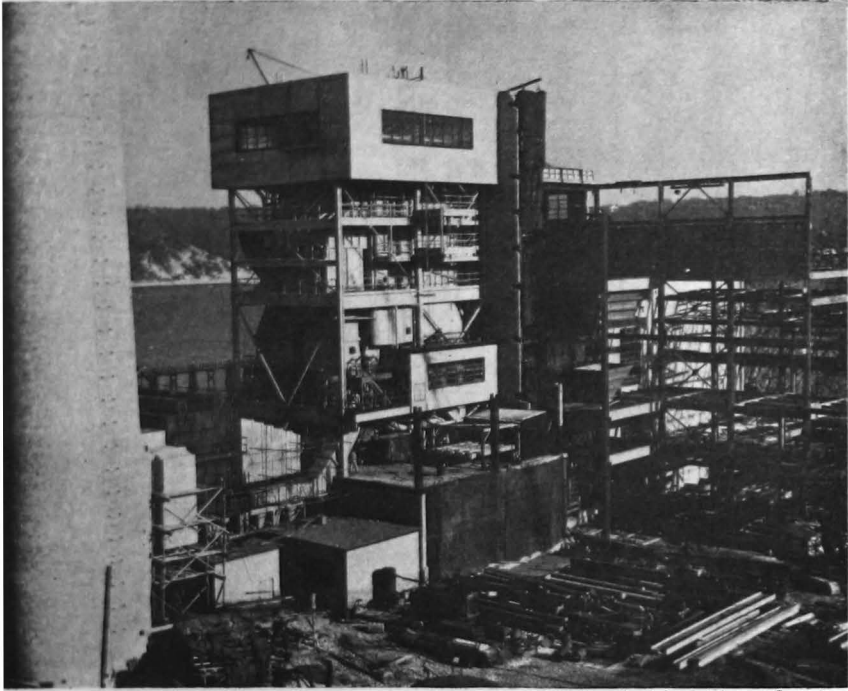

(Long Island Lighting Co.)

Fig. XV-8. Semi-outdoor plant, exterior.

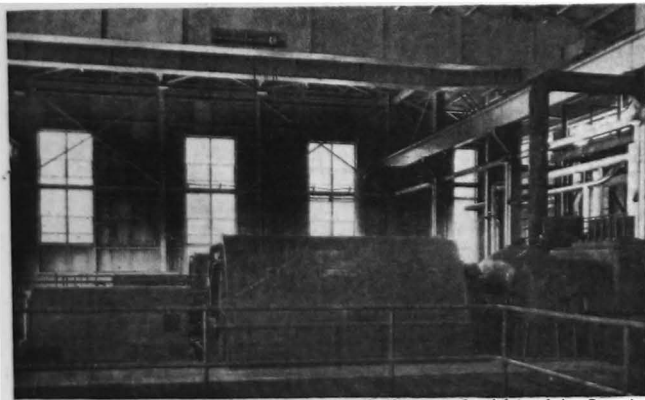

(Diamond Alkali Co.)

Fig. XV-9. Semi outdoor plant, interior.

Fig. XV-10.
(right) Out-
door plant,
exterior.

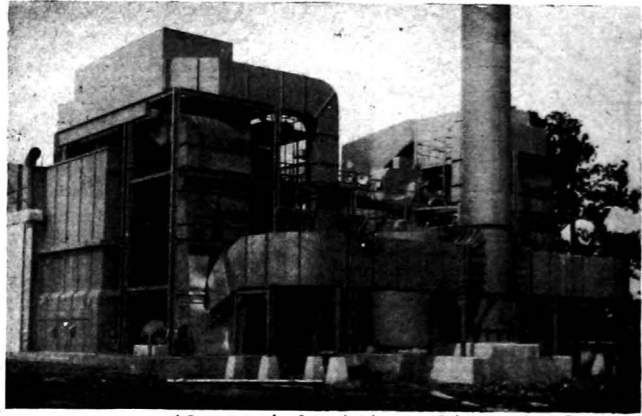

(Central Louisiana Electric Co.)

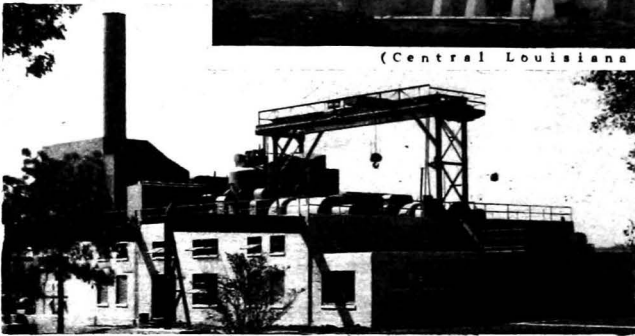
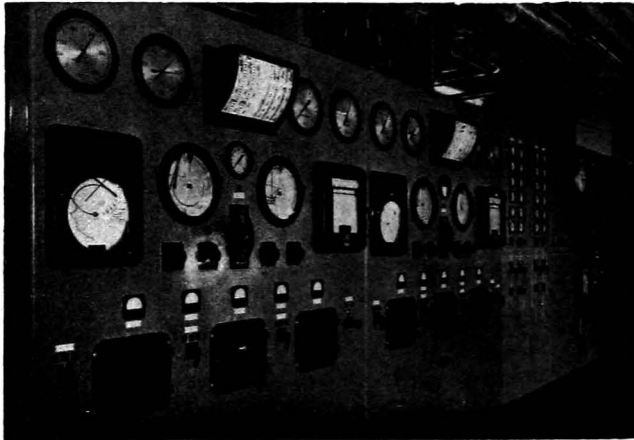

Fig. XV-11.
(left) Out-
door plant,
exterior.

(Central Louisiana Electric Co.)



(Central Louisiana Electric Co.)

Fig. XV-12. Outdoor plant, control shelter.

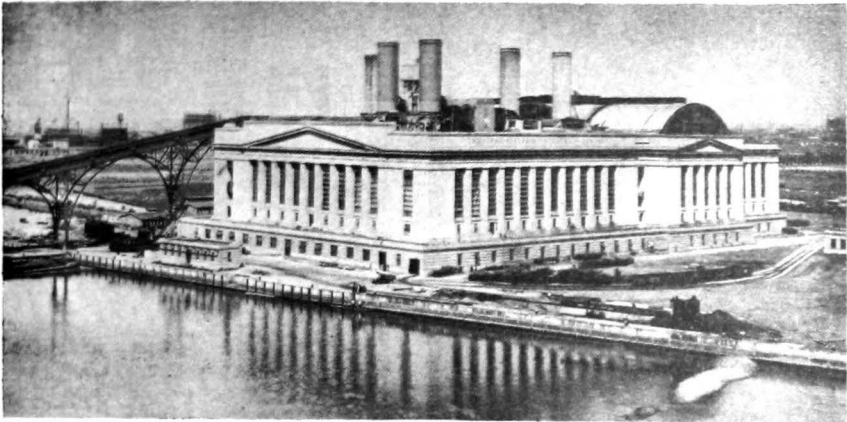

(Philadelphia Electric Co.)

Fig. XV-13. Enclosed plant, exterior.

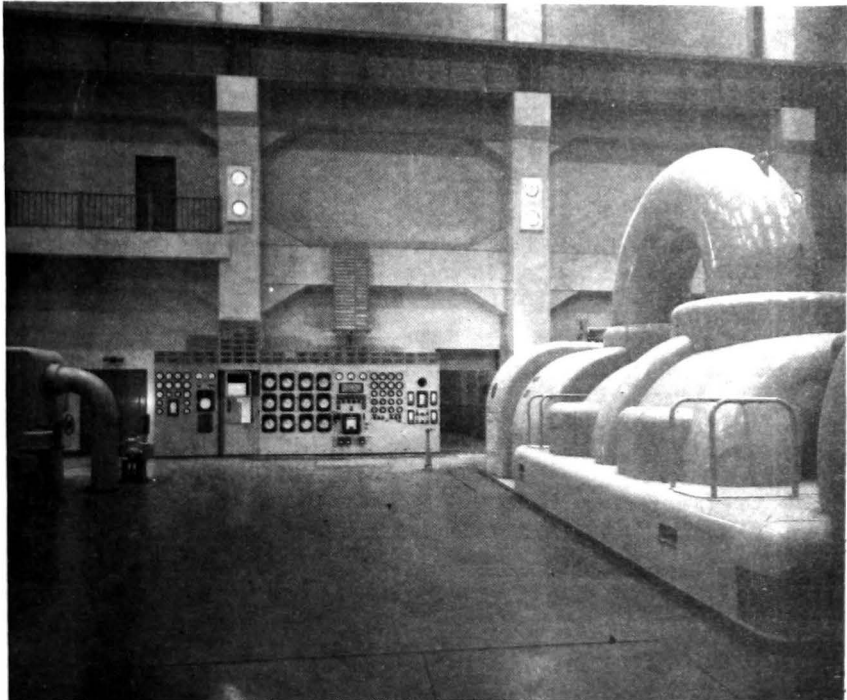

(Los Angeles Dept. of Water & Power)

Fig. XV-14. Enclosed plant, interior.

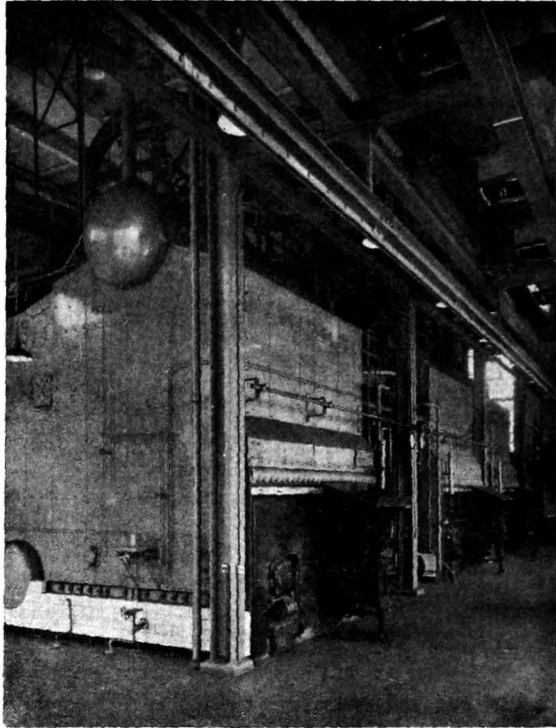

(Fairmont Coal Bureau)

FIG. XV-15. Enclosed plant, interior.

BIBLIOGRAPHY

Fargo, W. R., "Architecture as a Factor in Plant Design,"
Power Plant Engineering, April, 1931.

Sanderson, J. C., "Power Plant Substructure Problems,"
Transactions A.S.M.E., Volume 51, 1929.

PROJECT IV

1. Specify the head, capacity and motor size for the following pumps (assume ordinary entrances and exits):

- (a) Circulating water: No static lift.
- (b) Condensate: Static lift 40 feet.
- (c) Boiler feed: Static lift 20 feet.

2. The analysis of the raw water for makeup is: Calcium bicarbonate, 150 ppm; magnesium bicarbonate, 85 ppm; calcium sulphate, 50 ppm; magnesium chloride, 30 ppm; sodium chloride, 60 ppm. How much 90 o/o hydrated lime, 95 o/o soda ash and 95 o/o filter alum (using 8 ppm) would be required per thousand gallons of water to soften the water by the cold process, leaving a residual hardness of 50 ppm as calcium carbonate?

3. Estimate the draft and pressure losses in the air and flue gas circuits of the steam generator, and specify the capacity, pressure and motor size for the following fans:

- (a) Forced draft: Backward curved blades.
- (b) Induced draft: Forward curved blades.

4. Calculate the dimensions of the most economical brick stack to produce a draft of 0.5 inches of water. Ambient temperature 90 F and barometer 29.5 inches of mercury.

5. Make a preliminary plant layout drawing.

Note: The preceding calculations apply to the power plant of Projects I, II and III.

CHAPTER XVI

ECONOMICS OF LOAD DIVISION

111. In the intelligently operated power plant or power system the efforts of all operating and supervisory personnel are bent toward the production of power at the least possible cost. To a large extent the economy of operation is affected by the manner of division of load between units in a plant and plants in a system. It is the purpose of this chapter to discuss briefly the theory of the incremental rate method of load division and to show some of its applications.

112. The Incremental Rate Theory--The theory of incremental rates postulates that each succeeding block of load should be thrown on the plant or machine which exhibits the lowest incremental rate (slope of the input-output curve), regardless of the absolute efficiency of the machine or plant. This theory contradicts the widely held opinion that the most efficient plant or machine should be loaded fully and the less efficient plants or machines used to supply the balance of the demand. According to the incremental rate theory, this opinion is true only in the special case in which the incremental rate of the most efficient plant or machine is always less than that of the less efficient plant or machines. The theory can be substantiated by a very simple demonstration, as follows:

Figure XVI- (a) represents the input-output curves of two machines, A and B. For simplicity these curves are made parabolic so that equations for them can be differentiated algebraically to obtain the equations of the incremental rate curves. It is not necessary to the theory, however, that the curves be capable of being expressed in the form of simple equations because any curve can be differentiated by graphical or tabular methods. The input-output curves A and B can be expressed as:

$$I_a = 17 + O_a + 0.1 O_a^2$$

$$I_b = 6 + O_b + 0.15 O_b^2$$

where: I and O = input and output in
any desired units

The incremental rates for A and B are plotted in Figure XVI-1 (b), and can be expressed as:

$$\frac{dI_a}{dO_a} = R_a = 1 + 0.2 O_a$$

$$\frac{dI_b}{dO_b} = R_b = 1 + 0.3 O_b$$

Examination of the curves of Figure XVI-1 will reveal that while machine B has a greater absolute efficiency than machine A at any load, the incremental rate is also greater at any load above zero load. This indicates that additional

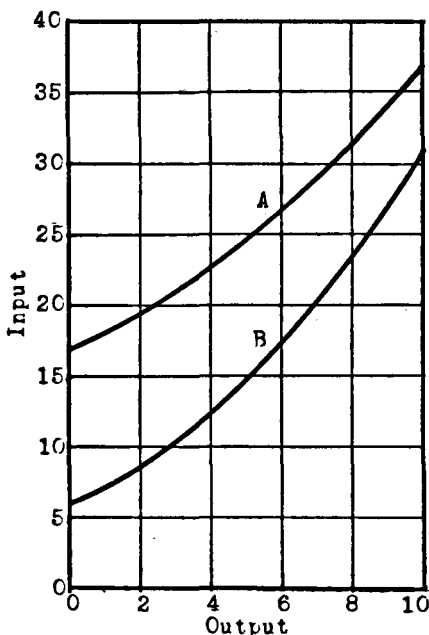

(a) Input-output curves

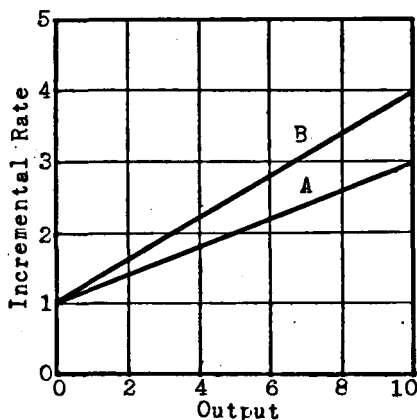

(b) Incremental rate-output curves

Fig. XVI-1. Machine operating characteristics.

blocks of load, according to the theory, will be handled at greater efficiency by machine A than by machine B.

113. Division of Load--A corollary to the requirement that succeeding blocks of load be supplied by plants or machines with the lowest incremental rate is that, for maximum overall efficiency, all plants or machines must be loaded to

the point at which the incremental rates are equal. This correlary can be substantiated by a simple demonstration, using the data for the machines of Figure XVI-1, as follows:

Suppose it is desired to produce a total output of 14 with machine A and machine B running together. Without regard to efficiency, it would be possible to obtain this output with an infinite number of combinations between 1C on one machine and 4 on the other. However, examination of the following table will show that one combination alone will produce an output of 14 with a minimum input. By interpolation the minimum total input is found to be at an output of

Output		Input		
A	B	A	B	Total
10	4	37.0	12.4	49.4
9	5	34.1	14.8	48.9
8	6	31.4	17.4	48.8
7	7	28.9	20.4	49.3
6	8	26.6	23.6	50.2
5	9	24.5	27.1	51.6
4	10	22.6	31.0	53.6

5.8 from machine B and 8.2 from machine A. Examination of Figure XVI-1 (b) will show that the incremental rates for both machines are 2.64.

114. Loading Schedules--It is now possible to demonstrate the derivation of loading curves or schedules for maximum economy. The trend of loading of machines A and B of the previous discussion is such as to bring machine A to its maximum load first, and the load on machine B at which this occurs can be shown graphically by combination of the incremental rate curves of Figure XVI-1 (b), as shown in Figure XVI-2. Beyond this point machine B will supply the additional load to full plant capacity.

115. Applications of the Incremental Rate Method--The term "machine" has been used rather loosely in the previous discussions to indicate that the incremental rate theory is applicable to any piece of apparatus or collection of apparatus for which input-output curves can be drawn.

Input-output curves for turbines may have shapes similar to those shown in the previous discussions, or they may be of a variety of other shapes and slopes depending upon the valve arrangement, variation of efficiency with load and

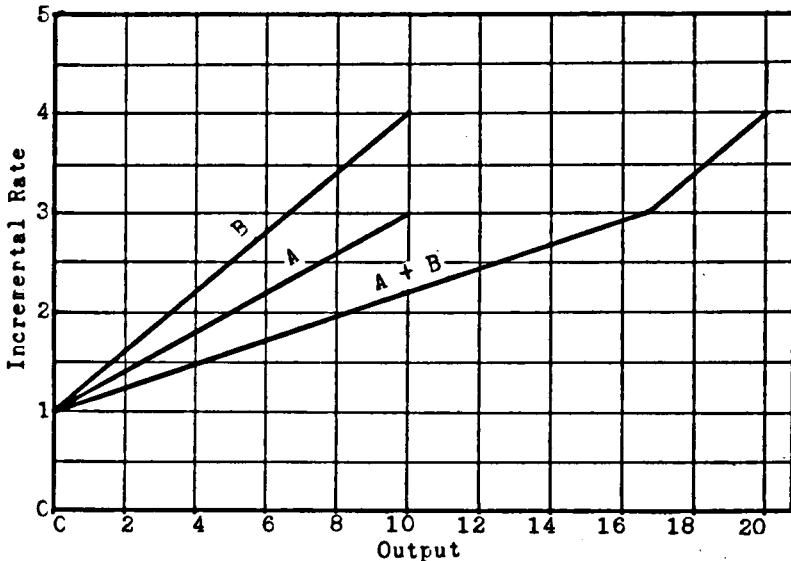

Fig. XVI-2. Plant loading curve.

the auxiliary power requirements. However, no matter what the shape, the basic theory is applicable to determination of the best load division.

The preceding remarks apply equally well to steam generators. Input-output curves can be derived from steam generator efficiency data and the incremental rate curves derived in turn from the input-output curves.

For the purposes of the system load dispatcher, the plant loading curves can be integrated to give plant input-output curves. These curves will be of use in deciding upon the system loading schedule. The plant loading curve of Figure XVI-2 was based upon the operation of two machines at all times, however, due to the better absolute efficiency of machine B, best economy would dictate the use of machine B alone up to a plant load of 10. At this load machine A would be brought on the line and the load divided between the two machines. Figure XVI-3 shows the plant loading curve replotted on this basis. This curve can be integrated in three parts: from zero to 10; from 10 to 16.7; and from 16.7 to 20. The equations are:

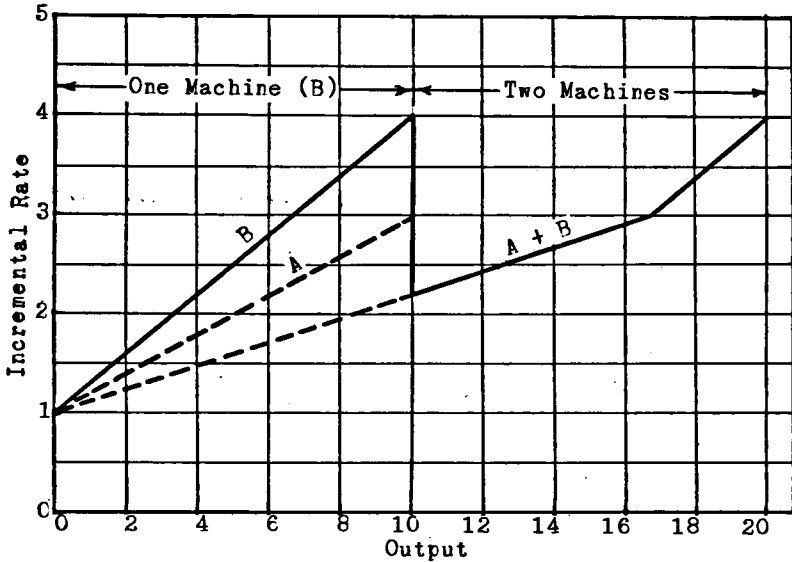

Fig. XVI-3. Plant loading curve.

$$I_0^0 = \int_0^{10} (1 + 0.3 O) dO = 0 + 0.15 O^2 + C_1$$

$$I_0^0 = \int_0^{16} (1 + \frac{2 O}{16.7}) dO = 0 + 0.06 O^2 + C_2$$

$$I_0^0 = \int_0^{20} (-2 + 0.3 O) dO = -2 O + 0.15 O^2 + C_3$$

When the constants are evaluated, the equations become:

$$I_0^0 = \int_0^{10} (1 + 0.3 O) dO = 6 + 0 + 0.15 O^2$$

$$I_0^0 = \int_0^{16} (1 + \frac{2 O}{16.7}) dO = 23 + 0 + 0.06 O^2$$

$$I_0^0 = \int_0^{20} (-2 + 0.3 O) dO = 48 - 2 O + 0.15 O^2$$

The plant input-output curve is then plotted as shown in Figure XVI-4.

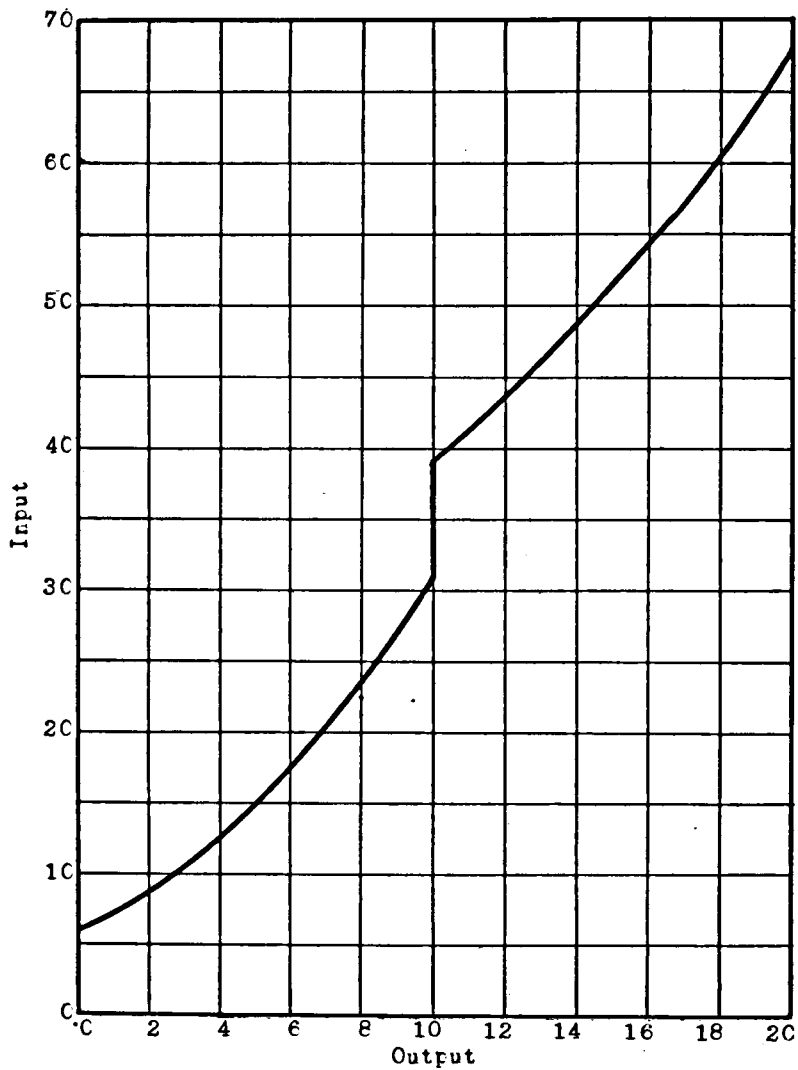

Fig. XVI-4. Plant input-output curve.

BIBLIOGRAPHY

Steinberg, M. J., and Smith, T. H., *Economy Loading of Power Plants and Electric Systems*, Wiley, New York, 1943.

CHAPTER XVII

DIESEL-ELECTRIC POWER PLANTS

116. The Diesel engine is at the present time the most efficient machine (with the exception of the mercury-steam binary vapor cycle) available for the conversion of the energy in fuel to a useful form. It is most unfortunate that the engines are limited in size to about 7000 horsepower. As mentioned in Chapter I, power plants with capacities up to about 7500 kw capacity may well contain Diesel engines, but above this capacity the steam turbine is supreme.

The Diesel engine takes its name from its inventor, Rudolph Diesel, who patented an engine in 1892 which was supposed to operate on the Carnot cycle. However, practical difficulties and development over the years has led to the modern Diesel engine which may be made to operate on the two-stroke or the four-stroke system. By far the greater number of modern Diesel engines operate on the two-stroke system because of the greater simplicity of the engine.

117. **Two-Stroke Diesel Cycle**--The two-stroke Diesel cycle, as the name implies, requires two strokes of the piston to complete a cycle. Referring to Figure XVII-1, it can be seen that with the piston at the bottom of the cylinder

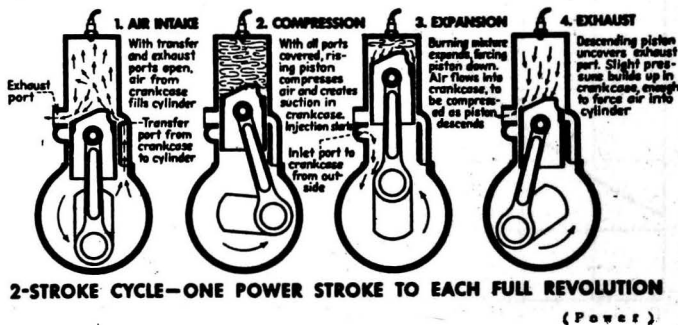

Fig. XVII-1. Two-stroke Diesel cycle.

scavenging air is blown in at one side of the cylinder and out at the other side, purging the cylinder of exhaust gases and charging it with fresh air. As the piston moves upward the scavenging and exhaust ports close and the air is compressed. When the piston reaches the top of its travel the

air temperature has risen to about 800 F, which is sufficient to cause ignition of the charge of fuel which is sprayed into the cylinder through an injector. The combustion of the fuel causes a further increase in temperature and the piston moves downward doing work. Sometimes the mechanical details are changed to employ a poppet valve in the cylinder head for the admission of scavenging air or for exhaust. Figure XVII-2 shows a fuel injector and Figures XVII-3 through XVII-5 show several two-stroke engines.

118. Four-Stroke Diesel Cycle--In this cycle, referring to Figure XVII-6, the first downward stroke of the piston is used for drawing in a charge of air through a poppet valve in the cylinder head. In the upward stroke the air charge is compressed. At the end of the compression stroke the fuel is sprayed into the cylinder through an injector and the piston moves downward on the power stroke. At the end of this stroke the exhaust valve in the cylinder

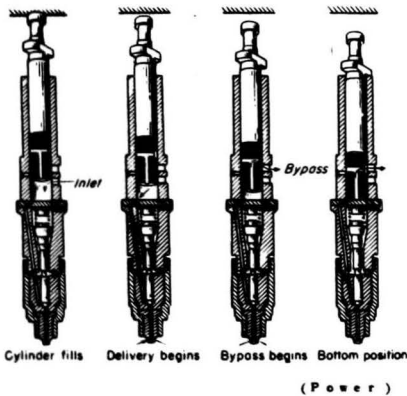
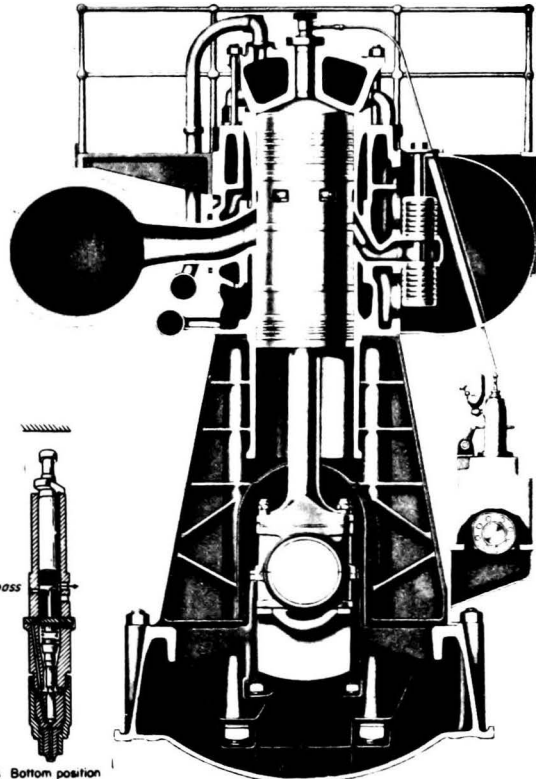
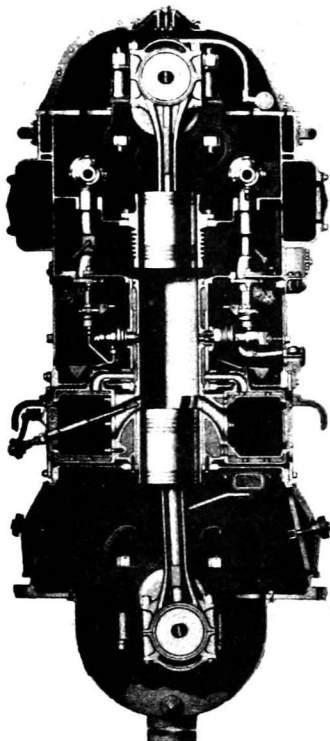

Fig. XVII-2. Fuel injector.



(Nordberg Mfg. Co.)

Fig. XVII-3. Large low speed two-stroke engine.



(Fairbanks, Morse & Co.)
 Fig. XVII-4. High speed opposed piston two-stroke engine.



(General Motors Corp.)

Fig. XVII-5. High speed V-type two-stroke engine.

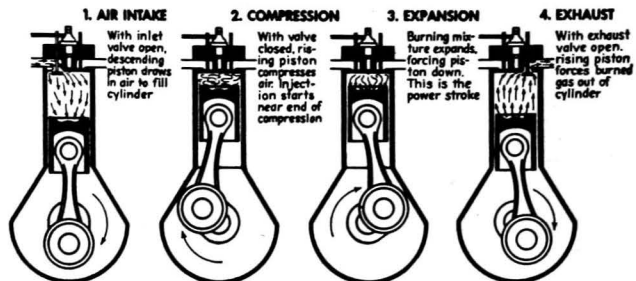

4-STROKE CYCLE—ONE POWER STROKE TO TWO FULL REVOLUTIONS

(Power.)

Fig. XVII-6. Four-stroke Diesel cycle.

head opens and on the upward stroke the exhaust gases are discharged from the cylinder. It would appear that the two-stroke engine would produce twice as much power for the same engine dimensions and speed as the four-stroke engine, but this is not true because the four-stroke engine has a much greater volumetric efficiency as an air compressor. Actually, the power produced per cylinder is almost the same, but the two-stroke cycle engine is preferred because of its greater simplicity. Figures XVII-7 through XVII-9 show several four-stroke cycle engines.

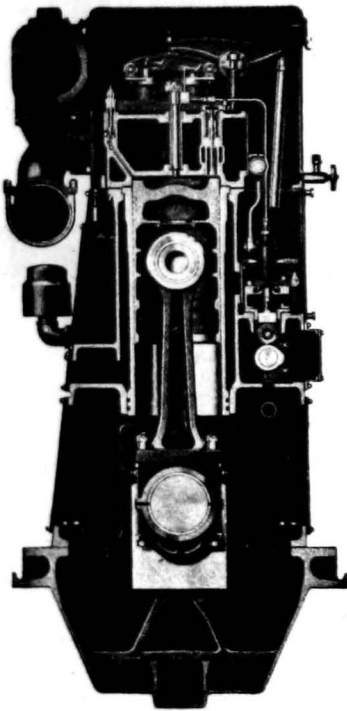

(National Supply Co.)

Fig. XVII-7. Medium speed four-stroke engine.

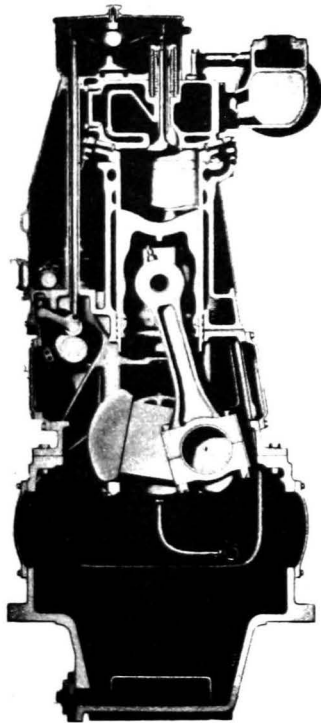

(Ingersoll-Rand Co.)

Fig. XVII-8. Medium speed four-stroke engine.

119. The Ideal Diesel Cycle--The ideal Diesel cycle, shown in Figure XVII-1C, consists of a constant pressure addition of heat from A to B; an adiabatic expansion from B to C; a constant volume rejection of heat from C to D; and an adiabatic compression from D to A. The efficiency of the

ideal cycle can be expressed as follows:

$$e_{t_c} = 1 - \frac{1}{r^n - 1} \frac{R^n - 1}{n(R - 1)}$$

where: r = compression ratio,

$$V_d/V_a \text{ (15 to 18)}$$

R = fuel cutoff ratio,

$$V_b/V_a$$

n = polytropic exponent

If n is given a value of 1.4, which would represent the adiabatic value for air, the efficiency obtained from the

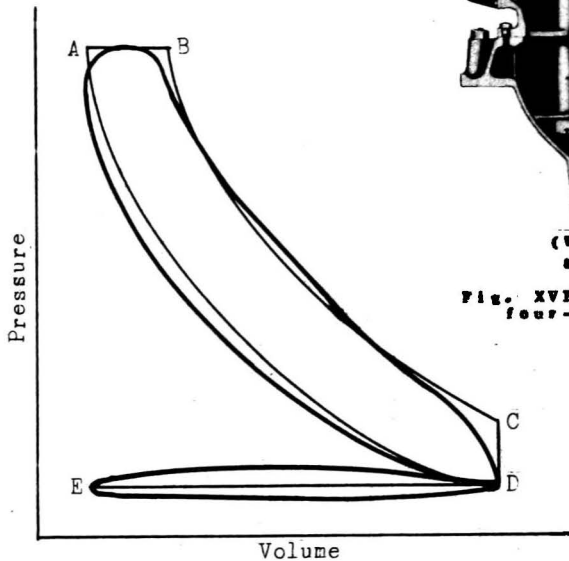
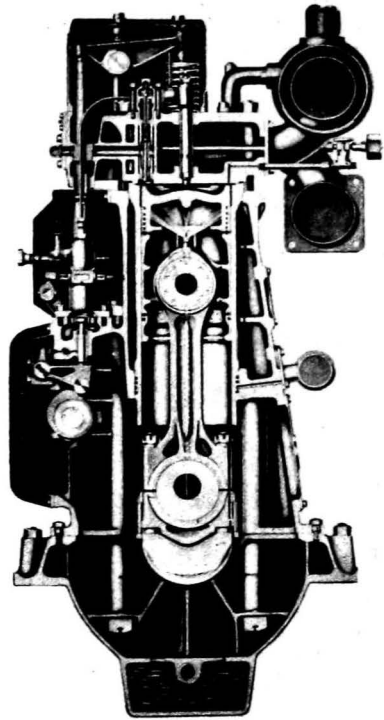

Fig. XVII-10. Ideal Diesel cycle.

shape of the air standard quite closely except for the difference in the value of n . The four-stroke engine, however, will exhibit a negative work loop DED due to losses in discharging the products of combustion and drawing in a fresh



(Vortington Pump & Machinery Co.)

Fig. XVII-9. Medium speed four-stroke engine.

equation would be called the air standard efficiency. Actually, the value of n averages about 1.35.

The two-stroke engine will follow the

air charge. The departure of n from the adiabatic value is due to the necessity of providing the cylinders with water jackets to prevent overheating.

120. Supercharging--The power output of Diesel engines can be increased by providing means for forcing more air into the cylinders, which in turn makes it possible to burn more fuel. The process involves increasing the initial air pressure, and the term applied is *supercharging*. Several systems of supercharging are used, as follows:

1. Positive displacement blowers or compressors.
 - a. Direct connected.
 - b. Motor driven.
2. Centrifugal or axial compressors.
 - a. Exhaust gas turbine driven.
 - b. Direct connected.
 - c. Motor driven.

The advantage of the supercharger lies in its ability to cause an increase in power of the engine which is greater than the power required to drive the supercharger. As a matter of fact, supercharging is necessary for any Diesel engine when it is operated at considerable distances above sea level because of the decrease in atmospheric pressure which results in lower peak cylinder pressures. The decrease in power of an unsupercharged engine with increasing altitude is such as to cause the engine to have only 70 per cent of its sea level power at 8000 feet and 50 per cent at 14000 feet. Figures XVII-11 through XVII-13 show several types of supercharger and scavenging blower.

121. Diesel Engine Efficiencies--The thermal efficiency of most Diesel engines will be about 30 per cent, and the heat balance will be about as follows:

Shaft output	30 o/o
Cooling water	30 o/o
Exhaust gas	30 o/o
Friction, radiation compressor	10 o/o

A not inconsiderable item in the operation of a Diesel engine is the lubricating oil economy. Lubri-

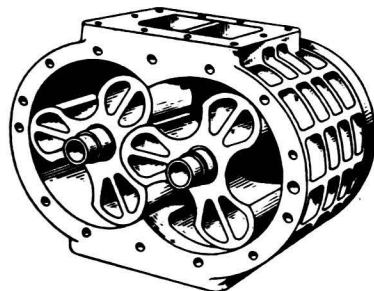

(Power)

Fig. XVII-11. Positive displacement blower.

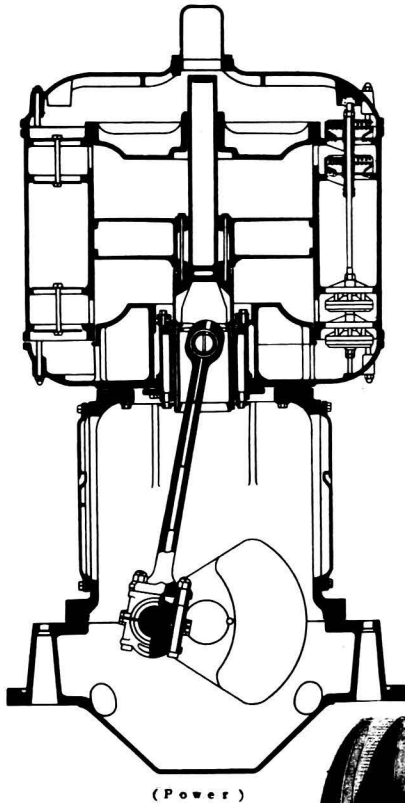

Fig. XVII-12.
Reciprocating
scavenging pump.

122. Diesel Engine Auxiliaries--The auxiliaries for a Diesel engine installation may be placed in several classifications, as follows:

cating oil will be consumed because at each combustion the lubricating oil film burns from the cylinder wall. Figure XVII-14 shows some data on fuel and lubricating oil economy for Diesel-electric plants.

Power output is directly proportional to speed, so that high speed engines will be more economical of space for a given output than will low speed engines. However, high speed engines (600 to 1200 rpm) have shorter lives and require higher grade fuel oils (number 2 or 3), so that a careful economic analysis with respect to expected life and cost must be made before deciding upon the particular type of engine for any given installation.

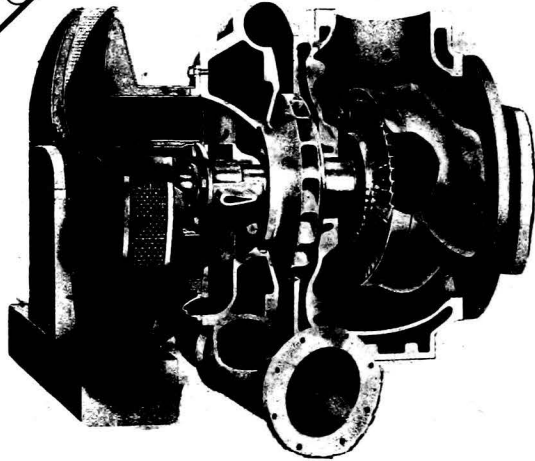

Fig. XVII-13. Exhaust gas turbine driven centrifugal blower.

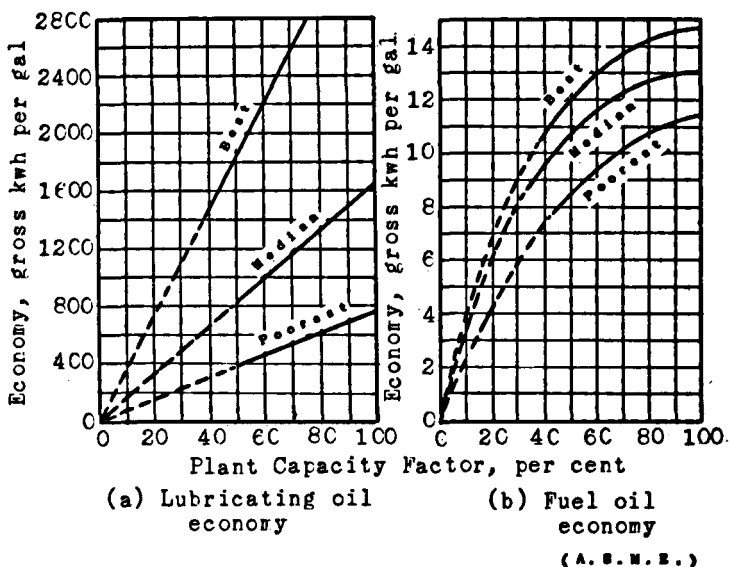

Fig. XVII-14. Diesel engine (fuel) and lubricating oil economy.

1. Fuel oil system.
2. Lubricating oil system.
3. Cooling water system.
4. Air intake system.
5. Exhaust system.
6. Starting air system.

Figure XVII-15 shows the arrangement of the various systems in relation to an engine. The systems can be designed in accordance with the fundamentals of fluid flow presented elsewhere in this book, but especial attention will have to be given to the air intake and exhaust systems in order to avoid conditions which would lead to resonance in the ducts.

BIBLIOGRAPHY

Anderson, J. W., *Diesel Engineering*, McGraw-Hill, New York, 1938.

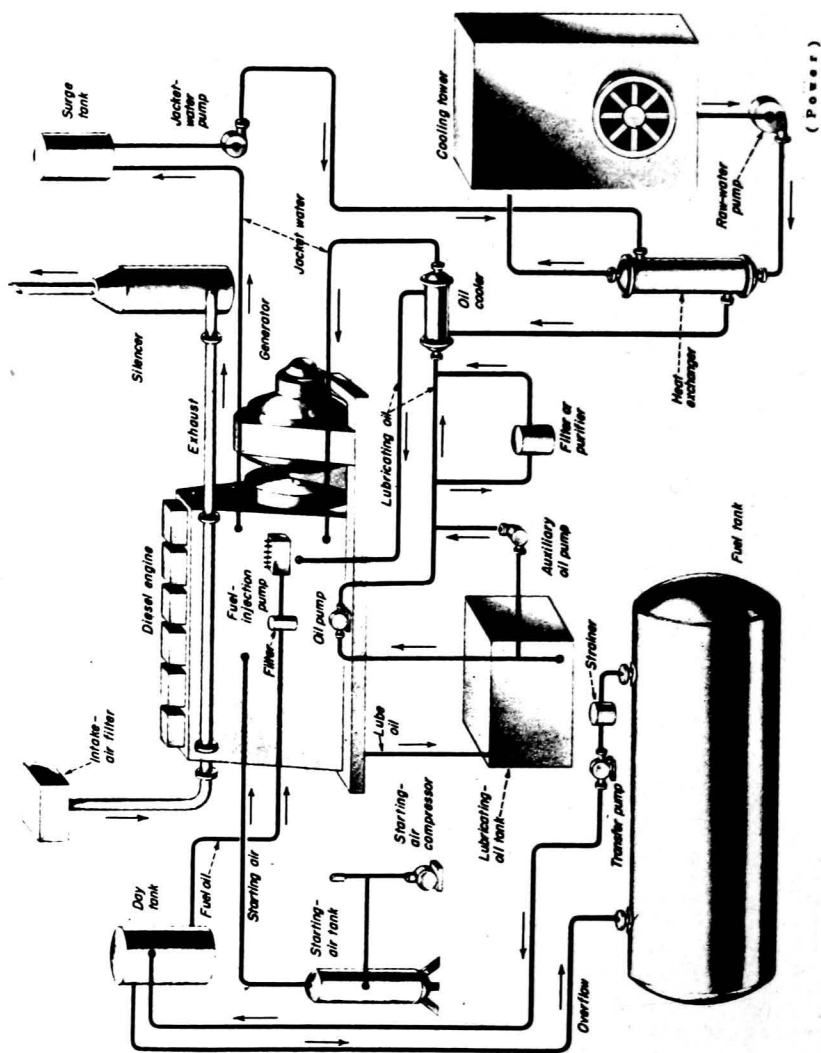

Fig. XVII-15. Diesel engine auxiliaries.

Kates, E. J., *Diesel Electric Plants*, Amer. Tech. Society, Chicago, 1945.

Ward, R. H., "The Diesel Engine and Public Utilities," *Transactions A.S.M.E.*, Volume 50, 1927-28.

CHAPTER XVIII
HYDRO-ELECTRIC POWER PLANTS

123. Hydro-electric power plants can be classified in two ways, as follows:

1. Water impoundment volume.
 - a. Storage plants.
 - b. Run-of-river plants.
2. Head on turbines.
 - a. High head (over 500 feet).
 - b. Medium head (50 to 500 feet).
 - c. Low head (under 50 feet).

The impoundment volume will affect the amount of power available at any particular time, that is, the *storage plant* will be able to supply a swinging load with little or no water loss, while the *run-of-river plant* operates best on base load status (the base load, of course, varying with seasonal stream flow). The head available will affect the choice of type of prime mover. *High head plants* characteristically use small water volumes and high rotational speeds with impulse types of turbines, while *medium and low head plants* use larger water volumes and lower rotational speeds with reaction type machines. Any of the types are available in sizes from 75C to 75,000 kilowatts capacity.

124. Impoundment Methods--Any hydro-electric plant will require a dam which may be high or low depending upon the topography of the dam site and the surrounding water-shed. Each case is unique and requires its own solution.

High dams (over 100 feet) may be of the arch type or of the gravity type. The arch dam depends upon the shape of the dam to transfer the water load to the enclosing rock walls which serve as abutments. Hoover Dam on the Colorado River is of this type. The gravity dam depends upon the mass of the dam itself to resist the water load and the enclosing rock walls merely serve to confine the water laterally. Grand Coulee Dam on the Columbia River is of the gravity type. The TVA system contains both types of dams.

Low dams (under 100 feet) are usually of the gravity type and may be of masonry construction, as with high dams, or they may be of earth fill with cores of rock, clay or concrete.

Figure XVIII-1 shows a concrete arch dam.

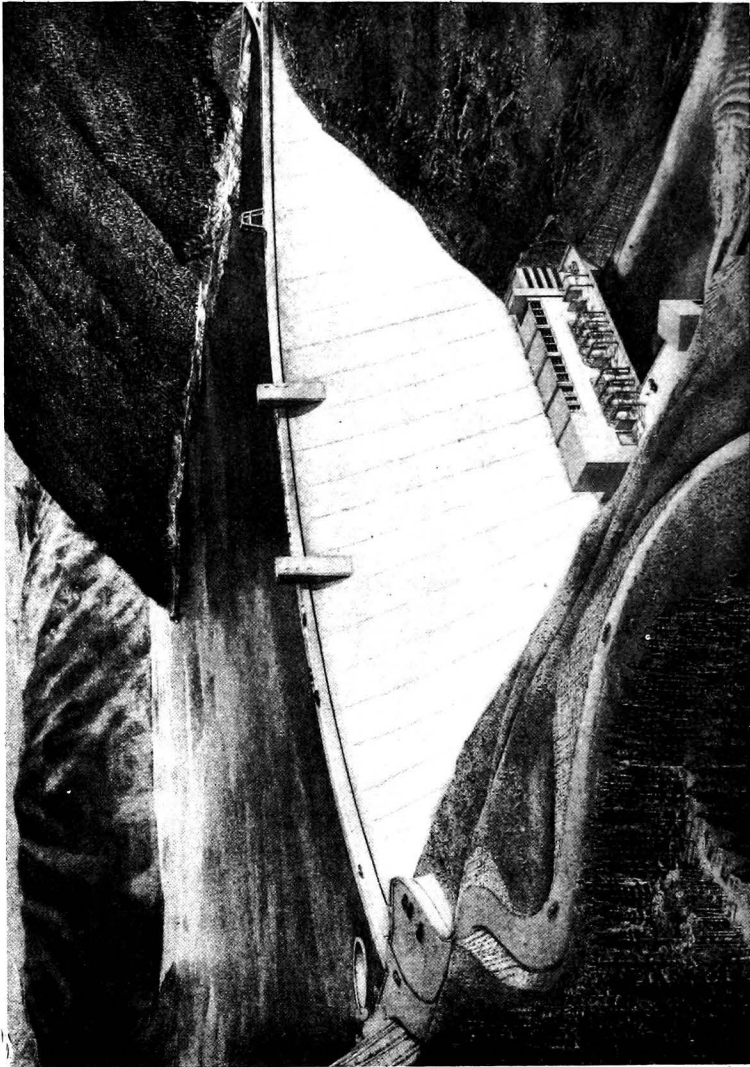

(U.S. Bureau of Reclamation)

Fig. XVIII-1. Concrete arch dam.

12b. Water Storage--The run-of-river plant requires little or no impoundment volume and the essential information for estimating the power capabilities of the site can

be obtained from a river flow duration curve. The flow duration curve can be constructed from a hydrograph, which is similar to an electrical load curve. Figure XVIII-2 shows a river hydrograph, and Figure XVIII-3 shows the flow duration curve derived from it. The minimum power available and the yearly power output can be estimated from these curves.

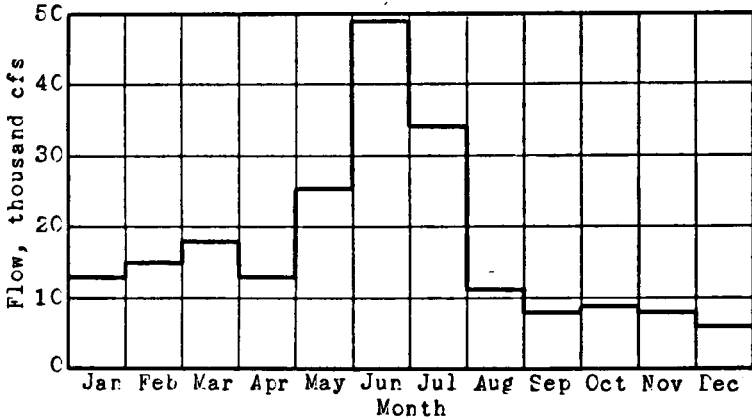

Fig. XVIII-2. River hydrograph.

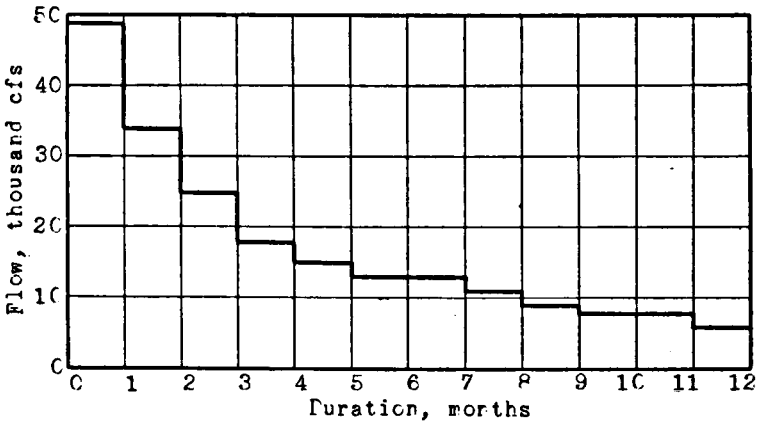

Fig. XVIII-3. River flow duration curve.

The storage plant makes use of a river mass flow curve in which cumulative water-shed runoff is plotted versus time

during the year. Such a curve, derived from Figure XVIII-2, is shown in Figure XVIII-4. Using this curve it is possible to estimate the maximum possible sustained flow to base load turbines by calculating the slope of the line drawn tangent to two similar yearly peaks (A and B in Figure XVIII-4). Whenever the slope of the mass flow curve is less than that of the tangent, the reservoir level will be decreasing, and vice versa. The total impoundment volume should be sufficient to maintain a minimum head on the turbines when the reservoir level is at its lowest, which would be at point C.

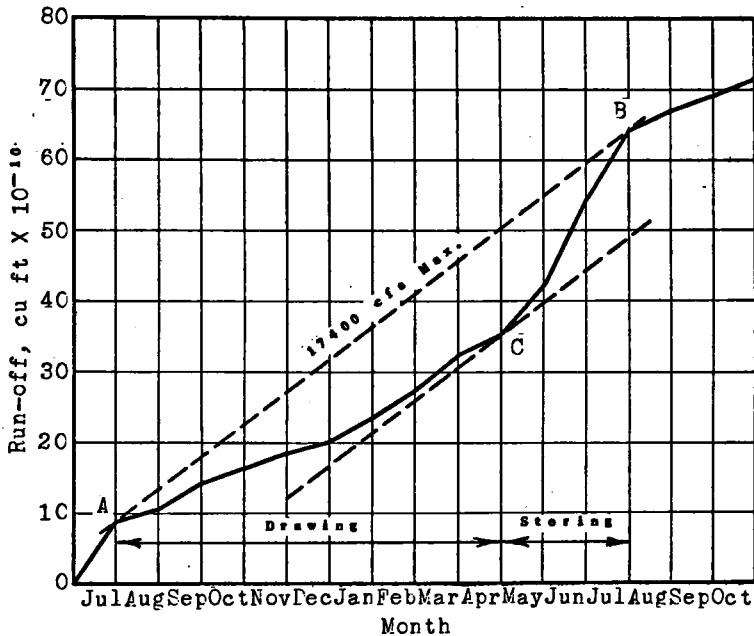

Fig. XVIII-4. River mass flow curve.

126. Hydraulic Turbines--The hydraulic impulse turbine is similar to the steam impulse turbine in that all of the pressure drop takes place in the nozzles. If it is assumed that the initial velocity is zero, the jet velocity is (assuming a perfect nozzle):

$$V = \sqrt{2gH} = \sqrt{2g(P_1 - P_2)/\rho}$$

where: V = jet velocity, ft/sec

H = head at jet inlet, ft of water

F_1 and F_2 = jet inlet and outlet pressures, lbs/sq ft
 v = specific volume of water, cu ft/lb

The power in the jet is:

$$\text{whp} = \frac{M H}{550} = \frac{M(P_1 - P_2)v}{550}$$

where: M = water flow, lbs/sec

but due to the fact that it is not possible to slow the jet down to zero velocity, and due to mechanical friction, the shaft horsepower will only amount to about 85 to 90 per cent of the jet horsepower. The impulse turbine is for very high head developments (over 900 feet) and operates at speeds between 300 and 400 rpm. Figure XVIII-7 shows an impulse turbine runner of the Pelton type with its needle nozzles. Two of the runners are overhung on one generator and the nozzles are so arranged that one per runner is the power nozzle and identical nozzles are used for surge relief. That is, as the power nozzle closes on a load decrease the relief nozzle opens an equal amount and then automatically closes slowly to prevent surges in the penstock (which is the name given to the pipe which delivers water to the nozzles from the reservoir). As an extra safety measure, the penstocks are equipped with surge tanks near the turbines.

For heads between 65 and 900 feet the Francis type of reaction turbine is used. The wheel, or runner, has curved blades which receive water through control gates from a volute chamber and discharge the water vertically downward. The action is very similar to that in a reaction steam turbine, some pressure drop taking place in the control gates giving some impulse effect, while the remainder of the pressure drop takes place in the runner. The water horsepower is the same as the jet horsepower for the impulse turbine, but the efficiency is higher, usually between 90 and 95 per cent. Figure XVIII-5 shows a Francis type turbine with an umbrella generator. These machines operate at speeds between 100 and 300 rpm.

For heads less than 65 feet the axial flow propeller type of reaction turbine is used. The runner may be of the Nagler type with fixed pitch blades or of the Kaplan type with adjustable pitch blades. The Kaplan runner is very well suited to run-of-river plants because the power output and efficiency can be maintained under reduced head condi-

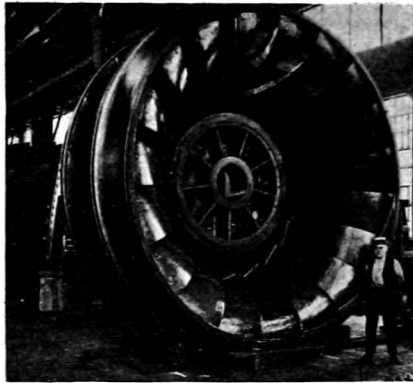

(a) Runner

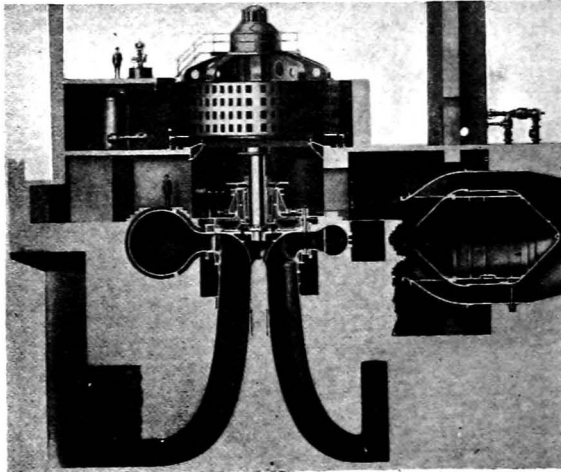

(b) General arrangement

(Vn. Crisp & Sons)

Fig. XVIII-5. Francis turbine.

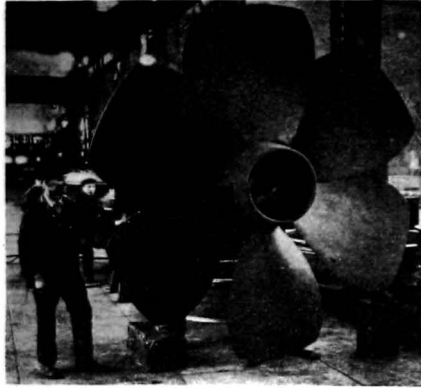

(a) Runner

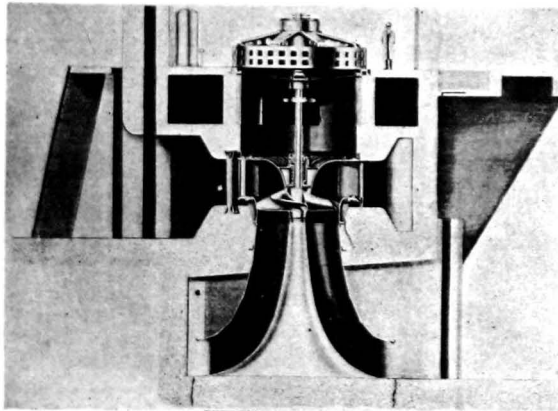

(b) General Arrangement

(Wm. Cramp & Sons)

Fig. XVIII-6. Nagler turbine.

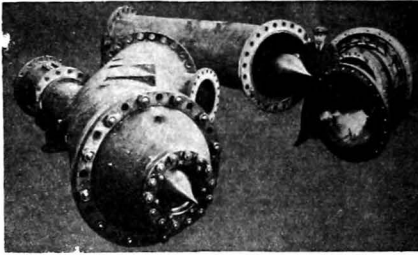

(a) Needle nozzles

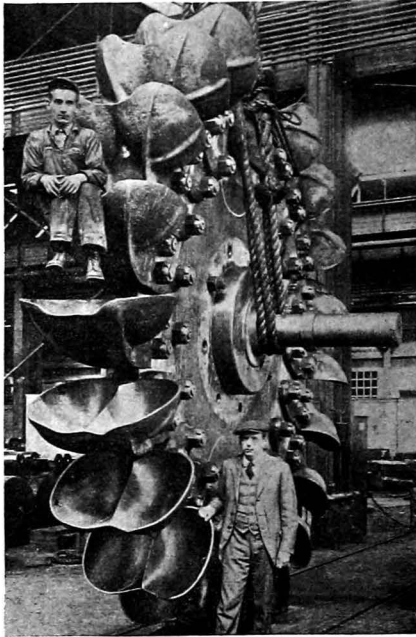

(b) Runner

(Allis-Chalmers Mfg. Co.)

Fig. XVIII-7. Pelton turbine.

tions. Water is supplied to the propeller through control gates in a manner similar to that used with the Francis runner. Efficiencies vary between 85 and 90 per cent and speeds between 60 and 100 rpm. Figure XVIII-6 shows a typical Nagler turbine connected to an umbrella type generator.

BIBLIOGRAPHY

- Creager, W. P., *Engineering for Dams*, Wiley, New York, 1945.
- Daugherty, R. L., *Hydraulic Turbines*, McGraw-Hill, New York, 1920.
- Hill, R. A., "Graphics of Temporary Flood Storage," *Engineering News-Record*, April, 1928.
- Merriman, T., "Dam Construction and Design," *Engineering News-Record*, February, 1929.
- Spannhake, W., *Centrifugal Pumps, Turbines and Propellers*, Mass. Inst. of Tech., Cambridge, 1934.

CHAPTER XIX

GAS TURBINE POWER PLANTS

127. In the last war the development of the gas turbine was given great impetus and at the present time several manufacturers are offering 5000 kilowatt units for use with heavy fuel oil or natural gas. Research is being conducted on pulverized coal burning units but difficulty is being experienced with flyash erosion in the turbines.

128. Gas Turbine Cycles--The simplest gas turbine cycle corresponds to the open Rankine vapor cycle, as shown in Figure XIX-1. Referring to the figure, air at atmospheric pressure and temperature is drawn in by the compressor, compressed and led to the combustion chamber where fuel is burned at constant pressure. The resulting high temperature combustion gases then expand to atmospheric pressure through a turbine and the unavailable energy is rejected to the atmosphere. Part

of the turbine work is used to drive the compressor and the remainder is available for doing useful work. Due to the fact that present turbine blading materials will withstand temperatures of only about 1200 F for long periods, secondary air in sufficient quantity to cool the combustion gases to a safe temperature must be supplied. The total air supplied amounts to between 100 and 150 pounds per pound of fuel oil. This large amount of excess air results in lowered cycle efficiency due to the increase in compressor power, but overall thermal efficiencies of 18 to 20 per cent are obtainable. An enthalpy-entropy diagram for the simple open cycle is shown in Figure XIX-2.

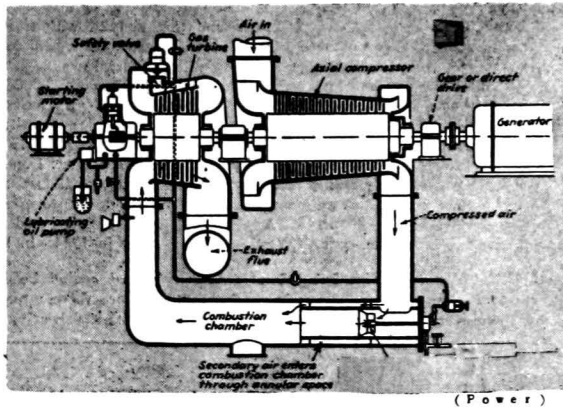

Fig. XIX-1. Simple open gas turbine cycle.

The simple open cycle may have a regenerator added to improve efficiency where the air temperature leaving the

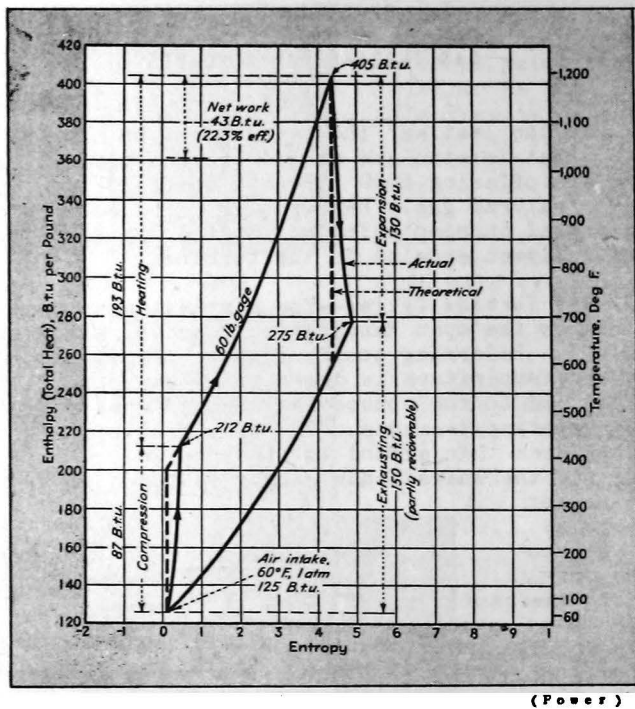

Fig. XIX-2. Simple open gas turbine cycle.

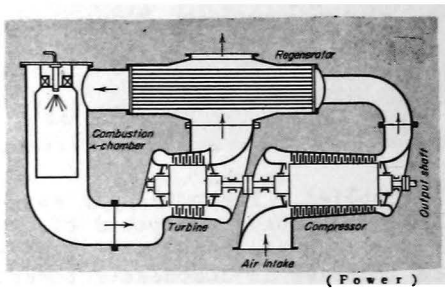

Fig. XIX-3. Open gas turbine cycle with regenerator.

compressor is less than the turbine exhaust temperature. Such an arrangement is shown in Figure XIX-3.

Other combinations with regeneration, multiple stage compression with intercooling and reheating will have higher efficiencies. Two of the various types of these more complex cycles are shown in Figures XIX-4 and XIX-5.

A closed gas turbine cycle has been proposed which makes use of a heat exchanger in the combustion chamber to make it possible to separate the combustion gases from the working fluid which can be made to operate at higher pressures

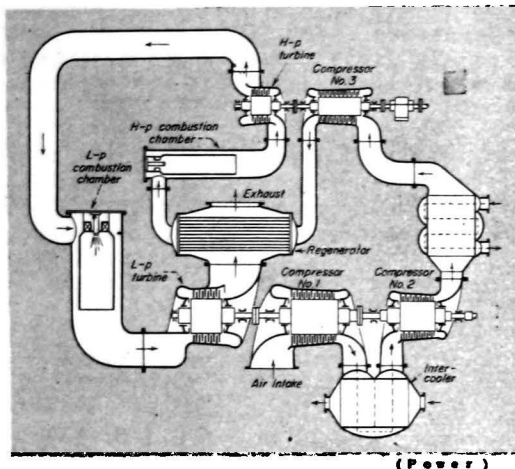

Fig. XIX-5. Open gas turbine cycle with reheat, intercooling and regeneration.

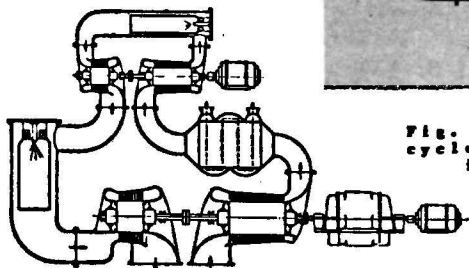

Fig. XIX-4. Open gas turbine cycle with reheat and intercooling.

where the density is greater, thus allowing smaller machines for the same output. Figure XIX-6 shows a diagram of the cycle. It will be noted that the

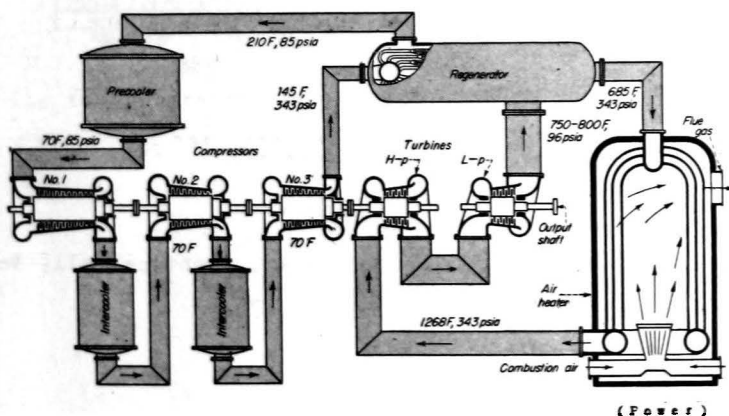
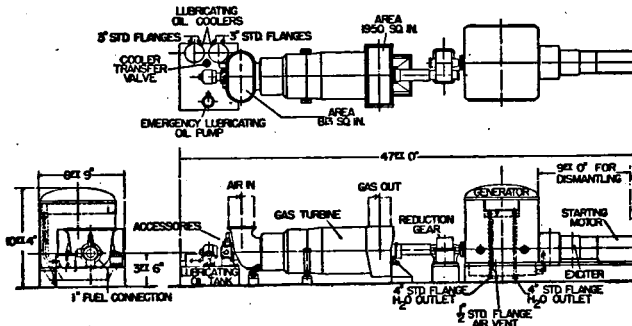

Fig. XIX-6. Closed gas turbine cycle.

cycle contains a precooler in which the unavailable energy is rejected. The efficiency of the closed cycle is slightly less than that of an equivalent open cycle, but the smaller size for the same output may overbalance the smaller efficiency.

129. Gas Turbine Plants--Up to the present time the principal application of the gas turbine in industry has been in the Houdry process of gasoline production where large quantities of compressed air are required. In these machines the excess turbine power is used to drive an oversized compressor and the extra air which is not needed for combustion goes to the process.

In the last few years several commercial gas turbo-generator installations with capacities up to 5000 kilowatts have been made. One of them is shown in Figure XIX-7. This particular machine is similar, except for the generator, to the units developed for use in locomotives.



(General Electric Co.)

Fig. XIX-7. Locomotive type gas turbo-generator.

BIBLIOGRAPHY

Sawyer, R. T., *The Modern Gas Turbine*, Prentice-Hall, New York, 1945.

TABLE XVII
continued

300-Pound Malleable Iron Fittings

WORKING PRESSURES

300 pounds steam or oil, 550° F.

- $\frac{1}{4}$ to 1-inch — 2000 pounds cold water, oil, or gas, non-shock
- $1\frac{1}{4}$ to 2-inch — 1500 pounds cold water, oil, or gas, non-shock
- $2\frac{1}{2}$ and 3-inch — 1000 pounds cold water, oil, or gas, non-shock

Dimensions, in Inches



90° Elbow



Tee



Cross



45° Elbow



90° Street Elbow



45° Street Elbow

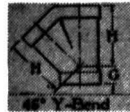

45° Y-Bend



Reducer



Cap



Coupling

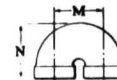

Return Bend



Thread Engagement

APPENDIX

307

Size	$\frac{1}{4}$	$\frac{3}{8}$	$\frac{1}{2}$	$\frac{3}{4}$	1	$1\frac{1}{4}$	$1\frac{1}{2}$	2	$2\frac{1}{2}$	3
A—Center to end	$\frac{19}{16}$	$\frac{11}{16}$	$1\frac{1}{4}$	$1\frac{7}{16}$	$1\frac{1}{2}$	$\frac{115}{16}$	$2\frac{1}{8}$	$2\frac{1}{2}$	$2\frac{11}{16}$	$3\frac{3}{8}$
B—Center to end, 45° Elbows	$\frac{13}{16}$	$\frac{7}{8}$	1	$1\frac{1}{8}$	$1\frac{1}{2}$	$1\frac{1}{2}$	$1\frac{11}{16}$	2	$2\frac{1}{4}$	$2\frac{1}{2}$
C—Center to end, 90° Street Elbows	$\frac{13}{16}$	$\frac{15}{16}$	$1\frac{1}{4}$	$1\frac{7}{16}$	$1\frac{1}{2}$	$\frac{115}{16}$	$2\frac{1}{8}$	$2\frac{1}{2}$	$2\frac{15}{16}$	$3\frac{3}{8}$
D—Center to end, 90° Street Elbows	$\frac{17}{16}$	$1\frac{3}{8}$	2	$2\frac{3}{16}$	$2\frac{9}{16}$	$2\frac{7}{8}$	$3\frac{1}{8}$	$3\frac{11}{16}$	$4\frac{1}{2}$	$5\frac{1}{8}$
E—Center to end, 45° Street Elbows	$\frac{3}{4}$	$\frac{11}{16}$	1	$1\frac{1}{8}$	$1\frac{1}{2}$	$1\frac{1}{2}$	$1\frac{11}{16}$	2		
F—Center to end, 45° Street Elbows	$1\frac{1}{8}$	$1\frac{1}{4}$	$1\frac{3}{8}$	$1\frac{9}{16}$	$1\frac{13}{16}$	$2\frac{1}{8}$	$2\frac{5}{16}$	$2\frac{11}{16}$		
G—Center to end, 45° Y-Bends			$\frac{3}{4}$	$\frac{7}{8}$	1	$\frac{11}{16}$	$1\frac{1}{8}$	$1\frac{1}{4}$	$1\frac{3}{8}$	2
H—Center to end, 45° Y-Bends			2	$2\frac{1}{8}$	$3\frac{1}{4}$	$3\frac{11}{16}$	$3\frac{1}{2}$	$5\frac{1}{4}$	$6\frac{1}{8}$	$6\frac{7}{8}$
J—End to end, Reducers		$\frac{17}{16}$	$\frac{111}{16}$	$1\frac{3}{4}$	2	$2\frac{3}{8}$	$2\frac{11}{16}$	$3\frac{3}{16}$	$3\frac{11}{16}$	$4\frac{1}{16}$
K—Height, Caps	$2\frac{5}{32}$	$\frac{3}{8}$	$\frac{11}{16}$	$1\frac{1}{4}$	$1\frac{3}{8}$	$1\frac{1}{2}$	$\frac{111}{16}$	$1\frac{13}{16}$	$2\frac{1}{8}$	$2\frac{1}{4}$
L—End to end, Couplings	$1\frac{3}{8}$	$1\frac{5}{8}$	$1\frac{7}{8}$	$2\frac{1}{8}$	$2\frac{3}{8}$	$2\frac{7}{8}$	$3\frac{1}{8}$	$4\frac{1}{8}$	$4\frac{1}{8}$	$4\frac{1}{8}$
Z—Thread Engagement	$\frac{3}{8}$	$\frac{3}{8}$	$\frac{1}{2}$	$\frac{9}{16}$	$1\frac{1}{16}$	$1\frac{1}{16}$	$1\frac{1}{16}$	$\frac{3}{4}$	$1\frac{1}{16}$	1

Return Bends

Size	1	1	1	$1\frac{1}{4}$	$1\frac{1}{4}$	$1\frac{1}{4}$	$1\frac{3}{4}$	$1\frac{3}{4}$	$1\frac{3}{4}$	$1\frac{1}{2}$	$1\frac{1}{2}$	2	2	2	2	
M—Center to center	$1\frac{3}{4}$	$2\frac{1}{2}$	3	$2\frac{1}{4}$	$2\frac{1}{2}$	3	$3\frac{1}{8}$	$4\frac{1}{8}$	$5\frac{1}{8}$	$6\frac{1}{8}$	$7\frac{1}{8}$	$8\frac{1}{8}$	$9\frac{1}{8}$	$10\frac{1}{8}$	$11\frac{1}{8}$	$12\frac{1}{8}$
N—Height	$2\frac{7}{8}$	$3\frac{1}{4}$	$3\frac{1}{2}$	$3\frac{9}{16}$	$3\frac{11}{16}$	$3\frac{13}{16}$	$4\frac{1}{16}$	$4\frac{1}{8}$	$4\frac{1}{4}$	$4\frac{3}{8}$	$4\frac{5}{8}$	$5\frac{1}{8}$	$5\frac{3}{8}$	$5\frac{5}{8}$	$6\frac{1}{8}$	$6\frac{3}{8}$

TABLE XVII
continued

Malleable Iron Unions and Union Fittings

WORKING PRESSURES

150 pounds steam

300 pounds cold water, oil, gas or gasoline, non-shock

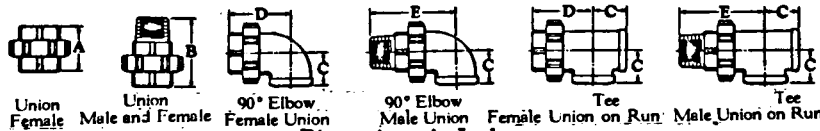

Dimensions, in Inches

Size	1/4	3/8	1/2	3/4	1	1 1/4	1 1/2	2	2 1/2	3
A	1 1/8	1 1/2	1 11/16	1 7/8	2 1/4	2 5/8	2 3/4	2 7/8	3 1/4	3 9/16
B	2 3/16	2 3/8	2 3/4	3	3 5/8	3 3/4	3 11/16	4 1/4	4 13/16	5 1/8
C	1 3/16	1 5/8	1 1/2	1 5/8	1 1/2	1 3/4	1 11/16	2 1/4		
D	1 11/16	1 7/8	2 1/8	2 1/4	2 7/8	3 1/8	3 3/8	3 3/4		
E	2 7/8	2 3/4	3	3 3/8	3 11/16	4 1/8	4 7/8	5 1/4		

300 pounds steam, 550° F.

600 pounds cold water, oil, gas, or gasoline, non-shock

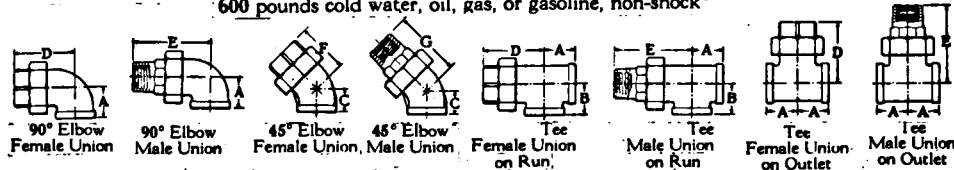

Dimensions, in Inches

Size	1/4	3/8	1/2	3/4	1	1 1/4	1 1/2	2	2 1/2	3	1 x 3/4	1 x 1/2	1 x 3/8
A	1 5/16	1 1/8	1 1/4	1 7/16	1 5/8	1 11/16	2 1/8	2 1/2	2 11/16	3 3/8	1 5/8	1 7/16	1 1/2
B	1 1/8	1 1/16	1 3/8	1 7/16	1 5/8	1 11/16	2 1/8	2 1/2	2 11/16	3 3/8	1 7/16	1 1/2	1 1/16
C	1 3/16	7/16	1	1 1/8	1 5/16	1 1/2	1 11/16	2	2 1/4				
D	2	2 1/4	2 7/16	2 3/8	3 3/16	3 11/16	3 11/16	4 1/2	5 1/4	5 11/16	2 3/4	2 7/8	3
E	2 3/16	2 7/8	3 3/16	3 3/4	4 1/8	4 3/8	4 7/8	5 3/8	6 7/16	7 3/16	3 11/16	3 13/16	3 11/16
F	1 5/8	1 3/4	1 11/16	2 3/16	2 1/2	2 7/8	3 1/8	3 11/16	4 3/16				
G	2 3/16	2 7/16	2 11/16	3 1/8	3 7/16	3 13/16	4 1/8	4 7/8	5 3/16				

TABLE XVII
continued

125-Pound Cast Iron Flanged Fittings

14 to 24-inch — 100 pounds steam

WORKING PRESSURES

1 1/2 to 12-inch — 125 pounds steam

12 to 14-inch — 175 pounds cold water, oil, or gas, non-shock

14 to 24-inch — 150 pounds cold water, oil, or gas, non-shock

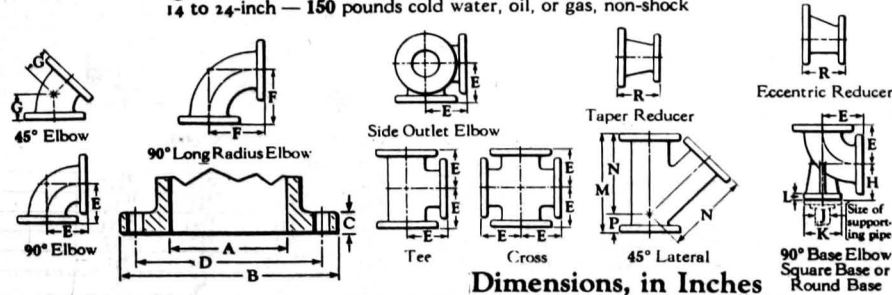

Dimensions, in Inches

Size	A	B	C	D	No. of bolts	Dia. of bolts	E	EE	F	G	H	J	K	L	M	N	P	R
1 1/2	1 1/2	5	9/16	3 7/8	4	1/2	4	8	5	2 1/4	3 3/4	1	4 1/4	3/8	9	7	2	
2	2	6	5/8	4 3/4	4	5/8	4 1/2	9	6 1/2	2 1/2	4 3/4	1 1/4	4 3/4	1/2	10 1/2	8	2 1/2	8
2 1/2	2 1/2	7	1 1/16	5 1/2	4	5/8	5	10	7	3	4 3/4	1 1/4	4 3/4	1/2	12	9 1/2	2 1/2	5 1/2
3	3	7 1/2	3/4	6	4	5/8	5 1/2	11	7 3/4	3	4 3/4	1 1/4	5	5/8	13	10	3	6
3 1/2	3 1/2	8 1/2	13/16	7	8	5/8	6	12	8 1/2	3 1/2	5 1/4	1 1/4	5	5/8	14 1/2	11 1/4	3	6 1/2
4	4	9	15/16	7 1/2	8	5/8	6 1/2	13	9	4	5 1/2	2	6	3/4	15	12	3	7
5	5	10	15/16	8 1/2	8	3/4	7 1/2	15	10 1/4	4 1/2	6 1/4	2 1/2	7	1 1/4	17	13 1/4	3 1/2	8
6	6	11	1	9 1/2	8	3/4	8	16	11 1/2	5	7	2 1/2	7	1 1/4	18	14 1/2	3 1/2	9
8	8	13 1/2	1 1/8	11 3/4	8	3/4	9	18	14	5 1/2	8 3/4	4	9	1 5/8	22	17 1/2	4 1/2	11
10	10	16	1 3/16	14 1/4	12	7/8	11	22	16 1/2	6 1/2	9 3/4	4	9	1 5/8	25 1/2	20 1/4	5	12
12	12	19	1 1/4	17	12	7/8	12	24	19	7 1/2	11 1/4	6	11	1	30	24 1/2	5 1/2	14
14	14	21	1 3/8	18 3/4	12	1	14	28	21 1/2	7 1/2	12 1/4	6	11	1	33	27	6	16
16	16	23 1/2	1 7/16	21 1/4	16	1	15	30	24	8	13 3/4	6	11	1	36 1/2	30	6 1/2	18
18	18	25	1 9/16	22 3/4	16	1 1/8	16 1/2	33	26 1/2	8 1/2	15	8	13 1/4	1 1/8	39	32	7	19
20	20	27 1/2	1 11/16	25	20	1 1/8	18	36	29	9 1/2	16	8	13 3/4	1 1/8	43	35	8	20
24	24	32	1 7/8	29 1/2	20	1 1/4	22	44	34	11	18 1/2	8	13 1/4	1 1/8	49 1/2	40 1/2	9	24

TABLE XVII
continued

250-Pound Cast Iron Flanged Fittings

WORKING PRESSURES

250 pounds steam

400 pounds cold water, oil, or gas, non-shock



90° Elbow



45° Elbow



Taper Reducer



Tee

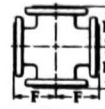

Cross

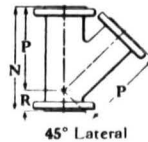
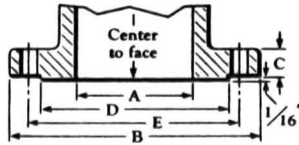

45° Lateral

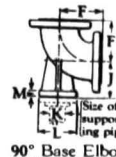

90° Base Elbow
Square Base or
Round Base

Dimensions, in Inches

Size	A	B	C	D	E	No. of bolts	Dia. of bolts	Dimensions, in Inches												
								F	FF	G	H	J	K	L	M	N	P	R	S	
2	2	6 1/2	7/8	4 3/16	5	8	5/8	5	10	6 1/2	3	4 1/2	1 1/4	5 1/4	3/4	11 1/4	9	12 1/4	8	
2 1/2	2 1/2	7 1/2	1	4 15/16	5 7/8	8	3/4	5 1/2	11 1	7	3 1/2	4 3/4	1 1/4	5 3/4	3/4	12	10 1/4	12 1/4	5 1/2	
3	3	8 1/4	1 1/8	5 1 1/16	6 5/8	8	3/4	6	12	7 3/4	3 1/2	5 1/4	1 1/4	6 1/4	13 1/16	14	11	3	6	
3 1/2	3 1/2	9	1 3/16	6 5/16	7 1/4	8	3/4	6 1/2	13	8 1/4	4	5 5/8	1 1/2	6 1/8	1 3/16	15 1/16	12 1/2	3	6 1/2	
4	4	10	1 1/4	6 15/16	7 3/4	8	3/4	7	14	9	4 1/2	6	2	6 1/2	1 3/8	16 1/2	13 1/2	3	7	
5	5	11	1 3/8	8 5/16	9 1/4	8	3/4	8	16	10 3/4	5	6 3/4	2 1/2	7 1/2	1	18 1/2	15	3 1/2	8	
6	6	12 1/2	1 7/8	9 1 1/16	10 5/8	12	3/4	8 1/2	17	11 1/4	5 1/2	7 1/2	2 1/2	7 1/2	1	21 1/2	17 1/2	4	9	
8	8	15	1 5/8	11 5/16	13	12	7/8	10	20	14	6	9	4	10	1 1/4	25 1/2	20 1/2	5	11	
10	10	17 1/2	1 7/8	14 1/16	15 1/4	16	1	11 1/2	23	16 1/2	7	10 1/2	4	10	1 1/4	29 1/2	24	5 1/2	12	
12	12	20 1/2	2	16 7/16	17 3/4	16	1 1/8	13	26	19	8	12	6	12 1/4	1 1/16	33 1/2	27 1/4	6	14	

TABLE XVII
continued

125-Pound Cast Iron Flanges 250-Pound

WORKING PRESSURES

- 1 to 12-inch — 125 pounds steam
- 14 to 24-inch — 100 pounds steam
- 1 to 12-inch — 175 pounds cold water, oil, or gas, non-shock
- 14 to 24-inch — 150 pounds cold water, oil, or gas, non-shock

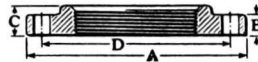

Size of pipe Inches	Dimensions, in Inches					
	A	B	C	D	No. of Bolts	Dia. of Bolts
1	4 1/4	7/16	1 1/16	3 3/8	4	1/2
1 1/4	4 5/8	1/2	1 3/16	3 1/2	4	1/2
1 1/2	5	9/16	7/8	3 7/8	4	1/2
2	6	5/8	1	4 3/4	4	5/8
2 1/2	7	1 1/16	1 3/16	5 1/2	4	5/8
3	7 1/2	3/4	1 1/4	6	4	5/8
3 1/2	8 1/2	13/16	1 1/4	7	8	5/8
4	9	1 5/16	1 5/16	7 1/2	8	5/8
5	10	1 5/16	1 7/16	8 1/2	8	3/4
6	11	1	1 9/16	9 1/2	8	3/4
8	13 1/2	1 1/8	1 3/4	11 3/4	8	3/4
10	16	1 3/16	1 15/16	14 1/4	12	7/8
12	19	1 1/4	2 3/16	17	12	7/8
14 OD	21	1 3/8	2 1/4	18 3/4	12	1
16 OD	23 1/2	1 7/8	2 1/2	21 1/4	16	1
18 OD	25	1 9/16	2 11/16	22 3/4	16	1 1/8
20 OD	27 1/2	1 11/16	2 7/8	25	20	1 1/8
24 OD	32	1 7/8	3 1/4	29 1/2	20	1 1/4

- ### WORKING PRESSURES
- 250 pounds steam
 - 400 pounds cold water, oil, or gas, non-shock

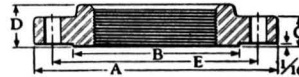

Dimensions, in Inches						
A	B	C	D	E	No. of Bolts	Dia. of Bolts
4 1/2	2 11/16	1 1/16	7/8	3 1/2	4	5/8
5 1/8	3 1/16	3/4	1	3 3/8	4	5/8
6 1/8	3 9/16	1 3/16	1 1/8	4 1/2	4	3/4
6 1/2	4 3/16	7/8	1 1/4	5	8	5/8
7 1/2	4 15/16	1	1 7/16	5 7/8	8	3/4
8 1/4	5 11/16	1 1/8	1 9/16	6 5/8	8	3/4
9	6 5/16	1 3/16	1 5/8	7 1/4	8	3/4
10	6 15/16	1 1/4	1 3/4	7 7/8	8	3/4
11	8 5/16	1 3/8	1 7/8	9 1/4	8	3/4
12 1/2	9 11/16	1 7/16	2	10 5/8	12	3/4
15	11 15/16	1 5/8	2 3/16	13	12	7/8
17 1/2	14 1/16	1 7/8	2 3/8	15 1/4	16	1
20 1/2	16 7/16	2	2 9/16	17 3/4	16	1 1/8
23	18 11/16	2 1/4	2 11/16	20 1/4	20	1 1/4
25 1/4	21 1/16	2 1/4	2 7/8	22 1/4	20	1 1/4
28	23 9/16	2 3/4	3 1/8	24 1/4	24	1 1/4
30 1/2	25 5/16	2 1/2	3 1/16	27	24	1 1/4
36	30 1/16	2 3/4	3 11/16	32	24	1 1/2

TABLE XVII
continued

Cast Steel Flanged Fittings

Dimensions, in Inches



90° Elbow

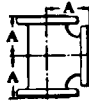

Tee

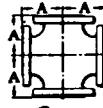

Cross

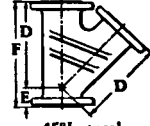

45° Lateral

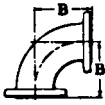

90° Long
Radius Elbow



45° Elbow



90° Base Elbow



Taper
Reducer

Class	Size	A	B	C	D	E	F	G	H	J	K
150 Pound	1	3½	5	1¾	5¾	1¾	7½				
	1¼	3¾	5½	2	6¼	1¾	8				
	1½	4	6	2¼	7	2	9				
	2	4½	6½	2½	8	2½	10½	5	4½	4¾	½
	2½	5	7	3	9½	2½	12	8½	4½	4¾	½
	3	5½	7¾	3	10	3	13	6	4¾	5	¾
	3½	6	8½	3½	11¼	3	14½	6½	5¼	5	¾
	4	6½	9	4	12	3	15	7	5½	6	¾
	5	7½	10¼	4½	13½	3½	17	8	6¼	7	1½
	6	8	11½	5	14½	3½	18	9	7	7	1½
	8	9	14	5½	17½	4½	22	11	8¾	9	1½
	10	11	16½	6½	20½	5	25½	12	9¾	9	1½
	12	12	19	7½	24½	5½	30	14	11¼	11	1
	14	14	21½	7½	27	6	33	16	12¾	11	1
	16	15	24	8	30	6½	36½	18	13¾	11	1
	18	16½	26½	8½	32	7	39	19	15	13½	1¼
	20	18	29	9½	35	8	43	20	16	13½	1¼
	24	22	34	11	40½	9	49½	24	18½	13½	1¼
300 Pound	1	4	5	2¼	6½	2	8½	4½			
	1¼	4¼	5½	2½	7¼	2¼	9½	4½			
	1½	4½	6	2¾	8½	2½	11	4½			
	2	5	6½	3	9	2½	11½	5	4½	5¼	¾
	2½	5½	7	3½	10½	2½	13	5½	4¾	5½	¾
	3	6	7¾	3½	11	3	14	6	5¼	6¼	1¼
	3½	6½	8½	4	12½	3	15½	6½	5¾	6½	1½
	4	7	9	4½	13½	3	16½	7	6	6½	¾
	5	8	10¼	5	15	3½	18½	8	6¾	7½	1
	6	8½	11½	5½	17½	4	21½	9	7½	7½	1
	8	10	14	6	20½	5	25½	11	9	10	1¼
	10	11½	16½	7	24	5½	29½	12	10½	10	1¼
12	13	19	8	27½	6	33½	14	12	12½	1½	

TABLE XVII
continued

Cast Steel Flanged Fittings

Dimensions, in Inches (Cont.)

Class	Size	A	C	D	E	F	G
600 Pound	1/2	3 1/4	2	5 1/4	1 1/4	7 1/2	5
	3/4	3 3/4	2 1/2	6 3/4	2	8 3/4	5
	1	4 1/4	2 1/2	7 1/4	2 1/4	9 1/2	5
	1 1/4	4 1/2	2 3/4	8	2 1/2	10 3/4	5
	1 1/2	4 3/4	3	9	2 3/4	11 3/4	5
	2	5 3/4	4 1/4	10 1/4	3 1/2	13 3/4	6
	2 1/2	6 1/2	4 1/2	11 1/2	3 1/2	15	6 3/4
	3	7	5	12 3/4	4	16 3/4	7 1/4
	3 1/2	7 1/2	5 1/2	14	4 1/4	18 1/4	7 3/4
	4	8 1/2	6	16 1/2	4 1/2	21	8 3/4
	5	10	7	19 1/4	6	25 1/2	10 1/4
	6	11	7 1/2	21	6 1/2	27 1/2	11 3/4
900 Pound	8	13	8 1/2	24 1/2	7	31 1/2	13 3/4
	10	15 1/2	9 1/2	29 1/2	8	37 1/2	15 3/4
	12	16 1/2	10	31 1/2	8 1/2	40	16 3/4
	3	7 1/2	5 1/2	14 1/2	4 1/2	19	7 1/4
	3 1/2	8 1/2	6	16 1/2	4 1/2	21	8 3/4
	4	9	6 1/2	17 1/2	5 1/2	23	9 1/4
	5	11	7 1/2	21	6 1/2	27 1/2	11 3/4
	6	12	8	22 1/2	6 1/2	29	12 1/4
	8	14 1/2	9	27 1/2	7 1/2	35	14 3/4

Class	Size	A	C	D	E	F	G
1500 Pound	1 1/2	6	4 1/4	11	3 1/2	14 1/2	6 1/4
	2	7 1/4	4 3/4	13 1/4	4	17 1/4	7 1/4
	2 1/2	8 1/4	5 1/4	15 1/4	4 1/2	19 3/4	8 1/4
	3	9 1/4	5 3/4	17 1/4	5	22 3/4	9 1/4
	3 1/2	9 3/4	6 1/4	18 1/4	5 1/2	23 3/4	9 3/4
	4	10 3/4	7 1/4	19 1/4	6	25 1/4	10 3/4
	5	13 1/4	8 1/4	23 1/4	7 1/2	30 3/4	13 1/4
	6	13 3/8	9 3/8	24 3/8	8 1/8	33	14 3/8
8	16 3/8	10 3/8	29 3/8	9 3/8	39	17	
2500 Pound	1/2	5 3/16					
	3/4	5 3/8					
	1	6 1/16	4				
	1 1/4	6 7/8	4 1/4				
	1 1/2	7 9/16	4 3/4				
	2	8 7/8	5 3/4	15 1/4	5 1/4	20 1/2	9 1/2
	2 1/2	10	6 1/4	17 1/4	5 3/4	23	10 1/2
	3	11 3/8	7 1/4	19 3/4	6 3/4	26 1/2	11 3/4
	4	13 1/4	8 1/2	23	7 3/4	30 3/4	13 1/2
	5	15 5/8	10	27 1/4	9 1/4	36 1/2	15 3/4
	6	18	11 1/2	31 1/4	10 1/2	41 3/4	18
	8	20 3/8	12 3/4	35 1/4	11 3/4	47	20 1/2
10	25	16	43 1/4	14 3/4	58	25 1/2	
12	28	17 3/4	49 1/4	16 1/4	65 1/2	29	

FORGED STEEL SOCKET WELDING
FITTINGS

DIMENSIONS, IN INCHES
(For Standard and Extra Strong Fittings)

WORKING PRESSURES

Pounds per Square Inch — Non-Shock

Temp. Deg. F.	Crane Carbon Steel Fittings		No. 4 Carbon-Molybdenum Steel Fittings (Made to order)	
	Stand-ard	Extra Strong	Stand-ard	Extra Strong
100	2000	3000	2000	3000
150	1900	2850	1900	2850
200	1800	2700	1800	2700
250	1700	2550	1700	2550
300	1600	2400	1600	2400
350	1500	2250	1500	2250
400	1400	2100	1400	2100
450	1300	1950	1300	1950
500	1200	1800	1200	1800
550	1120	1680	1150	1725
600	1040	1560	1100	1650
650	960	1440	1050	1575
700	880	1320	1000	1500
750	800	1200	950	1425
800	740	1100	900	1350
850	670	1000	850	1275
900	600	900	800	1200
950	530	795	640	960
1000	380	570	540	810

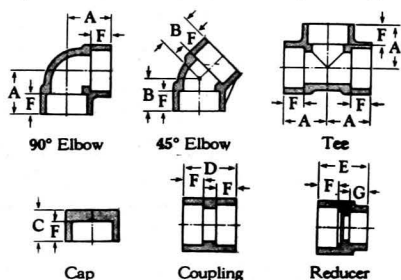

Size	1/4	3/8	1/2	3/4	1	1 1/4	1 1/2	2
A	1 3/16	3 1/32	1 1/2	1 5/16	1 1/2	1 3/4	2	2 3/8
B	1 1/16	1 3/16	7/8	1	1 1/8	1 5/16	1 7/16	1 11/16
C	3/4	7/8	1	1 1/8	1 1/8	1 3/4	1 3/4	1 1/2
D	1 3/8	1 1/8	1 3/4	1 7/8	2	2 1/8	2 1/4	2 3/4
E		1 3/8	1 1/2	1 5/8	1 3/4	2	2 1/8	2 1/4
F	7/16	9/16	5/8	1 1/16	3/4	1 3/16	7/8	1
G	Depth same as "F", depending on pipe size; e.g. 1/4" has socket 1/8" deep.							

TABLE XVII
continued

Forged Steel Flanges

Dimensions, in Inches

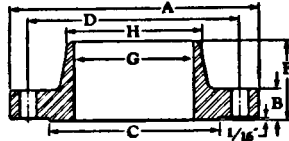

Welding Neck Flange
150 and 300-Pound



Screwed Flange
150 and 300-Pound

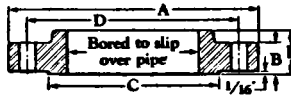

Slip-On Welding Flange
150 and 300-Pound

Class	Pipe Size	A	B	C	D	Bolts No.	Dis.	E	F	G	H
150 Pound	1	4 1/4	5/16	2	3 1/2	4	1 1/2	3/4	2 3/16	1.05	1.32
	1 1/4	4 5/8	3/8	2 1/2	3 1/2	4	1 1/2	13/16	2 1/4	1.38	1.66
	1 1/2	5	11/16	2 3/4	3 3/4	4	1 1/2	1/2	2 7/16	1.61	1.90
	2	6	3/4	3 3/8	4 3/4	4	1 1/2	1	2 1/2	2.07	2.38
	2 1/2	7	7/8	4 1/4	5 1/2	4	1 1/2	1 1/8	2 3/4	2.47	2.88
	3	7 1/2	15/16	5	6	4	1 1/2	1 1/4	2 3/4	3.07	3.50
	3 1/2	8 1/4	1 1/16	5 3/4	7	4	1 1/2	1 1/2	2 5/8	3.58	4.08
	4	9	1 1/8	6 3/8	7 1/2	4	1 1/2	1 1/2	3	4.03	4.50
	5	10	1 1/4	7 1/8	8 1/2	4	1 1/2	1 1/2	3 1/2	5.05	5.56
	6	11	1 1/2	8 1/4	9 1/2	4	1 1/2	1 1/2	3 3/4	6.07	6.63
	8	13 1/2	1 5/8	10 3/4	11 3/4	4	1 1/2	1 3/4	4	7.98	8.63
	10	16	1 3/4	12 3/4	14 1/4	12	1 1/2	2 1/8	4	10.02	10.75
	12	19	1 7/8	15	17	12	1 1/2	2 3/8	4 1/2	12.00	12.75
	14 OD	21	1 7/8	16 3/4	18 3/4	12	1	2 1/4	5		14.00
16 OD	23 1/2	1 7/8	18 1/2	21 1/4	16	1	2 1/2	5	Bore as ordered	16.00	18.00
18 OD	25	1 7/8	21	22 3/4	16	1 1/2	2 11/16	5 1/2		20.00	24.00
20 OD	27 1/2	1 11/16	23	25	20	1 1/2	2 7/8	5 11/16			
24 OD	32	1 7/8	27 1/4	29 1/2	20	1 1/4	3 1/4	6			
300 Pound	1	4 7/8	1 1/16	2	3 1/2	4	1 1/2	1 1/8	2 7/16	1.05	1.32
	1 1/4	5 1/4	3/8	2 1/2	3 3/8	4	1 1/2	1 1/8	2 9/16	1.38	1.66
	1 1/2	6 1/4	1 3/16	2 3/4	4 1/4	4	1 1/2	1 3/8	2 11/16	1.61	1.90
	2	6 1/2	1/2	3 3/8	5	4	1 1/2	1 5/8	2 3/4	2.07	2.38
	2 1/2	7 1/2	1	4 1/4	5 5/8	4	1 1/2	1 1/2	3	2.47	2.88
	3	8 1/4	1 1/8	5	6 3/4	4	1 1/2	1 11/16	3 1/4	3.07	3.50
	3 1/2	9	1 1/4	5 3/4	7 1/2	4	1 1/2	1 3/4	3 1/2	3.58	4.08
	4	10	1 1/2	6 3/8	7 3/4	4	1 1/2	1 7/8	3 3/4	4.03	4.50
	5	11	1 3/4	7 1/8	9 1/4	4	1 1/2	2	3 3/4	5.05	5.56
	6	12 1/2	1 7/8	8 1/2	10 3/4	12	1 1/2	2 1/8	3 3/4	6.07	6.63
	8	15	1 5/8	10 3/4	13	12	1 1/2	2 7/8	4 3/4	7.98	8.63
	10	17 1/2	1 3/4	12 3/4	15 1/4	16	1	2 3/4	4 3/4	10.02	10.75
12	20 1/2	2	15	17 3/4	16	1 1/2	2 7/8	5 1/4	12.00	12.75	

TABLE XVII
continued

Forged Steel Flanges

Dimensions, in Inches (Cont.)

Class	Pipe Size	A	B	C	D	Bolts No.	Di.	E	F	G	H
600 Pound	1/2	3 3/4	9/16	1 3/8	2 3/8	4	1/2	7/8	2 5/16	2 1/16	0.84
	3/4	4 5/8	5/8	1 11/16	3 1/4	4	5/8	1	2 1/2	2 3/4	1.05
	1	4 7/8	1 1/16	2	3 3/4	4	5/8	1 1/16	2 1 1/16	2 7/8	1.32
	1 1/4	5 1/4	1 3/16	2 1/2	3 7/8	4	5/8	1 1/8	2 7/8	2 5/8	1.66
	1 1/2	6 1/8	7/8	2 7/8	4 1/2	4	3/4	1 1/4	3	2 3/4	1.90
	2	6 1/2	1	3 3/8	5	8	3/4	1 7/16	3 3/8	2 7/8	2.38
	2 1/2	7 1/2	1 1/8	4 1/8	5 7/8	8	3/4	1 3/8	3 1/2	3 1/8	2.88
	3	8 1/4	1 1/4	5	6 5/8	8	3/4	1 1 3/16	3 1/2	3 1/4	3.50
	3 1/2	9	1 3/8	5 1/2	7 1/4	8	7/8	1 1 3/16	3 3/4	3 3/8	4.06
	4	10 3/4	1 1/2	6 3/16	8 1/2	8	7/8	2 1/4	4 1/4	4	4.50
	5	13	1 3/4	7 5/16	10 1/2	8	1	2 3/8	4 3/4	4 1/2	5.56
	6	14	1 7/8	8 1/2	11 1/2	12	1	2 5/8	4 7/8	4 5/8	6.63
900 Pound	8	16 1/2	2 3/16	10 5/8	13 3/4	12	1 1/8	3	5 1/2	5 1/4	8.63
	10	20	2 1/2	12 3/4	17	16	1 1/4	3 3/8	6 1/4	6	10.75
	12	22	2 5/8	15	19 1/4	20	1 1/4	3 3/8	6 3/4	6 1/2	12.75
	3	9 1/2	1 1/2	5	7 1/2	8	7/8	2 1/8	4 1/4	4	3.50
	3 1/2	10 3/4	1 5/8	5 1/2	8 1/4	8	7/8	2 3/16	4 3/8	4 1/4	4.06
	4	11 1/2	1 3/4	6 3/16	9 1/4	8	1 1/8	2 3/8	4 3/4	4 1/2	4.50
	5	13 3/4	2	7 5/16	11	8	1 1/4	3 3/8	5 1/4	5	5.56
	6	15	2 1/8	8 1/2	12 1/2	12	1 1/4	3 3/8	5 3/4	5 1/2	6.63
	8	18 1/2	2 1/2	10 5/8	15 1/2	12	1 1/4	4	6 3/4	6 3/8	8.63
	1 1/2	7	1 1/4	2 7/8	4 7/8	4	1	1 3/4	3 1/2	3 1/4	1.90
	2	8 1/2	1 1/2	3 3/8	6 1/2	8	7/8	2 1/4	4 1/4	4	2.38
	2 1/2	9 5/8	1 5/8	4 1/8	7 1/2	8	1	2 1/2	4 3/4	4 1/8	2.88
1500 Pound	3	10 1/2	1 7/8	5	8	8	1 1/4	2 7/8	4 7/8	4 3/4	3.50
	3 1/2	11	2	5 1/2	8 3/4	8	1 1/4	3 1/16	5	4 3/4	4.06
	4	12 3/4	2 1/8	6 3/16	9 1/2	8	1 1/4	3 5/16	5 1/8	4 7/8	4.50
	5	14 3/4	2 3/8	7 5/16	11 1/2	8	1 1/2	4 1/8	6 3/8	6 1/8	5.56
	6	15 1/2	3 1/4	8 1/2	12 1/2	12	1 1/4	4 1 1/16	7	6 3/4	6.63
	8	19	3 5/8	10 5/8	15 1/2	12	1 1/4	5 3/8	8 3/8	8 3/4	8.63
	1/2	5 1/4	1 3/16	1 3/8	3 3/4	4	3/4	1 1/16	3 1/8	2 7/8	0.84
	3/4	5 1/2	1 1/4	1 11/16	3 3/4	4	3/4	1 1 1/16	3 3/8	3 3/8	1.05
	1	6 1/4	1 3/8	2	4 1/4	4	7/8	1 1/8	3 3/4	3 1/2	1.32
	1 1/4	7 1/4	1 1/2	2 1/2	5 1/4	4	1	2 1/16	4	3 3/4	1.66
	1 1/2	8	1 3/4	2 7/8	5 3/4	4	1 1/2	2 3/8	4 5/8	4 3/8	1.90
	2	9 1/4	2	3 3/8	6 3/4	8	1	2 3/4	5 1/4	5	2.38
2 1/2	10 1/2	2 1/4	4 1/8	7 3/4	8	1 1/8	3 3/8	5 7/8	5 5/8	2.88	
3	12	2 5/8	5	9	8	1 1/4	3 3/8	6 3/8	6 3/8	3.50	
4	14	3	6 3/16	10 3/4	8	1 1/2	4 1/4	7 3/4	7 1/2	4.50	
5	16 1/2	3 3/8	7 5/16	12 3/4	8	1 3/4	5 1/8	9 1/4	9	5.56	
6	19	4 1/4	8 1/2	14 1/2	8	2	6	11	10 3/4	6.63	
8	21 3/4	5	10 5/8	17 1/4	12	2	7	12 3/4	12 1/2	8.63	
10	26 1/2	6 1/2	12 3/4	21 1/4	12	2 1/2	9	16 3/4	16 1/2	10.75	
12	30	7 1/4	15	24 3/4	12	2 3/4	10	18 1/2	18 1/4	12.75	

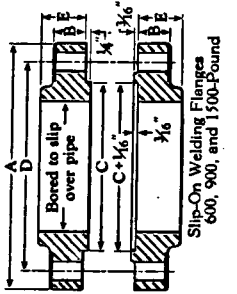
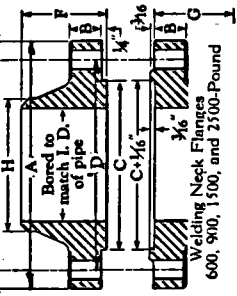
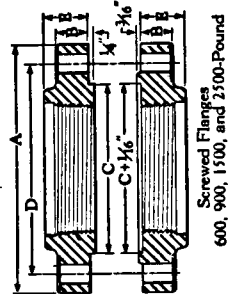
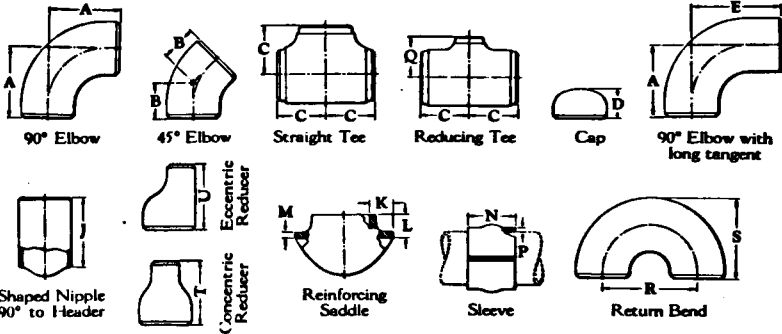

TABLE XVII
continued
Steel Butt-Welding Fittings
Dimensions, in Inches

Standard and Extra Strong Fittings have the same outside dimensions.



Elbows, Straight Tees, Caps, Nipples, Saddles, and Sleeves

Size	A	B	C	D	E	J	K	L	M	N	P
1/4	1 1/8	1 1/8	1 1/8	1 1/8	1 1/8
1	1 1/2	1 1/2	1 1/2	1 1/2	1 1/2
1 1/4	1 3/4	1 3/4	1 3/4	1 3/4	1 3/4	6
2	3	1 3/4	2 1/4	1 3/4	4 1/4	6	1 3/4	1 1/4	1/2	3	1/4
2 1/2	3 3/4	1 3/4	2 1/4	1 3/4	5	6	1 3/4	1 1/4	1/2	3	3/4
3	4 1/4	2	3 3/4	2	5 3/4	6	2	1 3/4	1/2	3	3/4
3 3/4	4 3/4	2 3/4	3 3/4	2 3/4	6 3/4	6	2	1 3/4	1/2	3 3/4	3/4
4	6	2 1/2	4 3/4	2 1/2	7 1/2	6	2	2	1/2	4	3/4
5	7 1/4	3 1/4	4 3/4	3	9	8	2	2	1/2	5	3/4
6	9	3 3/4	5 3/4	3 1/2	10 3/4	8	2 1/2	2 1/4	1/2	6	3/4
8	12	5	7	4	13 3/4	8	3	3	3/4	8	3/4
10	15	6 1/4	8 1/4	5	17	10	3 1/2	3 1/4	3/4	10	1/2
12	18	7 1/2	10	6	20 1/2	10	4	4	3/4	12	1/2
14 OD	16	7 3/4	...	6 1/2	4	4	3/4	14	1/2
16 OD	18	8 1/4	...	7	4	4	3/4	16	1/2
18 OD	20	9 1/4	...	8	4	4	3/4	18	1/2
20 OD	25	9	5	5	3/4	20	1/2
24 OD	30	10 1/2	5	5	3/4	24	1/2

Return Bends

Size of pipe	R	S
1	3	2 3/4
1 1/4	2 1/2	2 3/4
1 1/2	3 3/4	2 3/4
1 3/4	3	2 1/2
2	4	3 1/4
2 1/2	6	4 1/4
3	7 1/2	5 1/4
3 3/4	9	5
4	10 1/2	6 1/4
4 1/4	12	8 1/4
5	15	10 3/4
6	18	12 3/4
8	24	16 3/4
10	30	20 3/4
12	36	24 3/4

Reducing Tees

Size	C	Q	Size	C	Q
1 1/4 x 1 1/4 x 3/4	1 7/8	1 7/8	4 x 4 x 3	4 1/4	3 3/4
1 1/2 x 1 1/2 x 1 1/4	2 1/4	2 1/4	4 x 4 x 2 1/2	4 3/4	3 3/4
1 1/2 x 1 1/2 x 1 1/2	2 1/4	2 1/4	4 x 4 x 2	4 3/4	3 1/2
1 3/4 x 1 3/4 x 1 1/4	2 3/4	2 3/4	5 x 5 x 4	4 7/8	4 5/8
2 x 2 x 1 1/2	3 1/4	3 1/4	5 x 5 x 3	4 7/8	4 5/8
2 x 2 x 1 3/4	3 1/4	3 1/4	5 x 5 x 2 1/2	4 7/8	4 1/4
2 1/2 x 2 1/2 x 2	3 3/4	3 3/4	6 x 6 x 5	5 1/4	5 1/4
2 1/2 x 2 1/2 x 1 1/2	3	2 3/4	6 x 6 x 4	5 1/4	5 1/4
2 1/2 x 2 1/2 x 1 1/4	3	2 1/4	6 x 6 x 3	5 1/4	4 7/8
3 x 3 x 2 1/2	3 3/4	3 3/4	8 x 8 x 6	7	6 3/4
3 x 3 x 2	3 3/4	3 3/4	8 x 8 x 5	7	6 3/4
3 x 3 x 1 1/2	3 3/4	2 3/4	8 x 8 x 4	7	6 3/4
			10 x 10 x 8	8 1/2	8
			10 x 10 x 6	8 1/2	7 1/4
			12 x 12 x 10	10	9 1/2
			12 x 12 x 8	10	9
			12 x 12 x 6	10	8 3/4

Reducers

Size	T	U	Size	T	U	Size	T	U
1 1/4 x 3/4	2	2	3 x 2 1/2	3	3			
1 1/2 x 1 1/4	2 1/2	2 1/2	3 x 2	3	3			
1 3/4 x 1 1/2	3	3	3 x 1 1/2	3 1/2	3 1/2			
2 x 1 1/2	3 1/2	3 1/2	4 x 3	4	4			
2 1/2 x 2	4	4	4 x 2	4	4			
3 x 2 1/2	4 1/2	4 1/2	5 x 4	5	5			
3 1/2 x 3	5	5	5 x 3	5	5			
4 x 3 1/2	5 1/2	5 1/2	6 x 4	6	6			
4 1/2 x 4	6	6	8 x 6	8	8			
5 x 4 1/2	7	7	10 x 8	10	10			
5 1/2 x 5	8	8	12 x 10	12	12			
6 x 5 1/2	9	9	12 x 8	12	12			
6 1/2 x 6	10	10	12 x 6	12	12			

TABLE XVII
continued

Standard Types of Pipe Bends

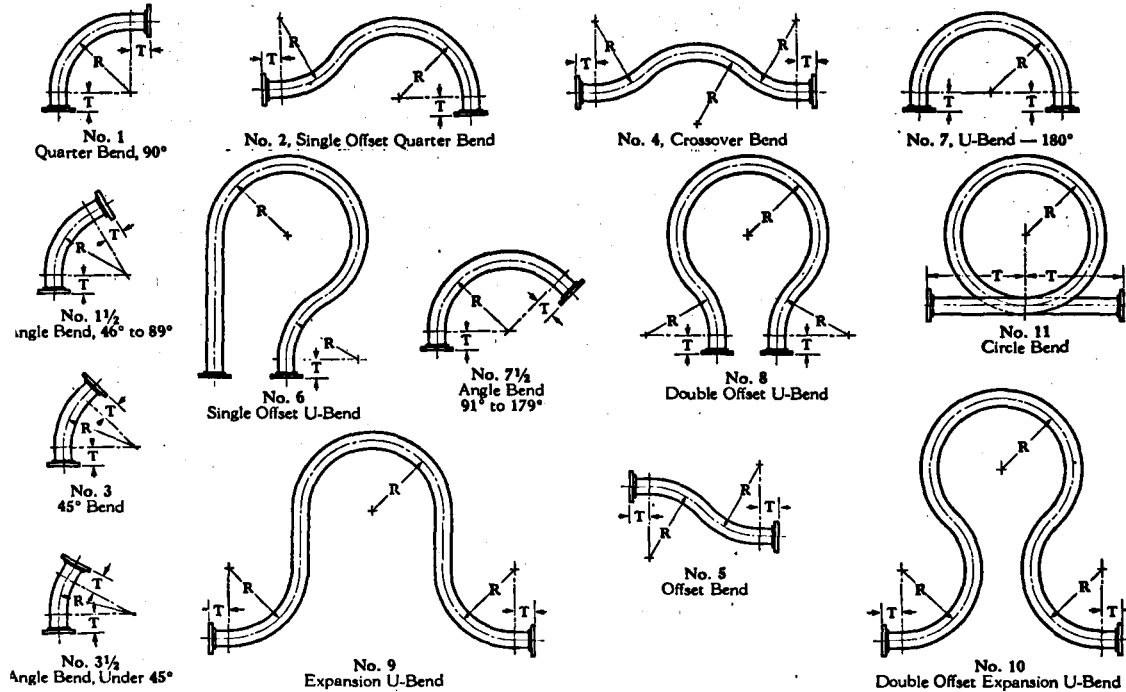

TABLE XVII
continued
Standard Types of Pipe Bends

Radii and Tangents of Pipe Bends, in Inches

Size of Pipe	Column "A"	Column "B"								Column "C"	
	R Minimum Recommended Radius Steel or Genuine Wrought Iron Pipe Standard or Extra Strong Weight	R Shortest Radii to which pipe can be bent								T Minimum Length of Tangent	
		Steel Pipe Only				Genuine Wrought Iron Pipe				Steel or Genuine Wrought Iron Pipe Standard or Extra Strong Weight	
		Threaded Ends, Screwed, or Welded Flanges		Cranelap Joints		Threaded Ends, Screwed, or Welded Flanges		Cranelap Joints			
Stand- ard Weight Pipe	Extra Strong Weight Pipe	Stand- ard Weight Pipe	Extra Strong Weight Pipe	Stand- ard Weight Pipe	Extra Strong Weight Pipe	Stand- ard Weight Pipe	Extra Strong Weight Pipe	Threaded Ends or Screwed Flanges	Cranelap Joints		
1/4	1 1/4	1	5/8			1 1/4	1			1	
3/8	1 3/8	1 1/4	3/4			1 3/8	1 1/2			1 1/4	
1/2	2 1/2	1 1/2	1	2	2	2 1/2	2	2 1/2	2	1 1/2	2
3/4	3 3/4	1 3/4	1 1/4	3	3	3	2 3/4	3	3	1 3/4	2
1	5	2	1 1/2	4	4	4	3	4	4	2	2
1 1/4	6 1/4	2 1/4	1 3/4	4	4	5	4	5	4	2	2 1/2
1 1/2	7 1/2	2 1/2	2	5	5	6	5	6	5	2 1/2	3
2	10	3	2 1/2	6	6	8	5	8	6	3	4
2 1/2	12 1/2	5	4 1/4	10	10	10	8	10	10	4	5
3	15	8	6	12	12	12	10	12	12	4	6
3 1/2	17 1/2	10	8	12	12	14	12	14	12	5	6
4	20	12	10	14	14	16	12	16	14	5	6
5	25	18	14	18	14	20	15	20	15	6	7
6	30	22	15	22	15	26	18	26	18	7	7
8	40	30	23	30	23	30	28	30	28	9	8
10	50	36	30	36	30	36	32	36	32	12	10
12	60	46	36	46	36	46	42	46	42	14	10
*14 OD	70	60	48	60	48	60	54	60	54	16	14
*16 OD	96	80	60	80	60	80	70	80	70	18	16
*18 OD	108	90	66	90	66	90	80	90	80	18	18
*20 OD	120	100	72	100	72	100	90	100	90	18	18
*24 OD	144	144	108	144	108	144	122	144	122	18	20

*For sizes 14-inch O.D. and larger, the radii shown are based upon pipe with a wall thickness of 1/8-inch or lighter under the "Standard Weight Pipe" column, and a wall thickness of 1/2-inch or heavier under the "Extra Strong Weight Pipe" column.

TABLE XXIV

**FORMULAS AND MOLECULAR AND EQUIVALENT WEIGHTS OF
SUBSTANCES FREQUENTLY APPEARING IN THE CHEMISTRY
OF WATER CONDITIONING**

<i>Substance</i>	<i>Formula</i>	<i>Weight of Molecule or Radical</i>	<i>Eq. Wt.</i>
Aluminum	Al	27.0	9.00
Aluminum chloride (crystal)	AlCl ₃	133.0	44.33
Aluminum chloride (anhydrous)	AlCl ₃ · 6H ₂ O	241.0	80.33
Aluminum sulphate (crystal)	Al ₂ (SO ₄) ₃ · 18H ₂ O	666.4	111.06
Aluminum sulphate (anhydrous)	Al ₂ (SO ₄) ₃	342.1	57.01
Ammonia	NH ₃	17.0	17.00
Ammonium alum	Al ₂ (SO ₄) ₃ (NH ₄) ₂ SO ₄ · 24H ₂ O	906.6	151.10
Potassium alum	Al ₂ (SO ₄) ₃ K ₂ SO ₄ · 24H ₂ O	948.8	158.13
Aluminum hydrate	Al(OH) ₃	78.0	26.00
Ammonium chloride	NH ₄ Cl	53.5	53.50
Ammonium (ion)	NH ₄	18.0	18.00
Ammonia water	NH ₄ OH	35.1	35.10
*Alumina	Al ₂ O ₃	102.0	17.00
Sodium aluminate	Na ₂ Al ₂ O ₄	164.0	27.33
Ammonium sulphate	(NH ₄) ₂ SO ₄	132.0	66.00
Barium	Ba	137.4	68.70
Barium carbonate	BaCO ₃	197.4	98.70
Barium chloride	BaCl ₂ · 2H ₂ O	244.3	122.15
Barium sulphate	BaSO ₄	233.4	116.70
Barium hydrate	Ba(OH) ₂	171.0	85.50
Barium oxide	BaO	153.0	76.50
Calcium	Ca	40.1	20.05
Calcium bicarbonate	Ca(HCO ₃) ₂	162.1	81.05
Calcium carbonate	CaCO ₃	100.1	50.05
Calcium chloride	CaCl ₂	111.0	55.50
Calcium hydrate (pure)	Ca(OH) ₂	74.1	37.05
Calcium hydrate (90%)	Ca(OH) ₂	41.10
Calcium oxide (pure)	CaO	56.1	28.05
Calcium oxide (90%)	CaO	31.17
Calcium sulphate (anhydrous)	CaSO ₄	136.2	68.08
Calcium sulphate (gypsum)	CaSO ₄ · 2H ₂ O	172.2	86.10
Calcium nitrate	Ca(NO ₃) ₂	164.1	82.05
Calcium phosphate	Ca ₃ (PO ₄) ₂	310.3	51.71
Carbon	C	12.0	3.00
Chloride (gas)	Cl ₂	70.9	35.45

Courtesy of the Cochrane Corp.

TABLE XXIV
continued

<i>Substance</i>	<i>Formula</i>	<i>Weight of Molecule or Radical</i>	<i>Eq. Wt.</i>
Copper	Cu	63.6	31.80
Copper sulphate	CuSO ₄	160.0	80.00
Iron (ferric)	Fe'''	55.8	18.60
Iron (ferrous)	Fe''	55.8	27.90
*Ferric oxide	Fe ₂ O ₃	159.6	26.60
*Iron oxide and alumina	R ₂ O ₃	109.0	18.20
Ferrous sulphate (copperas)	FeSO ₄ · 7H ₂ O	278.0	139.00
Ferric chloride	FeCl ₃	162.0	54.00
Ferric hydrate	Fe(OH) ₃	107.0	35.66
Ferric sulphate	Fe ₂ (SO ₄) ₃	400.0	66.66
Ferrous carbonate	FeCO ₃	116.0	58.00
Ferrous hydrate	Fe(OH) ₂	89.9	44.95
Ferrous oxide	FeO	71.8	35.90
Fluorine (gas)	F ₂	19.0	19.00
Hydrogen (gas)	H ₂	2.02	1.01
Hydrogen sulphide (gas)	H ₂ S	34.1
Lead	Pb	207.0	103.50
Magnesium	Mg	24.3	12.15
Magnesium oxide	MgO	40.3	20.15
Magnesium bicarbonate	Mg(HCO ₃) ₂	146.3	73.15
Magnesium carbonate	MgCO ₃	84.3	42.15
Magnesium chloride	MgCl ₂	95.2	47.60
Magnesium hydrate	Mg(OH) ₂	58.3	29.15
Magnesium nitrate	Mg(NO ₃) ₂	148.3	74.15
Magnesium phosphate	Mg ₃ (PO ₄) ₂	263.0	43.83
Magnesium sulphate	MgSO ₄	120.4	60.20
Nitrogen (gas)	N ₂	28.0
Oxygen (gas)	O ₂	32.0	8.00
Potassium	K	39.1	39.10
Potassium carbonate	K ₂ CO ₃	138.0	69.00
Potassium chloride	KCl	74.6	74.60
Potassium hydrate	KOH	56.1	56.10
Potassium iodide	KI	166.0	166.00
Potassium nitrate	KNO ₃	101.0	101.00
Potassium oxide	K ₂ O	94.2	47.10
Potassium permanganate	KMnO ₄	158.0	158.00
Potassium sulphate	K ₂ SO ₄	174.0	87.00
Silicon	Si	28.1	7.03
Silver	Ag	108.0	108.00
Silver chloride	AgCl	143.3	143.30
Silver nitrate	AgNO ₃	169.9	169.90
Silica	SiO ₂	60.1	30.05
Sodium	Na	23.0	23.00
Sodium bicarbonate	NaHCO ₃	84.0	84.00

TABLE XXIV
continued

<i>Substance</i>	<i>Formula</i>	<i>Weight of Molecule or Radical</i>	<i>Eq. Wt.</i>
Sodium carbonate	Na_2CO_3	106.0	53.00
Sodium chloride	NaCl	58.5	58.50
Sodium hydrate	NaOH	40.0	40.00
Sodium nitrate	NaNO_3	85.0	85.00
Sodium oxide	Na_2O	62.0	31.00
Sodium sulphite	Na_2SO_3	126.0	63.00
Sulphur dioxide (gas)	SO_2	64.1	32.05
Trisodium phosphate	$\text{Na}_3\text{PO}_4 \cdot 12\text{H}_2\text{O}$ (18.7% P_2O_5)	380.2	126.73
Trisodium phosphate (anhydrous)	Na_3PO_4 (43.3% P_2O_5)	164.0	54.66
Disodium phosphate	$\text{Na}_2\text{HPO}_4 \cdot 12\text{H}_2\text{O}$ (19.8% P_2O_5)	358.2	119.40
Disodium phosphate (anhydrous)	Na_2HPO_4 (50.0% P_2O_5)	142.0	47.33
Monosodium phosphate	$\text{NaH}_2\text{PO}_4 \cdot \text{H}_2\text{O}$ (51.4% P_2O_5)	138.1	46.03
Monosodium phosphate (anhydrous)	NaH_2PO_4 (59.1% P_2O_5)	120.1	40.03
Metaphosphate (Hagan)	NaPO_3 (69.5% P_2O_5)	102.0	34.00
Sodium sulphate	Na_2SO_4	142.0	71.00
Water	H_2O	18.0	9.00
ACID RADICALS			
Bicarbonate	HCO_3	61.0	61.00
Carbonate	CO_3	60.0	30.00
Carbon dioxide	CO_2	44.0	22.00
Chloride	Cl	35.46	35.46
Nitrate	NO_3	62.0	62.00
Hydrate	OH	17.0	17.00
Phosphate	PO_4	95.0	31.66
Phosphorous oxide	P_2O_5	142.0	23.67
Sulphate	SO_4	96.06	48.03
Sulphite	SO_3	80.1	40.05
ACIDS			
Hydrogen	H_2	2.0	1.00
Acetic acid	$\text{HC}_2\text{H}_3\text{O}_2$	60.0	60.00
Carbonic acid	H_2CO_3	62.0	31.00
Hydrochloric acid	HCl	36.46	36.46
Phosphoric acid	H_3PO_4	98.0	32.67
Sulphuric acid	H_2SO_4	98.1	49.05
Nitric acid	HNO_3	63.0	63.00
Sulphurous acid	H_2SO_3	82.1	41.05

* Al_2O_3 and Fe_2O_3 are commonly reported together as R_2O_3 , which for purpose of computation is given a mol. wt. of 109 and eq. wt. of 18.2 on the basis of 88% Al_2O_3 and 12% Fe_2O_3 .

TABLE XXV

STEAM TABLES

Courtesy of Combustion Engineering-Superheater, Inc.

Saturated Steam: Temperature Table

Temp. Fahr. t	ABSOLUTE PRESSURES		SPECIFIC VOLUME			ENTHALPY			ENTROPY			Temp. Fahr. t
	Lb. per Sq. In. p	In. Hg. 2.2 F.	Sat. Liquid v _l	Evap. v _{lg}	Sat. Vapor v _g	Sat. Liquid h _l	Evap. h _{lg}	Sat. Vapor h _g	Sat. Liquid s _l	Evap. s _{lg}	Sat. Vapor s _g	
82	0.0896	0.1906	0.01602	3305.7	3305.7	0	1075.1	1075.1	0	2.1865	2.1865	82
84	0.0961	0.1957	0.01602	3060.4	3060.4	2.01	1074.9	1076.9	0.0041	2.1755	2.1796	84
86	0.1041	0.2120	0.01602	2836.6	2836.6	4.08	1072.9	1076.9	0.0082	2.1645	2.1727	86
88	0.1126	0.2292	0.01602	2632.3	2632.3	6.04	1071.7	1077.7	0.0122	2.1533	2.1655	88
90	0.1217	0.2478	0.01602	2445.1	2445.1	8.05	1070.5	1078.6	0.0162	2.1422	2.1585	90
92	0.1315	0.2677	0.01602	2271.8	2271.8	10.06	1069.3	1079.4	0.0203	2.1314	2.1517	92
94	0.1420	0.2891	0.01603	2112.3	2112.3	12.06	1068.3	1080.3	0.0242	2.1207	2.1449	94
96	0.1532	0.3119	0.01603	1965.5	1965.5	14.07	1067.1	1081.3	0.0282	2.1102	2.1384	96
98	0.1652	0.3364	0.01603	1829.9	1829.9	16.07	1065.9	1082.0	0.0322	2.0996	2.1317	98
100	0.1780	0.3624	0.01602	1704.9	1704.9	18.07	1064.8	1082.9	0.0361	2.0891	2.1252	100
102	0.1916	0.3905	0.01603	1588.4	1588.4	20.07	1063.6	1083.7	0.0400	2.0786	2.1186	102
104	0.2062	0.4200	0.01603	1482.4	1482.4	22.07	1062.5	1084.6	0.0439	2.0684	2.1122	104
106	0.2219	0.4518	0.01603	1383.5	1383.5	24.07	1061.4	1085.5	0.0478	2.0582	2.1060	106
108	0.2384	0.4854	0.01603	1292.7	1292.7	26.07	1060.3	1086.3	0.0517	2.0479	2.0996	108
110	0.2561	0.5214	0.01603	1208.1	1208.1	28.07	1059.1	1087.2	0.0555	2.0379	2.0934	110
112	0.2749	0.5597	0.01604	1129.7	1129.7	30.06	1057.9	1088.0	0.0594	2.0278	2.0872	112
114	0.2949	0.6004	0.01604	1057.1	1057.1	32.06	1056.8	1088.9	0.0632	2.0180	2.0812	114
116	0.3162	0.6438	0.01604	989.6	989.6	34.06	1055.7	1089.8	0.0670	2.0082	2.0752	116
118	0.3388	0.6898	0.01605	927.0	927.0	36.05	1054.5	1090.5	0.0708	1.9983	2.0691	118
120	0.3628	0.7387	0.01605	868.9	868.9	38.05	1053.4	1091.5	0.0745	1.9887	2.0632	120
122	0.3883	0.7906	0.01606	814.9	814.9	40.04	1052.3	1092.3	0.0783	1.9792	2.0575	122
124	0.4153	0.8456	0.01606	764.7	764.7	42.04	1051.3	1093.3	0.0820	1.9697	2.0517	124
126	0.4440	0.9040	0.01607	718.0	718.0	44.03	1050.1	1094.1	0.0858	1.9603	2.0461	126
128	0.4744	0.9659	0.01607	674.4	674.4	46.03	1048.9	1094.9	0.0895	1.9508	2.0403	128
130	0.5067	1.032	0.01607	633.7	633.7	48.02	1047.8	1095.8	0.0932	1.9415	2.0347	130
132	0.5409	1.101	0.01608	595.8	595.8	50.02	1046.6	1096.6	0.0968	1.9321	2.0290	132
134	0.5772	1.175	0.01608	560.4	560.4	52.01	1045.5	1097.5	0.1006	1.9229	2.0236	134
136	0.6158	1.253	0.01608	527.6	527.6	54.01	1044.4	1098.4	0.1042	1.9139	2.0181	136
138	0.6556	1.335	0.01609	497.0	497.0	56.00	1043.3	1099.3	0.1079	1.9047	2.0128	138
140	0.6980	1.421	0.01610	468.4	468.4	58.00	1042.1	1100.1	0.1115	1.8958	2.0073	140
142	0.7429	1.513	0.01611	441.7	441.7	59.99	1040.9	1100.9	0.1151	1.8867	2.0018	142
144	0.7902	1.609	0.01611	416.7	416.7	61.98	1039.8	1101.8	0.1187	1.8779	1.9966	144
146	0.8403	1.711	0.01612	393.2	393.2	63.98	1038.7	1102.7	0.1222	1.8692	1.9915	146
148	0.8930	1.818	0.01613	371.3	371.3	65.98	1037.5	1103.5	0.1256	1.8604	1.9863	148
150	0.9487	1.932	0.01613	350.8	350.8	67.97	1036.4	1104.4	0.1290	1.8517	1.9812	150
152	1.0072	2.051	0.01614	331.5	331.5	69.96	1035.2	1105.2	0.1320	1.8430	1.9760	152
154	1.0689	2.176	0.01614	313.5	313.5	71.96	1034.1	1106.1	0.1360	1.8345	1.9711	154
156	1.1338	2.308	0.01615	296.5	296.5	73.96	1033.0	1107.0	0.1401	1.8261	1.9662	156
158	1.2020	2.447	0.01616	280.7	280.7	75.94	1032.0	1107.9	0.1436	1.8179	1.9615	158
160	1.274	2.594	0.01617	265.7	265.7	77.94	1030.9	1108.8	0.1471	1.8096	1.9567	160
162	1.350	2.749	0.01617	251.6	251.6	79.93	1029.7	1109.6	0.1506	1.8012	1.9518	162
164	1.429	2.909	0.01618	238.5	238.5	81.93	1028.6	1110.5	0.1541	1.7930	1.9471	164
166	1.512	3.076	0.01619	226.2	226.2	83.92	1027.5	1111.4	0.1576	1.7848	1.9424	166
168	1.600	3.256	0.01620	214.5	214.5	85.92	1026.4	1112.3	0.1610	1.7767	1.9377	168
170	1.692	3.445	0.01620	203.4	203.4	87.91	1025.3	1113.2	0.1645	1.7687	1.9332	170
172	1.788	3.640	0.01621	193.1	193.1	89.91	1024.1	1114.0	0.1679	1.7606	1.9285	172
174	1.888	3.846	0.01622	183.4	183.4	91.90	1023.0	1114.9	0.1714	1.7526	1.9240	174
176	1.994	4.062	0.01623	174.2	174.2	93.90	1021.8	1115.7	0.1748	1.7446	1.9194	176
178	2.106	4.296	0.01624	165.7	165.7	95.90	1020.7	1116.6	0.1782	1.7366	1.9150	178
180	2.221	4.522	0.01625	157.6	157.6	97.89	1019.5	1117.4	0.1816	1.7286	1.9105	180
182	2.343	4.770	0.01626	149.8	149.8	99.89	1018.3	1118.2	0.1849	1.7206	1.9058	182
184	2.470	5.029	0.01626	142.5	142.5	101.88	1017.2	1119.1	0.1883	1.7124	1.9011	184
186	2.602	5.300	0.01627	135.7	135.7	103.88	1016.0	1119.9	0.1917	1.7045	1.8973	186
188	2.742	5.582	0.01628	129.2	129.2	105.88	1014.9	1120.8	0.1950	1.6966	1.8930	188
190	2.887	5.878	0.01629	123.1	123.1	107.88	1013.7	1121.6	0.1984	1.6884	1.8885	190
192	3.039	6.187	0.01630	117.3	117.3	109.88	1012.5	1122.4	0.2017	1.6802	1.8845	192
194	3.198	6.511	0.01631	111.8	111.8	111.88	1011.3	1123.2	0.2050	1.6722	1.8802	194
196	3.363	6.847	0.01632	106.7	106.7	113.88	1010.2	1124.1	0.2083	1.6642	1.8762	196
198	3.536	7.199	0.01633	101.8	101.8	115.87	1009.0	1124.9	0.2116	1.6564	1.8720	198
200	3.716	7.566	0.01634	97.1	97.1	117.87	1007.8	1125.7	0.2149	1.6486	1.8679	200
202	3.904	7.948	0.01635	92.7	92.8	119.87	1006.7	1126.6	0.2181	1.6408	1.8639	202
204	4.100	8.348	0.01636	88.6	88.6	121.87	1005.5	1127.4	0.2214	1.6334	1.8598	204
206	4.308	8.765	0.01637	84.6	84.6	123.87	1004.4	1128.3	0.2247	1.6261	1.8560	206
208	4.518	9.198	0.01638	80.8	80.8	125.87	1003.3	1129.1	0.2279	1.6181	1.8520	208
210	4.730	9.649	0.01639	77.3	77.3	127.87	1002.2	1129.9	0.2311	1.6105	1.8480	210
212	4.970	10.12	0.01640	74.0	74.0	129.87	1001.0	1130.7	0.2343	1.6029	1.8441	212
214	5.210	10.61	0.01642	70.7	70.8	131.88	999.7	1131.6	0.2376	1.6029	1.8403	214
216	5.460	11.12	0.01643	67.7	67.7	133.88	998.5	1132.4	0.2408	1.5958	1.8366	216
218	5.720	11.65	0.01644	64.8	64.8	135.88	997.3	1133.2	0.2439	1.5885	1.8327	218

Saturated Steam: Temperature Table—(Continued)

Temp. Fahr. t	ABSOLUTE PRESSURE		SPECIFIC VOLUME			ENTHALPY			ENTROPY			Temp. Fahr. t
	Lb. per Sq. In. p	In. Hg. 32 F.	Sat. Liquid v _g	Evap. v _{fg}	Sat. Vapor v _g	Sat. Liquid h _f	Evap. h _{fg}	Sat. Vapor h _g	Sat. Liquid s _f	Evap. s _{fg}	Sat. Vapor s _g	
170	5.990	12.20	0.01645	62.12	62.14	137.89	996.1	1134.0	0.2471	1.5319	1.8290	170
172	6.272	12.77	0.01646	59.50	59.52	139.89	995.0	1134.9	0.2503	1.5751	1.8254	172
174	6.565	13.37	0.01647	57.01	57.03	141.89	993.8	1135.7	0.2535	1.5683	1.8218	174
176	6.869	13.99	0.01648	54.64	54.66	143.90	992.6	1136.5	0.2568	1.5615	1.8181	176
178	7.184	14.63	0.01650	52.39	52.41	145.90	991.4	1137.3	0.2598	1.5547	1.8145	178
180	7.510	15.29	0.01651	50.26	50.28	147.91	990.2	1138.1	0.2629	1.5479	1.8108	180
182	7.849	15.98	0.01652	48.22	48.24	149.92	989.0	1138.9	0.2661	1.5412	1.8073	182
184	8.201	16.70	0.01653	46.28	46.30	151.92	987.8	1139.7	0.2692	1.5346	1.8038	184
186	8.566	17.44	0.01654	44.43	44.45	153.93	986.6	1140.5	0.2723	1.5280	1.8003	186
188	8.944	18.21	0.01655	42.67	42.69	155.94	985.3	1141.3	0.2754	1.5213	1.7967	188
190	9.336	19.01	0.01657	40.99	41.01	157.95	984.1	1142.1	0.2785	1.5147	1.7932	190
192	9.744	19.84	0.01658	39.38	39.40	159.95	982.8	1142.8	0.2816	1.5081	1.7897	192
194	10.168	20.70	0.01659	37.84	37.86	161.96	981.5	1143.5	0.2847	1.5015	1.7862	194
196	10.605	21.59	0.01661	36.38	36.40	163.97	980.3	1144.3	0.2877	1.4951	1.7828	196
198	11.057	22.51	0.01662	34.98	35.00	165.98	979.0	1145.0	0.2908	1.4885	1.7793	198
200	11.525	23.46	0.01663	33.65	33.67	167.99	977.8	1145.8	0.2938	1.4822	1.7760	200
202	12.010	24.45	0.01665	32.37	32.39	170.01	976.6	1146.6	0.2969	1.4759	1.7728	202
204	12.512	25.47	0.01666	31.15	31.17	172.02	975.3	1147.3	0.2999	1.4695	1.7694	204
206	13.031	26.53	0.01667	29.99	30.01	174.03	974.1	1148.1	0.3029	1.4633	1.7662	206
208	13.568	27.62	0.01669	28.88	28.90	176.04	972.8	1148.8	0.3059	1.4570	1.7629	208
210	14.123	28.75	0.01670	27.81	27.83	178.06	971.5	1149.6	0.3090	1.4507	1.7597	210
212	14.696	29.92	0.01672	26.81	26.83	180.07	970.3	1150.4	0.3120	1.4446	1.7566	212
214	15.287		0.01674	25.85	25.87	182.10	969.3	1151.4	0.3165	1.4382	1.7517	214
216	15.896		0.01677	23.14	23.16	188.14	965.2	1153.3	0.3239	1.4201	1.7440	216
218	16.523		0.01681	21.16	21.17	193.18	961.9	1155.1	0.3313	1.4049	1.7362	218
220	17.168		0.01684	19.371	19.388	198.22	958.7	1156.9	0.3386	1.3900	1.7286	220
222	17.831		0.01688	17.761	17.778	203.28	955.3	1158.6	0.3459	1.3751	1.7210	222
224	18.512		0.01692	16.307	16.324	208.34	952.1	1160.4	0.3531	1.3607	1.7138	224
226	19.211		0.01696	15.010	15.027	213.41	948.7	1162.1	0.3604	1.3462	1.7066	226
228	19.928		0.01700	13.824	13.841	218.48	945.3	1163.8	0.3676	1.3320	1.6995	228
230	20.663		0.01704	12.735	12.752	223.56	942.0	1165.6	0.3747	1.3181	1.6928	230
232	21.416		0.01708	11.754	11.771	228.65	938.6	1167.3	0.3817	1.3042	1.6859	232
234	22.187		0.01713	10.881	10.878	233.74	935.2	1169.0	0.3888	1.2906	1.6794	234
236	22.976		0.01717	10.053	10.070	238.84	931.8	1170.6	0.3958	1.2770	1.6728	236
238	23.783		0.01721	9.313	9.330	243.94	928.3	1172.1	0.4027	1.2634	1.6661	238
240	24.608		0.01726	8.634	8.651	249.06	924.8	1173.7	0.4096	1.2500	1.6596	240
242	25.451		0.01731	8.015	8.032	254.18	921.0	1175.2	0.4165	1.2368	1.6533	242
244	26.312		0.01735	7.448	7.465	259.31	917.4	1176.7	0.4234	1.2237	1.6471	244
246	27.191		0.01740	6.931	6.948	264.45	913.7	1178.2	0.4302	1.2107	1.6409	246
248	28.088		0.01745	6.454	6.471	269.60	910.1	1179.7	0.4370	1.1980	1.6350	248
250	28.993		0.01750	6.014	6.032	274.76	906.3	1181.1	0.4437	1.1852	1.6299	250
252	29.916		0.01755	5.610	5.628	279.92	902.6	1182.5	0.4505	1.1727	1.6252	252
254	30.857		0.01760	5.239	5.257	285.10	898.8	1183.9	0.4571	1.1587	1.6188	254
256	31.816		0.01765	4.897	4.915	290.29	895.0	1185.3	0.4637	1.1479	1.6116	256
258	32.793		0.01771	4.583	4.601	295.49	891.1	1186.6	0.4703	1.1356	1.6059	258
260	33.788		0.01776	4.292	4.310	300.69	887.1	1187.8	0.4769	1.1234	1.6003	260
262	34.801		0.01782	4.021	4.039	305.91	883.2	1189.1	0.4835	1.1114	1.5949	262
264	35.832		0.01788	3.771	3.789	311.14	879.2	1190.3	0.4900	1.0994	1.5894	264
266	36.881		0.01793	3.539	3.557	316.38	875.1	1191.5	0.4966	1.0875	1.5841	266
268	37.948		0.01799	3.324	3.342	321.64	871.0	1192.6	0.5030	1.0757	1.5787	268
270	39.033		0.01805	3.126	3.144	326.91	866.8	1193.7	0.5094	1.0640	1.5734	270
272	40.136		0.01811	2.940	2.958	332.19	862.5	1194.7	0.5159	1.0522	1.5681	272
274	41.257		0.01817	2.768	2.786	337.48	858.2	1195.7	0.5223	1.0406	1.5629	274
276	42.396		0.01823	2.607	2.625	342.79	853.8	1196.6	0.5286	1.0291	1.5577	276
278	43.553		0.01830	2.458	2.476	348.11	849.4	1197.5	0.5350	1.0176	1.5526	278
280	44.728		0.01836	2.318	2.336	353.45	844.9	1198.4	0.5413	1.0062	1.5475	280
282	45.921		0.01843	2.189	2.207	358.80	840.4	1199.2	0.5476	0.9949	1.5425	282
284	47.132		0.01850	2.064	2.083	364.17	835.7	1199.9	0.5540	0.9835	1.5375	284
286	48.361		0.01857	1.9512	1.969	369.56	831.0	1200.6	0.5602	0.9722	1.5325	286
288	49.608		0.01864	1.8446	1.862	374.97	826.2	1201.3	0.5664	0.9610	1.5274	288
290	50.873		0.01871	1.7445	1.762	380.40	821.4	1201.8	0.5727	0.9499	1.5226	290
292	52.156		0.01878	1.6508	1.669	385.83	816.6	1202.4	0.5789	0.9390	1.5179	292
294	53.457		0.01886	1.5630	1.581	391.30	811.7	1203.0	0.5851	0.9280	1.5131	294
296	54.776		0.01894	1.4806	1.499	396.78	806.7	1203.5	0.5912	0.9170	1.5083	296
298	56.113		0.01902	1.4031	1.421	402.28	801.6	1203.9	0.5974	0.9061	1.5035	298
300	57.468		0.01910	1.3303	1.349	407.80	796.5	1204.3	0.6036	0.8953	1.4989	300
302	58.841		0.01918	1.2617	1.280	413.35	791.2	1204.6	0.6097	0.8843	1.4944	302
304	60.232		0.01926	1.1973	1.216	418.91	785.9	1204.8	0.6159	0.8735	1.4894	304
306	61.641		0.01934	1.1367	1.156	424.49	780.4	1204.9	0.6220	0.8628	1.4846	306
308	63.068		0.01943	1.0796	1.099	430.11	774.9	1205.0	0.6281	0.8518	1.4799	308
310	64.513		0.0195	1.0256	1.045	435.74	769.3	1205.0	0.6342	0.8410	1.4752	310
312	65.976		0.0196	0.9745	0.994	441.42	763.6	1205.0	0.6403	0.8303	1.4706	312
314	67.457		0.0197	0.9262	0.945	447.10	757.8	1204.9	0.6463	0.8195	1.4658	314
316	68.956		0.0198	0.8808	0.9006	452.84	751.9	1204.7	0.6524	0.8088	1.4612	316
318	70.473		0.0199	0.8379	0.8578	458.59	745.9	1204.5	0.6585	0.7980	1.4565	318

TABLE XXV
continued

Saturated Steam Temperature Table—(Concluded)

Temp. Fahr. t	Abs. Press. Lb./Sq. In. p	SPECIFIC VOLUMES			ENTHALPY			ENTROPY			Temp. Fahr. t
		Sat. Liquid v _l	Evap. v _{lg}	Sat. Vapor v _g	Sat. Liquid h _l	Evap. h _{lg}	Sat. Vapor h _g	Sat. Liquid s _l	Evap. s _{lg}	Sat. Vapor s _g	
880	566.12	0.0200	0.7972	0.8172	464.37	739.8	1204.2	0.6646	0.7872	1.4519	880
885	593.28	0.0201	0.7585	0.7786	470.18	733.6	1203.8	0.6708	0.7766	1.4472	885
890	621.44	0.0202	0.7219	0.7421	476.01	727.3	1203.3	0.6767	0.7658	1.4425	890
895	650.59	0.0203	0.6872	0.7075	481.90	720.8	1202.7	0.6827	0.7550	1.4377	895
900	680.80	0.0204	0.6544	0.6748	487.80	714.2	1202.0	0.6888	0.7442	1.4330	900
905	712.10	0.0206	0.6230	0.6436	493.8	707.5	1201.3	0.6949	0.7334	1.4283	905
910	744.55	0.0207	0.5932	0.6139	499.8	700.6	1200.6	0.7009	0.7225	1.4224	910
915	777.90	0.0209	0.5651	0.5859	505.8	693.6	1199.4	0.7070	0.7116	1.4166	915
920	812.68	0.0209	0.5382	0.5591	511.9	686.5	1198.4	0.7132	0.7007	1.4139	920
925	848.37	0.0210	0.5128	0.5338	518.0	679.2	1197.3	0.7192	0.6898	1.4090	925
930	885.20	0.0212	0.4885	0.5097	524.2	671.9	1196.1	0.7253	0.6789	1.4042	930
935	923.45	0.0213	0.4654	0.4867	530.4	664.6	1194.8	0.7314	0.6679	1.3993	935
940	962.80	0.0214	0.4433	0.4647	536.6	656.7	1193.3	0.7375	0.6569	1.3944	940
945	1003.6	0.0216	0.4222	0.4438	542.9	648.9	1191.8	0.7436	0.6458	1.3895	945
950	1045.6	0.0218	0.4021	0.4239	549.3	640.9	1190.2	0.7498	0.6347	1.3845	950
955	1088.6	0.0219	0.3830	0.4049	555.7	632.8	1188.3	0.7559	0.6234	1.3793	955
960	1133.4	0.0221	0.3648	0.3869	562.2	624.1	1186.3	0.7622	0.6120	1.3742	960
965	1179.3	0.0222	0.3472	0.3694	568.8	615.4	1184.2	0.7684	0.6006	1.3690	965
970	1226.7	0.0224	0.3304	0.3528	575.4	606.5	1181.9	0.7737	0.5890	1.3637	970
975	1275.7	0.0226	0.3143	0.3369	582.1	597.4	1179.5	0.7810	0.5774	1.3584	975
980	1326.1	0.0228	0.2989	0.3217	588.9	588.1	1177.0	0.7872	0.5658	1.3528	980
985	1378.1	0.0230	0.2840	0.3070	595.7	578.6	1174.3	0.7936	0.5538	1.3474	985
990	1431.5	0.0232	0.2699	0.2931	602.6	568.8	1171.4	0.8000	0.5419	1.3419	990
995	1486.5	0.0234	0.2563	0.2797	609.7	558.7	1168.4	0.8065	0.5297	1.3362	995
1000	1543.2	0.0236	0.2432	0.2668	616.8	548.4	1165.2	0.8130	0.5175	1.3305	1000
1005	1601.5	0.0239	0.2306	0.2546	624.1	537.7	1161.8	0.8196	0.5050	1.3246	1005
1010	1661.6	0.0241	0.2185	0.2426	631.5	526.6	1158.1	0.8263	0.4923	1.3186	1010
1015	1723.4	0.0244	0.2068	0.2312	638.9	515.3	1154.2	0.8330	0.4795	1.3125	1015
1020	1787.9	0.0247	0.1956	0.2202	646.5	503.7	1150.2	0.8398	0.4666	1.3063	1020
1025	1855.2	0.0250	0.1845	0.2095	654.3	491.5	1145.8	0.8467	0.4531	1.2999	1025
1030	1919.6	0.0253	0.1740	0.1993	662.2	478.8	1141.0	0.8537	0.4394	1.2931	1030
1035	1989.0	0.0256	0.1638	0.1894	670.4	465.5	1135.9	0.8609	0.4252	1.2861	1035
1040	2060.3	0.0260	0.1539	0.1799	678.7	452.0	1130.7	0.8681	0.4110	1.2791	1040
1045	2133.5	0.0264	0.1441	0.1705	687.3	437.8	1124.9	0.8756	0.3961	1.2717	1045
1050	2208.6	0.0268	0.1348	0.1616	696.0	422.7	1118.7	0.8832	0.3809	1.2641	1050
1055	2286.4	0.0273	0.1256	0.1530	705.2	407.0	1112.2	0.8910	0.3651	1.2561	1055
1060	2366.2	0.0278	0.1167	0.1445	714.4	390.5	1104.9	0.8991	0.3488	1.2478	1060
1065	2448.0	0.0283	0.1079	0.1362	724.5	372.1	1096.6	0.9074	0.3320	1.2382	1065
1070	2532.4	0.0290	0.0991	0.1281	734.6	353.3	1087.3	0.9161	0.3127	1.2286	1070
1075	2619.2	0.0297	0.0904	0.1201	745.5	332.8	1078.3	0.9253	0.2933	1.2186	1075
1080	2708.4	0.0306	0.0819	0.1115	757.3	310.0	1067.2	0.9352	0.2730	1.2072	1080
1085	2800.4	0.0316	0.0719	0.1032	770.1	284.5	1054.6	0.9459	0.2485	1.1944	1085
1090	2895.0	0.0328	0.0617	0.0945	784.2	254.9	1039.1	0.9579	0.2217	1.1798	1090
1095	2992.7	0.0345	0.0511	0.0856	801.3	219.1	1020.4	0.9730	0.1897	1.1617	1095
1100	3094.1	0.0369	0.0389	0.0758	823.9	171.7	995.6	0.9904	0.1481	1.1325	1100
1105	3198.1	0.0440	0.0167	0.0597	870.2	77.6	947.3	1.0305	0.0661	1.0906	1105
1105.24*	2308.2	0.0641	0	0.0641	910.3	0	910.3	1.0645	0	1.0645	1105.24*

* Critical temperature

TABLE XXV

continued

Saturated Steam: Pressure Table

Abs. Press. Lb./Sq. In. p	Temp. Fahr. t	SPECIFIC VOLUME			ENTHALPY			ENTROPY			Abs. Press. Lb./Sq. In. p
		Sat. Liquid v _l	Evap. v _{lg}	Sat. Vapor v _g	Sat. Liquid h _l	Evap. h _{lg}	Sat. Vapor h _g	Sat. Liquid s _l	Evap. s _{lg}	Sat. Vapor s _g	
0.0888	32.00	0.01602	3305.7	3305.7	0	1075.1	1075.1	0	2.1865	2.1865	0.0888
0.133	40.69	0.01602	2383.7	2383.7	8.74	1070.2	1078.9	0.0176	2.1388	2.1564	0.133
0.250	59.31	0.01603	1235.8	1235.8	27.38	1059.5	1086.9	0.0542	2.0414	2.0956	0.250
0.500	79.58	0.01607	641.71	641.73	47.80	1048.0	1095.8	0.0924	1.9434	2.0358	0.500
1	101.76	0.01614	333.77	333.79	69.72	1035.5	1105.2	0.1326	1.8443	1.9769	1
10	162.25	0.01641	73.584	73.600	130.13	1000.7	1130.8	0.2347	1.6090	1.8437	10
100	193.21	0.01638	38.445	38.416	161.17	982.2	1147.2	0.2824	1.4242	1.7876	100
14.696	212.00	0.01672	26.811	26.828	180.07	970.3	1150.4	0.3120	1.4446	1.7566	14.696
15	213.03	0.01672	26.303	26.320	181.11	969.6	1150.7	0.3135	1.4413	1.7548	15
20	227.96	0.01683	20.093	20.110	198.16	959.9	1156.1	0.3356	1.3959	1.7315	20
30	250.34	0.01700	13.746	13.763	218.83	945.2	1164.0	0.3680	1.3312	1.6992	30
40	267.24	0.01715	10.489	10.506	236.02	933.7	1169.7	0.3919	1.2844	1.6763	40
50	281.01	0.01727	8.505	8.522	250.09	923.9	1174.0	0.4110	1.2473	1.6583	50
60	292.71	0.01738	7.162	7.179	262.10	915.4	1177.5	0.4271	1.2166	1.6437	60
70	302.99	0.01748	6.193	6.210	272.61	907.9	1180.4	0.4409	1.1905	1.6314	70
80	312.03	0.01757	5.458	5.476	282.02	901.1	1183.1	0.4532	1.1677	1.6209	80
90	320.27	0.01766	4.880	4.898	290.57	894.8	1185.4	0.4641	1.1472	1.6113	90
100	327.83	0.01774	4.415	4.433	298.43	889.9	1187.3	0.4741	1.1287	1.6028	100
110	334.79	0.01782	4.032	4.050	305.69	883.3	1189.0	0.4832	1.1118	1.5950	110
120	341.26	0.01789	3.710	3.728	312.46	878.1	1190.6	0.4916	1.0963	1.5879	120
130	347.31	0.01796	3.437	3.455	318.81	873.2	1192.0	0.4995	1.0820	1.5815	130
140	353.03	0.01803	3.202	3.220	324.83	868.5	1193.3	0.5069	1.0686	1.5755	140
150	358.43	0.01809	2.998	3.016	330.53	863.9	1194.4	0.5138	1.0560	1.5699	150
160	363.55	0.01815	2.816	2.834	335.95	859.6	1195.5	0.5204	1.0442	1.5646	160
170	368.42	0.01821	2.656	2.674	341.11	855.2	1196.3	0.5266	1.0327	1.5593	170
180	373.08	0.01827	2.514	2.532	346.07	851.1	1197.2	0.5325	1.0220	1.5545	180
190	377.55	0.01833	2.386	2.404	350.83	847.2	1198.0	0.5382	1.0119	1.5501	190
200	381.82	0.01839	2.270	2.288	355.40	843.3	1198.7	0.5436	1.0021	1.5457	200
210	385.93	0.01844	2.165	2.183	359.80	839.6	1199.4	0.5488	0.9929	1.5417	210
220	389.89	0.01850	2.067	2.086	364.05	835.8	1199.9	0.5538	0.9838	1.5376	220
230	393.70	0.01855	1.980	1.999	368.16	832.2	1200.4	0.5585	0.9752	1.5337	230
240	397.40	0.01860	1.8990	1.918	372.16	828.7	1200.9	0.5632	0.9669	1.5301	240
250	400.97	0.01866	1.8244	1.843	376.04	825.4	1201.4	0.5677	0.9590	1.5267	250
260	404.43	0.01870	1.7555	1.7742	379.78	822.0	1201.8	0.5720	0.9513	1.5233	260
270	407.79	0.01875	1.6913	1.7101	383.43	818.8	1202.2	0.5761	0.9439	1.5200	270
280	411.06	0.01880	1.6316	1.6504	386.99	815.5	1202.5	0.5802	0.9369	1.5166	280
290	414.24	0.01885	1.5758	1.5947	390.47	812.4	1202.9	0.5841	0.9296	1.5137	290
300	417.33	0.01890	1.5237	1.5426	393.85	809.3	1203.2	0.5879	0.9228	1.5107	300
350	431.71	0.01912	1.3064	1.3255	409.70	794.7	1204.4	0.6057	0.8915	1.4972	350
400	444.58	0.0193	1.1416	1.1609	424.02	780.9	1204.9	0.6215	0.8635	1.4850	400
450	456.27	0.0195	1.0123	1.0318	437.18	767.8	1205.0	0.6357	0.8382	1.4739	450
500	467.00	0.0197	0.9077	0.9274	449.40	755.5	1204.9	0.6488	0.8153	1.4641	500
550	476.94	0.0199	0.8217	0.8416	460.83	743.6	1204.4	0.6609	0.7939	1.4548	550
600	486.21	0.0201	0.7494	0.7695	471.59	732.0	1203.5	0.6721	0.7739	1.4460	600
650	494.90	0.0203	0.6879	0.7082	481.73	721.0	1202.7	0.6826	0.7553	1.4379	650
700	503.09	0.0205	0.6347	0.6552	491.49	710.1	1201.6	0.6925	0.7376	1.4301	700
750	510.83	0.0207	0.5884	0.6091	500.8	699.4	1200.2	0.7019	0.7206	1.4225	750
800	518.20	0.0209	0.5476	0.5685	509.7	689.1	1198.5	0.7103	0.7047	1.4155	800
850	525.23	0.0210	0.5116	0.5326	518.3	678.9	1197.2	0.7194	0.6893	1.4087	850
900	531.94	0.0212	0.4794	0.5006	526.6	669.0	1195.6	0.7276	0.6746	1.4022	900
950	538.38	0.0214	0.4503	0.4717	534.6	659.2	1193.8	0.7355	0.6605	1.3960	950
1000	544.56	0.0216	0.4240	0.4456	542.4	649.5	1191.9	0.7431	0.6468	1.3909	1000
1050	550.52	0.0218	0.4001	0.4219	550.0	640.0	1190.0	0.7504	0.6335	1.3859	1050
1100	556.26	0.0219	0.3783	0.4002	557.4	630.4	1187.8	0.7575	0.6205	1.3780	1100
1150	561.81	0.0221	0.3583	0.3804	564.6	621.0	1185.6	0.7644	0.6079	1.3723	1150
1200	567.19	0.0223	0.3397	0.3620	571.7	611.5	1183.2	0.7712	0.5955	1.3667	1200
1250	572.39	0.0225	0.3228	0.3453	578.6	602.2	1180.8	0.7777	0.5835	1.3612	1250
1300	577.43	0.0227	0.3067	0.3294	585.4	592.9	1178.3	0.7840	0.5717	1.3557	1300
1350	582.32	0.0229	0.2918	0.3147	592.1	583.7	1175.8	0.7902	0.5602	1.3504	1350
1400	587.07	0.0231	0.2780	0.3011	598.6	574.6	1173.2	0.7963	0.5489	1.3452	1400
1450	591.70	0.0233	0.2652	0.2885	605.0	565.5	1170.5	0.8022	0.5379	1.3401	1450
1500	596.20	0.0235	0.2530	0.2765	611.4	556.3	1167.7	0.8081	0.5269	1.3350	1500
1550	600.59	0.0237	0.2416	0.2653	617.7	547.1	1164.8	0.8138	0.5160	1.3298	1550
1600	604.87	0.0239	0.2309	0.2548	623.9	538.0	1161.9	0.8195	0.5054	1.3246	1600
1650	609.05	0.0241	0.2207	0.2449	630.0	528.8	1158.8	0.8250	0.4948	1.3195	1650
1700	613.12	0.0243	0.2111	0.2354	636.1	519.6	1155.7	0.8304	0.4843	1.3147	1700
1750	617.11	0.0245	0.2020	0.2265	642.1	510.4	1152.5	0.8359	0.4740	1.3099	1750
1800	621.00	0.0248	0.1933	0.2180	648.0	501.3	1149.3	0.8412	0.4639	1.3051	1800
1850	624.82	0.0249	0.1850	0.2099	653.9	492.0	1145.9	0.8465	0.4537	1.3002	1850
1900	628.55	0.0252	0.1770	0.2022	659.9	482.5	1142.4	0.8517	0.4434	1.2951	1900
1950	632.20	0.0254	0.1695	0.1949	665.8	473.0	1138.8	0.8569	0.4332	1.2901	1950
2000	635.78	0.0257	0.1622	0.1879	671.7	463.5	1135.2	0.8620	0.4231	1.2851	2000
2100	642.73	0.0262	0.1486	0.1748	683.4	444.2	1127.6	0.8722	0.4029	1.2751	2100
2200	649.42	0.0267	0.1359	0.1626	695.0	424.4	1119.4	0.8823	0.3826	1.2649	2200
2300	655.87	0.0274	0.1240	0.1514	706.7	404.3	1111.0	0.8923	0.3624	1.2547	2300
2400	662.09	0.0283	0.1130	0.1410	718.5	384.0	1102.4	0.9025	0.3415	1.2438	2400
2500	668.10	0.0287	0.1026	0.1313	730.7	363.0	1093.0	0.9127	0.3195	1.2325	2500
2600	673.91	0.0295	0.0924	0.1219	743.1	337.0	1080.1	0.9232	0.2973	1.2202	2600
2700	679.54	0.0305	0.0818	0.1127	756.1	312.2	1068.3	0.9342	0.2740	1.2082	2700
2800	684.98	0.0316	0.0716	0.1032	770.0	284.6	1054.6	0.9458	0.2486	1.1944	2800
2900	690.26	0.0329	0.0612	0.0941	785.2	252.9	1038.1	0.9586	0.2199	1.1785	2900
3000	695.37	0.0346	0.0503	0.0849	802.6	216.7	1019.3	0.9731	0.1876	1.1607	3000
3100	700.29	0.0372	0.0390	0.0752	824.6	169.4	994.0	0.9916	0.1460	1.1376	3100
3200	705.04	0.0443	0.0153	0.0396	871.3	75.3	946.6	1.0311	0.0647	1.0958	3200
3306.3*	705.34	0.0541	0	0.0541	910.3	0	910.3	1.0645	0	1.0645	3306.3*

* Critical pressure

APPENDIX

TABLE XXV
continued

Superheated Steam

Abs. Press. Lb./Sq. In. Sat. Temp.)	Sat. Water	Sat. Steam	TEMPERATURE—DEGREES FAHRENHEIT																						
			300°	350°	400°	450°	500°	550°	600°	700°	800°	900°	1000°	1100°	1500°										
1 (101.76)	h	98.24	148.24	198.24	248.24	298.24	348.24	398.24	448.24	498.24	548.24	598.24	648.24	698.24	748.24	798.24	848.24	898.24	948.24	998.24	1048.24	1098.24	1148.24		
	v	0.0161	333.79	392.5	422.5	452.1	482.1	511.7	541.8	571.3	600.6	629.2	657.5	685.7	713.7	741.5	769.1	796.6	824.0	851.3	878.5	905.7	932.8	960.0	
	s	0.1326	1.9769	2.0491	2.0822	2.1128	2.1420	2.1694	2.1957	2.2206	2.2445	2.2675	2.2897	2.3113	2.3323	2.3527	2.3726	2.3920	2.4110	2.4297	2.4481	2.4662	2.4840	2.5016	2.5191
8 (162.25)	h	87.75	87.75	137.75	187.75	237.75	287.75	337.75	387.75	437.75	487.75	537.75	587.75	637.75	687.75	737.75	787.75	837.75	887.75	937.75	987.75	1037.75	1087.75	1137.75	
	v	0.0164	73.600	89.25	106.21	124.26	143.26	163.26	184.26	206.26	229.26	253.26	278.26	304.26	331.26	359.26	388.26	418.26	449.26	481.26	514.26	548.26	583.26	619.26	656.26
	s	0.1326	1.9769	1.9043	1.9349	1.9642	1.9920	2.0182	2.0429	2.0658	2.0871	2.1070	2.1257	2.1433	2.1600	2.1758	2.1907	2.2048	2.2182	2.2309	2.2430	2.2546	2.2658	2.2766	2.2870
10 (192.21)	h	6.79	56.79	106.79	156.79	206.79	256.79	306.79	356.79	406.79	456.79	506.79	556.79	606.79	656.79	706.79	756.79	806.79	856.79	906.79	956.79	1006.79	1056.79	1106.79	
	v	0.0166	38.482	48.98	60.21	73.06	87.42	103.26	120.54	139.26	159.42	181.06	204.16	228.76	254.86	282.46	311.56	342.16	374.26	407.86	442.96	479.56	517.66	557.26	598.36
	s	0.2347	1.8437	1.8710	1.9043	1.9349	1.9642	1.9920	2.0182	2.0429	2.0658	2.0871	2.1070	2.1257	2.1433	2.1600	2.1758	2.1907	2.2048	2.2182	2.2309	2.2430	2.2546	2.2658	2.2766
14.696 (212.00)	h	38.00	88.00	138.00	188.00	238.00	288.00	338.00	388.00	438.00	488.00	538.00	588.00	638.00	688.00	738.00	788.00	838.00	888.00	938.00	988.00	1038.00	1088.00	1138.00	
	v	0.0167	26.828	28.44	30.52	32.61	34.65	36.73	38.75	40.73	42.67	44.57	46.44	48.28	50.09	51.87	53.63	55.37	57.09	58.79	60.47	62.14	63.80	65.45	
	s	0.2347	1.8437	1.8710	1.9043	1.9349	1.9642	1.9920	2.0182	2.0429	2.0658	2.0871	2.1070	2.1257	2.1433	2.1600	2.1758	2.1907	2.2048	2.2182	2.2309	2.2430	2.2546	2.2658	
18 (213.03)	h	36.97	86.97	136.97	186.97	236.97	286.97	336.97	386.97	436.97	486.97	536.97	586.97	636.97	686.97	736.97	786.97	836.97	886.97	936.97	986.97	1036.97	1086.97	1136.97	
	v	0.0167	26.320	27.80	29.90	31.97	34.05	35.98	37.97	39.91	41.81	43.68	45.52	47.34	49.14	50.92	52.68	54.43	56.17	57.89	59.60	61.30	62.99	64.67	
	s	0.1811	1.1970	1.1692	1.1920	1.2154	1.2389	1.2621	1.2854	1.3083	1.3311	1.3537	1.3762	1.3986	1.4209	1.4431	1.4652	1.4872	1.5091	1.5309	1.5526	1.5742	1.5957	1.6171	1.6384
20 (227.90)	h	22.04	72.04	122.04	172.04	222.04	272.04	322.04	372.04	422.04	472.04	522.04	572.04	622.04	672.04	722.04	772.04	822.04	872.04	922.04	972.04	1022.04	1072.04	1122.04	
	v	0.0168	20.110	20.81	22.36	23.91	25.43	26.95	28.45	30.00	31.46	32.94	34.44	35.94	37.44	38.94	40.44	41.94	43.44	44.94	46.44	47.94	49.44	50.94	
	s	0.3532	1.7315	1.7685	1.7799	1.8101	1.8384	1.8646	1.8899	1.9138	1.9368	1.9589	1.9800	2.0011	2.0221	2.0431	2.0642	2.0852	2.1062	2.1272	2.1482	2.1692	2.1902	2.2112	2.2322
25 (240.07)	h	9.93	59.93	109.93	159.93	209.93	259.93	309.93	359.93	409.93	459.93	509.93	559.93	609.93	659.93	709.93	759.93	809.93	859.93	909.93	959.93	1009.93	1059.93	1109.93	
	v	0.0169	16.321	16.56	17.84	19.08	20.30	21.53	22.75	23.97	25.15	26.35	27.54	28.74	29.94	31.14	32.34	33.54	34.74	35.94	37.14	38.34	39.54	40.74	
	s	0.3532	1.7137	1.1663	1.1902	1.2141	1.2379	1.2617	1.2854	1.3092	1.3329	1.3566	1.3803	1.4040	1.4277	1.4514	1.4751	1.4988	1.5225	1.5462	1.5699	1.5936	1.6173	1.6410	1.6647
30 (250.34)	h	49.66	99.66	149.66	199.66	249.66	299.66	349.66	399.66	449.66	499.66	549.66	599.66	649.66	699.66	749.66	799.66	849.66	899.66	949.66	999.66	1049.66	1099.66	1149.66	
	v	0.0170	13.753	14.82	15.87	16.89	17.91	18.92	19.94	20.94	21.94	22.94	23.94	24.94	25.94	26.94	27.94	28.94	29.94	30.94	31.94	32.94	33.94	34.94	
	s	0.3680	1.6992	1.1835	1.2134	1.2432	1.2729	1.3026	1.3322	1.3618	1.3914	1.4210	1.4506	1.4802	1.5098	1.5394	1.5690	1.5986	1.6282	1.6578	1.6874	1.7170	1.7466	1.7762	1.8058
35 (259.28)	h	40.72	90.72	140.72	190.72	240.72	290.72	340.72	390.72	440.72	490.72	540.72	590.72	640.72	690.72	740.72	790.72	840.72	890.72	940.72	990.72	1040.72	1090.72	1140.72	
	v	0.0171	11.907	12.66	13.57	14.45	15.33	16.20	17.04	17.96	18.86	19.76	20.66	21.56	22.46	23.36	24.26	25.16	26.06	26.96	27.86	28.76	29.66	30.56	
	s	0.3807	1.6869	1.1858	1.2127	1.2396	1.2665	1.2934	1.3203	1.3472	1.3741	1.4010	1.4279	1.4548	1.4817	1.5086	1.5355	1.5624	1.5893	1.6162	1.6431	1.6700	1.6969	1.7238	1.7507
40 (267.24)	h	32.76	82.76	132.76	182.76	232.76	282.76	332.76	382.76	432.76	482.76	532.76	582.76	632.76	682.76	732.76	782.76	832.76	882.76	932.76	982.76	1032.76	1082.76	1132.76	
	v	0.0172	10.506	11.04	11.84	12.62	13.40	14.16	14.96	15.74	16.54	17.34	18.14	18.94	19.74	20.54	21.34	22.14	22.94	23.74	24.54	25.34	26.14	26.94	
	s	0.3919	1.6763	1.1897	1.7313	1.7606	1.7868	1.8123	1.8380	1.8640	1.8904	1.9174	1.9447	1.9723	2.0001	2.0281	2.0562	2.0844	2.1127	2.1411	2.1696	2.1982	2.2269	2.2557	2.2845
45 (274.45)	h	25.55	62.95	125.55	175.55	225.55	275.55	325.55	375.55	425.55	475.55	525.55	575.55	625.55	675.55	725.55	775.55	825.55	875.55	925.55	975.55	1025.55	1075.55	1125.55	
	v	0.0172	9.408	9.785	10.50	11.20	11.89	12.57	13.31	14.03	14.77	15.52	16.28	17.04	17.82	18.60	19.39	20.19	20.99	21.79	22.59	23.39	24.19	24.99	
	s	0.4019	1.6668	1.1854	1.2111	1.2358	1.2591	1.2813	1.3034	1.3255	1.3476	1.3696	1.3916	1.4136	1.4356	1.4576	1.4796	1.5016	1.5236	1.5456	1.5676	1.5896	1.6116	1.6336	1.6556
50 (281.01)	h	18.99	68.99	118.99	168.99	218.99	268.99	318.99	368.99	418.99	468.99	518.99	568.99	618.99	668.99	718.99	768.99	818.99	868.99	918.99	968.99	1018.99	1068.99	1118.99	
	v	0.0173	8.522	8.777	9.430	10.06	10.69	11.30	12.03	12.74	13.44	14.14	14.84	15.54	16.24	16.94	17.64	18.34	19.04	19.74	20.44	21.14	21.84	22.54	
	s	0.4110	1.6583	1.1874	1.2123	1.2352	1.2568	1.2782	1.2996	1.3209	1.3422	1.3634	1.3846	1.4058	1.4270	1.4482	1.4694	1.4906	1.5118	1.5330	1.5542	1.5754	1.5966	1.6178	1.6390
55 (287.07)	h	12.93	62.93	112.93	162.93	212.93	262.93	312.93	362.93	412.93	462.93	512.93	562.93	612.93	662.93	712.93	762.93	812.93	862.93	912.93	962.93	1012.93	1062.93	1112.93	
	v	0.0173	7.792	7.950	8.553	9.130	9.703	10.28	10.88	11.48	12.08	12.68	13.28	13.88	14.48	15.08	15.68	16.28	16.88	17.48	18.08	18.68	19.28	19.88	
	s	0.4163	1.6506	1.1860	1.2094	1.2316	1.2528	1.2732	1.2936	1.3140	1.3344	1.3548	1.3752	1.3956	1.4160	1.4364	1.4568	1.4772	1.4976	1.5180	1.5384	1.5588	1.5792	1.6000	
60 (292.71)	h	7.29	57.29	107.29	157.29	207.29	257.29	307.29	357.29	407.29	457.29	507.29	557.29	607.29	657.29	707.29	757.29	807.29	857.29	907.29	957.29	1007.29	1057.29	1107.29	
	v	0.0174	7.179	7.260	7.821	8.353	8.882	9.398	10.00	10.62	11.24	11.84	12.44	13.04	13.64	14.24									

TABLE XXV
continued

Superheated Steam—(Continued)

Abs. Press. Lb./Sq. In. (Sat. Temp.)	Sat. Steam	TEMPERATURE—DEGREES FAHRENHEIT															
		360°	380°	400°	420°	450°	500°	600°	700°	800°	900°	1000°	1100°	1200°			
80 (312.03)	Sh	0.0176	5.476	27.97	47.97	67.97	87.97	107.97	137.97	187.97	287.97	387.97	487.97	587.97	687.97	787.97	887.97
	v	282.02	1183.1	1200.0	1211.0	1221.2	1221.5	1221.5	1240.3	1255.7	1290.2	1329.3	1378.5	1428.2	1478.4	1529.7	1581.4
	s	0.4532	1.6200	1.6424	1.6560	1.6683	1.6804	1.6905	1.7077	1.7339	1.7823	1.8268	1.8679	1.9052	1.9426	1.9768	2.0093

Sh = superheat, deg. F.
v = specific volume, cu. ft. per lb.

h = enthalpy, B.t.u. per lb.
s = entropy, B.t.u. per deg. F. per lb.

TABLE XXV
continued

Superheated Steam—(Continued)

Abs. Press. (Sat. Temp.)		Sat. Water	Sat. Steam	TEMPERATURE—DEGREES FAHRENHEIT													
				420°	430°	440°	450°	460°	480°	500°	550°	600°	700°	800°	1000°	1100°	1200°
168 (366.01)	Sh			33.99	53.99	73.99	93.99	113.99	133.99	183.99	233.99	333.99	433.99	633.99	833.99	1033.99	1233.99
	v	0.0182	2.752	2.909	2.997	3.084	3.170	3.251	3.334	3.533	3.729	4.114	4.491	4.864	5.234	5.601	5.967
	h	338.55	1195.9	1217.4	1229.3	1241.1	1251.8	1262.4	1272.8	1298.5	1323.8	1374.5	1425.0	1475.9	1527.8	1579.7	1632.7
	s	0.5236	1.5619	1.5874	1.6011	1.6144	1.6262	1.6376	1.6468	1.6747	1.6991	1.7448	1.7865	1.8254	1.8622	1.8966	1.9295
170 (368.42)	Sh			31.58	51.58	71.58	91.58	111.58	131.58	181.58	231.58	331.58	431.58	631.58	831.58	1031.58	1231.58
	v	0.0182	2.674	2.816	2.903	2.988	3.071	3.151	3.232	3.426	3.617	3.991	4.357	4.720	5.079	5.438	5.792
	h	341.11	1196.3	1216.5	1228.4	1240.5	1251.3	1261.6	1272.3	1298.2	1323.5	1374.2	1424.9	1475.7	1527.6	1579.6	1632.7
	s	0.5266	1.5593	1.5832	1.5969	1.6105	1.6224	1.6337	1.6448	1.6711	1.6955	1.7412	1.7831	1.8219	1.8587	1.8931	1.9261
172 (370.77)	Sh			29.23	49.23	69.23	89.23	109.23	129.23	179.23	229.23	329.23	429.23	629.23	829.23	1029.23	1229.23
	v	0.0182	2.601	2.730	2.814	2.897	2.979	3.057	3.136	3.325	3.510	3.875	4.231	4.584	4.932	5.279	5.625
	h	343.61	1196.7	1215.6	1227.6	1239.9	1250.8	1261.3	1271.9	1297.8	1323.2	1374.0	1424.7	1475.6	1527.5	1579.5	1632.6
	s	0.5296	1.5569	1.5793	1.5931	1.6069	1.6189	1.6302	1.6414	1.6677	1.6922	1.7380	1.7799	1.8185	1.8553	1.8897	1.9227
180 (373.08)	Sh			26.92	46.92	66.92	86.92	106.92	126.92	176.92	226.92	326.92	426.92	626.92	826.92	1026.92	1226.92
	v	0.0183	2.532	2.648	2.731	2.812	2.892	2.968	3.045	3.229	3.410	3.765	4.112	4.455	4.794	5.132	5.468
	h	346.07	1197.2	1214.6	1226.8	1238.2	1250.2	1260.8	1271.5	1297.4	1322.8	1373.7	1424.6	1475.5	1527.4	1579.4	1632.5
	s	0.5325	1.5545	1.5751	1.5891	1.6030	1.6151	1.6265	1.6378	1.6641	1.6886	1.7345	1.7765	1.8154	1.8522	1.8866	1.9196
185 (375.34)	Sh			24.66	44.66	64.66	84.66	104.66	124.66	174.66	224.66	324.66	424.66	624.66	824.66	1024.66	1224.66
	v	0.0183	2.466	2.570	2.651	2.731	2.809	2.884	2.958	3.139	3.315	3.661	3.999	4.333	4.664	4.992	5.319
	h	348.47	1197.6	1215.7	1227.6	1238.4	1249.6	1260.3	1271.0	1297.4	1322.4	1373.4	1424.3	1475.3	1527.3	1579.3	1632.4
	s	0.5354	1.5522	1.5712	1.5853	1.5992	1.6116	1.6230	1.6343	1.6611	1.6853	1.7312	1.7733	1.8122	1.8491	1.8835	1.9165
190 (377.55)	Sh			22.45	42.45	62.45	82.45	102.45	122.45	172.45	222.45	322.45	422.45	622.45	822.45	1022.45	1222.45
	v	0.0183	2.404	2.498	2.576	2.654	2.731	2.804	2.877	3.053	3.225	3.563	3.893	4.218	4.540	4.860	5.179
	h	350.83	1198.0	1216.7	1228.1	1238.7	1249.0	1259.8	1270.5	1296.6	1322.1	1373.1	1424.1	1475.0	1527.0	1579.0	1632.3
	s	0.5382	1.5501	1.5674	1.5817	1.5959	1.6083	1.6199	1.6312	1.6577	1.6823	1.7282	1.7703	1.8093	1.8461	1.8806	1.9136
195 (379.70)	Sh			20.30	40.30	60.30	80.30	100.30	120.30	170.30	220.30	320.30	420.30	620.30	820.30	1020.30	1220.30
	v	0.0184	2.344	2.426	2.505	2.581	2.656	2.728	2.799	2.972	3.140	3.470	3.791	4.109	4.423	4.735	5.046
	h	353.13	1198.4	1217.7	1228.4	1237.0	1246.3	1255.3	1264.0	1290.2	1321.8	1372.9	1423.9	1475.0	1527.0	1579.1	1632.2
	s	0.5409	1.5479	1.5636	1.5780	1.5924	1.6048	1.6166	1.6279	1.6545	1.6792	1.7252	1.7673	1.8063	1.8432	1.8777	1.9107
200 (381.82)	Sh			18.18	38.18	58.18	78.18	98.18	118.18	168.18	218.18	318.18	418.18	618.18	818.18	1018.18	1218.18
	v	0.0184	2.288	2.360	2.437	2.512	2.585	2.656	2.726	2.895	3.059	3.381	3.697	4.005	4.311	4.616	4.919
	h	355.40	1198.7	1218.0	1228.7	1237.3	1246.3	1255.7	1264.4	1290.6	1321.4	1372.5	1423.5	1474.9	1526.8	1579.0	1632.1
	s	0.5436	1.5457	1.5599	1.5748	1.5892	1.6017	1.6133	1.6245	1.6511	1.6761	1.7221	1.7646	1.8036	1.8402	1.8749	1.9079
205 (383.99)	Sh			16.11	36.11	56.11	76.11	96.11	116.11	166.11	216.11	316.11	416.11	616.11	816.11	1016.11	1216.11
	v	0.0184	2.235	2.297	2.372	2.446	2.518	2.587	2.656	2.821	2.982	3.297	3.604	3.906	4.205	4.502	4.798
	h	357.61	1199.0	1219.7	1229.5	1238.1	1247.1	1256.4	1265.0	1291.2	1322.0	1373.1	1424.1	1475.6	1527.6	1579.6	1632.0
	s	0.5462	1.5436	1.5562	1.5709	1.5854	1.5983	1.6102	1.6216	1.6484	1.6731	1.7194	1.7616	1.8007	1.8377	1.8722	1.9052
210 (386.03)	Sh			14.07	34.07	54.07	74.07	94.07	114.07	164.07	214.07	314.07	414.07	614.07	814.07	1014.07	1214.07
	v	0.0184	2.183	2.237	2.311	2.384	2.454	2.522	2.589	2.751	2.909	3.216	3.516	3.812	4.104	4.395	4.683
	h	359.80	1199.4	1220.8	1230.8	1239.4	1248.5	1257.7	1266.0	1292.2	1323.0	1374.1	1425.1	1476.6	1528.6	1580.6	1632.0
	s	0.5488	1.5417	1.5527	1.5676	1.5821	1.5951	1.6071	1.6185	1.6454	1.6702	1.7165	1.7588	1.7980	1.8349	1.8695	1.9025
215 (387.93)	Sh			12.07	32.07	52.07	72.07	92.07	112.07	162.07	212.07	312.07	412.07	612.07	812.07	1012.07	1212.07
	v	0.0185	2.134	2.179	2.252	2.324	2.393	2.460	2.526	2.685	2.838	3.140	3.433	3.722	4.008	4.292	4.574
	h	361.95	1199.6	1207.8	1221.0	1234.0	1245.9	1257.2	1268.0	1294.6	1320.4	1371.9	1423.1	1474.4	1526.8	1578.7	1631.9
	s	0.5513	1.5395	1.5491	1.5643	1.5789	1.5920	1.6042	1.6156	1.6426	1.6675	1.7139	1.7562	1.7954	1.8324	1.8670	1.9000
220 (389.99)	Sh			10.11	30.11	50.11	70.11	90.11	110.11	160.11	210.11	310.11	410.11	610.11	810.11	1010.11	1210.11
	v	0.0185	2.086	2.124	2.196	2.267	2.335	2.400	2.465	2.621	2.772	3.067	3.354	3.637	3.916	4.193	4.469
	h	364.05	1199.9	1208.6	1220.1	1232.3	1245.2	1257.6	1269.5	1295.1	1320.0	1371.6	1422.9	1474.2	1526.8	1578.6	1631.8
	s	0.5538	1.5376	1.5457	1.5610	1.5757	1.5889	1.6013	1.6127	1.6397	1.6647	1.7112	1.7538	1.7928	1.8298	1.8644	1.8974
225 (391.81)	Sh			8.19	28.19	48.19	68.19	88.19	108.19	158.19	208.19	308.19	408.19	608.19	808.19	1008.19	1208.19
	v	0.0185	2.042	2.072	2.142	2.212	2.279	2.344	2.407	2.559	2.708	2.997	3.278	3.555	3.828	4.100	4.369
	h	366.11	1200.2	1209.5	1219.2	1229.3	1240.5	1252.6	1264.7	1290.3	1315.9	1367.4	1418.7	1470.0	1522.6	1575.5	1631.7
	s	0.5562	1.5358	1.5423	1.5577	1.5724	1.5858	1.5984	1.6099	1.6369	1.6619	1.7086	1.7510	1.7902	1.8272	1.8618	1.8948
230 (393.70)	Sh			6.30	26.30	46.30	66.30	86.30	106.30	156.30	206.30	306.30	406.30	606.30	806.30	1006.30	1206.30
	v	0.0186	1.9989	2.021	2.091	2.160	2.226	2.289	2.352	2.502	2.647	2.930	3.205	3.478	3.744	4.010	4.274
	h	368.16	1200.4	1209.4	1219.6	1230.1	1241.8	1254.6	1267.6	1293.3	1319.3	1371.1	1422.5	1473.8	1526.8	1579.4	1631.6
	s	0.5585	1.5337	1.5390	1.5544	1.5693	1.5827	1.5954	1.6071	1.6341	1.6594	1.7059	1.7484	1.7877	1.8247	1.8593	1.8923
235 (395.56)	Sh			4.44	24.44	44.44	64.44	84.44	104.44	154.44	204.44	304.44	404.44	604.44	804.44	1004.44	1204.44
	v	0.0186	1.9573	1.973	2.042	2.110	2.175	2.237	2.298	2.446	2.589	2.868	3.136	3.402	3.664	3.924	4.182
	h	370.17	1200.7	1209.3	1219.7	1230.8	1242.5	1255.0	1267.								

TABLE XXV
continued

Superheated Steam—(Continued)

Abs. Press. Lb./Sq. In. (Sat. Temp.)	Sat. Water	Sat. Steam	TEMPERATURE—DEGREES FAHRENHEIT																		
			430°	440°	450°	460°	470°	480°	490°	500°	520°	540°	560°	600°	700°	800°	1000°	1100°	1300°		
350 (400.97)	Sh		19.03	39.03	59.03	79.03	99.03	119.03	149.03	199.03	299.03	399.03	499.03	599.03	699.03	799.03					
	v	0.0187	1.8431	1.9065	1.9711	2.0334	2.0932	2.1515	2.2085	2.2620	2.4272	2.6897	2.9444	3.1949	3.4416	3.6867	3.9299				
	h	376.04	1201.4	1214.6	1228.3	1241.0	1253.2	1264.7	1274.5	1291.6	1317.9	1370.0	1421.7	1473.3	1525.8	1578.0	1631.3				
355 (402.71)	Sh		17.29	37.29	57.29	77.29	97.29	117.29	147.29	197.29	297.29	397.29	497.29	597.29	697.29	797.29					
	v	0.0187	1.8079	1.8286	1.8489	1.8689	1.8885	1.9075	1.9259	1.9437	2.0778	2.3754	2.6854	2.9944	3.3013	3.6054	3.9079				
	h	377.91	1201.6	1213.7	1227.5	1240.3	1252.6	1264.2	1274.2	1291.2	1317.5	1369.8	1421.5	1473.2	1525.5	1577.9	1631.2				
360 (404.43)	Sh		15.57	35.57	55.57	75.57	95.57	115.57	145.57	195.57	295.57	395.57	495.57	595.57	695.57	795.57					
	v	0.0187	1.7742	1.8246	1.8779	1.9432	2.0063	2.0675	2.1265	2.1919	2.3299	2.5833	2.8299	3.0701	3.3077	3.5437	3.7778				
	h	379.78	1201.8	1212.8	1226.6	1239.5	1252.0	1263.6	1273.8	1290.8	1317.1	1369.5	1421.3	1473.0	1525.4	1577.8	1631.1				
365 (406.12)	Sh		13.88	33.88	53.88	73.88	93.88	113.88	143.88	193.88	293.88	393.88	493.88	593.88	693.88	793.88					
	v	0.0187	1.7416	1.8246	1.9481	2.0622	2.1669	2.2619	2.3475	2.4237	2.5919	2.8754	3.1744	3.4784	3.7774	4.0716	4.3616				
	h	379.78	1201.8	1211.9	1225.7	1238.7	1251.2	1263.0	1273.4	1290.4	1316.9	1369.3	1421.1	1472.9	1525.3	1577.7	1631.0				
370 (407.79)	Sh		12.21	32.21	52.21	72.21	92.21	112.21	142.21	192.21	292.21	392.21	492.21	592.21	692.21	792.21					
	v	0.0188	1.7101	1.7485	1.8101	1.8622	1.9059	1.9515	1.9985	2.0465	2.1959	2.4847	2.7219	2.9568	3.1838	3.4112	3.6370				
	h	383.43	1202.2	1211.0	1224.9	1238.0	1250.6	1262.5	1273.0	1290.0	1316.4	1368.0	1420.9	1472.7	1525.1	1577.6	1631.0				
375 (409.44)	Sh		10.56	30.56	50.56	70.56	90.56	110.56	140.56	190.56	290.56	390.56	490.56	590.56	690.56	790.56					
	v	0.0188	1.6798	1.7127	1.7735	1.8219	1.8679	1.9122	1.9575	2.0031	2.1531	2.4427	2.6714	2.8974	3.1204	3.3404	3.5574				
	h	385.22	1202.3	1210.0	1224.1	1237.3	1250.0	1262.0	1272.6	1289.5	1316.1	1368.7	1420.7	1472.6	1525.0	1577.5	1630.9				
380 (411.06)	Sh		8.94	28.94	48.94	68.94	88.94	108.94	138.94	188.94	288.94	388.94	488.94	588.94	688.94	788.94					
	v	0.0188	1.6504	1.6780	1.7381	1.7937	1.8412	1.8898	1.9395	1.9901	2.1401	2.4301	2.6598	2.8874	3.1124	3.3354	3.5564				
	h	386.99	1202.5	1209.0	1223.2	1236.5	1249.4	1261.5	1272.2	1289.1	1315.7	1368.5	1420.5	1472.4	1524.8	1577.4	1630.8				
385 (412.66)	Sh		7.34	27.34	47.34	67.34	87.34	107.34	137.34	187.34	287.34	387.34	487.34	587.34	687.34	787.34					
	v	0.0188	1.6232	1.6446	1.7040	1.7510	1.8157	1.8687	1.9235	1.9795	2.1295	2.4195	2.6492	2.8742	3.0962	3.3162	3.5342				
	h	388.74	1202.7	1208.0	1222.3	1235.6	1248.7	1260.9	1271.8	1288.6	1315.4	1368.2	1420.3	1472.2	1524.7	1577.3	1630.7				
390 (414.24)	Sh		5.76	25.76	45.76	65.76	85.76	105.76	135.76	185.76	285.76	385.76	485.76	585.76	685.76	785.76					
	v	0.0189	1.5947	1.6122	1.6713	1.7173	1.7838	1.8338	1.8852	1.9379	2.0783	2.3683	2.6013	2.8263	3.0433	3.2583	3.4713				
	h	390.47	1202.9	1207.0	1221.4	1234.8	1248.0	1260.4	1271.4	1288.2	1315.0	1367.9	1420.1	1472.1	1524.6	1577.2	1630.6				
395 (415.80)	Sh		4.20	24.20	44.20	64.20	84.20	104.20	134.20	184.20	284.20	384.20	484.20	584.20	684.20	784.20					
	v	0.0189	1.5684	1.5809	1.6391	1.6948	1.7484	1.8001	1.8510	1.9023	2.0413	2.3313	2.5643	2.7893	3.0143	3.2373	3.4593				
	h	392.17	1203.0	1206.1	1220.5	1234.0	1247.4	1259.8	1271.0	1287.8	1314.7	1367.6	1419.9	1472.0	1524.5	1577.1	1630.5				
400 (417.33)	Sh		2.67	22.67	42.67	62.67	82.67	102.67	132.67	182.67	282.67	382.67	482.67	582.67	682.67	782.67					
	v	0.0189	1.5426	1.5506	1.6082	1.6634	1.7164	1.7677	1.8172	1.8656	2.0056	2.2956	2.4447	2.6547	2.8634	3.0704	3.2754				
	h	393.85	1203.2	1205.2	1219.5	1233.4	1246.6	1259.2	1270.5	1287.4	1314.4	1367.4	1419.7	1471.3	1524.0	1576.6	1630.4				
410 (420.35)	Sh		19.65	39.65	59.65	79.65	99.65	119.65	139.65	159.65	179.65	199.65	219.65	239.65	259.65	279.65					
	v	0.0189	1.4933	1.5495	1.6038	1.6555	1.7054	1.7540	1.8016	1.8484	1.9935	2.2835	2.5735	2.8635	3.1535	3.4435	3.7335				
	h	397.16	1203.5	1217.8	1231.5	1245.3	1259.0	1269.6	1286.4	1296.4	1313.5	1366.9	1419.3	1471.5	1524.1	1576.8	1630.3				
420 (423.29)	Sh		16.71	36.71	56.71	76.71	96.71	116.71	136.71	156.71	176.71	196.71	216.71	236.71	256.71	276.71					
	v	0.0190	1.4479	1.4943	1.5473	1.5982	1.6472	1.6954	1.7427	1.7892	1.8357	1.9757	2.2657	2.5557	2.8457	3.1357	3.4257				
	h	400.40	1203.8	1216.0	1229.9	1244.0	1258.6	1268.6	1285.6	1295.6	1312.8	1366.3	1418.9	1471.2	1523.8	1576.6	1630.1				
430 (426.16)	Sh		13.84	33.84	53.84	73.84	93.84	113.84	133.84	153.84	173.84	193.84	213.84	233.84	253.84	273.84					
	v	0.0190	1.4048	1.4424	1.4944	1.5445	1.5925	1.6397	1.7064	1.8138	2.0189	2.3183	2.6173	2.9163	3.2153	3.5143	3.8133				
	h	403.56	1204.0	1214.1	1228.2	1242.5	1256.5	1267.6	1284.7	1312.1	1365.8	1418.4	1470.8	1523.6	1576.4	1630.0					
440 (428.96)	Sh		11.04	31.04	51.04	71.04	91.04	111.04	131.04	151.04	171.04	191.04	211.04	231.04	251.04	271.04					
	v	0.0191	1.3640	1.3935	1.4446	1.4936	1.5409	1.5872	1.6525	1.7573	1.9572	2.1493	2.3368	2.5268	2.7207	2.9231	3.1241				
	h	406.65	1204.2	1212.2	1226.5	1241.0	1254.2	1266.6	1283.8	1311.4	1365.2	1418.0	1470.5	1523.3	1576.2	1629.8					
450 (431.71)	Sh		8.29	28.29	48.29	68.29	88.29	108.29	128.29	148.29	168.29	188.29	208.29	228.29	248.29	268.29					
	v	0.0191	1.3255	1.3472	1.3976	1.4460	1.4923	1.5377	1.6016	1.7011	1.9011	2.0863	2.2687	2.4475	2.6244	2.8000					
	h	409.70	1204.4	1210.3	1224.8	1239.5	1252.9	1265.5	1282.9	1310.8	1364.7	1417.6	1470.2	1523.0	1576.0	1629.0					
460 (434.39)	Sh		5.61	25.61	45.61	65.61	85.61	105.61	125.61	145.61	165.61	185.61	205.61	225.61	245.61	265.61					
	v	0.0192	1.2889	1.3035	1.3532	1.4008	1.4463	1.4909	1.5536	1.6538	1.8411	2.0266	2.2044	2.3784	2.5494	2.7184					
	h	412.67	1204.5	1208.5	1223.1	1238.0	1251.5	1264.5	1282.0	1309.9	1364.1	1417.2	1469.9	1522.8	1575.8	1629.4					

Sh = superheat, deg. F.
v = specific volume, cu. ft. per lb.

h = enthalpy, B.t.u. per lb.
s = entropy, B.t.u. per deg. F. per lb.

APPENDIX

TABLE XXV
continued

Superheated Steam—(Continued)

Abs. Press. (Sat. Temp.)	Sat. Water	Sat. Steam	TEMPERATURE—DEGREES FAHRENHEIT														
			450°	460°	480°	500°	520°	540°	560°	580°	600°	700°	800°	900°	1000°	1100°	1200°
870 (437.01)	Sh		22.99	42.99	62.99	82.99	102.99	122.99	142.99	162.99	262.99	362.99	462.99	562.99	662.99	762.99	
	v	0.0192	1.2545	1.3111	1.3579	1.4028	1.4466	1.4881	1.5286	1.5675	1.8063	1.7921	1.9703	2.1435	2.3131	2.4809	2.6471
	h	415.58	1204.6	1221.4	1236.5	1250.2	1263.4	1275.2	1286.7	1298.3	1309.1	1363.6	1416.8	1469.6	1522.6	1575.6	1629.2
880 (439.59)	Sh		20.41	40.41	60.41	80.41	100.41	120.41	140.41	160.41	260.41	360.41	460.41	560.41	660.41	760.41	
	v	0.0193	1.2217	1.2711	1.3173	1.3614	1.4045	1.4452	1.4850	1.5232	1.5612	1.7428	1.9168	2.0959	2.2512	2.4148	2.5768
	h	418.45	1204.7	1219.8	1235.0	1248.8	1262.3	1274.2	1286.0	1297.5	1308.4	1363.0	1416.4	1469.3	1522.2	1575.4	1629.1
890 (442.11)	Sh		17.89	37.89	57.89	77.89	97.89	117.89	137.89	157.89	257.89	357.89	457.89	557.89	657.89	757.89	
	v	0.0193	1.1904	1.2332	1.2788	1.3222	1.3647	1.4046	1.4436	1.4812	1.5184	1.6961	1.8661	2.0311	2.1925	2.3521	2.5101
	h	421.27	1204.8	1218.0	1233.4	1247.4	1261.2	1273.2	1285.1	1296.7	1307.7	1362.5	1416.0	1468.9	1522.0	1575.2	1628.9
400 (444.58)	Sh		15.42	35.42	55.42	75.42	95.42	115.42	135.42	155.42	255.42	355.42	455.42	555.42	655.42	755.42	
	v	0.0193	1.1609	1.1972	1.2422	1.2849	1.3269	1.3660	1.4042	1.4413	1.4777	1.6522	1.8179	1.9796	2.1367	2.2926	2.4475
	h	424.02	1204.9	1216.5	1231.6	1246.9	1262.5	1277.4	1292.6	1295.8	1307.0	1362.1	1415.5	1468.6	1521.5	1574.8	1628.5
410 (447.00)	Sh		13.00	33.00	53.00	73.00	93.00	113.00	133.00	153.00	253.00	353.00	453.00	553.00	653.00	753.00	
	v	0.0194	1.1327	1.1628	1.2071	1.2494	1.2906	1.3291	1.3669	1.4033	1.4390	1.6095	1.7722	1.9297	2.0887	2.2359	2.3864
	h	426.74	1205.0	1214.6	1230.2	1245.4	1261.8	1271.2	1283.5	1295.1	1306.2	1361.4	1415.8	1469.3	1521.4	1574.8	1628.6
420 (449.38)	Sh		10.62	30.62	50.62	70.62	90.62	110.62	130.62	150.62	250.62	350.62	450.62	550.62	650.62	750.62	
	v	0.0194	1.1058	1.1300	1.1738	1.2156	1.2561	1.2942	1.3312	1.3671	1.4021	1.5693	1.7285	1.8826	2.0332	2.1819	2.3290
	h	429.02	1205.0	1213.0	1228.6	1243.1	1257.5	1270.2	1282.6	1294.3	1305.4	1360.8	1414.6	1468.0	1521.2	1574.6	1628.2
430 (451.72)	Sh		8.28	28.28	48.28	68.28	88.28	108.28	128.28	148.28	248.28	348.28	448.28	548.28	648.28	748.28	
	v	0.0195	1.0800	1.0986	1.1419	1.1834	1.2233	1.2607	1.2972	1.3328	1.3670	1.5309	1.6869	1.8377	1.9850	2.1305	2.2742
	h	432.05	1205.0	1211.2	1227.0	1241.7	1256.3	1269.1	1281.8	1293.5	1304.6	1360.3	1413.8	1467.6	1520.9	1574.4	1628.2
440 (454.01)	Sh		5.99	25.99	45.99	65.99	85.99	105.99	125.99	145.99	245.99	345.99	445.99	545.99	645.99	745.99	
	v	0.0195	1.0554	1.0688	1.1116	1.1524	1.1918	1.2288	1.2648	1.2996	1.3334	1.4943	1.6472	1.7949	1.9390	2.0814	2.2220
	h	434.63	1205.0	1209.6	1225.3	1240.2	1255.0	1268.0	1280.9	1292.6	1303.9	1359.7	1413.8	1467.3	1520.6	1574.1	1628.0
450 (456.27)	Sh		3.73	23.73	43.73	63.73	83.73	103.73	123.73	143.73	243.73	343.73	443.73	543.73	643.73	743.73	
	v	0.0195	1.0318	1.0401	1.0824	1.1230	1.1617	1.1982	1.2337	1.2681	1.3013	1.4593	1.6092	1.7539	1.8951	2.0345	2.1729
	h	437.18	1205.0	1207.9	1223.7	1238.7	1253.8	1268.9	1282.0	1291.8	1303.1	1359.1	1413.4	1467.0	1520.3	1573.9	1627.8
460 (458.48)	Sh		21.52	41.52	61.52	81.52	101.52	121.52	141.52	161.52	261.52	361.52	461.52	561.52	661.52	761.52	
	v	0.0196	1.0092	1.0545	1.0946	1.1329	1.1690	1.2039	1.2379	1.2706	1.3023	1.4258	1.5729	1.7147	1.8530	1.9896	2.1243
	h	439.69	1205.0	1222.0	1237.2	1252.5	1265.8	1279.0	1291.0	1302.3	1308.3	1358.6	1413.0	1466.6	1520.0	1573.7	1627.7
470 (460.66)	Sh		19.34	39.34	59.34	79.34	99.34	119.34	139.34	159.34	259.34	359.34	459.34	559.34	659.34	759.34	
	v	0.0196	0.9875	1.0278	1.0676	1.1053	1.1410	1.1755	1.2091	1.2412	1.2719	1.3937	1.5381	1.6772	1.8127	1.9466	2.0785
	h	442.17	1205.0	1220.2	1235.5	1251.2	1264.7	1278.0	1290.0	1301.5	1308.0	1358.0	1412.5	1466.3	1520.0	1573.8	1627.8
480 (462.80)	Sh		17.20	37.20	57.20	77.20	97.20	117.20	137.20	157.20	257.20	357.20	457.20	557.20	657.20	757.20	
	v	0.0197	0.9665	1.0021	1.0418	1.0789	1.1141	1.1482	1.1813	1.2131	1.2436	1.3630	1.5049	1.6413	1.7742	1.9054	2.0347
	h	444.60	1205.0	1218.6	1234.2	1249.9	1263.5	1277.0	1289.1	1300.8	1307.5	1357.5	1412.1	1466.0	1519.5	1573.3	1627.3
490 (464.91)	Sh		15.09	35.09	55.09	75.09	95.09	115.09	135.09	155.09	255.09	355.09	455.09	555.09	655.09	755.09	
	v	0.0197	0.9466	0.9774	1.0162	1.0535	1.0884	1.1220	1.1548	1.1860	1.2156	1.3335	1.4729	1.5667	1.7371	1.8659	1.9927
	h	447.00	1204.9	1217.0	1232.7	1248.4	1262.3	1276.0	1288.3	1300.0	1306.9	1356.9	1411.7	1465.6	1519.2	1573.1	1627.1
500 (467.00)	Sh		13.00	33.00	53.00	73.00	93.00	113.00	133.00	153.00	253.00	353.00	453.00	553.00	653.00	753.00	
	v	0.0197	0.9274	0.9538	0.9926	1.0290	1.0636	1.0969	1.1292	1.1600	1.1890	1.3051	1.4417	1.5735	1.7016	1.8280	1.9532
	h	449.40	1204.9	1215.3	1231.4	1246.6	1261.1	1275.0	1287.3	1299.3	1305.3	1355.3	1411.2	1466.1	1518.8	1572.9	1627.3
510 (469.05)	Sh		10.95	30.95	50.95	70.95	90.95	110.95	130.95	150.95	250.95	350.95	450.95	550.95	650.95	750.95	
	v	0.0198	0.9090	0.9310	0.9695	1.0056	1.0397	1.0727	1.1046	1.1354	1.1650	1.2780	1.4127	1.5418	1.6675	1.7915	1.9135
	h	451.75	1204.8	1213.5	1229.6	1245.6	1259.9	1274.0	1286.6	1298.6	1304.6	1354.6	1409.3	1463.0	1516.7	1572.6	1626.8
520 (471.07)	Sh		8.93	28.93	48.93	68.93	88.93	108.93	128.93	148.93	248.93	348.93	448.93	548.93	648.93	748.93	
	v	0.0198	0.8912	0.9091	0.9472	0.9829	1.0169	1.0494	1.0810	1.1110	1.1400	1.2519	1.3844	1.5113	1.6347	1.7562	1.8768
	h	454.07	1204.7	1211.8	1224.2	1244.2	1258.6	1272.9	1285.8	1297.6	1303.4	1353.1	1410.4	1464.6	1518.4	1572.2	1626.6
530 (473.05)	Sh		6.95	26.95	46.95	66.95	86.95	106.95	126.95	146.95	246.95	346.95	446.95	546.95	646.95	746.95	
	v	0.0199	0.8741	0.8879	0.9258	0.9612	0.9948	1.0269	1.0582	1.0878	1.1160	1.2257	1.3571	1.4818	1.6031	1.7228	1.8402
	h	456.35	1204.6	1210.0	1225.5	1242.8	1257.3	1271.8	1284.8	1296.8	1302.8	1352.8	1410.0	1464.3	1518.1	1572.2	1626.4

Sh = superheat, deg. F.
v = specific volume, cu. ft. per lb.

h = enthalpy, B.t.u. per lb.
s = entropy, B.t.u. per deg. F. per lb.

TABLE XXV
continued

Superheated Steam—(Continued)

Abs. Press. (Lb./Sq. In.)	Sat. Temp. (°F.)	Sat. Water	Sat. Steam	TEMPERATURE—DEGREES FAHRENHEIT													
				500°	520°	540°	560°	600°	650°	700°	750°	800°	900°	1000°	1100°	1200°	
540 (475.02)	Sh			24.98	44.98	64.98	84.98	104.98	124.98	174.98	234.98	274.98	324.98	424.98	524.98	624.98	724.98
	v	0.0199	0.8576	0.9051	0.9401	0.9736	1.0054	1.0363	1.0655	1.1356	1.2025	1.2671	1.3309	1.4535	1.5727	1.6903	1.8058
	h	458.62	1204.5	1225.0	1241.4	1256.1	1270.7	1283.8	1296.0	1325.6	1354.0	1382.1	1409.8	1463.9	1517.8	1572.0	1626.2
	s	0.6585	1.4565	1.4781	1.4950	1.5098	1.5243	1.5370	1.5486	1.5759	1.6009	1.6246	1.6469	1.6884	1.7266	1.7625	1.7962
550 (476.94)	Sh			23.06	43.06	63.06	83.06	103.06	123.06	173.06	223.06	273.06	323.06	423.06	523.06	623.06	723.06
	v	0.0199	0.8416	0.8851	0.9198	0.9530	0.9846	1.0151	1.0441	1.1132	1.1791	1.2428	1.3055	1.4262	1.5434	1.6590	1.7724
	h	460.83	1204.4	1223.4	1240.0	1254.8	1269.6	1282.9	1295.2	1324.9	1353.3	1381.6	1409.2	1463.5	1517.5	1571.7	1626.0
	s	0.6609	1.4548	1.4748	1.4919	1.5068	1.5215	1.5344	1.5461	1.5735	1.5987	1.6224	1.6447	1.6862	1.7244	1.7603	1.7940
560 (478.85)	Sh			21.15	41.15	61.15	81.15	101.15	121.15	171.15	221.15	271.15	321.15	421.15	521.15	621.15	721.15
	v	0.0200	0.8253	0.8658	0.9003	0.9332	0.9644	0.9947	1.0233	1.0917	1.1566	1.2193	1.2810	1.3998	1.5151	1.6289	1.7403
	h	463.04	1204.3	1221.8	1238.5	1253.5	1268.5	1282.9	1295.2	1324.4	1352.9	1381.1	1408.7	1463.2	1517.2	1571.5	1625.8
	s	0.6632	1.4530	1.4714	1.4886	1.5038	1.5187	1.5318	1.5435	1.5711	1.5964	1.6202	1.6425	1.6841	1.7224	1.7584	1.7921
570 (480.73)	Sh			19.27	39.27	59.27	79.27	99.27	119.27	169.27	219.27	269.27	319.27	419.27	519.27	619.27	719.27
	v	0.0200	0.8114	0.8472	0.8814	0.9141	0.9450	0.9749	1.0033	1.0708	1.1348	1.1966	1.2575	1.3744	1.4879	1.5993	1.7093
	h	465.22	1204.1	1220.2	1236.9	1252.2	1267.3	1281.0	1293.5	1323.5	1352.3	1380.6	1408.3	1462.5	1516.7	1571.3	1625.6
	s	0.6655	1.4512	1.4681	1.4853	1.5008	1.5156	1.5291	1.5410	1.5686	1.5940	1.6179	1.6403	1.6820	1.7204	1.7564	1.7901
580 (482.58)	Sh			17.42	37.42	57.42	77.42	97.42	117.42	167.42	217.42	267.42	317.42	417.42	517.42	617.42	717.42
	v	0.0201	0.7968	0.8291	0.8631	0.8956	0.9263	0.9558	0.9839	1.0506	1.1137	1.1747	1.2347	1.3498	1.4616	1.5714	1.6794
	h	467.37	1204.0	1218.6	1235.5	1250.9	1266.3	1280.0	1292.6	1322.8	1351.6	1380.0	1407.8	1462.5	1516.8	1571.0	1625.4
	s	0.6677	1.4494	1.4648	1.4822	1.4978	1.5128	1.5264	1.5384	1.5662	1.5916	1.6158	1.6381	1.6799	1.7183	1.7543	1.7881
590 (484.41)	Sh			15.59	35.59	55.59	75.59	95.59	115.59	165.59	215.59	265.59	315.59	415.59	515.59	615.59	715.59
	v	0.0201	0.7831	0.8116	0.8455	0.8778	0.9082	0.9373	0.9653	1.0310	1.0934	1.1535	1.2128	1.3262	1.4360	1.5442	1.6505
	h	469.50	1203.8	1217.0	1234.0	1249.6	1265.0	1278.9	1291.8	1321.1	1351.1	1379.5	1407.4	1462.2	1516.4	1570.8	1625.3
	s	0.6699	1.4477	1.4616	1.4791	1.4949	1.5101	1.5236	1.5359	1.5638	1.5894	1.6134	1.6360	1.6778	1.7162	1.7522	1.7861
600 (486.21)	Sh			13.79	33.79	53.79	73.79	93.79	113.79	163.79	213.79	263.79	313.79	413.79	513.79	613.79	713.79
	v	0.0201	0.7695	0.7945	0.8284	0.8605	0.8907	0.9194	0.9471	1.0123	1.0738	1.1332	1.1915	1.3032	1.4115	1.5179	1.6224
	h	471.59	1203.6	1215.6	1232.5	1248.3	1263.7	1278.1	1290.9	1321.4	1350.5	1379.0	1407.0	1461.8	1516.0	1570.5	1625.0
	s	0.6721	1.4460	1.4586	1.4760	1.4920	1.5072	1.5212	1.5334	1.5615	1.5871	1.6112	1.6339	1.6757	1.7141	1.7502	1.7841
610 (487.99)	Sh			12.01	32.01	52.01	72.01	92.01	112.01	162.01	212.01	262.01	312.01	412.01	512.01	612.01	712.01
	v	0.0202	0.7565	0.7781	0.8120	0.8436	0.8736	0.9022	0.9296	0.9942	1.0548	1.1135	1.1708	1.2809	1.3878	1.4928	1.5964
	h	473.67	1203.5	1213.8	1230.9	1246.9	1262.5	1276.8	1289.6	1320.0	1350.0	1378.5	1406.5	1461.5	1515.8	1570.3	1624.9
	s	0.6743	1.4444	1.4552	1.4728	1.4890	1.5044	1.5183	1.5309	1.5591	1.5850	1.6091	1.6318	1.6738	1.7123	1.7484	1.7823
620 (489.75)	Sh			10.25	30.25	50.25	70.25	90.25	110.25	160.25	210.25	260.25	310.25	410.25	510.25	610.25	710.25
	v	0.0202	0.7438	0.7622	0.7960	0.8275	0.8572	0.8856	0.9127	0.9765	1.0364	1.0943	1.1505	1.2596	1.3648	1.4677	1.5707
	h	475.72	1203.3	1212.2	1229.5	1245.5	1261.3	1275.8	1289.1	1319.9	1349.3	1377.9	1406.1	1461.2	1515.5	1570.1	1624.7
	s	0.6764	1.4427	1.4520	1.4698	1.4860	1.5016	1.5157	1.5284	1.5568	1.5827	1.6068	1.6296	1.6717	1.7102	1.7464	1.7803
630 (491.49)	Sh			8.51	28.51	48.51	68.51	88.51	108.51	158.51	208.51	258.51	308.51	408.51	508.51	608.51	708.51
	v	0.0202	0.7316	0.7466	0.7802	0.8117	0.8413	0.8694	0.8963	0.9595	1.0187	1.0757	1.1312	1.2387	1.3423	1.4445	1.5449
	h	477.75	1203.1	1210.6	1227.8	1244.1	1260.1	1274.7	1288.3	1319.2	1348.7	1377.4	1405.7	1460.8	1515.2	1569.9	1624.5
	s	0.6785	1.4410	1.4488	1.4665	1.4820	1.4988	1.5130	1.5260	1.5545	1.5805	1.6047	1.6276	1.6697	1.7083	1.7445	1.7784
640 (493.21)	Sh			6.79	26.79	46.79	66.79	86.79	106.79	156.79	206.79	256.79	306.79	406.79	506.79	606.79	706.79
	v	0.0203	0.7197	0.7317	0.7651	0.7963	0.8258	0.8537	0.8804	0.9429	1.0015	1.0578	1.1124	1.2187	1.3210	1.4213	1.5193
	h	479.79	1202.9	1209.0	1226.3	1242.7	1258.9	1273.6	1287.4	1318.5	1348.2	1376.8	1405.2	1460.5	1515.0	1569.7	1624.3
	s	0.6806	1.4394	1.4458	1.4636	1.4802	1.4962	1.5105	1.5236	1.5523	1.5785	1.6026	1.6256	1.6678	1.7065	1.7427	1.7766
650 (494.90)	Sh			5.10	25.10	45.10	65.10	85.10	105.10	155.10	205.10	255.10	305.10	405.10	505.10	605.10	705.10
	v	0.0203	0.7082	0.7171	0.7504	0.7816	0.8107	0.8384	0.8648	0.9269	0.9846	1.0404	1.0944	1.1988	1.2999	1.3987	1.4958
	h	481.73	1202.7	1207.3	1224.8	1241.3	1257.6	1272.5	1286.5	1317.8	1347.6	1376.3	1404.7	1460.1	1514.7	1569.4	1624.1
	s	0.6826	1.4379	1.4427	1.4607	1.4774	1.4935	1.5080	1.5213	1.5501	1.5764	1.6006	1.6238	1.6659	1.7046	1.7408	1.7748
660 (496.58)	Sh			3.42	23.42	43.42	63.42	83.42	103.42	153.42	203.42	253.42	303.42	403.42	503.42	603.42	703.42
	v	0.0204	0.6969	0.7031	0.7361	0.7672	0.7962	0.8237	0.8499	0.9113	0.9686	1.0234	1.0769	1.1803	1.2797	1.3774	1.4727
	h	483.77	1202.5	1206.5	1223.5	1240.0	1256.4	1271.4	1285.5	1317.1	1347.0	1375.8	1404.3	1459.7	1514.4	1569.2	1624.0
	s	0.6847	1.4363	1.4396	1.4576	1.4746	1.4908	1.5054	1.5188	1.5479	1.5742	1.5985	1.6216	1.6639	1.7027	1.7390	1.7730
670 (498.23)	Sh			1.77	21.77	41.77	61.77	81.77	101.77	151.77	201.77	251.77	301.77	401.77	501.77	601.77	701.77
	v	0.0204	0.6861	0.6894	0.7224	0.7531	0.7820	0.8093	0.8354	0.8963	0.9527	1.0072	1.0599	1.1617	1.2600	1.3560	1.4503
	h	485.61	1202.3	1206.0	1223.1	1239.7	1255.1	1270.2	1284.5	1316.3	1346.3	1375.3	1403.9	1459.4	1514.1	1569.0	1623.8
	s	0.6867	1.4349	1.4367	1.4549	1.4721	1.4883	1.5030	1.5166	1.5459	1.5723	1.5968	1.6200	1.6624	1.7012	1.7376	1.7716
680 (499.87)	Sh			20.13	40.13	60.13	80.13	100.13	150.13	200.13	250.13	300.13	400.13				

TABLE XXV
continued

Superheated Steam (Continued)

Abs. Press. (Sat. Temp.)		Sat. Water	Sat. Steam	TEMPERATURE—DEGREES FAHRENHEIT															
				580°	600°	620°	640°	660°	680°	700°	720°	740°	760°	800°	800°	1000°	1100°	1200°	
1150 (561.81)	Sh			18.19	38.19	58.19	78.19	98.19	118.19	138.19	158.19	178.19	198.19	238.19	338.19	438.19	538.19	638.19	
	v	0.0221	0.3804	0.4035	0.4259	0.4468	0.4659	0.4839	0.5005	0.5165	0.5317	0.5467	0.5616	0.5889	0.6549	0.7166	0.7760	0.8333	
	h	564.6	1185.6	1207.4	1228.7	1248.6	1266.9	1284.4	1299.5	1314.1	1327.9	1346.1	1360.4	1411.7	1500.2	1557.8	1614.2	1671.3	1727.5
1175 (564.54)	Sh			15.46	35.46	55.46	75.46	95.46	115.46	135.46	155.46	175.46	195.46	235.46	335.46	435.46	535.46	635.46	
	v	0.0222	0.3710	0.3911	0.4133	0.4339	0.4530	0.4708	0.4874	0.5032	0.5183	0.5340	0.5494	0.5747	0.6396	0.7005	0.7598	0.8149	
	h	568.2	1184.4	1203.6	1225.4	1245.4	1264.6	1281.5	1297.3	1312.1	1326.1	1346.4	1360.4	1379.0	1449.4	1499.4	1558.8	1613.8	1674.8
1200 (567.19)	Sh			12.81	32.81	52.81	72.81	92.81	112.81	132.81	152.81	172.81	192.81	232.81	332.81	432.81	532.81	632.81	
	v	0.0223	0.3620	0.3793	0.4013	0.4219	0.4408	0.4585	0.4750	0.4907	0.5058	0.5211	0.5361	0.5613	0.6263	0.6863	0.7423	0.7975	
	h	571.7	1183.2	1200.2	1222.1	1242.6	1261.5	1279.2	1295.3	1310.3	1324.4	1345.0	1357.7	1439.5	1499.0	1558.6	1613.6	1673.6	1733.6
1225 (569.82)	Sh			10.18	30.18	50.18	70.18	90.18	110.18	130.18	150.18	170.18	190.18	230.18	330.18	430.18	530.18	630.18	
	v	0.0224	0.3534	0.3669	0.3895	0.4102	0.4290	0.4466	0.4631	0.4786	0.4934	0.5118	0.5284	0.5483	0.6133	0.6702	0.7264	0.7808	
	h	575.1	1182.0	1195.6	1216.6	1239.7	1256.8	1276.7	1293.3	1308.3	1324.4	1343.3	1376.4	1438.6	1498.0	1556.0	1613.0	1673.0	1733.0
1250 (572.39)	Sh			7.61	27.61	47.61	67.61	87.61	107.61	127.61	147.61	167.61	187.61	227.61	327.61	427.61	527.61	627.61	
	v	0.0225	0.3453	0.3549	0.3782	0.3991	0.4177	0.4354	0.4517	0.4672	0.4817	0.5021	0.5236	0.5490	0.5852	0.6420	0.6966	0.7488	
	h	578.6	1180.8	1199.9	1221.5	1236.7	1256.0	1274.5	1291.2	1306.6	1321.0	1349.9	1375.2	1437.7	1497.2	1555.4	1612.6	1672.6	1732.6
1275 (575.93)	Sh			5.07	25.07	45.07	65.07	85.07	105.07	125.07	145.07	165.07	185.07	225.07	325.07	425.07	525.07	625.07	
	v	0.0226	0.3371	0.3437	0.3672	0.3881	0.4068	0.4244	0.4406	0.4560	0.4705	0.4912	0.5241	0.5632	0.6202	0.6766	0.7288	0.7788	
	h	582.0	1179.5	1198.5	1219.2	1233.5	1253.3	1272.0	1289.0	1304.8	1319.4	1348.0	1373.9	1435.8	1495.7	1554.7	1612.0	1672.0	1732.0
1300 (577.43)	Sh			2.57	22.57	42.57	62.57	82.57	102.57	122.57	142.57	162.57	182.57	222.57	322.57	422.57	522.57	622.57	
	v	0.0227	0.3294	0.3329	0.3567	0.3776	0.3965	0.4140	0.4301	0.4453	0.4598	0.4803	0.5127	0.5730	0.6290	0.6826	0.7340	0.7830	
	h	587.7	1177.0	1197.0	1218.3	1233.5	1253.6	1270.9	1286.9	1302.8	1317.8	1336.9	1372.8	1435.8	1495.7	1554.7	1611.0	1671.0	1731.0
1325 (579.89)	Sh			20.11	40.11	60.11	80.11	100.11	120.11	140.11	160.11	180.11	220.11	320.11	420.11	520.11	620.11	720.11	
	v	0.0228	0.3220	0.3463	0.3673	0.3863	0.4037	0.4200	0.4350	0.4493	0.4696	0.5016	0.5611	0.6162	0.6702	0.7226	0.7719	0.8195	
	h	592.1	1175.8	1197.5	1219.2	1234.4	1254.6	1273.0	1289.7	1305.8	1321.4	1349.4	1375.9	1437.9	1497.9	1556.9	1613.9	1673.9	1733.9
1350 (582.32)	Sh			17.68	37.68	57.68	77.68	97.68	117.68	137.68	157.68	177.68	217.68	317.68	417.68	517.68	617.68	717.68	
	v	0.0229	0.3147	0.3363	0.3576	0.3766	0.3940	0.4105	0.4252	0.4393	0.4594	0.4911	0.5497	0.6042	0.6558	0.7057	0.7527	0.7975	
	h	592.1	1175.8	1197.5	1219.2	1234.4	1254.6	1273.0	1289.7	1305.8	1321.4	1349.4	1375.9	1437.9	1497.9	1556.9	1613.9	1673.9	1733.9
1375 (584.71)	Sh			15.29	35.29	55.29	75.29	95.29	115.29	135.29	155.29	175.29	215.29	315.29	415.29	515.29	615.29	715.29	
	v	0.0230	0.3078	0.3266	0.3460	0.3630	0.3787	0.3937	0.4079	0.4214	0.4352	0.4608	0.5387	0.5922	0.6432	0.6922	0.7382	0.7812	
	h	595.3	1174.5	1196.2	1217.9	1233.1	1253.3	1271.7	1288.4	1304.5	1320.1	1348.1	1374.6	1436.6	1496.6	1555.6	1612.6	1672.6	1732.6
1400 (587.07)	Sh			12.93	32.93	52.93	72.93	92.93	112.93	132.93	152.93	172.93	212.93	312.93	412.93	512.93	612.93	712.93	
	v	0.0231	0.3011	0.3172	0.3352	0.3513	0.3658	0.3797	0.3930	0.4057	0.4179	0.4396	0.4719	0.5283	0.5811	0.6313	0.6785	0.7227	
	h	598.6	1173.2	1194.9	1216.6	1231.8	1252.0	1270.4	1287.1	1303.2	1318.8	1346.8	1372.3	1434.3	1494.3	1553.3	1610.3	1670.3	1730.3
1425 (589.40)	Sh			10.60	30.60	50.60	70.60	90.60	110.60	130.60	150.60	210.60	310.60	410.60	510.60	610.60	710.60	810.60	
	v	0.0232	0.2947	0.3081	0.3297	0.3491	0.3668	0.3825	0.3972	0.4112	0.4248	0.4616	0.5180	0.5701	0.6195	0.6671	0.7119	0.7539	
	h	601.8	1171.8	1193.5	1215.2	1230.4	1250.6	1269.0	1285.7	1301.8	1317.4	1345.4	1371.9	1433.9	1493.9	1552.9	1609.9	1669.9	1729.9
1450 (591.70)	Sh			8.30	28.30	48.30	68.30	88.30	108.30	128.30	148.30	208.30	308.30	408.30	508.30	608.30	708.30	808.30	
	v	0.0233	0.2885	0.2991	0.3211	0.3405	0.3580	0.3739	0.3885	0.4025	0.4220	0.4524	0.5082	0.5597	0.6083	0.6552	0.7000	0.7419	
	h	605.0	1170.5	1192.2	1213.9	1229.1	1249.3	1267.7	1284.4	1300.5	1316.1	1344.1	1370.6	1432.6	1492.6	1551.6	1608.6	1668.6	1728.6
1475 (593.97)	Sh			6.03	26.03	46.03	66.03	86.03	106.03	126.03	146.03	206.03	306.03	406.03	506.03	606.03	706.03	806.03	
	v	0.0234	0.2824	0.2903	0.3126	0.3318	0.3495	0.3654	0.3801	0.3939	0.4129	0.4435	0.4986	0.5493	0.5973	0.6439	0.6874	0.7284	
	h	608.2	1169.1	1190.8	1212.5	1227.7	1247.9	1265.3	1282.0	1298.1	1313.7	1341.7	1367.2	1429.2	1489.2	1548.2	1605.2	1665.2	1725.2
1500 (596.20)	Sh			3.80	23.80	43.80	63.80	83.80	103.80	123.80	143.80	203.80	303.80	403.80	503.80	603.80	703.80	803.80	
	v	0.0235	0.2765	0.2817	0.3044	0.3236	0.3413	0.3573	0.3721	0.3856	0.4042	0.4349	0.4894	0.5396	0.5869	0.6322	0.6757	0.7167	
	h	611.4	1167.7	1189.4	1211.1	1226.3	1246.5	1264.9	1281.6	1297.7	1313.3	1341.3	1366.8	1428.8	1488.8	1547.8	1604.8	1664.8	1724.8
1525 (598.41)	Sh			21.59	41.59	61.59	81.59	101.59	121.59	141.59	161.59	201.59	301.59	401.59	501.59	601.59	701.59	801.59	
	v	0.0236	0.2708	0.2962	0.3158	0.3335	0.3495	0.3642	0.3777	0.3905	0.4025	0.4245	0.4564	0.5082	0.5597	0.6083	0.6552	0.7000	
	h	614.5	1166.2	1187.9	1209.6	1224.8	1245.0	1263.4	1280.1	1296.2	1311.8	1339.8	1365.3	1427.3	1487.3	1546.3	1603.3	1663.3	1723.3
1550 (600.59)	Sh			19.41	39.41	59.41	79.41	99.41	119.41	139.41	159.41	199.41	299.41	399.41	499.41	599.41	699.41	799.41	
	v	0.0237	0.2653	0.2883	0.3084	0.3261	0.3420	0.3567	0.3702	0.3821	0.3946	0.4176	0.4491	0.5008	0.5519	0.6000	0.6453	0.6874	
	h	617.7	1164.8	1186.5	1208.2	1223.4	1243.6	1262.0	1278.7	1294.8	1310.4	1338.4	1363.9	1425.9	1485.9	1544.9	1601.9	1661.9	1721.9

Sh = superheat, deg. F.
v = specific volume, cu. ft. per lb.

h = enthalpy, B.t.u. per lb.
s = entropy, B.t.u. per deg. F. per lb.

APPENDIX

TABLE XV
continued

Superheated Steam—(Continued)

Lb./Sq. In. (Sat. Temp.)	Sat. Water	Sat. Steam	TEMPERATURE—DEGREES FAHRENHEIT														
			630°	640°	650°	660°	700°	750°	760°	780°	800°	900°	1000°	1100°	1200°		
1878 (602.74)	Sb	17.26	37.26	57.26	77.26	97.26	117.26	137.26	157.26	177.26	197.26	297.26	397.26	497.26	597.26		
	v	0.0238	0.2599	0.2804	0.3008	0.3186	0.3345	0.3492	0.3627	0.3755	0.3877	0.3993	0.4105	0.4633	0.5117	0.6010	
	s	620.8	1163.4	1190.3	1216.9	1240.3	1261.3	1280.5	1297.6	1313.5	1328.8	1343.5	1357.8	1424.9	1486.8	1547.4	1606.2
1800 (604.87)	Sb	15.13	35.13	55.13	75.13	95.13	115.13	135.13	155.13	175.13	195.13	295.13	395.13	495.13	595.13		
	v	0.0239	0.2548	0.2730	0.2935	0.3114	0.3274	0.3421	0.3555	0.3682	0.3802	0.3919	0.4031	0.4554	0.5032	0.5482	0.5914
	s	623.9	1161.9	1186.3	1213.7	1237.6	1258.9	1278.4	1295.7	1311.8	1327.3	1342.2	1356.7	1423.1	1486.8	1547.0	1605.8
1838 (606.97)	Sb	13.03	33.03	53.03	73.03	93.03	113.03	133.03	153.03	173.03	193.03	293.03	393.03	493.03	593.03		
	v	0.0240	0.2497	0.2656	0.2864	0.3044	0.3203	0.3348	0.3484	0.3610	0.3729	0.3845	0.3957	0.4474	0.4948	0.5391	0.5818
	s	627.0	1160.4	1182.1	1210.2	1234.5	1256.2	1275.9	1293.5	1310.0	1325.8	1340.6	1355.2	1422.1	1485.3	1545.7	1604.2
1868 (609.05)	Sb	10.95	30.95	50.95	70.95	90.95	110.95	130.95	150.95	170.95	190.95	290.95	390.95	490.95	590.95		
	v	0.0241	0.2448	0.2583	0.2794	0.2976	0.3136	0.3280	0.3417	0.3542	0.3661	0.3778	0.3897	0.4399	0.4867	0.5305	0.5724
	s	630.0	1158.8	1177.8	1206.8	1231.7	1253.7	1273.6	1291.8	1308.4	1324.1	1339.3	1354.0	1421.1	1485.3	1545.7	1604.7
1878 (611.10)	Sb	8.90	28.90	48.90	68.90	88.90	108.90	128.90	148.90	168.90	188.90	288.90	388.90	488.90	588.90		
	v	0.0242	0.2401	0.2511	0.2726	0.2909	0.3068	0.3214	0.3350	0.3474	0.3592	0.3708	0.3817	0.4324	0.4787	0.5220	0.5634
	s	633.1	1157.2	1173.1	1203.2	1228.7	1251.0	1271.5	1290.7	1308.4	1324.1	1339.3	1354.0	1421.1	1485.3	1545.7	1604.1
1900 (613.12)	Sb	6.88	26.88	46.88	66.88	86.88	106.88	126.88	146.88	166.88	186.88	286.88	386.88	486.88	586.88		
	v	0.0243	0.2354	0.2441	0.2656	0.2844	0.3006	0.3152	0.3286	0.3411	0.3528	0.3641	0.3750	0.4254	0.4711	0.5139	0.5549
	s	636.1	1155.7	1168.1	1199.4	1225.7	1248.4	1269.4	1287.8	1304.7	1320.7	1336.2	1351.2	1420.1	1483.7	1544.4	1603.9
1938 (615.13)	Sb	4.87	24.87	44.87	64.87	84.87	104.87	124.87	144.87	164.87	184.87	284.87	384.87	484.87	584.87		
	v	0.0244	0.2309	0.2384	0.2599	0.2780	0.2943	0.3088	0.3222	0.3346	0.3463	0.3575	0.3684	0.4183	0.4636	0.5058	0.5464
	s	639.1	1154.1	1165.2	1195.6	1222.4	1245.8	1266.8	1285.5	1302.7	1318.9	1334.5	1349.5	1419.0	1482.9	1543.7	1603.4
1968 (617.11)	Sb	2.89	22.89	42.89	62.89	82.89	102.89	122.89	142.89	162.89	182.89	282.89	382.89	482.89	582.89		
	v	0.0245	0.2265	0.2329	0.2529	0.2718	0.2882	0.3028	0.3162	0.3285	0.3402	0.3518	0.3622	0.4116	0.4564	0.4982	0.5383
	s	642.1	1152.6	1162.0	1191.7	1219.2	1243.1	1264.5	1283.6	1300.9	1317.4	1333.1	1348.3	1418.1	1481.2	1543.3	1603.0
1978 (619.07)	Sb	20.93	40.93	60.93	80.93	100.93	120.93	140.93	160.93	180.93	280.93	380.93	480.93	580.93			
	v	0.0246	0.2222	0.2466	0.2657	0.2822	0.2968	0.3102	0.3225	0.3340	0.3452	0.3559	0.3663	0.4159	0.4603	0.4996	0.5302
	s	645.0	1150.9	1181.6	1216.0	1240.4	1262.1	1281.5	1299.0	1315.5	1331.5	1346.8	1361.9	1431.3	1491.3	1542.5	1602.3
1900 (621.00)	Sb	19.00	39.00	59.00	79.00	99.00	119.00	139.00	159.00	179.00	199.00	279.00	379.00	479.00	579.00		
	v	0.0247	0.2180	0.2405	0.2598	0.2764	0.2912	0.3045	0.3168	0.3283	0.3393	0.3499	0.3598	0.4095	0.4534	0.4924	0.5224
	s	648.0	1149.3	1183.7	1212.7	1237.6	1259.8	1279.6	1297.4	1313.9	1329.9	1345.3	1360.0	1430.6	1490.6	1542.0	1601.8
1938 (622.92)	Sb	17.08	37.08	57.08	77.08	97.08	117.08	137.08	157.08	177.08	197.08	277.08	377.08	477.08	577.08		
	v	0.0248	0.2139	0.2345	0.2540	0.2708	0.2855	0.2991	0.3112	0.3225	0.3338	0.3441	0.3538	0.4032	0.4467	0.4851	0.5151
	s	650.9	1147.7	1179.5	1209.4	1234.9	1257.3	1277.8	1295.6	1312.2	1328.2	1343.9	1360.0	1430.6	1490.6	1542.0	1601.8
1968 (624.82)	Sb	15.18	35.18	55.18	75.18	95.18	115.18	135.18	155.18	175.18	195.18	275.18	375.18	475.18	575.18		
	v	0.0249	0.2099	0.2285	0.2462	0.2611	0.2746	0.2882	0.2998	0.3105	0.3212	0.3318	0.3424	0.3916	0.4351	0.4734	0.5034
	s	653.9	1145.9	1175.1	1205.8	1231.8	1254.8	1275.6	1293.5	1310.5	1327.6	1344.4	1361.9	1432.6	1492.6	1544.0	1603.8
1978 (626.89)	Sb	13.31	33.31	53.31	73.31	93.31	113.31	133.31	153.31	173.31	193.31	273.31	373.31	473.31	573.31		
	v	0.0251	0.2060	0.2225	0.2427	0.2587	0.2746	0.2882	0.3003	0.3115	0.3223	0.3328	0.3433	0.3916	0.4351	0.4734	0.5034
	s	656.9	1144.2	1170.5	1202.3	1229.0	1253.5	1275.5	1294.8	1313.0	1330.9	1348.8	1366.8	1437.6	1497.6	1549.0	1608.8
1900 (628.55)	Sb	11.45	31.45	51.45	71.45	91.45	111.45	131.45	151.45	171.45	191.45	271.45	371.45	471.45	571.45		
	v	0.0252	0.2022	0.2169	0.2371	0.2531	0.2694	0.2845	0.2982	0.3105	0.3215	0.3324	0.3433	0.3916	0.4351	0.4734	0.5034
	s	659.9	1142.4	1165.6	1198.8	1225.0	1249.8	1271.0	1289.7	1307.0	1324.5	1342.0	1359.5	1430.6	1490.6	1542.0	1601.8
1938 (630.38)	Sb	9.82	29.82	49.82	69.82	89.82	109.82	129.82	149.82	169.82	189.82	269.82	369.82	469.82	569.82		
	v	0.0253	0.1985	0.2107	0.2317	0.2491	0.2664	0.2822	0.2968	0.3102	0.3225	0.3340	0.3452	0.3948	0.4383	0.4767	0.5067
	s	662.8	1140.6	1169.9	1195.0	1221.3	1247.3	1269.8	1289.7	1307.7	1325.1	1342.8	1360.8	1431.6	1491.6	1543.0	1602.8
1968 (632.20)	Sb	7.80	27.80	47.80	67.80	87.80	107.80	127.80	147.80	167.80	187.80	267.80	367.80	467.80	567.80		
	v	0.0254	0.1949	0.2049	0.2264	0.2440	0.2609	0.2776	0.2928	0.3064	0.3195	0.3326	0.3457	0.3954	0.4389	0.4773	0.5073
	s	665.8	1138.8	1165.6	1191.3	1218.0	1244.8	1268.5	1289.5	1308.4	1327.0	1345.6	1364.5	1435.4	1495.4	1546.8	1606.8
1978 (634.02)	Sb	6.00	26.00	46.00	66.00	86.00	106.00	126.00	146.00	166.00	186.00	266.00	366.00	466.00	566.00		
	v	0.0256	0.1913	0.1992	0.2212	0.2391	0.2544	0.2678	0.2798	0.2910	0.3016	0.3117	0.3218	0.3714	0.4149	0.4533	0.4927
	s	668.7	1137.0	1160.0	1187.5	1213.5	1240.2	1264.4	1286.6	1307.5	1327.8	1348.1	1368.4	1439.4	1499.4	1551.8	1612.2

Sb = superheat, deg. F.
v = specific volume, cu. ft. per lb.

h = enthalpy, B.t.u. per lb.
s = entropy, B.t.u. per deg. F. per lb.

TABLE XXV

continued

Superheated Steam—(Continued)

Abs. Press. Lb./Sq. In. (Sat. Temp.)	Sat. Water	Sat. Steam	TEMPERATURE—DEGREES FAHRENHEIT																
			660°	680°	700°	720°	740°	760°	780°	800°	820°	840°	860°	880°	900°	1000°	1100°	1200°	
3000 (635.78)	Sh		24.22	44.22	64.22	84.22	104.22	124.22	144.22	164.22	184.22	214.22	264.22	364.22	464.22	564.22			
	v	0.0257	0.1879	0.2162	0.2344	0.2428	0.2533	0.2752	0.2862	0.2966	0.3067	0.3165	0.3305	0.3528	0.3940	0.4319	0.4678		
	h	671.7	1135.2	1183.7	1214.3	1240.0	1262.4	1281.8	1299.6	1316.4	1332.7	1348.6	1371.1	1407.2	1473.5	1537.4	1598.6		
3038 (637.54)	Sh		22.46	42.46	62.46	82.46	102.46	122.46	142.46	162.46	182.46	212.46	262.46	362.46	462.46	562.46			
	v	0.0258	0.1845	0.2112	0.2296	0.2452	0.2587	0.2707	0.2816	0.2919	0.3020	0.3118	0.3257	0.3478	0.3887	0.4267	0.4617		
	h	674.7	1133.3	1179.9	1211.1	1237.5	1260.3	1280.1	1297.9	1314.8	1331.3	1347.1	1370.1	1406.2	1473.8	1537.0	1598.1		
3080 (639.29)	Sh		20.71	40.71	60.71	80.71	100.71	120.71	140.71	160.71	180.71	210.71	260.71	360.71	460.71	560.71			
	v	0.0259	0.1812	0.2062	0.2248	0.2405	0.2541	0.2661	0.2769	0.2872	0.2972	0.3067	0.3208	0.3428	0.3833	0.4205	0.4558		
	h	677.8	1131.4	1175.7	1207.7	1234.8	1257.9	1278.0	1295.9	1313.0	1329.5	1345.3	1368.6	1405.1	1472.8	1536.2	1597.4		
3078 (641.02)	Sh		18.98	38.98	58.98	78.98	98.98	118.98	138.98	158.98	178.98	208.98	258.98	358.98	458.98	558.98			
	v	0.0261	0.1780	0.2013	0.2200	0.2358	0.2494	0.2615	0.2724	0.2828	0.2927	0.3022	0.3161	0.3378	0.3782	0.4151	0.4499		
	h	680.5	1129.5	1171.5	1204.3	1231.6	1255.2	1275.7	1294.0	1311.5	1328.1	1344.0	1367.3	1403.1	1472.1	1535.7	1597.0		
3100 (642.73)	Sh		17.27	37.27	57.27	77.27	97.27	117.27	137.27	157.27	177.27	207.27	257.27	357.27	457.27	557.27			
	v	0.0262	0.1748	0.1964	0.2152	0.2310	0.2447	0.2568	0.2679	0.2783	0.2882	0.2977	0.3114	0.3329	0.3730	0.4096	0.4421		
	h	683.0	1125.0	1163.0	1197.3	1225.7	1250.2	1271.3	1290.2	1307.6	1324.8	1341.2	1364.7	1400.8	1471.0	1534.8	1596.4		
3188 (644.43)	Sh		15.57	35.57	55.57	75.57	95.57	115.57	135.57	155.57	175.57	205.57	255.57	355.57	455.57	555.57			
	v	0.0263	0.1716	0.1918	0.2108	0.2268	0.2406	0.2527	0.2637	0.2739	0.2838	0.2933	0.3070	0.3280	0.3682	0.4045	0.4368		
	h	686.3	1125.0	1163.0	1197.3	1225.7	1250.2	1271.3	1290.2	1307.6	1324.8	1341.2	1364.7	1400.8	1471.0	1534.8	1596.4		
3180 (646.11)	Sh		13.89	33.89	53.89	73.89	93.89	113.89	133.89	153.89	173.89	203.89	253.89	353.89	453.89	553.89			
	v	0.0265	0.1685	0.1872	0.2054	0.2225	0.2364	0.2485	0.2594	0.2695	0.2793	0.2889	0.3026	0.3240	0.3633	0.3993	0.4331		
	h	689.2	1123.5	1165.6	1193.7	1222.7	1247.7	1268.1	1288.1	1305.7	1322.7	1339.4	1363.2	1400.5	1469.4	1533.8	1595.3		
3178 (647.77)	Sh		12.23	32.23	52.23	72.23	92.23	112.23	132.23	152.23	172.23	202.23	252.23	352.23	452.23	552.23			
	v	0.0268	0.1655	0.1828	0.2018	0.2182	0.2321	0.2442	0.2552	0.2652	0.2752	0.2847	0.2983	0.3196	0.3587	0.3943	0.4279		
	h	692.0	1121.5	1154.3	1189.7	1219.8	1244.9	1265.5	1286.1	1304.0	1321.3	1338.0	1361.9	1399.4	1468.9	1533.1	1595.0		
3200 (649.42)	Sh		10.58	30.58	50.58	70.58	90.58	110.58	130.58	150.58	170.58	200.58	250.58	350.58	450.58	550.58			
	v	0.0267	0.1626	0.1773	0.1972	0.2138	0.2277	0.2399	0.2509	0.2612	0.2710	0.2804	0.2939	0.3151	0.3540	0.3893	0.4226		
	h	685.0	1119.4	1148.0	1185.8	1216.2	1241.8	1263.8	1283.6	1302.9	1321.5	1339.2	1363.0	1398.0	1467.9	1532.3	1594.3		
3235 (651.06)	Sh		8.94	28.94	48.94	68.94	88.94	108.94	128.94	148.94	168.94	198.94	248.94	348.94	448.94	548.94			
	v	0.0268	0.1597	0.1727	0.1931	0.2097	0.2237	0.2360	0.2471	0.2574	0.2674	0.2765	0.2900	0.3109	0.3495	0.3847	0.4175		
	h	697.9	1117.4	1142.7	1182.1	1213.3	1239.1	1261.4	1281.0	1300.5	1319.0	1335.2	1359.2	1397.0	1467.0	1531.9	1593.7		
3280 (652.67)	Sh		7.33	27.33	47.33	67.33	87.33	107.33	127.33	147.33	167.33	197.33	247.33	347.33	447.33	547.33			
	v	0.0270	0.1569	0.1680	0.1889	0.2055	0.2197	0.2320	0.2432	0.2535	0.2633	0.2726	0.2860	0.3068	0.3449	0.3800	0.4125		
	h	700.8	1115.3	1137.2	1178.0	1206.7	1236.5	1259.2	1279.6	1298.6	1316.3	1333.2	1357.8	1395.5	1465.8	1531.2	1593.1		
3278 (654.27)	Sh		5.73	25.73	45.73	65.73	85.73	105.73	125.73	145.73	165.73	195.73	245.73	345.73	445.73	545.73			
	v	0.0272	0.1542	0.1630	0.1848	0.2018	0.2159	0.2281	0.2393	0.2496	0.2594	0.2688	0.2821	0.3026	0.3407	0.3755	0.4077		
	h	703.8	1113.2	1130.8	1174.3	1207.1	1233.9	1256.7	1276.8	1296.8	1315.8	1332.1	1356.5	1394.4	1465.1	1530.7	1592.8		
3300 (655.87)	Sh		4.13	24.13	44.13	64.13	84.13	104.13	124.13	144.13	164.13	194.13	244.13	344.13	444.13	544.13			
	v	0.0274	0.1514	0.1580	0.1807	0.1980	0.2120	0.2241	0.2353	0.2457	0.2556	0.2649	0.2781	0.2986	0.3365	0.3709	0.4029		
	h	706.7	1111.0	1124.2	1169.9	1204.0	1230.9	1253.9	1275.0	1294.5	1312.9	1330.8	1355.2	1393.2	1464.3	1529.9	1592.2		
3325 (657.74)	Sh		2.26	22.26	42.26	62.26	82.26	102.26	122.26	142.26	162.26	192.26	242.26	342.26	442.26	542.26			
	v	0.0275	0.1488	0.1530	0.1766	0.1941	0.2083	0.2207	0.2319	0.2423	0.2520	0.2613	0.2744	0.2948	0.3324	0.3665	0.3983		
	h	709.7	1108.8	1117.1	1165.7	1200.4	1228.2	1252.0	1273.3	1293.0	1311.5	1329.0	1353.8	1391.1	1463.5	1528.7	1591.7		
3300 (659.00)	Sh		1.00	21.00	41.00	61.00	81.00	101.00	121.00	141.00	161.00	191.00	241.00	341.00	441.00	541.00			
	v	0.0277	0.1462	0.1479	0.1725	0.1901	0.2046	0.2172	0.2285	0.2389	0.2484	0.2576	0.2706	0.2910	0.3282	0.3621	0.3936		
	h	712.6	1106.5	1109.7	1161.2	1196.6	1225.8	1249.8	1271.7	1291.6	1309.8	1327.3	1352.1	1391.0	1462.3	1528.3	1590.9		
3375 (660.55)	Sh		19.45	39.45	59.45	79.45	99.45	119.45	139.45	159.45	179.45	209.45	259.45	359.45	459.45	559.45			
	v	0.0278	0.1436	0.1686	0.1863	0.2010	0.2137	0.2250	0.2353	0.2450	0.2541	0.2637	0.2762	0.2966	0.3345	0.3684	0.3992		
	h	715.6	1104.0	1115.2	1169.1	1219.4	1244.7	1269.5	1289.4	1308.3	1325.8	1350.8	1389.8	1461.7	1527.8	1590.4			
3400 (662.09)	Sh		17.91	37.91	57.91	77.91	97.91	117.91	137.91	157.91	177.91	207.91	257.91	357.91	457.91	557.91			
	v	0.0280	0.1410	0.1646	0.1824	0.1974	0.2101	0.2214	0.2317	0.2415	0.2506	0.2606	0.2736	0.2936	0.3315	0.3654	0.3962		
	h	718.5	1101.4	1122.8	1189.1	1239.4	1264.7	1289.5	1309.4	1327.3	1344.8	1369.8	1408.8	1480.7	1546.8	1611.9	1674.9		
3400 (662.09)	Sh		15.94	35.94	55.94	75.94	95.94	115.94	135.94	155.94	175.94	205.94	255.94	355.94	455.94	555.94			
	v	0.0285	0.1438	0.1688	0.1866	0.2016	0.2143	0.2256	0.2359	0.2456	0.2547	0.2643	0.2773	0.2977	0.3356	0.3695	0.3993		
	h	721.5	1108.8	1130.2	1196.5	1246.8	1272.1	1296.9	1316.8	1334.7	1352.2	1379.2	1418.2	1490.1	1556.2	1621.3	1684.3		

Sh = superheat, deg. F.

h = enthalpy, B.t.u. per lb.

v = specific volume, cu. ft. per lb.

s = entropy, B.t.u. per deg. F. per lb.

TABLE XXV
continued
Mollier Diagram for Steam

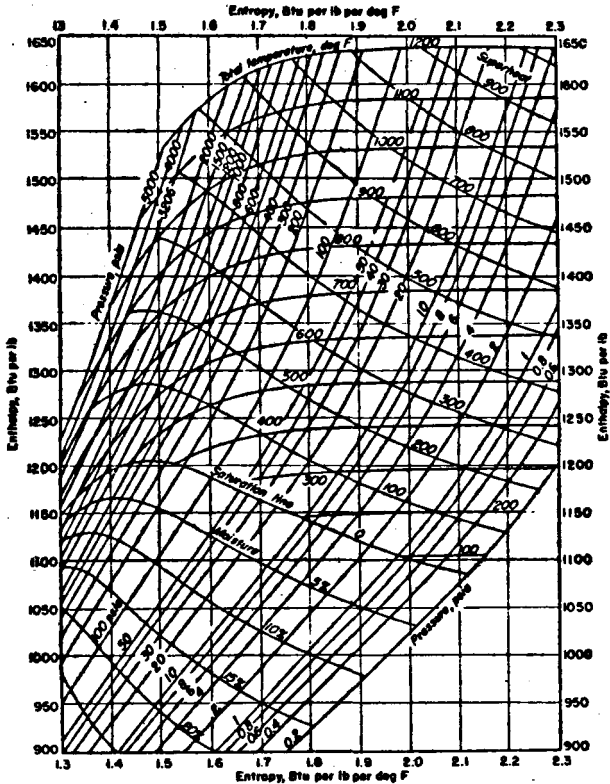

(Power)

INDEX

References are to pages

- A**
- Air-cooled wall, 153
 - Air ejector, condenser, 105
 - capacity, 105
 - characteristics, 105
 - Air, Diesel engine scavenging, 286
 - excess, 120
 - total, 120
 - Air heaters, economic surface, 169
 - heat transfer, 166
 - plate type, 166
 - recuperative, 165
 - regenerative, 166
 - tubular, 166
 - Air horsepower, 239
 - Altitude, Diesel engine rating, 291
 - Analysis, coal, 117
 - fuel oil, 117
 - gas, 117
 - proximate, 117
 - ultimate, 117
 - water, 210
 - Architecture, power plant, 273
 - Arithmetic mean temperature difference, 96
 - Ash handling, hydraulic, 233
 - mechanical, 233
 - Ash fusion temperature, 146
 - Automatic combustion controls, 256
- B**
- Babcock and Wilcox equation, 144
 - Balance, steam generator heat, 131
 - Barometric condenser, *see* Condenser
 - Binary vapor cycle, mercury-steam, 63
 - miscellaneous, 64
 - Blading, turbine, impulse, 74
 - impulse-reaction, 75
 - reaction, 74
 - Block Hopkinson demand rate, 35
 - Block meter rate, 34
 - Boiler feed pumps, *see* Pumps
 - Boilers, economical surface, 169
 - Boiler heat balance, *see* Steam generators
 - Boiler heat transfer, 141
 - Boiler horsepower, 130
 - Bomb calorimeter, 128
 - Bonds, 6
 - Brake horsepower, 68
 - Buildings, power plant, 273
 - Burners, fuel oil, 221
 - gas, 221
 - pulverized coal, 229
- C**
- Calorimeter, bomb, 128
 - gas, 128
 - Capacity factor, 19
 - Carnot cycle, 45
 - Carryover, boiler, 219
 - evaporator, 218
 - Caustic embrittlement, 218
 - Centrifugal pumps, *see* Pumps
 - Chain grate stokers, 225
 - Chimneys, *see* Stacks
 - Cinder trap, 233

- Circulating water pump, *see* Pumps.
- Closed heaters, 55, 101
 design, 103
 heat transfer, 102
 water velocity in tubes, 102
- Coal, analysis, 117
 calorimeter, 128
 classification, 117
 heating value, 126
 proximate analysis, 117
 ultimate analysis, 117.
- Coal handling, pulverizer system, 223
 stoker system, 224
 storage system, 222
- Collectors, dust, bag type, 234
 centrifugal, 233
 electrostatic, 233
 wet scrubber, 234
- Combustible, basis for analysis, 126
- Combustion, coal, 120
 fuel oil, 120
 gas, 121
- Combustion controls, automatic, 256
- Common stocks, 6
- Compression ratio, Diesel engine, 290
- Condensate pump, *see* Pumps
- Condensers, 89
 design, 97
 friction, tube, 188
 water boxes, 188
 heat transfer, 93
 mixing, barometric, 89
 jet, 89
 surface, 90
- Conductivity, electrolytic, 258
 thermal, gas film, 160
 insulation, 151, 194
 metals, 95
 refractories, 151
 scale, 95
 vapor film, 94, 160
 water film, 95
- Construction costs, power plant, 29
 index, 29
- Cooling ponds, 107
- Cooling towers, forced draft, 108
 induced draft, 108
- Corrosion, boiler, 218
- Correction, for engine efficiency, 79
- Costs, collection, 34
 distribution system, primary, 28
 secondary, 34
 engines, 71
 index, 28
 maintenance, 33
 power plants, 28
 steam generators, 141
 turbo-generators, 79
- Cotterill, 52
- Counterflow engine, 67
- Curtis, C. G., 73
- Customer element, 33
- Cutoff, steam engine, 69
- Cycle, binary vapor, 63
 Carnot, 45
 Diesel, 289
 Field, 56
 gas turbine, 303
 Rankine, 46
 closed, 46
 open, 47
 regenerative, 52
 reheating, 50
 reheating-regenerative, 56
 superposed, 59
 topping, *see* superposed
- Cyclone burner, horizontal, coal, 229
- D
- Dams, types, 295
- Deaerators, *see* Open heaters
- DeLaval, 73
- Demand factor, 8
 table, 9
- Depreciation, 30
- Design, station, 265
- Diagram factor, engine, 70

- Diesel cycle, 289
 Diesel engines, auxiliaries, 292
 four-stroke, 287
 fuel injectors, 287
 scavenging, 286
 supercharging, 291
 two-stroke, 286
 Diesel, Rudolph, 286
 Distribution system, primary, 4
 secondary, 4
 Diversity factor, 8
 table of, 9
 Division of load, 281
 Draft, fans, forced, 242
 induced, 242
 losses, air heater, 242
 burner, 243
 duct-work, 191
 economizers, 244
 fuel beds, 243
 steam generators, 242
 Drainage, heater, 102
 Drips, heater, *see* Drainage, heater
 Duct-work, design, 190
 draft losses, 191
 insulation, 194
 Duration curve, river flow, 297
 load, 14
 Dust collectors, bag type, 234
 centrifugal, 233
 electrostatic, 233
 wet scrubber, 234
- E
- Economics, insulation thickness, 196
 load division, 280
 power production, 25
 surface apportionment, steam generators, 169
 Economizers, arrangement, 163
 economical surface, 169
 heat transfer, 164
 Edison, Thomas, 1
 Efficiency, boiler, *see* Steam generator efficiency
 Efficiency, engine, internal, 49
 overall, 50
 steam engines, 73
 steam turbines, 75
 generator, 80
 mechanical, Diesel engines, 291
 hydraulic turbines, 299
 steam engines, 67
 steam turbines, 75, 80
 thermal, Diesel cycle, 291
 gas turbine cycle, 303
 vapor cycles, 46 *et seq.*
 Ejector, air, 105
 Embrittlement, caustic, 218
 Enclosed plant, 274
 Energy element, 32
 Engines, Diesel, 286, 287
 steam, cost, 71
 counterflow, 67
 cutoff, 69
 diagram factor, 70
 engine efficiency, 68
 indicator, 67
 mechanical efficiency, 67
 uniflow, 67
 Equipment, determination of size, 20
 Equivalent length, pipe fittings, 178
 duct bends, 191
 Evaporators, location in vapor cycle, 109
 long tube, forced circulation, 110
 natural circulation, 110
 multiple effect, 110
 shell and tube, 110
 Excess air, 120
 Expansion lines, 82
 Expansion ratio, steam engine, 69
 Extraction, *see* Regenerative cycle
- F
- Factors, capacity, 19
 demand, 8
 diversity, 8

- Factors, friction, 178
 - load, 19
 - use, 19
 - Fans, characteristics, 236
 - laws, 236
 - speeds, 240
 - types, 236
 - Federal utility, 7
 - Feed-water hardness, residual after treatment, 212
 - Feed-water heaters, closed, 55, 101
 - open, 53, 100
 - Feed-water treatment, cold lime and alum process, 211
 - cold lime-soda and alum process, 211
 - hot lime-soda process, 212
 - objectives, 212
 - zeolite processes, 215
 - Ferranti, 50
 - Field cycle, 56
 - Field, J. F.
 - Fire-tube boilers, 138
 - Fixed carbon, *see* Coal, proximate analysis
 - Fixed element, 27
 - Flue gas analysis, 128
 - Fluid meters, 258
 - Flyash, 233
 - Franchise, 26
 - Friction factor, 178
 - Fuel bed resistance, 243
 - Fuel handling equipment, 221
 - coal, 222
 - fuel oil, 221
 - gas, 221
 - see also specific equipment*
 - Fuel oil, analyses, 117
 - calorimeter, 128
 - heating value, 127
 - Furnaces, bottoms, fuel oil, 231
 - gas, 231
 - pulverized coal, 231
 - heat release, 147
 - walls, air-cooled, 153
 - insulated, 151
 - water-cooled, 146
 - Fusion temperature of ash, 146
- G
- Gages, pressure, 249
 - Gas, flue, analysis, 128
 - fuel, analyses, 117
 - calorimeter, 128
 - heating value, 127
 - Gas turbine cycles, 303
 - closed, 305
 - open, 303
 - Generator efficiency, 80
 - Governors, speed, 252
 - Grates, dumping, 225
 - travelling, 225
- H
- Hardness of water, 21C
 - Head, dynamic, 203
 - fan, 239
 - friction, 178
 - pressure, 203
 - pump, 203
 - static, 203
 - velocity, 203
 - Heat balance, Diesel engine, 291
 - steam generator, 131
 - Heat conductivity, *see* Conductivity; thermal
 - Heat transfer, air heaters, 166
 - boilers, 141
 - coefficients, steam generator components, 172
 - condensers, 93, 99
 - economizers, 164
 - feed-water heaters, 101
 - furnaces, 146
 - superheaters, 157
 - Heaters, closed, 55, 101
 - deaerating, 100
 - volume, 100
 - drainage, 102
 - heat transfer, 101
 - open, 53, 100
 - terminal difference, 101
 - venting, 103
 - Heating surface, apportionment of, 169
 - Heating value, fuel, higher, 126
 - lower, 126

- Historical background of power, 1
 Folding company, 6
 Horizontal cyclone burner, 229
 Horsepower, air, 239
 boiler, 130
 brake, 68
 indicated, 49, 68
 water, 203
 Hot lime-soda process, 212
 Hotwell, condenser, 97
 heater, 102
 Hydraulic turbines, Francis, 299
 impulse, 299
 Kaplan, 299
 Nagler, 299
 Pelton, 299
 reaction, 299
 Hydro-electric plants, run-of-river, 295
 storage, 295
 Hydrogen zeolite, 217
 Hydrograph, river, 297
 Hypothetical combinations, salts, 213
- I
- Impulse-reaction turbines, steam, 75
 Impulse turbines, hydro, 299
 steam, 73
 Income, power plant, 25
 Incremental rate theory, 280
 applications of, 282
 Index, cost, 28
 Indicated horsepower, 49, 68
 Indicator, engine, 49, 67
 Indicator diagram, Diesel engine, 287
 steam engine, 69
 Injector, fuel, Diesel engine, 287
 Installed capacity, power plants in U.S., 1
 Instruments, supervisory and control, 249
 Insulation, duct, 194
 economical thickness, 196
 furnace, 151
 pipe, 194
 Insurance, 30
 Investors' profit, 34
 Investment, distribution system, primary, 28
 secondary, 34
 plant, 28
- J
- Jet condenser, ~~see~~ Condenser
- K
- Kitteredge, A. E., 103
- L
- Level control, fluid, 253
 Life expectancy, power plant components, 30
 Lime and alum process, 211
 Lime-soda process, hot, 212
 Lime-soda and alum process, 211
 Load curves, daily, 9
 duration, 14
 growth, 13
 extension of, 24
 peak, 13
 Load factor, 19
 Logarithmic mean temperature difference, condensing vapors
 96
 counterflow, 157
 parallel flow, 159
 Losses, friction, ducts, 191
 pipe, 178
 pipe fittings, 178
 radiation, steam generators, 134
 furnace walls, 151
 Lubricating oil, economy, Diesel engines, 291
 steam turbines, 33.
- M
- Maintenance, 33
 capitalized, 32
 Management, cost of, 32
 Mass flow, gases, 144
 river, 297

- Maximum demand, 19
 Mean effective pressure, engine, 68
 Mean temperature difference, arithmetic, 96
 logarithmic, *see* Logarithmic mean temperature difference
 Mechanical efficiency, Diesel engines, 291
 hydraulic turbines, 299
 steam engines, 67
 steam turbines, 75, 80
 Mercury-steam binary vapor cycle, 63
 Mercury vapor, Mollier diagram, 65
 Mills, coal pulverizing, *see* Pulverizers
 Mixing condensers; barometric, 89
 jet, 89
 Mixing heaters, *see* Heaters, open
 Mollier diagram, mercury vapor, 65
 steam, 338
 Municipal utility, 6
- N
- Natural draft, 246
 Natural gas, analyses, 117
 combustion, 121
 Net assured capacity, 24
 Newcomen, 67
 Nusselt's equations, 95, 160
- O
- Oil, fuel, *see* Fuel oil
 Open heater, 53, 100
 Orsat flue gas analysis apparatus, 128
 Outdoor plant, 273
 Overfeed stoker, 224
- P
- Paper mill chemical recovery boiler, 233
 Parsons, C. A., 73
 Pearl Street Station, 1
 Permanent hardness, water, 210
 Petroleum, *see* Fuel oil
 pH, boiler water, 218
 controllers, 258
 Phosphates, 219
 Piping, 175
 fittings, 178
 equivalent lengths, 178
 friction, 178
 insulation, 194
 pressure drop, 178
 schedule number, 176
 size determination, 175
 Piston speed, steam engine, 70
 Plant buildings, enclosed, 274
 outdoor, 273
 semi-outdoor, 273
 Ponds, cooling, 107
 Power, Diesel, 3
 gas turbine, 303
 hydro, 3
 steam, 1
 Power plants, buildings, 273
 construction, 274
 design, 273
 Preferred standards, steam turbo-generators, 76
 Pressure compounded impulse steam turbine, 73
 Pressure gages, 249
 Pressure head, 203
 Primary air, 228
 Private utility, 6
 Production costs, 27
 Products of combustion, 128
 Profit element, 34
 Proximate analysis, coal, 117
 Public utilities, 5, 25
 Public Utilities Holding Company Act, 6
 Pulverized coal, firing systems, 223
 furnace bottoms, 231
 Pulverizers, coal, 228
 power requirements, 228
 Pumps, centrifugal, 200
 boiler feed, 205

- Pumps, centrifugal, circulating water, 205
 condensate, 205
 efficiencies, 204
 general purpose, 205
 laws of similarity, 205
 performance characteristics, 206
 speeds, 205
 duplex steam driven, 200
 gear, 200
 multiplex plunger, 200
 screw, 200
 turbine, 200
 Purifiers, steam, 219
- Q
- Quality of steam at end of expansion, 63
- R
- Radiation coefficients, 151
 Radiation losses, steam generator, 134
 calculation of, 151
 Rankine, W. J. M., 46
 Rankine cycle, 46
 efficiency ratio, 49
 ratio, 49
 Rateau, 73
 Rates, steam, 49
 requirements, 27
 types, 34
 Ratio of expansion, steam engine, 69
 Reaction turbines, hydro, 299
 steam, 73
 Reciprocating pumps, 200
 Refractories, 151
 Refrigeration, hotwell, condenser, 97
 heater, 102
 Regenerative cycle, 52
 extraction, 52
 feed-water temperatures, 52
 Regulators, feed-water, 254
 Reheaters, 50, 163
 Reheating cycle, 50
 Reheating-regenerative cycle, 56
- Reserve, spinning, 21
 standby, 21
 Resin, acid adsorbing, 218
 Retirement reserve, 30
 Revenue certificates, 6
 Reynolds' number, 178
 Reynolds, R. L., 52
 Room rate, 35
 Rotating pumps, 200
- S
- Scale, boiler, 210, 219
 condenser tube, 95
 Scales, coal weighing, 223
 Scavenging pumps, Diesel engines, 291
 Schedule number, pipe, 176
 Secondary air, 229
 Selection of number and size of units, 20
 Semi-outdoor plant, 273
 Sinking fund for bond retirement, 30
 Slagging, furnace, 148
 superheater, 16C
 Sodium zeolite, 216
 Speed control, 252
 Spinning reserve, 21
 Spray ponds, 107
 Spreader stoker, 225
 Stacks, design, 246
 draft produced, 246
 Standby reserve, 21
 Static head, 203
 Station design, 265
 Steam engines, *see* Engines
 Steam generators, 130
 convection surface, 141
 cost of, 141
 efficiency, 130
 fire-tube, 138
 heat balance, 131
 heat transfer, *see specific component*
 radiant surface, 148
 water-tube, 138
 Steam jet air pump, capacity, 105
 characteristics, 105
 Stefan-Boltzman relation, 151

Stocks, common, 6
 Stokers, coal, chain grate,
 225
 overfeed, 224
 spreader, 225
 travelling grate, 225
 underfeed, 225
 fuel burning rate, 225
 Superheaters, 156
 convection, 156
 heat transfer, 157
 radiant, 157
 temperature control, 156
 Superposed cycle, 59
 Surface condenser, *see* Con-
 denser
 Surface, heating, apportion-
 ment of, 169
 Surge tanks, hydro plant, 299
 steam plant, 101
 Systems, power, 4

T

Tanks, surge, hydro plant, 299
 steam plant, 101
 Taxes, ad valorem, 26, 29
 income, 34
 Temperature difference, mean,
see Mean temperature differ-
 ence
 Temporary hardness, water, 210
 Terminal difference, condenser,
 97
 heater, 101
 Thermal conductivity, *see* Con-
 ductivity, thermal
 Thermal efficiency, *see* *specif-
 ic cycle*
 Thermometers, 249
 Topping turbines, *see* Super-
 posed cycle
 Total air, 120
 Towers, cooling, forced draft,
 108
 induced draft, 108
 Transmission systems, 4
 Treatment, water, 210
 Tubes, condenser, 96
 Turbines, hydro, 298
 impulse, 299

Turbines, hydro, reaction,
 299
 governing, 252
 impulse, hydro, 299
 steam, 73
 impulse-reaction, steam,
 75
 reaction, hydro, 299
 steam, 73
 steam, engine efficiency,
 75
 large condensing, 79
 mechanical drive, 75
 small condensing, 76
 small non-condensing,
 76
 superposed, 59
 topping, *see* superposed
 Turbo-generators, preferred
 standards, 76
 cost of, 79
 TVA, 3.

U

Ultimate analysis, fuel, *see*
 Fuel
 Underfeed stoker, 225
 Uniflow engine, 67
 United States, cost and use of
 domestic electric service,
 25
 electrical production, 1
 heat rate of power plants,
 1
 installed capacity, 1
 standard of living, 1
 Use factor, 19
 Useful life of power plant
 components, 30
 Utility organization, 5

V

Vacuum, engine efficiency
 correction for, 79
 Vacuum pumps, 105
 Valves, steam engine, 67
 Valves, power plant, 178
 Vapor power cycles, 45
 Variable load element, 33
 Velocity compounded impulse
 steam turbine, 73

Velocity, duct, 19C
 pipe, 175
 tube, condenser, 95
 heater, 102
Viscosity, gases, 191
 petroleum oils, 178
 steam, 178
 water, 178
Volatile matter in fuels,
 see Fuels, analysis
Volume, furnace, 146
 open feed-water heaters,
 100

W

Walls, furnace, air-cooled,
 153

Walls, furnace, insulated,
 151
 water-cooled, 146
Water, boiler, 218
 treatment, 31C
 horsepower, 203
Water-tube boilers, 138
Watt, 67
Work relations, fans, 239
 pumps, 203

Z

Zeolite, hydrogen, 217
 sodium, 216
 softening processes, 215