

DEVELOPING VILLAGE INDIA

STUDIES IN VILLAGE PROBLEMS

NEW DELHI
IMPERIAL COUNCIL OF AGRICULTURAL RESEARCH
INDIA

X 9(J): 75.2

H6

13519

Editorial Committee

- SIR HERBERT STEWART, C.I.E., M.Sc., F.R.C.Sc.I., D.I.C., N.D.A.,
I.A.S., *Vice-Chairman, Imperial Council of Agricultural Research.*
- SARDAR BAHADUR SIR DATAR SINGH, Kt., F.R.A.S., *Joint Vice-Chairman, Imperial Council of Agricultural Research.*
- MAJOR G. WILLIAMSON, O.B.E., M.R.C.V.S., D.V.S.M., *Animal Husbandry Commissioner with the Government of India.*
- J. N. MUKHERJEE, C.B.E., D.Sc., F.N.I., F.R.A.S.B., F.C.S.,
Director, Imperial Agricultural Research Institute, New Delhi.
- F. C. MINETT, C.I.E., D.Sc., M.R.C.V.S., *Director, Imperial Veterinary Research Institute, Mukteswar.*
- Z. R. KOTHAYALLA, B.Ag., B.Sc., N.D.D., *Dairy Development Adviser to the Government of India.*
- K. C. SEN, D.Sc., *Director of Dairy Research, Bangalore.*
- BIRBAL SAHNI, M.A., Sc.D., (Cantab.), D.Sc., (Lond.), F.R.S.,
Professor of Botany, Lucknow University.
- A. C. JOSHI, D.Sc., F.N.I., *Professor of Botany, Government College, Lahore.*
- T. W. MILLEN, M.Sc., D.V.M., *Head of the Department of Animal Husbandry and Dairying, Allahabad Agricultural Institute, Allahabad.*
- S. KRISHNA, C.I.E., D.Sc., Ph.D., F.I.C., *Biochemist, Forest Research Institute, Dehra Dun.*
- M. S. RANDHAWA, M.Sc., I.C.S. F.N.I., F.I.A.Sc., F.N.A., *Secretary, Imperial Council of Agricultural Research.*

Editor

U. N. CHATTERJEE, D.Phil., D.Sc., F.N.A.Sc.

To
Indian Peasants
with whom now lies the
deciding vote and power



PREFACE

THE eyes of the world shift to India today, as one would mark, and the story of how new life is being brought to India's villages is obviously one of the few happy pages of her history. I feel all the more certain that we have lot of work to do. Work to do for millions of people with whom now lies the deciding vote and power. The Indian village must adjust itself to the conditions of the 20th century life, for the fact that the average annual income of the peasant is only sixty rupees is a sad comment on India's progress.

As an anthology of significant writing it stands for a re-affirmation of values, and as such every individual piece in each section should be eagerly read and discussed. The flow of manuscripts has been enormous, and it was not possible to utilize the whole material in a single publication. The contributors, as might be noted in the biographical notes, are authors with outstanding experience and authority. Every piece, in one form or other, decides the tempo of progress, for it carries modern scientific outlook and dramatic force of statement.

Now that every country is busy planning, India clearly cannot be left behind. For centuries, the Indian peasant has used the old plough and sickle ; for centuries, he has suffered from inhuman toil and drudgery. The time to repaint the picture has come. The primitive peasant economy dating from five thousand years old Mohenjo Daro period must be replaced by scientific development and scientific technique, so that the peasant gets leisure for educational and cultural pursuits.

Folk art, folk-dances, folk-songs—all have been given their place in the whole scheme, for they are the heartbeats of the village. There is always a soul behind every folk design, and as such it must be preserved. Every folk-dance is the real self-expression of the tribe or community, and as such, it must survive. Every folk-song is a window into the mind and heart of the people and as such it deserves every encouragement.

Complete with an up-to-date bibliography of literature on Rural Development subjects, this publication should be useful to Development workers and others interested in the problems of the village.

Developing Village India has been planned by Mr. M. S. Randhawa, Secretary, Imperial Council of Agricultural Research, who has been assisted by a devoted band of workers. Dr. U. N. Chatterjee has worked indefatigably in making this publication a success. Mr. N. S. Bisht has prepared some significant diagrams and rendered invaluable help in arranging the illustrations. And Mr. Devendra Satyarthi brought new ideas and new outlook : he is responsible for treatment of entire material and the artistic layout.

My grateful acknowledgments are due to all the learned contributors, and especially the Press Information Bureau for many valuable photographs.

New Delhi,
July 4, 1946.

DATAR SINGH.

CONTENTS

	PAGE
PREFACE	vii
DEVELOPING VILLAGE INDIA	1
ORGANIZATION	
ORGANIZATION FOR DEVELOPING VILLAGE INDIA	7
M. S. Randhawa	
STATE LEADERSHIP IN AGRARIAN ECONOMY	23
N. C. Mehta	
LAND MANAGEMENT AND ECONOMIC PLANNING	27
Tarlok Singh	
RURAL COMMUNITIES AND VILLAGE DEVELOPMENT	32
J. N. Mukherjee	
LESSONS OF MARTHANDAM	39
Miss Ouwerkerk	
THE VILLAGER'S MIND	43
J. M. Lobo-Prabhu	
THE ROLE OF EX-SERVICE MEN	47
F. L. Brayne	
RANGE OF COOPERATIVE SOCIETIES	51
Mohammed Ahsan & Zaheer Hussain	
THE PANCHAYATGHAR INSTITUTION	60
M. S. Randhawa	
PUBLICITY & PROPAGANDA	
THE KEY TO THE GROWER'S DOOR	69
Roger Thomas	
AGRICULTURAL EDUCATION AND PROPAGANDA IN THE VILLAGES	74
D. N. Mitra	
CAMPAIGNS, DRIVES AND WEEKS	81
M. S. Randhawa	
VILLAGE EXHIBITIONS AND FAIRS	83
M. R. Sharma	
RURAL BROADCASTING IN INDIA	86
D. D. Sabnis	
FILMS FOR THE VILLAGER	89
V. R. Bhatt	
AGRICULTURE & NUTRITION	
✓ PROBLEMS OF AGRICULTURE AND NUTRITION	99
Sir Pheroze Kharegat	
✓ CONSOLIDATION OF HOLDINGS	109
U. N. Chatterjee	
✓ MECHANIZATION OF INDIAN AGRICULTURE	114
D. R. Sethi	
MIXED FARMING	120
U. N. Chatterjee	
CHECKING SOIL EROSION	124
R. M. Gorrie	
INTRODUCING BETTER CROP VARIETIES	129
R. P. Pal	
SEED MULTIPLICATION	134
Fateh Singh	
UTILIZATION OF VILLAGE WASTES	136
C. N. Acharya	
COMBUSTIBLE GAS FROM COW DUNG	140
S. V. Desai	
SAVING CROPS FROM INSECT PESTS AND DISEASES	144
H. S. Pruthi	

	Page
THE NUTRITION PROBLEM OF THE VILLAGER	147
Afzal Hussain	
THE STORY OF THE RICE GRAIN	154
U. N. Chatterjee	
FOOD FACTS	155
From 'Nutrition'	
THE STORY OF THE WHEAT GRAIN	168
U. N. Chatterjee	
ANIMAL HUSBANDRY	
TOO MANY CATTLE	173
Grahme Williamson	
IMPROVING VILLAGE CATTLE	178
Sir Datar Singh	
POULTRY FARMING	181
A. J. MacDonald	
BEE-KEEPING	185
R. N. Muttoo	
THE VILLAGE POND AND FISH PRODUCTION	190
S. I. Hora	
HORTICULTURE	
PLANTING TREES IN VILLAGES	199
M. S. Randhawa	
VILLAGE ORCHARDS: MANGO	206
P. K. Sen	
VILLAGE ORCHARDS: CITRUS	210
Bal Singh Bajwa	
VILLAGE ORCHARDS: PAPAYA	215
K. C. Naik	
VEGETABLE CULTURE	219
Swarn Singh Purewal	
COTTAGE INDUSTRIES	
VILLAGE INDUSTRIES	227
J. C. Kumarappa	
COTTAGE INDUSTRIES	230
Ujjal Singh	
HEALTH & SANITATION	
HEALTH AND SANITATION PROBLEMS	237
M. S. Randhawa	
MODEL HOUSES FOR VILLAGES	242
Hari Chand	
AQUA PRIVY	244
R. N. Kaul	
SANITARY CONVENIENCES FOR VILLAGE SCHOOLS	247
S. N. Makand	
EDUCATION & CULTURE	
EDUCATING THE VILLAGER	251
K. G. Saiyidain	
WOMEN'S EDUCATION AND RURAL DEVELOPMENT	254
T. N. Kaul	
FOLK ART OF INDIA	257
Sailoz Mookherjea	
BASIC PRINCIPLES OF VILLAGE CEREMONIAL DECORATIONS	260
Bireswar Sen	
FOLK DANCES OF INDIA	266
Rajendra Shankar	
SONGS OF THE INDIAN COUNTRYSIDE	269
Devendra Satyarthi	

ILLUSTRATIONS

	PLATE	
COVER DESIGN by V. Bourlin		
1. DEMOCRACY IN VILLAGES : ELECTING A PANCHAYAT	M. S. Randhawa	1
2. A PANCHAYAT SETTling A DISPUTE	"	2
3. LISTENING TO A RADIO BROADCAST	"	3
4. INTERIOR OF A PANCHAYATGHAR	"	3
5. VILLAGE SCOUTS	"	4
6. LIFTING BAR-BELLS	"	5
7. PHYSICAL CULTURE	"	5
8. CHARITY BOX	"	6
9. THE DISTRICT HEALTH OFFICER	"	7
10. PANCHAYATGHAR READING-ROOM	"	8
11. AN ADULT NIGHT SCHOOL	"	8
12. SEED STORE IN A PANCHAYATGHAR	"	9
13. PLAN OF A MODEL PANCHAYATGHAR	N. S. Bisht	10
14. VILLAGERS READING A PANCHAYATGHAR POSTER	M. S. Randhawa	11
15. A VIEW OF THE RURAL UPLIFT EXHIBITION	P.I.B.	12
16. ENTRANCE GATE OF THE RURAL UPLIFT EXHIBITION	"	13
17. MEDAL OF RURAL DEVELOPMENT, UNITED PROVINCES	N. S. Bisht	14
18. VILLAGE CATTLE SHOW	P.I.B.	15
19. WRESTLING	M. S. Randhawa	16
20. BALLAD SINGERS OF ANDHRA	All India Radio, Madras	17
21. VILLAGERS LISTENING TO A RADIO BROADCAST	M. S. Randhawa	18
22. THE BALLAD OF ALHA	All India Radio, Lucknow	19
23. SHRI GOPAL AND PARTY	All India Radio, Delhi	20
24. THE MENACE OF MALARIA	Information Films of India	21
25. AGRICULTURAL SNAKES AND LADDERS	N. S. Bisht	22
26. A VILLAGE BEFORE CONSOLIDATION OF FIELDS	P.I.B.	23
27. A MODEL VILLAGE AFTER CONSOLIDATION OF HOLDINGS	"	23
28. THE AGRICULTURAL LADDER	N. S. Bisht	24
29. CORRECT LAND MANAGEMENT	P.I.B.	25
30. SOIL EROSION (1)	"	26
31. SOIL EROSION (2)	"	26
32. CHECKING SOIL EROSION (1)	R. M. Gorrie	27
33. CHECKING SOIL EROSION (2)	"	27
34. CHECKING SOIL EROSION (3)	"	27
35. CHECKING SOIL EROSION (4)	"	28
36. CHECKING SOIL EROSION (5)	"	28
37. CHECKING SOIL EROSION (6)	"	28
38. WHEAT VARIETIES (1)	B. P. Pal	29
39. WHEAT VARIETIES (2)	"	30
40. EMASCULATION	"	31
41. POLLINATION	"	31
42. CROSSING OPERATION COMPLETE	"	32
43. THE SINGLE PLANT OF WHEAT (1)	"	32
44. THE SINGLE PLANT OF WHEAT (2)	"	32
45. NEW VARIETIES OF WHEAT	"	33
46. IMPROVED WHEAT (I.P. 165)	"	34
47. IMPORTANT WHEAT VARIETIES	"	35
48. THE FIELD OF IMPROVED WHEAT (I.P. 165)	"	36
49. MANURE PITS	P.I.B.	37
50. DIGGING A MANURE PIT	"	38

51. WASTE OF MANURE	N. S. Bisht	39
52. COMPOSTING GOOD QUALITY MANURE	"	40
53. FERMENTATION TANK	"	41
54. GAS HOLDER	"	42
55. TERMITE GALLERY	H. S. Pruthi	43
56. DR. PRUTHI AND H.E. THE VICEROY	P.I.B.	43
57. A CONCRETE GRAIN SILO	"	44
58. THE STORY OF THE RICE GRAIN	N. S. Bisht	45
59. THE STORY OF THE WHEAT GRAIN	"	46
60. WHICH COUNTS?	Mrs. Francis Stewart	47
61. SONS OF THE SOIL	P.I.B.	48
62. 'ROSE' AND HER MALE CALF	"	49
63. A TYPICAL COW	"	50
64. A CATTLE DIP	"	51
65. THE THRESHING FLOOR	"	52
66. MEMBERS OF THE FAMILY	"	53
67. KALSI POULTRY FARM	"	54
68. TYPICAL COCKS (1)	A. J. MacDonald	55
69. TYPICAL COCKS (2)	"	55
70. TYPICAL COCKS (3)	"	55
71. A POULTRY FARM	P.I.B.	55
72. DRAG NET	S. L. Hora	56
73. AH! FISH ARE CAUGHT	"	57
74. THE MIRACULOUS NET	"	58
75. COMMUNITY WORK	"	59
76. DEVELOPING FISH CULTURE	"	60
77. NOW MONEY IS MADE	"	61
78. IDEA TURNED TO ACTUALITY	Fisheries Department, Bengal	62
79. A NEGLECTED VILLAGE POND	"	63
80. AN IMPROVED VILLAGE POND	"	64
81. VARIOUS TYPES OF VILLAGE PONDS	"	65
82. TREE PLANTATION PLAN FOR INDIA	N. S. Bisht	66
83. A MODEL TREE PLANTATION PLAN	"	67
84. PLANTING A TREE	"	68
85. VARIOUS TYPES OF TREE GUARDS	"	69
86. CULTIVATION MAKES DIFFERENCE (1)	P. K. Sen	70
87. CULTIVATION MAKES DIFFERENCE (2)	"	70
88. AN INTER-CROP WHEAT FIELD	"	71
89. AN OVER-AGED PAPAYA GROVE	Government Botanist, Coimbatore	72
90. CABBAGE IN THE LAND OF POTATOES	P.I.B.	73
91. POTATO PLANTING	"	74
92. POTATO GRADING	"	74
93. BASKET MAKING	"	75
94. HANDLOOMS	"	76
95. EMBROIDERY & KNITTING	"	77
96. SPINNING	"	77
97. BED-TAPE MAKING	"	78
98. IMPROVED VILLAGE WELL	The Concrete Association of India	79
99. ANOTHER IMPROVED VILLAGE WELL	"	80
100. CONCRETE ROAD IN A VILLAGE	"	81
101. ANTI-MALARIA PROPAGANDA	P.I.B.	82
102. A TOURING VACCINATOR	"	83
103. HAND PUMP AT WORK	S. L. Dhar	84
104. A VENTILATOR DESIGN	N. S. Bisht	85
105. THE CONTRAST (1)	"	86
106. THE CONTRAST (2)	"	86

107. A MODEL HOUSE	The Concrete Association of India	87
108. ANOTHER TYPICAL HOUSE	"	88
109. A DIFFERENT DESIGN	"	89
110. BAMBOO SEATS FOR TRENCH LATRINES	N. S. Bisht	90
111. SOAK PIT	"	91
112. FUNNEL URINE PIT	"	92
113. AT A MODERN NURSERY SCHOOL	P.I.B.	93
114. 'PLAYWAY' METHOD	Mrs. Stan Harding	94
115. LESSONS & PHYSICAL TRAINING	"	95
116. HAND WORK IN PROGRESS	P.I.B.	96
117. HER FIRST LESSON	"	97
118. WOMEN TRAINEES (1)	M. S. Randhawa	98
119. WOMEN TRAINEES (2)	"	99
120. GANESHJI	Sailoz Mookherjea	100
121. KARTIKEYA	"	101
122. ARJUNA	"	102
123. THE HORSE	"	103
124. THE DEER	"	104
125. 'ALOPANA' DESIGNS (1)	Bireswar Sen	105
126. 'ALOPANA' DESIGNS (2)	"	105
127. 'ALOPANA' DESIGNS (3)	"	106
128. 'ALOPANA' DESIGNS (4)	"	106
129. 'ALOPANA' DESIGNS (5)	"	106
130. 'HOLI' DANCE (1)	P.I.B.	107
131. 'HOLI' DANCE (2)	"	108
132. KATHAKALI (1)	"	109
133. KATHAKALI (2)	"	109
134. DEVENDRA SATYARTHI AND AN OLD PATHAN MINSTREL	R. B. Holmes	110
135. ANCIENT RHYTHM	P.I.B.	111
136. A SANTAL FAMILY	Devendra Satyarthi	112
137. EVOKING THE RAIN GOD	P.I.B.	113
138. SISTERS OF THE SPINNING-WHEEL	Devendra Satyarthi	114
139. GARBA DANCERS	P.I.B.	115
140. DAUGHTERS OF 'CHAND MAMA'	"	115
141. WELCOME TO ANCIENT FESTIVAL	Devendra Satyarthi	116
142. THE WOULD-BE BRIDE	"	116
143. SAVARA BOYS	"	117
144. AHA, MARRIAGE NEWS!	"	118

ABOUT THE CONTRIBUTORS

M. S. RANDHAWA, M.Sc., F.N.I., I.C.S., is famous for original development work in the United Provinces where he served as a District Officer for a number of years. He is at present the Secretary of the Imperial Council of Agricultural Research. He was deputed by Government of India as Secretary of the Indian Delegation to the Food and Agriculture Organization Conference of the United Nations held at Quebec City in 1945. A scientist turned administrator, he sees in science a panacea for all economic and social evils. He is a prolific writer and his forthcoming books *Beautifying India*, a plea for a tree plantation plan, and *Central Himalayas*, written in collaboration with Devendra Satyarthi and Bireswar Sen, will reveal his deep aesthetic sense and innate love of nature.

N. C. MEHTA, formerly Secretary, Imperial Council of Agricultural Research and now retired from Indian Civil Service, is well known in the field of Indian economics, and has almost an equal fame as a connoisseur of Indian painting.

TARLOK SINGH, a member of the Indian Civil Service, is the author of *Poverty and Social Change*. The results of his field work are revealing and significant. At present, he is Private Secretary to the Finance Member, Government of India.

J. N. MUKHERJEE, C.B.E., D.Sc., F.N.I., eminent in India for a special study of soil in its various aspects and problems of land utilization, is the Director of the Imperial Agricultural Research Institute, New Delhi. Dr. Mukherjee was for some years Professor of Chemistry in Calcutta University.

MISS OUWERKERK was attached to the Rural Welfare Centre at Marthandam in Travancore State. She is credited with a vast experience of village work, and she writes with zeal and imagination.

J. M. LOBO-PRABHU is Deputy Secretary in the Food Department, Government of India. He is a member of the Indian Civil Service, and took a good deal of interest in village work while he served as District Officer in the United Provinces.

F. L. BRAYNE came to India as a member of the Indian Civil Service, and in the Punjab, where he took up the pioneering work of village uplift, his name has become almost proverbial. He is the author of several books on rural reconstruction. Latterly, he was an adviser on Indian Affairs to the Director-General, Welfare, Education and Resettlement, General Headquarters, New Delhi, India.

MOHAMMED AHSAN & ZAHEER HUSSAIN are enthusiastic members of Cooperative Department in the Punjab.

ROGER THOMAS, an agriculturist by profession, is a prominent landlord in Sind. As Adviser on Agricultural matters to the Sind Government, he put forward a number of valuable suggestions. He writes and speaks on agricultural subjects with fervour and conviction.

D. N. MITRA, Rai Bahadur, carried out a continuous developmental work in Faridpur District in Bengal. His name is well known even as a pioneer collector of agricultural aphorisms which the peasants in Bengal, like their brethren in other provinces, have inherited from the past generations. Since retiring from the Agriculture Department, Bengal, he often writes in Bengali journals on agricultural matters.

M. R. SHARMA, Rai Sahib, Secretary, All-India Cattle Show Committee, New Delhi, has a thorough understanding of the village fairs and is hopeful of their bright future.

D. D. SABNIS works with the All India Radio, Delhi, and as such has something substantial to say revealing the background of rural broadcasting problem in India.

V. R. BHATT joined the Information and Arts Department, Government of India. He has closely studied the publicity problem with special reference to the cause of bringing new life to the Indian village.

SIR PHEROZE KHAREGAT, C.I.E., a member of the Indian Civil Service and formerly Vice-Chairman, Imperial Council of Agricultural Research, is at present Secretary, Department of Agriculture, Government of India. He is well-known as the author of the Memorandum on the Development of Agriculture and Animal Husbandry in India, popularly known as the Kharegat Plan. He is a recognized authority on the agricultural problems of India and has always the interests of the farmer close to his heart.

U. N. CHATTERJEE, D.Phil., D.Sc., F.N.A.Sc., who worked as Lecturer of Botany at University Colleges at Allahabad and Agra for over six years, claims a special study in various aspects of plant metabolism. At present he edits the *Indian Farming* and other journals of the Imperial Council of Agricultural Research.

D. R. SETHI, C.I.E., I.A.S., formerly Director of Agriculture in Bihar, joined the Government of India as Agricultural Development Commissioner. He planned the 'Grow More Food' campaign during the war years. He is very keen on mechanizing the agricultural operations in India.

R. M. GORRIE, D.Sc., a member of the Indian Forest Service, is in charge of the land reclamation work in the Punjab. He is an authority on soil erosion.

B. P. PAI, Ph.D., Imperial Economic Botanist at the Imperial Agricultural Research Institute, New Delhi, has carried on extensive and fruitful researches on improving crop plants and their breeding. Among his friends, Dr. Pal is also known for his artistic talents.

FATEH SINGH is Agricultural Production Adviser. Seed Multiplication is his pet theme.

C. N. ACHARYA, Pa.D., formerly attached with the Imperial Council of Agricultural Research as Chief Biochemist in charge of Compost Scheme, is at present Biochemist in the Department of Agriculture, Government of India.

S. V. DESAI, D.Sc., who is the Head of the Soil Science and Agricultural Chemistry Division of the Imperial Agricultural Research Institute, New Delhi, has tackled a number of problems concerning Agricultural Chemistry and Bacteriology.

H. S. PRUTHI, Ph.D., D.Sc., O.B.E., formerly attached to the Imperial Agricultural Research Institute, New Delhi, as Imperial Entomologist, is Plant Protection Adviser to the Government of India and Officer in Charge of Locust Research. He is the author of *Stored Grain Pests and their Control*.

AFZAL HUSSAIN, M.A., F.N.I., who was the Principal of the Punjab Agricultural College at Lyallpur and Vice-Chancellor of the Punjab University, is increasingly known to his countrymen as a member of the Famine Enquiry Commission. He is one of the leading scientists of the country. Originally an Agricultural Entomologist, he has specialized in studying India's nutrition problems.

GRAHME WILLIAMSON, O.B.E., M.R.C.V.S., D.V.S.M., formerly Professor of Animal Husbandry at Edinburgh and also attached to the Army Veterinary Corps, is the Animal Husbandry Commissioner with the Government of India. He keeps in close touch with the animal husbandry problems in the Indian village.

SIR DATAR SINGH owns one of the biggest farms in the Punjab. He has been attached to the Government of India as Cattle Utilization Officer for a number of years and claims credit for reorganizing scores of *Goshalas* and *Pinjrapoles* on scientific lines. At present he is the Vice-Chairman, Imperial Council of Agricultural Research.

A. J. MACDONALD, poultry expert at the Imperial Veterinary Research Institute, Izatnagar, has been a student of poultry production all his life and has applied his knowledge to India's profit.

R. N. MUTTOO, General Secretary, All-India Bee-Keepers' Association, is one of the editors of the *Indian Bee Journal*, published at Naini Tal in the United Provinces.

S. L. HORA, D.Sc., formerly attached to the Zoological Survey of India, is the Director of Fisheries in Bengal. He is equally well-known for developing inland and marine fisheries.

P. K. SEN, Ph.D., Horticulturist to the Government of Bihar, has specialized in the intermittent bearing of mango trees and the cure of the Black Tip disease in mango orchards.

BAL SINGH BAJWA, Fruit Specialist to the Punjab Government, has been carrying out an extensive survey of horticultural work. He has been abroad to enrich his experience.

K. C. NAIK is Horticulturist to the Government of Madras.

SWARN SINGH PUREWAL, Ph.D., Vegetable Specialist to the Punjab Government, is one of the few specialists on vegetables in India.

J. C. KUMARAPPA, founder-Secretary of the Indian Village Industries Association, possesses the fervour of a missionary.

UJJAL SINGH, M.L.A. (Punjab), is a well-known landlord and industrialist of the Punjab. He visited U.S.A. in 1945 in connection with the Food and Agriculture Organization Conference of the United Nations, held at Quebec City.

HARI CHAND, Rai Bahib, belongs to the Concrete Association of India, New Delhi.

R. N. KAUL, Major, I.M.S., is attached to the Health Department of the Government of India.

S. N. MAKAND, Major, I.M.S., is Director of Public Health in the Central Provinces.

K. G. SAIYIDAIN, formerly Professor at the Muslim University, joined Kashmir State as Director of Education. At present he is Educational Adviser to Rampur State. He is one of the foremost educationists of India: a powerful writer and speaker.

T. N. KAUL, a member of the Indian Civil Service, has taken special pains in village women's education and welfare in the United Provinces.

SAILOZ MOOKHERJEA, who spent a number of years wandering in Indian villages to collect specimens of folk-art, belongs to the group of modern artists of India.

BIRESWAR SEN, attached to the Government School of Arts and Crafts at Lucknow as Superintending Craftsman, is one of the great modern Indian artists, and has painted the Himalayas in inimitable colours. His approach to folk art is direct and sincere.

RAJENDRA SHANKAR, younger brother of Udai Shankar, the famous exponent of Indian dance, has travelled in India and various countries of the world as a member of his brother's troupe. He writes on the national value of Indian folk dances with power and balance.

DEVENDRA SATYARTHI spent twenty years in search of folk-songs. His collections in fifty Indian languages range over 300,000 songs—all collected from the living lips of the people. He has broadcast from every station of All India Radio. His articles published in the *Modern Review* and *Asia* (published at New York) won him an international repute. Poet, story-writer, playwright and essayist, he also writes in three Indian languages—Punjabi, Hindi and Urdu—and has written several books. *Giddha* and *Deeva Bale Sari Rat* in Punjabi, *Dharti Gati Hai* in Hindi, *Main Hoon Khana Badosh* and *Gae Ja Hindustan* in Urdu are his books on folk-songs. *Meet My People*, published in two volumes, reveals his long-ranged study of the Indian people and their songs and dances. Three of his forthcoming books—*The Plough and the Drum*, *Songs of the Indian People* and *Lament of the Wounded Doe*, will reveal more songs, and his photographic studies of the people who led him to the vast mine of Indian folklore.

INDIAN FARMING

Special Number, 1946

DEVELOPING VILLAGE INDIA

INDIAN FARMING which has been serving the Indian cultivator for the last six years and keeping him abreast with the latest developments in the sciences of Agriculture and Animal Husbandry, has given a lead to the country in placing the Indian rural problem in its various aspects before the people. This lead is timely as the political future of the country itself is on the anvil. A forum has been provided for village workers and others interested in rural problems of India to place their views before the people as to how villages of India should be developed. Fullest freedom has been given to the people representing different schools of thought to express their views regarding the manner in which the problems of the villages are to be tackled, a vast rural slum liquidated and famine and poverty which stalk the land abolished. The authors are responsible for their own views, which are not necessarily those of the Imperial Council of Agricultural Research.

Another feature of this publication is that instead of dealing in generalities, concrete proposals of practical nature have been made which, with slight modifications, can be adopted for developing an organization for village work on a country-wide scale and for organizing a mass attack on the problem of rural poverty.

Realization has been forced upon all thinkers, who take interest in the

economic problems of India, that if this country is to emerge from her pristine squalor, we must harness its entire resources in the service of the people. It has been said that India is a rich country inhabited by poor people. In our land and mineral resources, water-power, and above all in our man-power, we have potentialities which bear rich promise of turning this land of sorrow and hunger into a land of happiness and plenty. Our teeming population and its rate of growth have become a nightmare to economists some of whom seem to be suffering from acute Malthusian delirium. However, our big population may ultimately turn out to be an asset. Over-population is only a relative term. The country is over-populated as compared to its present stage of development of its resources but not so considering its potential resources. Our problem is to link man-power with the material resources through the medium of paper and to develop the country according to a plan. In planned scientific development lies the salvation of India. There will be work for idle hands, bread for hungry stomachs and leisure for cultural development for all. However, that can only be achieved if we lay aside our religious quarrels and change our parochial outlook and adopt scientific development as our religion for the next ten years. Discussing the problem of nutrition Mr. Afzal Husain says that our nutrition policy should be guided by

science rather than tradition. We would go farther and say that our entire conduct of life should be guided by science rather than tradition. By science we mean reason and organized and systematized knowledge. It is only when we view the problem of developing village India from this angle that we get the true perspective. What could be finer religion than that whose object is to rescue one-fifth of humanity from famine, pestilence and a sub-human mode of existence? For the next ten years we should fight a war against poverty and disease with martial fervour. This will be a war for saving lives and property. What could be a nobler and more inspiring task than this?

In the Memorandum of the Imperial Council of Agricultural Research on the Development of Agriculture and Animal Husbandry in India, a plan for developing the agricultural resources of the country has been outlined. Ultimately the work is to be done in the provinces. We have indicated a provincial organization for translating that plan into reality. Let us build up a *Panchayat* organization to link up the villager in the remotest hamlet of India with the developmental machinery of the Government. Let the State take up leadership in organizing and developing agrarian economy. Let the *Panchayats* take up the work of land management on a co-operative basis. Let us utilize the soldiers from the Army, who have learnt discipline and the virtues of regular work, in the task of rural development. Let us bring all available developmental facilities at the door of the cultivator by building *Panchayatghars* for groups of villages. Let us draw developmental programmes for each district, *tahsil* and village after conducting a thorough survey of local resources and studying local needs. We should fix quotas for individual workers so that we may have a yard-stick of our achievements. We should know how much

land is to be reclaimed, how many wells are to be sunk, how many trees are to be planted, what crops are to be sown, how many *Panchayatghars* are to be built, what cottage industries are to be developed and how many boys, girls and adults are to be educated.

We should harness all propaganda resources at our command, the radio, the film and the press for reminding the people of the task before them, and conditioning them to new ideas. Let us enthuse the entire population by organizing campaigns, drives and weeks. Let the countryside hum with activity.

Before undertaking developmental work on a mass scale, certain fundamental problems are to be tackled. No programme of agricultural development can succeed with fragmented and scattered holdings. Consolidation of holdings offers a partial solution, which is, however, practical considering the extreme individualism of the cultivator and his attachment for his land. Joint farming has been suggested as a compromise between collectivism and individualism and may perhaps be regarded as a stepping stone, which will ultimately lead to collective farming. In mixed farming we see commensalism of the plant, animal and man. Mixed farming coupled with intensive cultivation, holds promise in an over-populated country with scanty land, and farming traditions of 5,000 years.

Mechanized farming holds out a promise to the Indian cultivator of relieving him of toil and drudgery. The fodder saved by eliminating the bullock will feed the cow, who will produce more milk for man. Mechanization of agriculture, partial or complete, raises issues of fundamental importance. We have to make our choice between scientific development with scientific technique harnessed in the service of man, and primitive peasant economy dating from Neolithic Mohenjo Daro period. The choice is between the

motor-truck and the bullock-cart. There is a class of thinkers who would prefer the bicycle to walking, but hesitate to go in for the motor-bicycle. We have to decide the tempo of our progress. Perhaps the contribution of India towards the solution of this problem will lie in harmonizing the best features of the peasant economy with the modern industrial economy.

It is a well recognized fact that we have a considerable surplus agricultural population, which has been estimated at about 15½ million men, i.e. 28 per cent of our potential male agricultural workers which will have to be absorbed in industry, if we undertake the task of rationalization of our agriculture. This alone shows that agricultural reorganization on any large scale cannot be undertaken without a simultaneous growth of industry. The real solution of the problem of agricultural over-population lies in industrialization, which will absorb surplus man-power, raise the general level of living by producing cheap goods and by providing additional purchasing power. The agricultural worker must be provided an assured and equitable price for his produce so that he is able to purchase industrial products. The interests of the consumers and producers are intimately linked together. Without prosperous agriculture, industry cannot flourish, and without industry, agriculture cannot improve. No one will dispute the fact that a sound agricultural economy cannot be developed only with the help of imported machinery and while in the transitional phase it is necessary to import agricultural machinery from foreign markets; in due course, we must be able to manufacture our own machinery. The basis of our agricultural and industrial development is cheap power. In our rivers, we have an inexhaustible source of power, which must be tapped by building dams, which will provide irrigation for our thirsty land as well as

cheap power for our factories, and which will enable us to manufacture fertilizers and industrial goods. As Sir Jogendra Singh has so aptly said: "Alladin had only one jinnee to help him, while we have millions of jinn in our rivers to help our cultivators." Cheap power coupled with suitable machines can perform diverse functions on the farm. Even with the help of a very low powered motor, the farmer can cut his fodder, shell his corn, sharpen his tools and draw water from his well for use in home and the farm. Electrification will bring civilization to the vast and ancient rural slum of India and will brighten the drab and sordid existence of the Indian cultivator. Some people who raise objections against mechanization, probably do not realize the drudgery of the life of the peasant who still cuts his fodder with the primitive *gandasa*, carries heavy bundles of fodder crops on his head for long distances and spends a good deal of time pulling water from wells. Electrification and mechanization will reduce drudgery, will liberate the children of the farmer from farm work and will create leisure, which the farmer and his family can utilize in educational and cultural pursuits.

The major problems of agriculture and animal husbandry are also dealt with. We are told how the cultivator can help in saving the soil. It is also explained how better crop varieties are produced and multiplied for the benefit of the cultivator. Preparation of compost from village waste is described in a picturesque manner. The problem of fuel can be tackled by developing fuel plantations, growing crops like cotton and *Arhar* whose stalks provide fuel and by improving the *chulah*. A novel device for producing combustible gas from cow dung is explained.

A considerable quantity of food grains is eaten up by insect pests. Methods are suggested as to how stored grains

can be protected and crops can be saved from insect pests and diseases.

The problem of nutrition has been lucidly explained and we may soon adopt the slogan "Grow more tubers ; produce more milk ". The story of the rice grain is graphically narrated.

Our attention is drawn to our too many cattle. Methods are suggested for improving village cattle by various means. Practical hints are given for supplementing the income of the cultivator by poultry farming, bee-keeping and developing fish production in village ponds.

It is explained what trees should be planted in villages, and how vegetable culture can be encouraged. How cottage industries can help in absorbing the leisure hours of the cultivator and providing him with extra income has also been discussed. Health and sanitation problems of villages with particular reference to northern India have been discussed in broad outline and practical measures indicated for solving them.

Mass education is the key-stone of the arch of rural development. Without educating the villager no programme of development can be successfully carried out. Illiteracy stands like a curtain between the intelligentsia and the agricultural masses. Unless this curtain is lifted no permanent progress is possible.

Uneducated man is like a blind man to whom the vast heritage of mankind, which has been handed over in the form of books to successive generations, is entirely sealed. We must educate the villager and his children. Woman runs the home and ultimately the country. If she is illiterate, progressive ideas cannot spread in villages. Hence women's education occupies an important place in rural development.

Material and spiritual development must go side by side. Mere material progress with clean houses, good and wholesome food do not spell progress. If clean rooms, regular work, wholesome food could alone mean rural development then we may regard our district jails as the most highly developed places in India. Ultimately it is the spirit of man which counts. Culture has as much importance in developmental work as material progress. We must preserve our cultural heritage. The basic principles of village ceremonial decorations have been explained and the necessity of preserving this ancient art emphasized. The folk art of the villages must be preserved and fostered. We should also encourage folk dances so that people may have the joy of living. And let the songs of the people reverberate in the Indian countryside bringing joy and happiness to all.

1

ORGANIZATION

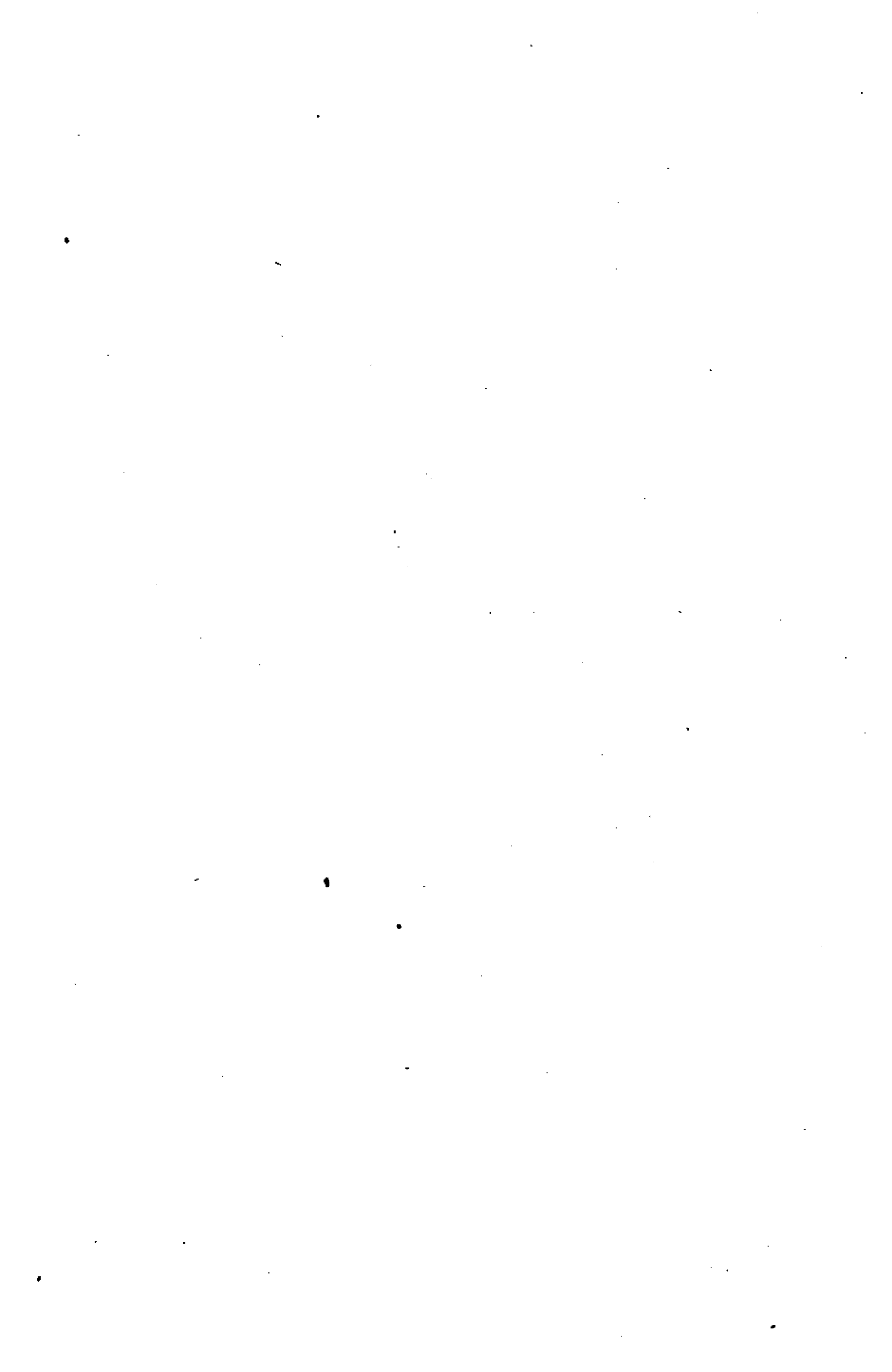

ORGANIZATION FOR DEVELOPING VILLAGE INDIA

By M. S. RANDHAWA

IN BRITISH INDIA we are faced with the task of liquidating a vast and ancient rural slum scattered in 500,000 villages over an area of 750,000 square miles, embracing a population of 300 millions which is 88.9 per cent of the total population. These 500,000 villages are included in 243 districts of 11 provinces in British India. An average district contains about 2,000 villages which are administered from four to five *tahsils*. Each village has a population of about 500 souls and is the ultimate unit of population. These villages are in different developmental stages; while the hand flail and the solid-wheeled bullock cart of Mohenjo Daro dating back to 3000 B.C. still survive in some parts of India, there are some villages, particularly in Northern India, which have gone far ahead and have adopted modern scientific methods of crop production. How are we to tackle this colossal task?

Till recently rural areas have suffered comparative neglect due to various reasons. Collection of taxes and maintenance of law and order were regarded as the primary functions of the government, and benefits of schools, hospitals and good roads were the privileges of urban population of towns only. Villages have been comparatively neglected due to their scattered nature, difficulties of communications and *laissez-faire* policy of the Government. Provision of educational facilities in towns gave a lead to townsmen over villagers. The preponderance of urban element in the executive offices of the Government has worked to

the detriment of the rural population, for power in the hands of those who have no first-hand experience of conditions in villages cannot be expected to be used for the betterment of people whose problems their rulers do not understand.

Brayne and Gandhi

Two individuals have made an outstanding contribution to the problem of rural development. These are Mr. F. L. Brayne and Mahatma Gandhi. Brayne may be regarded as pioneer of rural development in India. He started rural development work on a district scale, while posted as Deputy Commissioner in Gurgaon district of the Punjab. He laid emphasis on education of women, and on digging of manure pits by which it was sought to combine better farming with a clean village. Reviewing the Gurgaon Experiment, Sir Malcolm Darling writes:

“Pits were dug in thousands, Hissar bulls and Gurgaon ploughs bought in hundreds and Persian wheels put up in scores. Villages were cleaned and re-cleaned, multitudes attended the annual Palwal fair, large sums were raised for High Schools, and many girls went to school with the boys. Activity was unprecedented, and few who took part in it could resist its contagion except the peasant, who, being a docile apathetic creature, in nine cases out of ten merely did what he was told. Now, seven months later, all is changed, and the most optimistic estimate is that amongst the peasants themselves not more than

one-third of the activity remains. 'We got the district talking and thinking', says Mr. Brayne. This is true, but the remark of the zemindar who said that 80 per cent have gone to sleep again is probably also true."

However, the chief value of Brayne's work lies not in the results actually achieved in Gurgaon, but in directing the attention of the Indian people and the Government to the great problem of remaking village India.

Mahatma Gandhi's contribution lies in fostering cottage industries through *Ashrams* which have been named after him. As an example of what these Gandhi Ashrams have achieved, we may take the Ashram at Ranewan in Fyzabad district. It was organized by Dhirendra Mazumdar, a sincere and selfless worker who devoted his life to the work of revitalizing cottage industries in the backward villages of the United Provinces. Spinning of yarn was encouraged among village women and weavers provided with yarn for weaving cloth. Tanning of leather was done at the *Ashram* by Brahmins and Rajputs who also made chappals and suitcases. Paper making and making of *moonj*-mats, *durries* and woollen blankets was also encouraged. The villager found occupation for his leisure hours and many idle hands were put to useful work.

Explaining the Failures

Rural development is no longer in experimental pioneering stage, and time has come that it is conducted on a planned and organized basis by the State. However energetic, benevolent and bold a district officer may be, it has been seen that purely personal and official work usually languishes and finally disappears after the transfer of that officer. Explaining the reason of such failures, Sir Malcolm Darling writes :

"Such achievements have no root

for the only sanction behind them is personal authority, which is uncertain in its pressure and changeable in its direction. If it is desired to proceed by order—and the influence of a Deputy Commissioner, if strongly exerted, is inevitably transmuted into orders when it reaches the peasant—the only satisfactory method is legislation, for then orders can be directly given and permanently enforced; nor are the orders dependent upon the will of an official who may be here today and gone tomorrow. But if a particular remedy or reform is not a case for legislation—and in the sphere of rural reconstruction few are—the only way to get it permanently adopted is to convince people that it is for their good, and to make them feel this so strongly that they will apply it themselves. In that case the sanction behind it will be either the individual will or the collective force of public opinion expressed through the village community, or, it may be a cooperative society."

The ultimate failure of all work done under official guidance has taught us the lesson that the urge for betterment must come from the people themselves though all help, monetary as well as advisory, should be given by the Governmental agency. The villagers should be given all the help in developing *panchayats* and local leadership must be encouraged. The work done under official control may be likened to pouring water in a pond. Some of it seeps down, some of it evaporates, some of it is used, all of it stagnates and ultimately the pond dries up as soon as its artificial feeding is stopped. What is desired is to dig deep and to expose the well springs of life so that the fountain of village life keeps on supplying ever fresh and sparkling water.

Departmental Anarchy

Need of coordination of work among

developmental departments of the Provincial Governments has been felt by all workers who have experience of development work in the field. The chief departments which carry on work of this nature in the villages of the United Provinces are Revenue, Agriculture, Animal Husbandry and Veterinary, Co-operative, Education, Rural Development, Cane Development, Gur Development, Forest, Irrigation and Public Works and Public Health. In these departments there is lack of coordination from the top to the bottom and from the provincial headquarters to the field worker. Considerable duplication and overlapping results due to this departmental anarchy. The same work is being done by the workers of different departments. Seed stores are run by three separate departments, viz. Agriculture, Co-operative and Rural Development. Advice on sanitation is given by Public Health, Rural Development and Co-operative Departments. Libraries in villages are run by Education and Rural Development Departments separately. This departmental anarchy and lack of coordination has been the main obstacle in the way of a coherent and planned development of villages.

A Remedy

Mr. M. D. Chaturvedi, who was the Provincial Rural Development Officer under the first Congress Ministry, makes the following observations on this state of affairs and also suggests a remedy :

“The multiplicity of departments dealing with the development of the countryside in these Provinces is indeed baffling. To deal with the simple needs of the rural population in watertight compartments is neither possible nor desirable. Excessive departmentalization has led in the past to overlapping, inefficiency, mutual jealousy, dissipation of effort and the frittering away of the limited resources of the State. The poor

cultivator can ill-afford the luxury of having separate experts to advise him in matters relating to agriculture, welfare of cattle, cooperation, better living, marketing, health and sanitation. What he wants is a single friend, philosopher and guide who can deal with his difficulties on the spot and offer simple practical solutions. . . . The need of the hour is neither the expansion of the existing departments, nor the creation of new ones. What is required is the coordination of all development departments with the object of organizing a concerted drive for the development of the countryside viewed as a whole and not piecemeal. All overlapping and duplication must be courageously rooted out and various development departments be fused into a single development department with one common field staff which should carry out the behests of various departments in the villages.”

A New Organization

To effect coordination from the provincial headquarter to the village, the following organization is suggested, which is based on the proposals made by the Bengal Administration Enquiry Committee, Mr. M. D. Chaturvedi, and the personal observations of the author.

I. *Coordination of Development work at the Provincial Headquarter.*

(i) *Development Committee of the Cabinet.* It would have the Chief Minister as Chairman, Ministers in charge of Development Departments as members, and Provincial Development Officer as Secretary.

(ii) *Provincial Development Board.* It would consist of Secretaries to Government in Development Departments, the Provincial Development Officer and the Development Secretary, and Secretary of Finance Department. On this Board there will be one representative of *Panchayats* from each division. The functions of this Board would be to

prepare an integrated provincial development plan from the plans of different Departments, to draw a district plan for each district, and to keep watch over the execution of the provincial and district plans. Attached to the Board will be a Provincial Bureau of Statistics.

(iii) *Provincial Development Officer*. He will be the head of the Provincial Rural Development Department and Secretary of the Development Committee of the Cabinet. His powers will be the same as that of the head of a Department and Secretary to the Provincial Government. He will direct rural development activities through the District Officer and the District Development Officer.

II. *Coordination at District Headquarters.*

The biggest organization in the province with ramifications penetrating into the remotest village is the Revenue Department. Taking United Provinces as an example we find that it employs 27,443 *Patwaris*, 832 *Qanungos*, 200 *Tahsildars*, 380 Deputy Collectors and about 150 I.C.S. Officers. Previously all development work was carried through the agency of the Revenue Department under the guidance of the Collector. With progressive departmentalization, the district officer, as Mr. Chaturvedi observes, "has assumed the role of disinterested critic of various schemes, often launched in his jurisdiction without his knowledge. The tax-payer maintains an expensive machinery which must be made use of and not short-circuited."

The District Officer aided by the District Development Officer is the best person to coordinate and supervise developmental work. So far as developmental work is concerned he should be empowered to make an entry into the character rolls of all local officers of the development departments, such as Public Health, Agriculture, Veterinary, Education, Cooperative, Irrigation, etc. In his own turn he should submit a fortnightly

demi-official report on development work to the Provincial Development Officer, who should be empowered to make an entry in the character roll of the District Officer as far as development work is concerned.

The District Development Officer

Rural development work in the district was entrusted to joint magistrates or Deputy Collectors in the Rural Development scheme, launched in the United Provinces in 1935. These officers were designated as District Rural Development Officers and later on under the second scheme launched by the first Congress Ministry as Secretary of the District Rural Development Association, a body with a non-official chairman and a membership consisting of local heads of development departments, members of the Provincial Legislature, and other non-officials. Usually the Secretary was also a Sub-Divisional Officer, and had plenty of work to fully occupy him, and rural development was regarded merely as an appendage, not to be taken too seriously. Aided by a couple of clerks, he was supposed to administer development work in a population of about a million persons. It required a heroic individual inspired by lot of faith to work under such circumstances.

If rural development work, which should include consolidation of holdings, administration of work of all *panchayats* and agricultural improvements, is to be done on a district-wide scale, a much bigger organization is required. In this organization the District Development Officer has a key-role. Mr. M. D. Chaturvedi, thus defines the functions and qualifications of the District Development Officer :

"While various departments must maintain their separate identities at the top at the headquarters of the Government for purposes of actual execution of rural schemes, they must function through

a single authority in districts, known as the District Development Officer (D.D.O.). The field staff of all development departments must be common and should be placed under the D.D.O. It should be the business of experts to reduce their technical schemes to such simple forms as to be capable of execution by a development organizer with a general training and knowledge of rural conditions. It is difficult to conceive any agricultural, cooperative, forest, or for that matter any development scheme introduced for the amelioration of rural conditions to be so abstruse as to require an expert for its execution in each village. The job of the specialist must cease with the drawing up of a scheme, its execution being left to the district authorities.

..... Technical education, research and special schemes will continue to be under the direct control of various departments as heretofore. The field staff of all existing development departments must be transferred to the control of D.D.O. The heads of various departments will continue to exercise supervision of the progress of schemes through their administrative officers each in charge of a circle consisting of a number of districts. The District Development Officer, it will be seen, constitutes the key-stone of the entire edifice. The powers conferred on him must be commensurate with the duties he is expected to perform. Without being in charge of any sub-division he must exercise the powers of a Sub-Divisional Officer in all *Tahsils*. In short, he should have the powers of an Additional Collector. A second entry in the character rolls of all *Tahsildars* should be made by him regarding their cooperation in development activities. On the proper recruitment of D.D.Os depends the entire success of development schemes. They must be recruited from the Deputy Collectors (preferably with a science degree) and officers of corresponding

grade in other development departments; a number of posts being reserved for promotion from the ranks. They should have the status of a Deputy Collector with a special pay to compensate them for the arduous nature of their work. Special training courses extending over one year must be organized at the Agricultural College, Cawnpore, to acquaint the D.D.Os with agriculture, cooperation, forestry and other activities. They should be eligible for promotion to the administrative posts in their own departments and listed jobs in the Revenue Secretariat.

“ Communications being difficult, as they are, it is difficult for the D.D.O. to inspect the execution of various schemes frequently in his jurisdiction. An Assistant Development Officer (A.D.O.) must be provided at the headquarters of each *Tahsil*, who is to exercise the closest personal supervision on the execution of all schemes. The A.D.Os must be recruited from the present subordinate staff of Agricultural, Cooperative, Rural Development, Forest and other departments. They must be given a year's training in various developmental activities at a centre specially organized for the purpose. The A.D.Os must have the status of an Additional *Tahsildar*, his pay and prospects.

“ In districts where erosion, afforestation and reclamation of *usar* constitute the chief problems, the District Development Officer may well be selected from the gazetted forest staff to emphasize the forest bias of development activities. Similarly, forest rangers may be drafted to the *Tahsil* headquarters as Assistant Development Officers, and foresters and forest guards to the field staff. The Land Management Department, like other departments, will concern itself with education, research and special schemes which cover more than one district such as roadside avenues, afforestation of canal and railway lands,

RURAL DEVELOPMENT ORGANIZER

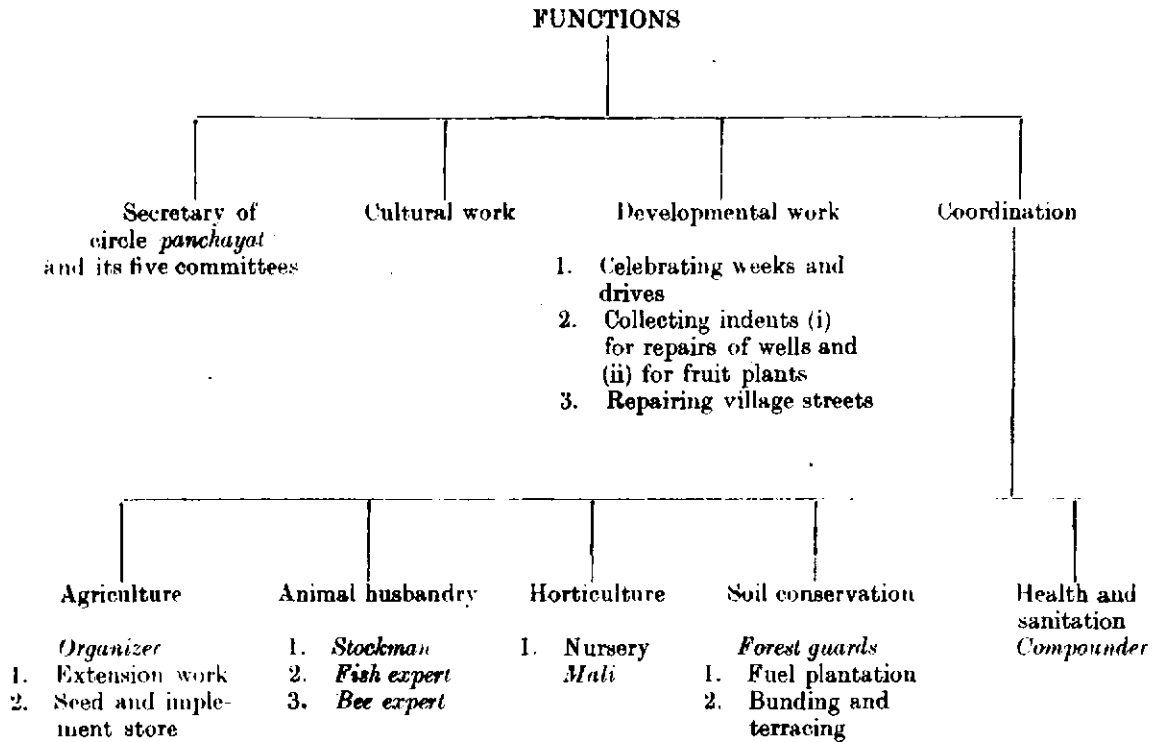

ravines, distribution of seed and plants, technical advice to private owners of wood-lands and management of State-owned blocks. The execution of village schemes such as renovation of groves, control of erosion, planting scattered trees, creation of grazing grounds and fuel and fodder reserves will best be carried out through the District Development Officer."

Rural Development Organizer

The success of the scheme of development greatly depends upon the personnel selected for guiding groups of villages in a development circle. In the selection of Rural Development Organizers choice should fall upon individuals, who come from cultivating classes of villagers, and have a progressive social outlook. They should be at least matriculates, and if young ex-soldiers who have the additional asset of army discipline are available, they should be preferred. Apart from educational qualifications, I used to impose three tests upon candidates, who came for selection before me at Fyzabad : firstly, willingness to drink water from the hands of a sweeper to test the social and cultural fitness of the candidate ; secondly, ability to lift a barbel about a maund in weight, as a test of physical fitness, and thirdly, ability to handle a plough in the field.

After selection the candidates should be given training in essentials of Agriculture, Horticulture, Animal Husbandry, Cooperation, Panchayat work, Rural Hygiene and Sanitation, etc., at Agricultural Colleges and specially equipped training centres. When fully trained these organizers should be given higher status and salary as compared with Agricultural Extension workers, Stockmen and Forest Guards, etc., whose work they will coordinate and supervise.

On appointment the main function of the Rural Development Organizer will be the guidance of the work of the

Panchayats, particularly of Circle *Panchayats* and of extension workers of various development departments, who will be working under his guidance, and cultural and propaganda work through the medium of talks, dramas, posters, charts, films, etc. He will bring a change in the mental outlook of the farmer. Too much emphasis cannot be laid upon the cultural side of rural development work, for a mere material change, not accompanied by a psychological change, cannot spell progress. Those who ignore the psychological aspect of the problem fail to realize that if sanitation, regular work and full meals alone mean rural development, then our district jails would be regarded as more fully developed as compared with villages. To quote the Bengal Famine Enquiry Commission again, "Economic development on the one hand and social and cultural development on the other cannot be separated into water-tight compartments, nor can the provision of social and cultural services be postponed until economic development is complete ; further, progress in the economic field is conditioned by progress in the social and cultural fields. Ignorance and ill-health, no less than poverty and economic insecurity, are responsible for a mental outlook, compounded of apathy, lethargy, resignation and lack of ambition, which must inevitably present obstacles at every stage to any scheme of planned development. Economic, social and cultural development must thus go hand in hand."

We are faced with the task of remaking a vast multitude of humanity, many of whom have sunk into sub-human conditions due to feudalism and poverty. To give them a feeling of dignity and self-respect, we require workers who know the people intimately and those who are prepared to work selflessly and indefatigably, sustained more by the joy of nobleness of the work itself rather than by lure of power and salaries.

The Russian Selosoviet

Have we anything to learn from the experience of other countries, which have problems similar to our own? In Russia before 1917, conditions were not very different from that of present day India. The Soviet system as organized in villages of the U.S.S.R. has many features which can be usefully adopted in organizing *panchayats* in villages of India.

By the term Selosoviet is meant a council of delegates chosen by the peasants of a village or agricultural district or community, from which land-owners, shop-keepers or persons of no occupation are avowedly excluded. As Sidney and Beatrice Webb describe: "The right of vote, and with it the right of eligibility for office, is avowedly based on active participation in socially useful work of one or other kind, by hand or by brain."

Sidney and Beatrice Webb in their classic study *Soviet Communism, a New Civilization*, have given a detailed description of the village soviet. It is thus that they describe the organization and functions of village soviets:

"The village meeting in the U.S.S.R., now including all residents or occupiers, male or female, over eighteen, not being among the 'deprived' categories, has lost some of the powers of the Mir, but is still unfettered by any precise limitation of what it may do. It may, however, now discuss any matters relating to the government, central or local. We are here concerned only with its position as the base of the pyramid of soviets. Whilst the meeting can still be held as often as is desired, and may, in practice, discuss anything in which its members are interested, a new and important function (if it has not less than 300 inhabitants) is the triennial election of the village soviet (selosoviet). This is conducted by an independent electoral commission, the president of which is appointed for each electoral area by the

presidium of the rayon. This president is assisted by ten members nominated by the village soviet itself. The commission fixes the date at which the election is to take place; appoints a chairman for each meeting; revises the existing list of persons excluded from the franchise, and causes this to be publicly posted in the village; and sees to it that the electors are, five days in advance, personally notified to attend, as a quorum of 40 per cent of the electorate must be present to avoid an adjournment.

"Wherever there is an active cell or nucleus of the Communist Party, this will usually prepare a 'slate' of recommended candidates, seldom confined to Party members: usually putting these forward only for a certain proportion of the places to be filled. The vote is taken, as has been immemorially the custom, by show of hands. . . . Finally the candidates who have received the votes of a majority of the meeting—the number having been thereby reduced to the number of places to be filled—are put simultaneously to the vote, now usually unanimous, and declared by the chairman to be elected.

"At this point it is well to remember that these meetings of the village electors are summoned, not merely triennially to elect the selosoviets, but also frequently throughout the three years, often six or eight times within twelve months. These meetings are habitually, though not invariably, held in the evening, and are reported to be numerous attended, often by more than half the total electorate, and not infrequently by nearly as large a proportion of women as of men. The discussions range over the whole field of public interests full expression being given to local desires. Thus the meeting may voice the popular desire for a public bath-house, or a village hall, or for the establishment or closing of the government vodka shop.

“The election of the soviets at first took place annually. A few years ago it was directed to be held every two years. Now it is, in village, rayon, oblast and republic alike, triennial. The recall can be exercised at any time by the electing body.

“Thus, it seems that the working constitution of the U.S.S.R.—taking, for the moment, only that part of it which lives in the villages and is represented in the pyramid of soviets—is rooted in an almost inconceivable amount of public discussion, in literally a million or two of small local meetings in the course of each year. Whether or not the vociferous debaters at these innumerable meetings get all the attention they desire, the political student will note, not only the amount of political education, but also the sense of continuous participation in public administration that such discussions create.

“The total number of rural electoral areas electing selosoviets was officially stated in 1931 as 71,780 when the number of villages and hamlets was given as 599,890, so that, on an average, eight or nine of these were united in each selosoviet.

“The agricultural population of the U.S.S.R. is settled mostly in villages. Isolated farms are found only in the north-western regions of the Union.

“(Note that a new election of the whole selosoviet is to be held (a) if more than half the elected members have resigned or left the district, and there is an insufficient number of ‘candidates’ (substitutes); (b) if a selosoviet does not follow the proletarian class-policy, or if it includes in its membership people who do not adhere to the above policy, or if it has manifested a general inactivity. —Decree of January 1, 1931).

“The Soviet Government is not content that the village soviet should deal only with the questions of local importance; and the newest decree insists that every

selosoviet should consider and discuss also affairs of rayon, oblast, republic and even U.S.S.R. importance. It is laid down, in a general say, that, within its territorial limits, the village soviet has control of the execution of all citizens and officials of the laws and instructions of the government.....The village soviet may, within its wide competence under the statute, issue obligatory ordinances and impose administrative penalties and fines. It may establish village courts, with jurisdiction over disputes as to property or conditions of employment and over petty offences. ...But perhaps the most interesting enlargement of the sphere of the village soviet is the range of duties assigned to it in connection with the newly developed kolkhosi or collective farms within its area. The village soviet is to instruct, to supervise, to inspect, to audit, to insist on the fulfilment of all obligations, and in obedience to all laws and regulations. Moreover, it is equally part of the duty of the village soviet to keep an eye on the operations of the state manufacturing and trading departments in its locality, and on those of the consumers' cooperative societies in order that the village customers may not be baulked in getting what they desire, and as failing to swell the receipts by their purchases. Within the village itself, there is practically nothing that the soviet may not organize, regulate or provide at the public expense, from roads and water supplies, through club houses and dance floors, up to schools, theatres and hospitals.

“Within the village the selosoviet is ‘sovereign’; meaning that nothing which it does requires the sanction of any higher authority before it is put in operation. Nor does the Government seem to grudge any amount of public expenditure on raising the standard of life of the mass of the people. Every public department at the republic capital,

or at Moscow, is, in fact, genuinely eager to stir all the 70,000 village soviets into the utmost public activity. Far from wanting to concentrate everything in the ministerial commissariats of the U.S.S.R. or even in those of the several constituent republics, the widest scope is given to each of the directly elected councils of the 70,000 villages, between the Baltic and the Pacific, to do all it can for its own people. The view taken by the central authorities is that it is only by the widely dispersed efforts of the local bodies—in fact, only by the active participation of the people themselves in their incessant meetings which the village soviet obeys—that the frightful social backwardness of the countryside can be, within this generation, overcome.

The Powers and Authorised Functions of the Village Soviet

I. In the sphere of Agriculture

(a) It elects the village statisticians-representatives and carries on all statistical work.

(b) It keeps the register of village households.

(c) It takes necessary steps to preserve the existing kilkhoses and to form the new ones.

(d) It discusses and sanctions the plans of collective farms and other cooperative organizations.

(e) It gives its conclusions as to requests for credits and equipment for the kilkhoses.

(f) It assists in the introduction of new methods in the collective farms.

(g) It supervises the distribution of labour and technical staff in the collective farms and attends to the discipline in the collective and soviet enterprises.

(h) It takes all necessary measures in increasing the area sown, and in raising the yield, and encourages the development of all kinds of farming and the introduction of agricultural improvements.

II. In the sphere of industry

(a) It runs its own industry.

(b) It controls the use of sandstone and clay on its territory.

(c) It supervises its home industry and assists kustars in creating artels.

(d) It supervises all enterprises on its territory and renders them the necessary assistance.

III. In the sphere of forestry

(a) It looks after the forests which have a local use.

(b) It develops timber and the wood-chemical industry.

(c) It supervises all woods and forests on its territory and renders assistance in preserving woods and forests from fire, damage, etc.

IV. In the sphere of supply, cooperation and trade

(a) It attracts the local population to cooperative organizations and improves their activities.

(b) It collects and controls funds for the purpose of cooperative and collectivisation of batraks (landless peasants).

(c) It fixes rents for shop premises and stalls.

V. In the sphere of finance and budget

(a) It collects taxes and rates.

(b) It collects fines and sells by auction the property of persons who have not paid them.

(c) It makes inventories of inheritances and communicates them to the Rayon Ispolkom.

(d) It deals with the self-taxation of the population.

VI. In the sphere of local government

(a) It deals with all housing questions, schools and hospital buildings, etc.

(b) It repairs local roads, bridges, etc.

VII. In the sphere of labour

(a) It attracts, if necessary, the local population to public works in making roads, organizing transport, etc.

VIII. In the sphere of education

(a) It liquidates illiteracy and opens all kinds of educational institutions.

(b) It supervises the public education of children, takes care of the homeless waifs, appoints trustees to them, etc.

(c) It assists the government in establishing agricultural and technical education, distributes young persons amongst different schools and factories, etc.

IX. *In the Sphere of Health*

(a) It supervises all hospitals and sanitary establishments, which are maintained on the Selosoviet Budget.

(b) It advances the knowledge of personal hygiene and develops physical culture.

X. *In the Sphere of the Defence of the Country*

(a) It keeps the register of all persons liable for military service.

(b) It registers horses, carriages and other requisites of war.

(c) It assists in recruiting.

XI. *In the Sphere of Judicial Prosecution*

(a) It forms a village judicial court.

(b) It attends to the strict fulfilment of the decisions of the court.

XII. *In the Sphere of Revolutionary Activities*

(a) It combats drunkenness, hooliganism and secret sale of alcoholic drink.

(b) It appoints village executive officers (ispolnitel).

(c) It collects administrative fines.

XIII. *In the Sphere of Administration*

(a) It registers deeds, issues identity cards, etc.

“It is, of course, not to be supposed that the immense catalogue of duties decreed in 1930, and recited summarily in Appendix IV of Part I, are actually being performed by the village soviets. Probably no selosoviet is dealing with all the matters prescribed, and the majority are doing but little. What is significant is that they are all empowered to take any action they choose in all these directions; and that they are being frequently exhorted to use this liberty to make their own decisions. Thus, what even the downtrodden Russian peasant

is gradually acquiring is a sense of political freedom.

Administrative Safeguards

“The principle may be summed up as freedom to err, subject always to veto and reversal by superior authority. Moreover, any decision or action by the village soviet may be vetoed and reversed by any higher authority, such as ispolkom, or executive committee of the rayon, . . . and the advice and instruction given by inspector or other official, or even by a visitor who is a Party member, will, if unheeded, in due course be supported and enforced by superior authority.

“Just as the Mir had its starosta, so the selosoviet has its president, with other executive officers, in addition to the secretary (who may or may not be a member of the soviet) whom it appoints. These executive officers, by a recent decree, are to number one for every seventy-five households in areas of complete collectivisation, and one for every fifty households in areas of incomplete collectivisation. They are appointed by the soviet for a term of two or three months. If they are members of a kolkhos, or collective farm, or employed in any public office at a wage or salary, they are entitled to take ‘time off’ for their public service under the selosoviet without loss of income. The duties of these village executives are to keep order; to protect public property; to keep open the highways and supervise sanitation; to report all violations of law, and to carry out the decisions of the village courts; as well as to perform any other functions that the soviet may put upon them.

“The soviet is required by decree to appoint besides its ispolkom, or executive committee, also a number of sections or committees to deal with separate parts of the work, and it is strongly urged to associate with its own members on these sections a large

proportion of the village residents. In the R.S.F.S.R. it is ordered that every selosoviet shall appoint at least seven sections, for agriculture, women's work and interests, education, cultural developments, finance, trade and cooperatives, and finally, for the general communal life. In addition, selosoviets appoint special committees to deal with particular collective farms, or to collect taxes, and also such officers as statisticians, harvest controllers, etc. Over and over again the decrees insist on the duty of the soviets to incite, persuade and press the apathetic toiling masses, and particularly the women, to take interest in public affairs, to join the sections, to attend the meetings, and to vote.

"At first the village soviets had no separate budget, and their receipts and expenditure formed part of the budget of the volost (now rayon). Now each selosoviet is ordered to make its own budget in the way prescribed by the constituent republic. Its revenues include the income derived from local public property and enterprises, the local taxes and dues collected within the village territory, including the agricultural tax and contributions to local revenues under various laws and agreements with the state, the constituent republic and the collective farms; and lastly, the 'self-assessments' levied by the village soviet itself. These latter require the majority decision of a special meeting at which not fewer than 50 per cent of the entire electorate must be present. The assessments most frequently levied are, we are informed, those for the building and maintenance of educational, health and cultural institutions; the improvement of communications by roads; veterinary and other agricultural institutions; fire protection; public baths and water supply from wells and ponds; the provision of a new burial-ground; and the employment of a village watchman."

The Village Panchayat

The village is the ultimate unit of administration as well as development. In the plan which we have outlined, the village *Panchayat* with judicial, developmental and cultural functions aided by the State organized *Panchayat-ghar* institution is to be the pivot of rural development. Such *Panchayats* elected on universal adult franchise and with such wide functions and powers do not exist anywhere in India, and will have to be created by legislation.

The Village *Panchayat* had wide all-embracing functions in Hindu India, as is evident from *Nitisira* of Shukracharya. In some ways it resembled the Russian Mir of the eighteenth century; it distributed land among cultivators, collected taxes and paid the government's share of produce on behalf of the village. With the advent of the British rule and centralization of administration of justice in district headquarters, the *Panchayat* organization became obsolete and disappeared. Only caste *Panchayat* continues to survive, particularly among Chamars and Pasis in the United Provinces, Pariahs and Dravidas in Andhra, etc., and its hold is due to social sanctions which it applies to recalcitrants.

Judicial *Panchayats* which are empowered to try petty cases of simple hurt, theft, cattle trespass, etc. exist in a number of provinces and have done good work. But such *Panchayats* have no developmental or cultural functions and even their judicial powers are severely limited.

Multi-purpose Panchayats

With the object of developing village India an all-embracing *Panchayat* organization is proposed which will associate the village with the developmental work of the Government at all stages. At the base will be the village *Panchayat* of five or more members, exercising judicial authority in the village,



M. S. RANDE

DEMOCRACY IN VILLAGES : ELECTING A PANCHAYAT



M. S. RANDHAWA

A PANCHAYAT SETTLING THE DISPUTE

and each individual member entrusted with developmental or cultural functions. It would be empowered to try civil cases of the money value of Rs. 100, and criminal cases of simple hurt, affray, trespass, cattle trespass, and petty theft upto the value of Rs. 100. The village *Panchayat* should have powers to inflict fine upto the limit of Rs. 100. The village *chowkidar* will work under the supervision of the *Panchayat*.

The Circle Panchayat

The Circle *Panchayat*, based on *Panchayatghar*, at the centre of developmental circle for ten villages will have special significance, and in its functions it will be equivalent to the selosoviet. The Rural Development Organizer will function as its Secretary and it will have five members from each village. These 50 members from ten villages will function through five committees, each having ten workers.

I. *Executive Committee*. Its Chairman will be resident of the village with *Panchayatghar* and it will have one member from each village. It will deal with day to day administrative business of Circle *Panchayat*, correspondence and accounts.

II. *Judicial Committee*. It will try all cases which are directly filed before it, or are transferred by the *Tahsil* Development Officer from a member of village *Panchayat*. Due to enmities and party factions and feuds, villagers do not trust their village *Panchayats* and transfer applications are commonly filed. Where there is good ground for transfer of such cases, these should be dealt with by Circle *Panchayats*. To obviate the risk of too many transfer applications, the villagers should have option of filing a case before the village *Panchayat* or Circle *Panchayat*. The Circle *Panchayat* should have higher powers, as compared with the village *Panchayat*. It should be empowered to try civil cases of the

money value of Rs. 500, and criminal cases of grievous hurt, riots, burglaries etc. It should have powers to inflict imprisonment upto six months and fine upto Rs. 500. Its orders should be executed through the local police station.

III. *Committee for Agriculture*. This Committee will draw a programme for development in Agriculture, Animal Husbandry, Land Utilization including forestry, Horticulture and Destruction of Pests for ten villages in the Circle, which will be executed by Village *Panchayats* under the guidance of Rural Development Organizer, Agriculture Extension Worker, Stockman and *Mali*. When the Circle *Panchayat* is developed to its ultimate extent, this Committee will supervise the cooperative farm, draw crop plans, and will decide how much area should be planted with fuel, fodder, fruit and ornamental trees. It will also introduce improved seed and agricultural implements, and take steps to exterminate stray dogs and monkeys.

IV. *Committee for Cooperative Marketing, Cottage Industries and Labour*. It will run the Cooperative Consumers Store, Museum of local Products and will arrange marketing of agricultural produce and products of cottage industries, sale of mosquito nets and quinine.

V. *Committee for Health, Sanitation, Education and Cultural Pursuits*. This Committee will look after adult education, libraries, propaganda, celebration of folk-dances, dramas and festivals, sports, health and sanitation problems, and also combat drunkenness and drug habits. One of its most important functions will be to combat evils of caste system, *purdah*, child marriage, and similar legacies of the past which are keeping the people of India backward.

Finance

For running an efficient organization, which is only possible if adequate staff is employed, the *Panchayats* should be

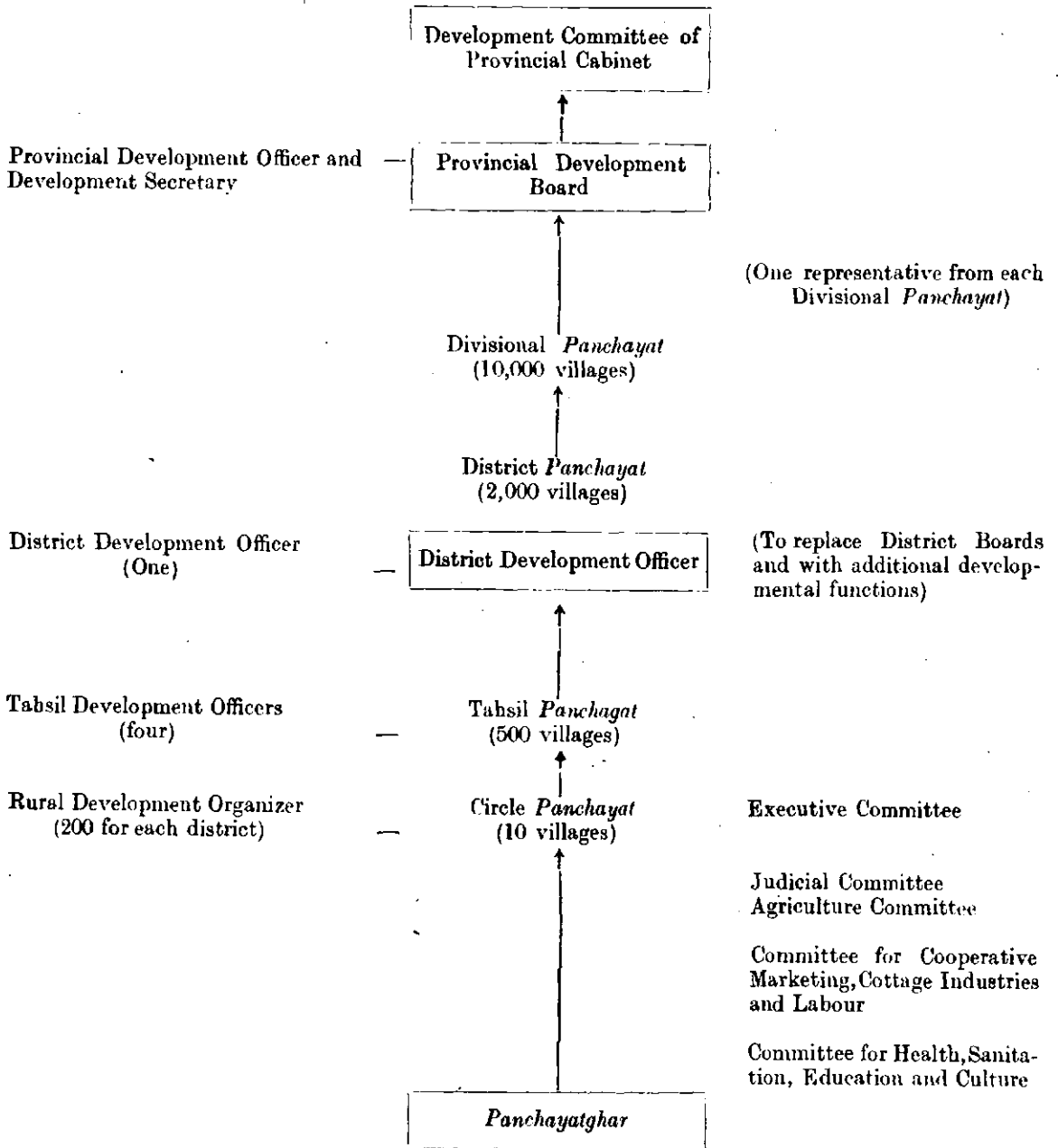

supplied with an adequate source of finance. A cess levied with land tax can alone supply an assured and reasonable income. This should be supplemented by proceeds of income from cattle-pounds fines and donations.

Tahsil Panchayat

The Circle *Panchayats* will elect a *Tahsil Panchayat*, which will represent 500 or odd villages of the *tahsil* with the *Tahsil* Development Officer as its chairman.

District Panchayat

The *Tahsil Panchayats* will elect a District *Panchayat* which will replace the existing District Boards, and will take over their functions. The District Development Officer will be the ex-officio chairman of the District *Panchayat*. He will deal with all developmental work, including consolidation of holdings, supervision of judicial work of *Panchayats*, and land acquisition work.

Divisional Panchayat

Each district will send representatives to a Divisional *Panchayat* which will, on the average, represent 10,000 villages, and will ultimately send one representative to the Provincial Development Board.

Official Agency

Only with the cooperation of the people and the government at all stages can developmental work make any substantial progress in the villages of India. At present there is distrust of the official agency, which will disappear with the complete transference of power to the people. A well organized and disciplined official agency is *sine quo non* of progress in developmental work. The villager is accustomed to be led and considering his frightful backwardness, only a strong and benevolent official agency staffed by persons who are inspired by zeal for work rather than

lure of salaries and allowances, aided by *Panchayats*, can lead him out of the morass in which he has got stuck.

In the scheme outlined above the official organization of technical experts and administrators, consisting of Rural Development Organizers, Extension Workers of Agriculture, Animal Husbandry, Land Utilization, Public Health, Cooperation, etc., *Tahsil* or District Development Officers, leading upto the Provincial Development Commissioner, runs parallel with the peoples' organization of *Panchayats*, ranging from the Village *Panchayat* to the Provincial Development Board.

Wanted a New Spirit

What is however more important than schemes is the spirit with which the schemes are worked. Unless the rural masses are enthused into action, and the administrative authorities work with a religious zeal, even the best of schemes is doomed to failure. New types of responsibilities devolve upon the government whose main function has been collection of taxes and policing the country. As the Famine Inquiry Commission observed :

"India does not lack the material resources necessary for advancement and prosperity, but these can be developed only by the efforts of human beings—by the governments and people of India and success depends on the spirit which sustains the country in the tremendous task with which it is faced. In the past apathy and defeatism have been all too prevalent. Doubts have been expressed whether the basic economic and social problems are soluble at all. Poverty and hunger have been accepted as part of the nature of things and much of the countryside may almost be described as a rural slum where the hopelessness engendered by slum conditions prevails. Such an attitude of mind, on the part of either rulers or ruled, is incompatible

with progress. Without vision and faith in the future little can be achieved.

“At present all governments are preparing plans of reconstruction and development in the post-war period. A new spirit and a new determination are abroad. But it is one thing to draw up plans, another to carry them out. A great responsibility rests on governments, administrators and government servants of all grades in organizing and stimulating the work of ‘nation building’. The duties of modern governments extend far beyond the maintenance of law and order; they include within their compass social and economic development in all its aspects. To build a new India dynamic rather than static qualities on the part of the administrations are required. Governments permeated by the ideas expressed in the aphorisms ‘safety first’ and ‘after us the deluge’ are inevitably stagnant and can achieve little or nothing. There is need, too,

for a change of tempo; to use a familiar phrase, the future pace of progress must be that of the motor car rather than that of the bullock cart. If administrations approach their duties in this spirit, we feel that the people as a whole will respond and cooperate in the work of development.”

Real Rural Development would only be possible if the organization and execution of the work is taken up by the people themselves through their *panchayats* with the official agency remaining in the background, always ready to guide and help. It is only then that the untapped energy of millions of people can be canalized for developing the countryside of India. When these committees will draw their own developmental programme according to their needs and execute them instead of looking like helpless orphans towards the Government, only then rural India will awaken from its age-long slumber.

STATE LEADERSHIP IN AGRARIAN ECONOMY

By N. C. MEHTA

INDIA faces an economic crisis of the utmost gravity. Our agricultural economy has been disrupted; it is now diseased, effete and ineffective. The principal asset of the country—namely its man-power is being frittered away for want of necessary organization and equipment. Despite the efforts of our huge population, we are no longer able to produce even enough food for bare subsistence. The reason is that the farmer has been left very much to his own unaided devices, which in practice amount only to uncoordinated labour, ignorance and helplessness with the minimum of scientific and technological resources. The share of the administration has been limited largely to enable him to produce enough atleast to pay for the elaborate, relatively expensive and inefficient machinery chiefly designed to maintain law and order. The role of the State has been on the whole passive. Now that the catastrophe has come, there has been a great searching of hearts. Frantic attempts are being made to tide over the crisis. But economic maladies work their way into the vitals of the body organism, and the treatment is never easy. I shall not waste more words in filling in the colours of a picture which is already grim. I shall briefly set down what I think should be done.

A remarkable publication entitled "A Food Plan for India" has recently been published by the Oxford University Press under the guidance of Professor A. V. Hill. It deserves to be deeply studied by all who are interested in the welfare of this vast country.

"The spearhead of attack on the economic development of India must therefore be the establishment of agriculture as the staple and prosperous industry without which any attempt at development in other fields, such as urban industrialization, will inevitably fail. It will be an economic disaster if India cannot be made self-sufficient in food supply."

There can be no dispute about the truth of the dictum above, nor about the admirable proposals made in this—perhaps the most comprehensive food plan outlined for this country. I shall not go over the same ground. I only want to make some remarks about some fundamental aspects of the problem itself.

The Fundamental Error

Agriculture in India has been treated, as elsewhere some years ago, as something distinct from and subject to other laws than manufacturing industries. This has been a fundamental error, which has resulted in hopeless neglect of our entire agricultural economy at the hands of the State as well as the public. The vast unemployment or under-employment of millions of our agriculturists for many months during the year has received but scant attention; the paucity of the farmer's equipment has been almost ignored. Our agricultural departments have primarily confined themselves to improve the practice of the individual farmer without putting at his disposal the smallest fraction of the knowledge of science and technology. Resources of man-power, material and skill have been

available to increase the economic well-being of the country, but they have languished for want of a coordinating agency. The result has been enormous wastage and misuse of our biggest national asset namely the country's manpower. Here are some remarks from the report of the National Resources Committee of U.S.A. for 1939 :

“Manpower is by far the most important resource of the Nation and the resource likely to involve the largest waste. The millions of individual workers constitute the backbone of production, and their activity as skilled and unskilled workers, managers, artisans, farmers, teachers, doctors, or independent business men, provides the primary basis for the nation's standard of living. . . In addition, the failure to use available manpower reduces the effectiveness of future production as idleness breeds frustration and loss of skills. The magnitude of losses from waste of manpower throw the wastes in the exploitation of natural resources into insignificance.”

State Auspices

The country's morale has suffered. It is no longer now a question of coaxing the farmer either by resounding exhortations or monetary temptations. These may have some temporary effect, but the problem now is to raise the productive standards of the country in the immediate future, and anything standing in the way of achieving such an objective must be ruthlessly removed. Agriculture must be treated as an industry—as the first concern of the administration. The State has now taken the responsibility of feeding every citizen of the country. It must undertake the corresponding obligation of seeing that every citizen in the country is enabled to maximize his output with the help of suitable implements, and sufficient knowledge of modern technique. If social and legal restrictions stand in the way of economic

efficiency, they have to go. It is a question of making up our mind as to the shape of life we envisage for the citizen of the country. If it is a standard of economic well-being guaranteeing to him a minimum standard of food, clothing, shelter, education and health, our whole outlook on the organization of our social and administrative machinery has to be changed. There has been far too much reliance without any justification on private initiative, despite practical experience to the contrary. Small-pox has been wiped out by compulsory vaccination; similarly inefficient breeding of cattle has to be eliminated by legislative compulsion, and the livestock of the country has to be replenished and enriched by the latest methods of artificial insemination under State auspices on the widest possible scale. Unless this is done, there would be no solution either to the milk problem of the country, or of producing even enough draught cattle for the elementary needs of our agricultural economy.

Regional Specialization

The hiatus between agriculture and industry has to be swept aside. The State must have its own factories for producing fertilizers and manufacturing agricultural machinery and implements, it must construct a series of silos and storage depots, and make arrangements for proper marketing of the produce throughout the country. The State, in other words, will have to extend its operations to a very much wider segment of our national life than heretofore. It will have to tame our rivers for purposes of irrigating the millions of acres still lying waste, and producing cheap power. The achievements of Tennessee Valley Scheme in the U.S.A. will have to be emulated without further delay, for we have ample power resources available in our great rivers and streams. Technologically the country has enormous

potentialities, for the relatively poor lands of Southern Bombay and the areas in the Central Provinces are perhaps most admirably adapted for becoming the great industrial hives of technological industries on the largest scale. These resources are at present unutilized, for the necessary organization is lacking. Regional specialization will have to be needed, if we have to use our existing natural resources to their fullest advantage. Modern technology is perhaps the greatest weapon that Man has forged principally during the past two or three centuries. It is at the very heart of our economic problem. We have been too much preoccupied with the past—whether in the matter of existing social and legal arrangements, or in the matter of actual methods of farming. Individual skill or labour is not enough by itself. In the modern world it has to be aided to the fullest extent by the resources of modern technology, which are the most precious legacy of intelligent humanity all the world over. Here are some wise remarks again from the report of the U.S.A. National Resources Committee :

“Often unskilled use of the best technique is more productive than skilled use of an obsolete technique. Unskilled but intelligent use of a steam shovel can be more productive than the most skilled use of pick and shovel. Understanding of the best known way of doing things can make the difference between a high and a low level of living. The Indians on this continent had much the same natural resources as exist today and had great personal skills, but they did not have modern techniques.”

Economic Standard

Our entire economic machine has run down, for it has been left too long to the mercy of the individual. With political freedom round the corner and

the rising tempo of public opinion clamouring for the right to live, something more than pious intentions is needed. Every Province has to have a Ministry of Agriculture devoted wholly to raise the standards of farming by putting at the disposal of the cultivator all that the machinery of a modern State can do. Such a ministry will have to have the courage of undertaking legislation to make it possible for the cultivator to have an economic holding, and also to enable him to keep the bulk of the fruits of his labour. Agriculture will have to be the enterprise, with the State as the principal adviser, legislator and financier, and the cultivator as the working partner. It will have to be socialism on a comprehensive scale, for the agriculturist is in the position of a patient, who cannot help himself to any appreciable degree. He has to be helped to stand on his own legs, if the society of which he is the most important member is to be rejuvenated. There is a terrible time lag in applying the resources of modern farming and technology developed so fruitfully in Europe and on the American continent. The pretexts are varied. It is forgotten that science knows no racial or communal frontiers. Modern technology is responsible for the prosperity of the great countries like Canada, Australia and the U.S.A. An industrious community like ours, with its great virtues of steadiness, tolerance and shrewd understanding of local conditions, needs only the organized help of the leaders responsible for running the administration, and the young scientists aware of the latest advances in agriculture. Unless the economic standard of the people increases—and this is not a problem which can be solved either rapidly or without very hard work, no amount of eloquence about the achievements of India in the past, or her place in the future, will have any meaning.

New Methods

Briefly the State will have to take charge of the individual farmer and raise the standard of his economic health by persuading him if possible, and compelling him where necessary to adopt the new methods of agriculture, for the country can rise as a whole only if our agricultural economy with its millions

of farms and lakhs of villages is to revive with a new sense of energy and well-being. We shall have to banish the idea lurking in the hinterland of our minds that poverty has anything noble about it. Once our mind is made up as to the kind of society that we want to nurture, it will not be difficult to prepare the detailed blueprints for reorientating our agrarian economy.

LAND MANAGEMENT AND ECONOMIC PLANNING

By TARLOK SINGH

IN recent discussions the relation between land management and economic planning has been almost completely overlooked. In a predominantly agricultural country, by far the greater proportion of social wealth arises from land. The exploitation of land and allied resources calls for economic institutions which are efficient and progressive and rely upon the use of capital and organization no less than firms engaged in industrial production. A sound system of land management is also essential for securing that institutional integration between rural and industrial economy, without which the rural masses can scarcely rise above the level of potential labourers and producers of raw materials. An examination of the existing system of land management will furnish, moreover, a practical approach to the changes which it is necessary to bring about in land tenures in order to secure a substantial measure of economic efficiency and social justice.

The Peasant Sector

Broadly speaking, rural society in India divides into two main categories—peasant society and non-peasant society. In peasant society we reckon two types of villages—those in which land belongs to peasant proprietors, and those in which tenants with fixed or permanent rights possess control over the use of land, but subject to the payment of rent to certain 'superior' parties who, in turn, are responsible to the State for the payment of its dues. Where peasant proprietors

hold the land, we have to consider two problems. The first of these arises from the fact that the majority of holdings almost everywhere in India are uneconomic, that is to say, they do not give sufficient work to a man assisted by his family, or what often comes to the same thing, to a plough and a pair of bullocks. Static techniques, inability to save and invest, indebtedness, exploitation by more powerful social and economic interests are the necessary consequences of this situation. The second problem is that of exorbitant rents which tenants-at-will are obliged to pay. Both problems are greatly complicated by the pressure of population and the absence of sources of fresh employment outside the agricultural economy. High rents are to no small extent responsible for absenteeism and increasing starvation of the soil.

In village communities in which hereditary tenants control the use of the land, both these problems exist, and in fact they are even more accentuated than in peasant villages of the first type. But they also have a third problem, not less serious and in some ways even more urgent than the others. This is the problem of superior rights. Unless these superior rights are in some way commuted or terminated, there can be no serious planning in peasant villages in *zamindari* areas. With each bit of land under a multiplicity of claims, some reminiscent of the worst forms of feudalism, there is neither incentive nor opportunity for efficient cultivation.

The Non-peasant Sector

In the non-peasant sector of this rural economy the issues are somewhat simpler. This sector consists of areas under big landlords who hold land directly without any intermediate interests between them and the tenants-at-will or the labourers who work for them, and areas directly held by the State. Big landlords have areas large enough to constitute efficient farms, but low taxation, high rents and failure by the State to enforce their social responsibility lead to a degree of inefficiency, neglect of the soil and exploitation of tenants and labourers which cannot be reconciled with any kind of progressive planning. Areas held by Provincial Governments are as a rule leased out on a temporary basis or sold out or allotted in the form of small holdings. The result is that they do not set the pace for efficient agriculture, and even virgin soils are rapidly 'mined' by private parties.

Planned Economy

A planned economy on its agricultural side may be envisaged as functioning through a number of units of production, registered under the law, and classified according to Provinces, States and smaller territorial divisions, such as district, *tahsil*, revenue circle, etc. Each unit prepares its plan, according to its own potentialities and the instructions issued by the supreme planning authority in the light of the requirements of the total economy. Planning thus involves two processes—general directions filtering downwards and concrete plans moving upwards, being subdivided or integrated territorially, as the case may be, at each stage. The plan for each unit of production will embody both short-term and long-term targets and will imply a programme of capital expenditure by the State as well as out of the resources of the unit itself.

State farms and large private estate farms can easily fit into this picture of a planned economy. They will conform to the general pattern of production set by the State and will dispose of their produce according to the demands of public policy. There will be some difference of opinion on the question whether private estates are consistent with a planned economy. In practice this issue is decided, not on *priorie* considerations, but on grounds of practical expediency, as dictated by availability of personnel, public opinion and the balance of social forces existing at a given moment of time. There will, however, be wide agreement that if private farms are allowed to continue as units in the planned economy, they should be subject to a differential system of taxation, in which the tax per acre increases fairly steeply with increase in the size of the farm. Alternatively, they may pay an agricultural income tax over and above the flat rates of land revenue paid by all farms. Secondly, the State is bound to set the terms on which agricultural labourers and tenants-at-will may be engaged.

Planning in Peasant Villages

The major difficulty in agricultural planning, which includes crop planning and the development of new resources, lies of course in peasant villages. In the conditions which prevail in India, the choice lies between voluntary co-operation in as many directions as possible, individual holdings being maintained intact, and some more integrated form of rural organization. There is still a large school of thought which sets much more store by cooperation on an individualistic basis. There is a real danger that the multi-purpose cooperative society may now take the place of the cooperative credit society as the institution most favoured by Indian cooperators, and this may put off attention to

fundamental problems by a decade or so. In certain conditions multi-purpose societies are the only means available to us, for instance, in hilly areas. Our problems have now reached such magnitude that we must realize that multi-purpose cooperative societies are essentially feeble organizations without any organic principle of growth. The individual motive in them is too dominant to permit of firm and lasting cooperation on a group basis for the simultaneous execution of different objectives. They can rarely produce sustained and unselfish leadership. Moreover, even if a multi-purpose cooperative society is occasionally successful, its benefits are practically confined to producers. It can barely touch the problem of village servants and labourers. It cannot prevent subdivision or sub-letting of land. Thwarted and over-ridden at every step by the rival claims of individuals, it cannot develop the area of a whole village as one productive unit, make increasing use of new techniques, and invest a large part of the surplus in new improvements. Nor, again, will it be able to integrate new industrial work into the life of the village.

Clearly something more integrated is necessary. Any institution which implies cooperation in all things except farming will not be equal to our needs. The strategic key to the whole problem of rural planning is social control over the management of land. This may take the form of complete collectivism in which all individuals are set at the same level. They may be differentiated as workers, but as owners the past is entirely disregarded. If peaceful change is desired, outright liquidation of peasant holdings is not a practical proposition in a society in which the right of ownership has long been valued and freely exercised. What is conceivable and practicable, however, is an intermediate system in which individual holdings are pooled

into a single unit of management, and the right of ownership is transmuted into a title to a certain income based essentially on the total contribution in land and fixed capital made by an individual to the village farm as a whole. The system of *joint village management*, which has recently been worked out in some detail, belongs to this intermediate category¹.

Joint Village Management

Joint village management is the most concrete form in which we can at present, in the light of sociological and economic conditions in our villages, express the general idea of cooperative farming. As a concept in social organization, however, it is more definite and more advanced than the idea of cooperation between peasants. In the first place, in taking the village as the unit of management, it is in line with the historic evolution of Indian society. The village stands above caste, tribe and religion and, therefore, as a unit of social organization, we have no better foundation for building the economic as well as the administrative structure of the country. Secondly, joint village management is an instrument of social change, not only for peasant owners, but for all sections of the village community, including village artisans and village servants and labourers. When a measure of collectivism is reinforced by rapid technical change, many of the inequalities and restrictions which bear heavily on agricultural labour, will become totally irrelevant to the economy of the village. Finally, joint management embraces communal action, not only in the management of land, but in the use and development of all resources of the village. Thus, given certain conditions, the village can easily become a major organization at base in the industrial structure of the country.

¹*Poverty and Social Change* (Longmans, 1945)

It is not possible in this short article to explain how joint management will work inside the village, how the claims of different parties will be met, or the stages by which the new system is to be introduced in every peasant village. Our object here is to emphasize that without some kind of integrated joint organization in every peasant village, adapted no doubt to the temperament and tradition of Indian rural society, a planned economy cannot be achieved. Joint management has to be brought about not only in villages in which the land belongs to peasant proprietors, but also where hereditary tenants hold occupancy rights subject to the rights of superior parties. In peasant villages in *zamindari* areas, the first step is to free the final category of tenants, who are now entitled to cultivate themselves or to let the land to others, from all association with or control from parties who stand above them. In other words, on the one hand, the occupancy tenants of each village have to be organized on the basis of joint management, and on the other, their new organization has to assume collective responsibility for paying the entire dues to the State, which will, in turn, compensate the various superior parties according to their respective claims as assessed and recorded before the introduction of joint management. This would be the ideal course, but conditions are probably not ripe for it. The practical course would seem to be first to acquire and terminate all superior rights and then to secure the reorganization of occupancy tenants on a cooperative basis. While the initial start is more difficult in villages in *zamindari* areas than in the non-*zamindari* areas, they can move very rapidly to a degree of joint village ownership which cannot yet be envisaged in villages in which peasant proprietors hold the land.

Industrial Expansion

The transformation of the peasant economy on the lines described above cannot be achieved by itself. It has to be part of a large programme or economic expansion. Agricultural reorganization will throw up a surplus of about 15½ million male adult workers in British India alone. If we take into account non-agricultural workers in rural areas and various classes of urban workers, we have to be prepared to find new employment in British India in the next ten or fifteen years for about 21 to 22 million male adult workers. Employment created by large-scale and small-scale industry, both in rural and urban areas, is in the nature of a spearhead. As we push on with industry we shall simultaneously create the means for new types of tertiary employment. If a guess may be hazarded, we have to be prepared to create industrial employment in British India sufficient to absorb 12 or 13 million workers in order to be in a position to carry out simultaneously the reorganization of the rural economy.

The Transition

With the completest possible concentration of national energy, we should still need a period of perhaps fifteen to twenty years before we can successfully complete the change over from petty farming to joint village management in the rural economy. We have, therefore, to consider whether we can secure the framework of a planned economy before the processes of basic reorganization are completed. In other words, can we secure some social instrument straightaway for the planning of rural economic life? We have at present no village organization, through which directions can be transmitted to individual farmers, or which can act on behalf of a village community. In the existing system, any positive assistance which

the State may wish to render almost inevitably involves selection as between individuals, and will therefore frequently take the form of patronage on the part of minor officials. Our village society has no internal, dynamic, cohesive principle of change, so that large-scale expenditure by the State, useful as it is in a limited sense, is certain nevertheless to involve an increasing measure of waste, corruption and frustration.

It is suggested, therefore, that the first preliminary to the setting up of a planned agricultural economy should be insisted that every village shall be reckoned as an economic unit and shall have a joint organization to act on its behalf. This joint organization has necessarily to be democratic in conception. It should contain representatives of all families, owners as well as non-owners, who belong to the village, and should function through a committee or *panchayat* elected by the village. The State should use this *panchayat* as the instrument through which all facilities and concessions of an economic or administrative character will pass to the village. It will be necessary to set up expert administrative machinery for the guidance of these new *panchayats*. For reasons, which need not be discussed in this place, judicial functions should be kept wholly out of the purview of these *panchayats*. *Panchayat* is an old and familiar word and embodies the conception of joint action on the part of a village, but much of the recent legislation on statutory *panchayats* lays undue stress on judicial functions and in doing so opens the way to disruption and disunity.

Panchayats conceived as the means through which the State transmits its directions as well as its benefits will transform the village at once into a unit in the planned economy. This unit will not function of course in a sufficiently integrated manner until joint village management takes the place of petty individualistic farming, but we shall have achieved a major step forward if each village begins to function forthwith as a single entity in the planned economy.

Central Issues

The major issues in rural reorganization may be summed up as follows :

- (i) Merging of individual holdings into large units of management, taking the village as the basis for this purpose ;
- (ii) Removing the nexus between occupancy tenants and superior parties in peasant villages of *zamindari* areas ;
- (iii) Organizing private estates into units in the planned economy and at the same time legislating (a) for the protection of the agricultural workers, (b) for the regulation of rents payable by tenants-at-will, and (c) for a differential system of taxation or for agricultural income tax ;
- (iv) Organizing areas belonging to the State into State farms ;
- (v) Integrating rural and industrial economy in every region.

Each of these tasks will become easier than it looks if we take the preliminary step of creating a planned farmework in which each village is treated as a unit by the State and acts as such in relation to every aspect of the life of its entire population.

RURAL COMMUNITIES AND VILLAGE DEVELOPMENT

By J. N. MUKHERJEE

FOR ages India has lived in her village homes. But the modern development of city life, of localized industries, of better amenities of life in the cities, of greater opportunities for employment, have all contributed to a distillation of the wealthier and more resourceful section of the population from the villages to the cities and towns. This process has been reinforced by the decline of village industries and the contrast in facilities for transport, education, recreation and maintenance of public hygiene.

The situation has been worsened in every respect by increasing pressure of population while the methods of science have not been harnessed to increase production in any commensurate degree. With more than 70 per cent of the population rendered inefficient as judged by present day standards, no nation can pull its weight.

Agriculture is India's basic industry and its efficiency depends on better hands. Progress in industrial production, too, depends on the healthy and skilled labour that mostly comes from the villages, where economic and social structure is unstable for the simple fact that the people live in a state of miserable backwardness. No industry can really prosper if good conditions for the workers' nutrition are missing and clothing and housing conditions are simply hopeless. The village all over India seems to breathe in pain both for primitive ways of agriculture and industrial development.

Experience of Centuries

Apart from social considerations, scientific and administrative aspects of the problems of conservation of land and water resources and of their optimum utilization demand that the villages and the rural communities must be integrated in all our plans for the fruition of the latter. No amount of blue-prints have much chance of delivering the goods unless the people are enthused and unless they participate actively and intelligently in the execution of the work contemplated among them. While the State must have the responsibility of central direction, control and coordination, these in themselves will act as strangle-holds unless authority is decentralized to make room for the active, informed and willing participation of rural communities. Such participation has to be deliberately fostered by governmental agencies and developed with sympathy and understanding. Too long has the idea dominated big and petty officials and better placed men that plans and blue-prints prepared for the development of the country's material resources should be executed according to order by rural communities where these plans impinge on them. It is true that most of them are illiterate and many perhaps half-witted through disease and malnutrition. But there is no dearth of native intelligence. While scientists are expected to educate the rural communities by demonstration and propaganda, as regards improved methods of agricultural

production and utilization of the produce, they also have to acquire the detailed knowledge of agricultural experience which has come to the peasant through centuries. The contribution to knowledge that our Agricultural departments have made so far, while not negligible even under conditions of limited personnel and facilities for research and surveys, is yet certainly not greater in proportion to what the rural communities have gathered through thousands of years. It is necessary that agricultural colleges and departments should take up survey of the old ways of agriculture.

New Plans

In an enthusiasm for improvements we should guard against the intoxicating influence of quickly gathered 'new' knowledge, when we try to interfere with the life of the communities living in a system of adjustment which they arrived at albeit by empirical experience. The old proverb 'Little learning is dangerous' is only too true when land use planning and land use patterns are concerned. As the work contemplated in our blueprints gets a move on and gathers momentum, it will be difficult to adjust it to any large scale defects in them which may be revealed with the progress of time. Such defects have to be avoided by proper study and investigations. It is not so easy to readjust such plans after they have got going without colossal losses in money and effort and without misery to large numbers of people. All implications of the programmes and their inter-relationships and the inter-dependence of their various aspects have to be visualized in advance with care and thought; and the scientific, technical, administrative and economic machinery in charge of the plans and programmes must not only take cognizance of this inter-dependence but also must have an organization suited to it.

Climates, soils, vegetation and animals

live in intimate association and act and interact on one another to greater or lesser degrees. They thus tend to live in a sort of 'dynamic' equilibrium. If the balance in this association is upset it may lead to disastrous consequences. Soils take a long time to grow but may be lost or damaged very quickly. The same is true of forests and watersheds. This physical and biological inter-dependence which science has taught us, is the most fundamental consideration which we have to reconcile and integrate in our plans for the conservation and optimum utilization of our natural resources.

Land and Water Resources

In the past human settlements and rural organizations and communal life have been based on a dim recognition of this inter-dependence. The land use pattern depends on it. The progress of science has, however, made definite what was vague and uncertain, and conscious what was dim intuition. Every village has a pattern determined by the natural resources of the locality, by economic and social factors and by the level of intelligence, information and organizing ability of the people living in it.

To make the best use of our land and water resources we have to make an inventory of these to determine their present use patterns and the needs of rural communities and the optimum methods of utilization consistent with conservation as dictated by scientific knowledge. The factors responsible for loss or damage to these resources and present misuses have to be studied with care by experts. A plan of the future land use pattern will have to be drawn up for each village and locality. Regional and then national land use patterns require to be prepared stage by stage by superimposing on these local patterns broader aspects of the physical features of the country and in order

to reconcile local, regional and national needs and policies. Our soil resources have to be protected from loss and damage by erosion resulting from uncontrolled run off, scouring by rivers and seas and wind, by waterlogging and salinity, and by floods. Their low level of productivity has to be built up to the optimum by judicious irrigation, use of fertilizers and manures, appropriate systems of crop rotations and, where necessary, by drainage. Based on the inventory of soil resources, the best form of use of a particular bit of land has to be determined. In our plans for the judicious utilization of soil resources we have to reconcile the demands of food production and livestock, timber and forest produce, raw materials for industries, buildings, and roads, sites for towns and villages, recreation and factories, communications and preservation of wild life, and last of all the landscapes that would enhance the beauty of the place. Rivers and inland water resources have to be conserved and their careers controlled to obtain power, secure water for irrigation, prevent floods, supply water of potable and industrial purposes, arrange for supply of fish, and ensure drainage on which the health of the soil, plant and animal depends.

The land and water resources of a country are the most vital assets of the people living in it—a point which need not be pressed in India or in any other part of the world at the present moment of world food shortage. They must be conserved and handed down to posterity in a stage of optimum utilization consistent with their conservation. Succeeding generations should have no occasion to blame us for ruining or damaging their national heritage. Scientific and social considerations are basic and should determine the objective and contents of the plan ; the economic, technical and administrative aspects are the means to achieve it. There should be no confusion

between the end and the means. Any adjustment between these two necessitated by practical considerations should be of the nature of an adaptation of the rate of development of the plan and should not lead to its distortion sacrificing essential aspects either of conservation or of optimum utilization.

Multiple Purpose Schemes

The physical and biological interdependence mentioned above makes it imperative that plans for optimum utilization of land and water resources must serve a multiplicity of interlinked purposes. They must be 'multiple purpose' schemes—as opposed to the more usual approach of our administrative system which plans on the basis of a multiplicity of single purpose schemes, in which the secretarial organizations and their scientific and technical appendage work in self-conscious and proud isolation. It is here that the core of the organizational aspect of the problems of planning lies. It is increasingly becoming apparent, however, that the necessity for thinking in terms of multiple purpose schemes has been realized. Knowledge of the work done by the Soil Conservation Service of the United States Department of Agriculture, by the Bureau of Reclamation of the United States Department of Interior and by the Tennessee Valley Authority has done a good deal for this realization. The Reconstruction Committee of the Viceroy's Council and the various Departments of the Central Government have considered several aspects of the problems involved in such schemes. The Damodar Valley Project has been undertaken on the analogy of the work of the Tennessee Valley Authority. However, we have no organization as yet for evolving and working out multiple purpose schemes in rural areas.

We have to plan what are the best places suitable for the location of the

residences and farm buildings, which of the land should be put under particular crops, forest and pasture, or fishery and preservation of wild life, roads, schools and hospitals, and for purposes of recreation and other requirements of the community. Towns and cities have to depend for their food and raw materials on the surrounding villages. They should not be located too far from each other. Big cities have realized their inherent instability and the defects of too much concentration of population from the point of view of supply of necessities of life, civic administration and defence. We have to provide in rural areas for the supply of water for drinking, for irrigation, for livestock and rural industries. It is not feasible to prepare blue-prints as if we have no human population and no social problems. We cannot plan the development of a region without reference to existing usages of land and water and the needs of the rural population. We have to take stock of these and make a detailed study of the factors governing them. Any other approach to the solution of our problems will be based on insufficient and unreliable knowledge and may be fraught with undesirable consequences. For it is not so easy, without colossal loss in money and effort and misery to the masses of the population, to readjust these countrywide plans of development when their defects are revealed only at a much later stage.

Not Lop-sided Development

A blue-print for improvement of rural areas has, after all is said and done, to be executed by the rural population. The state should not and cannot undertake its execution in all details. It is not feasible economically and it will soon be found that it is impossible administratively. The first step then is to take the inventory of the natural resources of the village or group of villages. Secondly to study in some

detail the present usages and needs of the local population and the difficulties which concern them in putting through their own ideas of better utilization and simultaneously to make blue-prints of possible improvements based on scientific, economic, social and administrative considerations. These three aspects must go hand in hand in making the blue-prints. The local, regional and national aspects will have to be reconciled. The scientific and administrative structure of this development should therefore be one built up from the bottom, keeping the reconciliation of broader physical aspects, direction, control and coordination at the higher level. It must also be of a decentralized pattern so that freedom and initiative are left in ample need to those who will have to execute the plan at the base. The plan has to be a 'multiple purpose' one and simultaneously reconcile diverse demands. It has to proceed in stages of approximation and be continuous there being no finality. The essential element for success is a balance. Lop-sided development may ruin the chances of success and the whole pattern. It is one integrated pattern and stress has to be laid to different aspects of it to the extent that they require for the preservation of the balance.

An American Comparison

A comparison of our set up for planning and effecting agricultural improvements with those in other countries reveals two very important differences. Firstly, we have nothing equivalent either in functions or in organization or numbers equal to farmers' unions or allied communal agencies in rural areas which in the United States, Canada or Australia play a vital part in agricultural improvements and soil conservation. They form active agencies for the propagation of the ideas underlying the plans and for their translation into practice.

The following quotations from *Miscellaneous Publications* No. 88 revised in May 1940 of the United States Department of Agriculture are intended to convey to the readers of this article the place 'farmer participation' has in coordinated agricultural planning as the subject is visualized by the United States Department of Agriculture:

"Research begins with analysis of problems but for the application of the results of research, the findings have to be organized and brought together into practical combinations and given shape in the form of plans of work for farmers to act. Although the farmer cannot deal with the national and regional aspects, he has to cooperate with his fellows and with public agencies which in turn must cooperate with him. All this takes planning. Coordinated agricultural planning has, among other things, also to integrate

- (i) National and regional crop adjustment,
- (ii) Marketing,
- (iii) Family rehabilitation with better family living as the goal,
- (iv) Proper care of soil on farm and non-farm land,
- (v) Tenure reform and land taxation,
- (vi) Public land buying, and
- (vii) Public aids to the action of citizens in allocating different resources among the most suitable uses.

"Such planning begins on watershed, forests, farm and ranch. It aims to develop information and programmes that farmers can use. It must take urban conditions into account since the cure of many agricultural problems begins in the cities. Only the creation of more city jobs can prevent the continual creation of new farms in regions of poor soil. . . . All land uses have to be considered.

"Such farm planning cannot be bounded by the farms, ranches and forests, or even by the rural population,

but should consider also the relationship between the town and the country."

The Mount Weather Agreement

The Mount Weather Agreement, July 1938, constitutes a landmark in the development of a concerted attack on the problems of land use in the history of conservation and utilization of soil and water resources. "*Farmer participation* is the backbone of the whole undertaking". It is recognized that "farmers have essential information, particularly with regard to their own localities, that the experts lack. Conversely, the experts know useful things that the farmers do not know. When the farmers and experts differ, they can get together best through an exchange of information. The Expert and the farmer need each other's knowledge. Farmers can participate in formulating and executing programmes. They must make decisions on the basis of their own experience and information supplied to them by specialists." The agreement thus emphasized (i) the part farm people must play in planning and action, the execution of the programme, and (ii) the need for reasonably uniform procedure whereby farmers may take responsibility for the development of sound land use plans, programmes, policies for the dual purpose (a) of correlating current action programmes to achieve stability of farm income and farm resources, and (b) of helping to determine and guide the longer time efforts to these ends.

"Specifically the agreement suggested four things:

"(i) That each State Extension Service should set up in each community and county, agricultural land use planning committees.

"(ii) That the County Committee should include official personnel both Federal and State, as well as at least ten farm people, and a few forest landowners in countries where forestry is a problem.

“(iii) That the County Committee should correlate on a county basis, the land use plans, programmes and policies developed by community and neighbourhood planning committees.

“(iv) That in each State there should be established an agricultural land use programme or policy committee with the Director of Extension as chairman and with certain Federal and State officials and a number of farm people as members.

“Subsequently the Department and the Extension Service signed a memorandum of agreement as to planning objectives, which outlined a programme in which will be correlated the suggestions and work of farmers, of the State agricultural extension services and experiment stations, and of the United States Department of Agriculture. Among the procedures to be used in carrying out the agreed objectives, will be at the Federal level agricultural adjustment, conservation, crop insurance, farm forestry, flood control, land retirement, rural rehabilitation, and water utilization; and at the State level research and extension programmes, and use of State authority in taxation, zoning and other matters in which the States have jurisdiction. At the local level the tax equalization machinery, the organization of school districts, and the provision of farm-to-market roads will be important to the effectuation of the plans.

“The object of the coordinated planning is to attack the farm problem as a whole, as well as in its several parts. . . . Farm by farm across the continent, there is one unified land use problem of which crop adjustment, forestry, grazing, etc., are merely aspects.”

Following are some of the objectives of this planning :

“(i) To acquire and diffuse useful information on subjects connected with agriculture in the most general and comprehensive sense.

“(ii) To assist farmers through research, experiment and education, to increase the efficiency and reduce the unit costs of their production.

“(iii) To assist farmers in improving the quality and increasing the variety of their production.

“(iv) To achieve a balanced agriculture and at the same time improve the general balance between industry and agriculture so that both farm and non-farm production can be increased in a harmonious ratio.

“(v) To promote security for both farmer and consumer through the maintenance of an ever-normal granary by means of efficient production, adjusted production, conservation of the soil, balanced marketing, and crop insurance; in other words, to help stabilize farm supplies and prices.

“(vi) To help to maintain the increase of the ownership of family-sized farms by the operating occupants, and in other ways to improve the land-tenure system.

“(vii) To promote the conservation of soil, water and desirable vegetation.

“(viii) To regain our agricultural export trade so far as it is practicable for us as a creditor nation to do so—ultimately through reciprocal trade agreements and international commodity conferences; meantime by methods of a more temporary nature.

“(ix) To work for the protection of the food and drug supply from adulteration, contamination and fraud, and the meat supply from disease.

“(x) To promote the intelligent consumption of Agricultural products.

“(xi) To eliminate or prevent social hazards and to correct economic abuses through the administration of various regulatory statutes.”

The quotations given above, it is hoped, will bring out the importance of ‘farmer participation’ in planning and action related to agricultural development on the one hand and the interdependence of physical, economic and

social aspect of the optimum utilization of land and water resources on the other.

Direct and Active Link

The second factor of importance which is missing in our present set up is the absence of an agency which will advise and guide farmers directly and study the difficulties confronting them and bring to them the scientific, technical, material, economic and administrative help required to solve them. In the United States, the United Kingdom, Canada and Australia there is a person designated as Agricultural Representative or County Agent whose business is to help farmers to organize their unions, to collect information on the basic aspects of agriculture as an industry such as yields of crops, farm economics, land-uses, problems of soil conservation, and on difficulties confronting the farmers. It is also his job to help the Agricultural Department, Federal or State, in arranging for the demonstration of promising results of research and to participate in the education of farmers in improving their agricultural practices by arranging among other things for lectures by scientific men on better methods. He calls upon experts in relevant Government departments to give the needed advice or educative talk to the farmers. He also transfers to the Research Stations and other relevant bodies the results of the demonstrations, their success or failure; the scientific and economic problems of the industry and information

of value on economics, marketing and other aspects. Such a direct and active link with the rural communities is immediately desirable.

It appears that immediate action regarding the second factor will be beneficial if under the Agricultural Departments posts with duties almost identical with those of a County Agent were created. Such a man must possess scientific knowledge of agriculture and experience of agricultural practices of the district where he will work. At this moment of emergency arising out of food shortage, it is essential that the limiting factors confronting the production of food crops even under existing conditions of agricultural practices are rapidly reviewed from village to village and such of them as are possible of quick redress are attended to. This information should be secured and collated for the larger administrative units stage by stage up to the Provincial and Central level. Such a process will give an estimate of what is possible to achieve during the next three, six and twelve months, and of the conditions to be fulfilled for such achievements. Such an Agent will also be able to arrange for the transfer of the needed help to the farmers. Action based on disjointed and uncoordinated information however energetic can only lead to dubious and temporary success. What is wanted in India is an all-out attack on the problem as regards what could be done immediately.

LESSONS OF MARTHANDAM

By MISS OUWERKERK

THE problem of rural reconstruction in India at the present day is fundamentally psychological as well as technical. There has been general agreement on the technical details of improving agriculture and village life for the past two decades and more. But the problems of spreading that technical knowledge to the villagers themselves and of securing their active cooperation for any programme which puts that knowledge into practice have hitherto proved unsuperable except in a few places.

The great achievement of Marthandam, the Y.M.C.A. Rural Reconstruction Centre in South Travancore, has been simply this: that it has succeeded in changing the psychology of the people. It has evoked in them enthusiasm, a desire to improve, a spirit of cooperation and a new self-respect. This new spirit among the people makes it possible to work out a comprehensive programme of rural reconstruction.

The familiar Y.M.C.A. blue triangle is intended to symbolize the three-fold development of spirit, mind and body. Marthandam has (with a cheerful disregard of geometrical accuracy) evolved a 'five-sided triangle', representing a development not only spiritual, mental and physical, but also economic and social. It must be emphasized that this programme of development, although it is sponsored by a Christian organization, aims to improve the whole community whatever the religion, the caste, the creed, age or sex of the people may be.

The pioneer of this work at Marthandam is Dr. Spencer Hatch, an American

brought out by the Y.M.C.A. for the purpose of doing rural work. He himself was brought up on a farm and holds high agricultural degree. But while he initiated the work, it in no sense depends on him; he worked out the principles and at the same time trained his successors so effectively that although he left India six years ago, the work has been carried on and is flourishing under his successors.

The essential technique of Marthandam, in Dr. Hatch's own words, is 'self-help with intimate expert counsel'. The Y.M.C.A. provides expert secretaries and a centre. This expert help is brought to the people in their own homes and villages, but the responsibility for carrying out the programme of activities is clearly thrown on the people themselves. The Demonstration Centre is at Marthandam itself, where the full-time secretaries reside; it is connected with the villages, through the village Y.M.C.A., of which there are about a hundred scattered through the villages of Travancore and Cochin. In the villages the work is carried on mainly by the members of these village Y.M.C.As, who give voluntary social service in their spare time. While most of the secretaries and committee members of these village groups are Christians, the work is by no means confined to Christians; many members of these groups are non-Christians, and non-Christians are also entrusted with leadership and responsibility to a very large degree. Contacts between the Demonstration Centre and the village groups is maintained largely through the Extension Secretary, who

travels from village to village supervising the work and giving advice and practical help.

An Intermediary

The Centre has also been remarkably successful in acting as an intermediary between the villagers and Government officials. As is indeed the fact throughout India, it is peculiarly difficult for Government officials to come into continuous intimate personal contact with the villagers. Often they have a very wide area to serve. Their position as officials frequently causes them to be regarded with a certain degree of suspicion; the villager, if he trusts the officer at all, tends to beg for favours from him rather than to look on him as a stimulus to active work. But the expert knowledge of the officials can be brought to the villagers in the Marthandam area through the medium of the secretaries of the Centre; these in their non-official capacity have won the confidence of the villagers on the one hand, and they are educated and important enough on the other to establish good relations with the officials.

A Collective Centre

The Rural Reconstruction Centre at Marthandam is in itself unimpressive, for the simple reason that the bulk of the work is carried on where it should be, namely in the villages. The Centre is in a fairly big house in a large village on the main bus road from Travancore to Cape Comorin. It is in a completely rural area, but within fairly easy reach of a large town and railway facilities. This is a strategic position, in that it can easily arrange for the transport of village produce to large consuming centres. At the Centre itself you will see a prize bull, a prize goat, model bee-hives, demonstration plots for improving grain and vegetable seeds, chicken runs with prize chickens, a weaving shed, and a fire-wood depot. Inside the house are small

stocks of village produce, Red Cross health charts, simple equipment for honey extraction and other cottage vocations. At the Centre cottage vocations are taught and agricultural improvements are tested. It acts also as a collecting centre for village produce which is marketed cooperatively. It is also used for a training school for village workers both professional and honorary.

The emphasis throughout is on self-help, and cooperation is the essence of the methods used. Cooperation in other parts of India has frequently been a failure, partly because it confined itself chiefly to agricultural credit. At Marthandam, the emphasis is on cooperation in production, and cooperative production is not regarded as complete until the product is marketed. Dr. Hatch's viewpoint is that the ignorant and impoverished villager will not be convinced of the efficacy of either cooperation or of better methods of production until he has in his hand the extra money that comes from using better methods. That extra money is the final and incontrovertible proof that rural reconstruction is worth while. It may be added that Marthandam cooperative societies are usually called clubs, and their rules are so simple that they can be understood by the most uneducated villager.

The Egg Selling Club

Perhaps the most successful project, and certainly the biggest, is the egg selling club. The Centre introduced better fowls (White Leghorns were found the most suitable) and crossed them with local chickens: these cross-bred fowls laid bigger eggs and far more of them. These fowls were then sold on credit to the villagers or they were given eggs for sitting. The Centre itself during the first years organized the selling of eggs and secured markets in the towns usually private consumers, schools, colleges, clubs, hotels. The Centre insisted on

high quality; eggs were weighed and tested at the Centre, and only those which came up to the prescribed standard were marketed. Consumers were prepared to pay double the market price for a large and guaranteed fresh egg; and thus the villagers found that they could get at least twice as much money for their eggs as they could have got in the open market. By 1939, the egg selling co-operative society became a self-governing body separate from the Y.M.C.A. Centre; and now several thousands of eggs are sold every week and the money returned in its entirety to the villagers.

The Honey Club

Another successful cooperative society is the honey club. The Marthandam Centre taught the villagers to use modern beehives and to extract the honey scientifically. Both beehives and extractors are simple and cheap and can be made by village craftsmen. The Centre taught the villagers to tame the wild Indian bee and to persuade it to live in a modern hive; it also taught them to plant suitable flowers for food for the bees. The honey is cured at the Centre and marketed cooperatively. Many of the bee-keepers are boys, and there are several instances of village boys paying their own fees to high schools out of the proceeds of their bee-keeping.

The Weavers' Club

The weavers' club is also a successful cooperative. The Centre has a weaving school, and has introduced improved looms in the surrounding villages. The yarn is bought cooperatively, and the cloth is also sold cooperatively. Experiments are made with new designs. The cooperative societies at one time provided the sarees for all the girl guides of Travancore—a steady and reasonably profitable market.

Bull Clubs

The Centre has done much to improve the standard of cattle in the surrounding area. The first prize bulls (Sindhis) were brought into the area by the Centre, which started Bull Clubs for the cooperative ownership of good seed bulls. There are a number of these clubs now, and there is a system of rotation of the bulls among the clubs every two years to prevent in-breeding.

Other Activities

It would be impossible to detail all the other activities carried on by the villagers of the area with the help of the Centre. High grades cashew nuts are tinned and sold through the Centre; this helps the poorest depressed class village women who traditionally do the hard and dirty work of cleaning the nuts. The Centre sells pure clean jaggery, *pappadams*, peanuts, vegetables, baskets, mats, fancy umbrellas, Christmas Cards—the list is almost endless. These activities taken together have contributed to the material uplift of the people of the surrounding villages. Their agricultural income has been improved, and they have been able to supplement it by income derived from really profitable cottage vocations.

Exhibitions and Lectures

The Centre has extensive social activities which meet the mental, physical and the spiritual needs of the people. Among these activities, the health programme takes a very important part. The people are as disease-ridden here as in other parts of India. Malaria, typhoid, smallpox are common; cholera epidemics have raged from time to time, hookworm is almost universal in some areas, and the people in general suffer from malnutrition and debility. The village Y.M.C.As are enlisted in a wide health programme. Health

exhibitions are held; lantern lectures are taken into villages by the extension secretary and his helpers. There is a great campaign for better sanitation and cleaner water supply. It is remarkable that one of the poorest villages in the area, inhabited almost entirely by depressed class people, was the first village to boast a bore-hole latrine in every house—such is the enthusiasm that this campaign has succeeded in rousing in the area. Perhaps in no aspect has the Centre been so successful in linking Government officials with the common people. The officials of the Public Health Department are always ready to assist the secretaries of the Centre in their health campaigns, to provide films, lantern slides, and assist with exhibitions and lectures.

Source of Inspiration

The Centre's educational activities are manifold. Through the village Y.M.C.As campaign for adult literacy is being carried out. The Centre itself has a good little library, and assists in the formation and maintenance of village libraries. Boxes of books are sent out to these tiny libraries. Many of the people of the area are still illiterate, but voluntary workers undertake to give readings in the evenings; in this way

the libraries have a vastly extended usefulness.

The Centre plays a large part in promoting boy scouts, girl guides and bluebirds in the area. It may be added that among these youngsters some of the most enthusiastic workers of the Centre's activities are to be found; they are always ready to help at exhibitions, and themselves undertake work in poultry keeping, bee-keeping and other cottage activities.

Alongside all these useful activities the Centre lays stress on recreation. A number of games suitable for villagers are played, and the Y.M.C.A. workers have done much to keep alive folk dancing and folk singing in the area.

Of the spiritual side it is difficult to speak in a short article. Dr. Hatch himself has emphasized that the basis of all his work is spiritual and that cooperation only has a meaning if it is essentially spiritual. He himself is uncompromisingly Christian, and finds his inspiration for all his work in Christianity. He appeals to his non-Christian friends to find their inspiration for their life and work in their own religion, and he has achieved a remarkable degree of inter-religious cooperation and inter-religious understanding in all that he and his colleagues have striven to do.

THE VILLAGER'S MIND

By J. M. LOBO-PRABHU

FROM the earliest days of my service, I was interested to know what the man behind the plough was thinking. During the three months, each year, which I spent as District Officer camping in villages, I made every effort to get into the skin of the cultivator. I met him in the fields and in his dwelling; I saw him in adversity and in comparative prosperity; I studied him when he came to the court and when he joined at bonfire chats I regularly held in my camps. I cannot say that I know him fully, but I have seen him steadily and as a whole.

In the psychology of the Indian cultivator, the dividing line between the conscious and the unconscious is most thin and vague. His thought is conditioned by instinct, intuition and habit. Opinion of the family, caste or village, tradition, even superstition predetermine his will and wishes. His mind has little independence and is part of an intangible whole to a degree inconsistent with his social and cultural evolution.

The causation of this mental attitude must be found in history. For more than two thousand years, Indian village life has been on the defensive, watching in 'patient deep disdain, the thundering legions' of conquerors from the time of Alexander, pass and repass the political stage. Accordingly Indian village life has conditioned itself to accept external changes in the same way as natural calamities. The attitude may be compared to that of a clam which on the slightest disturbance retires into its shell. The frequency and violence of natural calamities on a purely agricultural economy have reinforced this defensive

attitude. In fear of what is unavoidable and unpredictable, the cultivator has clung to the bedrock of his beliefs and habits. He has had no time or inclination for change in any form, the result being conservatism against all arguments factual or verbal. His ignorance is both the cause and result of this attitude. Literacy, accordingly, has no appeal except as a means of propitiating the gods or of escaping village life altogether. Individualism, similarly, is not encouraged because there is no room for experiment in a social organization designed for resisting change and for preserving the hard core of practices vital only for existence. Penalties at the hands of family and caste threaten and restrain adventure into anything new and unknown. To the fear complex, therefore, is added the herd complex and the village consequently remains fortified against the march of time and progress.

Resistance

The question that arises is, how a position so fortified can be reduced in the interest of the cultivator himself and of the country which cannot move until the largest proportion of its population, which lives in the villages, does so. The general co-efficient of progress is economic. Agriculture is the basis of India's economy and until its efficiency, which is less than half, is raised, progress in commerce and industry can be only a small part of what is possible. But agricultural practices are the weathered remains, which two thousand years have only worn down without changing for better. Their essential structure has shown itself to be

impervious to the attempts made in the name of rural development during the last fifteen years. The village has armed itself unconsciously and silently against all promises of improvement for fear it may imperil its means of existence. There may have been no resistance but the lack of cooperation and enthusiasm have been sufficient to break the impetus of the movement to change the agricultural conditions. Rural development, therefore, lies in its own ruins, a lesson to those who ignore the psychology of the villager, in the blue-prints they prepared for his improvement. In respect of social change, the resistance is even stronger, because while economic benefits can be proved in practice, sociological improvement becomes apparent only after a long time.

Good Intentions

The strategy in these circumstances may be first a frontal attack with all the forces of the State on the model of the Soviets. The village has learnt to accept the State as a relentless immutable force, whose laws it accepts and functionaries it obeys. The village however is not accustomed to the State approaching it in an advisory capacity without penalties but with benefits. The question arises if the State should enforce economic and social laws as it has so far enforced penal ones. This depends on the importance attached to economic and social discipline in the well being of the community. It may be argued that, with the country reduced to impotence by poverty and ignorance and threatened by over population and famine, the efficiency of agriculture is of vital concern for which individual liberty may be sacrificed. The fact, however, remains that if totalitarian methods are not to be misunderstood, they must be enforced by a Government which the people are persuaded to accept as their own. In this connection I may mention that in

several districts in the United Provinces, I was able to enforce measures which may be regarded as totalitarian, only after the villagers had come to believe in my good intentions. They capitulated to authority after I had shown myself as servant of their interests.

Age of Democracy

If economic discipline is not to be enforced positively by law, it can be imposed deviously and dexterously by barter of services which the State renders. These services are not many now, the most important and the only effective one being irrigation. Post-war plans, however, may include many services like subsidized seed, fertilizers, mechanical ploughing and improved implements. In the U.S.S.R., the policy of restricting the services of tractor ploughs only to villages which accepted the State plan was found even more effective against recalcitrance than the brutal measures which were adopted in the earlier stages of the State plan. An extension of this system of barter would be to make even the law serve the purposes of improvement. For instance, new rights in land may be made conditional on the acceptance of the discipline for improvement. In this connection an excellent opportunity was missed when permanent rights in land were conferred in the United Provinces without insisting on consolidation of holdings. If Provincial Governments have other rights to confer on tenants they will possess a leverage for enforcing measures to increase agricultural outturn the value of which to the cultivator and the country is far greater than that arising from the mere redistribution of income between the landlord and the tenant. The law also may be used against the trade to regulate the sale of agricultural seed and implements. If licences are introduced and restricted only to those who make improved implements and sell improved seeds far

better results will be achieved than by Government competing, as at present, with private agencies which provide seeds and implements. In respect of irrigation the leverage which Government possesses arises from the fact that the water available is sufficient only for small proportion of the village. If selection of this area is related to acceptance of the State plan, not only would the benefit from irrigation increase but also an example of improved agriculture will be set on a scale which the village will not ignore. As with individuals, so with entire village State help in the matter of tube wells, seed stores, hydro-electric schemes can be used in bargaining for improvement. A policy which may be designated as 'Multi-lever' can be devised, under which Government help will be conditional on self-help for the revolution necessary in agricultural practices.

Although the cultivator may yield to the *force majeure* of the State, it is desirable that he should be persuaded to the greatest extent possible that the State is acting in his best interests. The first step in this connection is a re-establishment of popular Government in the Provinces which fortunately is taking place. This, however, may not be enough, if the local officials who are the visible symbols of Government continue to be undemocratic and apathetic. One interesting suggestion is that gallop polls should be held periodically to find out if District Officers have made themselves felt in their charges. There is something to be said for the idea that in an age of democracy the services can be conditioned to serve the general public by fear of being condemned by random parties who cannot be canvassed or coerced.

Force of Visual Example

Even after the cultivator accepts the bonafides of the Government and the

officials, it will be necessary to make him see himself as others see him. The existing approach has been through the written and spoken word which have castigated the cultivator without convincing him. Even where village guides have been appointed, the propaganda has not been penetrative because it has appeared to the cultivator abstruse and unrelated to his own experience.

As he is constituted, the cultivator can be persuaded, if at all, by the force of visual example. This may take firstly the form of demonstrations of better living and earning.

In each village there should be a model farm and house, on the scale and within the means of the cultivator and therefore run by a cultivator himself. In the districts of the United Provinces, I made the village headman and the village patwari, the first on pain of losing his office, the second of losing his cultivation, which is permissive, incorporate as many improvements as possible in their houses and farms. The difficulty, however, was of finances. But if the State is willing to subsidize, so many fashion plates can be set up that the cultivator will be forced to know what is within his reach with the help of a little money, thought, and cooperation.

In any scheme of demonstration the village woman should not be neglected. She now brings extreme ingenuity in the preparation of food. She should be interested in the production of that food on which she sets so much value. Her power in the household is so considerable that if she can be interested in any degree, a powerful ally will be available in improving agriculture.

The best approach to the woman and also to the men of the village is by the stage and screen. Drama is indigenous to the villages and its potency for propaganda has been proved recently by the Soviets. Three dramas which I wrote and staged drew larger crowds than hundreds

of other meetings. The cultivator and his wife laughed and cried and had an emotional experience which also contained seeds of important information. What they would have resisted as straight advice they took in willingly as amusement. Films also can capitalize the emotional susceptibilities of the cultivator.

Every district, should have a dramatic company and touring talkie unit. The amusement provided by these should point a moral to the cultivator in respect of his work, health, and general well being. Dramas and songs, with a utilitarian motif, should also be encouraged generally in the villages. The radio can be useful but apart from technical difficulties, it suffers also by being too impersonal and mechanical to be attractive for long and too many. The approach to the cultivator has to be on his own plane by examples he sees and enjoys before he understands and adopts.

Peasant Psychology

The greatest problem of the country is the problem of increasing purchasing power. The cultivators who represent the largest population and are at the same time capable of the largest improvement in their income, deserve special consideration. Their physical possibilities are related to their psychological limitations. Obviously, their psychology is crazed with complexes, some of which will yield to attacks and others to a gentle massage. The proper approach has not been understood so far, but it is most important. In all post-war schemes, we may, therefore, take note not only of the interests but of the inclinations of the cultivator. We may actually undertake a survey of the peasant psychology. Thus we may help agriculture to become efficient and a sure foundation for the greater India of our plans.

THE ROLE OF EX-SERVICE MEN

By F. L. BRAYNE

THE ex-service man of this war will be a very different man from his father and uncle of the first Great War. He has learnt a lot of new things. He has seen the world and been thoroughly modernized. He has had many new experiences, and has become used to a very high standard of living. What will be his reaction to village life when he gets home, the discomfort and dullness, the insanitation and ill-health, the poor livelihood and the unhelpfulness, or worse, of the under-paid petty official?

Quite a number, perhaps the majority, will shrug their shoulders and, after a little grumbling, settle back more or less contentedly, as their ancestors did. Quite a lot will not take it lying down, and their dissatisfaction with the old environment must be canalized into constructive channels, so that they may be the spearhead of a new era in village life and not a thorn in the side of both the village and the authorities. Needless to say this will not happen of itself. It will require a definite programme of work, great initiative and drive from above, good organization, and a new spirit among the petty officials who interpret the policy of Government to the actual villagers among whom they live.

The service man is used to personal leadership and to a continual stream of inspiration coming down from the highest commanders. This is difficult to reproduce in civil life where officers are few and far between, the villages are far off and scattered, and the senior officers can rarely visit them to spread enthusiasm for the work of raising

standards of living. This is in fact the one part of service training which may be a handicap rather than an advantage in civil life. For the rest the more of what the man has learnt in the service and the more of his service habits and traditions he can bring back with him and apply to his civil life, the better.

The Advance Guard

Let us see what he has acquired in the services that can be utilized to improve village life. First, all his new skills and knowledge, his broad outlook, his experience of other countries. He should never be afraid of new things, new methods, new crops, new machines. He should have enough experience to realize that the ways of his ancestors are not necessarily the only and the best ways. He can be used as the advance guard of an attack upon out-of-date methods, and uneconomic and unhygienic customs.

Team Work

Then the Service man will bring his capacity for team work. In the Forces, caste, race and creed mattered nothing to him. All races, tribes and religions were comrades in battle. Can this asset be used to overcome the cliques and parties that make combined effort impossible and prevent the holdings being consolidated and the village roads mended? The Service man should be the ideal material for the development of a network of *panchayats* and cooperative societies for the improvement of every activity of village life.

Healthier Recreations

What about the self-control and self-respect he has learnt: his spirit of toleration and respect for others? Can that be transferred to civil life and so help to make an end of the quarrels, abuse and fighting which produce crime and litigation and their allies, bribery and false evidence? Perhaps the service man can replace these expensive and exciting diversions of village life by organized games, radio, newspapers and other cheaper and healthier recreations.

Better Villages

And then there is the service man's health drill, his appreciation of tidiness and cleanliness, the flowers he grows in his lines, the way every bit of waste water is used, not to make black mud and stinks but to grow fruit, flowers, and vegetables. What about the ventilators, the mosquito net, the rubbish bin, the latrine, the hay-box, the chimney over the cooking grate? If only he will bring all these things home with him what a lovely place the village will be to live in.

The demobilized man may have new and better notions about the part which his womenfolk must play in village life. Will he be content that they should continue to be ignorant and untrained drudges, grinding corn, kneading dung-cakes, and carrying rubbish on their heads? Will he not instal bullock-driven mills for his flour, use hay-boxes to keep things hot instead of a cow-dung fire, use wheel-barrows to carry rubbish, make the cooking and washing arrangements better, make his well comfortable and hygienic and provide latrines in place of the present insanitary and degrading custom? And will he not insist that the little girls must go to school? He is beginning to realize that education is just as important for women as for men. He is being taught that little boys and little girls should go to the same school

for the primary classes and be taught by female as well as male teachers. The ex-service man will certainly demand that there should be more adequate arrangements for medical and maternity aid for his womenfolk and he will expect that domestic training should also be made available for them.

Social Security

Finally, there is the money which he will bring home with him. Not a fortune, of course, but an average of several hundred rupees each. If only the Postal Department can gain the confidence of the men in time to persuade them to leave their money in the Savings Bank, a new era will start in rural India. Besides compelling a welcome expansion of the postal system, this will mean more money for the development of agriculture and rural industries, and for the general improvement of village life. Once the ex-service man demonstrates the value of thrift and savings, the saving habit may spread to the rest of the people, destroying the desire for gold and silver ornaments and for lavish and expensive display at every social ceremony, thereby laying the foundation of social security and producing capital for the development of India.

Pioneer of a New Era

The Army is very alive to the possibility of the sepoy being the pioneer of a new era in India. It is teaching him whatever is possible in the short space of time available, and with the present scarcity of civilian instructors and equipment. The Civil Government can never give all the help the villager would like to receive and it cannot yet give all the help it hopes to give when its post-war plans begin to bear fruit. Self-help and cooperation are, therefore, the keynotes of pre-release training in the Army.

All kinds of agricultural work, including

animal husbandry, and soil conservation are taught, as well as useful sidelines such as poultry, bees, rabbits, vegetables, fruit, ensilage.

Then there are all kinds of handicrafts and rural industries for those who want them. The Army hopes that this training will help greatly to break down the old prejudices against any kind of honest work which offers a living and there are many signs that it is succeeding. It is a joy to see the keenness of sepoys of all tribes to learn tailoring and weaving, iron work, wood work and many other crafts previously considered the monopoly of the lower castes.

It is obvious that the Army cannot hope to make either farmers or craftsmen in a few weeks or months. But what it can do, and is doing, is to convince the man that it is well worth while when he goes home to use modern methods and to find out all about the new crops and seeds and implements that are being recommended for his land. He can also be convinced that he can, if he tries, become a craftsman and that there are many profitable trades and crafts to practise once he is prepared to put his hand to any honest work and is not afraid of modern methods, designs, tools and machines.

The application of the principles of hygiene to village life and the principles and practice of cooperation are taught to all, so that they may help to spread good health in the villages and join in every kind of cooperative activity for the improvement of village life and livelihood.

The Army is also teaching the importance of saving and of leaving their money in the Savings Bank instead of taking large quantities of money home in cash. Finally, the Army is urging the sepoy to take home with him all the good customs and habits he has learnt in the Army and it is impressing on him the importance of the education and domestic training of the girls and women.

Raising the Standard

The Army is warning the sepoy of the difficulties and pitfalls ahead. It is begging him to be patient with the old folk at home, not to throw his weight about, not to despise and laugh at the old ways and the old leaders, but first to put his own home and farm in order, and thereby set such an example that the rest of the village will gladly cooperate with him in raising the whole standard of village life.

Administrative Machine

It is obvious that the Army is doing its utmost to enable the ex-service man to become the pioneer and the demonstrator of the new era which, we hope, is dawning for India. The soldier will have a very detailed knowledge of what to do to make the village worth living in and how farming and village crafts can be improved. But he cannot himself set the ball rolling. He is not the arbiter of his village, and he is not the civil authority. He is a stranger in his own home and is unorganized. The programme, the leadership, the organization and the drive must come from the civil authorities.

At present the low-paid petty official who represents the civil Government in the village has no inspiration and no programme and often invites the distrust rather than the confidence of the ex-service man. What is being done on the civil side to match the preparation being given to the soldier? Is the village being prepared to welcome him and to use his great qualities and all his new knowledge and experience? Has each district got its uplift programme ready? Are selected ex-service men being trained to reinforce the scanty and depleted social services and prepare for the great expansion needed to raise India's standard of living? Have plans been made to organize and coordinate the returning soldier? Has the necessary

publicity organization been built up, not a demonstration plot here and a cinema van there, but a full barrage of every kind of publicity, ancient and modern, eastern and western?

To raise the standard of living of a sub-continent will take an almighty effort. A simple definite programme must be drawn up with something in it for every man, woman and child. The whole administrative machine must be tuned up and toned up, coordinated and

reinforced. To reach every home in the remotest hamlet, a publicity campaign on scale hitherto undreamt of must be organized. Finally, inspiration and enthusiasm must pour down from the very top through all ranks of the civil staff and all classes of the public. This was how the war was won by the service men and they are now ready to cooperate with the civil Government in a similar campaign to win the peace.

RANGE OF COOPERATIVE SOCIETIES

By MOHAMMED AHSAN & ZAHEER HUSSAIN

INDIA with all her human and natural resources is steeped in poverty which finds no parallel in other parts of the world. Major part of the Indian population lives in villages, but the villagers, obviously live on the very margin of subsistence; they lack adequate purchasing power to prevent death from starvation and disease, as has been proved so tragically by the recent famine of Bengal which took such an awfully heavy toll of precious human lives.

The Indian farmer is physically as strong and naturally as intelligent as the peasant in Europe. His land, too, is more fertile than most of the land in Europe, yet we see all around a huge mass of poverty-stricken, ignorant, indebted and unhealthy rural folk; scattered, fragmented uneconomic holdings bearing poor crops; cattle of inferior breed giving little milk. The per capita income of the people is Rs. 65 per annum; it is so hopelessly small that it cannot possibly enable them to maintain a decent standard of living.

Low income has killed all ambition, initiative and desire in them. A large majority of the people inhabiting the countryside does not get enough to eat, and a still larger proportion does not receive a really satisfactory and balanced diet containing enough of animal protein, calcium and the required vitamins, and the result is poor physique, high maternal and infantile mortality, and a low expectation of life which is only 27 years as against 62 for an Englishman and 65 for an Australian. In a single year before the war over 8 lacs of people died in

Bengal alone from cholera, malaria, tuberculosis and enteric. Half of the mortality recorded in the whole of India occurs in children under ten years of age due to malnutrition.

The illiteracy percentage in India is 85 as compared with 10 in other principal countries, with the result that this vast mass of illiterate and ignorant men and women finds itself altogether incapable of taking an intelligent interest in private or social life, or of devising suitable measures to banish extreme form of poverty by increasing production with the aid of modern scientific methods.

Bane of the Existing Way

The truth of the matter seems to be that small man all over the world finds himself face to face with increasing economic difficulties, and is seeking some effective relief from the various forms of exploitation arising from the present competitive regime of private enterprise. He desires equalization of the comforts and privileges of life among all classes. He has become sick of seeing the paradox of poverty and misery amidst plenty resulting from the tremendous growth of scientific knowledge and technical research of recent years. He wants to see the earliest possible end of the existing economic order controlled by capitalism which has bred a bitter conflict of interest between the haves and have-nots—i.e. between the employer and the wage-earner, landlord and the tenant etc. He longs for a new social order in which exploitation of man by man should have no place, and in which poverty,

ignorance, superstition and disease should be things of the past. He seeks a society which should be consistent with the dignity of man, and which should function in the interest of the whole community and not merely in the interest of those lucky few whom destiny has made owners of the means of production—a society, in short, which should be based on principles of truth, justice and equity and not on blind greed for profit which is the bane of the existing capitalistic way of doing things.

Benefit of Collective Action

This kind of society and this new type of economic organization can come into existence through cooperation alone which claims to offer the best possible solution to the difficulties and sufferings of smaller men, particularly of those among them who are inhabitants of the rural areas. The greatest merit of cooperation lies in the fact that it works in the interest of labouring classes, farmers and small artisans and craftsmen who together constitute a large majority of the total population. It ensures a fair distribution of goods and services to consumers under current price-determining conditions. It is adaptable to the needs and requirements of different peoples, and can be an important and vital factor in the transformation of the capitalist system to a socialist commonwealth, and can lay down the foundation for a new form of everyday economy.

In simple words cooperation may be defined as a process of working together for the common good, and in a rather technical phraseology we may say that cooperation is a joint voluntary effort of poor but honest persons to improve their economic position by fair, just and honest means. The three main principles of cooperation are (i) persons join in it voluntarily, (ii) they join on terms of equality, and (iii) theirs' is a fellowship

of human beings, and not a party of capitalists.

Cooperation has proved in the west that it is capable of transforming the whole human being, his personality, his character, his attitude towards the community and even to life itself. It attempts to graft on to mankind a character which would fit men for a new form of society. Its chief attraction lies in the fact that it provides ample scope for individual initiative and freedom without the evils of individual selfishness, and offers scope for the benefit of collective action without the evils of bureaucratic collectivism which reduces the common people to mere small screws in the great machine of State. India can undoubtedly get more out of cooperation than out of a dozen acts of legislatures.

Ideal Organization

The most pressing problem is how to make rural life healthier and more attractive, that is to say, how to build better villages and improve the industry of agriculture in all its aspects. No stretch of imagination is needed to find out the reality that if a great majority of our small cultivators and artisans are poor and indebted it is so because they lack organization. In the modern age no class of workers, whether rich or poor, can do without organization. Sellers of *zamindar's* requirements and buyers of their produce are all organized. If the farmers want to compete with these organized bodies on equal terms, they too must organize themselves, and the only organization which suits small workers is cooperation, as has been so convincingly demonstrated by experience of western countries. This fact must never be lost sight of that farming as an industry depends as much upon an efficient, sound and appropriate organization as progress of trade, commerce and large-scale industries in larger cities depends upon special types of

organizations best suited to them. If the poorer and smaller classes of India learn to unite on cooperative basis not only for the amelioration of their economic conditions, but also for the betterment of their social, cultural, moral, educational and hygienic conditions for which they can effectively use the machinery of cooperative action, India would surely become far more prosperous and happy than it is today. If cooperation, which is without doubt the greatest humanitarian movement of the day, is rightly guided and properly worked, it can prove an explosive power which can blow India's poverty into atoms—it can prove, so to say, an atom bomb to the prevailing misery and destitution of this unfortunate country. If we really want that our homes and villages should be clean and healthy, crops and cattle good, lives of the people prosperous and happy, then we must seriously take to organizing ourselves on cooperative lines just as the people of Denmark began to do so long ago.

Experience of the Punjab

Problems awaiting solutions in rural areas of India are of multifarious nature. Happily there is no aspect of rural life which does not fall within the purview of cooperation and cannot be tackled effectively by this method. Most of our village problems are of a local nature and so can be attempted cooperatively by the residents of one village, but there are some whose solution needs the joint efforts of more than one village. A few important types of such problems as tackled by cooperation in the Punjab are described briefly below :

(i) Agricultural Credit

The most pressing problem which drew the earliest and greatest possible attention of the pioneers of the movement was that of agricultural credit. They found the agriculturists in acute financial difficulties because of the vicious

system of money-lending prevailing in the villages which was not only detrimental to the development of agriculture, but also prevented investments being made by the moneyed class into channels which could develop other resources of the country. Every one who could accumulate some money invested it in lending to the villagers because he could get from them high returns. The rate of interest prevalent in the Punjab villages before the inauguration of the cooperative credit societies ranged from 25 to 300 per cent.

The most popular form of cooperative credit society in this Province is the unlimited type with shares returnable after ten years and profits indivisible. The societies issue loans chiefly for productive purposes and for periods ranging ordinarily from three months to three years depending upon the object of the loan.

The various recent enactments in different provinces have very largely scared the usual credit agencies and have thereby diminished the flow of credit in rural areas. This contraction of credit may appear for the time being desirable in the interest of agriculturists, but the fact remains that the prosperity of farming as an industry must ultimately depend upon an adequate supply of cheap and controlled finance for productive and useful purposes in future, and the only agency that can reasonably be expected to fill the void created by the contraction of private credit is the cooperative credit society which can be run easily by the concerted efforts of the residents of one average-sized village. A good cooperative credit society by supplying credit at reasonable rates to its members for meeting their productive and legitimate needs, and by teaching them the urgently needed lesson of thrift and saving can prove a strong and successful battle against the evils of extravagance and the vicious moneylending

system of the country as in many places in India it has actually proved to be. For the prosperity and speedy progress of our villages it seems imperative that there must be a strong and well-founded cooperative credit society in each and every village so that the hold of the selfish and greedy moneylender on the peasants be not only relaxed but totally done away with. Our position with respect to cooperative credit here in the Punjab is sufficiently satisfactory, but with greater staff and closer supervision it can and should become still stronger. The Punjab has at present over 17,000 credit societies of unlimited liability with a membership of about $5\frac{1}{2}$ lacs and total working capital of 536 lacs of rupees. The work done by these societies in regard to thrift and savings can be gauged from the fact that their paid up share capital has reached 111 lacs, and deposits of members stand at 58 lacs, profits at 22 lacs and reserves at 152 lacs. Deposits of non-members amount to 35 lacs. In the year 1943-44 these societies advanced Rs. 113 lacs to their members for productive and useful purposes at a common rate of $9\frac{3}{4}$ per cent. On an average we have one cooperative society for every two villages in the Punjab.

An instance may be given here of useful work done by a typical village credit society. Bama Bala, a Cooperative Credit Society in District Montgomery, was registered in the year 1910. During the first eight years of its life it could not do much effective work and its capital was below Rs. 1,900. Mr. Stickland, the Registrar of Cooperative Societies, paid a visit to the society and explained to the members and the villagers how the society should work and gain in usefulness. A new chapter started in the life of the society. All the communities joined it, and in the year 1935 its membership rose to 122, its capital was more than Rs. 25,000

out of which owned funds were Rs. 12,500. The indebtedness of the members to outside agencies was reduced to Rs. 1,000. They must be free of all outside debts now. The society contributed Rs. 250 out of its common funds to District Board for the maintenance of English classes in the middle school for boys. Its Secretary became the Director of the Montgomery Central Cooperative Bank. The members started propaganda in the neighbouring villages for the organization of Credit Societies, and eventually a Banking Union was started at Bama Bala. The members took to the improvement of their agriculture, one of them installed a tube well worked by an oil engine. Several of the members started fruit gardening on commercial scale. The members also undertook the sale of their produce cooperatively. The rate of interest of the Society was reduced from 12 per cent per annum to 6 per cent per annum on punctual payments, those defaulting had to pay $12\frac{1}{2}$ per cent.

(ii) *Consolidation of Holdings*

The Cooperative Consolidation of Holdings Societies come next to credit societies in the Punjab. In these societies the object is to consolidate the holdings of the members in the village by mutual consent and agreement. This form of society is a unique example of cooperative effort. Several countries have tried to tackle this problem by various kinds of legislation but have failed. The achievement of Cooperative Consolidation of Holdings in this Province has been solely due to the members agreeing themselves to formulate a plan on the basis of which the land of different qualities in a village is re-distributed amongst the different owners. It is no less than a miracle to find widows, orphans, mortgagees and different kinds of right-holders being brought to a settlement acceptable to all. In some cases it took years to consolidate a village but as staff gained

experience, the results were speedier. To start with Government sanctioned some staff for this work, but the demand of the start of such societies was so great and keen that additional staff was employed at the expense of the members of the societies themselves. Number of societies at present is 1,875 with a membership of 240,000. More than 13.67 lacs acres have so far been consolidated in this Province, and every year at an average of 1 lac acres are being consolidated through these societies.

Consolidation causes a metamorphosis in the life of the village. All its economic and social life changes. New wells are sunk, better methods of agriculture are undertaken, improved seeds are bought and much more profitable crops are grown. Common land for expansion of the village *Abadi*, land for the use of *Kamines* and artisans, playgrounds, schools, places of worship, cremation grounds, graveyards, *daras*, manure pits, village tanks, grazing of cattle etc., are provided. Roads and paths to each field are provided and thus a fruitful source of quarrels arising out of trespass is avoided. There are also no disputes due to *banna shikni* which is a source of huge expense and prolonged litigation in several villages.

In Mustafa Abad Jattan in Gurdaspur District, the total area of the village was 5,225 *canals*. Previous to consolidation the number of plots in the village was 665, after consolidation it was reduced to 27. Previous to consolidation more than one-sixth of the area of the villages was lying waste because it could not be cultivated, now it is all under cultivation. Average area per plot previous to consolidation has now risen from 5 to 195 *canals*. Previous to consolidation there were only two wells in the village but six new wells have now been sunk. Land for common purposes which did not exist before has been provided.

In Ludhiana and Ambala Districts,

where groups of villages have been consolidated, straight roads connecting the villages have been constructed extending over several miles. Carting of the village produce to the market has become much easier and it has rendered both inner and outer communications very easy.

(iii) *Better Living Societies*

Prevention of wasteful expenditure which is rampant in the villages in the Punjab is a very difficult problem to tackle. No law could prove effective in changing the social life and practices of the people. The Cooperative Better Living Society has been found to be a successful device in reforming bad customs and inducing thrift. The members by their mutual consent agree to impose upon themselves various restrictions which no outside agency could do. Customs prevailing are impossible to be given up until the whole village, or the entire tribe joins hands to stop it. It is for this reason that cooperative organization has been found to be amply suitable.

The model bylaws framed by the Registrar cover a wide field of activity for this kind of society, a selection out of which is made according to the local circumstances prevailing in each village. There is a large number of societies in this Province; most of them exist side by side with the credit societies and at certain places they have been affiliated with Unions. These societies have brought about great economic improvement in the villages, and where they are effective they have not only controlled the expenditure but have also helped in stopping prolonged litigation going on between various parties in the villages. Some of these societies have been holding village competitions for improved methods of cultivation, home industries, cattle, implements, baby shows, rural games etc. A special staff has been sanctioned by the department to supervise these societies

whose total number now stands at 2,097 with a membership of 97,276.

In village Bhabra in Gurdaspur District the Better Living Society not only improved the condition of Bhabra village but was also instrumental in having societies started in the neighbouring villages as well. Previous to the start of the society there was always some litigation going on, and the villagers had to go to the civil and criminal courts at Gurdaspur at a distance of about six miles from the village. After the start of the Better Living Society not even a single civil or criminal case has gone to the court from this village. The people are living a happy and peaceful life and have effected several improvements. A lower primary school has been started which they want to raise to Upper Middle. Ch. Allah Rakha, the President of the Society although a petty *zamindar* has become a prominent person of that side on account of his selfless work. He takes active part in all the prominent cooperative activities in the district. Bhabra Better Living Society is shown to almost all the outside visitors who come to see the cooperative work round about Gurdaspur.

For obtaining expert advice and guidance for growing better crops and for the general improvement of agriculture residents of each separate village can form the Better Farming Society, for improving the breed of its cattle it can organize the Cooperative Cattle Breeding Society, for reforming its extravagant and wasteful customs it can start the Better Living Society, and for getting its daily provisions it can have the Cooperative Supply Society. Think of any useful common object and you can cooperate with others feeling the same need for its efficient achievement. Suppose you want to grow fruit trees and start bee-keeping and poultry farming along with a number of associates wanting

to do the same thing, for such objects you can form yourselves into Cooperative Fruit Plantation, Bee-keeping and Poultry Societies. For promoting the habit of thrift and savings, for clearing silt from water channels, for provision of human and veterinary first aid, for imparting compulsory education to children and adults, for promotion of economic and social knowledge, for improvement of the health and morals of the people, for development of cottage industries, for settling small disputes without recourse to courts, and for many other objects thought out and agreed upon by the members of a given community residing in isolated villages cooperative societies for such definite objects can be organized by them.

As regards bigger problems whose solution requires the cooperation of more than one village, a few instances may be given below.

The prevention of erosion through hill and rain torrents is an instance of a task which cannot be undertaken individually and must of necessity be done by the entire population. Erosion is raging havoc both under the Siwaliks on the east and the Suleman range on the west of the Punjab. Round the Siwaliks, however, a large number of Cooperative Anti-erosion and *Cho* Reclamation Societies have been formed and effect of erosion greatly checked by reforestation, controlled grazing, contour trenching, gully plugging, band making etc., in the hills, and by grass planting, tree growing, *wat-bandi* terracing etc., in the plains. If this problem had not been tackled cooperatively, the rapid pace with which erosion was proceeding in the sub-mountainous tracts of the Siwaliks, the districts of Hoshiarpur and Jullundur would have been turned into deserts in time. The level of the sub-soil water was going down rapidly, rendering lift irrigation impossible in some of the

tracts of these districts. The hill torrents were washing away agricultural land of the districts after every rainfall, and most of the tract was being rendered barren. With the anti-erosion activities undertaken by the cooperative societies the hills which were bare have now a heavy growth of plants and trees over them. The force of the torrents has very much weakened, soil erosion has been reduced, and a rise in the sub-soil water has been now observed during the last three years. The Suleman range where no such cooperative activity has as yet been started presents a horrible state; a miserable plight seems to await sub-mountainous tract on that side of river Indus.

The societies in Una and Garhshankar are doing substantial work. One of the societies in Una namely Lohara came into being for the cultivation and protection of fir and *sal* trees, and is carrying out its programme with an appreciable measure of success. There are 81 members on its rolls and it has by now 150,000 trees under its protection. If the price of one tree is assessed at Rs. 3 on the average, the total wealth on account of this large number of trees works out to Rs. 450,000, and it is an achievement of which the society can be justly proud. It has accumulated a decent profit of Rs. 3,986 which is put in the local credit society. The sale of grass, fire-wood and that of rosin account for this goodly profit. In village Badhera the society aims at preservation of the *shimlit* and the reclamation of the land rendered unculturable by the Swan river, and protects culturable land from the erosive action of this rivulet. It has 135 members and about Rs. 5,000 as its working capital. The grass cut from the reclaimed area and the rosin manufactured are sold by auction, and the average annual income aggregates to Rs. 3,000, an amount approximately equal to the land revenue of the village. This

society came into existence as far back as 1906, and has succeeded in producing wealth in the shape of 20,000 trees which if priced at Rs. 3 each on the average, will fetch Rs. 60,000. Land covering 3,840 acres under the Swan river is being reclaimed by the society; its achievements are creditable and it can boast of being the first of its kind in the district. Since its inception the society has saved more than a lac of rupees to its members. It is running a primary school on which Rs. 600 odd have been spent out of the common good fund. There is scarcity of water in the tract and Rs. 200 have already been expended on the construction of a well; another sum of Rs. 100 more is going to be used similarly for which sanction has already been obtained. Every year Rs. 60 are being spent on the maintenance of a drinking booth for the passersby.

The start of anti-erosion work not only ensures the ultimate usefulness of such societies, but after second or third year a source of ever rising income also becomes available for the village.

Total number of such societies in the Punjab is 276 with a membership of 10,237.

For making suitable arrangements for the profitable marketing of agricultural produce of a given locality, we need a big Cooperative Sale Society in some central market with a large membership extending over some 50 or 60 villages, since larger the amount of produce received by the society from its sincere and loyal members the better the prospects for its efficient and economic management and for commanding greater confidence and influence in the local and foreign markets. The Punjab has got today 37 Sale Societies and 22 Commission Shops with a total membership of 8,578 and 4,467 respectively.

If the object is to arrange for the provision of medical aid to both men and women residing in villages lying close

to one another it can be fulfilled by their organizing a Cooperative Medical Aid and Public Health Society, and employing therein paid doctors and Nurses, and fixing annual subscriptions and securing Government and District Board grants earmarked for such purposes.

The Punjab has made a modest start with 8 such societies having a total membership of 863. In 1943-44 these societies treated 433,000 member and 225,000 non-member patients.

Future Possibilities

Every Provincial Government is anxious to increase the prosperity and happiness of the Province and to adopt all possible measures to raise the standard of living of the people. There is a vast scope in all parts of India to increase national income by developing agriculture and animal husbandry on scientific lines, and by promoting industries both large-scale and cottage, by adopting up-to-date and most modern methods of work. Governments want to spare no efforts to consolidate fragmented land of the agriculturists on as large a scale as possible so that a large number of new wells be sunk and area under cultivation may increase. They are desirous of protecting land from erosion caused by hill torrents; of improving the breed of cattle by inducing people to keep pedigree bulls and selected cows and maintain a proper record of their milk yield; of bettering the prospects of sale of peasants' produce and purchase of their daily provisions; of instilling into them the much needed lesson of practising thrift and avoiding waste of all kinds; of reforming their habits, customs and injurious ways of life; of introducing new methods of farming and cultivation; of developing cottage industries and other auxiliary industries like Bee-keeping, Fruit Culture, Vegetable growing etc.; of increasing credit facilities to them and of improving their sanitation,

health morals, intellect and knowledge. In short every Provincial Government wants to devote greatest possible attention to solving each and every problem confronted by the people whether it relates to their economic and social activities or to cultural, moral, educational or any other activity. The task of Government will become much easier and all their useful schemes under Post-War Planning will have much greater chance of success if masses are first taught to unite themselves into groups for working out these schemes. It is obvious it cannot be an easy thing for Government officials to approach each and every individual and to explain to him the usefulness and advantages of the schemes intended to be introduced in rural areas for benefit of the village folk and as to how they are to be rendered a success. But if people have formed the habit of organizing themselves into cooperative associations for achieving their different economic and social objects a tremendously large net-work of various types of societies, such as Cooperative Consolidation of Holdings Societies, Better Farming Societies, Co-operative Stores and Supply Societies, Better Living and Cattle Breeding, Fruit Plantation, Beekeeping, Industrial, Labour, Thrift and Savings, Medical and Public Health, *Chh* Reclamation and Forest Preservation, Credit Societies, Adult Education etc., can be established in the countryside which would mean a best guarantee for the lasting and permanent improvement in the economic, cultural, social and intellectual position of the agricultural classes of this vast sub-continent.

In short there is hardly anything in the world which can not be done co-operatively provided the associates are really honest, thrifty, courageous, industrious, loyal and willing to learn new things and ideas and are imbued with a true cooperative and progressive spirit.

One thing to be remembered particularly and always about cooperation is that without good character there can be no successful cooperation. A cooperative society after all has no independent existence of its own, it is merely an expression of common efforts and aspirations of the members in a certain direction. We should not forget that members of a cooperative society join it not as capitalists but as human beings, and as such they must be gifted with moral qualities like thrift, honesty, industry, courage, unity, selflessness, loyalty, reliability and trustworthiness which are not only essential for man's

success in private and social life, but also can make an excellent substitute of capital which members of these societies generally do not have.

Since the future economic prosperity of India is to depend to a very large and marked extent on a big net-work of cooperative societies organized for various ends it behoves every well-wisher of the poorer masses and every patriot Indian to pay his best and closest attention to the firm establishment and efficient maintenance of these institutions which are to play such an important role in the future development of Indian villages.

THE PANCHAYATGHAR INSTITUTION

By M. S. RANDHAWA

WITH the inauguration of the Panchayatghar programme in 1938, rural development work in the United Provinces entered a new phase. This new type of institution is the result of well aimed joint efforts of Dr. K. N. Katju, Minister for Development, Mr. M. D. Chaturvedi, Rural Development Officer and myself. Literally a Panchayatghar means a house in which the Panchayat meets and outsiders on visit to a village can stay. Panchayatghars already existed in the western districts of the United Provinces and the eastern Jat districts of the Punjab.

As a result of the experimental work carried out by me in Fyzabad District in 1937-38, the term Panchayatghar acquired a new meaning. It became a new type of organizational institution which could become an effective lever for developing the villages and raising the villagers from their age-long slumber. We were groping for a programme and searching for an organization and in the Panchayatghar institution we discovered a new type of organizational institution which caught the imagination of the village people and canalized their energy into constructive work. The villages began to throb with new life.

The importance which the United Provinces Government, during the regime of the first Congress Ministry, attached to it can be gauged from the following remarks of Dr. Katju :

“I regard a *panchayatghar* as the very pivot of the whole rural development plan. A Panchayatghar does not merely

mean a building where villagers can come together and meet and discuss village topics. It is much more than this. It should be a living monument and symbol of village unity and organization and the centre of all village activities. It should inspire every resident of the village—man, woman and child—as an embodiment of their corporate life.”

The idea of a Panchayatghar embodies much more than the name signifies. The Panchayat houses which we built were not only meeting places of the Panchayats of the villages, where they drew developmental programmes for their villages and settled village disputes, but they were also nuclei of developmental work in villages under the rural development scheme.

A Panchayatghar was built for a group of 12 villages to start with. Each Panchayatghar had 5 rooms housing a library, a small dispensary, a cattle unit centre, a seed and implement store. In the central hall, a museum of posters and pictures of agricultural interest as well as of local cottage industries and crops was maintained. In the evenings it served as the village club where the villagers came to listen to radio news and at night time as an adult school.

Attached to each Panchayatghar was a well from which a nursery of popular fruit trees was irrigated. In some places cooperative stores were also housed in the Panchayatghar. It also served as a village guest-house and a meeting place where developmental officers like agricultural and veterinary inspectors, members of

the district health staff and rural development workers addressed the villagers.

Better Organization

Most of the workers in rural areas, who have devoted their lives in the service of the village people have realized that there is need of organized effort for awakening the village people from their age-long sleep. The unorganized efforts of sporadic workers seem to have been lost in the vast ocean of Indian villages without making any dent on the face of the countryside. This has meant wastage of a tremendous amount of energy which, if properly canalized would have given much better results. They have also felt that there is a strong need of a resident agency in the village itself to carry out a programme of development and to secure permanence and continuity for the work done. The Panchayat and Panchayatghar is an ideal agency for securing such permanence in rural development work.

In the United Provinces an extensive development programme was launched in selected villages through the agency of organizers who were given a special training in elements of agriculture, animal husbandry, cooperative, sanitation and public health problems. It was soon realized that a central institution in the form of a Panchayatghar was essential to coordinate the efforts of all development departments. In Panchayatghars we got buildings where all development work was concentrated and could be inspected. We have court-houses for dispensing justice and school buildings for imparting education. So there is no reason why such important work as rural development be handicapped due to lack of buildings for housing its multifarious developmental activities.

Bridging the Gulf

The gap which exists between agricultural research and its application in

practice in India has been deplored by many persons, who have reviewed agricultural practice in India. However, such a gap does not exist in the sphere of agricultural research alone but extends to all phases in our life. There is a microscopic minority of educated persons on the one side and a mass of uneducated and unorganized villagers on the other. This gap is largely accounted for by wide-spread illiteracy among the masses and only a national programme of mass education can help in bridging the gulf. Apart from mass education, there is need of organization and an institution, which can serve as a link between the farmer and the research worker. Panchayats can serve as such organizations and Panchayatghars as such institutions. Through the agency of Panchayatghars, we can bring the benefits of modern scientific developments to the villages; we can supply the villager with improved seed and implements of proved utility; we can supply him with saplings of fruit plants and vegetable seeds, quinine, mosquito nets, and above all, stimulate his mind with new ideas.

To raise a sound organization we should build from below upwards. Before we have Panchayatghars, we must have Panchayats. These Panchayats should have both judicial as well as developmental and cultural functions to form the base of the pyramid of development. There is need of organizing such Panchayats in all the villages.

Work in Fyzabad

A brief review of the work done in Fyzabad can serve as a guide for others. To propagate this idea and to explain the utility of Panchayatghars, mass meetings were organized in all the villages under the rural development scheme. Posters were designed showing pictorially the functions of the Panchayatghars. These were displayed on specially designed poster-boards in village

market places, primary schools and roadside wells. Amongst the literate section of the villagers, these posters proved to be of great utility in propagating the Panchayatghar idea.

Contributory Principle

Charity from Government or private individuals cannot serve any useful purpose in stimulating the villagers into action. Self-help supplemented by aid from Government can alone enthuse the villagers. The basic principle which we adopted was that one half of the cost be met by the villagers in cash, kind or both and the remaining half to be met by the Government. Every family in the village was made to contribute in some shape or form—in cash, kind or labour—towards the construction of the Panchayatghar. In villages where Panchayatghars were constructed by the villagers on this principle, they regarded these buildings as their own as they had made some contribution, in some form or other, in raising them. In some villages batches of 30 to 40 persons gave free labour for two or three days; some gave free service of their carts and bullocks for the carting of bricks; some gave bricks, timber, cement, iron rods as well as cash contributions. Levy of one rupee per plough also helped. Funds hoarded by the old Panchayats, which were lying idle, were also utilized. In one village where crops were suffering from the depredations of wild cattle, the villagers caught them in large numbers and later on sold them, the sale proceeds being utilized for the construction work.

In contrast with these buildings which were built on a cooperative basis by the villagers themselves, the buildings which the Taluqdars and rich Zamindars raised to please the officials never became popular and were shunned by the people who regarded them as coercive and alien institutions like the police stations.

Selection of Sites

The selection of a suitable site for the Panchayatghar, which is meant to be the nerve centre of the village, is of prime importance. As far as possible, those sites were selected which were easily accessible to the village people and where they would naturally like to assemble. Though suitable sites in some villages were readily available in others considerable opposition was encountered from landlords. Thus, a need of legislation for compulsory acquisition of land for making Panchayatghars was felt.

Improved Implements

Panchayatghars can serve as agencies for demonstration and sale of improved agricultural implements like chaff-cutters, iron ploughs and threshers. Here lies the necessity of linking up the firms manufacturing agricultural implements with the farmers through the agency of Panchayatghars. It is hoped that these firms will seize this excellent opportunity with the cooperation of Government. The other alternative is that Government may purchase these implements from the manufacturing firms and give these to the farmers on *takavi* system instead of giving loans in cash.

Rooms with cement floors to serve as seed stores were made in some places and seed of improved varieties of crops supplied by the Agriculture Department was stored and given to the villagers on *sawai* system. It is further suggested that packets containing seeds of vegetables may also be made available to the villagers from these seed stores. Unless these facilities are brought to the door of the cultivator through the agency of Panchayatghars, there is little likelihood of their being disseminated in practice. What the agriculturist requires is not so much of knowledge but facilities.



PLATE 3

LISTENING TO A RADIO BROADCAST
Ronahi Panchayatghar in Fyzabad District (above)

M. S. RANDHAWA

INTERIOR OF A PANCHAYATGHAR
Village Tahsinpore in Fyzabad (below)

M. S. RANDHAWA

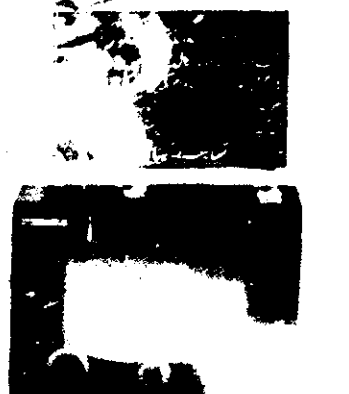
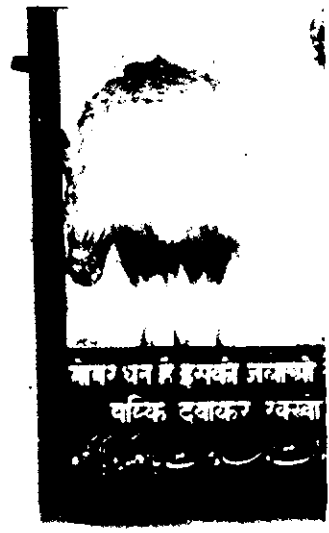
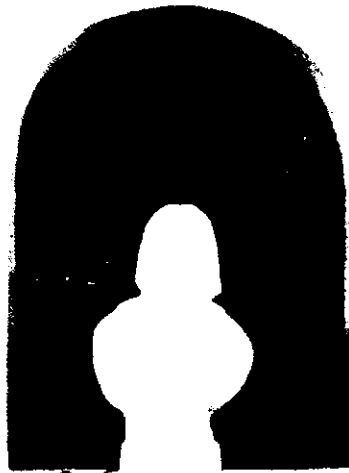
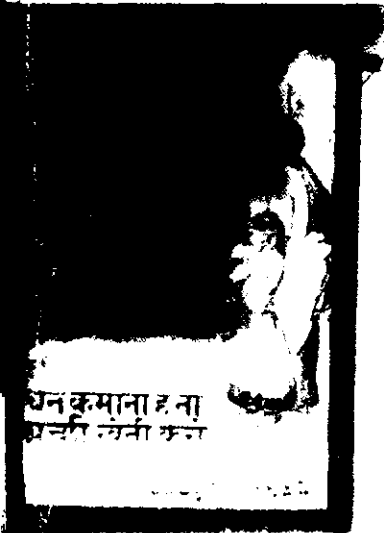



M. S. RANDHAWA

VILLAGE SCOUTS
In the United Provinces

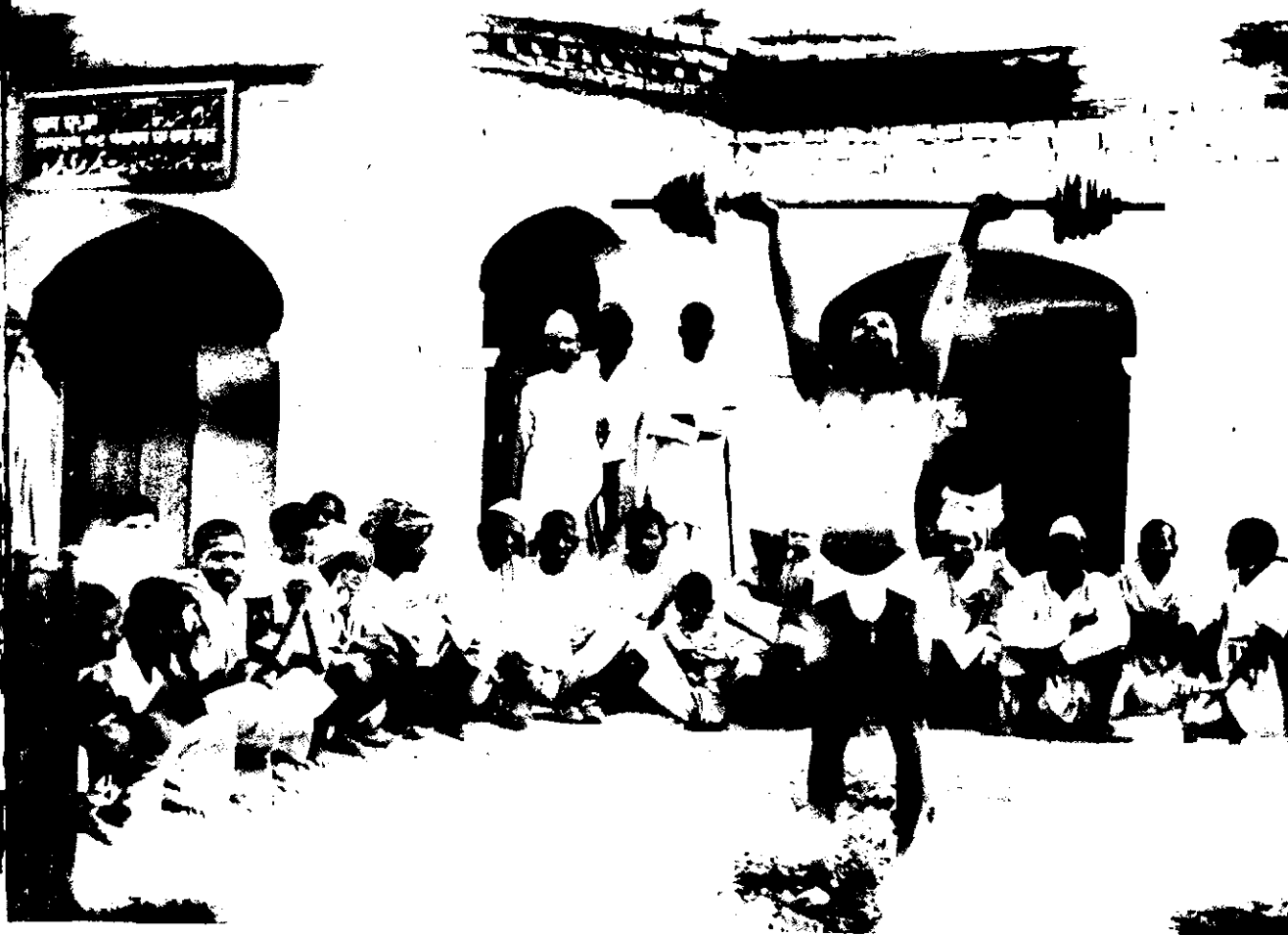

LIFTING BAR-BELLS
Tahsinpore Panchayatghar in Fyzabad



M. S. RANDHAWA

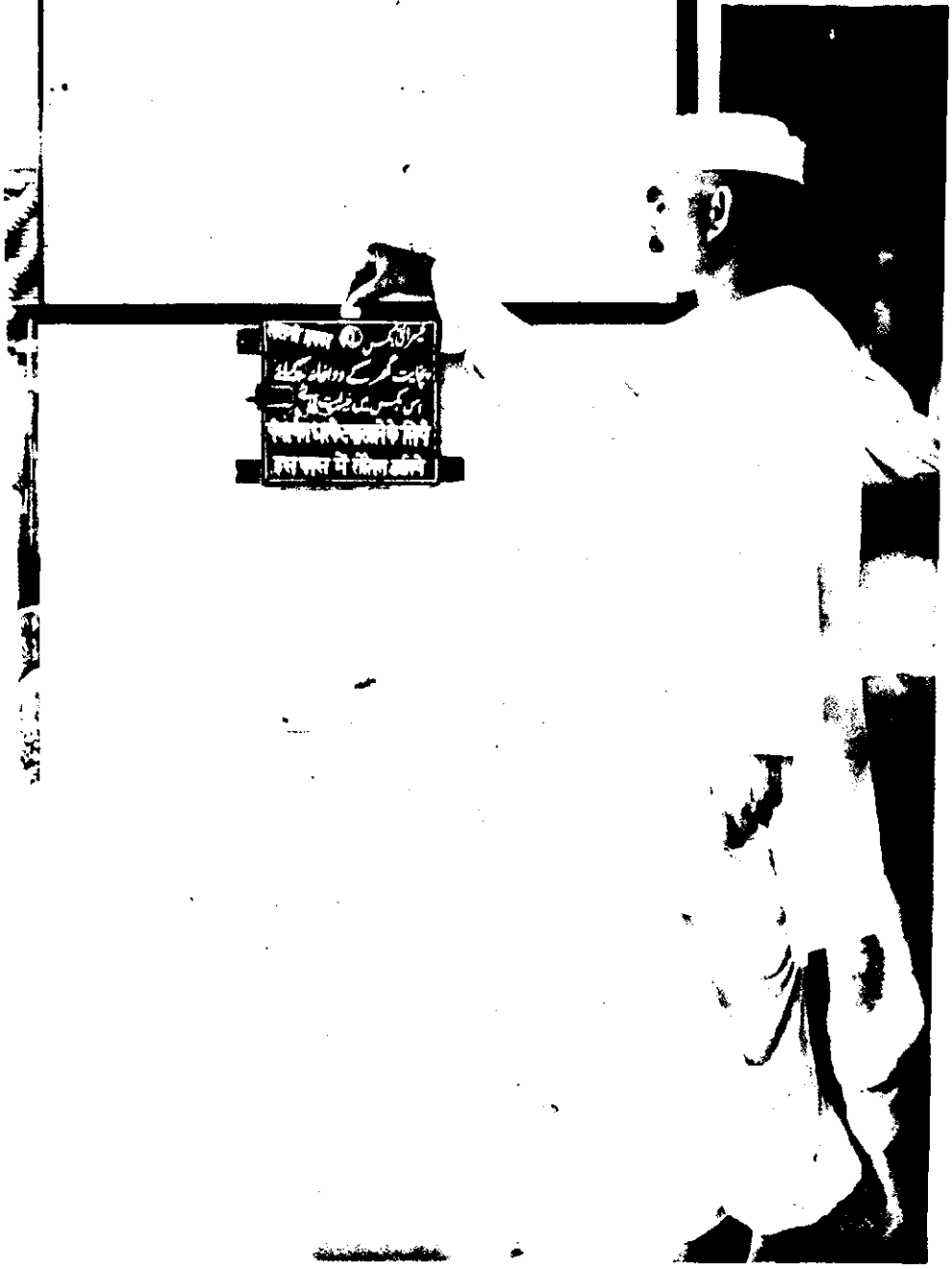

भारतीय
राज्य
भारतीय
राज्य

M. S. RANDHAWA

CHARITY BOX
For a Panchayatghar Dispensary



M. S. RANDHAWA

THE DISTRICT HEALTH OFFICER
Inoculating the villagers at Pant Panchayatghar of Kusmaha village in Fyzabad



PANCHAYATGHAR READING-ROOM
Village Pura Bazar in Fyzabad (above)

M. S. RANDHAWA

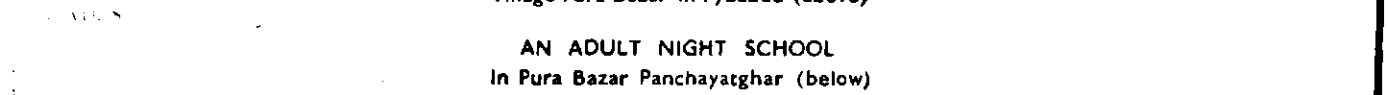

AN ADULT NIGHT SCHOOL
In Pura Bazar Panchayatghar (below)

M. S. RANDHAWA

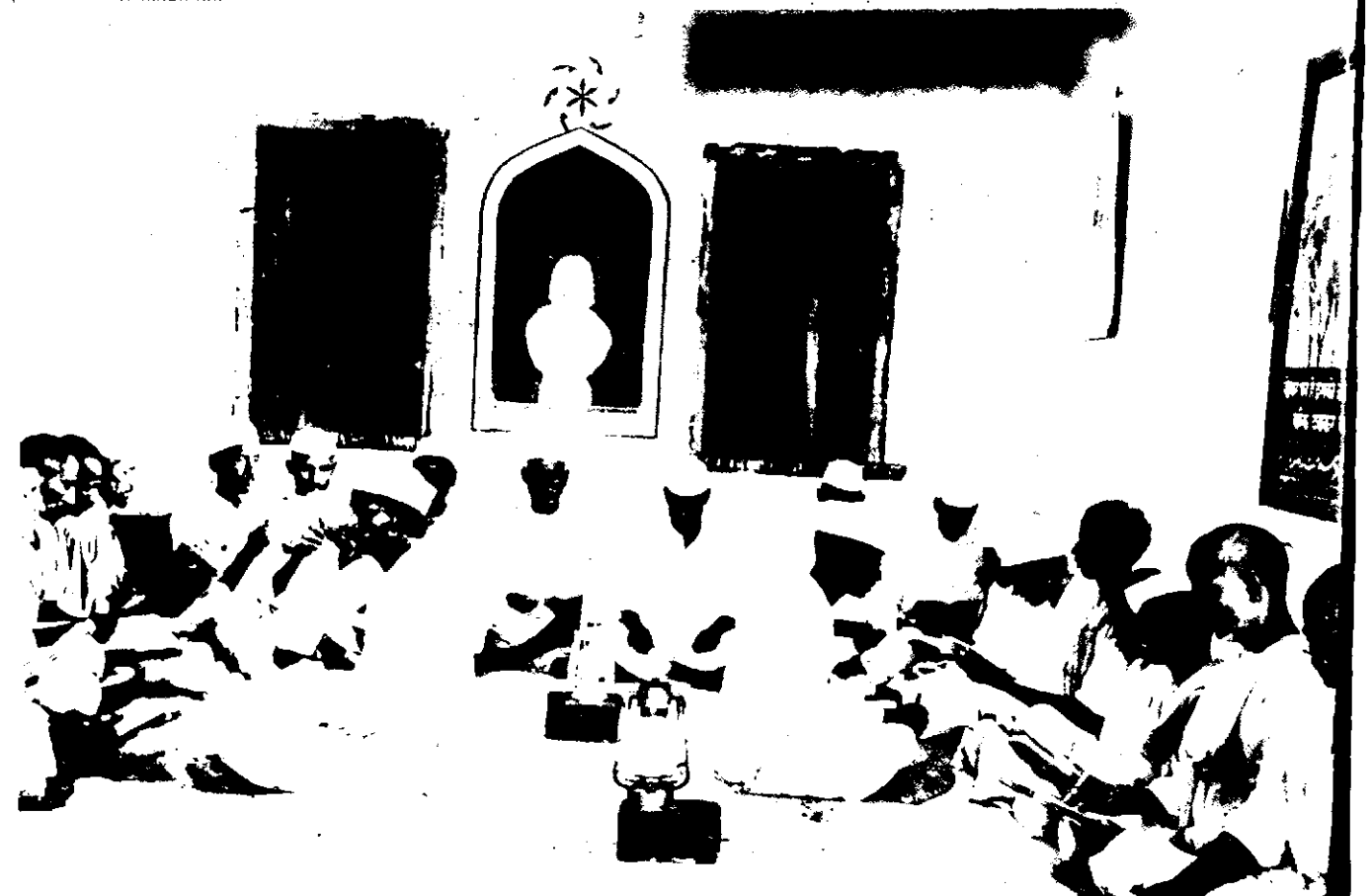



SEED STORE IN A PANCHAYATGHAR

M. S. RANDHAWA

Organisers Quarter	Co-operative Store (Salt, Sugar, Kerosene, Cloth, Mosquito nets)	Seed Store	Implement Store	Poultry Shed
--------------------	--	------------	-----------------	--------------

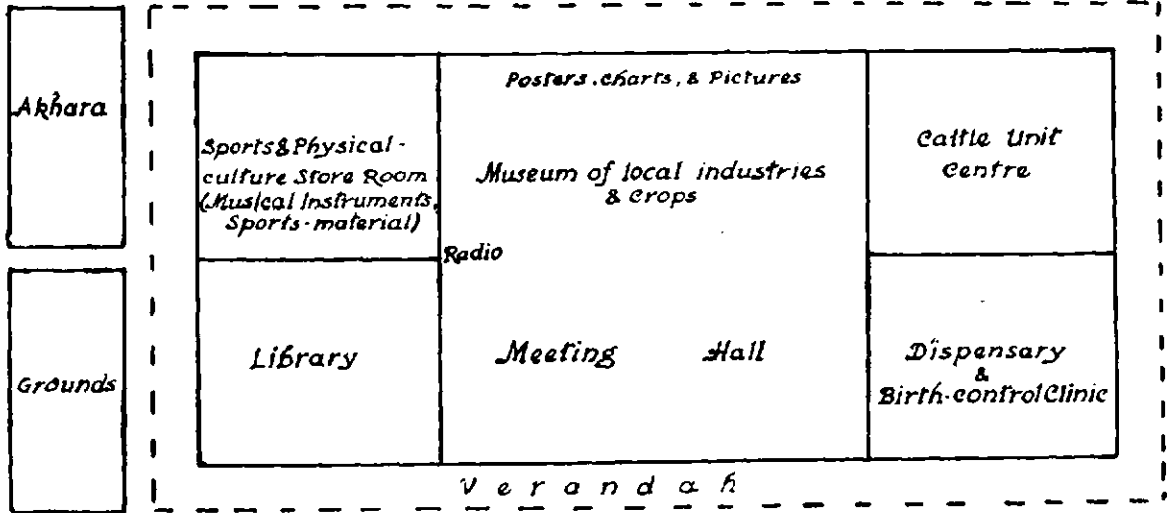

Nursery of Fruit Plants

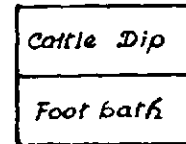

N. S. BISHT

PLAN OF A MODEL PANCHAYATGHAR

Cooperative Stores

The villagers are fleeced by village *baniyas* and shop-keepers who usually barter grain with cloth, sugar, salt and other necessities of village life. The prime necessities of the villagers are kerosene oil, salt, sugar and cloth. These should be purchased in the towns at wholesale rates and sold by the Panchayats at reasonable prices. Educated sons of *baniyas* and shop-keepers can serve as sale agents in such cooperative stores.

Nurseries of Fruit Trees

Nurseries of fruit plants such as grafted mangoes, lemons, papayas and kathal, under the charge of a *mali*, were also started. These were irrigated from wells made for the purpose. Saplings of these plants were distributed among villagers at cost price. We also encouraged sowing of flowering plants like marigold, zinnia, jasmine as well as flowering trees like Gul Mohur, Kachnar, Amaltas and Jacarandas. Thus, these Panchayatghars appeared like islands of beauty brightening up the villages.

Poultry

In villages inhabited by Moslems and those Hindus who have no objection against keeping poultry, the scheme of upgrading *desi* breeds of poultry can also be taken up through the agency of Panchayatghars. For this purpose it is necessary to have hatcheries at district headquarters with electric incubators. When the cockerels and pullets are three months old, these should be immunized against Ranikhet disease, fowl pox and tick fever and distributed to poultry farms of Panchayatghars.

The egg-laying capacity of *desi* hen is 50 to 60 eggs per annum. This can be improved by 10 to 15 per cent, and the size of the egg can also be increased, if they are upgraded by crossing them with cockerels of improved breeds like Rhode

Island Red, White Leghorns, and Black Minorca. The cockerels of these improved foreign breeds should be exchanged with *desi* cocks, weight by weight, at Poultry Farms of Panchayatghars on the condition that the person concerned does not keep *desi* cockerels. Concentrated work is necessary to make the scheme a success. A village should be selected and its poultry population saturated with new germ plasm and then another village should be tackled. This should be followed by propaganda on prophylaxis, proper feeding and housing. This scheme was tried by Dr. Spencer Hatch at Marthandam, and by the Government of the United Provinces during the second World War with considerable success. This is one of the quickest methods of providing the cultivator with extra income and deserves a trial in all provinces.

Museums

From the cultural and aesthetic point of view these villages were dreadfully bleak and cheerless. Our Panchayatghars not only served as models of cheerful and well-ventilated houses, but also as cultural museums decorated with pictures, educative posters, charts and radios. Coloured pictures of rural interest were excised from the old issues of the *Illustrated Weekly of India* and mounted on cardboard and were given suitable captions in Urdu and Hindi. Alcoves 2 feet wide 3 feet high and 10 inches deep were made on one of the walls of the hall room and were painted deep blue. Clay busts of historical personalities, who have contributed towards the development of India, like Buddha, Asoka, Ranjit Singh, Rabindranath Tagore and others were made by a local potter who had received training in the ceramics department of the Benares Hindu University. These clay busts were dried in the sun and baked like ordinary pitchers in crude furnaces and then painted white. These

busts silhouetted against the blue background made these rooms very attractive. Brief biographical notes in Urdu and Hindi recounting the achievements of these men and the contribution they have made towards human culture were painted on black tin plates. These busts not only reminded the villagers of their glorious heritage but also enhanced the beauty of the entire Panchayatghar from the aesthetic point of view.

Besides, the Panchayatghars were decorated with posters and charts dealing with problems of improvement of agriculture, better breeds of cattle, maternity and health problems and socio-economic evils like child marriage, wearing of ornaments, litigation, use of intoxicating and alcoholic liquors and waste of money on ceremonies of birth, marriage and death. These posters were mounted on plywood and were hung at a level of 5 feet from the ground. The poster boards displayed in the verandah were covered with wire-netting and were locked. The organizers were instructed to fix the posters with drawing pins and to replace them every fortnight.

In some of the villages excellent clay toys, baskets and embroideries are made. Some of these possessed considerable artistic merit and deserve to be encouraged. For this purpose some of the Panchayatghars can serve as museums of local manufactures. Apart from these, specimens of local crops, vegetables and fruits can also be exhibited in these buildings.

Libraries and Reading-Rooms

Libraries and reading-rooms were opened in all Panchayatghars. Newspapers, books as well as pamphlets and leaflets issued by the Rural Development, Education, Agriculture and Public Health Departments were collected, bound and placed in these libraries. The supply of books and magazines was supplemented by collections of copies

from city people. These libraries were placed in charge of teachers of adult schools. Big groups of villagers used to assemble in the evening while the literate villagers and the organizer read important extracts of news from daily papers to the illiterate ones.

Night Schools and Radios

Panchayatghars also housed village night schools. At night time groups of village boys used to assemble around kerosene hurricane lanterns with keen eyes and eager faces.

Radios were installed in all Panchayatghars. Arrangements for charging the batteries were made by the Government, who had appointed radio engineers, whose function was to look after the radio sets and to replace discharged batteries. The radios proved to be a great attraction to villagers and added to the popularity of the Panchayatghars. Nothing can beat the radio in relieving the dullness and monotony of village life and spreading enlightenment, culture and instruction.

Dispensaries for Men and Animals

In all Panchayatghars one room was used as a dispensary. A stock of medicines, which can be used for common ailments, such as malaria, cholera, stomach-ache, tooth-ache, ear and eye troubles, ring-worm, itch, ulcers and sores, was prepared. For storage of these medicines, empty cigarette tins and bottles were collected from the houses of city people. Illustrated charts describing the causes and treatment of common diseases as well as hints about diet and instructions about the use of medicines were prepared in Urdu and Hindi and supplied along with the medicines. Charity boxes were fixed in the verandahs with captions in Urdu and Hindi, asking the villagers to contribute for the dispensary.

Health Officers and vaccinators also used the Panchayatghars for inoculating and vaccinating the villagers during the

epidemics of cholera and small-pox.

One room was used for keeping medicines for common cattle diseases. A stockman, appointed by the Veterinary Department looked after these medicines and also castrated scrub bulls. Foot baths of cement were also constructed opposite these buildings. During cattle epidemics, particularly rinderpest and haemorrhagic septicaemia, common practice in the village was to have the name of god written on an earthen pot and hang it by a rope across the lane so that the cattle passing below it acquired immunity. Through the agency of Panchayatghars, veterinary surgeons could deal effectively with these with the aid of their sera and such superstitious practices will vanish.

Games and Scouting

In the open places near the Panchayatghars organized village games like *Kabadi*, tug-of-war, football and volleyball were encouraged for teaching co-operation and team work. Physical exercises like wrestling, *dands*, *baithaks*, weight lifting, running and jumping and massage with mustard oil developed the physique of the young people and also served as an outlet for excessive energy which otherwise fizzles out in crimes like affrays, riots and thefts. To meet this need of the villagers, *akharas* were started in front of the Panchayatghars and sets of weight lifting apparatus, *moonglis*, and parallel and horizontal bars were provided. Later on inter-village tournaments in *Kabadi*, tug-of-war, football and volleyball were also started and prizes were given in the form of shorts, shirts, *charkhas*, meston ploughs and chaff-cutters. Boy Scout movement, which teaches ideals of service, healthy outdoor life, and discipline was also encouraged. Most of the villages had Scout troops of

their own who turned up smartly on social and official functions.

Settling Disputes

Litigation is the only industry which flourishes in the villages at present. All the traffic in the district towns leads to the district courts. For most of the villagers litigation is the only amusement left and petty matters which can be settled in the villages come before the courts where the poor tillers of the soil are deprived of their hard-earned money by the *vakils*, *mukhtars*, petition-writers and dishonest court peons and *ahalmads*. Most of these disputes can be settled by the village Panchayats by mutual compromise, arbitration and otherwise. By settling these disputes in Panchayatghars, harmony and peace can be brought in village life.

Guest Houses

The Panchayatghars can also serve as village guest houses and marriage parties visiting the village can be accommodated in these buildings. A small fee can be levied from the host for such purpose. Utensils for visiting *barats* can also be kept in Panchayatghars. Many Panchayats in the Punjab have already purchased stocks of utensils for such purposes.

New Yearnings

The Panchayatghars can serve as nuclei of all developmental work providing facilities to the villagers which are not available to them at present. They will also serve as lighthouses radiating culture, knowledge and happiness, and we hope that the light from these buildings will penetrate the remotest nooks and corners of the villages, banishing ignorance and superstition. They will awaken new yearnings in the mind of the peasantry.



2

PUBLICITY & PROPAGANDA



THE KEY TO THE GROWER'S DOOR

By ROGER THOMAS

MUCH has been done by the Department of Agriculture in India to improve the lot of the cultivator, but in the aggregate what has been done is only a small fraction of its potential. Having regard to the paucity of the funds allotted in the past to the Department in relation to the size of the country and the prominent place which Agriculture takes in the national economy, it is a matter for congratulation that so much has been done with so little. What the Department of Agriculture has failed to do (with some notable exceptions such as sugarcane and jute) is to raise appreciably the productivity of the land.

In general the soils of India are capable of growing considerably heavier crops than they do at present. The present low yields constitute an important factor which contributes to the poverty of the agricultural masses. The cost of producing a maund of any crop, whether calculated in cash or in labour, is nearly always more expensive with poor crops than with good crops. The easiest and quickest way of lowering the cost of producing a maund of most crops is to increase the yield per acre. The optimum economic yields of crops will result from a number of contributing factors such as improved seeds and implements, manures, judicious irrigation (where available), control or evasion of pests and diseases, conservation of soil moisture and prevention of soil erosion, agronomic technique best suited to each type of crop etc. This long list, which is far from exhaustive, demands much new knowledge on the part

of the cultivator; it also demands the ready availability of the goods and services which he needs to enable him to attain high crop yields. How then can we give the cultivator the new knowledge which he seeks?

Individual Contacts

'How best to reach the grower' is a problem which has baffled and continues to baffle the Departments of Agriculture in India. It is axiomatic that you must reach him before you can teach him. But can he be reached? The answer is categorically 'Yes', but not unless and until we change our methods of publicity.

There is much useful knowledge the Department of Agriculture can teach to the cultivator which will enable him to improve his standard of living by growing bigger and better crops on his land. But what hope is there of making a deep impression on India's 300 million villagers with only a handful of district officials engaged in all the Provincial and State Departments of Agriculture in the country. Even if this staff is increased tenfold—as it may well be under the post-war plans—it will still remain a physical impossibility for the members of the district agricultural staff to make the desired frequent *individual* contacts with the teeming millions which constitute the farming community. Pamphlets, posters and lectures are of little use in Indian villages without personal and frequent contact between the publicists and the villagers.

Tempo of Progress

We may well ask why progress has been so slow in applying the results of research to agriculture in India, and is it not possible to hasten the tempo of developmental work in the villages. I am of the view that progress has been slow mainly because our methods of publicity are antiquated; and that the tempo of progress can be very considerably hastened without great cost. But there is little hope for any material change in the tempo of progress unless the villagers can be contacted *collectively*. This object will be achieved only by taking the fullest advantage of the new appliances which science and technology have in recent years placed in our hands. These are the mobile cinema and the radio. For village welfare work the mobile cinema excels. The radio will take second place as a medium for educative publicity until the illiteracy of the agricultural masses has in large part been liquidated.

An Uphill Task

The Indian cultivator may be conservative, apathetic, and dubious about any so-called improvements recommended by Agricultural officials. It is foolish to expect him to be otherwise. When free advice is given to him his first thought is: What if the 'improvements' refuse to 'improve'? His customary agricultural practices are dictated by the experience of many generations of his ancestors who have bought their experience dearly. The existing practices are the best adapted to the local conditions as he finds them after giving due regard to the limitations of the goods and services of which he can be assured. To change any of his established practices may mean disaster to him in depressed crop yields for reasons unforeseen by his adviser. The risks are ever present. Put yourself in his position and you would

most probably react as he does to unsolicited advice.

The emphasis which must be laid on a deep knowledge of village economy and a full appreciation of the difficulties facing the villager before we embark on teaching him his job. Increasing the staff engaged on distinct work in the Department of Agriculture, though urgently necessary, is in itself not enough. Most of the young graduates and diplomates turned out by our Agricultural Colleges are on first appointment divorced from the realities of village life. When they start 'educating' the villager, their new environment is so unlike what they have been accustomed to at College that most of them feel and act like fish on dry land. Courses of study in agricultural economics and also training in methods of publicity have in the past been deplorably neglected in our Agricultural Colleges. The gospel of village welfare cannot be properly preached without prior knowledge of those fundamentals which govern and dictate the way of life of the villagers. The teaching of agricultural economics in India should be concerned not with the out-worn theories of western writers but with the realities of village life and all that is meant by present methods of production, processing, marketing and distribution of farm produce. These studies should be coupled with the teaching of feasible means of instituting improvements in farm produce at every stage, from production to distribution.

Winning the confidence of the villager is an uphill task at any time. The task is rendered much more difficult through lack of appreciation of those factors which dictate the way of life of the villager. He resents being driven; but he can be led. He is amenable to friendly guidance; but he will not suffer dictation. Preaching to him about the folly of his ways will only antagonize him unless the preacher can demonstrate the practicability

and profitability of agricultural improvements under village conditions.

Running Commentary

The primary aim of all village publicity should be to educate the people—using education in its broadest sense, namely, the acquisition of desirable knowledge. To enable this to be done there is no need to wait until the illiteracy of the masses is liquidated. Much useful knowledge can be taught while we are waiting for the stigma of illiteracy to be removed. The villager is inherently as keen as the townsman to learn and particularly so anything which may be concerned with his welfare. He is not as conservative in his ideas as many would have us believe. He is much more receptive to new ideas in the mass than he is as an individual.

What then are the proclaimed advantages of the mobile cinema in this vital work? It affords variety in movement which is a most potent attractive force. It can always reach the village, and if not in a motor truck then on a bullock cart or a camel. It excites intelligent curiosity in the listener. It can make frequent visits. It inevitably collects a crowd and thereby solves at a stroke the greatest difficulty experienced by propagandists in village welfare, namely, convening the villagers in large numbers. They come without coercion and in a mood willing to listen attentively and to criticise intelligently. Men, women and children are all attracted. Here, indeed, is a new and a vital force in village publicity.

But let us not over-estimate the *educative* value of the mobile cinema. It should be regarded primarily as an *aid* to educative publicity. It will probably have little if any educative value in the initial stages, though it will undoubtedly serve this useful purpose once the audience has developed a sense of appreciation and of discrimination in the pictures

shown. This however takes time. The cinema, unaccompanied by educative propaganda in the form of lectures and demonstrations would be almost useless. Its greatest usefulness results from the facility which it affords the lecturer to speak to the villagers collectively and thereby enable him to put across what he has to preach.

In order to take the fullest advantage of the cinema when used in village publicity the pictures should be short and so should the lectures. No film or picture should exceed about 10 minutes duration. A running commentary by the lecturer in the colloquial language of the villagers can be much more effective than talkies. The lecturer should keep a close watch on the reaction of the audience to the lectures given. Should the audience show signs of boredom—be it inattention, sleepiness, or any of the more voluble symptoms of distraction—then bring the lecture to a speedy end; switch on the next film; and in the absence of anything more edifying a 'Micky-Mouse' or 'Donald Duck' will serve the desired purpose of wakening the dreamers from their lethargy and of resuming their interest and commanding their attention. The lecture then continues.

Publicity

Publicity is an art. Repetition is essential to its success. Variety is the spice of life; the clever publicist will serve up his dishes in many guises. An occasional visit to the village is of little use. He must come again and come soon. The memory of the village audience in matters concerned with village welfare needs to be refreshed frequently. When the subject of an address becomes the talk of the village then the lecturer will know that he is nearing success. The receptive capacity of man to new ideas is a personal factor and it varies as between man and man.

With all men there is a time-lag between the spoken word, its reception and its comprehension by the listener. This lag is customarily more pronounced in the villager than in the townsman for the simple reason that townspeople have had the opportunity to have their wits sharpened by closer and more frequent contact with their fellowmen. Hence the need for slow deliberate speech by the lecturer, such as the villager is accustomed to. Public speaking is an acquisition enjoyed by only a few, but with proper training and practice it can be fairly easily acquired by most men.

No agricultural publicity and propaganda in the villages is complete without practical demonstrations of what is being preached. The lectures should be linked not only with the cinema films and with still pictures but also with practical demonstrations in the villages and in the neighbouring fields. The villager learns much quicker from what he sees than from what he hears. With him example is always better than precept. The best field demonstration is the one undertaken by the more enterprising amongst the villagers on the advice of the lecturer. Samples of improved seeds, manures, implements, pests, etc., should invariably accompany the cinema outfit. All demonstrations should be linked with the development activities of the departments directly concerned. The ready availability of seeds, manures, implements, etc., recommended to the villager is a matter of the greatest importance. The goods recommended to him and the services which he is justifying in seeking must be brought within his easy reach; otherwise any advice given to him is mostly wasted effort.

The responsibilities which would devolve on publicity staff accompanying mobile cinemas will be heavy. The work will be arduous necessitating constant touring and living under conditions of much discomfort. None but men of

proved merit should be engaged on the work. Their pay should be such as to attract the best men. This can perhaps best be done by offering substantial allowances to those engaged on active publicity work associated with mobile cinemas. The man to be sought for is the one imbued with the missionary spirit. He is a rare bird and worth his weight in gold.

Before village publicity can hope to be really effective it must of necessity adapt itself to existing village conditions. It must give due regard to the illiteracy of the masses, to their ignorance, their simplicity, their integrity, their essentially practical outlook, and to their established social customs and traditions. Great care should be taken to ensure that what is recommended to the villager is both desirable and feasible. Advice based on theory alone can do great harm. All materials and labour used for demonstration purposes whether in the village or the field should be provided free of charge.

One of the major aims in village publicity should be to inculcate and develop the corporate spirit amongst villagers. A stepping stone to this end will be the recognition and encouragement of leadership especially amongst the young men. The formation of agricultural associations or village union boards should constitute an integral part of all rural reconstruction plans, and the maximum governmental use made of such corporate bodies. The monthly visits of the mobile cinema should greatly help to keep alive these bodies and to infuse and develop the corporate spirit.

Agricultural publicity should not be divorced from other spheres of village welfare. Rural reconstruction must be considered in its widest aspects. The attack on the problem of improving village welfare should be undertaken on all fronts simultaneously. It is a matter with which all the nation building

departments of Government are concerned. The departments which should be very closely associated with the mobile cinema in rural reconstruction are Agriculture, Animal Husbandry, Public Health, Education, Cooperative and Cottage Industries. These varied interests will necessitate the cinema outfit being accompanied by more than one lecturer.

A Training School and a 'Hollywood'

The training of the executive district staff in the proper methods of publicity is a matter which demands most careful attention. This specialized training is almost entirely lacking in most of the Departments of Agriculture in India. There is need for short courses of training in methods of publicity at every Agricultural College. The course should be made obligatory to all members of the staff irrespective as to whether they will be engaged on research work or developmental (district) work. Refresher courses should follow. It is clearly a matter in which the Centre would be justifiably expected to give assistance, particularly to smaller Provinces and States which are unable to provide adequate training facilities. There is the same need for a training school of publicity at the Centre where specialists, to be engaged in this work in the Provinces and States, could be trained in modern methods under Indian conditions.

At the same time there is equal need for the Centre to engage in the organized production of films concerned with those varied aspects of rural life which it is desired to publicise. Many of the films would be of all-India interest. Others

would be of regional or of local interest. The themes for desirable films would be decided in consultation with the Provincial and State Departments of Agriculture, Education, Health etc. This is no job for an amateur. Neither is it a job for an expert unless his equipment is up-to-date. A rural reconstruction 'Hollywood' at the Centre is a crying need.

Ultimate Expansion

I am fully aware of the fact that in many Provinces and States in India the mobile cinema already features prominently in the publicity campaigns of the respective Governments. I lay emphasis, firstly, on the intensified use of the mobile cinema as an experimental measure in concentrated areas comprising about twelve selected villages for each cinema unit in each District, and, secondly, on the use of the mobile cinema as an aid in coordinating the activities of all those Departments of Government concerned with rural reconstruction.

The main object of the experiment would be to try out the usefulness of the mobile cinema as an aid in hastening the tempo of progress in all aspects of village welfare. If the experiment is tried on the scale of one cinema unit in a selected concentrated area of each administrative district then it should suffice, within a period of two years from its inception, to establish its usefulness, its advantages and its defects. The form of ultimate expansion to cover every moderate-sized village would be dictated by the experience gained in the experimental stage.

AGRICULTURAL EDUCATION AND PROPAGANDA IN THE VILLAGES

By D. N. MITRA

AGRICULTURE in India has not improved much since the time of yore. It is still being carried on in many areas according to the same old primitive fashion and methods. The recommendations of the experts and the scientists are more to be found in their volumes of memoirs and bulletins than in the actual fields of the sons of the soil. There exists a wide gulf between the actual tiller of the soil and the scientist. As the Rev. Dr. Urquhart, a former Vice-Chancellor of the Calcutta University, said : " We have, on the one hand, a very considerable amount of scientific work which might be useful to agriculture and which has practical bearings, being carried on in our laboratories. On the other hand, there are efforts made in the country districts, such efforts as are being made so splendidly here¹—efforts made towards practical improvement of agriculture. But between these two movements there seems to be a great gulf fixed : they do not meet : they are aiming at the same end but they do not seem to come together."

A Wrong Notion

There is a wrong notion very widely current both here and abroad that the Indian cultivator is generally extremely conservative and loath to take up any ideas which are new to him or to adopt anything new in respect of new crops, improved implements, fertilizers, methods,

¹Referring to the scheme of training *Bhadrakul* youth in practical agriculture at the Faridpur Government Farm in Bengal.

etc. But this can at once be refuted by facts and figures and in fairness to him it should be said that he is not orthodox and conservative in this respect to the extent to which he is accused. His various limitations are to be taken into account in this connection. Of these, his poverty is the chief obstacle in his way. Knowing well that a certain new crop or a certain new fertilizer would be profitable to him in the end he has hardly the capital to invest in it. Only one example will be sufficient to show how he is handicapped in this respect. Potato is not grown in many suitable areas—though there is not any aversion on the part of the cultivator to grow it. On the other hand, he regards it as one of the most profitable crops. But the chief difficulty with him is the capital to invest for it. To plant one acre of land about 820 lb. of seed-potatoes are required and the cost of this quantity amounts to about Rs. 300 at the present moment and equally a large amount of money is required to meet the cost of fertilizers, and an average cultivator cannot very well afford to lay out the capital required for the cultivation of potatoes. It is therefore truly said that ' the cultivators in India possess the essential knowledge and the required skill but not the finance and the proper lead '.

It is also very loosely said that the illiteracy of the cultivator is another obstacle in the way of the improvement of agriculture in India. But in this case also, one should take a more lenient and liberal view. He may be illiterate, he may not know how to read and write

but he is intelligent and clever enough to know his business well, to understand things if they are put before him in an understandable manner and to adopt new methods if these are properly demonstrated and explained to him. He will not be slow to adopt a new crop or a new method if he is convinced that it will be profitable to him and he has the means and facilities to adopt it. The extent to which new strains of various crops—sugarcane, wheat, rice, pulses, tobacco, etc., and new crops like the English vegetables are being cultivated in recent times, will bear testimony to his intelligence and capacity to adopt new ideas and methods. Mollison and Sly very truly said: "When the Indian farmer has been given an object lesson clearly demonstrating the value of the innovation, he is by no means slow to appreciate the results." Opinions of many other experts who studied the psychology and the conditions of the Indian cultivator may be quoted to show that he is not slow to adopt new methods due to his so-called and much talked-of conservatism and illiteracy. The chief thing to be remembered in this connection is that to win the cultivator's confidence one should interest himself in his point of view. One must attempt to reconcile the triangular conflict between the man, the land and the animal. The greatest tragedy again is that the cultivator's confidence in the experts has been violently shaken and shattered in the past by their own actions in many cases, as someone has said: "The Agricultural Officer distributed the necessary materials just after the fair either because he did not receive the stock or because he did not receive any orders from his superiors. The Ammonium Sulphate was distributed as and when the Agricultural Department had stocks but not as and when the ryots required it." There is a legion of such instances coupled with instances in which seeds, manures, etc., were

recommended and supplied without any regard to the suitability of soil or climatic conditions. In many cases again, improved strains of crops were recommended which proved inferior to the local varieties at a very great cost to the cultivator.

Educating the Sons of the Soil

It will appear from what has been said above that it is not so much the cultivator's conservatism and illiteracy which have stood in the way of progress of Indian agriculture as the absence of suitable men to teach him and the absence of suitable demonstrations in each area to carry conviction with him have done. It therefore presupposes that in any scheme of agricultural education particularly for the benefit of the actual tillers of the soil two things are chiefly required: a body of competent teachers and a codified knowledge of agricultural practices which have definite advantages over those adopted by the cultivators. As regards competent teachers we must remember what Robert Wallace said: "It was in vain to hope as some imagined that the Cirencester graduates on their return to India would be qualified to begin to teach the natives better systems of agriculture than their own. They were qualified to do no such things." Many others—European and Indian—hold this view even at the present moment.

While formulating a scheme of agricultural education of a practical nature for the benefit of the cultivators we should also remember that one type of education will not suit the older and younger sections of the people and different types of practical training in agriculture should be adopted for adult cultivators, for their sons and wards without any school-education, and for the school-going children in the countryside.

The adult cultivators cannot be expected to lose time for their training, nor can they be expected to lose their

normal earning out of the soil during the period of the training. The following two types of practical training in improved methods of agriculture may therefore suit them :

(i) There should at least be a twenty-acre farm in each union or in each convenient unit. The farm should be divided into two blocks—one block to be run on improved methods and the other on local methods. Both the blocks should be cultivated on *barga* or share system. Conditions being more favourable to the cultivators, the improved methods should be such as will be suitable for the locality and will be within the reach of the cultivators. Each block should be divided into equal-sized plots and the same crops in the same areas should be grown in each. One and the same batch of cultivators should cultivate both the blocks at least for two years. And during this period they should be able to learn the improved methods thoroughly well and to see for themselves the difference between the improved methods and those adopted by them. A new batch may be employed after two years, and simple and practical talks may be given to them on different aspects of agriculture of the locality.

(ii) It will be a good idea to induce landlords to start a *barga* farm on improved methods close to their big offices or *Kutcheries* in the interior. I started a farm of this type at Haturia in Faridpur district in East Bengal in the estate of the late Raja P. N. Tagore of Calcutta. It was very successful. Both the Raja and his tenants were financially benefited by it. It was a small farm of about five acres of land, properly fenced and laid out. Improved strains of crops spread automatically in the adjacent areas.

In the case of cultivators without any school education, too, it should be remembered that they cannot be expected to lose the services and help

of their sons and wards in their field-operations and at the same time to spend money on their training. They should therefore earn even when they are being trained. The best thing will be to employ them on wages in the Government farms cultivated by hired labour. From the very beginning their wages should be such as will enable them to meet their living expenses on the farm. But if their work compares favourably with that of the other labourers of the farm they should be paid equal wages. They should live in the labourers' shed and should do all their work including cooking. They should be given work on the farm in such a way as will enable them to learn the cultivation of a crop from the beginning to the end. They should be thoroughly acquainted with the costing of each crop. This is very important. Generally during the evenings and particularly during the slack seasons simple talks should be given to them on soils, manures, rotation of crops, insect and fungus pests, etc. They should be employed on the farm at least for two years.

It may further be said that attached to each school there should be a farm. Boys of each class from the lowest to the highest should be divided into convenient groups and definite areas should be allotted to each group to work them with their own hands, the nature and volume of work being fixed according to the age and capacity of the boys of each class. Boys of the upper classes should have more definite work than the boys of the lower classes. Special prizes should be awarded for work on the farm. Both theoretical and practical examinations should be held at the time of annual examinations and marks added to the aggregate. It would be no good to assign tiny plots specially to the boys of the upper two classes, because it is not a play but a real training. The boys will be expected to apply their



M. S. RANJANA

VILLAGERS READING A PANCHAYATGHAR POSTER
Fyzabad District, United Provinces



P. 1. B.

A VIEW OF THE RURAL UPLIFT EXHIBITION
HELD IN DELHI IN MARCH, 1946

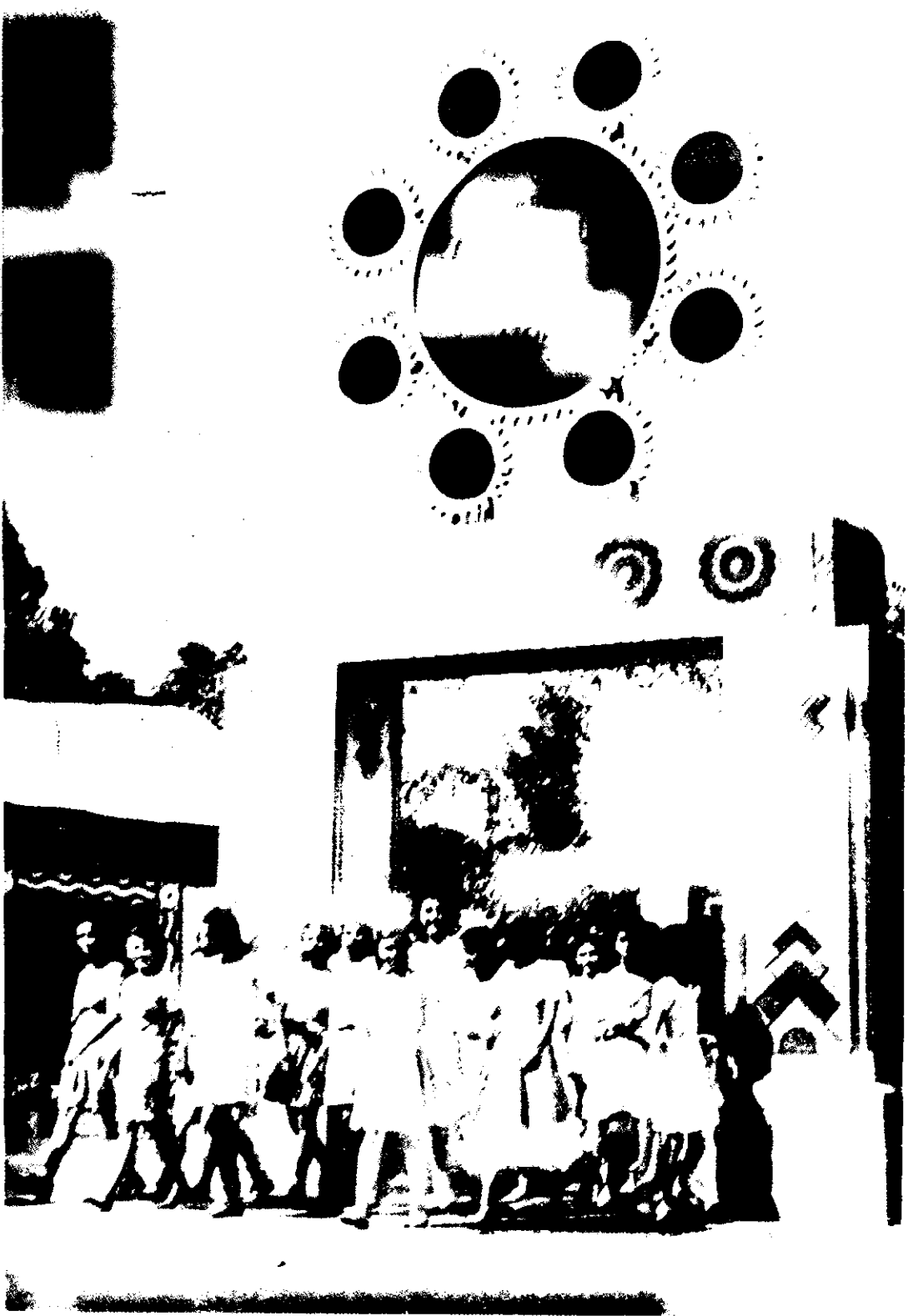

ENTRANCE GATE OF THE RURAL
UPLIFT EXHIBITION

P. T. B.



MEDAL OF RURAL DEVELOPMENT,
UNITED PROVINCES

knowledge to the agricultural operations carried on by their elders. It would be a good plan if the teachers of the school go round and see for themselves to what extent the boys have been successful. At the end of each season a show may be held at the school displaying the produce of the boys together with the produce of their elders grown according to their instructions. The Ceylon Scheme may be examined in this connection and adopted with modifications necessary for different conditions.

Special text books on agriculture should be prepared and they should be written by men who have practical experience of agriculture under different conditions and have a real command over the local language. The examples and illustrations given in the books should be based on crops and conditions prevalent in the locality. The books now in use are mostly uninteresting being merely translations of books in English. One or two real books will be enough for the purpose.

Facilities should also be available to the persons desirous of acquainting themselves with improved methods of agriculture with the object of applying them to their own lands and educating the men in their localities. For this purpose suitable persons may be invited to the District or Central Farms twice in a year, i.e., during the two main seasons and to stay at the farm for a month or so to acquaint themselves with the improved methods carried out there. Government should meet their travelling expenses and also the expenses during their stay at the farm.

In addition to the above types of elementary agricultural education in the countryside there should be a system of well-coordinated agricultural education in the country in all its stages, elementary, secondary and higher. After passing the Matriculation Examination the boys may join the Elementary Course for two years, and then they may join the higher

course—say B.Sc. course—for two years and then M.Sc. course for another two years. But each course should be complete in itself.

Delivering the Message

Side by side with the types of agricultural education an intensive publicity should be carried on in the countryside in season and out of season according to a definite programme to educate the people in improved methods of agriculture suitable for the conditions of each area. It should be remembered in this connection what Brayne has said: "Well-organized publicity greatly increases the amount of work done by each of rupee of Government money spent on rural reconstruction. The neglect of publicity is therefore a very short-sighted economy." Adequate propaganda connotes adequate funds for it and it is better not to have any propaganda at all rather than a half-hearted propaganda.

The success of publicity very largely, if not wholly, depends upon its personnel, as Brayne has put it: "Publicity is a technical subject. It is one thing to have a message for the villager. To deliver that message effectively is quite another thing and the technique has to be specially learnt. All therefore who are trying to teach the villager new ways and to popularize new things should receive definite training in publicity methods and technique." Briefly speaking, the publicity man should not only possess a capacity to talk well in the language of the people but should also have a full knowledge of the subject of his talk and of the suitability or otherwise of the conditions of the locality and of the people for the application of that knowledge. He must talk with force and conviction and in very clear terms. He must possess the temperament to live with the people in the rural areas and to share their joys and sorrows. In one word, by his words and deeds he

must prove himself as one of them.

As regards the methods of publicity all the modern methods such as wireless, cinema, dramas, songs and dances, verses, leaflets, pamphlets, posters, models, exhibitions, shows, competitions, meetings, demonstrations, press, etc., may be adopted. But of these the following are most important.

Demonstrations : Great care should be taken to hold demonstrations. It should be remembered in this connection that the scientist's recommendations and his laboratory results will not suit equally well the diverse local regional conditions. The failure of a demonstration in a certain area creates a long-standing distrust and the confidence of the people in the recommendations of the experts is so badly shaken that it cannot be restored very soon. It will also be a good plan to select two or three villages in a union and to start a demonstration centre—about two acres of land—in each and to run it for three years. In course of three years it is expected that the recommendations of the department suitable for the locality will be well-established in the area and after three years these centres may be shifted to new areas. Thus in course of a few years and with a limited staff almost all the villages in a district will have object lessons.

Special Weeks and Fortnights : In ample time before the sowing season Special Weeks and Fortnights may be held to inspire the people in the cultivation of recommended crops or in some improved methods. These weeks and fortnights should be well organized and well advertised, and displays and demonstrations should be the chief features of these weeks and fortnights as far as possible. Nothing should be done in haste and in a haphazard manner as is done in many instances at present.

Exhibitions and Shows : The exhibitions held in big cities and towns are not very popular with the people in the

countryside. They regard them as *tamashas* held for the *babus*, as the members of the educated community are generally called, and they visit them with diffidence just to see the fun. The amusements chiefly attract them there. The method of organization of these exhibitions should be changed to attract more people from the countryside and to make them really educative to them. Smaller shows held in the countryside are more popular with the people and they take an active part in their organization and regard them as their own achievements. Small shows displaying samples of new crops grown in a locality should be held in the countryside in each season to inspire and educate the people to grow them in larger areas. I introduced shows like Potato Show, English Vegetables Show, Wheat Show, Groundnut Show, etc., in the interior of the district of Faridpur in East Bengal with great success. There used to be a keen competition in each.

Local Festivals and Fairs : During the local festivals and fairs samples of crops, improved methods, posters, charts, diagrams, etc., should be displayed with advantage and at a very much less cost. In Bengal during the *Rath Jatra* festival, grafts, seedlings, seeds, etc., are sold in very large numbers and practically this is the occasion on which people buy grafts and seedlings of fruit trees. If arrangements are made for the sale of genuine seeds, plants, etc., during the festivals and fairs these will automatically be introduced on a wide scale in the countryside.

Sayings, Aphorisms and Songs : Sayings and songs were the chief media in ancient times for the education of the masses in most of the social, moral and economic matters and even in present times knowledge in the countryside spreads more rapidly and effectively through these media. In Bengal agricultural aphorisms known as *Khanar Bachan*, which guided

the agricultural operations of the country in ancient times, are still remembered and quoted. Other provinces have certainly their own agricultural aphorisms of the nature of *Khanar Bachan*. These aphorisms should be revived, modified and introduced. Then there are songs in Bengal known as *Tarja*, *Kabi* and *Jari*. They are sung by two parties—one party replying the other in verses. They cover a wide range of social, moral and economic life of the country and they are still very popular with the people in the rural areas and I can say from my own experience that these used to attract a larger audience during the exhibitions than the Cinema Shows. I once composed a few *Tarja* songs and organized a *Tarja* Party during the campaign for the voluntary restriction of jute in Bengal. The party used to visit the interior of the districts. It was a great success and was in demand.

Cinema : Short stories containing instructions and illustrations on improved methods of agriculture should be screened and they should have a background of the country life and should be such as would create a sustained interest in the minds of the people and a feeling that it is their own tale. The *Bhuler Phasal* and *Sonar Medal* films in Bengal prepared by me are in great demand by all the sections of the public.

Plays and Dances : Suitable plays should be introduced into local *Jatras* and they should deal with the country life and should have local bearings. Similarly new dances, dominating the present-day themes should be contributed to the old heritage of peasant dances.

Leaflets, Pamphlets, Posters and Folders : These should be widely circulated but it is more essential that their language should follow the peasant similes and metaphors and the materials contained in them should have local bearings.

Meetings : These should be widely

advertised and should be addressed by non-officials commanding respect and confidence of the people. Leaders of the country may be approached with a request to address some of the important meetings. It is very important to remember in this connection that arrangements should be made for very prompt supply of seeds, manures, etc., recommended in course of the talks and speeches if the season is near.

Press : All the sections of the Press should be approached with a request to make the publication of suitable articles on agriculture as one of their regular features.

People's Paper : Attempt should be made to encourage the publication of a 'People's Paper' in suitable localities with contributions from the local people.

Wireless : Talks should be brief and should contain facts and figures easily intelligible to the people in the countryside. In course of a wireless talk I once cited the instance of Charles Seabrook. Mr. Elmhirst remarked that the cultivators for whom the talk was intended would take it as a 'fairy tale' as they could not comprehend such a thing as a 30,000 acre farm, and the introduction of such examples in the talks would smell of incredulity to them.

People are Sensitive

It should be remembered that the publicity must be divested of any politics except the 'politics of agriculture'. No mention should even be made in it of the activities of the Government or of a Minister or of a high official nor should any of the propaganda materials contain any picture of any Minister or any member of the Government. I can say from my own experience that very informative and useful talks and speeches have been dismissed as a propaganda of the Government or coloured scheme of the Minister, for the only reason that in the course of these talks and speeches

mention was made here and there of the useful work the Government or the Minister-in-charge was doing for the country. Similarly, highly educative films have lost their value upon the people as they contained pictures of Ministers and high officials. A small whisper by any one of the audience is enough to minimize the value of a good

speech or a good film as a propaganda of the Government. For the same reasons even many high officials entertain a repulsion to many Government periodicals. The people are so sensitive that even a useful publication is rejected without its perusal only because it is printed at a Government Press. I have a personal experience of many instances of this nature.

CAMPAIGNS, DRIVES AND WEEKS

By M. S. RANDHAWA

RURAL Development work can be carried on at a considerable speed by organizing Campaigns, Drives and Weeks. The success of the rural Defence Savings Campaign in the United Provinces during World War II has convinced me that even the seemingly impossible can be achieved by bringing the governmental machinery into action from the District Officer down to the *Patwari*. Similar Drives and Campaigns can also be organized for activating developmental work. Competitive instinct can be exploited to the full by organizing competitions between villages, *parganas*, *tahsils* and districts.

In organizing Campaigns and Drives, the objectives should be carefully laid out, e.g., how many *Panchayatghars* are to be built in each district and *tahsil*, how many trees are to be planted, how many manure pits are to be dug, etc. This should be followed by intensive publicity and propaganda to generate enthusiasm among the people. All media of publicity, e.g., posters, poster-charts, broadcasting, songs and films should be used for preparing the people for the work. To provoke thought and interest question-and-answer methods ought to be used at meetings. *Mushairas* and *Kavi Sammelans* should also be organized and development themes should be given for composing poems. Stirring songs should be composed and disseminated by means of gramophone records and song parties in villages, so that the interest of the villager is fully awakened in the task laid before him.

Slogans and Symbols

Use of slogans and symbols should be

made to the fullest possible extent. The symbol selected for each Drive or Week should be simple and easily comprehensible to an average man, e.g., a tree for the Tree Plantation Week, a broom for Sanitation Week, a house for *Panchayatghar* Week, an iron plough or a chaff cutter for Improved Implements Drive, a well for Dig More Wells Drive, a cock for Poultry Week, etc. The symbol selected should be displayed on posters, hand-bills, etc., so that every one becomes familiar with it. The meeting halls should be decorated with cloths and flags bearing symbols and slogans. Red is the colour which attracts most attention, and should be extensively used in posters, covers of pamphlets and publicity vans. Speeches at the meetings should never exceed 30 minutes and should be preceded and followed by songs preferably sung by stalwart young men in scout uniforms, all standing. The technique of instigating collective replies of 'Yes' or 'No' which stimulate the ardour of the crowd should also be used.

Elements of a Drive

The Campaign should be given a spectacular start, e.g., a message from the Governor and the Prime Minister, a press conference by the Prime Minister and Development Minister, meetings and processions in the principal towns in the districts addressed by District Officers, members of the Legislature and local political leaders. A definite period, say two to three months should be fixed for each Campaign and Drive. As the *Manual of Field Publicity Organization* lays down: "A most important

point about campaigns is that however long-term they may be, they should not be carried out interminably. A definite period should be set for each campaign. This does not mean that the desired result will be secured within this period. The laying down of a date-line serves many purposes. It imports into the campaign the elements of a drive and forces the pace of activity; it ensures some tangible result to show when the campaign terminates; it allows for periodic stock-taking and enables variation to be introduced which is essential both for the effectiveness of our publicity and to prevent our workers from becoming stale."

The campaign should be also brought to a close in a spectacular manner. The results of the campaign showing the work done in each district, which should include both quality as well as quantity, should be widely published in newspapers, broadcast by radio and spotlighted in central places. The Development Minister should tour from district to district where meetings should be organized. He should distribute *Sanads*, Certificates and Medals to good workers from villages. Government servants should be rewarded by grant of titles and entries in their character rolls. There is nothing else which can whip a government servant into a frenzy of activity as award of a good entry in his character roll and this should be fully exploited.

I once organized a Blood Donors Campaign for the Blood Bank and found that even for such a difficult work many government servants came forward readily merely to earn a good entry in their rolls. The Governor and Minister of Development should address letters of appreciation to district officers who put in particularly meritorious work, and similar letters may also be addressed by the commissioners and district officers to their subordinates. Appreciation of honest hard work serves as a powerful stimulant and even lethargic persons are stimulated into unexpected and unprecedented activity.

Ancient Festivals and 'Weeks'

Work of a seasonal nature which does not require prolonged activity can best be executed by organizing 'Weeks'. It would be worth while to coordinate these 'Weeks' with Hindu seasonal festivals. The Tree Plantation Week may be celebrated in the middle of July in *Savan Jhoola* or *Teean* festival, while the Village Cleaning Week may coincide with *Dewali* which is celebrated after the monsoons when people whitewash their houses. Cultural festivals may coincide with *Holi*. Apart from this, Weeks such as Bunding and Terracing Week, Weed Destruction Week, Composting Week, etc., according to local needs and problems may also be observed.

VILLAGE EXHIBITIONS AND FAIRS

By M. R. SHARMA

VILLAGE fairs usually mean a gathering of people who assemble at more or less regular intervals at certain fixed places generally around shrines or other religious institutions. Along with some of these fairs an exhibition of local products, home industries, art and crafts is sometimes arranged. Often the beneficiary departments like Agriculture, Animal Husbandry, Public health, Co-operative and Marketing take an advantage of such gatherings to explain to the public both by practical demonstration and lectures the various measures that can help to ameliorate the condition of masses, both economically and socially.

The fairs are usually organized and run by any of the three agencies—(i) District Officers, (ii) Local bodies, i.e., District Boards, Local Boards, Municipal Committees or Panchayats, (iii) Private agencies like *zamindars* and religious institutions, under whose patronage such fairs are held. The help of the various departments, e.g., Police, Revenue, Public Health, Veterinary is usually taken in the management of these fairs.

Irrespective of their origin, fairs may be divided into two main classes—(i) Fairs which have acquired some importance in the livestock trade or in trade in agricultural products, and (ii) Fairs which have remained mostly religious in nature and no commercial importance is attached to them. Apart from these village fairs, village markets commonly known as *painths*, *hats* or *shandies* are also held mostly in the southern and eastern parts of India. Like the fairs, the village markets denote a gathering of people at a fixed place but at more frequent intervals than in the

case of fairs. They are generally held once a week. At the *hats* which are located at central places, agricultural and industrial produce from villages are marketed and at some of them livestock are also sold, bought or exchanged. They infuse liveliness in the otherwise dull rural life and at these places departmental propaganda can be carried. The Veterinary Department usually holds field Veterinary dispensaries at these places on the *hat* day.

The Role of the Fairs

The total number of fairs under the first category held in the various parts of India is about 1,700. About fifty per cent of these deal in livestock only, ten per cent both in livestock and livestock products while the remaining forty per cent handle agricultural produce only. It is not possible to give any approximate idea of the fairs held under category two. These are commonly held in conjunction with the religious festivals. The attendance at these fairs varies from a few hundreds to several thousands depending upon the nature and importance of a fair, and duration usually varies from one to seven days although few of the livestock fairs are held for a longer duration.

Usually the villagers leave their homes after taking their morning meals, spend the whole afternoon doing petty shopping, selling or buying of livestock or agricultural products, singing folk-songs and going round the different exhibitions displayed by the exhibitors. In the case of religious fairs, they will usually take a dip in the sacred tank or river or pay their homage to the place of worship. Women are rather more keen to attend

such functions and observe all the prevalent practices more strictly, and the children mostly come to enjoy funs and games, e.g., *pangoora* or merry-go-round etc., and to buy sweets and toys.

Transactions

The livestock is usually brought at the site of the fair in the morning and taken back if not sold in the evening. This is particularly the case in fairs where no admission fee is charged. Only those animals stay at the fairgrounds that have come up from a long distance. Admission fee is only charged in the case of some big well organized fairs, but the authorities usually charge a nominal charge for registering the sale deeds. There are no fixed hours of business and it continues throughout the day. The buyers make round at all hours convenient to them. Transactions may be made either directly between a seller and a buyer or through a broker. In fairs where unlicensed brokers are allowed to operate the dealings are usually reported to be unfair. The villagers attach lot of importance to some lucky or unlucky features in animals. These features play an important part in fixing the price of an animal. Other points considered by the villagers, who are mostly keen observers, are the breed, the quantity of milk yield, behaviour while being milked, sound udder and teats, age, calf at heels etc., in the case of milch animals and the stamina, breed, age, size and general appearance in the case of draught animals. The settlement of price in certain cases is rather interesting and may involve a good deal of time and repeated negotiations between the seller and the buyer or their representatives. Prices in some cases are settled under cover and in others either by a private treaty or by exchanging animals for animals. In the former case the buyer or his broker clasps the hands of a seller or his broker under the cover of a cloth and indicates

the prices he is prepared to pay by pressing the fingers of the hand.

New Suggestions

It is very important that full advantage should be taken by the departments entrusted to carry on propaganda for village uplift at such gatherings, which at present is lacking in certain cases. The departments concerned should as far as possible fix up dates for important departmental events in conjunction with these fairs and at the same site. This will save lot of unnecessary expenses and energy spent on propaganda and proper advantage can be taken of these huge voluntary gatherings.

The educational value of such fairs can be enhanced by the free distribution of literature, propaganda lectures, lectures with the aid of magic lanterns, cinema shows and musical parties by the various departments concerned.

A proper site is usually not available in some cases with the result that it causes lot of confusion. This should be provided and properly laid out.

Shady trees should be planted by the agency responsible for holding the shows at the site of the fairs.

Adequate arrangements for water supply both for human beings and animals are a necessity.

Arrangements for fodder for animals and facilities for food for the gatherings are essential.

The brokers should always be licensed to prevent cases of fraud.

These fairs are often a source of spreading contagious diseases both in human beings and livestock. The Public Health and Animal Husbandry Departments should be invited to help in this direction. Segregation wards at the premises are essential for any suspected cases.

Medical and veterinary aid should be provided at the premises; it is almost unavoidable.



P. 106.

VILLAGE CATTLE SHOW
In Kangra District, Punjab



Mr S. RANDHAWA

WRESTLING

Watch and ward arrangements by the police are very essential. The people must have a feeling of security.

Most of the village fairs have either no means of communication or they are very poor. The authorities concerned should be approached to provide better communications.

It is perhaps too much to suggest at the present stage that postal and telegraphic facilities, which are absent in most of the village fairs, will play important part in adding to the popularity of the fairs.

Animals Sports, e.g., races, jumps etc., which enhance the popularity of the shows, make them more interesting and help in production of stock with better speed and endurance.

Progressive India

The Animal Husbandry and Agriculture Departments are already arranging on most of these fairs, cattle and agriculture shows where prizes are awarded to the best of breeders or producers as the case may be. The livestock for judging should be classified into different classes, e.g., cows in calf, cows with calf at heels, heifers, young bulls, pairs of bullocks etc., and prizes given to the best. The number of prizes will depend on the entries, but it is best to keep it about one-third of the total number of entries in each class. Judging requires very careful and trained eyes and all efforts should be made to judge with a

definite aim and purpose. It is never possible to please all in judging and some local reputed breeders can be associated with advantage. These shows may be further extended where they are not provided. The real difficulty that mostly arises to arrange them is the funds. This can be managed, if the managing body that usually collects a certain percentage on the registration of sale deeds and from the rent of shops, etc., is invited to keep a certain percentage of the total income for such purposes. These shows not only help to judge the result of their efforts and to chalk out programmes for the future in the light of the results obtained, but they also provide entertainment and instructions to the public. They not only stimulate the existing interest but also create a healthy spirit of competition amongst the villagers. Indeed the great progress which these departments have reached in the recent years in villages should not have been possible, but for the knowledge, the inspiration and encouragement provided by these shows and the judging ring. The prizes, though small generate enthusiasm and competitive spirit which are so essential for the stimulation of any industry. India is an agricultural country and the prospects of improving the living standard and health of the mass of population depend on the production of larger and better crops and of more milk and better draught animals. Better village exhibitions and fairs will reveal a better and progressive India.

RURAL BROADCASTING IN INDIA

By D. D. SABNIS

N EARLY ten years ago when a giant mast reared its head on the northern outskirts of Delhi, the countryside around buzzed with strange rumours and colourful tales of a new intrusion into the placid life of the villager. Some described the 320 feet tall structure of steel as an affront to the rain god Indra whose wrath it was bound to excite in some shape or other. Evidence came readily enough in the unusually low monsoon that year which set the village wag's credit correspondingly high.

All India Radio quietly went about its work of spreading a network of community listening throughout the rural area of Delhi Province. Resignedly the villager listened to the *dehati* programme brought to him by the receiver installed in his village, and gradually he started liking it. But suspicion of the machine and of the mission behind it remained. To help them overcome it, parties from each village were invited to the Radio Station to speak or sing to their fellows and thus prove to them that the radio was not a diabolical contraption, and the voices they heard were not faked ones.

Looking back over these ten years, one marvels at the tremendous change that has taken place. Every village that possesses a radio set today regards itself in a highly privileged position and is the envy of all the others. Despite repeated announcements that the total number of receivers sanctioned has already been allotted to specified villages, requests for inclusion in the scheme continue to be received from the remaining villages in increasing numbers and with greater importunity than before.

Some of the unserved villages have even gone to the length of offering to build special rooms to house the receivers. There is a large and constant demand for extending the duration of the rural programme. Men, women and children—all of them look forward to the daily forty-five minutes of amusements, instruction and information which their radio *baja* faithfully brings to them at dusk after their day's work is done.

The evening meal is an important event in the daily life of the villager; but so is the evening broadcast. The two are strangely connected, as witness the grateful villager, who thanking All India Radio for the punctuality with which he got his evening meals, said; "Before you introduced women's programme, our women took their own time to cook, but now they finish it quite early so as to be in time to listen to their own programmes."

It was in 1938 that the Government of India got interested in the Delhi Rural Broadcasting scheme. Previous to this, a tentative attempt was made at the request of the Punjab Government from June 1936 to March 1938 with thirteen sets installed in the Punjab and four in the Delhi Province. In June 1938, the Government of India sanctioned a lakh of rupees. The beginning of the scheme was slow, but now 125 sets are in operation in the Delhi Province. In addition, there are twenty sets which are kept in reserve.

The programmes are varied and miscellaneous, and consist of news, talks, music, short stories, dramas, dialogues, weather reports, etc. They deal directly or indirectly with subjects that are



ALL INDIA RADIO, MADRAS

BALLAD SINGERS OF ANDHRA



M. S. RANDHAWA

VILLAGERS LISTENING TO A RADIO BROADCAST
Village Barai Khurd, Fyzabad



ALL INDIA RADIO, LUCKNOW

THE BALLAD OF ALHA

The story of Alha's heroic deeds still moves
the villagers in the United Provinces



ALL INDIA RADIO, DELHI

SHRI GOPAL AND PARTY
Broadcasting 'Bhajans' in the rural programme
of A. I. R., Delhi.

important to the villagers, who are invited to participate in the programmes. The music broadcast is mostly folk-music. A special programme is broadcast once a week for children and once a fortnight for women. In each of these, children and women from the villages participate.

As soon as Rural Broadcasting had established itself and audiences in the villages began to increase, it was noticed that in some of the villages, women began to flock in the vicinity of radio sets, but still at considerable distances from them. The feminine interest was regarded as an encouraging sign, and twenty-five extension loudspeakers were installed specially for women by way of an experiment.

30,000 Listeners

For community listening, a special type of receiving set has been perfected after careful experiments by the Research Department of All India Radio. It is designed to be fixed to a tree or other convenient support in the village meeting place. It is contained in a locked metal box, all the controls being inside, so that unauthorised interference is impossible. It is tuned in to the local station and is provided with an automatic time switch which 'turns it on' at the right moment.

The average attendance in each village varies between 50 to 100, depending upon the seasonal occupations of the villagers. On days when a special programme of *swangs* and the like are put on, their attendance increases three-fold. It can, therefore, be safely presumed that the potential audience in the Delhi Province is nearly 30,000 out of a total rural population of 200,000. This presents immense possibility not only of spreading education but also of being enabled to adopt a general policy in speaking directly to villagers all over the province.

The Pioneer Province

The distinction, however, of being the

first province to introduce village broadcasting in this country goes to the North-West Frontier Province. The scheme, known as the Peshawar Scheme, came into operation in 1935, with a .25 K.W. transmitter and a few village receiving sets which were made specially to resist heat, dust and insects. The sets had also to resist a natural agrarian curiosity which sometimes assumed a hostile and unpleasant form. A strange-looking box which, at fixed times or at the turn of a knob, produced music, speech and occasionally a few weird noises, obviously called for a little questioning before it could be accepted into the village scheme of things. But that was a passing phase, and not peculiar to the province.

The scheme, nevertheless, was by way of an experiment and like most experiments suffered from a number of initial handicaps. There was, of course, the problem of funds, and resultantly of staff. Absence of electricity meant batteries, their transport and recharging. The programmes to begin with were mainly digests of agricultural pamphlets and often tended to be above the heads of the rural audience. All these drawbacks and shortcomings notwithstanding, the experiment yielded valuable experience.

The march of events, however, has swept away most of the adverse factors which stood in the way of Peshawar Scheme yielding better results. The Malakand Hydro-Electric Scheme has largely solved the problem of electricity in the listening areas. The war generally accelerated the tempo and widened the scope of broadcasting. The people in the province and in the tribal areas have become more wireless-minded. The old .25 K.W. transmitter has been replaced by a transmitter which is forty times as powerful as the old one. The number of receiving sets is about one hundred now, and the rural programmes from Peshawar are given in Pushto on all the days of the week.

Other Provinces

Village broadcasting schemes are also in operation in the Punjab, the Madras Presidency, the United Provinces and Bengal.

In Bengal, the Government sanctioned in 1936 a scheme for the purchase, erection and maintenance for six months of 15 receiving sets in rural areas near Midnapore. These were installed within a radius of about 80 miles from Midnapore, and rural programmes in Bengal were given from the Calcutta Broadcasting Station. The experiment having proved successful, the period was extended, and the sets moved nearer Midnapore. The location of the sets was again changed in 1938-39. The scheme was discontinued by the Provincial Government in May 1939. The sets and batteries, which were lying idle, were taken over by All India Radio and installed in Jute Mills round about Calcutta for the benefit of the labour community. Programmes of twenty minute duration are at present given from Calcutta in Bengali on Wednesday and Thursday and in Hindustani on Saturday and Sunday. In addition, programmes of thirty minute duration for rural listeners are broadcast on Tuesday and Saturday.

In Bombay, sixteen sets were installed by the Provincial Government in 1937, and rural programmes were given in Marathi from the Bombay Station of All India Radio. The sets were subsequently withdrawn by the Local Government, and the programmes were discontinued with effect from the 1st May 1939. A more ambitious scheme was formally inaugurated by the Governor of Bombay on April 17, 1944. The Government has already secured more than 800 sets which are being installed in main villages in three districts—Bombay Suburban, Thana and Kolaba. The intention is to increase the distribution of the sets until the whole province

is covered. Rural programmes of forty minute duration are now a daily feature of All India Radio broadcasts from Bombay.

In Madras, rural programmes began on the 1st of November 1938, and used to be given in Tamil and Telugu for three days in the week in each language. When the Trichinopoly Station was opened in May 1939, the Tamil programmes were shifted to Trichinopoly. Tamil programmes are now being given every day from Trichinopoly and Telugu programmes on six days in the week from Madras. The siting, supervision and maintenance of the sets is under the direct control of Provincial Broadcasting Department of the Government of Madras. The number of village sets installed in 1944 by the Provincial Government was 468. The Provincial Broadcasting Department also undertakes to instal sets for District Boards and Municipalities.

In the Punjab, before the opening of the Lahore Station the Punjab Government financed a rural scheme for sets in the Punjab, for which programmes used to be given from the Delhi Station. With the opening of the Lahore Station, the Punjab sets were removed by the Provincial Government and sited nearer Lahore, and rural programmes are now given from Lahore on all days. The number of sets installed in rural areas by District Boards is about 100.

In the United Provinces, rural broadcast from Lucknow started on the 1st of July 1939. The duration at present is 30 minutes every day. The number of sets installed by the Provincial Government is about 103. All these are sited within a radius of about 100 miles from Lucknow within easy distance of the main roads emerging from Lucknow. Servicing and charging arrangements have been concentrated at Lucknow and are under the management of the Provincial Government.

FILMS FOR THE VILLAGER

By V. R. BHATT

CENTURIES ago when a Chinaman with an inventive turn of mind discovered the art of printing, few could have realized its future role in the history of human progress. For it took many more centuries before it could arrive in Europe and there like another Chinese invention, gun-powder, violently agitate and ultimately help to break up the medieval set-up of mind and government. Printing killed the clerical monopoly of learning and despite the evil uses to which it has been put, developed into the essential mechanical basis of civilized progress. It made possible the extension of education and the dissemination of knowledge on a scale which would have been impossible before.

This dissertation on printing is necessary to evaluate correctly the potentialities of the cinema which has behind it a history of less than half a century. During this period it has been used almost exclusively for the provision of entertainment and only in the last decade have people begun to recognize that the cinema presents, along with the radio, the biggest invention in instructional methods since printing. Much still remains to be done to exploit fully this new medium, but it would be an excusable exaggeration to assume that it can render to the Indian peasant, if properly utilized, much the same service as that performed by printing for western civilization.

The Indian peasant forms the background of the country, but he is poor and largely illiterate. Cradled in tradition—much of it outworn—he has rarely the mental equipment or the material means to adopt methods and practices which would raise his standard of living. It is

true that Government can and intends to provide him the material means but unless he is fitted mentally to take full advantage of these, no plan of development can succeed fully. In other words any development plan must attempt to convert the peasant from a passive beneficiary, which he is now, to an active beneficiary.

The importance of this factor has been fully realized and provided for in the development plans of the Central as well as Provincial Governments. Instructional propaganda for rural uplift forms a vital aspect of development plans and the value of the cinema in this work has been duly recognized. The Educational Development Plan¹ of the Government of India selects the film as one of the main mechanical aids to education and the Agricultural Plan² has recommended that the 'Mobile cinema should be used freely not only in educating the cultivator but also in his general uplift'.

Two Functions

The film has peculiar advantages over other mediums in the work of rural development. It requires no previous preparation on the part of the peasant such as the learning of alphabets, grammar and composition. The contact is instantaneous and both visual and aural. By its simple powers of explanation and virtues of mechanized repeated performance to an unlimited number of people, it becomes a cheap and easily comprehensible vehicle wherewith to bridge the gulf of illiteracy and carry to the rural mind, culture,

¹ Post-war Educational Development Plan known as the Sargent Report.

² Memorandum on the Development of Agriculture and Animal Husbandry in India and Advisory Council of Imperial Council of Agricultural Research.

information and entertainment. We can therefore consider the film as capable of performing two functions in rural development: as a medium of education and as a medium of entertainment. The primary emphasis must, for a long time to come, be on education and by this term is meant education in the broadest sense of the word: the ripening of social consciousness, better living, hygiene, co-operation, the avoidance of litigation, thrift, improved methods of agriculture, civics, etc. Entertainment is no doubt an essential need in the drab life of the peasant but as the role of films for entertainment purposes is well-known, I propose to deal with the educational aspect of films.

A State Enterprise

The method of film making, which has now come to be known as the 'documentary', has been proved by experience the most suitable for educational purposes. The documentary is a non-fiction film which interprets and describes life as it is in reality. Its function, to use a romantic definition, 'is to break apart reality and then to reform these brilliant fragments into a miniature universe in which truth is clarified, simplified, heightened and reconstructed'¹.

The documentary technique follows three varieties, all of which have their special uses in the work of rural uplift—(i) the live film which is made by filming actual people and things acting or being used as desired; (ii) the animated cartoon film; and (iii) the puppet animation film, known as 'puppetoon' which is made by the use of animated puppets. Of these three, the live documentary film is perhaps the easiest to produce in the present conditions in India. Technical and artistic talent is available in the country and the cost of production is comparatively low. So far the development of the documentary has been a

State enterprise in India while in other countries the State has had to subsidize this type of film which has proved unprofitable as a business proposition.

160 Documentary Films

In India the real development of the documentary started with the establishment of the Information Films of India under the auspices of the Information and Arts Department. The I.F.I. produced over 160 documentaries some of which have received international recognition. The majority of these films deal with general educational topics or are straight propaganda films. Thrift, anti-blackmarketing, social service, community manners, handicrafts, dances and music are some of the general subjects, and soil erosion, tube-wells and poultry-farming, some of the agricultural themes on which films have been produced. But a comprehensive programme of films specially made for rural uplift work can cover a wider field and embrace every aspect of the peasant's life.

New Information

Perhaps the most important aspect of rural uplift is to provide the peasant with a general education which will have the effect of enlarging his social conscience and awakening a desire in him for better things. The documentary film can be used here intensively to provide such education, as was done by the U.S.S.R. during its five-year plans. The Russians had to put across a revolution which uprooted the entire old order of things and had to infuse vast and illiterate communities with new ideas and notions which could raise them to active citizenship. They produced documentary films which surveyed the new technique of living and dramatized it. The genius of the makers of these films was such that the installation of a dairy, or a new irrigation scheme became invested with more excitement for the

¹ Ben Maddow at the Writers' Congress, Los Angeles, 1943.

THE MENACE OF MALARIA

PLATE 21



Russian peasants than a story of adventure or boy meeting girl. The hero was not the rich man's son who falls in love with the poor man's lovely daughter—characters so monotonously familiar in Indian films, but a new tractor or a plough.

The Russian technique and exploitation of the film can be adapted to suit Indian conditions. Specially produced films for the peasant can deal with cultural and social themes, health, nutrition, child welfare, domestic science, thrift, cooperation, lives of farmers in other countries and so on. Newsreels of happenings in India and abroad is another method of widening the peasant's outlook.

Apart from this general education, the peasant would require specialized instruction in improved agricultural practices. Here too there is vast scope for the use of the training and technical film of all the three varieties mentioned above. The illustrative power of the film, its ability to present many things which nobody can view at all, e.g., microscopic organisms, and its manoeuvrability to depict a phenomenon which takes normally a long period in a matter of a few minutes, make it an indispensable medium in agricultural extension work.

It can therefore be used freely to familiarize the peasant with new agricultural practices such as contour bunding, soil erosion measures, use of better manure, seed, the handling of improved ploughs etc., by direct and simple exposition. Similarly results of research and certain agricultural practices such as pest control work can be made more real if the peasant sees such of his enemies as are invisible to the naked eye, through the agency of the camera which can enlarge and show pictures taken through the microscope. Again, wherever it is necessary to explain processes such as ploughing, sowing, harvesting a crop which normally would take six months

or more, they can be presented within half an hour through a film. It is not of course suggested that the film by itself will be the complete answer in extension work but it will be very valuable to the demonstrator lecturer in visualizing and making easily comprehensible to the peasant the instruction or information sought to be conveyed.

Symbolic Figures

So far the uses of the live documentary film in rural uplift work have been discussed but the cartoons and the 'puppetoon' can also be utilized with advantage. The cartoon film has become familiar as a universal medium of amusement and propaganda but its potentialities as an instructional and training medium are not generally realized. During war time the cartoon film was used extensively in the U.S.A. to train pilots, naval ratings, soldiers and unskilled labourers to handle complicated machines. Subjects covered included the mechanics of war weapons, battle tactics and industrial processes. In one instance pilots were trained in fighter tactics and in another unskilled labour in an aeroplane plant were taught the process of flush riveting by the help of cartoon films. In India, too, apart from its utility as a general educational medium, the cartoon can be used to train peasants to handle unfamiliar implements and machines of agriculture or cottage industry. It can also dramatize and give new reality to such familiar things as the malaria mosquito and cereal-destroying weevil and rodents so that the peasant comprehends the life around him with a heightened interest. Cartoon animation can also be used in live films in depicting in a dramatic and graphic form a real fact or a great event. A significant example of this type is the I.F.I. documentary 'Kisan' that illustrates the comparative yields of wheat in India and foreign countries and the

increased yield obtainable through improved cultivation, the use of manure and good seed.

A further development of the cartoon technique is the puppet film or 'puppetoon' in which animated puppets replace cartoon drawings. Because puppets are three dimensional, they can give more realism to training themes. Although still in the experimental stage, the puppetoon proved useful in U.S.A. for training purposes during the war.

The production of cartoons and 'puppetoons' calls for specialized skill which few in India at present possess. There is however plenty of talent, which if properly trained can compete with the rest of the world, just as Indian live-film documentaries now compare favourably with foreign productions.

The value of puppetoon medium in India will be evident when it is recalled that the puppet-play is a folk art which is still alive in our villages. It will not be difficult to adopt the familiar symbolic figures used in village puppet dramas for puppetoons.

Information Films of India

Here is a selection of films produced by Information Films of India. They may be very useful for rural uplift work for beside a version in English, versions in Hindustani, Bengali, Tamil and Telugu are available in most cases.

White Gold: This is a film of the Military Dairy Farm, Lahore.

Daughter of India: Showing the important part played by the Indian Women in the War. A.R.P. Nursing, scrap collection, and all such activities essential to the successful prosecution of war, have Indian women in their ranks. This devotion to service and the right cause is characteristic of the women of India of olden times whose exploits are world famous.

Schools for Wives: Preaching domestic economy, which should play the leading

role in Indian home life.

Grow More Food: Emphasizing the Grow More Food Campaign dealing with vegetable gardening.

Indian Press or the Voice of the People: Showing the evolution of the press. The day begins with the fresh newspaper in modern India.

India's Prize Cattle: Showing the pride and wealth of India—India's priceless cattle.

Community Manners: Stressing the civic sense. In a community, manners have an important part to play. The film shows the wrong thing that is done in our community and also shows the right thing to do.

Land of Five Rivers: A documentary film on Irrigation in the Punjab, where canals are really a boon.

A Stitch in Time: A film on cloth economy; it brings a new message to the people.

Our Heritage Series I: It shows the ancient architectural monuments of Southern and Eastern India, the Ajanta caves with their frescoes, the Ellora temple, Mahabalipuram pagodas, Tanjore temple, Madura temple, Rameswaram, temple at Puri, Bhuvaneshwar temple and Gol Gombaz of Bijapur.

Our Heritage Series II: Showing the ancient architectural monuments of North India, the Taj Mahal, Kutab Minar, Fatchpur Sikri, Agra Fort, etc.

Handicrafts of India Series I: It deals with various handicraft industries in North India like Kashmir shawls, marble work etc.

Handicrafts of India Series II: Showing the various artistic handicrafts carried on in Northern India like Moradabad metal works, etc.

Invisible Power: Giving a vivid picture of the Punjab Hydro Electric Scheme—generation of electricity and the advantages to the Punjab from this project.

Winged Menace: Picturizing the

menace of locust and measures taken in India to counteract it.

Soil Erosion: Depicting causes and ways and means of prevention of soil erosion.

Dances of India: Giving an interesting account of Kathakali—India's oldest and most celebrated dance in Malabar.

School for Farmers: Introducing the Agricultural Bias School in the Bombay Presidency.

Handicrafts of Travancore: Dealing with the Handicrafts of Travancore State, showing the making of hats and handbags from screw-pine and works of art from buffalo-horns.

Tree of Wealth: Bringing the coconut tree of South India in bold relief and emphasizing the uses to which coconut is put.

Dances of India (Bharata Natyam): A short film in the series of four pictures in 'Dances of India'. Showing the rhythm and the movements of the well-known *Bharata Natyam*, the ancient dance of South India. Versions available only in English and Hindustani.

Kathak Dances: A short film picturizing the rhythm, movements and execution of Kathak, the well-known dance of Northern India.

Tube Wells: A short film describing the boring of the tube wells in the United Provinces, the immense benefit that the population have derived from this scheme of irrigation.

Mute Martyrs: A short film dealing with some of the common cruelties perpetrated on animals, e.g., horses, donkeys, etc., and ends with a strong message to the people to be kind to the animals.

Wood for War: Showing how the wood from Indian Forests is utilized to build sleepers for railway tracks, rifle butts, ammunition boxes and a host of other war material. It gives a useful and interesting information about some important trees grown on hills, how they

are sown and transported to plains on their way to war factories.

Musical Instruments of India: Introducing the musical instruments; instrumental music is the asset of the *ustads* everywhere.

Melody of Hindustan: The second film in the series 'Musical Instruments of India' and covers the construction and plan of *sarangi*, flute, *mridang* and *jaltarang*.

Handicrafts of South India: Covering some important handicrafts of South India, the making of works of art like the model of Trichy post from pitch, and ornamental box from sandalwood, idols from brass, etc.

In Rural Maharashtra: The first short film in the series 'Know Your India'. It describes the rural life of India—the life of a Marahatta *kisan* both in peace and in war, and has a recruiting bias.

Tribal Dances: A short film in the series 'Dances of India' and covers the Naga folk-dances and the Khatak dance of North-West Frontier.

Need of the Moment: A short film emphasizing the necessity of converting the town refuse into manure.

Pillars of Society: Contrasting India's modern banking system with that prevalent in olden days.

Our Northern Cousins: Showing the village life of the Rawalpindi Division of the Punjab.

Egging them on: A film on Poultry.

Potteries: Showing potteries manufactured in India.

Out of the Soil: Emphasizing the promotion of communal harmony.

Suds: A film on soap manufacture in India.

Pyrethrum: Introducing the anti-malaria drug 'Pyrethrum', its cultivation and manufacture.

India Tomorrow: Giving a glimpse of how India would be in the post-war period when the Government's plans are put through.

Village Life in South India: A short film on life in a South Indian village.

Village Cooperation: Stressing the need for cooperation in villages.

Ambala Village Life: A film in 'The Village Life in India' series, showing village life in Ambala District on the border of the Punjab.

Kisan: A short film on improvised methods in agriculture.

Over the Wires: A film on Telegraphs.

At Your Service: A film on Postal Service.

Home and Abroad

Here are some more documentary films which may be found to be no less useful for rural uplift. Some of them deal with things outside India, yet they may interest the Indian peasant if commentary in Indian languages retains the folk idioms and metaphors.

Rural Reconstruction Exhibition, Sind: Producer, Rural Reconstruction Department, Sind. One reel; length 250 feet. Language: Urdu.

Kulu Mela: Producer, Rural Commissioner, Punjab. Showing the Dasahra celebrations in Kulu. One reel; length 350 feet. Language: Urdu.

Madura: Producer, Central Camera Co., Bombay. One reel; length, 150 feet. Language: English, Urdu and Hindi.

Stalingrad: Producer, Central Camera Co., Bombay. One reel; length 150 feet. Language English, Urdu and Hindi.

Bali Dance: Producer, Agfa Co. One reel; length 150 feet. Language: English.

Natural Silk in India and Artificial Silk in Germany: Producer, Agfa Co. One reel; length 150 feet. Language: German.

Circulation of the Blood: Producer, Agfa Co. Three reels; length 400+350+150 feet. Language: English.

Malaria Conquered: Producer, Kodak Co. One reel, length 250 feet. Language: English, Urdu and Hindi.

Victory in the Desert: Producer, Kodak Co. One reel; length 250 feet. Language: English, Urdu and Hindi.

Kashmir Crafts: Producer, Kodak Co. One reel; length 350 feet. Language: English.

Dr. Do-little und Seine Tiere: (Dr. Do-little and his Animals). Producer, Agfa Co. Three reels; length, 250+200+200 feet. Language: German.

More Films

A number of documentary films available with the Food and Agriculture Organization of the United Nations, Washington, may inspire the Indian masses to go ahead keeping pace with progressive peoples of the world. Commentary in Indian languages in each case should not be very difficult to prepare. Here is a short account of these films:

Abundant Harvest: Producer, National Film Board. Length 16 mm.

According to Need: Producer, National Film Board. Length 16 mm.

Among the Hardwoods: Producer, Austrian Information Office. Length 35 mm.

Broken Dykes: Producer, British Ministry of Information. Length 35 mm.

Business of Farming: Producer, National Film Board. Length 16 mm.

Canning Step by Step: Producer, National Film Board. Length 16 mm.

Cereal Seed Disinfection: Producer, British Ministry of Information. Length 16 mm.

Certified for Seed: Producer, National Film Board. Length 16 mm.

Changing Face of India: Producer, British Ministry of Information. Length 35 mm.

Children First: National Film Board. 16 mm.

Clean Milk: British Ministry of Information. 35 mm.

Coastal Region: National Film Board. 16 mm.

- Cowboy:* United States Office of War Information. 16 mm.
- Crown of the Year:* British Ministry of Information. 16 mm.
- Democracy in Action:* United States Office of War Information. 35 mm.
- Early Start:* National Film Board. 35 mm.
- Eskimo Summer:* National Film Board. 16 mm.
- Farmers at War:* National Film Board. 16 mm.
- Farmers' Forum:* National Film Board. 16 mm.
- Farm Front:* National Film Board. 16 mm.
- A Farm is Reclaimed:* British Ministry of Information. 35 mm.
- Farm Work:* British Ministry of Information. 35 mm.
- Five Steps to Better Farm Living:* National Film Board. 16 mm.
- Food and Magic:* United States Department of Agriculture. 16 mm.
- Food and Soil:* United States Department of Agriculture. 16 mm.
- Food Secret of the Peace:* National Film Board. 35 mm.
- Forest Ranges:* United States Department of Agriculture. 35 mm.
- Freedom to Learn:* United States Office of War Information. 16 mm.
- French Town:* British Ministry of Information. 35 mm.
- A Friend for Supper:* National Film Board. 16 mm.
- Friends in Need:* National Film Board. 16 mm.
- Garden Friends and Foes:* British Ministry of Information. 16 mm.
- Gaspe Cod Fishermen:* National Film Board. 16 mm.
- Golden Fleece:* Austrian Information Office. 35 mm.
- Grain that Built:* United States Office of Inter-American Affairs. 16 mm.
- Grand Manan:* National Film Board. 16 mm.
- Grass and Clover Seed Production:* British Ministry of Information. 16 mm.
- Grim Pastures:* National Film Board. 16 mm.
- Farmer Henry Brown:* United States Office of War Information. 16 mm.
- Home to the Land:* National Film Board. 16 mm.
- Harvest shall come:* British Ministry of Information. 16 mm.
- High Plains:* United States Office of Inter-American Affairs. 16 mm.
- How to dig:* British Ministry of Information. 35 mm.
- How to thatch:* British Ministry of Information. 35 mm.
- Hygiene on the Farm:* British Ministry of Information. 35 mm.
- Just Weeds:* National Film Board. 16 mm.
- The Kick that brings the Chick:* A sound film. National Film Board. 16 mm.
- Land for Men:* National Film Board. 16 mm.
- Library on Wheels:* National Film Board. 16 mm.
- Main Dish:* National Film Board. 16 mm.
- Making Good Hay:* British Ministry of Information. 16 mm.
- Mexico builds a Democracy:* United States Office of Inter-American Affairs. 16 mm.
- Naples is a Battlefield:* British Ministry of Information. 16 mm.
- The New Earth:* Neth. Info. Office. 35 mm.
- New Plans for the Land:* National Film Board. 16 mm.
- Now the Peace:* National Film Board. 16 mm.
- Park on the Farm:* National Film Board. 16 mm.
- People's Bank:* National Film Board. 16 mm.
- Pipeline Builders:* National Film Board. 16 mm.
- Potato Blight:* British Ministry of Information. 16 mm.
- Power and the Land:* United States

Office of War Information. 16 mm.
Protection of Food: British Ministry of Information. 35 mm.
Realm of the Wild: United States Department of Agriculture. 16 mm.
Reseeding for Better Grass: British Ministry of Information. 16 mm.
River of Canada: National Film Board. 16 mm.
The River: United States Department of Agriculture. 16 mm.
Rural School Lunches: National Film Board. 35 mm.
Saving Crop: United States Department of Agriculture. 16 mm.
Seeds and Science: British Ministry of Information. 35 mm.
Six Slices a Day: National Film Board. 16 mm.
Ski in the Valley of the Saints: National Film Board. 16 mm.
Something You didn't eat: National Film Board. 35 mm.
Soviet Soil: National Film Board. 35 mm.
Sowing and Planting: British Ministry of Information. 35 mm.
A Star and the Sand: British Ministry of Information. 16 mm.
Timber Front: National Film Board. 16 mm.
Trappers of the Sea: National Film Board. 16 mm.
Tree of Wealth: British Ministry of Information. 16 mm.
Trees that reach the Sky: National Film Board. 16 mm.
Trees to tame the Wind: United States Office of Education. 16 mm.
Turn of the Furrow: British Ministry of Information.
Ukrainian Winter Holiday: National Film Board. 16 mm.
Valley of the Tennessee: United States Office of War Information. 16 mm.
Vegetable Seed Growing: British Ministry of Information. 35 mm.
Victory Harvest: United States Department of Agriculture. 16 mm.

Vitamins A B C and D: National Film Board. 16 mm.
Vitamin Wise: National Film Board. 16 mm.
Voice of China: National Film Board. 16 mm.
Water: Friend or Enemy: United States Office of Inter-American Affairs. 16 mm.
West Wind: National Film Board. 16 mm.
Wetlands: United States Department of Agriculture. 16 mm.
Winter Care of Dairy Cattle: National Film Board. 16 mm.
World of Plenty: British Ministry of Information. 16 mm.
You can't kill a City: National Film Board. 16 mm.
Young Farmers: British Ministry of Information. 16 mm.

Touring Cinema

Indian villages are so poor that it will be prohibitive in cost to maintain regular cinema houses even in the larger ones. The only practicable solution for the present is the use of the mobile cinema, that is, a cinema projector mounted on a motor-van touring from village to village. Most of the Provinces maintain, at the initiative and with the financial assistance of the Central Government, Field Publicity Organizations which possess one mobile cinema per district. A more extensive organization will be needed to serve even a small percentage of villages satisfactorily. Such an organization can not be run cheaply but it can be used for other purposes. The mobile cinema van can be utilized for distributing seed, farm implements, etc., or for transporting agricultural demonstrators and other development workers.

The touring cinema will certainly tone up the imagination of the Indian peasants and will make them capable of going ahead like the peasants in the scientifically developed countries of the modern world.

3

AGRICULTURE & NUTRITION



PROBLEMS OF AGRICULTURE AND NUTRITION

By SIR PHEROZE KHAREGAT

THE total population of India is 389 millions, of which 339 millions reside in rural areas. It may be said that about 80 per cent of the population is dependent on agriculture. There are some 60 million cultivated holdings in the country. The majority of cultivators either own their own land or have the right to cultivate it as tenants.

The total area of India is some 1,000 million acres, but adequate agricultural statistics are available in respect of only two-thirds of that area. The cultivated area is 280 million acres; this means an average holding of between four and five acres for each cultivator in addition to one acre which he keeps as 'current fallow'. On a per capita basis the area under cultivation, including fallow, is about 0.85 of an acre. From the products and income obtained from his limited holding the cultivator has to support himself and his family, pay his rent and obtain money to meet all his other needs. Accordingly farming is for the most part conducted on a subsistence basis. The typical small-holder keeps some 80 per cent of his produce for his own food, the remainder being sold in the market.

The Indian cultivator is handicapped, not only by the smallness of his holding, but also by the variation in the monsoon rainfall on which the greater part of Indian agriculture is dependent. The heavy debts which have been contracted by a large number of cultivators and the uncertainty about the prices which they are going to obtain for their products are also factors of great importance.

Even a brief reference to these basic facts provides a rough idea of the difficulties that have to be faced in India. It must of course be observed that, on account of the vast size of India, and the diversity of conditions in different parts of the country, there are numerous exceptions to any general statement about Indian agriculture.

In short, the problem of improving agriculture and nutrition is astronomic in its magnitude but has, so to speak, to be tackled on a microscopic scale in respect of individual small farmers. Industry is developing and industrial and urban areas present their special problems. But India remains a country of small villages and small cultivators following an immemorial and traditional habit of life. These facts must be borne in mind in framing any long-term policy and devising any plan or programme for giving effect to such a policy.

Food Production

In the years previous to the war some 80 per cent of total crops were food and fodder crops. The proportion of these to other crops varied from year to year, but only within small limits. The following table shows the principal crops of British India in a typical pre-war year, 1937-38.

Cereals: The most important food crops in India are the cereal grains and of these rice, wheat and the various millets are the most extensively cultivated. Quantitatively speaking, rice is the foremost crop; in British India the

area under rice slightly exceeds that under all other cereals put together. The annual yield fluctuates around 28 million tons. Rice is extensively cultivated in Eastern and Southern India. Wheat comes next in order of importance, being the staple crop in most parts of Northern and North-Western India. The annual yield is about 10 million tons.

TABLE I

*The Principal Crops of British India—(1937-38).
(Areas shown in millions of acres)*

Food grains (including pulses)	186.8
Fibres (mainly cotton and jute)	18.9
Oil seeds	17.0
Fodder crops	10.4
Fruits and vegetables (including root-crops)	3.8
Sugar	3.8
Drugs and narcotics (tea, coffee, opium, tobacco, etc.)	1.7
Condiments and spices	1.4
Miscellaneous	2.9
			246.7

The millets are extensively grown in most provinces, and constitute a very important food crop. The total production of millets is approximately 17.5 million tons. The principal millets grown are great millet (*Sorghum vulgare*) spiked millet (*Pennisetum tyopideum*) and common millet (*Eleusine corcana*). Barley is a crop of some importance in certain parts of Northern India, particularly in the United Provinces. The annual production is about two million tons. The production of maize, a crop cultivated mainly in the North, is about one or one and a half million tons. Tapioca, which is a root and not a cereal, is eaten as a food staple in only one part of India, namely Travancore, in the extreme south. The annual yield before the war may be estimated at about 1.5 million tons.

Pulses : Pulses are grown throughout India and form part of all Indian diets. They are of value as supplements to diets largely composed of cereals in that they contain various constituents in which cereals are deficient; besides this, they are essential to agriculture since the

moderate fertility of the soil could not be maintained without the cultivation of leguminous crops in rotation. *Cajanus indicus* and *Cicer arietinum* are the most popular of the considerable number sown. The annual yield of pulses is estimated as nine million tons.

Nuts and Oil Seeds : These are cultivated both as cash crops and for food. They include ground-nut, coconut, mustard, sesamum, rape-seed, etc. Except in certain parts of Northern India where milk fat (*ghee*) is reasonably abundant, vegetable oils are the main source of fat in the diet of the majority of the population. Linseed is usually grown principally for export, though linseed oil is consumed as food in certain areas. During the years just previous to the war, 33, 40 and 60 per cent respectively of the ground-nut, castor and linseed crops was exported.

Milk and Dairy Produce : The total annual production of milk is estimated as about 230,000 million litres, which gives a daily per capita intake of all milk products, in terms of liquid milk, of between six and seven ounces. Consumption varies greatly in different parts of India, being higher in the Northern Provinces than in the rest of the country. For example, in the Punjab milk consumption has been estimated as 19.7 ounces per capita daily, and in the Madras Presidency, with a population of some 50 millions, as 3.6 ounces. In many parts of India milk and milk products are consumed by the poorer classes in negligible amounts or not at all. It is said that 54 per cent of milk is obtained from cows, 43 per cent from buffaloes and 1.6 per cent from goats. The large goat population is in fact little used as a source of milk. The milk of Indian cows contains 25 to 50 per cent more fat than that of European cows, while buffalo milk contains more than twice as much. The higher fat content of milk produced in India compensates

to some extent for the extremely low yields per milking animal. About 27 per cent of the total milk supply is consumed as fluid milk. Some 60 per cent of the total outturn of milk is used for the manufacture of *ghee*, the 'butter-milk' which remains after the partial removal of the fat being consumed by the producer.

Meat: The livestock population in India is large, there being nearly one domestic animal per head of population. Meat nevertheless forms a very small part of the total food supply of the country, and the amount eaten by the greater part of the population is almost negligible. The consumption of poultry is of no quantitative importance. Wild game does not provide any appreciable addition to the meat supply.

Fish: Indian coastal waters are teaming with fish which represent a large potential source of food supply. Unfortunately it is a source which remains largely untapped, for the application of modern scientific and industrial technique to the fishing industry has as yet scarcely begun. The industry has, however, shown some expansion within recent years. Annual production is estimated at about 660,000 tons. The bulk of this is sea fish. In certain parts of the country, e.g., delta areas such as Bengal, fresh water fish is a food of considerable importance.

Eggs: The annual production of eggs is estimated at 3,300 millions. This production is very small in relation to the population and it may be said that eggs are consumed in negligible quantities by the poorer classes in villages and towns. Systematic poultry farming is confined to a few centres. The eggs laid by ordinary village hens are small in size in comparison with a good Danish or American egg.

Sugar: The production of sugar, refined and unrefined, is estimated as 4.3 million tons, which amounts to approximately

1.25 ounces per capita daily. The refining of sugar has become an important industry, now employing some 100,000 workers. Great attention has been given within recent years to the problem of increasing the production of sugar and improving methods of utilization and manufacture. In over 80 per cent of the area under sugar the old canes have been replaced by varieties which give higher yields and are more resistant to disease. India now produces more sugar than any other country in the world.

Fruits and Vegetables: In no country can the trend of production of fruits and vegetables be easily estimated statistically. It is not possible to obtain figures of production in small domestic gardens and allotments. The recorded area under vegetables in India is three million acres, and the estimated production nine million tons. The most commonly consumed vegetables are the brinjal or egg plant and the various gourds. In North India in the cold weather and in hill districts the familiar European vegetables—cabbage, cauliflower, etc.—grow and thrive. Potatoes occupy nearly half a million acres, the main crop being raised in the north in the winter. The production is estimated at two million tons. Indigenous leafy vegetables are also grown throughout the country. The area under fruits of all kinds is recorded as 1.8 million acres; of this 60 per cent is devoted to mangoes, 21 per cent to bananas and nearly 5 per cent to citrus fruits (oranges, etc.). Mangoes, which are of high nutritive value, are in season for a few months only, during which a glut tends to occur. Other fruits of some importance are guavas, pineapples, grapes and jack fruit.

Within recent years there has been a marked increase in the cultivation of citrus fruits, chiefly oranges, which grow well in most parts of India. The chief centres of cultivation are the Punjab,

Assam, the Central Provinces and the Madras Presidency. In Madras the area under citrus fruits increased from 7,300 acres in 1931 to 10,000 acres in 1936 and in other provinces a similar expansion has occurred. The growing popularity of oranges is a matter of common observation.

Imports and Exports: Imports and exports of food in normal times were small in relation to indigenous food production.

Food Consumption

A rough idea about the nature of Indian diets can be obtained from statistics of food production. These show that the main food of the country is cereals and that other foods are produced in relatively small quantities. But more detailed information is necessary to obtain a clear picture of Indian dietary habits. This has been provided by an extensive programme of diet surveys. Since 1936 some 100 surveys have been carried out, mainly by workers trained in the Nutrition Research Laboratories, Coonoor, in various parts of the country and in Burma, the method followed being approximately as follows. A group of families in a given area is chosen and a careful quantitative investigation is made of all the foods consumed by each family over a period of 10 to 20 days. The group usually consists of 10 to 25 families. Daily house to house visits, during which the foods are weighed in the raw state, are made by trained investigators. Surveys have sometimes been repeated in the same area at different seasons. The data obtained in the field are subsequently analyzed in various ways.

The surveys have covered about 1,500 families, including 5,000 to 6,000 individuals. Some 80 to 90 different areas, including both rural and urban areas, have been the venue of surveys, and investigations have been carried out in

most Provinces and States. There are, however, considerable areas in which dietary habits have not yet been studied. Further, the instance of the population surveyed is not a random one, either as regards the location of the survey or the individual families investigated in any particular place. Theoretically, in order to obtain a true picture of Indian dietary habits, villages for survey should be picked out by random selection throughout the country and the same process applied in choosing families for study within the village. For a number of reasons such a procedure is practically impossible. In spite of such difficulties in selection and the limited number of the persons in relation to the total population of India, it can be claimed that reasonably accurate information about diet in India has been obtained by the extensive diet survey programme.

The following conclusions can be drawn from the results of the surveys :

Quantitative Deficiency of Diets: Some of the groups included in the surveys were grossly underfed. For example, the average daily calorie intake per consumption unit of a group of poor villagers in South India was 1,700 and that of poor families in a Madras suburb 1,800. In 1937 the Nutrition Research Laboratories investigated a cross section of a village in South India when conditions in the district were normal. In some 50 per cent of the families calorie intake per consumption unit was below 2,300. Very similar observations have been made among other village populations elsewhere in India, and also in Ceylon.

The tentative estimate can be made that at least 30 per cent of the population of India is habitually *underfed* in normal times. Thirty per cent of the population means over 100 million people. This estimate agrees with that made by nutrition workers for Ceylon. It is based on the study of voluminous diet

survey records and also on general experience of the condition of the Indian people. The degree of under-nutrition is naturally not uniform, either in time or place. There are good areas which enjoy abundant rainfall or efficient irrigation; there are bad areas with recurrent drought and no irrigation in which the population lives permanently on the verge of famine. There are areas in which the economic condition of sections of the population fluctuates in accordance with the price and world demand for some cash crop. Major industries supporting thousands of workers have their periods of boom and slump. But, by and large, there is no doubt that a high percentage of the population does not get *enough* to eat, and this is a fundamental fact which all concerned with the task of improving the diet of the Indian people must realize. 'Enough food' takes precedence over 'the right kind of food'.

Quality of Diets

Rice Diets : The surveys show that the diet of the poor rice eater is very much the same all over India. In addition to his staple cereal the poor rice eater consumes only very small quantities of pulses, vegetables and meat. Intake of pulses is from 0.5 to 1.5 ounces daily; of non-leafy vegetables, 2 to 6 ounces; of vegetable oil, less than 1 ounce. Consumption of meat, fish and eggs does not often exceed 1.5 ounces and as a rule invariably less than this amount is taken. Leafy vegetables are eaten in small quantities, while the consumption of milk is negligible. Fruit is a rare ingredient in the diet. It is to be remarked that there is some disagreement between the calculated production of fruit per capita, based on agricultural statistics, and the actual intake of fruit observed in diet surveys. The same can also be said about milk.

Millet Diets : These are in general

similar to rice diets except that millet replaces rice as the main ingredient. In many districts the diet contains a mixture of cereals including one or other of the millets.

Wheat Diets : Generally speaking, milk production is higher in wheat-eating parts of India than elsewhere and milk and milk products are more prominent in the diet. Intake of pulses also tends to be greater. In their content of foods other than these, wheat diets resemble rice and milk diets. It is to be observed that an adequate intake of milk is by no means universal in wheat-eating areas.

Tapioca Diets : Tapioca (manioc) is grown and eaten only in the south west corner of India, i.e., in Travancore. In normal times, the diet of the poorer classes in many parts of Travancore is based on both rice and tapioca; it is only rarely that tapioca is the sole basic energy-yielding food. In general, diets containing tapioca are similar to rice diets in their content of such foods as milk, vegetables, meat, etc. Tapioca diets are of interest from the nutritional standpoint because of their deficiency in protein.

Middle Class Diets : Middle class diets differ from those of the poorer classes chiefly in containing more vegetables, fruit and milk products. Non-vegetarian middle class diets include relatively large quantities of fish, meat and eggs. The most important difference between the diets of the well-to-do and the poor throughout India is the greater amount of milk products included in the former. Various surveys carried out in different parts of the country have shown that there is a steady rise in the consumption of non-cereal foods, e.g., milk, vegetables and fruits, with increasing income, indicating that in India as well as elsewhere there is a close correlation between dietary standards and income level. This is true of industrial groups, but among very ignorant and primitive

groups, e.g., aboriginal tribes, and increase in prosperity may scarcely influence the consumption of the more valuable 'protective' foods.

Defects of Indian Diets : In terms of food constituents, the defects of Indian diets can be briefly summarized. Intake of total protein is usually sufficient when cereals form the bulk of the diet and calorie yield is adequate. Intake of proteins of high biological value from animal foods is, however, usually negligible. Intake of fat, whether in the form of vegetable or animal fat, is almost invariably low. Rice diets are usually deficient in calcium and this is true to a smaller extent of diets based on other cereals (except common millet). Insufficiency of vitamin A and carotene, and of various factors in the vitamin B₂ complex¹, is characteristic of most Indian diets. Intake of vitamin C is low, owing to the relatively low intake of fruits and vegetables. Deficiency of vitamin D is of importance in certain areas and under certain conditions. Only diets based on raw machine-milled rice are seriously deficient in vitamin B₁. Beriberi is a serious public health problem only in one considerable area in north-east Madras in which this kind of rice forms the staple food of the population.

It is to be observed that wheat and the various millets, as usually consumed in India, are not machine-milled and retain the greater part of the outer layers of the grain. Villagers in most rice-eating areas consume home-pounded rice. Machine-milled *par-boiled* rice is a staple food in a large part of South India. This kind of rice retains vitamin B₁ after milling and has in many respects the nutritive properties of a whole cereal.

Malnutrition

There is abundant evidence, from the clinical and public health side, of the

¹ Particularly riboflavin. Evidence is accumulating that riboflavin deficiency is of great importance in India.

ill effects of insufficient and faulty diet in India. The high infantile mortality rate and malnutrition stand in close relation. For example, in the beriberi area a very high mortality in breast-fed infants in the third and fourth months of life, due to infantile beriberi, has been recorded ; this is an example of how a deficient maternal diet (in this case a diet largely composed of raw machine-milled rice) may profoundly influence infantile mortality. Even more striking is the high mortality rate in young children throughout India. Half the mortality recorded in any given year occurs in children under 10 years, the corresponding figure for England being only some 12 per cent. Numerous lines of evidence converge to show that malnutrition is one of the chief causes of this rapid and tragic exit of young human beings from the world so soon after their arrival in it.

Systematic examination of groups of school children has revealed a high incidence of food deficiency diseases such as xerophthalmia, stomatitis and phrynoderna. General clinical assessment has also revealed a high incidence of malnutrition in this age group.

The female death rate during the reproductive period (15 to 45) is higher than the male, and the excess is largely due to mortality from child bearing. Estimates of maternal mortality in various parts of India vary from 16 to 24 per thousand live births, a very high rate. There is good evidence that diseases associated with faulty diet are of major importance in producing this high mortality. The anaemias of pregnancy are a serious public health problem.

Deficiency Diseases

Diseases directly due to insufficiency of some necessary constituent in the diet and capable of being prevented or cured by supplying that constituent—are in themselves a problem of public

health importance. In north east Madras beriberi in adults is a common disease, leading to much suffering and disability but not often to death. Beriberi in infants, as has already been pointed out, is the cause of many infant deaths in this area. Keratomalacia is the commonest cause of permanent blindness in South India ; it is also prevalent in other parts of the country. Nutritional oedema is commonly seen, particularly among children. Osteomalacia and rickets present a formidable public health problem in certain parts of Northern India. One of the commonest of deficiency states is a syndrome including stomatitis, dermatitis in the genital regions and sometimes superficial keratitis, which is associated with lack of the B₂ group of vitamins, and in particular with riboflavin deficiency. Various kinds of anaemia, associated with blood-destroying diseases such as malaria, hookworm and also with malnutrition, are highly prevalent in certain areas and groups. Goitre is another nutritional disease, highly prevalent in certain Himalayan and sub-Himalayan areas ; it is, in fact, a public health problem of very large dimensions. Severe scurvy is uncommon except in famine times. Further clinical research will unquestionably reveal other deficiency diseases, at present unrecognized. Diabetes—the scourge of the middle classes in India—can scarcely be included under this head, though its cause is presumably some long-continued error in diet. It has so far received little attention from nutrition research workers in India. Epidemic dropsy is a nutritional disease of considerable importance in Bengal. Recent work seems to have established that it is due to a toxic factor in the diet rather than to any dietetic deficiency, but it can none the less be described as a nutritional disease.

As regards the general relation between diet and disease, investigations in areas

of food scarcity and famine have thrown light on this question. Special mention may be made of the measures taken to combat famine in India. The Famine Code, which is the result of many years of practical experience in dealing with famine conditions, is an important and interesting contribution in the field of public health nutrition work. In famine areas there is invariably a striking increase in the incidence of numerous familiar diseases which are not normally considered to be associated with malnutrition. It is not unreasonable to suppose that the incidence of diseases which become more prevalent in times of food scarcity is influenced by diet in normal times.

Measures for Improved Nutrition

These can be only briefly outlined. A considerable amount of research on nutrition has been carried out in the Nutrition Research Laboratories, Coonoor, and in other institutions. In addition to the diet surveys, the nutritive value of Indian foods has been extensively studied. Investigations of the state of nutrition of groups of school children in various parts of the country have been made. Health bulletins and pamphlets on food and diet have been widely circulated. Nutrition officers trained in Coonoor are now included in the Health Departments of many Provinces and States and have carried out useful work. Interest in nutrition has been aroused and the educated classes are becoming aware of the extent and importance of the problem. It cannot, however, be claimed that the campaign for improved nutrition has as yet influenced the poorer classes in towns and villages—the majority of the population. A considerable amount of work has been done on food deficiency diseases, e.g., beriberi, rachitic diseases, keratomalacia, riboflavin deficiency. The rice problem, i.e., the problem of ensuring that raw rice will

not be consumed in a fully decorticated state almost lacking in vitamin B₁, has received considerable attention. Recently the Government of Madras has passed an order prohibiting the polishing of rice beyond a certain degree and this may have a dramatic effect on the incidence of beriberi.

There has been some development of schoolfeeding schemes and the nutritional aspects of maternity and child welfare work have received attention. In general clinical workers in India are becoming familiar with the elements of modern nutritional science and this has furthered the prevention and cure of deficiency diseases and malnutritional states by appropriate measures in hospitals and out-patient departments.

The public health nutrition worker comes up against the difficulty that the basic cause of malnutrition in India and elsewhere is the economic factor over which he has little control. But even in the existing economic circumstances, progress can be made in raising dietary standards and preventing malnutrition and deficiency diseases if the best use is made of available resources. The first essential is the education of those who in turn can educate the people. This means that greater emphasis must be laid on nutrition in the training of doctors and public health workers of all grades. It means that school teachers must be taught simple facts about food and diet, and impart them to their pupils. It means the education of the professional and administrative classes generally, including workers in agricultural, animal husbandry, and development departments.

Special mention may be made of the successful production of shark liver oil as a substitute for imported cod liver oil. This local industry has been developed within the last two years. The quantity produced is approximately equivalent, in terms of vitamin A content, to the

prewar import of cod liver oil. Shark liver oil is now being widely used throughout India in hospitals and dispensaries. The development of this successful local industry was the result of collaboration between nutrition workers and various Government departments.

Future Policy

India is self-sufficient as regards her food supply in the sense that both imports and exports on food in normal times are small in relation to total indigenous food production. But she is not self-sufficient in the sense that the population is abundantly or satisfactorily fed. In order to make the national diet more satisfactory from the standpoint of nutrition, far-reaching changes in production and consumption are necessary. The *direction* of these changes is illustrated in the following table.

TABLE II
Existing and Desirable Consumption

	Ounces per day per adult (or consumption unit)		Total quantities in million tons	
	Required for a balanced diet	Avail- able	Required	Avail- able
Cereals	16	18.5	48.0	55.5
Pulses	3	2.5	9.0	7.5
Sugar	2	1.8	6.0	5.3
Vegetables	6	3.0	18.0	9.0
Fruits	2	2.0	6.0	6.0
Fats and oils	1.5	0.6	4.5	1.9
Whole milk ¹	8	1.5	32.0	6.3
	per capita			
Butter milk	..	3.0	..	12.5
Meat, fish and eggs	2 to 3	0.5	6.0 to 9.0	1.5

The first column in the table shows a diet, in terms of ounces per adult man or consumption unit daily, which is *reasonably* well balanced and satisfactory in its contents of necessary

¹ The figures for available milk are based on existing information about the uses to which the milk supply is put. All the figures in the table should be regarded as illustrative rather than absolute. The table shows in a general way the existing trend of consumption and how this needs modification.

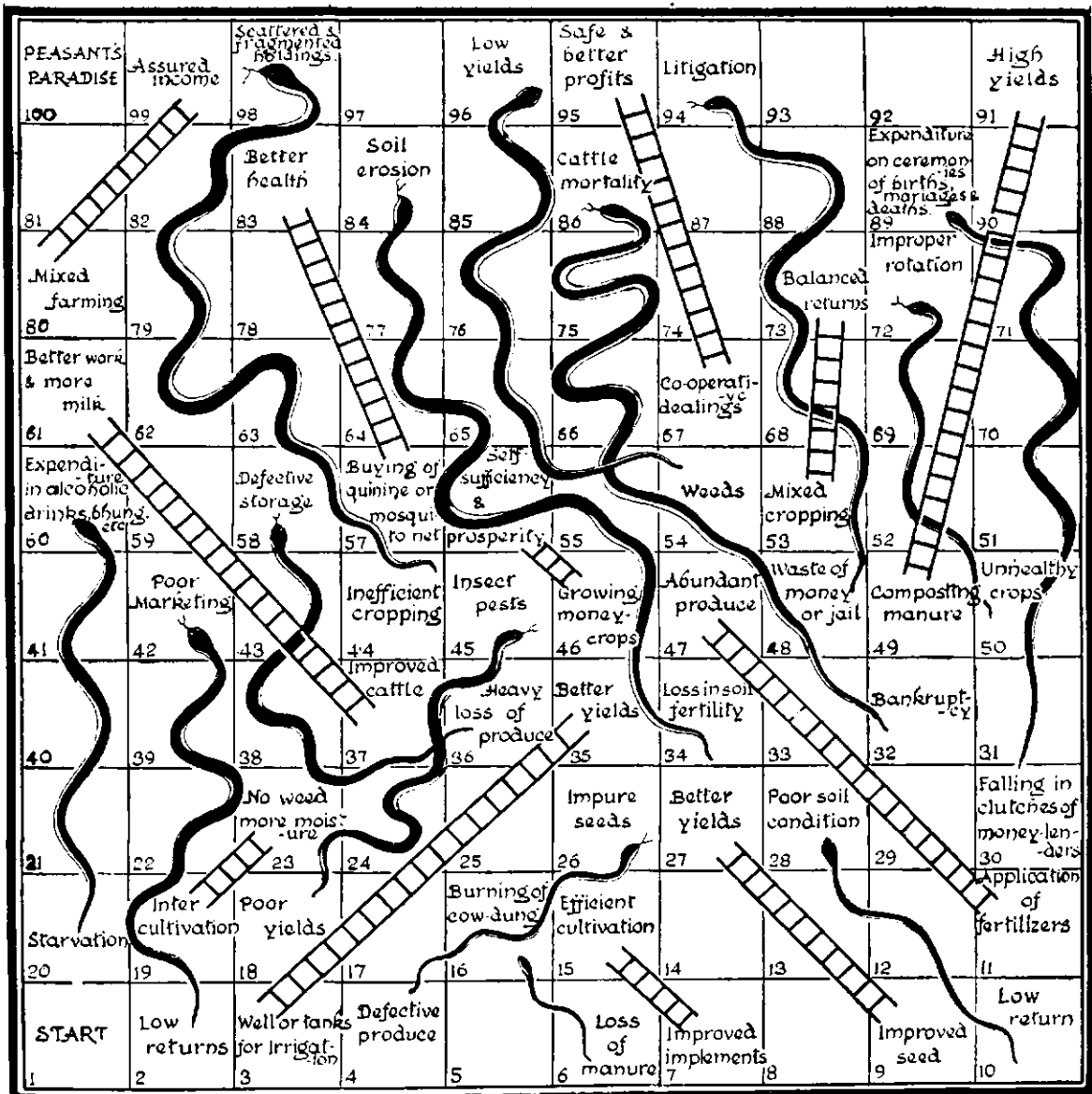

N. S. BISHT

AGRICULTURAL SNAKES AND LADDERS
 Unproductive and Productive Expenditure

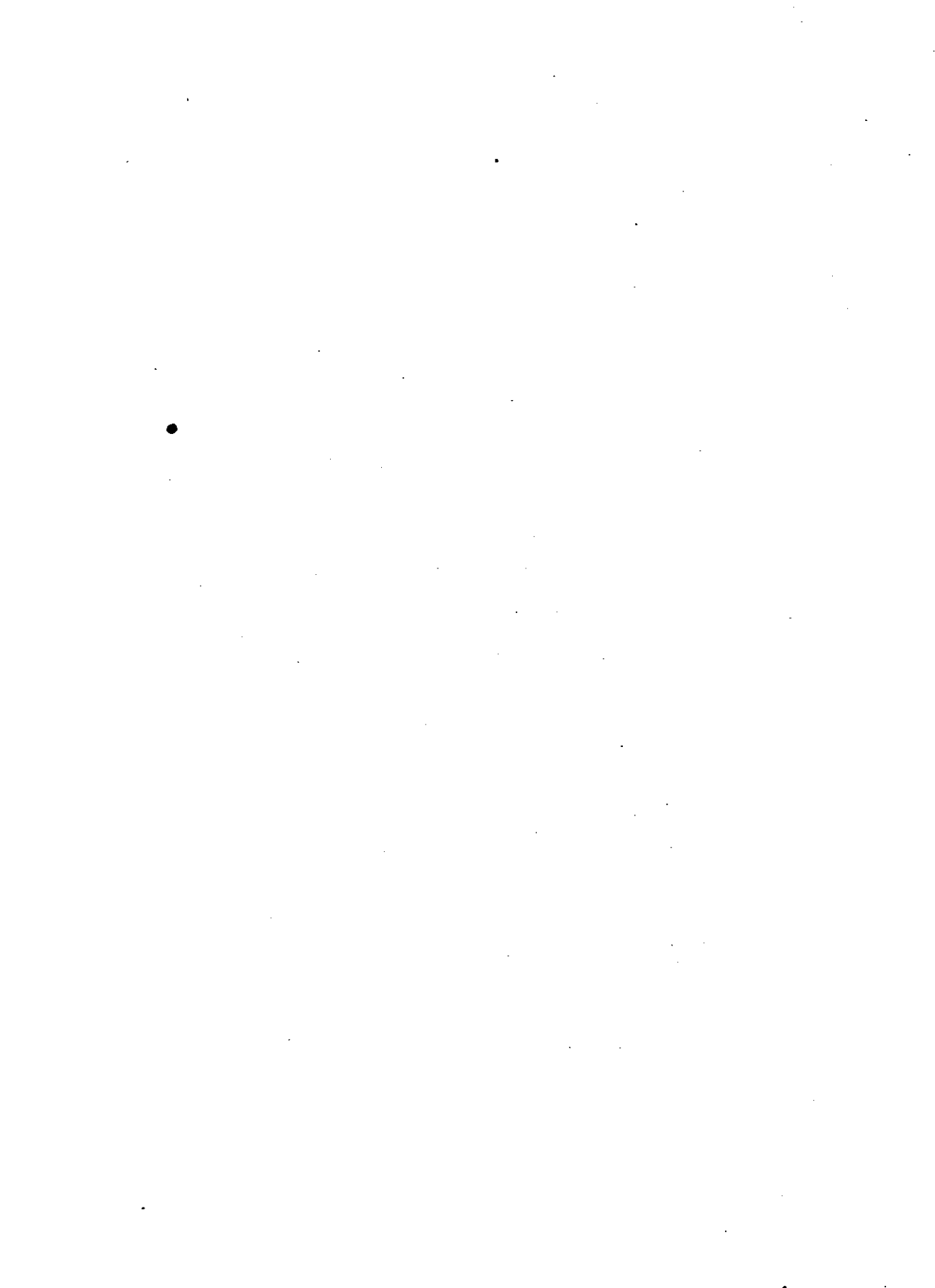

food constituents. The energy value of the diet is 2,600 calories, the item 'meat, fish and eggs' being regarded as an alternative to milk. The second column indicates approximately the quantities per adult man of the various foods at present produced. The difference between columns one and two shows roughly the changes in the production of the various main groups of food supplies necessary in order to bring the national diet to the desired level of adequacy.

Provided more 'supplementary' foods can be produced, the existing production of cereals will more than cover requirements. It is, however, to be observed that the former is sufficient only on this assumption. In the case of pulses, production is not far below requirements as estimated by nutrition workers; there are, however, great differences in the level of consumption in different parts of India. In rice-eating areas in which pulses are most needed as a supplement to the staple cereal, intake of pulses tends to be smaller than in wheat-eating areas.

Consumption of sugar also varies greatly in different parts of the country. In general, nutrition workers do not favour a high consumption of sugar, and a further substantial increase in the production of sugar for internal requirements cannot be considered of great importance from the nutritional standpoint. The figure of 2 oz. adopted in Table I, is less than the daily per capita consumption of sugar in England and the United States in normal times. Sugar, in spite of its nutritional aspects, supplies calories and, as has already been pointed out, a considerable proportion of the population of India has an inadequate caloric intake.

A hundred per cent increase in vegetable production is desirable, and here special emphasis must be laid on green leafy vegetables. With regard to fruit, it is difficult to estimate the existing consump-

tion, and the figure of 2 oz. given in the second column is probably inaccurate. Intake of fat is low and a very considerable increase in the production of fats and oils is desirable.

The most vital need of India, in the nutritional field, is an increased production of milk and milk products. The standard of 8 oz. per capita daily is far below that usually recommended by nutrition workers, but if even this level could be reached, the results obtained would be a great improvement in the nutritional status of the population. A discussion of the formidable difficulties which obstruct the development of the dairy industry would be outside the scope of this note.

India is by tradition not a meat-eating country and nutrition workers in India do not attach great importance to increasing production and consumption of this article of diet. Nevertheless some increase is desirable. The development of fish production is to be strongly recommended, and the same may be said of eggs.

In connection with the task of increasing food production in India, and raising standards of nutrition, the problem presented by the growth in population must not be overlooked. Numerous volumes have been written about the population problem, mostly pessimistic in tone. It is pointed out that while the population has rapidly increased within recent years, the area under food crops has not increased in proportion. Many authorities hold the view that the population problem is fundamental--that any increase in food production is likely to be absorbed by the requirements of the rapidly growing population. Certainly, in many parts of the country, the density of the population in relation to land available for grazing and crops is such that the increased production of foods which give a relatively low caloric return per unit area, such as milk and

meat, becomes very difficult. The different aspects of the population problem cannot be adequately discussed in this note. It is sufficient to say that they require careful study on the part of those concerned with the development of agriculture—the improvement of nutrition in India and that the facts which such studies elicit must be boldly faced.

The Goal

Problems of agriculture and nutrition have been studied in some detail in India and hence it is possible to formulate a long-term policy for the orientation of agricultural production in the right direction. The main problem is the development, based on scientific knowledge and methods, of agriculture, animal husbandry and fisheries. As regards food imports, adequate supplies of Burma rice may be regarded as essential, but

cereals other than rice are not required. Certain types of agricultural machinery and chemical manures can with advantage be imported.

The difficulties underlying the development of the food resources of India must not be minimized. The goal of improved nutrition can be attained only by untiring effort over a long period of years. Something can be done to tackle localized problems of nutrition by the use of concentrated foods such as fish liver oil, milk powder and dried yeast, or by synthetic vitamins and mineral preparations, and nutrition workers in India must carefully study the possibility of progress in this direction. Research on agriculture and nutrition must be actively pursued and public health nutrition work, in its various branches, pushed forward vigorously. But by and large the improvement of nutrition in India depends on the development of the food resources of India herself.

CONSOLIDATION OF HOLDINGS

By U. N. CHATTERJEE

FRAGMENTATION and scattering of holdings are among the major causes of the poverty of the Indian peasant, and it is essential that fragmentation should be looked upon as an unmitigated evil, for it involves a loss of time and energy and an inadequate return for the capital the peasant invests. It is a wasteful method of land utilization, and undermines the foundations of a sound agricultural practice.

Usually a peasant's holding in India consists of a number of scattered plots, which are further subdivided at each succession, and in extreme cases they are reduced to mere strips of land so narrow as to prevent easy movement or turning of bullocks at the time of ploughing. Fragmentation occurs because of the custom which allows each heir to take a share of each field wherever situated¹. It happens moreover on account of the difficulty in making a large number of agreements which would be necessary as a pre-requisite to a compact holding.

Again a cultivator would like to possess a piece of land in almost every soil type available in a village or a group of villages. He would cultivate different crops on different plots so that in the case of failure of one, he may fall back upon the remaining ones.

Virgin lands or culturable waste lands are being constantly brought under the plough due to the pressure of increasing population; they invariably lie outside the orbit of land where cultivation is usually practised. The acquisition of such lands by peasants leads inevitably

to scattered holdings. A similar situation arises when a peasant dies without a heir. This would result in other person or persons obtaining possession of his land, thus tending to bring far-removed areas under one cultivator, who cannot bestow the same attention to all of them. The various aspects of agricultural operations, e.g., manuring, ploughing, sowing, irrigation etc., are to be attended to at particular times, and the experience of centuries has proved that the nearer to the farmer's dwelling a plot is situated, the greater the attention it is likely to receive.

Loss of Labour, Land and Money

Much time is wasted in moving draught animals from one plot to another. The agricultural implements and bullocks are taken from field to field, thus resulting in waste of bullock power. As B. P. Jain has said: "It is calculated that expenditure for cultivation of land increases by 5.3 per cent for every 500 metres of distance for manual labour and ploughing, twenty to thirty-five per cent for transport of manure and fifteen to thirty-two per cent for transport of crops. It has been further observed that on compact holdings the income from farming would be increased by at least 20 per cent without any modification in the method of cultivation"².

Again the problem of irrigation will have to be faced. The water of a well sunk at one plot cannot be available to all the scattered plots. Even if the village is served by a canal, it is difficult to provide for separate irrigation

¹ C. F. Strickland, *Consolidation of Agricultural Holdings*, (1939), p. 3.

² *Agricultural Holdings in the United Provinces* (1937), p. 44.

arrangement for all the plots, and naturally it causes much loss of time and manual labour.

The isolated plots are demarcated by hedges, mud-walls and embankments, which occupy considerable space. To quote B. P. Jain again "hedges and boundary marks on ten plots of half acre each (in practice.....plots are even smaller than this) will occupy no less than 8.4 per cent of the total area."¹ The larger the number of plots, the greater will be the space wastage in boundary marks, and land can be saved and profitably utilized if the different plots are consolidated into one block.

The scattered holdings are a source of quarrels among villagers, for boundary disputes and cattle trespasses occur frequently and they lead to affrays and litigation; it is tragic indeed that a lot of money which can easily consolidate the economic position of the peasant should find its way to the lawyer.

Larger Holdings

It is not easy to think of effecting any improvement if the plots are scattered. The same plan and programme of improvement, however, may not be suitable to all of them. Any improvement may moreover be nullified by the condition of the adjacent neglected plots. For instance, eradication of weeds would be impossible if the nearby plots are permitted to remain infested. Again the operational cost of an improvement programme especially in the case of anti-erosion measures, will be prohibitive for a small area.

Similarly many improved methods of cultivation would be precluded from being put to practice on account of the small and scattered nature of the plots. Tractor cultivation will only remain a pious wish in such conditions on account of the cost involved. As a matter of fact, fragmented and scattered holdings

have stood in the way of capital being invested on large-scale farming. In order to acquire a sufficiently large area on which mechanized agriculture can possibly be remunerative, a person will have to contact a bewilderingly large number of landowners. "No technological schemes of increased production can work," says Nabagopal Das, "on an uneconomic holding of a size of no more than 2 to 4 acres. If therefore there is going to be any agricultural renaissance in India we must think in terms of farming on much larger holdings than we have at present."²

As a consequence of consolidation of holdings, the cultivator will have to reside at his farm; naturally it will do away with unhealthy living in cramped and congested areas, and the spread of infectious diseases and outbreaks of epidemics will also be minimized.

Russian Method

It would be a positive advantage to the peasant if instead of having widely scattered small plots of land, he had an equivalent compact block of land. Compactness of land brought about with the purpose of liquidating the scattered nature of plots is the real remedy—the consolidation of holdings. "It is a process," says C.F. Strickland, "whereby owners or right-holding tenants are persuaded or compelled to surrender their scattered plots and to receive in their place an equal area of land of the same quality in one or two blocks. An exchange of this kind has in the past three centuries been carried out in all countries of western and many countries of eastern Europe."³

There are, however, certain shortcomings, supposed or real, inherent in the consolidation of holdings. It is obviously advantageous where all the plots can be exchanged into an equivalent

¹ *Agricultural Holdings in the United Provinces* (1937), p. 46.

² *Agriculture in India*, (1944), p. 47.

³ *Consolidation of Agricultural Holdings*, p. 4.

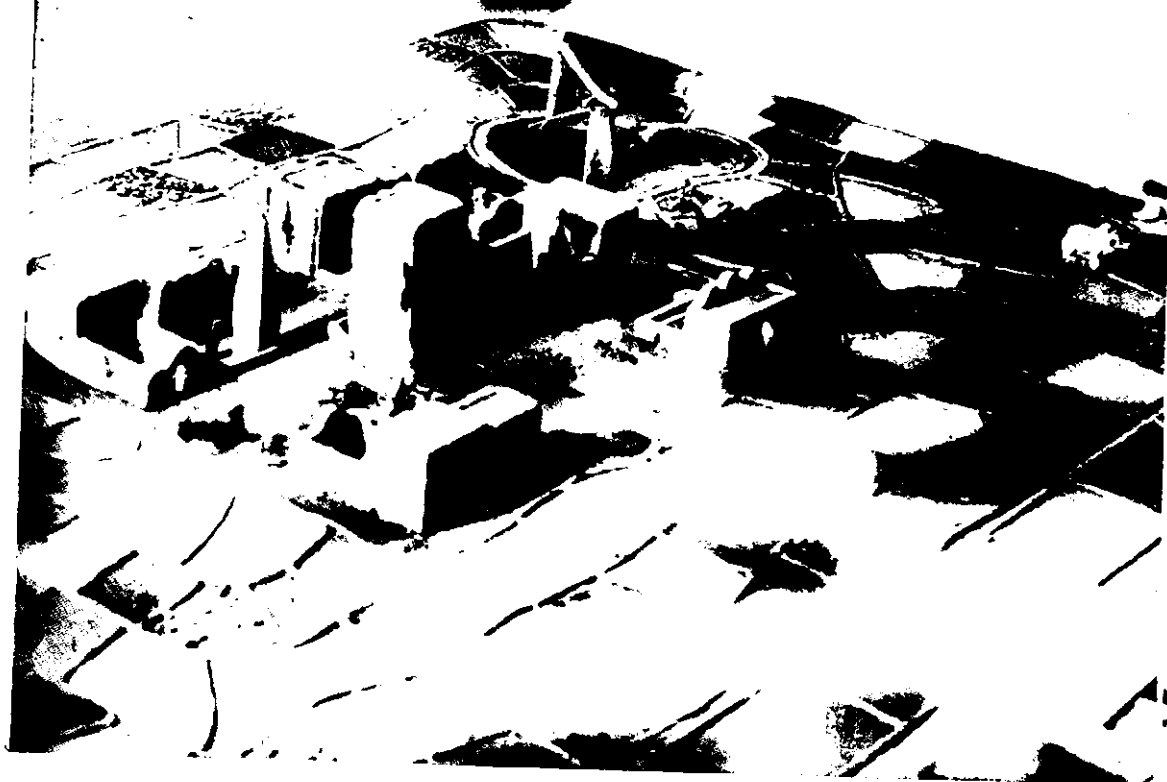

P. 1. B.

A VILLAGE BEFORE CONSOLIDATION OF FIELDS (above)
A MODEL VILLAGE AFTER CONSOLIDATION OF HOLDINGS (below),
As shown at Rural Uplift Exhibition at Delhi in March, 1946.

PLATE 23

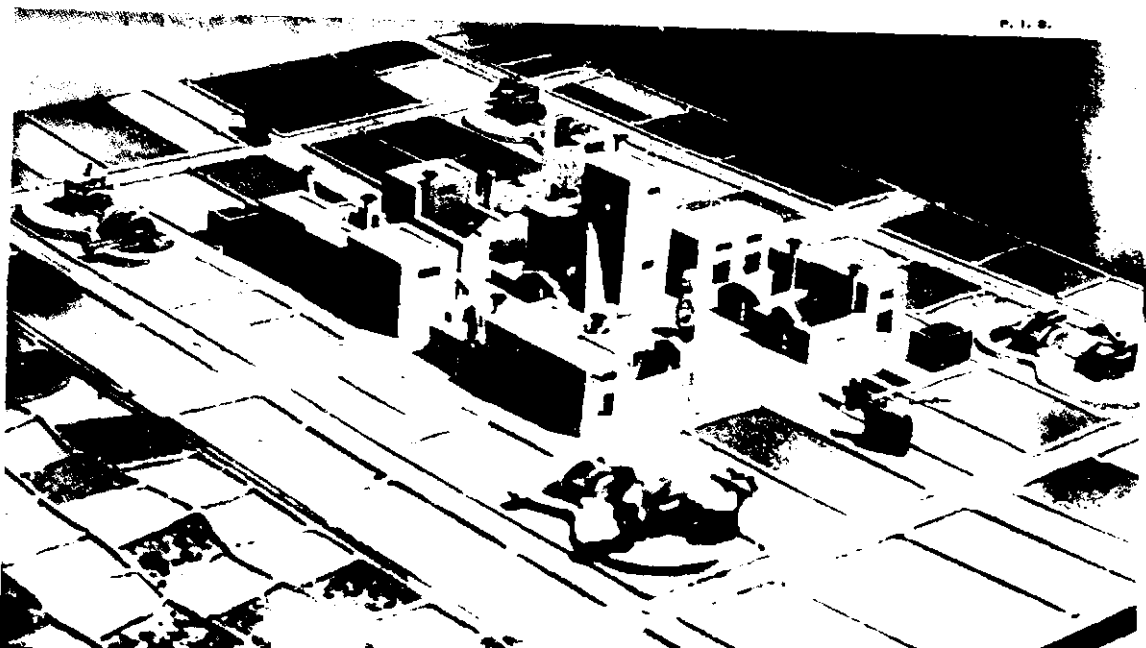

P. 1. B.

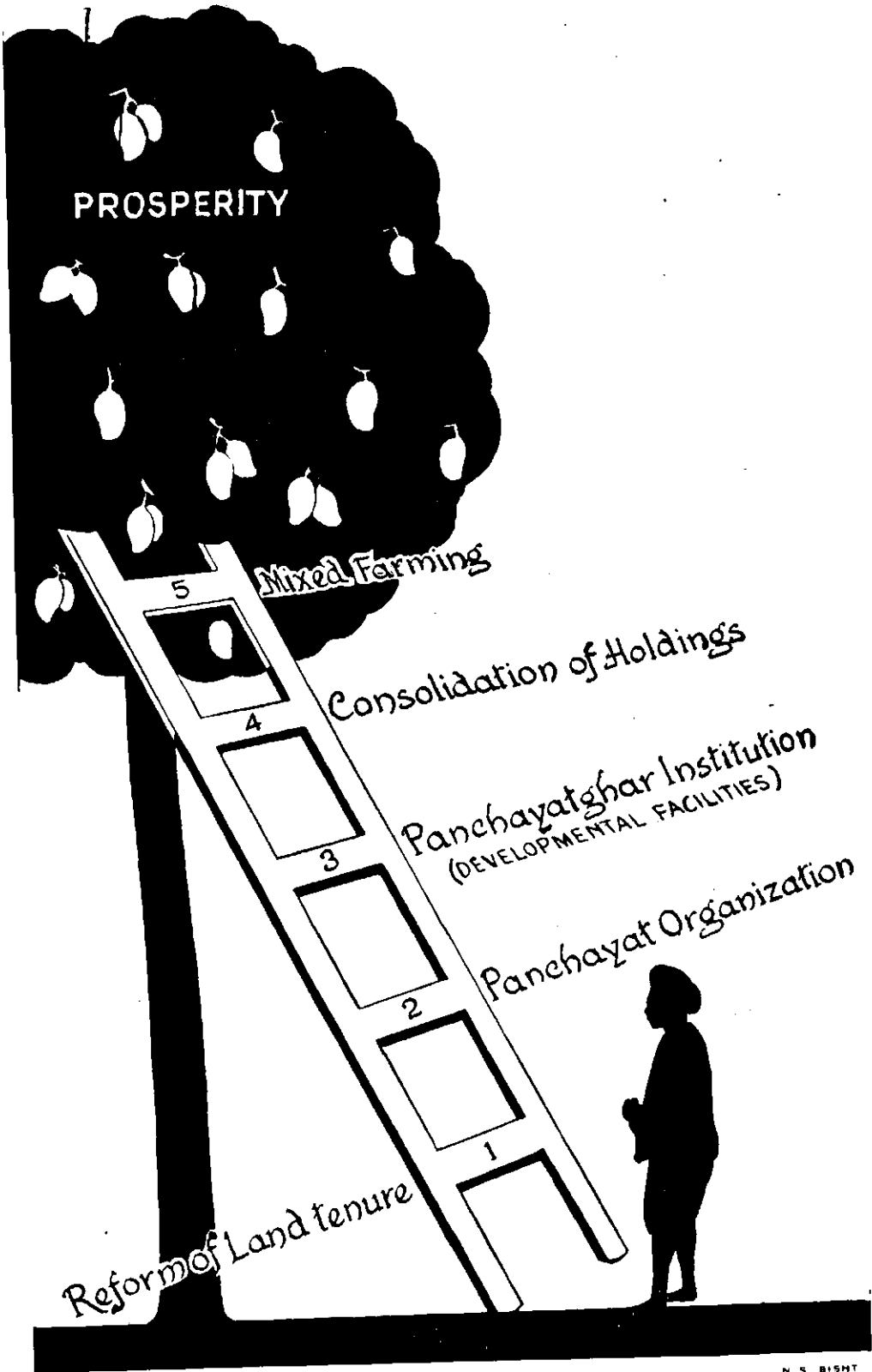

N S BISHI

THE AGRICULTURAL LADDER

block of uniform soil type. But in cases—and this may actually happen sometimes—in which different categories of fields are brought together, consolidation is disadvantageous in crops, and probably also the method of cultivation will vary in accordance with the nature of the plots.

The average Indian villager is deeply wedded to his field; he considers it to be a sacred trust handed over to him by his ancestors and develops a sentimental attachment for the land he calls his own. This psychology and attitude of mind have developed in him an abhorrence against any idea of parting with his land. Moreover, he is thoroughly acquainted with the fields that belong to him: he knows their quality, their productive capacity, their particular requirements: he knows what and how much to expect from them. This attitude will have to be moulded and overcome by putting before him the advantages of consolidation in a practical way, and it can be emphatically said that demonstration of films from a progressive country like Soviet Russia will inspire him to adopt the Russian method.

Compulsory Consolidation

It must be remembered that the land of a country is its greatest asset since it is on the produce of the land that its prosperity in every sphere depends. It may have been partitioned to the people of the country but any partition or apportionment does not divest the State of its responsibility to put its greatest asset to the most efficient service. If this view is accepted, the owners of different portions of a country's available land are to be regarded as trustees who, on behalf of the State, are managing their allotted spheres so as to derive from them the greatest benefit to the country, as the Royal Commission of Agriculture emphasizes: "...the evil effects of subdivision and fragmentation

are recognized but measures to cope with them have not been decided upon. Its evil effects are so great that the administration should not rest until a remedy has been found..... It is useless to think of real enduring agricultural progress without consolidation." Here is a justification for the State enforcing consolidation measures, by legislation if necessary, if it is convinced that consolidation of holdings is of real benefit to the country and to the peasants themselves.

Measures to cope with the fragmentation of holdings have to be formulated from two points of view: (i) Prevention of subdivision, and (ii) Reunion of scattered holdings. The Hindu Law of inheritance entitles every male member of a family to obtain a share in the ancestral property. According to Mohamadan Law women are also entitled to appropriate shares. To prevent subdivision these laws must be amended. Laws are made for human beings in their social setting and therefore must be adapted to the changing conditions of a society. If a particular law has outgrown its usefulness and there are sufficient reasons for altering it for the well-being of the people, legislation should be enacted to secure the effective legal sanction. If laws of inheritance are in some matters found wanting, they should be modified in the interest and welfare of those for whose benefit they were formulated in a social condition presumably different from what prevails at present. There are difficulties no doubt in the way of enforcing a legislation aiming at a compulsory restriping of land: the system of land tenure prevalent in the country and vested interests will tend to thwart every effort to readjust field boundaries. But opposition will have to be brooked, boldly faced and overcome.

Voluntary Basis

It would be preferable if, instead of

being enforced by the Government, restriping is effected on a voluntary basis, as C.F. Strickland has observed on cooperative consolidation of holdings in the Punjab :

“ An attack was directed on the evil (fragmentation) from the side of co-operation ; and where, in certain districts of the Punjab, the confidence of the peasant had been won by the success of cooperative credit and other societies, cooperative consolidation of holdings societies were first organized in the year 1920 on a voluntary basis without special legislation. Some concessions to the peasant's suspicions were made in the earlier period, the members being required only to accept the new consolidated holdings for four years, with the right to revert to their old scattered plots if they then wished. No reallotment, however, when once approved by the members, has ever been subsequently rejected, and the four-years limit was soon withdrawn.

“ Selected inspectors and sub-inspectors were employed on the responsible duty of repartition, and worked in collaboration with the elected committees of the cooperative consolidation societies. This staff, engaged on a task which might have been entrusted to the Revenue Department, was naturally paid by Government, though in recent years contributions have also been made by the villages which have applied for consolidation. By the month of July 1937, a total of 800,000 acres had been consolidated, and an area of at least 100,000 acres is now being annually completed. Before a society is registered and work begun, at least 90 per cent of the owners must join in the application, and offer for repartition at least 75 per cent of the village land. It is now usual to demand also a payment of 8 annas per acre from the owners towards the cost of the operation, and this sum is readily paid. The by-laws bind every

member to accept a scheme of partition which is approved by two-thirds of their number, to submit all disputes to arbitration, and to subject any future partition or rearrangement of the consolidated area to the decision of the society. The rapid advance annually made indicates that these conditions no longer alarm the peasant-farmer of the Punjab. It should be clearly understood that no pressure, official or other, is exerted on the peasantry either to initiate a demand for consolidation or to accept a reallotment plan when drawn up. The demand is voluntary in all cases, and the applications exceed the capacity of the allotted staff. It is for this reason that the condition of a levy per acre has been imposed.”¹

As a result of cooperative effort in the Punjab in 1936-37, 120,000 acres were consolidated; the plots were reduced from 200,000 in number to 29,400. Similar work was also carried out in the western districts of the United Provinces with encouraging results. Since 1926, 25,000 acres of land divided into 41,000 plots have been consolidated, reducing thereby the number to 4,000. In the North-West Frontier Province, where work was begun in 1930, the number of plots were reduced from 38,000 to 7,500 involving 26,000 acres and in Kashmir State 52,000 acres have been reconstituted into approximately 8,500 from 85,000 plots.

Special Enactment

Consolidation has also been successfully effected through special enactment. Says C. F. Strickland :

“ The outstanding example of consolidation through the revenue staff is the Chhattisgarh Division of the Central Provinces. The Consolidation of Holdings Act (VIII of 1928) provided for the appointment of Consolidation Officers who, on the application of two or more

¹ *Consolidation of Agricultural Holdings*, pp. 8-9.

permanent right-holders in any village, should open an inquiry, and if half the holders with two-thirds of the land agreed to the proposal, should draw up and carry into effect a scheme of repartition, placing the right-holders in possession of their new lands and overruling the objections, if necessary, of any persons who dislike their allotments. A *panchayat* of local residents is consulted throughout the operations, and the ultimate decision in case of objections lies with the Settlement Commissioner. Revenue proceedings concerning land under consolidation are transferred to the Consolidation Officer and are settled by him; he places in possession of disputed land the person whom he judges to be entitled to it, and a civil court has no jurisdiction in matters which he is empowered to decide.

"Success has been remarkable. Before April 1938 there were two Consolidation Officers and forty Inspectors, and over 1,100,000 acres had been repartitioned in 1,172 villages of Drug and Raipur Districts, the average size of a plot being raised from $\frac{1}{2}$ acre to $3\frac{1}{2}$ acres, and the total number of plots brought down from 2,370,000 to 354,000. The holdings are compact and profitable; consolidation is popular, and the entire cost is met by a levy, usually of 4 annas

an acre, on the villagers. The same benefits, which have resulted in other provinces, are realized also in Chhattisgarh: a saving of time, labour, money and land, a diminution of disputes, the opening of the peasant mind. In subsequent cases of inheritance or other transfer a voluntary effort to avoid fragmentation is made by the people."¹

A similar act was passed in the Punjab and extended to Gujrat, Rohtak and Sialkot districts in 1938. Consolidation of 5,000 acres had been effected and the work was being carried on in another 30,000 acres. In Baroda, consolidation of 27,000 acres was brought about under the Consolidation Act of 1921. As C. F. Strickland has rightly stressed: "Legislations are needed in Bengal, Bombay, the United Provinces, Mysore State and probably also in Madras and Hyderabad State on the lines of the Consolidation of Holdings Act of the Central Provinces."²

Benefits of consolidated holdings are patent enough, and if agriculture in India has to make headway, a programme of compulsory consolidation of holdings on an India-wide scale must be undertaken without delay.

¹ *Consolidation of Agricultural Holdings*, pp. 13-15.

² *Ibid.*, p. 19.

MECHANIZATION OF INDIAN AGRICULTURE

By D. R. SETHI

THIS short article is neither a plea for nor a condemnation of mechanization of agriculture in India. Its purpose is to present this subject in a broad general manner with the hope that it receives dispassionate consideration at the hands of those with whom lies the future of agricultural development in this country.

The most pressing and vital problem of the country today is to grow more food as quickly as possible. Whether mechanization of agriculture can contribute anything towards the solution of this vital problem is a subject which must receive very careful consideration. It cannot simply be brushed away because it is western in origin and is, therefore, something which must not be adopted.

Mechanization of agriculture means the performing of certain agricultural operations with the help of suitable machines. Broadly speaking mechanization in agriculture has two forms—mobile mechanization and the stationary type of mechanization. The mobile type of mechanization attempts to replace animal power on which the agriculture of the world has been based for very many centuries. Stationary type of mechanization aims at reducing the drudgery of certain operations which have to be performed either by human labour or by a combined effort of human beings and animals.

Mechanization of land can be complete; it can also be partial. In western countries, notably, in the North American Continent, mechanization of agriculture is more or less complete. This has been

necessary because of the shortage and high cost of farm labour. Complete mechanization on a vast scale has been adopted in Russia as a means to large scale exploitation of land and increased production therefrom, in spite of the fact that before the Sovietization of Russia, the whole agricultural structure of the country was on the basis of peasant farming. During World War II the United Kingdom was forced on account of manpower shortage to adopt partial mechanization on a large scale in order not only to keep up production, but also to expand production considerably. In the few instances that I have cited, there are lessons to be learnt by the framers of the future policy with regard to Indian agriculture and, particularly, with regard to the increased production of food. It is, probable, that in the early stages it may not be feasible or practical to completely mechanize agriculture in India but the possibilities of partial mechanization must receive very careful consideration.

The present cultivated land in India necessitates the maintaining of a very large number of bullocks for its cultivation. These animals have to be maintained adequately in order that they may till the soil to produce the food required both by human beings and by the cattle. To some extent cattle, therefore, compete for food with human beings; but they compete much more with the milk animals with the result that the milk animals are largely neglected. Milk production is totally inadequate and adequately nutritive food from this

source is non-available for human beings. There are also large areas of sub-marginal lands in the country which must be brought into cultivation in order to produce more food to feed the population. If the cultivation of these areas has to depend upon animal power, we will have to increase our cattle population considerably. They in turn will again compete for their food with human beings and with milk animals and it is a matter for very careful consideration whether mechanization of such lands and partial mechanization of cultivated lands would not be a more economical proposition.

The Possibility

If the agricultural production in India is to continue to depend upon small holdings and subsistence farming, it can be stated straightaway that mechanization has no place in such a system, nor such a system will ever be capable of producing the food which the country needs for feeding its population adequately. I cannot, however, imagine that the Governments in this country would be prepared to face such a situation which would force them every year to go with a beggar's bowl in their hands to foreign countries to purchase and bring in the food that is essential for feeding the population. Russia has successfully established the creation of large scale units by the collectivisation method. The question of collectivisation impinges on much bigger issues and until these issues are resolved, we must proceed on the assumption that Collectivisation will not be attempted in the near future. There are, however, alternatives to collectivisation which involve the pooling of land and which go under various names, such as, collective farming, co-operative farming, joint farm management, etc. Some such system or systems suited to local conditions will have to be evolved if farming in India is to be

taken out of the rut and raised to the status of productive farming. This type of land use, in my view, would lend itself to partial mechanization of agricultural operations. In the early stages, this partial mechanization will have to be run through State agencies.

Mechanization, in my view, is also essential in connection with certain specified agricultural problems. These are (i) anti-erosion dry farming operations, (ii) control of deep rooted pernicious weeds, such as, *kans* and *hariali*, (iii) bringing into cultivation new land, (iv) large scale cultivation on factory farms, private farms, grantee estates and plantations, and (v) the construction and maintenance of country roads, drainage and irrigation channels, etc. I will deal very briefly with each of these items and the possibility of mechanization in each case.

Serious erosion is taking place over vast tracts of good cultivated land and thousands of millions of tons of good earth is being washed into the sea every year. Large tracts of land either have gone out of cultivation as a result of erosion or are in the process of being destroyed. In areas of low rain-fall, moisture conservation methods which will yield a harvest where very little or none is secured at present in three out of five years is not an uncommon sight. In both cases the scope for the use of mechanical equipment through State agencies for purposes of contour ridging, construction of small and big embankments for the stoppage of erosion and the conservation of soil moisture is considerable. Instances exist where such mechanization has not only been very useful but has proved economical as compared to the work done by human or animal labour.

There are several million acres of land which are at present infested with deep rooted and pernicious weeds which not only hamper proper cultivation but

which are the main factors in decreased yields from these areas. It is also a fact that large tracts of land from amongst these infested areas have gone and are going out of cultivation. The only effective and economical method of controlling these weeds thereby saving land from going out of cultivation and increasing the yield of crops from these areas is by the use of mechanical appliances.

Large parts of cultivable but uncultivated land exist in the country. They have not so far been brought into cultivation because they suffer from certain handicaps, such as, malaria, wild animals, etc. Human and animal labour is extremely short in these areas. The only method by which these areas can be brought into production expeditiously is by the use of mechanical equipment. This presupposes that the other factors mentioned above which militate against these lands coming into production will be simultaneously controlled.

Mechanized agriculture on large farms and estates has already established its utility. These estates could not possibly hope to deal quickly and efficiently with their areas without the use of mechanical equipment.

A vast communication system linking up villages with markets is essential if this country is to advance agriculturally. Construction of village roads would be considerably expedited and better work would result if mechanical means are utilized. The completion of drainage projects both small and large could be considerably expedited by the use of machinery and the construction of village irrigation channels could be undertaken by the same equipment which may be needed for the construction of village roads.

Those who have knowledge of the drawbacks from which agricultural development in India suffers will, I

hope, agree that the scope for partial mechanization in our country is very considerable. This leads us to the consideration of the question whether, as many people believe, mechanization of agriculture even partially would not increase unemployment in a country where the majority of population over a great part of the year is unemployed. I confess I do not subscribe to the view that partial mechanization of agriculture would result in increased unemployment or that because of cheap labour available in the country mechanization will never be an economical proposition. Efficiency in agriculture means more production at a lower cost. Partial use of machinery would, in my view, lead to efficiency but it does not necessarily follow that this would mean fewer men upon the land. It may be fewer men per operation but not per acre. Partial mechanization would create several new classes of employment. This not only means more employment for men detached from land, such as artisans, but it also means a greater field of employment for educated classes. Mechanization would help to establish village industries and processing of agricultural produce will be possible within groups of villages. Those few who may not find employment on the land itself, would be able to find employment in the industry. They will probably get better wages and to that extent mechanization will help to raise their standard of life. Mechanization, I have already said, would lead to efficiency which in turn will mean an increase in the income of the village. A part of this increased income would go towards education not of the type we know today but of the type which will train and set up men in other walks of life. I would, therefore, appeal to those who hold the contrary view to give careful thought to the viewpoint that I have put forward, for I firmly believe that partial mechanization of our

agricultural operation is one of the factors that will definitely contribute towards increasing agricultural production which we so badly need.

Type of Machinery

Let me now turn to a consideration of the tools required for the mechanization of agriculture. I have already said that mechanization is of two types—mobile and stationary. For both purposes a machine that will produce power is essential. This machine in turn operates the appropriate tools to perform a given operation. The universally accepted power plant for agriculture for both types of operations is the tractor. A tractor is nothing more or nothing less than an engine which develops a certain amount of power and which is so manufactured that it is mobile. It may be mounted on wheels or it may be mounted on tracks. The motor is geared to the drive and the whole outfit either pulls the tools required to perform a certain operation or through suitable arrangements is capable of operating a stationary machine for performing certain non-mobile operations such as pumping of water, threshing of crops, pressing of oil seeds, etc. It is, therefore, superior to a stationary power unit inasmuch as it can not only do the job of a stationary unit, but also that performed by animal power.

Where only a stationary power unit is required, either a stationary engine or an electric motor is a suitable source of power.

Tractors are of various types and sizes. They range from 1 H.P. machines to 120 H.P. machines and in types they vary from a three wheel all purpose to the big trac-type machine required for industrial purposes.

The selection of a suitable machine is not very easy. Such factors as area to be cultivated, pairs of bullocks to be maintained, type of stationary work to

be done, initial cost of the machines, its maintenance and operational costs have to be taken into consideration. In countries where mechanization has advanced considerably, the standard agricultural tractor is a petrol motored machine mounted on three or four wheels. The usual H.P. of such machines is 15 to 30. The three-wheeled machine is popular in areas where row-crop cultivation has to be done, while for cereal farming the four-wheeled machine is the common type. Petrol motored machines are comparatively cheap to purchase and maintain and as petrol is very cheap in countries of their origin these machines can be operated very economically. Against this position, the conditions in India today are wholly against mechanization. Petrol is the most expensive fuel in the country and, therefore, apart from all other considerations the use of a petrol motor tractor is an uneconomical proposition. The cheapest fuel available in India is the high speed diesel but this can only be used in diesel motored tractors. These machines can only be purchased in larger sizes, and, therefore, cannot be used on small holdings of the order of 20 to 100 acres. As they are expensive to manufacture, their initial cost is high. They are expensive to maintain and specially trained operators are necessary for such motors. If India is forced in the years to come to depend for its fuel supply for agricultural purposes on diesel oil then I see a very restricted scope for any large scale mechanization. Instances are not wanting where certain countries have made petrol available for agricultural purposes free of import or excise duties. India will have to adopt somewhat similar system if mechanization on large scale is to go through. Small size tractors suitable for small farms are being manufactured and one could buy a machine which would render satisfactory service and would be able to operate economically

on a small holding of 20 to 25 acres. But these types are all fitted with engines operating on petrol.

The possession of a tractor does not mechanize agriculture. The tools it has to operate and their selection is much more important because on the suitability or otherwise of these tools depends the success or failure of mechanization. It is a regrettable fact that sound advice has not been available to the users of the power-operated agricultural machinery in this country. Manufacturers' agents naturally like to sell as large a number of expensive tools as they possibly can to a customer. This does not necessarily mean that the implements that are purchased are essentially necessary. It is not uncommon to find that when one goes in for a tractor one is also persuaded to purchase a multi-bottom mould-board plough as also a multi-disc plough. Why two ploughs, has never been explained and are we satisfied that a plough is an absolutely indispensable implement? I hold that under the Indo-Gangetic alluvial conditions for seasonal tillage of soil for the production of cereal crops, a plough is not necessary. In fact, in my view, a plough under these conditions does more harm than good in as much as by turning over the soil and exposing it to the terrific heat of the sun whatever little humus it contains is burnt out. A far more economical and more efficient method of preparing seed bed for cereals under these soil conditions is either a fixed tine cultivator with ducks foot shares or a harrow plough which is also known as a multi-disc or a wheat land plough, which in my view, are ideal implements. I have cited these examples in order to indicate how the selection of implements is of vital importance, if mechanization is to be efficient and economical. Greatest of care must, therefore, be taken and the best advice available should be consulted before a final selection is made.

As is well-known, soil conditions in India vary considerably. For this purpose the country can be divided broadly into four regions. These are: (i) the Indo-Gangetic Plains comprising Sind, Baluchistan, N.W.F. Province, the Punjab, the northern half of Rajputana, the United Provinces except Bundelkhand and that part of Bihar lying to the north of the Ganges and the whole of Western Bengal, (ii) areas comprising southern half of Rajputana, Central Provinces excluding Berar, Bundelkhand Division of the United Provinces and that part of Bihar lying to the south of the Ganges, (iii) the Deccan Plateau consisting mainly of the black cotton soils of India, and (iv) the rice growing areas of Madras, Orissa, Eastern States and eastern half of Bengal and the Province of Assam. The grouping of the country into these four broad regions not only demarcates one area from the other with regard to its predominant soil types but it also demarcates it from the point of view of crop production. It is necessary to co-relate soils and crop production in order to determine the right type of power-operated agricultural machinery.

In so far as the Indo-Gangetic region is concerned, the following types of agricultural tractors would be able to handle agricultural operations: (i) Generally speaking a diesel motor crawler tractor having draw bar pull 35 BHP and rated at 35 to 50 BHP would be suitable for all reclamation works. It will be in very rare case that a machine with a higher horse-power would be needed. (ii) For general agricultural purposes given suitable types of implements, a 20 to 25 BHP machine either mounted on three wheels or on four wheels on rubbers would be able to do the normal cultivation work in these tracts. I prefer a tricycle type of tractor as this would not only be suitable for general farming operations but would also be suitable for row crop cultivation.

For the second region, the types of tractors suggested for the first region would be unsuitable. Here predominant soils are heavy clays which vary in colour from light grey to black. They are very sticky and become extremely hard when dry. For reclamation purposes a crawler tractor with a rated BHP 50 to 65 would be essential in these areas. In some special cases, it may be necessary to have a 65 to 80 BHP crawler machine. For purposes of ordinary agricultural operations, it is my view that nothing less than a 35 BHP four or three-wheeled machine on rubbers would be necessary.

In the third region comprising mainly of the black cotton soils, the types of machines required would be the same as in the case of the second region except that where heavy operations are involved, such as reclamation of land or deep cultivation, it would be necessary to have 65 to 80 H.P. crawler machines.

I know of no suitable machinery or agricultural tractor which is capable of working satisfactorily under the wet rice land conditions for the cultivation of paddy over major part of the soils in region four. There are, however, large tracts of lands in this region comprising lateritic soils which grow dry crops, such as, *jowar*, groundnut, sugarcane, tobacco, etc. For these areas, a 35 BHP four-wheeled or three-wheeled machine with proper implements would be suitable.

A Plea

I do not wish to go into the economics of mechanization. That is a subject that must be dealt with separately. As I stated in the beginning, my main purpose is to focus attention on the broad principles and policies involved in the mechanization of agriculture in India. In order to be able to do this on a large scale, the Governments in India must set about considering the points at issue and the system or systems of farming that must necessarily be adopted

to step up production. If this is done, I for one hold that large-scale partial mechanization of farming will be an essential factor in stepping up agricultural production in this country. No mechanization on any large scale is likely to succeed unless the State takes a prominent part in such mechanization and for the first few years owns and operates the machines and implements required for the purpose. The successful operation of these machines will depend upon the establishment of an organization on the lines of Russian machines and Tractor stations which must be developed simultaneously by the State itself in order to ensure that tractors and their implements work efficiently. In the early stage it would not only be desirable, but would be necessary that operational costs in so far as their recovery from the cultivators is concerned, are heavily subsidized.

My plea for a dispassionate consideration of the possibilities of mechanization of Indian agriculture is a plea in the interest of the hungry masses of India. In support of my contention, I cannot do better than conclude by quoting the authoritative opinion of Late Sir Daniel Hall—an admitted authority on agriculture: "What is, however, worthy of consideration is the fact that the men who planned the Soviet organization, men lacking neither in knowledge of the material world nor a perception of affairs, did deliberately abandon the peasant structure of agriculture to which they had been habituated, and have attempted to replace it by large-scale exploitation of the land, using all the resources of science and machinery. The motive was to obtain increased production, more food for a vast population that was insufficiently fed and liable to famine and yet at the same time to liberate more labour for the other industries, whereby the total divisible wealth of the population would be increased."

MIXED FARMING

By U. N. CHATTERJEE

INDIA is a country predominantly agricultural. The great majority of her people practise agriculture or are directly dependent upon it for their living. It will therefore be not wrong to say that the Indians are a nation of farmers. Since about eighty per cent of her people are peasants living in villages, it is but natural that the prosperity of the country is dependent to a large extent upon the economic condition of these men. Therefore any step which aims at increasing the income of the farmer is a welcome move in the right direction.

Since ages crop production in India is dependent upon bullock power and cattle have come to be inseparably connected with agriculture in this country. A farmer's social position is evaluated in accordance with the number of cattle he possesses. A system of farm practice in which cattle is reared and kept in addition to crop production as a means of increasing the income of the farmer may be profitably adopted for improving the lot of the cultivator. The idea is to expect from the cattle maintained on the farm a return much more than what is spent on them; in another form this relation may be expressed as a complementary use of livestock and crops. This is a condition of farming known as mixed farming. Mixed farming therefore opens up another avenue of increasing the earning power of the farmer. Since in India other types of livestock than, occasionally, poultry and goats are not usually associated with agriculture, mixed farming in India has come to mean the complementary interdependence of crops and bullocks, milch cows and buffaloes.

There are obvious advantages in the system of mixed farming to the cultivator. The first and the foremost is the dairy products—milk, butter and *ghee*—which the cattle on a mixed farming unit yield. The milk and milk-products can be marketed thus bringing enhanced income to the farmer and also to some extent utilized for supplementing the diets of the peasant thus resulting in the physical well-being. Ultimately cultivator practising mixed farming is better off physically and financially as compared with other farmers practising ordinary farming methods.

In addition, there is another advantage of mixed farming. This is the gain in the form of manure which the farmer derives from the dung and urine of cattle. Thus the total quantity of farmyard manure increases per unit area of the farm and this, rich in nitrogen and other elements of plant food, when put back into the soil enhances its fertility and therefore the crop yield. The farmer thus stands to profit from the system of mixed farming.

Intensive Farming

A higher manurial treatment of the soil results in added fertility. This is, as a matter of fact, a prerequisite to intensive farming in the widest meaning of the term. So a greater production can be readily achieved even when acreage under a particular crop is conveniently reduced. The land thus saved may be better utilized for some other crop; this is advantageous in as much as the farmer can fall back upon an assured crop in case the other fails on account of some particular reason. The chances

of reaping a certain harvest increase with the increase in the number of crops sown. But keeping and maintaining cattle on the farm, as mixed farming connotes, would require an adequate supply of fodder. So in addition to food crops fodder must also be grown on the farm. Land therefore has to be allocated for fodder crop, reducing thereby the area under food crops. But this reduction need not lead to a proportional reduction of crop yield. Because of the increase in the quantity of farmyard manure on account of maintaining dairy animals on the farm, the fertility and consequently the productive capacity of the soil is enhanced. And therefore a small reduction in the cropping area is not expected to be of any consequence. The fodder produced will not only serve as cattle feed but will also serve as litter in the sheds, which will furnish raw materials for composting manure.

As mixed farming enhances the buying capacity of the farmer, he will be in a position to invest his surplus capital on improved agricultural implements, on better cattle, on disease-free seeds. The effect will be an all round progress of agricultural efficiency, a higher standard of living for the farmer and happier and a richer village.

Cattle Quality

It is not enough to maintain cattle on the farms. Constant vigilance should be exercised to see that the generations of cattle do not progressively deteriorate. It costs much money and means botheration to replace cattle which are not of the expected standard or specification. Any such degeneration may be prevented and heavy expenditure avoided by obtaining the services of proved and certified sires and by the removal or elimination of the scrub; all promiscuous breeding should be stopped. It is of course quite comprehensible that each cultivator practising mixed farming can

not afford to keep a certified bull all by himself. But such a bull may be maintained by the combined resources of a number of such farms. Another very promising and helpful solution of the problem has been developed of late and seems to be well on the way to popularity—this is artificial insemination. This method of breeding will do away with the necessity of keeping bulls by individual farmers and yet they can hope to obtain progeny of the desired type. The establishment of a regular artificial insemination service will indeed greatly help and accelerate the spread of mixed farming in the agricultural system of the country.

The I. C. A. R. Schemes

It is worthwhile to examine the possibility of mixed farming in different parts of the country. Its successful adoption in other countries encourages a belief that it can as well be profitable to the Indian peasants. The Imperial Council of Agricultural Research undertook to study the problem and sanctioned a number of research schemes in several provinces.

The United Provinces : The scheme in the United Provinces has been sanctioned in order to find out among others the possibility of the success of mixed farming in different areas of the province and to find out if the cultivators practising mixed farming have any economic advantage over those not doing so. In order that the study should be representative of the conditions prevailing in different parts of the province, blocks or units have been set up in the western, central and eastern districts: (i) Meerut and Bareilly in the western area, (ii) Bara Banki and Lucknow in the central area, and (iii) Gorakhpur in the eastern area of the Province. The programme of each unit was adjusted to local conditions and practices. In each unit provision was made for running controls for

comparison with the results obtained from mixed farming programmes. The milch cattle supplied at the inception of the scheme were obtained from Government Farms and any casualties were made good by *taqavi* on suitable terms.

Cultivation, on an intensive basis, was practised and crop rotation so adjusted as not to allow the land being left unutilized any time. Growing of cash crops and double cropping were encouraged. Leguminous fodder crops were cultivated on poorer soil and fallow land.

TABLE I¹

Profits from Mixed Farming in the United Provinces

Units	Type of farming	Area (acres)	Total profit		
			Rs.	a.	p.
Meerut (Rural)	Mixed Farming	11.4	2,300	6	9
	Control	10.7	1,212	11	3
Bareilly (Rural)	Mixed Farming	7.74	423	8	6
	Control	7.92	178	2	6
Lucknow (Rural)	Mixed Farming	7.00	610	8	9
	Control	8.00	282	5	6
Gorakhpur (Rural)	Mixed Farming	8.09	1,540	14	0
	Control	8.00	265	7	3
Gorakhpur (Urban)	Mixed Farming	8.46	880	1	6
	Control	8.81	576	12	6

An analysis of the data obtained shows that there was a general increase in income as a result of the adoption of mixed farming as compared to that of the controls. Besides increased income from crops, additional sources of profit were milk, milk-products, progeny and manure. Thus milk and milk-products of mixed farming units serve to enhance the buying capacity and general well-being of the cultivator, as also to increase returns per acre due to added soil fertility on account of greater quantities of manure obtained. The main object of the Scheme was amply fulfilled in that the mixed farming cultivator turns out

¹The data presented in this and the following Tables have been taken from the *Reports* presented to the Imperial Council of Agricultural Research by the Provinces concerned.

to be a better farming cultivator.

A selection of data showing income from mixed farming and control units will be helpful to bring out the fact that the former system is more profitable than the latter.

The Central Provinces: Two schemes have been sanctioned in the Central Provinces and Berar—one for the rice tract and the other for the cotton tract. The main object of both the schemes was essentially similar to that in the case of the United Provinces, viz., to demonstrate the advantages of mixed farming as compared with ordinary farm practices.

TABLE II

Profits from Mixed Farming in the Central Provinces (Rice Tract)

Unit	Net profit per acre from mixed farming			Net profit (average value) per acre from cultivation alone (controls)		
	Rs.	a.	p.	Rs.	a.	p.
Sangwa (Urban)	60	9	0	32	8	0
Surda (Urban)	72	2	0	28	11	0
Aurabandha (Rural)	49	3	0	40	6	6
Karikund (Rural)	55	5	0	16	14	6

TABLE III

Profits from Mixed Farming in the Central Provinces (Cotton Tract)

Unit	Net profit per acre from mixed farming			Net profit (average value) per acre from cultivation alone (controls)		
	Rs.	a.	p.	Rs.	a.	p.
Kanheri (Urban)	61	12	10	23	4	11
Shiwapur (Urban)	13	6	11	9	7	7
Ugwa (Rural)	32	7	1	16	2	5
Chikhalgaon (Rural)	16	10	2	13	8	7

The data collected indicate a much greater net profit from cultivation and dairying, i.e., from mixed farming per acre on each unit than that from cultivation alone. This is shown in Tables II and III.

Sind: The results of the Mixed Farming Scheme in Sind show that a cultivator can increase his income by Rs. 14 per acre if he adopts only improved methods of cultivation.

This can be enhanced to Rs. 20-1-2 if he maintains on his farm milch cattle in addition.

The North-West Frontier Province: A scheme of study has been sanctioned in the North-West Frontier Province with the object of comparing the remunerative effect of the mixed farming system with that of the ordinary farming in order to see how far the former system is more paying. From the data collected it may safely be concluded that the mixed farming system is decidedly more paying. The income derived as a result of adopting the two systems are compared in Table IV.

Thus as a result of the study of the mixed farming system in different Provinces, it can be stated without any fear of contradiction that cultivation and cattle keeping together give the farmer a more advantageous return than cultivation alone. In other words mixed farming helps the farmer to derive a greater income than would be possible if he were to practise ordinary cultivation methods. The fodder and maintenance cost of the cattle he keeps is more than compensated for by the sale of dairy products as also by the more intensive cultivation.

TABLE IV
Profits from Mixed Farming
in the North-West Frontier Province

Mixed Farming unit	Total net income of mixed farming unit			Total net income (average value) of control unit		
	Rs.	a.	p.	Rs.	a.	p.
Bhogarmang (total area 12 acres)	1,539	0	0	416	0	0
Shinkhari (total area 7 acres)	1,274	3	9	738	10	1
Paharpur (total area 12 acres)	1,857	6	9	234	7	0
Mithapur (total area 12 acres)	578	10	9	118	4	0
Doaba (total area 5 acres)	984	11	0	477	0	0
Hangu (total area 10 acres)	1,959	8	0	1,153	0	0
Swabi (total area 10 acres)	851	6	6	604	2	0
Gohati (total area 10 acres)	2,942	4	6	1,213	8	0

The latter is made possible as a result of increased quantity of dung available for a better manurial treatment of soil can be provided. The increased income adds to health and happiness of the farmer and places at his disposal a larger capital for investment. Briefly stated, the system of mixed farming solves the bread and milk problem of the farmer at one stroke.

CHECKING SOIL EROSION

By R. M. GORRIE

THE recent drought has taught us many lessons, but this is an exceedingly hard way of learning because it has brought much suffering and shortage. Probably the greatest single lesson which this suffering brings is the need for conserving all sources of water and moisture in the soil. Throughout the *barani* lands of India (dependent on rain water only) the drought has proved the urgent need for better forms of catching, spreading and percolating rain water on the soil. Had this been done effectively for the monsoon of 1945 many of the wheat fields which are now useless and shrivelled would still have been a crop worth harvesting as part of the *rabi* harvest of 1945-46. The reason, of course, is that the feeding roots of the crops get their moisture from a depth of 2 to 4 ft. and the moisture stored in the soil at this depth remains as a sort of storehouse or bank from year to year, and can be drawn upon by the plant even during periods of extreme drought. The recent trouble with our *rabi* crops has been not so much the failure of the winter rains as the failure of the owners of the fields to trap and store the liberal and sufficient rainfall of the previous monsoon.

How is the ordinary villager to ensure that this water bank underground will be replenished year by year? The individual owner of a small field can at least ensure by means of *wattbandi*, or some form of contour ridging round the lower edge of the field, that a considerable proportion of each rain storm is stored and held up as a puddle of water. For larger single fields or for consolidated blocks of holdings it should eventually be

possible to get the help of soil-moving machines but until they are available the work must be done by hand or by the bullock-drawn *karah* or scoop.

The Sub-soiler

Much of the water thus held up will of course evaporate in the course of the next few days but much will sweep underground to replenish the bank. In order to ensure that more goes into the ground than into the air, some form of soil working in the intervals of the monsoon storms is desirable, but the exact amount of ploughing and the condition of the soil when ploughable varies greatly from district to district, depending upon the clay content of the soil. In larger fields, or where cooperative societies can provide a collective basis for working, the use of the *sub-soiler* is very strongly recommended. This is merely a plough with a small shoe at the foot of a vertical knife, and its function is to cut through the sub-soil layer at a depth of anything from 18 to 24 or even 30 inches, thus breaking up the sub-soil which often contains a hard and impervious pan of clay. The sub-soiler does not turn a furrow right over and so does not bring the deeper layer of the sub-soil up to the surface, but merely shatters it and leaves it in its proper position, thus leaving the whole of the sub-soil layer in an open and fragmented condition which will obviously absorb a far greater proportion of the moisture as it percolates through the upper layers. Such an instrument cannot be drawn by an average pair of bullocks and would require either extra animals or a mechanical tractor.

American Example

Where fields occur in large blocks the cumulative drainage from all of them is apt to become a danger, particularly for a single cultivator whose fields are placed in the natural drainage path which carries the overflow from the fields of his neighbours uphill. In the course of war-time touring over most of India I have been appalled at the amount of thoughtlessness and lack of consideration for others which has prompted cultivators to allow such drainage to damage the fields of their neighbours who live downhill. In many cases this may have been unavoidable owing to so many able-bodied men having gone to the army, and in other places this is due to the tenancy customs which allow only an annual lease and provide no incentive for the tenant to improve his field. The need at the moment is for a rapid survey of all cultivated land by a competent team of officers who can advise both owners and tenants as to the best way of improving the system of field drainage and water conservation.

In America the last twelve years' experience of concentration upon this very problem of field drainage has shown that expensive masonry sills to allow the excess water of heavy downpours to escape without damaging the field bunds are in many cases necessary. The tendency is however to get away from masonry and to rely more upon *grassed outlets*. The idea of these is that the lowest point in the bund of each field is kept slightly concave but without any vertical earth faces and the whole of this shallow aperture is sown or planted with a good grass, usually 'buffalo grass' which is the same as our *dab* or *khabbal* (*Cynodon dactylon*). As this same grass is almost everywhere in Northern India a common turf grass, and as it can stand quite a considerable amount of drought without dying out, there

is no reason why this excellent example should not be copied. In most Indian practice, however, the cattle are allowed to graze in all fallow fields and, unless strictly controlled, they are likely to tear up and destroy such grassed surfaces. Unless reasonable control of grazing animals can be ensured, it is probably safer to stick to a simple brick or masonry sill. The reason for many of the existing sills failing is that the average cultivator will not take the trouble to maintain the rest of his earth bund at a slightly higher level than the wing wall of the spillway. The constant wearing of pathways by men and animals across the bunds is the commonest source of trouble, as these paths soon form low points through which the water finds an escape instead of being forced to fall over the masonry spillway.

Contour Bunds

In improving the water-holding capacity of existing fields, the ordinary field boundaries marking the holdings of individual owners must obviously mark where the bunds must lie. This usually takes the form of an elaborate pattern of square or practically square fields. When the slope of the ground as a whole is steep, this means that a great deal of earthwork has to be done in moving soil from the top corner to the bottom corner to level each field and build the bund at its bottom edge. This is by no means the most economical pattern of field. Nature built all her hills with rounded slopes and in order to catch the most water for the least work, man must follow her example. If a continuous level bund is marked out on any hillside it will follow a sinuous course, and, if field bunds are to function efficiently, they ought to follow this sinuous course. Whenever an opportunity arises for marking out a better pattern of field boundaries, such as at the time of consolidation of holdings, or

when *shamlat* (common land) is divided out to individual owners, that is the time to mark out the entire area with carefully aligned contour bunds. The contour bunds themselves will provide the best framework within which to mark out individual holdings. This is a point which many revenue officers continue to overlook in the course of consolidation work, but it is of vital importance if sloping land is to be put to its fullest use. Even where the slope is very gentle, heavy loss of soil may occur through sheet wash, and the actual data produced by Dr. Kanitkar in his Sholapur Experiments showed that for a slope of 1 in 80 as much as 52 tons of top soil per acre have been lost in a single heavy storm from a *jowar* crop. This was from land which to the untrained eye appeared to be almost flat. One shudders to think what the figures are for the unterraced cultivation in the sloping lands of the Central Provinces and the Punjab, particularly where sudden and very heavy storms carry away immense quantities of top soil in each monsoon.

Bench Terracing

What has been written above applies to the gentler slopes on which it is possible for a reasonable amount of labour to *make each field into a saucer* which will hold comfortably all the rain which is likely to fall upon it. In the higher hills both in the Himalayas and in the other ranges of Central and South India it is not economically feasible to do this. Wherever there are old-established settlements on hilly land, some form of bench terrace has been evolved and in fact it is safe to say that where a satisfactory terrace has not been found, that community has had to move on, for the loss of soil has been inevitably so great that farming became impossible there. The best example of complete bench terracing is seen in the hill rice

cultivation, where the ruling factor is the retention of water for long periods in each field. Unfortunately for other crops the same meticulous care is not taken and the fields between the benches are themselves sloping, so that serious soil loss continues, in spite of much hard work and expense having gone into the construction of the stone walls which form the benches. It is not essential for each field to be dead level, but each must be nearly so.

Where a fairly broad field is wanted, stone terrace walls are essential, but where a narrower field will serve, the terrace walls can be built-up of turf or of a grassy bank. But the safety of these is constantly threatened through the common practice of allowing grazing on bare fallow, when the hungry animals tear these grassy banks down and leave them weakened. They also get out of shape through ploughing every year right up to the edge, thus eventually making the turf wall bulge outwards. In this condition a heavy fall of wet snow may easily start a snow avalanche from the collapse of one of these bulgy parts. Once an avalanche has started it gains momentum and is apt to carry away the stronger benches lower in its path.

One advantage of a properly vegetated bank over a stone wall is that, if properly maintained, it is much more absorbent. With good turf banks maintained without bulges and with the ploughed land properly levelled between them, such land is not likely to develop gullies, because there is so little run-off. In the case of stone walls the absorption is less. In either case the natural drainage channels on the hillside should be left out of the benched area, unless the entire area of a small catchment is completely benched from the top downwards.

Another advantage of a turf bench as compared with a stone wall is that the snowfall is itself better disposed of, and

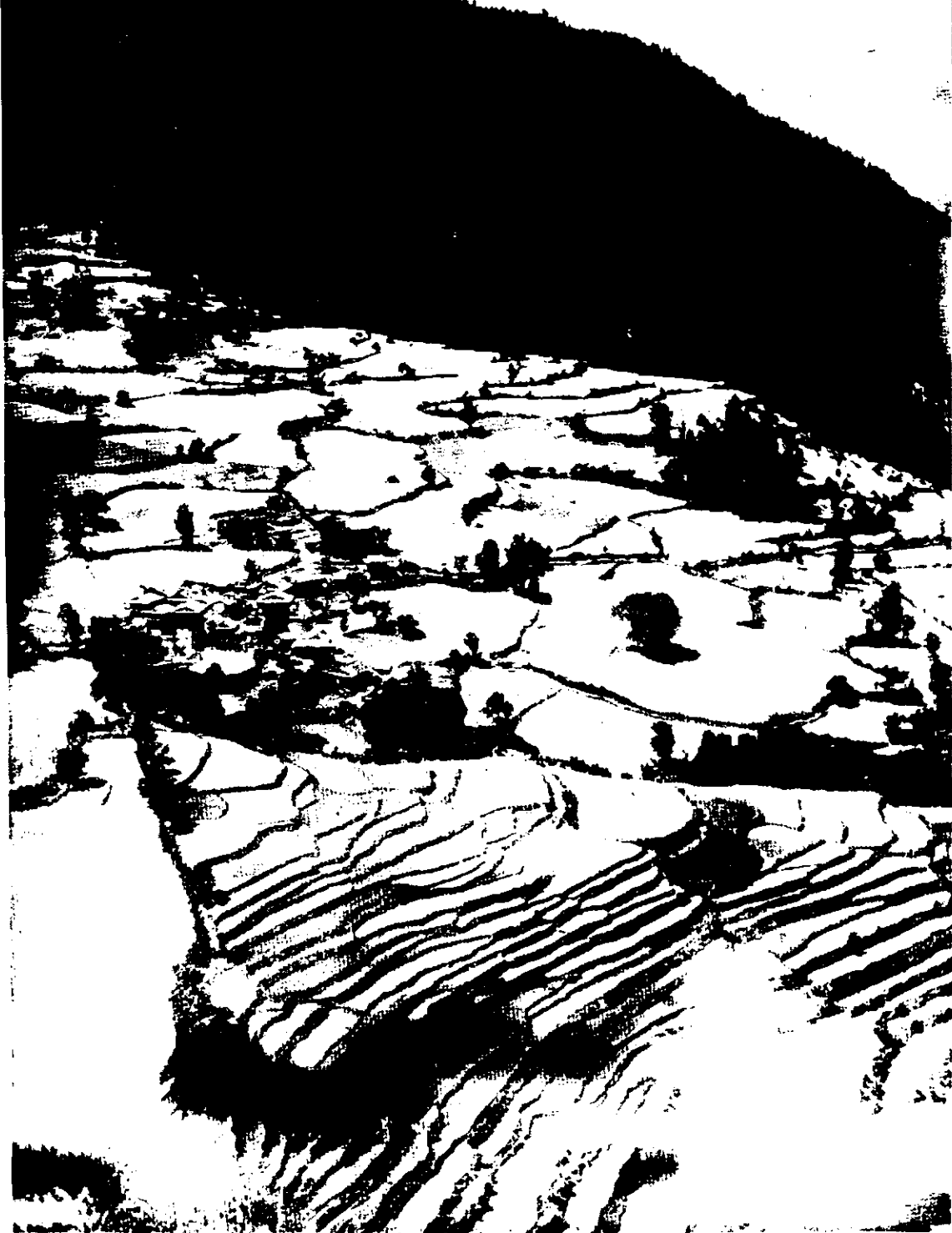

P. 1. 8.

CORRECT LAND MANAGEMENT

High hills covered in the forest and cultivated slopes properly terraced



P. 1. B.

PLATE 26

SOIL EROSION

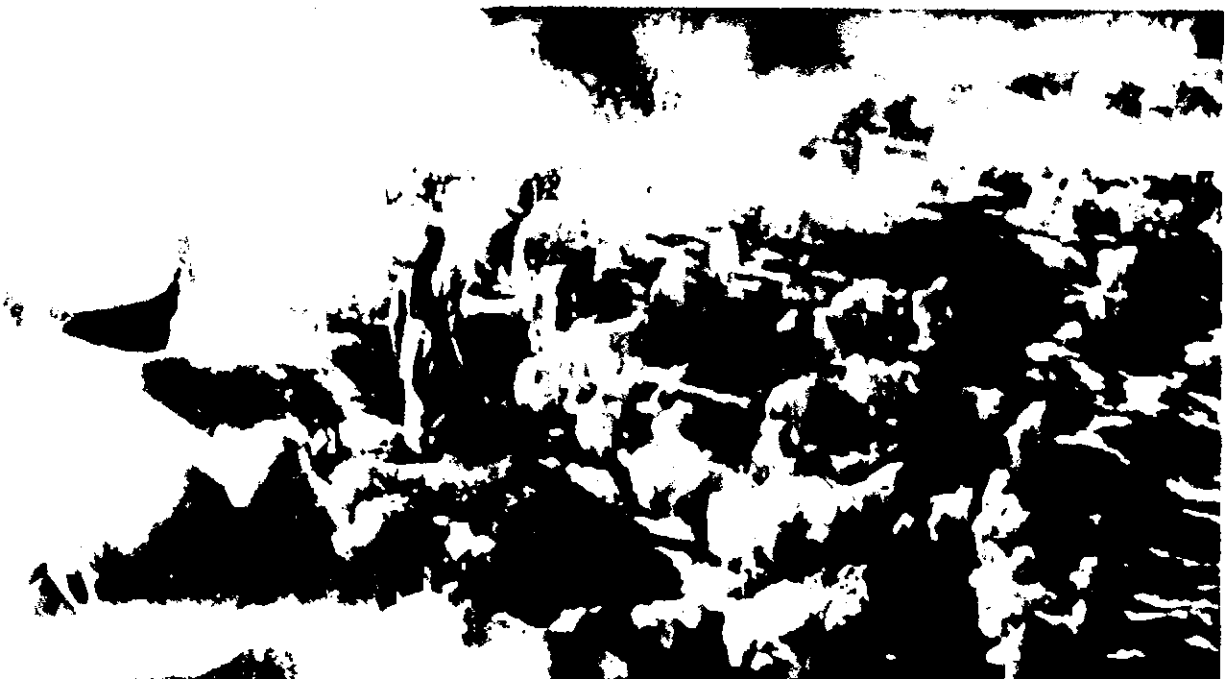

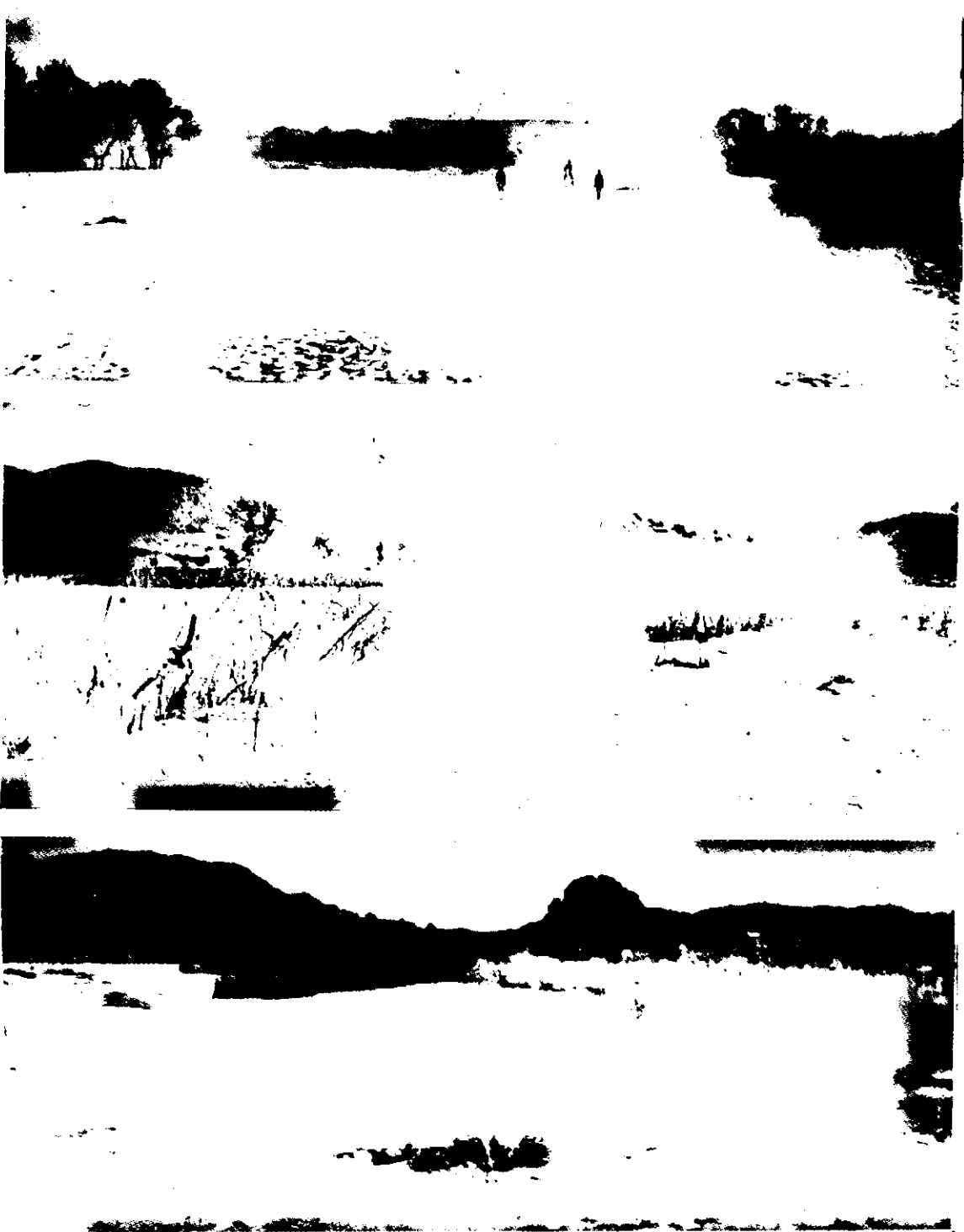

R. M. GORRIE

CHECKING SOIL EROSION (1)

A typical stretch of sandy waste in the path of a forest much of which could be reclaimed (above). The first stage in reclamation is the planting of sand loving plants (middle). The next stage is to run out advance strips of planting work (below).



R. M. GORRIE

CHECKING SOIL EROSION (2)

The raised portions of freshly deposited silt are immediately planted with Kawa grass (above). An area reclaimed by planting (middle). Harvesting of fodder grass in a reclaimed area.

frost does less harm. Under hard winter conditions snowfall is common down to 4,000 or even 3,000 ft. in the Punjab, but it never lies long at these levels. Snow falling upon hard frozen bare earth will disappear immediately the thaw comes, whereas the snow which has fallen on grassy benches will be all absorbed on the fields where it has fallen. Generally speaking, and apart from the rice cultivation blocks of fields, the bench terracing in the Punjab hills is too wide apart, and efforts must be made to reduce the width of fields by inserting intermediate walls in the blocks of fields already made.

Conservation of the Soil

Within the confines of the contour ridges or bench walls the individual cultivator plies his trade with the plough. Every furrow which points downhill is an invitation for the rains to wash away part of that field. It is absolutely essential that every cultivator should learn to plough *along the contour* when making the final furrow on which he does his sowing. It is only by this means that he can ensure a thorough percolation in every corner of his field. With dead level furrows running along the hillside every furrow forms a miniature contour bund and thus holds back the maximum quantity of water.

The best way to keep the soil absorptive is to manure it frequently and heavily with farmyard manure because this replaces the humus or decayed vegetable matter which forms an essential part of all soil. Its presence in newly cleared forest land explains why such excellent crops are obtained from such places in the first few years after clearing the jungle. These plant remains disappear rapidly with ploughing and constant cropping, and unless replaced artificially disappear from the soil. Without this humus content the mineral soil is incapable of maintaining the crumb

structure which keeps the soil in an absorptive condition.

It is realized that this advice about heavy manuring is a counsel of perfection which for many cultivators is not practicable, for most of the cow-dung is used as fuel instead of being returned to the fields. The demand for fuel and the absence of village forest plantations means that the land is starved of its essential food. It is difficult to know where the individual cultivator can break this vicious circle, for it will take a good many years of propaganda and active planting before sufficient village plantations can produce any appreciable quantity of firewood at a price at which the cultivator himself can buy it and use it. In the meantime we can only advocate the conservation of all the available plant remains from weeding and the cutting of jungle weeds to help and fill up the manure pits and by composting to make the manure go further. The cultivator is still a very long way from making full use of the material at his disposal and if composting could be insisted upon everywhere instead of being ignored, as is the usual custom, we should have gone a long way towards the proper conservation of the soil itself.

Control of Water

Many schemes and projects are now being discussed and planned for the better provision of irrigation, but in vast tracts of our Indian uplands no regular canal irrigation is possible. In such places, however, we must not be content to see the water going downhill to the sea or to the irrigated lands below. Every small catchment of even 2 to 3 acres of hilly land should be used as a trap for water so that whatever escapes from it is guided by means of *diversion ditches* into the fields on either side of the natural drainage channel. If these small catchments are already so badly

eroded that the water rushes down in an uncontrollable flood, the use of small check dams at frequent intervals will help to reduce the force of water. At a suitable point in the channel where a slightly larger check dam or bund can be built the water is caught and led out through a masonry, brick or cement outlet or spillway and from there onwards round the hillside in a ditch which must be graded so as to give a slight fall and ensure the passage of this water out into the fields. Such minor projects have never been undertaken by irrigation engineers but should be well within the capacity of a group of cultivators who are prepared to band themselves together and take cooperative action in their own defence.

The Reclamation

The question of grazing control is outside the scope of the present article as it is beyond the capacity of the individual cultivator to effect any drastic change. It is only through the combined action of many individuals that an all round improvement can be achieved in terms of better and fewer livestock, stall-feeding and grass cutting to replace indiscriminate grazing of the common by village herds, and better conservation of the waste lands of

each village as a whole. Nor I would like to advocate the planting of village forests as this again is a matter for the community as a whole rather than the individual cultivator.

The reclamation of the torrent-ruined land which can be made productive again by a simple type of afforestation is again the responsibility of the community rather than the individual, for if it is to be successful and permanent it requires to be done throughout the length of the torrent bed and not just at a few places. It can however be attempted by the individual and the method is simply to check the flow of floods gradually by confining them to a slightly narrower bed by means of 'heering bone' plantations of sand-loving plants such as *nara* (*Arundo donax*) and *banha* (*Vitex negundo*) set at a slight angle to the torrent's direction. Behind this outer defence *kana* grass (*Saccharum munja*) is planted fairly thickly in the sand. The effect is to persuade the floods to deposit part of their load of fine silt there and thus raise a new platform. If the edges of this are kept fully protected with a dense belt of every type of tree, grass and shrub which will succeed locally, the remainder can be planted up with *sissoo* or sown with *khair* or *babul* and so made fully productive as well as a defence for the fields behind.

INTRODUCING BETTER CROP VARIETIES

By B. P. PAL

IT is now universally recognized that the present rate of agricultural production in India falls far short of the country's demands. The immediate need therefore is to step up production by all possible means, to utilize to the utmost extent all our national resources and to adopt modern methods of science and technology towards attainment of this objective. Among the different means of bringing about an all-round increase in agricultural production one of the simplest and most economical ways is the cultivation of improved varieties of crop plants. It has been estimated that by this means a general rise of ten to fifteen per cent in the production per acre can be brought about; in many cases the production goes up much higher than this. Improved varieties of crop plants also yield products of better quality. These are the main factors which directly lead to higher monetary returns from the land. There are also other directions in which better crop plants help production. Everyone is aware of the colossal losses caused by diseases like rusts and smuts and by adverse conditions like frost and drought. By virtue of their superior constitution, improved varieties resist the attacks of diseases and withstand the rigours of frost and drought to a greater extent. Cultivation of these varieties therefore means lesser damage due to these causes.

Crop Improvement

The methods of producing better varieties include the introduction of new

forms, selection from variations occurring in nature and from those artificially induced by hybridization, etc., and, indeed, all those means by which conscious improvement of plants may be accomplished.

The traditional methods of crop improvement consist of introduction and selection. The former is the method of introducing in any given tract, varieties of superior worth which were previously not grown there. Improvement by selection consists of a systematic isolation of better strains from the mixed populations grown by the farmer. There are two kinds of selection work. In many crops, the breeder critically examines individual plants and picks out for growing in the succeeding year those which are promising. This is the method of single plant selection and is commonly practised in crops like wheat and paddy. In other crops like mustard and *bajra* the more suitable method is what is called mass selection, that is, picking out not individuals but a group of plants which conforms or is the nearest approach to the breeder's ideal. The application of these two methods of selection is based on the way in which fertilization and consequent seed formation take place. In crops like wheat and paddy, as a rule, the seeds are formed by the union of the sexual elements of one and the same plant or the same flower. This is known as self-fertilization. For the formation of seeds in crops like mustard and maize the union of the male element of one plant with

the female element of a different plant is the rule; this is called cross-fertilization. Good results have been achieved in the past and continue still to be achieved by these methods. But unfortunately their scope is restricted only to those varieties in which the desired combinations of characters are readily available. More often than not we find the useful characters distributed among several varieties. The problem then is to combine these useful characters, either all of them or as many as possible, in one variety, by means of hybridization.

Valuable Characters

Hybridization in plants has been in practice for a fairly long time now and this method has been responsible for remarkable successes in crop improvement. Obviously, by this method we can go only as far as the possible combination of the existing characters of the different varieties can take us. A stage will come, as it actually has in several cases, where all possible use has been made of these characters without attainment of the ideal. Further progress is possible only by producing or by discovering new and valuable characters; this is what modern plant breeding aims at.

The attempts at finding out new characters may be called the search for superior germ plasm. This search is progressing along two lines: firstly by various attempts to induce mutations, that is, permanent and hereditary changes in the constitution of the plant and secondly by a systematic and thorough survey of the wild plants from a genetical standpoint with the object of discovering valuable characters in them. When such characters are produced or discovered they will be suitably incorporated in the crop plants under cultivation.

Hereditary Changes

There are diverse means of bringing

about hereditary changes in plants; these include X-rays and ultra-violet rays. The most recent and by far the most successful agency is the alkaloid colchicine. This is a drug prepared from parts of the autumn crocus, *colchicum autumnale*, and has been known for a long time as a specific for gout. The influence of this alkaloid on plant tissues was discovered in the year 1937. Since then this method has been very widely employed in the production of new crop plants. One of the most valuable benefits of this method is that by its application we can successfully hybridize distantly related plants which would not ordinarily cross with each other.

The Hybrids

If useful results are to accrue, the survey of wild plants has to be thorough and must cover wide areas all the world over. Expeditions must go out for collection of plants from different countries, the plant material so collected must be carefully analyzed, and, finally, a study must be made of the nature of inheritance of the useful characters and of their inter-relationships, one with the other and with the environmental conditions. This is not an easy task and it cannot be achieved by just a handful of scientists. But the valuable results obtained so far illustrate the immense possibilities which this work opens out to the breeder. To quote a few instances, the cultivated potato is susceptible to the ravages of a disease which reduces the yield. Some of the wild relatives of potato discovered in South America are immune to the disease and this precious character is now being transferred to the cultivated forms. Plant breeders in Germany and Russia have produced hybrids between different crop plants, namely, wheat \times rye, wheat \times *Aegilops* and wheat \times *Agropyron*. The hybrid between wheat and rye has been named *Triticale*; this is an entirely new crop plant. The hybrids of wheat \times

Agropyron are perennial in habit, that is, the seed need not be sown every year as is done for wheat which is an annual ; these hybrids are also claimed to possess desirable characters such as high resistance to diseases, high yield, and large grains.

Coimbatore Sugarcane

There are several crops in which better varieties have directly helped agricultural production in India. The most striking success has been achieved in the case of sugarcane. The canes formerly cultivated in India were thin, low in yield and poor in quality. The superior canes bred at Coimbatore are more vigorous, many times higher in yield and richer in quality as compared to the local varieties. The Coimbatore canes naturally spread all over the country in a surprisingly short time and now nearly 80 per cent of the total area of sugarcane comes under the improved varieties. An eloquent testimony to the economic value of these canes is the fact that as the result of growing them, India which was till recently a sugar-importing country is now seeking markets for export of this commodity. Some of the Coimbatore canes which have become popular are Co. numbers, 205, 210, 213, 214, 244, 281, 290, 313, 331, 419 and 421.

Cotton Varieties

The average yield per acre of cotton for the quinquennium 1922-27 was 96 lb. ; this went up to 109 lb. in 1937-42 as the result of growing improved varieties. According to estimates of the Provincial and State Departments of Agriculture for the year 1943-44 the gross extra income realized by the growers of improved varieties of cotton worked out at Rs. 12/8/- per acre. During the same year at Ahmadnagar, the premium obtained for the improved variety *Jarila* ranged between Rs. 380 and 390 and that for the local variety between Rs. 320

and 325 per candy. In the Hyderabad State a variety of cotton known as *Gaorani* local had been under cultivation for a long time. It was a shy yielder, low in ginning outturn and difficult of clean picking. An improved strain named *Gaorani 6* was evolved by the State Department of Agriculture in the year 1934. During the next three years the new strain was tested against the local variety in the cultivators' fields in several villages and was found to be superior in the yield of seed cotton, ginning outturn and spinning properties. The additional income realized by the cultivation of this variety was Rs. 24 lacs in 1937-41. The Indian Central Cotton Committee has recommended better varieties for different tracts. In the Bombay Province, the improved strains *Jarila*, *Suyog*, *Jaywant* and 1027 are popular. In Sind, the Sind-American cottons, Sind Sudar and 289F are the improved strains. In the Punjab, the improved varieties 289F/K25, 289F/43, 4F and L.S.S. are grown over very wide areas while in the Central Provinces, V.434 is the outstanding one among the improved varieties.

Wheat Varieties

Many improved varieties of wheat are also very popular with the cultivators. The famous wheats evolved at Pusa in Bihar have made a name for high yield and better quality and many of them have definitely established their superior worth in regular yield trials conducted by the Departments of Agriculture. In one such trial at Pusa of the wheat I.P.52 against the local during 1932-1935, I.P.52 gave an average yield per acre of 1,219 lb. while the local gave only 884 lb. I.P.52 has been the favourite wheat with many of the cultivators in Bihar and the eastern United Provinces. I.P.165, another outstanding variety evolved from a cross between the Australian variety, Federation and I.P.4,

shows promise as an all round wheat of high merit for Northern India. It is a heavy yielder, the grain is bold and attractive and it is resistant to the rust and to the loose smut diseases. Wheat I.P.111 is a selection from I.P.4 and has come out very well in milling and baking tests. It is a hard wheat with large and shapely grain and has been reported to be as good as the best Manitoban wheats in milling and baking qualities. Among the improved wheats of the Punjab Agricultural Department, C.518

and C.591 are in high demand in the market and are grown in extensive areas; they are heavy yielders and the grain of C.591 is of very good quality.

The table that follows gives brief descriptions of some of the leading wheats evolved in Northern India and indicates the areas for which they are suited. It will however be appreciated that differences in soil, etc., occur even within the same tract and expert advice is therefore required for 'fitting' new varieties to particular districts.

TABLE I
Some leading varieties of wheat and the areas for which they are suited

Variety	Description	Areas for which suitable
I.P. 4	Awnless; rust resistant, medium; hard wheat. Suitable for sowing in low lying areas and as a second crop after rice on heavy soils. Liable to damage by pigs.	Bombay, Baroda, the United Provinces and the North-West Frontier Province.
I.P. 52	Bearded; medium in maturity; fairly rust resistant; heavy yielding; high quality, hard grain.	Central Provinces and Berar, Bombay, Baroda, Bihar and parts of Bengal and Assam.
I.P. 80-5	Fairly early in maturity; beardless; rust resistant; grain like I.P. 4	Assam, Bengal, the Punjab hills and parts of Madras including the hills.
I.P. 111	Early; beardless; rust resistant; high quality grain.	The United Provinces and the hills of Madras.
I.P. 125	Medium in maturity, rust resistant; bearded; heavy yielding; good quality grain.	South Eastern Punjab, the Western United Provinces and Baluchistan.
I.P. 165	Early; beardless; highly rust resistant, very heavy yielding; high quality large grain.	Parts of the Punjab, Baluchistan, Bihar, Kutch State, the United Provinces and Assam.
I.P. 114	Tall growing with upright straw; awns black; grain round, plump, small and deep amber coloured; liable to shed grain if allowed to stand after ripening; resistant to rust.	Sind.
Cawnpore 13	Bearded; early in maturity; high yield, suitable for both irrigated and non-irrigated wheat tracts of the United Provinces; grains generally white, semi-hard and bold.	The United Provinces and Baroda.
Punjab C. 518	Bearded; glumes densely felted; grains amber and semi-flinty; straw stiff and short, very resistant to lodging; fairly susceptible to yellow and black rusts, particularly to the former; does best on rich irrigated soils where it gives very high yields; not suitable for poor soils.	The Punjab and the North-West Frontier Province.
Punjab C. 591	Ears bearded; medium felted; grains amber, flinty and most attractive looking of all the wheats in India; straw tall, withstands lodging; tillering medium; susceptible to yellow rust and loose smut; makes excellent <i>chapatis</i> ; the grain fetches a premium in the market.	The Punjab and the North-West Frontier Province.
Punjab 8-A	Bearded; medium felted; grains amber, flinty; straw rather weak, susceptible to lodging; high tillering capacity.	The Punjab and Sind.



D. P. PAL

WHEAT VARIETIES
The principal types of ear shape



B. P. PAL

WHEAT VARIETIES

May be completely beardless or bearded to a varying extent



B. P. PAL

EMASCULATION

Removing the male elements (pollen-sacs) from the variety of wheat to be used as the mother parent

POLLINATION

Fertilizing the emasculated ear of wheat with pollen obtained from the variety selected as the male parent

B. P. PAL



CROSSING OPERATION COMPLETE (left)
Afterwards the ear is put into a bag and labelled



B. P. PAL



B. P. PAL



THE SINGLE PLANT OF WHEAT
Threshing (right above)
cleaning the grain (right below)

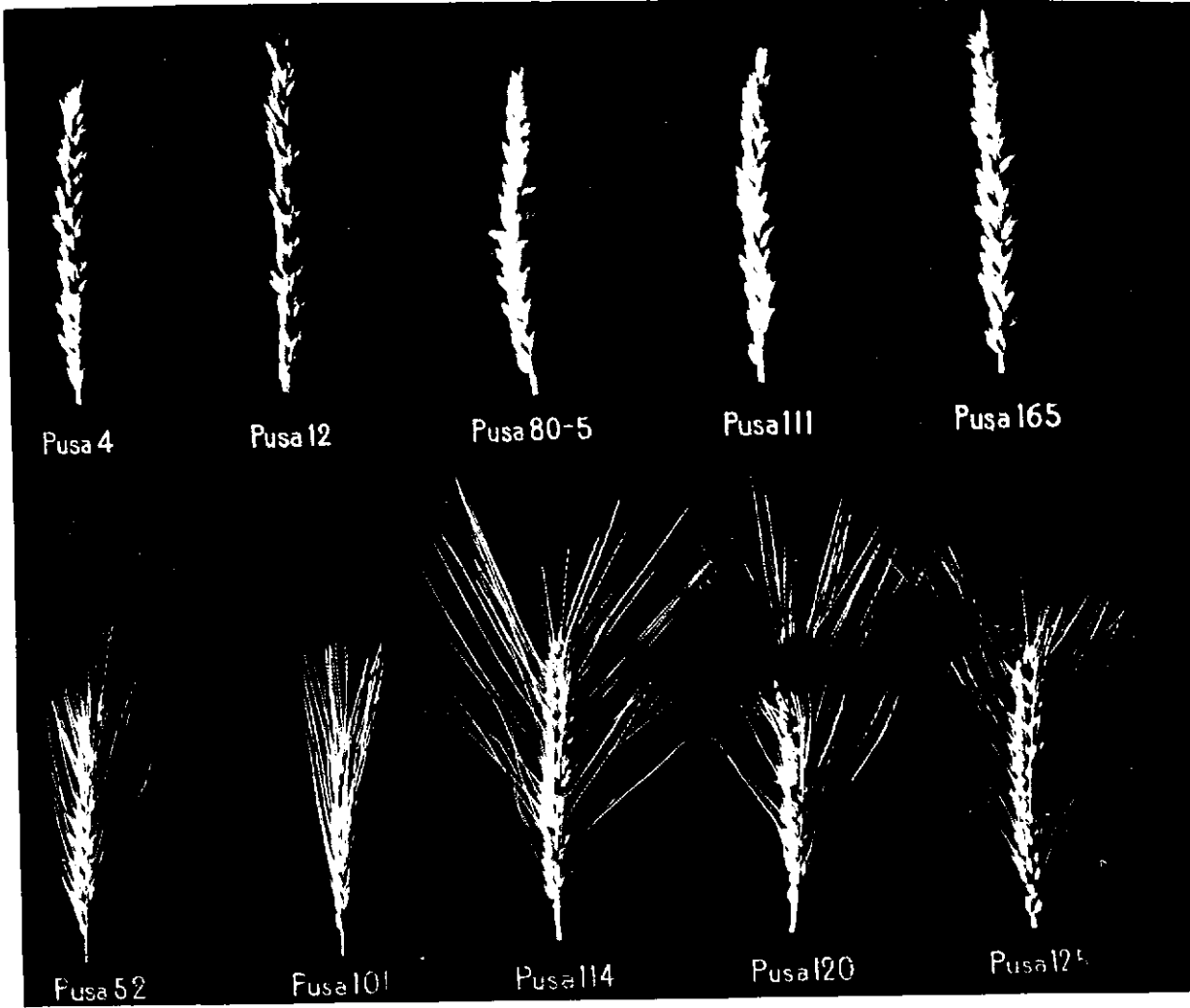

B. P. PAL

NEW VARIETIES OF WHEAT
Resulting from a cross being compared in a properly laid out
varietal trial at an experimental station

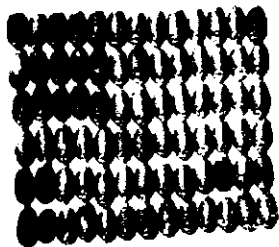
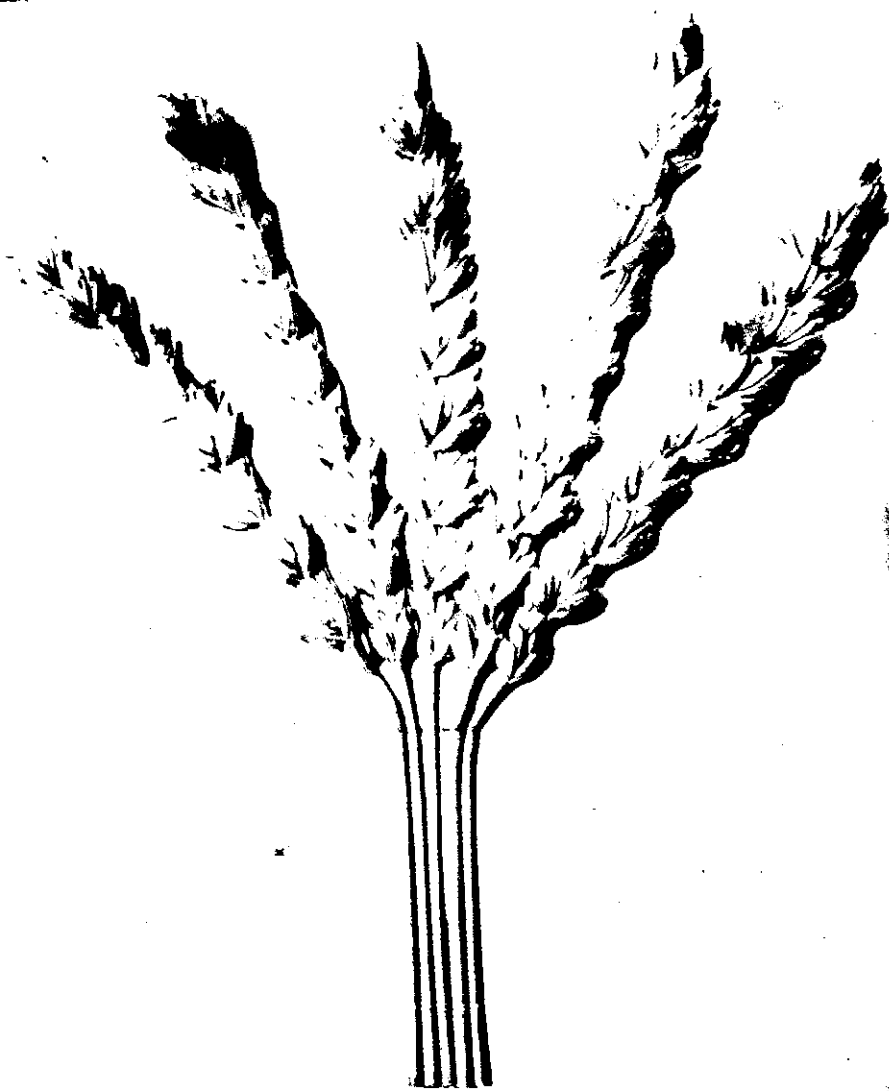

IMPROVED WHEAT (I. P. 165)
Ears and grains

B. P. PAL



B. P. PAL

IMPORTANT WHEAT VARIETIES
Ear samples developed at the Imperial Agricultural Research Institute





B. P. PAL

THE FIELD OF IMPROVED WHEAT (I. P. 165)
This particular field yielded at the rate of 40 maunds per acre

Seeds of Improved Varieties

The Departments of Agriculture of Bengal, Bombay and Madras have from time to time evolved and released for cultivation superior strains of paddy. Indrasail of Bengal, G.E.B. 24 of Madras and K.154 and K.540 of Bombay are worthy of special mention.

From the foregoing it will be clear that the Departments of Agriculture at the centre and in the provinces as well as the various crop committees have made a substantial contribution to crop production in India. In order to make further progress and to deal with problems that will inevitably arise from time to time they maintain research organizations for the purpose of breeding valuable stocks of the cultivated crop plants.

The full benefit of better varieties of crop plants can be realized by the cultivators only when sufficient quantities of the seeds are made available to them. The research stations cannot produce the seeds of improved varieties on a scale large enough to meet the demands of this vast country. We therefore require a separate organization for this work. The research stations will maintain seed farms for multiplication of pure seeds of the improved varieties. From there the seeds will have to be passed on to registered seed growers whose work is further to multiply the seeds on an extensive scale. It has been estimated that the distribution of such seeds and the recovery of the cost in kind or in cash necessitates the establishment of about 5,000 seed stores. In some cases like cotton and tobacco where uniformity of the produce is of primary importance, the growing of a particular variety in an area may have to be made obligatory. The cultivators should also be encouraged to obtain their seeds from some approved source

such as a Government or Cooperative Seed Depot or a licensed seed merchant.

Planned Research

The future prospects of plant breeding are very promising for the reason that breeders in the different organizations are now familiar with the needs of the country and with the methods of attacking different problems; the few instances cited earlier show that useful results in this line have not been lacking. But it must be emphasized in this connection that further progress in the production of new and better varieties of crop plants is by no means as easy as it has been in the past. There is now no room for haphazard methods of breeding, whether it is selection or hybridization. The breeding programme of any particular crop must be carefully thought out and arranged in accordance with a definite line of action for it is only by intelligent and deliberately planned research that further progress can be made.

One of the important steps in the development of agricultural production in India is to bring more land under cultivation. At present, the extent of the land which is cultivable waste and fallow is about 250 million acres. Naturally this land contains all manner of soil types including desert, jungle and forest under a variety of climatic conditions. The future task of the plant breeder is to fit into each one of these tracts the most productive varieties under the prevailing conditions of climate and soil. This may make it necessary in some cases to alter the heredity of the existing varieties or even to produce entirely new crop plants. To put it briefly, 'with the knowledge of the heredity of plants and methods for reshaping it, the plant breeder may be expected to make new plants to order. So the future is that of the breeder, once the new land has been brought under the plough'.

SEED MULTIPLICATION

By FATEH SINGH

PRODUCTION can be increased by ten to fifteen per cent in case of certain crops by the use of better seeds. The evolving of improved seed is usually a long and tedious process. Two methods are usually adopted—selection and hybridization. In the former the seeds of plants which look promising are selected and tried out and by a process of constant selection year after year some good seed is obtained. The other method involves the crossing of different varieties with a view to produce a new variety having the good qualities of both. This is a long time process and the quantity of seed thus obtained is very small.

Usually the next step is to try out the seed on the various types of soil and climate complexes obtainable in an area. This testing has to be done at the Government Experimental Farm and District Testing Plots where the new variety is compared with the existing ones which it is intended to replace. As a result of this a variety most suitable for a particular area is determined.

After this systematic multiplication of the selected seed is taken up. In India there are no commercial organizations to take up this work and the work is done on a Government Seed Farm under expert supervision of the officers of the Agriculture Department. Care has to be taken to 'rogue' the fields, i.e., to remove from the crop stray plants which are not true to type or owing to some accidental admixture have been produced from seed other than improved seed. The crop is thrashed separately and care taken to see that in this process it is not mixed with any other seed. The

produce is carefully stored in a suitably erected store at the Multiplication Farm so that it is preserved from insects and pests, humidity and inclement climatic conditions.

'A' Class Growers

After this the total quantity of seed so obtained is distributed amongst selected growers called 'A' class growers who are required to further multiply this seed on their fields. 'A' class growers are usually big cultivators who take interest in all agricultural operations and are given the seed at the market price even though it may have cost a higher amount. The crop on the fields of 'A' class growers is carefully rogued and steps taken to see that the seed produced is as pure as possible by frequent visits not only to the fields but also to the thrashing floors. They are usually given a premium varying according to local conditions from annas 8 to Rs. 2 above the market rate for the quality seeds that they are producing.

'B' Class Growers

As, however, the number of 'A' class growers is usually limited and multiplication does not usually reach sufficiently big proportions to cover reasonable proportions of the total area with improved seed after this stage of multiplication, the seed produced by 'A' class growers is carefully stored and then issued in the following year to 'B' class growers, who are comparatively small cultivators, for a further multiplication. The same precautions about roguing and separate thrashing are taken. The seed is supplied at market rate,

premium is given and roguing undertaken as in the case of 'A' class growers. Experience has shown that at this third stage of multiplication a sufficient quantity of improved seed becomes available for distribution on a commercial scale.

Process of Multiplication

In most cases it takes from five to ten years before this stage is reached, depending upon the seed rate of a particular crop and the area under multiplication. After this the seed is issued to the cultivators in general to replace the seed that they have been using in previous years. This process of multiplication has got to be continued further. During the following year a further area is put under improved seed. Even after the entire area is so covered it is necessary to see that multiplication is carried on to replace old stocks of seed issued to the cultivators during previous years as all seeds tend to

become impure after being sown again and again.

The Feeder Store

Storage in connection with improved seed is an important problem as without this any seed is likely to deteriorate and does not give the desired results. Storage is required not only for the nucleus seed on the experimental farm, but also for seed multiplied at the seed farm and also with 'A' and 'B' class growers. The storage accommodation has got to be co-related to the requirements of a particular area where seed is to be stored for issue to the cultivators. Usually the store at the district headquarters is big enough to work as a feeder store in a District and the *Tahsil* and *Thana* stores are of sufficient capacity to cover the acreage within their respective jurisdictions. Further distribution beyond the *Thana* is left either to co-operative societies or *panchayats*.

UTILIZATION OF VILLAGE WASTES

By C. N. ACHARYA

THE proper utilization of the village wastes forms the pivot round which hangs the successful rehabilitation and renovation of agriculture in India. The rapid increase in the population during the last hundred years and the need to make India self-contained, as far as possible, in the matter of food production, has brought to the forefront the need for improving the fertility status of the soils and its maintenance to a high level. The present low yields of Indian crops, which have given rise to a series of famines during the last few years, are attributable mainly to the gross neglect to return to the soil in the form of manure what is generally taken out of them in the form of crops. During a period of rapid urbanization which has occurred during the last hundred years, villages in India have been acting mainly as exporting centres for sending out the life and vitality of the soils to the towns in the form of food-grains, dairy products and the raw materials used in industry. They have not yet equipped themselves to see that the fertility of the land so exported for considerations of money, is replenished by the application of a sufficient quantity of manure of good quality.

There are ways in which the rural population can cooperate in making good the accumulated loss of fertility in the soils, and thus help to feed the nation better. The first is by getting back from the towns as much of compost manure as possible and applying the same to land. This must be done as a natural policy irrespective of cost, in order to

see that the present one-way drain is converted into a cyclic one and the lands become assured of a permanent existence. The second method is to apply to such of the crops, as would repay the additional expenditure involved, enough of purchased manures and fertilizers, e.g., oil cake, bone-meal, artificials, etc., and also to adopt such cultivation methods as would improve soil fertility, e.g., growing leguminous crops. These methods, however, have serious limitations and are applicable mainly to irrigated areas.

The third and most important method is to convert all the refuse material available in villages into good quality compost manure and to apply the same to agricultural land. This method is important not merely from the point of view of general considerations of returning to the land what is taken out of it, but also because of the huge quantities involved, as compared to other source of manure. It is possible to prepare about 500 million tons of good quality compost manure every year from the refuse material available in the six and a half lacs of villages in India ; and this quantity when applied to the land from year to year would increase our food production to a level of more than hundred million tons per year—enough to feed comfortably a population of 500 to 600 millions.

The Kharegat Plan

The organization that is needed to cover six and a half lacs of villages will no doubt be a huge one, but the problem is being approached on a practical basis



MANURE PITS



DIGGING A MANURE PIT

WASTE OF MANURE

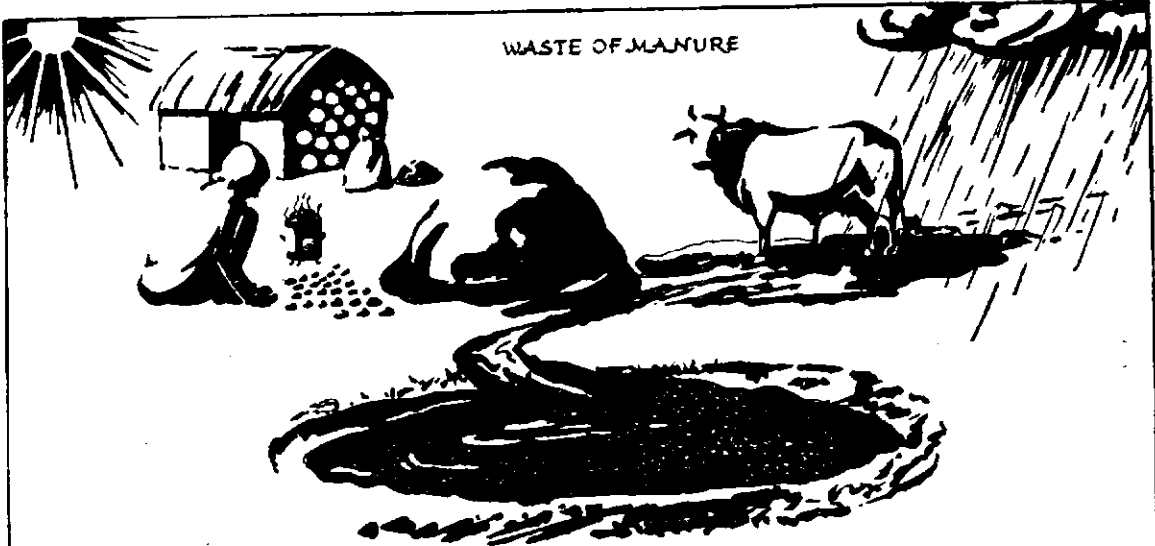

7/8 N.



LOW YIELD OF MANURE OF POOR QUALITY

POOR CROPS

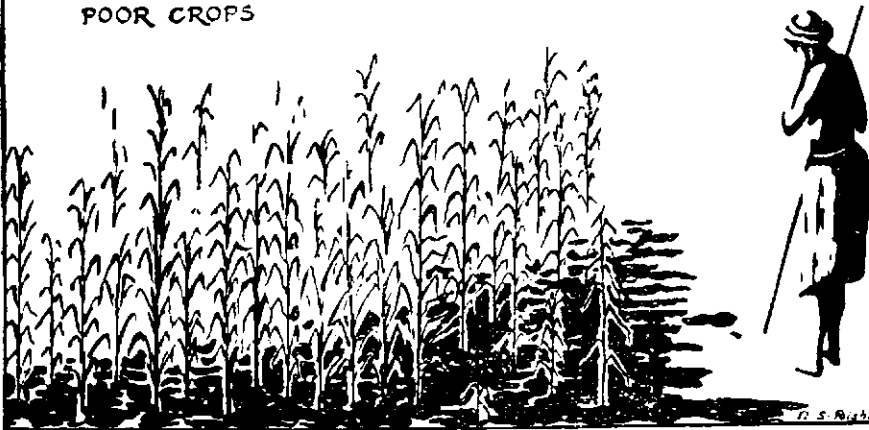

G. S. BISHOP

N. S. BISHOP

WASTE OF MANURE
That is why poor crops

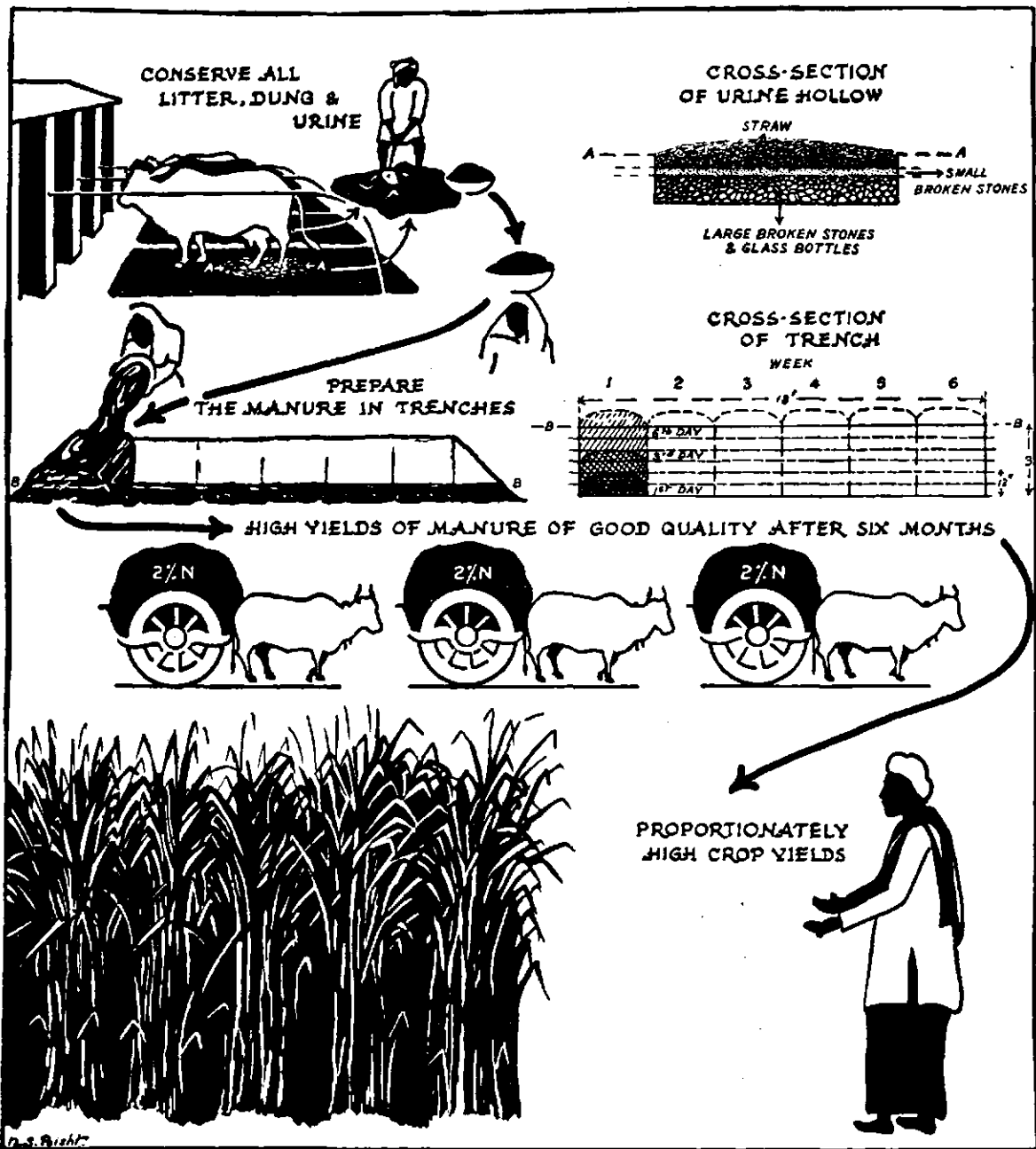

COMPOSTING GOOD QUALITY MANURE
That is why rich crops

under the Kharegat Plan, which aims at setting up a *kamdar*, i.e., *mistri* or *mukadam*, for each group of ten villages whose duty would be to persuade the villagers to adopt more efficient methods of agriculture. In the case of the manurial programme for instance, each village will be allotted a target, based either on the number of houses (say, 500 500 cu. ft. of manure per year) or on the number of cattle maintained (say 200 cu. ft. of manure per year); and it will be the duty of the *kamdar* to render all possible help that is needed to enable the villagers to reach the targets fixed for them. Under the post-war plans, the Provincial Governments are making financial provision for providing the villages not merely with the technical help of the *kamdar*, but also for help in other ways, e.g., (i) by acquiring special plots of land all round the villages which would be reserved for digging pits and storing manure; (ii) by giving grants of money in impecunious cases for digging pits; and (iii) by subsidizing, in some cases, the transport manure from one village to another. It is also proposed to offer prize-awards for the best performances in each group of ten villages.

The above programme of village reconstruction would not, however, meet with the desired success, unless it is backed up by the active cooperation—in fact, by the active initiative—of the villagers themselves. Local Committees of the villagers or the village *Panchayats*, wherever they are available, should take up the responsibility for fulfilling the targets fixed and should draw up local programmes specifying the type of help needed from the Government.

Village Compost Scheme

Schemes for manure preparation in villages are already in operation in a number of provinces, including the Punjab, United Provinces, Bengal, Bombay, Orissa, etc. Only the simplest

methods of manure preparation should be recommended to the villagers, since otherwise the process would not be adopted on a routine basis. The method of filling manure pits in sections and avoiding turnings altogether, is quite simple. Special attention would be paid to the question of conservation cattle-urine, since on this depends all hopes of improving our agricultural yields. It is not possible for us to increase the quantity of farmyard manure prepared in the country to any marked extent in the near future, owing to the serious limiting factor of fuel scarcity and the use of cattle dung as fuel. But it is possible for us easily to recover another one million tons of urine-nitrogen by absorption with waste-litter. The methods whereby the urine could be conserved for manure preparation without extra cost or trouble to the villagers can easily be explained to the peasants. The *kamdars* should introduce these methods in villages under their charge.

The Village Compost Scheme is working satisfactorily in the Punjab and the United Provinces. The Punjab is adopting trenches 25 ft. in length, seven to eight feet in breadth and three feet in depth, whereas the United Provinces are recommending pits twelve and a half feet in length, eight feet in breadth and two to three feet in depth. One trench of of the Punjab dimensions would be sufficient for a household to carry the refuse all the year round, whereas two to three trenches of the United Provinces dimensions would be necessary for a house. The advantage of the United Provinces specification is that the pits, being smaller in length, can be located even in congested areas. The trenches should be filled up in breadthwise sections (three feet at a time) with the material already used in the cattle-shed for absorbing cattle urine. In addition to dung, waste litter and urine, other habitation wastes such as household sweepings,

wood-ash, leaves, etc., should be added. No turnings are necessary, but when each section rises, in four or five days, to a height of one and a half or two feet above the ground level, the top should be plastered over with a paste of cattle-dung and earth (equal parts by weight), in order to conserve moisture and nitrogen and to prevent fly-breeding. The manure will be ready in four to six months' time, and a rich product containing over two per cent nitrogen (on dry basis) will be obtained, which would increase crop yields by 25 to 50 per cent. The quantity of manure that could be prepared in a year would no doubt depend on the type of crops grown locally and on the intensity of cropping, but a level of 500 cu. ft. per house per year (or 200 cu. ft. per year per head of cattle) has been reached in a large number of cases. It is possible to exceed the above limits by taking a little extra trouble to collect the weeds and stubbles on the farm and using them for absorbing urine in the cattle-shed.

In cases where large quantities of special types of refuse have to be dealt with, e.g., sugarcane trash, forest leaves, water hyacinth materials, etc., modifications of the composting method would be necessary and one or two turnings may have to be given to the mass before it becomes mature enough for application to the land. The local Agricultural Officer should be consulted for advice in such matters.

The Enterprise

The programme of manure production in villages outlined above is a cooperative village enterprise which would lead to a healthy competition between adjoining villages. It is not of course necessary that the householders should pool their refuse material at a central place for preparing the manure in common and then go for shares when the manure is ready. Such collective pooling together

of individual resources would no doubt be conditioned by and would run parallel with the development of cooperative and collective farming. Pending such development, individual production should be stimulated by the offer of rewards for best performances of individuals and for village totals.

In certain matters, however, there is considerable scope for collective action by villagers, e.g., (a) in removing water hyacinth from village surroundings and composting it; (b) utilizing leaf-fall from the adjoining forest or hill areas for manure preparation; (c) composting the refuse available in common areas situated in and round a village like road-sweepings, dust bin refuse, leaf-fall, etc. The Village Committee should set up public latrines all round the village, so that all human excrement is properly collected and converted into useful manure by composting it along with other rubbish available in the village, instead of allowing the above excreta and refuse to defile the road and canal sides and to pollute the air and water supplies of the village. Social and cooperative effort in this direction is urgently called for and is absolutely essential if the villages in India are to become once again sanitary and clean places, which would attract the educated men for settling there. The expenditure involved in such collective efforts would be more than repaid by the improved health of the village and by receipts from the sale of the manure produced.

A further important matter in which villagers can act collectively even now, is the planting of more trees for fuel and fodder in all vacant places round about each village and along the fences of the farms. There is a serious shortage of fuel in most parts of the country, which has led the farmers and towns-people to using dung-cakes as fuel. There is also a serious shortage of fodder for animals in this country, with the result that very little of waste litter becomes available

in the cattle-shed for manure preparation. The planting of a large number of rapidly growing, drought resistant trees, which would provide both fodder for cattle and fuel for men, would help to overcome the

present difficulties to a great extent and increase the quantity of organic manure prepared in the villages by 50 to 100 per cent. Plans on these lines are being drawn up for each Province in India.

COMBUSTIBLE GAS FROM COW DUNG

By S. V. DESAI

FROM time immemorial cow dung has been used as a manure and cow dung cakes in spite of the warnings by all scientific experts are still used as fuel and would continue to be used so long as a suitable substitute in the form of a cheaper fuel is not available. When cow dung is burnt its value as a nitrogenous and organic fertilizer is lost; and when cow dung is used as a manure it cannot serve the dual purpose of a manure and fuel. Experiments conducted at the Imperial Agricultural Research Institute, however, have shown the possibility of having this dual service from cow dung by an aerobic fermentation.

It is the usual practice to bury farm wastes in a manure pit before their application to the fields as a manure. During this storage under aerobic condition a part of the cellulosic matter is changed into carbon dioxide and portion of the N escapes in the form of ammonia. When the fermentation is allowed to proceed under strictly an aerobic condition the loss of N is minimized and the gases produced are methane, hydrogen and carbon dioxide. The composition of this mixture is such that the mixture can be used as a fuel gas. Under ordinary conditions these gases are not harnessed to any useful work. If the fermentation is allowed to proceed in closed vessels the gases can be utilized. A simple but at the same time efficient plant has been devised and worked in the Imperial Agricultural Research Institute, New Delhi and details have been published in the *Indian Farming*¹. The

¹Vol. VI, No. 2, February 1945.

plant consists of two parts—fermentation tank and a gas holder.

The Fermentation Tank

Any receptacle which can exclude the entrance of air can serve as a fermentation tank. It may be constructed out of iron, reinforced cement concrete or of masonry work either on the ground level or partly under ground and partly above ground. Perhaps a tank constructed out of reinforced cement concrete half above and half under ground would be suitable and cheap as well. The size of a fermentation tank would depend upon the material to be handled and should be about 50 times the volume of material to be handled daily excluding water. The roof of such a tank may either be fixed or a floating one as designed for the digestion tank for sewage disposal at Bombay (Dadar) and Poona, as the principle underlying both the processes, e.g., sludge digestion and fermentation of organic wastes is practically the same though in practice the sludge plant has to deal with a liquid containing three to seven per cent organic matter and the cow dung water mixture contains about fifteen per cent organic matter. The percentage of gas evolved is naturally double in the case of cow dung from equal volumes.

Two large openings are necessary in the fermentation tank, one for putting in the material and the other for letting out the fermented mass. The first one should open out into a funnel at the top and should go to the middle or further down to deliver the material without

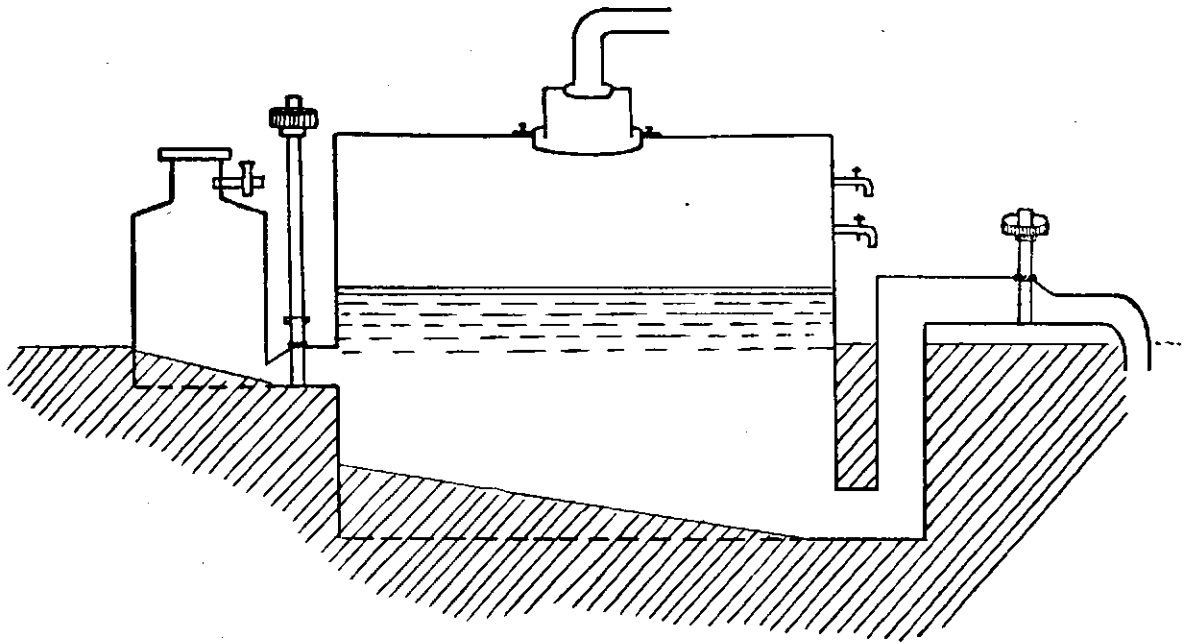

N. S. BIGHT

FERMENTATION TANK

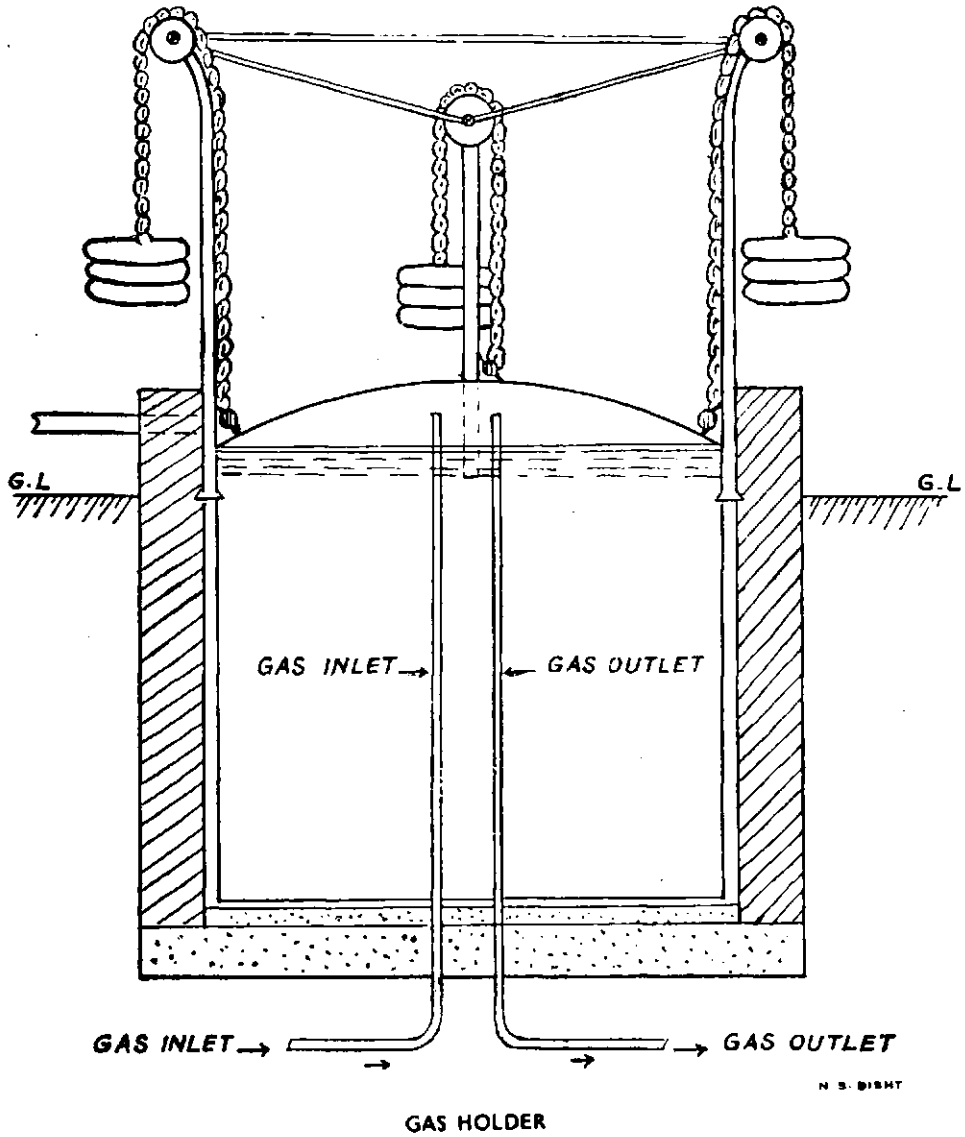

introduction of air while the material is put into the tank. The process being strictly an aerobic one it is essential that no air is let in. The opening should be of a suitable size, e.g., four to six inches dia. in small fermenters and six to twelve inches dia. for big ones to allow free passage of the mixture of cow dung and water without getting choked and it should be completely air tight, a gate valve opening may be preferred.

The exit opening for taking out the fermented material should also be of the similar size and so arranged that the liquid flows out from the bottom of the fermentation tank. This can be effected by bending the exit pipe inside so as to reach the bottom of the tank. The valve here should also be air and water tight.

The gas evolved accumulates at the top and it is led through a pipe fixed at the top of the fermentation tank to the gas holder where it opens at the inside top of the latter above the water level. Fermentation in the tank may at times be accompanied with frothing and care should be taken that the gas pipe is not choked in which case a pressure would be generated and may lead to the bursting of the fermentation tank. To allay this froth a stirrer may prove very useful, and it can be adjusted in the middle of the tank at the top by gland opening and its working once a day will reduce the frothing of the fermenting material and will ensure a thorough mixing. The stirrer may be provided with four blades in sets of two situated at equal distances from the top and the bottom; it has not much value, however, in the actual fermentation and evolution of gas and its installation may be dispensed with, if care is taken to see that the gas exit is not choked up at any time.

The Gas Holder

This is the other part of the plant. It can be made on any approved pattern

and as such it does not require much description. The usual type of inverted tank counterpoised by weights and dipped in water would meet the requirement. The water holding tank should be larger than the inverted gas holder and may be built under ground of masonry work, reinforced cement concrete or of iron sheets. The size would depend upon the quantity of material added and secondly on the output and consumption of the fuel gas. Perhaps a gas holder with half the cubical content of the fermenter would serve the purpose satisfactorily. One gas exit pipe is introduced through the bottom rising upto the top beyond the level of water. No special skill is required to start the plant. The fermentation tank is half filled with water and cow dung with litter in about equal proportion. A small addition of superphosphate chalk and ammonium sulphate in the beginning helps quick fermentation. Afterwards there is no need for any extraneous material to keep up the vigour once attained. The quantity of such materials as stated above may vary from one to ten per cent of the material put in.

The gas evolved in the first few days comprises mostly of carbon dioxide and so does not burn but as soon as the encompassed oxygen is used up within a week or ten days the gas contains a mixture of methane hydrogen and carbon dioxide in the proportion of 40 : 20 : 40 and burns with a perfectly smokeless blue flame. Care should however be taken not to let in air during the passage of fermentable material and all stop cocks should be rigidly air tight. The pilot plant erected in the division of Soil Science and Agricultural Chemistry has been working very satisfactorily for the last five years.

Manipulation of the weights arranged to counterbalance the weight of the gas holder makes introduction of fermentable material and exit of gas and fermented

manure easy. Weights are taken out when gas liberation is necessary and when the fermented matter is taken out for drying. When the weights are saddled on the pressure inside the fermenter is reduced and fermentable material can be easily put in.

When conditions are favourable one pound of raw cow dung can produce one c.ft. of fuel gas. A single individual consumes about 5,840 c.ft. of gas annually for cooking his food which comes to about sixteen c.ft. per day. Thus a family consisting of five or six members would consume 80 to 100 c.ft. of gas for all his normal needs of cooking which can be obtained from the droppings of one or two animals like cows, buffaloes or bullocks.

Fermentable material can be added either daily, weekly or fortnightly in the proportion of one part water and one part cow dung, but in the last two cases the manure is much more ripe. It takes about a fortnight for the complete fermentation of material added. So fermented material is taken out every fortnight for drying. The dried stuff is used as manure and has proved its superiority over farmyard manure by crop yields, N content and nitrifiability.

Working Basis

In India the production of raw cow dung is estimated at 800 million tons per year of which 40 per cent is used as manure and 40 per cent is burnt as fuel. Even if this latter 40 per cent is available for combined manure and gas production it would produce about 4,000 million c.ft. of gas per day which would cook the food of about 200 million people. The manure produced in such a way would retain all its N content in a more readily available form and would supply about 300,000 tons of N in excess of what is at present being used as manure. Further quantities may also be available from the dung of horses, sheep, goats, etc.

In sewage purification plants subsidiary tanks are erected for fermentation of the precipitated sludge. The gas evolved supply power and light not only for the plant but for its neighbourhood also. So there is ample scope and future for fuel gas plants all over India. The main advantages derived from such plants excluding the fuel gas production are that process is very hygienic, there would not be any foul smell, manure can be produced within a small space, and fly breeding would stop.

The process also offers an ideal opportunity for production of fuel gas for small laboratories, schools, colleges and other institutions where gas for burners is produced either from steam coal or from oil cracking plants which are difficult to operate and have considerable recurring expenditure while installation of plant working on this process would not only cost less to install but would also be very cheap to operate.

Such small plants have already come into being. Prof. N. V. Joshi has taken up the erection and supply of such small scale plants at Poona for home use and for small laboratories. For erection of sludge digestion tanks the firm of Messrs Duncan Stratton & Co., indicated that the capital cost of erection may approximately be calculated on the basis of rupees eleven per 1,000 c.ft. per annum.

It may also be stated that fuel gas obtained from sludge digestion is being compressed into cylinders and is used by the Bombay Municipality to run trucks fitted up to run on this gas. A four to five ton Ley Land lorry covered about 55 miles on four cylinders fixed thereon containing 1,400 c.ft. of free washed gas at a pressure of 3,000 lb. per sq. inch. Ordinarily this lorry was expected to do about six miles per gallon of petrol. It would thus work out that 155 c.ft. of this fuel gas was equivalent to one gallon of petrol.

This process can make cheap organized power available in rural areas which can be used for water lifting, lighting and other social and economical purposes to raise the standard of living of the rural area and at the same time improve the productivity of the land by supplying cheap and effective organic manure. The capital sunk in the erection of such plants can be recouped in twenty years time

by water and electricity or other rates on nominal basis. The whole economics requires to be worked out on actual working basis by erection of such plants in approved rural areas by the Government. This process of fuel gas production by fermentation has greater appeal than composting of refuse when the oxidation or burning away of organic matter is not utilized for any useful purpose.

SAVING CROPS FROM INSECT PESTS AND DISEASES

By HEM SINGH PRUTHI

INDIAN farmers generally get less produce from their lands than those in other countries both in Europe and Asia. The Central and Provincial Departments of Agriculture are assisting the farmers to improve their yields by arranging better facilities for irrigation, supply of manures, improved implements and seeds of high yielding varieties. However, crop-pests and plant diseases are taking heavy toll of land produce and in spite of the new efforts, the overall results of various improved methods of crop production are very small.

I would give a few examples showing the extent of damage caused by pests and diseases. The yield of valuable orchards in North-West India is being reduced by 50 per cent, in some cases even 90 per cent, on account of various fruit pests, e.g., Codling Moth, Woolly Aphis, leaf-eating caterpillars, etc. Orchard owners in Sind are cutting off their Citrus trees because of the white-fly pest. The fungus *Helminthosporium* is known to be one of the basic causes of Bengal famine. Red Rot of sugarcane may drop sugar production in the white-sugar belt of North-West India by about 75,000 tons in one season. Weevils destroy about three and a half million tons of grain every year valued at about eighty crores of rupees and in quantity enough to feed about fifteen million persons for one year.

In fact in the case of many vegetables, fruits, etc., farming is becoming un-economic due to ravages caused by pests and diseases. It was obviously in view of such facts that the Interim Commission

on Food and Agriculture of the Allied Nations gave very high priority to crop protection and the recent Indian Famine Commission concluded that if full benefits of irrigation and manuring are to be assured, effective steps must be taken to destroy pests, vermin, diseases, etc. Very recently the Royal Institute of International Affairs in London in its proposed plan for improving food situation in India has suggested concentration of efforts on five important points, of which one is the control of seed-borne diseases and insect pests of crops.

The Treatment

Admittedly control of the majority of insect pests and diseases requires expert supervision and equipment which are not readily available to the farmers, but many of the diseases and pests can be effectively controlled by taking simple and timely precautions. 'Prevention is better than cure' may aptly be applied to plant protection. Fungi which are responsible for a great deal of harm to field and orchard crops may be externally or internally seed-borne. In the former case, fungicides like copper and mercury, sulphur or formaldehyde dusts can be easily employed to disinfect the seed. The grain smuts of *jowar*, the covered smut of barley, the foot-rot of rice and the damping off of vegetables and other seedlings are also controlled in this manner. Where the disease is internally-borne as in the case of loose smut of wheat, the seed is soaked and then placed in hot water registering about 130°F., for ten minutes. The

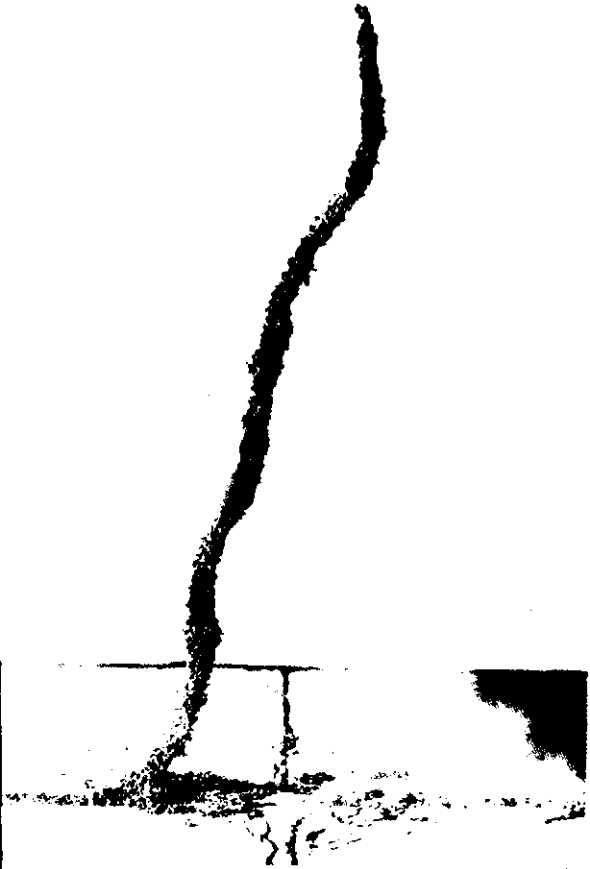

TERMITE GALLERY

Growing along with the seedling which will be soon destroyed by termite workers eating it under the gallery cover



Dr. PRUTHI AND H. E. THE VICEROY

Dr. Pruthi in the centre is seen explaining work on insects pests of crops to His Excellency



P. I. B.

A CONCRETE GRAIN SILO

This is of concrete, constructed out of pre-cast rings at Virar :
grain is seen flowing out from the mouth of the silo

disease causing fungus is thus effectively killed. An ingenious modification of this method has been evolved in the Punjab where the summer is very hot. The grain is soaked in water from early morning till noon, and then exposed to the sun till sundown.

If the disease is air-borne, as in the case of early and late blight of potato, mildew on grapes, mangoes or pears, leaf-curl of potatoes, rusts of figs, etc., timely spraying with fungicides like Bordeaux mixture will give efficient protection. Bordeaux spraying has been an established practice for controlling koleroga of Areca and coffee and rust on coffee.

The most important and simple method of preventing weevils infesting stored grain is to dry the grains well by spreading them out in the sun before storing them. It is also important to have damp proof stores, which are free from crevices, holes, etc., so as to prevent entry of rats, insects and other vermin.

Fruit flies cause immense damage to a variety of fruits and vegetables. It has been frequently demonstrated that if the infested fruits which generally fall off the trees are picked and burnt or buried, the incidence of the pest is kept down. This is a simple method requiring no elaborate arrangement or expense.

The Red hairy caterpillar causes heavy damage to *kharif* crops, particularly legumes, in Northern and Western India. The moths of this pest first appear in small numbers with the outbreak of the monsoon from their overwintering quarters. The moths are easily attracted by light and can therefore be collected and destroyed in large numbers by installing suitable light traps in the field. Paddy borer is another pest which can be controlled in this way.

Simple agricultural operations and cultural methods, like rotation of crops, field sanitation, deep ploughing, flooding, etc., can control quite a variety of pests

which cause severe damage to crops. For instance the removal of all stubble after harvest of paddy, sugarcane, *chulam* or cotton will prevent borers resting in them and attacking the subsequent crop. Many pests feed on weeds and grass when their food plants are not in the field. Army worm, Ric bug, Paddy mealy bug are examples of such pests. Periodical weeding of the fields would obviously keep down the severity of attack from such pests. Dead portions of trees or plants should be removed. In the case of orange tree, the withering of the small branches indicates borer attack. If such twigs are not removed, the borers work into the lower branches and damage the whole tree. Removal of dead and rotting tree-tops etc., in coconut grooves, reduce the damage by Rhinoceros beetles. Where paddy fields are infested by caterpillars; trimming the bunds and deep ploughing after harvest will destroy a large number of pupae and considerably reduce subsequent attacks. The rice grass-hoppers, and similar pests of other field crops can be collected and destroyed in large numbers by sweeping with bags and nets. Trimming the paddy seedlings before transplanting will greatly reduce the incidence of thrips, hispa and other insect pests. A little care in the selection of seed or seedlings, will go a long way towards producing a better crop.

Watch and Ward Service

Examples of such simple methods to combat pests and diseases of crops can be multiplied. But for the treatment to be effective, however simple it may be, a knowledge of the approximate times when various diseases appear in the field is necessary, and proper timing of the treatment is of utmost importance. It is therefore recommended that every Province should have a 'Watch and Ward Service' as an integral part of the development or extension staff of

the Agriculture Department. The members of this service should scout about and warn the farmers about the various pests and diseases which are already in the field in small numbers or are likely to occur in future and demonstrate the measures which can be readily taken by the farmer himself without waiting for an expert to come.

Indian farmers take considerable pains in carrying out laborious cultural operations. They should also be gradually encouraged to consider simple operations for saving their crops from diseases and pests as a part of their routine farming operations.

It is, however, necessary that this 'Watch and Ward Service' should be in a position to assist the farmer in carrying out actual control operations requiring technical supervision. Instead of merely telling the farmers to purchase spraying material and machinery this service

should possess the requisite equipment for lending to the farmers on hire if necessary, so that operations may be carried out at the right time.

The farmers themselves should feel responsible in the matter. Most of the insect pests and diseases being of migratory nature and since they often occur over large tracts, it is essential that every farmer should carry out sanitary or actual control operations regularly and properly otherwise good work done by his neighbours will go to waste because pests and diseases will go into the neighbour's field in spite of the control work carried out by the latter.

In some countries the farmers are required to carry out certain control operations under the law but if the Agricultural Departments establish well organized Plant Protection Services, the necessity for legal compulsion will be reduced to the minimum.

THE NUTRITION PROBLEM OF THE VILLAGER

By AFZAL HUSAIN

ACCORDING to the latest Census Report of India, out of a total population of 389 millions, over 339 millions, covering 87·2 per cent of the entire population, live in rural areas. Therefore, the nutrition problem of the Indian villager constitutes 88 per cent of the food problem, and may appropriately be described as *the National Food Problem of India*. The remaining twelve per cent concerns the urban areas, in other words, special concentrations of groups of population, and resolves itself mainly into the problem of procurement and distribution of food, with minor attempts to organize, on a small scale, production for instance, of vegetables, milk and poultry.

India has been for years a deficit country for food grains, and is likely to remain so for years. On which section of the population does the burden of this deficit finally fall? Is this shortage shared equally by the urban and rural population? It is generally accepted that thirty per cent of the population of India does not get enough to eat. Is this thirty per cent of the population uniformly distributed over the urban and rural areas? The nutrition experts tell us that the diet of the greater part of the population of India is unbalanced, and does not provide, in adequate quantities, the 'protective' foods. We are told that to attain self-sufficiency in 'protective' foods, the production of milk, flesh and fish must be increased by 300 per cent. Do the urban and rural areas share this shortage equally?

It would be logical to expect that the

producer of food would look to his own interests first, and he would be better fed than those who obtained food from him. Paradoxical though it may seem, it is a fact that on the whole the urban population is better fed than the rural. The reason for this is not far to seek. The better paid industrial labour is able to spend more on food than the less prosperous producer can. This is not peculiar to India; it is so all over the world. Moreover, organized and vocal industrial labour is able to look after itself better; large industrial concerns, to have efficient and contented labour, in their own interest, supply cheaper food to their workers, open canteens for them and provide them other facilities; corporations and even Government, to avoid disturbances and break down in essential services, organize food supply for the city population. On the other hand the rural population contains the poorest section of the community, is illiterate, mute, unorganized and is left to its own resources.

The Fateful 1943

When happened in Bengal during the fateful 1943, demonstrates the truth of what has been said above: "Only one section of the community suffered from starvation—the poorer classes in the rural areas. Well-to-do people, and industrial workers in Greater Calcutta and elsewhere did not go short of food in 1943. As the price of rice rose during the first half of 1943, the poor in the villages without sufficient stocks of grain in their possession found themselves

unable to buy food. The majority remained in their homes and of these many died.”¹

The conditions during a famine are a mere intensified picture of what happens, season after season, in the villages. What was demonstrated by the Bengal famine is going on imperceptibly but surely all the time. During certain parts of the year a vast proportion of the villagers, who cultivate holdings too small to provide them subsistence, suffer acute scarcity, even during years of good harvests.

Considering ‘Protective’ Foods

So much for food-grain. The same condition exhibits itself when we take into consideration ‘protective’ foods. Let us take the case of milk and milk products. The proportion of milch-cattle kept in urban areas is 3·5 per cent cows and 5 per cent milch-buffaloes. Therefore, approximately 96 per cent of the milk is produced in villages. There is a common belief that milk and milk products are scarce in urban areas and that their per capita consumption is smaller in towns than in villages. The facts ascertained do not bear this out. Daily per capita consumption of milk and milk products was investigated in twenty-three cities, and the result showed that the urban intake was almost double that of the country as a whole. The intake was particularly higher in the industrial centres. For instance in Bombay and Poona it was 4·6 times the provincial average, in Calcutta 3·3 times and in Madras, Lucknow, Cawnpore and Agra double to little more than double². The Report on the marketing of milk says: “It often happens that butter-milk is the only product left with the producer, and he sells away his entire production of milk and *ghee*.”

¹ *The Famine Inquiry Commission Report, 1945.*

² *Report on the Marketing of Milk in India and Burma, 1941.*

The following description of the nutritional standard of the peasant, by one whose knowledge of village life cannot be questioned, is a gloomy picture:

“If we look at the food they eat, barring Bengal, it is mostly vegetarian. Even in Bengal the peasant class does not eat meat diet. It eats fish because it is the cheapest food available. The only basis of selection of food is cheapness. Peas, gram, barley, sorgham and millets are their ordinary food. A gruel made of parched grain mixed with water is generally what the poor can afford to satisfy their hunger with. In order to make it palatable, they put in a pinch of salt and pepper; sugar of course they cannot afford to have. In Bengal and southern part of the country the worst kind of rice is the staple food of the agriculturist. He may cultivate wheat and may be exporting a large quantity of it out of the country³ but his poverty does not allow him to use it himself. Ordinarily he does not use vegetables, it is only on ceremonial occasions that this luxury is indulged in. For a man living on a vegetarian diet milk is quite essential to give nourishment. But in modern days of development every inch of ground is brought under cultivation, the majority cannot afford to keep milch cattle and even those who keep them, cannot afford to use milk or butter for their food and have to sell them and the only thing that remains to them is skimmed⁴ milk”⁵.

The few detailed investigations carried out, in certain parts of the country, support the view that the nutritional condition of the villagers is very unsatisfactory and needs immediate attention. An Inquiry⁶ into diets, state of nutrition and factors associated therewith,

³ Alas! This is no longer correct.

⁴ Probably *lassi* or butter-milk is meant.

⁵ Chowdhry Mukhtar Singh, *Rural India*.

⁶ Report on An Inquiry into Diets, State of Nutrition and factors associated therewith, in relation to Health in the Lyallpur District: Punjab Public Health Department.

in relation to health, was carried out recently in the district of Lyallpur, jointly by the Punjab Department of Public Health and the Board of Economic Inquiry, Punjab. This inquiry covered a period of full one year from July 1939 to June 1940. It dealt with 75 families actually engaged in agricultural pursuits, comprising 708 individuals of all ages, belonging to four main tribes—Muslim: Arain, Jats, Janglis; and Sikh Jats—and representing peasant-proprietors, owner-tenants and landless tenants. The actual area cultivated per family averaged for different groups from fifteen to thirty-nine acres. Agriculture contributed over 87 per cent of the family income. Food accounted for 47 to 50 per cent of domestic expenses. Out of the 75 families, 40 had deficit budget, and only 35 were able to meet their expenses, and of these only twenty-one families could balance their budgets from agricultural pursuits only. This inquiry was held during the period when war had not affected the economy of India. Regarding the quality of their diet the conclusions of the Inquiry invite immediate attention:

“There is a preponderance of cereals. Wheat is the chief cereal consumed followed by maize, whereas rice is used only occasionally. Next to cereals pulses occupy a prominent place in the dietary, except in the case of the Janglis. The consumption of vegetables in general and those of the leafy variety in particular is exceedingly low, in fact below the mark (8 to 10 oz. of vegetables daily per adult male consumption unit is the accepted standard in a balanced diet) except in the case of the Sikhs. Leaving aside the Sikh Jats, fruits practically find no place in the diet of the other tribes. All the tribes including the Sikhs are meat eaters, but the consumption of the flesh foods like meat, eggs and fish, etc., is nil for all practical purposes, the result being that the diets are ‘vegetarian’ in

character and composition. Again, with the exception of the Sikh Jats the intake of milk is highly inadequate in the case of all tribes. The inadequate consumption of milk and its products becomes all the more apparent when it is borne in mind that milk is the only source of the ‘proteins of animal origin’ in the diet in the absence of other ‘flesh foods’. Generally speaking, with the single exception of the Sikhs the diets of all other tribes were lacking in important ‘protective foods’ like vegetables and milk.”

The district of Lyallpur is undoubtedly one of the most flourishing agricultural tracts in India and shares with other ‘canal colonies’ the credit for the prosperity of the Punjab. In the canal colonies agriculture has not yet become ‘subsistence farming’ which is the case over a large part of the country.

If such is the condition of the nutrition of the cultivator in the most flourishing agricultural tract in India, what must it be in tracts not so fortunate? Another inquiry conducted by the same agencies on similar lines provides a comparison. This inquiry was conducted in the Kangra Valley—a mountainous region of the Punjab—from April to October, 1938, the pre-war period. Sixty families comprising 373 individuals were under observation. The average area cultivated by a family, dependant entirely on agriculture, was approximately nine acres. The families which were engaged on some other occupation in addition to agriculture, cultivated, on an average, about four acres. The average daily diet consisted largely of cereals. In the irrigated areas rice was the predominant cereal while in non-irrigated areas relatively large quantities of maize and wheat were consumed. Pulses occupied secondary place in the diet. Vegetables were not conspicuous and the quantity of green leafy vegetables consumed was very small. In the diet of twenty-four families no green leafy vegetable was

included. Only fourteen families ate some fruit. The amount of fat consumed was also extremely small and animal fat almost negligible. In twenty-four out of sixty families no butter, *ghee* or other animal fat was consumed. Meat was almost absent from the diets. Ten families consumed no milk or butter-milk at all. Less than half the families consumed milk throughout the year. There was only one family in which the quantity of milk consumed amounted to one pound daily over the six months' period of observation. Where protective foods were included in the diet, the quantity in most cases was quite inadequate. Approximately 50 per cent of the individuals, when examined, suffered from malnutrition in some degree.

This is the position in two tracts of what is often described as the best-fed province of India. The Punjab may be surplus in food grains—cereals and pulses, but in respect of other items of food it is short of requirements, and especially with regard to the 'protective foods'.

Let us take another Province. In 1939 the economic condition of 20,000 families from different parts of Bengal was investigated. Taking this as the basis, and with the help of information collected subsequently, the Famine Inquiry Commission¹ estimated that in Bengal 7.5 million families depended wholly or mainly on cultivation of land for their livelihood. Of these less than two millions held more than five acres each, and about the same number of families held two to five acres each. The remaining, i.e., 3.5 million families, held less than two acres each or were landless. It has been estimated that the minimum area of land required to keep an average family in reasonable comfort is five acres, if the land is capable of growing both *aus* and *aman* rice. Thus at least 5.5 million families possess land less than this minimum,

¹ Famine Inquiry Commission, *Report on Bengal*, 1945.

and therefore do not produce enough for their needs and during certain times of the year have to beg or borrow or live on less than subsistent rations. The poor physique is an abundant proof of this type of existence.

In all those regions where density of population is high, and the area of cultivated land per capita is small, or yields of crop very low, the nutritional condition is very unsatisfactory. The relative body weight is an index of the low intake of food and resulting malnutrition, as the following statement² shows :

Region	Daily intake of food (calories)	Average body weight of group (lb.)
Assam, Bengal, Bihar, Eastern United Provinces, Orissa, Madras.	2,000—2,500	100—120
Western United Provinces, Central Provinces, Bombay.	2,500—3,000	120—150
Punjab, N. W. F. P.	3,000—3,500	150—170

The Growing Deterioration

The growing deterioration in food situation, as a consequence of food production not keeping pace with increase in population, has affected the rural population more than the urban population.

Road development and facilities of transport have opened village to trade, and post-war development in this direction is sure to make further changes. This is all to the good. But inroads of urban influences have broken down the self-sufficiency of the village. It has destroyed village industries, and tapped village food resources to a dangerous degree. While the village maiden is able to get red powder and lip-sticks she has to obtain these in exchange for food. She used to spend her leisure in spinning and nothing has taken its place. There are no subsidiary occupations to add to the purchasing power. These changed

² Adapted from Radhakamal Mukherjee's *Population and Food Supply*.

conditions have adversely affected the food-supply of the villager.

This is a serious matter—"a bold peasantry, their country's pride. When once destroyed, can never be supplied", and it is being destroyed over a greater part of the country.

Possibilities of Improvement

How can the diet of the villager be improved? An economist will answer the question by emphasizing the necessity of increasing the earning capacity, and consequently the purchasing power of the villager. He will lay stress on the utilization by the cultivator of his abundant leisure for productive purposes. Encouragement of cottage industries and subsidiary occupations will be the prominent features of an economist's plan. An agricultural expert, while accepting this position, will lay greater stress upon increased production of food. If the villager has money to buy more and better food, the food must be there to be bought. The present situation is that according to estimates made we are short of practically every item of our diet, and there is not food available to meet the full requirements of the country. In these circumstances the first consideration should be increased production of food by all means possible. The increase should be such that it meets fully the demands of the entire population, only then will the rural population get all that it needs.

The diversity of agricultural and social conditions makes it impossible to suggest a simple formula of universal application. While a villager of means may obtain an abundant supply of what he needs, a person with low income has to obtain all his requirements as cheaply as possible. While fish may be a useful source of cheap nutritional food for a villager in East Bengal, it will be an expensive luxury for a person in the arid regions of West Punjab. While a meat eater may

get his supply of animal proteins from several sources, milk is the only source of such proteins for a vegetarian. The problems, therefore, are essentially local and the remedies suggested must be of application to local conditions, which will include the availability of material and resources of the consumer. There is need for a planned study of the nutritional problem of the villager both vertically and horizontally.

Our food planning must be based on the most rational utilization of our agricultural resources, the fundamental object being to produce a well-balanced diet most economically. We must not be satisfied with the cheapest food, but must attempt to produce the best food cheaply.

At present our food production is dominated by a food economy based on cereals, and we measure everything with the rod stick of rice, wheat or millets. We wish to obtain all constituents of a diet from this one source. Cereals may be the easiest crops to grow, but are they the best? We must radically change our outlook and for this it is necessary that we talk in terms of carbohydrates, fats, proteins, minerals, vitamins, and determine how best we can meet our needs of these components of our diet from sources which supply them most cheaply. It is abundantly evident that tubers can produce per acre carbohydrates much in excess of what millets, wheat or rice can yield. Let us change our farm economy with a view to obtaining our required quantities of carbohydrates from the smallest area of land. Having done that let us similarly deal with fats, oils, proteins, minerals and vitamins. So far we have not studied our cropping schemes with such an object in view. We have to determine what combination of staple crops, vegetables, fruits and animals will give us the best outturn in terms of a well-balanced food. For instance will

an acre under grapes, intersown with *berseem*, which is fed to cattle, produce a more valuable diet than the same area under mangoes? Will an acre of apples inter-cropped with potatoes produce more food per acre than the same area under one of these crops. Mixed farming, using the term in a much wider sense than that in which it is usually used, is likely to add variety to our diet and produce a well-balanced food. A careful study of all combinations of mixed farming should be made for different regions of the country and for cultivators possessing holdings of different sizes. Sufficient knowledge should be obtained to advise farmers of all grades to enable them to make the best use of their resources of land, water, manure, money, labour and opportunities. The Department of Agriculture should be able to provide to each individual a complete scheme of farm and domestic economy.

At present vegetables and fruits form an insignificant part of the diet of a villager. Mere propaganda concerning the value of these foods will be of no avail. We must give the villager varieties of vegetables and fruits which will bring him per acre more food than the crop he grows. Will not carrots serve the purpose of combining excellent food value with high yield? Will not bananas provide a palatable food of high value and give a very high yield per acre? Soybean has helped the Chinese and the Japanese to solve their nutrition problem. It is making headway in the United States. The nutrition experts of India, however, have given their verdict against this 'wonder-bean'. Is this to be accepted as the last word, or is it necessary to investigate fully the potentialities, agricultural, nutritional and industrial, of this crop and then determine its place in the farm economy of India?

The shortage of 'protective' foods is far more serious than the shortage of food-grains. Fish will be one of the

cheapest sources of animal protein in such regions as East Bengal, all along the sea coast, along rivers and other similar places, but it will remain an expensive article of diet in villages far removed from the source of supply. Dried fish will overcome the difficulties of transport; for the vast vegetarian population, however, we must have something other than fish.

To be cheap in the villages, an article of diet must be produced locally. It is milk, among the 'protective' foods, which satisfies this condition. The fundamental factor in the increase of milk production is cattle food. The possibilities of any great increase in cattle food are remote. The production of milk is lowest where density of human population is highest and exactly in these regions the need for milk is the greatest. Moreover, whatever cattle food is available it goes to the bullock, which provides farm labour, and the milch-cattle suffer. The only possible solution is the reduction in the number of bullocks by introducing mechanization in farming, on as large a scale as possible. This will be practicable on a large enough scale if tractors and implements are manufactured in the country, suitable designs are evolved to suit Indian conditions, service stations are established, and cheap fuel for agricultural machinery is made available. State must foster such an enterprise.

The goat has an important role to play in the solution of the food requirements of the poor peasant. It has a bad reputation as a destroyer of all vegetation, but it is also very correctly called 'poor man's cow'. Goat could be maintained where it would be impossible to maintain a cow. The annual yield of milk per goat is estimated at 200 lb. Certain breeds give double that quantity. At the Government Cattle Farm, Hissar, some goats have given 700 lb., per lactation, and a particular individual

went up to 1,000 lb. In the United States a doe of the Saanen breed produced under test conditions 4,161 lb. of milk in nine months.

Goats, sheep, pigs, wild mammals and wild birds are sources of flesh. Very little is known of the potentialities of wild life as a source of food.

Poultry is a luxury at present and does not enter into the dietary of an average villager. It is, however, an aid to his purchasing power and has a place in village economy.

Rabbit breeding is little known in India. A quick growing and rapidly

multiplying animal has a definite place in any scheme of diet improvement.

For success of any scheme that aims at introducing new ideas, it is necessary that careful investigations, on a comprehensive scale, dealing with holdings of different sizes, under different conditions, be undertaken. The object of such investigations would be to determine how best the villager's resources can be utilized, with a view to increased food production. It must be remembered that no such scheme can be successful which ignores price stabilization.

THE STORY OF THE RICE GRAIN

By U. N. CHATTERJEE

YOU may have seen me in the vast stretches of golden yellow paddy crops standing to be harvested in the monsoon regions of India. I am no stranger to the people inhabiting this land, for to most of them I bring health and nourishment and joy of living.

Yet the people who owe to me their life, and much that it connotes, are cruel to me: they deprive me of my lovely skin: they disfigure me and break away my parts before they make use of me. What a sad return for the services I render to them!

I am familiar to you as dull white little grains which must be boiled before being served. But that is my form after many a torture borne in silence at the hands of men. After harvesting, the grain, which I represent, is separated from the straw. This grain is covered with a brown grey husk which should doubtless be removed before I can possibly be of any service. But in doing so they hand me over to owners of rice-mills where I have to undergo processes known as milling and polishing. It is during this period that I suffer most and sustain severe injuries.

With the removal of husk in these mills, I lose several layers of my skin or seed coat and also a very important part of my body, the germ or embryo, which happens to be attached to my side. Little do people realize that these parts contain much health-giving and body-building materials which they need. The portions thus removed carry away about half the mineral matter contained in me, one-fourth of the proteins and the

major portion of the vitamin content—thiamine, riboflavine and rescin—all of which are essential food constituents and are required for the proper physical growth and maintenance of health. What is left behind is only the core of the grain consisting mainly of starchy material covered over by a thin remaining portion of the innermost of the skin-layers—the aleurone layer. The starch serves to provide energy but the aleurone layer being very rich in proteins and vitamin B undoubtedly possesses health-giving and waste-repairing properties.

If my food qualities are kept intact even as they happen to be after I emerge from milling and polishing treatments, I can benefit the human beings whom I have the privilege of serving. But no, 'sufferance is the badge of my tribe'. Before I am served out I must be cooked in boiling water. Much soluble material inside the grain, including vitamin B, passes out into the water in which I am cooked; this water is invariably thrown away, thereby further depriving me of much of the remaining nutritive materials. So when I am finally placed on the table I am a poor and miserable specimen of my initial self, lacking in quality and food value. No wonder that people have run me down as an article of food. But they have judged me wrongly.

I entreat the people, for whose service I am meant, to treat me gently, kindly and with consideration. I appeal to them not to injure me as they are prone to, for in so doing they are causing harm to themselves: they do not realize what they are losing.

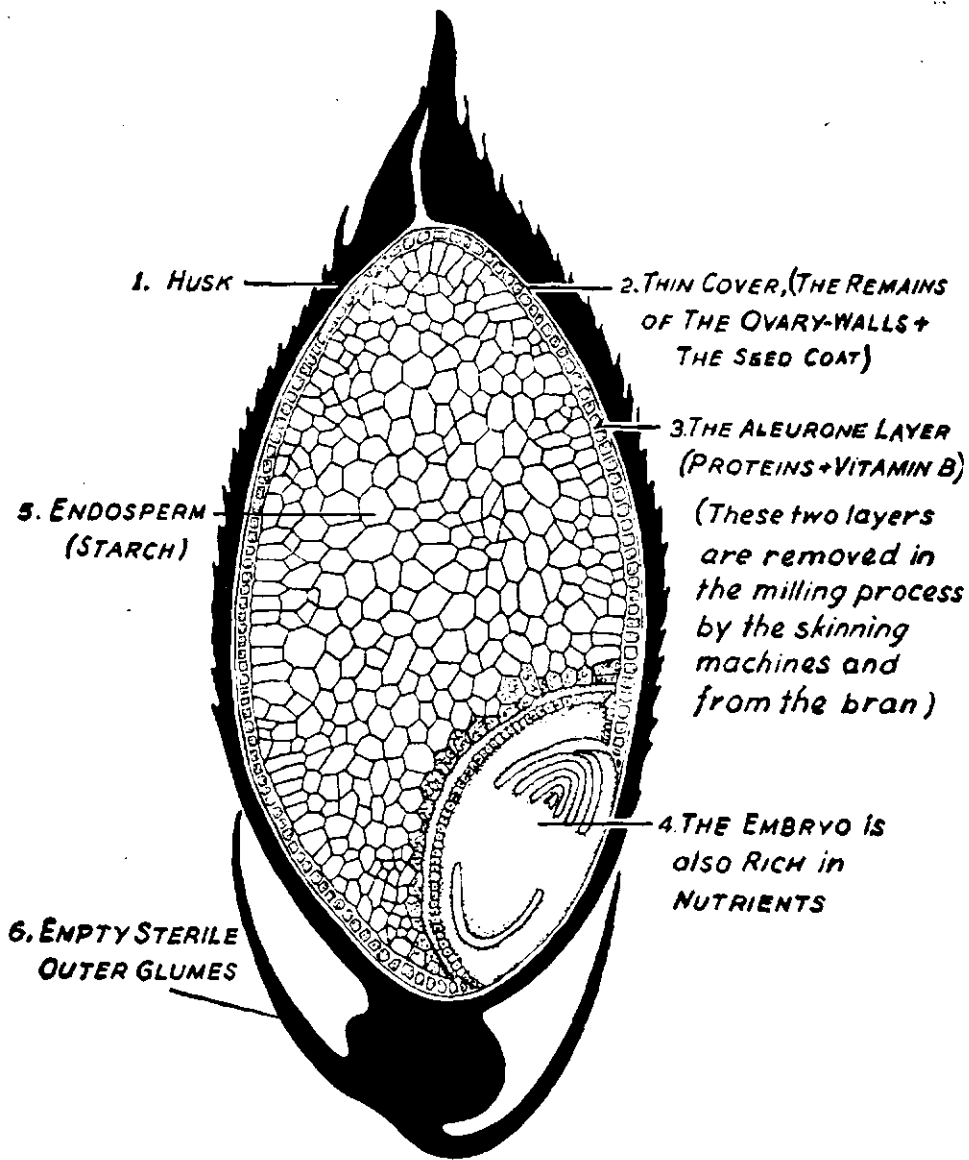

N. S. BISHOP

THE STORY OF THE RICE GRAIN

The lamentable neglect of the people is in not properly availing the richness in rice



FOOD FACTS

[Condensed from *Nutrition*]

PROTEIN is needed for the growth and repair of the body. Good sources include milk, meat, fish, eggs, pulses and nuts. Cereal grains are fairly rich.

Carbohydrates and fats are the body's chief source of fuel, but we could not live on these alone. The most important carbohydrates are sugar and starch. The vegetable fats and oils commonly used in India do not contain vitamins.

The best sources of vitamin A are fish liver oils, whole milk, butter, *ghee* and green leafy vegetables. Carrots and mangoes contain a good deal of it. Vitamin A is needed for growth and health and especially for keeping the eyes and skin in good condition.

Vitamin B₁ is needed for growth and health and for preventing the disease called beriberi. Best sources are wheat and rice bran, dried yeast, whole cereal grains and pulses.

Vitamin B₂ is also needed for growth and health and for preventing various diseases, including eye diseases and soreness of the lips and mouth. Best sources are dried yeast, milk, liver, meat, eggs and fish.

Vitamin C, which prevents scurvy, is found in fresh fruits and vegetables and sprouted grains.

Vitamin D is required by the bones. Rickets and osteomalacia are due to lack of it. It is found in whole milk, butter, *ghee* and fish liver oil. It can be manufactured in the skin by the action of sunlight.

The best source of calcium is milk. Green leafy vegetables are also a good source. Calcium is needed for building strong bones and for good growth and health.

Iron is needed to make blood. People suffering from blood destroying diseases such as malaria and hook-worm require more iron than healthy people. Whole cereals, pulses and leafy vegetables are among the foods richest in iron. Iron tablets can supply much more iron than can be obtained from ordinary foods.

Home-pounded or under-milled rice is better than very highly-milled white rice. Parboiled rice is better than raw rice. *Chappaties* and brown bread are better than white bread.

Cereal grains such as rice and wheat do not contain enough of the substances our bodies need. The diet should contain, in addition to cereals, milk, pulses, fruits and vegetables, especially green leafy vegetables, in sufficient amounts.

It is bad to eat too many sweets and sugary things. They do not supply us with protein, vitamins and mineral salts and may spoil the appetite for foods which are of greater value.

Milk is the best of all foods. It supplies all the substances which are lacking in cereal grains.

Calories : Fuel for the Human Machine

Foodstuffs supply fuel for the body. Proteins, fats and carbohydrates are sometimes known as the energy yielding food factors, since they are 'burned' or oxidized in the body to provide the energy necessary for life. Our present knowledge of what constitutes an adequate or optimum diet is based on an enormous amount of research work on human beings and laboratory animals carried out in many countries. We have a very fair idea of how much of each food factor is required and we can state

NUMBER OF MILCH CATTLE, YIELDS & ANNUAL PRODUCTION OF MILK IN DIFFERENT AREAS.

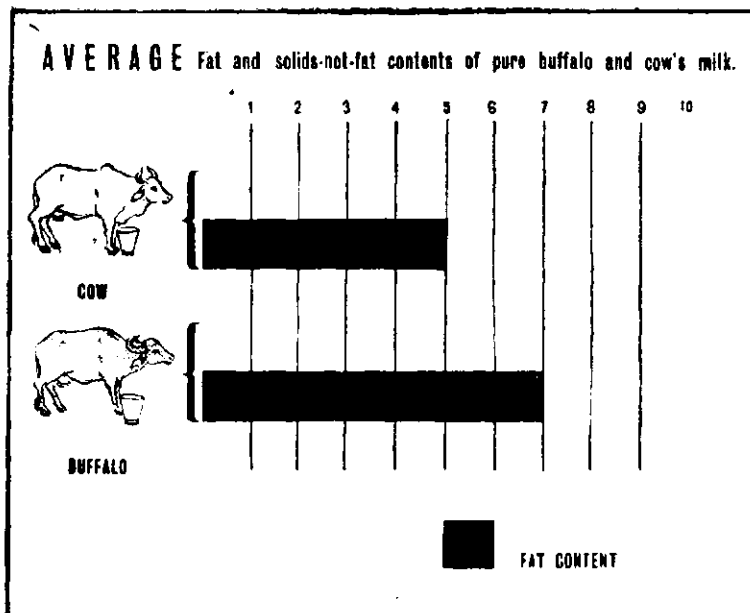
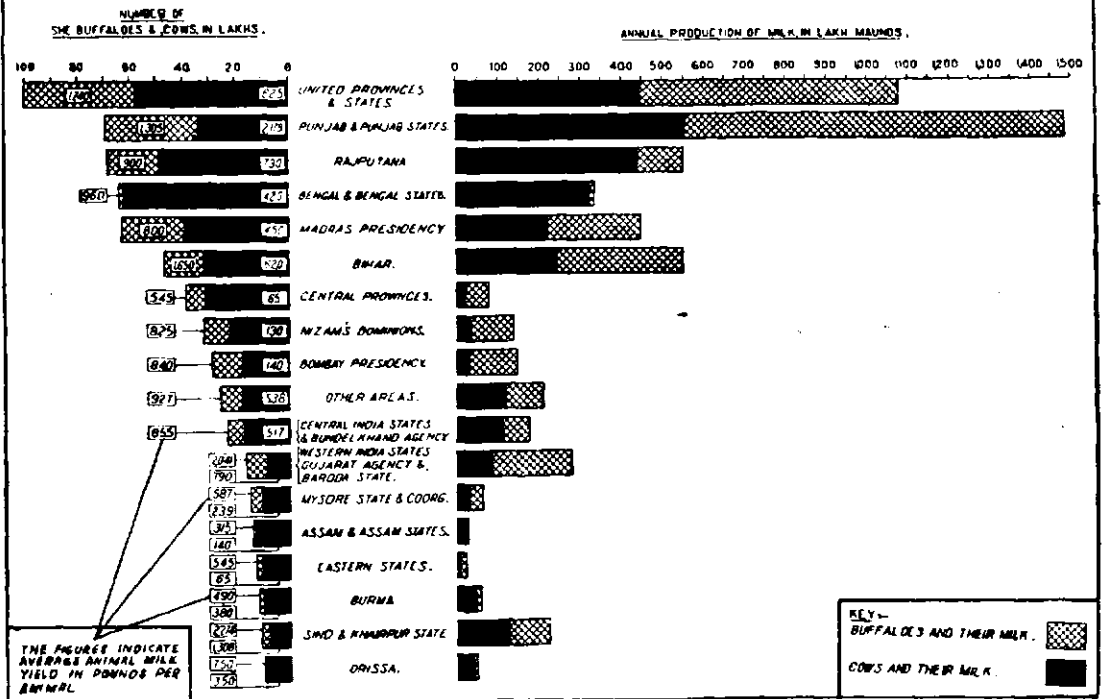

requirements in terms of common food-stuffs.

It is essential to know whether enough food is being provided and the nutrition worker, in setting up standards of food requirements, must work out standards to enable human beings to lead an energetic life at a reasonably high level of working capacity.

Quantitative food requirements are usually estimated in terms of heat units called calories. A food calorie may be defined as the amount of heat required to raise one kilogram (roughly one seer of water) through one degree centigrade (scale of temperature). Let us first illustrate the problem to be discussed by a simple example. A group of coolies is provided with a ration of 19 oz. rice and 2 oz. of pulse (*dhal*) per head per day, and very little food from other sources can be obtained by them. There are complaints that the coolies are lazy, that they work languidly and reluctantly. We will have to refer to the calorie chart.

Calorie Chart

Food	Calories per ounce
Ghee or cooking oils	255
Groundnut in shell	120
Sugar	110
Cereals or pulses	100
Condiments	60
Dry fruit	50
Goat meat	40
Milk	20
Potatoes	16
Fruit	13
Vegetables	6

Basic Calorie Requirements

Infants	Calories per day
1st week	200
1st month	240
2nd month	400
3rd month	450
5th month	600
8th month	700
12th month	800
Children	Calories per day
Child 4 & 5 years	1000
" 6 & 7 years	1300
" 8 & 9 years	1600
" 10 & 11 years	1800
" 12 & 13 years	2100

Adults	Calories per day
Adult male (over 14)	2600
Adult female (over 14)	2100
Expectant mother	2600
Nursing mother	3000

Additional Calorie Requirements

Type of work	Calories required per hour of work	Example
Light work	0—75	Domestic work Clerical work Tailoring work
Moderate work	75—150	Agricultural work
Heavy work	150—300	Sawing
Very heavy work	300 & upwards	Sports & digging.

By reference to our calorie chart and a simple calculation we discover that this amount of food would provide about 2,100 calories per day. The question arises: are they getting enough food? Or, in other words, are 2,100 calories a day sufficient for an adult man performing manual work?

An expert commission of the League of Nations had drawn up the standards of calorie requirements which apply to temperate climates.

India is mainly an agricultural country and the 'average Indian man' is engaged in manual occupation. There are justifiable reasons for reducing 'basic' calorie requirements in a warm country, in which the diet consumed is largely vegetarian, below the League of Nations standards. Let us suppose then an Indian male, of sedentary occupation, requires some 2,160 calories, a figure 10 per cent below that of the League Commission. Six hours 'moderate' work, at the lowest reckoning, will involve an increase of requirements to roughly 2,600. We shall not be very far out if we reckon the minimum calorie needs of an average Indian, engaged in ordinary easy-going agricultural or coolie work, as 2,500 to 2,600 calories per diem. Those who perform heavy manual work will probably require about 2,800 to 3,000 calories per day; if the agriculturist is to work strenuously on his holding, he must have a correspondingly high calorie intake. A similar high intake is required by athletic young

What you should eat

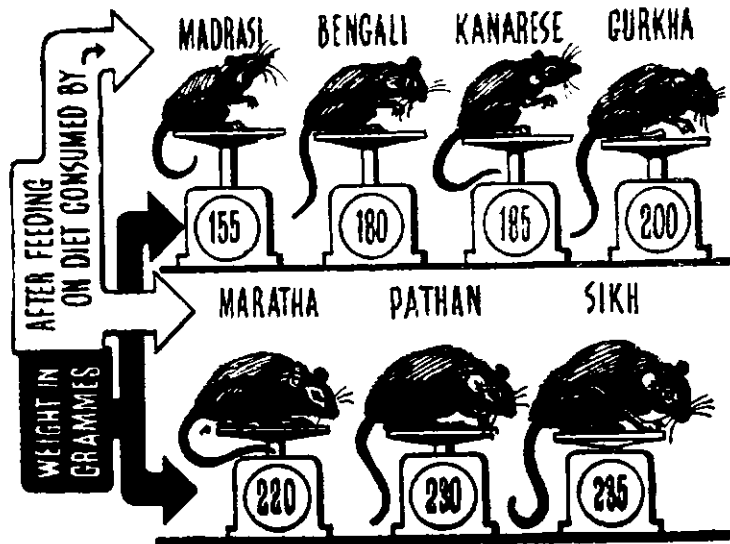
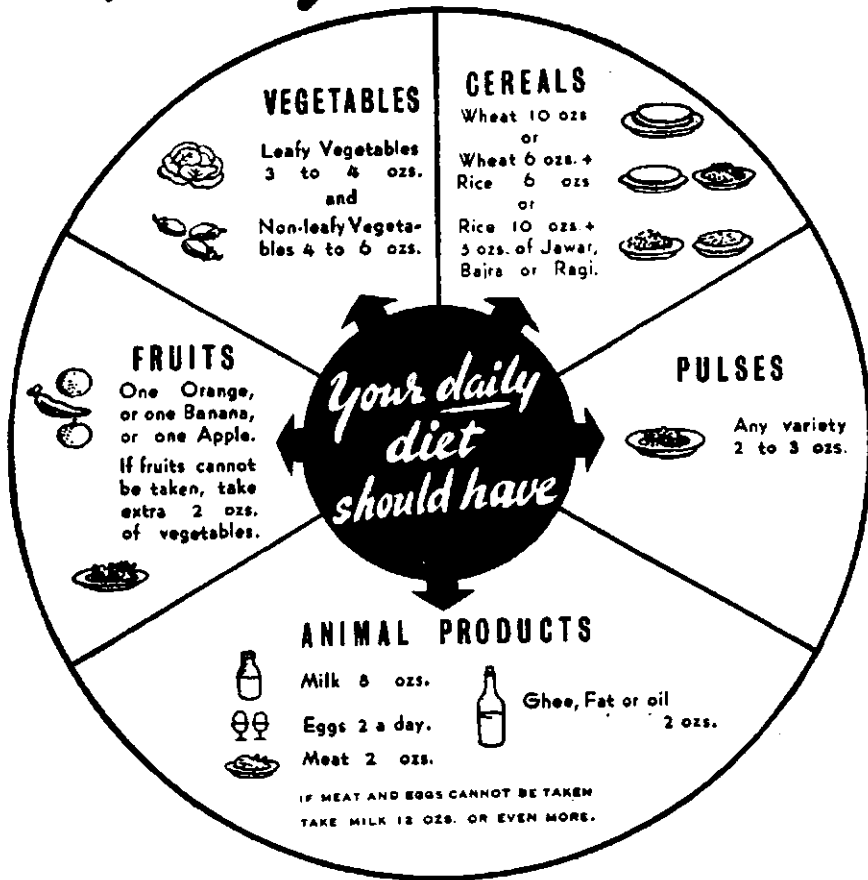

men such as university students. It scarcely needs to be said that a large man working in a cold climate will require more food than a small man working equally hard in a warm climate.

The scales of calorie requirements given in our calorie chart is put forward as sufficiently accurate for practical nutrition work in India.

It must be emphasized, however, that this scale is somewhat an arbitrary one. Physique, habits of life and other factors are so variable in different areas that no one scale of energy requirements could be entirely suitable for application throughout the country. A somewhat higher scale of requirements would perhaps be more appropriate for North India. It is possible that the proposed scale puts the requirements of an adult woman at too high a figure. During pregnancy and lactation, however, the needs of a woman may equal or exceed those of a man.

With the help of the chart we have given the calorie content of diets can be worked out and compared. Just take a pencil and paper and work out your own calorie requirements; then try to calculate whether your own meals supply your calorie needs.

Balanced Diet

For normal growth and development, it is essential that we should take the right kind of food. Food must supply proteins, fats, carbohydrates, vitamins, mineral salts and water, and we know what foods contain these substances.

A badly-fed child is often small for its age and then, its 'weight for height' will be below average. It will fall sick easily whereas a well-fed human being has a glossy skin and a glow of health. Human beings and particularly children cannot thrive at their best on a diet composed largely of cereals such as rice, millets, etc., and insufficiently supplemented by other foods. The vulnerable classes who are most likely to suffer

from various diseases of malnutrition by taking such diets are the infants, growing children and expectant and nursing mothers.

To make good the deficiencies of such defective diets, we should include those foods which are rich in proteins, vitamins and mineral salts, viz., milk, green vegetables, eggs, fruits, etc., in fair quantities, as they will protect the body against malnutrition.

For the daily requirements of an average 'rice eating' adult, a well-balanced diet should be:

Rice	10 oz.
Millets	5 oz.
Pulses	3 oz.
Milk	8 oz.
Non-leafy vegetables	6 oz.
Green-leafy vegetables	4 oz.
Fats and oils	2 oz.
Fruits	2 oz.

This diet contains all the important food factors in sufficient quantities with a fair 'margin of safety'. The chief cereal in this diet is rice, which can be substituted by wheat or millet when the latter are the staple cereals.

The simplest way of describing a balanced diet is to adopt the advice which an American nutrition expert has given:

- One-fifth for vegetables and fruits;
- One-fifth for milk, butter-milk, butter and *ghee*;
- One-fifth for meat, fish and eggs;
- One-fifth for cereals; and
- One-fifth for fats, sugars, spices and extras.

Protective Foods

It has always been assumed that diseases not due to heredity were due to presence of germs or other toxic agents. Later on it was discovered that some commonly occurring diseases arise from the absence of specific substances called vitamins in the food. Further investigations to ascertain whether deficiency in the supply of known substances might not be a source of disease, revealed that

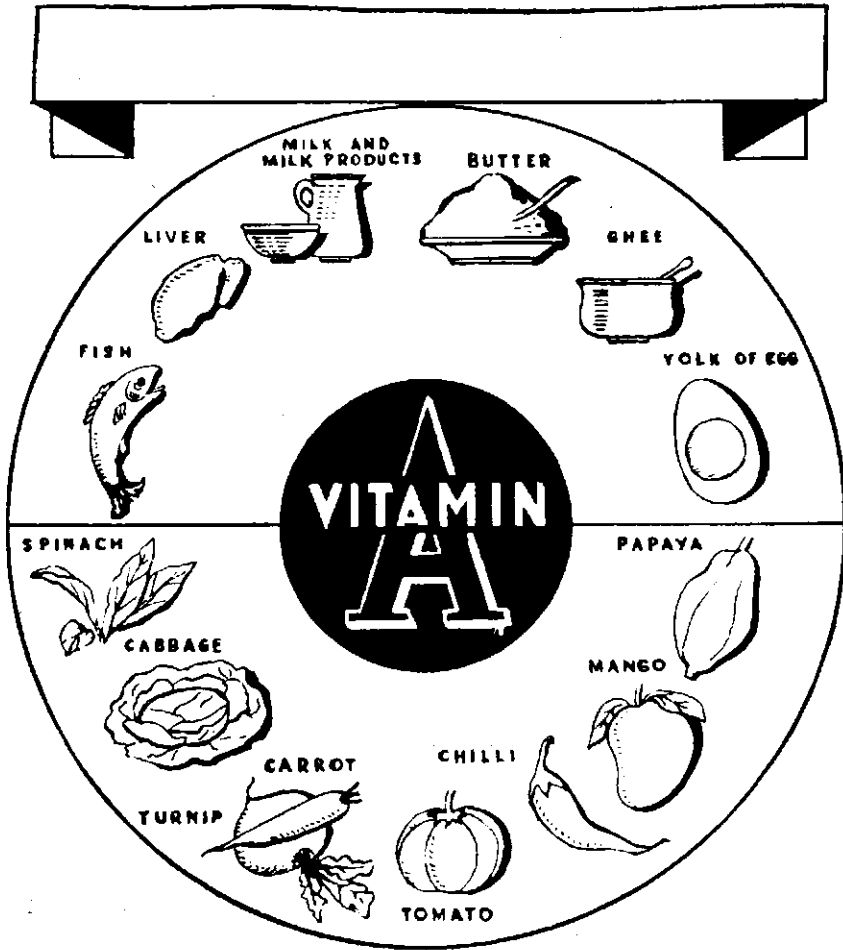

many diets in common use were deficient in some of the minerals, e.g., calcium and iron, with resulting ill-health and poor physique.

The foodstuffs rich in vitamins and minerals became known as the Protective Foods, because they protect against the deficiency diseases. They protect us against bodily weakness and provide strength, protect against disease and give health, protect infants and early mortality and give longevity.

Important examples of these are milk, eggs, fruits, vegetables, especially green leafy vegetables.

Vitamin A

Green, leafy and yellow vegetables are outstanding sources of vitamin A. Dairy products, eggs and liver (and fish liver oils) are the important animal sources. Vitamin A is well conserved in cooking. It is a fat soluble vitamin that, like all the other dietary essentials, is necessary for growth and development. It is concerned with the normal health of many of the soft tissues of the body. It is also concerned with vision. A deficiency of this factor may result in pathologic changes in the eye, skin, and other structures in the body probably resulting in an increased susceptibility to infections.

In these foods the vitamin A value is due to an orange pigment known as carotene or provitamin A, which is changed into vitamin A in the body. There is evidence that carotene in plant foods is not completely available to the body, but the vegetable foods are so rich in carotene that a single serving of some of them is capable of supplying more than the daily requirements for vitamin A. Milk, cream, butter, eggs and liver are outstanding sources of this dietary essential. In the foods of animal origin, it is present as vitamin A itself. Oleomargarine with vitamin A added provides one-eighth

of the daily adult allowance in each ounce but ordinary vegetable oleomargarine is lacking in this substance.

Deficiency in B₁

Four medical subjects received a diet deficient in vitamin B₁. The diet was otherwise adequate. It was noticed that in about 8 weeks' time definite subjective and objective symptoms appeared. These consisted of a decrease in appetite and work output, increased muscle tenderness (pain on pressure), pain, fatigue, desire for sleep and a deterioration in mental attitude, nervous stability and alertness. In passing, it may be noted that these symptoms were not of such a nature that an average man would need to ask for medical advice. There six people were receiving a small quantity of thiamin (pure B₁ vitamin). Daily additions of yeast concentrate containing about 15.5 mgs. of thiamin cured the signs and symptoms very promptly.

Vitamin in Carrots

Scientific work on the subject of stability vitamins in carrots was carried out in one of the laboratories in America. The findings are summarized below. Carrots are good sources of carotene or provitamin A as often present in vegetables and fruits. Fresh from the garden they are good sources of Vitamin C. Half the vitamin C is, however, lost before the carrot reaches the consumer, as freshly pulled ones lose their vitamin C rapidly unless kept cool and moist. The other vitamins present, e.g., A and small quantities of B are lost gradually. The loss is greater if they are kept in a warm place. During cooking and processing the loss is confined to water soluble vitamins B and C, particularly when considerable water is used in cooking. With steam cooking or with small amounts of water the losses are minimized. Prolonged cooking leads to greater loss.

CONTRIBUTION OF SELECTED SERVINGS OF A FEW FOODS AS PERCENTAGES
OF ADULT MALE ALLOWANCE (5000 INTERNATIONAL UNITS (I.U.))

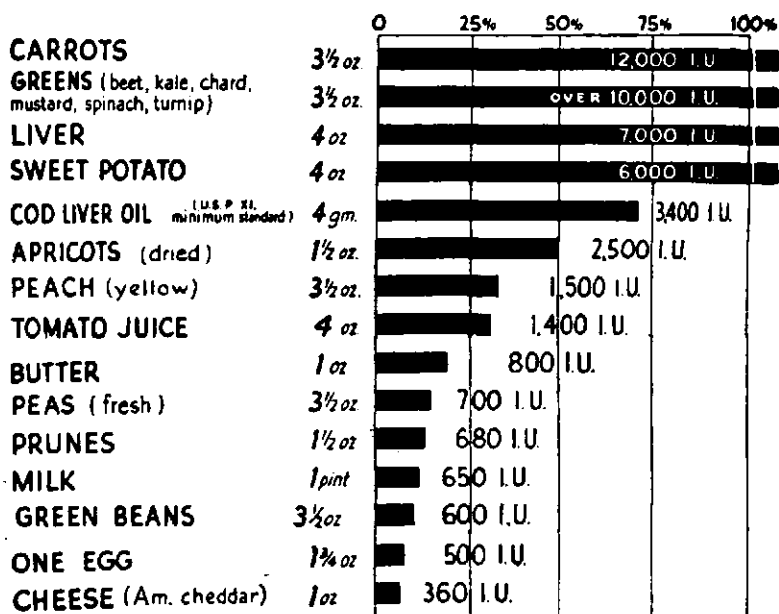

Effect of Cooking on Nutritive Value

The effect of heating and cooking on the nutritive value of foodstuffs is, on the whole, less pronounced than is generally supposed. Vitamin C is destroyed by moderate degrees of heating, and for this reason the inclusion of some raw fruit in the diet is desirable. Ordinary cooking causes little loss of proteins, fats and carbohydrates in cereals, pulses and meat; in the case of vegetables, however, there may be some protein lost on boiling, particularly when salt is used in cooking. There is a considerable loss of minerals and of the B group of vitamins when foods are washed and cooked; this loss is particularly large in the case of phosphorus in rice. During washing considerable amounts of minerals pass into the water, the proportion removed being greater than that removed by the subsequent cooking. Rice *congee* is not as a rule rich in elements contained in the original rice, and should not be regarded as being of high nutritive value.

Frying does not lead to much change in the nutritive value of foodstuffs, whether these are fried in deep or shallow fat. If *ghee* or butter is used for frying, there is some destruction of the vitamin A which these substances usually contain. The vitamin A and carotene in most foods are not seriously affected by ordinary cooking. The addition of washing soda (a strong alkali) to cooking water for the preservation of colour or to facilitate cooking, tends to promote vitamin destruction. Conversely, a substance like tamarind with high acidity has, when added to cooking water, a preservative effect.

Foods Rich in Vitamins

The following will be a very useful chart showing the presence of vitamin B₁ in various foods:

Animal foods: Liver and yolk of egg.
Vegetables: Leafy vegetables and tuberous roots.

SPECIAL NUMBER, 1946

Pulses: Lentils, red gram, Bengal gram, horse gram, cow gram, green gram and black gram.

Cereals: Rice, wheat, *jowar*, *bajra* and ragi.

Here is another significant food chart; it is highly useful to know the food values of various articles:

BUILDING	PROTECTIVE	ENERGY
Foods for building and repairing muscle	Foods for protection against ill-health	Foods for energy
Group A	Group B	Group C
<i>First Class</i>	<i>Vitamin A</i>	
Milk fresh, dried or condensed.	Milk fresh, full cream or condensed.	<i>Fats</i>
Cheese	Green Vegetables	Butter, margarine, suet, lard, dripping, cooking fat
Eggs fresh or dried.	Cheese	
Fish fresh or tinned.	These also build bones and teeth.	
Meat, bacon, offal meat	Butter, margarine, eggs fresh or canned.	
<i>Second Class</i>	Oily fish, fresh or canned.	
Should always be eaten with some of the first class.	Carrots, liver.	
Peas, beans fresh or dried.	<i>Vitamin B₁</i>	<i>Sugar</i>
Oatmeal	Peas, beans fresh or dried.	Sugar, syrup, jam, honey, dried fruit
	Lentils (<i>masoor</i>), national bread & flour, oatmeal	
	<i>Vitamin C</i>	<i>Starches</i>
	Green vegetables, root vegetables, potatoes, oranges, black currants, rose hips, tomatoes.	Potatoes, oatmeal, bread, flour, rice and other cereals

Some from each column each day

In the following chart the figures for A and B vitamin are expressed in International vitamin units per 100 grammes. Vitamin C is given in mgs. per 100 grammes. It should be remembered that rice and wheat contain no vitamin C, and flesh foods show only a trace of it.

	A	B	C
Cauliflower (<i>Phool gobhi</i>)	38	110	66
Ladies fingers (<i>Bhendi</i>)	58	21	16
Carrot (<i>Gajar</i>)	2,000 to 4,300	60	3
Cabbage (<i>Pattu gobhi</i>)	2,000	50	124
Spinach (<i>Palak</i>)	2,600 to 3,500	70	48
Lettuce (<i>Salad</i>)	2,200	90	15

Plant Groups and Rotations

The rotary system of cropping ensures that differing plants, with their different root systems and requirements, are able to make the fullest use of the soil. It also prevents to a large extent, the 'carry over' of certain pests and diseases.

Plant Groups			
A	B	C	
Beans, peas, onions, leeks, tomatoes, celery and lettuce.	Potatoes, beet, carrots, Swedes, celery and spinach.	Kales, Brussels, cabbage, cauliflower, spinach, and lettuce.	
Rotation of Groups			
1st Year	Plant group A	Plant group B	Plant group C
2nd Year	B	C	A
3rd Year	C	A	B

Food Deficiency Diseases

Food deficiencies may cause well recognized deficiency diseases. They are also certain to lead to general ill health, to increase greatly the susceptibility to many other diseases, and to impair efficiency and well-being.

In determining how far the absence of certain specific food factors leads to disease, one of the difficulties is that it is seldom possible to observe in man the effects of one food deficiency in isolation. Food deficiencies are usually multiple and the interpretation of their effects is

usually complicated by the presence of various infections. Some symptoms, particularly those of a general nature occurring in the earlier stages of a deficiency disease, may not only be characteristic of the lack of a particular food factor, but may well be the result of disease processes unrelated, or only indirectly related, to the dietary. For this reason the correct interpretation of the facts is a matter of much difficulty. It is not always helpful or justifiable to translate in terms of human beings the results of experiments on animals. The only satisfactory approach to the subject is a careful compilation and analysis of a multitude of detailed observations on both men and animals.

Nevertheless, a considerable number of specific deficiency diseases are now generally recognized. Some of these, such as scurvy and beriberi, have been known for a considerable time. Others have been associated with dietetic deficiency within the recent years. The subject is one on which much still remains uncertain. New relationships between food deficiency and disease are still no doubt to be discovered. It is possible, for instance, that tropical ulcers are directly associated with food deficiencies. Again, there is still considerable difference of opinion regarding the early signs and symptoms of deficiency diseases. While the later stages are comparatively well recognized, the early stages, in which of course the disease is much more susceptible to treatment, are likely still to pass unnoticed. Again, the effects of food deficiencies have so far only been considered in relation to the more obvious parts of the body, such as the skin, eyes, teeth, mouth, bones and blood, and little attention has been paid to their effect on tissues and organs more difficult of access and study.

The following chart will show the effects of malnutrition in the form of deficiency diseases.

Lack of vitamins	Deficiency diseases
Vitamin A	<p>Affections of the eye : Night blindness</p> <p>Keratomalacia — a common cause of blindness in India.</p> <p>Affections of the skin : Skin becomes dry and rough. Skin is covered in certain parts with small hard papules (toad skin).</p>
Vitamin B group	Impaired growth
" B ₁	Beriberi. Affection of the nervous system and blood circulation—legs become paralysed and heart weak. Loss of appetite.
" B ₂	Soreness of the mouth and tongue and white patches or ulcers at the corners of the lips. Eye troubles
Vitamin C	Scurvy—which affects teeth and gums and causes pain in the joints and painful swellings in different parts of the body particularly in the region of the ankles.
Vitamin D	Rickets (in infants and children). Osteomalacia (in adults, chiefly in women). In these diseases the bones become soft and bent, so that the person often becomes a cripple. Tooth decay

Fortifying Common Foods

Our sense of value must not be lost amidst the present day talk of vitamins. Within recent years there have been remarkable developments in synthetic vitamins and in America the large scale production of vitamin capsules has already reached gigantic proportions. The 'fortification' of common foods such as bread and margarine by incorporating vitamins is being done on a large scale in England and in the United States. We may, therefore, ask ourselves this question: Should vitamins be added to the everyday food of our people? With the safeguards of commonsense and prudence the answer is—Yes.

"The development of the manufacture of synthetic vitamins in India is recommended" says the Nutrition Advisory Committee. It must, however, be borne in mind that the administration of synthetic vitamins does not obviate the need for providing sufficient food.

For example, if they are to be given to under-nourished school children, a meal providing additional calories should also be supplied. That means more food as well.

The United Nations Conference on Food and Agriculture remarked: "The indiscriminate distribution of synthetic vitamins is not to be recommended as a public health procedure". Obviously, then, our nutrition workers have a part to play in organizing distribution along satisfactory lines and observing the results obtained. Keeping this warning in mind, there is a large scope for the vitamin industry in India; for instance, shark liver oil, full of vitamins A and D, is already being produced on a small scale. An increase in fish liver oil production largely depends on the development of our fisheries along modern lines. We shall have to compete with the imports of fish liver oil. So, measures are necessary to protect the growth of the shark liver oil industry and to develop it along satisfactory lines. Otherwise, it may disappear as it did once before in 1870. Carotene gives us vitamin A and we invent ways of producing it cheaply at home.

The manufacture of dried yeast and yeast extracts by the growth of yeast in molasses solution is another sound possibility. Yeast is of value as a supplement to poor Indian diet because of its richness in protein and vitamin of the B Group. It can be used in the treatment of malnutrition and deficiency diseases. Here is another chance for a new industry, for molasses is a product which is plentiful and cheap.

Cooking Fat

The food authorities in the U.S.A. are widely using shark liver oil to fortify oleomargarine. Perhaps, similar scope for the use of shark liver oil might be found in India to fortify animal and vegetable products used as cooking media. Products

thus fortified may be brought on an equal nutritive standard with *ghee* or butter and will eventually prove, from the mere dietetics point of view, a boon to countless people who, owing to the lack of sufficient means, are unable to afford *ghee* and butter.

A lead in this direction has already been taken in the province of Madras, where shark liver oil is being used to fortify malt at the Government Malt Factory, Coimbatore.

Food Minerals

The student of the practical problems of nutrition gives as much attention to mineral elements in food as to the energy yielding food-factors and vitamins. Apart from carbon, hydrogen, oxygen and sulphur, there are about thirteen elements which are essential components of human tissues, and a number of others which have been found in the body in very small amounts and may, or may not, fulfil an important physiological role. The essential mineral elements, like protein and fat, undergo metabolism and exchange; they are continually being discarded by the body and need replacing. Unless the loss is made good by the intake of equal quantities in water and food, physiological equilibrium cannot be maintained and health will suffer.

The functions fulfilled by the mineral elements in the body are manifold. The skeleton, for example, is largely composed of calcium phosphate. They are essential to the formation of various organic compounds which constitute the soft tissues. In solution in the body fluids, they influence the function of muscular contraction and nervous irritability, and supply material for the formation of digestive juices. They safeguard the comparative neutrality of the body fluids, including the blood. Without calcium, the blood will not coagulate. For the transport of oxygen from the lungs to the tissues, and of carbon dioxide from

the tissues to the lungs, haemoglobin is necessary, and iron is part of the haemoglobin molecule. Internal secretions or hormones, which profoundly influence the whole economy of the body, require mineral elements for their formation.

For the purpose of practical dietetics, particular stress must be laid on four elements: calcium, phosphorus, iron, and iodine. These are the elements which, as far as our present knowledge indicates, are most likely to be present in insufficient quantities in the human dietaries. Curious and remarkable deficiency diseases have been produced in the laboratory by depriving rats wholly of such elements as manganese, magnesium and zinc; their production indicates that these elements are essential to the mammalian organism, but there is yet no evidence that such diseases occur outside the laboratory. Deficiency of sodium chloride is a practical reality but it occurs in human beings only when excessive amounts of salt are lost in perspiring.

Food Yeast

In the case of wheat-eaters food yeast can be given easily by mixing with flour and *atta*. This will provide additional vitamins and proteins, some of which are lost in wheat milling. A mixture of 2 per cent food yeast does not make any alteration in the taste of bread, although the colour is slightly more brown. In the case of *chappatis* there is no noticeable change, nor are vitamins destroyed in the cooking process.

It is contemplated that with the experience gained it should be possible to expand the production of food yeast to much more than 3,000 tons a year in India, which could be introduced for civil consumption through schools, hospitals, health, welfare and maternity centres, reformatories etc., and be a powerful factor in the fight against malnutrition, which has increased manyfold owing to

war conditions. It is estimated that the cost to the consumer will not be more than 6 annas a pound.

Food yeast is far cheaper than any

animal product. In terms of yield per acre yeast is a most economical means of rapidly improving the protein content of deficient diets.

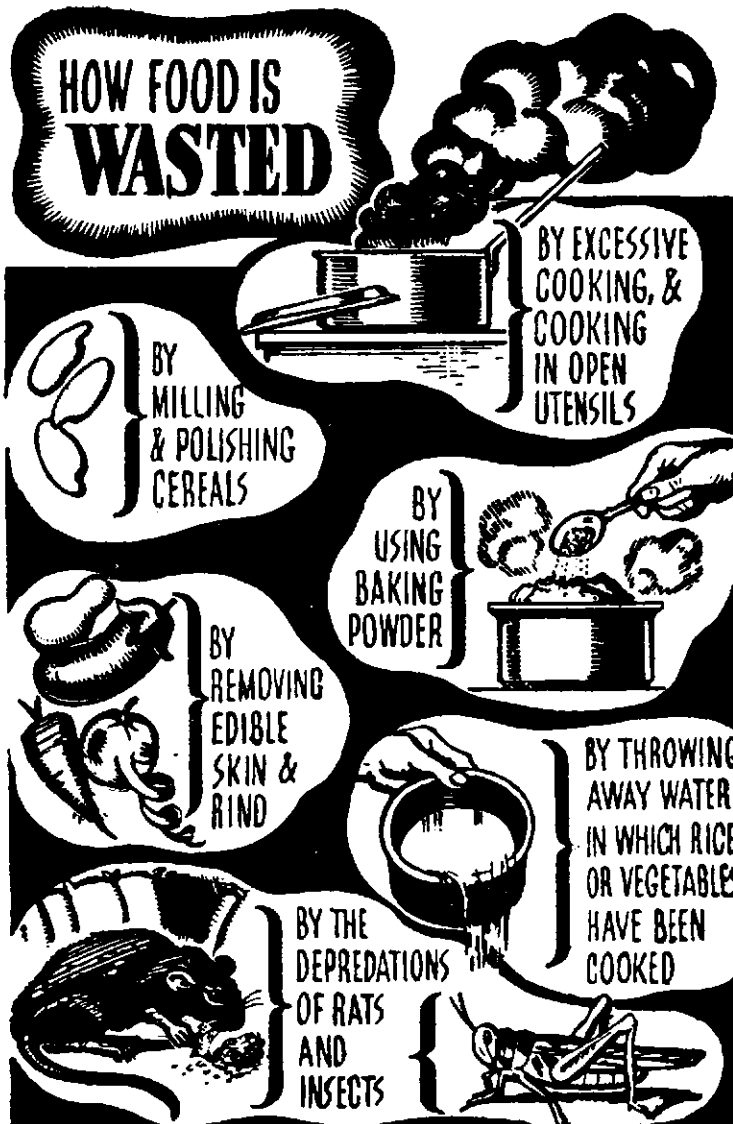

THE STORY OF THE WHEAT GRAIN

By U. N. CHATTERJEE

CAN you guess my age? Well, I am much older than the human civilization as revealed to you in pages of history. They found me in the excavated ruins of Mohenjo-Daro—already fully developed and capable of sustaining and nourishing the children of the earth. Mankind even in those early days depended on me to a great extent for its life and existence. I have witnessed the successive trappings of new comers from beyond the hills and have heard the rattlings of naked swords of many a conqueror; I have seen empires rise and fall. And yet I am here today at your service as of yore.

My original habitation was in the region now covered by Afghanistan and the areas surrounding it. But that does not matter. I am thoroughly at home on the plains of this vast country—specially in those of the north and north-western regions, where I grow as a winter crop. They put me into the soil in September-October. I grow and bloom during the cold season, the showers in winter being specially needed for my growth and development; and I am ready to be harvested with the approach of summer.

Having been cropped, I am removed to the threshing floor where the grain is separated from the straw and the coarse brownish outer covering, the glumes. And there accumulate little hillocks of grain, rich yellow in colour or amber or even red, ready to be transported for marketing or storage.

I occupy a proud place among the cereals of India—I happen to be in the envious position of being the most favoured one among them in this land

of ours. This is so not because they are unduly kind to me but because of my intrinsic merits. Nutrition experts have applauded me. I am richly endowed with proteins, carbohydrates, vitamin B, iron and phosphorus—all of which contribute to a sound body and healthy living.

But for the way they utilize me, I would be more serviceable indeed. As a preliminary step to putting me to use they powder me in mills into flour during which operation a large part of my vitamin B content gets lost; but this seems to be a necessary evil as milling reduces me to an acceptable form. Then the flour has to undergo a process of cleaning and sieving which removes the crushed remains of my skin or outer covering and a portion of the inner or aleurone layer, which together form the bran, and the little life-germ—the embryo. The bran contains proteins, vitamin B, iron and phosphorus and the embryo, proteins and vitamin B; and with their removal these nutritive elements become unavailable; people thus unwittingly deny themselves, in some measure at least, these nourishing constituents of the grain.

It may be mentioned here that the untreated flour containing the bran and the embryo, whole-meal flour as it is called, although somewhat brownish in appearance, should be considered preferable to the white flour obtained after cleaning. The reason is obvious; the whole-meal has the advantage of retaining all the health-giving elements mentioned above more or less intact.

Nonetheless, whatever that remains, even after these processes of milling and cleaning are over, serves to provide a wholesome diet with an ample supply of

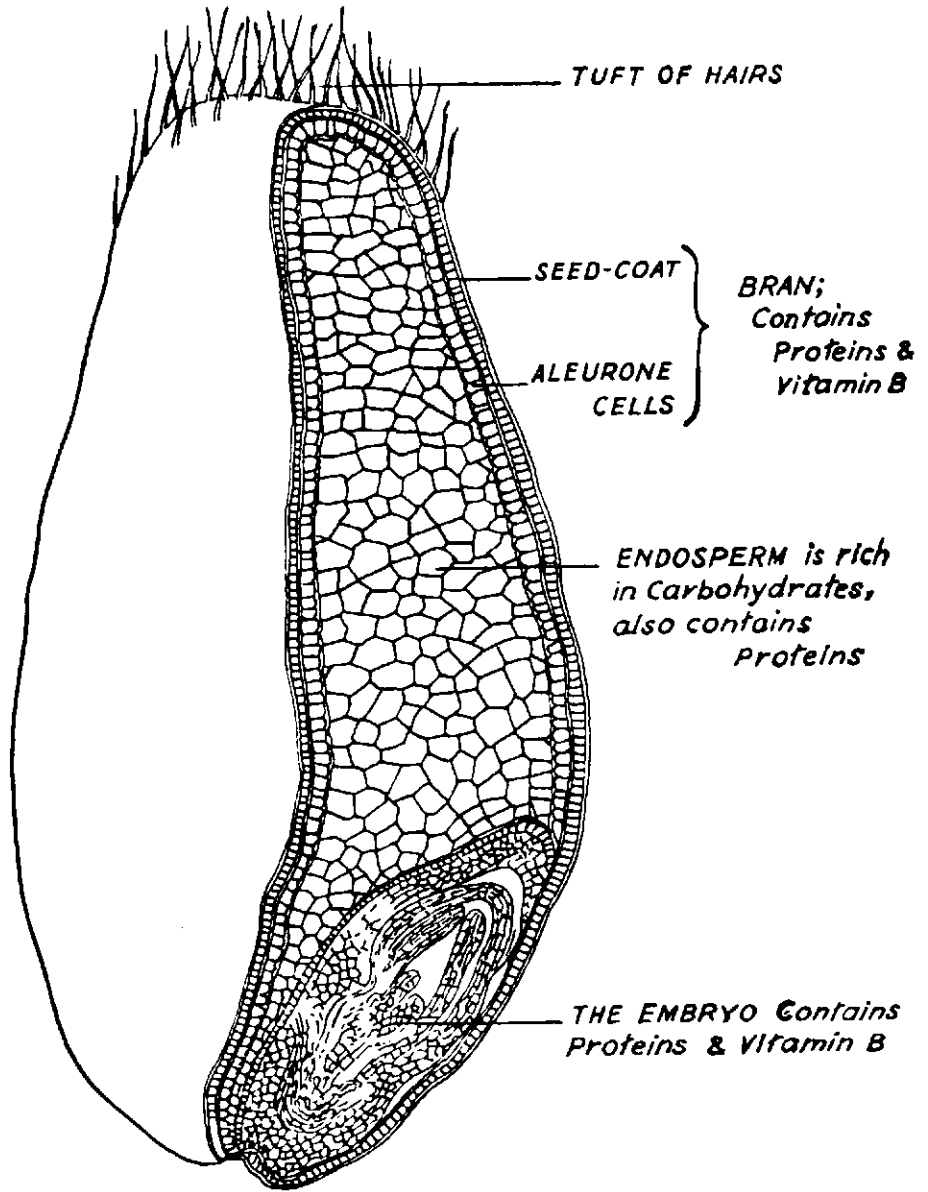

N. S. BENT

THE STORY OF THE WHEAT GRAIN
A pitiable tale of how wheat is not profitably used

carbohydrates and proteins derived mostly from the core of the grain—the endosperm. The carbohydrates are necessary for heat and energy and the proteins for flesh and muscles. That is the reason why I am preferred to other cereals;

that is why I have been able to gain the recommendation of the dietitian.

I am sought after by the healthiest section of the population for whose physical welfare I have always kept a constant vigil.



4

ANIMAL HUSBANDRY

TOO MANY CATTLE

By GRAHAME WILLIAMSON

IT is now well known that a good sized bovine weighing say 500 seers can be maintained on about two-thirds of the food required by two animals of half its size, and that it may produce as much as the two smaller animals do. It is even better known that there is a dreadful shortage of feeding stuffs of all description for the animals which India, under any conditions, must maintain for the present. As both these facts are uncontroversial and as the proper application of the first would go a long way to ease the cattle feeding situation to the owner and to the country, one would naturally assume that it would be readily acceptable and quickly applied, and yet in spite of the advice of innumerable authorities the fact remains that the cultivator continues to keep two bullocks where, in theory, one would suffice, and that the village remains apparently overburdened with underfed, under-developed low producing cattle.

The reason which is generally given to explain this state of affairs is that the cultivator is ignorant of his changed and changing circumstances, that he blindly follows tradition and practice, and that he is of a religion which abhors cattle slaughter. It is a plausible explanation and if it is the correct one, the remedy should be as straightforward and simple as the cause, educational propaganda, so that the two facts concerning overstocking and underfeeding may be drummed into the mind of the cultivator until their significance dawns upon him and he is roused to action and reform.

Hard Facts

Now the fact remains that in spite

of all the propaganda which has been carried on over the last half century and, in certain places it has been quite intense, the result, as far as it affects the subject we are now discussing, has been nil. No real change has been brought about by individual or collective effort, either official or unofficial, that is, where effort has been confined merely to showing the people why fewer cattle should be used and by helping them to obtain what are thought to be superior cattle. There must then be some other real cause which supports this apparently suicidal situation; something more than just thick-headedness and loyalty to religious precepts which are so apparently antagonistic to material welfare and which can be so easily circumvented.

The discrepancy between thought and action appears to lie in this, that the adviser tends to see his reforms take place on a background already prepared for their reception, while the cattle owner has to face the hard facts of the situation which continually confront him. It is quite obvious that before he can replace the few more efficient animals for the many less efficient ones, the circumstances under which he lives must be altered.

It must be admitted that as conditions are today there are certain advantages to be gained by a great number of cultivators in the maintenance of two small animals instead of one large one. In the struggle of a day-to-day life these advantages evidently outweigh the disadvantages as the owner sees them, and they have therefore got to be considered before reforms can be brought about for the ultimate benefit of the community.

The figures collected by the Royal Commission on Agriculture in India clearly show that the size of holding is connected with the number of cattle maintained: where there are many small holdings the number of cattle maintained is large.

Province	Total livestock per 100 acres cultivated land.	Average size of holdings. Acres
Bengal	104	2·8
U. P.	44	3·4
Assam	87	3·6
Bihar	69	3·7
Madras	49	5·8
Punjab	37	9·0
Bombay	24	12·4
C. P.	39	13·2

In Bengal about 43 per cent of the holdings are less than two acres and 54 per cent less than three acres.

Line of Reform

One can easily understand that in the absence of cooperation each small holder must have his pair of cattle. It is no use pointing out to him that if he would join with his neighbour and use one pair of good draught bullocks to do common work on contiguous holdings, the saving in food would be substantial. If economy is to be effected it will not be done by preaching good cattle to the owner, but by bringing about fundamental reforms in land tenure and social relationship. In other words, propaganda must be directed towards the authorities whose responsibility it is to develop cooperation, and not till cooperation is effected is it of much use to radically change the cultivators' cattle.

In the meantime whether the holding is small or large, the fact remains that when it comes to the threshing of corn and puddling of rice fields, eight feet are decidedly superior to four, and a weight of 250 lb. above each is as useful as, and perhaps more so, than twice that weight. There are other ways of threshing, but is there any other so economical for a man who has to deal

with some 80 maunds of material? Again, cooperation and the threshing mill may be a solution of the question, but the fact is that just now the threshing mill does not exist, while the bullocks do. The livestock reformer's efforts should, therefore, be directed to the possibility of evolving a cheaper and more efficient method of doing this work as a means of attaining his object.

It is futile to expect a man who has many small patches of ground to cultivate to keep even moderately large animals. They cannot do the continual quick twisting and turning that is necessary. Once again, therefore, the line of reform should lie not in attempting to change immediately the type of bullock to be used, but to first change the conditions of labour. If that cannot be done, then the number of bullocks must remain as they are now. Even with consolidation of holdings and cooperative unions for mutual help with equipment, a method would have to be devised whereby every cultivator could take equal advantage of the propitious ploughing days over the short period nature allows in many parts of India. The present extravagant system does afford that advantage.

It has been pointed out elsewhere that the desire for numbers rather than for quality is encouraged as an offset against death by disease. Greater numbers doubtless facilitate infection, but it must be admitted that there are other hazards than infectious disease and that the chance of losing half of one's capital against an equal chance of losing it all, is one that would be preferred by any sound businessman. The chance of one bullock falling down a well, or getting its leg broken, or being eaten by a tiger, is just half the chance of the same happening to two. Even the chance of loss from infectious diseases probably, in practice, is more favourable towards the pair than it is towards the single animal, especially in the case of anthrax,



WHICH COUNTS ?

Even less number of strong and sturdy cattle may be maintained
rather than too many cattle—lean and weak

MRS. FRANCIS STEWART BOND



tetanus, haemorrhagic septicaemia, and such other diseases as are not usually spread by direct contact. The fewer superior animals can be safeguarded against some of these infectious diseases with greater ease than the larger number of smaller animals can, but in all other aspects the hazard is the same for the large as for the small beast. For the community, therefore, in the matter of cattle health there may be much to be said for a fewer number of better cattle, but for the individual who has to stand the loss, the advantage is not so apparent and he is entitled to call on the public purse for assistance in insurance against the risk.

The Argument

As the whole policy of reducing the number of animals is aimed at saving cattle feed and thus making it easier for the owner to supply what is required, the paradoxical position is encountered whereby in many cases it may be easier, as things are today, for the owner to feed his two small animals than it would be to feed one large one, and therefore, until his conditions of existence are changed, the logic of the argument in favour of the few rather than the many is unsatisfying and unconvincing to him. Under the circumstances with which he is faced he naturally will consider only such reforms as jeopardize neither his, nor his family's, existence.

From the three acre holding of rice land, the cultivator might count on a return of about nine maunds of rice per acre with approximately 22 maunds of straw and, at the most, 27 seers of bran. His pair of 500 lb. bullocks needs at least 30 lb. of fodder per day, or 137 maunds per annum. It is evident then that if he devotes all his land to rice cultivation, he is short of feed requirements for even one pair of small bullocks. Even when applying all improved methods and increasing the yield of his

land 50 per cent, he cannot supply the cereals for an ordinary sized family and adequately maintain a pair of 500 lb. bullocks, a cow, and a weaned calf on the cultivated crops of his 3 acre holding in the thickly populated areas of heavy rainfall, and so he must turn to grazing and gleaning to supplement the cultivated fodder. It is in the dry season between the harvesting of the crops and before the ploughing has commenced, that grazing is feasible. It is in the critical two or three months of the year when grasses and vegetation are scarce and much dispersed that it is of greatest importance that his cattle should pick up sufficient upon which to exist. In such circumstances one pair of small animals has the advantage over one large animal. Each can cover the same amount of ground, each can pick up the same amount of material, but the requirements of each small one are only slightly more than half of that of the large ones. It is evident then that under these conditions many small animals may be kept alive where a few large ones would certainly die. The cure for this state of things is the collection of fodder when it is abundant and its conservation for a time of need. But we have already shown the difficulty of obtaining sufficient fodder off a 3 acre holding and so the owner must inevitably turn to the cultivated land outside his holding for any extra fodder to conserve. In areas where the holdings are very small uncultivated or grazing land is scarce or non-existent and in practically every area what grazing land there is, is free to a village or some such community. Thus the cattle of the cultivator, whose well-being is of vital importance to him and to the country, must compete for a living with the livestock of every member of the community whose determination to obtain as great a share of the common property as possible, has induced him to acquire anything on four

legs which can find free living on the common ground. The inevitable overstocking results in scarcity of grass, even in the time of so-called plenty; while the cutting and harvesting of the grass by an enterprising individual is resented by his neighbours and there is no possibility of the land being used rationally and fully. Whatever the advantages of free grazing may have been in former, less competitive, times, it must be admitted that today it is an unmitigated curse to India's cattle.

However, these are the conditions which confront the cultivator and he, being just as anxious as others to get his full share of anything going free in the shape of cattle feed, favours, both from inclination and expediency, the maintenance of the many cattle rather than the few.

In this aspect of the subject too, it is therefore necessary for the livestock improver to approach his goal indirectly and to turn his attention primarily towards grazing and grazing land reforms, a subject which, because it threatens to deprive many individuals of some paltry gain, is unpopular and difficult to handle. The practice of overstocking the available grazing lands of the country is criminally anti-social, but as yet no public opinion has been formed to counter it and no laws, except the few unpopular local forest ones, have been passed to kill it. The cultivator, faced with such a situation, will continue to keep two small animals where one under other conditions would suffice.

It has been estimated in Burn's Report of the Technological Possibilities of Agricultural Development in India that a reduction of 14 million bullocks might be brought about if the conditions we have outlined were changed, and the number of cows might be proportionately reduced; it would be folly to try to reduce the number of useful cattle until the conditions are changed. That term

'useful' however, is a relative one, but our readers will have little difficulty in withholding it from that class of cattle composed of bullocks which are passed work and cows passed breeding, the number of which in 1940 was computed to be 1.38 million. The only reasons for the continued existence of this drag upon the country's resources are those of sentiment and the possibility of gain to the greedy owner of the decrepit animal which he is allowed to maintain at public expense for the sake of the small quantity of fuel it may provide in the shape of dung. No country in these days can afford to pay so much, either for fuel or for sentiment, and any which indulges in the extravagance at the peril of its food supply, surely forfeits some of the world's sympathy.

The Effort

It is not suggested that all attempts at cattle improvement must wait until other reforms have taken place. On the contrary, the efforts which are being made to raise the efficiency of the cattle so that the cultivator will have an animal which will be as thrifty as its ancestors but which, under similar conditions, will give his owner more, is possible of achievement without fundamental reforms; so also progress against loss of efficiency and life from disease can certainly be made in the same circumstances. What this note is meant to emphasize, however, is that unless fundamental social reforms take place, there is no hope of the cattle in India being developed to the extent that they have been in other parts of the world, and that until that happens India will be the poorer and must do as best as she can with what in other conditions would be an unnecessary large number of cattle.

It is considered that the village uplift worker should be fully aware of this end of the reforms which are necessary

as well as the reasons which make them necessary. He should have them continually in mind, so that while he carries on his day-to-day improvements he should

realize that the improvements are superficial and that without fundamental changes, the full harvest of reforms is not to be reaped.

IMPROVING VILLAGE CATTLE

By SIR DATAR SINGH

UNFORTUNATELY, Indian Agriculture has developed along such lines as hardly provide enough of return to the cultivator. One of the chief factors responsible for such an unsatisfactory state of affairs is the poor condition of the cattle. It is almost impossible to do a single important operation on the farm without the aid of the bullock: the people have, therefore, realized the value of this animal from times immemorial, and their proverb that the earth is supported by a bull, is based on sound sense. Thus, the cow has been playing and will continue to play a very important part in the economics of Indian cultivation. The improvement of cattle means nothing else than the development of agriculture, and it is hardly too much to prognosticate that in any scheme of improvement of agriculture envisaged, the development of cattle will play a very important role in the history of its attainment.

Present Position

Numerically, India possesses the largest number of cattle as compared to any other country in the world. Out of the world's cattle population of 690 millions there are 215 millions found in India. It is nearly one-third of the world's cattle population. But the production of milk, when worked on the basis of per capita consumption, is extremely low in this country. It has been estimated that the average consumption of milk per head per day does not exceed seven ounces, while in other countries like New Zealand and Australia it is fifty-six and forty-five ounces respectively. According to the present day dietary

standards the quantity of milk required for the maintenance of satisfactory growth and health should be between twenty and thirty ounces per head per day. The output of milk would, therefore, need to be at least trebled in order to meet even the minimum requirements. At present, the average quantity of milk produced by an animal in a year is only 750 lb. The interval between two successive lactations is considerably longer than in most of the countries. Thus it will be evident that from economic point of view the present position of cattle in India is anything but satisfactory.

Possibilities

In order, therefore, to effect improvement in cattle, immediate attention will have to be devoted to the following important factors.

Feeding: At present our cattle, on the whole are so badly underfed that no improvement can be effected unless the feeding conditions are improved to a great extent. Malnutrition is perhaps the greatest single factor responsible for the degeneration of cattle to their present state. Against the total estimated annual requirements of 381 million tons of green fodder, 227.5 million of dry fodder and 77.5 million tons of concentrates there are only 169.1, 135.2 and 7.5 million tons available respectively. This will clearly show the magnitude of the problem of providing enough of nutrition to our cattle. Therefore, the very first step towards improvement will be to provide enough of suitable feeds for the cattle.

Increased Cultivation of Fodder Crops: At present, the tendency is to put



P. I. B.

SONS OF THE SOIL

Strong and sturdy livestock help a great deal for the prosperity of the peasant



P. I. B.

' ROSE ' AND HER MALE CALF

Sired by H. E.'s presentation bull ' Lionel ', the calf weighed 80 lb. at birth



P. I. B.

A TYPICAL COW

She won a special prize at All-India Cattle Show, New Delhi

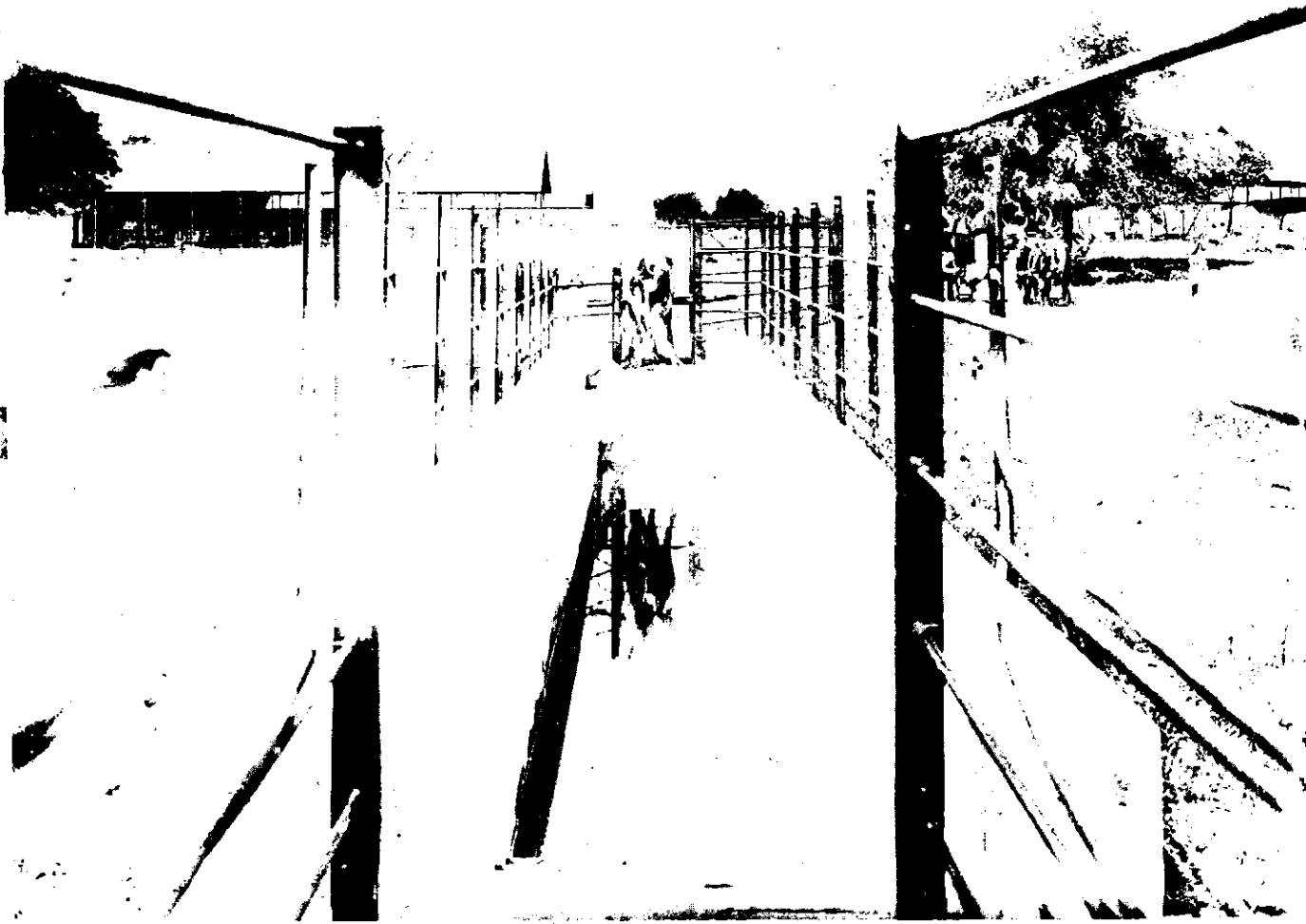

A CATTLE DIP

It is profitable if every village has one like this



THE THRESHING FLOOR

**Here the peasant gets his paddy and the livestock their
cherished food—the paddy-straw**



P. I. B.

MEMBERS OF THE FAMILY

Peasants seriously contemplate about the improvement for their cattle

more of area under cash crops, which give better returns than the fodder crops. All possible encouragement should be given to the cultivators to induce them to put more of acreage under such crops which are suitable as cattle feeds. Crops which are more nutritious and have better yields per acre should be cultivated in order to get better returns from the same area.

Proper Conservation of Fodder Crops : Silage making can be taken up under ordinary village conditions with great advantage.

Rationing of Cattle on Balanced Basis : This will go a long way to improving the condition of our cattle.

Introducing Rotational Grazing : On village pasture lands rotational grazing should be compulsorily introduced everywhere. On account of over-grazing, pasture lands deteriorate and it is essential that some pause should be given to grasses for recoupmnt. If one half of the pasture land is closed for some months and the remaining half is opened for grazing, there will be more grass for the village cattle, and at the same time, they can also have exercise in the open. At present, village pasture lands are more in the nature of exercise grounds and provide very little grass. If the policy of closure and rotational grazing is introduced, more food will be available for the cattle. In some cases, it may be necessary to plough the land and sow it with better quality grass.

Alkali Treated Paddy Straw : Cattle in rice straw areas are smaller in size and stunted in growth, and it has been found that one of the factors responsible for this is presence of excessive potash and its oxalate salts in the rice straw which has adverse effect of general metabolism including mineral as well. In a recent investigation carried out at the Imperial Veterinary Research Institute, it has been shown that the treatment with dilute solution of caustic soda increases

its nutritive value as well as its palatability as by this process, potash and some of its oxalate salts are washed away and fibre is made more digestible.

The group of experimental animals feeding on paddy straw consumed eight per cent more than the controls. The alkali treated straw fed animals at one centre were thus growing at 67 per cent accelerated rate than those fed on untreated straw, while at the other centre they were growing at 74 per cent enhanced rate.

The cost of treating the straw, which requires making of concrete tanks, free supply of water, caustic soda and labour, is about rupees four and annas four per maund as compared to rupees two per maund of untreated straw. For gain in a 100 per cent body weight, the cost of feeding and management was thirteen to fourteen pies more over the control group. The untreated straw fed animals required 67 to 74 additional days to make the same unit weight of grain.

Experiments on improving nutritive value of rice straw by mere washing it with water, which removes fairly high percentage of potash, are on the way. It has been observed that by feeding washed paddy straw, dry matter consumption is increased and the calcium balances improved. This process is more economical than treating the straw with alkali. And it is expected that it will go a long way in making up the deficiency of the cattle feed in the rice straw area.

Breeding : By judicious breeding, improvement in cattle can be achieved very effectively. At present, due to promiscuous matings there is a great degeneration in the quality. Material progress can only be achieved by increasing the number of good stud bulls. But at present, the number of such bulls fit for breeding is very small. It has been estimated that against our requirements of 250 stud bulls we have only

One available for this purpose. This acute shortage, to some extent, can be met with by the artificial insemination centres started under the scheme of the Imperial Council of Agricultural Research. These centres offer two advantages to the public: (i) approved bulls of suitable breeds will be available for service for the village cattle, and (ii) animals which ordinarily cannot be successfully impregnated due to some physiological defect can be served by artificial insemination methods.

Under the present system of letting loose bulls for breeding purposes in the villages a very common defect has been noticed. These animals are generally allowed to roam about in the locality with the result that so often these bulls damage the standing crops at night time causing great loss to the villagers. On account of this defect the villagers ill-treat these bulls and sometimes inflict serious injuries on their legs and most of them become lame. To overcome this difficulty, while the bull should be allowed to roam with the herd during day time, care-takers should be appointed to put the bull in an enclosure in the evenings. The villagers should be responsible for feeding the bull and the care-taker should collect quota of fodder from each house. The care-taker should preferably be a trained stockman so that he can give first aid treatment to the village animals and also can render assistance in case of cattle epidemics.

Along with the provision of the improved stud bulls, it will be necessary to castrate all the useless males in the villages, otherwise the good results achieved by the use of the improved bulls will be undone by the bad ones. No improvement worth the name is possible in cattle breeding unless it is rigorously supplemented by castration of useless males.

To meet the paucity of good breeding bulls in the country full use should be

made of the existing organizations and institutions such as *Gaushalas* and *Pinjrapoles*. It is estimated that there are, at present, about 3,000 *Gaushalas* in India with a population of over six lac heads of cattle which are being maintained at a cost of over 30 million rupees per annum. Out of the total population of about six lac cattle in these institutions there are about 20 per cent, classified as good. There are other 20 per cent, good for breeding, though not highly productive. At a very conservative estimate it is expected that, when re-organized on improved lines, these institutions will provide about 25,000 males fit for use as stud bulls every year for replacement in the *Gaushalas* and for free distribution in the neighbouring areas for the improvement of the village cattle. In addition to this, there will be about the same number of males available for bullock work and 50,000 improved female calves every year. In my opinion, therefore, the *Gaushalas* and *Pinjrapoles* possess not only great potentialities as a means of improving the milk supply of the towns but can also serve as centres for the preservation and betterment of the cattle wealth of the country.

Economic Emancipation

In the end, I must say that too much emphasis cannot be laid on the fact that in any scheme envisaged for the improvement of cattle on country-wide scale, the cooperation of the general public with the authorities is of utmost importance. The cultivator has a great part to play in the evolution of the economic emancipation of India. In any scheme of successful planning his part is of primary necessity. I am confident, therefore, that cultivators in this country will soon realize their responsibility and will do all in their power to get rid of their present ignorance and poverty which are the root cause of their present economic degeneration.

POULTRY FARMING

By A. J. MACDONALD

POUULTY production in India, before the outbreak of the Second World War, was almost entirely in the hands of the poorer classes. Though a certain number of birds were kept in the urban areas, the greater part of the production came from the villages. Commercial poultry farming as a specialized occupation was practically non-existent, except in the case of ducks, and it was unusual for any individual or family to keep more than ten to twelve laying birds. Under village conditions, fowls are looked upon as scavengers. Little or no hand-feeding is practised except during their early stages of growth. In the day time the birds are left to roam in search of food. In the evening, however, they are usually shut up for safety in small, dirty, ill-ventilated mud houses. Under these conditions the rate of growth is unsatisfactory, mortality in rearing is high and the egg production is low.

Prior to the war no serious attempts were made to increase production by means of large scale farms simply because the prices of poultry products were very low and the specialized producer could not compete with the cheap methods of production practised under village conditions. The low pre-war prices were largely due to very limited consumption which can be attributed to religious prejudice against including eggs and poultry in the diet, lack of knowledge of the nutritive value of poultry products and the low purchasing power of the general public. The war has, however, revolutionized the position in regard to production, for the consumption of eggs and poultry has greatly increased on account of the

demands from the defence services. The increased demands greatly enhanced the prices of poultry products but the benefit of this higher price was largely appropriated by the middleman. It is, nevertheless, true that the producers also shared the advantage of better prices but, owing to their ignorance and poverty, no serious efforts were made to increase production. In many areas the stocks of poultry were much reduced, for the more attractive prices offered by dealers tempted the producers to sell off breeding stock and the eggs which they would normally have kept back for replacement purposes. The shortage of supplies eventually forced the army to make good the deficiencies in supply by the establishment of large scale commercial farms designed on scientific lines. The civilian authorities also cooperated by introducing marketing schemes to ensure better prices to the producers and improving the general quality of the stock by the distribution of improved breeds of poultry. Improved facilities were also provided for the protection of birds against disease epidemics.

Future Development

With the termination of war and the consequent eventual decrease in demand for poultry products from the defence services it has now become necessary to review the position in regard to the future development of the poultry industry. The present food situation is undoubtedly very critical and every effort must be made to conserve vital supplies for human population. The average human diet in this country is far from satisfactory both as regards quality and

quantity. Cereals, which form the major bulk of the human diet, are deficient in proteins. The deficiency of protein in the diet can partly be made good by increasing the consumption of pulses but, as the proteins of vegetable sources are of inferior quality, it is highly desirable that part of the protein supplement should be of animal origin. The nutrition and dairy experts naturally advocate increased milk consumption but, though this is very desirable, it must be recognized that a big expansion in milk production would necessarily involve a big increase in fodder cultivation and a corresponding decrease in the area available for cereals which are so necessary to supply cheap sources of energy in the human diet. Eggs are an ideal substitute for milk and, as the present average annual consumption of eggs is only eight per head of population, it is highly desirable that egg production should be increased as far as is practical. The Nutrition Advisory Committee of the Indian Research Fund Association state that it is desirable that the annual egg consumption in India should be raised to 102,000 millions. As the present consumption is only about 3,000 million it is obvious that an immediate increase in production commensurate with the requirement is not possible nor practicable without seriously interfering with the cereal supply for the human diet. The immediate problem is, therefore, to increase production as far as practical without seriously interfering with the human food supply. Large scale increased production through the establishment of commercial farms does not seem at present to be very practical for it is necessary to feed about fourteen pounds of cereals to produce one three pound chicken and about four pounds of cereals to produce one pound of eggs. The establishment of commercial farms is also retarded by the present high costs of houses, equipment and feeding stuffs.

Poultry farmers are also reluctant to extend their activities on account of the uncertainty of the trend of poultry prices, for there is no guarantee that the present prices will be maintained over any considerable period. It, therefore, seems advisable that the main efforts to increase production should be directed to village conditions where production costs are relatively low. Under village conditions, the average egg production per annum is about 50 eggs per bird. It is generally assumed that the low egg production obtained in the village is due to the poor quality of the stock but recent work carried out by the Imperial Veterinary Research Institute indicates that the low production is primarily due to poor feeding, for ordinary village birds, if properly fed, will give an average of over 100 eggs per annum. Furthermore, good quality improved breeds which, under proper environmental conditions, give an average annual production of 150 eggs, do not normally give more than 50 eggs per bird when maintained under ordinary village conditions. Under modern conditions of poultry keeping, foreign breeds such as White Leghorns and Rhode Island Reds are undoubtedly more economic as they give more and bigger eggs and make a better utilization of the food consumed than ordinary country fowls (*desi*). As most of the work regarding poultry improvement in the villages has been devoted to distributing foreign breeds or their eggs, it is doubtful whether the results obtained have justified the expenditure involved. The introduction of improved breeds or crosses between them and country stocks improves egg size very markedly but it is doubtful whether this benefits the rural producer as he rarely receives payments for eggs on a quality basis. The introduction of foreign breeds into villages also introduces the problems of hatching and rearing as these breeds do not make as good mothers



KALSI POULTRY FARM
At Dehra Dun

P. I. B.

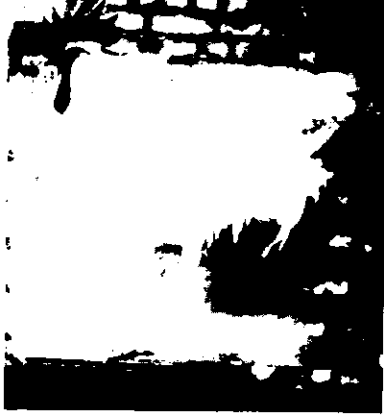

A. J. MACDONALD

1



2



3

TYPICAL COCKS

1. A white leghorn cock 2. A Rhode island red cock
3. A black minor cock, suitable for dry climate

PLATE 55

A POULTRY FARM

P. I. B.



as *desi* birds and artificial methods of rearing are not yet applicable to village conditions. It would, therefore, appear that improved stock should only be distributed to selected individuals who are prepared to maintain them under good environmental conditions.

Suggestions

The problem of feeding birds under village conditions requires much further investigation. The prevailing prices for eggs and poultry in the villages are too low to warrant the feeding of expensive well-balanced diets. From the available information, it would appear that the rate of growth and egg production could be greatly improved by the addition of proteins to the diet. The form of the protein supplement will necessarily depend on local conditions. In some villages separated milk or butter-milk might be added; in coastal areas dried fish could be used and in other areas, where these are not available, it should be possible to use cheap vegetable proteins supplemented with common salt. The marketing of poultry products is far from satisfactory, especially in rural areas, where the producer is almost entirely in the hands of the dealers. As the egg collectors offer the lowest possible price to the producer, it is highly desirable that the producers should be organized on a cooperative basis so that they can secure a remunerative price for their products. In the hot weather it is very essential that the eggs should be collected and sent to the consuming centre with the minimum of delay. As fertile eggs deteriorate much more rapidly than infertile ones at high temperatures, efforts should be made to persuade poultry keepers to produce only infertile eggs during the summer months. Losses from embryo development could also be prevented by the introduction of defertilization plants in the producing centres. Defertilized eggs keep equally as well as

infertile eggs and defertilization can be affected by holding eggs for 15 minutes in water maintained at a temperature of 135° F. Egg candling and grading should also be carried out much more extensively, for this would help to ensure good quality products to the public and help to raise market prices.

One of the major drawbacks in establishing a stable poultry industry is prevalence of diseases which periodically sweep away very large numbers of poultry. The *Ranikhet* disease, which was first diagnosed at Ranikhet in the Kumaon hills in 1927, has since established itself throughout the whole country. This disease is highly fatal and most of the birds in attacked flocks are wiped out. In some countries the disease has been stamped out by a ruthless slaughter policy, but control by this method is not practicable in India on account of the ignorance and poverty of the producers. A very successful vaccine against the *Ranikhet* disease, which renders birds permanently immune, has recently been evolved by workers at the Imperial Veterinary Research Institute, Mukteswar. The vaccine have been tried successfully in large scale field trials and regional depots for the storage and distribution of the vaccine have been opened or are about to be opened in various centres throughout the country. The establishment of these centres will enable all commercial producers to have their stocks protected against the *Ranikhet* epidemics. It will, however, not be possible to immunize all the stocks of birds maintained under village conditions but prompt vaccination of all stock in and around the affected areas should be of great benefit in restricting the spread of infection and even reducing losses in stocks which are infected with the disease.

Fowl pox is another disease which causes very heavy losses in production and high mortality amongst young

chickens. This disease can be effectively controlled by vaccination of the stock with pigeon pox vaccine. Under field conditions routine vaccination of all stock at the age of eight and twenty-four weeks is normally quite sufficient to guarantee freedom against losses.

Tick fever is another disease of major importance in all parts except South India. The presence of the tick (*Argus persicus*) which transmits the disease from fowl to fowl is often overlooked; for the adult tick only attacks fowls at night. The affected birds can be cured by an intramuscular injection of soamin or sulfarsenol. Birds can also be protected against tick fever by the injection of affected blood followed by a curative dose 48 hours later. Ticks also cause much direct loss through irritation and sucking of blood. Eradication of ticks is difficult under village conditions of poultry keeping and under these conditions it is advisable to remove the birds to fresh houses. In *pucca* houses ticks can be eliminated by the periodic use of a blow-lamp and by spraying with kerosene, preferably under pressure. Birds can also be safeguarded from attack by placing water or oil in anti-tick proof

cups placed below the perches.

Utility Breeding

Mention has already been made about the necessity of conserving food for the human diet and increasing poultry production as far as possible by expanding production under village conditions. In view of the necessity of supplementing the human diet with eggs in urban areas, where eggs are in deficient supply, it is, however, desirable to create a number of farms and run them on commercial lines. Commercial farms for the distribution of improved stock of fowls and hatching eggs should also be established throughout the country. In order that these farms may make the most efficient use of the food consumed, it is most desirable that more attention should be devoted to utility breeding, for the higher the egg production the lower the food consumption per dozen of eggs produced. In other countries utility breeding has been encouraged by the establishment of laying trials and it is highly desirable that such trials, both on all-India and provincial basis should be established as part of the post-war plan for the development of poultry.

BEE-KEEPING

By R. N. MUTTOO

LONG before man became civilizēd he had learnt the virtues of honey and was hunting bees' nests for the sake of their sweet product. Along with the bear and the badger, he too appreciated the virtues of honey. He would brave the bees and their stings to obtain this delicious food. A painting of the plaeolithic age in the Cuevas de Azana, Bicolor, near Valencia, shows him climbing a cliff to take honey from the wild bees' nest.

In those ancient days, the grubs of the bees would, perhaps, attract him quite as much as the honey. The one would provide him with nutritious nitrogenous food and the other a sweet carbohydrate energy food. Little wonder then that he was for long unmindful of the admixture of crushed bees' eggs and larvae juices in the honey he ate.

The transition from Man, the hunter of wild bees' nests, to Man, the bee-keeper of the modern type, has been very slow and gradual. Indeed even today, in India, the vast majority of us are still hunting wild bees' nests for our requirements of honey and beeswax.

Man had found out quite early in his career that bees could be persuaded to build their nests near his own dwelling and he had started providing them with suitable shelters. These shelters were of all sorts—mud and clay receptacles, baskets, wooden boxes, hollow logs and holes and crevices in walls were used for housing bees. In India today, 95 per cent of bee-keepers are still at this stage. By this means man has saved himself the trouble of going out in search of bees' nests—they are near him to be plundered in due season, or when a special guest arrives. There is otherwise

no advance in technique.

Till about a hundred years ago bee-keeping, the world over, had not progressed beyond this stage. In 1851, Father Langstroth of the United States, brought out his 'movable-frame hive' which revolutionized bee-keeping practice for the more progressive western nations. India is only now awakening to the advantages of these modern methods and it is the object of this article to bring out the salient features of these modern methods of scientific bee-keeping, and the advantages to be derived therefrom.

In the old method, the combs have to be cut and the honey pressed out of them. The resultant product, which sells in the bazars under the name of honey, is not clean. Besides honey, it contains such extraneous matter as juices of dead bees and bee larvae, crushed bees' eggs and dirt from hands. This product, moreover, soon ferments if not consumed quickly. In the olden days, they made a very good liquor out of this honey and called it mead.

The honey-comb serves both as a store-house of honey and pollen and as a cradle for developing bees. When the combs are cut and pressed out for the honey, the bees lose their homes; and, as this generally happens at a time when nectar is not available outside, the bees also perish soon after. They cannot build another home for themselves nor can they store enough surplus food to last them through the dearth period. It must be remembered that bees store quantities of honey in their combs and guard it with their lives, consuming it with miserliness for the most essential

purposes only, as a precaution against the dearth periods when flowers are not available in nature to provide them with the necessary food. These dearth periods vary with the locality. In the northern hilly areas, winter is the most difficult time for the bees. There are no flowers available for nectar-collection; and for weeks together the weather is too cold to permit bees to fly out. They spend this period inside their homes, eating up the stores, very frugally, to maintain the requisite temperature and their life-processes. If their stores of honey have been removed before the winter starts, they cannot survive.

Thus we see that the old methods result in impure, unclean honey which does not fetch a good price in the market. There is a loss of bees and combs, which reminds one of 'killing the goose which lays the golden eggs'.

Modern Methods

In the modern methods, the movable frame hive makes it possible for frames containing honey-filled combs to be lifted from the hive without disturbing the rest of the bees' nest. The bees are shaken off these honey combs and they re-enter their hives. The honey from these combs is taken out by a centrifugal machine which allows honey to be extracted from them without the combs being destroyed. The emptied combs are replaced in the hive and the bees immediately reoccupy them, clean them and then start refilling them.

The advantages of this new method are obvious and it is no wonder that this method has now replaced the old methods in the advanced countries of the world. We get the honey without the loss of bees and combs. Not a single bee need be killed in the process. The honey we get is pure and unmixed with bee larvae, etc. It is obtained and bottled without being touched by hands. The invention of the Queen Excluder makes it possible

to confine the queen, which is the only individual which lays eggs, to one part of the hive. The other parts of the hive being made inaccessible to the queen, egg-laying and brood-rearing are confined to only one portion of the hive which is known as the Brood Chamber. The other part is called the Super and in this part we get combs filled with honey only.

I have mentioned that bees have surplus honey in their hive for use in tiding over the dearth periods. It may be wondered how we provide for the maintenance of the bees when we remove their honey. We feed them sugar syrup; they collect it and store it in their combs where previously they had stored honey. Some laymen who visit the apiary at time when the bees are being fed sugar syrup, carry the mistaken impression that the sugar is converted into honey and sold as honey. The sugar fed is for the use of the bees when we have taken away their food reserves of honey.

Bee-keeping is not difficult to make any intelligent person master it and carry it on at his own home during spare hours. It is a most fascinating hobby. But like all other crafts, it has to be learnt.

Some people when they think of starting bee-keeping, immediately order some hives and bees. This is the wrong way to make the start. Ordering bees and appliances is about the last one of the many steps which have to be taken. The first step is to acquire knowledge of the theory and practice of bee-keeping. Theory is the foundation on which all bee-keeping practice is based. Many very good books exist in the English language explaining fully the theory of bee-keeping. These should be obtained and read. Periodicals on bees also exist, like the *British Bee Journal*, the *American Bee Journal*. In India, we have the *Indian Bee Journal*, published bi-monthly from Ramgarh in Nainital District of the United Provinces.

After reading some good literature on bees, one should take a short course of training in the practical handling of bees. The Agricultural Departments in several provinces in India, and in some States, hold periodically short courses of practical training in bee-keeping. Full information on the subject may be had from the Government Entomologist of your province.

Those who cannot spare the time for receiving training, may make their start after reading the books and learn by the method of trial and error. I myself learnt that way. It is an expensive and troublesome way. If you can visit the apiary of some one in your neighbourhood and see some bee-hives in actual working and have some of the practical operations demonstrated to you, like finding the queen, examining a hive, etc., it would be a great advantage.

Theory and Practice

When you have learnt both the theory and practice, enough of it to give you confidence to make a start, you may then proceed to order hives and necessary appliances and get acquainted with these when they arrive. Prepare your hives for the reception of bees, stand them at some suitable place where they will not be disturbed and where they will receive the morning and afternoon sun and some shade during the hottest part of the day. You have now to search for the bees to populate your hives.

When searching for bees, be careful which bee you go after, for some types are definitely dangerous to meddle with. In India, we have four different kinds of bees which make quantities of extractable honey. Firstly, there is *Apis dorsata*, the big bee of India. This builds its nest, consisting of single big comb, in the open, high up in the branches of tall trees or under the eaves of high buildings or in crevices in rocks. This bee will not live inside hives. All attempts to

domesticate it have failed uptill now. It is ferocious and the beginner must keep clear of it. Secondly, we have the little bee of India, *Apis florea*. This bee also builds a single comb about one foot in length and breadth; and she always builds it in the open, in branches of bushes, or in hedges, etc. The size of the comb varies greatly in different places. Sometimes it is very small, only as big as the palm of one's hand. This bee also does not like to live inside hives. But it is not dangerous in the least and on that account, and also on account of the excellent quality of its honey, it may be experimented with. The drawback to its commercial exploitation is that it produces very small quantities of honey. Then there is the third bee of the *Apis* family, known as *Apis indica*. This is of a size between the other two. This is the bee which is kept in hives. You will recognize it by the multiple parallel combs it builds. Another distinguishing feature is that it builds inside hollows and likes to work in the dark. You will find its nests inside hollow trees, in crevices in walls, underground in deserted rat holes and ant-hills, inside almirahs which have been left long unused, and in similar other places. The fourth type does not belong to the *Apis* genus at all. It is a very tiny bee, of the size of a gnat. It is stingless and produces minute quantities of rather sour-tasting honey, much in demand for some medicinal uses. It is not of any commercial importance.

The nest having been located, the next operation is to transfer it to a modern hive which has been previously prepared by you for receiving the bees.

Transferring is one of the most messy, if not the most messy, operations in bee-keeping. For success, it requires great coolness and patience.

The first thing to do is to make a hole, if one does not already exist, big enough for you to insert both your hands to

reach the combs. About half-an-hour or so before sunset, start the actual work of cutting down and transferring the combs. Cut with a sharp knife, each comb from the place of its attachment, keeping one hand under the comb as a precaution against its falling on the ground below. The knife may be wetted by dipping in water, before, during and after use. Great care is necessary to avoid bees being crushed or they become nasty and start stinging. Whatever you do, do not lose your temper; it will not help. If the bees become disturbed too much, stop the operation for a time. Leave them alone for a bit. It is fatal at this stage to give them smoke. That irritates them still further and they would recede far into the interior of the cavity and be out of your reach. The queen, particularly may be lost to you, for at such times she is the first to recede. Smoke should be used very moderately and the whole operation must be carried out causing the least possible disturbance to the bees.

Having cut the comb, gently brush off the bees from it and then tie it inside your frame, placing the cut surface against the top-bar of the frame. Banana fibre is good for tying the combs. Wide tape can also be used but would be expensive. Thin thread is unsuitable for it cuts through the soft and heavy combs. Having tied the comb securely inside the frame, place it gently in the hive, or carrying cage, as the case may be. Then proceed to cut the other combs, one by one, tying them similarly inside frames and placing the frames in the hive. Some combs may be too big for your frames. Such a comb will have to be trimmed to the size of your frame before tying. Frames should be placed very carefully and gently in the hive. If during the operation you spot the queen, and you should keep your eyes open for Her Majesty, catch her gently and cage her. Half your battle is won.

The bees will now of themselves follow here inside the hive, when the caged queen is placed inside. When all the frames have been tied up as indicated above, place the hive near the entrance hole of their old nest which should be closed. Leave it there till all the bees settle down. Now close the entrance of the hive and make it bee-tight before removing it to a place where it is to remain permanently.

The hive should be examined after a week. By this time the bees will have joined up all the combs with the wooden frames and so the fibres, with which the combs had been tied, can be cut away.

Contrary to the popular belief, bees cannot be tamed. They have not the necessary intelligence. They are creatures of instinct. Bee-keeping thus becomes a study of the habits of the bee and the application of that knowledge to derive benefit from them. Bee-keeping has been defined as 'applied bee behaviour'. We have to adapt our own methods, in all matters, to suit the habits and requirements of the bees in nature.

Most, if not all, localities in India are suitable for bee-keeping. A very common but entirely mistaken opinion held is that bee-keeping can only be a success in the hills. Many persons, in different provinces of India are keeping bees in the plains quite successfully. There is no doubt that the whole art in India is still in its infancy and our problems are many; but they can only be solved by our making an attempt at bee-keeping. Experience will, in time, remove all present-day difficulties.

When I say that bee-keeping can be carried on everywhere in India, I mean bee-keeping as a hobby, or as a side-line, subsidiary industry. For bee-keeping on a commercial scale, it is necessary to select a place which abounds in nectar-yielding flowers. A survey of the bee flora has to be undertaken. It is only

then that a commercial apiary can be located.

Anyone may 'keep' bees but only one, who can manipulate them so that they too keep him, can be termed a bee-keeper. A knowledge of the flora and weather conditions of one's locality is one of the first essentials of success.

Honey in India

A rough estimate places the total output of honey in India at five million pounds per annum. This is only about 1/20th of the total which can be collected in India if we can organize the industry and if bee-keeping comes to be extensively practised. We are annually losing so much food of high energy value.

An extension of bee-keeping will have other advantages as well. The scientist today relegates honey-production by the bee to a position of secondary importance. The primary service which the bee renders to man, he says, is that it pollinates his fruit and farm crops. The honey bee has been used in an organized and systematic manner by Russia for obtaining higher yields from certain crops. In India also, bees have been

found to increase the yield from crops like the *sarson* by about 10 per cent. Increased yields from apples, and from strawberries have been noticed by the author in the Kumaon Hills in the United Provinces. Further work in this direction is necessary and will repay itself. The production of some crops is entirely dependent on insects, e.g., such fruits as the almond and the papaya would not set fruit if there were no insects to help pollinate them. And of all insects, bees are most suitable for pollination purposes for they alone can be made available in sufficient number at the required place and at the required time. Their actions can be controlled by man for the betterment of his crops. Moreover, the honey-bee does not die out in winter as most other insects do. In early winter, specially in the hills, few if any insects are available for pollination purposes except the honeybee.

The application of the knowledge of the pollination activities of the honey-bee has many potentialities for greater production of food; and as the bee-keeping industry makes progress, naturally we will have more honey in India.

THE VILLAGE POND AND FISH PRODUCTION

By S. L. HORA

THE neglect, which the inland fisheries have suffered with the advent of British rule in India, was pointed out over three quarters of a century ago by Day¹. With the exception of the Royal Commission on Agriculture in India (1928), in recent years, no Government appears to have advocated the development of pond fisheries. The Commission observed that 'fish forms a specially valuable addition to a diet the staple of which is rice' and remarked that 'the development of inland fisheries in Bengal should be regarded as one of the most urgent measures of rural amelioration and we recommend that, if the financial position does not permit at present of the reconstitution of the department, at least one officer possessed of the necessary qualifications should be placed on special duty to promote interest among local authorities in the stocking of tanks with suitable fish and their conservation. The existing fishery departments in the Punjab, Bihar and Orissa and Madras should be strengthened for the same purpose'. These clear and far-sighted recommendations of the Commission lay buried in the Report and received much less attention from the Central or Provincial Governments than might have been expected.

In 1942, however, when the Directorate of Fisheries was revived in Bengal, one of its objects was 'to conduct investigations on tank fisheries with a view to

increasing the food supply of the province, thereby aiding in the Grow More Food campaign'. As no connected account of pond culture in India was then available, it was thought opportune to outline in a series of short articles, published in *Indian Farming*, a few hints on fish cultural practices with the object of inviting suggestions and criticisms from those engaged in the improvement of this industry. The Imperial Council of Agricultural Research thus took a lead in stimulating pond culture and by circulating a pamphlet entitled *Hints on the Development of Natural Freshwater Fisheries and Fish Farming*, written by me, infused new spirit into the country. As a result of this diffusion of knowledge, several schemes of development were taken up in the provinces and States. But soon the lack of trained personnel was keenly felt in executing the schemes and the Government of India started an Inland Fisheries Training Scheme under which trainees from all parts of India were given instructions and practical training at Calcutta for a period of six months under the Directorate of Fisheries, Bengal. A three weeks' course of instruction in Pond Culture has also been started for the training of ground staff and army personnel. All these measures for the improvement of inland fisheries, particularly regarding fish culture, had the active support and blessings of Sir Pheroze Kharegat, to whom rural India will always remain indebted.

Fish for Nutrition

The Famine Inquiry Commission in

INDIAN FARMING

¹In his *Report on the Fresh Water Fish and Fisheries of India and Burma* (1877) p. 104, Day attributed neglect of Indian fisheries to the British rules and regulations and indicated that where the supply of fish had not yet been materially diminished, the British had not 'possessed the country long enough to permit the fisheries being ruined'.

their final report (1945) refer to fish as a food of high nutritive value, and observe that in a country like India, in which the *per capita* intake of meat and milk is very small, fish has a special importance as a supplement to an ill-balanced cereal diet. They have also observed that at the present time the supply of fish is totally inadequate and suggest the development of sea, estuarine and inland fisheries as one of the most promising means of improving the diet of the people. The target for increased production is 300 per cent.

The country should be grateful to the Commission for reaffirming the value of developing Indian fisheries 'as one of the most promising means of improving the diet of the people', but I am afraid the sequence of development—sea, estuarine and inland—does not conform to the needs and requirements of the country and is not likely to fulfil the objectives the Commission had in view.

Exploiting Rivers and Lakes

Among freshwater fisheries, the exploitation of rivers, lakes and *jheels* has to be correlated with their productive capacity, natural recuperation, conservation, etc., and, therefore, they have to be very judiciously worked on a long-range plan in the interest of posterity, for if a fishery is depleted through over-fishing, it may take very long to replenish it to its original capacity. Owing to large seasonal production, these fisheries have to face the problems of refrigeration, transport and marketing as is the case with the marine and estuarine fisheries, though to a very small extent.

Benefits of Pond Culture

The Famine Inquiry Commission suggested that the Food Policy of the Government of India should serve two objectives: (i) providing the poor with sufficient, balanced diet and (ii) raising

his standard of living so as to enable him to buy protective foods. Both these objectives can be achieved by the proper utilization of the village pond. The ideal aimed at must be not only to make protective food available to every one but also to make each area self-sufficient in itself so as to do away with the necessity to transport food over long distances. If each village developed its own tank fisheries, it could feed itself without depending on supply from outside. If an excess in quantity is caught on a particular day, it could be stored in the tank itself and there will be very little chance of wastage. Thus the problems of distribution, preservation and marketing do not arise in the case of tank fisheries. Tank culture will provide an extra income from the sale of fish and would thereby increase the purchasing power of the farmer.

At present, an average village tank, is in an insanitary condition and almost neglected. It breeds mosquitoes and is a regular eye sore in picturesque rural surroundings. Unless there is a monetary objective behind their improvement, no amount of sermons can do any good. Fish culture is the only remedy to improve them, for it presupposes suitable embankments, clearing of excess vegetation, drying up the whole or a part every year or occasionally, and maintaining it in a sanitary condition for the healthy growth of fishes. Thus, fish culture alone can impart to a village pond sufficient dignity. If it is further explained that as the use of its water for irrigation to raise winter crops and the use of its banks and embankments for growing vegetables and fruits do not interfere with fish culture, I am sure its sanctity will become much greater. Milk is very scarce in India and increased production of milk depends not only on better breeds of cattle but to a very great extent on the availability of fodder. During the rains, there is a certain amount of green grass but in

the dry months use of tank water to produce fodder crops can keep the cattle in a fit condition. If you keep your cattle round your tank then the washings of the cattle-shed will be helpful to fertilize the tank water and encourage growth of fish. Duck rearing is another profitable cottage industry and the owner of a tank, besides rearing fish in it, growing vegetables and fruits on its embankments and irrigating his land for double cropping, can use it for duck rearing with advantage to the fishery. Ducks will control excess vegetation, feed on insects, snails and bivalves and fertilize the water with their excreta of great manurial value.

Any collection of water can be used for fish culture. An occasional pool, which dries up after two or three months, can be used as a nursery, while a short-seasonal pond, which dries up after five to six months, can be used as a rearing tank. Long-seasonal tanks, which dry up annually for a month or two, are the best for the growth of the fish while perennial tanks can be used for stocks. It is generally not realized that nothing decreases the productivity of a tank more rapidly than the continual immersion of its bottom.

I have attempted to show the manifold benefits of pond culture and to indicate how other food industries connected with the production of protective foods can be correlated with fish culture.

Causes for Neglect

We may now examine the causes that have brought about the neglect of pond fisheries and the measures that would seem to be necessary to resuscitate them.

The causes which led to the neglect of village ponds deserve a close study.

Owners Migrating to the Towns : With the growth of towns and cities, the landlords as well as important persons in the village, who could do something for the prosperity of the countryside,

began to flock to towns. Tanks, thus being neglected, mostly became silted up and over-grown with vegetation in course of time. Not only are these tanks now unfit for pisciculture but they have become breeding grounds of mosquitoes and other disease-spreading organisms.

Lack of Initiative and Enterprise on the Part of Owners : Even those landlords who still live in the countryside hardly have any initiative or energy to take to pond culture on scientific lines. This is partly due to the fact that most of the tank owners do not know that with a little labour and capital it is possible to get much more money-value from the fish crop than from other food crops under comparable conditions.

Reluctance of Owners to culture Fish on Sentimental Grounds : Fish culture, as a profession, used to be looked down upon, in the past, but fortunately through propaganda and demonstration, the prejudice, so far as Bengal is concerned, is gradually breaking down and more and more people are taking to pisciculture.

Reluctance of Owners to lease out Tanks : The same sentimental ground is also somewhat responsible for the reluctance of owners to lease out tanks for fish culture to enterprising persons or organizations. This is a very unfortunate position because neither the owners would develop their tanks themselves nor allow others to do it for a fair rent. It would thus appear that whereas there are some tank owners who would not develop or let out their tanks, there are persons who have no tanks of their own but are anxious to obtain others' tanks on reasonable terms for growing fish.

Want of Technical Knowledge : Even when tanks are available and really enthusiastic persons are there for fish culture, want of technical knowledge stands in the way of achieving the best possible results. Except in the vicinity of Calcutta, where fish farmers have picked up some technical knowledge by long experience,



S. L. HORA

DRAG NET

The fishermen are nicely doing their job



S. L. MORA

AH! FISH ARE CAUGHT
The fisherman is joyous for his day's reward



S. L. HORA

THE MIRACULOUS NET

Rightly proud are the fishermen of the heaps of fish



S. L. MORA

COMMUNITY WORK
The undersized fish being serfed for stocking a larger
and deeper pond

the method of pond culture in the rest of India, to say the least, is crude and primitive. Apart from detailed scientific knowledge in the technique of pisciculture, such basic ideas as manure, elimination of predatory fishes, provision of food for fish, etc., are almost new to fish farmers in rural areas. The result is that on account of imperfect methods, even those who take to fish culture for some time, find it unremunerative in comparison with other food crops and ultimately give it up in despair.

Multiple Ownership of Tanks: Multiple ownership of tanks is another stumbling block in the way of development of tanks. Even when some of the co-sharers are agreeable either to develop their tanks or lease them out to enterprising persons or organizations, the rest of the co-sharers may be unwilling and render any scheme of tank development infructuous. Even if it were assumed that all the co-sharers are reasonable enough not to put any impediment in the way of tank development by some of the co-sharers or by a lessee, it is not easy to contact them as they are often scattered over a wide area.

Non-availability of Fish Seed: This is another important factor which stands in the way of stocking tanks with fish, even when other conditions are satisfied. In many parts of rural Bengal, fry is difficult to get and even when they are available they are not of a suitable type and the yield is, therefore, not up to expectation. Fortunately, there is an organized fish fry trade in Bengal and, with some effort, this difficulty can be got over, but in several other parts of India the question of fish-seed supply is much more serious.

The Difficulties

The Directorate of Fisheries, Bengal has a number of schemes in operation, as well as in contemplation, for attacking the difficulties set out above. Constant

propaganda has been and is being carried on by the officers of the Directorate in favour of rural pisciculture and they are also disseminating technical knowledge regarding improved methods of carp farming. The difficulty of obtaining fry in the rural areas was partly solved by setting up nurseries in nine districts of Bengal last year and the same scheme is going to be taken up this year, too, on a more comprehensive scale. The Directorate also attended to the difficulties of fry catchers and carriers of spawn last year and was instrumental in removing most of the handicaps which cropped up as a result of the war emergency. Similar activities are going to be pursued this year too. The question of the development of tanks in the rural areas will, however, continue to remain a distressing factor unless some power is vested in the Government to transfer possession of such tanks from owners unable or unwilling to develop these tanks to enterprising persons or organizations on such terms as the Government may think fit.

The American Example

Some of my friends and critics scoff at the idea that in the present-day utilitarian world of machinery, chemicals and atomic energy, I should be advocating pond culture. This outlook can only be due to their ignorance of the immense possibilities of scientific pisciculture, as practised in Central Europe, Palestine and the United States, where it has become a classic example¹. From the United States, where the technique of refrigeration and transport is most highly developed, reports are being received that pond culture has caught the fancy of the farmers and new ponds are being excavated everywhere. The following extract from *NA. 380, BCSO 411* of the

¹ Gross, Raymond, Marshall and Orr, *A Fish-Farming Experiment in a Sea Loch. Nature*, Vol. 153, April 22, 1944, p. 483.

Australian Scientific Research Liaison Officer, Washington, should be read with interest in this country :

“ In the United States the SCS (Soil Conservation Service) has sponsored the building of small artificial lakes or ponds on farms for reasons of stock watering, reduction of fire hazards, and soil conservation and has recommended stocking them with fish, both for their value as sources of food and of recreation. The Fish and Wildlife Service has been very active in sponsoring this programme and in stocking streams, ponds, and lakes and doing fundamental research on ‘aquatic agriculture’. But their prime interest has been in game fish and not in food fish. The fish now usually used for stocking are black bass and blue gilled sunfish. The former is a game fish and sale of it as food is not permitted in most States of the Union. The latter is a forage fish, makes a good pan fish, and like the bass it is protected in many States. From the viewpoint of a converter of elementary foodstuffs to protein the carp would be much more efficient but there is considerable prejudice against carp as food in the U.S.A. except from special sources. Actually it is now a several million dollar business but is small in comparison with that it could be but for buyer prejudices. Carp would probably be the fish of choice for use in situations where the protein diet requires amplification. Its main disadvantage is that it muddies the water to such an extent that some other desirable species do not do well with it. It has a ‘stronger’ taste than the other species mentioned. Black bass and blue gill together make one of the best combinations to be successful in South Africa where both species have been introduced.

“ The SCS have records of the stocking of over 10,000 ponds in the last five years. Half of these were stocked in 1944; so the practice is very rapidly becoming popular. In addition there are

thousands of ponds which have been stocked by State agencies so the total cannot be estimated. The ponds serviced by the SCS have an average surface area of about two acres. Only a very few are 100 acres or more.

“ The yield from these ponds indicates that they can supply a useful quantity of food. Unfertilized ponds in Alabama have yielded 40 to 200 lb. of fish per acre per annum, while fertilized ponds have yielded 500 to 600 lb. per acre per annum. In Illinois the average is in the vicinity of 400 lb. per acre with a range from 215 to 1145 lb. per acre. These are unfertilized ponds and, as would be expected, fertilization is less effective in these than where the drainage is from poorer soils. The figures for the entire U.S. indicate that fertilization of fish ponds approximately doubles the yield. The cost of proper fertilization ranges from \$ 11 to \$ 20 per acre per season. Fertilization, therefore, is economical if the pond is properly stocked and adequately cropped. Probably greatest causes for poor fishing in stocked ponds are the presence of undesirable species and unsatisfactory combinations.”

Great Possibilities

In India, chemical fertilizers have not yet been used in fish farming but from the above it will be clear that possibilities of increasing protein food are immense through adopting proper cultural operations. The Indian carps do not muddy the water and can live happily in association with other suitable species. Moreover, Indian carps are in great demand by the rural population who have no prejudices against taking them. In fact, in the old Hindu literature these fish have been recommended as of fine flavour and of great nutritive value. The *rohita* carp of Bengal finds a special mention :

“ The fish that is black, scaly, white-sided and round-faced is called *rohita*. It is the best fish. Its flesh, when eaten



S. L. HORA

DEVELOPING FISH CULTURE

The fishermen are seen transferring undersized fish to another pond with earthen and metal containers



S. L. HORA

NOW MONEY IS MADE

The fisherman seen weighing and selling marketable sized fish



IDEA TURNED TO ACTUALITY

1. Plantain plant, 2. Vegetable garden, 3. Cattle shed, 4. Sugarcane plantation, 5. Homestead, 6. Coconut tree, 7. Duck farm, 8. Papaya tree, 9. Fish pond, 10. Pumpkins on bamboo platforms, 11. Tube well, 12. 'Donga'—a lift-irrigation device

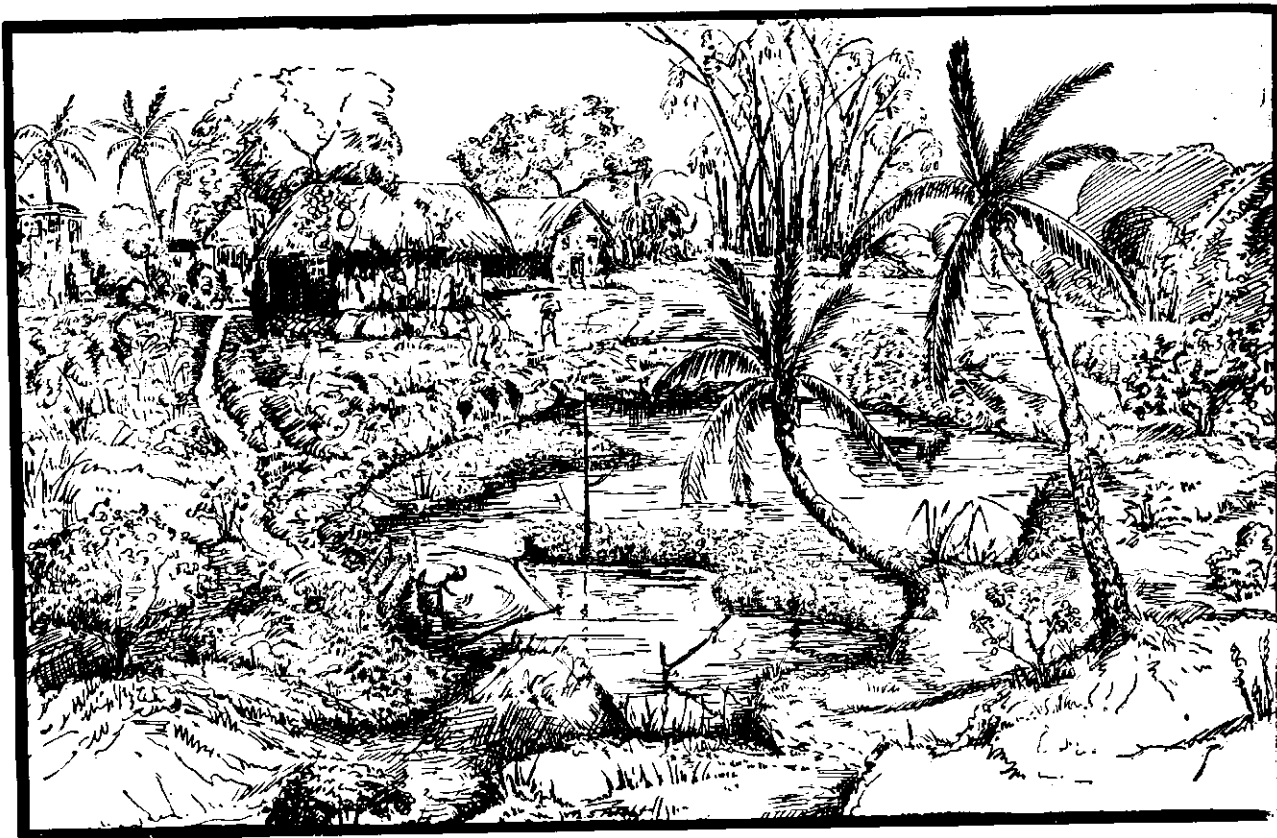

A NEGLECTED VILLAGE POND

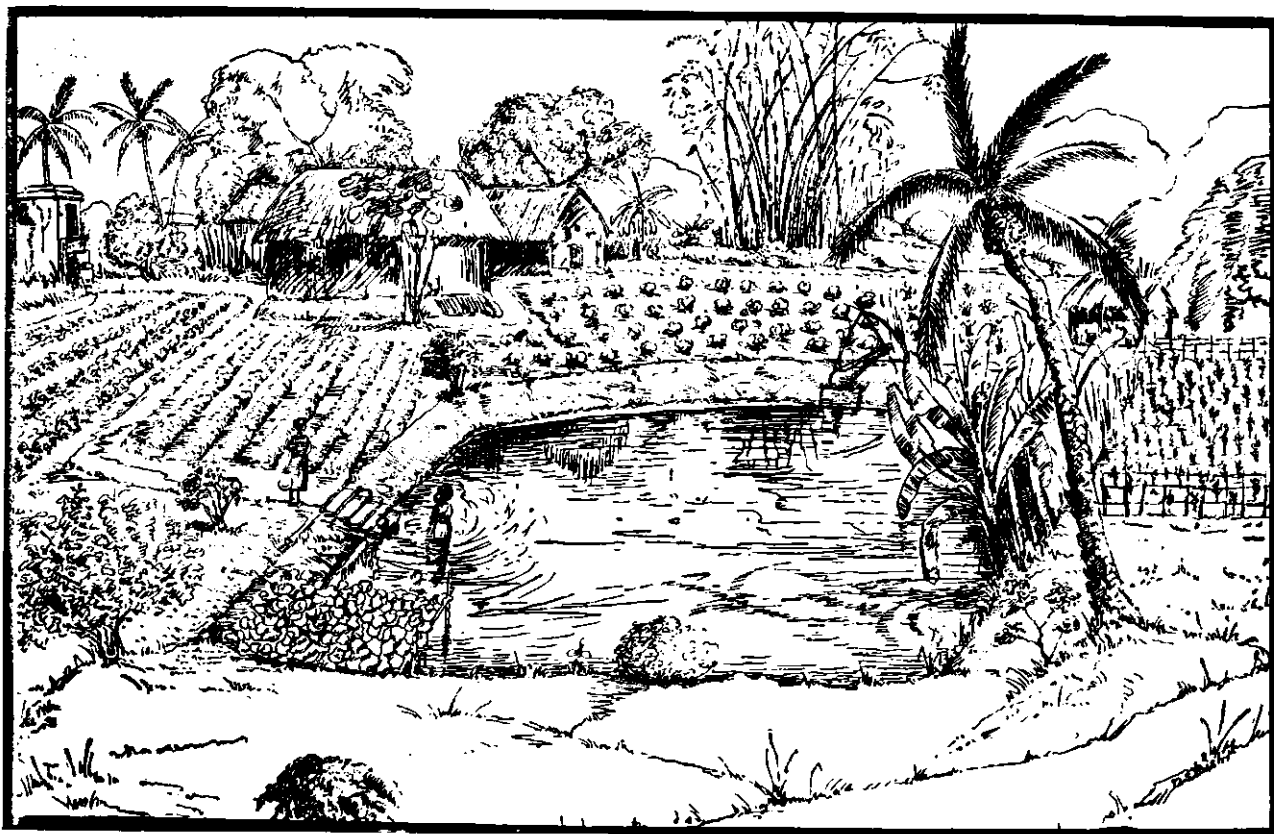

AN IMPROVED VILLAGE POND

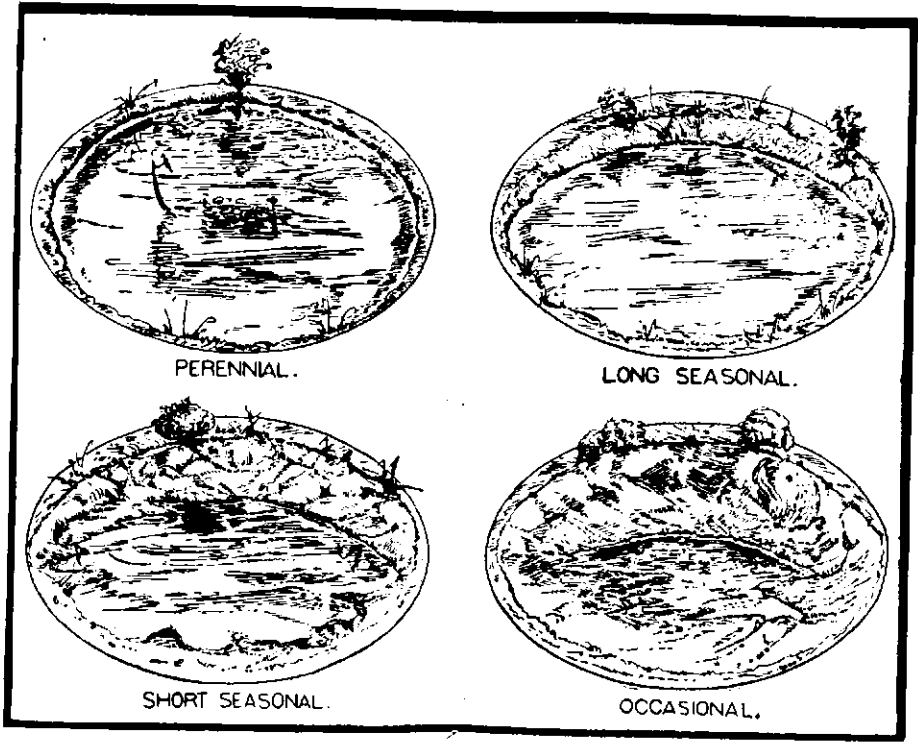

VARIOUS TYPES OF VILLAGE PONDS

warm, is also invigorating. It increases energy and cures one of *vata* (diseases like gout, pains in joints, etc.).

“*Bhavaprakasa* (a work on Ayurveda Medicine) gives the following description of the *rohita* carp :

“The red-bellied, red-faced, red-eyed, red-flanked, and black-tailed *rohita* is said by experts to be the best among fishes.”¹

During the war, *rohita* carp was sold by trade to the British and American armies as Indian salmon on account of the pink colour on the body and was evidently relished by troops.

I was told by one of the leading Indian chemists that there is no agricultural crop or animal husbandry practice by which it is possible to obtain 1,145 lb. of protein food per acre per annum. When this observation is coupled with the fact that fish can be grown in a low, waste land not suitable for agriculture, the economic value of a village pond is all the more enhanced. It would, therefore, appear an urgent necessity that in accordance with the recommendations of the Royal Commission on Agriculture in India, all provinces and States should employ officers possessing the necessary

¹ *Rajanirghantu (Dictionary of Medical Terms)*, XVII, p. 67.

qualifications to promote interest among farmers ‘in the stocking of tanks with suitable fish and their conservation’.

Malaria and Fish Culture

Malaria is enemy No. 1 in India and the usual anti-malaria measures so far adopted are not applicable to rural surroundings. Reporting Committee of the Malaria Commission of the League of Nations (1937) comprising of Hackett, Russell, Scharff and Senior White in their report on ‘The Present Use of Naturalistic Measures in the Control of Malaria’ observes: “The Committee desires to stress the fact that rural malaria, especially in the tropics, is one of the principal unsolved problems in the field of public health and that, in naturalistic methods of control, there appears to be a potential solution”.

Among naturalistic methods, the Committee has attached considerable importance to biological measures. For the improvement of sanitation of village ponds, these can be no better incentive than their utilization for fish culture. Both from the point of view of food production and sanitation of ponds, development of village pond fisheries should be an important item of the public health programme of India.

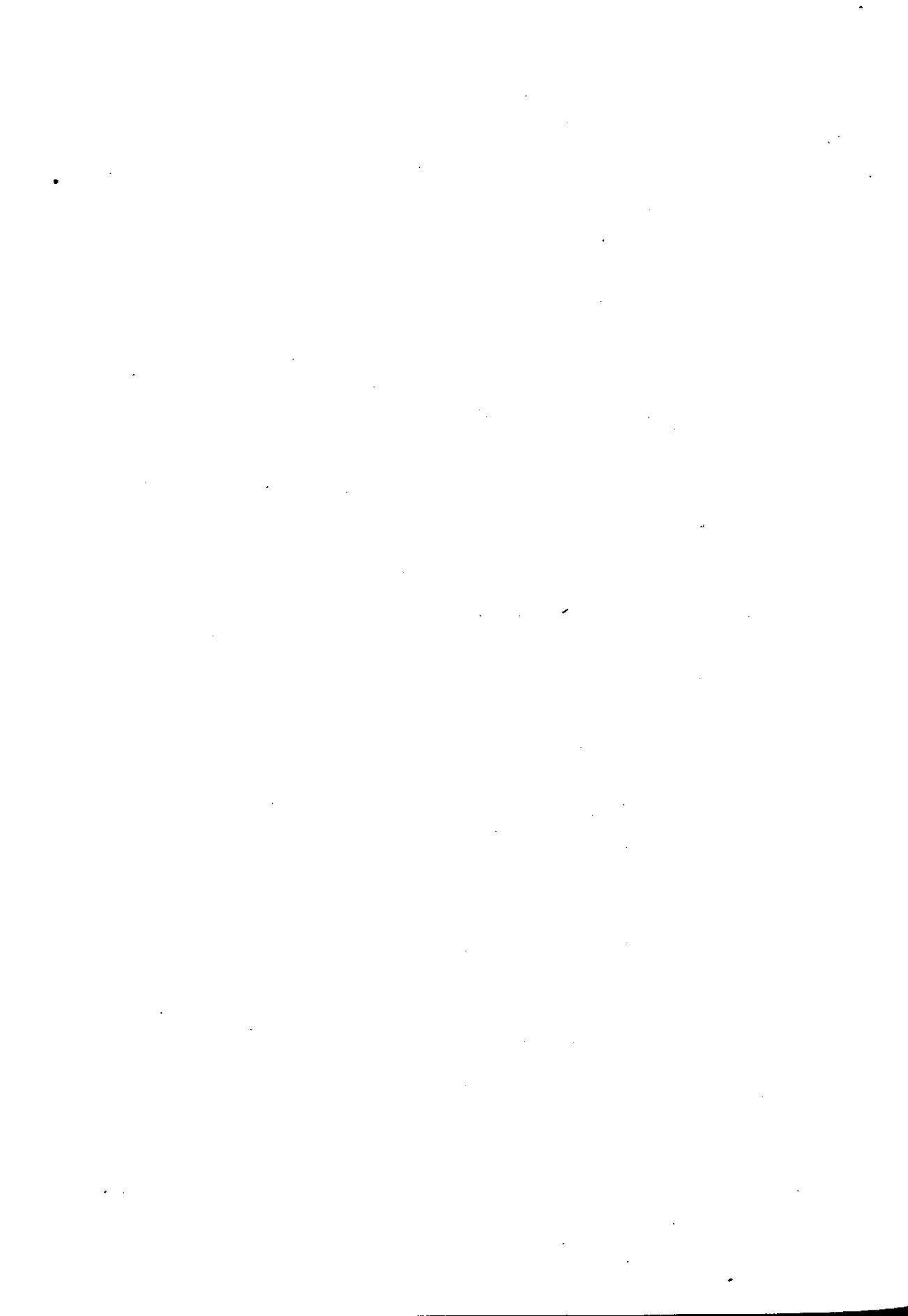

5

HORTICULTURE



PLANTING TREES IN VILLAGES

By M. S. RANDHAWA

GREAT opportunities exist in the villages of India for planting fruit, timber and fuel trees for the use of the villagers. Fuel and timber trees can be grown in village pasture lands and cattle sheds and fruit and ornamental trees in the compounds of houses, village schools, mosques, temples and *Gurudwaras*, boundaries of fields and bullock runs of wells fitted with persian wheels. To push forward a programme of tree planting there is need of propaganda on an extensive scale and of nurseries for supplying plants to the villagers. Needless to say that facilities in the form of readily available plants from nurseries raised for the purpose at district and *Tahsil* headquarters and *Panchayatghars* in villages are more important than mere propaganda.

A comprehensive tree plantation programme for villages would include renovation of existing orchards, planting new orchards, individual planting of fruit trees like mangoes, lemons, sweet limes, guavas, papayas, *kathal* and bananas in the compounds of houses of farmers or in the form of shelter belts in farms where the fields are consolidated in single blocks. It would also include raising of fuel plantations on waste lands which are commonly used for pasturing cattle.

Consolidation of scattered and fragmented holdings will greatly help in pushing forward tree plantation programmes in the villages. When scattered fields are brought together, homesteads similar to those in Europe can easily develop. The farmer with his family and livestock will live on the land and the problem of insanitary villages and inefficient cultivation will also vanish.

Man, Animal, Tree and Soil

The pattern of farming, which may suit the needs of teeming peasant population of the Indo-Gangetic alluvial plains of India, may be described as mixed farming, practised on an individual basis by farmers on consolidated blocks of land. Mixed farming may be described as commensalism, in which man, animal, tree and soil are linked together to their mutual advantage. Irrigated soil provides crops and trees for the benefit of man and the animal and they, in their turn, fertilize soil by providing manure. Under such a pattern of farming, each family keeps a couple of buffaloes or cows, some poultry, grows a patch of vegetables, crops, and fruit trees along the edges of the farm for use as well as sale. In wet areas, fish culture may also be done in a small tank in the farm.

Plantation Scheme

For a homestead in moderately wet areas an ideal plantation scheme would be like this :

A shelter belt of timber trees like *shisham* and *babul* at the back with fruit trees like grafted mangoes, papaya, guava, lemons and sweet limes on the remaining boundaries. A couple of *kathals* which provide the farmer's family with a delicious vegetable may also be grown. It may be mentioned that all the trees which we have listed are dwarf trees which cast little shade and hence are not injurious to crops. There are two trees which were very popular with ancient Hindus, and in their house-planting schemes, they always recommended their planting in certain specified

directions. These are: *bael* (*Aegle marmelos*) whose fruit is useful in digestive ailments, particularly diarrhoea and dysentery, and *amla* (*Phyllanthus emblica*) whose fruit has been found to be particularly rich in vitamin C and is used for making chutnies and pickles.

Cattle Sheds

Farmers in the Punjab, Sind and Rajputana usually own fair sized cattle sheds. Shade is an urgent necessity in cattle sheds for protecting cattle, particularly buffaloes, from the heat of the sun. Quick growing trees like *bakain* (*Melia azedarach*) should be planted in clumps in the compounds of cattle sheds interspersed with mulberry trees. These trees would require protection only in the first three years. Mulberry twigs are commonly used for making baskets for use in the cattle shed and the house in the Punjab, while *bakain* yields valuable insect-proof timber.

Fuel Plantations

Creation of fuel plantations has an important agricultural aspect. It is due to lack of fuel that the cultivator is forced to burn nearly one-half of cattle dung. Mr. Chaturvedi has estimated that the fuel value of a ton of fresh dung is equal to about $\frac{1}{3}$ ton of fire wood, which is worth about rupees four. The manurial value of a ton of fresh dung is approximately rupees nine. Thus, the loss involved in utilizing 50 million tons of manure as fuel in the United Provinces at rupees five per ton, amounts to 250 million rupees. If fuel plantations are raised, cow dung will be utilized for manurial purposes, and such plantations will also arrest wind and water erosion of soil.

Village *shamilat*, the common land which is used for pasturing cattle, is ideal for village plantations. Old fallow land which has been out of cultivation for a long time can also be taken up for plantation purposes. The question is

whether these plantations should be raised and managed by individual farmers or by the village *Panchayat*. Plantation under the supervision of the *Panchayat* and common ownership of the trees is an ideal solution, but the difficulty lies in the lack of corporate sense in many villages. Usually we find that everyone's responsibility is no one's responsibility, and trees planted with great effort are grazed by cattle. So we have to adopt both the remedies. In a village, where a *Panchayat* is functioning successfully the plantation should be raised by the *Panchayat*, which can also appoint village young men as guards for protecting the trees in the first two years.

In the *zemindari* and *taluqdari* villages of Oudh the waste land belongs to the zemindar or the taluqdar and not to the cultivators. This is the biggest obstacle in the way of tree plantation programmes in these villages. The tenants cannot be expected to plant trees for the benefit of zemindars and the zemindars are either too lazy to take up the plantation work themselves or the area of waste land under their control is too vast and scattered to be planted by them successfully. To overcome this difficulty in the way of progress, the proprietary rights in the waste lands must be given to the village *Panchayats*.

Individual Plantations

In some villages it would be more feasible to partition the village waste land into allotments. These allotments should be enclosed by *kutchas* walls to give protection to young trees. Where water table is fairly high a *kutchas* well may also be dug in the plot. Near the boundary wall thorny fuel trees like *babul* or mesquite (*Prosopis juliflora*) and in the middle area, fruit trees like *desi* mango and *kathal* may be planted. The fruit trees may occupy 25 per cent of the area and the remaining should be covered by fuel and timber trees.

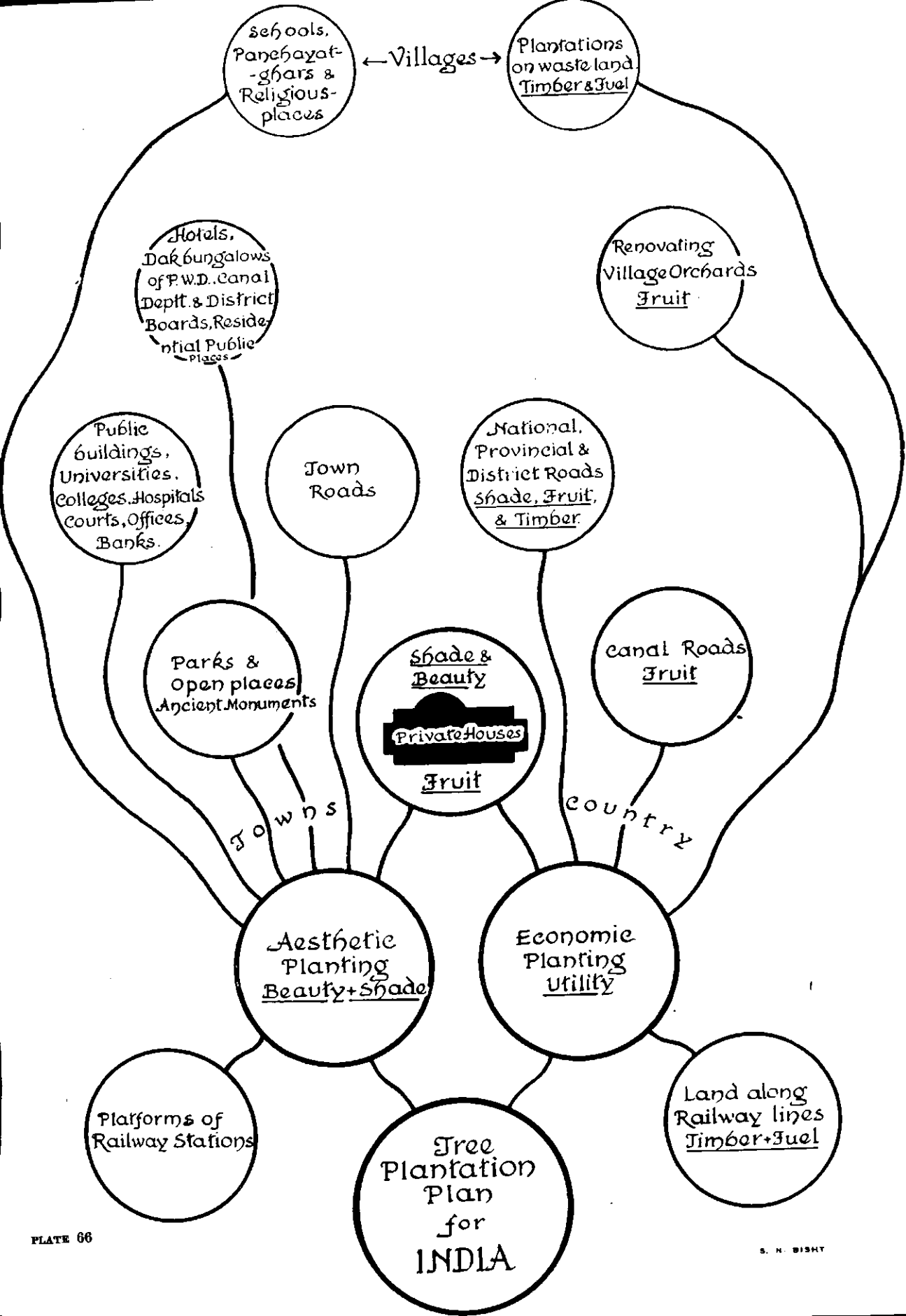

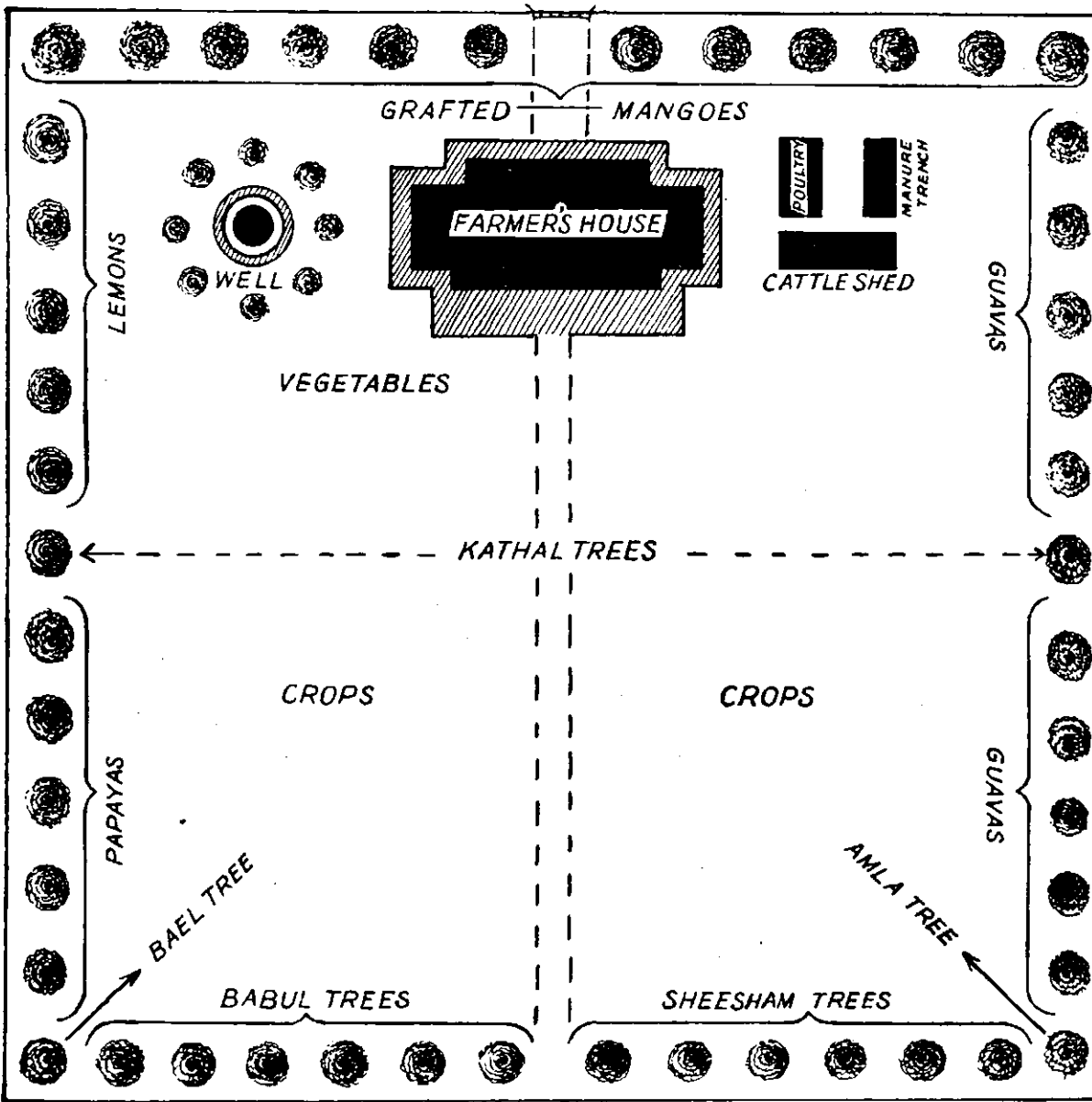

A MODEL TREE PLANTATION PLAN
For a small farm

N. S. BISHT

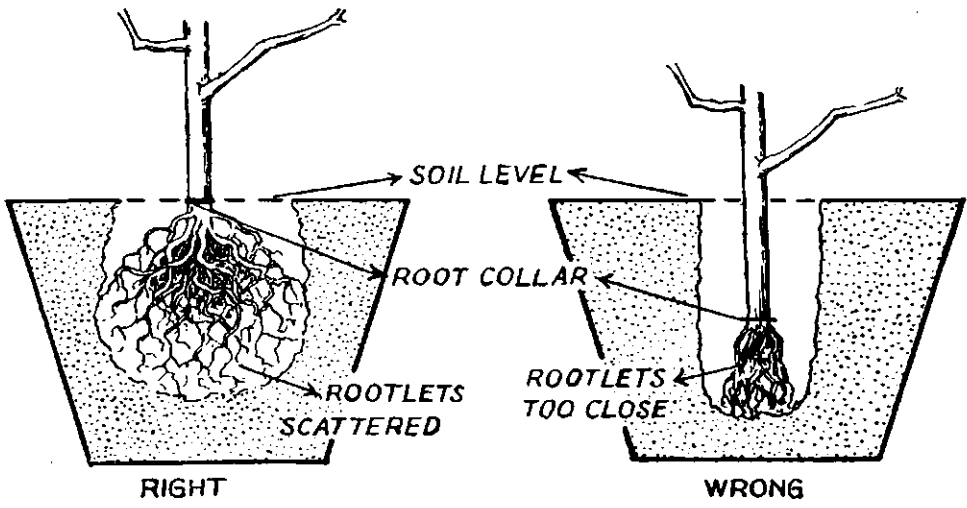

PLANTING A TREE
Follow the right method

N. S. BIRMT

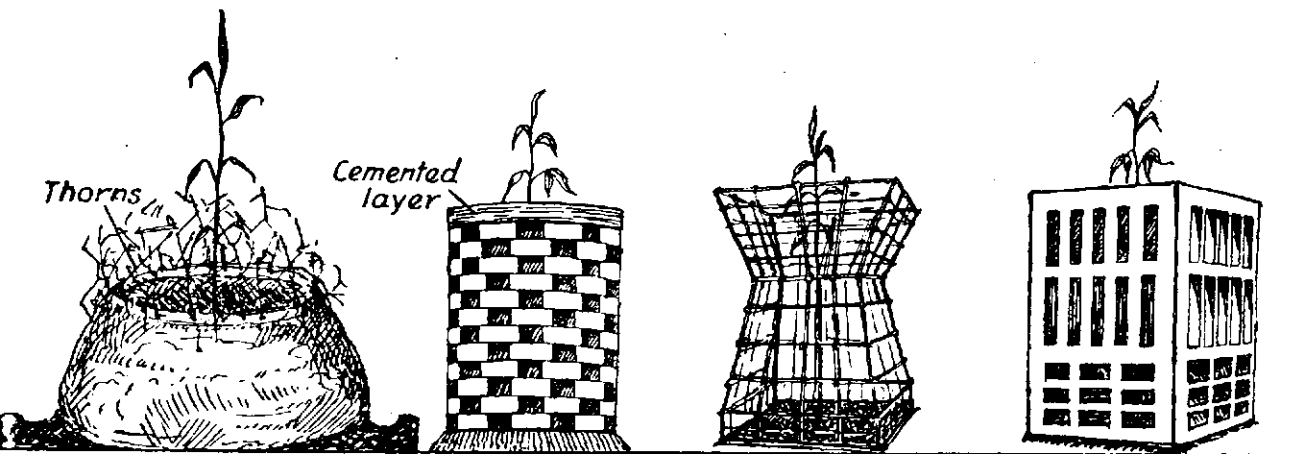

1 MUD-WALL & THORNS

2. BRICKS & CEMENT. 3. IRON-BARS & BARBED-WIRE

4. CEMENT-CONCRETE

VARIOUS TYPES OF TREE GUARDS

N. S. BISHT

Choice of Species

For an ideal village plantation we require trees which provide fuel and fruit as well as small timber for agricultural implements. So the species selected must be fast growing, easily grown and good coppicers. The following species are recommended :

For Fuel and Timber : *Babul* can grow almost anywhere in dry waterless tracts, eroded ravines and on marshy banks of *jhils*. Yields excellent fuel as well as fine timber for agricultural implements and wheels of bullock carts. Bark is used for tanning leather. *Shisham* yields excellent fuel and timber and is fast growing. It has been used extensively for covering sand-covered fields along the banks of *chos* in Hoshiarpur district and is a good coppicer. *Bakain* is a very fast growing tree and yields insect-proof timber for ploughs. Mesquite can easily grow in sandy and rocky soil. *Dhak* will grow on the worst soil and can even tolerate mild *usar*. It is a good coppicer. *Bamboos* can easily be planted near ponds. Bamboo has many uses in the farm. In case of mulberry only *desi toot* should be encouraged.

Desi Fruit Trees : Good varieties of *desi* mangoes with thin juice and good flavour and stones of grafted varieties like *safeda*, *duseri* and *langra*, should be selected and grown. In areas with rainfall over 30 inches *kathal* trees should be encouraged. *Mahua* is a popular tree in Oudh and is valued for its fruit as well as wood. It can grow on mild *usar*. *Jaman* variety with big-size fruit, known as *ra-jaman* should be encouraged. This is one of the few trees which can stand waterlogging and can be grown on areas liable to be flooded. *Imli* yields edible fruit as well as excellent coal for producer-gas engines.

Fodder Trees

Fodder trees provide valuable cattle feed in winter months when grasses are

not available. As compared to grasses, some leafy fodders, particularly those of *kachnar* and *toot* are exceptionally rich in essential nutrients as crude fats and proteins, lime and nitrogen-free extractives. The best leaf fodder species are *kachnar*, *toot nim* and *babul*. Fodder trees also deserve to be grown in village plantations.

Tree Crops

The Forest Tree Relation Department of the TVA have developed an unusual line of research which concerns the development of the so-called tree crops. Elaborate experiments were conducted to discover suitable trees and shrubs which will yield crops of fruits or nuts, which are either directly available for human consumption or can be fed to pigs or other livestock. Incidentally the bird population also multiplies. Black walnut, filberts and sumachs have proved a success. A very large experimental arboretum is maintained as well as several hundred demonstration farms, for work of this nature.

In India the subject of tree crops deserves attention by the Forest Department. Tree crops can be encouraged in Government forests as well as in private village forests. Wild fruit trees like *ber* (*Zizyphus jujuba*) and *toot* (*Morus alba*) can be propagated on waste land and forests on a big scale. *Ber* provides a delicious fruit of many varieties which is eaten both in fresh and dried condition. It is also an excellent fodder tree and its leaves are fed to goats and buffaloes. It is an extremely hardy tree which can stand drought as well as frost and is ideal for barren districts with comparatively poor rainfall. *Ber* also provides a valuable famine food. By selection and hybridization, the fruit can be considerably improved in size as well as in taste.

The Plan

Preparing Pits : Sites for pits should

be planned and located beforehand, preferably three to four months before planting. There is a tendency to plant too many trees, as from the size of saplings people often fail to realize their eventual growth and the space they will occupy when mature. Dwarf trees should be grown 15 to 20 ft. apart, and larger trees when planted in an avenue or a clump should be at least 30 ft. apart. Pits at least 4 ft. deep and 4 ft. in diameter should be dug at the sites selected in the month of March. Expose the soil to the sun in the months of April and May, and in early June mix the soil with old farm yard manure or compost in the ratio of 5 to 1. Mix them up thoroughly and fill the pit again with the mixture upto the ground level. Fresh or raw manure is not desirable as it is a standing invitation for white ants. Where the soil is unsuitable for the growth of plants as in *usar* and *bhur* areas, it should be discarded and good soil from some other locality be used for filling the pits. When the soil in the pits has subsided after the first two or three showers of rain, the pits are ready for receiving the saplings.

Transplanting: The best time for planting trees is between January and February and in the monsoon months from July to September. Where irrigation facilities are available winter is the best time for planting deciduous trees which shed leaves in that season. During winter they are in a dormant condition and are less likely to suffer damage when dug up. For evergreen and semi-deciduous trees the rainy season is the best time for planting. Where irrigation facilities are available, it is preferable to plant trees in the last week of February. In places where there are no irrigation facilities or the water supply is inadequate, planting should be done towards the end of July. If trees are planted in the month of February, the best time for planting is evening. During monsoons

the planting should be done on a rainy or a cloudy day. After removing the plant from the pot its roots should be loosened and straightened. Injured portions of the roots and branches should be cut off. The root-collar should be just under ground-level and care should be taken to secure the same position for the sapling in the pit as the one it has in the nursery. It is injurious to plant too deep by burying the stem under ground. Do not remove or break the balls of soil attached to the roots. Make a hole in the pit sufficiently deep to receive the roots of the sapling. Place the plant in an erect position in the hole thus made and pack the soil tight round the plant. After planting give it a thorough drenching. These precautions are necessary for successful growth of the saplings, and where these are not observed, the transplants mostly die or remain stunted.

The practice of planting more than one sapling in a single hole in the hope that at least one of them will strike root is wasteful and undesirable. Saplings of one to two years' growth get established in the pits in a few days. If there are any casualties they should be replaced without much delay.

Weeding and Hoeing: To understand the value of hoeing it is necessary to understand a few vital facts about the root-system of trees and related problems. Sir Albert Howard has made valuable observations on the root-system of fruit trees like guava, litchi and prunes. According to him most of the trees have a double root-system, a superficial root-system consisting of many freely branching roots running parallel to the surface and confined within 18 inches of the top soil as well as a deep root-system which grows vertically downwards and penetrates almost to the water table. During the hot months of March and April, the roots of the superficial system in deciduous trees pass into a dormant condition and

turn brown and the trees depend entirely on the deep root-system for its water requirements. In July, when the monsoon rains start and the surface soil becomes moist, the superficial root-system resumes its activity and many new rootlets are thrown out in all directions. These rootlets show aerotropic response till October.

Grass has a very harmful effect particularly on young trees and deciduous species suffer more than evergreens. Fruit trees are practically suffocated by the growth of grass and their fruits become small and tough. During monsoon rains the volume of carbon dioxide in the spaces of soil under grass increases about five fold as compared with the soil air of cultivated land. Carbon dioxide dissolves in the water film and the formation of humus, nitrification and mycorrhizal relationship are all affected. As compared with fruit trees like guava, litchi, loquat, forest trees like *dhak*, tamarind and *jarul* are able to compete with grasses and weeds on account of the fact that their deep root-system admits of growth during the dry season when the grass is dormant and the active roots of the surface system are resistant to a poor soil aeration and can successfully compete with grass for oxygen and other minerals. Nevertheless, for a healthy growth of the plants thorough weeding and hoeing are of much greater importance than irrigation. As soon as the soil is dry, the pits should be dug up with a hoe. Aeration of the roots stimulates growth and the removal of weeds, which rob the transplants of nutritive material, will naturally be beneficial. The entire diameter of the pits should be kept free from weeds. Do not dig wet soil. It is more likely to prove harmful and the churning of pasty liquid mud does not serve any useful purpose.

Irrigation : Most of our trees have two growing periods, in spring in the months of March and April and again during the

monsoon in the months of July to September. Where irrigation facilities are available it is desirable to plant trees in the month of February after the end of the cold weather. Young plants should be watered continuously from the month of March onwards, and particularly in the dry months of April, May and June, there should be at least five to six waterings a month. Each watering should be copious, so that water reaches the roots. Instead of a water can the trees should be irrigated by flow through a channel and the pits should be filled to the brim. Grindal recommends the vertical insertion of earthenware flower-pots in the pits and pouring of water in these. Where watering is done by hand, this is a good method and it insures against superficial watering by the gardeners. Light surface sprinkling, even if it is repeated every alternate day, is actually harmful to the trees, for such superficial waterings tend to keep the roots of the tree near about the surface and the water cannot reach the subsoil, thus resulting in slow and weak growth. On the other hand, if the watering is more thorough, the roots burrow deep down, thus resulting in a healthy growth of the tree. In the period between the waterings, the soil in the pits should be thoroughly hoed. The working of soil not only provides oxygen for respiration of the roots but also conserves moisture.

Where irrigation facilities are not available or are inadequate, the trees should not be irrigated in the month of March. Irrigation promotes the growth of new leaves and the rate of transpiration increases. If later on irrigation facilities are not available the saplings are damaged by excessive transpiration. In such circumstances, it is best not to irrigate the plants, for it is no use raising false hopes which cannot be satisfied later on, and it is better to leave the plants to their own resources.

Protection of Young Trees : The protection of young trees in the compound of a house is no great problem. But in public places and on the road-side it is a serious task. The main enemies of young trees are goats, cattle, monkeys and mischievous boys. The best solution is to provide tree-guards of bricks limed or cemented at the top, so that bricks are not removed by thieves. Tree-guards of bricks are suitable for public places. Along the roads in the countryside, however, tree-guards of bricks are expensive and are a standing temptation to villagers and cartmen who remove bricks for making *chulahs* for cooking their meals. In such cases mud structure affords the cheapest and the best protection. The ditch around a mud structure serves as a useful barrier against cows and buffaloes but it is also necessary to place thorns on the mud-walls to ward off monkeys, boys and goats.

Nurseries : Development of an adequate number of nurseries is an essential preliminary step in the planning of the growth of ornamental, fruit and shade trees. At present the number of nurseries is very inadequate and a big programme of expansion with more staff should be undertaken and definite quotas should be fixed for each nursery so that sloth and indifference on the part of individuals may not stand in the way.

Tree Plantation Drives and Weeks

The tree plantation programme which we have outlined is so vast that it can only be implemented if a gigantic effort is made on a nation-wide scale. Mass planting of trees has been undertaken in the Soviet Union particularly in dry areas where shelter belts of trees have been raised around farms, thus greatly modifying the climate. In the United States of America, during the last depression, a number of unemployed boys and young men were employed by the

Civilian Conservation Corps under President Roosevelt's New Deal for planting shrubs and trees in the area under the control of the TVA. About 75 million seedlings were planted by the American boys and 44 million by individual farmers. Camps were set up all over the big area of badly eroded and gullied land and plantation work was taken up on a mass-scale. In India also there is need of an effort of a similar nature. The Army, which has very little to do in peace-time, can be utilized for tree plantation drives of this nature and the farmers can also plant a number of trees on their farms under official leadership.

We should immediately establish nurseries in all Government, Municipal and Railway gardens and the compounds of dak bungalows, schools and *Panchayat-gahars* of villages. Indents should be collected from all villages under the development scheme through the agency of *patwaris* and rural development organizers, and thus a rough estimate can be had of the number of trees required. Nurseries should be raised a year in advance. Pits should be dug and manured in the month of May and tree plantation drives can be celebrated in the month of July when the rains have started in Northern India.

While posted at Rae Bareilly as Deputy Commissioner from 1941 to 1944, I initiated the celebration of such 'Tree Plantation Weeks'. All preliminary work was usually completed in the month of May. Sites for digging pits were selected in the compounds of public buildings such as Collectorate Office, District Courts, Municipal and District Board buildings, *tahsils*, schools, platforms of railway stations, houses of farmers and *panchayat-gahars*. Digging of pits, their manuring and filling was completed in the month of May, and indents for plants were collected from all departments and leading land-owners, and a collective order for supply of saplings was placed with

Government Gardens, Lucknow. Distribution of saplings and collection of bills was done through *tahsildars*. In the last week of July every year the plantation week was inaugurated with great enthusiasm and all persons of importance participated.

The cooperation of the District Boards who control a net work of village schools dotted all over the countryside is very essential. Griecsen mentions the existence of a 'Society of the Friends of Trees' in Tunis, in French North Africa, whose function is to bring together all people who love trees and are interested in encouraging their plantation. He states that packets of seeds of selected trees were supplied each year to the students of schools, which were sown during a selected week. We should also organize a society of lovers of trees to bring together all people who are interested in their propagation. Such a society ought to be organized under the auspices of the provincial Rural Development Departments. Seeds of *kachnar*, *amaltas*, gold mohurs, erythrinias and of fruit trees should be collected through the agency of the Horticultural Department and supplied to various schools through

their inspectors in pictorial packets containing a description of the tree with directions about planting. When the school work is inspected, the Inspector should see that the school teachers take sufficient interest, and those who show good work are encouraged by grant of certificates, *sanads*, cash prizes and good entries in their character rolls. It need hardly be emphasized that all manual work such as digging of pits, manuring, and irrigation should be done by the students and teachers rather than by hired labourers. Spades and *khurpas* should be provided to all schools at Government expense, and persian wheels should also be fitted on wells where the water level is suitable.

By organizing these Plantation Drives and Weeks, and planting fruit, fuel, timber and ornamental trees we can do a good deal of useful work. We will be increasing the wealth of the country by planting fuel and timber trees, improving the health of the people by providing them with vitamins in their dietary by planting fruit trees, and will be elevating their souls and developing aesthetic consciousness by planting beautiful flowering trees.

VILLAGE ORCHARDS : MANGO

By P. K. SEN

THE mango is the national fruit of India. It has been grown in the country from time immemorial. The Hindus called it *am* which in Sanskrit means provisions or victuals. They also called it *amrit-phal* or 'nectar fruit'; and in order to propagate it extensively they connected the mango—its fruit, flower, leaf and wood—inextricably with their religious ceremonies.

The Buddhists held the mango with an equal esteem. Lord Buddha himself was presented with a mango grove and, perhaps, this was how planting of mangoes in groves was started in India for their graceful shade and for fruits.

We find the fruiting branches of mango sculptured in the temples at Bharhut, which date back to 100 B.C. We also find references to flowering mangoes in the works of Kalidasa and Vatsayan, the writers who flourished in the 5th Century A.D.

Yuan Chwang, the Chinese traveller, who visited India between 632 and 645 A.D. is the first traveller who refers to the mango.

The Mohammedans took no time to appreciate the mango. As early as the reign of Muhammad Tuglak Shah (1325-1357), poet Amir Khusrau said in a verse originally composed in Persian :

'The mango is the pride of the garden,
The choicest fruit of Hindustan,
Other fruits we are content to eat
when ripe,
But the mango is good in all stages
of growth.'

Emperor Akbar (1556-1605) planted, near Darbhanga in Bihar, the *Lakh Bagh*, an orchard of a hundred thousand

mangoes. Nothing, perhaps, could be a better testimony of his esteem for this fruit and the importance which he attached to it, than this immense planting, made at a time when large orchards of fruit trees were almost unknown. The example set up by the Emperor led to the planting of orchards of mangoes all over the country.

In more recent times, the British and the continental authors have not hesitated to declare the Indian mango as the most delicious, wholesome and tasteful of fruits in the world.

Distribution and Uses

The mango is grown all over the plains of India, about 2,000 ft. above the sea level. The best regions are where the soil is deep and porous and the climate observes a well marked dry season occurring at the proper time of year. There is a legion of varieties, but in each region there are a few which are the best. The outstanding varieties are the *alfonso* of South-West India and the *langra* of North India. But there is a fair number of varieties in all parts which very nearly reach either of them in quality, and ripen as early, mid-season and late varieties during the season.

Besides being eaten as a ripe fruit, the mango is relished at all stages and a number of preparations are made of it. The green mango is used in curries, pickled with spices or preserved into jellies. When young the fruit is boiled, strained and mixed with milk and sugar to prepare as a custard known as *mango-phul*, or it may be cut into slices and dried to make *amchur*. When very young it can be cut into thin pieces and eaten

in salad. The *am-sharbat* prepared from young mangoes is a very cooling drink. Then again the expressed juice of the ripe fruit is dried into *amout* or *ambsath*, and now-a-days the ripe mango is canned and its juice preserved in scientific ways.

The mango is wholesome and rich in sugar and vitamins. In many parts of the countryside it, in season, forms the major food of the poor. There is a large demand of the fruit within the country and one need not doubt that a flourishing overseas trade can be built with mangoes if its culture, transport, storage and preservation facilities are improved.

Orchards, Old and New

From a recent report it appears that in the whole of India there are about eleven lac acres under mangoes. By far the largest proportion of those orchards are, however, old and are of seedling trees planted at a time when grafting did not come into wide practice. Then again, the orchards are not given very much of cultural attention in respect of regular cultivation, manuring, irrigation and control of diseases and pests. As a result production of the best type of fruits is not in plenty and fruiting is not regular.

But wherever there are orchards of grafted trees of the selected varieties, provided that proper care is bestowed on them, they are situated near towns or transport routes, a very good income, averaging Rs. 1,000 to 1,500 per acre per year, is easily obtained.

Essential Grafting

Development of mango cultivation in India is necessary for two reasons. Firstly, it is a fruit which the people are fond of and to introduce the fruit in the diet of the people mangoes must be a very desirable variety. Secondly, it is a fruit which will be liked all over

the world so that a prosperous trade can be built with it.

To develop mango cultivation with these two objects in view, it is essential to select the best varieties, to recommend to the people to grow the fruit in every house, to replant old orchards with grafted trees, to extend area under mango orchards and to induce the growers to take proper care of the plantations. Mangoes should also be planted on road sides, bunds and village commons.

Side by side it is important to develop marketing of the mango by arranging for better transport and introducing cold storage and preservation industries.

If India has only ten crore trees or about 25 lac acres of mango orchards the value of fruits produced would be no less than Rs. 100,00,00,000 annually, calculating on the basis of fruits worth rupees ten per tree per year. And the plantations, preservation industries and the trade will provide a good deal of employment.

Propagate only the best varieties of the respective regions which are the most delicious and which have demand in the market. Plant grafted trees in orchards and in houses. On road sides and village commons seedling trees may also be planted, but plant only the best varieties. This will in any case give much better fruits than the indifferent seedling trees.

Plants should be obtained from reliable nurseries as unless the variety you desire is supplied with care you cannot detect it until it has fruited and four to five years of your time and money and labour may be wasted. Happily in most provinces and States the Governments have taken steps to organize the nursery business.

If you have your own trees of such varieties as you wish to propagate you can make your own grafts. Inarching or approach grafting with root-stocks of mango seedlings is the commonest method in practice. About a year old seedlings

are usually grafted with scion shoots of about the same age. Rainy season is the best time for inarching mangoes.

Budding, sidegrafting and air-layering of mangoes are also possible under certain conditions. Budding *in situ*, i.e., to plant the seedlings which will provide root stocks in the orchard and then when they are established to bud them with the desired varieties has been recently introduced with great success in the Punjab.

Care of the Orchard

Trees should be planted well apart, 30 ft. to 40 ft. according to variety, climate and soil. Wind-break should be planted on the *loo* (hot wind) side of each area.

The orchard should be kept under clean cultivation by giving it regular ploughing. Usually three ploughings a year are essential, once after winter rains in January, once after the first showers in June or July and once at the end of the rains in October or November. Ploughing helps to retain soil moisture and also to add compost to the soil by digging fallen leaves and weeds into it. The best way to keep the orchard clean is to intercrop it as long as possible. This, in addition, ensures a profitable return until the trees come to full bearing. In the young orchard you can grow all kinds of crops both in *kharif* and *rabi* seasons, but remember to manure and irrigate the land for their sake and follow the usual system of crop rotation allowing for green manuring with sunn hemp once in two or three years. When the trees grow bigger and begin to shade the land, grow an intercrop only during the rainy season to keep the weed down. *Meth* (*Phaseolus aconitifolius*) is an excellent crop for the purpose. It thrives in partial shade, it is a very good fodder and it helps to increase the fertility of the soil.

A general manuring of the orchard

soil with farmyard manure or compost at the rate of 10 cartloads to the acre should be done every year. Under North Indian conditions it is recommended to apply this manure at the time of ploughing in October-November. The manure applied at this time becomes available to the trees in another two to three months in spring at the time of fruit setting and when new growth commences.

Trees should always be kept in healthy growth with sufficient manuring wherever necessary. Excessive manuring again is no good as it makes the tree strongly vegetative but shy in bearing. If in any year a tree fails to produce sufficient new shoots during summer, nitrogen should be applied to it in a quickly available form, e.g., sulphate of ammonia at the rate of five pounds (for six to eight years old trees) to ten pounds (for fifteen to twenty years old trees) about the beginning of June, three or four weeks before the rains set in. The best way to apply this manure is to spread it and dig it in the soil round the tree under its branches. After manuring, irrigate once lightly at the first instance and then give a liberal irrigation after two or three days.

Irrigate trees after fruits have formed. It is convenient to irrigate young trees in ring channels. For older trees it is advisable to irrigate the orchard by running water through cross furrows between trees. Irrigation will help the developing fruits and at the same time induce new growths which are essential for the next year's fruiting.

Where rainfall is within 30 inches and where there is usually no late rains, no special treatment is generally required for inducing fruiting. Growth in length of the new shoots is naturally checked early enough for the formation of flower buds. Where rainfall is high or late rains prevail, flowering can be induced by ringing. Ring branches which are



CULTIVATION MAKES DIFFERENCE

(Top) A sixteen-year old 'Bambai' mango tree without cultivation
(Bottom) Another sixteen-year old 'Bambai' mango tree with regular cultivation

P. K. SEN





AN INTER-CROP WHEAT FIELD
In a young mango orchard

P. K. SEN

about three to five inches thick. Remove bark in a ring $\frac{1}{3}$ to $\frac{1}{2}$ in. wide by clean cuts. Plaster the wound with grafting clay which can be easily prepared by mixing into a paste with water one part fresh cowdung and two parts good soil. This helps healing of the wound. Under Sabour (Bihar) conditions the first week of August has been found to be the best time for ringing. The object should be to ring the tree at such a time that the effect results before the time of flower bud differentiation in October-November and at the same time the wound heals up within the current season. Two half rings on the two sides of a branch, about two inches apart, is preferable to one complete ring, as the former method is less drastic but almost equally efficient.

Regular ploughing will keep the orchard clean. The orchard top should also be kept clear by judicious cutting off of branches (and removing alternate trees in old or congested orchards) in order to give the trees plenty of sunlight. This will reduce the incidence of pests and

diseases, as well as make the trees productive.

To control mango hoppers, sulphur dusting or spraying with fish-oil-resin soap solution or soapnut decoction is recommended: (i) Use finely powdered sulphur and dust thoroughly soon after flowering when the nymphs of the insects begin to appear on the developing floral shoots. Give two more dustings at fortnightly intervals. Dusting should be done on a clear day and it should be borne in mind that if the sulphur is washed away by rain within two or three days the dusting should be repeated. It is best to dust the sulphur when there is no strong wind. (ii) Give two rounds of spraying with fish-oil-resin soap of a strength of one pound in ten gallons of water, one at the time when flower buds begin to swell and the other about a fortnight later when flowers open out. Boil about 60 soap nuts in about a gallon of water, strain, dilute the decoction in twelve to fifteen gallons of water and spray like fish-oil-resin soap emulsion.

VILLAGE ORCHARDS : CITRUS

By BAL SINGH BAJWA

IT goes without saying that fruit culture is a more remunerative branch of agriculture than ordinary farming. This fact along with other temptations like the concession of enhanced supply of canal water for fruit gardens in the canal irrigated areas of the Punjab, supply of pedigree fruit plants of selected varieties at cheap rates by the Punjab Agricultural Department and last but not the least improved financial position of the farming community due to high rates of farm produce and hence their ability to invest their savings in more profitable avenues have made even an average cultivator fruit minded. Fruit gardens both big and small are springing up throughout the length and breadth of the Punjab. In these gardens, citrus fruits occupy a premier position as the climatic conditions obtaining in the major portion of the province are such as are eminently suited to the cultivation of these fruits and secondly because protected as they are by a thick leathery rind, their transport and marketing present fewer difficulties than most other fruits. According to the latest available statistics of acreage under different fruits mango occupies the top position comprising about 58 per cent of the total area under fruits in the Punjab, but taking into account the recent tendency of the fruit growers to put major portion of the area under citrus, it seems certain that it will steal a march over the mango in respect of the total acreage if it has not already done so during the last few years.

Broadly speaking, fruit growers in the Punjab may be divided into three categories, namely, big fruit growers, small

fruit growers and petty fruit growers. In the first category are included fruit growers who may possess anything from eighteen to hundred acres of garden area. In such plantings citrus fruits occupy 50 to 75 per cent of the total area depending upon the locality. Fruit growers possessing garden areas below 18 acres are considered as small and in some cases the area may hardly be a couple of acres. Such orchards are mostly stocked with citrus fruits and, more often than not, the entire area may be devoted to them to the total exclusion of all other fruits. In the third category are reckoned the people who have got very small holdings and who cannot afford to put any compact area under fruit trees as they have to grow crops like wheat, cotton, sugarcane, fodders, etc. They generally plant some fruit trees on water channels or round about the well. The fruit from these trees is utilized for home consumption.

The Process

The proper understanding of the important points is absolutely necessary as it would make all the difference between profit and loss in a commercial fruit garden.

Climate: Citrus fruits flourish in a wide range of climates. Barring the hilly tracts (over 3,000 ft.) they can be grown in every part of the province, provided irrigation facilities exist. From sub-montane to hot and dry southwestern districts, these fruits are found to grow to perfection. The *sangtra* orange (*Citrus nobilis* Lour.) relishes a somewhat cooler climate and is at its best in sub-montane districts, especially

in parts of Kangra and Gurdaspur districts. In hot and dry places the fruit tends to be acidic and a good number especially on the south-western side of the tree gets affected with sunburn. The *kaghzi* lime (*Citrus aurantifolia* Swingle) being the most susceptible to cold out of all citrus fruits thrives best in places free from frost hazard. The malta orange (*Citrus Sinensis* Osbeck.), sweet lime (*C. aurantifolia* var. Swingle), lemon (*C. limonia* Osbeck.) and grapefruit (*C. paradisi* Macf.) remain almost unper- turbed under trying conditions.

Soil: Though citrus trees possess a wide range of soil adaptability yet a loamy soil or a sandy loam with a slightly closer sub-soil and having a depth of at least six feet answers best for a citrus orchard. The longevity of the trees is greatly determined by the soil and a good soil eventually proves as great a source of pleasure and profit as a poor one that of penance and loss.

Location of the Garden: Unlike perish- able fruits like peach, plum, grape, pear, etc., citrus fruits can withstand the inroads of decay-producing organisms on account of their thick protective leathery rind and, with proper care, can be transported to distant places in perfect condition. Nevertheless, it is always economical to have the orchard in the proximity of a big market or failing that of a railway station or a metalled road to ensure as expeditious a transport as possible.

Establishing the Orchard: Having decided about the site the land is ploughed and cross ploughed deeply and brought to a fine tilth. It should be thoroughly levelled as it becomes difficult, if not impossible, to rectify the mistakes after the trees have been set. The planting is done either by square or hexagonal system, the distance from row to row as also from plant to plant in the rows being 20 to 25 ft. depending upon the ferti- lity of the soil, the rule being that richer

the soil and sub-soil the greater the distance. The trees are planted either in spring, viz., February-March, or in August-September. The plants should be obtained from Government nurseries or private nurseries reputed for the production of genuine and pedigree plants. In no case should a grower be lured into purchasing cheap plants of doubtful pedigree as eventually he will find them more costly and an eyesore in the garden. The plants should be budded on rootstocks found suitable for the commercial scion varieties. A regular and systematic experiment for testing the suitability of the various rootstocks and scions is underway at the Horticultural Research Station, Montgomery, for the last nine years and several years more must elapse before definite and final results are achieved. Pending the final outcome of these investigations, rough lemon (*jatti khatti*) may be regarded as the safest all-round stock for all citrus fruits. From even the interim reports of the above station one thing emerges definitely, that *kharna khatta* (*C. karna* Raf.), which is proving very vigorous for malta common and other scion varieties has been found to be altogether incom- patible with malta blood red and has resulted in an early senescence of the trees of this scion variety.

Choice of Varieties: An amateur fruit grower may satisfy his fancy to the full by growing a large number of varieties but a commercial fruit grower must confine himself to a few prolific varieties which may also possess outstanding dessert qualities. Another consideration of great importance is the harvesting seasons of different varieties and, in order that fruits may be available over a protracted period and hence command a better price, they should not overlap. A judicious selection of early, mid-season and late varieties should be made to extend the marketing time. An ideal combination in the case of malta orange

is (i) pine apple—an early, high quality, prolific variety ripening in December-January; (ii) blood red and jaffa—mid season varieties ripening in January-February; both possess high dessert qualities—the former has particularly caught the imagination of the public due to its attractive red colour of the pulp; in fact people have got a great weakness for it; (iii) valencia late—a late variety ripening in March-April; the fruit can hang in good condition on the trees upto middle of May.

In the case of *sangtra* orange planting of Natal Tight Skinned Naartjee, Nagpur and Coorg as early mid-season and late varieties respectively is commended to extend the season from end of November to end of February. It may be noted here that Nagpur orange in the Punjab does not retain its tight skin characteristic, becomes almost as loose skinned as the local type and also ripens along with it, i.e., in January-February, unlike the orange from Nagpur which sells in the Punjab markets from March onwards. Two new *sangtra* hybrids, viz., Wilking, and Kumow imported from the United States some years back are giving great promise of success both as regards yield and the quality of fruit. Their quality is superb and is much superior to all the varieties so far tried in the Experimental Fruit Garden at Lyallpur, the sugar percentage in the ripe fruit going upto even fifteen per cent while in none of the local varieties it exceeds 12. These varieties have not so far found their way to the orchards of private growers, as they are still under observation but their dissemination is contemplated after a couple of years.

The season for grape fruit extends from November to March and the varieties found suitable are Duncan, Foster and Marsh's seedless. The lemon season almost coincides with grape fruit, the important varieties being European, Eureka and Villa Franca. K. lime exhibits,

more or less, an ever bearing tendency but the main season extends from July to September. In other months, however, there is only a sprinkling of fruit.

Out of all the citrus fruits that are eaten out of hand, sweet lime becomes ready for use earliest in the season. It is quite edible in August when still in the green stage. Gradually the rind loses its green pigment till it assumes a glossy yellow appearance in November and the fruit of some strains can hang on the trees in this condition till mid-January. There are at present no well defined standard varieties of sour lime and sweet lime. The growers are advised to plant selected strains of these fruits possessing desirable characteristics such as good vigour and high yielding power of the trees, medium to big size of fruit, typical shape, i.e., round in the case of sweet lime and round or oval in the case of sour lime; thin rind, abundant juice, high soluble solids in sweet lime and high acid content in sour lime; less rag, marked flavour and aroma and a fewer number of seeds.

The Allocation of Area: Malta orange, due to its marked adaptability to different tracts, and because it can stand long transshipments and on account of the high quality of its fruit for which it has become the most popular of all citrus fruits, is allotted about 50 per cent of the area in a commercial orchard. The *sangtra* orange, being not very well suited for growing in the plains as already alluded to and because of the loose texture of its skin, cannot stand transportation well, and hence must be marketed in the immediate neighbourhood of the area in which it is produced, may be allotted only ten per cent. Its watch and ward is also comparatively more difficult as at the time of its maturity, the fruit becomes very enticing to crows which play havoc with it. Sweet lime may be allotted fifteen per cent, and sour lime, lemon and grape fruit ten per

cent each. The apportionment of area suggested above cannot, however, be adopted rigidly under all conditions as it will be influenced by the location of the orchard and its environmental conditions. In low hills and sub-montane tracts, the area under the *sangtra* orange may be increased to 30 per cent or even more with a corresponding reduction in the area under the malta orange. If there is a juice or squash factory in the vicinity of the garden, the area under lemon may be increased to fifteen to twenty per cent or even more with a proportionate decrease in the area under sweet lime. Hitherto there has been a prejudice against lemon in the Punjab markets where it was considered as akin to *galgal* but now with the establishment of squash factories here and there the demand for this fruit is becoming greater. It may be noted that it is very much superior to sour lime in vigour of trees, productivity, resistance to frost and diseases like citrus canker and withertip. The grape fruit is a comparatively new introduction and the masses have not so far taken fancy to it. There is, however, a good demand for it in big cities where it fetches incredibly high prices. For some years past, the fruit has been selling at Rs. 25 per hundred and the income from the various orchards, both Government and private, has varied from Rs. 2,000 to Rs. 5,000 per acre. These alluring figures of income have, however, been obtained by proper marketing of the fruit to distant places and when a grower can undertake to do likewise, he may increase the area under this fruit from five to ten per cent.

Windbreaks: They are a necessary adjunct of a fruit garden and that they may give effective protection to the trees and the fruits thereof from high winds and duststorms and hence reduce shedding of fruits. Their planting should precede that of the main fruit trees by at least a couple of years. Roughly a

100 ft. tall windbreak tree will give protection upto 400 ft. or about 20 rows of trees. *Shisham* (*Delborgia sisoo*), mulberry (*Morus indica*), seedling mango (*Mangifera indica* L.) *jamun* (*Eugenia jambolana*), *ber* (*Ziziphus jujuba*) eucalyptus and poplar are some of the trees suitable for this purpose. Trees like *jamun*, mango, and *ber* in addition to serving as windbreaks also give income from their fruit. A row of *ber* trees planted along a length of about 850 ft. in the Government Garden, Lyallpur, gave an income of Rs. 800 in the year 1945.

Care of Young Trees: The stock of newly planted trees exhibits a marked tendency to send out sprouts which should be removed as early as they arise otherwise they smother the growth of the main plant. The tree should be trained properly by developing a clear straight vertical stem to a height of about 1½ ft. and allowing the main frame work of branches to develop above this height in such a way that they are well distributed on all sides. The stems may be white washed to protect them against sunburn till they have provided themselves with a sufficient canopy. It must be borne in mind that a sun-scorched tree seldom recovers and is best replaced. The fruits of young trees can be protected against sunburn by growing a row of *jantar* (*Sesbania aegyptiaca*) plants in March-April on the south-west side of each row of trees. This plant makes a remarkable growth and attains good size in 3 to 4 months. At Lyallpur the results of three years' observations have shown that the damage on the south-west side of the trees was reduced from 21.4 to 11.7 per cent in the case of malta orange and from 21.5 to 6.6 per cent in the case of *sangtra* orange protected by *jantar* hedge.

Irrigation: Citrus trees being ever-green, transpire large amounts of water. Their culture should be attempted in

localities where irrigation facilities exist. In the spring, when trees are in bloom, only conservative application should be given to promote good flowering and setting but when the fruit is set, the water supply should be ample as at this time there seems a decided correlation between shedding of fruits due to hot winds and moisture content of the soil. If channel and basin system of irrigation is adopted, it will be necessary to apply irrigation every week or ten days in summer and every two to three weeks in winter; but if the flood system is practised, it may be deferred to two weeks in summer and three to four weeks in winter. The channel and basin system can be adopted for the first four to five years but later on it is advisable to practise flood system as the feeding root zone extends far away from the base of the tree.

Manuring : Most of the citrus growers in this province do not manure their trees regularly and in some cases the method of application is defective. Most of the growers think that the exposure of roots is a necessary prelude to the application of manure which is generally dumped near the trunk. The common practice of manuring close to the base of the tree has nothing to recommend it. Prolific root occurrence is always at a distance from the main stem and the number of feeding roots close to the stem is surprisingly small. The health of the trees is unnecessarily jeopardized by exposing the roots, as this exposure is sure to lead to slow demise of the trees by weakening the roots and by the entry of disease organisms through the wounds caused. This system must give way to broadcasting the manure under the trees upto the spread of the branches and hoeing in the same by means of spade. The well-rotten farm yard manure is the best all-round manure as it contains almost all the essential elements and

about one to two maunds per tree should be applied in February annually.

Inter-crops : They should be of the leguminous type so that they do not impoverish the soil and compete with the fruit trees in drawing nourishment from the soil. Crops like berseem, *senji* gram, peas, winter vegetables, cowpeas, pulses and summer vegetables may be grown. It has been seen that judicious inter-cropping in the first 4 to 5 years of the life of the garden can yield as much income as a corresponding area of land not planted with fruit trees.

Pests, Diseases and their Control : Citrus canker, withertip, and of insect pests, *citrus psylla* are the major scourges to which these fruits fall a prey. Sour lime and grape fruit are highly susceptible to citrus canker and in order to keep them free from the disease, an orthodox spraying programme must be followed. Timeliness, thoroughness and persistence are the watch words of success. All dry and diseased wood as well as affected leaves should be pruned and a combined rosin-Bordeaux spray given in January-February before the trees come into bloom. The spraying may be repeated as often as the severity of the infection warrants.

Picking, Packing and Marketing : Colour of the fruit, juiciness, total soluble solids, acidity and flavour are fairly good indications of maturity. They increase gradually upto a time and then begin to dwindle and the best picking time is round about the peak. Premature picking of the fruit brings poor returns. Because the fruit can seemingly withstand rough handling, due attention is not paid to its proper picking and this results in the shortening of its post-harvest life. The fruit should be picked by means of a clipper and placed gently in baskets and after cleaning and wrapping may be packed in standard sized boxes for transport.

VILLAGE ORCHARDS : PAPAYA

By K. C. NAIK

IN any plan for increased food production, a crop which is capable of yielding over 10,000 lb. of food per acre in a year cannot but find a prominent place. Expressed in terms of food energy per unit area, if that crop produces roughly twice as much as that of a cereal like wheat or one and a half times as much as that of a heavy-yielding vegetable like potato, the relative importance of it is brought out in even greater relief. If in addition, that crop is easy and profitable to grow, is adaptable to a diversity of soils and climates, and is also a highly economical and important source of certain valuable vitamins and minerals, it deserves a high priority in the present drive, for 'Grow More Food'. Papaya, scientifically called as *Carica papaya*, is the fruit that answers the above requirements, possessing special virtues for economic exploitation of land, particularly in India with its high density of population and with little suitable waste land to be brought under the plough, and above all, with its acute recurring shortages of food.

The merits of the papaya are not exhausted by the facts set forth above. Though largely used for dessert and as a breakfast food, and prized as such for its sweet and agreeable taste no less than for its valuable digestive properties and high vitamin A and C contents, the fruit can also be processed in many ways for manufacturing a variety of products. Culinary art has also devised numerous methods of using the fruit in the home in the form of confectionery and vegetable dishes. For softening tough meat either by cooking with unripe fruit or by wrapping in crushed leaves, papaya

has long been reputed. Papain is a valuable enzyme prepared from the juice of the fruit and the plant, the pharmaceutical application of which is reported to have engaged the attention of about thirty reputed firms in the United States of America in 1938. During the cholera epidemic in 1943-44 in South India, papain was used as a valuable cholera bacteriophage by the King Institute, Guindy. Almost every part of the plant has also been used for medicinal purposes in different countries of the world.

It is not surprising that much has already been written about this important crop, so that the reader can have access to over 100 publications dealing mainly with its cultural aspects. The present contribution is an attempt to summarize briefly the latest available information, with the hope that it may be of some help to persons interested in papaya production. For details the readers are invited to consult the selected literature given in this article or to refer to the horticultural workers in their respective provinces or States.

Successful papaya production is possible in almost all parts of the country, both in home compounds and on an extensive plantation scale, excepting elevations exceeding about 5,000 ft. from the sea level and on sites subject to frosts or frequent cyclonic weather. It grows on a wide range of soils, although the best performance is seen on rich loams of uniform texture upto about six feet in depth, to which the roots forage normally in search of moisture and food. Perfect soil drainage is by far the most important requisite; for in its absence

the trees are liable to damage and even devastation by collar rot disease.

The papaya is universally raised from seed for commercial plantings. Being subject to cross-pollination in nature, the trees raised from seed have a mixed inheritance, which makes them highly variable. To ensure standardized fruit quality with tree characters and yielding capacities resembling the seed parents, it has therefore been recommended that seeds only from the best trees should be used, and such a selection should be pursued in successive generations. Selection programmes on these lines have been followed in recent years by several reputed seed firms in the country.

Young Seedlings

The seed progenies do not all turn out to be fruit-bearing trees. According to the distribution of sex in this fruit, thirteen different forms have been described. Of these, the important groups are : (i) the male trees which are incapable of producing fruit until they change their sex, as some often do, (ii) the female trees, which are the main fruit-producers, and which are never known to alter their sex, and (iii) the various forms of perfect-flowered trees, which produce a bulk of irregular-shaped fruits and rarely yield heavy crops, and are therefore of little or no economic value so far.

Observations show that in seedling plantations as many as 60 per cent of the trees may turn out to be the unproductive males. Elaborate studies have failed to give any reliable means of detecting the sex in papayas before the trees flower. These facts have led research workers to try vegetative propagation methods. Rooting papaya cuttings, though found successful to a degree, is not feasible on a commercial scale, because of the difficulty to secure the required number of cuttings for large-scale plantings. Grafting by approach method on seedling papaya root-stock as well as on mountain

papaya (*Carica candamarcensis*) of 1 to 2.5 cm. stem-thickness, has been recently tried with cent per cent success at Burliar Fruit Station in Madras. Side and cleft grafting on about 30-day-old papaya seedling root-stock has also been attempted with equally high success by me at Sabour in Bihar. In both these cases, the limiting factor is the unavailability of an adequate number of scion shoots. Further, experience of growers in Florida seems to show that grafted trees degenerate progressively, so that grafted plantations of the fruit have now become things of the past in that country.

On selecting the parent tree, the seeds are extracted only from the ripe fruits. They are then washed in water to remove the gelatinous covering and dried in shade. In order to secure maximum germination, the seeds are best sown as soon after extraction as possible. Roughly four to eight ounces of seed may suffice for raising the required number of trees for an acre.

The seeds may be sown in raised seed beds or in seed pans, pots or other containers commonly used in nurseries. Sowing in beds is regarded as superior for securing higher germination and the least damage from damping off disease. Sowing may be done in any part of the year except during the hottest, rainiest or coldest periods. In most parts of the country, June to November provides the optimum sowing season. The seeds are dibbled at a depth of half-an-inch, with a spacing of one half to one inch in the row and about nine inches between the rows. They are then covered with soil first, followed by a thin layer of sand. Watering is done immediately after the sowing, preferably with a can fitted with a fine 'rose'. Watering should continue regularly and on every day thereafter except during rains, but only during the cool morning or evening hours. An artificial shade with thatch

may be useful to protect the young seedlings from heavy rains and severe sun.

Transplantation

Germination occurs in about three weeks, a few days after which the seedlings should be thinned out to a spacing of two to three inches in the row. The surplus seedlings can be transplanted into a separate bed if lifted out with care along with a ball of earth around their roots. Some growers transplant all the seedlings a month after sowing to new beds, while most are content to transplant the seedlings to the final sites when they are six to nine inches high in about 75 days after sowing. In the former case the final setting out in the field is usually done when the transplanted seedlings in the new beds attain a height of about twelve inches. Whatever be the method adopted, it is necessary to clip off most of the leaves three or four days before every lifting operation. At the time of lifting also it is essential that every plant is taken out with a ball of earth and is put in its new site with the minimum delay of after lifting.

It is also possible to raise a plantation by sowing the seeds direct in the final orchard sites, but this is a practice which is reported to result in a low crop yield on one hand, and in an increased cost of orchard maintenance on the other.

Male and Female Trees

The fact that the male trees are unproductive should not mislead one to the inference that they should all be eliminated from the plantations. Although papayas are known to fruit even when the pollen-bearing male or hermaphrodite trees are not close by, the fruits that set under such conditions are relatively few in number and are reduced in size, besides being seedless. For normal development of fruit and for securing high yields, it is necessary to

retain about one male tree to every ten to twenty female trees in the plantation and spread out the male trees in all parts of the orchard. The most effective and the only feasible way now open to ensure the required proportion of male and female trees is to plant in the field 3 to 4 seedlings in each pit, roughly one foot apart from each other. As soon as the plants flower, only one tree is retained per pit and the rest are cut off, keeping in view the required proportion between male and female trees.

Easy of Culture

Being easy of culture, the papaya requires but little skilled attention in the orchard. The usual operations preliminary to planting in the form of several ploughings and harrowings, marking out the sites for the plants and digging of pits of about three feet cube, are common to papaya as to several other fruits. A strong windbreak may be raised along with or well ahead of the planting. Cool or cloudy days should be chosen for the planting and even then the actual lifting out and setting in the field may as far as possible be attended to in the evenings. Eight to ten feet on the square is the normal spacing given to the trees. Watering the trees is done in basins immediately after planting and regularly thereafter whenever the first six inches of soil is found dry by rough tests. Excess of moisture at the roots and prolonged contact of it with the stem are to be avoided. The latter is easy if the basin is made to slope away from the trunk gently.

For a gross feeder like the papaya liberal applications of manure are necessary. Among the several suggestions made, that by Cheema and Dani seems appropriate to most Indian plantations. It consists of the application of 20 lb. of well-rotted farm yard manure to the tree while planting, followed by 80 to 100 lb. of the same after 4 to 5 months, with a

third application in the same quantity in the succeeding year before the rains set in. Bone meal or bone ash is also recommended to be applied after the rains in about September. Excellent crops of papaya have also been raised in several places entirely on the effluent.

Inter-cropping of the papaya orchard with vegetables can be done during the first few months of planting. Some grow the papaya itself as an inter-crop in larger tree plantations as of *litchi*, guava, mango and sapota, a practice that has much to commend it during the early life of the orchards.

A shallow rooted plant like the papaya with its feeding roots appearing below four to six inches of the soil surface, cannot naturally relish deep soil culture. To keep down weeds, frequent hoeing of the basins with hand tools or shallow inter-cultivation with implements like the Planet Junior hand hoes are suggested.

In about six months of planting, seedling papaya trees begin to flower, and in another six months the fruits will be ready for harvest. Except during the colder seasons, the trees continue to flower and fruit almost all the time. Periodical inspection of the trees to thin out fruits, which cause over-crowding on the stem, is necessary. When a change of rind colour to yellow is observed on the fruit, it may be deemed ready for harvest. The fruit should be handled with care at all stages. A soft wood wool padding to the baskets or box in which the fruits are to be kept or transported, and a single layer packing of uniform-sized fruits are recommended to enhance the sale value.

Yield of Fruits

The yield of fruits has been variously estimated in different parts of the country and is believed to range in normal plantations from 30 to 150 fruits per tree, each weighing from one to over 16 lb.

The acreage yield may work out from 30,000 to even over 60,000 lb. All these figures relate to the first three years of the plantation. In the end of the third year, the papaya will have passed out of its profitable bearing age, and the trees may therefore be grubbed out.

True to the Parents

A very large number of so-called papaya varieties are found in cultivation. As a matter of fact none of these is a real variety, since it cannot be relied upon to reproduce the parental characters in all the progenies. However, due to continuous selection, several seedling races are found to produce fairly large proportions of progenies true to the parents. Of these, the Washington and Honeydew enjoy considerable popularity over wide stretches of this country. There are several others also enjoying regional reputations. Imported races and strains from Hawaii, South Africa and Ceylon in recent years have almost everywhere failed to reach the standard of the local ones and are therefore gradually fading out of our commercial orchards.

Literature

Space does not permit the treatment of methods of papain collection. Voluminous literature as well as hints from horticultural workers in this country are available to the readers interested in the subject:

Cheema, G. S. and Dani, P. G., *Papaya Cultivation in the Bombay Presidency excluding Sind*. Bulletin 162; Department of Agriculture, Bombay, 1930.

Higgins, J. E. and Holt, V. S., *The Papaya in Hawaii*. Bulletin 32; Hawaii Agricultural Experimental Station, 1914.

Hofmeyr, J. D. H. and le Roux, J. C., *Farming in South Africa*, August 1939.

Iyengar, S. R. Srinivasa. *Bibliographical Series 5, Papaya and Papain*, April 1941.

Livingstone, B., *Papaya Culture in Florida Promises Profits*. *The Magazine of Florida*, April 1938.



GOVERNMENT BOTANIST, COIMBATOR

AN OVER-AGED PAPAYA GROVE
These trees were planted more than four years ago

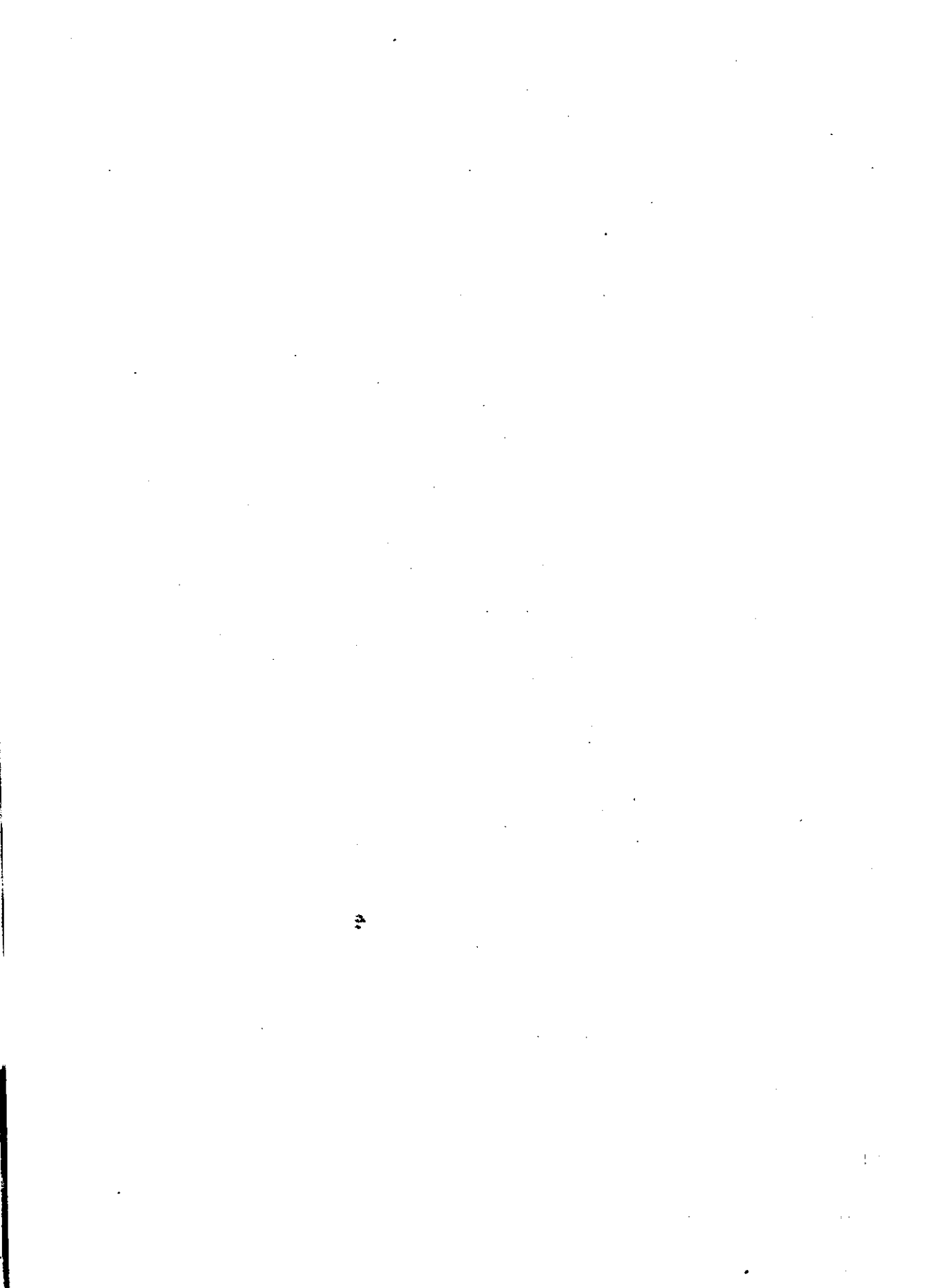

VEGETABLE CULTURE

By SWARN SINGH PUREWAL

CONDITIONS of life in rural areas in India are extremely unsatisfactory and any scheme for 'Developing Village India' must embrace a large variety of activities in order to raise the standard of living and improve the body and mind of the village people. Their purchasing power must be increased through increased agricultural production and obtaining better value for the produce, establishing cottage industries, providing better education, recreation, sanitation and proper food and prevention of diseases so as to lead them on to a fuller and richer life. Human beings and animals must be fed properly to get the most out of them. Man inherits certain possibilities and how these possibilities develop depends on his environment; and the most fundamental influence in his environment is of food. It builds and shapes his body and through the glands and hormones and nervous system it modifies his mental and emotional make-up. Obviously, food has ever remained a powerful influence in the historical achievements of man.

Vegetables are an indispensable item in human diet and as such vegetable growing must be recommended as a part and parcel of any Rural Reconstruction programme. The net returns per acre from vegetables are also much higher than those from farm crops like wheat, cotton, maize, etc., as most of the vegetable crops are of short duration and occupy the land for a comparatively shorter period, enabling the grower to raise two to three crops on the same piece of land in one year. Vegetable growing being the most intensive type of farming, employs the greatest amount

of labour for each unit of area under cultivation, thus providing employment to a comparatively larger number of people. The division and sub-division of the agricultural land has resulted in small, uneconomic holdings and their owners by taking to vegetable growing can derive fairly good income to ensure a decent living. There is also one great disadvantage to the village grower that he does not have access to a ready market as that in the vicinity of large towns and cities. The handicap of being away from the market, however, can be overcome to a certain extent by growing more of those vegetables which can be stored at least for short periods before arrangements can be made for their disposal, for example, potato, onion, winter squash, sweet potato and chilli. Thus there is a double advantage in growing vegetables, and not only does the peasant add to his income but he improves his family diet as well.

Food Value

For keeping good health varied and well-balanced diet is necessary. For an adult about 60 per cent of the food calories should be in the form of starches and sugars, about 25 to 30 per cent in the form of fats and 10 to 12 per cent in the form of proteins. In addition a wide range of minerals and vitamins must be supplied. It is essentially for the liberal supply of vitamins and minerals that we should include vegetables in our diet as other food materials are deficient in them. These are necessary for normal nutrition, proper growth and maintenance of good health and reproduction. Furthermore, vegetables

contain free organic acids which improve the palatability of food and increase the appetite. They help to increase the bulk of food for satisfying the capacity of the bowels resulting in proper digestion, assimilation and elimination of the body waste. Some of the vegetables like potato, sweet potato and certain root crops, bulbs and tubers are a valuable source of carbohydrates and others like peas and beans furnish high quality proteins.

As a source of vitamins leafy vegetables are of the greatest value. Their green leaves are as a rule a rich source of vitamins A and B and C. Such vegetables as lettuce, cabbage, pepper, carrot and onion if taken raw, constitute a very rich source of vitamin C. Tomatoes which can be consumed daily in adequate quantities furnish a sufficient supply of this vitamin to meet successfully the body requirements. Vitamin B is irregularly distributed in vegetables and seem to be more concentrated in seeds than in leaves and peas and beans both fresh and dried, are good source of it. Vitamin C is formed in the growth of the green plants and while green leaves are a fairly good source, they should be supplemented by richer sources as milk and eggs.

As sources of mineral elements of the many kinds required by the body, vegetables hold a very high place in the diet. Vegetables such as spinach chard, cabbage, asparagus, coriander, mint and green beans are especially valuable as sources of calcium, iron and copper which are essential for building haemoglobin of the red blood corpuscles. Deficiency of copper may cause anaemia and that of magnesium fits. Iodine is useful for the control of goiter. Although the iodine content of vegetables is not so much dependent on the kind as it is on the place of growth, such vegetables as asparagus, lady's finger and summer squash are a good source of iodine. In

localities where iodine is lacking or deficient in the soil and water fertilizer containing iodine should be applied to the vegetables to increase their iodine content.

Vegetables are not generally considered important for the supply of proteins, fats and carbohydrates and we have to look for the supply of these essential or basic substances to such articles of food as cereals, pulses, meats, vegetable oils, butter and *ghee* and to the vegetables more particularly for vitamins, minerals and roughage. Vegetables, fruits and milk are the three best sources of these regulatory substances in the diet, and therefore the human dietary should be built around these; and so far as vegetables are concerned, every one of us should endeavour to have at least two servings daily.

For Home and Market

In view of the knowledge of the health giving properties and greater net returns from vegetable crops it is highly desirable that vegetables be produced more extensively than hithertofore. Every dweller of the village, town and city who has a piece of land for vegetable growing should make his family self-supporting in home grown vegetables. Thousands of farmers and other dwellers of rural areas are unable to get fresh vegetables unless they grow them. There are other thousands who do not get fresh vegetables unless grown at home because they do not purchase them even if available. Therefore it is essential that every farmer in the villages should have a *home garden*. He should set apart a plot on his land that can exclusively be used for the growing of vegetables. The selection of the site will largely be determined by such considerations as the type of soil, ease and convenience of irrigation, protection from birds and prevailing winds especially drying and severe winds, absence of large trees and condition of drainage.



CABBAGE IN THE LAND OF POTATOES

Cabbage in the Nilgiris—The land of potatoes, is grown in the 'rest' period: two potato crops in a year yield over 250 million potatoes, for which half the available land on the slopes is utilized.



POTATO PLANTING (left)

Medium size potatoes of about the size of a hen's egg are used for seeds. Stored in a dry and comparatively warm place these sprout and in about a month and a half shoots start coming out of the rose end of the tubers. The object of this is to secure a few weeks' growth before planting takes place. The seeds thus prepared are planted in the open on deep well drained medium soil. Due to the slope of hills plough cannot be used. So the ground is prepared with digging forks. Ridges in which the seeds are planted are so prepared that the sun falls on either side of the rows and the rain does not drain away the soil.

In this picture, one woman is seen planting the seeds at the appropriate distance while the other is applying artificial manure.

PLATE 74

POTATO GRADING

Daughters of the Nilgiris must finish the grading of potatoes before taking them to sheds for storing

P. J. B.



The farmers in the villages situated in the vicinity of large towns and cities where ready market for their produce is at hand should take up *market gardening*, i.e., intensive vegetable growing for sale in the local market. A successful market gardener is required to be a good general grower and a good salesman as he usually has to sell his own produce. He should grow many different kinds of vegetables throughout the year in order to keep the supply constantly flowing to the market. Out-of-season vegetables, both early and late, should be produced because invariably they bring good income owing to prevailing high prices. This may be accomplished by sowing early summer vegetables in autumn and providing them protection against severe cold and frost during the winter. Early summer vegetables like cauliflower can be grown under partial shade. Late varieties of peas, turnip and carrot which will mature towards the end of the season may be grown to great advantage. If a farmer is situated far away from big markets and he wishes to take up commercial vegetable gardening he should resort to *truck growing*, i.e., the productions of special crops like chilli, onion and potato in relatively large quantities for distant markets.

Important Factors

Every market gardener, truck grower or home gardener can grow vegetables with success if he understands the important factors of production. These are concerned with climate, suitability of soil and maintenance of soil fertility, supply of reliable seed of good varieties, seeding, raising and transplanting of seedlings, cultural operations including thinning, weeding and watering, control of diseases and insect pests and harvesting and handling.

Climate: Of all the factors of vegetable production, climate is the most important in determining the choice of selection of

vegetables to be grown in a particular locality and we can hardly exercise any control over this factor. The most important climatic factors are temperature, atmospheric humidity and rainfall. Of these temperature is the most important and under outdoor culture we may succeed to a certain extent in controlling this factor by regulating the time of sowing of the various crops.

Soil: Any soil which is suitable for growing the ordinary farm crops can be successfully employed for the cultivation of vegetables. A well-drained, deep, friable sandy loam soil with plenty of organic matter is considered to be the best for the production of common vegetables. There are certain vegetables which either require a heavier or a comparatively lighter soil. Their needs can be satisfied by the application of varying amounts of organic manures. What really matters is the condition of the soil before sowing or planting a crop. The finer the tilth, the better the results. Before sowing or planting a crop the soil should be so thoroughly prepared that its texture is in the most satisfactory condition and the surface looks swollen. No clod should be traceable in the field. The level should be perfect before the field is divided into suitable sized plots for facilitating even distribution of irrigation water. The level of the individual plot must also be looked to. Then the lay-out can be done as required by the kind of vegetable to be grown.

The problem of maintaining the soil fertility is very important. The farmer may practise the principle of 'productive powers of the soil to be taxed to the utmost' provided he does not exploit this to the utter exhaustion of the soil. He should not burn the candle at both ends because the use of whip against a hungry slow-moving horse will not take the place of grain to be fed to him. The natural fertilizing agencies such as rain, snow, frost and sunlight must be

used to full advantage. The soil of a vacant field should be stirred occasionally to subject it to the action of these natural agencies. The principle of rotation of crops should be exercised as far as possible. The crops of exhausting nature should not be sown continuously on the same piece of land.

The application of farm yard manure should be supplemented with artificial fertilizers and green manuring crops. With majority of the vegetable crops applications at the rate of 10 to 15 tons of farm yard manure per acre and supplementing it with ammonium sulphate or nitrate of soda at the rate of 160 to 240 lb. per acre would give more profitable returns than heavy applications of manure alone.

Seed Supply: One of the primary requirements for success in vegetable growing is the use of good seed which is viable, clean of weed seeds and foreign matter, free from disease and insect injury and true to its name and kind. Good viability or high percentage of germination of seed is very essential as the success of the crop largely depends on good germination and consequent good stand of the crop. Therefore to guard against a financial loss and failure of the crop, the grower should not fail to test the seed for its germinating power, or the grower should make it a point to buy seeds from those agencies that make it a regular practice of testing seeds for viability before offering them for sale.

Seeding of Vegetables: The seeds of most of the summer vegetables, peas and beans, turnip and radish, carrot and okra are generally sown direct in the field. In order to obtain a satisfactory germination of these seeds it is necessary that conditions essential to successful germination be fulfilled. These conditions are, an adequate supply of moisture, the presence of oxygen and a proper temperature for the kind of seed in

question. In case of seeds which can be planted deep, it is possible to insure sufficient moisture in deeper layers of the soil for complete germination; but in case of other seeds, which must be sown shallow owing to small size and others which take longer time to germinate, provision must be made for a continuous supply of moisture. This can be done by sowing the seed on ridges so that moisture may be supplied by repeated irrigations till the germination is completed. Before sowing a crop, the grower must judge the depth, distance and thickness of seeding and method of sowing the seed.

The depth of sowing is determined by the size of the seed, kind of soil, amount of moisture and the season. The seed should not be planted too deep in the soil for the seedlings to push their way to the surface, nor should they be planted too shallow to deprive them of sufficient moisture. As a rule, small seeds are sown shallower than large ones. In sandy soils the depth of sowing is a little more than in heavy soils. For early spring sowings the seed is sown shallow to get the necessary warmth from the sun near the surface of the soil. In summer months the depth of sowing should be greater as there is rapid evaporation near the surface.

The distance of planting depends upon the ultimate size of the plants at maturity, methods of tillage to be employed, variety of vegetable to be sown, kind of soil and the season of planting. In short under any condition or factor which tends to increase the size of the plant, the distance of planting should be kept proportionately more.

Thickness of seeding is very important for securing a uniform stand of the crop in spite of the failure of some of the seeds or unfavourable soil conditions. If on germination the stand is too thick a proper distance can be secured by thinning, but on the contrary if the stand

is thin the filling of gaps and re-seeding will be inconvenient and the cause of uneven maturity of the crop.

Raising Seedlings: In general practice some of the vegetable crops, notably cole crops, tomato, egg plant, chilli, celery, etc., are grown by transplanting seedlings. There are indeed certain advantages in doing so. The time of the land is saved enabling the grower to produce more crops on the same land. The production of early crops to take advantage of the early market is made possible. The sowing period of the crops is lengthened by planting seed several weeks earlier than the weather would permit outdoor planting. There is also a certain amount of saving in the seed which is usually costly.

In order to raise the seedlings successfully a piece of land preferably sandy loam, well drained and lavishly supplied with humus should be selected. If the soil is heavy some silt or sand should be added to the land and mixed well with the soil. The place should be protected and its level should be about 6 inches higher than the surrounding soil. A permanent source of water supply should be near at hand. Before sowing the seed, the nursery plot should be completely freed from weeds and prepared well to a fine tilth. The seed is either sown in rows or broadcast and covered over with a light layer of fine soil or compost. Watering should be done by a fine spray from the sprinkling can. Sufficient moisture should be maintained till all the seeds have germinated. Steps must also be taken to check the black ants which usually carry away the seed and sprouts of the germinating seedlings. This can be easily done by digging a small ditch around the plot and keeping it filled with water till the plants are well-established. Protection should also be provided to the young seedlings against the direct scorching rays of the sun, heavy showers of rain or the frost as

the case may be.

Transplanting: The seedlings are ready for transplanting in the course of 4 to 6 weeks. They should be hardened 4 to 5 days before transplanting by withholding water or exposing them to the sun or by doing both. For successful transplanting the plants should not be allowed to suffer from lack of moisture during transplantation. A thorough watering of the plants should be done in the seed bed a few hours before digging them out. Plants should be carried to the field as quickly as possible with their roots in water or wrapped in a wet rag or with moist soil sticking to the roots. Transplanting should always be done in the evening and the field irrigated immediately after transplantation.

Hoeing and Weeding: Thorough hoeing and weeding of the vegetable crops is a very necessary operation to prevent the loss of moisture and plant food materials from the soil through the control of weeds and soil mulch formation. Hoeing facilitates aeration of the soil and free extension of root systems of the plants. Certain harmful insects are also exposed and destroyed.

Insect and Pest Control: The control of pests and diseases is an essential part of vegetable culture since with proper precaution to control these enemies serious losses of crops can usually be avoided. Both diseases and insect pests are more serious with vegetable crops owing to the intensive nature of vegetable forming and more succulent condition of the vegetable crops plants. Instances are on record to show that yield of potato and celery have been increased by spraying against blight. Yield of onion has been increased by spraying the crop for the control of thrips. Many more examples can be given but these show the importance of knowing what injury is being done by diseases and insects and the necessity of their control.

Measures such as rotation of crops, destruction of refuse harbouring diseases and insects, destruction of affected plants, picking of insects with hand and killing the insects and preventing disease injury by spraying and dusting may be adopted to a great advantage.

Harvesting: Vegetables should be harvested at such a stage of maturity that they do not reach the consumer in a bad condition. No rules can be given for the determination of the proper time of harvesting, as it varies with the kind of crop, weather conditions at the time of harvest and the distance to the market. Therefore the grower has to exercise his own judgment in this regard. Some crops as peas and beans deteriorate in quality if delayed in harvesting at the right stage of edible maturity. Therefore it is advisable to harvest them as soon as this stage is reached. Other vegetables like carrot, egg plant, turnip and beet grow oversized if not harvested at the stage of edible maturity and lose heavily in quality. Tomatoes and melons do not develop superior quality if harvested under-ripe. Therefore they should be allowed to remain on the vines as long

as possible and should be brought to the consumer in good condition. The produce should preferably be graded before sending it to the market. Graded products bring much better price than ungraded ones.

Future of Vegetable Culture

There is a wide scope for the extension of cultivation of vegetables in the country. At the present time the annual production of vegetables is only 9 million tons. Large though this figure may appear it is inadequate to meet the requirements for a suitably balanced diet in minimum quantity for our 400 million people. To meet our requirements fully the production of vegetables will have to be easily doubled. Furthermore, by increasing the production and consumption of vegetables, we will not only improve our health but will also reserve a good deal of grain for the nation when it faces a grim food famine. Vegetables like carrot, potato and sweet potato, which yield much more heavily than cereals and can serve as a fair substitute for grain, should be grown extensively.

6

COTTAGE INDUSTRIES



VILLAGE INDUSTRIES

By J. C. KUMARAPPA

THE developing of Village India should be concerned primarily with the betterment of the villager. We have to be interested in the persons rather than in the materials. Villages ought not to be looked upon as sources of raw materials for the mills and as a convenient market for articles produced by the mills and as a prolific breeding farm for mill labour. This has unfortunately been the attitude generated by the spread of centralized industries under private enterprise for over a century.

With the use of machinery in which large amount of capital was invested the machine owners found it necessary to locate these plants in places where they could be safe and be conveniently controlled instead of being located where raw materials are easily available and where the markets are within reach. For instance, one would think that the logical location for a cotton mill would be where cotton is grown and where cotton goods are used by the people. India grows cotton and is practically dependent on cotton cloth for clothing its people. Yet the mills were located at Manchester. This was because the people who sunk their capital in these wanted to have them where they would be safe and where they could conveniently manage them themselves. This consideration had led to the anomalous situation in which cotton grown 6,000 miles away was spun and woven in mills beyond the oceans and then the finished goods were carried back another 6,000 miles, to where the cotton was grown, to be sold.

Under this system it is but natural that there can be no personal relationship between the raw material producers

and the millowners. The raw material producers only exist as functions of the machine and not as human entities with personalities of their own. Immediately this personal touch was dispensed with their mutual relationship deteriorated giving place purely to money consideration. Profit and profit alone directed their activities. This led to a progressive deterioration in human relationships and had given rise to the need for political control over the lives of raw material producers by resorting to violence. This form of political, social and economic organization would be deplored by every right thinking individual under cool and calm consideration but yet this is the most prevalent organization today causing periodical world wars and much distress.

The Remedy

We have to release humanity from this scourge. The grip of money has to be loosened and the people set free to live their own lives. If this is accomplished people will be free to develop their personalities and interests as they wish to and the world will be richer for it. The source of the evil indicates the remedy. We have to do away with a system where industries depend upon raw material drawn from distant places and have to cultivate markets at the ends of the earth. Every industry must be located at the source of the raw material and must produce goods that will be sold locally.

Further, even under such conditions methods of production where large amount of capital is a fundamental need will reduce the bulk of the people into

wage slaves as the majority of the population do not possess such accumulated wealth. Therefore, we must also fall back on methods of production where it is possible to manufacture articles with simple tools or machinery.

Decentralized Industries

Thus we come to the conclusion that industries that can engender individual freedom and give full scope for the development of individuality must be located at places where raw materials are available and where there is a ready market. In such industries goods should be capable of being processed by the use of simple tools within the easy reach of the people. This brings us to methods of decentralized production obtaining in our villages.

Often we are told that such industries are inefficient. Yes. If we allow such colossal ignorance to prevail in large scale industries they will be still less efficient. Efficiency does not depend upon the amount of machines we use. It is directly related to the extent of scientific thought and research brought to bear on the subject. Because of the resources available to financiers it has been possible for them to make the best use of the talents turned out by our universities but our village industries have been languishing for lack of these. A large textile mill can employ dozens of scientists in well equipped laboratories to work on their problems but what can a poor village weaver do? This duty of research should fall on the State. But in India the State has been practically completely oblivious of the existence of village industries. Even the agricultural researches have been mainly centred round the possibility of producing raw materials for the mills—sugarcane, cotton, tobacco etc. These have in many instances been antagonistic to the rise of village industries. Until we infuse into our village industries modern scientific knowledge

our village industries cannot be expected to stand on their feet.

For instance, village tanning follows to this day most crude methods of collecting the hides, imperfect processes of tanning are carried out with the result that the tanner hardly gets a fraction of the return that he can get if he were trained scientifically to flay the animal, make meat meal and bone meal manure out of the carcase, and obtain guts, glue and other by-products and utilizes horns, etc., for industrial uses. Crores of rupees of wealth is being thrown away every year through ignorance of modern methods.

As we have already mentioned in passing, these industries should supply the local needs. This by itself does not discharge their full liability. Economic activity of man is many-sided. Of course it supplies his physical needs. But in doing so it also functions in various ways. This should be the core of man's life by which all his faculties are fed and enriched. Work is food to his higher faculties. Just as food sustains, develops, and provides the needed energy for the body so also work properly organized, supplies the needs for the maintenance and growth of the personality of man. Work produces effect not only on material things but also on the man who is working. It may be said that perhaps the more important result is the effect on man. Without work man deteriorates.

In nature's cycle also these industries play a part. By being located in the place from where the raw materials are obtained industries help to complete the cycle which will be broken if distance intervenes. Groundnut grown in a certain place is crushed into oil in that place and the cake is used as manure, then the cycle is completed. But if the nuts are exported to Germany the soil is impoverished. Large-scale industries break into the natural cycle and destroy the natural order of things.

Supposing we take the primary need of providing light for an hour or so after sunset, the effort to meet this need must not only provide light but should also be woven closely into the pattern of life of the village. If this need is met by using kerosene oil there is no natural cycle. Kerosene oil is a by-product of petroleum which is extracted from the bowels of the earth. Practically all this stuff comes from other countries. Therefore, villagers have to part with the wealth they produce to obtain this. Apart from obtaining this oil itself, to burn it lamps are also imported from Austria, Germany, U. S. A. etc. This again means parting with village production. Instead of using kerosene oil if we could devise a lamp that will burn, say, using groundnut oil or other vegetable oil this will fit into the everyday life pattern of a village. The farmer will grow the groundnut, the *teli* will extract the oil, the tinker will make the lamp and so on. The provision of light alone will cause to circulate within our villages over Rs. 10 crores of wealth which are now being drained outside the country.

Apart from the material wealth, the effort to devise the lamp and improve it will give full play to the resourcefulness of those who have a flare for invention not only in this line but also in other spheres. Kerosene oil being a thin and light oil rises by capillary attraction up the wick against gravitation. But vegetable oils being thicker will not so rise; hence, the flame has to be gravity-fed by having overhead reservoir for the oil. This raises many problems to exercise the ingenuity of the lamp designer. At present all such men are being wasted or are being turned into manual labours.

Prosperity and Peace

In the above illustration, we had dealt with only one and that a minor one of our needs. If we meet all our needs in this way our villages ought to be humming with activity and provide a wide field for the most talented and intelligent to exercise his gifts. Even the primary needs such as food, clothing and shelter are themselves rich in possibilities. The best of food materials are produced in our villages but the demon of ignorance and false ideas make us waste a great deal of it by following wrong processes such as polishing rice, or preparing *maida*, or storing in a wasteful manner. We do not make the best use of waste water or manure or nightsoil, thus making inroads into the natural order. Even the cooking is wasteful; we bake, boil and fry killing all nutrition out of the food products. Our combinations in the menu are badly balanced. In the end we suffer from disease, want and malnutrition. If all this is properly organized in an enlightened way villages can provide all they need, waste little, and enjoy prosperity and health. It is within our reach to supply all our needs. We can by better organization and by satisfactory dissemination of knowledge and by provision of facilities for research use village industries for the development of a national culture and for giving tone to our civilization.

If this can be achieved it would be possible for villages to be working within the field of self-sufficiency, with little use for the extension of money economy, with fuller personal freedom, without interference from outside. Thus will the development of village industries contribute towards fuller nationhood, happier humanity and a peaceful world.

COTTAGE INDUSTRIES

By UJJAL SINGH

THE Indian Industrial Commission of 1918 made the following observations regarding Cottage Industries :

“ A general review of evidence tendered to us, supplemented by numerous inspections in the towns and villages that we have visited, confirms us in the conclusion that cottage industries are a very important feature of the industrial life of India.”

Before the Industrial Revolution in Europe, India was not only manufacturing goods for her internal needs but also exported goods, particularly fabrics, made by her skilled workers and artisans. The steam engine and factory competition coupled with political subjugation have a great setback to her domestic industries. Cottage industries have, however, survived because: (i) they are to some extent adapted to their environment, (ii) progress of factory industry has not been sufficiently rapid, (iii) traditional preference of the consumer for certain types of cottage-made goods, (iv) defective means of transport which have afforded a kind of natural protection to the cottage worker in the remote village or town, (v) certain amount of patriotic fervour created in favour of cottage goods, and (vi) small farm basis of land system to which cottage industries serve as a useful adjunct. All these factors will, however, lose their force as time passes.

In modern times of mass production and specialization, to devise schemes of encouraging cottage industries, might appear to some a questionable proposition. But we have to consider the whole problem of industrial development in India keeping in view the conditions

prevailing in this country.

India is primarily an agricultural country with its population living in villages. Her increasing population can not fully be employed on agriculture. The pressure on land is increasing every day. Industrial occupations alone can relieve that pressure. Even those who are engaged in agriculture have slack seasons and slack hours of the day. Those without work can be employed in big factories but the partially employed can supplement their income by some sort of industrial work which they can do at homes. Cottage industries can, therefore, be a source of additional income to the cultivators. Besides, big factory business leads to congestion and unhygienic conditions which unless properly handled, lead to unhealthy living. In cottage industries there is no divorce of labour from land and no concentration into factories. And particularly, at the present moment, the difficulties of procuring machinery from abroad for factory business, are proving a great handicap to industrial development. Such industries as can be developed under cottage conditions should therefore receive the best attention and encouragement at the hands of the Government.

Japan and Switzerland

For the development of these small scale industries we can learn a good deal from Japan and Switzerland. For their success, the cottage industries have got to be modernized in the way of tools, designs and market arrangements.

The position of domestic industries in Japan can well be understood from the following extracts from *Japan's Economic*

Position by J. E. Orchard, Professor of Columbia University :

“The larger factory is the exception and in only two groups of industries i.e., cotton spinning and weaving and Iron and Steel products, has it become the dominant unit of production.

“The other industries of Japan have their roots more firmly embedded in the country.

“The domestic workshops are numerous and among the factories, the small establishment is a vital unit, if not the all important unit of production.”

Such industries as are carried on in village homes in Japan are, weaving of silk and woollen cloth; dyeing and printing of cloth; making of pottery; rubber goods; toys; clothing; straw braid and hats; paper lanterns; umbrellas; toilet brushes; cutlery; lacquerware, etc.

In Japan, the domestic industries are organized on a contract basis. The raw materials are purchased and the finished products disposed of by an entrepreneur who in some industries is the wholesale or retail merchant and in others the jobber. The actual manufacturing is done under a contract system in domestic workshops, and if an article is complicated it may go into a number of hands. For example the lantern is sent to six different families, each completing one process. The industrial success of modern Japan is due to the attention paid not only to the education and technical training for cottage workers but to the building up of business organizations, which take over the products of their industry and dispose of them all over the world.

In Switzerland one-third of the industrial population is engaged in cottage industry, chiefly watch and ribbon making. All cottage workers are linked with a manufacturer. As a famous author observes: “The keynote of the Swiss System is expert control and a constant market. This success of the Swiss System

depends upon two factors—(i) practical business control, and (ii) reasonable intelligence on the part of the working population.”

New Spirit in Old Crafts

Some of the village industries in India which have not adapted themselves to new conditions have either become extinct or have a precarious existence. Although the hereditary craftsman has an advantage over an unskilled worker, he is no match however for a trained and skilled labour. The cottage worker has no expert designer unless he is linked with either a businessman or a Government organization. And above all, marketing of finished products presents great difficulties as the cottage worker need not necessarily cater to the needs of his village community. A marketing organization is therefore essential for the success of cottage industries.

Of all the cottage industries in India, handloom weaving industry is the most important. It has been estimated that there are about two and a half million handlooms in the country and the number of those depending on this industry is nearly ten millions. The economic position of the weaver in general has not been satisfactory and has been the subject of enquiry by the Government of India and the Provincial Governments. The Fact Finding Committee (Handloom and Mills) of the Government of India submitted its report in 1942 and its suggestions and recommendations have still to be considered by the Government. In some of the provinces to name only, the Punjab, by organizing peripatetic demonstration parties and exhibitions and by setting up weaving institutions for teaching upto date methods of weaving, dyeing and finishing, the industry has been modernized to some extent. The result is that new lines of manufacture have been introduced e.g., furnishing fabrics—curtains, tapestry,

suiting and shirtings in striped and checked designs, bed covers and teapoy covers, etc. The chief need of the industry is the supply of new designs to suit new tastes and fashions, and credit and marketing facilities. In the present day conditions in India such facilities can be provided only by the Government on an extensive and organized basis.

Wool spinning and weaving industry on a cottage scale is carried on principally in the Punjab and the United Provinces. The woollen goods produced by handloom workers are blankets, *loies* and *dhusas*, carpets, coarse coating and shirtings. Of late improvements have been made in the industry particularly in the Punjab by the setting up of a marketing organization, the main functions of which are finishing, improvement of designs and provision of marketing facilities. Besides, the Department of Industries maintains a number of travelling institutes and demonstration parties for giving training in wool spinning and weaving. The war gave a big fillip to this industry.

Hosiery is another industry which is carried on cottage scale although there are a few large mills also. This industry has spread rapidly in the Punjab and gives employment to over 20,000 persons. The Punjab Government has established a Hosiery Institute at Ludhiana for the training of workers.

The dyer's craft boasts of great antiquity in this country. The cottage workers are producing bewildering designs and a variety of colours and subtle shades to suit modern tastes. But the industry needs encouragement at the hands of the Government.

Metal industry which includes the cutlery and surgical instruments industry is carried on in different parts of the country on cottage as well as factory scale. The war suddenly increased the demand for these goods and thus offered

a splendid opportunity to the workers. It must be recorded that the workers have shown not only remarkable skill in technique and workmanship but also extraordinary adaptability in producing an enormous quantity of most delicate instruments for the defence forces. The quality however is not of a high standard and it is here that expert guidance is needed.

The sports goods industry is almost entirely confined to Sialkot in the Punjab. Although there are a few large scale factories, the cottage worker is the main stay of production. The goods manufactured comprise of tennis and badminton rackets, football covers, cricket and hockey balls, tennis and badminton guts, cricket bats, hockey and polo sticks, etc. The industry gives employment to over 20,000 operatives and a fairly large percentage of its production is exported overseas.

The other notable cottage and small scale industries are oil pressing; pottery; sericulture; glue; wood work; tanning and leather goods; button making; bee-keeping; dairy farming—milk products; ghee, etc.; hats and caps; laces; umbrellas and umbrella hand making; pencil making; rubber goods; cane furniture; also cane and basket ware; matting, etc.; soaps, toilet material; tooth powders, etc.; toys and dolls of wood, marble, ivory and from bones and horns, etc.

Industrialization or Disaster

According to Sir M. Visvesvaraya, the average income from industries per head of population in India is estimated at about rupees fifteen. The corresponding income in the United Kingdom is probably over Rs. 700 and in United States about Rs. 1,100. The smallness of income from this source accounts for the extreme poverty and deep distress of our people and it is the duty of every right-minded



BASKET MAKING

The sale of baskets made in the class helps to provide additional amenities for this village school in the Punjab



P. 11 B

HANDLOOMS



P. 1. B.

EMBROIDERY & KNITTING

SPINNING

P. 1. B.





P. J. B.

BED-TAPE MAKING

citizen to take vigorous steps to remedy the defect.

What measures must be adopted to provide impetus to the cottage industry and what agency should be employed in the execution of those measures, are the two questions which have to be answered.

Sir Visvesvaraya suggests two basic principles: (i) that groups of villages each consisting of ten villages and a population of about 15,000 may be formed as working units, and (ii) that a committee of about dozen representative citizens in each village group be constituted which should be made responsible for the industrial progress of the group of villages included in the unit. These suggestions are deserving of consideration coming as they do from an eminent thinker on the subject. But my own view is that unless the Government takes the initiative and seriously undertakes to develop cottage industries, no great progress will be possible. Before the Government prepares expensive schemes for developing cottage industries and spends big amounts of money in them, it must be determined (i) what industries we are going to develop on cottage scale, and (ii) what lines of production are we to assign to cottage industries—the artistic or the coarse? We should have in every province a special provincial

committee consisting of industrialists, cottage workers, businessmen and legislators presided over by the Minister of Industries. A special officer of the rank of Deputy Director should be made incharge of the development of cottage industries. The provincial committees should do all the planning and set up district organizations for the types of industries suited for the area. The Government must undertake to provide for the training of cottage workers, credit facilities, expert designers and marketing arrangements, for ensuring the success and steady development of cottage industries. It is not the ideas or the schemes that are lacking but the will to execute them. Unless the Government makes up its mind to industrialize India and pursues the matter with vigour and zeal, nothing tangible will be achieved.

India today is on the verge of disaster. Her teeming millions are in dire need of the minimum social services which every civilized Government must provide. Poverty in the country must be banished. The choice for the Government is industrialization or disaster. Let us hope that the National Government will soon take up the question of fostering cottage industries in right earnest and thereby save the country from a serious catastrophe.



7

HEALTH & SANITATION



HEALTH AND SANITATION PROBLEMS

By M. S. RANDHAWA

A PROGRAMME of health and sanitation measures occupies an important place in rural development work. But propaganda for sanitary living should follow rather than precede measures which increase the wealth of the peasant. There are some exceptions to this general statement, e.g., manure pits. The composting of manure, organic waste and rubbish in pits will not only mean cleaner village streets and houses, but will also add to the wealth of the peasant. In some cases rural development has been mistakenly identified with sanitation propaganda only, and a number of cases are known where well-intentioned educated ladies from the richer classes have been going to villages with the object of inducing the peasants and their women to live a cleaner life and to keep their children well washed. Such efforts have met with very tepid response. After a brief excitement the village again sinks in its age-long inertia and such visits are remembered mainly for the amusement which the colourful sarees of the welfare workers provided to the village people. Why are the villagers indifferent to a work of this nature? It is a well-known fact that most of the people in villages live in stark poverty following a routine which has not been varied for centuries and to such people whose lives are dull and miserable, clean living seldom has any charm. As Mr. C. F. Strickland writes: "Clean living does not appeal to a man or woman whose life is dull and pinched. Interest him, awaken him, give him new occupations, and he will almost spontaneously raise

his level of personal behaviour, will at least respond to a stimulus in that direction. So long he is bored and wretched, the man, frequently also, though somewhat less than the woman, regards hygienic advice with indifference, if not with annoyance; when he is brightened by a general change of outlook he feels cleaner and acts accordingly. Many of the health aid schemes of the Government and private bodies are ineffectual for this psychological reason, and will not make a real dent in the popular mind until that mind has been first cultivated in other ways. In other words, an approach to villagers with a programme consisting of health measures is a mistaken approach." Mr. Strickland has correctly indicated the place of sanitation propaganda in rural development. Those who advise the peasants to have windows and sky-lights in their houses should, first of all, ensure them better income so that they are able to buy quilts and woollen blankets. It is more due to lack of sufficient warm bed clothes rather than aversion for sky-lights that the villagers in Northern India sleep in houses without windows and sky-lights. However, this does not mean that we should allow the villages to continue to stink. What is implied is that our programme of village development should be comprehensive and economic betterment should go hand in hand with rural sanitation.

Rural Dispensaries

There are thousands of villages in India which are without medical facilities of any sort and the villagers have to rely

on quacks, who give them charms, amulets and useless concoctions for their hard earned rupees. Thousands of persons are swept away in epidemics, scores of young women die during child-birth and a large number of persons are incapacitated by malaria. Most of the diseases which cause so much wastage, are preventible. It has been estimated that the average number of deaths from preventible diseases is five to six million per annum and the average number of days lost to labour are two to three weeks in each year. Expenditure on medical aid and building of rural dispensaries is like a long-term investment with slow but sure returns and, even from the purely bloodless economic point of view, would result in increased production. As Sir Walter Layton says: "Wise expenditure on social services and particularly, health and education, should be remunerative in the sense of increasing the wealth producing power, and therefore the taxable capacity of a country." Colossal waste of man-power takes place due to malaria from September to November, in the eastern districts of the United Provinces, Bihar and Bengal, and thousands of acres of fertile land in the sub-Himalayan *Terai* zone is lying useless due to the prevalence of malaria. A comprehensive malaria control programme is indicated.

Most of the provincial governments have schemes for making dispensaries in rural areas in their post-war development programmes. The object is that medical aid should be made available to all persons. These plans should be energetically implemented. The people should also come forward to share the financial burden with the State. Most of our charity is misdirected and it is spent on feeding beggars and building *dharamshalas* and unwanted wells. This money should be spent for the alleviation of human suffering in villages and our rich people should build dispensaries in rural

areas.

Health Vans

Due to the scattered nature of villages and the great distances which separate them in arid areas, motor vans equipped with essential medicines, under the charge of a doctor assisted by a driver-compounder, can be very useful. A hospital on wheels will be a boon to villages and remote hamlets.

Medicine Chests

Medicine chests containing quinine pills, potassium permanganate, ointments for sores and indigenous medicines for common diseases have served a useful purpose in the villages of the United Provinces which are far away from hospitals. Such chests have been supplied to nearly all villages with *panchayats* through the agency of District Medical Officers of Health. Along with these chests, pictorial charts containing the names, symptoms, causes and treatment of common diseases, can serve a useful purpose. These chests are usually placed in the custody of the *sarpanch* of the Village *Panchayat*, the Rural Development Organizer, the village school-master or the *patwari*, who are expected to keep a register showing the names of persons to whom they have distributed the medicines.

Medical Aid & Training of 'Dais'

There is need of women's hospitals with a lady doctor in charge, in all *tehsil* headquarters, where arrangements should also be made for training village *dais*. An adequate stipend should be given to induce them to go in for training in view of the high cost of living in towns during the training period. When the number of trained *dais* available becomes sufficient it may be worth while to introduce the system of licensing so that only qualified *dais* are allowed to practise. The *dais* need instruction in the anatomy

of the parts involved in, and dangers of using unclean hands and instruments during child-birth and in the detection of abnormal cases before labour begins. They should be provided with outfits containing all that is necessary for conducting a normal case of labour. The *dais* may also be taught practical and scientific methods of birth control as a knowledge of this type is greatly in demand in villages. Thus population control and alleviation of suffering due to disease can go hand in hand.

Excellent work in training village *dais* has been done by American missionaries at Siwait in Allahabad district.

Rural Sanitation

Paving of village streets, arrangements for the drainage of waste water from houses and wells, disposal of human excreta, cleaning of village streets and destruction of stray dogs are the main problems of rural sanitation in the plains of Northern India.

Streets in villages, particularly in the rainy season, become so slushy and muddy that it becomes impossible for people to walk and the villagers wear stilt-like wooden sandals on which they hop from one dry bit of land to another over puddles. Paving of village streets, with a drain in the middle, particularly where the houses are *pucca* on a contributory basis—half of the cost being met by the villagers and the remaining half by the Government—is an urgent necessity. For keeping the streets clean, it is also necessary that the *panchayats* should employ sweepers.

Metalling & Tarring of Through Roads

It is absolutely necessary in the interest of the health of millions of people that the sections of district roads passing through village *abadis* are metalled and tarred. When a motor vehicle passes on a *kuchcha* road through a village *abadi* it raises clouds of dust which settle down

after a long time. Dust laden with disease germs causes tuberculosis, coughs and colds. If these sections of roads are tarred, millions of people will benefit and lung diseases will be appreciably reduced. This work should be given priority to new constructions in our road programmes.

Water and Sanitary Problem

The problem of protected water supply for the village is of great importance. So far as individual houses are concerned, it has been partially solved by the installation of hand-pumps which could be had at the modest cost of Rs. 25 in pre-war days. In some districts of the Punjab, such hand-pumps have been installed in the houses of villagers on a fairly large scale. Where the water level is above 30 ft. from the surface, such pumps function economically and deserve to be introduced on a large scale. If such hand-pumps are installed by a Government agency at cost price on *takavi*, it will be a considerable help.

However, the well will continue to be of importance in a large number of villages, particularly in poorer areas and arid tracts where the water level is very deep. In most of the villages wells are surrounded by puddles of stagnant water, polluting the water of the well. Most of the wells are open and thus insects, squirrels and even lizards find their way into the water. Above all is the evil practice of every one bringing his own bucket to take out water. In this way germs of diseases like cholera, diarrhoea and enteric fever spread from house to house. Moreover, people bathe and wash dirty clothes on the parapet of wells and dirty water splashes into the well.

Parapetting of wells with cement has been done on a large scale in the villages under the rural development scheme in the United Provinces. Such parapets have sloping sides, so that the villagers cannot place their pitchers on them.

Wooden frames with iron or wooden pulleys are also provided. Parapetting considerably improves the appearance of the wells as well as of the village and also ensures clean water supply to some extent.

In villages in the canal colonies of the Punjab, Persian wheels have been installed on wells for drawing water. The water is collected in a reservoir which is fitted with taps, from which women fill their pitchers and under which people also bathe. Troughs are made on one side for watering cattle and provision is also made for the washing of clothes. The Persian wheel is usually worked by a male buffalo, who is maintained by a caretaker appointed by the village *panchayat*. This method eliminates drudgery and the individual bucket.

The *panchayats* should also have the wells cleaned once a year and also arrange for liming or permanganation of wells during epidemics of cholera.

Soakage Pits : For draining waste water, soakage pits have worked satisfactorily in areas where sand occurs in the sub-soil at a depth of six feet or so. A pit five to six ft. in diameter is dug, the bottom is covered with broken pieces of bricks and over it fine sand or gravel is laid.

Planting Trees for Drainage : With the installation of hand pumps in the houses, drainage has become an important problem in the villages of the Punjab. Only *pucca* streets with central drains can meet this problem. As regards waste water from the wells, where people bring their cattle for watering, various remedies have been suggested. Soakage pits have been tried in many places. However, it has been seen that after some months, these pits become saturated and cease to function. Where land is available, trees with a high rate of transpiration, like eucalyptus and plantains may be grown to drain waste water. In the young stage, these trees require

to be protected from cattle by building enclosures of mud or bricks.

Destruction of Stray Dogs : Our villages swarm with *pariah* dogs, who not only make the streets dirty by their excrements but also howl dismally during winter nights due to cold. A false sense of humanitarianism keeps these unwanted animals alive in a semi-starved condition. Destruction of these dogs on a large scale is necessary. Incidentally their blood and bones can serve a useful manurial purpose.

Disposal of Human Excreta : Village streets and fields in the immediate vicinity of the village stink with human excreta. Small children usually ease themselves on the streets. Mr. Brayne is not wrong when he says that the best manured land in Indian villages are its streets. Apart from the sense of decency, the practice of answering the call of nature exposed to public gaze is wasteful and unhealthy. Dried by the heat of the sun, human excreta is carried by the wind and is responsible for red and sore eyes among village children. The following methods have been suggested for coping with this problem :

Gandhi's 'Khurpa' Method : Mahatma Gandhi has suggested that when a person goes out to answer a call of nature in a field, he should carry a *khurpa* with him ; before easing himself he should dig a hole 6 in. deep and later on he should cover it before leaving. This method is practicable in the case of grown-ups, who have the habit of rising up early in the morning.

Pit Latrines : Each farmer is expected to dig two pits for storing his manure. If two planks of wood are placed across the pit which is screened by a *kuchche* wall, it can serve as a pit latrine. The night soil will get covered with rubbish from the cattle shed. When properly fermented, night soil also becomes an odourless manure, which is not unlike manure from cow dung.



THE CONCRETE ASSOCIATION OF INDIA

IMPROVED VILLAGE WELL



THE CONCRETE ASSOCIATION OF INDIA

ANOTHER IMPROVED VILLAGE WELL

Complete with housing and windlass, bath room and drinking trough
for animals at village Sahibabad, Daulatpur

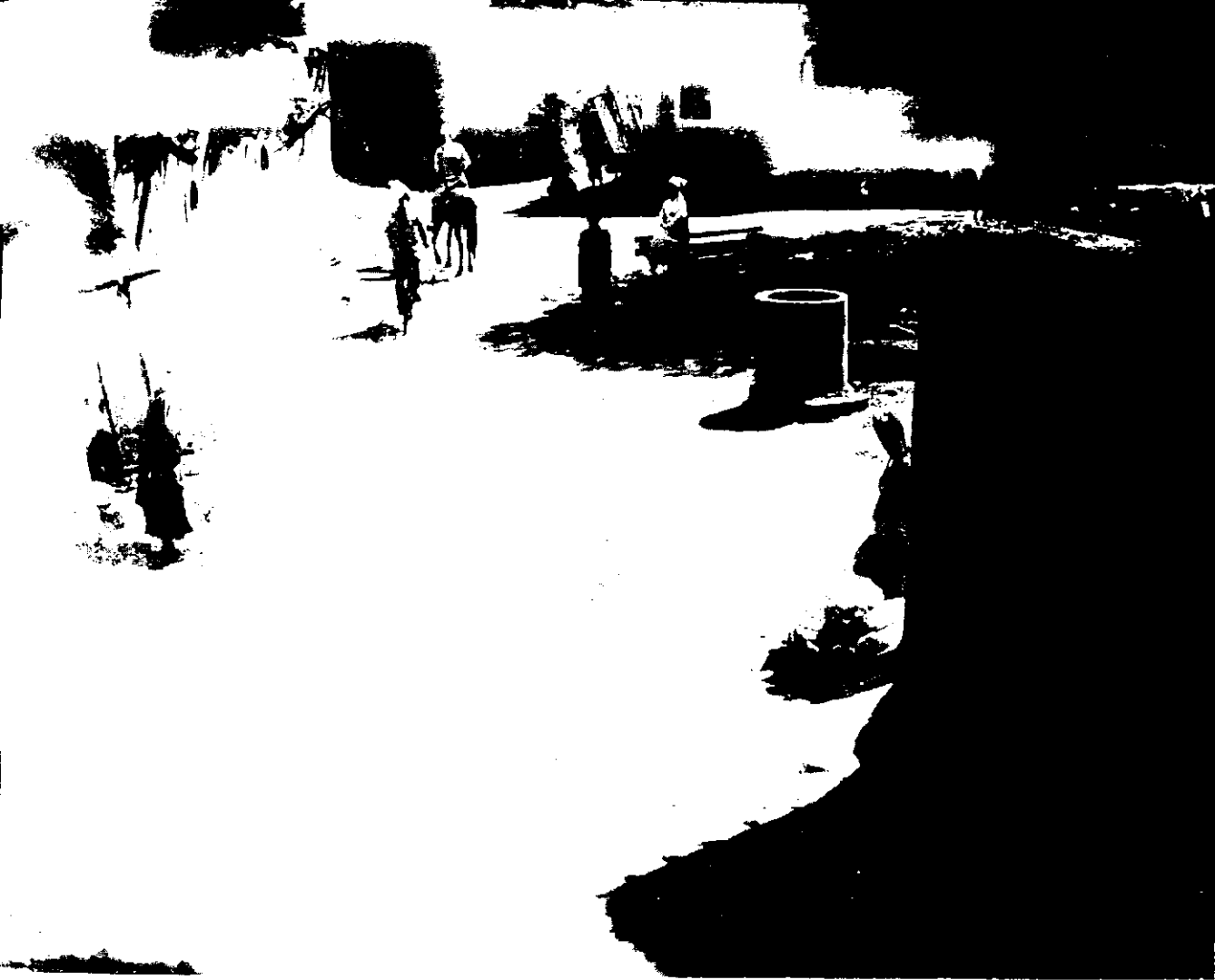

THE CONCRETE ASSOCIATION OF INDIA

CONCRETE ROAD IN A VILLAGE

This road, seven feet wide, at village Sahibabad Daulatpur is a real boon to the people. Watch the dust bin and the ventilators



ANTI-MALARIA PROPAGANDA

Malaria presents one of the worst threats to public health in India. The Health Survey and Development Committee recommended the expansion of Malaria Institute of India. Here is a lorry fitted with anti-malaria slogans touring to educate the villagers



A TOURING VACCINATOR

The Health Survey and Development Committee also recommended the establishment of provincial malaria organizations and malaria control units. Here is a touring vaccinator in a village in the United Provinces.

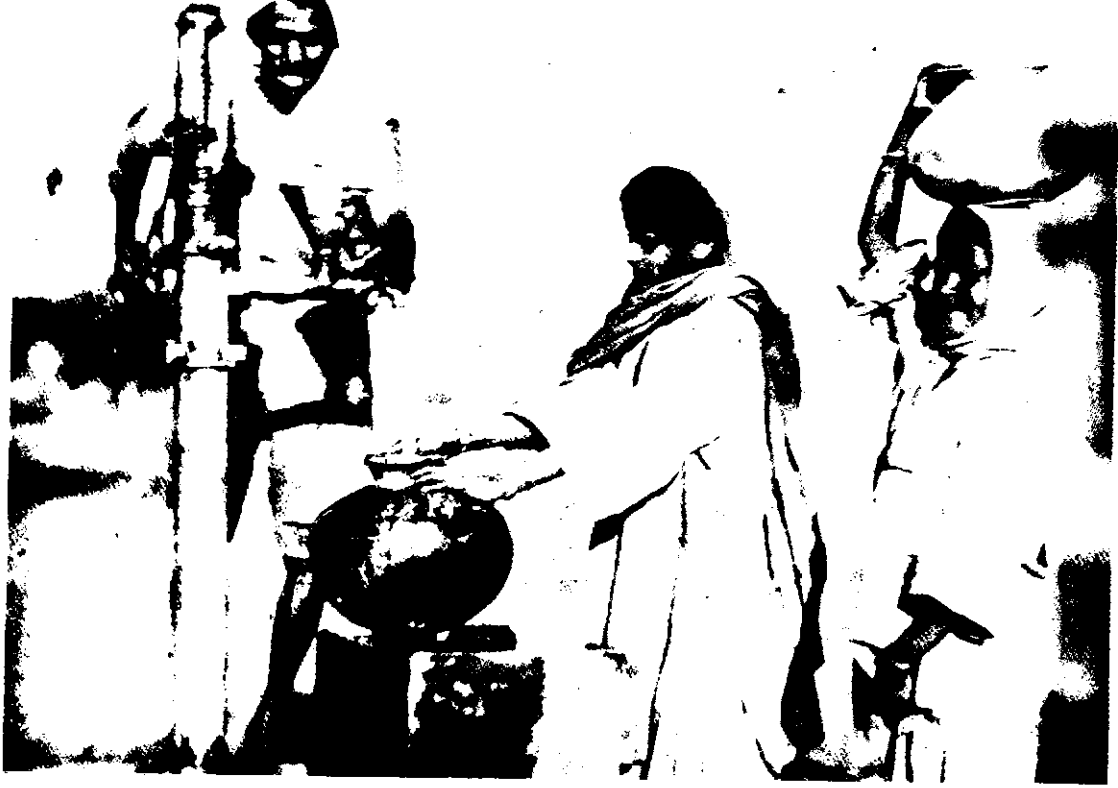

HAND PUMP AT WORK

S. L. DHAR

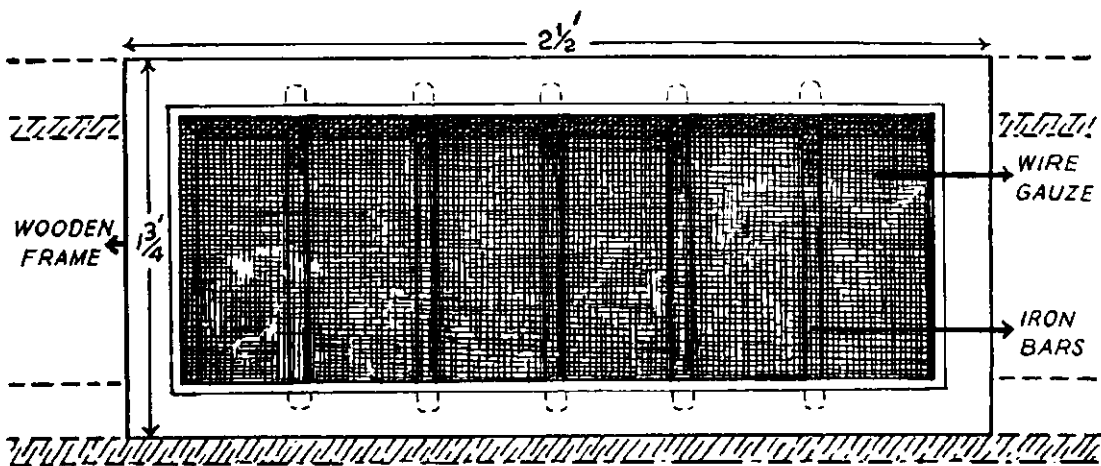

A VENTILATOR DESIGN

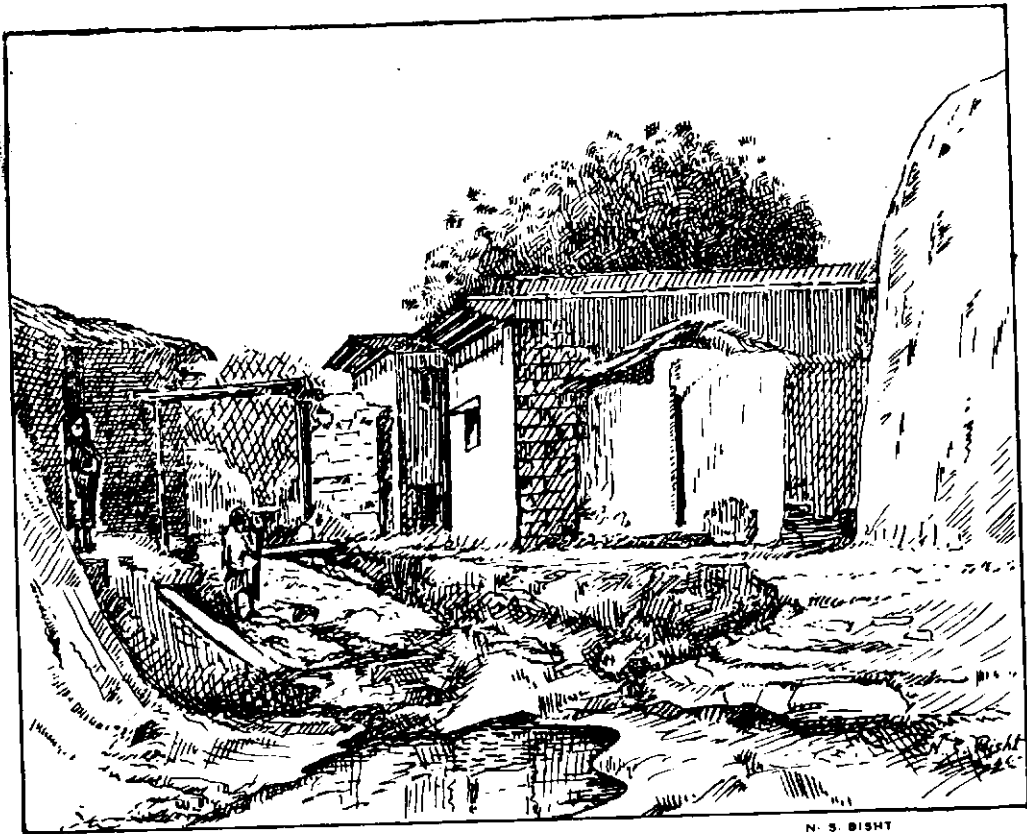

THE CONTRAST
Paved streets are a boon to a village

N. S. BISHT



Bored Hole Latrine: A hole is bored with the help of a special borer upto a depth of 20 to 30 ft., and on this is placed a stone slab or a wooden plank with a hole 9 inches in diameter. No bad smell results as bacteria soon decompose the organic matter. After some months manure can be taken out. Such latrines can be made in the court-yard of houses in those tracts only where water level is deep.

Village Cleanliness Week

When the crops are harvested, thrashed and stored in the month of April, the cultivator has plenty of leisure. In the month of May, the villagers are comparatively free and they can devote attention to repairing of their houses, foot-paths and village streets, to digging of manure pits. At Rai Bareli, we used to observe a Village Cleanliness Week from 24th May to 31st May in all

villages under the Rural Development Scheme. On every day, a meeting was held at the *panchayatghar* of the village, a procession (*prabhat pheri*) taken out with boy scouts of the village, and the villagers singing songs on sanitation and shouting slogans. The programme of practical work spread over seven days was as follows:—(i) repairs of thatch and tiles of roofs, (ii) plastering of walls, (iii) writing of slogans on walls, (iv) white-washing of interiors of rooms in case of well-to-do persons, (v) general cleaning of rooms and compounds of houses, (vi) repair of village foot-paths and streets and filling of pits and holes, (vii) repair of wells, (viii) repair of cattle-sheds, (ix) washing of animals and holding a cattle-show, (x) digging of new manure pits and renovation of old ones, (xi) washing of clothes and teaching personal cleanliness, (xii) holding a baby show, and (xiii) village sports, camp-fire, folk-songs and dances.

MODEL HOUSES FOR VILLAGES

By HARI CHAND

INDIA is a vast country with great diversity in climate inducing different modes of living, and houses have to be designed to suit different climates or conditions. Extreme temperatures prevail in Northern India, ranging from minus temperature to 120° F. in the shade. On the Great Deccan Plateau we again have extremes of temperature. In the south of India the climate is tropical and temperature seldom falls below 70° F.

It is obvious from the brief survey that no one type of architecture or even constructional material can cope efficiently with this variety of conditions, for even in one province the climate at one end differs from the climate of the other.

The price of structural materials varies according to the availability. For instance in the Indo-Gangetic alluvial tracts of Northern India, stone metal is scarce, but clay is cheap and easily available. Therefore, the indication here is that brick should be used wherever possible. In the Deccan Plateau stone metal is plentiful, and hollow blocks and other types of concrete can be used. In the Himalayan forest areas wood is the obvious building material. Area by area, therefore, architects and builders have to take local conditions into account and design houses to obtain the maximum of comfort and convenience using local supplies to the utmost.

Designs and Improvements

The building material in the majority of the villages consist of baked mud in some sort of wooden frame covered in most cases with thatch, or in well-to-do villages, with clay tile of the country variety.

The villager would not easily change

his habits or his mode of house construction. He must be assisted by every available means which can educate him to realize that there are better houses than those made of mud. Travelling exhibitions, picture shows and demonstrations—all these can inspire the villager to have a better house for his family than the one he inherited from his parents. The peasant, if he has some imagination, will take steps to see that his new home is better in design or at least an improvement on the old one. It is then up to the builders and *mistries* of India to help him build on more weather-proof, sanitary and permanent lines.

I would refer to steps taken recently by progressive organizations, who bring to the notice of the public latest improvements and designs in house building. They take the shape of *pukka* houses and their models. Practical demonstrations are given to the villager at his door step where he can personally assess the value of *pukka* construction. In fact in one recent example it was noticed that demonstrations given in the above manner were quickly followed by numerous requests for duplication on their personal account thus showing that the Indian villager today is more alive to the advantages of *pukka* construction and has every desire to improve his living conditions provided this can be carried out at a reasonable cost and building material and facilities are placed within his reach.

Example of Sahibabad-Daulatpur: A few such improvements were recently carried out, as far as the conditions permitted, in the village Sahibabad-Daulatpur in Delhi Province, ten miles

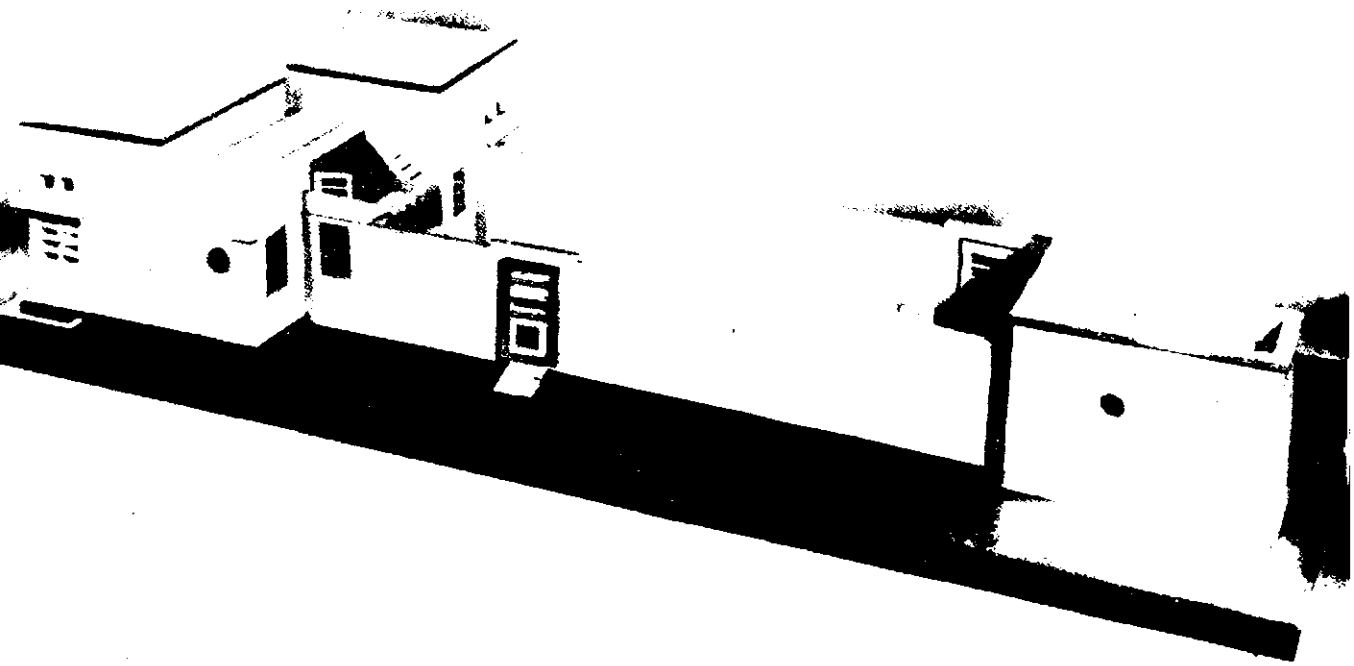

THE CONCRETE ASSOCIATION OF INDIA, BOMBAY

A MODEL HOUSE
with 3 rooms, a spacious open courtyard
and a cattle-shed



THE CONCRETE ASSOCIATION OF INDIA

ANOTHER TYPICAL HOUSE
Self-contained with 2 rooms, a kitchen with
separate cattle-shed and store

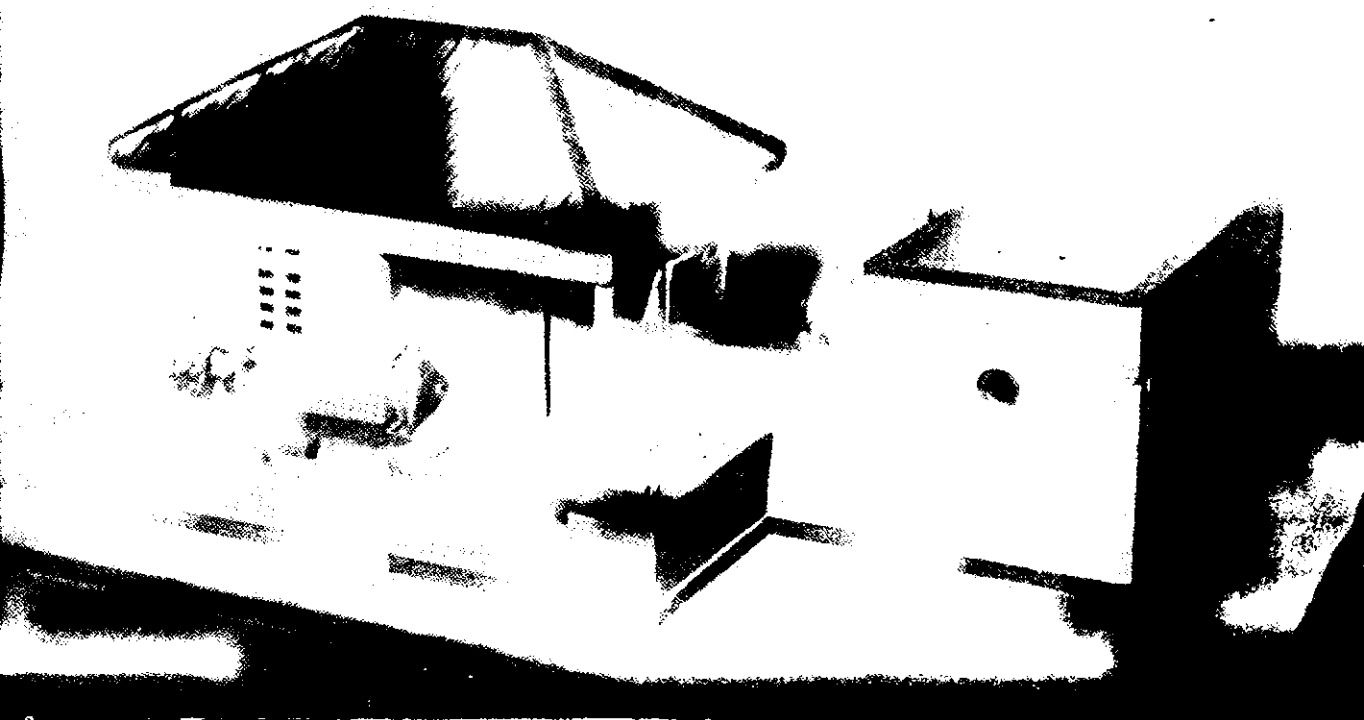

THE CONCRETE ASSOCIATION OF INDIA

A DIFFERENT DESIGN

Consisting of 2 rooms with separate cattle-shed and a storage accommodation with also a front compound

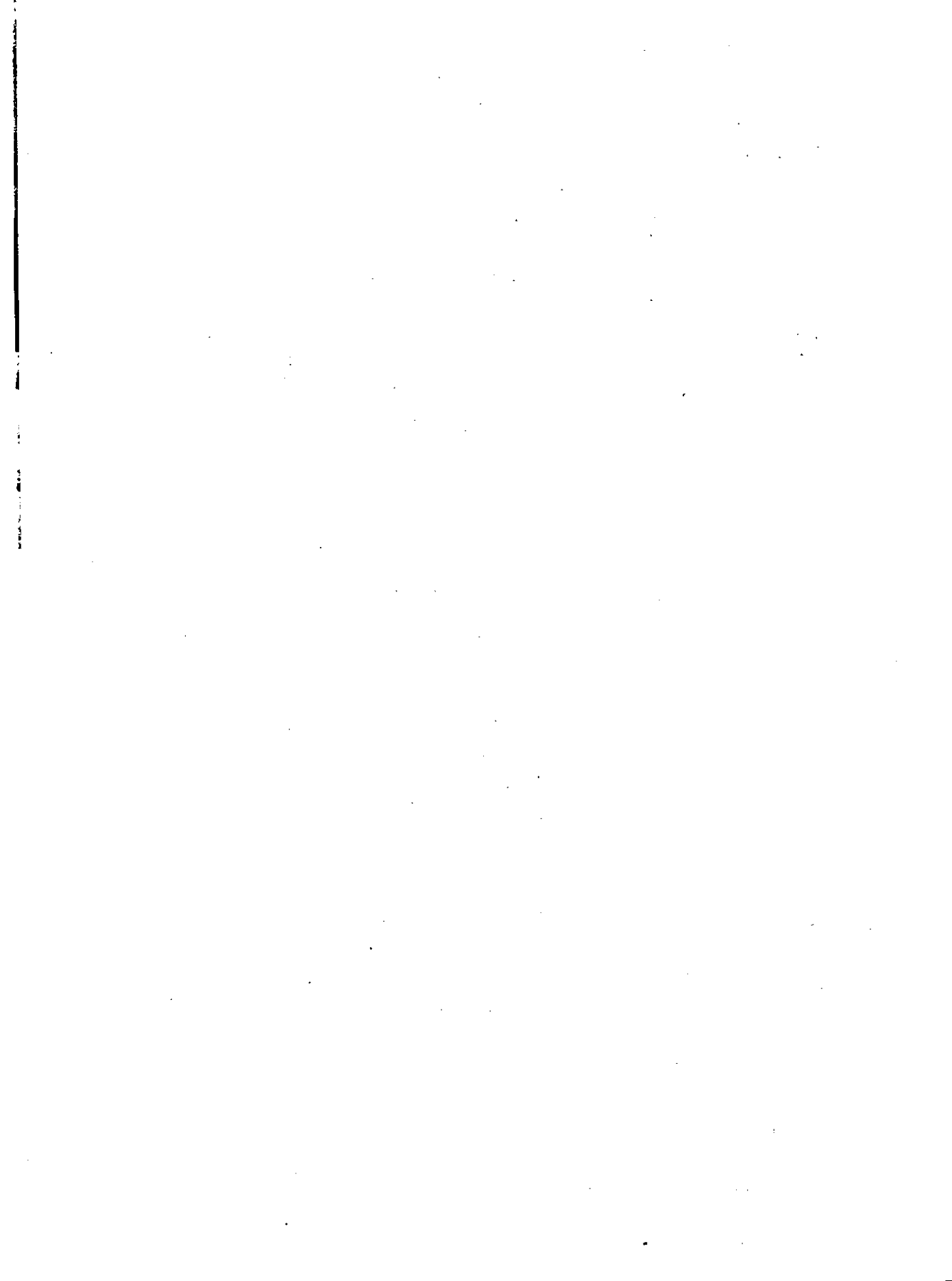

from Delhi, where the lay-out of a model village, with model village houses of various types suitable for different climatic conditions, illustrates good examples of what can be done on similar lines in other parts of the country.

Village Planning

A home does not merely consist in a house; its comfort greatly depends on its surrounding, accessibility and freedom from flooding, dust and flies. Here we get into the domain of the village planner, who must examine present conditions and find out how modern amenities of civilization can be brought to the door of the Indian village at minimum cost.

Village planning consists of many

things, and obviously the general lay-out of the village with regard to the sun, prevailing wind, configuration of the ground, neighbouring hills and rivers, is most essential. Evil smelling trades should be properly placed, for instance lee-ward side lavatories and washing places. The main residential portion should be open to the prevailing wind.

Provision will have to be made for *Panchayatghars* or play grounds. Animals should not be housed with people. Roads should not be allowed to become drains. Insecticides as D.D.T. for the extermination of insect should be placed within the villagers' grasp.

AQUA PRIVY

By R. N. KAUL

IN smaller towns and in villages in India, where water flushed latrines and a complete sewage system cannot be introduced, the provision of satisfactory public latrines and conservancy has created a problem for the officers of the Public Health Department which has so far not been solved. Innumerable types and designs have been developed, few of which have proved really satisfactory.

The common types in use are :

The Bucket or Pail Latrines : Very difficult to keep clean and involving considerable expense in carriage and disposal.

The Trench Latrines : Only satisfactory for temporary camps.

Bore Hole Latrines : Not satisfactory in the typical stony country in the Deccan, or where the subsoil water level is high. These latrines are a potential source of contamination where the drinking water is mainly from surface wells.

Aqua Privy and Its Advantages

These are very satisfactory but require closed sewers and a complete sewage disposal system.

A form of latrine which we find efficient in Dominions is the Aqua Privy. This type of latrine was first devised by a Missionary in Bengal and has been modified in detail, while maintaining the scientific principle involved. This type may be strongly recommended. It has seven advantages: (i) water flushing is not required and the effluent is very small quantity, clear and free of smell, (ii) the whole expense of disposal is eliminated, (iii) there is no access to flies, (iv) hook worm infection is eliminated, (v) contamination of drinking water

can be easily avoided, (vi) the tanks work automatically with the minimum of attention, and (vii) the design is very simple and the process is based on chemical and bacteriological action.

The plan attached is very simple. It is for four seats (two for males and two for females) with a roof and compartments with doors to each seat. It is sufficient for about 100 persons. Smaller and large types can be made and should have at least two cubic feet fluid content per head. Single seated domestic latrines are easily designed on this principle.

Working System

Aqua Privy latrine consists of a first or digesting tank below the seat or seats connected to a second or aeration tank from which the effluent emerges.

In the first tank anaerobic organisms digest and liquify organic matter. The second tank, to which a free current of air is supplied encourages aerobic organisms to complete the process.

The supply of one *lota* of water by each user gives the dilution most suitable for efficient working. No other water must be added except the minimum required for washing the pan from time to time. The pan should be as near as possible, funnel-shaped with no ledge on which faecal matter will collect.

It is not possible to combine these tanks with a water flushed latrine. Nor is any form of septic tank suitable for combination with a water flushed latrine. The effluent from water flushed latrine can only be suitably dealt with enclosed sewers and a sewage farm.

Reference to the design will show that the faecal matter enters the first tank

through an air tight pan-seat-pipe which dips 4 inches and no more below the fluid level. The whole system is filled with water upto the level of the final exit or effluent pipe is the second tank before it is used. Between the tanks is one submerged opening of 6 inches in diameter. The pan seat pipe, being submerged, prevents the escape of offensive gas through the seat, and no 'trap' is required. The excreta fall into the water and the faecal matter soon forms a scum in which the anaerobic bacteria develop.

Human excreta are made up of mineral and organic matter. The mineral matter consists of small quantities of clay, sand, iron, and insoluble compounds. These accumulate at the bottom of the system as 'sludge'. The sludge only needs removal every two or more years. The submerged opening between the tanks is 4 feet from the floor to leave room for the accumulation of sludge. The organic matter is animal and vegetable and consists mainly of proteins, carbohydrates, and fats. These give a very offensive smell unless enclosed. It is in this mixture that the anaerobic organism acts.

In the first tank the complex compounds are slowly broken up by bacterial action. The proteins are broken into amino acids. The carbohydrates are turned into alcohols of simple compounds. The amino-acids act on the fats. These liquified products are freely dissolved in the water so as to reach the central or second tank.

The bacteria which act upon the sewage in the first tank are known as 'anaerobic' because they act only in the absence of oxygen. Air must, therefore, be excluded and the tank air-tight. The system must be completely water-tight.

In the process in the first chamber there is a certain amount of decomposition with liberation of gases. The gases usually found in this chamber are carbon dioxide,

sulphuretted hydrogen, carburated hydrogen and nitrogen. These gases are formed under some pressure above the fluid. To relieve any pressure and prevent the fluid surface being pressed down in the first chamber, a 2-inch gas-pipe is placed well above the water level between the first and second tanks and through this small pipe excess of gas enters the second tank and passes off by the ventilating shaft. No air will enter the anaerobic tank, but the level of the fluid will be maintained.

The action that takes place in the second (or middle) tank is purely aerobic. For this action a continuous current of air must enter the tank and this is allowed by providing a 6-inch diameter effluent pipe, which must always be kept open. The pipe is straight, the water level lipping its lower surface so that a current of air continuously plays on the water surface. There should be no bends. The air escapes by a steady draught up the ventilating shaft. It is this air which gives proper facilities to the aerobic bacteria to do their work of oxidation and nitrification. With this simple arrangement the aerobic bacteria flourish and work effectively in eliminating pathogenic bacteria. In this tank the amino-acids and the fatty acids are further converted into gases such as nitrogen, carbon dioxide and into water. The gases escape by the ventilating shaft.

This whole process liquifies and purifies sewage into a clear effluent with no smell.

Economical Too

This aqua privy is advocated as economical. It is very efficient for institutions, and for municipal district and *taluka* towns where there is no system of closed sewers. There is no annual expenditure for night soil cart, trenching grounds and extra sweepers. The initial cost of such a latrine cannot be considered excessive if the yearly recurring expenditure is taken into consideration. Such

latrine pays for itself in three or four years, in saving recurring charges.

To construct one aqua privy costs more than a pail latrine but once built the recurring charges are very small.

	At pre-war rates (1)	At present rates (2)
6 Nos. Six seated pail latrine for 100 persons cost about	Rs. 2,100	Rs. 4,800
6 Nos. Four seated aqua privy for 100 persons cost about	Rs. 8,400	Rs. 15,000

The annual recurring charges for six pail latrines are :

	At pre-war rates (1) Rs.	At present rates (2) Rs.
3 Sweepers at (1) Rs. 12 a month and (2) at Rs. 25 p. m.	432	900
2 Night soil carts at (1) Rs. 20 and (2) Rs. 50 p. m.	720	1,200
2 Kamaties at trenching ground (1) at Rs. 10 and (2) Rs. 20 p. m.	240	480
Repairs and receptacles.	400	500
Total Rs.	1,792	3,080
		say Rs. 3,000

The annual recurring charges for 6 aqua privies.

1 Sweeper (1) at Rs. 12 a month and (2) at Rs. 25 p.m.	144	300
Repairs.	200	400
Total Rs.	344	700

At the end of six years the six unsatisfactory pail latrines will cost Rs. 4,800 + Rs. 3,000 × 6 = 22,800. At the end

of six years, the efficient aqua privy will cost Rs. 15,000 + Rs. 700 × 6 = Rs. 19,200 and every succeeding year there will be a saving of about Rs. 2,300—say Rs. 2,000 according to present rates.

Further Improvement

The design of the improved type of aqua privy has a clinker filter provided and the effluent will be found much cleaner than that of one without a filter. The design is strongly recommended to district local boards and municipalities. One precaution is essential that the construction must be put in the hands of an engineer who will use only good material and strictly adhere to the details of the design.

An aqua privy of this type should not be combined with a water flushed system.

If the ground slope permits, the effluent from the aqua privy should be let on the top of the clinkers through a percolating pipe so as to make clinker filter to act as a downward flow filter. In this case, the vertical pipes for diverting the flow will not be required. The outlet of the clinker filter should be taken from the bottom. In such a case the aqua privy will have to be situated within a short distance from a local depression or nalla.

SANITARY CONVENIENCES FOR VILLAGE SCHOOLS

By S. N. MAKAND

SCHOOLS in rural areas are not generally provided with any kind of sanitary conveniences for boys and girls. Where such conveniences do exist, they are either so structurally defective or so badly served and maintained that they are worse than useless and children use the school compound for urination and go a little further afield for defecation.

I have frequently noticed that the immediate surroundings of school buildings are extensively polluted by children and no manner of check over them is exercised by the school authorities.

Such practices are not only insanitary but indecent, and it is desirable that children should be taught to refrain from them, so that when they grow up they will exert a powerful influence over the sanitation and amenities of their villages and thereby improve village life.

The provision of *pucca* and permanent sanitary conveniences is usually beyond the financial means of school authorities and there is the additional difficulty of obtaining frequent and regular service for them. For these reasons, at present, such structures may be ruled out.

A more economical, useful and practical measure would be the provision of trench latrines and absorption pits for urinals where a suitable site, well removed from sources of water-supply, can be obtained within the school compound or nearby.

Trenches and Pits

Latrine trenches should be 12 to 15 inches in width, 2 to 2½ feet in depth and 12 to 15 feet in length, sub-divided (to secure privacy) into sections of 3 feet

each, by small *tatta* partitions 2½ feet wide by 2½ to 3 feet high. The trenches should also be screened off from public view by *tatta* enclosure, 3 to 4 feet in height. The earth removed from the trenches should be well broken up and pulverized and kept in heaps near each trench section as to be readily available for use. An iron or wooden hand shovel, large enough to hold about a pound of earth, should be provided for each earth heap to enable the children to lift the earth and deposit a few shovelful of it over their excreta so as to fully cover it up. The children should be directed to sit straddling across the trench while using it. They should not use it sideways but across. They should be given clear and repeated instructions how to use these trenches. The trenches should be inspected by a teacher each day after school closing to see that they are neat and tidy and that all dirt is completely covered up. Negligent children should be corrected and suitably dealt with. When the trench is about half full, it should be completely filled up with earth and rammed down and another trench dug and screens and partitions re-erected. A filled trench should not be interfered with for at least six months. If the manure from the trench is excavated, care should be taken that it is replaced by an equal quantity of clean earth.

Absorption pits for urinals should be 3 to 4 feet or more in diameter, 5 to 6 feet in depth and filled with graded stones, the lowest being the biggest (about full or half brick size) and the topmost layer of about ½ to 1 inch size. The margins of

the pit should be raised by an earth mound to prevent surface rain water from entering it and bricks or flat stones should be arranged all round to serve as pedestals. A circular pit can be easily sub-divided into four compartments by the placing of two *tatta* or corrugated iron screens ($2\frac{1}{2}$ feet high) across the pit, at right angles to each other. These could be tied to four wooden posts, one at each sector. The

lower edge of the screen should be at least 9 inches clear of the upper surface of the pit filling, so that it is not soiled.

If the school medical officer and the authorities cooperate in this matter and make these arrangements, in consultation with each other, I have no doubt that an easy and fairly satisfactory solution of the present difficulty will be evolved.

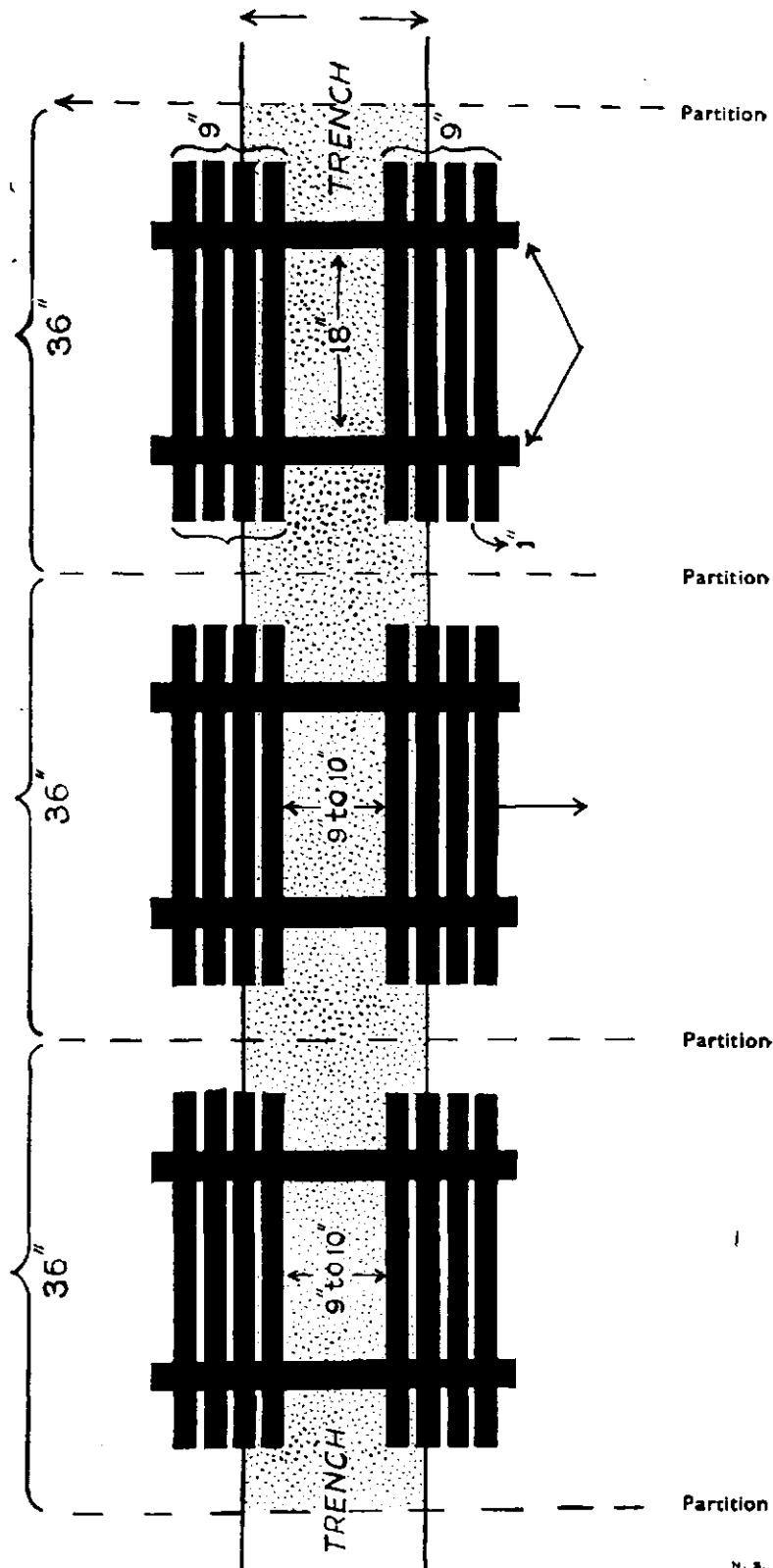

N. S. BIGHT

BOMBOO SEATS FOR TRENCH LATRINES

Consisting of four cross bamboo bars, each 2 feet long and 1½ inches thick tied with strong strings to the supporting bars with one Inch interspaces

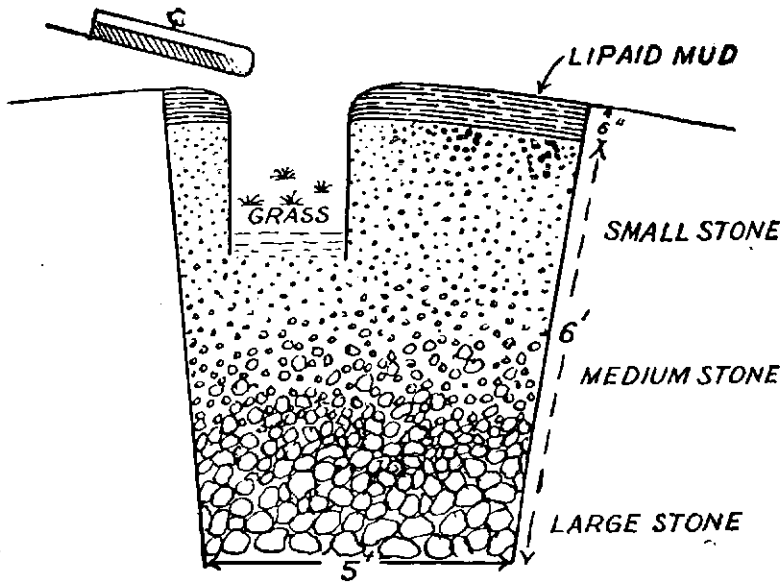

N. S. BIGHT

SOAK PIT

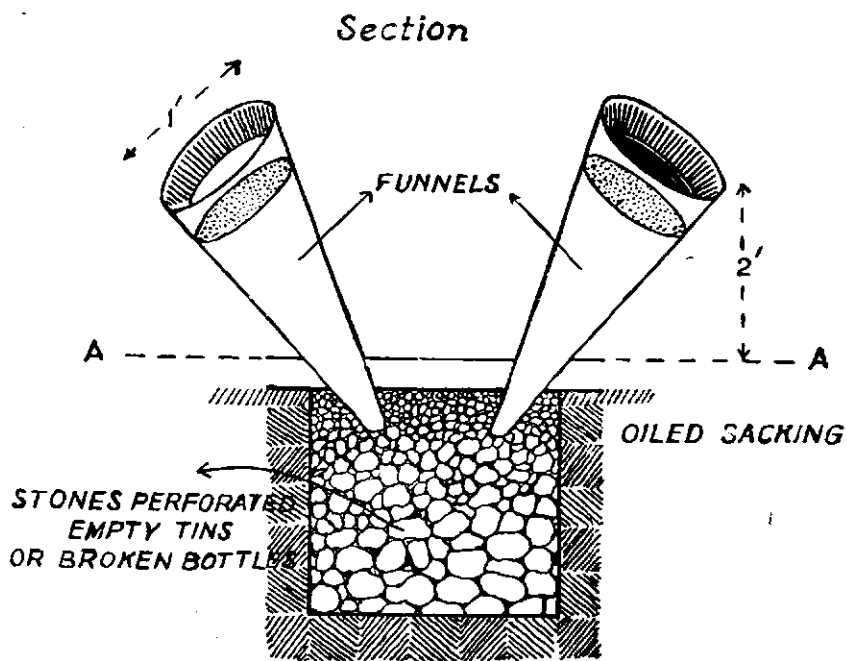
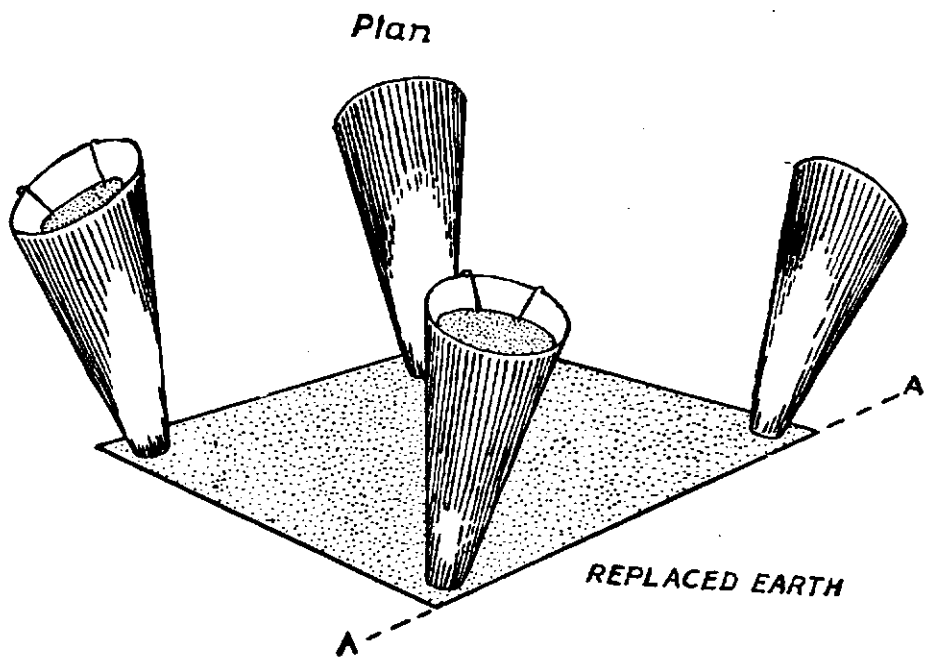

FUNNEL URINE PIT

W. S. BISHOP

8

EDUCATION & CULTURE

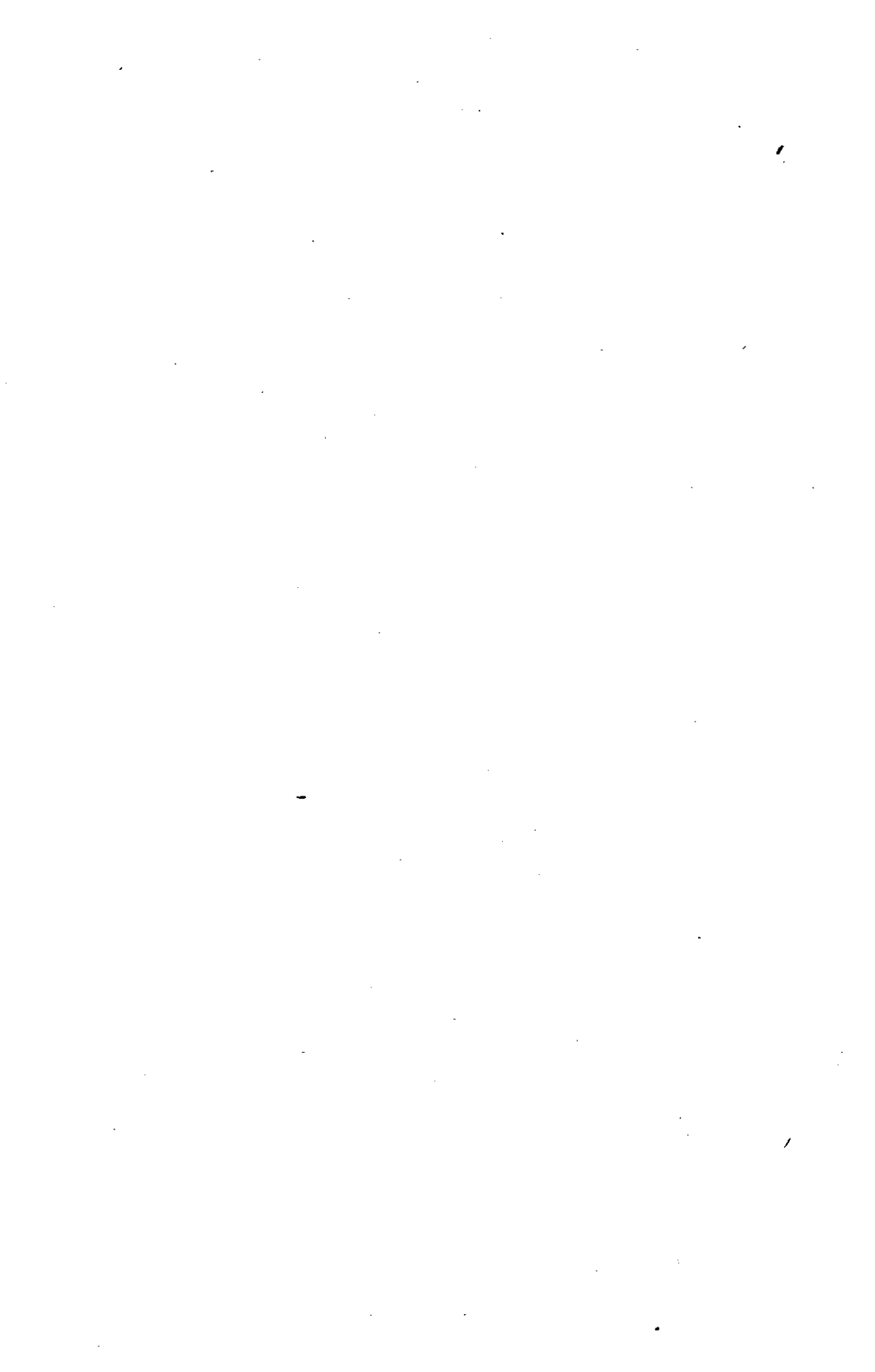

EDUCATING THE VILLAGER

By K. G. SAIYIDAIN

DISCUSSING the comprehensive theme of 'Educating the Villager' in India is a tall order, which I am not in a position at present to execute. I shall, therefore, confine myself in these few pages to a few salient features of the existing situation because, without considering them, rural education will continue to be the miserable trickle which has failed to irrigate the countryside during the last century and a half.

Rural India is predominantly illiterate and it is desperately necessary to remove this illiteracy. This *cannot* be done through a scanty and meagrely conceived system of voluntary primary education, given for a very short duration, to less than 30 per cent of the children. Because it is scanty and meagrely conceived, it fails to appeal to the interest or the imagination of the people; because it is voluntary, it leaves out a large majority of children untouched; and because it is given for a short duration—for about 50 per cent of the children, it lasts less than two years!—it fails to give effective, adequate and permanent literacy, to say nothing of any proper social or moral or civic training. Does it not show fairly conclusively that this sort of education, untouched by vision and uninformed by a frank recognition of the facts of the situation, cannot cut much ice?

The Remedy

What is the remedy? The reply is obvious and easy to give, though the recipe is by no means easy to act upon. It will not be possible to solve the problem of educating the Indian villagers, in their hundreds of millions, unless a satisfactory

system of compulsory education on a nation-wide scale is introduced as quickly as possible. Compulsion will no doubt cause some economic hardship to the parents and arouse a certain measure of opposition. But that is part of the game and no big, beneficent measure has ever gone through, in any country without such birth-pangs and without the opposition both of vested interests and shortsighted ignorance. Luckily enlightened public opinion, and more recently even official opinion, has veered round to the view that, without radical and large scale measures the present *impasse* cannot be overcome. The Scheme of Basic National Education and the Sargent Scheme are welcome pointers in this direction. The latter has worked out the implications of such a proposal, both human and financial, in considerable detail and they are big enough to frighten the timid and the unimaginative. But there is no other alternative, no other way out. We shall have to train the teachers and build the schools and provide the books and the furniture and the other requisites, set up the necessary administrative machinery—and *find the money for the purpose*, even though this may call for a radical readjustment of our socio-economic order and large scale industrial developments.

A 'Pincer Movement'

This is, however, only one side of the picture. Primary education caters for the young while ignorance and illiteracy are just as much the lot of the village adult as of the village child. We cannot have the slightest hope of liquidating the vast mass of illiteracy from the

countryside if we confine our efforts to the children only. We shall have to plan equally urgently and vigorously for the education of the adults also. This problem of adult education has been even more aggressively neglected in India than primary education and, till the recent publication of the Scheme of Post-War Educational Development, there was no consciousness of the fact that adult education forms an integral and desperately important part of the general educational structure. Sporadic attempts were made here and there, from time to time, but they represented either the temporary enthusiasm of a public spirited group or individual or the personal interest of some high-placed official. There has been no steady, systematic, large scale movement of generously conceived adult education yet. Perhaps 'education', in the wider sense, has come to the masses, during the last few decades, mainly through political activities and awakening and through such catastrophes of human stupidity—politely but wrongly called 'natural catastrophes'—as the two 'Great' wars and the Bengal Famine. But this incidental education, this by-product of a great travail, is obviously a mixed affair—it enlightens but it also embitters and it is always overlaid by a great deal of propaganda which is not always synonymous with education! So, what is needed is an all-out drive not only for the liquidation of illiteracy but also for raising the social, cultural and intellectual standard of the villagers far above the present level. It is not merely that they cannot read or write: they have been deprived for ever so long of knowledge and enlightenment; they do not know their own rights and duties; they are unaware of their possibilities and their strength and they are denied access to the kingdom of the mind. Their lives are one perpetual, unrelieved struggle against a relentless fate to make a scanty living for themselves and to

produce food and other things for all those who depend on them. While the most essential and inevitable productive work, on which the very life of the country depends, remains largely *their* concern, cultural, social and other amenities tend to gravitate more and more towards the towns and cities, leaving the countryside dark and dismal. This upset balance has to be redressed and the countryside must be given its full share in all that makes life worth while—education and books and amusements and social activities and enjoyment of the manifold products of culture. The Adult Education agencies must become largely responsible for their provision which will not only instruct but also amuse and inspire the adults. I use the word 'agencies' rather than centres advisedly, because I envisage different types of institutions, doing adult education work—ordinary centres which will try to liquidate illiteracy and also arrange talks, discussions and other corporate activities for the benefit of their members; institutions concerned with the higher or continued education and cultural advancement of literate adults like the *Volksschule* of Denmark or 'People's Colleges' of Sweden or the proposed 'County Colleges' of Great Britain; organizations providing the possibility of contact between the villagers and such cultural influences as art and craft museums, libraries, theatres, cinemas (if they can be made cultural!), radio and other agencies for the 'dissemination of thought'. Obviously, there will have to be a variety of types, catering for different people and different kinds of needs but they will all be inspired by one common motive or purpose—to make the life of the villager richer, happier and more useful to himself and to the community. By organizing such a 'pincer movement' from the side of primary as well as adult education there will be some likelihood of the



AT A MODERN NURSERY SCHOOL

Mysore State presents an ideal nursery school system for very young children adopted very widely with up-to-date equipments. Here is a picture class—a sight of colour and life.

P. I. B.



MRS. STAN HARDING

'PLAYWAY' METHOD

Applied to geography, the 'playway' method can prove very successful. The village students, seen in this picture from the Punjab, are aptly, fixing cards bearing the names of rivers and towns on sketch maps of their province. The side that finishes the game first and secures the highest marks for accuracy is the winner.



LESSONS & PHYSICAL TRAINING

MRS. STAN HARDING

Both may be made greatly recreational. Here we find the lessons in reading, writing, arithmetic and geography in progress while on the left some of the children appear 'to fly through the air with the greatest ease'.



HAND WORK IN PROGRESS

**Each class in every school should be given hand work
to do for additional funds**

obstinate problem being solved within a reasonable period of time.

Type of Education

I have not said anything so far regarding the type and quality of education to be provided in these schools and adult education centres to be established for the villagers. The theme is as tempting as it is wide, but I cannot go into all its ramifications here. One central principle needs to be stressed in clear terms. No school in the countryside can capture the loyalty or the imagination of the villagers if it is divorced from the realities of their life and their main interests and preoccupations. It is, therefore, essential to organize schools in such a way that to the child as well as his parents, it will appear to provide a better organized and more intelligent extension of the home activities and the work of the farm and the workshop. There will be, of course, a good deal more but these will be the basis and the rest will arise out of them and irradiate them. It is not only good *tactics* to have such a school; it is also good educational policy.

Educative Resources

Experience has shown—and the recent experiments in large scale evacuation of children from London and the big English cities to the countryside have provided a remarkable testimony to it—that there are infinite educative resources in the countryside which a wise and understanding teacher, not slavishly tied to his books, can utilize: the procession of the seasons, the life of the plants and animals, the beauty of birds and flowers, the joy of strenuous work for raising the crops, the pleasure of

cooperative endeavour. This linking up of education to life—life in general, and the life of the particular community—is basic to all educational reform and is particularly valuable for the education of the villagers. No doubt, one of the objectives of good education would be to release the villager from some of the limitations that fetter him normally in the village economy. But this release will not come through ignoring the realities—either good or bad—of village life but by facing them frankly and courageously and exploiting them so far as possible for educational ends. Even the ugly and limiting features are grist to the teacher's mill because their critical study enables him to give reality and concreteness to his work. In the case of adult education, likewise, the approach will have to be from the point of view of the needs and the psychology of the adults. A study of their requirements and their difficulties, of all that they aspire for and all that stands in their way will be the starting point of all thoughts about curriculum and methods. The teacher of an Adult Centre or a People's College should know where the shoe pinches and his whole success will depend on his being able to make the adults feel that what they are doing and learning does actually help them in dealing with the 'pinching' situation. Teaching divorced from this motivation is lifeless and boring; learning without this realization lacks all life-giving quality. In the degree that our schools and adult institutions can give life to the children and the adults and 'give it abundantly' they will be fulfilling their real function. Otherwise, all the time, money and energy spent on them will be wasted.

WOMEN'S EDUCATION AND RURAL DEVELOPMENT

By T. N. KAUL

EDUCATION is of vital importance in any field of development and most of our social evils are due to lack of education among our womenfolk. The bias against women's education is even stronger in rural than in urban areas and unless we can convince the villager that education will do his womenfolk real good and mean a happier, healthier and wealthier home for him, he will not send his daughter or sister to school. Any system of women's education for rural areas must, therefore, have a rural and practical bias and not be spread over too long a period, otherwise the villager will think that his womenfolk will become *mem sahibs* and neglect him and the home. This is the trouble with most of our District Board Girls' Schools and we find that the girls lapse into illiteracy and ignorance shortly after passing their lower or upper middle, because apart from the three R's and academic education they are not taught anything that may be of use to them in married life.

With this end in view I launched two experiments in rural education for women in Fyzabad and Farrukhabad districts in the United Provinces, and it would be worthwhile considering their practical aspects and the results achieved.

The 1940 Fyzabad Scheme

After considerable propaganda for three months in rural development in villages by Mr. D. Mujamdar, Chairman Rural Development Association, Fyzabad, about 60 village women, mostly married, between the age of 18 and 35, who had studied upto the fourth class, were

selected from about 100 applicants for admission to the Training Camp. Emphasis was laid on their being married, so that they might go back to their village homes after training and take up the work among the married women and the unmarried girls in their own villages. An initial difficulty was experienced owing to the fact that many of them had their babies with them; the difficulty, however, proved to be a boon, because we were able to start a Child Welfare Centre along with the Training Camp, where these children were looked after by a trained nurse and a *dai*, and all the women were given practical training in child welfare and home nursing.

The Training Camp was housed in a *pukka* building with class-rooms, a common room, a dining hall, a kitchen and the teachers' quarters. The girls themselves were housed in thatched huts to give a rural bias to their training. Each one of them was given a monthly stipend of about Rs. 6 for pocket expenses, free books, a set of two uniforms and free board and lodging. The Camp was supervised by a trained and qualified lady, Miss Sushila Agha, Provincial Organizing Commissioner for Girl Guiding of the Hindustan Scout Association. She was helped by two trained teachers, a spinning instructor, a tailor and by the teachers of the Government Girls' High School and the staff of the Public Health, Cooperative, Agricultural and Rural Development Departments. Emphasis was laid on the practical aspect of teaching various subjects, such as sewing, knitting, spinning, laundry, cooking and



HER FIRST LESSON

Public-spirited men and women are engaged today in adult education, though they touch only the fringe of the problem of eradicating illiteracy among the adult population of India. The task awaiting planners in this field was for the first time brought out in the report on post-war educational development submitted by the Central Advisory Board of Education. The Report included a scheme for adult education which provided, among other things, that within 25 years from the beginning of the scheme, every person under 40, irrespective of sex, shall have been taught to read and write. About 90 million adults would be made literate at the end of this period, and teaching staff numbering about 2,38,000 would be employed at the peak period. The Report also recommended compulsory and free basic education for all children



M. S. RANDHAWA

WOMEN TRAINEES (I)
At Fyzabad



M. S. RANDHAWA

WOMEN TRAINEES (2)
Performing drill to music at Fyzabad camp



other domestic sciences, home nursing, child welfare, gardening, agriculture, girl guiding, folk-music and the three R's. A batch of girls was placed in charge of the kitchen, the Child Welfare Centre and other departments by turns. They were deputed for field work to nearby villages on Sundays.

We were surprised to find at the end of six months that these village women, who looked so shy and simple, had great potentialities for learning practical things. Fifty of them, who passed at the end of the training, were sent back to their villages where they set up girls' schools and Women Welfare Centres. The schools proved very popular and useful, and the teachers were given another refresher course of three months next year.

The Centre was run for the first year with public subscription and some aid from the Rural Development Department. But when Government found its utility, they took it over, and now it is being run as a Provincial Training Centre for Women Welfare Workers in villages. They have done very useful work not only in educating village women and village girls, but also in looking after soldiers' families in rural areas as *fauji sevadarnis*.

The 1945 Farrukhabad Scheme

There was some difficulty in getting women of the right qualifications and age in Farrukhabad district owing to the prejudice against women's education among Muslims, Thakurs and Brahmins of this area and we were able to select only thirty women from all over the district to undergo a training at Fatehgarh for a period of nine months. Of these about a third were Christians, a third Thakurs and Brahmins and a third belonged to other castes. This Centre was opened mainly to train these women to work as *fauji sevadarnis*, and women welfare workers in soldiers' villages. Over and above the things

taught in Fyzabad, they were given necessary training in the welfare of soldiers' families, e.g., to write letters for them, check their family allotments and pensions, report on any inconveniences or shortage of necessary commodities.

When these women finished their training they were sent to soldiers' villages to teach in the girls' schools and to do welfare work among the womenfolk. The Rural Development Officer, United Provinces intended to take over this institution also and it was proposed to add a training class for war widows.

Future Motherhood of Rural India

In conclusion, I shall point out the following for the serious consideration of all interested in the rural development :

(i) There must be more primary and middle girls' schools in rural areas, at least one primary school to every village of 500 or more, and one middle school to every village or a collection of villages with 1,000 or more population.

(ii) Teachers for such schools should be properly trained not only in the three R's, but also in practical household and rural subjects such as spinning, sewing, knitting, cooking, child welfare and home nursing, village sanitation and hygiene, elementary agriculture and gardening, etc.

(iii) Training centres for such teachers should be started as soon as possible in all districts and all District Board women teachers should be sent for such training and for attending further refresher courses every year, preferably from April to September when villagers are comparatively free.

(iv) The training scheme in each district should be undertaken by the Rural Development Department with the aid of local bodies. The latter should be responsible for guaranteeing employment to such trained teachers in their schools, preferably in the villages where they are married and command local influence and respect.

(v) Such training centres should be open to public spirited women who wish to do social welfare work in the rural areas, far apart from starting schools for the unmarried girls it is also important to do welfare work among the grown-ups.

(vi) All this is going to cost money. If a beginning is made in one or two districts of each division every year depending on the size of the division, the scheme can be completed in four or five years in the United Provinces. The expansion of girls' schools in rural areas can be spread over a similar period. The estimated cost of a training camp for thirty women in each district for a period of six months is about Rs. 10,000 and if ten districts are taken up every year,

it would mean a cost of one lac of rupees a year, which is by no means an extravagance considering the importance of training teachers for the future motherhood of rural India.

The more delay we make in educating the womenfolk in rural areas, the more difficult it will be for any scheme of rural development to succeed. The argument that we must first solve the problem of women's education in towns where the demand is greater is a fallacy, for the need is greater in rural areas. Without sacrificing women's education in urban areas, we must pay increasing attention to our sisters in the villages who have been neglected more than even the crops and cattle in the past.

FOLK ART OF INDIA

By SAILOZ MOOKHERJEA

THE mellowed warmth of the lamp inside the shrine of Siva at Benares heartens the men and women who hold their palms over its flicker and lay them over their hearts—the spirit of centuries reviving a broken spirit. Perhaps many pilgrims have heaved uneasy sighs and passed away on the way, leaving the footprints of their yearnings pointing towards the Holy City. A pair of newly-weds would shyly voice in trembling whispers the deep-rooted desire. An old woman leaning on her staff would offer herself in utter renunciation. There pervades the spirit of the Hindu religion, the seed of which has been implanted in the praying crowd through ages of devoted belief. Out of the shrine, I stepped into the quadrangle where reigns Nandi or Siva's Bull, couchant in majestic nonchalance, the massed vermilion of his form radiating the spirit of creative impulse and quickening the sombre precincts to life.

I was not simply a religious pilgrim. The untouched wealth of beauty hidden away in the little villages and back streets of India had inspired me and it was against the religious background that I was able to determine the real significance of folk art.

Soon I met a band of artists busy painting on the walls inside the city. They belonged to the oldest families of Benares and their artistic imagination and skill were schooled in the deep-sprung religious fervour of Indian art. In their traditional unsophisticated way, they were decorating the walls with scenes from the Ramayana. The simple devout occupation of these artists of the soil so fired by imagination that I

devoted the whole of my stay in the city in discovering more of their work to be better able to appreciate their true merit. I found that apart from unfolding the legendary lore of India, they had also taken interest in portraying scenes from daily life. In the domain of decorative art, too, they plied their brush with untutored skill and were also deftly shaping ingenious toys and masks.

The Traditional Spirit

Constant association with the works of the folk artists of India brought to my mind the thought that unlike western art, emphasizing the visual aspects of an object in order to unfold a sensuous experience, Art in the East is based on a tradition of spirit, born of lofty meditation and refined into perfection through centuries of culture and development. Unconcerned with the realistic presentment of an objective world, Art in the East seeks to express the contemplative sentiment and soul of the artist by direct, pure and poignant methods. It follows a way that has neither limit nor end. Through the medium of an organic subject it aims to express in its innate spirituality.

Though seemingly crude to unsympathetic eyes, the workmanship of the Indian folk artists may truly be described as modern. The primeval strand of its fabric, steeped in the Hindu tradition of spirit and perfected through ages of devout practice, remains undefiled even to this day. This is a pure art free from all stamp of foreign influence, though it often leads the unimaginative to view it as rudimentary and inferior. The truth is very much the otherwise. The flat

two-dimensional grammar of the Indian folk art speaks of highly cultivated level. Primary colours are used throughout; lemon-yellow, brown, vermilion, pink, blue, mauve and green of all shades. The harmonious composition and the perspective accentuated with an outline in blood black always shows masterly treatment in the truly modern trend.

The scenes from the Ramayana depicted with a synthetic economy of line and colour, are remarkable for their sense of composition. Rama's leaving for his exile forms a favourite theme. The choice and grouping of Rama, Lakshmana and Mahabira in rhythmic composition of colourful harmony, with the tree in the background maintaining the balance of the perspective, is an example of meritorious craftsmanship. The treatment of primary colours, Rama in blue and Mahabira in vermilion and the costumes in lemon-yellow, in a relaxed manner of the brush, is an artistry of rare brilliance and an index of the artist's mastery of line and colour. Ganesha in the traditional Hindu style is another specimen which directly appeals to one's artistic sense. In the story of Radha and Krishna again runs a tenor of religious sentiment and the artist has striven with success to penetrate beyond what strikes his sense of vision and grasp the spiritual element latent in every object. Krishna, dallying with his mate and putting a bunch of flowers in her hair with the traditional Kadamba tree in the background, is drawn in a delightful riot of harmonious colours. The style adopted strongly suggests to us the work of Matisse, though we are aware of the fact that our artists are not Matisse's but poor creators of a forgotten land.

Art of the East

Decorative art in Indian folk style finds expression in the many delightful patterns drawn from animal forms, such as the deer, the fish, the horse, the

elephant, the peacock, etc. The characteristic trait of the subject is ably captured, and it lives on the wall as a symbol of the artist's skill and imagination, his faith and sincerity.

The drawings in monochrome, adorning the walls of the homesteads, suggest the work of Old Masters. They are of great educative value. Scenes from daily life are drawn in soulful lines, though they unluckily look meaningless and crude to sophisticated eyes.

The *pata* stylists among the Indian folk artists have a language of their own—a language that may even profitably inspire the modern Indian artist with its pure and typical idioms. With the *pata* style as the basis, the modern artist would have an infinite scope of channelling it to shape his thoughts and emotions with better finish and craftsmanship, for the greatest value of the Art of the East is to be found in the poetical atmosphere of becoming one with nature. Through the appreciation of a single phenomenon we unconsciously touch and understand all the phenomena of nature. Our sense of beauty always sleeps until the moment when nature enters our vision.

Refinement and Liveliness

The folk artist obviously desires to produce the effect of simplicity and order with a summary treatment of form freed from the tyranny of visual realism. The simple and direct treatment is naturally the main factor, as seen in the drawings of children. The artist's choice of colours does not rest on a scientific basis but on a choice that will at once express his feelings. The refinement of classicism combined with a liveliness and a new vitality, yet in conformity with the ancient tradition, are interesting traits of the Indian folk art. There is a marked tendency towards constructive forms in preference to technique and utility in the decorative works. About all, the artist



SALOZ MOOKHERJEA

GANESHJI



SALOZ MOOKHERJEA

KARTIKEYA

Orissa School : painted on palm leaf



SALOZ MOOKHERJEA

ARJUNA

Orissa School : painted on palm leaf



SALLOZ MOOKHERJEA

THE HORSE

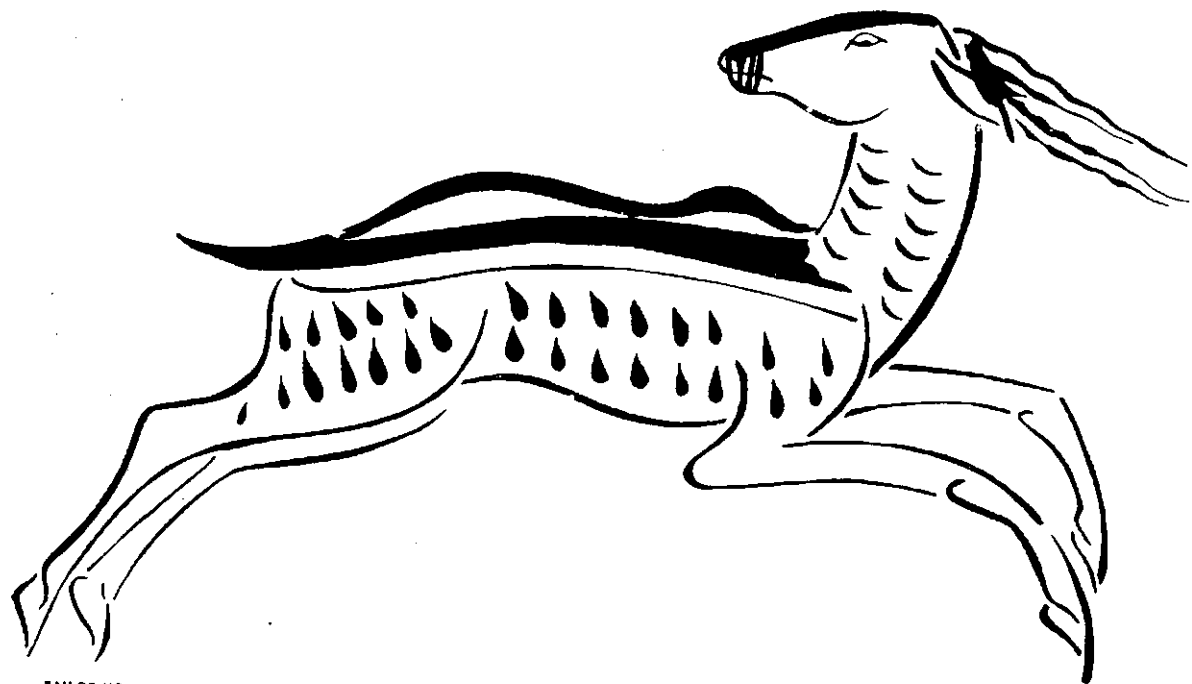

SALOZ MOOKHERJEA

THE DEER



does not wish to be guided by mere external form but by his inner contemplation. He plays with ultimate things, though he rarely seems to fully grasp them.

Reading of the Painting

The spirit of folk art is one everywhere. The effect of the tradition and customs of the different provinces, however, have influenced the main stream and produced the various schools, viz., the Upper India, the Rajput, the Orissa, the Kangra, the Bengal, etc. They speak almost the same language, though the idiom differs from place to place. History never marred the beauty of the language of folk art, for side by side with the intermixture of blood as various tribes entered the doors of India, there always went on the process of cultural assimilation.

A critic of Indian folk art, however, would at once mark that though Buddhism immensely influenced the Art of the East, yet it seems to have left no impress on the Indian folk art.

Identical subjects are often dealt with by the various schools of folk art. The employment of animal forms, such as the deer, the horse or the fish on the walls in many delightfully ingenious patterns is a spontaneous expression of the artist's imagination—the artist whose soul is steeped in the history and culture of his motherland. The brush wakes up the ancient spirit. The whole form looks vital: lines and colours, too, are very much alive. The language of the brush is effected through continuation of the

brush-stroke. The artist never gives up the essential simplicity and love of nature; the basic colours never lose their charm for him.

The pictures in monochrome have also a distinctive character. Even through a single colour a wide range of thought and sentiment is effectively expressed. We have an idiom, 'the reading of the painting' which means not the appreciation of the visual form but the understanding of the spirit of the artist through what is pictorially presented, the depicted object itself being a suggestion to the imagination of the beholder. The single colour medium is employed to suggest the presence of colourful bloom, green foliage or the brown limbs of trees. This is done not by exposition but by enlightenment through contemplation.

Proud Heritage

The spirit of patriotism and faith in ancient culture seem to be the key-notes of the tradition of folk art in India. It is the true spirit that has been woven into the fabric of national life.

It is essential that the modern artist should look forward, but it is also essential to understand that there is no future without a past. India must be proud of its past heritage that reaches back to the very dawn of human consciousness. And in this age of the people India must listen to the call of the village for the revival of folk art, for in a vast country like India every province has its own art forms which embody the people's experience of centuries.

BASIC PRINCIPLES OF VILLAGE CEREMONIAL DECORATIONS

By BIRESWAR SEN

FROM time immemorial, folk-arts of various types have been practised all over India. Much of it still remains to be catalogued and investigated into by the learned pandits, both from the point of view of aesthetics as well that of ethnology and primitive religion. With the incipient sophistication of modern times, folk-art is in danger of complete extinction unless something is done to preserve or at least to record its past achievements.

It is true that efforts have already been made to collect and preserve the typical examples of folk-art in Bengal by the University of Calcutta, The Indian Museum, the Viswa-Bharati Kala Bhawan and the Bangiya Sahitya Parishad, but steps must be taken on an All-India basis, especially in the so-called 'backward' districts and 'unregulated' areas, where the harvest is still bound to be rich and plentiful. Apart from museum-pieces, a complete record must be made of the various ritual decorations made by the women-folk during the various seasonal festivals and 'dasa-karma' (ten-sacramental) rites. School and College education for girls is ringing the death-knell of these ritual decorations and the time might soon come when they will be completely wiped out of our social life.

Ancient Affinities

Rural development schemes, which function only in terms of *panchayats*, sanitation, social hygiene, *maktabs* or *pathshalas*, cover only a part of the problem. These will only function

properly where the elements of joy and beauty are added to them. Efforts to resuscitate village crafts are at present being conducted only with an eye to financial returns, but it is never considered for a moment that unless these village products possess the element of beauty, they will have very little commercial value—to say nothing of aesthetic appeal. Sophisticated trained teachers are some times being sent to 'improve' the arts and crafts of the villages with disastrous results, for the combination of trained talent and village simplicity produces something that is neither fish, nor flesh nor red herring. If the villagers are to work out their destinies, they must be guided to do it in their own natural way without a superficial grafting of city sophistication. Critics have waxed eloquent over the village decorations, folk-arts, toys, embroidery, ritual pottery, wicker work, basketry and wood-carving, discovering Egyptian, Assyrian, Sumerian or Hellenic affinities, but no body has tried to probe deep down into its basic elements. Unless these basic elements are known and practised, it is impossible to preserve the naive and unsophisticated character of the rural crafts, for superimposition of art-school talent will only make matters worse and make them lose their distinctive primitive flavour sooner than is anticipated.

Read between the Lines

I believe that the adoption of these basic elements will preserve the simplicity and rhythmic character of village decorations and recommend its adoption

at the village centres as an experimental measure. My own experiments in the classroom were very satisfactory, but laboratory tests must be followed through by large scale commercial ventures for it is only on the wider background of universality that a new discovery can be properly assessed and valued.

The human mind works with certain basic ideas, certain basic sounds and certain basic movements. It is not easy to find out what these basic elements are, but a life-time of observation will permit a man to read between the lines and discover the principles of unity in a mass of apparently unconnected diversity.

For the purpose of pattern-making or ritual decorations as practised in the villages the basic elements are seven. Really, they are two, the rest of them being off-shoots or off-springs. A straight line and a semi-circle are the fundamental



basic parent elements. They are like the father and the mother of family in more sense than one, as we shall endeavour to show later on. A straight line possesses a uniform quality; when produced in either direction it will nevertheless point at the same direction either to the right or to the left. Even after producing it will preserve its primal character, i.e., look exactly the same as before, except for the change in its length.

As opposed to the straight line, we have the curved line. The simplest uniform curve is a semi-circle. Most of my readers will perhaps ask me, why not a circle? I prefer the semi-circle because the circle is really an enclosed space and not a line. These two elements are the basic parents and correspond to the basic duality inherent in every thing in this universe. They are like *purusha* and *prakriti*—the horizontal line suggesting

unimmutability, calm imperturbability and actionlessness or immobility, the semi-circle suggesting movement, encircling cycles of creation, endless gyrations of life and action. To use Kinetic nomenclature, one is *static* and the other *dynamic*—calm and cressence, *Siva* and *Shakti*!

Interaction between these two elements will produce fused forms, bearing affinities, which are unmistakable, to one or the other of the parental elements. A straight line actuated upon by dynamic energy will break itself up into *peaks*, just as a stick forced from both ends would break up into a \vee or inverted \wedge . This is the third element of our basic forms, and since it resembles the father, we shall call it the son and heir-apparent.



The rest of the family are all daughters, which is as it should be in these days of aggressive feminism. They are the *circle*, really a completion of the semi-circle, but doubly more rotund than the mothercurve, the semi-circle.



The second daughter is a spiral curling either clockwise or anti-clockwise. It is really composed of semi-circles, each smaller than the other, swelling in opposite directions like this.



The second daughter thus takes after the mother-curve, but has more concentrated energy perhaps, like a coiled spring—full of unimaginable potentialities.



The third basic curve is wavy, either like this



or like this



waves or semi-circular rounded waves.



In either case, they are composed of semi-circular curves and may be regarded as the third daughter of the family.

Lastly come the curves of another kind—coil, the ropy coil, resembling the twisted coil of ropes. She is the youngest daughter of

the family and is really composed of a short straight line in the middle and semi-circles at both ends, like this.



These are the seven basic elements, the seven pillars of wisdom. The seven colours of the rainbow, the seven notes of the complicated music of decoration.

We know from our Indian musical notes that they are seven in number—sa, re, ga, ma, pa, dha and ni. Above this there are graver octaves and below this the sharper ones. Continuing our musical analogy the graver octaves of our basic elements are those drawn with *thicker lines* and the sharper octaves are those that are drawn with *thinner lines*. To illustrate graphically :

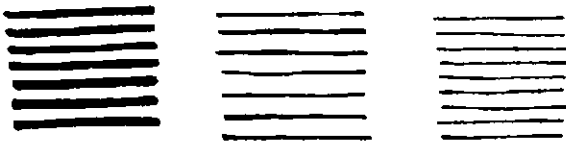

The thicker the lines are, the more sonorous becomes the design. This graduation of thick and thin lines applies to all the basic curves. Heavier and **fatter** lines always seem to strike the graver notes in a design.

Beauty in Repetitions

It is an elementary and common knowledge that repetition is the soul of design. A particular unit may not look very beautiful by itself, but when it is repeated in the form of a chain or a group or block, it is immediately invested with an 'esprit de corps' which was entirely absent from the individual unit. The veriest tyro with the typewriter knows that although X is not a beautiful letter in itself, when it is typed repeatedly, it forms a chain like this XXXXXXXX, which is not so bad-looking after all. When a single soldier goes about the street, he is not in any way particularly conspicuous (unless, of course, he is a guardsman or cuirassier). If two soldiers walk together, there is always something to attract the eye—the steps and the swing especially. If three, still better; in fact, the more the merrier. I do not know of a finer sight than a troop of marching soldiers in full uniform swinging along gallantly to the tune of military music or a group of cavalry men with flowing tunics and flashing sabres, riding four abreast, with spurs and chains a-jingling.

To come back to our own topic, no single curve or line ever looks particularly beautiful by itself unless it is repeated. When it is repeated, it is immediately invested with a new beauty. Lines, peaks, spirals, waves will at once look interesting when they are drawn out as a chain and repeated longitudinally, as below :

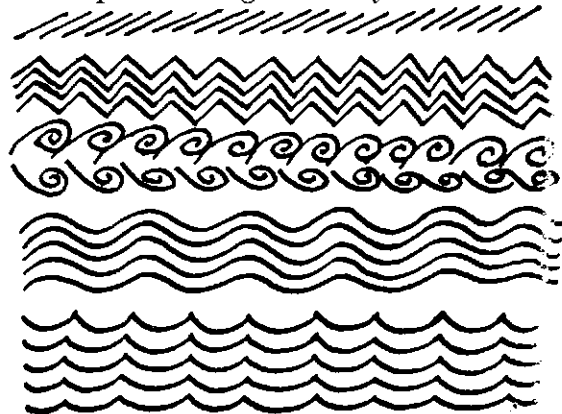

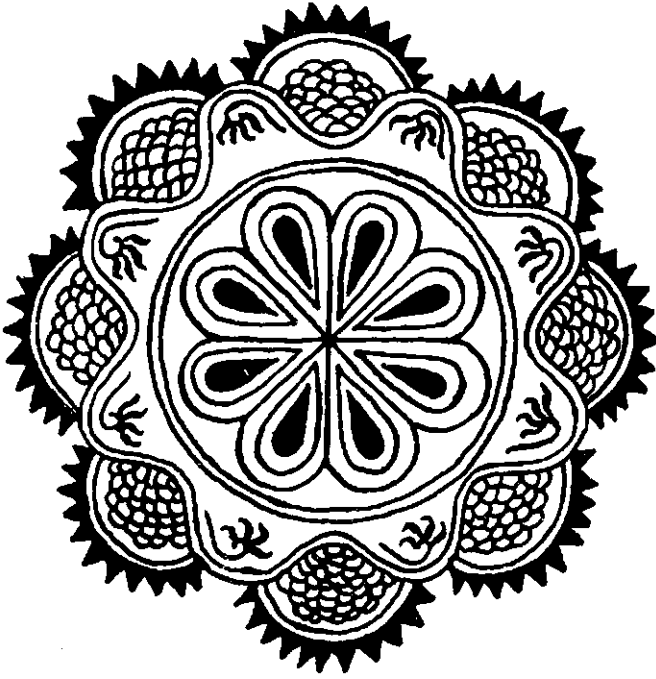

BIRESWAR SEN

'ALOPANA' DESIGNS (I)

Every woman and girl in Bengal loves to draw the *alopana* designs which are considered auspicious

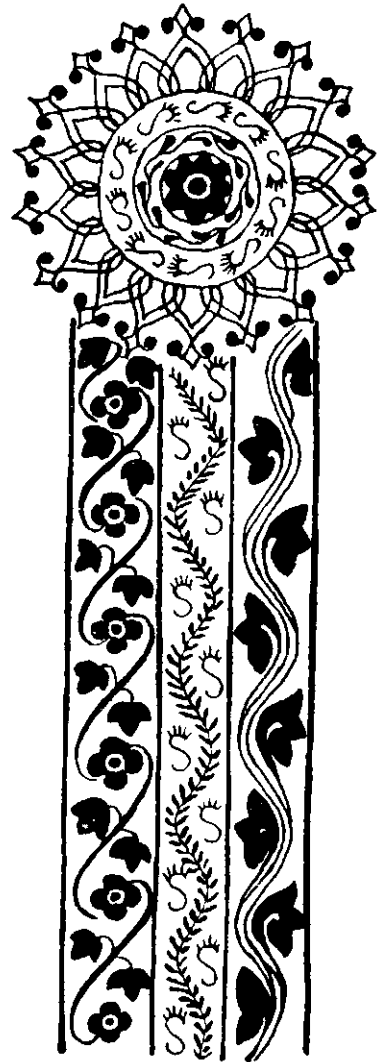

BIRESWAR SEN

'ALOPANA' DESIGNS (2)

Some of these designs, seemingly of ancient origin, look rather primitive. But the women and girls in Bengal, who draw them on earth and doorways with some powder as a part of religious service, would praise their art with gusto : they will show you the sun and the moon, flowers and birds and trees, as also human figures and precious necklaces and other ornaments in their simple and unsophisticated heritage of folk-art

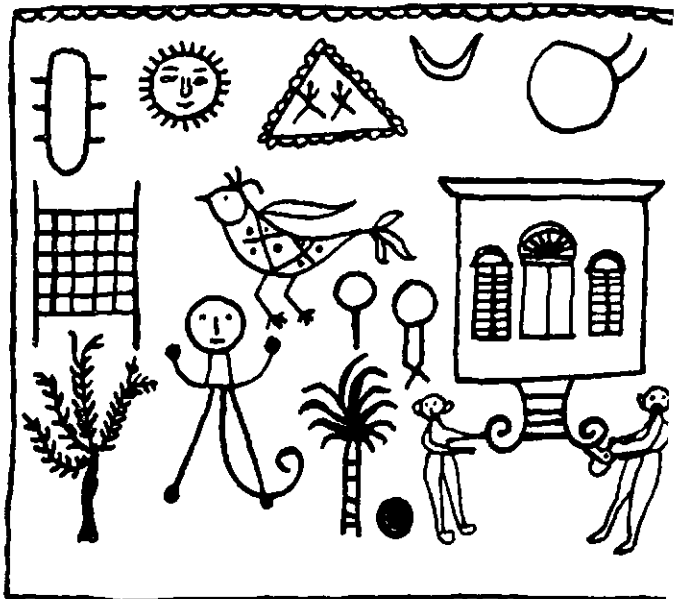
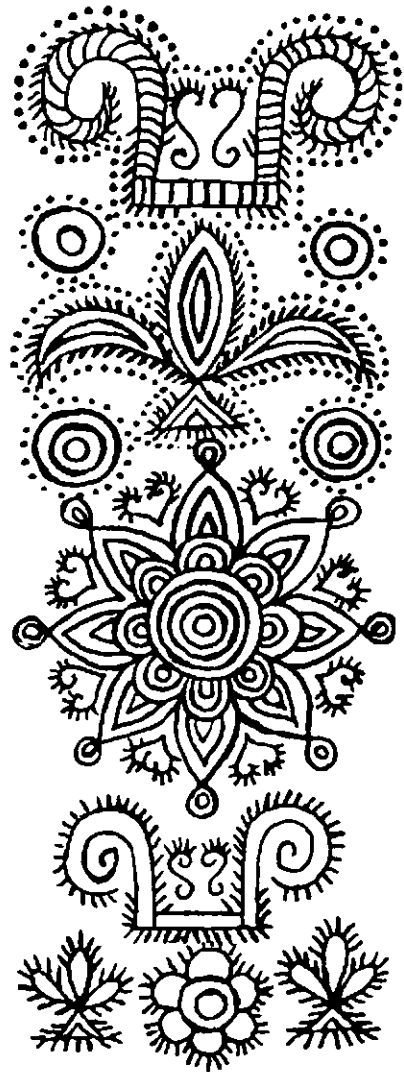
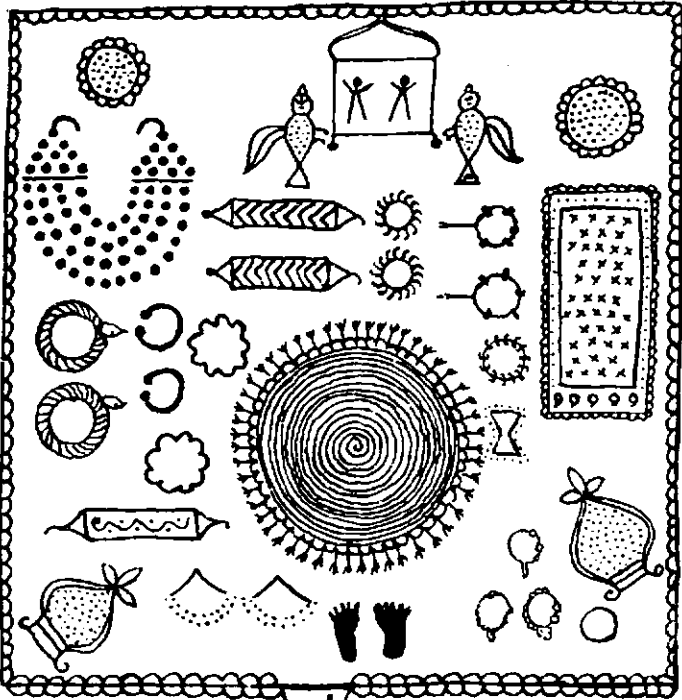

Instinctive Variations

If the octaves are changed, then the same designs will take a different look. If they are interchanged, there will be still more beauty and variety, as below :



By the judicious change of the thickness of the lines the same design, which would otherwise look uninteresting and insipid, can be made to look bright and cheerful. This change of octaves can be

practised with all the seven basic curves and much of the simple beauty of village decorations comes from instinctive variations of the thickness of the lines which compose a decoration.

Charming and Appealing

Pushing our musical analogy a little further we find that village decorations are given added charm and appeal by a variation of the *tempo*. No Indian music can be regarded as complete, unless both the *sur* and the *tala* are harmonized properly. Normally speaking, the *talas* are three in the main—*druta* or quick, normal, and *vilambita* or delayed. Let us now see how the village artist plays the tune of his design by variegating the seven basic notes of his rustic flute. The parent line and curve are unimmutable and not subject to the influence of the changing tempo, like the dominus and the domina of Indian families. They are extremely conservative and not open to changing fashions, but the children are. This is how the changing tempo affects the children. Take the peak for instance. This is the normal peak, all lines inclined at an angle of 45° to the horizontal :



When the tempo becomes quicker the peaks rise and fall in quicker succession like this :



Or if the young man is living a still faster life, the seismograph records his actions like this :



Poor fellow, he seems to be burning the candle at both ends and the sands of life run fast ! On the other hand if he is a sober solid type of man, his steps

are slow measured and deliberate like this,



or even like this.



But usually the quicker tempo adds more life and vivacity to the design, for in life as in design, one crowded hour of glorious life is worth an age without a name.

The changing tempo also affects the other curves—those on the distaff side, in a similar way. The waves become either like this,



or like this when the tempo is quicker still :

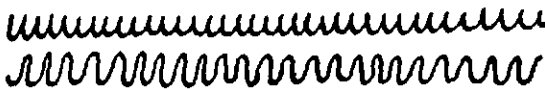

When slower they look like this, staid and stately young matrons sailing through life like heavy Spanish galleons, undisturbed and unruffled by the winds that blow :



Spirals that curve quickly towards the vertex are said to be of fast tempo.

Those that take a longer time to curl up and to come to the point are called slow in the uptake, like this :



We have, perhaps, pushed the musical analogy far enough. A little more and we have done. We know that the seven musical notes are the distinctive notes of animals, 'sa' denoting the cry of the peacock, 're' the bellowing of a bull,



'ga' the braying of a jack ass, 'pa' the high-pitched cooing of the brain-fever bird and so on and so forth. But this does not actually mean that synthetic music can be concocted by putting all these animals together in a cage and making them cry, bellow, bray or coo. That would be madness. Even if music were madness, there must be some sort of method in the vocal lunacy. The method is a proper combination of the various notes. Let us see how the village artist combines the various basic units for his music of lines—the lines that sing. The simplest village design is like this,



combining the peaks with circles or dots. When the peaks are combined with semi-circles they become the popular curtain cloth design :



When peaks, waves and circles combine the design is formed as below :



When peaks and spirals combine, the following design is formed :



Similarly spirals and waves,



waves and rope-coil curves,

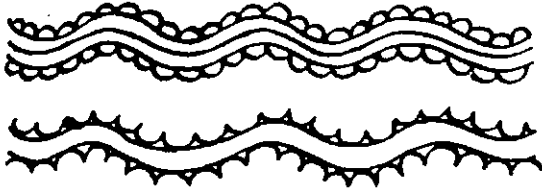

waves and semi-circles,

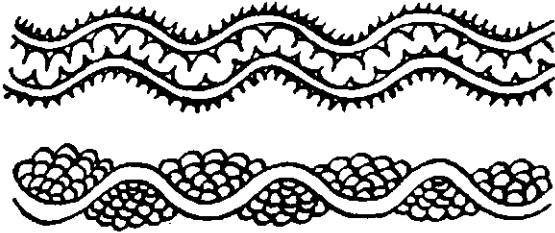

will make the above designs.

Mathematically calculated, the scope of those designs will be infinite and added to this if the octaves and tempo are changed, the number of potential designs would reach an astronomical figure. Up-till now we have not said anything about colours and shades and tints. With

the added beauty of colour, the end to these village artists' repet

March with the Times

It is not possible to do justice to such a vast and interesting subject in a small article like this, but from what I have roughly indicated the average reader will at once guess the illimitable material which is at our disposal and which lies still untapped by our modern artists and decorators. A collection of these village decorations will be of supreme value to the designers, especially in textile and pottery designing and many of my adaptations from village craft-designs were immediately picked up by connoisseurs when they were propagated through the Government of United Provinces Handicrafts a few years ago. We have our geodetic, geological, archaeological, zoological and other survey departments. We shall indeed be marching with the times, if we have an artistic survey of the village arts and crafts, before they are completely extinct like the dodo.

FOLK DANCES OF INDIA

By RAJENDRA SHANKAR

REAL India still lives in the villages, where generations of our ancestors have kept the ancient culture alive. Small villages and big villages, poor villages and prosperous villages, there they have been, knit harmoniously together, forming the backbone of Indian society. Everything assumed a meaning in keeping with the general and ultimate purpose of life, creating a standard with definite patterns.

As time went on and conditions changed with the advent of machines, villages began to be drained of young and ambitious men who went out to serve in factories, railways, docks, offices and households. With a life of freedom, artificiality and ease, they soon settled down in towns or were cut off for the best part of their lives from villages. Thus we see how the real life flows out of the villages in the shape of labour, fruits, timber and crops while hardly anything goes back to the people who cling to their village homelands.

In towns we are very much cut off from real rural life and yet we form an opinion of the peasantry being lazy, backward and hypocritical. We know so little at first hand about their misery and suffering, their under-nourished children, wallowing in dust and mud, and the poor huddling together in winter under the same torn mattress inside a smoky ill-thatched hut. Most of the villages are completely cut off from towns. In Europe and America, students, lawyers, artists and holiday-makers go to the villages and farms during vacation or summer and a link of friendship and understanding is at once forged. But in India no one would like to go to the

countryside unless he is forced to face a life of no entertainments or society and boredom.

The simple people of the villages, in spite of their deep-rooted poverty, have a great faith and a great vitality. Their sorrows and calamities they endure with a faith in God, and at the slightest opportunity they try to revel in festivities and merry making that their souls ever yearn after. All over India, the sons of the soil express their glee and happiness in songs, dances and festivities centering round child-birth, marriage, sowing, harvesting, and various religious ceremonies.

Source of Inspiration

All artists feel that the villages in India have a significant character and a great deal of indigenous art in pottery, handicraft, songs and dances. Even today they give a glimpse of purity. All over India during Holi, Moharram, Ramlleela, Nagpanchmi, Jublan, Onam, harvesting and other festivities, one sees different types of folk-dances. They are as haunting and simple as they are varied. With appropriate, songs, musical background and rhythmic accompaniments, they go on till the participants drift into a frenzy and begin to weave a spell over the onlookers.

The songs are simple, direct and touching. Even the primitive tribes like the Santhals, Nagas and Bhils have their own treasure of songs and dances. The Gond and the Ahir, the Dhobi and the Chamar all have their special types—the outpourings of a true and honest soul laid bare in terms of their limited vocabulary. And yet this simplicity is their strength.

For an ardent artist seeking the basic

urge for the expression of life, the art of the countryside affords a great and rich source of inspiration. There one finds the maddening riot of rhythm and melody, movement and expression and from a complete forgetfulness and surrender of the personality is born a dynamic force which guides a dancer of these dances on through the blissful state of a trance where he ceases to be a mere tiller of the soil and rises to the level of a true artist. Whatever might be the comparative merit of his work, it is important to note the transporting and intoxicating touch of real art which makes us forget the poor looks and means of the villager. This is no exaggeration for anyone who seeks for the elusive quality in art of self forgetfulness and a tremendous flow of inspired expression and movements from the state of a trance. All the countryside artist needs is to get enough encouragement and support.

It is painful to see how degeneration sets in on account of a lack of sympathy and encouragement. Cheap film music sung to the accompaniment of a grinning, out-of-tune harmonium and a deliberate attempt at a stronger doze of vulgarization have been attempted to please the onlookers. It is, therefore, high time that something should be done to save some of the most remarkable types of dances and songs from cheap importations and vulgar aping.

Special rural broadcast programmes evoke interest in the few who are lucky to hear them. But a systematic and thorough study of the problem by people who really love and appreciate rural folk dances and songs would help not only in gathering and making a wonderful collection of what is characteristic but would also suggest means for creating conditions that could allow talented artists among them to work and experiment with a view to improve their art in keeping with the spirit of the age.

Trained teachers could be employed to incorporate small one-act plays, action songs and different interesting forms in the study of the boys. Better still, a small theatre with a museum for the study of agriculture, geography and customs could be built near the *panchayat* with a play ground. This would encourage interest and also help the revival of some of the most remarkable acrobatic dances that would assure health and entertainment.

There is a striking similarity in the peasant dances all over the world. They all abound in a spirit of abandon, great zeal and gusto, transmissible, energetic movements, quick jumps and pirouettes and, withal, have an unassuming simplicity. With the touring film units such short reels taken during festivals and under appropriate atmosphere could be shown in the villages. This would at once excite the artist in them who would once more begin working out the forms that have lain dormant through disuse, crushed and rusted through lack of appreciation and patronage.

Art Revival

In America, Europe, Russia and other parts of the world there is a great movement afoot to resuscitate the rural art forms. Dancers, singers and dramatists have combined to evoke a new interest, a new life in the villages and their children by giving them a stage and proper training for harnessing their native talents. In India, lovers of folk dances and songs have worked against heavy odds, unaided in most cases, to make collections and adaptations, but nothing worthwhile can come out unless an organized and well-planned effort is made. The Indian People's Theatre Association has restored a representative collection of folk dances from all over India in its tour repertoire, but the measure of its real success will be read in the amount of work it can do to enable the villagers have their own

museum theatres attached to the *panchayat* and school with a healthy impetus to work for an all India rural folk dance and song competition. Uday Shankar, who is perhaps the most ardent lover of all art forms in the countryside, owns his initial inspiration to an old dancer, a chamar by caste, in Nasiathpur, a small village near Ghazipur in the United Provinces. Even after all his international success, Uday Shankar cannot forget how rich India is in its folk dances. His adaptations of the peasant dances have won him applause all over the world. This is just mentioned by the way to impress the countryside artists who scoff at what they have inherited and find a means of salvation in copying hybrid compositions that their own forms have originally inspired, as they so often see in films.

Unity of Culture

For dancers in towns who have a leaning and love for rural forms, it is necessary that they go and spend some time in villages during the dance months well-known for different types of dances. They will find a fund of richness and variety in their compositions, metres, steps and rhythms, in the simplicity of their costumes, makeup and ornaments with leaves, stems and flowers. For the presentation on the modern stage or screen they might improve the steps, cut down the time, add to the music and enrich the costume, but it is the real tapping of the vein of art, of its fundamental spirit and simplicity that they should study, capture and retain. When the villagers dance or sing *bhajans*, they forget all their woes and worries, hunger and poverty. When they revert back to normal or sub-normal life, it is with a vigour renewed, hope replenished. Dances and *bhajans* have drawn the villages together, to inform and educate, to please and entertain, to help them cleanse themselves of sins and lapses,

to reshape and refashion their lives and mould their character for the attainment of the final beatitude of life enjoined by religion. Songs of Kabir, Tukaram, Mirabai, Jaideva, Chaitanya, Tyagaraja and Nandanar have given song and rhythm, hope and faith, and a tremendous philosophy of endurance to the masses. Thus through centuries of ups and downs, floods and droughts, India has remained undivided because of her culture and arts, kept alive through her picturesque ceremonies, customs, songs and dances. This unifying factor of unity of peoples over such a vast sub-continent is by no means an insignificant force.

Peasant Art

Uday Shankar had a great scheme for coming in touch with this tremendous natural source of inspiration in the villages. He is at present transcribing more forcefully in his first film *Kalpna* which is nearing completion. He feels it a debt of honour to his countrymen in the village homelands where, for apparent reasons, he could not go with his dances and contact them in person. And I can do no better than end by quoting what once he said to me when we were discussing plans of the revival and revitalization of dance and music in the Indian villages.

“Folk dances and songs”, he emphasized, “touch me very deeply. They are so near to life—simple and natural. From my own experience and experiments with the students of the Centre¹ I find that for the fuller growth of the artist, a study of the art of the peasant is indispensable. Musicians and dancers will get new ideas and inspiration and will also be doing a great service to the country through their intimate contact with the peasants and their sincere attempt to know and understand more of the indigenous treasures of our country.”

¹ The Uday Shankar India Culture Centre at Almora, 1938 to 1944.



'HOLI' DANCE (1)

Fisherwomen in Maharashtra have a special dance
associated with the Holi festival



P. J. B.

' HOLI ' DANCE (2)

**The fishergirls in Maharashtra would join in the Holi dance separately :
dance rhythms run in their blood**

KATHAKALI (1)
Krishna in a characteristic love scene



P. I. B.

KATHAKALI (2)
A dancer in woman's costume





R. B. HOLMES

" This is my wish, ye friends so dear
Where the hill breezes do not carry
Dust, trodden by horses of accursed Moguls,
There in a grave so deep
May the free Khushal sleep. "

DEVENDRA SATYARTHI & AN OLD PATHAN MINSTREL

Sung in Pashtu. Pathan folk-songs are rich in ease of expression and unique air of freedom and chivalry. Love songs and ballads are many. But the Pathan feels more at home with war songs. That is why, some of the heroic compositions of Khushal Khan Khattak, who was a contemporary of the Mogul King Aurangzeb, have been mixed up with folk-songs. Khushal fought more than once against Aurangzeb and was once imprisoned by him for three years in Agra fort: his most popular song, from which a few lines are quoted above, has been translated into Urdu by the Late Sir Mohammed Iqbal retaining the fire of the original

SONGS OF THE INDIAN COUNTRYSIDE

By DEVENDRA SATYARTHI

SONGS of the Indian people, like the outpourings of China in *The Book of Songs*¹, dating from 800 to 600 B.C., give a clear picture of the very early Indian life. But India, unhappily today, does not feel proud of such an ancient anthology of folk-songs. It was only in the twelfth century A.D. that Hem Chandra in his *Prakrita Grammar* gave specimens of *dohas* as actually sung in Rajputana and the neighbouring linguistic zones. Presumably, the South Indian scholars gave much importance to folk-songs at an earlier period, for Tamil *Sangam* literature of over a thousand years ago, is quite rich with such references. Yet we find no trace of the single-minded ideal of collecting peasant melodies from the length and breadth of the country, and as the Late Mahamahopadhyaya Dr. Swaminatha Aiyar told me: "The greater book of Tamil songs still remains unwritten, for the songs everywhere hang from the living lips of the rural communities, and someone should only catch hold of them to restore a great antiquity—the very life-story of the musical folk-genius of *Tamilnad*."

Today, it is possible, however, to relish the songs of the Indian people as a whole, and W.G. Archer has aptly emphasized: "Hitherto this subject has been shunned by ethnologists and, if we except the few caste poems included by Russel and Hiralal in their *Tribes and Castes of Central Provinces* and the poems in the works of Sarat Chandra Roy, there are scarcely any books earlier than the last ten years which deal at all with

the poetry of village and jungle India. Yet nothing could be more relevant to Indian anthropology. For only through its songs do the attitudes of a tribe or caste become clear and it is not until the poetry has been understood that a tribe is understood."² The songs must be relished only through translation, as it is impossible to directly study the originals with profit in different dialects; for India possesses many rich languages.

The translator gives out in the common medium, yet the originals are of supreme value. To present the songs as mere originals alone will not do; someone must translate the words to solve the puzzle. No translation is indeed authentic without the original and there is no other way to test the accuracy, for in many cases a song may be more of the translator than of the tribe itself.

How to really relish the words of folk-songs? "To this question", says W. G. Archer, "we would give an unequivocal answer. We believe that little is gained by printing originals side by side with their translations. Those who can relish the poetry may be many, and for these, poetry should either be printed as *poetry* or it should not be printed at all. To make a linguistic puzzle a necessary pendant to a poem is to rob it of almost all its power and charm. The best method, therefore, is to print the originals as a separate publication and to supply the translations with a finding list. Such a course not only provides the critic with a stick but if care is taken it may also give the poems back to the people.

¹ Translated by Arthur Waley.

² *Man in India: Folk-Song Number*, March 1943, p. 1.

We suggest that at a time when oral traditions are weakening all over India this is a gesture which no anthropologist should grudge."¹

Translator's Role

The translator has a very difficult task before him. It is not always possible to reproduce the same essence and the flowing feelings of the original in another language. Of course, one must try to be as accurate in meaning as possible with the text. Broadly speaking, the translators of the Oriental poetry may be classified into four groups as Eunice Tietjens has stated in the introduction to her anthology, *The Poetry of the Orient*. Firstly, we have those who reproduce as exactly as possible the rhythmic and rhyme scheme of the original, sticking close to the sense throughout: secondly, we have those who would not reproduce the form of the original, for they aptly feel that the result will be a distortion owing to the fact that the ear which must now hear this version is not the same ear for which it came into existence; thus they would use a native rhythm to give almost the impression of an original poem in their own language: thirdly, we have those who know by experience that it is very seldom possible to do full justice to both form and content; thus they would stick to the content and would let the form take care of itself—the medium being the free verse irrespective of the original form: and fourthly, we have those who, losing all hope of doing justice to the original, follow a sort of conscientious exactness of the meaning of the original words—their medium is a plain prose.

In India Macdonell, more or less, belongs to the first class, while the majority of translators belong to the second class. In his introduction to *Hindi Folk-Songs*², A. G. Shirreff says

¹ *Man in India: Folk-Song Number*, March 1943, pp. 1-2.

² Published by Hindi Mandir, Allahabad (1936).

expressly that 'in the translations which follow my aim has been to give as accurate a rendering as possible in a form which may remind English readers of folk-poetry with which they are very familiar'. Of course, he discovered many resemblances between folk-songs of the United Provinces and English ballads. But, obviously, he translated the word *sari* as 'gown' and *ta yahi ranban men* as 'under the greenwood tree'. It must be emphasized here that this idea of rendering songs in verse with the aim of reminding English people of their own ballads is wishful. Translators such as Griffith, R. C. Dutt and Sir Edwin Arnold, who often produced beautiful poems, followed a similar method; the result is that we cannot call them satisfactory translations of the originals. Dr. and Mrs. Seligman, while translating the Vedda folk-songs of Ceylon, followed the prose medium, as also N. E. Parry, who gave us a number of beautiful Lakher folk-songs.

"If translations are to be of value", says W. G. Archer, laying down some significant principles for translating folk-songs, "it is obvious that they should conform to certain standards. The most evident is that the translation should itself be a poem. If it is not a poem, if it does not create the effect of poetry, it is merely a degradation of its original, an act of murder. The second requisite is that the translation should correspond with the original. If it does not correspond, it loses all claim to scientific value. It ceases to be the translation of a poem. It becomes a poem by a translator. Such a poem may have value as poetry but it has none at all as science. The problem of translating Indian folk poetry is in essentials how to produce a version which contains all the elements both of poetry and science.

"It will be evident that to this problem no solutions will be perfect. A poem is a combination of certain images, certain

rhythms and certain effects of music, and only if a translation could provide an exact parallel for each of these elements could it be perfect. In actual fact, a translation from a tribal language into English can parallel only one of these elements. Differences of verbal structure are so great that if parallel images are retained, the rhythms will be different. If the rhythms are maintained, the images will suffer, while no form of English can reproduce the musical efforts of Hindi, Uraon, Gondi, or Mundari. 'Certain things', said Ezra Pound, 'are translatable from one language to another, a tale or an image will translate; music will practically never translate.' A translation becomes possible, therefore, only when there is no attempt at all at *complete* correspondence.

"We believe that the best solution so far reached is that of Arthur Waley. In translating from the Chinese Arthur Waley was faced with problems which are identical with those of Indian languages. His solution has been a series of versions¹ in which the literal meaning of the translation corresponds with the literal meaning of the original. In particular, the images are never added to and never subtracted from. The poem as a system of images remains in translation what it is in the original. Instead, however, of attempting a duplication of rhyme, rhythm, or music, his versions use the rhythms and sound effects which come most naturally to the English. The original form is abandoned and instead the effect is to create a new form which is valid for a contemporary sensibility. We believe that in terms of this solution translations of Indian folk poetry can preserve all the elements essential for anthropology while still retaining the ingredients of poetry".

¹ 170 *Chinese Poems* (Constable, 1918), *More Translations from the Chinese* (Allen and Unwin, 1919), *The Temple and other Poems* (Allen and Unwin, 1923), *The Book of Songs* (Allen and Unwin, 1937).

Arthur Waley himself says: "Above all, considering images to be the soul of poetry, I have avoided either adding images of my own or suppressing those of the original."²

Oral Tradition

India has a long oral tradition. It may be assumed that some of the oldest Indian aboriginal songs, in their passage through the minds of the people generation after generation, are much more ancient than the earliest written poetry in India. Community singing kept the creative genius alive for centuries; new songs came into being extempore making the people's musical autobiography rich in detail and true to the spirit of the changing life.

Assaying the songs of a people superficially we miss their real value. Music follows the words and translates the spirit of each song separately. Some of the castes and tribes of India have melodies peculiar to them. The aboriginal music in the remote corners and forest-clad cliffy pockets of India gives us an idea of her pre-historic voice.

Folk songs of India reveal the emotional levels on which the Indian people have lived at the various stages of their history. The earliest of these songs must presumably belong to the nomadic stage of life and embody the wanderings of the people. The wandering minstrel continues this collective emotion well into the agricultural stage when some kind of stability comes to characterize life, and wanderlust and nomadic freedom grow into nostalgia of a sort. Thus a strange depth and sincerity of feeling belongs to the minstrel's songs. And as the community settles in villages, it happens to have a new set of myths and gods.

Every event of the individual's life in the village is celebrated in song in the same way as that of the community's life. In fact the individual event at this stage

² 170 *Chinese Poems*, p. 19.

is so free from singularity that its appeal is intensely communal. A son is born not only to its parents, but as the future soldier and defender of its life and interests, to the entire village, nay, the entire little community. Similarly the marriage song and the dirge too are always songs of the whole community.

".....unless the circumstances in which songs are used have been thoroughly explored and the stock imagery understood," says Arthur Waley, "many songs are likely to be classed as pointless and irrational, which are in reality full of the most precise and logical meaning. It is well known that as transmitted to us by ethnologists a great many primitive songs appear to be nonsensical. Indeed Heinz Werner, in the *Ursprunge der Lyrics*, has put forward a theory of successive stages through which poetry passes. The songs of very primitive people are, according to him, merely unintelligible noises, those of people not quite so savage begin to harbour a little, vague meaning; till we finally come to entirely rational and explicit poetry of civilized communities. I do not know whether any part of this theory is true. It is certain, at any rate, that the supposed irrationality of some primitive poetry is an illusion due to the fact that the transmitters have failed to relate the songs to the social system which produced them, failed to grasp the system of imagery employed, and failed in many cases to obtain a proper explanation of dialect words, archaisms, and euphonic distortions."¹

Every language has its own treasure of folk-songs. Every cultural unit has its own musical heritage. Songs of various provinces, in spite of differences in language and culture, show a deep underlying fundamental unity. One at once thinks of the cultural fabric of five thousand years old—the Mohanjo-Daro period.

¹ In a foreword to W. G. Archer's *The Blue Grove* (Allen and Unwin, 1940)

Languages have changed. Culture patterns have blended to gain 'new lustre from the new association and contrasts'. Everywhere in India women are the real custodians of ancient folk songs: the oral tradition, strong in myth and legends, is maintained by the old women of the village.

Cradle songs, for instance, have the same motif everywhere. Marriage songs evoke the same emotions corresponding to the community's social life. Harvest songs again praise the wealth of the village in almost uniform musical colour and idiom. Every class of songs, however, follows its own poetical technique. One must not lack curiosity about it. For the example of a field worker from Easter Island, whose business had been to collect specimens of popular literature and who was on his return unable to say whether the islanders made use of rhyme strikes a note of irony.

"Spinning songs are clever enough," an old woman once told me. "They remain hidden from me while my hand is away from the handle of the spinning-wheel." It reminded me of the words of a Kashmiri boatman who said: "The tunes of my songs will certainly fall flat if I sing without actually plying my heart-shaped paddle." Work songs, all over the world, show an obvious, psychological connection between tunes and the tasks of manual labour; they are hardly to be severed from the efforts and movements they were invented to fit. I noticed in various parts of India, Burma and Ceylon how difficult it was to collect the songs of toil from villagers while they were away from their work. Some of them would sing voluntarily, but they would often fail to produce the genuine music of their songs of toil. Back at their work, their songs would rush out correctly.

Poetry of the Soil

Maxim Gorky was right when he said that you can understand the soul of a



ANCIENT RHYTHM

Thousands of folk-songs all over India are dance songs and folk dances, like folk songs are rich in variety and colour. Some of the folk-dances, profitably, touch the fringe of classical dance like the Bharata Natyam—the deliberate art dance that sets forth a given theme by means of song and gesture combined, as in this picture by Rukmini Devi, the prominent exponent of Bharata Natyam in South India.



DEVENDRA BATTYARTHI

A SANTAL FAMILY

Santal folk-songs inspired India's great poet Rabindranath Tagore. Every Santal village is a mine of folk melodies and dance tunes; every man and woman in the Santal village looks picturesque as also a born singer, ever ready to translate the day-to-day struggle of life in poetry and song.



EVOKING THE RAIN GOD

Rain songs, ranging from happy prayers to Indra to sad and tragic cries of the people, in fear of famine, form a separate treasure. Even Rabindranath Tagore in his *Barsha Mangal*, a scene from which as staged at Santiniketan is shown in this picture, strikes a note of folk-music.



DEVENDRA SATYARTHI

SISTERS OF THE SPINNING-WHEEL

Many folk-songs are spinning melodies in various parts of India and more so in the Punjab. These village girls cherishingly address the spinning-wheel as if to seek its advice on day-to-day problems of life.

people better through its folk-songs than through its religion. Songs, growing year by year like a fertile land, are ever changing. Yet they remain the same; songs of the varied passions; songs of hopes and sadness; songs of elementary feelings. The beliefs of the people are always there, their love for the changing seasons and village comforts: songs of the plough and the spinning-wheel; songs of good harvests; songs of daily life in the village and the fields—'a deposit left by the river of time' that may aptly be called the poetry of earth and sky.

The plough and the spinning-wheel as symbols of agriculture and handicraft are dear to the Indian villager. The conception of a plough god seems to have inspired the song of the Savara tribesman in Orissa:

I salute your hands, O Plough,
I salute your feet.
The *sal* tree I ever praise,
For you are wrought of it indeed.
May you be ever strong,
May you be ever ready for work.
I salute your hands, O Plough,
I salute your feet.

The Savara tribesman, it may be emphasized, has not much changed with the time and it is easy to estimate the age of his song that may well be over thousands of years.

The spinning-wheel on the other hand is treated as a guardian. The song of the sad Punjabi bride addressed to the spinning-wheel is a poignant example of Indian folk poetry. The girl raises her own voice into the mouth of the spinning-wheel as she sits spinning the rough cotton into fine thread; as she spins, her woe mingles with her duty:

Ghoon, ghoon, O spinning-wheel, *ghoon ghoon*,
Should I spin the red roll of carded cotton or not?
Spin, girl, spin, O spin, girl, spin.
Far off is my father-in-law's home, O spinning-wheel,
Should I live there or not?
Live, girl, live, O live, girl, live.
Long, long is my woe, O spinning-wheel,
Should I tell or not?
Tell, girl, tell, O tell, girl, tell.

My husband is of tender years, O spinning-wheel,
Should I stay with him or not?
Stay, girl, stay, O stay, girl, stay.

Ghoon, ghoon, O spinning-wheel, *ghoon, ghoon*,
Should I spin the red roll of carded cotton or not?
Spin, girl, spin, O spin, girl, spin.

In districts scores of miles apart, variants of the same songs may be heard. Old songs live in the memory. But the peasant women continue to make attempts at new ones. Those women who would make new songs are always expected to have the richest treasure of old songs at their tongues' end. They actually worship the genius of the old. Thus the art of the folk-song renews from age to age.

The song of the Earth Goddess that comes again luckily from the Savara tribesman may be taken as the voice of the Indian people at large:

Earth Goddess, you are our mother,
Give us a smiling look.
It's time to reap paddy and our heart is full,
We wish to spend the whole day in songs.
Earth Goddess, when you smile for a while,
The paddy bears more corn,
Earth Goddess, when you are happy for a while,
The paddy ears shine like gold.
Earth Goddess, we are born of you,
When we die, we return to you,
Again and again we are born of you,
Again and again we return to you.
Again and again you give us your smiles,
Again and again new life the paddy ears give us,
Earth Goddess, you are our mother,
Smile for a while looking at us.

Or as the peasants sing in Bundelkhand:

Mother Earth, lamp-black you have put in your eyes,
You have put vermilion, too, in the parting of your hair.
Wearing the green you stand,
You have charmed the whole world.

The god Indra is still worshipped in song. Here is another song translated from Brajbhasha. It has all the poetry of a woman's heart, which is really a feast to the listeners:

On the sandal seat you sit, King Indra,
Your feet with milk I shall wash,
Be kind today, King Indra, on our land.

The white rice I shall cook,
The well-washed, green *moog dal*, too,
Be kind, King Indra, on our land.

In the copper cup the *ghee* I shall heat,
Four *papers* too, I shall prepare for you,
Be kind, King Indra, on our land.

You will eat and I shall watch your hands,
You will walk and I shall see your feet,
Be kind, King Indra, on our land.

You will sleep on the *panch rang* couch,
The royal carpet I shall spread under you,
Be kind, King Indra, on our land.

The people pray for the rains. Indra must be kind. But sometimes the rains fail, as the famine song translated from Maithili in Tirhut expresses it :

Slowly, slowly pour down, god Indra,
Without water comes famine, O *Ram* !

The green plains are dry, the ponds are dry,
Dry, too, are my brother's fields, O *Ram* !
Slowly, slowly, pour down, god Indra,
Without water comes famine, O *Ram* !

The Brahmin widow takes to the plough,
The ploughshare jumps and hits at her heel.
Slowly, slowly, pour down, god Indra,
Without water comes famine, O *Ram* !

Dirty water is left in the washerman's house,
Where all the Brahmins now take their bath, O *Ram* !
Slowly, slowly pour down, god Indra,
Without water comes famine, O *Ram* !

They use this water to wash their *dhotis* and sacred threads,
They use it in their sacred marks, too,
Slowly, slowly, pour down, god Indra,
Without water comes famine, O *Ram* !

Daughters and sons go about quarrelling,
The landlords won't open their stores for us.
Slowly, slowly pour down, god Indra,
Without water comes famine, O *Ram* !

The village *patwari* enters wrong figures,
They weigh us old wretched corn as our wages,
Slowly, slowly, pour down, god Indra,
Without water comes famine, O *Ram* !

Songs, both old and new, are bound up with everyday life in every province of India. The Punjabi dirge, born of long centuries of war from about 1400 to 1800 A.D. is sung even today :

Since this afternoon, my lord turned sulky,
And no more he spoke to me.
The wheat crops are all ripe,
The roses all in bloom.
Your earning I want no more,
To the Punjab, O khan, come soon.

You rode and went away,
All others, in the village, are here.
Our house looks empty,
The countryard fills me with fear.
Since this afternoon, my lord turned sulky,
And no more he spoke to me.

The Khan may not be necessarily the Muslim husband of some village woman. He must have been some Sikh soldier, presumably, whom his wife loved as dearly as a Muslim warrior's wife loved her own Khan. Anand K. Coomaraswamy, who heard this song from Abdul Rahim, a Punjabi court-singer of Kapurthala State, observed in his *Art and Swadeshi* : "... a beautiful lament for the beloved, expresses also the attachment of the Punjabi people to their land....with pathetic helplessness a woman prays her lord to return from the land of Death, as if he had gone away from home to another part of India or perhaps emigrated in search of work".

Some of the songs are symbolic. The *singni* fish in the Gond song of the Central Province represents the whole tribe suffering under the oppressing landlord :
In the fisherman's house is born a son,
Carrying on his head a fishing-net;
The *singni* fish weeps, *dhar, dhar*—
My life-long enemy is born today,
Ah me, my life-long enemy is born today.

Or, for instance, the dark she-snake in a song of Malabar that seems to represent death :

"Whence do you come, O dark she-snake ?"
"My eggs I laid, I'm going away."
"Dark mother, you are never kind, O never,
Innumerable eggs you have laid,
Now hundreds and thousands of serpent-kins will come out,
When so many of them will appear, O Father,
Where will there be shelter for the poor son of man ?"

The song of the Assamese bride strikes a universal note, and one may well remember the parting tears of Shakuntala when leaving Sage Kanva as depicted by Kalidasa. The Assamese song, like a miniature, looks significant :

The birds bring their offsprings up
To adorn the boughs of trees :
Ah me, it is to adorn another's home
With love and care my mother has brought me up.

The Rajasthani song that seems to mingle joy with sorrow again brings the image of sparrow for the village girl :

The moon has come above us in the sky,
The constellations are fading, fading.
Sister, now come home,
Else mother will beat you, beat you.
The grandfather will abuse you,
Your elder brother will stop him, stop him.
Don't you abuse this sister mine,
My sister is a sparrow, sparrow.
She will fly away today,
Or tomorrow at dawn she will fly away, fly away.
Another four days of *sawan*¹ she is with us,
Then the son-in-law will take her away, take her away.

Marriage may insure a happy life, as depicted in a song of the Garba dance from Idar in Gujarat frontier :

To Gujarat you had gone, my love,
To Gujarat far away;
And bells you brought from there, my love,
Jingling bells for my feet.
The queenly wearer of the bells is now deep in the measure.
Go slow, my love, go slow,
Follow in my wake, my love,
Follow in my wake,
I know your ways, my love.
To Bombay you had gone, my love,
To Bombay far away;
And *halva* you brought from there, my love,
Rich luscious *halva* sweet,
The queenly sharer of the feast is now deep in the pleasure.
Go slow, my love, go slow,
Follow in my wake,
I know your ways, my love.

The deep-rooted love flowing out in a Bengali song is really sweet and delicate for its poetic colour and flavour :

At midnight come to the flower-woodland, O *bhramara*²,
At midnight come to the flower-woodland.
I will light the lamp of the moon,
All the night I will keep awake,
To dew-drops I will tell my tales, O *bhramara*,
At midnight come to the flower-woodland.
Should I drop asleep,
I shall tread the path of dreams towards you,
Come with silent steps, O *bhramara*,
At midnight come to the flower-woodland.
See your song stops not,
See my sleep breaks not,
See the flowers' sleep breaks not,

¹ The month July-August.

² The bumble-bee.

See the twigs' sleep breaks not, O *bhramara*,
At midnight come to the flower-woodland'.

The Tamil wife in South India, on the other hand, looks sad as depicted in a song which is powerful for its significant details :

I have come to this new life,
The mud-walls enclose it,
The creak of the well-pulley disturbs my dreams.
Even when my baby is asleep,
I polish the brass-pots with ashes,
And tremble at the sound of the chiding footfall.
My mother-in-law stands at all doorways,
She has taunts harder than a poor man's fate,
A death has parted me and my playmates.
My child-life is cremated,
Many times I am hurt for the trees of my village,
And the peace of the village-shrine.
But on Fridays I bind my hair with flowers,
My blood is a tide—when I see flowers,
I can only think of them so.
Each pool is a glass and I bend over,
What is this god come into my life ?
He comes into my dreams like the fitful sun on a monsoon day.

His shadow is bright as he walks into the dim room,
I go about with downcast expression,
And hear the laughter of the village women mocking me.
They whisper nameless jests,
Their laughter follows after me,
But my heart is proud like the *sirisha* bloom on the bough.
I am sore with the trammels of this life,
I press against the wall with downcast eyes,
But my heart laughs when I hear a voice.³

Again, the Garhwali girl who has been married across the four mountains, chooses to send her sad message through her song :

Go, lucky girl, to your father's home,
Pray take this message for my mother;
Tell her : ' You are mother mine,
To meet you, mother, I ever pine.'
Tell my father : ' You did well,
For silver you sold me and threw me in misery.'
Across the four mountains he wedded me off,
My brothers, too, only needed silver.

³ This beautiful folk-song of Bengal has been sung in big music-halls all over India by the well known poet and play-wright, Hirendranath Chattopadhyaya, who sings it offering a blending of *Baul* and *Bhatial*—the significant modes of Bengali folk music. Lately, this song has been profitably adapted in a Hindustani film produced by Bombay Talkies.

⁴ M. Anantnarayan, *The Village Bride from Folk-lore*, The Triveni, Jan.-June, 1941.

Tell my brother: 'I shall wait for you,
 News of mine you'll get when you see me.'
 A long, long way, mother, is our water-spring;
 Mother, winter in *Poo* is simply killing.

Folk-dances, rich in colour and variety, have their own songs. The *Thakrya* dance of the Dangi Bhils, for instance, offers a grand sight. It is a monsoon dance: the dancers imitate the movements of the peacock at the sight of rain and their song follows the rhythm of the rain festival in the jungle. Another significant feature of the *Thakrya* dance is that it is exclusively a male dance while many Bhil dances belong to women. Good rain ensures good harvest. Thus, the peasant community naturally prays to rain-clouds as also the tribal gods to win their favour.

I would like to bring out here a popular Bhil folk-song, associated with the *Thakrya* dance for countless generations; the earth, the cow, *Kansari*, the corn-goddess, the sun, the moon and the stars—all appear as divine figures: Hanuman, who is the god of the village, is aptly invoked for strength, the god *Mahisha* for protection of the cattle, even father and mother are invoked following the ancient tradition of ancestor-worship which would nicely blend in the culture of any animist community; and the *Sati* cult, based on the sacrifice of the tribal women who had burnt themselves on the pyres of their husbands, figures as a befitting pattern on the surface of Bhil life. The song, translated by D. P. Khanapurkar, retains the images sensitively throughout:

I bow to Mother Earth,
 Deathless is your body, oh, peacock!
 I bow to Mother cow,
 Deathless is your body, oh, peacock!
 I bow to Mother *Kansari*,
 Deathless is your body, oh, peacock!
 I bow to the Sun and Moon.
 Deathless is your body, oh, peacock!
 I bow to the shining stars,
 Deathless is your body, oh, peacock!

† The month December-January

I bow to Morning star,
 Deathless is your body, oh, peacock!
 I bow to the clouds,
 Deathless is your body, oh, peacock!
 I bow to Hanuman,
 Deathless is your body, oh, peacock!
 I bow to *Mahisha*,
 Deathless is your body, oh, peacock!
 I bow to father and mother,
 Deathless is your body, oh, peacock!
 I bow to *Sati*,
 Deathless is your body, oh, peacock!

Whether it is the song of an individual or of the tribe as a whole, the note of sincerity runs throughout. Songs of joy mingle with the songs of sorrow; there is an effect of blending of colours—a blending of a cry and a prayer.

The *Andhra* song, sung under the stars, as I heard it, in praise of the jaggery that a village girl has brought from the weekly market for her lover, has a note of satire about it, for he fails to appreciate the jaggery:

O where were you born and where me!
 How far lies the *Raipuri Pass*!
 How far from here is *Raidruga Fort*, my love,
 How far from here is *Raidruga Fort*!
 Roaming from shop to shop,
 This fine jaggery I brought to you.
 O you say the jaggery is inferior, my love,
 O you, say the jaggery is inferior!
 Ha ha! we look merely like husband and wife, my love.
 O we look like husband and wife.

Everywhere the singing voice of the people greets us. The refrain may be repeated several times, when the singer swings in joy, every time with varying inflection; the lilt of the song enchants the whole atmosphere, mixed with joy and sorrows—maybe, the singer has noticed the tears in the eyes of some innocent bird, as depicted in the Tamil song of the *Ak-Kati* bird:

Ak-Kati, O *Ak-Kati*,
 Where did you lay your eggs?
 Raising the stone on the rock in the dense forest,
 I laid my eggs.
 I hatched and got only three little ones,
 Searching the grain for the first little one,
 I crossed the three *kadam* distance.

GARBA DANCERS

Gujarat is proud of its Garba dance, which is originally the dance of the goddess. Yet most of the Garba songs deal with daily life of the village.



P. I. B.

P. I. B.

DAUGHTERS OF 'CHAND MAMA'

Peasant girls in Andhra Desa in South India show a special regard for *Chand Mama*, or the 'maternal uncle moon', who is addressed in song and dance over and over again.





DEVENDRA SATYARTHI

WELCOME TO ANCIENT FESTIVAL

In spite of economic troubles, the village women always celebrate the seasonal and ceremonial festivals that add colour to village life.

THE WOULD-BE BRIDE

"Money or no money, my marriage must come"

DEVENDRA SATYARTHI



SAVARA BOYS

Boys in aboriginal India have their own songs. These kiddies of Savara tribe, photographed in a remote village in Orissa, supplied the author with scores of their chants and dance songs.

DEVENDRA SATYARTHI





DEVENDRA SATYARTHI

AHA, MARRIAGE NEWS!

Marriage in the village is always a community affair, and more so in aboriginal India. These Lambadi women, photographed in Andhra Desa in South India, love to sing marriage songs handed down through oral tradition.

Searching the grain for the middle one,

I crossed the four *kulam* distance.

Searching the grain for the third one,

I crossed the greater distance.

The cruel washerboy sat there seeking game,

He spread his net.

Both of my feet were caught in the snare,

Fluttering my wings I wept and wept;

Tears of sorrow flowed back the four *kadam* distance !

Lament of the She-frog, translated from Tamil, again, has all the spirit of a dirge. The herdsman, who looks so fond of song and pipe, always sings of things that make up village life. As he returns home with his herd in the evening, the atmosphere is again poignant with the ancient melody, wherein the she-frog weeps over the death of her husband as a village woman would do in her bitter sorrow :

Here and there and everywhere, my lord, my god,

At many places, my lord,

I searched and searched for you, my god,

But I found you nowhere, O nowhere.

Insects have gathered round you, my god,

Your feet are dangling down,

Riding the black horse,

You are leaving me, my lord.

Under the tall plantain

Stands your mother-in-law's hut :

Without telling anybody.

You are leaving me, my lord.

The world looks changed, my lord, my god,

The season looks sad and gloomy ;

No more do I have the milky moonrise in my heart,

Now death must come to me.

Dear, I weep and curse the cruel carter,

I curse his cart as I curse the road ;

Dear you never gave me a child,

Now how will run our family-line ?

Another Tamil song picturizes the daily struggle of life :

We have rice and we have *dal*,

No oven, that's the trouble.

The wind blows, carrying about the dust,

Alas, we have no door, that's the trouble.

My wife comes and stands before me,

No *sari* to give her, that's the trouble.

The beggar comes and stands at the gate,

Not a *dhela* to give her, that's the trouble.

Songs of family life are many. Here are a number of these, sung by women in

Karnatak, as they sit down to grind corn in the millstone :

I

As father's memory comes, the stale food gets hot;

As the Ganges-like mother's memory comes,

My dirty hair look clean.

II

Talk between mother and daughter is the rhythm of a song

Like the two-stringed instruments played together,

Like the sound of the Halsangi temple-bells at sunrise.

III

Mother, how can I praise my father-in-law's home before you ?

Mother, my life is not joyful,

It is like the plantains artificially ripened in the basket.

IV

Do not go to mother's home when mother is not there, my heart,

The calf comes to the dry tank and turns back,

Imagine the pain of it.

V

The sea is great, they say ;

But the mountain is greater, my princely brother,

Dawn at the hill is red and gold.

VI

What a life is the barren woman's life !

Like the hired bullock's constant labour,

Then one day lying and dying.

VII

I won't have a bride from the West Coast,

She would stretch her legs on the ground before everybody,

Will she be able to live nicely in fear of the neighbours ?

Side by side with old songs are sung the new ones that seem to be still in the melting pot. One constant theme in the new ones is the economic depression. The Ahir wants to leave the village. But his wife does not agree, as we find in a *Birha*, translated from Bhojpuri :

At your feet I fall down, darling,

Do not go to the town :

Eat the wheat with the cooked mustard leaves,

Pass your days in the village, darling.

The wheat bread is a dream in many Ahir families. The Bhojpuri *Birhas* from the United Provinces give every detail of home life :

Beholding big, big bins, don't be mistaken, Nirahua,

Even the she-rat fasts here ;

Our children lick up the *lapsi*,

The *mahua* we sell to make a living.

The *lapsi* is the staple food of the poor Ahir; the coarsest part of the wheat flour is first soaked in water, and after some

time it is filtered and the water is heated. As it reaches the boiling point some *gur* is mixed.

The song of the Malabar peasant is a cry against social injustice. Instead of addressing Indra the peasant addresses the sun and the earth in the refrain. Each line expresses a highly charged emotion; the rhythm throughout flows like a hill stream falling into the backwaters of Malabar :

Says the landlord, eat the coconut, drink a few drops of toddy,

I say, I will die and you won't even mourn for me ;
Grow, grow, O paddy, full of sweet milk,
The landlord wears silk,
O Earth, O Sun, I see no justice.

Says the landlord, birds are happy but you are sad,
I say, I will die to be born a bird on earth :
Cry and jingle, O drums and bells,
Our sweat the landlord sells,
O Earth, O Sun, I see no justice.

Says the landlord, trees are green but you are withered,
I say, I will die to be born a tree on earth :
Blow, blow, O sea breeze, tell your tale,
The landlord never hears our wail,
O Earth, O Sun, I see no justice.

Says the landlord, don't we pray to the same gods ?
I say, no home have I, no temple, nor gods ;
Go, go, O plough, go deep,
Where doesn't the landlord creep ?
O Earth, O Sun, I see no justice.

Says the landlord, I will give you a plot of land,
I say, do not tell a lie ;
Come, come, milk and honey,
The landlord carries bags of money,
O Earth, O Sun, I see no justice.

Provincial and linguistic barriers actually disappear when we realize the great message of unity that runs throughout these songs of earth and sky. The song that follows is sung on the banks of the Kosi river in Northern India; yet it seems to echo the voice of the Malabar peasant :

'Hard days have overwhelmed me! Anxieties have killed me!

By taking loans I worked my fields;
I worked my fields; my paddy the Kosi swept away:
Anxieties have killed me!
By selling my bowl and dish I pay my landlord;
I pay my landlord, and the traders call me scoundrel!
My sons are naked! My daughters and naked!

The clothes of my wife are torn and old;
Anxieties have killed me.
Food has run short and fuel run short;
As fuel runs short, I fast in the morning!
Anxieties have killed me!
Hard days have overwhelmed me!

Here is another song from the banks of the Kosi river. It is a greater cry. Edwin Prideaux, writing at length on *Mother Kosi Songs*; tells us: "Mother Kosi has long held sway. She visits the land, meting out punishment, giving rewards, striking with dread terror, and often with whims difficult for her subjects to comprehend. Her father is Himalaya—father of many maidens—the Creator Siva enthroned in the heights. Famous she is, and more powerful than all others. Worshipped in song and a constant presence, her influence is very real to the people in her tracts."¹ 'For everything money is asked', that has been given the colour of a semi-refrain, makes a bitter comment on the whole situation. Nature is cruel. Yet man's injustice to man is no less. 'Haste, haste, O Sarkar!', the refrain of the song raises the whole piece to the level of a political outpouring of the people :

'From mother Kosi's water, thousands have fallen sick,
There is no counting how many have left this world.
Haste, haste, O Sarkar!
All we subjects are being washed away in Kosi's mid-stream.
Haste, haste, O Sarkar!
From colds come fevers; fever lasts all day.
Haste, haste, O Sarkar!
There is no cloth for our bodies; how can we carry on?
Haste, haste, O Sarkar!
In hospitals no medicine is given; the doctor is a cheat.
Haste, haste, O Sarkar!
For everything money is asked; how can we carry on?
Haste, haste, O Sarkar!
By selling family ornaments we had prepared our fields.
Haste, haste, O Sarkar!
One day I saw a dry river-bed; in the night it became
a torrent.
Haste, haste, O Sarkar!
In the morning I saw on all sides that all was under water.
Haste, haste, O Sarkar!
When an officer comes this way, his Orderly is bold.
Haste, haste, O Sarkar!
For everything money is asked; how can we carry on?

¹ *Man in India*: Folk-Song Number, March 1943, p. 61.

Switching the Spirit

The continuity of folk music has kept the Indian village and its musical language alive: it holds the soul of the community everywhere. It is varied and rich and has a primitive dignity, especially when intended for group singing. Handed down for generations by word of mouth, it has variations that add to its richness. Numerous stories are told about poets being enchanted by a simple folk melody floating up through the calm moonlit night.

"The earliest texts," says D. P. Mukerji, "refer both to the classical (*marga*) and the folk (*deshi*) types. The former being associated with rituals, was careful of voice-production, accuracy of pronunciation, and the chant-like movement of the songs. Although we do not have the structural features of ancient folk-songs, we have reasons to believe that they gave greater latitude to verbal element, the ordinary human feelings, and the usual group-activities through occupations, festivals and the like. Both classical and folk types had room for courses. The two types did not materially differ, otherwise the constant give and take, of which we have numerous evidences, would not have been possible. Folk-tunes, regional songs and styles, even non-Indian were incorporated into the classical texture, and the new classical style in its turn was always affecting folk-music a great deal"¹

Ever changing yet ever the same, the musical language of the Indian people, emerging from the virgin soil of culture, has a long story to tell. Like the Khyber Pass, that has known countless invaders, it has known similes and metaphors dear to the invaders in their time-old songs. Who knows how many new tunes and dance rhythms came from outside which were assimilated in the native culture.

"Ancient India, like ancient China," says Jawaharlal Nehru, "was a world in itself, a culture and a civilization which gave scope to all things. Foreign influences poured in and often influenced that culture and were absorbed."²

The generous give and take took place between the folk and classical styles. The real composers always encouraged it. In ancient and medieval times, the essential appeal of art had more importance. Says D. P. Mukerji: "Throughout the Muslim period, the exchange between *marga* (classical) and *deshi* (folk, regional) styles continued."³

Discussing further, Mukerji explains: "*Thumri* and *Tappa* are usually considered by the classicist as decadent. The beauty of *Thumri*-singing consists in its ability to convey musically as many shades of meaning as the words can bear, while that of *Tappa* lies in the quick display of various permutations and combinations of notes. The *tans* used in *Thumri* should be made to appear like a garland of small crystals, crisp and brittle, and those of *Tappa*, a flow of mercury globules. The glory of the decadent court of Lucknow, *Thumri*, through its analogues like *Dadra*, *Chaittee*, *Sawani*—the last two being the seasonal varieties of the summer and the rains—reaches out into folk-songs as they are actually sung today in the villages of Hindustan. (In fact, the analogues seem to be matrices of *Thumri*.) And so does *Tappa* through the songs of the camel-drivers of Sind, Rajputana and the Punjab. The spiral of the folk and the courtly styles is once more evident.

"The social urge behind the co-existence of the above types, and there are many more, is unmistakable. *Alap*, *Dhrupad*, *Kheyal*, *Thumri*, *Dadra*, *Tappa*—it is a procession from the abstract to the concrete and the human, with an increasing prominence of the verbal.

¹ *Indian Music: An Introduction*, (Kutub, 1945), p. 9.

² *The Discovery of India* (The Signet Press, 1946), p. 56.

³ *Indian Music: An Introduction*, p. 12.

From the 'classical' point of view it is decadence and regression; but if we look closely into the verbal texture, it is an enrichment of music by fresh content which, in terms of the common emotions of the daily living of men and women in the countryside, may sometimes be described as 'literary', non-musical and impure, but which, in the light of its apt musical garment still possesses sufficient musical appeal for the unsophisticated many. Certain *Thumri* pieces are no doubt highly urbanized and sophisticated, but there are many others which can be easily linked with the various *deshi* styles in which 'meaning' dominates music. The Indian texts pay due regard to them (*artha-sangeet*—meaningful songs, *anibadha*—open songs, *deshi*—folk or indigenous); only the purists do not. In short, the social urge has expressed itself in Indian music (as it has done in the Western) in the humanization of the abstract modes, as also the collectivisation of the same, because these non-classical, so-called 'inferior' styles are sung in groups whereas the classical is almost invariably a solo performance.¹

The other two folk styles mainly of religious appeal are *bhajan*, dear to Meera Bai and Tulsidas, and *kirtan*, equally dear to Chandidas, who gave charmingly sweet *padawalis* to Bengal. *Kawali* is the Moslem version of *bhajan* and *kirtan*.

Rabindranath Tagore composed well over 2,500 songs in Bengali, some of which have reached the huts of peasants and boatmen in the remote villages. They were originally inspired by Santal and other folk melodies. The poet was right when he once told me at Santiniketan: "Long after my poems are forgotten my songs will be sung by the people." He was a great lover of the *Bauls*, who go about from village to village singing mystic songs on the *ek-tara*,

¹ *Indian Music: An Introduction*, pp. 24-25

the one-stringed instrument. The fact that Tagore had a great regard for folk-genius was discussed by Dr. Amyia Chakravarty while addressing a literary society at Calcutta: "When we consider that he planted his educational colony in the heart of villages some of which are even today inhabited by primitive Santal tribes, we must know that he had formed his concepts regarding folk-life, and was advocating contact with folk-art as a conscious poet. In his youth, and later, Rabindranath collected a number of folk songs belonging to East Bengal and published them along with his interpretative notes and reflections which are well-known in Bengali homes. The work done by the poet to revive our interest in folk art and literature would demand a reference to the poet's own songs on which he has incorporated old folk tunes or improvised new tunes on the basis of the old ones. . . . Rabindranath Tagore was universal because he was regional. By sending his creative roots deep down in the soil of Bengal, the poet had effected contact with perennial springs of inspiration. Bengal's customs and folklore, her mythologies and her beautiful old crafts, Bengal's songs sung by her boatmen and by the tillers of the soil, the old and vital words that are still used by the peasants, entered into the heart of his verse. His songs are resonant with folk tunes, and old rhymes just as his poetry is filled with the poetry of common life. . . . His poetry drew from ancient poetry and song, but the urge was towards revelation, and thus he combined the new and the old in order to express the deepest truths of our humanity."

From the earliest days down to the modern period a sort of mutual give and take and a wider assimilation of folk and art music has been going on: neither of the two have lost anything, on the other hand both have gained in scope and richness.

Tribal Culture

"In examining the economic organization of many primitive societies and assessing the function of the various economic activities therein," as Dr. D. N. Majumdar puts it, "we find how the economic motives represented in economic 'lores', for example, determine economic behaviour and how traditional patterns of life sanction economic mores. The life long chain of reciprocity and mutuality of obligations displayed for example, by the Melanesian society in the organization and functioning of the 'kula' system, the diverse customs and practices, 'folkways and mores' which define the limits of individual freedom and social lapses, the system of land tenure defined by the cultural stage of particular social groups, the springs of social behaviour as for example, the entertainment of the guest at any part of the day or night among the North American Indians which make it a social etiquette for them not to question the propriety or otherwise of appropriation by guests of the valuable belongings to the host, or the tacitly recognized obligation among some of polyandrous tribes of the cis-Himalayas to provide the comforts of a home and the sexual rights over their own women to those of their guests who may not have scruples in the matter, all tend to show how the various cultural activities are inter-related, and form elements of a smoothly functioning organization, the efficiency of which determines the strength and survival of social groups." ¹

Stressing the argument further, Dr. Majumdar observes: "The political life of a people, the various manifestations of political maladjustment, the attitudes that we develop towards institutions indigenous and imported, the role of leadership and the qualities that are regarded as indispensable for it, their

meaning and fulfilment are deeply rooted in the pattern of cultures the people own, so that a proper understanding of all these is necessary in the interest of cultural progress and cultural dynamics. The tribal organizations of most of the primitive tribes in India show unmistakable signs of alien influence. Under the ancient Indian political system or the Indo-Aryan system in Vedic times the primitive tribes were more or less free to live their accustomed life in the forests and hidden recesses of hills, they were free to try their indigenous patterns of control and government and pursue their crude and self-sufficient tribal economy as gleaners and collectors, hunters and shepherds. With the spread of the 'plough' cultivation possibly after the Indo-Aryan invasion of Northern India, the conquering kings contacted the aboriginal and semi-aboriginal tribes by friendly overtures even offering to marry the daughters of the tribal chiefs, and their supporters became wardens and forest guards, helpers and willing collaborators. The latter very often stood on equal status with the conquering hordes and were saved from being yoked to slavery or serfdom or from unequal competition with their richly endowed allies.

"The pattern of economic life that was worked out in Buddhist times, could absorb the various tribal groups into economic partnership, commensal or symbiotic, with their more advanced compatriots so that there was little disintegration of tribal cultures. Islam also did not interfere with tribal life or its cultural moorings, for the urban civilization that it encouraged had no need for the aboriginal elements and when converts were made from them, the social status conceded to them more than compensated for consequent detribalization that was inevitable. It is only the contacts with European or quasi-European cultures which led to

¹ *Seven Balls of Garhwal*, Introduction, p. ii.

discomforts among the tribal peoples even to depopulation in their ranks. Cultural contacts signify partial activity in relation to the total of which it is a part. As Prof. Malinowski has said, 'we do not bring civilization as a whole to the natives' and the fragments that we do bring are distorted or blended in the process. It is due to the 'fragmental contacts' maloriented in their setting, aggravated in some parts of India by unchecked missionary efforts, that the primitive tribes have learnt to despise themselves, their religion and even their tribal systems. The general influence of such contacts has, however, more or less been selective, yet the extent of damage to the already disintegrating social structure in tribal society has been serious and in some cases irreparable."¹

Further, one would deplore the recent contacts of the Indian army and the allied forces, the 'duration of which has been long enough to work permanent changes in the outlook and personality of the people both men and women'. The sanctity of tribal life has gone: no more tribal self-sufficiency: the new economic basis of competition has gripped the tribal culture. The tribesmen are more and more forced out of their time-honoured seclusions. A strange economic transition! The womenfolk too are forced, under the stress of competition, to leave their village homes: even young girls face the same life, as the old tribal patriarch would say: 'Our girls are gone, they do not return home at night and the boys pine for them.' What a change! 'Mothers wait for their daughters' return for days and weeks often, and no news of them can be had. One day a lorry stops by the wayside, girls get down giggling, enter their home with sweets and trinkets and money which silence criticism.' The tribal culture, undoubtedly, has always allowed a greater freedom of movement. But

¹ *Snow Balls of Garhwal*, Introduction, pp. ii-iv.

premarital licence was hitherto confined to the tribe itself. The girl, who misbehaved, was helped by the tribal *panchayat* to marry the youth responsible for the offence. But today the tribe is helpless. 'It is therefore not surprising to find batches of young boys and girls daily lining up the railway tracks, singing 'Humpty Dumpty', of his great fall and how, all the king's men and all the king's horses could not put Humpty together again. No longer do we hear the hymns and songs in praise of the rain god which boys and girls generally sang during the summer and invoked him to shower his blessings on the sun parched fields or to pour water into their tanks and wells. No longer is it customary for the householder to sprinkle water on nude children as a magical device to bring down rains, a sight even today familiar in many parts of Northern India.' For the tribal boys and young girls prefer to raise a 'money crop' instead of the 'food crop' as their forefathers continued for untold centuries. Inflation and high prices brought money to the tribal villages during the long years of war, but the tribe lost much of its ancient culture while working in the remote tea-gardens, mining centres and factories.

"What is needed today," says Dr. Majumdar, "is a planned social economy for the tribal people in which purposeful attacks on the various cultural fronts must be organized, of course with the acquiescence of tribal societies, so that the tribal people may feel themselves as part of the greater culture represented by the castes, exterior and interior. A philosophy of segregation of tribal society has been advanced by some people which if conceded, will perpetuate tribal discomforts, agrestic serfdom and shameless exploitation of tribal life and labour.

"While such is the case with the general cultural life in tribal society today, it is no wonder that a complete

reorientation of outlook has taken place with respect to the folk aspects of their culture. Folk-songs, folk-art, folk-ways and mores represent in some form the mechanism of cultural control. Every society finds sanction for its social activities, ceremonies and festivals in a rich store of folk-songs, folklores and in proverbs and myths which channel tribal education according to the pattern of the society concerned. The spontaneous submission to established code of conduct in tribal society rules out individual aberrations so much so that some anthropologists find the primitive man even slavish in his compliance with the tribal code of behaviour, yet it has conserved tribal values and has helped survival of tribes who otherwise would have been swept off their feet by contacts and clash of cultures."¹

The Ethnographic and Folk-culture Society with its headquarters at Lucknow came into being last year. Luckily, Dr. Majumdar, who has been given the responsibility of being the General Secretary of the Society, has arranged to publish a 'Folk-culture Series' with the help of his post-graduate students. *Snow Balls of Garhwal* is the first volume of the series; the second volume, *Field Songs of Chattisgrh* by Prof. S. C. Dube of Hislop College, Nagpur, will shortly be published.

I would like to mention another society at Calcutta: it is Asiatic Folk Literature Society, with Dr. Kalidas Nag as its first president. It was started in 1943, and has arranged a number of lectures by eminent folklorists on tribal songs in the light of tribal cultures of Asia.

The malaise of culture is decay of spirit. It should no more be allowed to continue. The violent attack of modernism on tribal culture and art must be checked with the united strength of the nation.

¹ *Snow Balls of Garhwal*, Introduction, pp. ix-x.

Folk Song Movement

The Folk Song Movement has touched the remotest corners of India during the last seventy-five years, since 1871, when Charles E. Gover's *The Folk Songs of Southern India* was published at Madras. We have Jhabber Chand Meghani in Kathiawar well known for his thousands of old genuine songs devotedly collected and edited with sociological comments in Gujarati.

Mansuruddin and Jasimuddin have explored Bengali songs after the Late Dr. Dinesh Chandra Sen and Chandra Kumar Dey. In the Punjab, we have Ramsaran Das and Harjeet Singh, whose collections published in Punjabi show a great scientific accuracy of the texts. Ram Naresh Tripathi gave a lead in Hindi; Ram Iqbal Sinha Rakesh's work for Maithili songs, and Krishnadev Upadhyaya's zeal for Bhojpuri songs are deep and dignified. In Rajasthan we had a trio in Suryakaran Pareek, Ram Sinha and Narottamdas Swami, though the hand of Death has snatched away the first of the three friends. In Andhra we have Nedunuri Gangadharan, who has collected over 4,000 Telugu folk-songs. In *Tamilnad* Sri Jagannathan, who is associated with the leading Tamil monthly, *Kalaimahal*, has published his studies of Tamil folklore and has promised to collect and publish more Tamil songs. In place of Temple and Grierson, we have amidst us two Englishmen—Verrier Elwin, well known for his studies in the Gond anthropology and folk-songs, and W. G. Archer, author of *The Blue Grove*—The Poetry of the Uraons, who has also published about half a dozen anthologies of songs in original texts collected with local collaborators among the aboriginal tribes in Santal Parganas and Chota Nagpur.

We are indebted to All-India Radio for the expansion of programmes dealing with folk songs. But it must be emphasized that the real folk melodies and

peasant rhythms should be retained with a greater accuracy. It is essential that original songs sung by the actual folk singers in the village itself or in the studio, if it is really difficult to take the recording machine to the village, are recorded to make a real museum of folk music. Further improvements by the radio artists may not be checked, for no real art would allow that sort of control. But any *improvement* that kills actually the soul of folk art is no improvement. We have every hope that a great institution like All-India Radio can afford to have a museum of folk-music that will ensure real revival and progress of Indian folk music. Similarly, we can expect the Indian film companies to contribute to the revival of folk music and dance; this will reduce the vulgarity

of cheap film music which we often notice these days.

The Folk Song Movement has inspired the new Indian poets everywhere. A new India is rising today from the earth—India rich in the green and gold of her harvests and with her face towards the future. The songs of changed attitude are springing up everywhere. The new poets have really discovered a world of virgin poetry in the countryside. It is no good simply naming the rivers and mountains on the map of India: folk songs reveal the real India—rich and varied in landscape and life. History looks so poor—it has very little to tell us of the people. But folk-songs, coming down to us through countless generations, help us to rewrite the history of the people.

BIBLIOGRAPHY

This bibliography, compiled especially for *Developing Village India*, is comprehensive. Best and varied works done in the field of rural uplift and village economy and culture have been grouped together.

ORGANIZATION

Cooperation

- Clavert, H., *The Law and Principles of Co-operation*. Thacker and Spink.
Report of Maclagan Committee on Co-operation.
Mukherji, P., *The Co-operative Movement in India*. Thacker Spink. 1928.
Raine, J. L., *The Co-operative Movement in India*. 1928.
Strickland, C. F., *Introduction to Co-operation in India*. Oxford University Press.

Panchayat

- Butterworth, Julien E., *Rural School Administration*. Macmillan. 1926.
Summond, J. G., *Panchayats in India*. Oxford University Press, 1937.
Matthai, John, *Village Government in British India*.

General

- Niyar, S. Subramania, *Economic Life in a Malabar Village*. Bangalore Printing and Publishing Co. 1925.
Butterworth, Julien E., *Rural School Administration*. Macmillan. 1926.
de Mello, F. M., *The Problems of Rural Reconstruction in India*. Oxford University Press. 1934.
Emerson, G., *Voiceless India*. Allen & Unwin. 1931.
Ganguli, N., *The Problems of Rural India*.
Hatch, D. Spencer, *Further Upward in Rural India*. Oxford University Press. 1938.
Hatch, D. Spencer, *Up from Poverty in Rural India*. Oxford University Press. 1938.
Heinrich, J. C., *The Psychology of a Suppressed People*. Allen & Unwin.

- Strickland, C. F., *Rural Welfare in India*. Oxford University Press. 1932.
Strickland, C. F., *Review of Rural Welfare Activities in India*. Oxford University Press. 1932.
Strickland, C. F., *The Progress of Rural Welfare in India*. Oxford University Press. 1936.
Mukerji, R. K., *Fields and Farmers of Oudh*.
Whitehead, Bishop, *Indian Problems*. Constable. 1934.
Wiser, W. H., *Behind Mud Walls*. Allen & Unwin. 1932.
Young, Miriam., *Seen and Heard in a Punjab Village*. Student Christian Movement. 1931.
Schopneyer, C. H., *Extension Projects in Rural Community Organization*. Extension Service Circular 43. United States Department of Agriculture. 1927.
Baden-Powell, B. H., *The Origin and Growth of Village Communities in India*. Swan Sonnenschein, London. 1908.
Higginbottom, Sam., *The Gospel and the Plough*. Macmillan. 1921.
Holland, W. E. S., *The Indian Outlook*. Edinburgh House Press. 1926.
Hyder, Nazimuddin, *Talks on Rural Development in India*. Kakori (Lucknow). 1942.
Machicol, N., *India in the Dark Wood*. Edinburgh House Press. 1930.
Neil, S., *Out of Bondage*. Edinburgh House Press. 1931.
Pearson, W. W., *Shantiniketan*.
Reade, M., *The Indian Peasant Uprooted*. Longmans. 1931.
Simon Report, Indian Statutory Commission on Reforms. 1929.
Slater, G., *Some South Indian Villages*. Oxford University Press. 1918.

PUBLICITY & PROPAGANDA

General

- Brayne, F. L., *Lecture Notes on Rural Reconstruction*. Feroze Printing Press, Lahore.
Brayne, F. L., *The Boy Scout in the Village*. Uttam Chand Kapur & Sons, Lahore.
Brayne, F. L., *The Remaking of Village India*. Oxford University Press. 1929.
Brayne, F. L., *The Village Dynamo*. R. S. Munshi Gulab

- Singh & Sons, Lahore.
Burns, W., *Sons of the Soil*. Manager of Publications, Delhi. 1941.
Christlieb, M. L., *Indian Neighbours*. Student Christian Movement. 1930.
Cole, G. D. H., *Social Theory*. Federic Stokes. 1940.
Darling, M. L., *Rusticus Loquitur*. Oxford University Press. 1930.

AGRICULTURE & NUTRITION

Agriculture and Agricultural Economics

- Burns, W., *Technological Possibilities of Agricultural Development in India*. 1944.

- Howard, Albert and Gabriella, L. C., *Indian Agriculture*. Oxford University Press. 1928.
Howard, Albert., *Crop Production in India*. 1924.

- Howard, Albert and Howard, Gabriella L. C., *The Development of Indian Agriculture*. Oxford University Press. 1931.
- Howard, A. and Wad, Y. D., *The Waste Products of Agriculture*. Oxford University Press. 1931.
- Jain, B. P., *Agricultural Holdings in the United Provinces*. 1937.
- Jevons, S., *Consolidation of Agricultural Holdings in the United Provinces*.
- Keatings, G., *Agricultural Progress in Western India*. Longmans. 1921.
- Linlithgow, Lord., *The Indian Peasant*. Faber. 1932.
- Linlithgow Report*: Royal Commission on Agriculture. H. M. Stationery Office. 1928.
- MacKenna, J., *Agriculture in India*. 1915.
- Mann, H. H., *Land and Labour in a Deccan Village*. Oxford University Press. 1921.
- Mukhtyar, G. G., *Life and Labour in a South Gujerat Village*. Longmans. 1930.
- Strickland, C. F., *Consolidation of Agricultural Holdings*. Oxford University Press. 1939.
- Wilcox, O. W., *Reshaping Agriculture*. Norton Wright. 1934.
- Darling M. L., *Wisdom and Waste in the Punjab Village*.
- Darling, M. L., *The Punjab Peasant in Prosperity and Debt*. Oxford University Press. 1932.
- Jack, J. C., *The Economic Life of a Bengal District*. Oxford University Press. 1927.
- Jathar and Berry, *Indian Economics*.
- Moreland, W. E., *Introduction to Economics for Indian Students*.
- Mukerji, R. K., *Rural Economy of India*.
Famine Inquiry Commission Report. 1945.
- Nutrition Pamphlets of Food and Agricultural Organization of the United Nations*.
- Wu, Hsien, *Nutrition in the Far East*. League of Nations, Geneva. 1937.
- The Nutritive Value of Indian Foods and the Planning of Satisfactory Diets*. Health Bulletin No. 23. Manager of Publications, Delhi. 1944.
- Misra, S. K., *Hints on Human Nutrition*. Nagpur Agricultural College Magazine, Vol. 16, No. 3, 1942. p. 93.
- Wilson, D. C. and Widdowson, E. M., *Compastur Nutritional Survey of Various Indian Communities*. Indian Medical Research Memoirs No. 34. 1942.
- Ukil, A. C., *Planning Wartime Nutrition*. Science and Culture, Vol. 7, 1942, p. 607.
- Titus, H. W., *Value and Role of Eggs in Nutrition*. Harper Adams Utility Poultry Journal, Vol. 27, 1942, p. 95.
- Drammond, J. C., *Wartime Nutrition and its Lessons for the Future*. Journal of Society of Arts, Vol. 90 No. 4614, 1942, p. 422.
- Nutrition Value of Indian Foods and the Planning of Satisfactory Diets*. Health Bulletin No. 23, Manager of Publications, Delhi. 1937.
- Wiser, Mrs. C. V., *Foods of a Hindu Village of North India*. Government Press, Allahabad. 1936.
- Mecarrison, R., *Food*. Macmillan. 1936.
- World Nutrition*. Vety. Record Department, 11-12-43.
- Masani, M. R., *Your Food*; Tata Studies in Current Affairs. Padma Publication Ltd. Bombay. 1944.
- Table of Indian Food Values and Vitamin*. All-India Village Industries Association, Wardha.

ANIMAL HUSBANDRY

- Livestock: Their Breeding and Feeding*
- Proceedings of the Meeting of the Animal Husbandry Wing of the Board of Agriculture and Animal Husbandry*. With appendices. 1st meeting, held from 20th to 23rd February, 1933. Board of Agriculture and Animal Husbandry, Delhi. 1934.
- Annual Reports*: All-India Cow Conference Association, 1922, 1923 and 1926, Calcutta.
- Baldrey, F. S. H., *Indigenous Breeds of Cattle in Rajputana*. With photographs. Calcutta. 1911.
- Walker, G. K., *Cattle Survey of the Amritsar District*. Department of Agriculture, Lahore. 1910.
- Watson, J. A. S., Camerson, James and Garrad, G. H., *Cattle Breeder's Handbook*. The Farmer and Stock-Breeder Manuals. Edited by H. C. Long, London. 1926.
- Gehlot, H., *Preservation of Farm Animals*. Illustrated. Jodhpur. 1933.
- Cattle Census Report of the United Provinces of Agra and Oudh*. Allahabad. 1935.
- Sampson, H. C., *Brief Survey of Madras Livestock*. Department of Agriculture, Madras, Vol. IV, Bulletin No. 72. Madras. 1917.
- Definition of Characteristics of Seven Breeds of Cattle of All-India Importance*. Miscellaneous Bulletin No. 27, Imperial Council of Agricultural Research, Delhi. 1939.
- Talaskar, V. R., *Mother of Prosperity: Cow Protection through Ages*. Poona. 1938.
- Blackwood, J. R., *Survey and Census of the Cattle of Bengal*. Calcutta. 1915.
- Report on the Cattle Census of the Bengal Presidency*. Bengal, Department of Agriculture, Calcutta. 1920 & 1930.
- Report on the Cattle Census of Bihar and Orissa*. Government of Bihar and Orissa, Patna. 1930.
- Chatterjee, Nilananda, *Condition of Cattle in India*. With an introduction by Sir J. G. Woodroffe. Illustrated. Calcutta. 1926.
- Gunn, W. D., *Cattle of Southern India*. Madras, Department of Agriculture. Volume III. Bulletin No. 60. Madras. 1909.
- Hewlett, K., *Breeds of Indian Cattle in Bombay Presidency*. Calcutta. 1912.
- Meadows, D., *Report on the Dhanni Breed of Cattle*. Department of Agriculture, Punjab. Lahore. 1915.
- Milne, G., *Note on Cattle in Bihar and Orissa*. Patna. 1914.
- Tweed, Isa., *Cow-keeping in India*. 4th edition with illustrations. Calcutta. 1920.
- Maniam, E. V. S., *Cattle Wealth of India*. Cawnpore. 1938.
- Catalogue of the First All-India Cattle Show*. 1938.
- Catalogue of the Second All-India Cattle Show*. 1939.

- Brief Survey of Some of the Important Breeds of Cattle in India.* Part III (1941) Prize winners at the Second and Third All-India Cattle Shows. Imperial Council of Agricultural Research. 1941.
- Jani, D. H., *Romance of the Cow.* Bombay Humanitarian League, Bombay. 1938.
- Das Gupta, S. C., *The Cow in India.* Two Volumes. Khadi Pratishtan, Sodepur, Calcutta.
- Inder Singh and Harbans Singh, *Survey of the Breeds of Cattle in India.*
- Desai, *Cow Protection.* Bombay.
- Rice, V. A., *Breeding and Improvement of Farm Animals.* 1934. 2nd edition. London.
- Aggarwala, A. C., *Feeding and Milking of Cows.* Lahore. 1931.
- Allan, R. G., *Outline of the Scientific Feeding of Farm Animals.* Nagpur. 1925.
- Aggarwala, A. C., *Feeding and Milking of Cattle.*
- Fodder Problem in the Bombay Presidency.* Government of Bombay. 1914.
- Smith, W., *Fodder Needs of India from a Dairy Point of View.* 1922.
- Dairying*
- Joshi, L. L., *The Milk Problem in Indian Cities.*
- Ghare, B. K., *Manual of Dairy Farm.*
- Roshan Lal, *Milk Supply of Lahore.*
- Mankad, J. N., *Milk Problem.* Bombay.
- Tweed, Isa., *Dairy Farming in the East.*
- Kartar Singh, *Notes on Dairying.* Lahore. 1920.
- Kartar Singh, *Punjab Dairying.* In Urdu.
- Harbans Singh, *Laverian.* In Punjabi.
- Godbole, N. N. and Sadgopal, *Comparative Study of the Utility of the Milks and Ghees of the Indian Cow and Buffalo as Human Food Materials.* 1932.
- Nelson, J. A. and Trout, G. M., *Judging Dairy Products.* Milwaukee. 1934.
- Raison, C., *Milk Trade.* With a foreword by J. F. Blackshaw. 2 vols. London. 1933.
- Davies, W. L., *Indian Indigenous Milk Products.* Calcutta. 1940.
- Poultry*
- Parkhurst, R. T., *Comparative Value of Various Protein Feeds for Laying Hens: Single Comb White Leghorns.* National Institute of Poultry Husbandry, Harper Adams Agricultural College. Newport. Bulletin No. 4. Shrewsbury. 1930.
- Annual Report of the Poultry Expert to Government Punjab, Gurdaspur.* 1929-30. Punjab, Department of Agriculture, Lahore. 1931.
- Tweed, Isa., *Poultry-keeping in India.* 6th edition, revised and brought upto date by Mrs. M. V. Lord. Calcutta. 1927.
- Murghi-i-Sakar.* A monthly journal dealing with poultry. United Provinces Poultry Association, Lucknow. Lucknow. 1933 and 1934.
- Regulations regarding the Sale of Eggs for Hatching Purposes and Fowls for Breeding Purposes:* Gurdaspur Government Poultry Farm. Punjab, Department of Agriculture. Lahore.
- Tweed, Isa., *Indian Handbook on Ducks, Geese, Turkeys Guinea-fowls, Pigeons, Pea-fowls and Rabbits.* 2nd edition with illustrations. Calcutta. 1921.
- Fox, Mrs., *Manual of Poultry Farming.*
- Bee Keeping*
- Collection of Papers on Bee-keeping in India.* Calcutta. 1883.
- Edwardes, Tickner, *Bee-keeping; Do's and Don'ts.* London. 1925.
- Edwardes, Tickner, *Bee-keeping for All: A Manual of Honey Craft with 40 illustrations.* 4th edition, revised. London. 1934.
- Edwardes, Tickner, *Lore of the Honey-Bee.* 16th edition. London. 1933.
- Langstroth, L. L., *Hive and Honey Bee.* Revised and rewritten by C. P. Dadant. 23rd edition. Hamilton. 1927.
- Pellett, F. C., *Productive Bee-keeping: Modern Methods of Production and Marketing of Honey.* London. 1928.
- Williams, Canning, *Story of the Hive: A Bee-lover's Book.* London. 1928.
- Ghosh, C. C., *Bee-keeping.* Imperial Council of Agricultural Research, Miscellaneous Bulletin No. 6. Delhi. 1936.
- Phillips, E. F., *Bee-keeping:* New York. 1928.
- Rahman, K. A. and Sardar Singh, *Bee-keeping in the Punjab.* Punjab, Department of Agriculture. Lahore. 1940.
- Fisheries*
- Annual Reports, 1908-18 and 1919-20.* Fisheries Department. Madras.
- Thomas, H. S., *Tank Fishing in India.* 2nd edition. Edited by W. S. Burke with illustrations. Calcutta. 1927.
- Madras, Fisheries Department. *Report on a Systematic Survey of Deep Sea Fishing Grounds* by S. T. Lady Goschen (1927-29) by B. S. Raj. Report No. III of 1929. Madras Fisheries Bulletin, Vol. XXIII, pages 153 to 187. Madras. 1931.
- Report on a Systematic Survey of Deep Sea Fishing Grounds* by S. T. Lady Goschen (1928-29) and by B. Sundara Raj (Report No. III) of 1930. Madras, Fisheries Department. Madras Fisheries Bulletin, Vol. XXIV, pages 199-232. Madras. 1933.

HORTICULTURE

- General*
- Protection of Fruit Trees from Frost.* Punjab Department of Agriculture, Leaflet 31.
- Protecting Trees from Sun-burn.* Punjab Department of Agriculture, Leaflet No. 51. 1930.
- Fruit Gardening: Planting of Fruit Trees, Selection Plants and Wind Breaks.* Punjab Department of Agriculture, Leaflets 68 and 70.

Barakzai, M.U.F., *First Report on Fruit Culture as practised round about Tharushah in Nawabshah District of Sind*. Bombay, Department of Agriculture. Bulletin 88. 1918.

Fruit Culture as practised near Shikarpur in Sind. Bombay Department of Agriculture. Bulletin 98. 1920.

Burns, J. G., *Notes on Fruit Culture in the Hills of United Provinces*. Department of Agriculture, Fruit Series. Bulletin 10. 1939.

Burns, W., *Firwinger's Manual of Gardening for India*. Thacker, Spink and Co., Calcutta. 1930.

Cheema, G. S., *Recent Progress in Fruit Growing in India and Abroad*. Agriculture and Livestock in India, Vol. 5, 1935, p. 473.

Hayes, W.B., *Fruit Growing in India*. Kitabistan, Allahabad, 1945.

Hea, W., *Planting and Early Care of Young Fruit Trees*. United Provinces, Department of Agriculture, Fruit Series, Bulletin No. 1. 1933.

Howard, A., *First Report on the Fruit Experiments at Pusa*. Pusa Agricultural Research Institute. Bulletin 16. 1906.

Howard, A., *Second Report on the Fruit Experiments at Pusa*. Pusa Agricultural Research Institute. Bulletin 16. 1910.

Howard, A. and Howard, G. L. C., *Improvement of Fruit Culture in Baluchistan*. Quetta Fruit Experiment Station Bulletin No. 91. Calcutta. 1918.

Johnson, F. H., *Orchards: Their Making and Maintenance on the Plains of the United Provinces*. United Provinces Department of Agriculture, Fruit Series, Bulletin No. 4. 1933.

Parnjpye, H. P. and Siddaramaiya, N. R., *Report on Present Condition and Prospects of Fruit Growing Industry in H. E. H. Nizam's Dominions*. Hyderabad Department of Agriculture, Bulletin No. 8. 1933.

Patwardhan, G. B., *Fruit Culture in Palitan and Jannagar*. Bombay Department of Agriculture. Bulletin No. 101.

Putwardhan, G. B., and Deshmukh, G. B., *A Handbook of Horticultural Practices*. G. B. Patwardhan, Poona. 1931.

Popenoe, W., *Manual of Tropical and Subtropical Fruits*. Macmillan Co., New York. 1920.

Set, G. B., *Some Practical Hints on the Management of Orchards in India*. A. J. I. Vol. 16, 1921, pp. 525-528.

Singh U. B., *Some Diseases of Fruits of Nut Trees in Kumaun*. Imperial Council of Agricultural Research, Miscellaneous Bulletin No. 51.

Sukh Dyal, *Tropical Fruits: Growing of Fruits, their Picking, Packing and Preservation*. Chemical Publishing Co. Brooklyn, N. Y.

Loquat

Singh. C. P., *The loquat*. United Provinces Department of Agriculture, Fruit Series, Bulletin 19. 1940.

Peach

Gupta, K. N., *Peach and Nectarine growing in the United Provinces*. United Provinces Department of Agriculture. 1942.

Citrus Fruits

Allen, R. G., *Citrus Cultivation*. United Provinces Department of Agriculture, Fruit Series Bulletin 6. 1934.

Bonavia, E., *The Cultivated Oranges and Lemons, etc., of India and Ceylon*. W. H. Allen and Co., London. 1890.

Cheema, G. S. and Bhat, S. S., *The Die-back Disease of Citrus Trees and its Relation to the Soils of Western India*. Bombay Department of Agriculture, Bulletin No. 155. 1938.

Dey, P. K., *Two Common Diseases of Citrus Trees in the United Provinces*. United Provinces Department of Agriculture, Fruit Series Bulletin 7. 1934.

Orange

Orange Cultivation in Assam. Assam Department of Agriculture, Bulletin No. 2. 1928.

Orange. Bihar Department of Agriculture, 'Grow More Fruit' Leaflet, No. 69. 1944.

Brown, W. R., *The Orange: A Trial of Stocks at Peshawar*. Pusa Agricultural Research Bulletin 93. 1920.

Davies, H. J., *Notes on Oranges and Lemons*. United Provinces Department of Agriculture, Bulletin 38. 1918.

Mitra, S. K. and Khongwir, P. C., *Orange Cultivation in Assam*. Department of Agriculture, Assam. Bulletin 2. 1928.

Shrivastava, K. P., *The Cultivation of Oranges in the Central Provinces and Berar*. Central Provinces and Berar, Department of Agriculture, Bulletin 19. 1931.

Fig

Cheema, G. S., *The Fig Industry in Asia Minor*. Bombay, Department of Agriculture, Bulletin 131. 1936.

Hints on Fig Cultivation. Bombay, Department of Agriculture, Leaflet 4. 1928.

Gandhi, S. R., *Investigations in Fig Culture and Treatment*. Bombay, Department of Agriculture, Bulletin 117. 1924.

Smith, W. S., *The Fig in Rural Areas*. United Provinces, Department of Agriculture, Fruit Series, Bulletin 20. 1940.

Guava

Kulkarni, L. B., *The Cultivation of Guavas near Poona, Dharwar and Limbgaon*. Bombay, Department of Agriculture, Bulletin 40. 1911.

Smith, W. S., *The Guava*. United Provinces, Department of Agriculture, Fruit Series Bulletin 8. 1934.

Mango

Allen, R. G., *Modern Mango Cultivation*. United Provinces, Department of Agriculture, Fruit Series Bulletin 13. 1935.

Care of the Mango Orchards. Bihar, Department of Agriculture, 'Grow More Food' Leaflet No. 38. 1943.

Mangoes. Bihar, Department of Agriculture, a 'Grow More Food' Leaflet No. 70. 1944.

Renovate Your Old Mango Orchards. Bihar, Department of Agriculture. 'Grow More Food' Leaflet, No. 38. 1943.

Bhat, S. S., *Mango, the King of Fruits*. Baroda, Department of Agriculture, 'Grow More Food' Bulletin. 1939.

Bhat, S. S., *Classification of Mangoes*. Baroda, Department of Agriculture, 'Grow More Food' Bulletin. 1944.

Litchi

How to propagate the Litchi. Bihar, Department of Agriculture, 'Grow More Food' Leaflet, No. 40. 1943.

Hints on Litchi Cultivation. Bihar, Department of Agriculture. 'Grow More Food' Leaflet No. 39.

Litchi. Bihar. Department of Agriculture. 'Grow More Food' Leaflet No. 71. 1944.

Cashew

Paul, W. R. C., *Cashew Nut Industry of South India*. Trop. Agricult., Ceylon, Vol. 87, 1936, pp. 166-73.

Coconut

Coconut Cultivation. Bombay, Department of Agriculture, Leaflet No. 14. 1932.

Date Palm

Milne, D., *Date Cultivation in the Punjab*. 1911.

Milne, D., *The Date Palm and its Cultivation in the Punjab*. 1918.

Pomegranate

Economic Method of Controlling the Pomegranate Caterpillar. Bombay, Department of Agriculture, Leaflet No. 23. 1927.

How to Grow Pomegranates. Bombay, Department of Agriculture, Leaflet No. 2. 1912.

Papaya

Papaya. Bihar, Department of Agriculture, 'Grow More Food' Leaflet No. 68. 1944.

Papaya. Bengal, Department of Agriculture. Leaflet No. 5. 1944.

Davies, H. J., *Notes on the History, Uses and Cultivation of the Papaya*. United Provinces, Department of Agriculture, Bulletin No. 37. 1919.

Head, W., *The Papaya or Papeeta—Its Cultivation in the United Provinces*. United Provinces, Department of Agriculture, Bulletin 60. 1932 and Fruit Series Bulletin No. 2. 1933.

Sethi, D. K., *Hints on the Cultivation of Papaya*. Bihar and Orissa, Department of Agriculture, Bulletin No. 4. 1932.

Ber-Jujube

Khare, J. L., *Ber (Zizyphus jujuba) Fruit and its Fly*. Pusa Agricultural Research Bulletin No. 43. 1934.

Grewia (Falsa)

Cultivation of Phalsa Syrup and Juice. Punjab, Department of Agriculture, Leaflet No. 114. 1934.

Strawberry

Cultivation of Strawberries. Punjab, Department of Agriculture, Leaflet No. 61.

Swarup, S. R., *The Strawberry: Its Cultivation and Economic Possibilities in the United Provinces*. United Provinces, Department of Agriculture, Fruit Series Bulletin No. 5. 1933.

Banana

Leaflet on Banana Cultivation. Bihar, Department of Agriculture, 'Grow More Food' Leaflet, No. 35. 1943.

Banana. Bengal, Department of Agriculture, Leaflet No. 1. 1945.

Cherian Jacob, A. K., *South Indian Bananas*. Madras, Agricultural Journal Vol. 22, 1934, p. 41.

Pine-apple

Govindan Nambiar, E. K., *Pine-apple Cultivation in Malabar*. Madras Agricultural Journal, Vol. 22, 1934. p. 311.

Jogi Raju, *General Hints on Pine-apple Cultivation*. Madras Agricultural Journal, Vol. 19, 1931, p. 70.

Muthayya Nathar, A. M., *Note on the Cultivation of Pine-apples on the Lower Palni Hills*. Madras Agricultural Journal, Vol. 21, 1933.

Ramdas, N., *Note on Pine-apple Cultivation*. Madras Agricultural Journal, Vol. 19, 1931, p. 68.

Sane, V., *A Note on Pine-apple*. United Provinces, Department of Agriculture, Fruit Series Bulletin No. 9.

Grapes

Bhat, S. S., *Grape Growing in Baroda*. Baroda, Department of Agriculture. 'Grow More Food' Bulletin.

Gandhi, S. R., *Grape Culture in Western India*. Bombay, Department of Agriculture, Bulletin 156. 1928.

Mustafa, A. M. and Ginai, M. A., *Grape Growing in Baluchistan*. Imperial Council of Agricultural Research, Miscellaneous Bulletin No. 40. 1941.

Prayag, S. H., *Some Observations on the Inflorescence and Flowers of the Grape*. A. J. I. Vol. 16, 1921 pp. 60-64.

Uppal, B. N., Cheema, G. S. and Kamat, M. N., *Powdery Mildew of the Grape and its Control in Bombay*. Bombay, Department of Agriculture, Bulletin No. 163. 1930.

COTTAGE INDUSTRIES

All-India Village Industries Association: Annual Reports, 1936-1940. Maganvadi, Wardha. Three annas.

Athawale, Dr., *Hand-made Paper Industry in the United Provinces*. United Provinces, Department of Industries.

Aiyar, S. Subbarama, *Economic Life in a Malabar Village*. Chitral, A. M., *Bee-keeping*. All India Village Industries Association, Maganvadi, Wardha. Eight Annas.

Gregg, Richard B., *Economics of Khaddar*. Ganesan. 1928.

- Gandhi, M. K., *Handloom and Charkha*. Young India. 1926.
- Joshi, K. B., *Soap making*. All India Village Industries Association, Maganvadi, Wardha. Twelve Annas.
- Kumarappa, J. C., *Women and Village Industries*. All India Village Industries Association, Maganvadi, Wardha. One Anna.
- Kumarappa, B., *Village Industries and Reconstruction*. All India Village Industries Association, Maganvadi, Wardha. Three Annas.
- Matheson, Cecile M., *Indian Industry*. Oxford University Press. 1930.
- Naik, G. B., *Palm Gur*. All India Village Industries Association, Maganvadi, Wardha. Two Annas.
- Orissa, Development Department, *Bulletins* :
 No. 4 for 1939: *Indigenous Drinking Straws*.
 No. 5 for 1939: *Jelly Making to Prevent Wastage of Blackberry Fruit in Villages*.
 No. 1 for 1940: *Sample Soap Making in Village Homes*.
 No. 3 for 1940: *Raw Materials for Soap in Orissa*.
 No. 4 for 1940: *Permanent Writing Ink from Local Tannin Materials*.
- Paper Making*. All-India Village Industries Association. Maganvadi. Twelve Annas.
- Patel, J. P., *Oil Pressing*. All India Village Industries Association Maganvadi, Wardha. Twelve Annas.
- Ramakrishnan, V. G., *Co-operation and Development of Cottage Industries*. Madras Journal of Co-operation, Vol. 37, No. 8, February 1946, pp. 315-326, and No. 9, March 1946, pp. 365-375.
- Saxena, M. L., *Role of Cottage Industries in the Rural Economy of India*. Cawnpore, Agricultural College Students Union Magazine, Vol. 3, No. 2, January 1942, p. 30.
- Sarin, J. L., *Revival of Cottage Chemical Industries in the Punjab*. Current Science, Vol. 7 No. 10, 1942, p. 495.
- Sarolian, H., *Some Village Industries*. Current Science, Vol. 10, 1936, p. 66.
- United Provinces, Department of Industries and Commerce, *Bulletins, New Series*—
 No. 1 *Schemes for Educated Unemployed*.
 No. 5 *Wooden Toys: How to Make Them*.
 No. 23 *Pre-metal Period of Industrial Renaissance in the United Provinces* (Cottage Industries in Rural Areas).
- Vaugh, M., *Cottage Industries*. Allahabad Farmer, Vol. 13, 1939, p. 26.
- Visvesvaraya, Sir M., *Village Industrialization*. All-India Manufacturers' Organization, Bombay. Rupees One and Annas Four. 1945.

HEALTH & SANITATION

- Bhore's Committee's Report, Boul-Hole Latrines—A Latrine for Every Home*. L. No. 15, Public Health Department, Travancore. 1932.
- Brayne, F. L., *Socrates in an Indian Village*. Oxford University Press. 1929.
- Brayne, F. L., *Socrates Persists in India*.
- Hatch, D. Spencer, *Rural Reconstruction in India: The Broader Basis for Health Improvement in any Country*. Pamphlet for Inter-Governmental Rural Hygiene Conference, League of Nations, Geneva. 1937.
- Jackson, F. K. and Wad, Y. D., *The Sanitary Disposal and Agricultural Utilization of Habitation Wastes by the Indore Process*. Institute of Plant Industry Indore, Bulletin No. 1. 1935.
- Joshi Committee Report on the Age of Consent in India*. Government of India Publication. 1929.
- Lankester, A., *Tuberculosis in India*. Butterworth. 1920.
- J. N. Norman Walker, *Indian Village Health*.
Preparatory Papers Relating to British India: Inter-Governmental Conference of Far Eastern Countries on Rural Hygiene, League of Nations, Geneva. 1937.
- Turner and Goldsmith, *Sanitation in India*.

EDUCATION & CULTURE

- Education*
- Anderson and Whitehead, Bishop, *Christian Education in India*. Macmillan.
- Brayne, F. L. and Ryburn, W. M., *Socrates at School*. Oxford University Press. 1935.
- Butterfield, K. L., *The Christian Mission in Rural India*. International Missionary Council. 1930.
- Commission on Village Education*. Oxford University Press. 5s. 1930.
- Dutt, G. S., *A Woman of India*. Hogarth. 1929.
- Hartog Report: Interim-Report of the Statutory Commission* His Majesty's Stationery Office. 1929.
- McKee, W. J., *New Schools for Young India*. Oxford University Press. 1926.
- Moomaw, I. W., *Education and Village Improvement*.
- Olcott, *Village Schools in India*. Oxford University Press. 1926.
- Parkinson, J. E., and Sanderson, *Rural Education in England and the Punjab*. Government of India Occasional Reports No. 15. Government Press, Calcutta.
- Ryburn, W. M. and King, E. L., *The New Light*. Y. M. C. A. Publishing House, Calcutta.
- Thorndyke, E. L., *Adult Learning*. Macmillan. 1928.
- Van Doren, *Fourteen Experiments in Rural Education*. 1929. Calcutta Association Press.
- Van Doren, Alice B., *Projects in Indian Education*. Calcutta Association Press. 1931.
- Folk Art*
- Tagore, Abanindranath, *Bangalar Brata*. In Bengali.
- Mookherjea, Sailoz, *Folk Art of India*. Dhoomimal Dharamdas, Stationers, New Delhi. 1946.
- Folk Drama*
- Arnold, Alvin G., *The Little Country Theatre*. Macmillan. 1922.

100
0460 x 2

Drummond, A. M., *The Country Theatre*. Cornell Country Life Series, Ithaca. 1920.

Hatch, Emily Gilchrist, *The Indian Theatre*. Cornell University. 1928.

Moran, J. Sterling. *The Community Fair*. Farmers Bulletin No. 870. United States, Department of Agriculture. 1926.

Folk Dances

Hatch, Emily Gilchrist. *Kathakali: The Indigenous Drama of Malabar*. Cornell University. 1934.

Banerji, Projesh. *The Folk Dance of India*. Kitabistan, Allahabad. 1944.

Chatterji, Santosh. *Devadasi: Temple Dancer*. The Book House, 15, College Square, Calcutta.

Spreen, Hildegard L., *Folk Dances of South India*. Oxford University Press. 1945.

Folk Songs

Gover, C. E., *Folk-Songs of Southern India*. Madras. 1871.
Ratan Devi, *Thirty Indian Songs*. London.

Elwin, Verrier and Hivale, Shamrao, *Songs of the Forest*. Allen and Unwin, London. 1935.

Archer, W. G., *The Blue Grove: Uraon Folk Poetry*. Allen and Unwin, London. 1940.

Folk-Song Number, Man in India, March, 1943.

Elwin, Verrier and Hivale, Shamrao, *Folk-Songs of the Maikel Hills*. Oxford University Press. 1945.

N. S. Bhandari, *Snow Balls of Garhwal*. Edited by Dr. D. N. Majumdar. Universal Publishers Ltd., Lucknow. 1943.

Devendra Satyarthi, *Meet My People*. Sangam Publishers Ltd., Lahore. 1946.