

THE  
VIEWS AND OPINIONS

OF

BRIGADIER-GENERAL JOHN JACOB, C.B.,

AIDE-DE-CAMP TO THE QUEEN;  
AIDE-DE-CAMP TO THE GOVERNOR-GENERAL OF INDIA, &c. &c. &c.  
LATE COMMANDING-IN-CHIEF THE BRITISH FORCES IN PERSIA;  
AT PRESENT COMMANDING THE SIND IRREGULAR HORSE,  
AND POLITICAL SUPERINTENDENT OF THE  
NORTH-WEST FRONTIER OF SIND.

COLLECTED AND EDITED

BY

CAPTAIN LEWIS PELLY,

AUTHOR OF "OUR NORTH-WEST FRONTIER."

---

SECOND EDITION.

---

LONDON:  
SMITH, ELDER & CO., 65, CORNHILL.  
BOMBAY: SMITH, TAYLOR & CO.

---

1858.

V2, LOC M12

A858

1066

“ I have sometimes thought it a great pity that every one seems ashamed of publishing to the world that a certain able man is alive and still usable. But no sooner is the able man disabled by death, than any number of Biographers will abuse the poor world for letting him slip through their fingers.’

“ Well, well, neighbour, I am thinking it would require some pluck to print thy virtues and sign my name. Yet, peradventure, and we were both honest, a man might dare even this.”—*Old Novel*.

---

“ Here is an earnest, truth-speaking man ; no theorizer, sentimentalizer, but a practical man of work and endeavour, man of sufferance and endurance. The thing that he speaks is not a hearsay, but a thing that he has himself known, and by experience become assured of. \* \* \* His grand excellency is this, that he is genuine. As his primary faculty, the foundation of all others, is Intellect, depth and force of Vision ; so his primary virtue is Justice, the Courage to be just. \* \* \* He lives, as he counsels and commands, not commodiously in the Reputable, the Plausible, the Half, but resolutely in the Whole, the Good, the True.”—*Thomas Carlyle*.

---

ERRATUM.

Page 253, line 4, for saddle-bag *read* saddle-cloth.

# TRACTS ON THE NATIVE ARMY OF INDIA.

By BRIGADIER-GENERAL JOHN JACOB, C.B.

*The First Complete Edition, including New Matter never before Published.*

*Octavo, price 2s. 6d.*

---

## RIFLE PRACTICE.

By BRIGADIER-GENERAL JOHN JACOB, C.B.

*Fourth Edition, Corrected and Enlarged, with Plates. Octavo, price 2s.*

# CONTENTS.

	PAGE
PREFACE . . . . .	xi

## PART I.

### CIVIL ADMINISTRATION.

The Secret of our Rule in India . . . . .	1
Moral Being . . . . .	2
European Officers should not be wasted on Trivial Employ- ments . . . . .	3
Natural Forces . . . . .	3
The Control of Predatory Tribes . . . . .	4
Interference with Trade opposed to the Laws of Political Eco- nomy . . . . .	5
The Liberty of the Press . . . . .	6
On Missionaries; and the Interference of the State in matters appertaining to Religion . . . . .	8
Selection <i>versus</i> Examination . . . . .	9
Reduction of Civil Salaries . . . . .	14
Should Officers unable to Pass in the Language of a District be removed from Office? . . . . .	17
Non-Removal of Incompetent Officials . . . . .	18
Abolition of Statute Labour advocated . . . . .	18
Minute on Objections urged against the Abolition of Forced Labour in Sind . . . . .	21
Abolition of Forced Labour in Sind . . . . .	26
Calculation of Labour Rates in certain Districts . . . . .	34
Wheel-Carriages and Bridges . . . . .	35
Repairs of Roads by Contracts . . . . .	37
Plans and Estimates <i>versus</i> a Road and Canal . . . . .	38
A Navigable Canal to the Indus, and the Requirements of Kur- rachee as a Port . . . . .	40
Public Ferries . . . . .	41

	PAGE
Remarks on a Railway to connect the Indus with the Seaport of Kurrachee . . . . .	43
Travellers' Bungalows and Serais . . . . .	49
Trade creates a Market, but does not necessarily follow a Mar- ket-place . . . . .	50
Political Science related to all Science . . . . .	51
Customs and Pier Dues . . . . .	52
Frontier Trade Returns . . . . .	52
The Indus Flotilla and Forest Conservancy beyond the sphere of the State's Functions . . . . .	53
Engineer and Normal Class Scholars should not be limited to Government Employ . . . . .	54
Remarks on the Revenue System of the North-West Provinces	55
Revenue Settlement . . . . .	57
Titles to Land, and Leases . . . . .	59
Artificial Encouragement to Agriculture . . . . .	71
Management of Pastoral Hill Tracts . . . . .	71
Tax not the Desert . . . . .	73
Restoration and Duties of Village Accountants . . . . .	78
Salaries to Village Accountants . . . . .	74
Protection of Bunds by Contracts . . . . .	76
Tank-Digging . . . . .	78
Effect of removing Dams . . . . .	79
Increased Cultivation followed by more abundant Rain in the Desert . . . . .	80
Moral Influence exerted as an Element in securing large num- bers of Labourers among Rude Tribes . . . . .	80
Military Commissions as Courts of Civil Judicature . . . . .	83
Police Confessions . . . . .	83
On the Supply of Carriage in a Free Market . . . . .	84

---

## PART II.

### ON MILITARY MATTERS.

On the Arming of a Free People ; and on the true Principles of the Organisation of the Armies of England . . . . .	93
The Defects of the Bengal Army . . . . .	101
Comparison between the Systems obtaining in the Armies of Bengal and Bombay . . . . .	117

	PAGE
Remarks on the State of the Native Army of India in general ; upon the Principles whereon its Efficiency depends ; and on the Means whereby its existing Defects may be remedied . . . . .	124
Sildar Horse . . . . .	135
On granting Compensation to Sildar Corps . . . . .	164
Sildar Rifle Corps . . . . .	168
Three Memoranda on the Constitution of the Sind Irregular Horse, as exemplifying the Sildar Principle . . . . .	170
Carriage Arrangements of the Sind Irregular Horse . . . . .	189
Camp Supplies and Baggage Corps . . . . .	193
The Military Fund . . . . .	203
Furlough Regulations . . . . .	204
Daily Orderly-Room to be held by every Commanding Officer . . . . .	209
The Vices of the Seniority System in the Native Army . . . . .	211
Fixed Head-Quarters for Regiments . . . . .	213
The Obedience of Soldiers not to depend on their own pleasure . . . . .	214
On the Purchase of Horses by Government for Military Pur- poses . . . . .	214
Stud-bred Horses . . . . .	217
The Military Board and Audit Department . . . . .	219

## MISCELLANEOUS SUBJECTS.

Military Rules on High Caste Men . . . . .	220
Sepoy Mutineers and their Officers . . . . .	220
Powers of Commanding Officers, and Candidates for Enlistment . . . . .	221
Prize Property . . . . .	221
Fortifications . . . . .	222
Flank Companies and Sizing . . . . .	222
Qualifications of Staff Officers . . . . .	222
Night Attack by Shere Mahomed . . . . .	222
The Sepoy's Musket . . . . .	223
Horse Fairs . . . . .	223
Cavalry Swords . . . . .	224
The Point and Cut . . . . .	225
Cloth Pantaloons versus Leather Breeches for Mounted Men . . . . .	227
Horse Artillery and Cavalry Charges . . . . .	228
Good Tools do not make Bad Workmen . . . . .	228
The Greatest Danger to our Indian Empire . . . . .	229
Removal of a Prohibitory Order . . . . .	230
Cavalry Charges should succeed . . . . .	230
European and Native Soldiers on Service . . . . .	231

	PAGE
Directions for a Saddle . . . . .	282
Memoranda on Rifles, in their Application to the Purposes of War, and on Rifle Practice . . . . .	288
Penetration of Jacob's Iron-pointed Rifle Balls . . . . .	275
Best Army Rifle . . . . .	275
Explanation of the Difference between the Minié and Jacob Rifle Ball . . . . .	280

---

### PART III.

#### RELATING TO THE NORTH-WEST FRONTIER OF INDIA.

Memoir of the First Campaign in the Hills North of Kutchee, to the North-West of the Frontier of Sind . . . . .	287
Subsequent Proceedings on the North West Frontier of Sind up to the close of the year 1847 . . . . .	317
Appendix to the Memoir . . . . .	326
Arrangements carried into effect for the Security and Pro- perity of that portion of the North-West Frontier forming the Boundary between Sind and Beloochistan, comprising—	
Memorandum on the Principles of Procedure on the North- West Frontier of Sind . . . . .	349
Summary of Arrangements made on the North-West Frontier of Sind . . . . .	353
Military System introduced for the protection of the North- West Frontier of Sind . . . . .	356
Disarming of the North-West Frontier of Sind . . . . .	362
Mistaken Leniency towards Marauders . . . . .	364
Standing Orders for the Frontier Posts of the North-West Frontier of Sind . . . . .	367
Assessment on the Land of the Frontier District of Sind . . . . .	367
Advice to a Native Prince . . . . .	369
The Brahoocce, Affighans, and Pathans, considered as Recruits for our Armies . . . . .	370
Suggestions towards the Permanent Defence of the North-West Frontier of India . . . . .	375
Memorandum of Proposed Arrangements in case of a British Force being stationed at Quetta, or at other convenient Spot above the Bolan Pass . . . . .	385



## PART IV.

## RELATING TO THE PERSIAN WAR.

	PAGE
Its Policy . . . . .	401
On the Policy of invading Persia . . . . .	403
The Valleys of the Karoon and Euphrates; and Russian Policy . . . . .	403
Cavalry for Transport by Sea to the Persian Gulf . . . . .	406
Military Requirements in the Expedition to the Persian Gulf . . . . .	407
On Holding our own Ground after Victory . . . . .	408
Kuzistan having become ours by Conquest, should be permanently occupied . . . . .	409
Water Supplies at Bushire and Karrack . . . . .	411
Mohumra, Karrack, and Bushire, considered as places for Troops to summer in . . . . .	411
Insalubrity of Mohumra . . . . .	412
Supplies from Bombay . . . . .	413
Supplies from the Valley of the Euphrates . . . . .	413
Employment of the Men in Hutting themselves . . . . .	414
It is better to be, than to seem, strong . . . . .	414
Bushire as a Point of Embarkation . . . . .	415
Orientalers are commanded, not by Etiquette, but by Habitual Nobility of Being . . . . .	415
The School of Smooth Words . . . . .	416

## PART V.

## OBSERVATIONS ON THE PRESENT CONDITION OF INDIA, AND ON THE REORGANIZATION OF ITS CIVIL AND MILITARY ADMINISTRATION.

Three Extracts on the present Condition of India . . . . .	419
A Scheme for the Reorganization of the Civil and Military Administration of India . . . . .	425
Reply to some Observations on the Scheme of Reorganization . . . . .	439

CONTENTS.

ADDENDA.

	PAGE
Security for the Good Conduct of Recruits . . . . .	447
Order relative to the Mahomedan Festival of the Mohurrum . . . . .	448

---

INDEX . . . . .	451
-----------------	-----

## PREFACE.

---

WE frequently find theorists advocating the application of Natural Law to the affairs of men. We more frequently find the legislators and actors in these affairs working in contempt or ignorance of that law. But it is of very rare occurrence to meet a man possessing at once the ability, will, and opportunity himself to apply the Law of Nature in many departments of common business. And believing that General Jacob has both faithfully and successfully so applied it, I have collected some of his views, and now lay them before the public, in the hope that they may become as useful to others as they have been to myself.

I beg the reader to bear in mind, when perusing the following papers, that they are not the effusions of a mere theorist, but contain some of the pungent maxims arrived at by a man whose life has been passed in action. Himself believing in Universal Law, the General has dared to apply its principles to business immediately in hand, presuming that what was true for the whole could not but prove true for

the particulars of this whole. And thus, testing his theory by practice, and finding his assumptions borne out by practical results, he now claims to affirm these with the authority of a master.

The foregoing observations apply equally to the papers upon civil and upon military matters. But it is upon their application to the latter that I propose to remark: for it is but too manifest that our existing military system in India has failed; and that if England still purpose to hold India, she must do so by means either of undisguised English military occupation, or of a Native army re-organised on sound and lasting principles.

Choosing the former course, we must be prepared to maintain in India an English force as large as, or larger than, we were able to maintain in the Crimea; to acknowledge before all the world that our rule in India is based, not on the good-will of the governed, but upon palpable military occupation; to maintain our English army in India, still undiminished, in the event of an European war; to increase this army in the contingency of our European enemies extending their influence into Asia; to drain (beyond the drain already involved in our government as foreigners) India of that wealth which is now returned to her in the form of pay and pensions to a vast Native military establishment; and, lastly, to create and provide for discontent among a large section of our Indian subjects who now trust to the military profession for subsistence.

Choosing the latter course, it is incumbent on us to lose no time in availing ourselves of such material for

a loyal and efficient Native army, as may be ready to hand; and in availing ourselves of all workmen able to fashion this material into shape.

Convinced that neither the present military resources of England, nor the present financial resources of India, could permanently support, in India, an English army equal to holding our Eastern empire; and convinced, moreover, that if those resources could respond to this demand, England would not be justified in subjecting India to an English military occupation—I accept the alternative of reorganising our Native army; and I appeal to the military papers contained in this volume, and to the practice upon which they are founded, in proof of the assertion which I now publish—that we have at least one man among us who can discern and point out to us the material for a Native army, and who has shown himself able to organise it into loyalty and efficiency.

It is unquestionable that, standing alone, at the hazard of his commission, and subjected to prolonged obloquy and opposition, General Jacob has during a period of many years past, exposed the vices of the system now failing us; has predicted that the combined direct and indirect operation of this system would result in failure; and has, at the same time, advocated, elaborated, and carried into effect, under very adverse circumstances, and without once faltering, a new system, capable of bearing every test, and which, though often assailed,—and sometimes virulently,—has never yet been shown to be hollow or defective.

Whether for good or for ill these principles, which

General Jacob has exemplified in the constitution of his regiments of Sind Irregular Horse, have, from the first, had in view the reformation of our Native armies in India. The reformation thus exemplified has, from the first, been declared to be, not in degree, but in essence; to aim, not at a modification of the existing system, but at a radical, essential abolition of this system, in favour of another by him introduced. This latter was, in the first instance, tried with one, subsequently with a second, and is about to be tried with a third regiment of horse. In the two first instances, the men enlisted were drawn from the very heart of those districts now in revolt. In both these instances, the experiment met with strenuous and continued opposition from all quarters; and was stigmatised as mere theory, inapplicable to the real practice of war. In both instances it proved, under severe and prolonged trial, to be completely successful.

There remained, however, one supposed objection to the permanent and extended application of the General's system. It was this—that though successful when carried out under his immediate direction, it would fail if entrusted to less able men. Nevertheless, one of the regiments so trained was recently sent on foreign service under the command of a young lieutenant; was harassed by sea as cavalry seldom have been harassed; and was then scattered under its *Native* officers to Kurrachee, Bombay, Poona, and elsewhere. Yet those detachments remained staunch under their native officers while mutiny was being enacted in these stations,

by regular troops; and showed, as plainly as need be, that *the School* had formed both officers and men.

Meantime, the other regiment so trained remained, under another officer, on the frontier; and this officer's military powers were unavoidably contracted by the presence of a senior officer in command of an irregular corps from Bengal. To the rear of this frontier was the station of Shikarpoor, holding disaffected regular troops;\* to its right front was the Punjaub, in which nearly every regular regiment was in revolt or disarmed; to its left front was the State of Khelat, in temporary disorder, attributable to the Khan's demise; and in its immediate neighbourhood was a border chief† striving to awaken rebellion. Yet this second regiment

\* The most important arm, the Native Artillery, actually broke out into open mutiny; while one of the most trusted Subedars in the only Native Infantry regiment at the station of Shikarpoor was arrested, and soon after executed, as ringleader of a plot to mutiny and murder. I should add, that no European troops were stationed within several hundred miles of the frontier.

† This borderer wrote to all his neighbouring chiefs, calling upon them to strike a blow for freedom. He told them it would be in vain to tamper with the troopers of the Sind Horse, but that they should all assemble at Jacobabad on an appointed day, under pretence of making their usual obeisance, and should, then and there, upon a signal to be by him given, rise and murder the European officers, and afterwards raise the surrounding country.

Among the chiefs so addressed was one, of whose tribe some five hundred men had, within the past ten years, been destroyed by the officer then commanding the Sind Horse. Yet he, like all his neighbours, returned for answer that the English Government had

stood and stands staunch, although in a position, and under temptations, than which it were difficult to imagine any more trying to the loyalty of mercenaries.

I am well aware that, in thus plainly laying the truth before the public, I may incur, from some persons, the charge of undue presumption. But I am not less confident that every man, really careful for the honour and welfare of our Indian Government and its army, will dispassionately consider whether the system advocated and practised by General Jacob is or is not adapted to our requirements; and, in the event of his denying its suitability, that he will support his denial by valid reasons, and endeavour himself to submit a system which Theory may argue, and practice have proved, to be preferable. Meanwhile, to those who look for precedent I would suggest that our own history affords an example of an army remodelled upon a regiment of Silidar Horse—which regiment was Cromwell's.

Having found occasion to use the term “Bengal,”

been just to them, and that they would take no part in the proposed massacre. Many of them also sent in trusty agents, bearing news of what had occurred.

Upon receiving this intelligence, the officer commanding called for two of his native officers, informed them of the plot, and directed them to provide for its frustration, and for securing its ringleader. They arranged accordingly; and the borderer had no sooner arrived upon the day appointed, than he was quietly arrested. Yet his plot had been divulged to some hundreds of the men in the lines; and its divulgence was, further, known to many of the border chiefs on the frontier. The traitor alone remained ignorant of his own betrayal.



in connection with the defects of our military system, I deem it on every account proper to explain that I am far from intending to cast reflections upon any officer or body of officers. The development of the present crisis has assured me that our failure is attributable, not to individuals, but to system; and for the framing of this system the executive are not responsible.

For myself, had not the Indian army, to which I belong, been disgraced by mutiny, I had assuredly remained silent. But as matters are, I should deem myself culpable in neglecting to submit to our legislators, and the English people, information which they should, in the present crisis, possess; and towards supplying which I chance, by a long residence with General Jacob, on his personal Staff,\* to have been favourably circumstanced.

I am convinced that no unprejudiced person, accurately acquainted with the history of our native army, can read these military papers, or become familiar with the practice on which they result, without perceiving that the principles advocated are in exact conformity with whatever has been or still may be worthy in the constitution of that army. I believe there is scarcely a commanding officer or an adjutant of a regiment who would not at once acknowledge that the details in which he has found

\* As Assistant in the Revenue and General Department when the General was acting as Commissioner in Sind; as Aide-de-Camp when he was in Command of the Cavalry Division Persian Field Force; and as Political Secretary when he was Commander-in-Chief in Persia.

himself hampered are those pointed out in these papers. And all who have perused the works of the late Sir John Malcolm, and the selections from the correspondence of the late Lord Metcalfe, recently edited by Mr. Kaye, will be impressed with the coincidence of the principles enunciated by these statesmen with those independently practised by General Jacob. One principle, common to all three writers, cannot be too strongly urged. It is this—*That from the moment when the command of a Native Regiment becomes less sought for than other employ, we may date the commencement of our downfall. To render this command so sought for, we must place the commander in a position to be looked up to by his own men, and by society, whether English or native; and we must support him in the exercise of full authority. To do this involves selection,—selection, that is, of officers for a class of appointments more essential to the existence of our rule in India than any other class of appointments whatsoever, be they military or civil.*

LEWIS PELLY.

CAMP POKRUM,  
December 1857.

**PÀRT I**

**CIVIL ADMINISTRATION:**

# CIVIL ADMINISTRATION.

---

## THE SECRET OF OUR RULE IN INDIA.

To the Anglo-Saxon race self-government is essential. But force the Oriental to take his share in government, and you will soon have no government at all. The former considers that which unnecessarily interferes with his freedom to be wrong, and thinks and acts upon the principle that all men have equal rights. The latter considers being compelled to govern himself as the greatest oppression and tyranny. He expects to be ruled, and to be ruled well; otherwise he will, perhaps, rebel and destroy his bad rulers. But in no case will he attempt to establish freedom.

It is obvious that two races of men with principles of action and feelings different, can never be successfully managed by adopting one system, and forcing it alike on both. But while incapable of self-government, the natives of India, like other human beings, feel gratitude and devotion towards those who raise their moral, intellectual, and social position; and are actuated by a strong wish and earnest zeal to show that they are worthy of the respectable position to which they are

raised. Too mistrustful of their equals to submit to their rule, they cheerfully submit to an English gentleman, whom they all acknowledge and feel to be their superior.

We hold India, then, by being in reality, as in reputation, a superior race to the Asiatic; and if this natural superiority did not exist, we should not, and could not, retain the country for one week. If, then, we really are a morally superior race, governed by higher motives, and possessing higher attributes than the Asiatics, the more the natives of India are able to understand us, and the more we improve their capacity for so understanding, the firmer will become our power. Away, then, with the assumption of equality; and let us accept our true position of a dominant race. So placed, let us establish our rule by setting them a high example, by making them feel the value of truth and honesty, and by raising their moral and intellectual powers.

But if we are not superior to the Indians, the attempt to retain our sovereignty over them will be as hopeless as it will be vicious. And England neither can nor wishes to be powerful in evil.—(1854.)

#### MORAL BEING.

I would untiringly inculcate the maxim: *Be*. Be yourself; and all the attributes and effects which nature has attached to that condition of existence must necessarily attend and follow you. Our rank in the universe depends on our real nature—on what *we are*, not on what we seem, or others think us, to be; and I would remind you, that among these rude people in

particular our real intentions and motives are those which tell. If we really do wish them well, and always act fairly, honestly, and justly towards them, their old mistrust will certainly disappear. For our real character, and the real nature of our proceedings, must necessarily produce their natural results.—(1857.)

**EUROPEAN OFFICERS SHOULD NOT BE WASTED ON  
TRIVIAL EMPLOYMENTS.**

Whatever tends to make European gentlemen “cheap”—to lessen their evident value—to hold up their vices rather than their virtues to the view of the natives—to show them to the natives only in inferior positions, where their powers are not called forth, and where they have little influence for good—must tend to destroy in no slight degree the hold we have on the people. Whatever, on the contrary, raises the European character in the eyes of the natives of India, and in reality, must greatly add to our security and power.—(1854.)

**NATURAL FORCES.**

Our regulation authorities do not seem to have any idea of *natural* causes, or to know that natural forces exist. Yet all other forces are contemptible, and deceptive appearances only. Our present proceedings are exactly like those of a man who, wanting a great forest, should stick some huge branches into the earth, and then think the business done. His labours would make a grand display for a while, but in one season or so all would rot and disappear.

But if he sowed acorns—feeble-looking things at

first, but containing mighty *principles* of life and growth—he would assuredly raise giant oaks, whose strength might resist the utmost force of the storm for a thousand years.—(1856.)

#### THE CONTROL OF PREDATORY TRIBES.

It is moral more than physical force which is required to control predatory tribes : both are doubtless necessary, but the latter is so, chiefly, to enable us to apply the other. Justice, honesty, high principles, unswerving firmness, and force without violence, succeed best with these men, as with others. If we imitate their crimes, on pretence of retaliation, we only perpetuate the evil. The power of the border marauder does not wholly consist in the damage he is able to cause, or in the terror he is able to inspire, but in the fact that his name and deeds are associated, even in the minds of those he injures, with chivalric daring, and attributes not altogether bad. But if the trade of marauder be proved to be unsuccessful, and disreputable, it soon receives the ridicule and contempt of all.

The province of—— and the frontier district of——, containing more than 10,000 square miles, and some 100,000 of the wildest and most untameable men on earth, were formerly one continued scene of rapine, murder, and every conceivable horror; yet in the course of a few years' *just* administration, these borderers have settled down to peaceful industry, and to as late of repose as little disturbed by violence as many of our old districts in India.

The most active and the most violent of the old robber tribes are now cheerful and thriving agricul-

turalists. And, believe me, the principles which have guided proceedings in this instance are of universal application. If we *are just and true*, we shall be trusted even by the Affghans, whatever measures we may find it necessary to undertake.—(1856.)

#### INTERFERENCE WITH TRADE OPPOSED TO THE LAWS OF POLITICAL ECONOMY.

I am astounded at finding that the export of corn has been prohibited by proclamation; and that the prices of the market have been regulated by general orders. I do assure you, I cannot imagine any publications more certain to contravene the universally received laws of political economy than these documents, which defeat, moreover, the very object for which they profess to have been issued, namely the maintenance of an abundant supply and low prices.

But such notifications not only tend to produce present scarcity, but are calculated to leave deep and lasting ill consequences to the trade of —, and to cause deplorable ill consequences, in this country, to the reputation of the British Government for wisdom and justice. For it cannot but be expected that the evil effects of such authoritative interference with trade, and with the rights of private persons, will be felt long after such interference shall cease.

The confidence of merchants and traders is delicately sensitive; and, when once justly shaken, cannot be speedily restored to a healthy state. Supplies will not readily flow from distant points towards a market which is not free, and where the rates of sale and purchase are arbitrarily regulated in lieu of being left



to be adjusted naturally, by the existing relations of supply and demand.

I beg that all restrictions of every description on the commerce and external trade of this place may be immediately removed by proclamation, and that, henceforth, no interference with the private rights of buyers and sellers may be permitted, on any pretence whatsoever.—(1857.)

### THE LIBERTY OF THE PRESS.

I am very glad indeed that you cancelled the letter you drafted relative to the newspaper criticisms on your proceedings. Rely upon it, every public man will best command public praise by deserving it; and every attempt to stop the mouths, even of false railers, is unwise and weak. Let those who will, rail on! If you are abused, the abuse will only excite reaction in your favour; but if you wince under criticism or censure, the chastisement will be thought to be merited. It is what we *are*, not what is said of us, that is alone worth thinking on.

Every servant of the public should glory in publicity; and if he be really striving simply and solely for the public good, he will rejoice in seeing his proceedings subjected to the full light of public opinion, which, more surely than any other means, will expose his errors and defects. It is only evil that dreads publicity.

It is the fashion to abuse the Indian press for its scurrility and falsehood. But the press, like the government, is everywhere indicative of the people supporting it. If society be scurrilous, the press,

which is the expression of its contributors, will be scurrilous also. If, again, the Government, and those possessing accurate information, maintain secrecy, the press must seek information from unreliable sources. But it is illogical to argue that the press, which is dependent for its existence upon the subscriptions of the public, would wilfully mislead that public, or adopt language other than that which was found to be most popular and remunerative.

On the whole, however the press may libel you, you have, and Government should also have, but three remedies, viz., to inform the editor of the real facts of the case in point; secondly, to employ a governmental organ for publishing the truth; or lastly, to prosecute the libeller according to law.

Even assuming the lowest ground for argument, and contending in conformity with the views of the narrowest and least scrupulous minds, I should still maintain that it is unwise to gag the press. When all are free to speak, men know that the worst is said. Ill-will and sedition evaporate in words, and the public believe as much as they please of what they see printed. But when the public voice is stifled, suspicion, distrust, fear, discontent, and almost every other public ill, commence.

\* \* \* \* \*

I would wish to see every government and every public man live down calumny and falsehood. If you really are good, be sure that the consequences which nature has attached to that goodness must ensue. It is not more certain that a pound of matter, scatter it how you will, still weighs one pound in God's universe,

than that a good performed, hide it, deny it how you will, has its due and certain weight in the same universe. In this, as in all else, the law of the moral is identical with that of the physical world. Therefore, I say again, *be yourself*, and leave consequences to the Author of all being: perfect freedom is perfect law.—(*March, 1857.*)

ON MISSIONARIES; AND THE INTERFERENCE OF THE STATE IN MATTERS APPERTAINING TO RELIGION.

To interfere with the labours of the missionary, by whatsoever church or sect deputed, would be as unjust and impolitic as to interfere with the business of any person trading or professing. Let the missionary preach, and, if he can, convert, so long as he remains, and be generally known to be, wholly unconnected with the State. But the interference of Government, or the members of Government in their official capacities, to countenance or sanction the endeavours of missionaries, or any other ministers of religion, is, in India, fraught with evil. And every semblance, even, of such sanction or countenance, should be studiously avoided.

There is no maxim of government more certainly true and wise than that all interference whatever on the part of Government with the creeds or religions of the people is mischievous and unjust. This maxim is in my opinion true in all places, and at all times. But such interference, whether for patronage or discouragement, must be more than usually unwise where, as in India, there are many different faiths, and those the most ancient and revered of any on earth, existing

among two hundred millions of men, who cling to their religion as to their life; while the governing class, who propose to make their own faith the religion of the State, may count their numbers, probably, as one to ten thousand of those subjects on whom their doctrines are to be forced.

It seems to me unwise to carry our State religion to India at all, even as respects Englishmen in this country. In our public capacity, as governors of hundreds of millions of men, of twenty different faiths and sects, we cannot, with justice or propriety, exclusively patronise *any* religion. Absolute freedom should be allowed to all so long as they do not annoy others. But Government should identify itself with none. It appears most injudicious to *parade* our State religion. In short, a State religion in India is absolutely incompatible with the security of our empire.— (1857.)

#### SELECTION *versus* EXAMINATION.

Among the objections to our competitive examinations, and in fact to our examinations generally, are the following:—That they are limited to intellectual acquirements, and wholly ignore moral and physical acquirements. That even in regard of intellectual acquirements, they do not test those which are most requisite in civil and military servants of the public. That the candidates are generally of an age when it is impossible for any examiner to predicate, or reasonably to infer, what their future value as public servants may be. And, that the examinations have a tendency to force the young brain; and thus to deteriorate the

material out of which our public servants are to be formed.

Experience shows that the highest order of mind is by no means of the quickest growth. The future statesman may very probably appear a dull and stupid, or an idle boy, while the clever clerk is learning by rote. The mental power of the former is growing; he is acquiring that power with which he will afterwards work; and, it may be, is training his body in those manly sports natural to youth. The latter, meantime, is carrying to his nest the thoughts of other men, without once attempting to assimilate them into his own being, or to originate fresh thought. And yet it would be the clever clerk, and not the embryo statesman—the receptive and not the creative mind—that would carry off the prize at our examinations.

Look, for instance, at the competitive examinations for entry into our Indian civil service. These tests are excellent in their way; but they most assuredly do not test the qualities which we desire to see in our civil administrators of India. The test of superintending a factory were infinitely preferable, for by this the candidate would at least prove himself able to organize labour, and to manage men; whereas, by the other, he is simply shown to be a more or less efficient scholar. And the argument that the most brilliant among our public men have also been accomplished scholars, appears to me wholly without force when applied to the question now under discussion. It were as reasonable to allege that all candidates must possess extraordinary physical endurance because our lord chancellors have shown themselves to possess

this among numerous other excellencies. We are not dealing with the geniuses of English administration, but with the average material of administrative capacity which the gentry of England supply for the government of India. Observe, again, the effects of our examinations in the native languages. Nobody denies that every officer who undertakes to command, or to deal with, the natives of India, should, among other qualifications, possess that of communicating with these natives. But the objection is to selecting this one qualification, and making it the one test upon which all appointments in India shall depend. Nor is this all; for the examination in this case also fails of securing that which it professes to aim at, viz., the appointment of none but officers able to communicate with the natives in their vernacular tongue.

Let us examine a little into these two objections:

*1st.*—An officer is required, say to command a body of horse, or to take charge of a collectorate. What is the one question asked regarding the nominee? It is this: "Has he passed in the language?" If he have passed, he is appointed; if he have not passed, he is rejected. Yet the commander or the collector should surely possess qualities of infinitely greater importance than that of grammatical knowledge of a native language,—qualities which, if they did possess, would most certainly induce them to so far acquaint themselves with the vernacular as business should require; and qualities which, if they did not possess, would be in no degree compensated by a knowledge of all the languages of India.

*2nd.*—It is notorious that as a body (there are of

course brilliant exceptions) the passed officers have less knowledge of the language for practical purposes than the unpassed. That is to say, they show themselves less able to communicate with the mass of natives with whom they come in contact. This assertion may seem paradoxical; but it should be remembered that while the one young man has been studying books the other has been studying men. The former will be able to read a native book, or to converse with his Moonshee in elegant phraseology, but will be probably quite incapable of understanding the expressions of a peasant, or of making the peasant understand him. The latter would be quite unable to read a word of the book; but having been associated with the *people*, would talk with them readily. A knowledge of the thoughts, habits, beliefs, desires, wants, &c., of the natives of India, is to be gathered, not from Hindoostanee books, but from intercourse with the people.

It is remarkable, again, that while passing in the native vernacular is considered as the *sine quâ non* for detachment from a native regiment upon miscellaneous employ, the rejection of a candidate involves his remaining in command of native troops,—a position which, one would suppose, required, equally with or more than any other, a knowledge of the sepoys' language. Fortunately, however, a knowledge of the language is widely different from a passed examination in the vernacular; and thus some of the best practical linguists, and those most intimately acquainted with the ideas of their men, remain with their regiments.

But, in truth, unless the chief business to be performed related to such knowledge of oriental language, there should be no need of passing any examination in any native tongue whatsoever. The best security for fitness in this, as in other respects, is in the opinion and approval of the candidate's superiors, who if efficient themselves, and allowed sufficient power, would take very good care that their subordinates were as well qualified in this as in any other portion of their duty. But this arrangement would necessitate the maintenance of competent superiors. It would, in truth, go to the root of the matter, and involve the selection of proper men at the head of affairs. And in this lies the secret of opposition to, and the certainty of success for, a system of selection. I firmly believe that at this very hour we have in India a total amount of English talent and energy adequate for all the administrative requirements of our empire; provided only this total were so organized and distributed as to ensure its acting with full effect. But as matters at present are, we cripple the entire body by wasting the energies and crushing the minds of thousands of English gentlemen upon trivial military duties, which could equally well, and with far greater general advantage, be performed by native officers properly trained; while at the same time we overtask another portion of the body, by confining the administration of the empire to the members of the civil service. Nor is this all; for the continual emergencies of the service requiring that the military members shall be availed of as civilians, we are often compelled to accept this material without having



prepared it, and, when rendered really efficient, to discard it, to make room for a civilian, to the *detriment* of the general administration, and to the disgust of the military officer, who thus finds himself excluded from active and lucrative employ, not because he is inefficient, but because an officer—possibly an inferior one—belongs to another service, which enjoys the monopoly of administering the empire.

But I am convinced that, in India at least, we must ere long discard examinations and monopoly, and adopt selection. The energies and moral excellence introduced into India by a given number of English officers form the general stock of power for the civil and military government of the country. This stock forms the sole import to counterbalance the millions sterling of which, as foreigners, we annually drain India. And it is surely incumbent on us to use this stock in the most profitable manner possible, by adopting a system which tends to develop and improve English energies and moral power, and by selecting from the whole body in accordance with the principles advocated in my remarks on the native army.

#### REDUCTION OF CIVIL SALARIES.

Reason, experience, and observation alike concur to convince me that the civil officers in this province are much underpaid; and that the salaries of the appointments, although not, perhaps, always of the individuals now holding them, might be considerably raised, with advantage to the State.

I arrive at this conclusion on purely economical principles, holding that to be the best and most judi-

ciously adjusted rate of salary which ensures the largest return to the State.

There is no investment of capital in this world comparable, with regard to the return which it produces, to liberal payment of efficient civil officers in India. Every reduction of salary below that which is necessary to command the highest available moral power and intellectual vigour on the part of our revenue officers, and civil officers generally, must assuredly result in the exclusion from the public treasury of many thousands of times the amount supposed to be so saved in the salaries. A decent mediocrity of talent may be secured, perhaps, at what appear to be more economical rates even than those now paid for the services of English gentlemen in this country; but the effects of such reduction will assuredly be most lamentable.

The energy and moral excellence which we introduce into India by means of English officers form the only articles of import—the only possible means—by which we can restore and repay to India the amount of capital which, as foreign rulers, we are and must be continually draining from the country.

Whatever tends to add to the self-confidence of the timid Asiatic, to increase the active working-power of the people, to give them new thoughts and new desires, and to put them in the way of advancement generally, must, in like proportion, add directly to the wealth of the nation, and consequently to the revenue of Government.

A single European officer in a large district is often able, in a few years' time, by the influence

of personal character alone, to multiply the wealth of the people, and of course the Government share of that wealth, fourfold. I have myself witnessed instances of this: such effects might almost always be produced if care were taken to choose men for appointments on the principle of fitness alone, by causing them to feel that their services are appreciated, and by furnishing them with the means of residing comfortably and free from sordid cares in the country in which they are labouring. But such effects will never follow when civil officers are underpaid, and, therefore, probably of inferior ability in the first place, and also made discontented and unwilling to throw their whole force and energy into the public service of a Government which holds their labours cheap.

It is not less pay, but more English mind (which is cheap at any price), which is required for India. The underpaid official will, if he feel himself not fairly appreciated by Government, assuredly not remain in the country, or, if he do continue to hold his appointment, he will probably be of an inferior stamp of mind, and will get through his duty with stolid listlessness, which will cause everything to stagnate around him.

In introducing European honesty, energy, perseverance, knowledge, high principle, and ability, into this country, we are, in fact, importing so much life; every single human creature within the range of such influence becomes a higher order of being, and possibly tenfold more productive, as respects the public wealth than before.

On the other hand, to employ the listless, indifferent, and unintellectual European in the revenue, magisterial, or indeed, in the performance of any civil duties, is bringing in death—is to dry up, as it were, the very sources of natural wealth, and to destroy the public revenue.—(1856.)

SHOULD OFFICERS UNABLE TO PASS IN THE LANGUAGE OF A DISTRICT BE REMOVED FROM OFFICE?

I would on no account fix a time within which an officer on civil employ must pass an examination in the language of the district.

All such rules operate, I think, injuriously to the public service. It often happens that the officer most highly qualified for the work entrusted to him, and most able and willing to perform the duties of his appointment efficiently, is, under the proposed rule, excluded, because unable *to satisfy a committee* as to his knowledge of a language, an acquaintance with which may be the only qualification possessed by the successful candidate.

If, from want of knowledge of the language, or owing to any other deficiency, an officer cannot perform his duty in a perfectly satisfactory manner, he should, after a fair time allowed for trial, be removed from his office. But long experience assures us that those who appear to be the best linguists before a committee are not always those who are best able to interchange ideas with the country people.—(1856.)

### NON-REMOVAL OF INCOMPETENT OFFICIALS.

A man in office, known to be inefficient, is sometimes allowed to remain, because there is no superior who will take upon himself the odious task of causing a good-natured, and perhaps really estimable individual, to be removed from a position for which, nevertheless, he has shown himself to be unfit. This is a great evil; and, in its consequences, so widely disastrous as to render the non-removal criminal. It is to indulge benevolence at the expense of conscience, or to deceive oneself by undue regard for a friend. But it should be borne in mind by public men, that omissions of this description injure frequently thousands of square miles of cultivation, and affect the rights, the happiness, and the civilization of thousands of human beings. He who, fearing to offend the few with whom he is in immediate contact, consents to perpetuate evil influence on the many subject to his control, is unfit to rule. And, however the circumstances of the case may appear to the ruler himself, such shrinking from duty does practically resemble the conduct of Alexander, who burnt Persepolis to please a courtesan.—(1857.)

### ABOLITION OF STATUTE LABOUR ADVOCATED.

I have laboured hard for many years to inculcate on all around me the evil effect on all parties—even on those supposed to benefit by the arrangement—of interfering with market prices, and the great and certain advantages to the consumer as well as the producer of absolutely free trade.

I have, during a long series of years, enforced

absolute freedom for market prices in the bazar of the Scinde Irregular Horse with the happiest effect, notwithstanding that great opposition and prejudice had at first to be overcome. The supply of two strong cavalry regiments is equal to the transaction of a large town, so that the scale of the business has been sufficiently large, while it has been tried under great variety of circumstances.

Whatever those circumstances might be, I always insisted that every man should sell at whatever rate he chose to every one whatever, and that all purchasers should pay at those rates, even though the prices rose to a thousand rupees a seer for grain.

The effect of this has been that—with the exception of a part of the period, when we were at a station where the proceedings of the collector disordered all the natural relations of demand and supply—the bazar has always been most amply supplied at the lowest possible rates.

A proclamation almost exactly similar to that now received from you had been already published by me throughout the district under my charge, a copy supplied to every thana and outpost, and to every kardar and tuppadar, &c.

The proclamation now received will also be published as directed.

As connected with this subject, I beg permission to remark that similar principles might, with the greatest possible advantage, be applied to the question of statute labour. The present state of affairs in this respect is of enormous evil: it crushes every energy, and, more than all else, stops real improvement in the country.

It reduces the peasantry to a species of slavery, *causes all labour* to be looked on as *an intolerable hardship*, and places it in the power of ill-disposed zemindars to delay or to prevent the execution of all public works.

The remedy appears to me at once evident, simple, practical, and most readily applicable. Thus, a certain amount of labour for canals, or other public works, is due from certain villages or lands. This labour is evidently due from the landlords of the villages or lands, who receive all the profits—from those, in fact, who own them and their produce.

Let, then, the number of labourers which a landlord is bound to supply for any work be engaged and regularly paid by the British officers, at the full market rate of hire, whatever it may be, each man receiving his hire personally. The amount, whatever it may be, to be recovered from the zemindar from whom the supply of labour may be due.

This plan seems calculated to meet every difficulty.

The labourer would not be cheated, and, at the same time, it would be directly for the advantage of the zemindars to keep the price of labour low, and every effort and all fair means would be employed by them to induce the labourers to offer themselves for the work, and thereby keep the supply equal to the demand.

The labour market would soon assume a healthy state; the habit of free labour established, all odium would be removed from it, all men would endeavour to share in its profits, and labourers would be procurable in the greatest possible numbers, at the lowest fair rates, for all public works.

All parties must largely share in the profit of such an arrangement. Its effect on the society generally would be like that of restoring a sickly and feeble body to vigorous health and strength. The actual amount of labour available, and the productiveness of the people generally, would become enormously increased: for one willing and free working man will do as much as five or six "statute labourers"; exactly as the vigorous and healthy individual can do five times as much work as one suffering from the languor of disease or famine.

At the same time, the moral effects must prove unspeakably great, but they will readily suggest themselves, and it is perhaps unnecessary to enter on them here.—(1855.)

#### MINUTE ON OBJECTIONS URGED AGAINST THE ABOLITION OF FORCED LABOUR IN SCINDE.

This letter of ——'s appears to me to be written under entirely erroneous impressions as to facts, and undoubtedly with very mistaken ideas as to the true principles involved in the questions of which he treats.

All experience and all reason prove that the freest market is the cheapest market.

The increased demand for labour mentioned in ——'s first paragraph *will* probably cause—and ought in reason and justice to be permitted to cause—a rise in the price of labour.

If this price rise to such a height as to make it profitable for labourers to immigrate into Scinde, they will immigrate accordingly, and the price of labour



will soon adjust itself to the **LOWEST NATURAL RATE**, which natural rate is always the best for all parties in the end.

If, on the other hand, the increased demand do not cause the price of labour to rise sufficiently high to induce the labourers to offer themselves for the work, it never can be a profitable transaction for Government to import labourers from other countries.

For, with respect to the countries here in question, Government could never with reason hope to effect this so cheaply as could the labourers themselves.

**BUT THE FACT REALLY IS, THAT THERE IS AN ABUNDANT SUPPLY OF LABOUR IN SCINDE, WHICH HAS HITHERTO BEEN KEPT OUT OF THE MARKET BY OUR INSISTING ON REDUCING THE LABOURING MAN TO THE CONDITION OF A SLAVE, AND BY OUR EFFORTS TO FORCE THE MARKET BY AUTHORITY.**

To remedy this, —— would prescribe more authority! But the reports of the executive officers all over the province show that a full supply of labourers is always obtainable at fair rates of wages. If the rates rise above these, we need not fear! **A FREE PEOPLE WILL NOT LONG CONSENT TO REMAIN IDLE AND POOR, WHEN SOME OF THEIR BRETHREN AROUND AND AMONG THEM ARE DAILY GROWING RICH BY THEIR INDUSTRY.**

Every one will soon be anxious for work, and down will come the prices to their lowest healthy level.

It is the *slave* who abhors labour, for he works for a task-master.

The *freeman* glories in his industry, for he labours for himself and his children,—for food, for luxury, for

the gratification of every natural and artificial desire and want.

— is manifestly in error in supposing that an increased rate of payment by Government for labour in this country must be injurious to the interests of the State.

Whatever stimulates the industry and adds to the productive power of the people, must undoubtedly in like proportion directly add to the public revenue.

Scinde is capable of yielding ten times the revenue it now pays: THE REVENUE IS NOW LOW, BECAUSE THE PEOPLE ARE POOR, AND ARE WITHOUT THE CAPITAL NECESSARY FOR CULTIVATING THE GROUND.

As the people become rich, and WHEN THEY FEEL FREE TO USE THEIR LABOUR AND WEALTH AS THEY PLEASE, cultivation will extend, and population increase. Every rupee paid to *the inhabitants of the country* for their labour, above the amount necessary to purchase their mere subsistence, will be returned to the soil, and ultimately be restored with large interest to the Government treasury.

But the *foreign* labourer will take with him out of the country all his surplus earnings; none such will return to the ground, but the profit will be entirely transferred to other countries.

It is abundantly certain that the most natural, most simple, most healthy, and most economical method of obtaining labour, is to pay whatever may be necessary to command the required supply in the open market: all good authorities are agreed on this head.

Private persons, if left freely to themselves, generally know their own interests much better than does

any government. Labourers will speedily flock to a field where they are highly paid and fairly treated. There is no need to "import" them: they will, if there be a natural want of their services, soon come of themselves.

It is undoubtedly the truest economy for Government to abstain from interfering with market prices.

This had, I thought, been considered by well-informed persons as axiomatic, at least since the time of Edmund Burke. (Vide his "Thoughts and Details on Scarcity.")

But there are higher and nobler principles than any which — has touched on, which point to the self-same end as do considerations of immediate profit and loss.

We have NO MORE RIGHT to force any man to labour for less than he chooses to work for, than we have to steal his household property. To attempt to do so is *criminal*; and to speak of the "*extortionate*" demands of LABOURERS appears to me to imply confused ideas of natural right and wrong.

The labourer *demand*s nothing: the employer may possibly *demand* the labourer's services, and—as formerly in Scinde, until the practice was prohibited and abolished by me—may sometimes enforce his demand by unjust violence; but the poor labourer can only *offer* his services, and—having no capital but those services—he must either obtain work or starve.

Nothing tends to repress the productive energies of a people more than a sense of injustice. The labourer working for Government HAS A RIGHT to such a share of the public wealth as the labour which he performs

may represent, or may be fairly equivalent to. This *cannot* be arbitrarily assigned; it can only be known—*only be ascertained*—by allowing every man to fix his own price on his exertions.

If he value these too highly, we need not employ him: hunger will soon teach him what his labour is really worth in the market.

On the other hand, the labourer has no right to *more* than this due share; and to give him more has also a depressing effect on productiveness, as it may tend to encourage idleness, and waste the public capital. The true and just amount *can only be discovered* in a perfectly free market.

Freedom, moreover, develops every manly attribute, increases all the natural powers, IS THE STRONGEST POSSIBLE STIMULUS TO INDUSTRY, AND VASTLY AUGMENTS THE PRODUCTIVE POWERS OF THE PEOPLE; whose energies and self-respect are, on the contrary, crushed by slavery and injustice.

A labourer who has once experienced the advantage of being fully paid for his freely offered labour is not likely ever wilfully to remain idle when work is to be had.

THE SLAVE FLIES FROM HIS WORK, WHICH TO HIM IS ASSOCIATED WITH MISERY AND DEGRADATION; THE FREE LABOURER GOES REJOICING TO HIS TASK, FOR TO HIM IT IS THE SOURCE OF EVERY COMFORT AND HAPPINESS IN LIFE:

WHEREFORE, THE SLAVE IS IN THE END RUIN-  
OUSLY COSTLY AND FREE LABOUR IS COMPARATIVELY  
CHEAP ALL OVER THE WORLD.

This is the case, proportionally, in every degree and with respect to every approximation to absolute

slavery or perfect freedom. Every approach to injustice to the labourer LESSENS his productiveness, drives men from the field of labour, and *injures* the Government revenue.

There is no escape from this axiom, that the freest market is the cheapest market all over the world, and with regard to everything which has an exchangeable value among mankind.

Government have called on the Commissioner on his return to the province to report on ——'s letter, but I think it my duty to leave this minute on record, for communication to Government, or not, as the Commissioner may think proper.

I am further of opinion, that, to aid in the execution of public works, a corps of Sindhee labourers might be permanently embodied with much advantage to all parties.—(*March, 1857.*)

#### ABOLITION OF FORCED LABOUR IN SCINDE.

In the —— collectorate, all canals, above a certain size, are cleared, or are supposed to be cleared, by the officers of Government, and a water-tax is levied to meet the cost. But owing to attempting to work at rates very greatly below the fair value of labour, much fraud and confusion has been there introduced.

False measurements were habitually used; the people were debased, disgusted, and defrauded; while the public revenue was frequently wasted to an enormous extent, and large sums were expended on clearing canals which yielded little or no return, and, at the same time, the most valuable and productive feeders were often neglected. Much improvement in these

respects was introduced by —; but to bring matters to a healthy state, and to prevent enormous loss of revenue, an entire change of system appears necessary. The statistics of canal-clearances, &c., are much the same in the — as in the — collectorate.

In the — collectorate, only the main feeders have been cleared, wholly or partially, at the expense of Government and under Government superintendence. The zemindars make their own arrangements for the clearance of their private canals, and with these no interference seems necessary. But in —, also, “statute” or forced labour is largely had recourse to, even when the work is superintended by Government officers. In some instances these statute labourers receive food, or some trifling money payment; in others, nothing whatever is paid to them, though they may be kept at the work for months together.

I would respectfully observe that the question of the advantage or disadvantage of pressed labour appears to me to depend on those laws of political economy which are as well established as the truths of geometry. No disputed doctrines are involved in this matter. The principles on which I rested my arguments are, it seems to me, as self-evident as the axioms of the mathematician.

The differences of opinion shown in the summary now forwarded appear to me to have been caused solely by want of study and of acquaintance with the general laws affecting the matters in question. To say, with regard to such matters, that what may be right with respect to one part of a country might be wrong with regard to another, appears to be like

asserting that though a triangle might have three sides at Bath, yet at Bristol it must have four.

The natural laws and principles on which the truth of the matter depends may be shown very clearly in a few words.

A certain amount of labour has to be performed by the inhabitants of a country in order to make that country productive. In the case of Scinde this labour is canal-clearing, and such like irrigational works.

The amount of work to be done is the same in whatever form it may be represented or be brought to account; its real value is always the same. And this must be taken from the people of the country in some shape or other, in whatever manner the work be performed.

It is evidently indifferent whether the actual work performed be called so many cubic feet of earth, so many rupees, or so many days of human labour. These all represent the same thing, and, however reckoned, the work so represented requires ultimately the same amount of the capital existing in the country to be expended in its performance.

The capital of the country may be in this instance represented by the amount of labour available.

The arguments brought forward by me, and maintained by —, are to this effect: that paying a full and fair rate of wages for the labour required—that is, paying such a price as might be sufficient to induce a full supply of labourers to offer themselves of their own accord—tends to make men work with greater power and energy; to add to the number of men willing and able to work; and thus to increase the

capital, and necessarily, of course, the revenue of the country.

On the other hand, forcing men to work without pay, or with insufficient pay, disgusts them with labour; drives them into idleness; excites all manner of ill-feeling; produces a very great amount of crime, disorder, and disaffection; and thus destroys a great proportion of the capital, and, therefore, of the revenue of the country.

This question I would urge as being one of the greatest importance. I have little doubt, if the matter should remain in the hands of — or myself, but that forced labour of every kind may gradually ere long be totally abolished in Scinde; but meanwhile, much evil may be, and must be, caused by the remains of such a system; and I would therefore suggest that, inasmuch as many men bow to authority who are deaf to reason, it would be highly beneficial to the revenue, and to the country generally; if it were at once positively prohibited to have recourse to statute, or forced, or unpaid, or ill-paid labour, under any circumstances whatever.

It is evident that whatever drives that labour from employment, whatever induces idleness and weakens the productive energies of the people, must exactly, in like proportion, injure the public revenue. Twist and turn the subject as we will, the facts are as I have endeavoured to set forth, and in this, as in all else, the eternal law of Nature and of God holds true — that to be unjust is to be unwise.

The manner in which I would propose to carry out these principles is as follows:—



All canals, being main feeders, and generally such as have hitherto been cleared out by Government partially or wholly by means of forced or statute labour, and the revenue returns from which show that it would be advantageous that Government should continue to clear, be henceforth cleared by hired or contract labour, paid for only at free market rates.

The work to be superintended by Government officers, and paid for by measurement; a rate being at first assumed, such as may be considered fair, and afterwards increased or decreased, as it may be found to affect the labour market on the spot.

The amount of available labour in the country, and of the work to be performed, must be generally nearly a constant quantity, so that the natural and fair rate of hire will very soon be ascertained. Little change will afterwards be found requisite, and estimates can then be prepared with certainty and precision.

I have found it an excellent plan to divide the work of excavation into small portions, such as five or ten rupees' worth, and to allow labourers to contract for the execution of one or any number of these portions within the required time.

Under this arrangement, a man and his family can get through a surprising amount of work, while the least possible amount of superintendence is required. Even the little children do something, while each member of the family works at any time of the day he pleases; and I have often observed the people continuing their task all night, relieving each other as they found convenient. This plan I would recommend for general adoption.

Wherever statute labour may have been due for the clearance of canals, I would recommend the levy of a water-rate on the lands irrigated; the rate being proportioned to the number of labourers which the zemindars holding those lands have hitherto been compelled to supply.

Any zemindars who may wish to clear their own canals, without Government aid or interference, should be permitted to do so; and from them, of course, no water-rate should be levied for lands so irrigated.

But whenever Government is called on to interfere in the work, the clearance should be executed in the same manner as that of the main feeders.

These rules appear to be applicable to every species of canal superintendence; and however the canal department may be arranged, the adoption of the above rules throughout the province of Scinde would, I think, meet every difficulty, and tend to abolish every abuse.

It nowhere appears that Government ever authorized the practice of seizing labourers and making them work without pay; but, on the contrary, it seems evident that Government supposed the amount estimated and sanctioned for canal-excavations to have been a fair equivalent for the work to be performed.

The system of forced labour appears to be an abuse which existed under the government of the Ameers, and which has been heedlessly allowed by the local officers to continue since the annexation of Scinde.

A monstrous idea seems gradually to have estab-

lished itself in the minds of the civil officers, to the effect that whenever they fancied that more canal work ought to be done than the sum of money allowed by Government would pay for, they were at liberty to force the people of the country to execute such work without remuneration. But it is evident to me, that however such an idea may have arisen, the assumption of a right to force men to labour unpaid is, in this instance, as little supported by authority as by reason.

The fact of such a barbarous practice having existed under a rude native government can never suffice to justify its continuance under British rule; while its ill effects, which now prove to be absolutely ruinous, must have been comparatively little felt under the native princes, for the simple reason that under the native rule the whole revenue of the country, however drawn from the people, justly or unjustly, by fair means or by foul, was again expended among them, and thus capital was to some extent circulated, and though much injustice was done to individuals, nothing was lost to the whole community.

Under the practice which — and myself have been labouring to put a stop to, the estimates were never trustworthy; the measurements were untrue; and the rates of account were not those by which the work was really executed: the whole arrangement was as faulty and unsound as its results were evil.

In introducing a more healthy system, with work truly and fairly performed, accounted for, and paid for, it will doubtless be necessary at first to raise the estimates and the amount sanctioned for canal clearances; but it is equally certain that the real cost to

the State will be actually much less, because the work will be better done, and the people will not be impoverished.

Having now personally witnessed the ruinous effects of the old system throughout the province, and being deeply impressed with the urgent necessity of its abolition, I have thought it necessary to follow up —'s intentions, and at once to prohibit, in anticipation of orders, the use of forced labour throughout Scinde. I have done this as the only means of restoring productiveness to the country, and preventing a greater and still increasing loss of revenue to the State; and in so doing I trust that I shall receive support and approbation.—(1856.)

*Notice.*

- I. Statute or forced labour is abolished.
- II. Every man is at perfect liberty to work when, where, and at what rates he may please.
- III. Any Government servant who may hereafter be guilty of compelling any person to labour, whether upon canals or any other public or private work, will be liable to be dismissed from the Government service, and to legal prosecution by the injured parties.
- IV. Every work, of whatever description, may be performed either by means of contract or measured task-work, or by payment of daily task wages, at the discretion and pleasure of the parties immediately concerned. But no person must henceforth assume the right arbitrarily to fix the rates at which labourers or others are to be paid for work performed. Such

rates must always be fixed by free consent and mutual agreement of the parties themselves.

#### CALCULATION OF LABOUR RATES IN CERTAIN DISTRICTS.

I cause the nature and extent of the proposed work to be explained by proclamation all over the country, and then invite tenders for its execution by contract. Having thus ascertained that the work can be executed for a certain sum, and that no one giving good security would undertake it for a less amount, I calculate the rates in my estimate forwarded for sanction, so as to meet the sum required.

This I find to be the very best mode of obtaining fair work at fair cost, and I have never yet been disappointed in the result. The rates thus estimated cannot, it appears to me, be higher than is necessary. In executing thus, in these particular districts, we do the best possible, I think. Something, however, must be left to my discretion. I will be responsible that the works proposed be executed for the amounts mentioned, that full value be received for the public money expended, that the means allowed be not wasted, and that the work answer the purpose intended. I will answer, in short, for the general result; but I cannot pretend to be able to conform always to the rates of the engineer department, or to make estimates correct in minute detail.—(1853.)

*Note.*—This practice has been found eminently successful.—(1857.)

### WHEEL-CARRIAGES AND BRIDGES.

With regard to bridges, those built without lime-cement stand tolerably well when the arch-joints are correctly drawn to a centre, and when the bricks are rubbed, and carefully laid, so as to fit, with very little mud between them. But whenever lime is procurable at a reasonable cost, it would be far better to build the bridges with lime mortar throughout, and this would ultimately prove the more economical plan. But the first cost would be great, and the time and establishment required would exceed those at my disposal.

To give a permanent pavement to bridges built without cement would be out of place. On the whole, it has seemed preferable to secure moderately-good roads at the least possible expenditure of time, money, and labour, than to have the prospect of better roads ten years hence. Indeed, with the means available in this country, ten years would not have sufficed to construct all my bridges with lime, mortar, and paved roadways.

Accordingly, I set to work (not altogether in ignorance of constructive art) after a fashion of my own, without establishments, without any aid whatever, and with the people of the country alone. The result is, that a country which was almost impassable is now traversed with ease and comfort, at all seasons, in every direction. And the work has been accomplished in one year, at a very trifling comparative cost.

With regard to the preservation of the roadways of the bridges, experience shows that the most effectual

way of protecting the masonry in this district is to keep it well covered with earth. The bridges near camps or towns, which necessarily are those most used, should be covered with stable litter or such like, which, if renewed occasionally, till the whole be consolidated into an elastic mass, stands better than anything else. No ordinary metal will bind in so very dry a climate. The earthing of the bridges should be included in the road-repair contracts.

With regard to the question of wheel-carriages with iron tire, &c., everything in my power has been done to endeavour to introduce a better construction of vehicle; but I have for some time past abandoned all attempts of the kind, being convinced that they are useless.

The introduction of wheel-carriages with iron tire, &c. might be an advantage in many ways, but would not, I think, benefit the roads much, if at all; the whole ground of the country, with the exception of a few patches of salt earth here and there, being such that the roads become speedily reduced to an impalpable powder, many inches in depth, *whatever description of wheel-carriage be used.*

The roads are excellent for camels, by which the traffic of the country is almost wholly carried on, the carts being chiefly used for the transport of agricultural produce: but the roads in such a soil could not be made well adapted even for the best wheel-carriages without metal, which is not readily procurable, but which, I think, from the excessive dryness of the air, would be found not to answer.

Bridges always passable, and straight roads from

place to place, form an immense improvement on the former condition of things ; but it would be unreasonable to hope for roads really good for wheel-carriages in this country.

The introduction and general use of an improved description of wheel-carriage with iron tire, &c., implies a complete change in the entire native population or society ; it involves the necessity for the existence in each little village of such artificers as are now not to be met with in twelve places throughout the province ; it involves, also, the existence of increased capital, new wants, and improved habits, among the country-folk generally : all this may come in due time naturally, as civilization advances.

But as things now are, the carts at present in use are, perhaps, better adapted to the means and wants of the people than anything we could hope to succeed in substituting for them.

The things are rude and noisy, it is true, and at first sight seem ridiculous : but they can be constructed in any village at a cost of four or five rupees each ; they can be kept in repair by the village carpenter : while the loads they carry are as heavy as could well be drawn (I have carried from six to eight hundredweight of iron) by a pair of bullocks on these roads.—(1854.)

#### REPAIRS OF ROADS BY CONTRACTS.

I request attention to the annual repairs of roads. If the contract for repairing them be made for one year only, it evidently becomes the advantage of the contractor to execute the work as cheaply—that is, as



badly—as possible, just keeping within the terms of the contract. In fact, the worse the work may be done, the more the man will profit by it.

There must be a continual endeavour on the part of the contractor to conceal defects, instead of remedying them. In such extended works as these roads and bridges, the means at our disposal do not admit of the continual and minute surveillance necessary to guard against this, and the evil becomes most serious. Besides this, even where the contractor behaves with perfect honesty, he cannot, to advantage, lay out capital on the work for one year, as he could do were his contract extended over a longer period.

On the other hand, where the contract has been entered into for a series of years, it becomes the *interest of the contractor* to execute the repairs in the strongest and most durable manner; while not only will the work (quality being equal) be executed at considerably less cost, but repairs must be much less frequently required, and the nuisance of continually breaking up bridges be avoided.—(1853.)

#### PLANS AND ESTIMATES *versus* A ROAD AND CANAL.

We have occupied the country for fifteen years, and for the last ten years and more it has been our own, yet *still this most important little piece of road in the whole province* is even in a worse state now than it was in 1839. There have been far too many “plans and estimates,” and too many discussions for any *work* to be done; and now that the thing has been given up to the tender mercies of “the board,” it may, I fear, be classed with a Chancery suit, and we may

expect nothing but plans, estimates, and wise opinions to all eternity! Yet the business presents not the least difficulty, and the whole might have been accomplished in one season by contract at a very moderate cost.

It is as plain as the day, that to secure constant dry communication by land, and straight communication by water, between—— and ——, all that is necessary to be done is to dig a canal from one place to the other, throw the earth excavated to one side only, and on the top of this bank make your road,—all the watercourses crossed by the bank being of course bridged. What can be simpler or better for the purpose? This was proposed by me in 1840; and, in spite of all the plans and estimates, I doubt if anything better has been thought of since.

As things are now, the road by land—very bad at all times—is quite impassable for four months in the year; while, though the direct distance be only twenty-two miles, the distance by water is about seventy!

The bank on which the road would be carried would abot ethyf five feet wide at top, but nowhere more than seven high—generally much less. But last season experiments were made with a bank ten feet thick, apparently in order to ascertain whether one of five times that breadth would stand or not. The strange devices played off on this little piece of road, or rather no road, during the last twelve years, are almost incredible. The money wasted would have made the work properly several times over, I believe.  
—(1854.)

**A NAVIGABLE CANAL TO THE INDUS, AND THE  
REQUIREMENTS OF KURRACHEE AS A PORT.**

The measures really requisite to affording this port free scope for becoming whatever its geographical or commercial position may admit of its becoming, may be summarised as follows :—

*1st.*—The bar at the entrance of the harbour should be so far removed as to render it possible for ships of heavy burthen to enter the port at all seasons, without risk or hindrance.

*2nd.*—A steam-dredge should be maintained in the harbour ready to remove silt or sand accumulating along the fair-way channel.

*3rd.*—Two European and four native pilots should be appointed.

*4th.*—The Chinnee Creek should be reclaimed, in view to improving the salubrity of the neighbourhood, and for the convenient extension of building-ground.

*5th.*—A navigable canal should be constructed to connect the port with the Indus. No work is of so great importance to the prosperity of the port as this. It would afford that supply of fresh water which is vitally essential to the full development of every great seaport town. It would furnish, by the cultivation along its banks, those necessaries of life which have now to be brought from a distance, at considerable risk of loss or damage, and consequently at an enhanced value. It would maintain an unbroken water communication between the Indus, its tributaries, and this their natural outlet on the sea coast. It would obviate the inconvenience at present experienced

during the monsoon months, when communication by sea between the mouths of the Indus and the harbour is closed. It would make the port independent of the Ghizree Creek, the passage through which is tedious and uncertain. Above all, it would be a sure and necessary preparatory to the introduction of the railway, which all considerations, as well political as commercial, induce me to conclude must—unless it be permitted to fail—ignore the town of Hyderabad, and all merely provincial termini, and seek, by the directest route practicable, that one sole, fixed point, viz., Sehwan, where all possible lines of communication and trade from the northward concentrate. A glance at the map shows these lines to pass from the north and north-east down the Punjaub, and from the north-west—that is, from Affghanistan, the Khelat State, and Central Asia in general—down the Bolan Pass.

*Lastly.*—Establish your telegraphic line along your north-west frontier, and connect its Kurrachee terminus so soon as possible with London.—(1856.)

#### PUBLIC FERRIES.

I consider the farming of ferries to be an evil. The object of Government is economically to provide means of safe and commodious transit for the public across the river; and no more effectual means could be devised for defeating this object than the farming system.

The system of licensing is doubtless a great improvement on the farming arrangement. But, under the circumstances existing on the ———, I am con-

vinced that the best plan would be to make all the ferries on the river wholly free and open to the unrestrained action of public competition.

The experiment of freedom has accordingly been tried at numerous ferries, where, owing to the scantiness of the population, it was thought that the experiment would be most likely to fail. I was assured repeatedly by those who should have been trustworthy authorities, that the greatest inconvenience to the public would certainly ensue if my principles on this subject were to be carried into practice. Nevertheless, as these principles appeared to me as being universally true, the experiment was fairly tried, and found to prove perfectly successful. The public have never been better accommodated: boats have always been ready in sufficient numbers, and of sufficient size, and the rate of hire has somewhat decreased;—the truth being that the trade in ferry passage, like all other trades, follows the well-known laws of demand and supply.

It has been urged in regard of the ferries contracted for, that the contractors would not care for the smaller ferries. Possibly so; for, holding a monopoly, their gains are independent, to some extent, of the amount and quality of accommodation which they provide. But where all is left free, ferries will certainly be established, men and boats will be ready for hire at all points where ferries were required, and people were willing to pay for their passage. Free competition must undoubtedly afford the amplest accommodation at the cheapest rate, and exactly of that quality and quantity best adapted to the wants of the public.

Municipalities are of course at liberty under this system to establish their own ferries under their own arrangements; provided always they do not prevent other parties plying for hire.

Approaches to ferries should be considered as parts of the road with which they are connected, and provided for accordingly: they no more require special arrangement than the approaches to a bridge.— (1856.)

REMARKS ON A RAILWAY TO CONNECT THE INDUS  
WITH THE SEAPORT OF KURRACHEE.

On the subject of the railway in Scinde I have clear and decided opinions.

It seems that by the terms of the contract entered into by the railway company and Government, the railway should be taken from Kurrachee to Kotree,—Kotree being the only available point which can be described as being “at or near to Hyderabad.”

The contracting parties appear to have forgotten that to reach Hyderabad from Kurrachee, the river must be crossed. But be this as it may, it appears to me to be clear, that in any wise scheme for a railway in Scinde, whether considered as a part of a great northern line, or solely as a means of connecting the traffic of the Indus with the sea, Hyderabad should be totally neglected. In my opinion, the mention of Hyderabad at all, in connection with the scheme of a railway in Scinde, is a very grave error, and one which could only have been caused by the absence of correct information and of due consideration.

Hyderabad is not even on the Indus: this town is

some four miles from the river. It is on no great permanent line of communication, and has the Indus where the stream is greatest running between it and the seaport at Kotree, the station on the western bank of the river opposite Hyderabad, which appears to be the only available point for the railway terminus within the terms of the contract. The whole place for several miles around is insecure; any station formed there would be liable to be carried away bodily by the river at any moment during the inundation. It rests wholly on the alluvial soil, which near the banks of the Indus is never safe anywhere from year to year; while this particular spot, Kotree, has been, within my recollection, several times on the point of destruction.

Supposing other circumstances to be favourable, it seems, then, that to make Kotree the terminus of the railway would be to incur great risk of loss and destruction.

Such a site for the river terminus of the railway might probably ere long result in rendering a considerable portion of the line absolutely useless; for if the terminus at Kotree were carried away by the river, a new and more safe site must be sought for, and a new line constructed, to connect with it.

But it appears to me to be almost certain that, until a water communication shall have been established between the Indus and the harbour of Kur-rachee, any railway constructed merely to connect the seaport with the river will prove an enormous failure.

To give a chance of a profitable return from such

a railway, we must first connect the seaport with the Indus by water; and the best project for this purpose with which I am acquainted is the canal proposed and planned by the late Lieutenant Chapman.

By such a canal, the river would be perfectly connected at all seasons with Kurrachee as respects navigation; and at the same time an inexhaustible supply of fresh water would be provided, and a large tract of country now desert waste would be rendered productive.

The one great want at all large seaport towns, sooner or later, is a full supply of fresh water.

The proposed canal would, in meeting this want, supply the means of life and growth to a large city and seaport at Kurrachee, which could not exist without it, and which, with it, must ultimately become the chief, or probably the only, outlet to the ocean of the commerce of a portion of the globe far more extensive than even the whole of the countries drained by the Indus and its tributaries.

The growth and vitality of such a seaport are essential to the full employment and success of the railway which leads to it; and the construction of such a canal as that proposed, instead of being in anywise antagonistic to the rail, is, in my opinion, a work necessary to be undertaken in the first instance, to enable the railway to prove really remunerative.

Again, the bulky agricultural produce borne by the river boats, which would not bear the cost of transport by rail, would by means of this canal be at once transferable with the utmost facility to the sea-going craft in the Kurrachee harbour. While a very large tract



of country now lying waste for want of water would, by means of the canal, become highly productive; and its produce, both of pasture and arable land, would reach the market at the seaport in the easiest and cheapest manner by means of the canal itself, which had fertilised the ground.

At present, even to supply the existing limited demands, Kurrachee is compelled to import by sea large quantities of grass, grain, firewood., &c., from Kutch and Kattywar.

Indeed, whether a railway be constructed or not, I am quite convinced that sooner or later such a canal must be constructed.

It is very improbable that any railway, constructed *merely* to connect the Indus with the seaport, will ever prove remunerative. But the natural commercial road to the ocean of the greater part of the countries from Bokhara to Mekran,—of a very large portion, in fact, of Central Asia,—is that by the Bolan Pass.

This road, and the country in the table-land of Affghanistan near the head of the pass, is in the territory of the Khan of Khelat. The government and people of this country have for a long time past been entirely friendly and well disposed towards us, and towards the extension of commerce.

We have it in our power to improve this grand natural and almost sole outlet,—the Bolan,—as a commercial road, to almost any extent.

Sooner or later, it *must* become the channel of a mighty stream of commerce from Central Asia to the ocean,—there is no other great road.

From Dadur, at the foot of the Bolan, to Sehwan, in Middle Scinde, the country is the most favourable possible for a railway. It is almost a dead level, hard, dry plain. Sehwan is on the Indus, and is nearly in a straight line from Dadur to Kurrachee.

Such a railway will at some future time assuredly be laid down, and it appears to me that, if a railway is now to be made to connect the Indus with the sea, Sehwan is the proper point for its river terminus.

Such a line, straight through the hills from Kurrachee to Sehwan, or its neighbourhood, would not only at once serve to bring all the produce of Upper Scinde and the Punjaub by the shortest possible route to the sea, but would ultimately form a most valuable portion of the main line of one of the greatest railways in the world.

The station at Sehwan would occupy a rocky site, and apparently the most permanent position along the whole course of the Indus in Scinde; and in this respect it must be considered as a highly eligible situation for a river terminus for a railway, considered as a means of connecting the Indus with the ocean: while ALL the great northern lines of road naturally converge to and pass through this point. If it be proposed to continue the railway from Kotree to Sehwan along the valley of the Indus, it will be found that the peculiar nature of the hills which abut on the river at the latter place will present a practically insuperable obstacle to the communication, whether by tunnel or otherwise.

With regard to the direct line through the hills from Sehwan to the sea, I may observe that I know

the road well personally, having repeatedly traversed it at all seasons. It does not appear to me that any very serious engineering difficulties exist anywhere along its whole course; but to speak with any degree of certainty on such matters without a regular survey, and critical examination, is of course out of the question.

But supposing this line of road to be as practicable as it is said—and I believe truly said—to be, it must, I think, be the best possible, as being the shortest from point to point, and as avoiding all crossing of the Indus, lying, as this route does throughout, on the same side of that river as the seaport. I can imagine no change of circumstances which will not tend to add to the advantages of this route, and to lessen those of every other.

Whatever may become of the question of the railway, it appears to me to be certain that the wisest possible course of proceeding, at present, for improving the commercial communication through Scinde, would be to construct Lieutenant Chapman's canal, and to complete as speedily as possible good broad metalled roads from Kurrachee along the valley of the Indus over the Lukhee Hills, and also straight through the western hills by the line proposed above for the railway, from Kurrachee to Jungar and Sehwan.

The profit which must ensue from these works, the increased productive power and wealth which they must create in the country, might perhaps—if anything could do so—make remunerative even the short line of railway from Kotree to Kurrachee.—(*July, 1856.*)

### TRAVELLERS' BUNGALOWS AND SERAIS

I have the honour to observe that, in my opinion, it would be of the greatest advantage to the public, and, therefore, necessary to Government, if good travellers' bungalows were erected at convenient distances along the chief lines of communication throughout

---

Every bungalow should have plenty of roomy out-houses or sheds, which can be erected and kept in repair at a trifling expense, while it is of the greatest importance that every one travelling in this country in the hot season should be able to find cover.

At each station, quite distinct from these bungalows, it would be well to have a large shed, for the accommodation of native traders and travellers.

I am certain myself that all such accommodation, made available to the public entirely free from all payment whatever, must result eventually in a pecuniary return to the State.

Thus, by way of example, say one-third of the produce of the land belongs to the State, and comes into the public treasury; the country is not half peopled, and not half cultivated; every increase of means of the people is employed in increased cultivation: wherefore, everything which adds to the means of the people, in like proportion adds to the revenue.

Travellers and traders are attracted by good roads, good accommodation, and safety. The amount which such persons expend among the people is out of all proportion greater than any fees which could be collected from them: one-third of such expenditure

almost always finds its way eventually into the coffers of the State; while the free passage of strangers through a country excites new wants, new desires, and new efforts to gratify them, and thereby adds to the energies as well as to the means of the people.

On the other hand, the imposition of fees for accommodation is a merely deceptive gain: the impost, however just it may appear, is assuredly unwise. The amount collected is itself trifling, but the injurious effect of such collections may be very great. They tend to keep strangers out of the country, and to impede their progress through it; and assuredly every rupee so received into the public treasury keeps three rupees out of it.

This principle is a law of nature; its effects are certain. Even the establishment for registering traffic on this frontier acts repulsively; and though we collect no import or export duties, we actually pay an establishment to impede trade and injure the revenue.—(1854.)

**TRADE CREATES A MARKET, BUT DOES NOT NECESSARILY FOLLOW A MARKET-PLACE.**

I am unable to concur in the opinion that the increase of exports is attributable to the proclamation of fairs; and that the most important element of success still wanting is the establishment of a market at ——. For I consider that to believe the development of trade to be consequent and dependent upon the establishment of a market is to mistake an effect for a cause. Trade implies and creates a market, but does not necessarily involve a market-place artificially pre-

pared for it. In like manner, to assume that the proclamation of a fair is sufficient to attract commerce, under a free government, is, in my opinion, to assume that a measure which, in barbaric countries, where the highways of commerce are unsafe, is essential to the congregation of merchants and to the rendering of trade possible, is applicable also to a civilized state, wherein the functions of Government should be strictly confined to the removal of obstacles, and should in no instance extend to direct interference with commercial enterprise, whether for stimulus or restriction. And my belief is, that the impetus given to the exports of this province shortly subsequent to the period when the proclamation under notice was issued, is attributable to the construction of a series of bridged roads, to the abolition of frontier duties, and to the reduction of transit dues in the neighbouring territory. —(1856.)

#### POLITICAL SCIENCE RELATED TO ALL SCIENCE.

It is false political economy to increase the rates of import duties, or to tax duty-free goods, as temporary expedients, to be given up when “the land-tax and other revenues have expanded to sufficient dimensions to *permit of a reduction of the tax on trade.*” The land revenue will and must increase by the reduction of taxes on trade, and in proportion very much greater than any such reduction. — should be told that to form correct ideas of the principles—the natural laws—at work in the science of political economy, it is most necessary to study what other minds have written thereon. In fact, to understand any science thoroughly,

acquaintance with all science is necessary, for nothing is isolated in nature. Political economy, for example, may be treated chemically, as Liebig shows in his "Letters"—*vide* page 467.—(*March*, 1856.)

#### CUSTOMS AND PIER DUES.

I am of opinion that the pier fees should be abolished so soon as practicable, and that all parties, of whatever description, should be allowed the free and wholly untaxed use of the pier. If, as apprehended, the present pier accommodation prove, under a system of freedom, insufficient for the accommodation of goods and passengers, additional accommodation should be provided. But the policy of securing free and unimpeded means of transit in every direction, and under all circumstances, appears to me as unquestionable. \* \* \* —(1856.)

The levy of a moderate import duty, which formerly existed, could not check the introduction of machinery into this country. While the difficulty experienced in defining precisely what articles constitute machinery causes much discontent and uncertainty. \* \* \* —(1856.)

\* \* \* Either goods should be passed on the valuation of the importer, or, on his declining to pay the duty on the appraised value, the goods should be purchased on account of Government. The one rule is a perfect check on the other. \* \* \* —(1856.)

#### FRONTIER TRADE RETURNS.

The annoyance to traders and the impediment to trade, caused by the vexatious interference to which

they were subjected by the measures necessary to obtain the information requisite for the framing of trade returns, were at least equal to that caused by the levy of the old transit dues.

The happiest effects have followed the introduction of perfect freedom of trade on the frontier; and if a large increase of the trade itself be held to be of more value and importance than the preparation of trade returns on paper, it is certain that the abolition of the establishment maintained for registering the trade was a most just and wise proceeding.—(1856.)

#### THE INDUS FLOTILLA AND FOREST CONSERVANCY BEYOND THE SPHERE OF THE STATE'S FUNCTIONS.

If the flotilla be maintained, as at present, by Government, arrangements should be made for rendering it complete in itself, and independent of the dockyard at Bombay: in other words, proper docks, and the requisite establishment for repairing and building river-steamers and flats, should be prepared on the Indus itself. But, in my opinion, it would be advisable for the flotilla to be made over wholly to private enterprise. The effects of Government agency in this matter are, that traffic on the Indus by steam is uncertain, irregular, and costly. The people are driven, by the proceedings of the flotilla servants, from the banks of the river; and the agency itself is more costly to Government than would be that of private companies contracting with Government to perform the transit accommodation required by the State along the line of the Indus.



The conservancy of the forests by Government agency should also, I think, cease ; and the forests be let in long lease to private parties, similarly with other landed estates. A clause should be entered in the lease providing for the maintenance, during the entire term of the lease, of the forests in proper condition. I am aware that, owing to the requirements of the State and the people, in regard to fire and building-wood, many administrators, who, in other particulars, justly limit the functions of Government, yet shrink from asserting the principle of non-interference in this instance : nevertheless, it seems plain, that in regard of steam requirements, the transit companies would be as careful to maintain an adequate supply of fuel as of machinery, and that the lessees of forest land would be as anxious to produce a remunerative supply of timber for general sale as are the lessees of ordinary estates in regard of corn.

**ENGINEER AND NORMAL CLASS SCHOLARS SHOULD NOT  
BE LIMITED TO GOVERNMENT EMPLOY.**

It seems that a wish is evinced by many of the educational authorities to stipulate with the scholars of the engineering class, and with the teachers of the normal school, that they shall accept no employment other than that of Government. But from this measure I wholly dissent. The object of Government in maintaining institutions of the above description is to create in the country a better description of artificers and a higher class of public instructors. And every normal teacher or engineer who proceeds into the districts, whether upon private or public employ, tends

directly to further this object. The knowledge he has gained is at some time applied to use, and influences those around him. Thus education and engineering knowledge become general, and the State indirectly profits a thousand-fold. Whereas, every stipulation for limiting the sphere of the scholar's future exertions tends to limit the sphere of the whole, and to reduce the supply of candidates proportionately. Every scholar leaving the school, and working for his own profit, carries with him into the districts the knowledge he has acquired, and becomes a centre of practical instruction.

#### REMARKS ON THE REVENUE SYSTEM OF THE NORTH-WEST PROVINCES.

It remains only to notice one particular in which I propose to deviate from the practice which I understand to have obtained in our North-West Provinces. It relates to the system of coparcenary in a village, with joint and mutual responsibility on the part of the villagers to pay the Government demand upon the entire village. This coparcenary is not, I believe, compulsory; and can, upon the petition of one partner or more, be in part or wholly dissolved, each partner thus becoming responsible for his own estate or share in an estate. I gather, also, that under certain rights of "pre-emption," which are declared to "exist in communities of landholders," a member of such community may transfer his share, whether by sale or otherwise. But it appears to me, that whatever may be the advantage of thus preserving the village system in provinces where this system may yet survive, it

would not be consistent with the spirit of our rule to introduce among a people already too prone to follow various modifications of caste rules, a system which, in my respectful opinion, is artificial, and of a tendency to lead the community to the conclusion that Government have sanctioned their allotted spheres in life.

It is true, as I before observed, that, upon petition, the coparcenary may be dissolved. But, as the natives are found in this quarter, it would require an individual to possess unusual force of character to assert his independence; and, when asserted, it might create ill-will between him and those with whom he should live in daily friendly relations. And, on the whole, it appears to me that no method of procedure is at once so simple and so adequate to all the true and permanent requirements, as well of the peasant as of Government, as that which—after ascertaining and recording, in respect of lands already claimed and brought under the plough, the names of all parties having rights therein, together with the nature and extent of these rights—determines what the demands of Government should be against each and all of these parties, and then fixes and records what in perpetuity or for a long term of years are the exact limits of these demands.

While, in regard of lands unclaimed and lying waste, it should be generally understood that, upon application being made, any person might receive at the hands of Government such area as he may require, on long lease, upon terms admitting of the lessee's reaping a fair profit upon all labour and capital that may be expended.

By adopting this course of procedure, Government would, I consider, exercise all its own legitimate functions, and would place the entire community in a position to adjust itself in the readiest and best manner possible, and in that wherein all its energies would most certainly be called forth. The relations of neighbours would be wholesome and lasting, in that, while they would one and all be independent, it would be to the common interest of one and all freely to assist one another.

I beg, however, to add, that in thus expressing my opinion I am far from presuming to criticise proceedings which may have resulted beneficially under circumstances differing from those to be encountered here. But I have, at the same time, no hesitation in submitting that, in so far as this province is concerned, we should, by binding up the peasantry in village coparcenaries, or by sanctioning their being so bound up, interfere directly or indirectly with the social freedom of society. We should place the agriculturalists in false relations among themselves; should increase indolence and want of independent spirit; and, precisely in proportion as we might prove successful in creating and maintaining the village communities to be so composed, should tend to stereotype society, to nip the expansive energy of the people, and thereby to check industry, and to diminish the sources of wealth and of increased public revenue.—(*August, 1856.*)

#### REVENUE SETTLEMENT.

We cannot too earnestly bear in mind that a revenue survey and settlement is merely a short name

for proceedings involving the rights, good order, and advancement of the true interests of the Government we serve, and of the people confided to our charge. When boundaries have once been clearly defined and permanently marked, and when agricultural rights have been fairly ascertained and registered, the collector and magistrate should exercise his revenue powers as seldom as possible, and should endeavour never to appear unless in his judicial capacity. To prevent neighbour interfering with neighbour; to positively resist all undue interference on the part of Government agency, whether high or low; to leave the people alone and let them grow: in this lies the essence of a really good collector. He should never for an instant allow the appearance of his next revenue report to weigh against any measure which he knows to be right, and for the permanent good of his districts. For myself, I have long perceived, that despite the best intentions on the part of our home and Indian governors, we have sadly overtaxed the people. They have no surplus; no room for growth; no spare cash wherewith to indulge any wish, even for the cheapest luxury. And, fully aware of all that has been said in favour of exactly adjusting the Government demand to the quality of the soil and its facilities of waterage, I am persuaded that, with our defective information of the real resources of the country, and perhaps under any circumstances, we should better and more permanently have developed our agricultural wealth, should have more surely secured the comfort and the increasing productive powers of the agricultural classes, and should at this

day have been richer as a Government, and with more certain prospect of future increase, both for the people and Government, had we in the first instance limited our demand to that which the poorer soils can bear, and had we considered the waterage not as a separate tax, but as included in the one sole demand per acre upon the land.

Above all, avoid over-governing and unnecessarily interfering. Depend on it, the people understand their own interests better than you do. See that all men know, and feel secure in, their rights. Remove all obstructions to free intercommunication; and then stand by to keep the peace.

#### TITLES TO LAND, AND LEASES.

I learn that in some parts of the — collectorate considerable extents of arable land have been thrown out of cultivation, owing to what seems to me an unquestionable misapprehension of the instructions which have from time to time been issued relative to proprietary rights and claims upon the soil.

It appears that when a cultivator rents land upon which a zemindar or other claimant may hold an admitted right to a portion of the surplus produce, whether under the name of “lappa” or what not, the practice is to demand from such cultivator the same rate of tax which Government may be levying from similar lands cultivated by a proprietor subjected to no claim intermediate between himself and the State; and then to allow the zemindar, lappawalla, or other claimant, to levy what he may claim as his due from the cultivator also. In other words, the Government

having levied what is assumed to be the full tax which the cultivator can pay, and yet retain a fair profit upon his own labour and capital expended,—having, that is to say, taken as much of the surplus produce as can be equitably taken,—another and third party, under the name of lappawalla or zemindar, is allowed to make a further demand upon the remaining produce, which Government had left to the cultivator as necessary to a fair profit on his own labour and capital. Nor is this all; for when the cultivator, gradually impoverished, by the levy of this double land-tax, is compelled to relinquish his fields, it is supposed that no other tender of tenancy can be accepted, unless upon condition of the applicant's assenting to the double tax which had already ruined his predecessor.

Manifestly, such a mode of procedure must inevitably lay waste and ruin any country subjected to it; and, in the instances under notice, amply accounts for the wide tracts of good land, with facilities for waterage, which, during my tour through the districts, I observed to be lying waste.

As manifestly it never would or could have been the intention of Government that any tax should be levied from the cultivator, whether on behalf of Government or by the zemindar, unless upon the surplus produce, I consider it is necessary to explain that no rules should be held as rules inculcating that Government and all other claimants on the soil are to be in the first instance satisfied to the full, and then the remainder, if any, of the produce, to be left with its immediate producer, the tenant or cultivator; but

that all rules should invariably be understood in the spirit in which they were written, viz. as pointing out to the revenue and settlement officers, that claims of the specified descriptions would be advanced in different parts of the province, for greater or lesser portions of the surplus produce of the land, and that, where found, the settlement officer should carefully investigate them.

And deeming it further essential to preclude the possibility of measures so widely disastrous in their effects as those now commented on being stereotyped under the regular settlement, I think it right to lay down the following propositions, which, taken in connection with former correspondence on the same subject, will, I trust, render it impossible for any revenue or settlement officer to feel himself at a loss to determine who may have claims upon any given area of land, what may be the nature of those claims, upon what terms they are to be admitted, and from what particular portion of the gross produce of the said land they are to be satisfied.

I. All lands, of whatsoever description, must fall under one or other of the three following headings:—  
 1. Lands lying waste, and unclaimed. 2. Lands lying waste, but claimed, wholly or in part. 3. Lands claimed, brought under the plough, and cropped, whether annually or after a shorter or longer succession of fallows.

*1st Heading—Waste Lands, Unclaimed.*

II. Wherever any revenue or settlement officer



may find land coming under the first heading (waste and unclaimed), he is at perfect liberty to grant all or any portion of the said land in lease for a short or long term of years, upon such terms as he may consider expedient and equitable; and subject, of course, to the confirmation of competent authority.

III. Leases so made shall be drawn up, duly signed, and witnessed; and shall be administered in exact conformity with the terms specified in the deed itself.

IV. In leases so made of waste lands unclaimed, the sole parties having any claim whatsoever upon the land leased are the Government and the lessee. And every man in the country is perfectly free to contract for such lease, without let or hindrance on the part of any jagheerdar, zemindar, or other party, provided he (the lessee) be willing to accept the terms, and give the security required by the leasing officer, in the deed of lease.

V. It is not necessary that the lessee should be one, and one only. On the contrary, if two or more persons tender to accept a lease, they shall severally, and with joint responsibility, sign the deed, as set forth in Rule III., and shall jointly and severally be held responsible for the fulfilment of the terms of the lease.

VI. Should the lessee so contracting make private arrangements with third parties, whether in view to sub-letting, or other contract or advantage, he is at liberty so to do. But in the event of any dispute arising consequent upon the sub-tenancies, or

other private arrangements, such dispute shall be tried in the ordinary manner of a civil suit in the civil courts.

VII. And no sub-tenant, private contractor with the lessee, or other third party, shall be admitted by the revenue officer as having any claim whatsoever upon the land leased, which land, upon the expiry of the lease, shall revert free and unencumbered to the Government, unless the same or some other lessee shall accept the said land in further lease, upon terms to be re-adjusted and registered in the form laid down in Rule III.

VIII. Upon the lease being re-adjusted, preference should be given to the former lessee over any indifferent party.

*2nd Heading — Lands lying Waste, but Claimed, wholly or in part.*

IX. Wherever the revenue or settlement officer may find lands lying waste, but nevertheless wholly or in part claimed, he should, after thoroughly satisfying himself of the validity of such claim, interrogate the claimant as to whether he were able and willing either to cultivate all or any portion of the land himself, or to produce other parties to do so under his superintendence, or under his guarantee of the Government tax. Evidence should also be taken from trustworthy persons as to the period during which the land in question may have remained waste. And if it should appear that the land had lain waste for a continuous period of six years, and that the claimant was still unable or unwilling to take the responsibility

of paying the Government tax upon all or any portion of it, this whole or portion should be declared to be unclaimed waste land, and should be treated in exact conformity with the rules already enumerated in regard of lands lying waste and unclaimed (viz. Rules II. to VII., inclusive). For no deviation should be allowed from the rule that every claim upon the surplus produce of land—every claim, that is, to participate in rent, whether under the appellation of zemindaree, lappa, or other name—does by its origin and nature imply and involve the Government's receiving its fair amount of revenue also; and that, therefore, unless the claimant can ensure the latter, he cannot equitably advance the former.

X. But should it, on the other hand, be ascertained that the land claimed, although at present lying waste, had been cultivated within the period of limitation, viz. six years, and that there existed a reasonable probability of its being again brought under the plough within a moderate term, say of one or two years, it will in such case remain in the discretion of the settling officer to allow the claimant one or two years' law, or, in the event of another party offering to take the land in lease, to grant such lease, for a long or short term, and to decide that, during the term of the said lease, the claim should remain dormant, but be capable of revival at the expiry of the lease, in the event of the claimant being then in a position to fulfil, and willing to satisfy, the conditions inherent in the origin of the claim.

XI. Waste land claimed, and thus to be brought

again under cultivation, will, of course, be dealt with as land claimed and already under the plough, as set forth under the next heading.

*3rd Heading—Lands Claimed, and under Crop or lying Fallow.*

XII. Under this heading, it is manifest that all claims must be either upon the means requisite to production, or upon the profits of production.

*Clause 1.* By the means requisite to production is understood the outlay of capital and labour, and the fair equivalent for risk in, and interest upon, this outlay, without which the producer cannot subsist and continue to produce.

*Clause 2.* By the profits upon production is understood the surplus yield of produce over and above the outlay requisite to production, as set forth in the receding clause.

XIII. And it is to be clearly understood and acted upon, that on no occasion, and under no circumstances whatsoever, should claims upon the said surplus yield be allowed to fall upon the means necessary to enable the producer to continue production. In other words, whenever there may exist one or more parties other than the Government, having valid claims upon the surplus produce, the claims of Government and of the other claimants must be so settled as that the total of them shall not exceed the total of the said surplus yield. For example, suppose an estate to yield a gross produce whose money equivalent should be equal to Rs. 300 annually; and that of these Rs. 300 some Rs. 166½ were expended in the tillage, waterage,

and other outlays requisite to secure the said gross produce, while Rs.  $33\frac{1}{2}$  were required as an equivalent for risks and interest on outlay.

*Clause 2.* Further, suppose this estate to be held successively under the following tenures:—1. By the proprietor, holding direct from Government, and cultivating the estate himself. 2. By a zemindar, holding a claim of greater or lesser value upon the surplus produce, and cultivating the estate by hired labour.

. *Clause 3.* In either case, it is evident that, if any portion greater than Rs. 100 be taken in the shape of rent or surplus produce, whether by one or more claimants, such excess must be taken from the remaining sum,  $\text{Rs. } 166\frac{2}{3} + 33\frac{1}{2} = \text{Rs. } 200$ , which are required in order to render continued full production possible, and must therefore inevitably result in the state of matters described as being now visible in parts of the — collectorate.

*Clause 4.* It follows, then, that this state of affairs, can be avoided only by Government and all other parties limiting the aggregate of their claims upon the estate to an annual demand not greater than that of Rs. 100.

*Clause 5.* If, then, as supposed in the first instance, Government should make its demand direct upon the cultivating proprietor, it should consider that beyond the Rs.  $166\frac{2}{3}$  requisite for tillage, waterage, &c., the proprietor should also be allowed a certain margin on account of risks and interest, &c. This margin has been now supposed equal to Rs.  $33\frac{1}{2}$ . There would then remain a balance of Rs. 100 leviable as rent,

and which balance would, accordingly, form the limit of the possible Government demand, although it would not follow that Government should in every case demand this full amount.

*Clause 6.* Again, suppose, as stated in the second instance, that a zemindar or other claimant upon the said estate should intervene between the actual cultivator and the Government: in such case, Government should not, as appears to have been the practice in some instances, levy the full rent of Rs. 100 direct from the cultivator, and then leave the zemindar to levy his perhaps indefinite demand from the cultivator also. But Government should, on the contrary, first admit that, be the claims on the surplus produce what they may, Rs. 200 must remain with the producer, or otherwise production would eventually cease; and that therefore, be the claims on the surplus produce what they may, they must not in the aggregate exceed Rs. 100. So much admitted, it would next remain to be ascertained who the claimants may be, what the validity of their claims, and what their extent. Suppose, then, it to be ascertained that the zemindar took all risks, and provided all capital, &c., requisite to production: Government would in such case consider him entitled to the margin set apart as before shown, as an equivalent to those risks, &c., viz. Rs. 33½, and would consider the limit of the extreme Government demand to be Rs. 100, leaving the remaining Rs. 200 in the hands of the zemindar, to do with as he might please.

*Clause 7.* But suppose the proved claim of the claimant to be merely that of a small and specified

lappa: it would then be open to Government to select either of two courses, viz., to constitute the claimant, if he be so willing and able, the responsible tax-payer of Government, defining, at the same time, the rights of his sub-tenant, or cultivator, and so to levy upon the claimant the Government's fair tax; or, in the second place, to settle directly with the sub-tenant or cultivator in the manner laid down in regard of the cultivating proprietor, viz., to allow the party settled with Rs. 166 $\frac{2}{3}$ , on account of outlay requisite for tillage, waterage, &c., Rs. 33 $\frac{1}{3}$  on account of interest and risks, and to consider the Government demand limited to the remaining Rs. 100. But, in this second case, the lappawalla would have no claim whatsoever against the sub-tenant's or cultivator's Rs. 250. On the contrary, whatever he might receive, he would receive out of this Rs. 100 surplus.

*Clause 8.* But although, in each and all of these examples, Rs. 100 forms the limit which the Government could demand, and yet admit of production continuing, and the producer's subsisting and fairly meeting his risks and outlay, yet it does not follow that Government should in all cases demand the Rs. 100 in full. On the contrary, in the case of the lappa claimant, referred to in the preceding paragraph, a specified portion of the Rs. 100 would be set aside for him. In like manner, but in greater proportion, would a zemindar proving a claim to the entire rent, minus the Government tax thereon, participate in the Rs. 100.

XIV. The settlement officers should bear in mind that, having determined what the Government demand

upon any given area shall be, and having further particularised upon whom the demands shall be made, they have reached the limit to which the interference of Government can legitimately extend in regard of Government's relation to the soil. And any further inquiries and decisions which the settlement officer may record are purely of a judicial character, having for their object,—1. To determine clearly, and for a permanence, what the exact position of the tax-payer may be, to the end that, when he has entered into his contract of lease with Government, he may not be subjected to the fraudulent claims of other parties.—2. To decide and record, once for all, all rights and claims in this soil which might otherwise come before the ordinary civil courts, held at times and in places where it would be impracticable for the judge to collate evidence of the fulness and reliability which is usually open to the settlement officer.

XV. The determination of these claims (other than those of the Government) and relations being of this purely judicial nature, the settlement officer should be most careful to avoid checking the individual freedom and energies of the villagers, by binding up the entire community, as it were into one body corporate. To do this would be to return in spirit to rules of caste, and to nip the energies of the people in the bud. Nothing of this character, therefore, should be attempted. On the contrary, while recording what may be the proved rights and claims upon a given area of land, the settlement officer should never omit to make all the villagers understand that every man, be he whom he may, is at perfect liberty to



employ his labour and capital in such place and in such manner as he may consider most advantageous to his own interests. And that it is, therefore, quite open to him and his neighbours to take up new lands, or lands lying waste, in lease, upon his own account, if he consider such course preferable to remaining on land whereon other parties may hold claims proved and admitted before the settlement officer.

XVI. If the settlement and revenue officers will constantly and effectually impress the foregoing freedom of action upon the villagers, and decide upon and register the proved claims, we may then become perfectly assured that, in regard of determining all rights in the soil, and in removing at the same time all obstacles to the free development of agricultural industry, we shall have accomplished all that is practicable with advantage. And if, after such warning and adjudication, it should be found that the villagers still remain in the hands of the bunya, or remain as sub-tenants or mere labourers, while it is wholly at their option to take up fresh lands upon their own account and on equitable terms, we may also become assured that the party voluntarily remaining thus trammelled and subordinate does so on account of circumstances subsisting between the bunya or the zemindar and himself, which induce him to consider that, on the whole, it is preferable to remain in his present position rather than try his venture elsewhere. To obviate or ameliorate circumstances of the description here alluded to is beyond the power, as it is beyond the province, of Government. They can diminish and cease only with the growing intelli-

gence, honesty, and industry of those who suffer from them.

In the foregoing rules, no mention is made of "jagheer," "hissadaree," or other rights to the Government share. These rights are alienations, in part or altogether, of the Government share.

#### ARTIFICIAL ENCOURAGEMENT TO AGRICULTURE.

It is the practice in some districts to endeavour to stimulate the exertions of peasantry towards the cultivation of some peculiar produce—such, for instance, as linseed or indigo—by proclaiming rewards or honorary distinction to the individual who may successfully extend the cultivation of the specified produce. But it seems to me, that the effect of this artificial encouragement on the part of Government is to defeat the object in view. In brief, it unhealthily interferes with the natural market of the articles thus forced into existence; and, by disturbing the free adjustment of demand and supply, tends in the long-run to diminish the latter. The fair profits of farming, in an open market, are the best and sole legitimate stimulants of an extended cultivation.

#### MANAGEMENT OF PASTORAL HILL TRACTS.

I instructed the collector that I did not anticipate we should be enabled to turn this region to any profitable account by collecting a revenue from the present scanty agricultural produce of its rain lands, and that I should not deem it advisable to levy such tax, even although cultivation should be extended; but that the hill tracts were chiefly valuable as grazing-

lands, and that we might do something towards ameliorating the condition of the hillmen, by assisting them to construct a few wells or bunds for supplying their cattle and themselves with water; by endeavouring to introduce into their villages or grazing districts some form of patelship; by ascertaining, registering, and *perhaps* levying some slight capitation tax upon the cattle; and by opening up roads through the more frequented villages, to enable the hillmen to bring the produce of their flocks and herds readily to market.

With the object of more accurately ascertaining the social statistics of this region, I supplied the collector with a form of statement, showing the name of every village, tract or valley; the names of the chief men, and approximate estimate of the numbers of inhabitants; the size and description of boundaries; the number of flocks and herds; and the number of wells. But, above all, I impressed on him the necessity of bearing in mind throughout these proceedings with the people of the hill tracts, that they are essentially a pastoral, and, therefore, in some degree a nomadic race, and that no attempt should be made towards compelling them to have recourse to agriculture; on the contrary, that they should be left wholly free to choose their own mode of life, as circumstances might permit.

The staple wealth of these districts naturally consists in flocks and herds. These, together with ghee, wool, and other pastoral produce, they can exchange for the more varied commodities of the plains, thereby commanding the supplies of distant markets at a less cost than they could be produced for at home; and I

think that our object should be to promote these interchanges, by means of improved communications, and thus gradually to create, among these half-civilized races, new wants, increased productiveness, and a higher social condition. By thus encouraging its natural development, we should tend to supply wants now much felt in the plains. And as the hill region lies along our western frontier, we should, by civilizing and attaching to us its wild people, tend to cause a corresponding extension of wholesome English influence among exterior tribes, and so, permanently and by the most unexceptional means, to strengthen our front, whether for peaceful or warlike operations.

#### TAX NOT THE DESERT.

The Thurr or Desert District yields a coarse but very nutritious grass. I would not, however, recommend that any grazing-fee should be levied upon this: for it appears to me that, in a tract like the Thurr, our main object should be to induce the tribes to refrain from plunder, and settle down peaceably to the agriculture of the neighbouring lowlands; and that, in order to secure this result, we should render their circumstances easy, by leaving untaxed their pastoral wealth.

#### RESTORATION AND DUTIES OF VILLAGE ACCOUNTANTS.

Government have resolved upon restoring the ancient office of putwaree or village accountant, which fell into desuetude when the village communities were broken up. This agency is intended to record and preserve the rights of the cultivator, and to

supply full and accurate agricultural statistics. These registers will be maintained in a form so clear, simple, and public, as to preclude the possibility of the abuse of power on the part of Government servants. These accountants will be paid by Government; but their being thus rendered Government servants does not preclude their keeping the accounts, or providing for the interests, of the cultivator. On the contrary, these agents are intended to form the connecting link between Government and the land-tax payers, in their mutual relations. It will be their duty equally to protect the Government revenue from fraud on the part of the cultivator, and the cultivator from undue interference on the part of the Government officials. The putwaree's records will eventually be kept in the provincial vernacular; but in the first instance general intelligence and good character should determine the selection. And no candidate should be rejected simply because he does not understand a particular written character. A Hindoo villager may be as apt material for an accountant as a Persian writer, although he may be conversant only with the 'khoda-wadee' mode of writing.

#### SALARIES TO VILLAGE ACCOUNTANTS.

The question is in fact reduced to this :—Shall the putwaree (village accountant) be paid by Government in cash, or be remunerated in kind or what not by the cultivators? Viewed from a financial point merely, it is manifestly immaterial which alternative be adopted. For if the cultivator should pay this tax, allowance would be made accordingly in the revenue

settlement; otherwise the labour of the cultivation would be indirectly forced to the amount of the tax. If, on the contrary, Government should pay the putwaree, the revenue demand upon the cultivator would be proportionately increased. In other words, the interest of Government and the cultivator being identical, and there being a given amount of wealth to be partitioned in equitable and recognised proportions between these two parties, it is evidently indifferent whether these portions be allotted under the name of revenue, or pay to putwarees.

The question of who should be the direct remunerator of the putwaree must, then, depend upon considerations other than those of finance. And it appears to me, that, when introducing a settlement whose chief intent and use is to define, register, and secure the rights and obligations of both Government and cultivator in their relations to the soil, it would be neither consistent nor wise to leave the wages of the connecting link—the putwaree—between the two parties unfixed, undefined, and liable to the caprice and convenience of the less wealthy and less intelligent party. For these, and other reasons, I beg you will act upon the principle that all putwarees are to be paid in cash, by Government. The exact amount of remuneration in every individual case, being dependent upon the yield and difficulties of the particular charge, may be left to the discretion of the settling officer.—  
(*April, 1856*).

### PROTECTION OF BUNDS BY CONTRACTS.

I am of opinion that these disbursements are the most unsatisfactory that are made. They are wholly unchecked, and are made at a season when frauds can be, and doubtless are frequently committed.

It becomes necessary, therefore, to remedy the present unsatisfactory state of this public expenditure, and to endeavour so to provide, as that, while the bunds shall be efficiently watched and guarded, no charges shall be made on such account other than may be fairly and necessarily incurred.

It may not, perhaps, be practicable to make these provisions with any great degree of accuracy: still something may be done; and I quite concur in a recent suggestion that the zemindars, really interested in the security of these bunds, should be invited to enter into contracts for their maintenance. Accordingly I request that, upon all future occasions of providing for abkalanee expenses, you will be guided by the rules now transmitted.

It is possible that, for a year or two, the tenders for these contracts may be unreasonably high; and in the first instance, therefore, no contract should be entered into for a longer period than one season. But sooner or later the market will certainly find its own level, and it will then remain in the discretion of the local officers to grant contracts for one or more years, as they may deem expedient.

Whether the work be given to contract or be estimated for (*vide* Rule VI.), each and every work, given in contract or estimated, should be reported, so

that the Government may be informed beforehand of the amounts to be expended, during each successive year, in watching and protecting the bunds in this province.

*Rules relative to the Preservation of Bunds.*

I. The watching and protection of bunds will, for the future, be performed by contract.

II. With this view, the collector or his deputy will annually invite tenders for the watching and protection of all bunds situate within their districts.

III. All parties making tender shall provide full and good security. The security should be some substantial native banker, who should agree to make good whatever cost may be necessary, in the opinion of the officer making the contract, to complete any portion of the work contracted for, which the contractor may have failed properly to execute.

IV. The parties directly interested in the preservation of the bunds must be those who will be able to undertake the contracts for keeping them in repair at the smallest cost to the State, and greatest profit to themselves; and the officers concerned in these transactions should endeavour, as much as possible, to induce a right understanding of this business among the zemindars whose lands the bunds affect.

V. The work the contractor will be expected to perform is, before the water reaches the bunds, to fill up all cattle-tracks, to fill up any sinking, all cracks or ruts, and all rat-holes; to repair, and, where necessary, to renew the "juk." When the water comes on the bund, the contractor must keep up the number of watchers ordered. He must at



once stop all leaks and breaches, and repair all damages done by rain.

VI. Failing any tender, the probable expenses of watching and protecting bund or bunds should be approximately estimated, upon a calculation of the average expenses of former years, allowances being of course made for any accidental circumstances that may affect the particular season under estimate.

#### TANK DIGGING.

The object contemplated in digging the — tank was to try whether a considerable body of fresh water could not be made to penetrate into the ground during the inundation of the Indus, and whether thereby it might not be possible to render the sub-soil sweet, and to make the wells in the neighbourhood of the tank supply a sufficiency of fresh water all the year round. It was also expected that eventually the tank itself might be made to contain water throughout the year.

The experiment, as far as it has gone, has been perfectly successful, and the tank has proved a very great blessing to the people. One of the wells in its neighbourhood, into which the river-water was not turned, purposely to try the percolation of the tank, has been rendered perfectly sweet, whereas before it was brackish. The tank itself contained water two months after the subsidence of the inundation; and if dug deeper would never be dry. \* \* \* Of course no masonry is used for lining the tank.—(1852).

## EFFECT OF REMOVING DAMS.

I find that all the offshoots from the main feeder have had their mouths constructed with dams projecting far into the channel of the main feeder. This practice is most injurious under any circumstances, is liable to the greatest abuse, and has been the cause of much unfairness in the supply of water to the landholders, without corresponding benefit to any party.

While these dams greatly impeded the onward flow of the water in the main channel, they really added very little, if anything, to the quantity flowing into the smaller canals, which (the main channel being sufficiently full) must be regulated by the quantity drawn off from them for irrigation. \* \* \* I therefore determined to remove every particle of dam. Upon this, many of the landholders refused to clear their canals, and gave out that the removal of these dams would prevent them getting a drop of water, and that every rupee expended on their water-cuts would be wasted. Such, however, proved to be the increased supply, owing to the free clearing and opening of the main channel, that the water, even in these uncleared canals leading from it, stood two feet higher than usual, and, in many instances had to be banked out of the fields. \* \* \*

Many of the landholders have now admitted the unreasonableness of their opposition; and the complete exposure of the fallacy of their strong prejudices in this matter will, I doubt not, be of great benefit generally among the country-folk.—(1853).

**INCREASED CULTIVATION FOLLOWED BY MORE  
ABUNDANT RAIN IN THE DESERT.**

My remarks regarding the boundary line on this frontier, and the advantage of having the political to coincide with the geographical boundary of the desert, were founded on the supposed permanency of the latter. No change appeared to have occurred between the time of my first visiting the desert and that of recording my opinion—an interval of twelve years. According to the traditions of the natives, no important change had occurred for nearly a century, and its limit appeared to me to be as permanent as that of the sea shore. It now, however, seems that the desert is partially disappearing, and that its line is no certain boundary. I attribute this disappearance in part to the greatly increased cultivation along the border, which tends to augment the fall of rain. It is true the natives attribute this fall to the blessing of God, which may be true enough; but the secondary cause is cultivation. And I anticipate that if peace and quiet continue, and a few more such seasons as the last occur, the great part of that which was formerly a desert will become arable or pasture land.—(1851).

**MORAL INFLUENCE EXERTED AS AN ELEMENT IN  
SECURING LARGE NUMBERS OF LABOURERS AMONG  
RUDE TRIBES.**

In judging the rates of labour at which I believe it practicable to excavate a large canal leading from the Indus through the heart of the desert to the hills

of Beloochistan, I rested my calculations on principles which refer to wild tribes, human passions, and a patriarchal rule. Not indeed that I disregarded the rules of ordinary civil engineering. But possessing an intimate knowledge of the country, of the people, of their statistics and habits, and taking into my account moral forces and influence, which I knew could be exerted by myself and my lieutenants in aid of the work, I arrived at the conclusion that the project of the great desert canal could be successfully carried out at the cost mentioned by me,—a cost for which, I am equally certain, it could not be carried out by the Public Works department, proceeding on principles having reference to a more regular, a more civilized, and a more highly-organised state of society.

The forces here employed are not apparently such as are commonly calculated on: yet I have used them largely: have found them of mighty power, and to lead to excellent results. I thus reckoned on them according to my own experience and knowledge.

I would allude to one instance, that of the canal leading through the desert to Khyree Ghuree. This canal has been extended some thirty miles, with an average sectional area of about two hundred square feet. It has been executed at the rate of one thousand cubic feet per rupee, and the largest boats can move along it through the middle of the desert. The mode of procedure was as follows:—Those tribesmen wishing to become holders of the lands to be watered by the canal were assembled, the scheme freely discussed for some days; and, upon their becoming convinced of its utility, every man under-

took to perform a part of the excavation proportioned to the area of his lands, receiving a similar proportion of the total sum allowed by Government for the work.

A contract to such effect was then regularly drawn up, and signed by every individual, the work was justly apportioned, and the result is, that the canal is completed in good style, without any professional aid, and to the entire satisfaction of every man concerned in it. The people are as proud of their work, and boast of it as loudly, as they would, in former times, have boasted of a successful foray. The return to Government upon its original outlay is fifty, and will soon be seventy-five, per cent.

The truth is, that having during a long series of years dwelt among, and, by acting justly, obtained the confidence of the tribes, we found it possible to collect a large number of men from the neighbouring territory, who were ready to work at very moderate rates upon a popular public work. But these men would not have worked under, or even appeared before strangers; and I am well assured that had the work been undertaken by professional officers, not only would the preliminary requirements have delayed, and the professional rates have enhanced the cost of its execution, but labourers would not have been forthcoming to execute it.

The principles I had found successful in the case of the Khyree Ghuree canal, I had proposed to adopt in the case of the great desert canal. And I would not advise that, in such a country, and among such a people, any proceedings in this matter should be com-

menced, unless upon the principles I have tried, and proved to be sound.—(1856).

#### MILITARY COMMISSIONS AS COURTS OF CIVIL JUDICATURE.

These trials were always rehearsed before the “civil judge-advocate,” and then the farce was duly played off, all being well drilled in their parts before three officers, forming what was called a military commission. The members of these commissions were sworn to try the titles to lands, cases of bribery, &c., by civil officers, and all manner of such like things relating to revenue matters, &c., “according to the custom of war in like cases.”

The trials were a mere pretence, a veil to delude the public, the only real authority being the pleasure of the Governor.

But even up to the present moment the want of proper courts of justice is one of the greatest wants. Though it may be true that the system in India, with its eternal appeals and reversals, &c., is so bad that it is better to have none, still it is a serious want. There is now no court in which an action can be brought against the collector or against Government; while—and this is the greatest evil of all in practice—the revenue officers, having the whole judicial duties of the province to perform, have little time left to attend to their proper fiscal duties.—(1854).

#### POLICE CONFESSIONS.

I would point out to you that a police officer is quite forgetful of his duty who, on any occasion, even asks, however gently, a prisoner to confess: violence

of any kind on the part of a police officer, in such cases is a deeply criminal offence, for which several years' imprisonment with hard labour would be a just reward.

Police officers should not only never resort to violence or threats to obtain confessions, but should invariably abstain even from persuasion in such cases. Police officers or men should *not even be permitted to receive confessions*, and should be rebuked when they presume to do so.

It is the function of a magistrate alone to receive the confessions of criminals, and this cannot be too often or too carefully impressed on the minds of Eastern policemen. The neglect of this well-known rule has been, in many instances, throughout India, the cause of extensive and deplorable evils.

These principles have been investigated by some of the ablest men of the day. They are in accordance with sound sense and reason; and they continually receive the stamp of the highest legal authorities, in being taught and enforced by the judges in our courts of law.—(1856).

#### ON THE SUPPLY OF CARRIAGE IN A FREE MARKET.

I have to remark, that there are no orders or regulations whatever in force in regard to the supply of carriage for public or private purposes in the bazar of Jacobabad. In this, as in all other respects, everything has been left to find its own level.

To meet existing demands, however, divers persons have established themselves at Jacobabad, who profess to supply, and who do actually supply tattoos, camels,

&c., as required, for hire ; but these people are acting entirely as private traders, and are not interfered with by authority in any way. In this, as in all other respects, our market is perfectly free. Every effort has been made to remove obstacles to free trade ; but in all other respects, even on emergencies, interference with the natural adjustment of demand and supply has been studiously avoided.

It is absolutely certain that the cheapest market is the freest market ; and it is only the effects of interference which cause even superficial observers ever to think otherwise.

When slaves are first emancipated—unfitted for freedom, they commit outrages and excesses : but these evils are the effects, and the very worst effects, of slavery, which debases body and soul, destroys self-respect, and unfits men to take their places as social beings ; not of freedom which tends to bring out every good quality, and to make men see that their well-being is involved in that of all around them. The same laws hold good in trade on the largest or on a small scale—the law is universal.

Interference with a man's right to sell, how and where, and at what price he chooses, keeps sellers from the market, limits supplies, and raises prices.

Compelling men to sell at certain rates, or in any manner contrary to their own will, is a species of robbery ; it can only be perpetuated by violence on one hand, and by the payment of exorbitant prices by the consumer to meet the cost of the machinery by which this force is applied, as well as the price of the supply, on the other.



The extra price paid by the consumer for the article he requires in such cases not only has no tendency to improve the rate of supply, but is actually expended in hiring men to drive traders away from the market. Like all principles which oppose nature's laws, the evils caused thereby must increase until they become perceptible to the dullest understandings, or until a dead lock occurs.

On the other hand, where perfect freedom is carefully maintained, the most exorbitant prices are those which soonest adjust themselves. Where real freedom exists, no combination can possibly long maintain prices above their natural rates, while competition must bring them down to the lowest healthy prices.

It is evident, where a vicious system of interference has long prevailed, especially among Orientals (who are naturally dependent, and who fear to stand alone, trusting to truth; industry, honesty, only for success), that when all restraint may be withdrawn, some time may be required to enable natural causes to act, and to restore the equilibrium which has been disturbed by our faulty proceedings.

During this interval, the market may not be supplied at all, or may be very badly supplied; but to restore health we must pay nature's penalty for vice, whether moral or corporeal.

We must be content to *pay*; we must open new channels of intercourse; we must seek supplies further off: all this honestly persevered in for a very moderate period brings everything into a sound, healthy, vigorous state! obstacles having been re-

moved, everything flows towards the spot where it is wanted, and all parties are more than satisfied.

These laws are as well known and recognised generally as the theorems of Euclid; but there always seems to be a difficulty in applying them to *particular* occasions. Men seem to want firmness and faith to follow out, even in such matters, principles which their reason tells them are true. But a very little perseverance would resolve all doubts.

In these cases, the inconvenience at first experienced often falls very severely on individuals; and, indeed, let these proceed as they will, the evil never can be remedied until Government and its officers, in their public capacity, act in conformity with the natural law.

For instance, any violent or sudden change in a market must take time to adjust itself properly.

The move of even one regiment, under present arrangements, constitutes such a change.

A demand suddenly arises; the supply is not forthcoming: the only remedy applied by Government, or its official, is *force*; every man's property is seized, and an enormous evil perpetrated, which, as all such evils must do, ultimately causes to the public revenue a loss, through indirect channels, enormously greater than any requisite direct payment could amount to.

Let the only wise principle be established, and always be enforced, that the State, requiring anything, is bound to purchase it, like other people, fairly in open market, and all difficulty disappears.

One sudden payment of an immense sum, to enable

a regiment to move, would at once open the eyes of our rulers to the necessity of putting matters on a more healthy footing. Yet it is certain that the injury to the revenue of the State, through the effects on trade and agriculture, is almost infinitely greater than the loss which would be caused by such payment.

The remedy manifestly is to cause our troops to be maintained in a moveable state; officers and men being at all times provided with proper carriage. There is no difficulty in this; I have practised it with a large body of troops, for fourteen years past, with perfect success.

The effect of such a healthy system is that the presence of such troops, whether stationary or moving, is felt to be the greatest blessing by all the country-folk.

The people find a ready market for labour and supplies, and the troops find, and are made to feel practically, that the good-will of the people is of vast importance to their comfort and convenience.

A large proportion of all such expenditure as that on the permanent carriage of troops, also speedily finds its way by a thousand indirect channels to the Government treasury.

By expenditure on the permanent carriage of soldiers I mean, of course, *bond fide* expenditure: the sums laid out on gomashtas, contractors, and all manner of commissariat underlings, come under very different conditions.

To have things in a healthy state, the soldier must be his own commissary.

In regard to the different working of the systems under discussion, it may not be amiss to note one glaring fact.

In December, 1845, when troops were suddenly ordered from Sind to take part in the Punjaub war, I was in the act of mounting my horse one morning for parade at Hyderabad, when the Assistant Quarter-master-General came to me from the General, and asked when I should be able to march with my regiment on service to Bhawalpoor.

I replied that I was ready to march that moment. This was scarcely understood, until I explained that such actually was my meaning; but march I did that same day, with the whole corps complete and in perfect order, without any external aid whatever.

At the same time, the necessity of the speedy march of the regular troops from Hyderabad was strenuously urged on General Simpson by Sir C. Napier. To supply carriage there was the newly-formed Baggage Corps, and, besides this resource, the whole country was "driven" far and wide by collector and commissary.

Yet, in spite of every effort, and of all this heavy machinery, not a single regiment, even of infantry, could be moved one march until fifteen days after the Sind Irregular Horse had departed; by which time we were encamped at Roree, some 220 miles distant.

Yet the cost paid for carriage by the State on this occasion would probably have paid that of the carriage of the Sind Irregular Horse for ten years together; and in the one case the money would have been

expended to the improvement of the revenue, while in the other the operation caused grievous injury to the country generally, and thus to the Government treasury.—(*July, 1855.*)

**PART II.**  
**ON MILITARY MATTERS.**

# MILITARY MATTERS.

---

ON THE ARMING OF A FREE PEOPLE; AND ON THE  
TRUE PRINCIPLES OF THE ORGANISATION OF THE  
ARMIES OF ENGLAND.

THE maintenance of a large standing army by a perfectly free people is an unnecessary expenditure, and diminishes the total available amount of national labour, and, consequently, of national wealth. This expenditure is unnecessary, because every legitimate object for which a standing army is maintained would be more effectually attained by the abolition than by the support of such a force; and it diminishes the total of national labour and wealth, because it implies the setting apart of a portion of that labour exclusively for the unproductive business of war.

The legitimate object for the maintenance of a standing army is the defence of the nation; and this object could be most effectually attained, in the case of a people really free, by abolishing a separate army, and rendering the entire nation defensively warlike.

This abolition of the separate army would imply its incorporation with the remainder of the people; and

thus, while the abolition of a separate army would involve a direct saving to that remainder, it would also increase the total amount of available natural labour by the amount which the incorporation of the separate would add to the general national stock.

To understand what is meant by rendering a nation defensively warlike, we need only look back through English history, to a period prior to that of the first introduction of a standing army, when the English people really were thus warlike. In those times, every village had its archery-ground, every country church its place of arms, and every graveyard its yews. The entire youth and peasantry of the country were then trained, by habitual practice, to the skilful use of those weapons which, in the event of war, they would be called upon to use in battle. The effect of thus habituating the people to the use of warlike weapons, and of associating the use with their pastimes and sport, was the highest development of individual skill, combined with pride and pleasure and absolute faith in the use of the weapon,—qualities which have ever been found to be invaluable in actual war; and which, while they admitted of the soldiers readily understanding combined action, rendered them also independent and self-reliant.

Accustom the peasantry of England to the use of those arms which the advanced state of mechanical science and art have enabled us to invent, as our ancestors were accustomed to the use of the bow, and the native qualities of the Englishman would soon again become as pre-eminently valuable as were those of the bowmen of Cressy, Poitiers, Agincourt, or



even of Homildon Hill and Flodden, and it would be impossible for any foreign power to insult them on their own ground.

But the thus rendering of a free people warlike presupposes them to be represented by a really free Government. For there can be no question that, to a Government wilfully despotic, the existence of the power and spirit implied in a free people habituated to arms would be dangerous in the extreme; and this arrangement, therefore, although well suited for England, could not be adopted by our Continental neighbours with safety to existing despotisms. But assuming that an army is still to be maintained in England, and admitting that the maintenance of armies is absolutely essential to her colonial and Indian rule, it seems to me that there exist principles upon which all these armies should be organised, and upon organising them in accordance with which their efficient maintenance must depend.

Soldiers, like other servants of the State, observe the law of demand and supply; and the supply of soldiers will always be regulated by the rates of wages held out to them, by the description and remoteness of the work to be performed, and by the description of the masters to be served for these rates. On this subject, then, we may learn from the manufacturer. If he desire to establish a factory, and to collect and organise the several grades and descriptions of skilled labour implied in this organisation, he proceeds to invite these grades and descriptions at what he believes to be the several market values. If the trade be dangerous, the rates will rise proportionably. If

the manufacturer be of ill-repute as a master, the collection of servants will be proportionably difficult. If prospects of promotion and pension in case of injury be held out, labour will respond at once to these advantages. Eventually the factory is started, and is maintained simply upon the principle of paying every man, from the highest to the lowest, engaged therein, what his labour may be worth, and by causing the engaged to feel dismissal from employ as a more or less grievous punishment.

What is to the interest of the manufacturer in the establishment of a factory, is to the interest of the State in the establishment of an army. Let the State, therefore, accord to its soldiers such pay and position as to draw into its ranks the flower of its yeomen and peasantry; train them in accordance with their noble nature, by appealing to the highest and best faculties of man; and arm them with weapons suited to skilful workmen. Let there be regiments of counties;—let, that is, each regiment have permanent head-quarters, where a considerable district around might be interested in the conduct of the corps in the field; where recruits might be enlisted, and where families, pensioners, &c., might reside in comfort during the absence of the regiment in the field. Let there be a liberal scale of pensions allowed for all ranks of officers and men, both for wounds and long service. Let the service be such that dismissal from it may be felt as a grievous punishment. Let promotion to the highest ranks be open to all who may deserve it. Let even the marshal's baton be within the reach of the grasp of the

private soldier who may prove himself worthy and able to wield it.

For the rest, the admission of common-sense, and the operation of public opinion where no concealment is allowed, will necessarily at once sweep away the enormous and wasteful follies of half-pay, purchase and sale of commissions, unwieldy and inefficient weapons, unfit clothing and accoutrements, and all similar follies.

Allow the principle of admitting the free exercise of reason and common-sense under the eye of the public, and all evil must disappear; while the best men for every post, and the best means of effecting every object, must soon be known, and, when once known, must be employed.

In the adoption of such principles exists the real efficiency of army organisation; yet this seems not to have been thought of on any hand, and has not even been noticed by late writers on the subject.

Yet it might have been remembered that the best cavalry the world ever saw (and acknowledged to have been so by universal consent) was an *English* *silidar* corps—the Ironsides of Cromwell. The excellence of these soldiers did not depend on their being large men or small men, or heavy or light, or anything else with respect to their mere carcasses. It was caused by their high moral nature and mental culture. And the private soldiers of Cromwell were eagerly sought for as officers elsewhere, and the whole history of the world could not show their peers.

Experience gained in real work, and upon a sufficiently extended scale, during a period of many years,

has convinced me that the principles which rendered the soldiers of Cromwell irresistible may still be applied with like effect; and that even with the poor Asiatic something may be done in this way, for it is working in the right direction, in the path of nature's laws. Man's power—that which constitutes him man and not brute—depends on his brain, not his muscles; on his mind, not his body. Improve the moral and intellectual being of the men; lead them upwards and onwards by their best and noblest attributes, and not through sordid hopes and fears,—make them love their duty, and do it, *because it is right to do so*,—and success will attend our endeavours, be the material worked on European or Asiatic.

But how different in its operation is this principle of attracting by adequate inducements the men best suited to the military requirements of the State, of supplying these men with the best weapons possible, and of developing all their powers—from that which at present obtains in our military system, of enticing recruits at rates lower than the market permits; of arming them inefficiently; of attempting to govern them by the fear of punishment, and that punishment bodily pain; and of retaining them in the service by penal enactment.

Is it to be wondered at, that however excellent the raw material whence our army *might* be drawn, it should be found, under the working of such a system, often difficult to obtain for the service of the State any but the most inferior class of our citizens or peasants; that the supply even of these does not meet the demand; and that the army of England holds a

position at an immense distance behind the position which the general advance of the nation in moral and intellectual power should have enabled it to hold ?

The chief evil of the present system is the existence, and perpetual renewal, of a special code for the army. The effect of the Mutiny Act is altogether injurious to the military force of England ; it is as an instrument for harm in the hands of the ministry of the Crown ; and it possesses no redeeming qualities whatsoever. I speak advisedly, after long experience, and after expending on this subject an amount of thought and labour which few men have either the inclination or opportunity to bestow, when I assert that no special laws are necessary for the good government of soldiers. Those commanders whose object is good—who proceed towards that object on right principles, in accordance with nature's laws ; who appeal to men's best and highest qualities, instead of to the most base ; who endeavour to cultivate, draw forth, and aid in the development of, the powers and good qualities of those under them—will always be able to lead without the support of unreasoning authority ; while it is certain that the more intellectual the men really become, the more easy will it be for real intellectual and moral power to govern them.

But the military code enables the wrong man to be kept uppermost, and all manner of outrages on common-sense to be practised in the army, without much scandal, until the time for real warlike exertion arrives. Then real workmen are absolutely necessary, and the amateurs at once fail. While the steam-engine is at rest, and its fire is out, any one may

pretend to be competent to its management; but get up the steam, and the real engineer alone is able to maintain and to guide, with safety and utility, the mighty power of the machine.

This has well been shown in our war with Russia. There has been plenty of power, for even the poorest material of Englishmen is comparatively powerful. Our soldiers are still unmatched in fight, and show a martyr's endurance of misery; but these warriors have been systematically trained to helplessness. The natural qualities of the men make them, in the actual shock of battle and in the struggle of personal combat, the most formidable soldiers in the world: they are the best and bravest of the earth. But what has their military education done for these noble beings? It has merely crippled them, body and soul! What the stock, the belts, the pipeclay, the tight coat, the knapsack, &c., are to the soldiers' bodies, their moral and intellectual training has been to their minds: they must only think, as Frederic's soldiers prayed, according to regulation.

The men can do nothing for themselves; while their amateur leaders and heads of departments can neither feed, clothe, shelter, nor move the army. At the commencement of operations, our generals endeavoured to enforce regulations regarding stocks and jackets, &c. And with such matters many of them seem alone competent to deal.

Under our present system, there can be no long reach of understanding of military affairs, and no practical readiness in handling and supplying the wants of soldiers in the field: it seems abundantly

certain that thousands of our English merchants are really better able to command an English army than many of our general officers.

To attempt to reform, that is, to improve on, the present system, is plainly futile. It must be entirely abandoned, and new principles (directly the opposite of those now acted on) adopted, or continual failure may be expected.

The military arrangements should be thrown open to public view and public opinion: *evil things cannot bear the light*, and will disappear before it—generally without the harsh exertion of force or punishment. Reason, good sense, good feeling, with individual activity and practical knowledge, should be the guides; and the rule should be, to endeavour to develop these as much as possible in all members of the army, of whatever rank.

At present, every law of nature is reversed in our military system; and the rule of brute force is substituted for that of reason.—(1855.)

#### THE DEFECTS OF THE BENGAL ARMY.

The defects and indiscipline of the Bengal army, even as compared with the other armies of India,—in which also numerous faults and deficiencies might be pointed out,—are manifold and glaring. Let us inquire what really are these defects, and what the best method of remedying them. Let the officers of the Bengal army apply themselves fairly and honestly to the task of reform, where reform is really needed, AND LET THEM NOT FLATTER THEMSELVES, AS IT TOO OFTEN IS THE CASE. that THEY HAVE REMEDIED A DEFECT

WHEN THEY HAVE ONLY CONCEALED IT, OR DENIED ITS EXISTENCE: old sores must be laid open, with an unsparing hand, and the caustic be freely applied, before they can be properly healed,—let not the patient think the surgeon an enemy because he gives pain.

For myself, I shall endeavour to write exactly as if I were myself an officer of the Bengal army: my judgment may be erroneous, and my opinions unsound; but my motives are undoubtedly good—they are the wish honestly to serve my honourable masters and my country, and to benefit, in my humble capacity, the service to which I am proud to belong. I have served altogether twenty-three years, have never been absent from my duty, and have long commanded a native corps of high repute; during the course of my service I have seen a good deal of the Bengal army, and have conversed much with its officers.

With the opportunities and experience above-mentioned, my observations and opinions may be useless and unsound, but they cannot justly be deemed presumptuous or hasty.

The most serious faults existing in, and peculiar to the Bengal army, appear to me to be as follow:—

*First.*—The absence of the highest moral tone, and of a simple and vigorous Anglo-Saxon honesty in dealing with Asiatics on the part of the English officers of the army of Bengal.

*Secondly.*—The want of power placed in the hands of regimental commanding officers; the want of confidence reposed in, and support afforded to them, by the Commander-in-Chief and by Government.



*Thirdly.*—The most pernicious system of drawing pay by companies direct from the divisional paymaster, instead of by regiments, which again tends to bring regimental commanders in contempt, and to reduce their power and usefulness.

*Fourthly.*—The most defective system of conducting officers' messes.

*Fifthly.*—The entire absence of a proper confidence between the officers and the native soldiers.

*Sixthly.*—The most pernicious practice of attending to the caste of native soldiers, thereby frequently excluding from our ranks the best material for soldiers, and enlisting the very worst.

*Seventhly.*—The very bad and fatally injurious system of promotion existing with respect to native officers and soldiers.

*Eighthly.*—The entire absence of a proper discipline throughout the native part of the Bengal army.

Ample proof of the first-mentioned fault is found in proceedings towards mutineers—in the late orders to the Bengal army regarding courts of requests, &c.—in disclosures which have been made regarding gambling affairs, banking transactions, &c., too notorious to require detailing, and too extensive and numerous to be attributable to causes affecting individuals only. These proofs are public, and patent to all men.

The defect being admitted, where shall we look for the cause and the remedy? One cause appears to me to consist in the lowering of the English character, by insensibly adopting Asiatic habits, manners, and feelings. The Anglo-Saxon becoming partly merged

in the Hindoo. That is extensively the case in the army of Bengal.

From the moment a young officer sets foot in the Bengal presidency, he is perpetually reminded that every English idea and habit is the sure mark of a griffin (that is, of a fool). He must not go out in the sunshine—he must travel in a palkee instead of on horseback; he must be punkaed, and tattied, and God knows what else; he must have a “khansa-maun,” a “kidmutgar,” a sirdar-bearer, and bearers, and a host of other servants—one for his pipe, another for his umbrella, another for his bottle, another for his chair, &c.—all to do the work of one man; and which work would be done by one man in the case of a Bombay griffin. By all these people the youth is called “ghureeb purwar,” “hoodawund,” &c. &c.

This state of affairs bewilders the new comer, till, resigning himself to his fate, he becomes accustomed to it, and gradually loses part of the manliness of the Anglo-Saxon character. With the external luxurious and lazy habits of Hindoostan, he imperceptibly adopts somewhat of Oriental morality.

Another cause is the difficulty existing in obtaining furlough to Europe, which, if removed, would effect a wonderful improvement on the tone of Indian society: this cause, although of grave importance, is, of course, not peculiar to Bengal, but common to all India.

The remedy is evident,—LET IT BE THE FASHION TO BE ENGLISH. It is a fallacy to suppose that the climate compels to be otherwise. There are faults

enough, I suppose, in the European society of the Western presidency, but assuredly it is ten times more English than that of Bengal; yet the climate is no better than that of the latter.

Let the griffin have no more than two body-servants at most; let him have no one in his service who will not do such work as his master bids him do: if the Hindoos object to such service, there are plenty of Mussulmans, ready, willing, and able to take their places, and with no more prejudices than a Christian.

Let the young man never enter a palkee, but go about on the back of his pony; let him not fear the sun—it may tan his cheeks, but it will not hurt him.

It is your effeminate gentlefolk, who live in dark houses artificially cooled, with a dozen Hindoos at work, with fans and flappers to beat the flies off them, who suffer by exposure—not the hardy young Englishman, who, if not intemperate, soon becomes acclimated; and the more readily so the less he regards the sunshine, which is healthy enough in moderation; *experto crede*.

Let him, in short, while studying the character of the natives of India as deeply as possible, and making himself completely acquainted with their habits, thoughts, feelings, modes of expression, &c., endeavour himself by all means in his power to remain a *thoroughly* ENGLISH gentleman. As he succeeds in doing so, he will assuredly succeed in commanding the respect and regard of every native around him. ALL OUR POWER IN INDIA RESTS ON THIS. We may lay it down as an absolute certainty, that the millions of natives which a handful of Englishmen govern in

this vast continent will not consent to be governed by a *handful of their equals*. Our power consists in our being essentially different from them, and in their belief in our moral superiority only. The only thing which can endanger the existence of this power, is the destruction or weakening of that belief.

The state of the body will often affect the mind; habits and manners will act on, and be reacted on by, morals and religion.

Let us then be English in all things, to the utmost of our power, internally and externally—in morals, in habits, and in feelings, allowing absolute freedom of opinion and fair play to all men—and all will be well.

The second evil is notorious : it has been frequently remarked on, its existence is everywhere acknowledged, and its effects are lamentable. The commanding officer of a regiment in the Bengal army is almost powerless for good : he is allowed to do nothing ; his men are almost taught to despise him ; and in many instances of late years the sepoy's have been allowed and encouraged to forward written complaints against their commanders direct to army head-quarters. What can be worse than this ? It is utterly destructive of all military discipline and soldier-like pride.

The third and fourth mentioned evils are closely connected with the second. In the Bengal army the practice prevails of each commander of a company drawing pay for that company himself separately, direct from the divisional paymaster, so that the pecuniary transactions of the regiment are carried on, in a great measure, independently of the commanding officer, and often without his knowledge ; as, for exam-

ple, has appeared in some late disclosures regarding banking transactions, wherein the officers commanding companies appear to have made arrangements with divisional paymasters for the recovery, by regular instalments, of payments on account of various banking transactions, without the commanding officers of the regiments knowing anything of the matter. All these also tend to reduce the useful power of regimental commandants, and make them be despised.

With regard to messes, the state of affairs is very bad. In some regiments no mess exists: the maintaining a mess is not only not made compulsory, but even where a mess is maintained, it is optional with officers whether to belong to it or not. Such a state of affairs is fraught with the worst consequences: it breaks a regiment up into separate parties, and gives rise to all manner of ill-feeling. It also lessens the power and good influence of the commanding officer in an extraordinary degree. It takes away much of the support which a commander quietly and imperceptibly receives from all well-disposed officers, who have a proper pride in their noble profession; and it enables others, who may be ill-disposed, to work mischief unperceived, till its effects become apparent in the bad state of the regiment.\*

The remedy for all these evils is in the hands of the Commander-in-Chief and of Government: let the commander of a regiment be systematically and effectually supported in the exercise of his legitimate powers; let those powers be as ample as possible in

\* This defect has lately been to some extent remedied.

every respect; regarding regimental affairs, let all turn, centre, and rest on him; and with these full powers, make him responsible that all goes well. If it do not, displace him from his command. Let there be a regimental paymaster, to whom the company officers send their muster rolls, and whose duty it is to draw the pay of the regiment, under the authority of the regimental commander.

Let the mess be a public institution, to belong to which is compulsory on all officers. Let the commanding officers be held responsible that it be conducted with due and proper regard to economy, comfort, and propriety, and give them full power to enforce such a state of things. There is nothing new in these rules; they exist with the happiest effect in the other armies of India, and would be equally advantageous to that of Bengal.

The fifth evil is notorious, and is plainly proved by men deserting their officers in the field, by frequent mutinies, &c., where nothing has been known by the officers of what was going on, until it resulted in open resistance to authority. The causes of this are various, part depending on what has been mentioned above, but chiefly on the abominable system of recognising caste in our ranks, and on the absurd system of promotion, whereby the native officers are absolutely useless.

The remedies are, of course, as described with respect to those causes.

The sixth evil is of a very grave and important nature. The effect of enlisting men of a certain caste or creed, to the exclusion of others, in the Indian

army, is to subject that army to the control, not of the Government and of the Articles of War, but to that of Brahmins and Goseins, Moollas and Fakeers. By this system a man is not to be chosen on account of his fitness to be a soldier, his willingness and strength, docility and courage, but because he is a twice-born worshipper of Vishnoo. Whatever his other qualifications, if a man think that a stone with a patch of red paint on it is not to be worshipped as the Creator—still more, if he have been a shoemaker, &c.—he is not to be admitted into the ranks of the Bengal army, for fear of offending the lazy and insolent Brahmins. The consequences are ruinous to discipline. BY REASON OF THIS, A NATIVE SOLDIER IN Bengal IS FAR MORE AFRAID OF AN OFFENCE AGAINST CASTE THAN OF AN OFFENCE AGAINST THE ARTICLES OF WAR, AND BY THIS MEANS A DEGREE OF POWER RESTS WITH THE PRIVATE SOLDIER, which is entirely incompatible with all healthy rule.

TREACHERY, MUTINY, VILLANY OF ALL KINDS, MAY BE CARRIED ON AMONG THE PRIVATE SOLDIERS UNKNOWN TO THEIR OFFICERS, TO ANY EXTENT, WHERE THE MEN ARE OF ONE CASTE OF HINDOOS, AND WHERE THE RULES OF CASTE ARE MORE REGARDED THAN THOSE OF MILITARY DISCIPLINE. To such an extent does this evil exist, that I have known a Bengal commanding officer express his regret at being compelled to discharge an excellent sepoy, because the other men had discovered him to be of inferior caste, and had demanded his dismissal. To a Bombay officer such a state of affairs appears incredible—it amounts to open mutiny; but it is the normal state of the Bengal army at present. It is

curious, that though the Bengal sepoy have contrived to have it believed that their religion is concerned in this business of caste, in our ranks nothing is further from the truth. In conjunction with the system of promotion which prevails, THIS ATTENTION TO CASTE KEEPS ALL REAL POWER IN THE HANDS OF THE PRIVATE SOLDIER; and, as they think, saves them from much trouble and annoyance: but when they assert that this evil is a necessary consequence of their religion, the Bengal sepoy state the contrary to truth.

This is positively proved by that which takes place in the army of Bombay, wherein hundreds and thousands of men from Hindoostan, from the same villages, of the same caste, and even of the same families—brothers by the same fathers and mothers—as the fine gentlemen of the Bengal army, are seen in the ranks, shoulder to shoulder—nay, even sleeping in the same tent—with the Muratha, the Dher, and the Purwaree, without scruple or thought of objection. The one prides himself on being a Hindoo, the other on being a soldier. Which pride is the best for our purpose? The system of regarding caste is the original cause of many other evils in the Bengal army; and much of what has been said regarding the adoption of Asiatic manners tells again heavily here.\* The Bombay sepoy, whatever faults he may have, has

\* The fact is, that when, without giving offence, the English officer shows, by his habitual conduct towards the sepoy, that he feels their caste prejudices, &c., to be marks of INFERIORITY, which excite only his pity and regret, the sepoy endeavours to keep all such caste prejudices, &c., as much as possible out of sight, will never allow them to interfere with duty, and will never willingly obtrude them on notice at all.



one great excellence, which is, that he looks on the European soldier as his model in all things pertaining to soldiership, and endeavours to imitate him. Like the European soldier, the native sepoy of Bombay will turn his hand to any labour which he may be ordered to execute.

If the lines require cleaning, &c., &c., a working-party of sepoys is ordered out as a matter of course, with pickaxe and powrah, and the work is well done. The technical term "working party" is as familiar in the mouth of a Bombay sepoy as "shoulder arms." Nay, I have known more than once the men of a Bombay regiment to volunteer for such work as building their officers' houses, mess-room, &c., and to do the work well, too, making the bricks, mixing the mud, &c., &c., entirely by themselves. This would not be credited by the greater part of the Bengal army; and to such a state of helplessness has the recognition of caste in the ranks brought the Bengal sepoy, that a regiment of native cavalry, as I have repeatedly witnessed, is unable to picket, unsaddle, or groom its horses, until the arrival of its syces and grass-cutters—sometimes, as I have seen, several hours after the arrival of the regiment at its ground. In a Bombay regiment, before that time had elapsed, the horses would have been picketed, groomed, fed, and watered, stables would have been over, the tents pitched, and the men have had their breakfast. To such an incredible extent has this helplessness been carried, and recognised by authority, that a Bengal sentry cannot think of striking the gong at his own quarter-guard, and men called "gunta pandays" are

actually maintained, and paid for by Government, to do this duty for them. It is the khansamaun, kidmutgar, hookah-burdar, &c., &c., over again. The remedy is obvious: never allow any reference to caste when enlisting men. If others now in the service object, let them be told that Government does not care one pin whether its sepoy be Hindoos, or Mussulmans, or Brahmins, or Purwarees, so long as they be good soldiers; and that if they do not like the rules of the service, they may leave it. If they still object, or make any difficulty about the matter, discharge them on the spot. There are millions of better men ready to occupy their places. Let also the use of entrenching tools be part of the drill of the sepoy, as much as is the musket exercise; and when he has learnt this, let him be occasionally employed in working-parties, &c., to prevent his forgetting it again. This trifle would be found to possess much more importance than at first sight appears to attach to it.

The seventh evil—the bad system of promotion—is the worst of all; its effects are crushingly ruinous. In the Bengal army the promotion of natives is made to depend on seniority only, so that if a man keep clear of actual crime, and lives long enough, he must become a commissioned officer, however unfit for the office.

Under this system, the private soldier feels himself entirely independent of his officers; he knows that they neither hasten nor retard his advance in the service. He has nothing to do but to live, and get through his duties with listless stupidity, and with

the least possible trouble to himself. No exertion on his part can help him;—talent, courage, fidelity, nor good conduct are of any avail. Confidence and pride in each other, between men and officers, cannot exist. There is no real co-operation; for the one being powerless to aid, the other becomes careless of offending. This is the effect on the private soldier. The system is equally, if not more baneful, as respects the native officers, commissioned and non-commissioned. The whole of the native commissioned officers are entirely useless—the amount of their pay is a dead loss to the State; every one of them is unfit for service by reason of imbecility, produced by old age, or, where in rare instances the man may not be altogether in his second childhood, he is entirely useless from having been educated in a bad school. All should have been pensioned long ago: but, alas! if the present system of promotion be continued, the getting rid of these poor old gentlemen, who cut such painfully ridiculous figures in the Bengal regiments, would be of no use whatever, for the non-commissioned officers, who would have to be promoted in their places, are but little better—even the very naiques (corporals) are almost too old for service.

How very different is the state of affairs under a proper-system of promotion by merit alone? It gives the commanding officers of regiments and companies a good deal more trouble, certainly, in making promotions; but how are they repaid? If they rally and honestly do their best to choose the men for promotion without partiality, favour, or affection, but by merit and fitness alone, it is soon found that every

man in the regiment (at least every man who is fit to be in our ranks) exerts himself to aid his officers. A degree of vigour and activity, amounting to a new life, is infused into every part of the regiment. The men, seeing all the prizes of the service within their reach, exert themselves to obtain them. They can only obtain their end by becoming good soldiers—by learning their duty, and performing it to the satisfaction of their superiors.

The native officers, being chosen with regard alone to their qualifications, and their fitness to hold commissions, are alike proud of the distinction they have acquired by their appointments, and able to perform their duties. They are not enfeebled by age; and the consciousness that their respectability and success in life depend on their own conduct makes them exert themselves willingly and zealously in maintaining the discipline and reputation of the service in which they acquire honour. The ill effects of the one system, and the excellencies of the other, appear to me so self-evident, and have been both proved on so large a scale, that I should consider it to be insulting to the understanding of my readers were I to enlarge on it, if it were not for the astonishing fact that such an evil system of promotion still actually exists in Bengal, and has been lately enforced, in spite of reason, common-sense, and experience, by —.

With such a system of promotion, the good and the bad, the clever and the foolish, the brave and the timid, the energetic and the imbecile, are nearly all on a par. The officers are powerless for good; and the men, keeping just clear of open violence, have their

OWN way in all things. IT IS ASTONISHING, AND SAYS MUCH FOR THE GOODNESS OF THE RAW MATERIAL OF THE BENGAL ARMY, THAT, UNDER SUCH ARRANGEMENTS, THE WHOLE FABRIC HAS NOT ENTIRELY FALLEN TO PIECES. THE THING IS ROTTEN THROUGHOUT, AND DISCIPLINE THERE IS NONE ; BUT IT IS WONDERFUL THAT EVEN THE OUTWARD SEMBLANCE OF AN ARMY HAS BEEN STILL MAINTAINED UNDER SUCH DEPLORABLE MIS-MANAGEMENT.

The eighth evil—the want of discipline—is the necessary consequence of much that has already been described. In speaking of want of discipline, I do not only mean that which is shown by serious mutinies and misconduct on extraordinary occasions, but also as evinced in the ordinary every-day routine of duty in the Bengal army : this is such as to be almost incredible to an officer of the Royal army, or of the other armies of India. The first thing done by a Bengal sepoy when he mounts guard, is to strip himself of arms, accoutrements, and clothing ; the muskets are piled, and a sentry is posted, who remains generally (not always) properly accoutred, &c. All the others, including non-commissioned officers, disarm and strip : if there be any water near, they go and dabble in it after the fashion of all Hindoostanees ; otherwise they cover themselves with sheets and go to sleep, quite naked, with the exception of a “lungootee.” When the sentry thinks that he has been on long enough, he bawls out for some one to relieve him : after a while, up gets a sepoy from beneath his sheet, and, after a few yawns and stretches, puts on his clothes and accoutrements, but

does not take his musket—that would be too much trouble, and endanger upsetting the whole pile; he then goes to the sentry, takes his musket from him, and occupies his place; away goes the relieved man, and strips like the others. No naique attends with the relief; he remains fast asleep under his sheet. Now this state of things I have myself seen in hundreds of cases. It is so astonishing to a Bombay officer that he cannot help remarking on it; yet I have been assured by numerous Bengal officers that this is the regular way of mounting guard. It should be borne in mind, also, that in the Bengal army four men are allowed to a sentry, instead of three, as with the other armies; so that a sepoy with them is on sentry only six hours altogether, during his tour of twenty-four hours, instead of eight, as usual.

But it is by no means uncommon in the Bengal army to relieve a guard once a week, and even at longer intervals, when the state of affairs above mentioned must take place, even if it were not so on other occasions. This was the case when the Bombay and Bengal troops met at Peshawur; and considerable grumbling and complaining took place when Sir H. Dundas insisted on the guards being relieved daily. To the mind of any practical soldier, no further proof is necessary on this subject—want of discipline. He must at once see that where guards are relieved weekly, where the sentries relieve each other as they please, and where the whole guard strips naked, there can be *no discipline whatever*. It is useless to ask whether a man can read and write, when you find that he does not know a letter of his

alphabet. If it were necessary, however, I could adduce abundance of other facts to the same purport. The remedy is apparent, from what has been said before. Such are some of the reforms peculiarly required by Bengal. But there are many others equally requisite, with regard to the native Indian army generally; for instance, with respect to the regimental orderly-room.—(1851.)

#### COMPARISON BETWEEN THE SYSTEMS OBTAINING IN THE ARMIES OF BENGAL AND BOMBAY.

The native soldiers in the Indian army, other than those of Bengal, are, though formed of exactly the same raw material, essentially different from them in training and in discipline, in habit and in feeling. The normal state of the Bengal army is such as must appear to an officer of the Royal, or of the Bombay army, as a state of mutiny! I have known the men leave the ranks by hundreds at a time, without leave, to cook, to plunder, or what not. Yet such is the force of habit, that the excessive want, or rather, total absence, of discipline, and all the gross evils which pervade the native army of Bengal, are looked on by the European officers of that army as necessary consequences of employing a native army at all. Having little opportunity of comparing the native soldier of Bengal with others differently educated, their eyes are never opened to the true cause of the existing evils—they attribute all to the deficiency in the *numbers* of the European officers. The fact being, that they are already more numerous than is

necessary to real efficiency, and that, unless means were adopted to improve their *quality*, addition to the numbers would be hurtful.

The officers are not too few, but they mistake their proper functions, and act on wrong principles. The officers of the Bengal army are formed exactly of the same materials as those of the other armies of India; their native soldiers of material, in its raw state, perhaps, somewhat better than that of the others; but from the hour he enters the service, the Bengal officer *is trained to sink the European and adopt the Asiatic*. In the Bombay army the "feeble Hindoo" becomes half European, and adopts the feelings and ideas of Europeans, as far as they refer to his position as a soldier, till they become his own. In Bengal, the European becomes half Hindoo, and thus the commanding influence of superior energy and superior moral character (I deny any superiority of intellect) is, in a great measure, lost. This pervades the whole society in Bengal; but its effects are most glaringly apparent in the army. In the Bengal army there is a constant studying of men's *castes*, which the EUROPEAN APPEARS TO THINK AS MUCH OF, AND TO ESTEEM AS HIGHLY, AS DO THE NATIVES THEMSELVES; and the sepoys, instead of looking on the European officers as superior beings, are compelled to consider them as bad Hindoos! Instead of being taught to pride themselves on their *soldiership* and discipline, the sepoys are trained to pride themselves on their absurdities of caste, and think that their power and value are best shown by refusing to obey any orders which they please to say do not accord with their religious



prejudices. It is a grave mistake to suppose that religious feelings have any real influence on these occasions—it is a mistake which would be ridiculous if its consequences were not so serious; but it is certain that the Bengal sepoy is a stickler for his imaginary *rights of caste* for the *sake of increased power*: he knows well that Government never intend any insult to his creed, however absurd it may be; but he knows that by crying out about his caste, he keeps power in his hands, saves himself from many of the hardships of service, and makes his officers afraid of him. This is proved by what takes place in the other armies of India. In the army of Bombay, even a Purwaree may, and often does, rise to the rank of subadar by his own merit; in Bengal, such a man would not even be admitted into the ranks, for fear of his contaminating those fine gentlemen the Brahmins; yet in the Bombay army the Brahmin (father, brother, or son, it may be, of him of Bengal) stands shoulder to shoulder in the ranks—nay, sleeps in the same tent—with his Purwaree fellow-soldier, and dreams not of any objection to the arrangement! If this subject be mentioned to a Bombay Brahmin sepoy, as it is sometimes by *Bengal* officers, who are always asking the men about their caste, the ready answer is, “What do I care; is he not the soldier of the State?” The reply speaks volumes, and shows a state of affairs which officers of the Bengal army *cannot conceive*.

The system of promotion in the Bengal army is exactly in keeping with the principle of the immutability of caste. No individual merit can advance, no

individual incapacity nor misconduct (unless actually criminal) can retard the promotion of the Bengal sepoy,—seniority alone is considered. What is the consequence? The men, not feeling that their prospects of advancement in the service depend on the favourable opinions of their European officers, want the most powerful stimulus to good conduct. They are never disciplined (as I understand the word), are often mutinous, and never acquire the knowledge of their profession which may qualify them to hold commissions with advantage to the service.

The Bengal native officers are inefficient, and necessarily so under the present system, because they are chosen without any regard whatever to their fitness to hold commissions, and because they are almost always worn out with age before they receive them. It is often objected by Bengal officers that the pension-list of Bombay is much larger in proportion than that of Bengal. It is so: but why? Poor old wretches, feeble in body and imbecile in mind, who would in Bombay have been pensioned off ages ago, still remain holding commissions in the Bengal army. Does this arrangement cause any saving to the State? Does it really enable a greater military power to be maintained at the less cost? Again, the assertion that few men of any pretensions to independence will submit to our rigid drill, &c., is erroneous as a general rule, however agreeable it may be to Bengal experience. Men of good family, &c., will enter the service fast enough if the service be worth entering,—witness the Sind Irregular Horse. But reverting to the question of European officers, it is certainly true that more officers

of artillery and engineers are required for the Indian army,—the duties of these officers are generally quite independent of the number of men under their command; and many more European officers are required with European troops than with natives, owing to the presence of the native officers with the latter. With scientific corps the number of officers has no reference to the number of the men; it must be regulated altogether by other circumstances. The great number of European officers now allowed prevents the native officer, whatever his merit, from attaining a responsible or very respectable position in the army; thereby keeping out of its ranks natives of birth, wealth, and family, and preventing in the native soldier the full development of that love for, and pride in the service, which are essential to great efficiency. There are already too many European officers with reference to regimental duties only. A certain number of European officers is necessary, but very few suffice. Three to a regiment, actually present, is, perhaps, the best number. The duties of subaltern officers, and even of captains of troops and companies, are most efficiently performed by native officers.

If there were but one European officer in a regiment, he would, if possessed of proper qualifications,—if not trained in a school which makes him half Hindoo, and if *entrusted with proper power* and authority,—soon form around him such a body of native officers as would make the corps far more effective under the one Englishman than it could be under any number of Europeans who held the opinions, with regard to native troops, which now, to a great

extent, prevail among the officers of the Bengal army.

Take for example the corps of Sind Irregular Horse, 1,600 strong: this has but five European officers, yet it has on all occasions proved to be perfectly efficient, and is generally believed, by those best able to judge, to be the best native cavalry corps in India. Yet this corps is *most carefully and minutely drilled*, and is armed and accoutred in the European style. The squadron and troop commanders of the Sind Irregular Horse are natives, yet the greater part of them perform their duties as well, and in all respects as efficiently, as the best European officers, whether in quarters, on parade, on the line of march, or in battle.

No Bengal officer can understand this; but it is nevertheless the truth. There is no native regiment in the Bengal army, horse or foot, in which the duty is carried on with such steady regularity, as that with which all is conducted in the Sind Irregular Horse, with its two and a half Europeans to a regiment. There are no soldiers on earth better disciplined than those of this corps. Their discipline is founded on the mutual pride, confidence, respect, and good feeling which exist between them and their European officers. They are confessedly among the best native soldiers in India, yet they cost the State less than one-half of the "regular" native soldiers, and they have been trained, educated, and altogether treated, after a fashion diametrically opposed to *Bengal* principles.

I repeat, then, that the ordinary state of the Bengal army is such as must appear, to an officer of the Royal

or of the Bombay army, to be a state of *mutiny*. The men are *not* taught and trained instinctively to obey orders, and even the European officers are afraid of them. This is not wholly the fault of the regimental officers of Bengal. The evil is produced and perpetuated by the false ideas formed from the first moment a young officer enters the service in the school of errors, which the native army of Bengal is at present; and by the fatal effects of taking all power from regimental officers, and concentrating it at army head-quarters, thus producing an artificial sameness of dull stagnation, instead of encouraging the natural uniformity of progressive improvement.

In the Bombay army, on the contrary, the native officer is invaluable, and his authority is respected, though he be the lowest of the low in caste; because the practice in Bombay is for the European officers to make the Hindoos SOLDIERS, instead of, as in Bengal, the sepoys making the European officers half Hindoos.—(1850.)

[In a work published by General Jacob in 1854, he remarks that “the evil influence of the state of affairs in the larger body is, I fear, fast communicating itself to the Bombay army also.” He considers, I believe, that the orders, which have within the past few years been increasing, for the assimilation of administrative details to the practice obtaining in Bengal, to be the main cause of the altered condition of the lesser body. Like causes produce like effects.—EDITOR.]

REMARKS ON THE STATE OF THE NATIVE ARMY OF INDIA IN GENERAL; UPON THE PRINCIPLES WHEREON ITS EFFICIENCY DEPENDS; AND ON THE MEANS WHEREBY ITS EXISTING DEFECTS MAY BE REMEDIED.

On all sides we hear outcries regarding the state of the native army of India.

The most conflicting opinions are given to the world, and continually uttered in conversation, with regard to the merits of the Indian soldiers, the number of officers with native regiments, &c.

Little light has lately been thrown on the matter, and as directly opposite opinions cannot both be just, much false doctrine has been promulgated, and much truth concealed.

The subject of the native army of India was long ago discussed, and most ably handled by Sir John Malcolm. (*Vide* his "Political History and Government of India.") He well knew the native soldier: his words have now, in some instances, proved prophetic.

The position of European officers of native regiments, whether in command or otherwise, is no longer a favourite position, and the native army has been thereby ruined, as he foretold that it would be.

(Particularly the army of Bengal.)

Every officer of a native regiment of the line now endeavours to get away from his corps, to escape from regimental duty, by every effort in his power. The "REFUSE" only remain. All proper feeling is thus totally destroyed between the native soldier and his European superior.

At the same time, the genius of the Indian, of the Oriental generally, has been so little understood, that, with the best possible intentions at head-quarters, the greatest possible evil has been caused, by the attempt to govern and treat the sepoy like an Englishman.

The native soldiers, to be in a really efficient state, must look on their immediate commander, the head of the regiment, as their absolute prince—as the paramount authority, as far as they are concerned.

Concentrating all real power at head-quarters of the army, and leaving none to the commanding officers of regiments, has been attended with ruinous results.

In many instances, the sepoy has been allowed and encouraged to look on his regimental commander as his natural enemy; and, in the Bengal army, at least, to forward secret complaints against him to army head-quarters. While courts-martial, articles of war, rules and regulations, bewilder the native soldier, and fill his mind with the idea that his officers are wishing to keep him out of his rights—he knows not what, but certainly important ones, or such a fuss would not be made about them.

The only principle of military discipline which a native Indian soldier thoroughly understands is obedience to his commanding officer. He cannot, without great injury to efficiency, be taught to look beyond him.

On the regimental commander he should, and must, to be in a healthy state, wholly depend. Enlistment, discharge, promotion to all ranks, and everything else should rest with the regimental commander alone.

There should be no Articles of War (at least none of the nature of those at present in force, to the ruin of our native army); but the commanding officer should have full powers in his own right over his men.

The want of power entrusted to regimental commanders is one enormous evil now existing in our native army. It is, perhaps, a necessary consequence of another very great error.

The seniority rise among the officers of a native regiment, originally appointed at hazard, renders it impossible at present to ensure there being at the head of each native regiment a man capable of wielding the powers necessary to govern it efficiently and well. This is the great difficulty experienced at headquarters; this is the stumbling-block of all honest reformers, and must be overcome and removed before anything can be done towards effectually remedying existing difficulties.

The posting of officers to native regiments without regard to qualification, is a proceeding attended with ruinous consequences.

The presence of unselected Europeans, in such numbers as are at present borne on the strength of native corps of the line, is not less ruinous.

Qualifications, not numbers, are necessary for the leaders of native Indian soldiers. One active, energetic, right-feeling, and right-thinking English gentleman can, even when alone, infuse an excellent spirit into thousands of these Eastern soldiers, till they will follow him anywhere, obey him in all things, and feel the greatest pride in acting in his absence as



they know he would wish them to do if present. The feelings thus engendered are most powerful and most honourable.

The native officers and men feel the deepest gratitude towards him who has raised their moral, intellectual, and worldly position, and are actuated by the strongest wish and energetic zeal to show that they are worthy of the respectable position in which they find themselves.

With thirty Europeans, on the contrary, instead of one, the native officer finds himself of no importance, and the sepoy becomes a lifeless automaton.

The Englishman becomes too common to be held in proper and wholesome respect. He is seen holding no important position, but in the performance of trifling duties which any native officer or non-commissioned officer would do equally well. He is often seen idling away his time in frivolous, or wasting his energies in vicious, pursuits. The prestige of the superior race is thus destroyed, while it too often happens that the European officer, having nothing important to occupy him, loses somewhat of his own self-respect.

The young boy is placed in command of the old subadar, from whom, when anything is to be done, he has to crave instruction; and the men see that, so far from taking a pride in them and in the service, their European officers are generally longing to be removed from them, craving intensely for staff appointments, &c.

The example of the idle, the evil-minded, and the indifferent, does more harm than the good can remedy.

To be in a healthy state, the native soldier should never see his European officer living an idle, useless life, or holding a degraded or unimportant position. While the European officer should be proud of his men, and, as Sir J. Malcolm most justly observed ("Government of India," Appendix E, paragraph 25), it should be arranged that the command of native corps should be the most sought after of all existing appointments.

A most unwise adoption of every useless form of office paper-work, style of dress, and accoutrements, has accompanied the excess of indifferent European officers with the native Indian army. Real efficiency has been in all things sacrificed to appearance. Voluminous "returns" &c., on paper, pervert the attention of commanding officers and adjutants from their really important duties, while knapsacks, basket-hats, stocks, tight clothing, pipeclayed belts, and other unspeakable absurdities, introduced in imitation of European follies, are quite sufficient to crush and cripple the soldiers, without much effort on the part of an enemy.

But it is not my intention at present to enter into minute details. My wish is now only to set forth the true principles on which the efficiency of our native Indian army depends.

I will, therefore, now briefly endeavour to show how, in my opinion, all the defects now existing in our native Indian army may be remedied.

*The principles I contend for have proved true in practice.*

The presence of a great number of European officers, and the assimilation of everything to an Euro-

pean model, however absurd that model may be, has enabled the native army to accord in all outward appearances, ceremonies, and forms, to the European armies, but its real efficiency has been thereby destroyed. A sepoy of the line, dressed in a tight coat, trousers in which he can scarcely walk, and cannot stoop at all; bound to an immense and totally useless knapsack, so that he can hardly breathe; strapped, belted, and pipeclayed within a hair's-breadth of his life; with a rigid basket-chako on his head, which requires the skill of a juggler to balance there, and which cuts deep into his brow if worn for an hour; and with a leather stock round his neck, to complete his absurd costume—when compared with the same sepoy, clothed, armed, and accoutred solely with regard to his comfort and efficiency, forms the most perfect example of what is madly called the “regular” system with many European officers, contrasted with the system of common-sense now recommended for adoption.

Let the common-sense system be adopted, and nearly one-half of the cost of the native army of India might be saved to the State by reduction in the number of European officers, while the real strength and military power of the army would be more than doubled.

It is quite as absurd to force all our European forms of courts-martial, &c., &c., on our native soldiers, as it is to force them to cripple themselves with our ridiculous chakos, &c., instead of their own most soldier-like, easy, and neat pugrees. Let the foolish system which crushes the native soldier, and requires so many Europeans to render him useless, all go.

together. Abolish it, *in toto*, and have recourse to common-sense, reason, and experience.

It will not be difficult, if prejudice be lost sight of for awhile, to show how principles, similar to those proved to lead to good results, can be applied with overpowering advantage to the native army of India generally.

Few European officers only, and those carefully selected and entrusted with full powers, must be appointed to native regiments.

Three officers to a regiment would suffice. Let four be appointed—a commandant, a second in command, an adjutant, and a quartermaster.

No army rank solely to be regarded, but individuals to be selected on the professed principle, at least, of being best qualified.

Sir John Malcolm proposed that the regiments of officers should be retained as they now stand in the "Army List," but not have regiments of men attached to them. All officers of the native Indian army to be, in fact, unattached; and that, from the whole body, properly qualified individuals should be selected for staff appointments, &c., &c. The plan appears a good one, and practicable enough, but it appears to me that we have a better. Let all the officers of the Indian army be borne on the strength of the European portion of it. We know that any amount of excess of English officers with English regiments can do no harm, and the numbers of officers of artillery and engineers are totally irrespective of the numbers of the men of those corps.

Suppose, then, in round numbers, the Bombay army to be composed as follows :—

Let each regiment or battalion of officers consist of—

2 Colonels.	
4 Lieutenant-Colonels.	
4 Majors.	
16 Captains.	
16 Lieutenants.	
16 Ensigns.	
<hr/>	
Total.....	58
Say that there be six battalions of artillery, 58 each.....	348
Three battalions of engineers.....	174
Four European regiments of infantry.....	232
One European regiment of cavalry .....	58
<hr/>	
Total European officers for the whole army.....	812
<hr/>	
Of these there would be appointed to, say—	
80 Native infantry regiments, at 4 each.....	120
6 Native cavalry regiments.....	24
Staff appointments, say.....	180
Sick and on furlough .....	80
<hr/>	
Total.....	404
<hr/>	
Remaining for duty with 14 European battalions.....	408
<hr/>	

(I would have no native artillery). Numbers and details might be altered and re-arranged to any extent, but the above will show the principle on which a sufficient fund of European energy and talent might be placed at the disposal of the Indian Government for the performance of public duties of all kinds; the highest appointments being the prizes for the most worthy. While the principle of posting a few selected officers to native regiments, instead of a

crowd taken at hazard, might be fully carried out, and for all manner of duty the individual most fitted might easily be selected, without incurring the enormous cost of more Europeans, or having to face the apparently insurmountable difficulties of an Indian staff appointment corps (it is nonsense calling it a staff corps, which means quite a different thing). The appointments to native regiments, both of horse and foot, should be considered as the highest prizes of all in their various grades, and should be made so both in station and emolument. The allowances should be such as to cause the commands of native corps to be sought after by lieutenant-colonels, and to have commandants of that rank in the army would be an advantage; but rank *alone* should never be considered in such appointments. The principle of giving them to those best qualified for them should always be acted upon, and strictly followed out.

All pipeclay, metaphorical and actual, should be at once abolished; black leather accoutrements should be adopted, and no difficulties should be made or allowed to exist with regard to the introduction of improvements generally, in respect to arms, clothing, accoutrements, and all else.

The pay of both men and officers should be increased, and every man should be compelled (as in good sildar corps) at all times and in all places to be provided with sufficient carriage for his kit, &c.

These principles might perhaps be better followed out by placing all the European gentlemen required for the public service in India, whether civil or military, on one unattached list, letting them rise in

the list by seniority only, calling them generals, colonels, &c., &c., as at present, and assigning to each grade a proper and liberal amount of pay even while unemployed.

From this general stock all officers might be selected, according to merit and qualification, for every appointment and duty whatsoever, the amount of pay as to the "unemployed" being allowed to all grades of officers while on leave on any account in any part of the world, and on retirement from the service.

Under such arrangements, and so organised, the native army of India would be fully capable of going anywhere and doing anything. It would be equal to the encounter with equal numbers of any troops in continental Europe, and of course far superior to any Asiatic enemy.

It is a grave mistake to suppose, as we are often told, that it is necessary to enlist men of the Northern tribes—Pathans, Belooche, Goorkas, &c.—to enable our Indian army to encounter successfully the warlike tribes now on our Indian frontier.

The Mussulmans of *Hindoostan* are the very best men for our army. The Pathans, &c., are faithless and treacherous. These Hindoostanees are very bold, brave, strong, well-made, active men, fully equal in these respects to the Affghans (though the latter be the stouter-looking of the two). They are generally most excellent horsemen, and many enlist in our cavalry regiments, but under the present system no great numbers are found in the infantry corps of the line. As an example of the qualities of these Hindoostanee horsemen, I may point to the fact that very

lately a regular Persian battalion—perfectly well drilled, armed, accoutred, &c., after the best European model, composed of splendid men, who stood perfectly firm, bold, and confident in their array—was ridden over and utterly destroyed by Major John Forbes and **ONE TROOP ONLY** of the 3rd Regiment of Bombay Light Cavalry.\* Have *any* soldiers ever done better?

There cannot be better Eastern soldiers than these men make when properly treated. They have scarcely more prejudices of religion, &c., than Englishmen, whatever the Bengal officers may fancy; they have most liberal ideas as compared with those of the Hindoo sepoys, to whom they are in every way superior beings. With all this, they are the most faithful and trustworthy of any men in India; they are, in fact, more like gentlemen than any other class of Indians.

With such men in our ranks, and fixed head-quarters for each regiment, where their families could remain in safety and comfort while the corps might be absent on service, the native troops of the Indian army might be employed on foreign service for any length of time, and at any distance from their homes; and the time may possibly not be far distant when their services may be of the greatest value.—(1854.)

*Note, added in 1857.*

After the fullest study of the subject, I am convinced that Sir John Malcolm's original proposal was

\* This passage was added in 1857.



better than mine, in one respect: that the best possible arrangement would be to have all the officers in one list unattached, rising in army rank by seniority in the whole body; and from this general list to select for every duty whatever—regimental, staff, military, political, and civil. I would pay even the unemployed officers fairly, so as to keep them easily above sordid want. The mere presence of a number of English gentlemen would be of the utmost advantage to our rule in India, while most of them would, while “unemployed,” be engaged in qualifying themselves for employment, which they could only do in this country.—(1857.)

#### SILIDAR HORSE.

*Remarks on an Article in the “Calcutta Review” for March 1846, entitled “Hints on Irregular Cavalry,” &c.*

The Bengal irregular cavalry is still, comparatively speaking, badly horsed and ill found, and *must* be so on the present miserable pittance of pay,—Rs. 20 a man and horse,—which sum is altogether insufficient to support a respectable horseman. Bad customs ought immediately to be changed, which can always be done if the commandant be fit for his situation. With regard to the qualifications mentioned by Captain Trower as necessary for a commandant of irregular cavalry, and on which the reviewer remarks that “such men are not to be obtained in these degenerate days,” it appears to me that the Bengal army must be in a miserable plight if such men be

not obtainable by hundreds. Some of the qualifications mentioned by Captain Trower are of little moment, such as not being of hasty temper, conciliatory manners, &c. These things, however desirable, are little thought of by the men (who are excellent judges of their officers' real characters), if higher and more necessary qualities exist. The supposing it necessary to flatter men's prejudices, &c., which appears to be so much insisted on throughout the Bengal army, is a sad mistake,—it is the *greatest evil* which can exist,—it is the destruction of all mutual confidence and respect. It creates and fosters those very prejudices and mutual misunderstandings which it professes to “conciliate.” Why did the soldiers of the Tenth Legion love Cæsar? Because they were proud of him, not because he coaxed them. Men and soldiers, native or European, hate being commanded by “spoons.” Show the men that you respect and regard them as *soldiers* and *men*, not as *Hindoos* or what not; treat all men under your command as men and soldiers, without any regard to (although without giving offence to) caste or prejudices; treat the native officers as gentlemen, and you will soon understand each other perfectly. The differences of religion, &c., between officer and man are forgotten—positively never thought of: you have one common interest, and the European commander, if worthy by nature of his command, becomes the object of the most profound respect and regard—even though his demeanour be not very “conciliatory.”

There are other qualifications, besides those mentioned by Captain Trower, which, in my opinion, are

essential to, or very desirable for, a good commandant of irregular cavalry. He should, if possible, be a good and successful partisan soldier, quick in danger, fertile in resources: indeed, until a commanding officer and his regiment have been on service together, the corps must be considered in a greater or less degree in an imperfect state: the proper feeling between each other can hardly exist. But after all, everything else is of trifling consideration when compared with a natural *talent for command*,—that quality, or combination of qualities, whereby a commander gains not only the respect of his own men, but makes them *respect themselves*, and raises their character in their own estimation, and in that of the world. This is the grand secret of being loved, respected, almost adored, by the native soldier. Get him “abroo;” let him find himself honoured and respected wherever he goes,—even among strangers, on account of the service he belongs to, and there is nothing he will not gladly do to please his commander; there is no inconvenience he will not willingly undergo to maintain or increase the abroo of the regiment. The commandant and his men are naturally proud of, and confident in each other: the discipline is perfect, for it is the discipline of the heart.

Commanding officers should be most carefully chosen by Government, with whom the means of judging correctly *do certainly* exist. When once appointed, they should have ample powers—they should in fact be absolute in their regiments; they should have all promotions in their hands, and power to discharge any man of any rank. The appointment,

also, of the subordinate European officers should rest with them: they should be allowed to go their own way to work in all things, but be held strictly responsible for the efficiency of their regiments in every way; no excuse should be admitted. If the regiment be not what Government wishes, and has a right to expect it to be, the commandant should be removed at once. In fact, it should be a contract between the commandant and Government. A good commander will always make a good regiment: its state will be the best possible both for the men and Government. Without a properly qualified commander, no rules, orders, nor regulations, will avail in the least; they will only make bad worse. The sepoy should never think of looking to higher authority than the commander of his regiment, who should be the patriarch of his tribe, the chief of his clan; every member of the regiment should feel identity of interest with him, and instinctively look to him as his natural head. Unless this state of things be fully carried out, the regiment is imperfect; where it exists, all is healthy and strong. To do justice to *sildar* cavalry, Government cannot give commandants too much power; there should be *no* rules, *no* code of laws, nor any trammels whatever. This I consider essentially the one thing needful. Whatever trouble it may be supposed to give Government in the choice of officers, scores of well qualified men do exist in the Indian armies, and Government can find them if they think proper to do so.

With regard to making "Horse Guards" of the irregular cavalry, some grievous errors prevail. It is

not the European *discipline* which native gentlemen dislike—it is the stable duties, the European riding-school, and all those little harassing frivolities, having no connection with duty under arms, which exist in the regular cavalry, and are so disgusting to the purely Indian soldier; and ABOVE ALL, *the low rank, below the junior cornet*, to which he can ever hope to attain. With the exception of the riding-school (that is, the dragoon riding-school), sword exercise, and stable duties, the silidar cavalry (the word irregular ought to be abolished) may be, and ought to be, as well disciplined and drilled as the regulars. When mounted and under arms, there ought to be no difference, except that in the regular cavalry, the powers of the horses being more equal, and the horses better drilled, than those of silidar corps can *be now*, their movements must always be more steady, and their formations made with more squareness and precision, than those of the silidar cavalry; but in proportion as this difference lessens, the silidar cavalry is good. The *discipline* of the latter ought to be *better* than that of the regulars, inasmuch as you have better security—the men have more at stake, and discharge from the service is a very severe punishment.

With regard to the number of assamees or silidarees allowed to be held by one individual, no rule should be laid down: it may be for the advantage of the service that a certain individual should hold fifty or a hundred assamees, and as regards another individual, it may be advantageous that he should not be allowed to hold more than three: of this the commandant is the proper judge; all should rest with

him. One man, I believe, in the Nizam's service holds five hundred assamees, and one in the Guzerat Horse some three hundred.

The assamees are of course hereditary, and saleable property, but only during good behaviour, and subject to the commandant's approval. All assamees are liable to be forfeited for misconduct on the part of the silidar, by sentence of a punchayet, and the orders of the commandant. The system of allowing men not in the service to hold a very great number of horses in a regiment works, I am told, excellently well in the Nizam's service, and in the Guzerat Horse, but for the foreign service it is altogether bad; indeed it could not exist long, for the absent silidar would find so little profit, even from his five hundred horses, *that he would sell off as soon as possible*. Not a single assamee in the Sind Irregular Horse is now held by any one not belonging to the corps; and in my opinion the system of "be-nokur" silidars is bad under *any* circumstances, but for a regiment always serving at a distance from the men's native country, as in the Sind Horse, the system is certainly most injurious, and Captain Jacob with much labour completely destroyed it in that corps.

On the death of a silidar, whose heir is not a member of the corps, the horse and assamee are sold by auction, and the amount realised paid to the heir as a part of the estate. The heir, unless in the regiment, or a youth likely to be soon fit for service, is never allowed to retain the assamee.

The reviewer is in grievous error about bargheers: if the state of affairs he describes be that of the

Bengal irregular cavalry, it is nevertheless very bad. The bargheer is certainly more likely to misconduct himself than the silidar, and therefore to remedy this in the Sind Horse no bargheer is admitted without two silidars becoming security for him. This security is not a mere form, but is always enforced. Under this simple arrangement, it is not found that the bargheers are much more liable to misconduct themselves than the silidars.\*

It is also a very grave error on the part of the reviewer, and one likely to lead to much harm, to assert that "every additional bargheer is a burden on the State," and that it would be better to have all silidars. I can on this point speak positively, and with certainty, after having belonged to an irregular corps almost constantly on service for many years. *There is no doubt about it!* So far from agreeing with the reviewer, I assert, then, that the ONE-HORSE SILIDAR IS THE WORST OF ALL, and that a regiment composed wholly of such men would be wretchedly inefficient. The one-horse silidar is always poor and miserable; his horse is badly fed and cared for; he cannot afford to keep a pony nor a syce; and, on the

\* In the Nizam's cavalry, the silidar enlists his own bargheers, who are responsible to him, and under his command. Nothing of this kind is allowed in the Sind Horse. The bargheer is not under the authority of the silidar in any way whatever: he is enlisted by the commandant as a soldier of the State, not as the servant of the silidar. It is not even thought necessary that the bargheer should always be placed on the horse of the silidar who is his security, although of course he is generally so placed. The bargheer may at any time be transferred to any horse; but it is a rule to consult the wishes of the men, and to keep friends and relations together as much as possible.

whole, I consider him worse off than the bargheer : *at least one-half more pay would be required to maintain a regiment of one-horse silidars than on the present plan, equal efficiency being supposed in both.*

I am quite certain that for a regiment intended for service, and at a distance from the men's homes, your three-horse silidar hath no fellow for efficiency : he keeps a tattoo or two, or probably a camel, a syce, and a grass-cutter, so that he and his two bargheers, with their servants, form a very comfortable little family. He has generally a little money in hand, instead of being in debt, and can on a pinch get on for two or three months without pay (the Sind Horse have often had to do this), and is altogether as superior a man as possible in every way to the miserable one-horse silidar. When a man has more than eight or ten horses on service, some of them are apt to be neglected : they cannot always, perhaps, be together, and the bargheers may cheat both the horses and the silidar ; but the three or four-horse silidar is the true mean—he is not poor, and everything is done under his own eye.

The reviewer is also greatly in error about a russaldar being “ entitled to five assamees, &c., &c.” The russaldar may be entitled to hold—that is, he is *allowed* to hold—five or five hundred assamees, but these are not *taken from others* to be given to him ; if he wish for more horses than he already has, he must buy them, and the assamees too. “ The russaldar who is promoted claims a like number of assamees : where is he to get them ? ” says the reviewer. Now all this shows such profound ignorance of the genius



of the service, that it is difficult to deal with it without much explanation. All that the russaldar has, I repeat, is the permission to hold a certain number of horses in the regiment: he must get these horses how he can—by purchase, of course; for I should think that any vacant assamees in the gift of the commandant would rather be presented to poor and well-deserving *sowars*, who could not so well afford to purchase, than to the rich russaldar, who had the means of buying any number. The russaldar is entitled to have so many horses, as he is entitled to wear the russaldar's coat; but he must first buy that coat—he has no-right to another man's. But it is a great error on the part of Government interfering at all in the matter of the number of horses held by individuals; it should be entirely discretionary with the commandant.

With regard to six-horse silidars being excused sentry, the idea appears to me bad in principle, and even absurd: the men ought never to be allowed to suppose that *they are degraded by performing the duties of a soldier.*

With regard to men of good family, whether six-horse silidars or not, it is well after a short time, *when they have thoroughly learnt their duties as private soldiers*, to promote them, but until that takes place there should be no distinction allowed. Every rank in the service should be considered honourable, even that of the private sowar.

The remark about Government not reducing the number of bargheers also betrays bad principles. Government ought not to interfere at all in the mat-

ter; such interference would be highly injurious, if not ruinous, to the service. The proper men for irregular cavalry are doubtless the Mussulmans of Hindoostan. The men of the Nizam's service are the best horsemen in India, I believe; and the service being so popular, there are always hundreds of excellent oomedwars to choose from. Whenever a vacancy occurs, a *bargheer* will pay for his place Rs. 400. Such men cannot\* misbehave—they have too much at stake; neither do they require drilling—they are trained soldiers before their enlistment. But this state of things, which has so many advantages, cannot exist when the regiment is constantly serving in a foreign country.

The remarks about "keeping up the prices of assamees," &c., betray the existence of some lamentable evils in the Bengal irregular cavalry. A thing is only worth what it will fetch: if the attempt be made to force an artificial price, either above or below the real one, immense evil is the consequence. Something of the kind formerly existed in the Sind Horse, or rather among the men of the Poona Horse who were transferred to form the new corps. The old assamees of the Poona Horse were supposed to be worth Rs. 500 each, and at this rate they constantly changed hands; but the silidars were all in debt, and the sale was not real—it was merely a transfer of debts in the bankers' books. There were no means of knowing the real value. Afterwards, as the Sind Horse was raised, and

\* It is not, of course, meant *literally* that a man *cannot* misbehave as one of my antagonists ("H") gravely proceeds to refute. A man *can* cut his throat if he likes, but it is not usual to do so.

new assamees were offered for sale, it was found that their value was only about Rs. 300 or less, and to maintain the regulated price of Rs. 500 it was thought advisable by the commanding officer to form an assamee fund by subscriptions from the silidars, from which fund the difference of price was made up to the silidar who sold his horse and assamee. This appeared to Captain Jacob a strange, troublesome, useless, and complicated proceeding; wherefore he abolished the assamee fund, repaid the money to the subscribers, and let everything find its own natural level. No matter whether a silidar chose to sell his assamee for Rs. 5 or Rs. 500, one thing was insisted on—that all sales should be for ready money. The change produced was like magic: within a few months afterwards a horse in the Sind Irregular Horse would sell by auction for *ready cash* for Rs. 500 and Rs. 520, or even more; and these prices were maintained till the raising of the new regiment threw so many assamees into the market gratis. With the exception of allowing no one not a member of the regiment to purchase, and of insisting on ready money being paid, every silidar is free to sell his horse and assamee as may seem good to him.

The recommendation of the reviewer as to the filling up of assamees vacant by death, &c., is not sound: the assamee is not vacated by death unless the deceased leave no heirs, in which case it lapses to the commandant, who gives it to any deserving man, or orders it to be sold for the benefit of the regimental fund. If there be heirs, the assamee is just as much

their property as anything else belonging to the deceased, and should never be otherwise disposed of.

The fixing the price of assamees at a certain sum is very bad (as has been proved on a large scale in the Sind Horse), and leads to all manner of evil: they are just worth what they will fetch at a public *bonâ fide* sale, neither more nor less. The remark that this would enable many bargheers to purchase *without getting irretrievably into debt*, exposes the besetting sin of the irregular cavalry of Bengal. A silidar in debt is *absolutely and altogether unfit* for the service: he ought always to have a little money in hand, or he cannot be efficient. A rule is established, and acted on, in the Sind Horse, whereby any man borrowing money for the purpose of buying a horse, *ipso facto*, forfeits his assamee. Men who cannot afford to buy and equip a horse are totally unfit to be silidars. When men once begin to borrow, there is no end to it; their pay will not suffice to cover the interest of their debts; they are ground down to the earth, and always at the mercy of their creditors.\*

With regard to the sons of native officers, why should they not enter as bargheers? Very many ex-

\* Since these pages were written, another fact has occurred which bears on the subject. Another regiment of Sind Irregular Horse has been raised, 800 strong, mounted, clothed, armed, accoutred, and drilled, all in first-rate style, without allowing a man to borrow a rupee. This fact speaks volumes. *By being forced to keep out of debt, the men are compelled to save money in spite of themselves.* The only exceptions to this were a few men who came from the Nizam's cavalry. These men brought their debts with them, which was not known to Major Jacob till after they had joined the Sind Irregular Horse.

cellent men do so enter, but soon purchase assamees and get promoted also. With regard to bargheers selling their places, I am of opinion that it ought not to be thought of. But the reviewer says, who will buy? The answer is plain: in the Nizam's service the place of a bargheer sells for Rs. 400; but if it be worth nothing, as in the Bengal irregular cavalry, of course it will sell for nothing. The rate of pay in Bengal is much too low, and it appears to me most injudicious to bring down the pay of the Poona Horse to the same rate, the expenses at Seroor being about double those in Bengal. To be really efficient, a private sowar in Bengal should receive Rs. 30, and in Sind and the Bombay presidency in general Rs. 45. The adoption of these rates would be true economy in the end: a bad article is not cheap, though purchased at a low price.

With regard to the expediency of altering the denominations of the different ranks, as proposed by Captain Trower, and objected to by the reviewer, it is merely a return to the old nomenclature, which is in my opinion in some respects the better of the two: the Bengal ranks have only lately been introduced into the Bombay army, and appear strange, and some of them unmeaning and troublesome. Why call a native adjutant a "wordee major," or a pay duffedar a "wukheel?"—What on earth is a "nakeeb?" This man ought to be replaced by a kote duffedar major, whose duties are defined and well understood. The reviewer says that he has a great objection to Captain Trower's one great russaldar, who he says will apparently have no specific duty, &c.; and then he talks

nonsense about his "cocking up his beak," &c. Now, after many years' experience of his use, I assert that the one great russaldar, or a russaldar major, is invaluable in a regiment of irregular cavalry. He holds the place of subadar major of the regulars, and *no number of European* officers could supply his place. But the fact is, that the value of native officers is not properly understood in the army of Bengal. They have in that army little power over the men, are perfectly separated in heart and feeling from the European officers, and only half understand each other: moreover, they are very often old imbeciles, incapable of active exertion, whether of mind or body. But it is not so with us. A native officer or soldier after twenty years' service in the Bombay army is half an Englishman in feeling. He is not valued, either by himself or others, on account of his caste, &c., but according to his ability as a soldier, and his conduct as a man: he is much more proud of being an officer than of being a Brahmin or a Syud. Whatever, then, may be the case at present in Bengal, it is certain that a russaldar major, properly selected, is of the greatest advantage to the well-being of a regiment. He completes the chain connecting the natives with the Europeans; and, when really what he ought to be, affords the greatest support to the authority of the commanding officer: besides which, the appointment is one of great repute and respectability, and is something to look forward to as a reward for long and meritorious service.

The reviewer's remarks about kettle-drums and trumpets do not appear to be judicious. The kettle-

drum is an absurd affair altogether, and ought to be abolished: it is fit rather for the establishment of a nautch-woman than for use as a soldier-like instrument. Its very appearance is ridiculous. A trumpet to each troop is quite sufficient, and nothing else ought to be allowed. With regard to the drums adding to the consequence of the russaldars, it may be truly remarked, that if the russaldars be fit for their places they would blush to hear that their respectability rested on such things. Teach them to pride themselves upon their officer-like qualities, and they will not affect such childish folly.

We now come to the regimental fund,—a most important subject,—about which the reviewer is shockingly in the dark, or the system in the Bengal irregular cavalry is shockingly bad.

The whole affair appears so monstrous, that, instead of attempting to point out the evils of the system described by the reviewer, I will simply mention what is the state of affairs in the Sind Horse.

There is a regimental fund, formed by the subscription monthly of fourteen annas per horse, and two annas per man; all fines, &c. also go to the fund. On the death of a horse, the owner receives Rs. 100 from the fund, to assist him in the purchase of another. The farriers and artificers of sorts are paid from this fund, and some other things of general benefit supported by it. There is *no* regimental banker, and no shop-keeper in the regimental bazar dare give a man credit beyond the end of the month (this rule is strictly enforced). *Any man getting into debt to purchase a horse forfeits his assamee.* Debt is

considered to be the utter destruction of efficiency; and a most constant watch is kept, and the most stringent rules are enforced, against it. A man in debt is considered just as unfit for the service as if he had lost his limbs, and is treated accordingly. In consequence, the men are *not* in debt at all, as they never need be, and therefore are always ready for service: no more notice or preparation is required to march the regiment one thousand miles than to turn it out for parade, — indeed, the Sind Horse have seldom received more than twelve hours' warning before a march. We have only to consider that whatever the rate of pay, much or little, incurring debt *must reduce* the amount by the whole sum paid for interest: if the pay be already too small, borrowing money, to be repaid with interest from that pay, only makes the state of affairs infinitely worse. Yet to such an extent does this evil exist in the irregular cavalry of Bengal, that an old and excellent commandant told me that he had been obliged when he took command of his regiment, to borrow, on his own personal responsibility, some *three lakhs of rupees* to pay off the men's debts, so as to get rid of the ruinous rate of interest they were then paying; and that, after all, in a few years' time, by reason of a famine, they were as bad as ever—*hopelessly* involved! Another commandant told me that before he could come to Sind he had to borrow a very large sum (some Rs. 80,000) from the Agra Bank. I know also numerous other cases in point. This state of affairs appears to me to be so utterly destructive of everything like military efficiency, that it is astounding



how things can go on at all under it. The system is rotten at the core, though tolerably fair outside.

With regard to the arms of irregular cavalry, after many trials, I am certain that the native sword and a good percussion carbine are the only weapons for use, save that the officers and duffedars may carry pistols. The Government carbine is almost, if not quite, *useless* to the native horseman, however well it may answer for a dragoon; it is much too long, and, from being of musket bore, is far too heavy and clumsy.\* After many trials, and much correspondence with the makers in England, Captain Jacob got a manufacturer to supply the Sind Horse with a very perfect carbine, description as follows —

Length of barrel, 22 inches.

Bore, 17 gauge.

Weight altogether, under 6 lbs.

Percussion lock of the best construction, half-cock just above the nipple, with sliding stop.

These pieces are exactly adapted to the men, and are *most formidable weapons*.† They are used easily

\* The Government percussion pistols are *most disgracefully bad*. Those procured lately from England for the Sind Irregular Horse are beautiful and excellent, but rather expensive, costing Rs. 56 a pair. They are supplied to the native officers and non-commissioned officers. The Government cavalry fire-arms have been completely spoiled by the adoption of the musket bore in place of the 17 gauge.

† Vide despatch about the fight of Zemanee on the 1st October 1847. I have seen the same thing often before as occurred on that day, but not to the same extent. No *swordsmen* on earth could have killed five times their own number of armed, brave, and desperate enemies, fighting for their lives, which was accomplished by the Sind Irregular Horse in the fight of the Zemanee, in two hours' time.

on horseback in one hand; and in the hands of the old sowars, who make the muzzle nearly touch an enemy before firing, their effect is terrific. The sowars make excellent practice with them on foot: at a hundred yards it is quite equal to the generality of infantry regiments with percussion muskets. The lance is in my opinion (formed after considerable experience of its use both in the chase and in battle), useless for light cavalry; it may be very showy, but out of five hundred lancers not half a score will be found really masters of their weapon for war. The sword and carbine are "*facile princeps*" among light horsemen's weapons: there cannot be better carbines than those of the Sind Horse, but they are rather expensive, costing at Hyderabad about Rs. 28 each; but the men are delighted with them, and would gladly pay much more for them if necessary. The matchlocks I should class with the kettle-drums. I know them well!

The truth of the story about the Brahooees and Skinner's Horse at Dadur is not exactly as stated by the reviewer. The Sind Horse were present also, which he appears not to have known. The best Brahooees who ever drew sword would *never dream* of standing a regular charge: it is easy to do "great havoc" on flying enemies; but after all, not much *was* done on that occasion. The enemy (after a feint of advancing, to gain time for the Khan and others to escape), bolted;—that is the whole matter. As to the fire of matchlocks from horseback before the charge doing any execution, it is too absurd to be thought of.

With regard to the uniform of irregular cavalry, most officers appear pretty nearly agreed except as to colour, and to the head dress. For the latter, there is nothing in my opinion to be mentioned in the same breath with the common scarlet pugree; it fits close to the head, protects it from the sun, and partly from a cut; is never in the way, looks beautiful and soldier-like, and withal is as light as a feather. Its cost also is trifling. The dress of the Sind Irregular Horse is a dark green cloth "alkalug" (tunic, with silver lace and embroidery for the officers), white drawers, jack-boots, red pugree, and "kumer bund." The saddle-cloth is green and red, and the horse accoutrements are also covered with green and red cloth: the whole looks well, plain, and soldier-like. The dress of the native officers is very handsome.

With regard to the supply of clothing, the remarks of the reviewer again show the crying evil which exists in the Bengal army, want of mutual understanding and proper feeling between European and native. With us no such feelings as those described could, I should hope, take place or be dreamt of, and it is sad to think that they should exist in Bengal. An officer is not liable to be thought a tailor because he interests himself about the clothing of his men, their arms and equipments in general, and procures them for them of far better quality, and cheaper, than they could get them themselves. They are delighted with, and most grateful for, all such arrangements: "Who else have we to look to—are you not our father?" say they!

Is it likely that those whom you have led in a thousand difficulties and dangers, who are proud of their commander, and he of them—when you perfectly understand each other, when you have been intimately associated with each other for many years, under all kinds of circumstances, till the accident of one being Christian, another Mussulman, &c., is completely forgotten—is it to be supposed, I say, that *anything* you please to do for the good of your men will be misrepresented among them? Away with such nonsense!

Besides carbines and pistols, the Sind Horse are supplied from England with pouches and belts, cap-pouches and sword-belts, of black patent leather. The clothing, horse accoutrements, &c., are supplied by the army clothing agent in Bombay, of excellent quality, and at a rate which, though high, is cheaper than they could be procured in any other way. Every man is under regular monthly clothing stoppages from the day he enters the service. What can be better? All that about troop officers and regimental bankers is bad in principle, and worse in practice. That abominable incubus, the regimental banker, is the root of all evil! Thank God there is no such monster with us!

With regard to the marching of irregular cavalry, of course they are, or ought to be, always able to move at a moment's warning. The Sind Horse is so, and seldom has more than twelve hours' notice for a march of any length, or for any service: every man always is provided with a sufficiency of camels, tattoos, &c.

With regard to the regimental bazars, they appear to be excellently managed in the Nizam's cavalry (however, they have had little experience of desert countries as yet, I fancy). With us, we cannot carry at the outside more than five days' food for man and horse; but it appears to me, that if the necessary supplies exist in the country through which the regiment is marching, the bazar can supply itself from day to day. If, again, as has often happened to the Sind Horse, the supplies do not exist, no bazar, however perfect, could carry them for above a few days, for this plain reason, that the cost of transport alone of one month's food for man and horse amounts in this country to more than the sowar's whole-pay. When, then, the country does not afford the necessary supplies, the commissariat must feed the irregulars as well as any other part of the army, or they starve; but if food exist in the country, the sowars will get it somehow. The proper rule is this: let the commanding officer of the regiment certify, on honour, that sufficient supplies do not exist, and then only let the necessary food be carried and supplied at a reasonable rate by the commissariat. This is the rule in Sind. The men detest being obliged to have recourse to the "godown" (as they call it), and would far rather purchase elsewhere, so that no abuse is likely to occur.

In every regiment there is a "koti," or bank, says our reviewer. Marry! is there in every Bengal regiment! And this koti or bank appears to me to be a crushing evil! It paralyses every energy; nearly every man is hopelessly in debt; frequently he cannot

even pay the interest of these debts. His self-respect is gone; he is put to all kind of shifts—sometimes most disreputable ones—to enable him to keep up appearances; and after all his horse is starved, and, with his rider, alike unfit for any efficient service away from his home. The bank is of essential service in buying remounts, &c., says the reviewer: he, however, admits that it has ill consequences, but ends by saying that it is of no use to argue the question, because no corps *can be serviceable without one!!*

Strange infatuation this! But so true is it, that habit will reconcile us to anything: that which we are accustomed to appears best. Exactly the reverse of the statement of the reviewer is the truth. No corps can be serviceable with one of the banks and regimental bankers in full force!

There is neither bank nor bankers in the Sind Horse, and any man found borrowing money for the purpose of buying a horse, *ipso facto*, forfeits his assamee. *If a man have not a little money of his own he is unfit to be a silidar*, and his being allowed to become or to remain one without the means (independent of borrowing) of supporting himself and his horse respectably and efficiently, is, I consider, absolutely ruinous to the regiment in which such practices exist. The pay allowed (Rs. 20 per man and horse to a Bengal regiment, and Rs. 30 to the Sind Horse,) is not sufficient, any how, to maintain the horseman as he ought to be: how then can he pay the interest of his debts? A horseman in debt I consider *utterly ruined* as a soldier: he may turn

out for ordinary duties, or make a decent appearance on parade now and then, but for real service he is worth nothing. The evil once begun, the debt once allowed, it goes on rapidly increasing; the case is hopeless; there is *no* remedy: the silidar in debt is useless, and ought at once to be discharged. There is no rule of such vital importance to the efficiency of a silidar corps—none which requires such constant watchfulness and determined resolution to enforce—as this: *NEVER to allow a horse to be purchased with borrowed money, and never to allow pauper silidars.* If the contrary be the state of affairs in the Bengal irregular cavalry, the commanding officers of regiments ought at once to stop it, sell the horses and assamees of every silidar in debt, pay the debts with the proceeds as far as they would go, pitch the regimental shroff to the devil, and never allow a man to borrow a rupee again—no, not to save his life. But, alas! the great mass of these debts has been incurred under the sanction and signature of the commandants,—a suicidal proceeding, which renders them powerless.

If things cannot be carried on without borrowing money, they must become worse *with* borrowing, which lessens the man's means by the whole amount of the interest paid for the loan. If moneyed men will not enter the service, leave the ranks vacant till they *will* do so, or until Government increase the pay! The system of borrowing money is alike deceptive and ruinous. It cannot be too much insisted on, that a man without sufficient ready money of his own to purchase his horse and equipments is unfit to be a

silidar, and should *never, on any account*, be allowed to be one.

The application of articles of war and regimental courts-martial, forms of law, &c. to corps of irregular cavalry, is injurious in the highest degree (and in this I speak advisedly and with confidence). Of course, if a man commit murder or such like, try him as a camp-follower, but all ordinary offences should be left to be dealt with by the commandant of the regiment. The introduction of regimental courts-martial is *very* bad,—it is unmixed evil! The punchayet is ten thousand times more efficient. The genius of the service should be kept in mind. The native officers of irregular cavalry are *really* officers: the russaldar is as much commanding officer of his troop as the captain of regular cavalry is of his. The native officers of irregular cavalry do not hold the places of the native, but of the *European officers* of the regular army. They are men accustomed to think and act for themselves. A punchayet composed of them, and the proceedings of which are conducted after their own fashion, is, out of all comparison, a more just and efficient tribunal than the native court-martial, with its European superintendent, interpreter, articles of war, forms of law, &c. &c.

There never yet has been a court-martial at all in the Sind Irregular Horse, and a punchayet is seldom known to fail in its duty; and, indeed, I have never heard of a single case in which its decisions were not strictly just. A regimental punchayet in the Sind Irregular Horse is composed of a russaldar as president, and four other native officers as members:



none below the degree of a commissioned officer are allowed to sit. Their method of proceeding is peculiar, but exactly adapted to the ideas of the men themselves, which our forms of courts-martial most certainly *are not*. The witnesses are sworn at the discretion of the court, and all evidence is recorded in Persian. The sentence of course requires confirmation by the commandant before it can be carried into effect.

A punchayet has power to inflict forfeiture of one or more assamees, fine, imprisonment (in the regimental guard), or to recommend dismissal.

The commandant of a corps of irregular cavalry ought to have it in his power to discharge any man, even a russuldar, from the service ; and all promotions should be absolutely in his hands, even to the highest grades. The appointment of the European officers should also be left to him. He should also have magisterial powers,—which, indeed, he in general has with us.

With regard to silidars neglecting horses, the proper proceeding is simple enough. The commanding officer sees a horse in bad order, or unfit for service : he immediately, as a matter of course, orders the man to get another, and his horse's pay lapses to the fund till he does so. As to the silidar being ruined, I repeat, that if the silidar have not sufficient money of his own to purchase and maintain a good horse, he is useless ; and the sooner he is turned out of the regiment, or at least ordered to sell his assamee, the better. I have never heard any man of the Sind Irregular Horse object to this proceeding in the case

of bad horses,—its justice is at once felt and acknowledged by all: indeed, the more respectable silidars often do not wait to be told to change a horse, but, when they think that an animal will not be approved of by the commandant, frequently of their own accord bring another horse, to be passed and entered in place of the bad one.

This is the proper state of affairs. The men see that the object of the commandant is the respectability of the corps and the good of the whole, and that in the end this is for the good of each individual in it. Horses in the Sind Irregular Horse are always examined by the commandant himself, and, if approved of, branded in his presence.

The reviewer's remarks about pensions appear just; but after all, perhaps pensions are not much required in a silidar corps on a proper scale of pay, and properly constructed.

With regard to standards, in my opinion they are a *nuisance*. The Sind Horse have standards, having won them at Meeanee, but the corps would be better without them: they are never of any use, and on real service are only in the way; the better a regiment behaves, sometimes, the more risk there is of losing its standards.

The idea of teaching the sowars the sword exercise is silly: they are far better swordsmen than the regulars as it is. With regard to the riding-school, it is different; and, if proper pay were allowed, I would establish one,—not, of course, precisely in the dragoon style, but appointing some of the best riders among the old sowars regularly to teach the recruits

to ride after their own fashion, and to *drill the horses*. In the Nizam's service this is not required, for only fully trained men are taken into the service, which the number of candidates in waiting always enables a commanding officer to act up to, the service being so popular.

It is different in the Sind Horse. Our pay is small, the country is not liked, the climate is bad, and everything very expensive; consequently, our raw material is somewhat inferior, and to make it equal to the other requires more labour in working up. Men will rather take service in the Bengal Irregular Cavalry than in that of Sind: the difference of pay is not adequate to the increased expenses and inconveniences of distance from home, severer discipline, &c.

In my opinion, it would be greatly to the advantage of Government, and materially add to the strength of the Indian army, were all the regular (that is *bar-gheer*) cavalry made European: of course much fewer regiments would be required, say half the number now existing, the present cavalry officers of two native regiments being appointed to one of Europeans; and all the native cavalry made *sildar* corps, on a scale of pay and establishment which, though at a less cost, would enable them to be superior to any native cavalry now existing. The cost of each trooper of the regular cavalry of the Bombay army is about Rs. 83 a month. The cost of each man of the Sind Irregular Horse as it now stands is about Rs. 36; and the cost of each man of the proposed *sildar* cavalry would be Rs. 58 monthly. The saving in the native cavalry would pay the increased expense of

the European soldiers, and the increase of strength would be *very great*; for I maintain that the sildar cavalry on the proposed scale would be *superior* in every way to the native cavalry now existing. The best among the native gentry, who now have no connection with the army, would be proud and delighted to enter such a service, where the native officers have real command and authority, and where much of that harassing stable duty, &c., &c., which is so disagreeable to them, does not exist. Not only would the service be composed of a class of men very superior as soldiers to any now entering the native army, but the political effects of such a service would be immense: the most influential native sirdars, men of landed property, and so forth, throughout India, would have a distinct interest in this part of the British army, which would be filled with their brothers and sons. Neither could their connection with the army in this manner ever be attended with danger to the State, for to their position in the British army would they feel that they owed greatly increased respectability and honour: they would be grateful to the British Government, and be proud to serve, instead of only fearing it. The effect of such a state of things, in securing the fidelity and attachment of the people in general, must be very great. At the same time, not only is the cost of such a service much less than that of the present native cavalry, which has no connection at all with the most influential and best families of India, but the sildar corps is, from its construction, at all times much more ready and much more easily moved than any other troops whatever; and by its

movement the State is *put to no extra expense*, save in the extreme case of a march through a desert country for more than a few days successively

There is but one thing required to ensure the perfect success of the proposed scheme, viz., a proper choice of officers to command, and the entrusting them with full and sufficient powers. The subordinate grades of European officers would then form an excellent school for future commandants, and the supply would never fail. The commandants should always be allowed to choose their own European officers. The service should always be one of careful selection; and if the commandants be really and honestly chosen by merit and fitness alone, Government need never find difficulty in appointing properly qualified individuals. The officers of the regular cavalry are, *in general*, not well adapted for a silidar corps. But if they should possess the necessary qualifications, and be above the *prejudices caused by education and habit*, they would in such case certainly be the best. A certain number of the native officers and men of the "regular" cavalry might with advantage be incorporated into the silidar corps (some of the best men of the Sind Irregular Horse are volunteers received at various times from the regular cavalry of Bombay); but a general transfer would not succeed at all—indeed it would ruin everything. One other thing especially should be borne in mind, viz., the absolute necessity of not appointing more than three European officers (besides the doctor) to each silidar regiment. The essence of the proposed advantages of the construction of the corps consists principally in

the respectable position held by the native officers inducing a very superior class of men to enter the service. This state of things is not compatible with many European officers: quality, not quantity, is required. This cannot be too much insisted on.

It is proposed to take the "Political Advantages of Silidar Cavalry in India" as the theme of an essay hereafter. The subject is well worth the grave consideration of Government.—(1847.)

#### ON GRANTING COMPENSATION TO SILIDAR CORPS.

The whole system of granting compensation to men of silidar corps appears to me to be founded on false principles; to be most injurious to the service, by striking at the root of that which forms the peculiar strength and advantage of a silidar corps, viz., its entire independence of external aid; to be contrary to true economy, inasmuch as it entails a great and uncertain expense on the State, without an equivalent benefit resulting in increased efficiency; to open a door to fraud; and to cause the worst conducted corps, or the worst individual silidars, to be the most costly to Government.

The regulations in force since 1849 with regard to compensation for horses of irregular cavalry dying of fatigue, &c., also involve another practice which appears to me to be fraught with the greatest evil to the service. I allude to the assembling of committees of cavalry officers to ascertain the circumstances of the case, &c. Such a rule can only be understood by the native soldiers as implying that Government distrusted their commandant, and thought it possible

that he might cheat the State, or allow others to do so. I can hardly imagine anything more calculated to destroy mutual respect and proper soldierly pride than such a proceeding. The rule has never been acted on in the Sind Irregular Horse, and I trust that it never will be. My opinion of the evil working of such arrangements—checks, as they are called—is neither vague nor theoretical.

Let Government call for returns, showing the amount of compensation for horses drawn by regiments of irregular cavalry while serving on this frontier, in the Punjaub, or in similar positions, receiving the same rate of pay as the Sind Irregular Horse, under the operation of such checks, and compare it with the amount drawn by the Sind Irregular Horse on the same account, while entirely free from any such interference, during the last nine years of almost constant active service, including a share in several great battles, and the practical working of the two systems will at once be apparent. \* \* \*

I have been informed, that when the 6th Regiment Bengal Irregular Cavalry was posted at Khanghur in 1844-45, it received compensation for about five hundred horses. Another corps of Bengal Irregular Cavalry, when serving on this frontier, had, when I visited its lines, three out of four horses suffering from sore backs. The horses were still worked in that state; those dying or becoming unserviceable being, of course, paid for by Government, under the committee system. How was this? It was assuredly not owing to the superiority, or otherwise, of individuals; but clearly because such a system makes

men helpless, careless, improvident, and dishonest—in a word, unsoldierlike.

As an illustration of this principle, I beg to mention what appears to me exactly a case in point. When on service, in the year 1844-45, I found that more of our horses were laid up with sore backs than I thought right. The owners and riders of the horses had always plausible and ready excuses to offer; nevertheless, it appeared to me that the evil could be stopped, and, accordingly, I ordered that the bargheer riding a horse becoming sore-backed should forfeit to the regimental fund at the rate of one rupee a month, and the silidar owning the horse two rupees, until the animal should be well again; and that, meanwhile, the horse should not be ridden, nor anything whatever be carried on his back.

This rule caused much dissatisfaction at first, especially among the senior native officers, who, having a great number of horses, were usually the most careless silidars, and suffered most. However, I was certain of my ground, and remained firm; when in a very short time the advantage of the arrangement so much complained of became apparent to every man in the regiment; the penalty became virtually a dead letter, for there was scarcely a sore back remaining, and now such a thing is almost unknown in the whole corps.

There is no better method of making a man take care of his horse than making him lose by the injury or death of the animal. My own opinion is firm, after much consideration of the subject, that all manner of compensation to men of silidar cavalry should be



avoided as much as possible, as undoubtedly tending to injure their efficiency and make them helpless. Any increase of monthly pay which the men may receive will, up to a certain amount, in proper hands, be attended by a more than proportional increase of efficiency: but it is otherwise with occasional grants of compensation and such like; these cannot be regularly calculated on, and the prudent and steady soldier does not depend on them; while they tend to destroy honourable feeling, by enabling a rogue sometimes to obtain more than the honest man, and the owners of the worst horses to receive the most pay.

With regard to compensation for horses, the only exceptions which I would make are in the cases of horses actually killed in battle, drowned, or lost when proceeding on duty by sea, and such like; where it must be evident that no care or providence on the part of the man could have prevented the loss, and that the condition and quality of the horse had nothing to do with the matter.

Whatever may be the fair amount, on a liberal average, necessary to enable a silidar (free from debt, which ought not to be allowed) to maintain a serviceable horse, &c., it should be included in his monthly pay, which being sufficient for the purpose, he should be left to make his own arrangements, under the direction of his regimental commander; but no excuse should ever be admitted for inefficiency, and no external assistance, under any but very extraordinary circumstances, should be either looked for or granted.

The system, then, of casting the horses of silidar

cavalry by committee, and Government paying for them, being shown not only to be enormously expensive to the State, but attended with positive evil to the service, it appears unnecessary to discuss the question as to what is to become of the cast horses.

However, my opinion is clear, that such petty savings as the one in question, with regard to the silidar service, do harm, as tending to check a certain degree of liberality which is expected from, and which is essential to, a good silidar, and to produce a feeling towards Government in the native mind which it is most desirable to avoid.—(1856.)

#### SILIDAR RIFLE CORPS.

It would, I have not the least doubt, be perfectly easy and very advantageous to the State to raise and organize infantry on the same principles which I have acted on with the Sind Irregular Horse. Such infantry would be the most efficient in India. The only difficulty which I anticipate is the apparently invincible prejudice of authority. I must have no courts-martial or articles of war. I want no lawyers among my men, neither do I wish to govern them by force or by fear.

I will have "sober God-fearing men in my troops," as said old Cromwell, and will govern them by appealing to their higher, not to their basest attributes. Actual crimes can be dealt with by me and my lieutenants as civil magistrates: all else must be left entirely to my discretion.

The men should receive ten rupees a month each, and provide their own arms, accoutrements, clothing,

&c., &c., just as do the Sind Irregular Horse, under regimental arrangements made and controlled by me. Nothing extra to be furnished by Government except hospital stores and hospital tent medicines, ammunition, and carriage for these. I should have full power to enlist, discharge, promote, and reduce, also of fining or otherwise punishing men, without articles of war, as with the Sind Irregular Horse.

The choice and removal of officers to rest wholly with me. I should arm the men with rifles; and it would be our chief peculiarity—for which purpose the amount of pay is calculated—that all should at all times be provided with proper means of carriage of kit to take the field at a moment's notice, as with the Sind Irregular Horse. Carriage for the hospital and ammunition being permanently maintained at Government cost.

Permanent head-quarters to be at Jacobabad, but the corps to be available for service anywhere, always returning, however, when its tour of service was over. Families, Pensioners, &c., to remain always at head-quarters.

I would also add to each regiment of Sind Irregular Horse a troop of Silidar Horse Artillery; the troop to form part of the regiment.

A force so organized would be complete in itself; would be independent of departments; would be able to move anywhere at a few hours' warning; and would be capable of long and rapid forced marches, the riflemen availing themselves of their baggage ponies, &c., to reach the place of action.—(1855.)

THREE MEMORANDA ON THE CONSTITUTION OF THE  
SIND IRREGULAR HORSE, AS EXEMPLIFYING THE  
SILIDAR PRINCIPLE.

*Memorandum, No. I.*

On the raising of the 1st Regiment of Sind Irregular Horse, two hundred men were transferred from the Poona Horse to the new corps. The men so transferred appeared to consider that they had a right to a sum of Rs. 500—neither more nor less—for each assamee they might choose to dispose of. This right appeared to have been recognised by commanding officers, and the assamees were constantly transferred at that price. At the same time, there was hardly ever a real sale; every man was deeply in debt to the regimental banker; and the sum of Rs. 500 for an assamee was merely transferred in the banker's books from one name to another. On the raising of the Sind Irregular Horse, the new assamees were presented, of course, either to deserving men of those received from the Poona Horse, or to others newly enlisted.

The silidars could assert no such claim for a guaranteed price, with regard to the new assamees, as they had preferred with respect to those of the Poona Horse; and, in consequence, the greatest confusion existed. ( )

There were three or four descriptions of assamees in the corps, such as original Poona assamees, presented Poona assamees, new assamees presented, and

new assamees purchased, all coming under different rules.

The commanding officer attempted to remedy this great evil, by forming an assamee fund. This fund was formed by large monthly subscriptions from the silidars of the corps; the prices of the horses were registered; and on the sale of an assamee, the difference between the price of the horse and Rs. 500 was made good from the fund.

This contrivance, which was an attempt to remedy one error by another, was found greatly to increase the evils of an already vicious system; and, on my joining the Sind Irregular Horse, nothing could have been more confused than the silidaree system in the regiment.

Nothing was left to find its natural level; and, in spite of all guarantees and artificial supports, there was no confidence in the system, and the assamees were actually worth nothing; while many of them were held by women, children, shroffs, and all manner of persons not in the regiment at all. Wherefore, thinking that it was manifestly impossible that a respectable military corps could exist under such arrangements, so soon as I had sufficiently mastered the subject to see my way clearly, I ordered that the assamee fund should be abolished, and the money repaid to the subscribers. I explained to the regiment that Government did not recognise the sale of assamees at all, but that the proceeding had been permitted as a private arrangement among the silidars, for their own convenience; that all differences between assamees, however acquired, would immediately cease.

That all assamees, held by persons not belonging to the corps, should be considered vacant on the death of the horses now representing them in the regiment.

That whenever a silidar might be permitted to sell an assamee, the sale should be by public auction, for ready money only; that no one should be allowed to bid except bargheers and silidars not holding already more than two horses in the corps. No borrowing of money, in order to purchase, to be allowed.

That under every circumstance, the assamees should be held only during good behaviour; and that no sale or transfer should ever take place without the express permission of the commandant first obtained.

Finally, that the price of an assamee was just what it would fetch, whether Rs. 5 or Rs. 500.

These rules have been strictly acted on in the Sind Irregular Horse since 1842, and with the happiest results.

The silidars were at first somewhat startled at the complete overthrow of all their accustomed habits and received ideas concerning silidar arrangements, and I was even told that the ready-money sales would be absolutely impossible; but the arrangements had not long been in force before their benefit was apparent to all.

The drain on the capital of the regiment by silidars not in the service, and by the interest paid to shroffs under the system of purchasing on credit, being stopped, it was found that not only were ready-money purchases perfectly practicable, but the prices rapidly rose.

Since I joined the Sind Irregular Horse, 1,100

assamees have been presented free to the men of the corps, each man on receiving his assamee paying Rs. 20 donation to the regimental fund. At the time of raising my second regiment, when 800 places were given to the silidars, of course there was little or no selling of assamees, but soon afterwards they were sold for Rs. 600 to Rs. 700. This is the price which they still fetch, and appears to be the rate to which they have settled down.

With regard to the prices thus obtaining, it should be borne in mind that, under the system in force in the Sind Irregular Horse, the price of an assamee must be wholly regulated by the pecuniary means of the poorer members of the corps, no one not in the regiment, and no silidar holding three or more horses, being allowed to purchase. As the silidar assamees had long been considered as hereditary property, and had been sold as parts of the estates of deceased men, I did not think it advisable suddenly to disturb the arrangement, especially while, before the augmentation of the corps, so large a proportion of the assamees had been purchased.

But I am disposed to think that it would have been better had I done so at once; and that in a corps untrammelled by old customs, assamees should be vacated by the death of the silidar: at the same time, if the deceased silidars left sons or brothers in the regiment, being eligible persons, it would be well always, as a favour, to transfer the assamees of the deceased to them.

In all these things, consideration for the good of the service should be paramount.

But experience convinces me that the permitting property in, and the sale of, assamees, is necessary to the well-being of a silidar corps. It gives the greatest security for the good conduct of the men, who are not likely to misbehave when they have embarked their whole property in the service.

The right of property in the assamees gives a tone to the whole structure of a silidar corps, without which its greatest strength would be wanting. It is this which makes the best soldiers in India attach themselves to the service, till they look on their regiment as their country, and their place in it as their estate.

It should be fully understood that it is assumed that Government does not recognise the right of property in the assamees any further than a private regimental arrangement, and that all purchases of assamees are made with a full knowledge of the fact that if the corps be disbanded to-morrow the silidars have no claim on the State on account of any such purchases.

Unless on a greatly increased rate of pay, it would not, I am of opinion, be practicable to raise a regiment, in which the silidar had to commence by the purchase of his assamee,—that is, if the purchase-money amounted to anything like the value which the assamee would be worth soon after the complete formation of the corps.

But the principles of political economy are as true, as regards the sale of assamees, as of other things; and if the new assamees were sold for what they would fetch, as in the Sind Irregular Horse, their real value would at once be apparent.



With an entirely new corps for general service, the value of the assamees would at first, in my opinion, be almost nominal.

I have not the smallest doubt but that the best proceeding on raising a regiment would be to give the assamees to the silidars free, and if they were afterwards allowed to sell them, it would be by favour and permission of the commanding officer.

Even supposing that it were possible, which I do not believe it would be, to get respectable silidars to pay a round sum for their assamees on the first raising of a corps, and that the money so paid was to be applied to the formation of a fund, I have a strong opinion that the arrangement would be absolutely ruinous to the regiment.

It would, in fact, be re-introducing the state of affairs which was found so injurious in the Sind Irregular Horse, and which was in that corps remedied with so much labour:

Such a proceeding would tend to destroy the self-dependence which constitutes the silidar's peculiar strength.

The less Government interferes with him the better: he should receive his pay, and be left to make his arrangements for performing his part of the contract, being compelled always to have man, horse, arms, &c. complete and ready for service; no assistance being given, and no excuse accepted.

On the whole, I have not the least doubt, after nine years' constant attention to the subject, but that the best system of silidar arrangements is, that Government should not recognise the sale of assamees at all;

but that their sale should be permitted, at the discretion of commanding officers, as a private arrangement between the men of the regiment. That such sales should be *bonâ fide*, for ready money only; and that only members of the corps should be allowed to purchase or to hold assamees in the corps.

I am of opinion that it would have been much better if Government had never recognised even the distinction between bargheer and silidar; and if it were to refuse to do so now, a silidar corps should be mustered and paid as so many sowars, &c.; the horse being considered as part of the man, and commanding officers being held strictly responsible that everything be kept in an efficient state; all details being left to them to manage as they can.

It is undoubtedly possible that, under a different system, with less left to the regiment, and more established by general rule and regulation, no silidar corps would ever be in a very bad condition; but it is certain that such a system would reduce all to a decent mediocrity; the genius of the service would be changed, and a tame and listless spirit everywhere take the place of emulation and zeal, of attachment to, and pride in the service.

I have seen a good deal of silidar cavalry under each of these conditions; and the opinions above expressed are founded as much on actual observation as on reflection.

It will be perceived that all I have written above refers solely to a silidar regiment, considered as a body of cavalry soldiers for general service in any part of the world.—(1850.)

*Memorandum* No. II.

The subject of the pay, &c. of the Sind Irregular Horse is a very difficult and a very delicate one for me, so deeply interested as my feelings are in it, to write on, so as, on the one hand, to do it justice and set its merits fairly forth, and, on the other hand, to avoid the appearance of presumption and undue personal bias.

The truth is, that the Sind Irregular Horse is not now an irregular corps at all, and cannot be fairly judged of if confounded with really irregular corps. The whole daily routine of duty in the Sind Horse is carried on with quite as much steady regularity, and in just as good style, as I have ever known in the best regiments of regular native cavalry. The only resemblance, as far as I can understand, which exists between the Sind Irregular Horse and the other regiments of irregular cavalry of the Indian army, inclusive of the Nizam's service, is that all are sildar corps. In everything else, the Sind Horse essentially differs from them all. The Sind Irregular Horse stands alone, and it is a new service lately called into existence, and the capabilities of which are only now being gradually developed.

I was appointed to command one irregular regiment, and afterwards to raise another: I have made both regular. The corps has been formed and trained after a fashion entirely opposed to all formerly received opinions, to time-honoured prejudices, and to

reputed experience. Whether I have done right or wrong in so acting it is for my superiors to judge,— I have at least worked honestly and zealously, to the best of my judgment; and the result has been that the corps, man for man, even in its still infant state, carries far more military power with it, under all the various circumstances of war, than any irregular corps (more even than our “regular” native cavalry under most circumstances); and it appears certain, that had the Sind Irregular Horse been formed on the model of other corps of irregular cavalry, it could not possibly have performed the service it has done: disgraceful failure would, in all probability, have followed attempts to do with irregulars that which the Sind Horse has done with complete success.

The corps has been constructed so as to retain the activity, independence, and readiness of the best irregular cavalry, with the solid strength, certainty, and steadiness of action of the regulars. It is armed in a style very superior to any other cavalry in India, regular or irregular.

The present rate of pay would suffice well, probably, for a really irregular corps; but an irregular corps could not possibly have done the duty which has been successfully performed by the Sind Irregular Horse, and other troops must also have been employed. The pay allowed is not sufficient for regular sildar cavalry, and on it they cannot be what, with a more liberal scale of allowances, they might easily, and with true economy, be made.

It is true that the Sind Horse has hitherto done whatever duty has been required of it in a satisfactory

manner ; but it must be borne in mind that the best and most influential of its native officers were formed in a different school, and entered the service during the Muratha war, under the attractions (to the uneducated native mind) of a perfectly irregular service, and on a scale of pay very far above that now allowed.

Many of these men, although all their prejudices, habits, and opinions were in favour of the irregular system, possess excellent sound common-sense, and are becoming gradually convinced of the superior advantages of a higher and stricter discipline, freedom from debt, more careful training, regular routine of duty, drill, &c., and seeing the success and honour to which these things led, they have entered heart and soul into the new order of things. Some of these native officers are men of good family and considerable landed property: being also excellent officers, their influence is invaluable in the regiment, and no number of European officers would make amends for the loss of it; but we may look in vain for a succession of such men on our present rate of pay in Sind. It is not to be expected that such men will leave their homes to serve at first as private soldiers, under a strict discipline, in a foreign country, on ten rupees a month.

My constant endeavour has been to make the Sind Horse fit for service in any part of the world; and, to the extent of the means allowed, these endeavours have possibly succeeded. But the corps could not have been efficient had it been organized on the system prevailing even in the best irregular cavalry of

India. We cannot allow one man (and he not always even in the regiment) to hold all the horses in a troop, squadron, or more, ridden by bargheers of his own choosing, and thereby induce men of birth, wealth, and influence, to connect themselves with the service; such a system may, and does, after a fashion, succeed with local corps serving at or near the men's native homes, but would be ruinous in a corps intended for general service; the regiment so constructed could not long exist in a foreign country and on rough service; and if called on so to serve permanently would assuredly fall to pieces, or rapidly deteriorate, the actual working soldiers not having sufficient interest in the service to induce them to submit to its inconvenience under such circumstances. The Sind Irregular Horse labours under many disadvantages when compared with the service in India. To enable the men to do the work required of them, it has been necessary to make the corps, with regard to drill, discipline, and, in fact, to all intents and purposes, regular cavalry; it is armed and accoutred in a very superior manner to any cavalry I have ever seen in India; its horses, also, though not equal to those of the regular cavalry, are very much superior to those of any corps of irregular cavalry with which I am acquainted. The service in Sind is not generally liked by the Indian soldier—in fact, it is much disliked by the class of men from whom the best cavalry soldiers in India are to be obtained; and our expenses are great: from all these causes combined, the raw material of the Sind Irregular Horse must at present be inferior to that of the irregular cavalry

serving in India. The men generally prefer ease and comfort, on seven rupees a month, in Bengal, to hard work, strict discipline, and bad, or at least disagreeable climate, on ten rupees a month, in Sind.

That we have hitherto succeeded so well as we have done is chiefly owing to the high character which we have been so fortunate as to obtain : in fact, this has been our greatest strength ; by reason of it we get a better class of recruits than would otherwise join our ranks ; and the men have willingly submitted to all kinds of inconveniences, losses, and hardships, for the sake of reputation, which they would not have done for the pay. But there is a limit to this, and that limit I think the Sind Horse has attained.

As an instance of the extraordinary expenses which service in this country entails on a silidar corps, I may mention the virulent epizootic disease which prevailed among the horses of both regiments of Sind Irregular Horse during the year 1847, and which has not yet entirely left us. This was brought by me to the notice of Government, not with the intention of applying for any compensation to the silidar, but that Government might know of the losses which the men's small pay had to cover. A return of horses which died of the disease above mentioned ("malignant epidemic catarrh"), was appended to the report, the average price paid for horses in the Sind Horse being about Rs. 200 each. The loss and injury to the regiment by reason of this unprecedented mortality among the horses have been very great, and to an extent which could hardly have been contemplated by

Government when fixing the scale of pay to the men ; but I did not wish to apply for compensation for such losses, because it appears to me that the system of granting compensation, pensions, or any extra allowances whatever, to silidar corps under any circumstances is bad, and that it would be far the best economy for the State to consider all these things fairly in the regular monthly pay allowed, and to leave the regiment to arrange all details itself, the commandant being responsible to Government, and the men to the commandant, that perfect efficiency be always maintained. Our present rate of pay is not sufficient to enable the men to mount themselves as they ought to be mounted, or to meet extraordinary losses fairly, and the service must suffer injury accordingly.

It should be borne in mind that up to a certain amount every additional rupee allowed is attended with an increase of strength and efficiency in far greater proportion than the increase of pay. There is no analogy in this respect between silidar corps and the rest of the army, for the "regular" troops being mounted, armed, clothed, &c., &c., &c., by the State, the amount of pay which the men receive has no influence whatever on the state of a regiment in all these essentials ; but it is all in all to the silidar, who provides everything for himself. In this, as in everything else, it is true economy to pay a good price for a good article, instead of aiming at cheapness, without sufficient regard to quality : the sum paid in the latter case is too often absolutely thrown away, while in the former full value is received for every pice expended.



If Government were to raise our pay, for each sowar and his horse, to Rs. 45, instead of Rs. 30 monthly, with proportionate increase to the superior ranks, a regular silidar cavalry would speedily be formed very far superior to any native cavalry now existing in the East, in every respect, yet costing the State in time of peace less than two-thirds, and in time of war less than one-third of the cost of the present regular cavalry of the Bombay army. No compensation, commissariat charges, pensions, nor any extra allowance whatever, would be required under any circumstances, with the single exception that, should the regiment be ordered to proceed on service to Europe, to Egypt, or elsewhere beyond sea, passage for man, horse, followers, and baggage cattle, would be supplied by the State. Such a cavalry would be available for service in any part of the world—it would go anywhere and do anything. Wherever there was purchase in money, it would subsist without any aid but its regular monthly pay; and it would carry with it the greatest military power at the smallest possible cost to the State.

*Memorandum, No. III.*

It would be of very great advantage to the corps were there more native officers allowed to each regiment, viz :—

- 1 Russaldar major, at . . . . 300 rupees per month.
- 1 Native quartermaster, at 75 rupees per month.
- 1 Kote duffedar major at . . 55 rupees per month.

The above "effective;" also the undermentioned "non-effective :"—

1 Farrier major, staff pay,	25 rupees per month.
16 Farriers . . . . .	5 rupees each per month.

The *nakeeb* to be abolished. It would also be a great improvement to abolish the *wukeels* now allowed, and to give, in their places, an effective pay *duffedar* to each troop, on a salary of Rs. 45 a month.

The above will, I trust, suffice to bring the question of pay to the Sind Irregular Horse fairly before Government; but whatever may be its decision on that point, I trust that the designation of the corps may be changed, as recommended (after closely examining us) by Colonel the Honorable Sir H Dundas, C.B., commanding the troops in Sind.

It would be conferring a very high honour on the corps to order it to be styled "*Sildar Light Cavalry*" instead of "*Irregular Horse*;" it would be an honour deeply and gratefully felt by every man and officer in the corps; it would be a reward for past services, and a stimulus to future exertion on the part of us all: lastly, I hope I may be allowed to say, with honest pride, but without presumption, that it would be an honour which we have fairly earned, and a favour which we may reasonably hope for from a Government ever ready to acknowledge the zealous services of its faithful though humble servants.\* \* \*

An adequate establishment must exist, in some form or other, whether paid for and recognised by Government or not, in every disciplined regiment, whether called irregular or otherwise.

If this establishment do not exist in the irregular cavalry of —, the consequence necessarily follows

that there is a corresponding defect in their discipline.

When the — irregular cavalry were stationed on this very frontier, now guarded by the Sind Irregular Horse, the whole country exhibited one scene of violence and bloodshed—of fear and disorder. There was no peace anywhere on the border, save where there was a void, desert waste.

The soldiers of the State—the irregular cavalry—were only seen shut up in forts, or flying from the enemy, on the one hand, or destroying their friends—the unresisting peasantry of the country—on the other.

The notorious state of the frontier detachments, and the general orders by the Governor of Sind of the 23rd June and 4th July 1844, afford full proof of the former position. The latter is sufficiently shown by the pensions which Government is paying to some fifty or sixty of the survivors of those wretched people, who recovered from the wounds they received from the hands of the troops who should have protected them.

The brigade at Shikarpoor was kept constantly on the alert, and, as I was informed by the general officer in command, was in continual expectation of being attacked by the mountain robbers, who invaded the country at their pleasure. On the contrary, what was the state of affairs on the same frontier when guarded by the Sind Irregular Horse in the year 1842, during the awfully trying period of the Cabool disasters?—and what has been the state of affairs on this frontier since the Sind Irregular Horse again became the border force in January, 1847?

On the former occasion the poor people of the country looked on the men of the Sind Irregular Horse as their friends and protectors, and aided them in every way in their power. There were many sharp encounters with the enemy, in which the men of the Sind Irregular Horse were invariably successful; and the general result of the proceedings was acknowledged by the Political Agent in Sind and Beloochistan.

On the second occasion the results of similar conduct have been even more valuable: plunder, rapine, and disorder, which existed to a fearful extent wherever there were inhabitants along this frontier, have entirely ceased; hostile inroads into the British territory, formerly so common and so formidable, are entirely unknown; peace, quiet, industry, and plenty, with full protection for life and property, everywhere prevail; towns, villages, and green fields are gradually taking the place of a frightful wilderness.

The people, who are fast returning to the country, are contented and happy, well-disposed towards, and confident in the Government. The change produced for the better is so great as to be almost incredible by those who have not seen it. It has been produced by nothing but the discipline of the Sind Irregular Horse. To produce and maintain this discipline has been my constant study and unceasing labour, since Government did me the honour to entrust me with the command of the corps in the year 1841.

I have never been absent a day from my duty; I have never swerved from my purpose for one moment; but have endeavoured, to the utmost of my ability, in

spite of all prejudices, to make the Sind Irregular Horse efficient for all manner of service in any part of the world, and against any enemy; to develop the powers of the native soldiers of India; to do justice to those powers, and render them fully available for the successful performance of any duty which might be entrusted to the men of the corps; to attach those men to the service and to the Government, by their pride in their profession, until their feelings and affections became warmly excited in favour of good order and military discipline, so that little coercion be necessary—for example, there has never yet been a court-martial in the Sind Irregular Horse. I have laboured at this task for ten years past. How far I have succeeded is known to the Commander-in-Chief and to the Government of Bombay.

Sir Charles Napier and Sir Willoughby Cotton have both recorded, in general orders, that I have brought the Sind Irregular Horse "to perfection." It is certain that the words of the historian, Macaulay, are as truly applicable hitherto to the men of the Sind Irregular Horse as they are to the Ironsides of Cromwell, the earliest sildar corps on record. In the mountains and plains of Kutchee, in Sind, in the Desert, or in the Punjaub, the men of the Sind Irregular Horse, often surrounded with difficulties, sometimes contending against tenfold odds, not only have never failed to conquer, but have never failed to destroy and break in pieces whatever force was opposed to them.

They came, at length, to regard the day of battle as a day of certain triumph, and marched against

the most renowned soldiers of Asia with disdainful confidence. This spirit, which they have hitherto invariably shown, whether under personal command of their European or of their native officers, without a single European present, together with their orderly and regular conduct in quarters, has been produced by their discipline alone. This discipline is not dependent on one man—it has little or no reference to individuals; it depends on a regular and proper system being introduced and maintained in the corps.

As conducting towards the introduction and maintenance of such a discipline among our native troops, an adequate establishment is necessary. The duty cannot go on properly without it. I beg leave most respectfully to submit, that ten years' hard labour, unremitting study of, and close attention to, these matters, resulting in invariable success, whether myself present or not—and rewarded, I am proud to say, with high praise from all my superiors—entitle me to be heard on this subject: and will, I trust, be sufficient to acquit me of presumption in again urging my request that the slight alterations required to complete the establishment of the Sind Irregular Horse on a proper, sound, and soldier-like footing may be granted. You may rest assured that the State will be richly repaid for whatever extra expense may be caused by the grant of the establishment applied for, even if it be granted to all the irregular cavalry regiments in India.—(1851.)

## CARRIAGE ARRANGEMENTS OF THE SIND IRREGULAR HORSE.

The following minute was penned by order of a general officer who had just then reviewed a regiment (800 sabres when complete) of the Sind Irregular Horse:—

“The whole of the baggage was packed and laden on the reverse flank of the column, ready for a march, and everything was in that state of preparation, with only a day’s warning, that the whole body on parade, numbering 796 sabres, could have moved, on the sounding of the trumpet, in any direction where their services might be required.

“The whole of these appointments, as well as the horse furniture, are perfectly uniform and complete, even to the small leather water-mussucks for the use of the men, carried under the belly of the horse, attached to the girths. In short, the marching order parade proved, what I had long heard, that the Sind Irregular Horse were ready and able to march at the shortest notice, complete in every respect, and quite independent of the people of the country, in respect of carriage. Nothing can, I conceive, be more soldier-like and complete than the marching order of the Sind Irregular Horse.”

Gèneral (then Major) Jacob being called on to report the description and quantity of baggage and animals required by each regiment, submitted as follows:—

“Reason and experience have convinced me that the very best, or rather the only good, check on

excess of baggage, is compelling officers and soldiers at all times, and in all places, to be provided with carriage; their means being limited, they cannot carry too much.

“It is only necessary to insist on a sufficiency of baggage animals being maintained by each and all, and these animals being private property, the men never injure them by overloading or ill-treatment.

“No wheel-carriages are ever allowed in the Sind Irregular Horse; in other respects, no restriction is placed on the nature of carriage. The soldiers keep camels, ponies, or mules, as they please.

“No carriage is ever allowed to be *hired*, under any circumstances. All men are made to keep their own baggage animals.

“These rules are enforced by heavy fines on those who break them; but for many years past everything in the Irregular Horse has worked perfectly smooth, and the last instance of a soldier having been fined for being unprovided with proper carriage occurred more than five years ago, the offender on that occasion being an officer lately received from the regular cavalry.

“Carriage is always ready, sufficient in quantity and quality, to carry the men’s bedding, cooking apparatus, tents for such as choose to carry them, and three days’ food for man and horse, when necessary. No more preparation is required for a march of any distance than for a parade.

“The only delay beyond the time occupied in saddling and loading, is the few hours necessary for



bringing in the baggage animals from the jungle or country, where they go daily for forage.

“ I have never found more than twelve hours' warning necessary to enable the whole corps of Sind Irregular Horse to commence a march of any length.

“ For instance, in December, 1845, when General Simpson received orders to move a brigade from Hyderabad to Bhawalpoor with all possible despatch, I was in the act of mounting my horse for parade when the assistant quartermaster-general rode up and asked me from the General when I should be ready to march. I replied that we were always ready; and we actually did march the same day, reaching Roree with the whole regiment in perfect order, and fully equipped, before a man of the “ regular ” troops could be moved from Hyderabad (fifteen days after our departure), although they were aided by a “ Baggage Corps,” by the commissariat department, the collector, and the police authorities, while the Sind Irregular Horse was wholly independent of all external aid. \* \* \*

“ The whole essence of the strength of the sildar system with reference to carriage, as to all else, consists in the men being made to provide for themselves in all respects, and the commanding officer being left to make his own rules and arrangements untrammelled by the forms and regulations of the regular army. - Thus, the regiment is rendered at all times complete in itself, and independent of all other departments. \* \* \*

“ It should be borne in mind, that there is no fixed proportion established, and that the more carriage the men have in their possession, and the more baggage

they can carry, the more efficient is the regiment in the field, and the more independent of daily supplies from the country through which it may be marching.

“The syces, grass-cutters, &c., generally travel mounted on the baggage animals, which is a very great advantage; and I have always found all to keep up with the regiment, even on long marches, such as forty miles a day.

“The success of these arrangements has been caused especially by the absence of any but regimental regulations, and by the absence of everything not found to be useful; by the commanding officer being left to manage matters as he finds best, the men not being made to be mere machines, but intelligent *individuals*, not controlled by fear of punishment, but each one exerting himself to be at all times ready, able, and willing to do his duty as a soldier, and proud of being and appearing to be so.

“Our strength is not so much in our array as in the personal character and habits of the individuals, engendered by such a system as exists in the Sind Irregular Horse.

“The discipline is perfect, for all wish to obey and to do their best; none look to higher authorities than the commander of the corps; while the possession of full powers by the commanding officer almost prevents the necessity of ever using these powers, dismissal from the service being a severe punishment even to a private sowar.”—(1853.)

### CAMP SUPPLIES AND BAGGAGE CORPS.

In the East it is generally a more difficult business to reach than to beat the enemy. And the success of an expedition often depends upon the management of your baggage animals and supplies. These, like all other marketable articles, follow the law of supply and demand, and the secret of collecting and maintaining a full commissariat lies in *attracting* all the resources of the country into your camp. This can only be done by publishing, by means of your agents, what you require, and by paying punctually, and in accordance with the free adjustment of the market, for what you purchase. Do this, and nothing can prevent your obtaining supplies so long as the country affords them; no, not even the presence of the enemy in your neighbourhood. For in the East we have seldom to deal with a hostile population; they are generally indifferent to either army. It is true that, as under such circumstances was found to be the case in Afghanistan, prices may temporarily remain exorbitantly high; but in the long-run they will certainly adjust themselves, and the tendency is always in this direction. But every attempt to arrange by other means—above all, every attempt to regulate prices or to restrict the market—upsets supplies and induces scarcity. Nevertheless, the crowds of camp followers, baggage animals, and provisions, implied in the presence of a good camp bazar, have been matter of astonishment and horror to officers not experienced in eastern campaigning; and attempts have been made to remedy the supposed evil by organizing baggage

corps, which, however, only create the evil they are supposed to remedy. I will give you an instance of such an attempt; in the Hill campaign of 1845, owing to the emptiness of the military chests, and the absence of proper commissariat arrangements, operations were suspended ere well begun. The failure was ascribed to the want of a baggage corps, and, with a view to preventing similar failures in future campaigns, the embodying of a Camel Baggage Corps was ordered by Government. The establishment of the corps was ultimately fixed at 1,000 privates and 1,000 camels.

About three hundred camels were required to move a regiment of native infantry, inclusive of tents, ammunition, and the private baggage of officers and men, but without any commissariat stores; and supposing but one-half of the European officers to be present, two hundred of these camels would be employed in the carriage of the private baggage of the officers and men. When the camels of the baggage corps were thus employed, they were paid for by the men using them, at the rate of ten rupees each camel per mensem.

The camels were attached to regiments, and paid for only during actual service, which, for the period of the existence of the corps, may have amounted on the average to one-fourth of the whole time.

The baggage corps existed from the middle of the year 1845 till the end of 1851, or six and a half years. Its total cost during that period amounted to Rs. 14,87,855 per thousand camels.

The total amount received during that period, as

the hire of 1,000 camels, from officers and men, amounts to Rs. 1,95,000.

The total loss to the State, therefore, on 1,000 camels of the corps, employed in carrying the private baggage of the troops, amounts to Rs. 12,92,855, or nearly thirteen lakhs of rupees, in excess of the cost of moving the troops under the old system, on this one item alone.

Again, as respects the camels of the baggage corps employed in carrying the tents, ammunition, and the public stores belonging to the troops.

The cost of 1,000 camels on the baggage corps system being, as before, Rs. 14,87,855.

The cost of hiring 1,000 camels by the commissariat department, when required for the movement of troops under the arrangement heretofore adopted in India, would amount during the same period to Rs. 12,000 per mensem, according to the usual rate of Rs. 12 per camel. This is the Bombay rate. That of Bengal, on service, is about Rs. 8. But these camels were accustomed to carry about double the loads allotted to those of the baggage corps. Their cost must, therefore, be reduced by one-half when compared to the others; they were also only engaged when required. Assuming this period to have been three months in the year, as before; and the total cost on the commissariat contract system of 1,000 camels during six and a half years, employed in carrying the public stores of the regiments, amounts to Rs. 1,17,000: total loss to the State on 1,000 camels so employed amounts to Rs. 13,70,855.

The men of the baggage corps were supposed to be

soldiers as well as camel-men; so that on the line of march, in camp, and while out grazing, no other baggage-guard would ever be required. This was generally, though not always, the case on ordinary marches, through a friendly country, where a guard was only required as a matter of form; but when treasure or other valuables had to be transported, and whatever the nature of the loads in the field in an enemy's country, it was always found necessary to employ the soldiers of the line in guarding the camels, &c., as usual. Thus no real advantage was, in practice, gained by the camel-men being considered as sepoy.

On the other hand, the attempt to make them soldiers seems to have spoiled them as camel-men; for while the common camels of the country could, without ever being fed on grain, with ease carry a load of 400 lbs. on the average, and the best of them very much more than this, the camels of the baggage corps could with difficulty carry the smallest weight allotted to them by the orders of the Governor of Sind, namely, 240 lbs. They also, from the ignorance and bad management of the sepoy camel-men, became so sickly, and died so fast, that anywhere but in a country abounding in camels the corps could not have existed for six months. But in such a country, the facilities of hiring camels in any numbers, when required, is so great, that a baggage corps becomes there more than usually unnecessary.

A baggage corps, as has been shown, is exceedingly advantageous to the private convenience and comfort of the officers and men: the boon granted by its use is about equal to the grant of double batta to the

troops while in the field ; but the amount paid by the State for this boon is, as shown by the figures set forth before, something more than seven times the amount by which the troops benefit by the arrangement. Moreover, as respects the facility of moving troops, the baggage corps could only be of use in a friendly country, abounding in supplies, inasmuch as, under any other circumstances, as large a commissariat establishment of cattle, &c., &c., must be entertained, as if the baggage corps did not exist, for the purpose of carrying food, &c., for man and beast ; nay, a *larger* commissariat establishment must be maintained by reason of the baggage corps, because the sepoy camel-men, &c., of that corps must be fed and provided for like the real soldiers of the army. Extra carriage must also be provided for the conveyance of the tents, ammunition, and the officers' and men's baggage of the baggage corps itself, or, which amounts to the same thing, these must be carried on the camels of the baggage corps, and the amount of available carriage for the rest of the army be lessened by so much.

Again, a baggage corps is evidently useless, even in a friendly country, for the transport of battering trains or other heavy stores : for this, recourse must be had to the old commissariat arrangements, or to something equivalent to them.

It appears, then, that a corps, on the model of the late Sind Camel Baggage Corps, could only be maintained in a country abounding in camels, in which these animals could be readily purchased or hired as wanted ; or evidently under circumstances wherein

such a corps must be very little required for the convenience of the troops, who could easily provide themselves with carriage without it.

*Secondly.*—That such a corps could only be maintained at a cost, out of all reasonable proportion, greater than the value of the benefits accruing from it.

*Thirdly.*—That under those circumstances wherein alone it becomes a matter of any real difficulty to move troops in India and the countries bordering on it, viz. when it becomes necessary to carry all the supplies for the use of the troops with the moving army itself, such a baggage corps becomes entirely useless, being unable to carry a month's supply of food even for itself. Under the old commissariat arrangements, there was never more than one driver to five camels, each camel carrying about 5 cwt. The camel corps had more than a man to each camel, and that camel carried 240 lbs.

*Fourthly.*—When the army is serving in an enemy's country, and it consequently becomes of the greatest advantage to reduce the "*impedimenta*" as much as possible, a baggage corps, on the model of that lately disbanded, &c. tends only to increase, instead of to diminish, the necessary train. An officer, even of ability, and though experienced in the armies of Europe, may well be excused for at first sight becoming alarmed at the train found necessary for moving troops in time of war in the East, and being dismayed at all the danger and disorder which apparently must accompany such a crowd of animals and followers; but it is soon perceived that the greatest evil in the matter exists in imagination and inexperience,



and that the real difficulties have long ago been mastered, and the whole affair reduced to systematic rule by those to whom the subject is familiar.

The arrangements for supplying armies in the field in India, and conducting the enormous trains of beasts of burden which accompany them, have been brought to the greatest perfection by the commissariat department of Bengal. The details of the arrangements are well known to most old Indian officers who have served much in an enemy's country; the general results are familiar to all officers of local experience in India; and when these arrangements are properly understood by a general, they enable him to reduce to sufficient form, order, and regularity, that which at first appears an interminable, incongruous, and riotous mass of confusion. It is not, perhaps, necessary here to enter into the details of the gigantic arrangements of the Indian commissariat department. But it has been acknowledged as an axiom by the greatest generals who ever led armies in India, that the safety of an army, or the success of a campaign, depends at least as much on the state of the "bazar" of the army as on the goodness of the troops. The remarks of the Duke of Wellington on Colonel Monson's disastrous retreat are very instructive on this point. The Duke shows clearly that the whole of that serious misfortune was caused by the inefficiency of the Colonel's bazar and commissariat arrangements; and states, that he himself made it a point always to have in his camp a month's provisions for his whole force. The multitude of traders of all sorts, and the immense train of baggage animals, which this implies,

and which the Duke justly considered as essentially necessary to his safety and success, might have been considered by an inexperienced officer as ruinous to the army; but few would probably have had the boldness to propose, as a remedy for the apparent evil, an arrangement by which the number of men to be fed would be greatly multiplied, and the means of transport greatly diminished. Yet such was the scheme not only proposed, but attempted to be carried into effect, under the title of the Sind Camel Baggage Corps, to the amazement of all Indian officers of experience, and to the great delight of thoughtless young subalterns.

The experiment of the Camel Baggage Corps cost the revenue of India £159,000 sterling; yet, notwithstanding the enormous outlay lavished on it, and quite irrespective of the inadequacy of the return to the amount of capital expended, it proved a complete failure. It was at once discovered that it was impossible to carry into full effect the original scheme; and, to move troops on real service, as many extra camels had to be provided as if the camel corps had not existed. The attempt to transport the stores and provisions of an army by any such arrangement as that of the baggage corps was at once, in effect, abandoned, and the baggage corps camels were employed solely in conveyance of the tents, muskets, and ammunition in charge of regiments, and of the private baggage of the officers and men. For the carriage of the latter, it had been hitherto the custom for the officers and men to make their own arrangements, and to supply themselves as they could; so that the

baggage corps relieved them of considerable trouble and expense, and the scheme was in consequence considered, by the parties who profited by it, as excellent and praiseworthy.

This circumstance may go far to account for the astonishing fact of such a baggage corps having been continued in existence for six and a half years!

Having discussed the merits of this method of transporting the private baggage and tents of an army, let us now see if our Indian experience will enable us to propose a better plan.

First, let us observe, that for the transport of provisions and stores, park guns, ammunition (other than that in regimental charge),—in short, for the carriage of at least nineteen-twentieths of the whole train accompanying an Indian army *in the field*, *nothing can be imagined more perfect than the system of the Bengal commissariat* as it appeared with the first army of Affghanistan, in 1839.

But still, however small a proportion it may be, as to the general train following an army in the field, the carriage of the regimental baggage, public and private, is, for many reasons, a matter of great importance.

Under the present system, the march of regiments is sometimes considerably delayed for want of such carriage; while our officers and sepoys, having everything done and provided for them by others, become helpless, and unable to shift for themselves.

This is almost always the case with our regular army. But let us take a hint from the despised irregular, who marches at once when ordered, without troubling collector or commissary.

The scheme, then, proposed in the place of the awfully expensive baggage corps, is as follows:—

Let the plan of paying batta in the field be wholly abolished. Let officers and soldiers of the native army receive one rate of pay under all circumstances. Let there be no allowances. Let this rate of pay be sufficient fairly to meet actual wants, which can easily be calculated, and then insist on every officer and man being at all times, and in all places, provided with a proper description of carriage to enable all to move anywhere at once at a moment's warning. Let the quarter-master of each regiment have a contract for the carriage of tents, ammunition, &c., and hold commanding officers strictly responsible that everything is always kept in an efficient state for immediate service.

This is no fanciful scheme; it is done to our hand; in all good sildar corps it has been long proved on a large scale, and with admirable success.

The indirect benefits of such a system would be nearly as great as those more directly accruing from it.

The sepoy, instead of being pipeclayed automatons, would become comparatively clever and sensible men, able to provide themselves with whatever might be necessary, without giving the slightest annoyance to the people of the country, with whom they would necessarily take care to be on the best terms.

There would also be, in this system, the best possible check on men carrying too much baggage. A sepoy, who had to keep himself provided with proper carriage at his own expense, would very soon discover

what articles were necessary to be carried; and would assuredly carry none which were useless or superfluous.

The men might be a little awkward at first, from not being accustomed to such work, but would very soon master every difficulty.

If more leisure time were required for the proper performance of their new duties, abolish pipeclay, give the men black belts, and at least one hour more a day would be at their disposal. The ill effects of pipeclay, of leather stocks, of chacos, and of knapsacks for soldiers in India, are unspeakable; and the wisdom of using them in the army resembles that of a manufacturer who should tie up the limbs or disable the right arms of his artificers, in the hope of improving their handiwork.

#### THE MILITARY FUND.

Unquestionably the military fund has, by encouraging imprudent marriages, been attended with very ill consequences. The knowledge that, in the event of death, the widow and children will be provided for by this fund, has, more than any other cause perhaps, contributed to the uncommon spectacle of an army a large percentage of whose subaltern officers are married. Aware that in any event there will be the provision of this fund for the widow and children, the parents of the bride are less careful of requiring from the bridegroom those very qualities—thrift, energy, and power of general management—without possessing which no young soldier should take on himself the responsibilities of the marriage state. Again,

the youth himself, also trusting to the fund, rushes into marriage, without having previously cultivated, or even considered concerning those qualities, attention to which would, in the absence of any fund, have been forced on him before he either would or could have married. In short, under the operation of the military fund, the tendency is to cause precisely those to marry who neither should, nor, without the provision of the fund, could marry. And whatever good may, in individual cases, have resulted from this fund, I am not the less of opinion that it is in fact a joint stock company for the promotion of imprudent marriages.

#### FURLOUGH REGULATIONS.

Another subject of vital importance to India—not only to the army, but to all the services, and to the whole people of the country, natives as well as Europeans—is the furlough regulations.

The existing rules are not adapted to the present state of things; they belong to days long gone by, when a period of twelve months or more was necessary to receive from England an answer to a letter from Bombay.

Moreover, the present rules regarding leave of absence are excessively unfair in another respect. Their tendency in every way is to favour the least valuable servants of Government—those who are continually suffering from real or imaginary sickness, and on that account continually absent from their duty.

It is an undoubted physiological fact, that hard-working, energetic men, who continually exercise

themselves in bodily and mental occupation, suffer the least from ill health. They have no time to be sick. Authorities are agreed on this point. For example, Copland (Med. Dict. page 562) says:—

“When the mental energies are depressed by grief, anxiety, disappointment, fear, &c., the powers of life are less able to oppose the debilitating causes of disease which invade them from without, and of which nature all the exciting causes of fevers, particularly those which, as specific or contagious and miasmatic, generally partake in a most marked manner. On the other hand, when the mind is elevated by success, by hope, by confidence, and the other exciting passions, the depressing causes make little or no impression upon the constitution, and individuals thus circumstanced almost always escape from diseases which readily invade the fearful, the dejected, and the disappointed.”

Again, Copland (Med. Dict. page 920, para. 118):—“Confidence, continued mental occupation, and moderate excitement are especially efficacious in resisting the causes of most fevers.

“There is a moral courage sometimes possessed by persons, the weakest perhaps in respect of physical power, that enables them to resist infectious and epidemic influences more successfully than the most robust, who are not thus mentally endowed.”

On the other hand, it is certain that a large portion of the sickness which causes so many officers to be absent from their duty in India is produced by feebleness of character, by idleness, laziness, listlessness, or languor.

Now, I would not for a moment wish to lessen the indulgences granted by a beneficent Government to such of its faithful servants as might have the misfortune to be suffering from ill health. I would leave the rules regarding leave of absence on sick certificate as they are; but, assuredly, I would so order matters that long-continued, honest, unremitting, and valuable labour should be deemed to constitute at least as good a title to the favour of a furlough to England as the want of health alone.

Moreover, if such furlough were *obtainable* at moderate intervals, and with greater facilities than at present, the number of sick certificates would assuredly be immensely decreased. It is probable that after a while they would *almost* wholly disappear.

The evil done, both to England and to India, by the present furlough regulations, is incalculable.

A large proportion of the Indian officers who can now return to England is composed of those worn out in the service, of the aged, the feeble, the sickly, the discontented, the idle, and the lazy; while the energetic, the active-minded, the able, the zealous, and the strong, are compelled, for the most part, to remain at their work in India without any intermission, without a day of real rest, until their failing vigour qualify them also for the indulgence of a visit to their native land.

In English society, by reason of this state of affairs, India is not fairly represented.

The real working men of India—the soldiers, the magistrates, the statesmen, all those men of clear heads, strong minds, and active habits, by whose



practised intelligence and honourable labours our Indian empire is held together—have little connection with, or influence on, the English public. They are very rarely seen in England.

From this cause it proceeds that, in the imagination of the people of England, the idea of an Indian officer, military or civil, is always connected with those of rice and curry and diseased livers.

From this cause chiefly results the deplorable ignorance regarding Indian affairs which prevails, even among educated gentlefolk, in England. How easily might all these evils be rectified!

Let us have recourse to a principle as old as the history of man—the institution of the Sabbath. This at once satisfies all our wants, and meets every difficulty in every single point; while no objection whatever can be brought against it, save by those who would wish, if possible, still to retain a dark veil between India and England for their own supposed private advantage, but to the grievous injury of both countries.

My proposal is to give every officer, civil or military, every seventh year to himself, if he wished to avail himself of the indulgence; to allow him, during that period, to go wherever it might please him to go, whether in India or any other part of the world; to allow him, during that year, to receive HIS FULL INDIAN ALLOWANCES, to retain his staff appointment if he held one, but during his absence not to receive the staff salary, which should go to the officer who might officiate until his return. If an officer should wish to remain in India, even in the very camp in which he was serving, and there to enjoy his Sabbatical year, he

should be allowed to do so. The year should be his own, to employ as he pleased.

If an officer chose to allow his Sabbath to pass by, and to wait till he had served twelve years, he should be allowed two years' rest on furlough; after eighteen years' uninterrupted work three years should be allowed, and so on.

The consequences of this arrangement would be great and numerous, and all of them good,—good for the Government, good for the people, and good for the services. The amount of vigour infused into Indian society by this means would be almost incredible. Hope, looking forward to the enjoyment of the Sabbath, would stimulate even the lazy and the idle to work hard during the six years of labour.

The continual return to England, and reflux into India, of the tide of Europeans, would be to the body, moral and politic, exactly what the circulation of the blood is to the animal body. England would be our lungs: the old blood would be there aërated, and new life, health, and strength thereby sent flowing vigorously to every corner and extremity of our empire. Energy and health would everywhere take the place of languor and disease.

The outcry for more Europeans would be at an end, for those now in the service would be found willing and able cheerfully to do well double the amount of work which is now thought to tax their powers too highly.

**THERE WOULD BE A FAR MORE EQUAL DISTRIBUTION OF THE EMOLUMENTS OF STAFF APPOINTMENTS, BY REASON OF THE NUMBER OF OFFICIATING MEN.** There would also

be a far greater number of men well acquainted with, and ready efficiently to perform, the duties of such appointments, to the great advantage of the service, which now often suffers from the inexperience of new incumbents.

Society in the two countries would become one, and all manner of blessings would indirectly follow.

Let any man of sound common-sense, and a tolerable knowledge of the subject, think over the matter, and he must be convinced at once of the truth of the conclusions set forth above.

The doctrine is founded on the laws of nature, and its truth will be the more apparent the more those laws are studied.

#### DAILY ORDERLY-ROOM TO BE HELD BY EVERY COMMANDING OFFICER.

The commanding officer of every regiment should, every day of his life, hold his orderly-room in some convenient public place, where the commanding officer, his staff, and all the European officers not otherwise engaged, should assemble. Here all regimental business should be transacted in public. Every man in the regiment should have an opportunity, every day, of seeing his commanding officer.

Everything being done with perfect openness, in the presence of all the English officers, many common sources of discontent and grievance, real or imaginary, would be removed. Every officer would be habitually well acquainted with everything relating to the regiment, and would be undergoing a course of

education calculated, better than any other, to fit him for command in his turn.

While the habitual daily presence of all the English officers around the commanding officer would afford him the best possible support in doing right, and impose the most effective check on wrong: a very ordinary mortal might, under such an arrangement, be safely trusted with absolute powers, while no officer's qualifications could ever be for a moment doubtful. Where everything is open to the public, common-sense has the fairest chance of prevailing, and "regulation" need be but little intruded.

Officers need be troubled as little as possible with form, dress, ceremony, and matters of etiquette at their daily orderly-room; and the inconvenience of daily attendance would speedily be overcome by an increasing feeling of interest in all regimental affairs, and all irksomeness would be removed by the grant of leave of absence when required for any rational purpose.

The arrangement here contemplated appears to me to be of the very highest importance to the welfare of the native army of India; and I may observe that I have myself practised it with satisfactory effect during the past fifteen years.

The commanding officer of every regiment, native or European, should hold orderly-room every day of his life in some public place, hearing every man who has anything to say to him. Where is the objection to men being properly dressed on these occasions? Coming to the commanding officer at improper times, and in an improper manner, if permitted, gives rise

to backbiting, or the reputation of it. Everything should be open and public between the officers and men.—(1854.)

### THE VICES OF THE SENIORITY SYSTEM IN THE NATIVE ARMY.

It is a fatal error to suppose that we are guilty of breach of faith in promoting according to merit, instead of according to seniority; for the sepoys, on enlistment, know and think nothing about their rights to promotion: they enlist to obey orders, and serve the State; and their notions of seniority are always acquired after they enter the service, under the influence of a vicious system. But the evident and unavoidable consequence of promoting according to the seniority system only is the paralysation and ultimate ruin of the army. Talent, skill, energy, high principle, and soldierlike pride fall crushed and powerless under its operation. Of what use is it for the zealous European officer to endeavour to instruct the native, and to make him really, and not in name only, a soldier? Of what use is it for the latter to endeavour to learn, when neither instruction, nor acquirement, nor merit of any kind, avail to advance the sepoy a single step? \* \* \*

The fact is, that the native officers of the Bengal army have been purposely made powerless for evil or for good. Why, then, blame these poor old gentlemen? Make them really efficient, by promoting, not the oldest, but the most able and deserving men; make their advancement depend only on their merits,

*as estimated by their regimental commander ; and you will have no mutinies.* \* \* \*

Where the native army is in a proper state, NOTHING will induce the sepoys to remedy a supposed grievance by force, nor even to represent it, except through their officers, to whom they entirely trust for protection. It is the seniority system (with other causes) which has ruined the discipline of the Bengal army, and destroyed mutual confidence between officers and men. The evil influence of this state of affairs in the larger body is, I fear, fast communicating itself to the Bombay army also.—(1854.)

\* \* \* I plainly and deliberately assert, that any one who, wishing well to the native army of India, advocates promoting the native officers and non-commissioned officers of that army by seniority only, must undoubtedly be deplorably ignorant of the real merits of the matter.

My means of forming correct opinions on these matters have been stated in my paper on the native Indian army, and need not be here repeated.

I have been accused of asserting that it is right to place the brave old “sepoy at the caprice of prejudiced and ignorant commanding officers.” But I never asserted any such thing ; but rather strongly advocated the having as commanding officers men *not* governed by caprice, ignorance, &c., and leaving the promotions to *them* : and I now assert that such is the only wise course of proceeding.

Men are often very good soldiers, having three or four medals on their breasts, &c., who are as unfit to be drillmasters as any old woman taken at haphazard

out of a village ; yet such men are recommended for promotion, if senior, rather than one really efficient.

It is difficult enough to find half a dozen really good drill-masters in any regiment ; but if they are to be chosen not by qualification but by seniority, it would be far better to have none at all.

The seniority system, so far from being just, is the greatest possible injustice to the really deserving men, while it holds out the greatest possible encouragement to the lazy, the idle, and the good-for-nothing. Throw everything open to fair competition, and let the best man win. This is the style of justice which sèpoys and all other men really like best in their hearts. Let there be no favouritism ; but let the European officers honestly and continually endeavour to choose the *best* men for promotion, and the best possible feeling will assuredly be created and maintained between them and their native soldiers.

My officers and myself have acted on these principles for twelve years with one regiment, and for eight years past with two regiments, with good effect, although I have but two European officers under me for each regiment. The whole corps of the Sind Irregular Horse is as if it had but one heart and mind ; any difference of feeling on common interest between the officers and men would be as unnatural as a quarrel between a man's hand and limbs.—  
(1854.)

#### FIXED HEAD-QUARTERS FOR REGIMENTS.

Our system of fixed regimental head-quarters, where all the families reside, affords an additional

and most powerful security for good conduct. It forms a very strong bond of attachment to the service, which no other corps possesses. It makes the commandant the patriarch of the regiment, as he should be. The success which has attended the introduction and maintenance, during many years, of this system, with the two regiments of Sind Irregular Horse, affords a safe ground for recommending its adoption on the proposed military reconstruction of our native army. Depend on it, that where this security is enforced, we may readily increase the numbers of our sepoy without risk of adding to those of the mutineers.—(1857.)

**THE OBEDIENCE OF SOLDIERS NOT TO DEPEND ON  
THEIR OWN PLEASURE.**

It has been said that Government can supply the places of the mutineers with Goorkas. This measure may be wise ; but it is not wise to allow the discipline and obedience of your soldiers to depend on *their* good will and pleasure ; and it is certain that the Goorkas would soon be as bad soldiers as the Hindoos of the Bengal army if treated in the same way. The Hindoostanee Mussulmans are the best materials for our soldiers *in proper hands*.—(1854.)

**ON THE PURCHASE OF HORSES BY GOVERNMENT FOR  
MILITARY PURPOSES.**

Understanding that it is in contemplation to purchase, in the valley of the Euphrates, a large number of horses for military service in India, I venture to submit a few remarks upon this subject, founded upon



a long and somewhat extensive experience of the horse market and cavalry requirements.

And it seems to me, that if Government sends its own agents to purchase horses, whether in Turkish Arabia or elsewhere, it would, by this direct and sudden interference with the usual channels of this trade, tend to lessen the supply passing through these channels, without causing an equivalent increase of supply through the extraordinary channel. The presence of the Government agents in the horse-breeding districts would, of course, disturb and injure the market for horses at Bombay and other places. The prices of horses would immediately be raised in the districts themselves. And experience proves, that the employment of Government agency in businesses of this description is almost invariably attended with so much difficulty and delay, as would render the purchase of the horses useless in so far as immediate service in India is concerned.

Again, in respect of cost: horses of a size and description inferior to those of the class of horse now purchased in Bombay for Indian cavalry could not be obtained in the breeding districts, and in any considerable number, at a less average price than 35*l.* each; a rate, which, by the time the horses should reach Bombay by means of the proverbially costly agency of Government, would most assuredly increase to the present remount price in Bombay of 50*l.* So that the general result of Government's direct appearance in the market would in this, as in all other markets, be to disturb the common market, to lessen and delay the total supply, and to enhance prices.

I would suggest, then, that the best plan Government could adopt for purchasing horses would be to inform the horse merchants at Bombay, Kurrachee, and elsewhere, that Government is prepared to purchase an extraordinary large number of horses at the present remount prices; and that if the required number cannot be collected of the present standard height, Government will accept horses something—say an inch—below this standard, at the same rates; or horses of a yet lower standard, at reduced rates.

The standard of the first class of horses would then be 14 hands 1 inch, instead of, as at present, 14 hands 2 inches; and the standard of the second class might be fixed at 14 hands. These sizes may seem very small, but it is certain that some of the best Arab horses, able to carry any weight, and equal to any service, are no larger: and that horses of these sizes, if well-shaped and well-bred, are better fitted for hard work as cavalry horses in the field than are the tall country and stud-bred horses.

Remount agencies, with the requisite establishments, might be stationed at convenient points, for the purpose of purchasing from the dealers, in accordance with the above suggestion; and I am persuaded that in this manner, while Government avoided disordering, and confined itself to healthily stimulating the market, it would at the same time be preserved from all risks of bidding against itself in different markets, and would obtain, ready for immediate service, as large a supply of really serviceable horses as the countries whence they are drawn can supply.—(1857.)

## STUD-BRED HORSES.

There is no doubt but that the stud-bred horse of India is the worst of all. But had the physiology of horse-breeding been understood and attended to, this horse would probably by this time have been the best of all on earth.

Having recourse to English horses at all for breeding purposes in India was a grave error.

The English horse was formed from the Eastern horse, and having become peculiarly well adapted to the climate, &c. of England, to bring him back to the East again was to undo all that the English breeders had been doing for centuries. Arab horses should alone have been used to breed from after the first start, which must necessarily have been made with a sufficient number of mares, the best procurable of any breed, as Arab mares are not obtainable.

The qualities of individuals should have been carefully and scientifically studied before bringing them together. On this depends the whole success of the scheme. To ensure a good produce, it is by no means sufficient to put a good dam to a good sire. The excellencies of each may be great, but may be neutralized in the produce by *similar* defects in each.

Both parents may be generally good, but may possess peculiarities, which if exaggerated in the produce, would render it useless. Many breeders suppose that a sire and dam, being both winners of races, ought to produce winners; but their *excellencies*, though *great*, may be *unlike*, and their *defects*, though small, may be *alike*; in which case it is next

to certain that in the produce the excellencies will have disappeared, and the defects be enormously increased. Were all stallions of other breeds now in the studs at once sold off, and none but the best Arabs used to breed from, in future, no mare or horse of any other breed being hereafter admitted, Government might reasonably expect in twenty years' time to possess the finest breed of horses in the world—so quiet and docile that they might be used entire, without any of the evils now complained of. But the physiology of the business and individual incongruity must in every case, and with every breed, be most carefully attended to, or the result will be a failure. A stallion originally vicious should never be employed. One becoming so should immediately be removed from the stud. Really good Arabs are never vicious.

As to the Cabool and Affghan horse generally, he is a fine large horse to look at, but his real powers are contemptible. He is in reality the worst horse out of all the breeds in the East. The first horses to fail in any fast work in the hot weather are *always* the Cabooles. In fact, as riding horses, they are as bad as can be, though they answer well for draught.

The Arab horse is *unapproachable* in excellence, for military and general purposes, by any other breed on earth.

A good Arab will *fly* with fifteen stone on his back. He will thrive on any fare, never loses his temper, is bold, gentle, docile, and enduring—while he has almost as much sense and reason as some men.

Next to the Arab in the East ranks the Persian.

The best *country* horses with us are those of Katty-

war, Kutch, and the valley of the Bheema. These three breeds are excellent. Then follow next in merit the horses of the Thurr and Guzerat; then those of Kutchee and Khelat; then Punjaubees, Kandaharees, and Cabooles; and, last of all, the Bengal-stud breed. The Toorkaman horse is *excellent*, but a real Toorkaman is never procurable in the market.

#### THE MILITARY BOARD AND AUDIT DEPARTMENT.

These are hindrances to the conduct of public business. Ruinous delay and prolonged correspondence are the attributes of the Board; while the system of audit trammels honest men without checking rogues. A dishonest servant, by conforming to the forms of the audit department, can cause a false account to be passed; while an honest servant is so hampered by the forms, that it is with great difficulty, and after long delay only, that he can obtain payment for his just expenditure.

---

## MISCELLANEOUS SUBJECTS.

### MILITARY RULES ON HIGH CASTE MEN.

It is a positive fact that when a proper discipline and a proper soldierly pride exist, the men of high caste give less trouble about their castes than the low-caste men. The cry about caste among the sepoys of Bengal has no real connection with their religion; it is maintained as good policy, to enable them to keep power in their own hands. But doubtless the best materials for soldiers in India are the Hindoostan Mussulmans, who are highly-civilised beings, with no castes at all.—(1854.)

### SEPOY MUTINEERS AND THEIR OFFICERS.

I deny the possibility of the sepoys mutinying while their English officers are alive *and do their duty*. Men are *not* suddenly most vicious, and would never mutiny for trifles, when they know that the **FIRST STEP** must be that which *they* know and feel, even among themselves, to be a detestable crime—the murder of their officers. Let the officers have calmly made up their minds to be obeyed or be killed, and there would be little disobedience. To show they were in earnest, let the first man guilty of open mutiny be shot on the spot by his commanding officer, and the thing would spread no further: let there be no talking or reasoning with the offenders on such occasions.

It is not that officers want the determination necessary to carry out this course successfully, but such proceedings are *not the fashion* at present, and the officers feel doubtful of support at head quarters. Yet what is here advocated is undoubtedly wholesome, good, and merciful.—(1854.)

#### POWERS OF COMMANDING OFFICERS, AND CANDIDATES FOR ENLISTMENT.

Let commanding officers have power to dismiss and to promote, and Government might enlist a million of excellent men in India in a day, in spite of any impertinent opposition on the part of Brahmins, &c.

If the commanding officers had more power, and were left to make their own arrangements with their corps, there would always be with each regiment a good body of “oomedwars” (candidates for enlistment) ready instantly to take the place of any discharged men.

There are generally fifty or more of these “oomedwars” with the Sind Irregular Horse, so that they have always the pick of good, seasoned, and half-trained men, eager to serve.—(1854.)

#### PRIZE PROPERTY.

I loudly and frequently uttered my opinion that no conquest gave any right over the private personal property of individuals, much less over that of women and children: and that, be the right what it might, it was a shame to strip ladies of their dresses and furniture.

### FORTIFICATIONS.

Peshawur is one of the very few places where I would build a fortress. But, in general, we want no fortifications: to be reduced to defend ourselves is tantamount to defeat in India. We must assume the superiority, be worthy of it, and keep it.—(1854.)

### FLANK COMPANIES AND SIZING.

All flank companies are bad in principle. So also is all "sizing." The companies should all be alike, and all able to act in any part of the line in which they may find themselves.—(1854.)

### QUALIFICATION OF STAFF OFFICERS.

The work of most staff appointments requires superior qualifications, and involves superior responsibilities to those belonging to the command of a company of sepoys.

If higher qualifications be required, you must pay for them, or you will not get them. You cannot buy good steel at the price of iron.

The error is in employing such numbers of costly Europeans in command of native companies, whose duties would be just as well or better performed by native officers properly chosen, and formed in a good school.—(1854.)

### NIGHT ATTACK BY SHERE MAHOMED.

In June, 1843, Shere Mahomed, with some ten thousand men, attempted to surprise my camp; but I attacked him with eight hundred native soldiers of all



arms, on his line of march; totally defeated and dispersed his army; and took all his artillery.—(1854.)

#### THE SEPOY'S MUSKET.

The sepoy's musket is too light for the ball, or the ball is too heavy for the musket. Call it what you will, the recoil is more than the sepoy can properly bear.—(1854.)

#### HORSE FAIRS.

These fairs appear to be silly things; their day is gone by. They were useful once, in order that the traders might have that safety for goods and person in congregated numbers which they had not singly; but at present, it seems to me that if we make roads, abolish dues, and generally clear away obstacles, we do all that Government should do. The trade in horses, like all other trades, will then best develop itself. But if we interfere by proclaiming a particular day for congregating horse-dealers, we tend to spread abroad the impression that the fair is a Government matter; and the particularization of one day leads the distant Hill men to infer that the other days of the year are not equally open to them. It is argued that our proclamations do not have this effect; if so, what is the use of issuing them? If they have the effect, then Government appears authoritatively to interfere in the market, oversteps its proper limits, and does harm. There is, of course, no objection to Government preparing serais, for the reception of travellers, and facilitation of intercommunication; to do this is, in fact, to remove an obstacle to transit.

## CAVALRY SWORDS.

It is no mistake to arm cavalry sepoy with good *cutting* swords of one uniform pattern. The English sword—not the Government regulation iron, but a weapon made in England, of good steel, and of proper shape—is infinitely better than any Eastern blade. All the native soldiers prefer it, and even my wild Beloochees are all begging to be allowed to buy these swords at any price. The things cut of themselves, however unskilfully handled.

The steel scabbard is best, *if* it have a complete wooden scabbard inside it,—a construction, however, which I have never yet been able to persuade any English maker to adopt or to understand. They always leave the wood open, or imperfectly closed at the edge, where it is wanted most, and put a lot of screws and iron springs about the mouth of the scabbard, which totally defeat the object of the wooden lining. The scabbards of the Sind Horse are of wood and leather, made as strong as may be ; but still they wear out too fast, and break too often to please me. My own swords have metal scabbards, made large purposely, and lined with complete wooden scabbards, in this country, the bell-mouth being formed of wood. These scabbards are best of all.

Great mistakes exist regarding the respective powers of the edges and points of swords. On foot, or when moving slowly, it is unnecessary to argue in favour of the point of the fencer—its superiority is evident to all. But on horseback, *the speed of the horse prevents the swordsman from drawing back his*

*arm with sufficient rapidity after a homethrust.* So that if going at speed, as every cavalry man ought to be in attacking, his sword, after passing through his enemy, is very liable to be knocked out of his hand, the weapon running up to the hilt, and then, of course, violently stopping. This has occurred to myself, when I should have been disarmed had not the sword been buckled to my wrist with a very strong leather strap. The same thing must have occurred to others. Such a tremendous twist, too, will certainly break any but a very first-rate blade, and is not a fair trial for a good sword. Wherefore, for cavalry soldiers, curved cutting blades are best. Straight swords will not cut, save in skilful hands; curved blades cut fearfully, with very little or no skill on the part of the soldier. —(1854.)

### THE POINT AND CUT.

Experience in real fight shows that, for horse soldiers, the cut is far more deadly and effective in every way than the point of the sword.

The straight sword, and the use of its point, are far more formidable than the cutting sword in the hands of men on foot, and I was myself strongly prejudiced in their favour for use on horseback also, until many trials in the field quite convinced me of the contrary.

On horseback, when moving at a rapid pace, as the cavalry soldier ought always to be in attacking, the arm, after a home-thrust, cannot be drawn back sufficiently quickly; the speed of the horse carries all forward with great velocity, and the blade runs up to the hilt, or breaks, before it can be withdrawn.

I have had my own sword forcibly struck from my hand in this manner, the hilt striking with the greatest violence against a man's breast after the blade had passed through his body. The blade happened to be very good and strong, and the hilt was attached to my wrist by a stout leather strap: neither gave way; but, as the horse passed on at speed, the body of the tall heavy man who had assailed me was turned completely round and over by the blade of the sword in it, before the weapon could free itself.

The violence of the shock, and the concurrent circumstances, attending this and hundreds of other somewhat similar circumstances, perfectly convince me that on such occasions the chances are ten to one that the sword will break or the cavalry soldier be torn from his seat; or both these accidents may occur.

I have for long past had not a doubt but that the cutting sword is by far the most formidable weapon for the hands of the cavalry soldier.

The old curved dragoon sabre is about its best form: these blades, made of the best English cast steel, mounted with steel basket-hilts, with the scabbards lined with a complete *scabbard of wood*, appear to me to be the most perfect weapons possible.

The native soldiers much prefer them to any eastern blade whatever, and I can imagine nothing more effective.

I have never used any sword exercise with the men of the Sind Irregular Horse, thinking that it is not required; but I have myself witnessed very many instances of the terrible power of their cutting weapons, and those of the enemy.

Two remarkable instances occur to me, which it may be well to mention.

At the battle of Meanee, a well mounted Belooch warrior was flourishing his sword, and challenging all comers. A sowar of the Sind Irregular Horse rode at him at speed, and in an instant cut the man's head off at one blow. In the same battle, a sowar of the Sind Irregular Horse, riding hard at the man opposed to him,—a stout, able-bodied Belooch on foot, armed with sword and shield,—the latter was knocked violently down by the horse's shoulder; but as he lay on his back on the ground, the Belooch warrior struck upwards so violent a blow with his heavy curved blade, that the sword cut completely through both branches of the under jaw of the sowar's horse; and the front part of the animal's lower jaw, with all its incisor teeth, remained hanging by a piece of skin only.

The force of this blow appeared to me so extraordinary, that I for long preserved the skull of the horse on which it took effect.

In my opinion, it would be of very great advantage to replace the straight swords at present in use by the broad curved cutting blade, like those now used by the Sind Irregular Horse.—(1854.)

#### CLOTH PANTALOONS *versus* LEATHER BREECHES FOR MOUNTED MEN.

The cloth *pantaloons* are out of all proportion superior to the leathers. The soldier always covers them or the seat over with leather, which gives them the advantage of leather breeches without their incon-

veniences. The long trowsers are, however, bad. Cloth pantaloons and jack-boots should be worn by all mounted men.—(1854.)

#### HORSE ARTILLERY AND CAVALRY CHARGES.

The closer the horse artillery can accompany the cavalry the better.—(1854.)

#### GOOD TOOLS DO NOT MAKE BAD WORKMEN.

The possessing superior weapons does not tend to keep strong and brave men from closing with their foes. The bowmen who won the fields of Cressy, Poitiers, Agincourt, and Flodden—did they fear to close because they had the power to strike at a distance, and did actually destroy the enemy's men-at-arms afar off, in spite of plate and mail, hauberk and helmet? Nothing was then esteemed sure fence against an English arrow: but when England was in exclusive possession of such a powerful missile weapon, were her sons less brave, *less* inclined to *grapple* with their foes, than were their neighbours? Does the seaman—the English sailor—feel less inclined to board because his skill in gunnery is improved? Away with such nonsense!

The Minié rifle, or rather the Minié ball, has most serious defects; the gun may at any moment become unserviceable, the ball, or rather a leaden tube which *was* the ball, remaining in the barrel. This happens about once in ten shots. Even when the ball is not left behind, it often, from being blown into a tube, drops short and feebly from the gun. These cups and balls are wholly untrustworthy.

I have expended a small fortune on these things, and have probably made more experiments with fire-arms than any man living. Ten years ago I offered Government a rifle which is still quite unequalled for military purposes. It was rejected, because the Court of Directors did not require anything superior to the two-grooved rifles then in use with the English army. Yet the two-grooved rifle is the worst of all, being painfully difficult to load, and because the ball, being confined in one direction only, is at liberty to roll or lean over in the other, so that the *conical ball cannot be used*. On the use and proper shape of *this* ball, however, depends the whole power of the rifle at long distances.

My rifle loads more easily than a common smooth-bored musket, and never becomes so foul from firing as to cause any difficulty in loading. However loose the ball, it still follows the twist of the rifle grooves with perfect accuracy. It is effective at 1,800 yards, and just as good as a common musket at 20 yards, or any other distance.—(1854.)

#### THE GREATEST DANGER TO OUR INDIAN EMPIRE.

There is more danger to our Indian empire from the state of the Bengal army—from the feeling which there exists between the native and European, and thence spreads throughout the length and breadth of the land—than from all other causes combined. Let Government look to this; it is a serious and most important truth.—(*Extracted from a pamphlet published in 1850.*)

## REMOVAL OF A PROHIBITORY ORDER.

The order issued by —, prohibiting officers from proceeding out of camp beyond the cavalry pickets, appears to be no longer necessary, and is hereby countermanded.

In removing this restriction, it is expected that the officers of this force will exercise due discretion as to the distance and direction in which they may proceed, and that their soldierlike tact and common-sense will enable them to take care of themselves in an enemy's country.

When proceeding out of camp in pursuit of field sports, for their own amusement, all officers and their followers should be well armed, and they should constantly bear in mind that foolish rashness and want of circumspection are quite as unsoldierlike and blameable as are timidity and excess of caution.

The brigadier-general has no wish to impose unnecessary restrictions on the officers and soldiers of the force; he is convinced of that manly confidence, ready intelligence, and habit of self-reliance which are invaluable in war in the absence of such restrictions; and feels confident, that the conduct of those now entrusted to his command will be such as to justify and confirm this conviction.—(1857.)

## CAVALRY CHARGES SHOULD SUCCEED.

The whole of the orthodox education of our cavalry soldiers tends to teach them that to attack infantry prepared, and standing firm and steady in square, is madness, and *must* prove unsuccessful. The moral



force of an enemy so prepared is thus increased, and becomes to ordinary minds very formidable. It is certain, nevertheless, that a cavalry charge delivered home is irresistible by any infantry that ever stood in the field.—(1857.)

#### EUROPEAN AND NATIVE SOLDIERS ON SERVICE.

The only European portion of our whole strength of six thousand men of all arms retained at —— consists of two companies of artillery: the conduct of these English soldiers has been in the highest degree praiseworthy—no men could possibly have behaved better; they have been what English soldiers should always be in the Indian army—excellent examples of good conduct for their Asiatic brethren in arms, the sepoys.

The main body of the field force has consisted of eight native regiments—horse and foot—of the Bombay army. The conduct of these regiments has been such as to do honour to the army to which they belong. Their discipline is perfect, and is of that high order which rests, not on external pressure only, such as the fear of punishment, but on the influence of good feeling, self-respect, honesty of purpose, and an honourable determination to do their duty to the State.

The cheerful alacrity and manly power with which every sort of work has been performed by the men of this field force, whether the task fell within the scope of ordinary military duty or consisted in working at trenches or erecting buildings, has been most commendable; while their just, kind, and conciliatory bearing towards the inhabitants of the country in

which they are serving, and their habitually steady and orderly conduct at all times, have been worthy of the faithful soldiers of a great and benign Government.

The impression left on the minds of the peaceful inhabitants of —— by the conduct of the British troops during their occupation of —— and its neighbourhood must prove deep and lasting.

The soldiers—irresistible in war, and before whom the best troops of —— had fallen or fled in terror—have been felt throughout the protracted period of their residence in this country to be the greatest benefactors and protectors of the inhabitants; and the people of —— now feel, on our departure, as if their best friends were quitting them.

In the minds of all those who have come in contact with our troops during this expedition, the idea of our British army will remain impressed as the combination of the highest power with the highest benevolence and justice.

To leave such a reputation behind us may be as valuable to our country as the most brilliant success in war.—(*July, 1857.*)

#### DIRECTIONS FOR A SADDLE TO MESSRS. GARDEN AND SON.

I shall be obliged by your making me a saddle with pommel cut away, and stuffed flaps coming well forward at the knee, like a large hunting-saddle, without pistol holsters, but with wallets; also bags or pockets under the cantle; plenty of D's or straps, and any other contrivances which your experience may

suggest ; three girths and surcingle, but ~~no~~ copper-  
nor breastplate. Everything as good and strong as  
possible. A bill-hook, or "Milton hatchet," should  
be attached. The saddle-bag should be of thick felt,  
dark colour, and of size to come under the saddle-  
bags. The bridle should have the field-collar and  
head-stall in one, with bit not too heavy or broad, but  
suited for Arab horses. The reins to be no thicker  
than those of an ordinary military bridle—a stiff rein  
is a great defect.

The object in view is to find the best pattern of  
horse gear for real service. Everything superfluous  
should, therefore, be removed ; while everything really  
useful should be retained or added. We want as  
little weight as possible consistent with a *full degree*  
of *strength* and durability. Bearing these requisites  
in mind, oblige me by the aid of your skill and expe-  
rience, and turn me out a saddle with its appurte-  
nances as seems best to you.

#### MEMORANDA ON RIFLES IN THEIR APPLICATION TO THE PURPOSES OF WAR ; AND ON RIFLE PRACTICE.

##### *Memorandum, No. I.*

Man has been called a tool-making animal ; and it  
is certain that the perfection of tools and machinery  
is a clear and certain mark of advancing civilization,  
of the progress of the rule of mind over matter, of  
the development and operation of those laws by which  
the working of the human brain makes the force of  
one civilized man equal that of the stalwart limbs of  
thousands, or even millions of untaught and ignorant  
barbarians.

In no country on earth has this been more apparent than in England; to no people on earth have the tools and machinery of the arts been of more importance than to the English.

It was said, and truly said, by one of the greatest of modern statesmen, that it was the spinning machinery of Arkwright which enabled England so long to stand alone, and to stand successfully, against the world in arms.

If such be the value of the tools employed in the arts of peace, those used in war must be even of greater importance. On success in war often depends the power to follow peaceful pursuits; on the high state of the art of war the practice of all other arts may depend.

The military art, like all others, can only approach towards perfection by the use of the most perfect tools and machinery attainable.

Yet, notwithstanding this certain truth, it is notorious that the inferiority of the arms used by modern English soldiers was, for long, a disgrace to the intelligence of the age, and an outrage on common sense, when compared with the high state of perfection to which the manufacture of arms, as of all other tools and machinery, has been brought in England.

Impressed with the importance of the subject to the policy of nations, and having been a diligent amateur mechanic since childhood, I have, for twenty-five years past, paid much attention to the improvement of rifled FIRE-ARMS, with which I have, during the last ten years, been carrying on a great variety of

experiments, on a scale probably almost unequalled, even by public bodies, elsewhere.

The result of these experiments I have, from time to time, freely communicated to Government; in doing so I had no thought whatever of honour or reward of any kind, and in truth I have received but little encouragement from authority. In placing at the disposal of Government the knowledge which I have acquired with great labour and expense, I have been actuated solely by the wish of being useful to my country, and thought that I was doing my duty to the public in making known what might prove of the highest importance to the success of our arms in war.

I have prepared a pattern rifle for the army (specimens of which have been given to Government) lighter, far more handy and convenient in every way, than the rifles hitherto in use, of 24-gauge bore only (that is, the spherical ball of which weighs twenty-four to the pound), with which a tolerably good shot can certainly strike an object the size of a man, once out of three times, at a thousand yards distance, and of which the full effective range is above 2,000 yards—the ball, at that range, still flying with deadly velocity. These rifles, proposed for the army, I have only sighted up to 1,800 yards, but the sights could easily be adjusted for longer ranges if necessary.

The charge of powder used has been small—two drachms only for a ball weighing one and three quarter ounces; but this is sufficient. Further experiments have shown that the 32-gauge bore is better than the 24, the ball not being reduced in weight, but made somewhat longer.

The description of my proposed pattern rifle for the army\* is as follows: single barrel, thirty inches long, very stout near the breech, 24-gauge, four-grooved; grooves to take one complete turn in thirty inches of length, patent breech, good locks, main-spring connected with tumbler by link, half-cock little above nipple, trap in butt; full-stock barrel attached to stock by bands secured with spring catches; steel ramrod with deep hollow head, so as not to press on the shell tubes in loading; sword bayonet twenty-four inches long, of the best cast steel; case-hardened iron mountings, and no brass or bright metal anywhere about the piece; folding sight six inches long, with slide, both the sight itself and its slide to be made with springs, to prevent their working loose. Weight of the whole, with sword included, about ten and a half pounds.

The above makes a very beautiful and wonderfully effective weapon; but the short double barrel was afterwards found to be much better.

I have other pieces of the same calibre (24-gauge), but made a little heavier, which make excellent practice at a range of 2,000 yards, the balls at that distance penetrating about four inches into very hard dry sun-burnt brick; that is, having sufficient force to go through two or more men. Regular practice at a further range than 2,000 yards I have not yet tried; but from what I have seen of the effect at that distance, I am convinced that with these balls, which I am now using, a moderately light and perfectly

\*For the best description of army rifle determined on (after continued experiments) in 1856, *vide* paper at the end of these memoranda.

handy rifle may be made to possess as much effectual power at a distance of 3,000 yards as the old two-grooved rifle with the round ball at 300.

A double 24-gauge rifle of mine, by Manton, twenty-four inches long, with iron-pointed balls two and a half diameters long, and with two and a half drachms of powder, requires a sight four and a half inches high for 2,000 yards, the distance of sight from muzzle being nineteen inches. The other elevations may be judged of from this.

The experiments by which these results have been arrived at extend over a long series of years, but they may be shortly summed up; and only during the last ten years have I had the means and opportunity of carrying them on upon a scale sufficiently large.

I have up to this time had some fifty or more rifles made, of all sorts and descriptions, while the cost of target walls alone, used in the course of these experiments, amounts to several hundred pounds, and powder and lead have been expended by the ton.

Our rifle practice-ground at Jacobabad is the best possible, being the perfectly-smooth dead level plain of the desert; the line of targets stretching away in front of the lines of the Sind Irregular Horse.

These targets are walls of "kutchra" (sun-dried) brick, which here attains nearly to the hardness of stone.

There is a small building, open to the front, for the accommodation of the shooters, and at accurately measured distances from this, the walls are erected at 100, 200, 300, 400, 500, 600, 800, 1,000, 1,200, 1,400, 1,600, 1,800, and 2,000 yards. The 2,000 yard

wall is forty feet high, fifty feet long, and three feet thick with supporting wing-walls and counterforts, plastered and whitewashed on the face; and others are of similar construction, and of size proportionate to their distances: all are marked with circular black bulls'-eyes, of one inch radius for each hundred yards, and raised one foot from the ground for each hundred yards of range.

The shooting-shed contains various heavy carriages or rests, with horizontal and vertical screw adjustments, in which rifles can be fixed for trial and fired, instead of from the shoulder. These carriages do not, however, improve the practice, as will be shown hereafter.

The rifles which have been here used are of all calibres, from the single 8-gauge of fifteen pounds weight, throwing a ball of near four ounces, to a double 32-gauge, weighing six pounds.

Such are the arms (described at greater length in the following memoranda) with which I would propose to arm the British soldier. Their use implies skilful workmen in our ranks, instead of pipeclayed automatons. It implies, further, an entire change in our tactics, so as to give full scope not only to the bodily, but to the high moral and intellectual powers of our men.

English soldiers so armed and developed would overpower and destroy any number of mere masses of semi-barbarous or ordinary enemies. With open files and ranks, each man a skilful single combatant, but still all acting in perfect concert (as would be easy, with such brave, trusty, intelligent, and skilful men), they would sweep their enemies from the earth, them-



selves almost unseen ; while a single discharge from a company at 1,000 yards' distance would annihilate the best field battery now existing.

With such infantry, so armed, our artillery must be abolished, or *improved*. And cavalry would be of little value against them.

### *Memorandum, No. II.*

Our proceedings at Jacobabad with the apparatus described in the foregoing memorandum, up to the commencement of 1854, are set forth in the following memoranda.

It was very early in these trials discovered that the two-grooved rifle has defects which render it quite unfit for the army.

If its ball be made to fit loosely, it is at liberty to roll in the direction of its two grooves, and thus the advantage of rifling the piece is, in some measure, thrown away.

If the ball be made to fit tightly, the difficulty of loading becomes a most serious evil. The two-grooved rifle was therefore, after trial, rejected.

The four-grooved rifle, with the ball with two bands round it (No. 1 of Plate 1) was then tried, and found to be wholly free from the defects of the two-grooved and polygrooved rifles. Other shaped balls were also tried ; but, as their use has been superseded by others of a better shape, it is not thought necessary to describe them.

The two bands gave such a firm hold on the grooves of the barrel that, though the ball was made so loose as to drop into the barrel, and the twist of the rifle's

grooves was more than usual, the ball always followed the sweep of the grooves exactly; the gun was more easy to load than even a common smooth bored musket, while in accuracy of performance the piece was surpassed by none. The balls provided for the two-grooved rifle, or the common musket ball cartridge, could be used for it on emergency, if necessary; and the piece seemed to have such important advantages for military purposes over the rifles in use in the army, that the results of the experiments, &c., were, in the year 1846, placed freely at the disposal of the Indian Government.

But the proposed four-grooved rifle was rejected by authority, for the reason that the two-grooved rifle, which was thought good enough for the Royal army, was good enough for the soldiers in India.

The best nature of *gun* being now established, experiments were continued to determine the best shaped ball.

All manner of forms were tried, until, after a series of experiments carried on diligently for many years, the conical ball (No. 2 of Plate 1) proved *very greatly* superior to all other shapes thought of up to that time. The round ball was found of little use after 300 yards. This conical ball, though heavier than the round ball of the same calibre in the proportion of three to two, required a charge of powder in the inverse proportion of these weights; that is to say, the charge of the round ball being three drachms, that for the conical ball, with the same range and elevation, was but two drachms.

All manner of rifles were tried, both breech and

muzzle loading, of every length, weight, &c., of various twists to the grooves, and of various calibres from 32 to 8-gauge.

The conical ball (No. 2) for a long time held its ground against all others; its advantages were overpowering, and excellent practice was made with it at 600 and even 800 yards.

The experiments had reached this point long before the Minié ball appeared; but immediately that invention was known, great things were expected of it, and it was tried in the fairest manner, and on a large scale.

The original Minié ball with iron cup is shown in figure No. 3.

After long and patient trials, for months together, it was found to *fail completely*.

Under the most favourable circumstances, it never equalled, or even approached to, the excellence of the conical ball (No. 2); and it was liable to the enormous defect of having the iron cup blown through the ball, the resulting tube of lead not unfrequently remaining firmly and most immoveably fixed in the barrel.

The ball had another great defect: it was cast from the foremost end, so that the roughness left by the ingate of the mould, defects of air-holes, &c., must occur *where the form of the ball was required to be most perfect*.

The Minié ball, to our great disappointment, was then condemned; but others, with modifications of the expansion principle, were then largely tried, of all manner of shapes. That shown by Figure No. 4 was the most promising; it was made with projections to

fit the grooves, so that its hold on the rifles was not dependent on the expansion only; it was cast at the hinder end; the conical forepart gave it great advantages in getting through the air; while the hole in the hinder part was reduced in depth, so as to avoid, as it was hoped, the chance of its being blown into a tube.

Still this "improved" Minié ball proved on trial no way superior to the ball No. 2; while, though no iron cups were used, still the balls occasionally were blown into tubes, and thus often rendered the gun unserviceable for the time.

Figure No. 5 was then tried; and this succeeded well, having apparently some small advantage over the conical ball, No. 2.

It will be observed, that a perfect and very firm hold on the screw formed by the rifle grooves is given by the projections on the ball, quite independently of the action of the expansion principle; while the conical hollow at the back part of the ball gives sufficient expansion to close all windage when the piece is fired, however loose the ball may be when inserted in loading.

The hold on the grooves of the gun being so great even with the ball quite loose, it was found that the *twist of the rifles could be increased to any extent* required, without the least danger of what is technically termed "stripping;" that is, of the ball being driven through the barrel without following the sweep of the grooves. The rifles were therefore made with the grooves taking one whole turn in thirty inches of length; and this twist was found to answer admirably.

The shape of the ball being found to have such great influence on the resistance of the air to its flight, and the twist of the rifles being found of full power to keep the point of the ball foremost with unerring certainty, even in the longest ranges, the form of the ball was still further studied, till that of Figure No. 6 was finally adopted; and this shape, after hundreds of thousands of experiments, proves to be quite perfect. Some of the results obtained are most curious. For instance: the weights of the balls Nos. 1, 2, and 6 are very nearly in the proportion to each other of the Nos. 2, 3, and 4; but the charges of powder required for them, with the same elevation, are in the *inverse ratio* of their weights;—so much is the resistance of the air reduced by the shape of the ball, that No. 6, being double the weight of No 1, requires only one-half of its charge of powder.

The ball No. 6 is perfectly and accurately effective up to 1,200 yards, and probably to much greater distances. The effect of its shape in overcoming the resistance of the air is so great, that its progressive velocity, after a flight of 1,200 yards, is but very little reduced; and even at 1,400 yards' distance, or further, the percussion shells of this shape burst well.

These percussion rifle shells constitute the *most formidable missile ever invented by man*. They are perfectly simple, and safe in use; and, when properly made, cannot be injured by time, weather, &c.; while they range to the longest distance, with accuracy quite equal to that of the solid balls.

The shell tubes are best made primed only at the points with detonating powder, the remainder being

filled with common gunpowder. These answer admirably; they never burst in the gun; and the comparatively slow ignition of the gunpowder allows the shell to penetrate deeply before bursting, and thereby increases its destructive effect.

The great reduction of the resistance of the air to projectiles of this shape enables us, with the usual initial velocity, to reduce the elevation required for long ranges so much, that the ground between the rifleman and his mark becomes no longer so safe by reason of the high curve of the flight of the projectile; and errors in judging of distance become, in proportion, of less serious importance.

Judging from our practice at Jacobabad, it seems certain that two good riflemen, so armed, could, in ten minutes, annihilate the best field battery of artillery now existing. \*

The shells are formed as shown in Fig. 1, Plate 2: a copper tube of proper size and shape, filled with percussion powder in the usual way, is thrust into a deep opening cast in the fore end of the ball. The tube is first dipped in melted resin, "kit," or such like cement, so that it cannot ever become loose; the ramrod end is hollow, so as to press wholly on the lead in loading; all other particulars will be apparent from the figure.

The bead form of the hinder end is not required, the simple flat end being found quite sufficient. The solid lead gives way under the pressure of the fired gunpowder quite sufficiently to cause the shell or ball to fit the barrel perfectly air-tight.

It seems evident, that if the arms above described

be supplied to our soldiers, their power would be increased at least four-fold. The army which should first adopt these weapons would thereby obtain an advantage equal to that of the exclusive possession of fire-arms a century ago. One effect of these would be that the whole of our field artillery must become *totally useless*.

The guns must be rifled also! In which case shrapnell shells, of the shape of Fig. No. 6, would be fully effective at distances of 5,000 yards or more.

Nay, from subsequent experiments with my pointed balls, it seems that three times this range may be accomplished with cannon. Good practice has been made at Jacobabad with 8-gauge shells, and with iron pointed balls of like size, at ranges of 2,000 and 2,400 yards. Flat-ended shells with the fore-part as shown in Fig. No. 6 of the Plate, and three diameters in length, are now found to answer admirably for the smaller calibres. The 32-gauge is large enough for anything, and with the shells above-mentioned, and a charge of 2 drachms of powder, a correct range of a mile and more is readily obtainable. The 32-gauge shells may carry the same bursting charge as has been used with the 16-gauge, so that the destructive power of the explosion is as great with the smaller as with the larger shell.

For cannon shot, the hold on the rifle grooves could be given by a wooden bottom (Fig. 2, Plate 2,) formed with proper projections to fit the grooves, and fixed to the shot by a square tenon cast on the latter, and a mortice through the wood. The twist of the grooves might be one-half turn in the length of the

gun, but experiment only can determine the proper proportion.

The exact description of rifle (now, 1857,) recommended for use throughout the army is given in the paper annexed.

The charge of powder mentioned is the quantity of good sporting powder, which is found most convenient. If the musket powder be of less strength, the charge should, of course, be slightly increased in proportion; and probably two and a half drachms may be found to be best.

---

The annexed table of times of flight, &c., is curious. The initial velocity appears to be but little reduced in the long ranges. The numbers in the table are the mean of hundreds of experiments.



PARTICULARS OF SHELL PRACTICE WITH 8-GAUGE RIFLES.

Jacobabad, 1853-54.

GUN.				Range.	Weight of Shell.	Charge of Powder.	Angle of Elevation.	Time of Flight.	Remarks.	
Nature of gun.	Length of Barrel.	Distances of Sight from Muzzle.	Height of Sight.							Weight.
	Inches.	Inches.	Inches.	lbs. oz.	Yards.	os. grs.	Drachms	Seconds.		
Double 8-Gauge Charge. }	20	16	.75	13 8	400	3 12	2½	2° 42'	1.89	Two guns of this size used, both made by John Manton. The grooves take one whole turn in 24 inches.
			.92		500			3 19	2.3	
			1.1		600			3 57	2.8	
			1.3		700			4 40	3.25	
			1.5		800			5 24	3.75	
			1.7		900			6 7	4.38	
			1.9		1000			6 50	4.71	
			2.1		1100			7 33	5.2	
2.3	1200	8 16	5.68							
Single 8 Gauge Four-Grooved. }	24	19½	.85	14 8	400	3 12	2½	2° 33'	1.82	Two guns of this size used, both made by John Manton. The grooves take one complete turn in 24 inches. NOTE.—With a charge of 3 drachms, these guns make excellent practice at 1,600 yards, and shells never fail to burst at that range.
			1.03		500			3 5	2.23	
			1.22		600			3 39	2.47	
			1.42		700			4 15	3.1	
			1.63		800			4 53	3.66	
			1.8		900			5 24	3.96	
			2.1		1000			6 18	4.52	
			2.4		1100			7 12	5.05	
2.7	1200	8 6	5.61							

*Memorandum, No. III.*

The foregoing memorandum was forwarded to the military authorities, and a committee of artillery officers was assembled to report on its subject.

This committee conducted its proceedings, no doubt, with the greatest fairness: but, owing possibly in some measure to imperfect explanation on my part, and to other causes not necessary to detail, fell into several mistakes, which rendered the inquiry totally useless for the object in view.

The pattern rifle proposed by me for the army was described in the above memoranda; but at that time I had no rifles of proper pattern for the army ready, and the four-grooved rifle forwarded by me with the paper on the subject was of construction altogether different.

The rifle forwarded was made for me purposely, exactly resembling the two-grooved rifles in use with the army, with all their defects, with the sole exception of its having four grooves instead of two. This piece was made for me many years ago, with the sole object of obviating the difficulty in loading the two-grooved rifle.

All this is set forth in the first part of the above memorandum, and was explained to the military authorities, &c., in 1846, as therein mentioned.

The only trial, then, between this piece and the common two-grooved rifle, which could have been of any practical use, should have been made with round balls, with the one and two bands respectively. It would then have been found that, with the usual tight-fitting balls of the two-grooved rifle, the number

of shots capable of being fired with accuracy in a given time would have been about ten to one in favour of the four-grooved piece.

The circumstance of easy or difficult loading is of the greatest practical importance; the committee, however, did not even allude to it.

Yet, with a view to easy loading alone was the piece forwarded by me made. In making it exactly like the rifles in use, I had this object in view: namely, to show how the great defect of the two-grooved rifles—difficult loading—could be at once obviated, by adding two more grooves to the pieces then in use, and using the two-banded ball.

Two additional grooves could easily have been made in the two-grooved rifles by any ordinary armourer, or even by the soldiers themselves, thus: Take a cylindrical piece of hard wood about two inches long, of size to fit the bore of the piece: through this drive a peg, to be left projecting a little at each end to fit into the two grooves of the barrel; at right angles to this, in the wooden cylinder, insert a steel cutter, with its edge of the breadth of the required grooves; screw the ramrod into the wooden cylinder, and thrust it up and down inside the barrel; the pegs give the lead for the twist of the new groove, which must thus be exactly parallel to the old ones. To make the cut of the proper depth, insert pieces of paper, card, or spills of wood, between the cylinder, on the side opposite the cutter, and the barrel. When one groove has been cut thus, take the tool out of the barrel, turn it half round, and cut the other in like manner. I have found this simple method perfectly effective.

Thus the improvement proposed could at once have been adopted into the service, without additional expense.

Easy loading alone was what this piece was intended to effect; in other respects it was neither better nor worse than the rifles then in use in the army. All other improvements referred to the shape of the *ball* only, and of course equally affected both rifles; save that the conical ball No. 2 of the memorandum, or of other such like shapes, cannot be used with effect from the two-grooved barrel, by reason of their being at liberty to lean over to one side in the direction of the grooves, so that the axis of the ball may not coincide with the axis of the gun.

The committee, however, apparently not knowing the object with which the piece was made, nor that it was of old date, seemed to imagine that the four-grooved rifle before them was of the pattern recommended by me, and proceeded to try it against one of the two-grooved rifles, using *the same balls for each*; when of course it was found that the differences between the pieces were merely accidental—such as might have occurred between two individual muskets of similar pattern.

The result, therefore, of the inquiry, was of no practical use whatever; but, on the contrary, with the best possible intention, the proceedings tended only to mislead.

The rifles used were of the old musket bore, and much too light, in proportion to the diameter of their bore, to enable a proper shaped ball to be used with a proper charge of powder; so that no great accuracy

nor penetration at long ranges could be expected; and their practice at 800 yards seems to have been inferior to contemporary practice at Jacobabad (with leaden balls only) at 1,200.

Little practical advantage, indeed, was to be expected from the proceedings of a committee, however ably and honestly composed, unless the members had some previous practical acquaintance with the particular matter in hand, and the proposer of the improved weapons, &c., had been present to explain matters personally.

As an example, the committee fired the rifles "fixed almost immoveably" in a species of carriage; naturally thinking thereby to ensure accuracy of practice.

Experience shows, however, that by far better practice can be made by firing from the shoulder, than by fixing the barrel in any vice or carriage.

It was not long before this was discovered; and numerous trials placed the fact beyond doubt, and led to the discovery of the cause.

I had made several apparently excellent carriages for rifles, very strong and heavy, with screw adjustments, both for altitude and azimuth; yet, to my amazement, no practice nearly equal to that from the shoulder could be made with them.

The reason I discovered by grasping the barrel while being fired. The metal appeared in a state of strong vibration, like the ringing of a bell; and the whole matter was at once accounted for. The vibration was not perceptible to the eye; and the barrel, when examined after firing, appeared to be in the same position as before; but the velocity of its vibration

when fired probably bore considerable ratio to that of fired gunpowder, and necessarily threw the ball quitting its muzzle upwards, downwards, right or left, in an irregular and quite uncertain manner. Take a stiff steel spring, hold it in the hand, and it can be made to vibrate only with great difficulty, or not at all. Screw it fast in a vice, and the least touch makes it vibrate rapidly. In like manner, the gun fired from the shoulder gives way, moves, and alters its position much, probably; but this motion is slow, and does not affect the flight of the ball in a degree approaching to the effect of the rapid *vibrations of the metal itself*; which do not take place when the gun is not fixed immoveably.

This at first seems curious; but however it be, there is no doubt of the fact as stated above. In these experiments by the committee, also, the rifles were laid with a gunner's quadrant; which does not seem to be a workmanlike or effective method for small arms. A long folding sight, with slide, is by far the best method of elevating the piece, whether in actual use in war or for experimental practice.

These sights should be made with springs, both to the sight itself and to the slide, to prevent their working loose and falling down of themselves.

Since the date of these proceedings, the experiments at Jacobabad have been continued with a great many new rifles, and with curious and important results; such, that the progress made throws all former proposals for improved balls for rifles for the army in the back-ground.

The ball No. 6 of the foregoing memorandum, there described as of perfect shape, is indeed, so long as it retains that shape in front. With a charge of powder equal to one-fifteenth of the weight of the ball, or less, these balls, of lead only, performed admirably; so that a good shot could, with them, at a distance of 1,000 yards, put nearly every ball into a circle of four feet radius.

Nothing could have been better as far as it went; but rifles were now procured of heavier metal, in proportion to the bore of 16 and 24 and 32-gauge, and the balls were tried with larger charges; it being supposed that they could be used with advantage with an initial velocity at least equal to that used with the ordinary round ball.

It proved, however, on trial, that such was not the case, and a new law was at once developed. A very slight increase of charge caused the lead to change its shape under the pressure of the gunpowder; so that the balls of the shape of the ball No. 6. when inserted into the barrel, came out in a form resembling the annexed sketch (Fig. a).

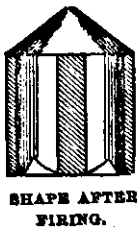

It was in vain attempted to remedy this by lengthening the ball, which was increased to two and a half and three diameters; and by making holes in the after-part, as in the Minié ball. Wads also of all manner of kinds—loose, and attached to the balls in various ways—were employed, but without avail.

The lead was found totally incapable of preserving

any resemblance to its original form (Fig. *b* of the annexed sketch), under the pressure of a charge of powder equal to one-eighth of the weight of the ball. The balls of three diameters in length, from the 24-gauge guns, whose fore-part was shaped as that of the ball No. 6, came out of the rifle in the form shown in Fig. *c*.

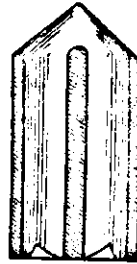
Fig. *b*.SHAPE OF THE FORE PART OF THESE  
BALLS BEFORE FIRING.Fig. *c*.

SHAPE AFTER FIRING.

These proved the best of all the lead balls, and ranged, with deadly force and considerable accuracy, up to 1,600 yards, or further; but of course all advantage of the peculiar form adapted to overcome the resistance of the air was lost. Manton's steel points were tried with these balls, but these were worse than the others; the lead was squeezed forward by one side of the point in an irregular manner, as represented in Fig. *d*; the ball assumed this shape, and would not fly truly.

Fig. *d*

The limit of the powers of leaden balls had thus been attained; and to proceed further it became



necessary to find a method of constructing rifle balls, so that the fore-part should be capable of sustaining the pressure of large charges of fired gunpowder without change of form, and thereby retain that shape best adapted for overcoming the resistance of the air, on which all accurate distance practice depends; and at the same time having the part of the ball next the powder sufficiently soft and yielding to spread out under its pressure, so as to fill the barrel and grooves perfectly air-tight. This problem was speedily solved; the fore-part of the ball was cast of zinc, in a separate mould, of the shape of Figs. *e*, *f*.

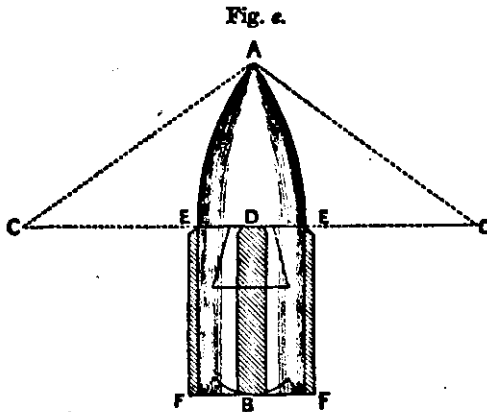

RIFLE BALL COMPLETE, WITH THE FOREPART OF  
ZINC OR IRON.



ZINC OR IRON  
POINT.

$AD = 1\frac{1}{2}$  diameters.

$DB =$  ditto.

$DC = 2$  diameters.

$AC = 2\frac{1}{2}$  ditto.

From *E* to *F* the ball is cylindrical.

From *E* to *A* its sides are defined by arcs of circles described from the centres *C* with the radius *CA*.

Finally, the best shape for ball and shell was found

to be  $2\frac{1}{2}$  diameters in length, the cylindrical part being 1 diameter only.

These points were placed in the full-sized mould, and the lead cast on to them, the complete ball being formed as shown in the diagram. Subsequently, the bead form of the large end of the ball and shell was abandoned, and the end is now made quite flat.

I was at first doubtful whether the small specific gravity of the zinc would not prove of disadvantage so great as to overcome the benefit of its hardness: but, on trial, nothing could have proved more perfectly effective.

The 24-gauge balls, of the increased length of two and a half and three diameters, proved admirably effective at ranges up to 2,000 yards, which had never before been attained. Ultimately the ball and shell of two and a half diameters in length proved to be the best.

No change whatever took place in the form of the zinc fore-part of the balls with the largest charges, while their penetration was found enormous, being not less than four inches at 2,000, and nearly three times that depth at 1,000 yards, into very hard dry kutchu brick. At the same time, the accuracy of the flight of these balls was truly wonderful.

It may be here remarked, that in the published reports of the Enfield rifle practice, it is stated that the twist of the rifle grooves throws the ball to the right or left, according as a right or left handed screw may be employed.

This seems to be wholly erroneous: no such effect is observed in my practice. There may be some such

*tendency* to deviation from such cause, but it must be of small amount, and is not perceptible.

The real facts of the matter seem to be these: considering the person of the rifleman as a cylindrical column, the recoil of a gun fired from the right shoulder is a force acting at a distance from the axis of that column, and therefore tending not only to drive it back, but to run it round on its axis. The muzzle of the gun, therefore, must receive a certain degree of motion to the right hand when fired.

It was found here, in many thousands of trials, that on a calm day the balls of the guns which recoiled with the greatest force, fired from the right shoulder, always deviated to the right hand; this deviation amounting to about twenty feet at 800 yards.

That the cause of this is correctly assigned above is thus proved. The same gun fired from the *left* shoulder *threw* the ball to the *left*. With the guns recoiling most, such as the 8-gauge rifles, used with a four-ounce ball and three-drachm charge, the deviation was very great; with the 32-gauge rifles, of which the recoil was slight, this regular deviation did not occur at all. These effects were observed *always* to occur, without any respect whatever to the amount of twist given to the grooves of the rifle. In practice, a perfect remedy was found for this deviation, or for any other similar errors, caused by the action of wind or anything else. When taking aim, leaning the gun over a little to the left perfectly counteracted the deviation to the right; and by practice the habit is

formed of instinctively adjusting the amount of the lateral inclination thus given to the sight, so as correctly to compensate the error.

Thus the matter stands at present. The limit of the powers of these missiles has, I am certain, not yet even been approached.

The iron points for the balls I now have made by compression from rod-iron; these answer admirably, and are much superior to anything cast.

These points could probably be made wholesale, at such prices that the ammunition could be prepared at no more cost than the common musket cartridges; while the power of the weapon would be about three times that of the best Minié rifles.

A 32-gauge ball of three diameters in length, with this iron point, is perfectly effective up to ranges of 2,500 yards or more. Shells, also, of this size appear to be quite large enough for all ordinary purposes; they take the same sized tubes as those before used for the 16-gauge shells, and never fail. On the whole, I should recommend the 32-gauge bore for general use.

I have tried every expedient I could think of as a substitute for the greased patch for rifle balls, but always had to return to this. Any species of wad, however attached to the ball, retards its flight so much as to render distant practice impossible, whatever may be the initial velocity used.

The best method I am acquainted with of preparing military rifle ammunition is to stitch slightly to the balls patches of thin cotton cloth completely deprived

of starch (or conjee), and then to dip them in melted tallow.

The fore-part of the ball' being hard, cannot be injured by any maltreatment by the ramrod, nor by knocking about against each other, and are best carried loose in a pouch; the powder being in blank cartridges, in a separate partition.

*Memorandum, No IV.*

For cannon, especially field pieces, similar shot to these found so effective for small arms might be used, perhaps, with advantage, instead of the shot, with wooden bottoms, formerly proposed by me.

The only objection seems to be the cost of the lead; which, however, would not probably be very great, as the quantity may be much reduced by making the dove-tailed tenon of the iron larger.

Shot, partly of lead, for rifled cannon, have been, I understand, not long ago tried, and found to fail, at Woolwich; but these proposed by me are of entirely different construction, and seem free from the defects of the others.

Nothing but actual trial can decide the merits of these things; and if such trials be made, it should be borne in mind that great weight is essential to the correct performance of rifled cannon. The observations on the vibrations of the barrels of small arms tell here with redoubled force. Strength to resist the bursting force of the powder is by no means sufficient—weight and mass are required; and, whatever the strength may be, the rifled cannon should not be of

less weight than one hundred and twenty times that of its shot.

Judging from experiments made, as an old artillery officer as well as a rifleman and practical mechanic, I am deliberately of opinion that a four-grooved rifled iron gun, of a bore of four inches in diameter, weighing *not less* than twenty-four hundred weight, could be made to throw shot to a distance of ten miles and more with force and accuracy.

The "Lancaster" guns *must*, I think, fail. The mode of rifling adopted in them is the *very worst possible*. It is only the two-grooved rifle in disguise. (See Fig. g.)

Fig. g.

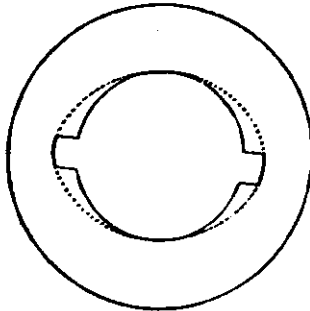

Let the shoulders of the grooves of a two-grooved rifle be removed, as shown by the dotted line in the sketch, and you have the Lancaster rifle.

But by the removal of these shoulders, the friction, if the twist be considerable, becomes *enormous*: the ball and the bore are not quite round, but nearly so; wherefore, as the ball is compelled to follow the twist of the bore, it acts like a "cam," and endeavours to burst the gun; or the dotted part in the sketch

becomes a very acute wedge, which the spiral motion causes to be driven with great force into the bore as the ball is driven out.

The heat developed by the friction must be very great, and the tendency of the gun to burst, or the shell to crush, also very great.

It would be far better than this to use a four-grooved rifle, with projections on the ball, *even of iron*, with a greased leather patch.

One more remark appears requisite.

The twist I now use, and which I find best, is one turn in thirty inches, or, better still, four-fifths of a turn in the length of the barrel.

This I find to maintain the spiral motion of the ball quite up to the last, in the long ranges attained by my rifles; and a rapid spiral motion is necessary to preserve the light end of the ball truly foremost throughout its long flight; which it is perfectly successful in doing.

The grooves should be *full deep, and of breadth equal to that of the lands*; the bands on the balls or shells being made to correspond so as to fit the grooves nicely, but quite easily, with a greased patch round them. It may be well to observe that thin *cotton cloth, well washed to free it from size, &c.*, should be used for patches. This seemingly trifling circumstance is of importance, for the use of improper cloth for patches, or having these imperfectly greased, often causes the time required for loading to be multiplied *tenfold*. The patch should contain *as little substance of cloth*, and *as much grease*, as possible.

For rifled cannon, the iron shot of two and a half diameters long will probably, as for small arms, be found to be the best; the shot might be cast with bands on it to fit the grooves, and be used with a well greased leather patch. This, I feel convinced, would succeed better than any other contrivance of wooden or leaden bottoms, &c.

Cast-iron will probably prove to be best for rifled cannon, they can be so easily made of this material; and the weight required to resist the recoil properly is amply sufficient to ensure adequate strength to resist the largest charges.

---

[Witton and Daw, 57, Threadneedle Street; Garden, 200, Picadilly, London; and Swinburn, of Birmingham, are all in possession of full information regarding the results of my rifle practice, &c.]





REPORT OF RIFLE PRACTICE AT JACOBABAD.

Date.	Description of Rifle.	CHARGE.		Number of Rounds.	Range, Yards.	Elevation.	Time of Flight.	SHOT STRUCK DISTANT FROM THE CENTRE, FEET.					By whom Fired.	Remarks.	
		Nature and Weight of Shot or Shell.	Powder.					Right.	Left.	In Bull's Eye.	Over.	Under.			
1854 December 6th.	Single. 16 Gauge. 30 in. long. Weight 102½ lb.	Lead-ended Shells.	3 drams.	1	1000	4° 36'		3	..	..	..	..	Lieutenant Green.		
				2				..	..	..	15	..			
				3				..	..	3	..	..			..
				4				..	..	..	..	15			..
				5				..	..	10	..	..			..
				6				..	..	6	..	..			..
				7				..	..	7	..	..			1
				8				..	..	..	..	..			..
				9				..	..	2	..	..			..
				10				..	..	4	..	..			..
December 9th.				1	1200	6° 1'		3	3	..	..	Maj. Jacob	Burst at Muzzle.		
				2				..	..	..	..			4	
				3				12	..	..	..			..	
				4				..	..	1	..			..	
				5				..	..	..	3			..	
				6				..	..	4	..			..	
				7				10	..	..	10			..	
				8				..	..	..	10			..	
				9				..	..	..	..			6	
				10				..	..	..	3			..	
				11				..	..	..	..			3	
				12				4	..	..	12			..	
				13				12	..	..	..			..	

REPORT OF RIFLE PRACTICE AT JACOBABAD.

Date.	Description of Rifle.	CHARGE.		Number of Rounds.	Range, Yards.	Elevation.	Time of Flight.	SHOT STRUCK DISTANT FROM THE CENTRE, FEET.					By whom Fired.	Remarks.									
		Nature and Weight of Shot or Shell.	Powder.					Right.	Left.	In Bull's Eye.	Over.	Under.											
1884 19th December.	Single. 16 gauge. 30 in. long. Weight 10 1/2 lbs.	Flat-bottom Shells.	3 drams	1	1000	4° 36'		..	..	..	5	..	Lient. M. Green.										
				2				..	..	..	..	..											
				3				..	..	..	..	..											
				4				..	..	..	..	..											
				5				..	..	..	..	..											
				6				..	..	..	..	..											
				7				..	..	..	..	..											
				8				..	..	..	..	..											
				9				..	..	..	..	..											
				10				..	..	..	..	4											
December 24th.	Single. 8 gauge. 24 inches long. Weight 14 lb. 8 oz.	Flat bottom Shells.	3 drams.	1	1200	7° 0'		..	8	..	10	..	Lient. M. Green.										
				2				..	7	..	10	..											
				3				..	6	..	10	..											
				4				..	..	..	..	8											
				5				..	..	..	..	..											
				December 24th.				Single. 16 gauge. 30 in. long.	Flat ended Shells.	3 drams.	1	1200			6° 1'		..	..	..	6	..		
											2						..	..	..	..	..		
											3						..	..	..	..	..		
											4						..	..	..	..	..		
											5						..	..	..	..	..		
December 24th.	Single. 16 gauge. 30 in. long.	Flat ended Shells.	3 drams.	6	1200	6° 1'		..	..	..	..	..											
				7				..	..	..	..	..											
				8				..	..	..	..	..											
				9				..	..	..	..	..											
				10				..	..	..	..	..											

REPORT OF RIFLE PRACTICE AT JACOBABAD.

Date.	Description of Rifle.	CHARGE.		Number of Rounds.	Range, Yards.	Elevation.	Time of Flight.	SHOT STRUCK DISTANT FROM THE CENTRE, FEET.					By whom Fired.	Remarks.
		Nature and Weight of Shot or Shell.	Powder.					Right.	Left.	In Bull's Eye.	Over.	Under.		
1855 May 18th.	Single. 8 gauge. &c.	Shells, Nos. 8dr.	8 drams.	1	1800	13° 7'	..	8	..	15	..	Maj. Jacob	All the shells burst in the wall with full effect.	
				2			..	..	..	15	..			
				3			10	..	..	10	..			
				4			..	..	..	..	3			
				5			8	10	..	..	3			
				6			..	..	..	8	..			
				7			..	1	..	4	..			
				8			..	..	..	..	4			
				9			..	3	..	..	1			
				10			..	1	..	..	3			
				11			..	1	..	8	..			
				12			..	2	..	..	..			
										1	2000			15° 52'
				2			..	..	15	..				

REPORT OF RIFLE PRACTICE AT JACOBABAD.

Date.	Description of Rifle.	CHARGE.		Number of Rounds.	Range, Yards.	Elevation.	Time of Flight.	SHOT STRUCK DISTANT FROM THE CENTER, FEET.					By whom Fired.	Remarks.
		Nature and Weight of Shot or Shell.	Powder.					Right.	Left.	In Bull's Eye.	Over.	Under.		
1855 August 2nd.	Single. 8 gauge. 24 in. long. Weight 14lbs. 8oz.	Flat-bottom Shells, with thick wad and patch.	3 drams.	1	3000	16°		..	..	..	..	..	Maj. Jacob	Over wall. Grazed 20 ft. short.
				2				..	..	..	..	..		
				3				..	10	..	..	..		
				4				..	8	..	10	..		
				5				..	1	..	8	..		
				6				..	5	..	10	..		
				7				..	2	..	6	..		
				8				..	1	..	2	..		
				9				..	..	..	..	..		
				10				..	..	..	..	..		
				11				..	..	..	..	..		
				12				..	10	..	10	..		
				4th August.				Single. 8 gauge, as above.	Flat-bottom Shells, &c. as before	3 drams	1	3000		
2	..	..	..		..	..								
3	..	..	..		..	..								
4	..	..	..		..	..								
5	..	1	..		3	..								
6	..	15	..		..	..								
7	..	13	..		..	..								
8	..	8	..		12	..								
9	..	10	..		15	..								
10	..	..	..		20	..								
11	..	..	..		..	..								
12	..	..	..		..	..								
13	..	3	..		12	..								
14	..	3	..		15	..								
15	..	..	..		..	..								

REPORT OF RIFLE PRACTICE AT JACOBABAD.

Date.	Description of Rifle.	CHARGE.		Height of Sight.	Range, Yards.	Elevation.	Time of Flight.	SHOT STRUCK DISTANT FROM THE CENTER, FEET.					By whom Fired.	Remarks.						
		Nature and Weight of Shot or Shell.	Powder.					Right.	Left.	In Bull's Eye.	Over.	Under.								
1854	Four grooved. Single. 8 gauge. 24 in. long. Weight 14 lbs. 8 oz. Distance of sight from muzzle, 18.75 in.	Flat bottom Shells. 3oz. 8dr.	4 drams.	in.	4 16	2000	12 30 24	9	12											
				3 81	1900	11 29 10	8	51												
				3 47	1800	10 28	8	7 30												
				3 14	1700	9 30	24	7 30												
				2 82	1600	8 33	11	6 71												
				2 52	1500	7 39	16	6 14												
				2 24	1400	6 44	15	5 60												
				1 98	1300	5 1 41	5	5 6												
				1 74	1200	5 18	7	4 57												
				1 52	1100	4 38	6	4 9												
1 32	1000	4 1 31	3	3 62																
				1 14	900	3 28 45	3	203												
				97	800	2 37 41	2	785												
				81	700	2 28 25	2	38												
				66	600	2 0 5														
				51	500	1 33 26														
				No. of rounds.																
August 30th, 1855.	Single. 16 gauge. 30 in. long. Weight 10 lbs.	3 drams.		1	1000	4° 30'			3	..	..	..	1	Maj. Jacob	All the shot burst w... in the wall.					
				2					1	..	..	..	2							
				3					..	..	..	..	..							
				4					..	..	..	..	..							
				5					..	..	..	..	..							
				6					..	..	..	..	..							
				7					..	..	..	..	..							
				8					..	..	..	..	..							
				9					..	..	..	..	..							
				10					..	..	..	..	..							

No. 2,277.

*Head Quarters, Mahableswur, 16th April, 1856.*

FROM the ADJUTANT-GENERAL of the Army,

TO the SECRETARY TO GOVERNMENT,

Military Department, Bombay.

SIR,—With reference to previous correspondence on the subject of Lieutenant-Colonel John Jacob's rifle and rifle balls, I am directed to make the following report, for the information of the Right Honourable the Governor in Council:—

2. His Excellency the Commander-in-Chief having desired to see the effect of the elongated conical shells, recommended by Lieutenant-Colonel Jacob, C.B., to be introduced into the army, a butt for rifle practice was built of sunburnt bricks on the Flats at Bombay, twenty feet high, and of a similar width.

3. The rifles used were four-grooved, 24-gauge, as recommended by Lieutenant-Colonel Jacob for use in the army, the charge for all distances being  $2\frac{1}{2}$  drachms of powder. The shell is cast with four bands on the cylindrical part, which fit exactly to the grooves; used with a thin greased patch. The rifle loads with the greatest ease, and without any force.

4. The rifles were fired from the shoulder, but placed on the army regulation aiming rest, as adopted by Lord Frederick Fitzclarence, which gave a correct direction and elevation.

5. At ranges from 300 to 1,200 yards, the flight of the shell was always point foremost, and the elevation at the extreme range inconsiderable. The shells

which struck the butt invariably burst with full effect; and practice was made by the many officers who attended, at distances which could not have been attained with any other known missile.

6. The result was convincing—that, before a small body of marksmen armed with such weapons, no battery of artillery could long hold its ground. A box filled with powder was exploded by a shell fired at 300 yards, and from the effect of the shells on the butt, it was evident that the same result would have been attained at the greatest range from which practice was made, viz. 1,200 yards; for the shells on exploding at such distances tore out large fragments of the wall. Unfortunately, at this practice, the wind was very high, with much dust.

7. The expectation formed of these shells by Lieutenant-Colonel Jacob, and his experiments with them, as shown in the accompanying report, are fully borne out by the practice made at Bombay; and the result of six shots fired by Colonel Green and Major Woosnam at 1,000 yards is shown in the annexed diagram.

8. The accuracy of flight attained by projectiles of the peculiar form on which Lieutenant-Colonel Jacob's shells and balls are cast, has now carried the use of fire-arms far beyond anything which has come under the notice of officers in this country, and the experiment made at Bombay can be attested by the following gentlemen who witnessed the practice :—

His Excellency Sir Henry Somerset.

Honorable Arthur Malet, Member of Council.

Major-General Lester, Commandant of Artillery.



Colonel Green, C.B., Deputy Adjutant-General  
of the Army.

Colonel Willoughby, C.B., Principal Commissary  
of Ordnance.

Lieutenant-Colonel Swanson, Member of the  
Military Board.

Mr. Bellasis, Civil Service.

Major Stock, Assistant Adjutant-General.

Major Shaw, Assistant Commissary-General.

Major Woosman, Agent for Gunpowder.

9. It would appear, therefore, a matter of deep importance that the subject of rifle shells and bullets *of the form recommended by Lieutenant-Colonel Jacob* be brought under the special attention of the home authorities, for they can be equally well adapted to the Enfield Pritchett rifle, now being introduced generally into the Royal army. His Excellency begs therefore to recommend that this report may be transmitted with that view to the Honourable the Court of Directors.

I have the honour to be, &c.

(Signed) H. HANCOCK, Colonel,  
Adjutant-General of the Army.

(True copy,)

(Signed) EDWARD GREEN, Colonel,  
Deputy Adjutant-General of the Army.

## REPORT OF RIFLE PRACTICE, BOMBAY.

*Present*,—Colonel Green and Major Woosnam.

Range, 1000 yards.

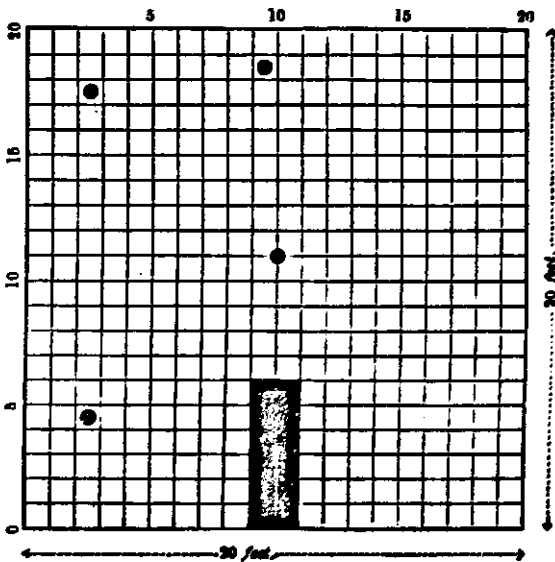
*Scale of feet.**Description of Rifle (Soldier's) recommended by  
Colonel Jacob.*Charge,— $2\frac{1}{2}$  drachms.

Elevation,—as marked on the sight.

Remarks,—Clear, calm morning. Six rounds fired.

H.G.

## (MEMORANDUM.)

## RIFLE PRACTICE AT KURRACHEE.

*Friday, 5th September, 1856.*

A powder-box was prepared for explosion by rifle shells, at a range of (1,800) one thousand eight hundred yards.

The box consisted of two boards, one and a quarter inch thick and ten feet square, put together with a space of one inch between their surfaces; this space was filled with gunpowder, and was found to contain a charge of above 500 lbs. The box was placed against the butt, on the ground, and after being loaded, was well tarred over. At 7 A.M. on the 5th of September, 1856, rifle practice was commenced with shells at this box, from a distance of 1,800 yards. The morning at first was dark and cloudy; but after a few shots had been fired the weather improved and soon became very favourable as regards light, although a fresh breeze was blowing across the range from right to left.

The shooters were —

Captain Gibbard, Artillery, 24-gauge army rifle.

Captain Thatcher, Major }  
of Brigade ..... } 16-gauge Manton.

Colonel Jacob..... 24-gauge Manton.

Captain Scott, A.D.C. .... 32-gauge Manton.

The undermentioned gentlemen were also present: —

Colonel Trevelyan, Artillery.

Lieutenant De Vitre, Artillery.

Captain Pirie, Lieutenant of Police.

For the first few rounds, the shells struck near the foot of the butt ; but as the morning brightened, the practice improved, and many shells in succession struck close over and around the box,—so close, indeed, that to the naked eye they appeared actually to strike it. The practice was steadily and deliberately continued, but the powder still remained untouched, till Colonel Jacob's little double rifle had been fired twenty times. The last few shots from this rifle were all very near to the box, and, when fired for the twenty-first time, the shell from the second barrel struck the box and exploded the powder. The effect was magnificent, the distance being so great, and the charge in the box so heavy. So violent was the explosion, that it was thought at first that the butt wall had been blown down ; but when the smoke cleared, the wall was seen standing uninjured. This wall is built of stone, ten feet thick at the base and one and a half at top, is 100 feet long and 50 feet high. A large portion of surface near the powder-box was a good deal shattered, but the damage was only superficial, and the butt was not seriously injured.

Throughout the practice at Kurrachee, no rest of any kind was used. The rifles were always fired from the shoulder, the shooter standing up.

On further examination, it appeared that a large portion of the surface of the butt wall, about twenty feet square, was blown in to a depth of nine inches, and that the back of the wall near the base had bulged three inches. //

Plate 3.

Form of Ball and Shell finally adopted  
by Col. Jacob.

March 1857.

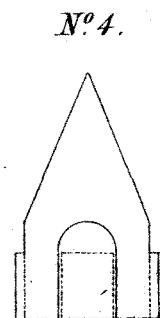
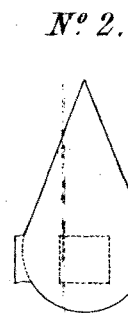
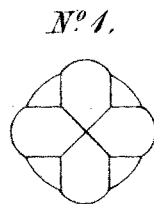
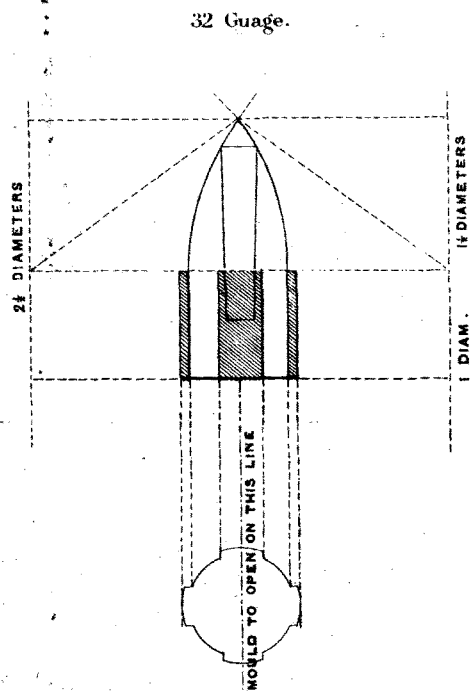

Improved Minié Balls used without Cups

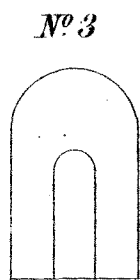

Original Minié Ball  
with iron cup.

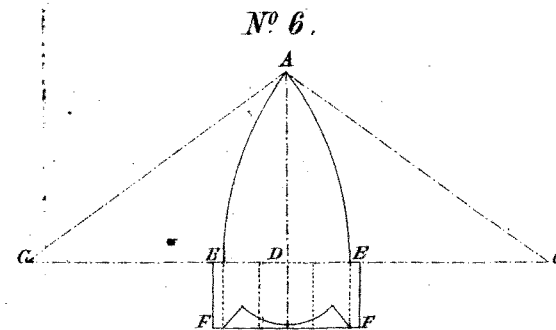

N° 6 Perfect shape for Rifle Balls

- A. B. 2 Diameters
- C. D. 2 " "
- A. C. 2 1/2 " "
- B. D. 1/2 " "

From E, to F, the ball is cylindrical, from A, to E it is defined by arcs of circles described from the centres C, with the radius C. A.

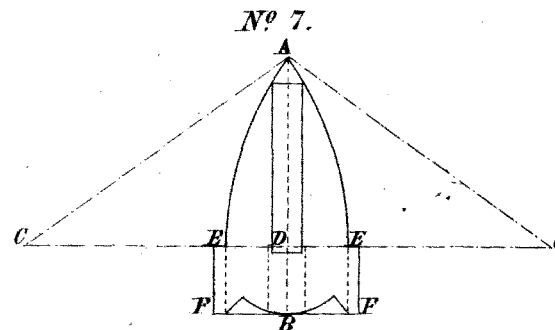

Rifle Shell formed exactly as Ball N° 6, but cast with a deep hole at the smaller end in which is fixed a Copper Tube filled with detonating powder.

The shells and balls are now found to answer best when made quite flat at the large end—the cylindrical part being increased in length to 4 1/2 diameters

The moulds for these shells or balls should always be made to open in the middle of a pair of bands. The ends of both ball and shell quite flat. The shell-tube well primed at the point with percussion powder, and filled with fine gunpowder.

SHOT OR SHELL FOR RIFLE CANNON.

*Note.* The weight of these Shot will be more than double that of the common Round Shot of the same Calibre, the weight of the Gun must be proportioned to that of the Shot not to its diameter.

Fig. 1.

From E, to F, the Shot is cylindrical  
From A, to E, it is defined by circular arcs described from the centres C, C, with the radius C. A.

A. B. — 2 Diameters.  
D. B. —  $\frac{1}{2}$  \_\_\_\_\_  
C. D. — 2 \_\_\_\_\_  
C. A. —  $2\frac{1}{2}$  \_\_\_\_\_

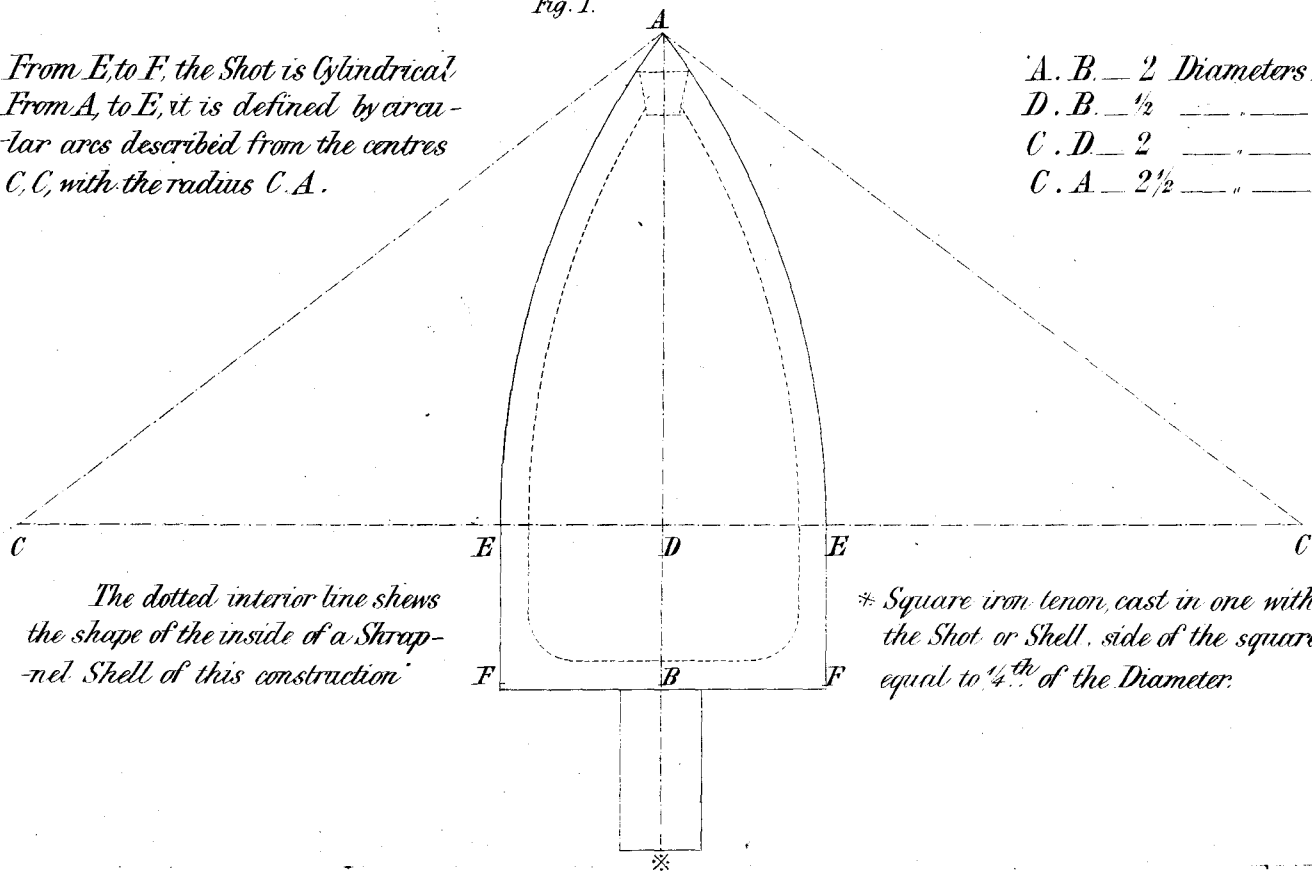

The dotted interior line shews the shape of the inside of a Shrapnel Shell of this construction

\* Square iron tenon, cast in one with the Shot or Shell, side of the square equal to  $\frac{1}{4}^{th}$  of the Diameter.

Hard wood bottom with Square Mortice in the Centre to fit on to the tail Tenon of the Shot, to which it is to be wedged fast

Fig. 2.

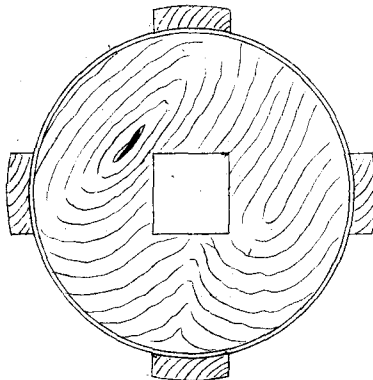

An iron ring is driven on to each end of the bottom to secure it from splitting.  
Thickness of bottom exclusive of iron rings — equal to half the Diameter.

### PENETRATION OF JACOB'S IRON-POINTED RIFLE BALLS.

At Kurrachee, on the 26th of September, 1856, a 24-gauge iron-pointed ball, fired with a charge of  $2\frac{1}{2}$  drachms of powder at a distance of twenty-five yards, penetrated clean through eighteen deal planks, each three-quarters of an inch thick, and smashed itself all to pieces against stones on the other side.

Present,—

Colonel Jacob.

Captain Scott, A.D.C.

Lieutenant Macdonald, Revenue Survey.

Again, at Kurrachee, on the 29th September, 1856, a 24-gauge iron-pointed ball, with a charge of  $2\frac{1}{2}$  drachms of powder, was fired at twenty-five deal boards, each a little more than three-quarters of an inch thick, the whole thickness of all the boards together being twenty inches; the boards were packed close, one behind the other, and wedged fast into a box. The rifle was fired at twenty-five yards distance. The ball penetrated clean through the whole twenty-five planks, and buried itself its whole length in a block of hard wood  $2\frac{1}{2}$  inches thick which was behind the mass of boards, breaking this block into two pieces.

### BEST ARMY RIFLE, WITH APPARATUS COMPLETE IN CASE.

Double 32-gauge—four-grooved—DEEP grooves, of breadth equal to that of LANDS, to take four-fifths of a turn in the length of the barrel—barrels the best

that can be made, twenty-four (24) inches long, weight of pair of barrels alone about six pounds, NOT LESS—the ends of the lands to be rounded off at the muzzle—patent breech—no side vents—first sight EXACTLY PARALLEL to the bore—the muzzle sight being raised if necessary for this purpose—four points to be inserted inside the barrel near the breech for tearing open a blank cartridge when rammed down whole—full stock, well bent, of the best heart walnut wood, attached to barrels by bands—best plain case-hardened mountings—folding sight attached to the barrel 20 inches from the muzzle, five (5) inches long, secured by spring below, protected by projecting wings when lying flat on the barrel, the slide of this sight to be well secured by springs at its back, so as never to work loose—the slide to come down quite low on the sight, the top of the sight and bottom of its slot to be notched. The sight, &c., to be *strongly* made and *nicely finished, marked and engraved* for distances as per annexed scale—leaf sights, folding flush for 100 and 200 yards—muzzle sight to be fine. Best locks, *strong mainsprings, and heavy cocks*. Half cock *half an inch* above nipple (not less). Triggers easy to pull, plenty of play in the cocks, external vents in nipples to be *small*—six spare nipples to each, of size to fit Eley's No. 13 and No. 26 caps—one mould for balls, and two for Jacob's shells, flat-ended, two and a half ( $2\frac{1}{2}$ ) diameters long—moulds to be made of good *steel*, to open in the *middle of one pair of bands*—the balls and their bands of size and depth to fit the barrel nicely, but *easily* with a patch, exact diameter of bore in decimals of an inch .529—



of shell or ball .524—plugs of shell-moulds to fit Jacob's shell-tubes ("long 16-gauge," as made by Eley)—plugs or cores of shell-moulds to have wooden cross-handles. *Best* double-edged straight sword, with blade 30 inches long, to attach to rifle by ring round the muzzle of both barrels, as well as by spring socket, with scabbard and belt complete (scabbard of *strong* wood covered with leather, with case-hardened mountings riveted on)—all properly fitted into gun-case (two small ammunition pouches on the belt—one to hold powder-flask or blank cartridges and caps, the other balls, patches, turnkey). The sword to be made with good steel or case-hardened iron, half-basket hilt. Short powder-flasks of copper, covered with hogskin—charges  $2\frac{1}{2}$ ,  $2\frac{3}{4}$ , 3 drachms—spare tops with charges of 2,  $2\frac{1}{4}$ ,  $2\frac{1}{2}$ , drachms—stout steel ramrod in the gun with deep hollow head, so as not to press on the shell-tubes in loading—the rod below the hollow head not to be filed away too much, as if thin it is liable to split on the iron balls. Grip of ramrod at both ends to be well roughened. Stout spare ramrod with knob handle and deep hollow head—brass tube of the length of the barrels for loading with powder when cartridges are not used—patch punches ( $1\frac{1}{2}$  inches)—small stores, cleaning apparatus, &c., &c., as usual, fitted into a rough stout roomy case. The rifle to fit into the case when put together stock and barrel—the partitions in the case to be very strongly fixed by screws, &c., all of the best quality as to usefulness; strength and durability to be especially considered—appearance only of little importance.

Strong leather sling to attach by good *steel* loops

and screws—rifle to fit into case with the sling attached.

There should be proper receptacles in the gun-case for some shells or balls, caps, patches, &c.; the partitions, &c., to be very strongly fixed.

A pair of scissors, pair of pliers, a corkscrew, and a knife—a ladle and a shallow melting-pot in gun-case—plenty of turnkeys and screw-drivers, oil bottle, &c., all very strong and good, and serviceable for hard work.

Eley's percussion tubes for Jacob's rifle shells long 16-gauge, primed at the points with detonating powder, and filled with gunpowder.

Cap and tube-makers recommended by Colonel John Jacob—

Messrs. Eley, Brothers, 38, Broad Street, Golden Square, London.

Gun-makers. { Messrs. Witton and Daw, 57, Thread-  
needle Street, London.  
Messrs. Swinburn and Son, 16 & 17,  
Russell Street, Birmingham.

# ELEVATIONS FOR THE SIGHTS OF JACOBS' RIFLES.

(To face page 278.)

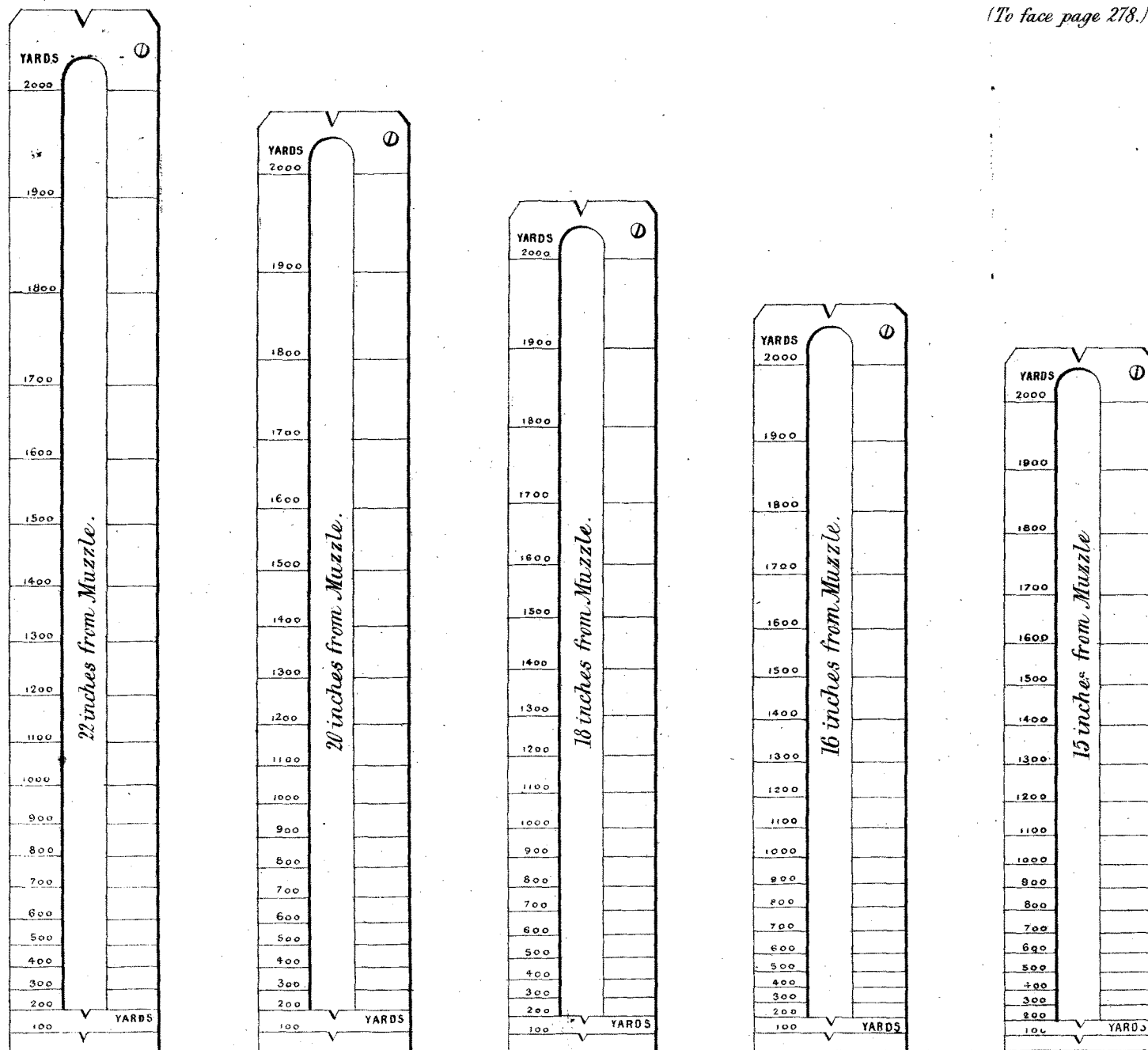

SCALE TO COMMENCE FROM A LINE EXACTLY PARALLEL TO THE BORE OF THE GUN.

PROPORTIONS RECOMMENDED FOR JACOBS RIFLES  
FOR GENERAL PURPOSES.

10th September, 1857.

16	.665	.660	Equal to land.	Four.	30	.042	26	10	5.5	22	
24	.582	.577			28	.036	23	7	5.0	20	
32	.529	.524			26	.038	21	6	4.5	18	
48	.463	.458			24	.030	19	5	4.0	16	
64	.421	.416			22	.026	18	4	3.75	15	
				Twist of Grooves one whole turn, in inches of length.		Depth of Grooves and height of Bands on Ball or Shell, dec. inch.		Weight of single or of pair of double Barrels, pounds.		Distance of Sight from Muzzle.	
				Or four-fifths of a turn in the length of the barrel.		Or about one-sixteenth of the diameter.					

Ball or Shell, 2 $\frac{1}{2}$  diameters long, shaped as below, the end quite flat:—

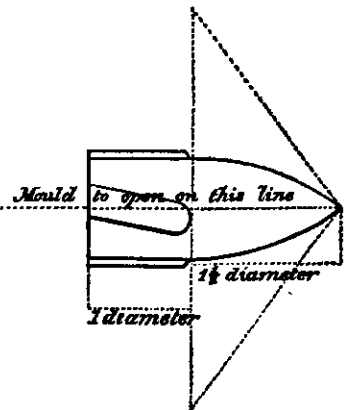

*N.B.*—It is found that the double rib performs better than the single. The weight of the single barrel, to perform satisfactorily, must be equal to that of the pair of the double barrel.

For general purposes with shells the 32-gauge is recommended. But if balls only are to be used, one of the smaller calibres will be found to answer admirably.

EXPLANATION OF THE DIFFERENCE BETWEEN THE  
MINIÉ AND JACOB RIFLE BALL.

The Enfield rifle is peculiarly adapted for use with the Minié ball, with which it performs well up to 800 yards. But the very peculiarities which make the Enfield rifle answer perfectly for the Minié projectiles quite unfit it for use with mine. Let us consider what these peculiarities are.

The Minié ball possesses IN ITSELF the tendency to keep its proper end foremost in its flight; it therefore requires very little twist to keep it in the right path.

The large hollow in its hinder end makes it comparatively light in proportion to its diameter; a less charge, therefore, of powder is required to give it the same *initial* velocity, as one of my projectiles of like calibre. Again, the hollow in the Minié ball renders it likely to be blown into a tube if much projectile force be suddenly applied to it.

For this ball, therefore, a *thin* barrel only is necessary, and the grooves may be shallow, and have but very little twist. At the same time, in order to get as much projectile force to act on the ball as it will bear without injury, it is requisite to lengthen the barrel, so as to make the power act *for as long a time* as possible on the ball; while it is actually found that an inferior description of powder (that is, a slow burning powder) is the best for the Minié ball and Enfield rifle. The Minié ball will not stand a great force acting with great velocity on it—the lead gives way under the shock; wherefore it is necessary to impress this ball with a *more feeble force, acting for*

*a longer time on it*, in order to produce an adequate projectile effect.

Well, then, the long weak barrel, with very little twist in the grooves, answers admirably to fulfil the conditions required so far. But, on the other hand, the shape of the Minié ball is by no means well adapted for overcoming the resistance of the air; while its want of solidity, owing to the hollow in its after-part, also very much lessens its virtual specific gravity and momentum, and thus adds to the effect of the air's resistance on its fore-part.

The shape of the ball used by me (those of two and a half diameters in length are, I think, best,) is that which I find by experience to be the best adapted for overcoming the resistance of the air, and, being perfectly solid behind, this ball is capable of sustaining the shocks of **ANY CHARGE OF POWDER WHATEVER.**

It has, however, a strong tendency to fly with the wrong end first, exactly contrary to the behaviour of the Minié; and to counteract this perversity, a great twist in the rifle grooves, giving a rapid spiral motion to the ball in its flight is necessary.

In proportion to its calibre, this ball is very much heavier than the Minié: to give it the same velocity, then, it is necessary to use a larger charge: but the advantage of the shape of its fore-part in overcoming the resistance of the air, as compared with other projectiles, is only fully developed at high velocities, which **CANNOT BE ECONOMICALLY USED WITH ROUND-ENDED BALLS LIKE THE MINIE**, on account of the excessive increase of resistance which they sustain. With my projectiles, then, a **HIGHER** velocity than

that given to the Minié is proper ; the charge, therefore, must be still further increased for this purpose ; wherefore the barrel of the rifle must be very strong. Again, the ball is capable of standing the force of any sudden shock, so that a large charge of the best powder procurable may be used to advantage ; and no great time is required in which to impress the necessary projectile velocity on the ball,—a short barrel, therefore, is indicated. For my projectiles, therefore, we require a **SHORT STOUT BARREL WITH DEEP GROOVES AND GREAT TWIST**. If we attempt to use these projectiles with a long thin barrel, like the Enfield, **THEY MUST FAIL SIGNALLY**. The weight of the ball and its solid resistance are too great for the weaker barrel, which trembles, shakes and vibrates, when fired, to a degree which shows it to be altogether overstrained ; in fact, the iron of the barrel must be distorted into a series of waves as the ball passes along it, and the elastic action of so thin a tube near the muzzle end must make it jerk the ball about in a wonderful manner as it leaves it. Under the operation of this irregular elastic action of the metal of the barrel, the heavy end of the ball is almost certain to get foremost, or it may even fly about sideways,—in fact, its flight must be altogether irregular. *For it is only to the steady quiet action of a rapid spiral motion that these balls remain in their unnatural position of point foremost*, which, however, they retain accurately and invariably **DURING A FLIGHT EVEN OF A MILE AND A QUARTER, WHEN FIRED FROM A PIECE ADAPTED TO THEIR USE**, with a proper charge.

The short barrel, if found sufficient to enable us to

impress a proper velocity on the ball, has very great contingent advantages. The effect of all sorts of errors, personal and instrumental, on the flight of the *ball*, must evidently be proportionate to the time during which the causes act: the effect of the recoil, for instance, on the ball, must be twice as great in a rifle thirty-six inches long as in one of eighteen inches, for the gun must have been acting on the shoulder, and the giving way of the shoulder, &c., on the ball, twice as long in the one case as in the other.

In practice, the proportion of advantage is very much MORE IN FAVOUR of the SHORT BARRELS; because a certain time is required to act at all, or at least to act at all sensibly, on the shoulder; and with a short barrel the ball may have left the gun before the latter may have changed its position in the least.

With regard to the sizes of rifles, I think 32-gauge is large enough for anything, and that twenty-four inches is long enough for the barrel *of any calibre whatever*; the grooves should be full deep, of breadth equal to that of the lands, and may turn once in three feet of length. For an army rifle, requiring to be adapted for use as a pike, the short barrel is no disadvantage, for the requisite length may easily be made up by using a longer sword.

The 24-gauge is, however, quite unexceptionable, and I think the best rifle I have is of that calibre.

The balls and shells of two and a half diameters long, are, I think, the best.

Swinburn & Son, 16 & 17, Russell Street, Birmingham, are the best men, I think, for army rifles



in England. They know my pattern, and have worked for me.

A fourth edition of my book on rifles has just been published by Smith, Elder & Co., 65, Cornhill, and you would find its contents interesting, as would all others engaged in such pursuits. The thing costs two shillings, I believe, and contains the results of twenty years' labour.

\* \* \* \* \*

**PART III.**

**RELATING TO**

**THE NORTH-WEST FRONTIER OF INDIA.**

## THE NORTH-WEST FRONTIER OF INDIA.

---

### MEMOIR OF THE FIRST CAMPAIGN IN THE HILLS NORTH OF KUTCHEE, TO THE NORTH-WEST OF THE FRONTIER OF SIND.

IN the year 1839, after Lord Keane and his army had passed through Kutchee *en route* to Affghanistan, the predatory tribes inhabiting the eastern part of that province, namely the Doombkees and Jekranees, with others of less note associated with them, infested the road from the neighbourhood of Shikarpoor to the mouth of the Bolan in such numbers, and with such boldness, that a whole regiment was required to escort a convoy in safety from Shikarpoor to Dadur. The matter was of serious importance, for the safety of the army in Affghanistan might depend on the supplies forwarded to it from Sind; while the number of troops in Upper Sind was totally inadequate to the furnishing, for a continuance, the strong escorts required. The heat, also, in this part of the world, from April to October, is more deadly than the sword of a human enemy, and scarcely an escort at this time marched through the country without losing many men from this cause alone.

Mr. Bell, the political agent, in vain made every

effort to obtain a free passage through Kutchee by negotiation and pecuniary arrangements with the plundering tribes; their chiefs were deaf to all persuasion, and scorned every offer.

The Doombkees and Jekranees reside wholly in the plain of Kutchee, and possessed the towns of Lahree, Poolijee, and Chuttur, with some villages in that neighbourhood and the adjoining lands. Their fighting men were all mounted; they were, indeed, tribes of horsemen. The Murrees and Boogtees inhabited the neighbouring hills; the chief town of the former Kahun, of the latter Deyra. These mountain tribes were nearly all footmen, and seldom or never ventured in hostile guise into the plain country. While the Doombkees and Jekranees were in power, the horsemen were far too strong for them in the plain, while, on the other hand, they were safe in their mountain fastnesses from the attacks of the lowlanders. Such being the respective positions, these warlike tribes, with occasional exceptions, were usually on friendly terms, and afforded each other mutual support.

The head of the whole Doombkee tribe by birth was, and is still, Belooch Khan, of Lahree: but he being of a quiet, peaceable disposition, preferred a life of ease at home to one of stormy adventure and predatory warfare: he never joined in any plundering excursion, and quarrelled with nobody, but lived like a quiet country gentleman, in the midst of his turbulent brethren. He was, on this account, held in contempt by the warlike part of his tribe; and Beejar Khan, in power, influence, and all else but name, had,

long before we entered the country, made himself the real head, not only of the Doombkees, but also of the associated tribe of Jekranees. Beejar Khan was a man of considerable ability ; he not only kept his wild riders completely under his authority, but was far-famed for his justice and excellent civil arrangements. His ryots, far from being oppressed, were protected and made much of ; his lands were well cultivated, and the traders, as well as the peasantry of the whole country, were safe and contented under his rule. He paid his revenue regularly to his feudal lord, the Khan of Khelat, who therefore seldom troubled himself with regard to his other proceedings. All this internal good management enabled the Doombkee leader to carry on his predatory excursions systematically, and on an extensive scale, against any of his neighbours offering a fair prospect of a valuable booty. Beejar had at this time under his control from one thousand to one thousand five hundred horse, the best and boldest in the country ; and incited by his prince, Mehrab Khan (or rather by his traitorous wuzeer Mahomed Hussun), as well as by inclination and habit, he now directed all his efforts against the valuable British convoys, &c., passing within his reach through Kutchee. This was the state of the people. It may be well also to describe their principal towns.

Lahree, the abode of Belooch Khan, is—or rather was at that time, for it has since been ruined by Murree plunderers—a considerable town, well supplied with shops, containing about two thousand inhabitants, and surrounded by a good sound mud wall,

about twenty feet high, and well flanked with round towers. From the character of the chief, Belooch Khan, already described, his town had no connection with the predatory riders of Kutchée.

The chief town possessed by Beejar Khan and his part of the Doombkee tribe was Poolijee. This place consisted of two villages, about three-quarters of a mile apart; that one towards the north was a small place, about seven hundred yards in circumference; it had been originally surrounded by a good high mud wall with towers, but these had been allowed to decay; some of the towers and large portions of the wall had fallen down; manure and heaps of rubbish had accumulated in and outside these openings, and this place could not be considered as at all defensible against a resolute enemy. The other village was much larger, being a mile and a half in circumference: it is surrounded by a mud wall about seven feet high, and, for about two feet from the top, not more than four inches thick. On the south side, where is the principal entrance, the wall is flanked by round towers; but by far the greater part of the whole circumference of the place is unprovided with any flanking defence. The wall is, and was when first seen by the British, in a wretchedly crazy state; in it were numerous holes and wide cracks, which had been filled up with a few thorns, to prevent the egress of the cattle of the village. A man standing at the foot of the wall, and laying hold of the top, which was within easy reach with his hands, could with ease pull down many square feet of the wall at once; and this has several times been done by way of experiment by the writer of this paper.

Within this enclosure, not far from its north-eastern side, was another small square mud building, with round towers at the angles: this was also completely decayed, but was still capable of some defence by determined men. It could not, however, have held out after the town had been taken. The place was supplied with water from five temporary wells outside the town, on the south side, about one hundred yards distant from the wall.

Durya Khan, the Jekranee chief associated with Beejar and the Doombkees, occupied the town of Chuttur, nine miles south of Poolijee. This is an older, and was a more important place as regarded its peaceable inhabitants, and it contained a good bazar. It is about the same size as the principal Poolijee, and surrounded by a wall a little higher than, but of a similar description, and in a similar state to, that above described.

The village of Shahpoor, belonging to a Syud, by name Enayut Shah,—a peer or saint by birth, but by birth only, for his private character was and is anything but saintly. This place was protected chiefly by the holy character of the peer; it was occasionally occupied by the Doombkees and Jekranees, but none of them permanently resided there. In size it was about a mile in circumference; it is not surrounded by a wall for defence, but the houses, touching each other nearly all round, leave only two regular entrances. The houses generally are the usual low mud huts of the country, but there are two fine large upper-storied and terrace-roofed houses adjoining the north side of the village, and a high square tower

towards the eastern side. From the roofs of these houses the whole place was overlooked and commanded, and they were well adapted for defence.

The permanent inhabitants of Shahpoor amounted to about one thousand. But there were generally nearly double that number of Jutts encamped in their mat tents close to the village. These were the attendants of the syud's camels, of which he possessed some ten thousand. The channel of an occasional mountain torrent runs near the south side of Shahpoor, and an abundant supply of good water is found by digging pits in its beds. This good supply of water, which is a very rare thing in Eastern Kutchee, is the sole advantage which this spot presents as a site for a town,—the immediate neighbourhood is a dreary waste of barren plain, and hills of drift-sand; at a distance, however, of four or five miles from Shahpoor, abundant forage exists for horses as well as camels.

The place is remarkable for its dust-storms, which, bad everywhere in Upper Sind and Kutchee, are here of almost incredible violence and density. They occur frequently, at all seasons of the year, sometimes changing the light of mid-day to an intensity of darkness to which no ordinary night ever approaches, and this darkness in severe storms lasts occasionally for one, two, or more hours. These dust-storms on both sides of the desert are sometimes accompanied by blasts of the simoom, a poisonous wind, which is equally destructive to vegetable and animal life.

Such was the state of the people and of the country, when, at the request of the political officers, a detachment was ordered, in the month of June 1839, to



proceed from Sukkur and Shikarpoor against Beejar Khan. The season was one of intense heat, which has never since been equalled: the thermometer in the hospital shed at Shikarpoor stood commonly at  $130^{\circ}$ , and on several days reached the astonishing height of  $140^{\circ}$ —one day it even stood at  $143^{\circ}$ . The wind appeared like a blast from a furnace, and this even at midnight. Such was the weather in which British soldiers were sent forth for the first time to proceed against the wild tribes of Eastern Beloochistan.

There had been left behind, from the army of Lord Keane, at Sukkur, about one hundred and fifty European soldiers, men chosen from every regiment of the army, Royal and Company's, and from every troop of horse and company of foot artillery, of both the Bengal and Bombay presidencies.

These men were of course the worst which could be found: they were composed of those who could not march, who were troublesome, disorderly, discontented, or feeble. These men were placed under the command of Lieutenant Jacob,\* the only artillery officer in Upper Sind, and of Lieutenant Corry, of her Majesty's 17th Regiment. Lieutenant Jacob was now directed to choose men from these Europeans to form a company of artillery, to proceed with the force to Kutchee. Accordingly he selected twenty artillerymen, the best he could find, twenty men belonging to the infantry, and, with Lieutenant Corry and these forty men, marched from Sukkur on the 3rd June,

\* The Author of this Memoir.—EDITH.

1839, *en route* to Shikarpoor, having sent his battery in advance by water to that place.

On the first day's march of ten miles, seven of the soldiers were struck dead by the heat, and Lieutenant Corry was brought in dying; the poor fellow rallied a little at night, but as the heat returned next day he also relapsed and died. Four other men were sent back to Sukkur on camel litters, but they also died, either on the road or immediately after reaching the hospital. No treatment appeared to have the smallest effect in checking this fearful mortality. The men became appalled, and wished not to proceed; but a few words from their officer roused their English hearts to further exertion: at night the detachment marched on, but though the men were never directly exposed to the sun, the heat was too great for human nature to bear, and four men died before or on reaching Shikarpoor. Thus, in three very short marches, out of a detachment of two officers and forty men, one officer and fifteen men had been struck dead. It appeared to the military authorities that it was impossible at such a season to prosecute the intended expedition, and the attempt was abandoned for the present, to be renewed when the deadly heat should be moderated.

Accordingly, early in the month of October, 1839, a force consisting of a wing of the 1st Grenadier Regiment of Bombay Native Infantry, about four hundred and fifty strong, the light company of the 5th Regiment of Bombay Native Infantry, about eighty strong, and a bullock battery, composed of two-24-pounder howitzers and one 6-pounder gun, marched

from Sukkur *en route* to Poolijee, for the purpose of operating against Beejar Khan, and the predatory tribes of Kutchee described above.

It was thought inadvisable to have any European soldiers with the force; and Lieutenant Jacob was ordered to form a native company of artillery as he could. He had a havildar and eleven Golundauze sepoy, and a few gun lascars, to commence with; and he was allowed to select a party of men from the Bombay 23rd Regiment, to complete the number required.

A company of pioneers was also formed, consisting of one regular sapper, and three regular pioneers, the remainder of store and tent lascars, to the number of fifty in all.\* These companies, notwithstanding their motley appearance, were soon sufficiently trained and organised for service, and proved afterwards eminently efficient, with the exception of the men of the 23rd Regiment. This regiment, it appeared, had the fashion of priding itself on the *caste* of its members, instead of on their soldiership—more like a regiment of the Bengal army than one of Bombay; and, notwithstanding the ridicule of the havildar and sepoy of the Golundauze, who happened to be all Brahmins, but who thoroughly despised such nonsense, gave so much trouble, and proved so very useless in consequence, that the artillery officer soon left them behind, and they were replaced by a native officer and men of the Bombay 5th Regiment of Native Infantry. This regiment was at this time one of the best, perhaps *the* best, in the Bombay army: its men were perfect specimens of the Bombay sepoy, as described

by Sir John Malcolm—"The true descendants of Seewajie's mountain rats, whom not all the pride and power of the armies of Hindustan could prevent from marching to the gates of Delhi"; small, and not at all good-looking, but of an amazing energy and activity, and full of zeal and courage, and with sinews that no labour could tire, and hearts that no danger could daunt. Very respectful and warmly attached to their officers, they not only feared no enemy under their guidance, but rejoiced at the prospect of meeting a formidable foe for the sake of the "name of the regiment." They were full of soldier-like pride and zeal for the service, while they shrunk from no sort of labour or fatigue, and endured cold, hunger, and continual duty with an admirable cheerfulness and alacrity.

Major Billamore, of the 1st Bombay Grenadier Regiment, commanded the whole force; Captain Raitt the Grenadier regiment; Captain Lewis Brown, afterwards well-known as "Kahun Brown," the light company of the 5th; and Lieutenant Jacob the artillery.

This little force crossed the desert, and marched to Shahpoor without incident worth relating; thence it proceeded to Chuttur and Poolijee,—the former place was then occupied by Lieutenant Amiel with four hundred Belooch horsemen, lately enlisted into the British service by the political agent, Mr. Bell. On the arrival of Major Billamore at Shahpoor, Beejer Khan, with the chief part of the Doombkee and Jekranee tribes, still occupied Poolijee; but on the force reaching that place, it was found deserted, nearly

destroyed by fire, and still burning. Beejar Khan and all his people had abandoned the town, and taken to the hills for safety.

The force now encamped at Poolijee, until the political officers, from whom the commanding officer had to receive his instructions, should make up their minds as to what further was to be done. The part of the Doombkee tribe, under the chief, Belooch Khan, inhabiting Lahree and its neighbourhood, had once offered complete submission to the British political officers: this was accepted; nor could the utmost efforts of Beejar, nor persuasion nor reproach, ever afterwards induce him, Belooch Khan, to commit himself in hostility against the English.

While the force remained encamped at Poolijee, Beejar, having in vain summoned aid from Belooch Khan, suddenly left the hills with his own followers, and entered the plain near Poolijee, as if to attack Major Billamore. The Major had at that time no cavalry with him; but on this particular day, Lieutenant Amiel, who was not in any way under Major Billamore's orders, had arrived at Poolijee with two hundred of his Belooch levy of horse, and occupied the town.

The town of Poolijee is distant from the hills little more than five miles. About three miles of this distance, next the hills, is open stony ground; there is then thick jungle for about one mile, and the remaining space next Poolijee is richly cultivated arable land, which was at this time covered with high standing corn. Having received information of the enemy having left the hills, Major Billamore moved

from his camp for the purpose of meeting him in the plain. Meanwhile the intelligence had also reached the officer in command of the Belooch horse in the town, who immediately galloped out with his men, passed by Major Billamore's force, then moving through the jungle, and entered the plain beyond. Here the horsemen fell in with the enemy, and immediately turned and fled at speed; some twenty-five of them were cut down, the enemy not losing a man; the remainder escaped, owing to the fleetness of their mares. So quickly did all this take place, that Major Billamore, on clearing the jungle, had only a distant view of the enemy filing over the first low range of hills. Without cavalry, pursuit was hopeless; to attempt it, absurd; and the major returned to his camp, Lieutenant Amiel and his cavaliers again returning to Chutta, and shortly afterwards to Shahpoor, where they thenceforth remained.

On the representation of Major Billamore as to the necessity of his having cavalry at his disposal, to enable him to act effectively against these border robbers, a detachment of one hundred and eighty irregular horse, under command of Lieutenant Clarke, of the 2nd Bombay Grenadier Regiment, was ordered to join the force at Poolijee. This detachment, formerly posted in Kutch (Bhooj), had just before been transferred from the Poona Irregular Horse, in order to form the nucleus of the new corps, at that time ordered to be raised in Sind, since well-known by the name of the Sind Irregular Horse.

On the arrival of Lieutenant Clarke and his detachment at Chuttur, he received information of a

strong party of Beejar Khan's horsemen having left the hills that evening to plunder. Acting at once on this information, and guided by a man of the village who had been plundered shortly before, Lieutenant Clarke went out about midnight with one-half of his men, and managed matters so well, that just before daybreak he fell in with the Doombkees, about three hundred in number, dismounted in a corn-field; they had just time to spring on their mares before Clarke closed with them, and in doing so, abandoned some of their arms, and nearly all the plunder. They fled up the dry bed of the Teywaugh river, and were vigorously pursued by the Sind Irregular Horse. About fifty of the marauders were killed, and eleven were taken prisoners.

To appreciate this exploit as it deserves, and properly to understand the position of Major Billamore's force, it should be borne in mind that the country, its people, and all belonging to it, were at this time entirely unknown to the officers and men of the Indian army. Everything was as different as can well be imagined from anything any one had experienced in India. Since then all has become as familiar to them as the localities of Guzerat or of the Deccan; but at that time all of them, officers and men, were "griffins" in this country, and had to find out everything for themselves. No information was to be acquired from anyone; no European had previously entered that part of the country, while the few natives who could have assisted the British officers were more afraid of the border robbers than inclined to trust to British protection.

Lieutenant Amiel, who had lately been joined at Shahpoor by two hundred and fifty of Skinner's Hindoostanee Irregular Horse, now reported to Major Billamore that a strong body of the Doombkees and Jekranees had for some time past been assembled at Ooch, and that they came nearly every night to plunder about Shahpoor. On this, Major Billamore, with thirty infantry and sixty of the Sind Irregular Horse, accompanied by Captain Brown, Lieutenants Clarke and Jacob, proceeded to Ooch.

As this Ooch is one of the most curious places in existence, it may be as well to describe it. The place is not only curious in itself, but very interesting, as affording proof positive of the correctness of the description given, by "the Father of History," of places on the caravan roads in Africa, where fresh water runs out of hills of salt. East of Shahpoor is a low and very irregular range of hills, composed of soft sandstone, in masses more like hard earth than rock, and mingled with pebbles of limestone and flint, and with a good deal of gypsum. At a spot twelve miles E.S.E. from Shahpoor there is in these hills the entrance to a little valley some five or six hundred yards wide. Through this runs the bed of an occasional mountain torrent, known by the name of the Muzzerdaun; and along the northern side of this torrent bed, for an extent of a mile and a half in length, some twenty-five or thirty feet in height, is a rounded bank, partly covered with coarse reeds, and, where it is not so, entirely covered with a thick *incrustation of efflorescent salt*. On the top of the bank grow a few date-trees, which trees are found nowhere



else in Kutchee. From this bank, nearly all over it, *from top to bottom*, continually exudes water, which, though not exactly sweet to a fastidious taste, is highly esteemed by a thirsty traveller, and is largely drunk by man and beast without any ill effects, except to strangers. The natives, who are accustomed to its use, appear not to think it bad or disagreeable, and call it fresh. This water, trickling down the bank of salt, collects into a small stream, which, at a distance of about a mile from the hill southward, is lost in the desert.

The only permanent inhabitant of this spot is a solitary fakeer, and even he is not always at home; there is no building whatever, nor remains of a building, save the fakeer's hut of reed sticks and mud. The place is, however, in tolerably quiet times, the favourite resort of large numbers of Jutts, who, with camels and other cattle to the amount of many thousands, sometimes encamp there for several months together.

The country all around is of the most desolate appearance; perfectly bare and barren, hill and plain, varied by drift-sand, being alone visible anywhere, and this makes the green and moist spot Ooch the more remarkable. This place Major Billamore and party had to discover for themselves; no one could be found to guide them; the general direction alone was pointed out, and the distance given.

As the Major approached Ooch, single horsemen were seen galloping from all quarters towards one spot, and towards this also rode the British officers and horsemen: they soon found themselves in the

middle of the Belooch encampment. The enemy's horsemen, in number about one hundred, had time to spring on their mares, which are always kept ready saddled, and, well knowing the country, which is of a nature most difficult to a stranger, easily effected their escape unhurt. The footmen, in about equal number, with some women and children, while the cavalry had in vain attempted to close with their fleet-footed foes, climbed to the top of the hills, whence, having secured the women and children in caves, they opened a smart matchlock fire. The infantry detachment was of course far behind, but Clarke soon dismounted some of his men, when Major Billamore, with them and his European officers, immediately attacked the enemy on the hill. In entire ignorance, as they at that time were, of our usages, the barbarians refused to surrender till about twenty of their men were killed, and several others wounded; when, seeing resistance hopeless, and the women in our possession, the remainder surrendered, and were forwarded to Shahpoor with the cattle, &c., taken from the enemy. Major Billamore had received information from these prisoners that the leaders of the party he had surprised at Ooch were Janee and Rahmut, the two most enterprising and most famous of the Belooch warriors.

In the hope of again meeting with these noted freebooters, and thinking it possible, from their well-known boldness and personal courage, that they might even attack him, Major Billamore determined to remain for the night at Ooch; and, sending back the infantry to Shahpoor, to endeavour in the morning to

follow up the enemy with his cavalry. This was carried into effect; but after wandering next day many miles in vain, over an unknown and pathless waste, the attempt to reach such active enemies was unwillingly abandoned, and the troop returned to Ooch. Scarcely, however, had the horses of the party time to drink, when, as if by magic, suddenly appeared, not half a mile off, opposite to an opening in the hills, Janee, Rahmut, and a hundred Beloochees, mounted and drawn up in regular line, as if to charge the British detachment. With the speed of thought, the men of the latter were in their saddles, the next instant they were formed and riding at the enemy so fairly opposed to them. Janee and his men drew their swords and advanced with a shout, and valiant deeds appeared about to take place; the ground looked firm and level for a fair passage of arms, when suddenly every horse of the British detachment sunk into the earth, some planted over girth and saddle-flap, many rolled over and over, and all in helpless confusion. The cunning Belooch had drawn them into an extensive quicksand! One European officer of the whole party, being admirably mounted, alone struggled on through it; but Janee carelessly or generously took no notice of him as he still rode towards him, but with shouts of laughter the Belooch riders went off at speed, and disappeared from, almost as suddenly as they appeared on, the scene. Major Billamore and party, unable to catch their active and subtle foes, returned to Shahpoor, and thence to Poolijee, where, at last, final instructions were received from the political officers, and, in

the beginning of the month of November, 1839, the force proceeded in two detachments to enter the Murree and Boogtee hills, wherein the Doombkees and Jekranees had found refuge.

One party proceeded *vid* the Goree Pass, near Poolijee, towards Deyra, and the other *vid* Lahree, and the pass near that town, towards Kahun.

The first party consisted of Major Billamore and Captain Brown, who acted as staff officers to the force. The light company of the 5th Regiment, under Lieutenant Stanley, a company of the Grenadiers, the artillery under Lieutenant Jacob, and one hundred and twenty men of the Sind Irregular Horse under Lieutenant Clarke. The detachment proceeding to Kahun was commanded by Captain Raitt, and consisted of the main body of the Grenadier regiment, and sixty of Clarke's horsemen.

Nothing whatever was procurable, it was said, in the hills, but water, wood, and a little grass; so that, even for so small a force to be in an efficient state, extensive commissariat arrangements were required. With little or no assistance from either the military or civil authorities at head-quarters, and without public treasure, these arrangements were admirably made by the officers of the force. There was little experience, indeed, for all were on their first campaign; but the officers were full of unconquerable zeal, of an energy which nothing could tire, and thrilling with those chivalrous thoughts of military service to which the youthful soldier, alas! is alone allowed to give place in his mind, but which cause fatigue, hardship, danger, difficulty, and impossibility

itself to disappear before them. The greatest point was to provide food for the artillery bullocks, of which one hundred and twenty necessarily accompanied the force. The mention of bullocks may raise a smile on the face of the modern artilleryman. In these days a bullock battery is unknown—its place has been taken by the well-appointed and well-horsed battery now in use, equipped and provided in every possible way, fully manned and officered, &c. &c.

The modern horse battery is beautiful, soldier-like, and complete; nevertheless, when I hear sometimes its *immeasurable* superiority over “the old beef affair” talked of, I cannot help silently thinking of Major Billamore’s artillery in the Murree Hills, and of the subsequent performances of the Bengal Horse Artillery and of Bombay horse batteries in the same locality; and a thought then crosses the mind that the *material* is not all in all in these things! Let, then, those laugh who may. The bullocks were the object of great care and attention; it was managed not only to carry a full allowance of grain for a month, but a supply of forage enough for a week’s consumption was also taken; all this care was well repaid in the sequel.

There was no baggage corps nor camel corps, but there was common-sense; nothing was forgotten that foresight could provide for, or means at command procure. Thus provided, the two detachments entered the hills, and both reached the respective halting-places, Deyra and Kahun, by regular marches; not without much labour certainly, owing to the difficult nature of the country. Neither detachment was

opposed by the enemy, who attempted no serious molestation to the advance of the troops into the very heart of their mountain fastnesses. Major Billamore was met at Sungseela, eighteen or twenty miles from Deyra, by Islam Khan, the son and heir of Beebruck Khan, the head of the Boogtee tribe; this Islam Khan is now grey-headed, old-looking, careworn, and feeble; he was then a young, active, handsome man. So well does trouble supply the place of years! He spoke tolerable Hindoostanee, was very civil, full of expressions of friendship in his father's name and his own, and thus conducted the Major and party to Deyra.

The town of Deyra is a small place, about one hundred and fifty yards square, surrounded with a good strong mud wall, twenty feet high, with towers at the angles, and one gate in the middle of the eastern face. It is supplied with water by a small sparkling stream from the hills on the north side of the valley, distant about two miles. On this little stream, about half a mile from the town, Major Billamore's camp was pitched.

The town was full of people; there was a good bazar apparently in it, and in and about the place there must have been some seven hundred or eight hundred armed men. At first everything was smooth and friendly; but after a few days, when the British detachment had been well scrutinised, its very small numerical strength appeared to be exciting contempt among the proud mountaineers. They soon showed their hostility in various ways, and private information was received that the main body of the Boogtee tribe,

under Alim Khan (chief of the Kulpur branch of that tribe), was fast assembling at a spot in the hills near Deyra, for the purpose of attacking the British detachment. Nearly all the armed Beloochees gradually left Deyra; Islam Khan still came daily to call on Major Billamore, full of professions of friendship, &c., until one day, on which these professions had been more than usually profuse, he also disappeared from Deyra. The old chief, Beebruck, was still in the town; he was very feeble, and could not, without much difficulty, ride any considerable distance on horseback.

Information then reached Major Billamore that the whole Boogtea tribe was ready to attack the detachment, and that, on the departure of old Beebruck, this attack would take place. Measures were taken to prevent the old man's departure; he made an attempt to leave the place during the night, but was stopped and detained.

Meanwhile, very similar proceedings had been going on at Kahun; at both places the apparent weakness of the British detachments tempted the treacherous Beloochees to attempt their destruction.

Captain Raitt, finding his provisions likely to run short, and that, from the hostile bearing of the people, no more would be in all probability obtainable, under orders from Major Billamore, left a company of the Grenadiers, under command of Lieutenant Peacocke, strongly posted in a small fort about a mile from the town of Kahun, and marched with the rest of his detachment to Deyra.

It was on the night after his arrival at that place

that the old Boogtee chief attempted to leave it, in order to join his tribe, now up in arms against Major Billamore. The British detachment at Deyra was under arms the whole of that night, but no attack was made until after daybreak, when the videttes galloped in, reporting the enemy to be approaching in full force. The Boogtees, about twelve hundred in number, were soon seen approaching through the jungle from the eastward; their line presented a most formidable appearance to the small British detachment; they were strong, fierce-looking men, and came on with loud shouts, with much flourishing of swords and firing of matchlocks. During this advance of the enemy's line, the old chief, Beebruck, had been allowed, on some specious pretence, to go to a little distance outside the town, in charge of a file of sepoy; and an attempt, very nearly successful, was now made by the Boogtees to carry him off. A small party of horsemen contrived to approach unseen up the bed of a nulla, and suddenly made a dash at the sepoy guarding Beebruck; these, however, stood firm, and in an instant Clarke, perceiving what was going on, sprang to the spot, struck one of the Boogtees from his horse, seized another by the throat, and brought him, as well as the old chief, back prisoner. The enemy continued to advance, but the firm, silent array of the British detachment appeared to appal them. Savage and fierce as the Belooch warriors appeared, they feared to close with their foes; not a musket-shot was fired, nor was a man hurt on our side. A tremendously noisy but distant and harmless fire of matchlocks was maintained for some



time by the mountaineers, who then withdrew, with a loss of thirty-three men and some horses killed by the fire of the British artillery, in addition to others wounded.

The town of Deyra had hitherto been treated as a friendly place; it was now taken possession of, and all property found in it proclaimed to be lawful prize. The British detachment moved inside the walls, and was quartered in the houses in the town. A considerable quantity of grain and flour found in the town was handed over to the commissariat, and formed a most opportune addition to the means at Major Billamore's disposal; while a great part of the force henceforth lived chiefly on mutton and beef, so that the slender stores of the detachment were made to last during the whole period it was in the hills, or for three and a half months, without the smallest assistance or support during that time being ever received from headquarters, or from the plain country.

The Boogtee chief, Beebruck, was sent to Shahpoor, well guarded, and handed over to the political officers.

The enemy occupied the hills round Deyra, cut off the stream of water which supplied the place, and prevented any forage being brought in. Captain Brown proceeded with a detachment to turn the water on again, which he succeeded in doing after a slight skirmish, in which a few of the mountaineers were killed; he then remained at the spring all day, by which time a large pit close to Deyra had become filled with water, so that the shutting off the water, if repeated, could give no further annoyance for many days to come.

Next day, a party consisting of one hundred and fifty infantry under Captain Raitt, and one hundred of the Sind Irregular Horse under Lieutenant Clarke, proceeded with all the camels of the detachment to some fields, about seven miles west of Deyra, to bring in forage.

This was too tempting an opportunity for the Boogtees to lose; they accordingly assembled in great numbers in the hills at a place called Tructnee, close to the spot, and the camels had hardly been loaded with forage when the mountaineers, outnumbering the British detachment in the proportion of five to one, came down sword in hand and with loud shouts on the sepoy. Captain Raitt, an excellent and stout-hearted officer, received them with a rapid and well-sustained fire; but, unchecked by the musketry, the swordsmen rushed on, and were not ten yards from the bayonets of the infantry when Clark let loose his horsemen: in an instant the mountaineers were broken, struck down, trampled under foot, and compelled to flight; seventy-nine of them were killed, a great many more wounded, but the remainder found safe refuge in their hills, and the horsemen were recalled. The loss on the British side was trifling: three men of the infantry were killed, and nine or ten wounded, some of them severely; of the horsemen one only was slain, but many were wounded, including their gallant leader Lieutenant Clarke. There were three leaders of the Boogtees, remarkable by being the only mounted men among them: these were all killed, and this severe defeat convinced the whole from that day forth that it was useless to attempt a

fair fight against the British troops. Major Billamore now determined to leave part of his force at Deyra for a while, and to proceed with the remainder to Kahun, thence to return to the plain by the best route he could find.

It was considered of importance that his artillery should accompany him to Kahun, in order to show the mountain tribes that their most difficult high and rugged hills were not inaccessible to our guns; but the nature of the country was reported by the officers who had just passed through it to be so difficult as to render the transport of artillery through it a matter of *absolute impossibility*: the artillery officer was however still confident; wherefore Major Billamore allowed him to take a detachment, and examine the worst part of the road himself.

He therefore proceeded from Deyra with a company of infantry under Lieutenant Stanley, of the 5th Regiment, and a troop of the Sind Irregular Horse under Lieutenant Clarke. On entering the Murrow valley they were fired on by a small party of the Boogtees, who immediately fled, but one of them was overtaken and killed by the horsemen. The plain was covered with corn-fields, and in these were numerous flocks of sheep and herds of cattle. These were with much trouble secured, to the number of several thousand sheep, and about one thousand head of oxen and cows; and the artillery officer, with his detachment, then halted for the night at a small walled village, by name Meerza-ke-Ghuree, which he found newly deserted. Lieutenant Peacocke was known to be on his march from Kahun, and Lieutenant

Jacob expected him next day, when he intended to hand over to him the captured cattle to convoy to Deyra. This accordingly took place: Lieutenant Peacocke brought the cattle safely to Deyra, where it proved of the greatest service to the British troops, rendering them independent of all further supplies, most of the men living on flesh meat as mentioned above.

The artillery officer and his party proceeded onwards towards Kahun, and encamped at Kateychee-ke-Ghuree. The enemy, both Murrees and Boogtees, prowled about the camp at night, and fired into it, but, finding everyone on the alert, attempted nothing serious. On the next and two following days, the extemporary pioneers who had accompanied the party from Deyra were set to work on the road, and four very bad places were made passable for the artillery; the rest of the road was thought difficult, but still practicable. Beyond Kateychee-ke-Ghuree, towards Kahun, Captain Raitt and his officers had reported that there were no parts of the road absolutely impassable; wherefore, having removed the worst difficulties of the route, Lieutenant Jacob thought it unnecessary to proceed further, returned with his party to Deyra, and reported to Major Billamore that he was ready to proceed with his artillery to Kahun, and to reach that place in two marches from Deyra, if necessary, while Captain Raitt's detachment had performed the journey in three. A few days afterwards, Major Billamore, Captain Brown, with the light company of the 5th under Lieutenant Stanley, a company of the Grenadiers under Lieutenant Wise-

man, a troop of the Sind Irregular Horse under a native officer, and the artillery under Lieutenant Jacob, marched from Deyra towards Kahun; they marched at six in the morning, and, working hard without ceasing all day, reached Kateychee-ke-Ghuree, distant twenty miles, at eight o'clock in the evening. Here it came on to rain heavily, and it was necessary, in consequence, to halt for two days. The weather was intensely cold; everything was covered with a thick coating of ice: the sepoy were almost frozen to death, but they bore all cheerfully. Kahun was distant about twenty-five miles; there was water only at one spot on the road, and this was about half-way to Kahun. Information was now received that the whole Murree tribe had assembled near the water, expecting the detachment to halt at that place, and intending to attack it unawares: to defeat this purpose, it was proposed to march at once straight to Kahun, and take possession of the place. This was carried into effect. As soon as the rain ceased, and the state of the ground would admit of camels moving, Major Billamore and his detachment proceeded direct to Kahun. Some difficult hills occurred on the road, over which the artillery-carriages were transported with great labour; but starting early in the morning from Kateychee-ke-Ghuree, the detachment reached Kahun in safety shortly after dark, having met with no opposition, and having seen no enemy by the way. The town was found quite deserted, and was occupied next day by the British troops.

The artillery officer who had examined and sketched, as well as he could, the whole of the country passed

over by the force since leaving Poolijee, now thought that a nearer route could be found back to that place than the long, very difficult, and circuitous road *vid* Lahree; he had picked up a man\* of the Mussoorree branch of the Boogtee tribe, who had long been resident as a herdsman in the Boogtee and Murree hills, and this man, in answer to inquiries, said that there did exist a path over the mountains bounding the south side of the valley of Kahum, which he was willing and able to point out. Under his guidance the artillery officer, with some difficulty, proceeded to the top of the mountain; the path was only a sheep-walk, and seemed tremendously difficult even for a single horseman; the part over and through the mountain was about four miles in length. This was the pass of "Nuffosk," a place whose name has since become so familiar, then first beheld by European eyes.

The rock, though hard, was found to yield to the pickaxe and crowbar; and the artilleryman thought that he could in a few days, notwithstanding the apparently awful difficulty of the task, cut a road out of the hill-side over which a gun might be dragged.

Major Billamore gladly assented; for the objects, to effect which the force had entered the hills, had been completely accomplished. Beejar Khan, with Durya Khan, the head of the Jekranees, Toork Ali, Janee, Rahmut, with other chiefs of less note—in short, the whole of the border robbers who had taken refuge in the hills—finding, from the proceed-

\* By name Shere Beg; the same who was afterwards of much use to Major Brown, when besieged in Kahua.

ings at Kahun and Deyra, that the mountain tribes themselves were not safe in their rocky fastnesses, had gone in and surrendered to the political officers. The mountaineers had seen that they could not stand before the British troops, even in their own hills; and that these hills, even the highest of them, proved no obstacle to the transport of the British artillery. Such, then, being the case, it was desirable to return to Poolijee and the plain country with all despatch.

The pioneers and all the camp followers were then set to work at the road over Nuffoosk, and in three days it was thought practicable for the artillery. The Murrees offered no serious opposition to the work. They collected in great numbers about the neighbouring hills, and occasionally approached so near to the workpeople, gesticulating and flourishing swords, that they had to be attacked and driven off by the guard; but in general they contented themselves with firing long shots at the artilleryman and his party, which did no damage.

On the fourth day the 24-pounder howitzer and the other carriages were dragged over the mountain. The road was found passable enough; but, from the great steepness and length of the pass, the labour was very great. However, before evening, Major Billamore and his detachment had crossed "*Nuffoosk*," and encamped on the very spot on which Major Clibborn, in 1840, gained so signal a victory over, and with tremendous loss to, the Murree tribe; and then, appalled by the fearful heat and want of water, unfortunately followed up his victory by all the consequences which usually attend on a disastrous defeat.

Next day the detachment marched to "Surtoff," safely descended that great mountain, and thence proceeded, without further adventure, in three or four marches to Poolijee, which it reached on the 11th of February, 1840, about three and a half months since it had marched from that place to enter the hills. Here also, shortly afterwards, arrived in perfect safety Captain Raitt and the remainder of the force. Every object had been fully accomplished, without serious loss, and without a shadow of a disaster. The mountaineers had been thoroughly beaten whenever encountered: the robbers, who had fled for shelter among them, compelled to surrender. The mountains had been penetrated in every direction, and roads made in the very heart of them. In short, nothing could have been more complete than was in every way the success of this expedition.

So little was this success understood, that unthinking persons supposed a similar feat to be easy enough for *any men* to perform, and this idea led to serious disaster. Little detachments were sent to occupy dangerous posts; little parties sent to guard immense convoys of camels: carelessness prevailed everywhere; the fierce and formidable mountaineers were despised, and this contempt met with severe punishment.

The secret of the success of Major Billamore's detachment was, that every member of the force, down to the humblest bullock-driver and camel-man, worked and felt as if he had some very dear personal object in view. To produce this feeling appears to me to be one of the chief attributes of a good soldier.

The beneficial effects of the first hill campaign



were very great—they are still felt: for the mountaineers, having once seen the British troops and artillery march all over their worst mountains, know that the same can be done again.

The proceedings of the British troops, who first entered the formidable mountains north of Kutchee, and encountered their fierce inhabitants, are but little known beyond this country. Their commanding officer hated writing, contented himself with a verbal report of the matter to his superiors, and very soon all appeared to be forgotten. In the account above given are omitted numerous adventures, many slight encounters, personal fights, and single combats with the enemy, and such like, which, if duly set forth in glowing terms, might, without any exaggeration, have given an air of romance to the story. As it is, the simple truth has been told in the plainest language. Such was the hill campaign of 1839-40, conducted by one major, one captain, and six subalterns, with seven hundred native soldiers, totally unaided by others.

#### SUBSEQUENT PROCEEDINGS ON THE NORTH-WEST FRONTIER OF SIND, UP TO THE CLOSE OF THE YEAR 1847.

When the British forces first entered the country in 1839, the position of these tribes was as has been already described under the proper head.

After the hill campaign in 1845, that portion of the Doombkee tribe which had surrendered at Trukhee was placed under a chief, by name Jummal Khan, on lands near Janadeyra, on the Sind Frontier.

Durya Khan and Toork Ali, with the Jekranees and some men of other clans, were settled at Jana-deyra itself and its neighbourhood.

The lands were granted to these men free for three years, which grant was afterwards, at Major Jacob's request, altered to a free grant in perpetuity, and it was expected that they would now take to agricultural pursuits, and entirely leave their former predatory habits.

A commissioner was appointed to reside at Jana-deyra, and superintend the reformed Beloochees.

A strong detachment was posted at Shahpoor, in Kutchee, and the other frontier arrangements were made as before described.

These arrangements did not prove successful. The Doombkees, Jekranees, Kosahs, Boordees, &c., with or without permission, made repeated plundering excursions from British Sind into the neighbouring countries, both hill and plain. The Boogtees did the same from their side into Sind: murder and robbery everywhere prevailed.

The troops were shut up in forts, and did nothing to protect the people. The people themselves were encouraged to bear arms, and to commit acts of violence; the lives and property of the Boogtees being ordered to be taken and destroyed wherever and however found, and a reward of ten rupees per head being offered for the destruction of the whole tribe, and proclaimed throughout the country.

The district along the border was left uncultivated; the canals were not cleared out for many years, and nearly all the peaceable people left the country. The

troops were perfectly isolated in their entrenchments no supplies were drawn from the country-folk but all were fed as if on shipboard, by the commissariat, even at the distant outpost of Shahpoor, in Kutchee. The troops and camp followers were supplied with every article of consumption from the public stores, forwarded by the commissariat department, at an enormous cost, from Shikarpoor, some sixty miles distant. Even the horses of the cavalry were fed in like manner.

The troops, so placed, being completely separated from the inhabitants of the country, and holding little or no communication with them, were entirely ignorant of their nature and habits; knew not friend from foe; were always in a state of alarm, and expecting to be attacked, even at Shikarpoor itself.

Notwithstanding that the Boogtees had been proclaimed outlaws, a price set on the head of every man of the tribe, and all of them ordered to be treated as enemies wherever found, they were not subdued—not, indeed, in any way weakened, by any of the proceedings of the Governor of Sind.

The removal of the Jekranees and Doombkees from Kutchee left the Sind border temptingly open to their incursions, and they failed not to take advantage of the circumstances, until at last, becoming more and more bold by impunity, they assembled a force of some 1,500 armed men, mostly on foot; and on the 10th December, 1846, marched into Sind, passed through the British outposts, who dared not to attack them, to within fifteen miles of Shikarpoor, and remained twenty-four hours within the British territory, secured

every head of cattle in the country around, and returned to their hills, some seventy-five miles distant, with all their booty, in perfect safety.

The Boogtees on this occasion conducted their proceedings in the most cool and systematic manner: they brought with them, besides the armed force above mentioned, nearly five hundred unarmed followers, to drive the cattle, of which they obtained, by their own account, some fifteen thousand head. This inroad was thought to be in too great force for the detachments on the outposts to attempt anything against it.

Timely information reached the Shahpoor post, but no troops moved from it against the invading Boogtees.

A regiment of cavalry and two hundred native rifles were sent from Shikarpoor to repel the invaders. The cavalry came on them at Hoodoo, some forty-five miles from Shikarpoor—the Boogtees *en masse*, their unarmed attendants meanwhile diligently continuing to drive on the cattle towards Loree Kooshtuck and the hills. However, the British troops were ignorant of the ground, thought the robbers too strong to be attacked, and returned to Shikarpoor without attempting anything further, the Boogtees ultimately reaching their hills, with all their prey, without the loss of a man, save one killed by a distant random shot from the matchlock of a Jekranee.

One regiment of the Sind Irregular Horse, then at Hyderabad, was now ordered up with all speed to the frontier, where it arrived on the 9th January, 1847.

Major Jacob was appointed to command the frontier,

and since then has held this post. On arrival at Khanghur, desolation and terror was found to prevail everywhere in the country. No man could go in safety from place to place, even on the main line of communication from Shikarpoor to Jaghun, without a strong escort.

Not a man of the Belooch settlers, the Jekranees and Doombkees, had as yet attempted any peaceful labour, or ever put his hand to any agricultural implement. There were no made roads in any part of the country, and no bridges; indeed, there was not a single mile of good road in all Upper Sind.

At Khanghur there was no village and bazar, and but four or five wretched huts, containing twenty-two souls in all; the cavalry detachment was found on arrival *locked up* in the fort, the gate not being opened at eight o'clock in the morning; and this was the normal state of things.

On the night before the arrival of the Sind Irregular Horse, the Boogtees had carried off some camels from a detachment of the Baggage Corps between Jaghun and Shikarpoor; and this was their last successful attempt at plundering in Sind. Our predecessors, during the previous four years, knew little or nothing of the country, or of the people on the border; the men of the Sind Irregular Horse were familiar with both, and this gave them confidence and power.

After assuming the command and relieving the outposts, Major Jacob at once ordered all idea of defensive operations to be abandoned; every detach-

ment was posted in the open plain, without any defensive works whatever ; patrols were sent in every direction in which it was thought an enemy might appear, and these parties crossed and met so often that support was almost certain to be at hand if wanted. The parties were sent to distances of forty miles into and beyond the desert, and along the frontier line.

Whenever a party of the Sind Irregular Horse came on any of the plunderers, it always fell on them at once, charging any number, however superior, without the smallest hesitation.

Against such sudden attacks the robber horsemen never attempted a stand ; they always fled at once, frequently sustaining heavy loss in men, and never succeeding in obtaining any plunder.

These proceedings, and particularly the tracks, daily renewed, of our parties all over the desert, and at all the watering-places near the hills, far beyond the British border, alarmed the robbers, and prevented their ever feeling safe, and they soon ceased to make attempts on the British territory, although still plundering all Kutchee. Meanwhile, Major Jacob had discovered that not only the Boordees and Muzzarees, who were always inveterate marauders, but the Belooch settlers at Janadeyra, had been, all along, systematically carrying on plundering excursions on a considerable scale, entirely unknown to their commissioner, residing among them.

The horses of these Jekranees and Doombkees had been taken from them a year before, by order of Sir C. Napier, and sold by auction ; but Major Jacob

found that the sale had been fictitious, and that, according to the custom of the country, the former owners still retained shares in these horses.

It may be proper to explain here, that, among the Belooch border tribes of Sind, a horse (or rather mare, for they ride only the latter), very seldom belongs to one man only; and sometimes the property in one mare is shared among as many as twenty men.

Thus, when the horses of the Jekranees and Doombkees were supposed to have been finally disposed of, only certain shares in them had been sold; the animals were kept by various zemindars all over the country, and whenever a foray from Sind was agreed on, the horses were ready for their old masters. The men left Janadeyra, &c., by ones and twos, went for their horses, and then proceeded to the appointed rendezvous, generally in the territory of Meer Ali Moorad, the village of Thool being a favourite place.

These musters sometimes amounted to as many as a hundred horse or more, with many other men on foot. After the foray into the hills, or elsewhere, the booty obtained was shared at some place beyond the British boundary, the plunderers dispersed, replaced the horses with the zemindars, and returned, one by one, to their homes.

The existence of these proceedings had never been suspected until pointed out by Major Jacob, and then at first they were thought impossible; but having good information of what was going on, Major Jacob caused the places of these predatory rendezvous to be suddenly surrounded by parties of the Sind Irregular Horse, just after the return of a body of Jekranee

plunderers from a foray; the robbers were all secured, with their horses, arms, and a large quantity of stolen cattle.

Concealment was no longer possible, and Major Jacob now obtained permission to disarm every man in the country, not being a Government servant, which was at once done.

At the same time, Major Jacob set five hundred of the Jekranees to work to clear the Noorwah canal (a main feeder cleared by Government, then belonging to Ali Moorad). The men were very awkward at first, but were strong, energetic, cheerful, and good-natured; they soon became used to the tools, and were then able to do a better day's work, and of course to earn more pay, than the ordinary Sindhee labourers. The men seemed proud of this, and the experiment was perfectly successful.

Soon afterwards the Belooch settlers took to manual labour, in their own fields, with spirit and even pride. From that time they were really conquered and reformed. They are now the most hard-working, industrious, well-behaved, cheerful set of men in all Sind.

Their numbers amount to about two thousand adult males, but, for three years past, not a man of them has been convicted, or even accused, of any crime whatever, great or small; yet seven or eight years ago they were the terror of the country, murderers and robbers to a man.

\* \* \* Our own subjects ceased to be robbers, the occupation of a "lootoo" ceased to be respectable, and has now become a subject of shame



instead of glory to the wild hordes themselves. Peace, quiet, safety for life and property, were thus established along the border; while the Boogtees, who, now shut out from Sind, persisted in making predatory inroads on the plains of Kutchee, were, on the 1st October, 1847, in one of the incursions, intercepted by a detachment of the Sind Irregular Horse, under Lieutenant Merewether, and signally punished. On this occasion, about one-half of the whole fighting men of the tribe were killed or taken prisoners. The strength of the tribe was completely broken, and the Boogtee chiefs soon came in to the British authorities in Sind, and surrendered at discretion. They, with the greater part of their followers, men, women, and children, to the number of some two thousand, were settled on lands near Larkhana.

The prisoners were released, and some of the men taken into the British service as police, and all might have remained in peace and comfort at their new settlement, had it not been for the intrigues of one Aliff Khan, a distinguished Patan officer, then native adjutant of the Sind Police. Frightened by continual threats and demands of bribes by the police officer, Aliff Khan, the Boogtee chiefs, in March, 1848, fled and again returned to their hills. On this occasion, one of the wives of the chief Islam Khan, the families of some others of the principal men of the Boogtees, and altogether some seven hundred or eight hundred persons of the tribe, remained in Sind.

The chiefs, who had fled to the hills, made several attempts to renew predatory inroads, but without success, and, after a while, they again came to the

political superintendent on the frontier, to beg for mercy and favour, the tribe being completely broken, and incapable of further mischief. That portion of it settled in Sind was allowed to return to the hills, and they did so in October, 1851. Some of the best of the men belonging to it were afterwards taken into the British service, and the Kulpur chief, Allum Khan, with thirty of his followers, are now enrolled in the Belooch Mounted Guides, employed on the Sind Frontier, in which capacity they have proved faithful, diligent, and generally very useful.

---

## APPENDIX.

*Field Orders by Major BILLAMORE, Commanding, &c.*

*Poolijee, 11th February, 1840.*

As the field force under Major Billamore is about to be broken up, the commanding officer has much pleasure in testifying to the general good conduct and steady behaviour of the troops composing it.

For upwards of three months they have been subjected to many hardships and privations, which have been encountered and overcome, not only without a murmur, but with a cheerful alacrity which reflects the highest credit on them.

To the officers and men composing the force, the commanding officer offers his thanks for their willing and cordial co-operation, in effecting the objects for which they were ordered to take the field.

To Lieutenant Jacob, commanding the artillery, the thanks of the commanding officer are especially due, for the very able and efficient manner in which he conducted his battery, over an unknown and difficult country, offering obstacles of no ordinary nature.

Major Billamore will have much pleasure in bringing to the notice of the brigadier commanding in Upper Sind, the uniform good conduct of the troops employed under him.

By order,

(Signed) L. BROWN,  
Captain 5th Regiment N. I., Staff Officer.

---

*Brigade Orders by Brigadier GORDON, Commanding  
in Upper Sind.*

*Sukkur, 3rd February, 1840.*

Brigadier Gordon, in turning over the command of the troops in Upper Sind to Brigadier Stevenson, cannot take leave of them without expressing his warmest feelings for their general good conduct, and the cheerfulness with which they have performed their duty, under, perhaps (at the season their exertions were called for), one of the most trying climates in the world. To the commanding officers his thanks are justly due.

To the field force under Major Billamore, and to his judicious and zealous operations, the present tranquillity of those hitherto barbarous tracts may be mainly attributed;\* and the active exertions of

\* This shows the immediate effect of the first hill campaign.

Lieutenant Jacob, now commanding the artillery, under Major Billamore, have repeatedly come to the notice of the brigadier, and afforded him the highest satisfaction.

By order,  
 (Signed) T. CLIBBORN, Captain,  
 Major of Brigade.

---

No. 2556 OF 1842.

*From the POLITICAL AGENT in Sind and Beloochistan,  
 to Lieutenant JACOB, Commanding the Sind  
 Irregular Horse.\**

*Sukkur, 9th November, 1842.*

I cannot depart from Sind without performing my duty to yourself and the corps you command, in acknowledging the great obligations I am under to you, to Lieutenants Malcolm and Fitzgerald, and to the native officers and men of the Sind Irregular Ressala.

For the first time, within the memory of man, Kutchee and Upper Sind have been for a whole year entirely free from the irruptions of the hill tribes, by which villages were annually destroyed, lives and property sacrificed, and the whole country kept in a state of fever.

During the past year, the emissaries of our enemies had been unremitting in their exertions to instigate the northern hill tribes to resume their marauding

\* This letter, published to the Sind Irregular Horse by order of the Political Agent, shows the state of the Sind frontier during the year 1842, up to the arrival of Sir C. Napier in the country.

habits, with a view to disturb our communication with Affghanistan through Sind and Kutchee, and so far succeeded, that large bands of freebooters were at one time assembled for the purpose, under some of the most noted of their former leaders; but in vain they strove to effect their objects, which were solely counteracted by the indomitable zeal with which you, your officers, and men, so constantly exposed yourselves, especially throughout the hot months, whereby every attempt of the marauders to enter the plains was baffled; the extraordinary vigilance you have exerted, and strict discipline you have maintained, not merely in the Sind Ressala, but also among the quotas of Belooch horse which were under your orders, has deterred the northern tribes from committing themselves in hostility during the late exciting period, in dread of the corps you so ably commanded.

I am bound, accordingly, to attribute to the Sind Irregular Horse the profound tranquillity which has been preserved in Upper Sind and Kutchee; and I beg you will accept yourself, and convey to your officers and men, my grateful thanks.

I have the honour to annex an extract, paragraph 11, from despatch I addressed to Mr. Secretary Maddock, the 9th ultimo, expressing my obligation to you personally.

I have the honour to be, sir,

Your most obedient servant,

(Signed) J. OUTRAM,

Political Agent in Sind and Beloochistan.

*Manifesto by His Excellency Major-General Sir C. J.  
NAPIER, G.C.B., Governor of Sind.\**

*Sukkur, 13th January, 1845.*

Being about to cross the Sind frontier at the head of a strong body of troops, I think it right to state to the neighbouring tribes why I thus invade the territory of our friend the Khan of Khelat, in order that these tribes may be satisfied as to the cause of my movements, and that they may not think the said movements arise from the desire of acquiring territory or molesting allies.

His Highness the Khan of Khelat has given us permission to enter his territories; and had he not done so, I must still have invaded them for the protection of our own subjects.

These territories are occupied, as regards our immediate frontier, by three powerful and predatory tribes, the Doombkees, Jekranees, and the Boogtees (there are also others of inferior note). These tribes are in open rebellion against their sovereign, the Khan of Khelat. During the whole of last summer they were excited by the hopes of pillage, to make, without the slightest pretext, frequent predatory inroads on the Sind territory, plundering villages, murdering many of the inhabitants, and devastating the country. In several instances they were engaged with our outposts; and on one occasion, falling on two hundred unarmed and unopposing grasscutters, they massacred nearly the whole of them, together with an officer's party of

\* This manifesto clearly shows the state of the Sind frontier after two years of Sir C. Napier's administration.

cavalry who were guarding these poor people, and whom the robbers surprised. Many villages on our frontier were left desolate; the inhabitants of which, abandoning their crops, fled further into the interior of Sind, calling aloud upon me, as Governor of the province, to give them protection. On my part, I applied to their sovereign, the Khan of Khelat, to control his subjects. He promised to do this; but they were not controlled.

I believe his Highness the Khan has the most friendly intentions with regard to the British Government; but it was evident that the arch-robber and rebel, Beejar Khan Doombkee, was too powerful in arms to be reduced to obedience by his prince. So true is this, that he openly bestowed in jaghire large tracts of his sovereign's territory, and to which the latter was constrained to submit. I was, therefore, obliged to reinforce our outposts against this unexpected and unprovoked enemy; and on one occasion our troops wholly failed in an attack made upon Beejar Khan. This was at the period of the year when the heat was so very great as to be insupportable to human beings exposed to mid-day sun.

My orders to the frontier posts were then issued to remain on the defensive during the hot weather. These orders, together with the success of Beejar Khan, rendered the robber tribes more daring. They frequently entered the Sindian frontier in search of plunder, and were on two or three occasions attacked in our own territory, and defeated by the troops, the police, and the villagers themselves, who several times turned out to aid the troops.

It must be evident to every one, that such a state of things could not be suffered by any regular government; and I was directed by the Governor-General of India to take such steps as were necessary to tranquillise the frontier and protect the people of Sind.

I have here to remark that the Ex-Ameer, Shere Mahomed, had located himself among these robbers, and excited them to plunder Sind. He was also in hopes of exciting an insurrection in his favour. But the chiefs of Sind had no desire for his return; still less would the people of Sind assist him, conscious of having a degree of protection under the British Government which they never experienced under that of the Ameers. The Ameer consequently gave over his attempts, and retired to the Sikh territory.

Such was the state of things on the frontier when the cold season arrived; and, in consequence of the solicitations made by me to the Khan of Khelat, His Highness made a feeble effort against his rebel subjects: he advanced from Dadur to Poolijee.

It is evident the rebels well knew the danger they would incur were they to meet their prince on the plain, when he would be assisted at any moment by the British, and each day's march brought him nearer to our outposts.

The strength of the rebels lay in the Boogtee mountains: and to the mountains they of course retired. Among these celebrated defiles and passes the Khan dared not pursue them. The amount of his forces did not exceed two thousand men, and these were by no means under his command: an immediate retreat was decided upon by His Highness.



While this prince was at Poolijee, I sent a vakeel to beg that he would allow me to have a conference with him either at Poolijee, at Dadur, at Bagh, at Gundava, or any other place His Highness chose to appoint. His answer was a refusal, for reasons which I cannot make public, without doing His Highness an injury.

My vakeel therefore returned; but I felt that it was necessary to have in writing His Highness's formal acknowledgment of his inability to control his subjects, the Doombkees, Jekranees, and Boogtees, and his desire that I would punish their rebellion and their murderous inroads upon the Sind territory.

It was also necessary that I should have His Highness's reasons in writing for not meeting me. I therefore despatched Mr. Brown, the Secretary to the Sind Government, who is a personal friend of the Khan's, and possessing my highest confidence, in hopes some arrangements might be made for a united exertion to repress these mountain tribes; but in vain. The state of the Khan's territory beyond the Bolan Pass rendered him unable to attend to the affairs of Kutchee; and he appeared to hold nothing but a nominal sovereignty over that rich tract of country, of which Bagh is the centre.

On Mr. Brown's return from Bagh, so daring were the robber tribes, that he was nearly taken (and to be taken by them is synonymous with being murdered), by three hundred cavalry belonging to the rebels, who had pushed about eighty miles from their haunts for the express purpose of waylaying Mr. Brown. The course to be pursued by me has now become clear and

decisive. It is to enter the Boogtee mountains, and attack these robber tribes in their fastnesses. They are the Pindarees of the Indus.

As Mr. Brown rode through the villages he found them miserable. I will use the words of his report to me :—

“The route I pursued through Kutchee was by Kunda, Kassim-ke-Gote, and Bagh, which line I remember in former days to be richly cultivated. It is now a desert. I did not meet with an acre of cultivation in Kutchee: the condition of the people is most miserable. They have no security for their property—villages are daily plundered by the hill robbers. I heard many villagers (some of whom were wounded) declare that, if they were not protected, they would fly the country and come to Sind.” It is certainly not my duty to protect these poor people, the inhabitants of Kutchee; but it is my duty to protect the inhabitants of Sind; and therefore I shall march, on the 16th of January, beyond the frontier, at the head of a strong force, accompanied by the Sindian chiefs Wullee Mahomed, Chandiah, Ahmed Khan Mugsee, and many others, at the head of many thousands of their followers\*, all determined to revenge their plundered villages upon the mountain tribes. I shall also be assisted by His Highness Ali Moorad, Talpoor, who will march against the enemy, by whom his frontier has also been molested.

It is no small satisfaction to me that I find the Sindian chiefs, who but two years ago stood opposed to us in battle at Meeanee, now eager to draw the

\* The whole of these thousands amounted to about six hundred.

sword and fight under British colours. It gives no equivocal proof of their contentment with the government of Sind.

What the result of these operations may be, it is impossible to say; but I hope it will be such as permanently to secure the tranquillity of the Sindian frontier, and enable our ally, the Khan of Khelat, to recover the rule of his country from these robbers. With this last I have nothing to do. The moment I have punished the robbers I shall retire within our own frontier\*, satisfied that I have performed my duty to the East India Company, to the people of Sind, and to humanity.

(Signed) C. J. NAPIER, Major-General,  
Governor of Sind.

---

*General Orders by His Excellency Major-General  
Sir C. NAPIER, G.C.B., Governor of Sind.†*

*Head-Quarters, Camp Shahpoor,  
19th January, 1845.*

No. 1.—There are two circumstances, which occurred in the opening of this campaign against the robber tribes, which excite the admiration of the

\* Sir C. Napier did not withdraw his troops within the Sind frontier; a strong detachment was posted at Shahpoor, thirty miles beyond the British frontier, and retained there for more than three years.

† The breadth of the desert between Sind and Kutchee is, from Khanghur to Manoottee, twenty-one miles; from Rojaun to Shahpoor, where the Sind Irregular Horse marched on the occasion referred to in this order, is thirty-seven miles; from Khanghur to Ooch, where

Major-General and Governor, and which he thinks it right to make the subject of a separate order. The first is, that in the prompt and dangerous attack for cavalry of a village like Shahpoor, in the highest degree defensible, and built for defence, and which was defended, that Captain Jacob and his men carried it with the rapidity of lightning, and, while losing men, did not injure one of the defenders, but captured them all. This is a very rare and very glorious instance of perfect discipline, as well as courage, on the part of the Sind Horse; and though to men less acquainted with war it may appear trifling, yet, in the mind of the Major-General and Governor, it stamps both the Sind Horse and its commandant as first-rate soldiers—prompt, resolute, obedient, and humane, even in the momentary excitement of action, against the most furious of enemies.

The Major-General Governor feels the greatest satisfaction in thus publicly mentioning Captain Jacob and his corps, for thus setting an example so honourable to themselves and to the army.

This order to be translated, and to be read to every regiment, European and native, serving in Sind.

By order,  
 (Signed) E. GREEN, Major,  
 Assistant Adjutant-General.

Sir C. Napier marched on commencing the hill campaign, is twenty-eight miles. This last-named distance Sir C. Napier in his despatch calls forty miles; Sir W. Napier doubles this, and says that the desert is eighty miles wide.

*Extract from General Orders by His Excellency  
Major-General Sir C. NAPIER, G.C.B., Govern-  
nor of Sind.*

*Head-Quarters, Trukkee, 11th March, 1845.*

Twenty-five brave robbers, on foot, well armed with swords, shields, and matchlocks, met twenty of the Sind Horse patrolling in the desert. The robbers gave a volley and charged. The Sind Horse met them; a combat with sabres ensued. The Sind Horse had one man killed and two wounded; four horses killed and two wounded. Of the enemy, every man fell, sword in hand. Quarter was repeatedly offered to these stern gladiators, but they refused, and every robber bit the dust. Honour be to their courage—more honour to their conquerors. Another laurel leaf has been added to the rich wreath of Jacob's Horse. The conduct of Jemedar Guffoor Mahomed and his companions demands the Governor's highest approbation; and he will report their gallantry to the Governor-General of India, and to the Commander-in-Chief of the Bombay army, as soon as Captain Jacob sends in the names of these brave men.\*

(Signed) C. J. NAPIER, G.C.B.,  
Governor of Sind.

True extract, (Signed) E. GREEN, Major,  
Assistant Adjutant-General.

\* Sir W. Napier calls the detachment of the Sind Irregular Horse mentioned in this order "Moguls;" he might as well style the Men of Kent "Jutta."—The men of the Sind Irregular Horse are Hindoostanees.

No. 1201 OF 1846.

*From Captain GOLDNEY, Collector and Magistrate,  
Shikarpoor.*

SIR,—I beg to report for your information, that, in obedience to His Excellency's instructions, I have issued notices that a reward of ten rupees will be paid for every Boogtee prisoner delivered to frontier posts.

May I request that you will intimate the same to the officers commanding the outposts, both native and European, lest any untoward circumstances should occur in the receipt of the prisoners, or the payment, or certificate for payment, of the stipulated reward, to damp the zeal of our borderers.

I have the honour to be, sir,

Your most obedient servant,

(Signed) P. GOLDNEY,\*

Collector and Magistrate.

*Shikarpoor, 8th August, 1846.*

*Directions of His Excellency the GOVERNOR OF SIND,  
regarding the Treatment of the Boogtees after  
the Hill Campaign.†*

*Dated 8th January, 1846.*

SIR,—By direction of His Excellency the Governor, I have the honour to inform you that the Boogtees

\* This letter, with proclamation in English and Persian, was published all over the border country, by order of Sir C. Napier.

† This order was also published throughout Upper Sind, and was never countermanded.

are outlaws; and all cattle belonging to them, and themselves, are to be captured or killed when they come near the frontier.

I have the honour to be, sir,

Your most obedient servant,

(Signed) E. J. BROWN,

Secretary to the Government of Sind.

*Kurrachee, 8th January, 1846.*

---

NOTIFICATION, *Political Department.*

*Bombay Castle, October 27th, 1847.*

The Honourable the Governor in Council is pleased to direct that the following despatch from Colonel the Honourable H. Dundas, commanding the troops in Sind, to the Adjutant-General of the Army, with the accompanying reports from Major Jacob and Lieutenant Merewether, of the Sind Irregular Horse, be published for general information.

The skilful arrangements and judicious precautions of Major Jacob, and the admirable conduct and daring spirit of Lieutenant Merewether, and the party of the Sind Horse under his command, have combined to achieve a signal and most important service. By the destruction of this large body of marauders assembled on the frontier, the peace of the British territories has, it may be hoped, been effectually secured, and the Governor in Council feels that the highest praise is due to all who have borne any part in this gallant and successful exploit. The Sind Horse on this occasion has added another to the many recorded instances of valour, and devo-

tion to its duty, which have always been conspicuous in the short but brilliant career of this distinguished corps.

By order of the Honourable the Governor in Council,

(Signed) A. MALET,  
Chief Secretary to Government.

---

*To the ADJUTANT-GENERAL of the ARMY, Poona.*

SIR,—It is with the greatest satisfaction I have the honour to transmit, for the information of His Excellency the Commander-in-Chief, the enclosed copies of despatches received through Lieutenant-Colonel Shaw, commanding in Upper Sind, from Major Jacob, commanding the Sind Irregular Horse and the frontier, and from Lieutenant Merewether, Second in Command of the 1st Regiment, and commanding detachment at Shahpoor, detailing a most complete and decisive success, gained by Lieutenant Merewether and one hundred and thirty-two men of all ranks of the 1st Regiment Sind Horse, over the combined Boogtee tribe of Beloochees, on the 1st instant.

These reports are so complete in themselves that it only remains for me to submit them for the perusal of his Excellency, adding, however, the meed of praise due to Major Jacob and Lieutenant Merewether.

To the former officer for the excellence of the arrangements which have been made by him, since the frontier has been placed under his charge by His Excellency Sir Charles Napier, G.C.B., who, having



the highest confidence in Major Jacob's skill and ability (always conspicuous), that officer has now shown how fully it was deserved. To these arrangements may be attributed the most signal success that has ever attended the careful watching of this long-vexed frontier, which has ended in the total destruction of the most notorious freebooters in Kutchee.

Major Jacob's activity, skill, and judgment, have been long known to his military superiors, and I am most happy in being the means of reporting the success which has at last attended his unremitting vigilance and untiring exertions.

To the conduct of Lieutenant Merewether I would also most particularly call the attention of His Excellency the Commander-in-Chief. This officer, though young in years and service, has been most actively employed in the field almost throughout that period of service, and always with credit to himself. He wears a medal for the battle of Hyderabad, and, since he has been with the Sind Horse, formed under the eye of Major Jacob, he has now proved himself a first-rate cavalry officer.

His conduct on the present occasion speaks for itself, in his well and modestly worded despatch. Watching for months, in the desert, an enemy artful and daring as these Boogtee robbers have shown themselves, he has bided his time, and, when that time came, has swept them from the face of the earth.

He appears to have manœuvred his squadron with great skill and judgment, and the fearful loss of life on the part of the robbers will prove to His Excel-

lency with what gallantry and determination the charges were made and executed.

While mentioning the conduct of the European officers, I must not fail to speak of the squadron which Lieutenant Merewether commanded and led. Officers and men of the Sind Horse appear to be of one heart and mind, and the devotion to the service, and gallantry of the native officer, non-commissioned officers, and troopers, which formed Lieutenant Merewether's small force, is beyond all praise. I have therefore thought it right to send the whole of their names to his Excellency, for such notice as he may think their gallant conduct deserves.

I have the honour to be, &c.

(Signed) H. DUNDAS, Colonel,  
Commanding the Troops in Sind.

*Head Quarters, Kurrachee, 7th October, 1847.*

---

*To Lieutenant-Colonel M. SHAW, Commanding in  
Upper Sind.*

SIR,—I have the honour herewith to forward a report from Lieutenant Merewether, commanding at Shahpoor, of proceedings with regard to the inroad of the Boogtee tribe, reported by me to you yesterday. Lieutenant Merewether's letter requires no comment,—it sets forth distinctly and fully the particulars of the most perfectly successful affair of the kind I have ever witnessed or heard of. One hundred and thirty-three men killed nearly six hundred enemies, and made prisoners one hundred and twenty, in two hours' fighting, the enemy resisting manfully the

whole time, and obstinately refusing quarter. Five hundred and sixty dead bodies have been counted; and there are probably more lying about in the jungle.

The conduct of Lieutenant Merewether himself has been beyond praise, and shows a rare and most excellent unison of implicit obedience and great military skill, of cool and careful prudence with the most daring courage.

I have the honour to be, &c.

(Signed) J. JACOB, Major,

Commanding Sind Irregular Horse, Frontier.

*Shahpoor, 2nd October, 1847.*

---

*To Major JACOB, Commanding Frontier, Khanghur.*

SIR,—Having received the good intelligence of the whole Boogtee force having entered the plain, as already reported to you, I have the honour to inform you that I started at half-past one o'clock on the morning of the 1st October, with a party of the Sind Irregular Horse, amounting to one hundred and thirty-three men of all ranks, from Shahpoor, in pursuit of the enemy. I arrived at the Zemanee river just as it became light enough to see clearly the tracks of the enemy. I observed a spot in the bed of the Zemanee river where they had apparently halted for a short time; from the marks, I was of opinion that their strength might be six or seven hundred footmen, with a small party of horse. I thence proceeded, according to your instructions, along the foot of the small hills, intending to take post in the

Teywaugh, thinking that the enemy would certainly return that way, and the ground being favourable for cavalry to act on. However, I had not proceeded a quarter of a mile beyond the Zemanee river, when Jan Mahomed Kyheeree, who was a short distance in advance, came back and informed me that he heard loud shouting and much noise in the direction of Koonree. My detachment was marching in column of troops; I wheeled them into line, and proceeded in the direction of Koonree. When near the jungle about that place, I saw the enemy formed in a deep and long line to my left. They appeared to be making a side movement towards the jungle. I therefore passed rapidly along their front, to cut them off from the jungle, and drive them to the open plain. They were at this time posted in some rough broken ground, with sand hillocks and bushes: but apparently fancying, from my galloping along their front, that I did not intend to attack them, they left their vantage ground, and rushed forward to attack me, with much firing, loud shouts, and howls. This at once gave me all I wished for, namely, a fair field; I immediately changed front to the left, which the men did most steadily, as if on parade. When my change of position was executed, I charged. The charge was made steadily and rapidly, with irresistible effect. The Boogtees had formed a solid mass to receive us, but were overthrown at the first onset, with terrible loss. They then moved off towards the hills, distant about three miles, in disorder, but shouldering together as closely as they could. We continued our attacks, killing numbers, until on

recrossing the Zemanee river, they made another short stand. They were again overthrown, and driven into the open plain. They were now approaching the low hills, when Russaidar Shaik Ali, very judiciously getting some men in advance, cut them off from that place of refuge, and they turned back towards Koonree. Their numbers were now getting small; but though repeated offers of quarter were made to them, they obstinately continued to fight, until the destruction was so great that their numbers were reduced to about one hundred and twenty, many of whom were wounded. At last, seeing resistance utterly hopeless, they were induced to throw down their arms and surrender. Not a single footman escaped capture or death; two horsemen alone out of the whole force of the enemy, stated by the prisoners to have been full seven hundred in all, including twenty-five horseman. Among the slain are several chieftains of note, in fact, all the leaders of repute in the tribe. The undermentioned were recognised among the dead:—

Hundoo. . . . . Nothane.

Kora. . . . . Kulpur.

Kurreemdad. . . . . Raimoozye.

Jumah. . . (Outlaw) Jekrane.

Chuttah. . . (Outlaw) Jekrane.

(Killed in the attack on Kundrane.)

Kumber. . . . . Nephew of the

Shumbrane chief, "Lango."

Also a nephew of Hundoo's, name unknown.

Sunjur. . . . . Rind.

There were also many others, esteemed as warlike

characters, but of less note, killed. Neither Islam Khan nor Alim Khan were with the party.

Our own loss has, I am happy to say, been trifling compared to the result, as shown by the annexed return of killed and wounded: nine of our horses were killed and ten wounded, seven of them mortally so. Amongst the wounded is your own horse, which I was riding at the time; he has received two severe sword-cuts, one on the loins close behind the saddle, and the other on the heel. After all was over I returned to Shahpoor, *via* Chuttur, to which latter place I had sent all the prisoners able to march, under the custody of Naib Russaldar Azeem Khan. Russaidar Shaik Ali, with the remainder of my detachment, I left at Koonree, to take care of the wounded till I could send out assistance and carriage from this place. All returned to Shahpoor this morning.

Before I fell in with the enemy, they had attempted to plunder the village of Kundranee, whence they were beaten off by the head man, Deen Mahomed Kyheeree, in splendid style; Deen Mahomed and his people killing the notorious "Chuttah" Jekranee and others, and taking one prisoner. Three determined attacks were made by the Boogtees on the fort, and at one time the assailants had actually reached the top of the wall, but were thrown back by the defenders.

All my native officers and men behaved well in this affair: nothing could be more perfect than the steadiness, resolution, and quickness which they showed throughout; but I beg particularly to bring to your notice the excellent conduct of—

Russaidar Shaik Ali.

Naib Russaldar Azeem Khan.

Sowar Sulleen Khan.

„ Bujjoo Khan.

„ Bahadoor Khan.

„ Kurreem Khan.

I saw these four sowars each kill several of the enemy in fair stand-up fight, hand to hand; but nearly all must have done equally well, although it be not possible for me to specify every man's deeds individually. I beg leave also to remark that the destructive effect of our little carbines, used in the hand, at close quarters, was quite terrible to behold. Every shot appeared to kill or disable an enemy, who were often, by reason of the bushes and broken ground, enabled just to keep out of sword's reach.

I must not omit to mention that Jan Mahomed Kyheeree, with four of his followers, was close to me during nearly the whole of the action, and behaved exceedingly well. Jan Mahomed fought stoutly, killing several of the enemy before his sword broke over the head of another.

I have made the best provision I can for the wounded prisoners, who are being carefully attended to by Assistant-Surgeon J. Pirie.

I have the honour to be, &c.

(Signed) W. MEREWETHER, Lieutenant,  
2nd in Command S. I. H., Comg. Outposts,  
Shahpoor.

*Shahpoor, 2nd October, 1847.*

*General Orders by the COMMANDER-IN-CHIEF.**Head-Quarters, Poona, 30th October, 1847.*

1. Lieutenant Merewether, Second in Command of the 1st Sind Irregular Horse, has, with one hundred and thirty-two men of that corps, executed a brilliant exploit. He routed and totally defeated a body of seven hundred freebooters, belonging to the Boogtee tribe of Beloochees, on the 1st instant, who, notwithstanding quarter was repeatedly offered to them, obstinately refused the boon, and provoked their own destruction.

The coolness and military science this officer exemplified in taking up his position, the promptness with which he wheeled his men into line, and the gallantry with which he instantly attacked his numerous enemy, merit the Commander-in-Chief's warm approbation, which he thus publicly offers to Lieutenant Merewether, and the men of the Sind Horse who participated with him on this occasion.

The Sind Horse, on every service on which they have been employed, have conducted themselves in the most gallant manner; and to Captain Jacob, who commands, and has brought them to this state of perfection, the Commander-in-Chief offers his meed of praise and approbation, and begs that officer will accept the high opinion his Excellency entertains of his distinguished merit.

(Signed) H. HANCOCK, Lieutenant-Colonel,  
Acting Adjutant-General of the Army.



MEMORANDUM ON THE PRINCIPLES OF PROCEDURE ON  
THE NORTH-WEST FRONTIER OF SIND.

Entirely offensive measures on the part of the troops, the possibility of attack by the marauders never being contemplated. No defensive works whatever allowed anywhere; existing ones destroyed or abandoned; the troops always freely exposed, and obstacles to rapid movements removed, as much as possible. The people protected.

No distinction permitted between plundering and killing by private persons, whether friend or foe. Robbery and murder treated as equally criminal, whether the victim be a British subject or not.

The plea of family blood-feud, or retaliation, in such cases, considered as an aggravating circumstance, as proving the most deliberate malice aforethought. No private person allowed to bear arms, or possess arms, without written permission.

The highest moral ground always taken in all dealings with the predatory tribes, *treating them always as of an inferior nature so long as they persist in their misdeeds; as mere vulgar, criminal, and disreputable persons, with whom it is a disgrace for respectable persons to have any dealings, and whom all good men must, as a matter of course, look on as objects of pity, not of dread—with hatred, possibly, but never with fear.*

As perfect information as possible of all movements, or intended movements, of the plundering tribes residing beyond our border. Such information acted

on with the greatest activity, our knowledge of the nature and habits of the Belooch robbers being sufficient to enable us in almost every single instance to judge correctly of their probable proceedings, and effectually to check and counteract them at a distance from the British boundary.

The feeling instilled into every soldier employed being, that he was altogether of a superior nature to the robber—a good man against a criminal; the plunderers being always considered, not as enemies, but as malefactors.

The strictest justice always acted on; and no success, or want of success, or any other circumstance whatever, being allowed to influence the terms offered to, or the treatment of offenders, whether whole tribes or individuals. Violence, robbery, bloodshed, held as equally criminal and disreputable in all men; the abandonment of such practices, and the adoption of peaceful and industrial habits, being considered as most honourable, and encouraged in every way. A few words will sum up the whole system. At first, put down all violence with the strong hand; then, your force being known, felt, and respected, endeavour to excite men's better natures, till all men, seeing that your object is good, and of the greatest general benefit to the community, join heart and hand to aid in putting down or preventing violence.

This is the essence of the whole business.

The principles on which we have acted on the Sind Frontier since January, 1847, have always been exactly the same. The great power of a machine is shown by its smooth and easy working; a noise and

struggle show the effects of opposition, and therefore, in fact, a deficiency of power. The working of true principles is now apparent here, in the almost total absence of open physical force.

When we came to the Sind Frontier in 1847, the people had no idea of any power but violence. The proceedings of the British authorities tended to confirm this state of feeling.

When the men of Kutchee plundered in Sind, the only remedy applied was to encourage the Sindhees to plunder in Kutchee. Both parties then were equally guiltless or equally criminal; no idea of moral superiority was thought of.

Such being the case, it was absolutely necessary, in the first instance, to have recourse to violent measures, to show the predatory tribes that we possessed, in far greater degree than themselves, the only power which they respected—mere brute force.

Our first year (1847) on the border was one of enormous bodily labour; we had, literally, to lie down to rest with our boots and swords on, for many months together. We crushed the robbers by main force, and proved far superior to them even in activity. And at that time but one regiment of the Sind Irregular Horse was on the frontier.

When our frontier was in a disturbed state, I had my posts close to the hills, esteeming this arrangement to be an *advantage*. Since quiet has been established, I have withdrawn them, save as respects some Belooch guides. But though we had succeeded in forcibly subduing the robber tribes, I should have considered our proceedings as a failure

had it been necessary to continue to use violent measures.

Having, by the use of force, made ourselves feared and respected, we were able to apply better means, and to appeal to higher motives than *fear*. This I had in view from the very first.

The barbarians now feel (which they could hardly imagine before) that strength, courage, and activity may be possessed in the highest degree by those also influenced by gentle and benevolent motives.

Under the influence of this growing feeling, the character of the border plunderers has been changed; whole tribes, within and without our border, amounting to more than twenty thousand souls, have totally abandoned their former predatory habits, and taken to peaceable pursuits.

Our Jekranees and Doombkees, formerly the wildest of the border riders, are now the most honest and industrious people in all Sind.

Every man of the Sind Irregular Horse is looked on and treated as a friend by all the country-folk. In truth, the moral power of their bold and kindly bearing and proceedings has spread far and wide through the country, and effected what no mere force would have done. Even the Murrees, who have not felt our physical force much, are fast coming under this influence, and are beginning to feel themselves disreputable.

If the irritation and excitement to evil practices, caused by the incursions of our Muzzarees, and other proceedings practised and permitted elsewhere, do not interfere with the full development of the causes now

at work on our border, it seems to me certain that perfect peace and quiet will be established among *all* the tribes in hill and plain, whose sole or chief pursuits have hitherto been robbery and murder.— (1854.)

SUMMARY OF ARRANGEMENTS MADE ON THE  
NORTH-WEST FRONTIER OF SIND.

At first the country appeared not to be habitable by man. It was a dreary waste of sand, swept for eight months in the year by burning and noxious winds, and was almost wholly deserted. Even at Khanghur (now Jacobabad) there were but five miserable families, amounting in all to about twenty souls. The troops at Khanghur, Shahpoor, and the other posts, were shut up within walls and entrenchments, completely isolated from the country-folk.

The troops were fed, both man and horse, as if on ship-board, by the commissariat department. Provisions, even to forage for the cavalry horses, were stored at the various fortified posts for their use. So completely were the troops without fresh supplies, that, to remedy the effects of stale provisions, it was thought necessary regularly to issue with each man's daily rations a quantity of lime-juice, and large stores of this article were found at Khanghur, &c., when the Sind Irregular Horse took charge of the posts.

Everything was as in a state of siege in an enemy's country. Even the outpost of Shahpoor was, until the arrival of the Sind Irregular Horse, supplied with every article of food from Shikarpoor, a distance of sixty miles, at enormous cost to the State.

The troops, both officers and men, were necessarily totally ignorant of the country and of the people; and their sole and most anxious and most natural wish was to get away as speedily as possible from such an unpleasant abode.

On taking charge of the frontier, and finding matters as above mentioned, I earnestly considered what would be the best means of remedying this deplorable state of affairs.

It appeared to me that the thing of the first importance to this end was to make it apparent to every one that it was intended to make this country habitable, and to make it our permanent residence. So long as the Government officers and the troops were in a wild, unsettled state, and demeaned themselves as if in a hostile country, it could not reasonably be expected that the poor people could feel secure or tranquil.

I therefore proceeded to build a large house as a residence for myself and lieutenants, to plant a garden in the desert, and to make all other arrangements for myself, officers, and men, as if they were to remain on this frontier for the remainder of their lives.

The forts I pulled down, as impertinent to cavalry, and peculiarly improper for Oriental border war, in which moral force is of such mighty power.

But though the proper principles of action were determined on, it was no light task to carry them into effect: the country was a desert, almost wholly destitute of permanent inhabitants, and a great part of the year without water,—the water naturally in the soil being as salt as that of the sea, while rain

was excessively rare, the average fall not amounting to one inch per annum. The difficulties to be overcome were great; but knowing the excellence of my officers and men, and confident in the cordial support of all under me, I thought them not insuperable; and the result has justified my opinion: steady perseverance in sound principles has commanded complete success.

The old mud fort of Khanghur has disappeared, but near its site there is now the large and flourishing town of Jacobabad, completely open, without the least attempt at any sort of defensive arrangement by means of walls or works, with bazars containing some four hundred well-stocked shops.

On the formerly desert border of Upper Sind there are now always supplies for *an army*, without any assistance from, or interference on the part of the State at all, in any way. Where there was formerly only sufficient brackish water for a squadron of horse, there are now tanks and wells affording an unlimited supply of excellent fresh water. Peace, plenty, and perfect security everywhere prevail in a district where formerly all was terror and disorder on the one hand, or a pathless, silent desert on the other.

Not only has peace and quiet been thus established, but, during the last three years, under the direction of the Commissioner in Sind, roads and bridges have been constructed by me all over the country, in communication with the frontier, to Shikarpoor, Larkhana, Kusmore, &c., &c., amounting altogether to nearly six hundred miles in length. Canals have been excavated, which are bringing a great part even

of the desert under cultivation, and are rapidly changing the whole face of the country from arid waste to corn-field and pasture.—(1854.)

**MILITARY SYSTEM INTRODUCED FOR THE PROTECTION  
OF THE NORTH-WEST FRONTIER OF SIND.**

The officer commanding the frontier in 1847 resided at Shikarpoor, which place was considered as the frontier head-quarters. The outposts were,—

*Strength of Detachment.*

Shahpoor. . . .A troop of regular cavalry, two companies of infantry, and one field-piece.

Khanghur. . . .A troop of regular cavalry.

Rojaun . . . . .Twenty-five men of regular cavalry.

Mobarukpoor. Twenty-five men of regular cavalry.

Meerpoor. . . . .A troop of regular cavalry, and fifty infantry.

The lines of the detachment at Shahpoor were constructed so as to form a species of field fort. There were mud forts at Khanghur, Rojaun, and Mobarukpoor, of considerable strength, which were occupied by the detachments. The detachment at Meerpoor was quartered in the town, which is nearly open, being only protected by some detached towers. At Janadeyra the Jekranee tribes were located under the superintendence of an European commissioner. At Shahpoor were five European officers, at Khanghur one, and at Meerpoor two.

The frontier to the westward, from Khyree Ghuree to Kumber, was guarded by the Camel Corps at



Larkhana, but they had no regularly established outposts.

Boordeeka, from Meerpoor to Kusmore, was unoccupied by our troops. At Kusmore was a strong detachment of police. Each post reported separately to Shikarpoor. The people along both sides of the border were permitted to bear arms, and an unarmed man was very rarely seen. The disorder prevailing was such, that our own subjects, living within the Sind border, were in the habit of proceeding on predatory excursions in considerable numbers, with perfect impunity.

There was no system of patrols along the border; the detachments at the posts were independent of each other, shut up within walls, and thinking only of acting on the defensive. The communication from post to post was difficult, for want of roads and bridges; and the district of Boordeeka was a nest of robbers.

Terror and alarm prevailed everywhere along the frontier, which were greatly increased by the impunity with which the hill plunderers invaded Sind, and carried off their spoil close to our posts and even from the neighbourhood of Shikarpoor, at which place even the troops were continually expecting to be attacked.

Under these circumstances, it appeared to me that the power of the robber tribes consisted in the terror with which they were regarded; that their real strength was contemptible; and that a great deal of the disorder which prevailed in the country was caused by our own subjects.

That it was impossible to protect the people of the country, or to gain their confidence, while our detachments were shut up in forts, and acted chiefly on the defensive.

As soon as I had been entrusted with the necessary discretionary power, I proceeded to disarm every man in the country, not being in Government employ, and to imprison all men found leaving Sind and crossing the border, on predatory excursions. A road was cut, and the canals bridged between the posts; patrols were kept going, day and night, along the whole line; and from Khanghur, which was made frontier head-quarters, strong parties went daily and nightly to one or the other of the watering-places at the foot of the hills on the other side of the desert, such as Ooch, Punnian, Hoodoo, Goree Naree, &c.

These patrols were accompanied by good Belooch guides and puggees; and were, as often as possible, commanded by myself or my European lieutenants. Belooch scouts were also kept at Hassan-ke-Ghuree, and spies were frequently sent into the hills. The Shahpoor detachment patrolled the country from the Teywaugh to Hoodoo, and various persons were, from that post, maintained as spies in the hills. Good information was thus generally obtained of the assembly and intended movements of the hill tribes in force; and as the whole desert was crossed in every direction by our patrols daily, even through the hot season, no small parties of robbers could ever approach the British border with impunity, for no party of the Sind Irregular Horse, however small, ever hesitated to fall on any body of the robbers, however large; and

after two or three encounters such as that alluded to by Sir C. Napier in General Order of 20th February, 1847, where eighteen men discomfited two hundred and killed several of them, the latter scarcely ever attempted a stand when met with.

It was a curious circumstance, and one very characteristic of the predatory border tribes, that while the mountaineers were in the habit of plundering the whole country, they disposed of much of the plunder in Sind, and the marauding chiefs and others had regular accounts current with Bunyas living in the towns and villages in Sind, who were, for long, never even suspected of being in league with robbers, with whom they were in constant intimate communication. Not only was a ready market for the plunder provided, but the hill robbers, who were laying waste the country, were supplied with food from Sind and the plains of Kutchee; while, from their close connection with the Sind Bunyas, they were always kept fully informed of all our proceedings which might in any way concern them. I had in my possession, in 1847, the account-books of some Bunyas of Meerpoor, showing most extensive dealings with Islam Khan, Boogtee, and other predatory chiefs in the hills, for years past; and a number of intercepted letters placed the existence of the correspondence above mentioned beyond doubt.

The establishing of our frontier patrols, and the strict watch kept day and night on the border, entirely put a stop to these proceedings; but such impudence had been caused by long impunity, that a merchant of Shikarpoor loudly complained of my

having stopped a camel-load of matchlocks, which he was sending to the hills across the frontier near Hassan-ke-Ghuree. The predatory tribes, finding themselves completely cut off from Sind, and totally unable to plunder, as heretofore, in small bodies, assembled in force, and, after threatening a descent on Sind in various points, proceeded to attack the Kyheerees in Kutchee; but —, in command of the Shahpoor post, had been long and patiently watching their proceedings in that quarter; and this skilful officer, on the 1st October, 1847, having thrown his squadron between the mountaineers and their hills, fell on them in such sort, that, although they outnumbered him more than five to one, he nearly annihilated the Boogtee tribe.

Since that day, the task of keeping the border has been comparatively very easy. Soon after that affair, I was allowed to make my own arrangements for the permanent guarding of this frontier. I then withdrew the posts from Shahpoor and Meerpoor (that at Mobarukpoor I had long before transferred to Dil Morad-ke-Ghuree), established a chain of posts from Kumber to Kusmore, with lines at each place; sunk wells where required, and cut a road from Hassan-ke-Ghuree to Kusmore, through the dense jungle of Boordeeka.

The duty of guarding this frontier has now become a simple matter of routine: patrols always go daily from post to post in both directions; my Belooch scouts, who are kept always moving about the desert, and who have constant free communication with the country-folk, give timely information of everything

stirring, when a special party is immediately sent to any point indicated.

Having gained the entire confidence of the peasantry of the country, who now despise the mountaineers as much as they formerly dreaded them, these people also are of material assistance to us, and every strange footstep on the border is certain to be speedily reported to one or other of the posts, and to be immediately followed.

For the relief of the detachments at the frontier posts, the plan I have adopted is this: two parties leave Khanghur on the first of every month; one proceeds to Dil Morad-ke-Ghuree, and the other to Rojaun; the parties at these two posts, being relieved, proceed to relieve the detachments at the next posts; and so on to the end of the chain—the last party, on being relieved, returning to head-quarters at Khanghur.

By this means, the men become well acquainted with the country, familiar with the duties of each post, while the work is fairly apportioned. A good body of men is kept at head-quarters, so that drill and discipline do not suffer; and troops are always moving about the frontier, in addition to the regular patrols.

On the Kutchee side, the Kyheerees living at Poolijee, Chuttur, &c., keep me fully informed of all proceedings in their neighbourhood, and in their hills in that direction.

While, having full political powers, and the vakeels of the Khan of Khelat and of Meer Ali Morad residing with me, I find no difficulty in dealing with the subjects of those princes, who have issued strict orders

to all their people to obey me as they would themselves.

The greatest physical difficulty I have found on this frontier has been the want of water. In the year 1847 we were greatly distressed on this account, and I had to bring water from Janadeyra, on camels, to supply the men, who, in the hottest weather in May and June, scarcely ever obtained a full allowance of even brackish water; this was the more felt as we were without shelter, the lines not being built, and had to be out patrolling to such distances that we were in the saddle frequently for twenty-four hours together.

Arrangements have been made for permanently correcting this evil, which I have every reason to believe will prove successful.

There are no fortifications or field works at any of my posts; and I am certain that the moral force gained by the absence of such works very far exceeds any strength they could give in border war. There was a fort at Khanghur, which was occupied by a detachment when we came to the frontier; but I had this fort pulled down and totally razed, with the happiest effect on the country.

#### DISARMING OF THE NORTH-WEST FRONTIER OF SIND.

None who are not in the service of Government are allowed to bear arms without a special license.

The rule forbidding all but the military and police to carry arms without such a written license is strictly enforced. Of late years, no penalty has been found necessary beyond the forfeiture of the arms, when no

good cause could be shown for ignorance of, or non-compliance with, the rule.

As the possession of arms in a man's own house is not forbidden, and no search is ever made for them without special cause, the rule can never be made an instrument of oppression or extortion by our native officials.

Nor does it leave the people defenceless in case of their villages being actually attacked by a band of plunderers.

Its simple operation is to draw a clear line of distinction between the armed servants of Government and all other persons. It thus helps a people, long used to obtain redress for themselves, to understand that there are such things as public wrongs, and a public agency to redress them.

Moreover, it marks every armed man not in the service of Government who may move about the country, and renders it easier to trace him. Every shepherd boy learns to distinguish the armed malefactor from a neighbouring shepherd or traveller, which cannot be done when all bear arms. The effect is found to be, that petty thieves and robbers cease to carry with them their arms, which would excite observation, and facilitate their detection.

But the most decided and remarkable effect is to put a stop to private feuds, and retaliation between frontier tribes, and to check inroads of armed men from beyond our frontier. Our own people, when they can do so with impunity, are as much addicted to plunder and aggression as their foreign neighbours. On a frontier where clan-feuds have been rife for

centuries, it must be impossible to say what is aggression and what retaliation. As long as it is supposed that we allow our own subjects to retaliate, our neighbours will feel justified in doing the same; but when we begin by prohibiting our own people from taking the law into their own hands, and compel them to submit their feuds and claims for compensation to the arbitration of the Government authorities, foreigners as well as our own subjects become convinced that we are in earnest; and such sense of justice as may still exist, even among the rudest, is enlisted on the side of good order, and excites some respect for measures which might otherwise, perhaps, not be fully comprehended.

#### MISTAKEN LENIENCY TOWARDS MARAUDERS.

With reference to the commutation of the punishment of these prisoners (two borderers, convicted of murdering a policeman in the execution of his duty) from death to transportation, I have the honour most respectfully to point out that, from my knowledge of the habits, feelings, and modes of reasoning among these border tribes, I am convinced that serious mischief will be caused by this apparent mercy.

No one living can be more impressed than I am with the evils of unnecessary severity.

The only legitimate object of punishment is the prevention of crime—that is, the protection of man from injury.

The practice, or attempt at the practice, of revengeful, retaliatory, or retributive punishment, is



itself criminal, and always defeats the real object and intention of all just human punishment.

It has been chiefly by keeping this principle constantly in view, always acting on it, and endeavouring to impress its truth on the semi-barbarous people of the country entrusted to my charge, that I have succeeded in replacing the state of terror, disorder, bloodshed, and rapine, which prevailed here throughout the whole land up to the year 1847, by the profound peace, tranquillity, and safety for person and property, which has existed on this border for long past.

I have endeavoured, and with partial success, to convince these wild Belooch tribes, that attacks and inroads on their neighbours, where their property may be carried off and their lives destroyed, are merely vulgar robbery and murder, alike hateful to God and man, and likely, under our rule, to be as disastrous in their consequences to the perpetrators as they are totally unnecessary for their protection. I have endeavoured, in all things, and with some success, to appeal to the highest and most generous feelings of human nature, rather than to the basest, such as fear.

One of the most manly and warlike tribes in the whole country is the Doombkee tribe, of which the murdered man in this instance was a member.

Under the old state of things, a severe and bloody revenge would have been taken by them on the Muzzarecs. As it is, the quietest, best behaved, and best disposed people on the border are these Doombkees, who have completely adopted our principles, and

abandoned their lawless pursuits, trusting entirely to our power and will to protect them.

The commuted punishment to which the murderers in this case are sentenced will, perhaps, be thought by the prisoners themselves as worse than death; but if the object be, not to hurt the criminal, but to prevent crime, it will be equivalent to no punishment at all; as it will be so regarded by the people of this country.

I know well what now will be the feelings of these men, the Muzzarees, when they hear that the murderers are not to be executed. It will be considered as a triumph for the Muzzaree robbers, and a disgrace for the brave and faithful Doombkees. It will be thought and said on both sides, that the Sirkar is more tender of the lives of those who openly defy its authority than of those of its most orderly and faithful subjects. The Muzzaree will taunt the Doombkees with their having killed one of their tribe with impunity, and the Doombkees will feel shame.

I have lived for nearly seventeen years among these people, and long experience and intimate knowledge of their habits and modes of reasoning assure me that such will be their thoughts, words, and deeds.

Knowing this, it seems to be my duty to bring it to the notice of higher authority, otherwise the best intentions of Government may result in deplorable evil.

Under all the circumstances of the case, I beg leave most respectfully, but with most serious earnestness, to recommend that Government be moved to

confirm the sentence of death on these and other similar murderers, and that the sentence be carried into effect by the execution of the criminals at Kusmore, near where the crime was committed.—(1855.)

#### STANDING ORDERS FOR THE FRONTIER POSTS OF THE NORTH-WEST FRONTIER OF SIND.

No policemen are employed on frontier duties.

With regard to the instructions given to the frontier posts, something is left to the discretion of the native officers in command. The standing orders are, to send patrols along the border road and the northward daily; to keep the Belooch guides constantly at work; to send a party instantly in the direction in which an enemy may be indicated; to report all occurrences to the posts on each side of them, and to cause the information to be rapidly forwarded to head-quarters; to stop all armed men, not having passes signed by me, nor being servants of Government, and to disarm them; to be particularly attentive to all complaints of the country-folk, and to preserve the strictest discipline in their detachments.—(1853.)

#### ASSESSMENT ON THE LAND OF THE FRONTIER DISTRICT OF SIND.

I have fixed the assessment on all lands in the district under my charge at one rupee per beega of 2,500 square yards per annum, without any regard to season or crop.

I have maturely considered this matter, and feel quite convinced that this low and simple assessment

would yield a very greatly increased, and, probably, ultimately a maximum revenue.

I should propose that, as at present, one-third of the area of the land held by a zemindar, and specified in his grant, be accounted as under cultivation, and that on this the revenue, at the rate of one rupee per beega per annum, be levied, however the land may be employed, and without respect to produce.

Under the proposed arrangement, all vexation whatever would be removed from the collection of the revenue; the ground once measured, and the area recorded in the zemindar's "putta," there will be no possible room for fraud by any party, and the whole business would be reduced to the simplest possible form.

While the moderate rate of assessment proposed would enable us to dispense with all remissions and other temporary or casual adjustments, which are the most fertile sources of injury and fraud—of loss of revenue on the one hand, and of careless improvidence on the other.

It seems to me quite unnecessary, and of evil consequence, to vary the assessment with the nature of the produce cultivated. Where this is done, it is tantamount to giving a premium for the inferior grains, &c., and also of inferior skill and industry.

Let all pay alike for the use of the land, and the free action of natural laws will speedily adjust everything in the best possible manner, and on the soundest possible basis.

That which yields the greatest return will be most cultivated, and the best lands will be first taken; but

increased cultivation of the more valuable grains will speedily bring down their prices, and if there be a real demand for inferior kinds they will rise in price, and again be cultivated, in exact proportion to the wants of the people.

As respects the quality of the land, it does not vary so much in Upper Sind as to render it advisable to have a varying assessment on this account, while there is an almost unlimited extent of new, and hitherto waste, land in the district, which is all perfectly able to bear the amount of assessment proposed.

There is sufficient good land available for all, and more than all, the cultivators, and this will be the case, probably, for ages to come.

Under such circumstances, no inconvenience can arise from taxing all the land alike; while the simplicity and certainty of the arrangement will, as much as the moderate assessment, prove inducements to extend cultivation.

I should propose to guarantee to the zemindars—and to mention this in their puttās—that there should be no increase of assessment for a period of twenty years, when revision might take place, if thought necessary.

Payment of the land revenue to be considered due on the 1st May annually for the past year.—(1855).

#### ADVICE TO A NATIVE PRINCE.

It must be evident, from my actions as well as words, that from the first I have had but one plain object in view; that my sole object, and that of my Government, in this business, is to arrange matters

so that there may be a strong and friendly Government established throughout the dominions of your highness. To bring this about, it is necessary that the officers of your highness should be faithful, active, and united.

Your highness engages to prevent all outrage by your subjects on British territory; but to cause the country to be prosperous and wealthy, and the Government of your highness to be respected, it is necessary to do more than this.

Measures should be taken to protect life and property within your highness's own dominions also; and I strongly advise your highness, as your very true friend, to adopt means to ensure this result.

No oppression or violence should be allowed, whether by great or small.

Justice should be strictly administered to all men. Cultivators and traders should be encouraged and protected, roads made safe and easy, and no private transit, or such like exactions, should be allowed. All this cannot be accomplished without exertion; but if your highness attend to this advice, and act on it, the State of — will, under your highness's rule, by God's blessing, become rich, powerful, and respected. But without some such arrangements, and efforts from within, no amount of external assistance alone will make it really strong and flourishing.

Your highness should understand that the pecuniary aid now to be given to you by the British Government is really of far more value to your highness than would be assistance by force of arms, inasmuch as, in the latter case, it must be apparent to all that your

highness, wanting strength yourself, is only upheld by British troops. On the other hand, the aid now to be afforded to your highness will, with proper arrangement, materially assist your highness in establishing a strong Government of your own, in improving your own resources in various ways, and in making such arrangements as will cause your country to become rich, flourishing, and powerful, as it is the wish of the British Government that it should be.

The matter stands as if a man, being sick and weakly, were assaulted by an enemy, and a friend at hand strike that enemy down: in this case one enemy may be overthrown, but the weak man is no stronger than before, nor in any way permanently benefited. But if, instead of acting thus, the friend, when the other is threatened, administer food, medicine, &c., and thus cause the weak man to become healthy and vigorous, and able to support and defend himself by his own strength, the assistance thus afforded is far more important than the other, and the benefit is evidently infinitely greater.

Your highness may rest assured that no effort will be wanting on my part to enable your highness to carry out measures such as I have alluded to; and that they, and they only, can lead to the happiness and prosperity of your highness, your nobles, and your people.—(1854.)

**THE BRAHOOEES, AFFGHANS, AND PATANS (BEING A POPULAR APPELLATION OF THE AFFGHANS) CONSIDERED AS RECRUITS FOR OUR ARMIES.**

To obtain recruits to be made cavalry, or any other

soldiers, from the kafilas arriving from Affghanistan, &c., is an absolute impossibility. We might as well expect to enlist soldiers from among the Bunyas of Shikarpoor.

Leaving, however, the kafilas out of the question, and supposing recruits to be obtained from the *élite* of the Brahocees and Affghans, I am of opinion that enlisting such men would be found in the highest degree injudicious, and injurious to the service.

A residence among, and close association with, these people, for more than fifteen years, with opportunities of observing and trying them in every way, enables me to write with confidence and certainty regarding them.

Every Brahocee (the Belooch of Khelat) whom we enlist is certainly either a thief, a coward, or a traitor, or is, very probably, all three combined.

The Affghans are more ferocious, but have far less real courage than the Hindoostanee; they have more cunning and less intellect: they have more muscular development with *far less* endurance.

Both the Affghans and Brahocees are absolutely faithless and untrustworthy, whereby they are *never* to be depended on as soldiers in war.

Both are quarrelsome, unruly, and murderous, in quarters in peace; and in domestic life both are given to the most detestable vices, which lead to all manner of evil.

Whatever may be thought of these people by those who do not know them well, it is certain that the Mussulmans of Hindoostan are altogether superior beings in every way to the Affghans and Beloochees,



and are incalculably better adapted by nature to make good soldiers.

In my opinion, not rashly formed, one good Hindoostanee soldier carries as much military power with him as any three of the best of the others.

At the battle of Goojerat, 4,000 of the very best men of Affghanistan, the *élite* of Dost Mahomed's army, splendid men, on splendid horses, as they were described by the officers present, commanded by the son and nephews of the Ameer in person, were overthrown, beaten to pieces, and driven from the field with tremendous loss, by 243 Hindoostanees of the Sind Irregular Horse, leaving their leaders slain, and their standards in the hands of the victors.

I might point to numerous other similar instances against the Belooch, also, if necessary. Even where there is no suspicion of faithlessness, the Affghans and Beloochees are then, as the materials for soldiers, altogether inferior to that which we have in such abundance ready to our hands in India.

But these Affghans, &c., are also utterly *faithless*, and we can never feel a just confidence that they will be true in the hour of need. The Hindoostanee Mussulman has a high feeling of honour—these men have *none whatever*: their absolute faithlessness and treachery appear incredible to those who do not know them, and form a startling contrast to the frank, open manner, the free, manly *bearing*, the burly forms and fair faces, of these Affghan men; which, until taught by experience, we naturally associate with the possession of European virtues. Of late years, I have never admitted either Belooch or Affghan into our ranks,

and there has not been for many years past a man of either race in the corps, though the *élite* of both are at my disposal.

But formerly, when they were in our ranks, I have seen these great, strong, tall, fair-faced warriors throw themselves from *their horses, and weep like children* in fatigue, difficulty, and danger, amidst the derision of the Hindoostanees, who were always ready to dare or to endure anything, without a murmur.

The subject of enlisting men of these foreign tribes, who are, undoubtedly, immeasurably inferior to the men of India in all military qualities, and, in fact, in everything but personal appearance, appears to me to be one of considerable importance; yet so little is the truth of the subject known, that great numbers of Brahocees, foreigners from the Khelat territories, have been enlisted in the —, and are now sepoy's in the corps.

It must be evident, that this practice is fraught with extreme danger; for in case of service against the tribes beyond the border,—*the brethren of these people*,—we should assuredly have in our ranks as many spies and traitors as we had Brahocees. For service in other parts of the world, the objections to these men as soldiers would be general only, but on this frontier they become special and overwhelming.

Were I proceeding on service against the tribes bordering on our frontier, I should consider the real strength of my force to be increased by the absence of such soldiers. They could not be trusted without imminent risk of failure and disgrace.—(1853.)

SUGGESTIONS TOWARDS THE PERMANENT DEFENCE OF  
THE NORTH-WEST FRONTIER OF INDIA.

It seems to me that if arrangements for the permanent defence of our North-West Frontier be not speedily applied, and manfully carried out, they will have caused the loss of our Indian empire within the next generation of men.

The first enormous error consisted in not at once, after your report of the state of the Turkish army at Erzeroom, sending a strong force, under an able commander, to that country, and then driving every Russian back to the north of the Caucasian range. The next error was allowing Kars to be taken; and thirdly, after all this had been committed, another egregious error was perpetrated in not making Russia withdraw from Turkish Armenia BEFORE we moved a man out of the Crimea.

The fall of Kars caused Persia to quarrel with our ambassador; but, with true Oriental cunning, wishing to be prepared for our ultimate success, the Persian Government pretended that the quarrel was personal only.

Now Kars is still held by Russia, and Persia invades Beloochistan and Affghanistan; being of course quite convinced that we have been well beaten, and that Russia is all powerful. This effect is all that Russia proposed to produce by the delay in evacuating Kars, &c. She will now withdraw, and remain apparently perfectly quiescent.

But the result will be, that Russia, all-powerful in Persia, will use that country as she pleases, herself

unseen all the while ; she will—as she is now in fact doing—endeavour quietly and steadily to place Persia in settled possession of Herat, and probably of Kandahar, as well as of a considerable portion of Beloochistan.

While firmly securing her hold of these countries by means of the Persian Government, Russia will be recruiting her own strength for another European war. In this it is *possible*, though in my opinion not altogether probable, France may NOT be our ally. If we remain friends with France, the renewal of the war will only be deferred a little ; but in any case, whenever the next occasion of war may arise, Russia will, under the policy she is now pursuing in the East, be able to occupy, not Herat only, but Kandahar, with an army of 50,000 Europeans and as much Persian rabble as she pleases, *before we have begun to think seriously about the matter* ; and Russia might then soon be in full possession of the Punjaub and Sind, in spite of all the tardy efforts of our stupid and unwieldy though really gigantic strength.

It is Ulysses and Polyphemus all over ! I would now make the giant mind his eye.

If not—if we persist in our present blindness—and our rulers, instead of attending to questions of really vital importance, persist in occupying themselves in miserable fiddling about the salaries of the hardest working men on earth, while they should be looking the coming danger to the whole empire fairly in the face, then good-bye to England's Eastern power—we shall gradually recede further and further, till all be lost.

The time for action is now, and the wise proceeding is that which I have proposed. Nothing short of this will answer, or will be safe.

By the arrangements proposed, we should place between us and the enemy several wild and warlike nations, devoted to our service; and render it *impossible* for an European army to approach our Indian frontiers with hostile intent.

*Ultimately*, Herat might become an English fortress; but this move would not be required for many years, and long before it had become advisable to make it, all Affghanistan would be devoted to us.

However, looking onward to a great European war, with a fortress at Herat, and a garrison of 20,000 men there (which would not *necessarily* involve any increase to our Indian army, or at least to its cost), India would be as firmly locked in our grasp as if surrounded by the ocean. For no invader could ever enter by any of the paths over the Hindoo Khoosh, &c., without exposing his flank or rear to destructive attacks from a strong force, fresh, vigorous, and well supplied, from the garrison of Herat.

But this is looking far forward, to the time when Russia, having been shut out from her long-cherished schemes towards Constantinople, shall have again matured her preparations for advance in a new direction, and have poured her whole strength on our Indian frontier.

At present, all that is required to be done is to ensure the certainty of success and security on our own frontier. \* \* \* \* \*

I have for long past thought over the subject of

the arrangements proper to secure our North-Western Frontier of India permanently in such a manner as to obviate the necessity of any alarm, unusual stir, or hasty operations of any kind, in consequence of movements of enemies, or possible enemies, from without.

At present, it appears to me that we are in a great measure in the position of a mighty army without any outposts of any kind. The whole host is liable to be perplexed and disturbed to its centre even by any small body of adventurers, who may confidently approach its unwieldy strength with impunity.

It seems to me that we now have the best possible opportunity of remedying this state of things—an opportunity offering a combination of circumstances favourable to our purpose such as must very rarely occur.

Beloochistan is entirely at our disposal, the people being really most friendly towards us, and, since the late treaty with Khelat, more so than ever; Dost Mahomed and the Affghans generally are inclined to favour our advances, and the fairest possible reason for precautionary measures on our part exists in the Persian advance to Herat, and through Seistan; while we have peace throughout the old provinces of India and in Europe; with perfectly settled tranquillity in Sind and in the Punjaub.

There are but two great roads into our Indian empire from the north-west—but two roads, in fact, by which it is possible for a modern army to march.

One of these, the Bolan, lies through an entirely

friendly country. The Khelat territory extends to Pesheen, forty miles beyond the head of the pass, in the table-land of Affghanistan, and is inhabited by Belooch and Brahocee tribes, who are of an entirely different race from the Affghans.

The road through the Bolan is, even at present, generally good, and sufficiently easy for an army to proceed by it, with all its artillery, stores, &c. This road is also the shortest from Herat to British India, and is the natural outlet to the ocean of the commerce of a very large portion of Central Asia.

From the foot of the Bolan, one continuous and almost dead level plain extends for nearly six hundred miles through Kutchee and Sind to the sea.

The only other great road, the Khyber, is very differently circumstanced. The people are unfriendly and barbarous, the country is far more difficult, and the distance greater; while there is already a strong division of our army at Peshawur, so that we are tolerably well secured in that quarter—quite sufficiently secured, indeed, under the arrangements contemplated by me, because from Quetta we could operate on the flank and rear of any army attempting to proceed towards the Khyber Pass; so that, with a British force at Quetta, the other road would be shut to an invader, inasmuch as we could reach Herat itself before an invading army could even arrive at Cabool.

Such a position would form the bastion of the front attacked, and nothing could, with hope of success, be attempted against us until this salient were disposed of. We may, I think, then, leave the Khyber without further discussion of the statistics of

this road at present, and confine our attention to the Bolan.

The more the matter is considered in all its bearings, relations, and consequences, the more certain it will appear that there should be a good British force at Quetta, a good made road from that place through the Bolan Pass to Dadur, and thence continued through Kutchee to the British frontier, to connect with the lines of road in Sind. The portion of this road from Dadur to the sea must, I think, eventually become a railway, but probably not till a very long period has passed by.

When we were fairly established at Quetta, we might, I think, then subsidise the Affghans with advantage; but UNTIL WE WERE SO ESTABLISHED, such a measure would, it seems to me, be unwise. The Affghans would not be true to us if we really required their services, and might probably turn against us the very means with which we had supplied them. Such a proceeding would only be characteristic of the people.

But in the first instance, on commencing the arrangements for establishing ourselves at Quetta, in addition to the subsidy now payable to the Khan of Khelat under the present treaty, I would take into our pay a body of his troops, both horse and foot, to be entirely under their own officers, and managed in their own fashion.

Such wild irregulars are invaluable *when there is a certain force of our own soldiers* to form a nucleus of strength, and give tone to the whole. Such a nucleus would be formed by the frontier field force



which I have proposed for Sind, and these troops of Khelat would completely connect us with the people of the country generally—a point of great importance. They would take the ordinary escort duties, and such like, and would perform all the work which the Cossacks do for the Russian army, which is that which in general our regular soldiers perform the worst, and which is that by which they are most exhausted and demoralised.

The numbers of these auxiliaries could at any time be increased to any extent thought proper; their employment would make us in a great measure independent of the Affghans, while the enjoyment of regular pay by the Khelat people would have great influence on the Affghans generally. All would be anxious to obtain the same advantages, while our evident strength, independent of Affghan aid, in their immediate neighbourhood, would be the best security for their good faith.

We might then, if we pleased, and it were necessary, safely, and with advantage, subsidise all Affghanistan with money and arms; and the propriety of so doing would, under the proposed conditions, be in no way dependent on the success or on the life of Dost Mahomed; nor would there then be much danger or possibility of our subsidy being misapplied to the prosecution of internal feuds, for such abuses could not occur without being immediately known to and checked by the political agent at Quetta.

If we really intend (as I always suppose that we do really intend) to be fair and just to all men, and to conduct our public proceedings towards other states

and other people according to the principles which guide the intercourse of honest men in private life, the true interest of Affghanistan must be one with our own, and be felt to be so by all its people.

If all distrust of us be removed from the Affghan mind, as it has been removed from the minds of the Government and people of Khelat, the whole country would aid us heart and hand, and an invasion of India would be *impossible*. The invaders would be starved, or destroyed in detail.

The confidence in us, and the perception of their own interest being identical with ours, which would certainly be engendered in the minds of the Affghans by the development and full operation of the means proposed, would constitute the surest, and indeed, the only needful precautions required. The amount of subsidy would be determined by the course of events.

But it is certain that the state of feeling towards us among the Affghans would depend on our real intentions towards them. It is useless to attempt to conceal these from the cunning Affghan; but straightforward honesty and justice, if habitually exercised, in accordance with our real nature, exert irresistible control at all times over all Asiatics, and they will do so in this instance; although we must expect, at first, to have to undo the evil caused by the impressions left by our proceedings and practices during our former invasion and occupation of Affghanistan. But however well disposed they may be, or may become, towards us, neither Affghan nor Belooch will obey or live at peace with their equals; the tribes have endless and deadly feuds with each other, and, if left to

themselves, or only supplied with arms and money by us at a distance, they could not be kept to any combined purpose or long-continued effort. The greatest public considerations would always be postponed to the gratification of private revenge or personal pique. No good effect would be produced by our assistance, and the means supplied would be wasted in unworthy quarrels and intrigues.

The English mind, to whose leading all these wild spirits will bow, must actually be present among them, and a sufficient British force be on the spot to support moral power and dignity, and to give tone to the whole.

There is nothing in the arrangements proposed by me in the least degree resembling our first proceedings in Affghanistan. History has now justly decided that the former measure was in itself at the very outset a great crime and a great error; and in carrying it out, the principles of common justice, common honesty, and common-sense, were at every turn ignored and offended against.

These proceedings were alike foolish and wicked to that degree which must always appear incredible to those who were not, as I was, partly behind the scenes at the time, and in a position to be acquainted with the whole details of the business after its completion.

In the arrangements now proposed, we should act in no respect otherwise than as we might be prepared to justify before all good men in the world, or before the throne of God; and those entrusted with the work should be "men with some conscience in what

they do," than which nothing has more influence over Oriental minds. To attempt to compete with them in cunning, as did poor —— and ——, is to ensure failure; we command the Asiatics by high moral power alone.

We should in the present case occupy a position in the undisputed territory of an ally, with his most cordial assent and approval, and to his great advantage.

We should offend or threaten no one whatever, save those who came to attack and invade our Indian empire. We should have all the people of the country with us.

Our worst enemies could not reasonably object to such a move on our part. Russia, it may be said, might on our move found an assertion of right or necessity of advancing on her side to Khiva or elsewhere. Be it so! I would not make the smallest objection.

Those know but little of Russian policy who imagine that most plausible pretexts would ever be wanting when she thought that she could move with advantage.

If Russia bring with her advance a better civilization, and a higher moral tone—if she introduce European honesty, European ideas, and European commerce into Central Asia—the better for us. All that tends to good must ultimately be for our advantage—for the advantage of free England. But can Russia do this?

Will she, can she, make known to the clever Asiatics a better, nobler, and higher moral power than they are now acquainted with? I much doubt this.

If Russia attempt to proceed by violence, injustice, and falsehood, she will exasperate the whole people against her, and will entirely fail, or will at all events be powerless against us with the people on our side.

In any point of view, and under any circumstances whatever, the arrangement on the frontier of India can never be wise or safe while, AS AT PRESENT, THE UNDISTURBED TRANQUILLITY OF THIS VAST EMPIRE IS DEPENDENT, NOT ON ITS OWN MIGHTY INTERNAL STRENGTH, BUT ON THE FORBEARANCE OF OUR ENEMIES OR NEIGHBOURS OUTSIDE.

I would remedy this at once, effectually and permanently, by establishing ourselves firmly, and in sufficient force, in a position the mere possession of which would preclude all possibility of successful invasion; which would give us, by moral influence, a full control over Affghanistan, establish the most friendly relations with us throughout the country, and which would ere long bring down a full stream of valuable commerce from all Central Asia to the sea.

Supposing these views to be approved, and that it were intended to carry the proposed measure into effect, I should propose to arrange the details as mentioned in a separate paper accompanying this letter.      \*      \*      \*

**MEMORANDUM OF PROPOSED ARRANGEMENTS IN CASE OF  
A BRITISH FORCE BEING STATIONED AT QUETTA,  
OR AT ANY OTHER CONVENIENT SPOT ABOVE THE  
BOLAN PASS.**

In the first instance, to enable the Sind Irregular Horse, now forming the frontier force, and the officers

there employed, to be advanced, some permanent arrangement should be made for the administration of the frontier district of Upper Sind.

This should be constituted, as at present, an entirely separate charge, under an officer in subordination to the Commissioner in Sind; with orders to communicate with the Political Commissioner at Quetta on the political business of the frontier, and to attend to his instructions. This officer to be styled "Superintendent of the Frontier Districts of Upper Sind," and to receive a salary of Rupees 1,500 per mensem, with travelling allowance of ten rupees per diem.

A Lieutenant of Police to be appointed for the Sind frontier district, on the same scale of allowances as the other lieutenants of police in Sind. This officer, and the Sind frontier police, to be under the orders of the political superintendent, and quite distinct from the general police of the province. The mounted police now employed in the frontier district to be increased to 400 men, and 300 foot police to be raised, and to be armed and equipped like the rural police of Sind, to complete the frontier police force.

A civil surgeon and an assistant surgeon, in charge of the police, to be appointed, on the usual allowances. An ample establishment of medical subordinates should be allowed.

No troops to be stationed on the frontier, which would become a purely civil and political charge. No troops to be quartered in Upper Sind at all.

The military stations of Shikarpoor and Hyderabad,

together with the arsenal at the latter place, to be abolished.

A Political Commissioner on the Frontier of India to be appointed, with full powers, civil and military, over all departments, &c. To have his head-quarters at Quetta; or any convenient spot above the Bolan Pass, with a staff of—

- 1 Military Secretary,
- 1 Political Secretary,
- 1 Assistant Secretary,
- 1 Private Secretary and Aide-de-camp.

Under the orders of the Political Commissioner it is proposed that there should be a field force, organized as follows:—

#### FRONTIER FIELD FORCE.

##### *Cavalry.*

The whole of the Sind Irregular Horse to be moved to Quetta, with 2,000 Belooch irregular cavalry, armed, equipped, and officered after the fashion of the troops of Khelat, attached to form the cavalry brigade of the proposed frontier field force. Each regiment of horse, with 1,000 Belooch attached, to be under its own regimental commander.

This cavalry brigade to be commanded by a brigadier, with a major of brigade, and a quartermaster and interpreter of brigade, as his staff.

##### *Infantry.*

Two regiments, armed with Jacob's rifles, each 1,000 strong, with 1,000 Belooch irregular infantry attached, formed into one brigade, commanded by a brigadier, with staff as mentioned for the cavalry.

*Artillery.*

Two troops of horse artillery,  
 Two horse field batteries,  
 Brigadier and staff as above,  
 Ordnance depôt as for a division,

The artillery to be raised for the purpose, not forming part of the Indian artillery, or in any way under the authorities of the Indian army.

*Engineers.*

1 Executive engineer,  
 2 Assistant executive engineers.

The whole field force to be commanded, under the Political Commissioner, by a brigadier-general, with the usual staff of a division.

In case of war or other circumstances occurring to render the proceeding advisable, any number of regular troops might be stationed and accommodated at Quetta.

But, in the first instance, the irregular field force above detailed should alone be established above the Bolan Pass. This force should form the solid nucleus of, and give strength and tone to, the subsidiary troops of the native powers; and eventually, all arrangements being previously completed, regular troops might follow when required, their numbers being regulated by the position of affairs and the prospects towards the North-west. But permanent accommodation need only be provided for the frontier field force of the strength detailed above.     •     •     •

The resources of the Khelat State are considerable. If the chiefs were united, as they formerly were, against us, they could bring forty thousand good men



into the field; but their Government and nobles generally are very poor, and their whole social framework was dreadfully shaken by our proceedings with regard to their former head.

Much has, however, lately been done to remedy the ill effects of these proceedings; and the great want now in the Khelat State is an able man to guide the councils of the Khan.

Were we established at Quetta, as I have proposed, all the resources of Beloochistan would be completely at our disposal, while none would be wasted. And though assistance in arms and money from us may, and probably will, enable the Khelat people for a time to prevent the Persians from overrunning or establishing themselves in their country, yet I am quite convinced that Beloochistan, if seriously invaded by a regular army of Persians, under Russian guidance, will not be able successfully to resist without the aid of European minds from our side to direct its force.

Jalk, or Julluck, is close to the Khelat frontier.

This frontier, wherever the country is inhabited, is sufficiently well recognised; but it is not very definitively marked; the country itself is mostly wild desolate hills, and sands without water; the fertile spots being at long intervals and of small extent.

Nooskee is the nearest place to the frontier where the Khan of Khelat maintains any troops. Even this is a very miserable place,—a little fertile plain, three or four miles long, and of about half that breadth, surrounded by barren rocky hills and drift-sand. There is, however, a good stream of water there, and

the spot is well adapted for the first place of assembly of the Khelat troops to resist attack from the North-west.

It is quite clear to me, that the occupation of the Persian seaports, however valuable a measure as a diversion in aid of other operations, will not suffice really to protect our Indian frontier from insult, even if such proceedings should suffice, as seems to be thought doubtful, to relieve us of the immediate pressure now commencing on the side of Beloochistan.

It is evidently not merely Persia with whom we have now to deal, but Persia guided, moved, and aided by Russia; and from this circumstance, the proceedings near our frontier now appear to be of a much more serious nature than any mere Persian occupation or threatenings of Herat, which have been so often made or attempted during the last twenty years. Wherefore, our demonstrations by sea, if no simultaneous proceedings be undertaken by land on our North-west frontier, will, it seems to me, have no effect but to make Russia push Persia on the more vigorously in this direction while we are still unprepared.

A descent on the coast of Persia would not now cause such consternation as did our first demonstration in that quarter. The Persians have learned to regard such attacks at their real worth. If an invasion in force of the interior of Persia were not contemplated, the Persians would possibly not regard the capture of a seaport with special dread; and the Russian officers would not fail to perceive (when such is really the case) that our proceedings by sea are

really demonstrations only. They would also explain to the Persians, that even if we were to attempt a real advance into the heart of Persia, our movements must be slow and inconsequential, compared to the mighty effect of a rapid but steady advance in force on our unprotected North-western frontier, whereby the Persians would be able to place themselves in firm and secure possession of Kandahar. Such a move, they would argue (and I think justly argue, if we did not meditate permanent conquest in Persia), would soon compel us to withdraw our forces from Persia, to concentrate them for a severe struggle with a Russo-Persian army on the plains of Northern India; and the Russian argument would be sound and just in proportion as the temporary occupation of Lahore or Delhi by an enemy would be more injurious to us than the like occupation of Ispahan would be to Persia.

I would occupy Quetta—NOT MERELY AS A SUDDEN MOVE, CONSEQUENT ON THE HOSTILE DEMONSTRATIONS OF PERSIA, BUT PERMANENTLY, AS A PEACEFUL ARRANGEMENT NECESSARY FOR OUR FIXED REPOSE.

I am convinced that no other measures than such as I have proposed can possibly secure our Indian frontier, and that some such measures must of necessity be ultimately adopted.

Unless we do advance in the direction indicated, it is doubtful whether ultimately even Beloochistan may not fall under Persian and Russian influence. And with regard to Affghanistan, if we do not so advance, there can be no reasonable doubt whatever but that Kandahar must ere very long become a Persian—

that is a Russian—province. The cleverness, activity, watchfulness, and steady perseverance of Russia in such matters are well known; but these powers will fail before us if we proceed with open honesty and WISDOM.

Success is now in our own hands, and may be commanded with ease. Our position may be permanently secured with perfect safety, and with comparatively trifling labour and cost.

But if we remain idly looking on from the valley of the Indus at the movements going on above the Bolan, we shall, it seems to me, be throwing away the fairest possible opportunity of settling for ever the question of the invasion of India by Russia; and the results will be, it seems to me, ultimately, such as no English statesman would like to contemplate. \* \* \*

We should not view this question with the eyes of men who served in Affghanistan during the Affghan war. My own service, and consequent personal knowledge of the statistics of these countries and people on our frontier, have been continuous from our first entrance into Affghanistan to the present time. I am thus well acquainted with the very great changes which have taken place during the last ten years, and which are such as to render altogether inapplicable to the present state of affairs most of the supposed drawbacks to the advantages of the plan of operations on which I propose now to act, however just the objections urged might have been under the conditions formerly existing.

There is as much difference between the question of posting troops above the Bolan at present and

formerly as there would be between now moving troops up the Bhore Ghaut, and doing so under the conditions of the road being as it was up to 1829, and the country above being occupied by a hostile Muratha army and population. The Bolan Pass *presents no difficulties for the party which holds it*, and we should hold it securely at Quetta.

The road through this pass I would improve, so as to make it the easiest mountain road possible for us; but I would make such arrangements that the force at Quetta could, *by occupying the pass itself, if necessary*, hold it against all the world.

I would connect the foot of the pass at once by a good road with Sind, and ultimately by a railroad, and, by means of the subsidised troops of Khelat acting as police, I would maintain the most perfect security along the whole line.

The British camp at Quetta would not then be in any way isolated; it would, indeed, be as little isolated in reality as are the camp and town of Kurrachee at present, which, owing to the want of connection by canal with the Indus, are still chiefly supplied, even with such things as grass, grain, and firewood, by sea.

As regards the tribes which hang about Quetta, I may observe, that for many years past the frontier districts of Sind, and the whole plain of Kutchee, have been as quiet and peaceable as our old province of Guzerat, or even more so.

The most formidable and most famous of the robber chiefs and their tribes have quietly settled down into the condition of contented, happy, and most industrious agriculturists.

The former exploits of the old plunderers are fast becoming forgotten, and, as the last generation of border riders is passing away, no others are being formed to take their places.

The tribes which formerly overran all Kutchee and Northern Sind,—the Boogtees, Doombkees, Jek-ranees, &c.,—so far from being now under little control, are, almost to a man, ready to obey my orders to the uttermost. They are our most obedient, humble servants, and have been brought to this state without any loss of self-respect or manliness on their part. The men have actually been reformed, and now feel themselves stronger, better, and happier than before. The Kahurs of the Bolan have for years past been perfectly quiet and submissive, while the great mass of Brahoee subjects of the Khan of Khelat to the westward of Kutchee and the Bolan are as quiet and peaceable a race, with respect to their conduct towards Government, as any in the East, although they are by no means unwarlike in their own fashion, and under their own chiefs.

The country intervening between our proposed camp at Quetta and Sind would be perfectly occupied and governed for us by the Khelat authorities,—more perfectly so, indeed, than it could probably be by our own officers and police,—not only without our incurring any odium as foreign rulers, but while we should be looked on as the best of friends. . . .

For the last seven years, in fact, the Khelat territory from the Bolan to Sind has been as much under our influence and real control, for just and useful purposes, as any part of our own provinces.

With regard to the capability of Shawl to support the force which I propose to entertain there, this point was certainly not overlooked by me; for I have always been in the habit of considering such arrangements to be the most important of all in military operations, and I have had to attend continually to such matters on a sufficiently large scale during a long course of years. \* \* \*

Yet, by acting on what seemed to me to be just principles, I have found that all difficulties disappeared; and, under the steady action of such principles, some hundreds of square miles, even of the desert itself, have been converted into fertile fields while a town sprung up spontaneously, adjoining our camp, in a wild desolate region, and contains already more than six thousand inhabitants, quite independent of the troops and camp followers, with a flourishing bazar of some hundreds of shops. This town now affords supplies sufficient for an army, and is still rapidly increasing in size and importance.

I would apply similar principles to those which have been acted on here, with a certainty of the like effect, to my proposed advance to Quetta.

The pecuniary cost of supporting the troops, after the first outlay on account of quarters and public buildings, would be absolutely nothing beyond their regular pay. The proposed roads, and the other arrangements for the forward move generally, would ultimately be a source of commercial profit; while, as to the other considerations, I may observe that such civil government as we already exert in Kutchee, through the political superintendent on the frontier,

we should continue to exert; but it would not be at all necessary or advisable to assume, in these respects, greater power, either in nature or extent, than we now virtually possess and exercise.

Indeed, it seems very probable that it would not be found necessary that any other troops should be permanently posted there; for, with the means of communication and transport which I proposed to establish, any force of regular troops which circumstances might call for could with ease and rapidity be sent from Sind, or the old provinces of India, to Quetta, where every species of provision would be ready for their accommodation, and which place would then form the point from which military operations would commence.

The road from the frontier of Sind to the head of the Bolan being improved, and made available at all times and seasons, and a body of the Khelat troops being subsidised, as I propose, by us, no further public arrangements would be necessary for supplying the irregular field force in Shawl, and no extra cost need be incurred on that head.

The valleys of Moostung, Pesheen, and Shawl, produce large quantities of excellent wheat and lucern; sheep are procurable by millions, and all that the neighbouring country could supply would assuredly flow into our camp; while grain and cattle from Kutchee (where the prices are generally very much lower than in Sind itself) would be brought up the Bolan by private traders, in any quantities required to meet the demand.

Provision must undoubtedly be made for consump-



tion during the winter season, as is habitually done by all the inhabitants of that country. But no Government commissariat arrangements would be requisite; while, in case of unforeseen accident, or any emergent necessity arising, the cavalry, who require the greatest provision, could, during the winter, when the ground is covered with snow, and military operations are necessarily suspended, be moved in a march of six days to Dadur, where supplies are at all times abundant.

However, I consider it to be certain that the establishment of the field force at Quetta would result in the growth of a large commercial town at that place; the resources of which would, as in the instance of Jacobabad, suffice for the wants of an army.

In a financial point of view, as I have already observed, the cost of the proposed measures, when compared with the results, would be positively trifling; and, in considering the cost of *these* arrangements, IT MAY BE WELL TO BEAR IN MIND, ALSO, THE COST OF SUCH EXPEDITIONS AS THAT NOW BEING UNDERTAKEN AGAINST PERSIA BY SEA, and the value of the stake which the arrangements proposed by me are intended to secure to us. This value is, I am fully convinced, commensurate with that of our Indian empire. \* \* \*

You wish the red line of England on the map to advance no further. But to enable this red line to retain its present position,—to prevent its being driven back or erased from the map,—it is, it appears to me, ABSOLUTELY NECESSARY TO OCCUPY POSTS IN ADVANCE OF IT. I cannot see how, consistently with

safety, it can *ever* be otherwise with regard to a great empire held by a FOREIGN government as we hold India.

If our deeds be true and JUST, no consequences whatever need be feared. But supineness on our part now would, it seems to me, be most unjust towards India.

A war WITHIN our own territory, with a European enemy, might be ruinous to our reputation, and might entirely undermine our strength, although that strength might have sufficed successfully to meet a world in arms in a field BEYOND our own boundary.

The evils even of successful war are terrible; and such evils are undoubtedly most severely felt—are most intolerable, in fact—in those countries the most accustomed to regular civilization, and uniform un-deviating routine of civil administration.

A severe struggle WITHIN our own established and long settled limits with a powerful invader—although attended with immediate success to us—might shake our power in India to its very foundation; might certainly for a while overturn all our civil arrangements, destroy our revenue, and render it necessary to maintain large armies in the field in the interior of our dominions for a protracted period, in order to restore that internal tranquillity which might not be in the LEAST DISTURBED even by MANY BATTLES fought BEYOND our frontier, and which would be completely preserved by the arrangements which I have contemplated.

---

PART IV.

RELATING TO

THE PERSIAN WAR.

## THE PERSIAN WAR.

---

### ITS POLICY.

I HAD proposed to undertake such arrangements as would result in placing the frontier of our Indian empire in a state of *permanent* and INCREASING security and repose ; to create such organization, in fact, as would render India *unassailable* by a European or other power from the north-west ; and I propose to effect this without any rushing about or appearance of much unusual exertion at all. None of the plans of proceeding which I find advocated or thought of elsewhere will do anything like this, or will even tend to induce such a result ; which could, it appears to me, be as little attained by *sending armies up* the Bolan, as by sending armies to Persia, if mere military expeditions were intended.

The effects of such expeditions as that now being undertaken against Persia will be momentary only, will be enormously expensive, and will leave matters on our frontier of India, as regards security from threat, insult, or real attack, exactly as before.

If the expedition be undertaken in order to punish Persia for insolence, &c., well and good : let us then understand that revenge is our sole object ; and this

we may indeed accomplish, if thought worth our while. I have nothing to say to such proceedings. But if our object be to secure India, we must fail lamentably, and, after wasting immense resources, be compelled, under far greater difficulties than any which now exist, to undertake, ultimately, some such course of proceeding as that indicated by me. \* \* \*

With regard to possible operations against Persia, it appears to me that Persia might be assailed, *if need be*, with full effect from her sea faces.

We might take possession of Bunder Abbas and of Bushire, from which places we threaten Kirman and Shiraz.

No sudden, hurried operations appear to me to be necessary or advisable. We might strengthen ourselves at Bushire, and show an intention of permanently retaining it until Herat were relinquished by Persia, and such other arrangements established there as we might approve of.

If necessary, we might, when our position was settled and secured at the seaports, and all arrangements were matured, march an army on Shiraz without any very great difficulty. From Shiraz, should it be necessary to continue the war, the very heart of Persia is open to us, *vid* Ispahan.

But I am convinced that all this will not be requisite to insure the complete submission of Persia, and to place our Indian frontier generally in the most permanently secure state for the future.

It might be advisable to occupy the seaports mentioned above, and in force sufficient to threaten seriously all Persia: but we should, I think, find

really proceeding further with invasion in that quarter unnecessary; for it appears to me that we could command success by another far more easy and more certain mode of proceeding.—*Vide* Frontier Arrangements.—(*January, 1857.*)

#### ON THE POLICY OF INVADING PERSIA.

I hold a decided opinion that the Persian expedition on which we are engaged, carried out on the plan of invasion, which has been determined on by the English Government, is a great error; and I am quite convinced that ere long this will be as evident to others as it now is to me. But the course of action having been determined on, no effort on my part shall be wanting to command success 'in any part of the proceedings which it may fall to my lot to conduct; and I trust, that having strong convictions of my own, conscientiously arrived at and expressed, I shall not be found deficient in the force and energy necessary to the just execution of those of others.—(*February, 1857.*)

#### THE VALLEYS OF THE KAROON AND EUPHRATES; AND RUSSIAN POLICY.

——'s report is not very encouraging, but I think that we have better information regarding the valley of the Karoon, and that its statistics are not quite so unfavourable as would appear from ——'s report.

We know what the country was formerly; and it appears to me that such a tract, watered by such a river, must be able to supply forage and grain for a large cavalry force.

My own opinion with regard to the plan of proceeding is not at all in favour of making a rush through the hills into the interior of Persia, in the hope of frightening the Shah into submission.

Russia would not fail at once to see and inform the Persian Government of our faulty position, with the sea for our base, barren countries all around the isolated valley in which we were operating, immense ranges of mountains across our communications with the sea, and across the line of our further advance.

Under such circumstances, the wisest advice which Russia could give, as our enemy and to our enemy, would be,—“Induce them to advance into the interior as far as you can; every step they make must render ultimate success less and less possible for them.” I would not advise any such course, but would occupy the whole maritime provinces between the mountains and the sea, from the Euphrates to Bunder Abbas. This would give us, either in our own possession or in that of perfectly friendly allies, the whole line of land communication between the Mediterranean and India, and render us independent of Egypt and of French influence there.

I would inform the Shah that, he not having afforded us the satisfaction which we required, and which we had a right to require, we intended to keep this country permanently, and to annex it for ever to the British empire.

Kuzistan would undoubtedly prove a most valuable possession to us, while the ancient wealth and ancient history of Ormus seem to prove that Bunder Abbas

is the natural outlet for the whole commerce of Persia by sea. The interior of the country must undoubtedly be more accessible from that port than from any other.

In establishing ourselves in these provinces, the mountains, now presenting such formidable difficulties in our way, would prove rather an advantage to us, as forming a wall of defence to us on the north.

We might proceed steadily to organize the whole country we had taken, and might probably restore the district of Kuzistan to its pristine fertility and importance, while the whole of the warlike and manly tribes of Khoords, as well as the Arabs, would be ready to serve us against all the world—*for money*.

In possession of this line of country, opening on the valley of the Euphrates, taking these maritime provinces, especially the valley of the Karoon, as our base, with full arsenals, magazines, and supplies of all kinds ready there, instead of being immediately dependent on distant support from Bombay and Sind, we should be in a position, in case of a renewed war with Russia, to march an Anglo-Turkish army into Georgia, and, there co-operating with other forces sent, if necessary, *viâ* Trebizond, to drive the Russians behind the Caucasus, and to keep them there.

With complete command of the Black Sea, and being paramount on the ocean generally, England then could not be in a better position for engaging in a war single-handed with Russia.

We should be independent of the French alliance in a great measure, and have the most direct route to



India in our own hands, or securely open to us ; while, without first taking Constantinople, no other power could interfere with us on the battle-field, or ever approach the seat of war.

Russia must see all the consequences of our permanently settling ourselves in possession of Kuzistan ; and, unless now prepared to fight with us “à l’outrance,” and to throw her full strength on India (which she undoubtedly is not), would assuredly be inclined, on perceiving symptoms of such intentions on our part, to advise the Shah to accede to any terms whatever rather than risk placing us in such a favourable position for offensive measures against herself. All this seems worthy of consideration.—  
(*February, 1857.*)

#### CAVALRY FOR TRANSPORT BY SEA TO THE PERSIAN GULF.

Whatever cavalry I shipped for the Gulf, I would ship complete in every respect ; and I would do this even if it were certain that one-half of the horses should die on the passage. The despatch of dismounted troopers would end in failure in the event of cavalry being required. As regards the description of cavalry to be shipped, I would select it from the Bombay regular corps. The 3rd, which it seems alone is available for this service, is as good a regiment as could be. The organization which gives the silidar cavalry a great advantage by land is the worst for transport by ship ; the readiness and completeness of the latter is in great measure dependent on a great number of followers, baggage cattle, &c., which to

transport by sea is intolerably troublesome, and very costly, while without them the efficiency of a sildar corps would be materially injured. European cavalry, particularly as at present organized, should never be employed upon service like that about to be undertaken. They would be in the way in Persia. They could not stand the sun; and would be unable to move without supplies, and shelter, and baggage cattle, very greatly in excess, or of a description more difficult to procure than those which would be required for the march of any native corps. It would be more difficult, also, to provide for their wounded; and the men themselves are, as at present trained, by no means so handy for light cavalry duties as natives of India are. They are, in fact, unable to shift for themselves; and are totally ignorant of the habits and feelings of the people among whom they would be serving.—(*February, 1857.*)

#### MILITARY REQUIREMENTS IN THE EXPEDITION TO THE PERSIAN GULF.

All the proposed reinforcements of infantry and artillery, native and European, should be sent to us without the least delay. The European infantry are invaluable. But we want no European cavalry; they would only trammel us, and be a continual source of weakness, rather than an addition of strength in this country, and upon such a service. Plenty of materials for temporary barracks, huts, &c. for the troops should be sent at once from Bombay, also from Kurrachee. If necessary, the European infantry and artillery might, with proper protection, be kept at

Bushire during the summer, without any serious inconvenience or suffering. Plenty of carpenters and tools should be sent to us with all speed from Kutch, from Sind, and from Bombay; also some smiths. We can get none below the passes, and I doubt if we shall be able to get any in Persia at all. The Persian authorities have secured all the artificers in the country for their own arsenals. The climate of Bushire has been represented as being worse than it really is.

Large supplies of provisions, including screwed hay, should be sent from Kurrachee, Bombay, and other places in India, without any delay, for the monsoon is close at hand. I would also despatch all the steamers we could spare with transports to Kurrachee, for this purpose, and would also have all manner of supplies sent in country craft from the Euphrates.

With full supplies at Bushire, and with the reinforcements which you mention it is proposed to send us, we shall, I am confident, be in a position to undertake any military operations you may think proper to enter on at present.—(*March, 1857.*)

#### ON HOLDING OUR OWN GROUND AFTER VICTORY.

The Persian forces at the entrance of the hills at Nanarck must be attacked in the first instance: they would probably escape into the mountains without much loss; but no matter,—we should clear the plain of them, and should then get such supplies as the country might afford—which would not be much, however, I imagine.

After beating the enemy at Nanarck, WE MUST NOT

GO BACK A FOOT: we must make all our arrangements beforehand for remaining on the ground, and holding it up to the hills.

We might then place our European troops at Gurikhan or elsewhere, as you propose, and all our proceedings in this quarter might, I think, be carried out most satisfactorily. Indeed we might, I think, if we had troops enough, even advance to Shiraz this season.—(*March, 1857.*)

**KUZISTAN, HAVING BECOME OURS BY CONQUEST, SHOULD BE PERMANENTLY OCCUPIED.**

It is clear to me that we should not have invaded Persia by sea, and that it was most unwise to do so with the intention of penetrating into the interior, or indeed for any purpose but a diversion in favour of more serious operations elsewhere; unless we were prepared for, and determined, if necessary, to engage in a great war with Russia.

We *have*, however, invaded Persia in force; we *have* obtained possession of Mohumra, and, virtually, of the whole line of the Karoon river, and now to abandon this district, and to restore it to Persia, appears to me to be an error equalling the original fault we committed when, with a view to the security of India, we came here at all.

We should hold the province of Kuzistan by the fairest possible right which war can give to any power. Persia was engaged in an invasion of India, and was endeavouring by every means to create a rebellion in our own provinces.

To retain this piece of country, which we had been

compelled to occupy, and from which we had driven the Persian forces, would be most *just*. This appears to me to be the first consideration, for the wrong is *never* the expedient, and those are not profound politicians who think or act otherwise.

Further, the possession of Kuzistan would confer on us the most important advantages. The province was once most fertile and wealthy; its natural advantages are as great as ever, and the former prosperity of Susiana might, under our rule, be easily restored. The province is divided from the rest of Persia by ranges of mountains, forming a most complete natural barrier; it is inhabited by people of the Arab race, who generally dislike the Persians, and who would warmly welcome our rule.

It is traversed by rivers navigable throughout, from hill to sea, and it adjoins the valley of the Euphrates, completely commanding the outlet of that river to the ocean.

The possession of this province of Kuzistan would, it appears to me, be as valuable to England as Georgia is to Russia. In the event of another war with Russia, England, in possession of Kuzistan, would be able to meet Russia independently of all aid from allies. The advantages of the position are self-evident: it is now our own: and to abandon it would be to resign an advantage which may hereafter be of paramount importance.

In possession of Kuzistan, the ports of Persia elsewhere would be of comparatively little importance to us; but I would recommend the retaining of Bushire.  
—(*April*, 1857.)

### WATER SUPPLIES AT BUSHIRE AND KARRACK.

I am convinced, myself, that the very best place for troops in the Persian Gulf is the island of Karrack, which abounds in fine springs of beautiful water. But I am quite convinced that this peace will be confirmed, and that our best proceeding will be to get the troops, especially the Europeans, out of the country as soon as possible.

I have no doubt but that the aqueduct you mention could be made easily enough; but there is plenty of good water for the supply of the camp here in the numerous wells in front of the lines, and all over the ground, as far as Bushire, and further.—(1857.)

### MOHUMRA, KARRACK, AND BUSHIRE, CONSIDERED AS PLACES FOR TROOPS TO SUMMER IN.

We know what the deltas of large rivers are all over the world.

I care not what particular spot you select in them or near them; a few miles here or there, or a few feet, or a hundred feet, of higher or lower level, make no difference. The locality is deadly, and must be so, during and after the inundation.

Mohumra, or other place near the mouth of the Euphrates, is only valuable, and should only be occupied, as the extremity of the Karoon line. If we have not this line, to attempt to hold the mouth of the river is *madness*; we should have all the injury and inconvenience, and none of the advantage.

The loss by sickness in one season would probably be fifty times greater than any which we could suffer

in retaking the place if necessary; while in the one case the survivors would be broken-hearted and demoralised, and in the other strengthened and encouraged to further exertions.

There are but two places in the Gulf where you can quarter your troops, under existing circumstances, with any sort of wisdom or propriety. These are Karrack and Bushire. The former is a beautiful place, with plenty of excellent water.

Send a sufficient force there, without any cavalry of course, and then provide cover for the coming hot season.

Keep the native cavalry, two batteries of artillery, and four native infantry regiments, here at Bushire, as detailed by me in my former letters to — and yourself; and send away all the rest at once to Kur-rachee and Bombay.

It appears to me a very grave mistake in keeping a man at Mohumra at all. The ships would hold the place for the present. Keep two large ships of war at Mohumra; if the crews get sickly, the ships can leave alternately, and go on a cruise for health.—  
(*May, 1857.*)

#### INSALUBRITY OF MOHUMRA.

The — had to be withdrawn from Mohumra long ago, her crew having become totally disabled by sickness, and nearly all the men on board having been in raving delirium from fever. They are slowly recovering here. But the ships generally are much less healthy than we are on shore; and it is clear to me that the evil opinion of this climate was formed in

consequence of those who described it having resided either in the town, which is a dreadful hole, or afloat.—(*July, 1857.*)

#### SUPPLIES FROM BOMBAY.

I certainly had not imagined before that the Bombay Presidency possessed such mighty resources at once available, or that its departments were at all capable of the gigantic efforts necessary for successfully carrying out such admirable arrangements on so grand a scale.

Well, indeed, it is that it has been so! for our information regarding the resources available for us in this country seems to have been sadly defective, and it is now clear to me, that the wonderful efficiency of the arrangements for supplying, from Bombay, every possible want of this force in Persia, has alone prevented the most serious ill consequences occurring to this expedition, which I am, now more than ever, convinced we ought never to have entered on.—(*May 1857.*)

#### SUPPLIES FROM THE VALLEY OF THE EUPHRATES.

It may be well to remark, that on the occupation of Mohumra I was informed that no supplies could be sent to us from the Euphrates, and none have been sent except building materials, mats, reeds, &c., of which we have received a great quantity from the river. Indeed, at first, after the landing at Mohumra, the commissariat department at Bushire was called upon to send up forage and firewood for the troops there.—(*June, 1857.*)



over by the force since leaving Poolijee, now thought that a nearer route could be found back to that place than the long, very difficult, and circuitous road *vid* Lahree; he had picked up a man\* of the Mussoorree branch of the Boogtee tribe, who had long been resident as a herdsman in the Boogtee and Murree hills, and this man, in answer to inquiries, said that there did exist a path over the mountains bounding the south side of the valley of Kahun, which he was willing and able to point out. Under his guidance the artillery officer, with some difficulty, proceeded to the top of the mountain; the path was only a sheep-walk, and seemed tremendously difficult even for a single horseman; the part over and through the mountain was about four miles in length. This was the pass of "Nuffoosk," a place whose name has since become so familiar, then first beheld by European eyes.

The rock, though hard, was found to yield to the pickaxe and crowbar; and the artilleryman thought that he could in a few days, notwithstanding the apparently awful difficulty of the task, cut a road out of the hill-side over which a gun might be dragged.

Major Billamore gladly assented; for the objects, to effect which the force had entered the hills, had been completely accomplished. Beejar Khan, with Durya Khan, the head of the Jekranees, Toork Ali, Janee, Rahmut, with other chiefs of less note—in short, the whole of the border robbers who had taken refuge in the hills—finding, from the proceed-

\* By name Shere Beg; the same who was afterwards of much use to Major Brown, when besieged in Kahun.

ings at Kahun and Deyra, that the mountain tribes themselves were not safe in their rocky fastnesses, had gone in and surrendered to the political officers. The mountaineers had seen that they could not stand before the British troops, even in their own hills; and that these hills, even the highest of them, proved no obstacle to the transport of the British artillery. Such, then, being the case, it was desirable to return to Poolijee and the plain country with all despatch.

The pioneers and all the camp followers were then set to work at the road over Nuffoosk, and in three days it was thought practicable for the artillery. The Murrees offered no serious opposition to the work. They collected in great numbers about the neighbouring hills, and occasionally approached so near to the workpeople, gesticulating and flourishing swords, that they had to be attacked and driven off by the guard; but in general they contented themselves with firing long shots at the artilleryman and his party, which did no damage.

On the fourth day the 24-pounder howitzer and the other carriages were dragged over the mountain. The road was found passable enough; but, from the great steepness and length of the pass, the labour was very great. However, before evening, Major Billamore and his detachment had crossed "*Nuffoosk*," and encamped on the very spot on which Major Clibborn, in 1840, gained so signal a victory over, and with tremendous loss to, the Murree tribe; and then, appalled by the fearful heat and want of water, unfortunately followed up his victory by all the consequences which usually attend on a disastrous defeat.

miserable Persian writer. But happily, both reason and experience assure us that a high moral nature, a nobility of being, appearing habitually in our actions, our conduct, and bearing towards all men, *command* from all Orientals such a respect as it is far beyond the power of any number of moonshees, or of any defects as to matters of etiquette and formality, to injure in the least.—(1857.)

#### THE SCHOOL OF SMOOTH WORDS.

The strictest justice and fairness, with a generous liberality, should be followed; but a confident courage and most uncompromising firmness should be shown in all our dealings with these Asiatics. I have no patience with the school of smooth words, low cunning, and present-making.     •     •     •

In truth, it appears to me to be above all of the utmost importance to England, that she be represented in this country by straightforward, open, liberal English gentlemen, not by clever and cunning diplomatists.—(1857.)

**PART V.**

**OBSERVATIONS**

**ON THE**

**PRESENT CONDITION OF INDIA,**

**AND ON THE**

**REORGANISATION OF ITS CIVIL AND MILITARY**  
**ADMINISTRATION.**

## PRESENT CONDITION OF INDIA, &c.

---

### THREE EXTRACTS ON THE PRESENT CONDITION OF INDIA.

#### *Extract No. I.*

I HAVE long foreseen what is now occurring, and long ago pointed out that the worst effects of the system prevailing in our native army were degradation of the European mind, and destruction of those powers by which we command the Asiatics. For twenty years past, the Europeans connected with Bengal have been sedulously occupied in concealing faults instead of attempting to remedy them. The causes of the defects were never fairly investigated, while, for discussing them, I was threatened with expulsion from the service. The only remedy proposed or attempted was, to add more European bodies to the Indian army, instead of cultivating European brains.

However, I have no apprehension regarding the ultimate results of the present outbreak. And so let us have no recrimination,—no blaming individuals,—or saying “I always said so.” Let England set to work manfully, by her own forces, energies, and resources, to remedy the existing evils—asking no help, craving no forbearance from any foreign nation ;

and though the effort required may be great, it will be successful, and will be nobly repaid. Everything in the East thereafter will be established on a firmer and sounder basis. I have no fear for the English *nation*; the people will, I am sure, rise with indignant energy, and make any effort which may be requisite to restore health to our Indian empire.

Meantime, I believe, if the English now in India would only retain confidence, we could re-conquer India with the forces we still have at our disposal. For myself, I am most willing and ready to lead against the mutineers the force now with me, which is composed of native soldiers alone; and I am as certain as I am of my own existence that they would do their duty as faithfully as any European on earth. And I am grievously disappointed—more so than I have ever felt in my life before—at this force being detained in Persia, when, had it been landed as one body in Sind, it might have marched to any part of India.—(*July, 1857.*)

*Extract No. II.*

I cannot express to you how gladly I would now be at work in India; and I am now begging hard for permission to leave a small detachment at Karrack, and return with the remainder of my field force. It is composed, with the exception of a few European artillerymen, wholly of native troops, who are in excellent condition, and in good temper for work. If I could land them as a whole at Kurrachee, we should be ready to move anywhere. And, as you know, the military power of 6,000 men who have

already worked together, and become accustomed to their commander, is not to be estimated by the muster-roll.

As regards the mutiny, I see no reason to change a thought or a word which I have formerly expressed on the subject of our rule in India. To my personal knowledge, for twenty years past, and for how much longer I know not, the European mind in Bengal has been sedulously engaged in concealing faults, instead of remedying them. And, as I have been endeavouring to convince the public during the past ten years, the consequences of such deception could not be other than we now see them.

This degradation of the English mind is worse than all; because it deadens the perception of right and wrong in those who should, from their positions, be able to remedy the evils now disgracing us. In this diseased body, the most diseased particles now seem to have been selected as the centres from which to generate new life and health. Indeed, it seems to me that Bengal has not within itself nearly sufficient vitality to recover, if it ever possessed, a healthy tone. To re-establish our Indian empire, an imperial effort of all England and India will be required, and I feel certain such an effort will be made, and that it will succeed. But it must proceed from a very different order of mind from that which has been formed in our Indian, especially our Bengal, school. What we require are men of power, firmness, and insight; possessing causality, original thought, perception of general law, and able to stand alone. \* \* \*

The difficulties now encountering us are of our own

creation. India, and the people of India, offer us none—positively none whatever. They aid us at every town, and cry aloud, “Govern us”—“We are satisfied to have your rule, and are most willing to follow if you lead.” What practically has been our reply?—“No; we will not govern; we will sink ourselves to *your* level of moral power, and we will all govern together.” In fact, we first destroy all our own power of Government,—by making our officers contemptible, by making them degraded in their own eyes, by stopping the whole moral growth; and then we suppose, or pretend to suppose, that, by so doing, we have rendered the natives of India capable of self-government.

Truly, no person, no thing opposes us except our own follies—our own persistence in opposing natural law. On this subject, there is an excellent passage in Macaulay’s *Essay on the Life of Clive*, where he criticises the remarks of Sir J. Malcolm on the Omichund business. It truly describes the whole source of our power in the East; and, indeed, of real permanent power everywhere. But it is very rare to find men who will always *work* with such principles; most of the very best that I see faint at heart when they think of applying them to others, even although they think that they are themselves convinced of their truth.

I have myself always been looked on as a visionary for applying and inculcating them, at all seasons and to all things: yet nothing can be more practical—more adapted to every-day use—than they are; and we *must act* on them, or we shall fall.—(*July, 1857.*)



*Extract No. III.*

— writes about the non-introduction of Christianity and ensigns passing in Hindoostanee as the props of the falling empire. Good God! has the manhood of our nation altogether departed, and dissolved into such streams of drivel as these?

The poor missionaries are good, harmless men; harmless because unconnected with Government— which is as well known to the people as to us. But the passing of the poor ensigns is only ADDING GREATLY TO THE VERY EVIL which is crushing our power in the East, and which has produced all the lamentable results now taking place. The ensign would be infinitely better employed on the hill-side after a boar, than in breaking his heart and stupifying his brains over his Hindoostanee books.

Search for *honestly*, promote, and employ the best men, each according to his peculiar ability in any given line; *and whatever acquirement may really be necessary or advantageous for the work will always be forthcoming in abundance.* No examinations are wanted—*they are all deceptive.* Responsible heads of departments and commanding officers are the best examiners and the best teachers. They will for their own sakes educate—draw out the powers of—their own assistants, the men of their choice. If these will not learn, let them be rejected; but let the master workman judge, not the committee. It is useless to attempt to drive English gentlemen by force, in the hope of improving them,—such a course only destroys whatever good they may have by nature.

The remedy proposed by — regarding the ensigns is exactly equivalent to attempting to increase the supply of cotton by ordering all the cultivators to be flogged periodically until they had passed a book examination on agriculture.

I have been preaching till I am wearied out. I have practised what I preach, on a large scale: a whole people have been civilized, and warmly attached to this rule, by this practice. The principles applicable to our native army I have proved before the whole world for fifteen years together; yet still the attempt is made to govern the Asiatic by *emasculating* the mind of the European gentleman, and using English bodies rather than English brain. Failure, anarchy, and contempt must follow! The attempt is like trying to think with one's muscles.

Yet, have I advocated any wild, doubtful, or partial theory? or have we indeed no MEN left? So far from this being the case, the truth of the principles I preach is self-evident; and any honest, true-hearted, and manly English gentleman can apply them everywhere with *certainty of success*.

My excellent lieutenants — and — took them to Turkey, and though they applied them under circumstances of great difficulty, they found them as truly powerful to govern Bashis and Arnauts as they had proved with Hindoostanees and Beloochees.

The Asiatic bows before generous honesty and high moral power—before manliness, in fact. He scorns moonshees, and laughs at “passed” men.

## A SCHEME

FOR THE REORGANISATION OF THE CIVIL AND MILITARY  
ADMINISTRATION OF INDIA.

---

## PRELIMINARY OBSERVATIONS.

THE faults which have led to the existing lamentable state of the native army of India are not those of individuals, but of system.

Whatever may be the general causes which have now convulsed the Eastern World,—*and these are not unknown to me*,—it is certain that no external influence would have sufficed to have turned our own native Indian army against us, had not that army been internally in a most weak and unhealthy state.

This weak state has *not* been the primary cause of the outbreak which has taken place, but the absence of healthy strength in our army has certainly enabled external influences, which otherwise would have passed unnoticed, to act with fatal effect.

The cause of our weakness is inherent in our Indian military system. We have, since the great Madras mutiny in 1806, sedulously persisted in separating the sepoy from his European regimental superiors. We have endeavoured to place him "*en rapport*" with the Commander-in-Chief—a potentate who is generally as a myth to the native soldier! and have made

him despise his own European officers, and cease to regard them as superiors.

This state of things acts and reacts on both parties ; and perhaps the most fatal effect of long persistence in the system we have pursued is the actual degradation of the European mind which follows on the stagnation which it produces.

The sepoy has been taught to despise his English officers, and to consider them as his natural enemies ; and the English officers have consequently become, to a certain extent, unworthy of his respect.

Without due exercise, the strongest natural powers fade and disappear. Slavery unfits men for freedom ;  
**AND THE POWER OF COMMANDING COMES WITH THE EXERCISE OF COMMAND.**

The natives of India are quite incapable of self-government. *They do not in the least understand what it means. They cannot conceive that a subject can have any rights whatever not dependent on the favour of the sovereign.* They expect their sovereign to govern them absolutely, and according to his own superior knowledge and ability, not according to their instructions.

We have never appeared to them to have acted as sovereigns in India ; we have, on the contrary, shown what appear to the Asiatic to be marks of fear, *and of distrust of our own rights*, throughout our whole administration ; and we have, with unaccountable infatuation *hitherto maintained a descendant of Timoor on the throne of his fathers as Emperor of India at Delhi!* We hold India as foreign con-

querors only ; but we have been perpetually proclaiming to the natives of India that they are our equals ; that we only rule as their representatives, and by their sufferance ; that they are not bound to obey us, and that we have no right to command them.

Our "regulations," civil and military, are all to the same effect.

Our articles of war form a ludicrous specimen of this unwise system.

The English soldier, as a free citizen, is on an equality with his officer : he has rights as such, which he well understands, and which he is able to make use of ; and a portion of such rights he voluntarily surrenders on entering the army. Our mutiny act defines what portion of such rights he thus surrenders ; and he retains all others.

The pre-existing equality is the very essence of the articles of war.

But this equality is precisely what does not exist with respect to the Indian soldier ; he does not even want such equality, he understands nothing about it. In his ordinary state, before enlisting as a soldier, he must either be a despot himself, or be subject to despotic rule.

*It is, indeed, only because the European officer is a superior being by nature to the Asiatic, that we hold India at all.*

The native of India enters our service without an idea beyond that of implicit obedience to his officers being his duty. He cannot even imagine any other state of things, if the officers are to have any authority over him at all.

Yet, with amazing absurdity, the first thing we do is to read and explain to him our articles of war, in order to impress on him the belief that his *natural and ordinary state is to be one of disobedience to his officers* ; and that he is not bound to obey them, except in certain special instances defined by the articles !

He soon perceives that his officers are quite powerless, and that their demeanour, formed in the regulation school, shows that they do not in the least expect him to be obedient. His obedience is always, even by Government, treated as a great and somewhat unexpected favour.

Nothing can be weaker than this.

Such a state of things must tend to develop the worst qualities only of both parties, native and European.

The army is therefore not bound together by any strong internal force, AND THE LEAST PRESSURE FROM WITHOUT MUST CAUSE IT TO FALL TO PIECES.

Brought up in such a school, but few of the officers of our native Indian army can be expected to be qualified to carry out the measures necessary for the reorganization of that army.

An almost superhuman power of original thought and character would be requisite to enable a man successfully to resist the baneful influences, exposed to which he has passed half a lifetime or more ; and it would be most unjust now to visit the officers of the army of Bengal with severe punishment for what has occurred, and the scheme which I have here proposed seems calculated to meet every difficulty in this respect.

Under the arrangements indicated, it will ere long be discovered what each officer on the general list may be fit for, and he may then be employed accordingly to the greatest advantage.

If on fair trial he appear to be totally useless, let him be removed, and let him retire on full or half-pay, according to his period of service. But in the variety of work required to be performed in India, this will rarely be requisite.

It is essential to the successful working of the organization proposed, that the officers on the unemployed list should be fairly and even liberally paid. The presence alone of a number of English gentlemen in India is attended with much advantage to the English Government; and these should have the means of living respectably, and of pursuing those studies and occupations which may qualify them for public employment in this country.

Under a system by which every man must feel that his standing and advancement in the service and in society depended wholly on his own industry, acquirement, and cultivated natural powers, the greatest possible amount of mental power and moral growth must be developed. And while the *numbers* of Europeans in the public service in India might even ultimately be much reduced, their *commanding power* would be very greatly—almost infinitely—increased.

Where cases of abuse of power occur, as occur they must and will, let them be dealt with *individually*. Avoid, as much as possible, making *general* regulations, which destroy all healthy mental development. Avoid striving too much after outward uniformity:

the same just principles, applied equally well and with equal success by different men, may cause different arrangements with respect to unimportant details.

No two leaves on a tree may be exactly alike, but the same vital process has produced all from the same substances.

Forcing all men's minds into one mould is fatal to mental power.

Let the system be such as to tend to cultivate and to develop such power. Let men apply their powers as they find best adapted to produce the desired effect, *making them strictly responsible for results.*

If officers will not exert themselves, or if they have done their best in vain, and the results are unsatisfactory, such officers are in their wrong places; remove them to the unemployed list, till work more fitted for their powers be ready for them.

The obvious objection to the organization proposed, is the difficulty of finding properly qualified officers for the higher commands. But it is certain that time will speedily remedy this,—*the school will soon form such officers, and nothing else will do so.*

We must expect to meet with some difficulties at first in remedying such long-continued and deep-seated errors; but if our *principles* of action be sound, their tendency in practice will be to bring about the best possible state of affairs.

However the *details* may be arranged and carried out, it appears to me to be quite certain, that until the principles here maintained be acknowledged and be acted on, the British Indian empire can never be in a sound or satisfactory state.



I have studied the subject with all the patient research and observation, and with all the power of thought, I could bring to bear on it. I have had, in practice, opportunities of applying, on a tolerably extensive scale, the principles which I advocate, such as have fallen to the lot of few men living. They have never failed of success. They are of universal application, being founded on natural laws; and, if carried out fairly in India, they would speedily render our Asiatic soldiers quite as trustworthy as their European brethren in arms.

THE GOODNESS OF THE SEPOY DEPENDS ON WHAT HIS ENGLISH OFFICER INSTILS INTO HIS MIND.

THE RAW MATERIAL HAS NO POWER FOR GOOD, AND VERY LITTLE FOR EVIL.

The native Indian soldiers are to us collectively exactly like the limbs of our bodies individually. They are the bones and muscles of the whole frame, of which the Europeans are the brains and nerves; and when the latter are healthy and vigorous, the former will always be perfectly obedient, and strong only to do our bidding.

Our system has paralysed the brains, and it is not surprising that the limbs should have lost all healthy vital force, and be moved about convulsively under the action of any external influence to which they may be subjected.

---

#### SCHEME.

The Queen of England formally to assume the style and title of Empress of India.

The armies of the several Indian presidencies to be henceforth styled the royal armies of India.

In each of these armies, the whole of the European officers of the cavalry and infantry of all ranks, and the European officers of the artillery and engineers above the rank of colonel, to be formed into one general gradation list, in which, under ordinary circumstances, all will rise by seniority.

Rank in this list to be the only permanent rank; all regimental and other rank being temporary only, and to continue only so long as officers may be serving with regiments, or be otherwise actively employed.

In case of officers being promoted for good service, &c., by the Queen, they are to take their places in the general gradation list according to the dates of their promotions, and to enjoy every advantage, exactly as if they had risen to such places by seniority only.

This general gradation list to be styled the "unemployed list." All the officers borne on it, who may hold no special appointments, will reside in India at such places as Government may direct, but will perform no public functions.

A fourth presidency and fourth army to be added to India; our Bombay and Bengal armies together being divided into three equal parts for this purpose. The new presidency and army to be styled the North-West presidency, &c.

The whole establishment of European officers may be somewhat less than at present; but under the proposed arrangement the number of officers to form the whole general list can readily be adjusted in practice to meet the demands of the public service. When

these are once correctly ascertained, no further change will probably be requisite.

For an army of the strength of the present army of Bombay, the following establishment might be proper :—

No.	Battalions or Regiments.	Colonels.	Lt. Cols.	Captains.	Lieuts.
5	Artillery .....	5	10	50	50
4	Engineers.....	4	8	40	40
3	Cavalry .....	3	6	30	30
33	Infantry .....	33	66	330	330
45	Totals .....	45	90	450	450

Generals 5, Lieutenant-Generals 10, Major-Generals 15.

The ranks of Major and Ensign to be abolished.

The several ranks of officers while unemployed in India to receive pay as follows :—

Generals .....	Rs. 1,500	per mensem.
Lieutenant-Generals .....	„ 1,200	„
Major-Generals .....	„ 1,000	„
Colonel .....	„ 600	„
Lieutenant-Colonel .....	„ 400	„
Captain .....	„ 300	„
Lieutenant .....	„ 200	„

These rates of pay to be received wherever residing, by permission, in India, and the like number of pounds per annum being allowed to each while absent from India on leave to Europe. The option of retiring on full pay of the rank attained to in the general list to be allowed after thirty years' residence in India, and after twenty years on half-pay. Leave of absence to be granted at the discretion of the local Governments.

No distinction to be made with regard to leave on account of ill-health or of private affairs.

Subscriptions to military and all other funds to cease to be compulsory.

A distinct and separate civil service to be prospectively abolished.

All candidates appointed to the Indian service to be educated at a military college in England, and to reside at such college for at least two years, and not more than four years. The minimum age for admission to be fourteen, and the maximum eighteen years.

The course at the college to include full instruction in mechanical and physical science generally, and in political economy; also riding, rifle practice, and hardy exercises.

The residence at the college to be free of all pecuniary charge to the cadet, unless he decline proceeding to join the service in India in due course; in which case, to cover all cost to the State, he should pay at the rate of 100*l.* per annum for the period during which he has resided at the college.

From the general list, formed as above mentioned, officers are to be selected for every species of public employment, civil and military.

For each native Indian infantry regiment the establishment of English officers may be as follows; the pay assigned to each being in all cases staff pay, to be drawn in addition to the pay due to each according to his rank in the general list. But though an officer may hold a lower rank on the general list than that which is assigned to his position in a regiment, &c., the temporary rank is always to hold good for precedence and command during the period of employment.

*For a Native Indian Regiment.*

1 Colonel .....	Rs. 600	} Regimental pay, in addition to unemployed pay, as per rank in general list.
1 Lieutenant-Colonel .....	" 400	
2 Captains (to be Adjutant and Quartermaster) each ... ..	" 300	

For the cavalry, the like establishment to be allowed, with an allowance of one hundred rupees per mensem extra to each rank, to meet the cost of horses and other expenses.

*For the General Staff of the Army.*

1 Major-General, to be Adjutant-General of the Army, with staff pay .....	Rs. 1,500
1 Colonel, to be Deputy Adjutant-General .....	" 500

And the like for the Quartermaster-General's department.

*For a Brigade of any strength.*

1 Major-General .....	Rs. 1,000	Staff pay.
1 Captain (Major of Brigade) .....	" 400	" "

*For a Division.*

1 Lieutenant General .....	Rs. 3,000	Staff pay.
1 Lieut.-Colonel (Adjutant-General) .....	" 400	" "
1 " (Quartermaster-General) .....	" 400	" "
1 Captain (Aide-de-Camp) .....	" 300	" "

Proper office establishment, &c. &c., to be allowed to commanding and staff officers. Company allowance, &c., as usual.

All officers, when absent on leave beyond the division in which they may be serving, are to receive unemployed pay only; and, if other officers act for them when absent, even within the division, otherwise than on duty, the like rule is to be in force; the officer acting for the absentee receiving his staff pay in addition to his own.

Officers of the rank of Captain on the general list to be considered eligible for selection for any of the

higher regimental ranks. Lieutenants on the general list are not to be considered as eligible for higher regimental or other active employment than the rank of Lieutenant-Colonel.

At their own request, and with the approbation of regimental commanding officers, any unemployed officers may be attached to do duty with regiments, without extra pay.

The recommendations of officers commanding regiments, with respect to the appointment of officers to fill vacancies in their corps, or to their removal therefrom to the unemployed list, in consequence of proved incapacity, to be attended to.

All enlistments, discharges, promotions to, and reductions from, every rank, of native officers and soldiers, are to rest with the Colonels of regiments, and are to be signified by them, with reasons, &c., if necessary, in regimental orders.

Articles of war for native Indian troops to be entirely abolished.

Colonels commanding native regiments to have full magisterial authority over all ranks of natives in their regiments, soldiers, and followers.

The extent of such powers to be the infliction of imprisonment with hard labour for a period of seven years, without the confirmation of higher authority being required; to imprisonment with hard labour for fourteen years, subject to the confirmation of the General Officer commanding the brigade; to transportation or capital punishment, subject to the confirmation of the General commanding the division or field force.

Regimental Lieutenant-Colonels and Captains are likewise to have magisterial powers, under the control of the Colonel commanding the regiment, and to such extent as he may think proper to authorise. In all cases involving the award of a graver punishment than three months' imprisonment with hard labour, the infliction of a corporal punishment of twenty-five lashes, or of a fine above fifty rupees, regular proceedings of the trial are to be recorded in full, to be laid before the General Officer commanding when required.

Cases of less serious nature may be dealt with summarily, on due investigation by the commanding officer at public orderly-room; a record of all such summary proceedings being kept in a book provided for the purpose, for the inspection of the General Officer commanding.

Colonels of regiments are to be held strictly and solely responsible to their superior officers, and to the State, and not to the native Indian soldier, for the propriety of such proceedings.

Permanent head-quarters to be established for each regiment, and carriage to be kept up at all times.

For the European infantry, the establishment of officers per regiment may be—

1 Colonel.....	Rs. 600	Staff pay.
2 Lieutenant-Colonels, each .....	400	„
10 Captains, each .....	300	„
1 Adjutant .....	300	} To rank above the Lieutenants.
1 Quartermaster .....	300	
10 Lieutenants, each .....	200	

#### *Artillery.*

Artillery and Engineer officers each to be in a separate general list, up to the rank of Colonel

inclusive, and thereafter to be incorporated into the general list of the whole army, the senior Colonel of artillery or engineers, when senior in the army, being promoted to Major-General as vacancies may occur.

Unemployed pay to be the same for all arms. Employed pay, whether regimental or ordnance, &c., to be allowed as for the cavalry.

Each battalion of artillery to have field officers and staff as for a European regiment, the number of Captains and Lieutenants being regulated according to circumstances, to the number on leave, and required for the ordnance and other professional staff services.

All artillery officers in India to be considered as "employed" when not on leave.

In the ordnance department the rank and pay of the various grades to be adjusted as follows:—

Senior Commissary.....	as Colonel.
"    Deputy .....	as Lieutenant-Colonel.
Commissaries of Divisions .....	as Captains.
Assistant    "    " .....	as Lieutenants.

### *Engineers.*

Engineer officers, attached to the engineer corps, or holding other military appointments, to be on the same footing as artillery officers. But the duties of engineer officers generally in India are purely civil, and their salaries, &c., must be adjusted specially for each appointment.

In all appointments other than military, officers will receive their unemployed military pay in addition to such emolument as may be assigned to them in their civil capacities; and when absent on leave, or



on any account other than public duty, beyond the range of their immediate superior, they will receive only the unemployed rates of pay.—(October 1857.)

REPLY TO SOME OBSERVATIONS ON THE SCHEME OF  
REORGANIZATION.

The objections which you mention to my proposed arrangements for the reorganization of the Indian service are such as have frequently been adduced against such proposals.

I think that such objections have been brought forward by myself, when considering these matters in my own mind, even more strongly than they have been urged on me by others.

I think also that I have discussed them fully; and however formidable they may at first sight appear, it seems quite certain that these objections are without real force; and, indeed, that they rather point to advantages than to defects, to strength rather than to weakness. Their sum total appears to me to amount to this—where there is life there is also liability to disease. But, while admitting this to be self-evident truth, we surely need not conclude therefore, that, in order to prevent disease, it would be well to allow of no life.

The stock of power which in the case in question—the Indian administration—we have to apply to the work before us, is the *total amount of the moral and intellectual faculties of the English gentlemen in the service.*

Whatever tends to lessen the higher mental attributes and the general energy of mind of these English

gentlemen, does in like proportion *diminish* our administrative, our ruling forces ; and whatever tends to produce misapplication of existing individual attributes and energies, in like manner uselessly *wastes* our disposable administrative power. In the organization existing at present in the Indian service, these defects are essentially inherent to a ruinous extent. Moral growth, and the development of mental power and of cultivated individual energy, are systematically crushed. Natural forces are never recognised or thought of, and mechanical regulation is ever substituted for vital power. SUCH ARRANGEMENTS CANNOT ENDURE.

There is no LIFE in our present system ; there was none in it from the first : and the whole structure has now fallen to pieces before the eyes of the world.

The stoutest prop of dead timber will, after a while, decay and fall down ; but each single little grain, even of mustard seed, contains in itself a *living principle*, which may expand and grow and reproduce for ever !

One of the greatest evils of our present system is, that its long continued habitual action has so obscured the judgment of many of our best authorities, that the very defects which have been produced by it appear to them to be reasons for its continuance.

Our system has crushed the life out of the minds of our officers, and destroyed individual power ; and now it is said that we cannot change this system *because* individual force of character is wanting, and we can find no living men fit to exercise the powers with which it is proposed to entrust them. This is

exactly equivalent to saying that slaves are unfit for freedom, and therefore slavery must continue.

The decisive answer to this is, that the objection refers to an evil of an ephemeral nature only, which must speedily disappear before the remedy proposed, —to an evil which is indeed caused solely by the measure it is proposed to alter.

Slaves may often be unfit for freedom; but the existing slaves are individuals only, who will soon disappear from the scene; while the action of the proposed remedy is perpetual. Establish freedom, and men will become worthy of being free. Few men by nature may be fit to command others; but let our system be such as to TEND TO DEVELOP, instead of to destroy, commanding power, and a sufficient supply of such power will not long be wanting. In the administration of a great empire, useful employment can always be found *for men of every capacity, high and low*. The great thing is to get men into their natural places, where they *can feel themselves useful*, and justly respect themselves. They will then continually grow in mind, and daily acquire more and more power to command themselves, and others. This applies to high and low, without exception. The proposed condition is one of health, and must add to individual power. Let it never be forgotten, THAT THE POWER OF BEING COMMANDED IS ESSENTIALLY THE SAME AS THE POWER OF COMMANDING; even as the corpuscles of a living body are most vigorously alive *when they most completely conform to the general life-current which pervades the whole frame, and to which they contribute*. The power of being commanded is not the

mere blind submission of an inanimate substance to external impulse, but a living and powerful force, *which contributes greatly to the controlling power of a living HEAD*, but which has *no* existence under blind and dead mechanical regulation.

*We have few men able to command, and NO SUCCESSION OF COMMANDERS, BECAUSE we strive to command by crushing the individual power of those under us.*

The organization which I propose to introduce would effect two objects of vast importance: it would create a strong *tendency* to cultivate, to draw out, to expand, and to increase, moral power and mental energy generally; thereby giving us a very great, and continually increasing, *addition to the total amount of administrative and governing forces at our disposal.* It would also cause a strong tendency to such adjustment as would place every individual in that position in which his powers could be *most usefully applied*; thereby enabling us to produce, with the forces at our disposal, the greatest possible effect. It is the CREATION OF SUCH TENDENCIES, such LAWS OF PROGRESS, —to keep continually and silently acting in our system,—which appears to me to be of paramount importance. The mustard seed principle should be continually thought of in such matters. *It will indeed remove mountains!* We are always inclined to over-government—it is the greatest evil in India: we cannot bear to leave anything to natural forces, and to the action of living principles; but must have a blind, unyielding, unexpanding regulation for everything. Nothing can live by such regulation! We should rather confine our attention to removing

obstacles to natural development, and to the action of natural law.

*We should expect to meet with all manner of absurdities and extravagancies and disorders AT FIRST under the system which I proposed.* A very great number of the men trained and habitually formed under the old system would probably not be able to work under the new; as their unfitness became apparent they should be removed elsewhere, or got rid of altogether.

Gradually, things would become better and better, till the best possible condition of affairs had been arrived at; when mighty energies under perfect control would everywhere appear.

Our administrative machinery may, I think, well be likened to the steam-engine. Our apparatus is old, weak, and badly adjusted; and instead of improving the working-gear as it became unable to bear a strain on it, we have nearly extinguished our fires, and reduced the steam so low, that the engine can only just move itself, and can do no work at all: there may be no danger now of anything breaking, even as not a farthing can pass the Indian audit office—but THERE IS NO POWER.

I would do with the machine of the State as with the engine.

Stoke the fire, and get up the steam a little. The old engineer would probably exclaim that the boiler would burst, and the engine go to pieces. The reply might be, very possibly—they may do so, for there is a lot of rotten stuff in them; but we will go quietly to work at first, and we will soon restore each part

which may fail. The steam being now turned on, the worn-out old nuts, bolts, rods, and valves probably begin to break, and fly off in every direction; and perhaps the triumph of the old party might be completed by a plate flying out of the boiler, and putting the fire out altogether. But the WORKMAN, the real engineer, nothing appalled, would say—all this I was prepared for: this is just what we wanted: we now know where the weakest parts are, and will soon put all to rights. Accordingly, under his directions, on goes a stout plate to the boiler; valves, rods, and bolts, of due strength, are all speedily in their places; and the engine in a few days is again in motion, as smoothly and as easily as ever, *but now with full power, and doing an infinity of work.*

The analogy appears to me to be complete, and exact.

The principles advocated by me appear to be natural laws: I cannot conceive that they *could* fail of success when fairly acted on.

I have applied them myself for fifteen years together, on every occasion and at every opportunity: they have never failed of complete success; although, in every instance, almost all men were against me; and those supposed to be the ablest authorities looked on my proceedings as little short of madness—“Utopian nonsense.”

There is an order of mind which cannot conceive how the earth can be held to the sun without some such contrivance as a chain cable. But we know that the most powerful forces are those which are least apparent to our vulgar senses. The smallest seed re-

presents a greater force than the heaviest and most massive rock.

I should be obliged if you would again look over my "Observations" on the Reorganisation Scheme; I condensed them and made them as short as I could; but I think you will find that all real difficulties are satisfactorily disposed of.—(*December 1857.*)

---

## A D D E N D A.

---

### SECURITY FOR THE GOOD CONDUCT OF RECRUITS.

\* \* \* You are aware that during many years it has been our practice to require security from two silidars for the good conduct of every recruit enlisted. This security is absolute; to the end that the securities deem a fault committed by the soldier for whom they are responsible as chargeable against themselves. The advantages of this system are at present being curiously illustrated, by the fact that the men of the two regiments already formed cannot be induced to go security even for their own relatives in Hindoostan, who are desirous of entering the third regiment, and from whom they may have been separated during the past two years. Many applications have been made to our silidars for such security; but the reply has been—"No; it is true you were loyal when we parted. But God knows what may be in your hearts now. The times are treacherous. Come first, and show what you are, and what you have been doing, and then we may agree!"—(1857.)



ORDER RELATIVE TO THE MAHOMEDAN FESTIVAL OF  
THE MOHURRUM.

[*Note by the* EDITOR.—The subjoined order was issued by General Jacob in 1854, in a camp adjoining a town where some ten thousand Mussulmans resided. Yet no murmur or dissentient voice was heard; and the Mussulman soldiers, whom the order affected, have not only themselves abstained from infringing the command during subsequent years, but have, by their example of cheerful obedience, prevented a corps of Bengal irregular cavalry, recently stationed in the same camp, from attempting any infringement of it also.

The order directly interferes with the religious ceremonies of the natives. Yet it was felt by the men to be based not on mere regulation, but on reason, and cheerfully obeyed accordingly; for they felt that the sole relation between a military commandant and his soldiers is the military relation.

A discipline which so controls and guides the minds of men, while developing and increasing their individual power and sense of freedom, must absolutely be founded on true and lasting principles—principles which, if applied to our Indian armies, would add tenfold military power to our arms, at one-half the cost to the State.]

---

The camp at — has been, for the last week, the scene of wild disorder, such as is in the highest degree disgraceful to good soldiers.

A shameful uproar has been going on day and night, and this under the pretence of religious ceremonies.

The commanding officer has nothing to do with religious ceremonies.

All men may worship God as they please, and may act and believe as they choose, in matters of religion ; but no men have a right to annoy their neighbours, or to neglect their duty, on pretence of serving God.

The officers and men of the —— have the name of, and are supposed to be, excellent soldiers, and not mad fakeers.

They are placed at the most advanced and most honourable post in all the Bombay presidency. The commanding officer believes that they are in every way worthy of their honour, and would be sorry if, under his command, they ever became unworthy of their high position.

The commanding officer feels it to be the greatest honour to command such soldiers, but that it would be a disgrace to be at the head of a body of mad and disorderly fakeers and drummers.

He therefore now informs the ——, that in future no noisy processions, nor any disorderly display whatever, under pretence of religion, or of anything else, shall ever be allowed in, or in the neighbourhood of, any camp of ——.

This order is to be read on the first of every month until further orders, and is to be hung up in the bazar in the town of ——, and at the kutcheree.  
—(1854.)

# INDEX.

## A.

Accountants, village, restoration and duties of, 73 ; the connecting-link between Government and the cultivator, 74 ; necessary qualifications for, 74 ; salaries to, 74 ; who should pay them? 74 ; bearings of, and reply to, the question, 75.

Administration, civil, 1, 419-424 ; military, 93, 419-424 ; of the North-West frontier of Sind, 349 ; scheme for the re-organization of the Indian army, 425-431.

Advice, to a native prince, 369.

Afghanistan, state of, in 1839, 287 ; invasion of, by Persia, 375 ; friendly to the British, 377 ; changes in, within the last ten years, 392.

Afghans, the, as recruits for our armies, 371 ; their character, 372 ; their appearance, and conduct in times of danger, 374 ; subsidising of, 380, 381.

Agriculture, artificial encouragement to, impolitic, 71 ; its sole legitimate stimulants, 71.

Ahmed Khan Mugsee, Sindian chief, 334.

Alif Khan, and his intrigues with Boogtee settlers, 325.

Alim Khan, Boogtee chief, 307, 326.

Ali Moorad, Meer, rendezvous of marauders in his territory, 323 ; takes part in Sir C. Napier's hill campaign, 334.

Amiel, Lieutenant, and his Belooch horsemen, 298, 300.

Anglo-Saxon, the, contrasted with the Oriental, 1, 427 ; the dominant race in India, 2 ; deteriorating in Bengal, 101, 117, 419, 421, 428.

Apparatus, for army rifle, 275.

Arabia, purchase of horses in, 214.

Arabs, 405.

Arkwright, what his spinning machinery has done for England, 234.

Armies, of Bengal and Bombay : comparison between the systems obtain-

ing in, 117 ; normal condition of the Bengal army a state of mutiny, 117, 122 ; Bengalee idea of the cause, 117 ; the true causes, 118, 123 ; state of affairs in the Bombay army, 119 ; seniority system of promotion in Bengal, 119 ; drilling, 120 ; proportions of European officers requisite with European and native troops, 120, 121 ; example in the Sind Irregular Horse, 122 ; discipline and character of that corps, 122 ; state of affairs in Bengal extending to Bombay, and why, 123, 212.

Armies of England : remarks on the true principles of their organization, 93 ; supply of soldiers how regulated, 95 ; inducements and rewards to be adopted, 96 ; the Ironsides of Cromwell an English sildar corps, 97 ; source of their excellence, 97 ; present military system, and its operation, 98 ; chief evil a special code, 99 ; working of the military code, 99 ; natural qualities of British soldiers, 100 ; what their military education has done for them, 100 ; present system must be abandoned, 101 ; base for new arrangements, 101.

Armies, recruits and recruiting for, 98, 108, 133, 371, 447.

Arming a free people, remarks on, 93 ; a large standing army unnecessary, 93 ; legitimate object how to be attained, 93 ; the English people of old really warlike, 94 ; might again be made so, 94 ; description of Government necessary for such a people, 95 ; system dangerous to despotisms, 95 ; supply of soldiers how regulated, 95 ; lesson from the manufacturer, 95 ; application of it, 96 ; principles to be adopted in organizing an army, 96 ; Cromwell's soldiers, 97 ; how to improve present material, 98 ; no special laws necessary, 99.

Arms, training in the use of, 94 ; of irregular cavalry, 151 ; the sepoy's

- musket, 223 ; cavalry swords, 224 ; rifles, 228, 233, 275.
- Army, native of India :** remarks on its state and efficiency, and the means of remedying its existing defects, 124 ; the subject long ago discussed, 124 ; defects of the present system, 124 ; principle of discipline the sepoy best understands, 125 ; want of power in regimental commanders one enormous evil, 124, 126 ; unselected European officers another, 126 ; influence of English officers with sepoys, 126, 431 ; imitation of European follies unwise, 128, 203 ; its effects on efficiency, 129 ; example of the "regular" system, 129 ; common-sense recommended, 129 ; principles to be regarded in the appointment of European officers, 130 ; Sir John Malcolm's proposition, 130, 134 ; plan proposed for the Bombay army, 131 ; how its principles might be better followed out, 132 ; result of such arrangements, 133 ; the Mussulmans of Hindoostan the best men for the army, 133, 214 ; example of their qualities, 133 ; the Indian army might be employed abroad, 134 ; re-consideration of Sir J. Malcolm's proposition, 134 ; vices of the seniority system of promotion, 211 ; scheme for reorganization, 425-431.
- Army, of Bengal :** its defects and indisciplinable manifold and glaring, 101 ; motives for exposing them, 102 ; the most serious faults, 102 ; first fault, conduct of English officers in dealing with Asiatics, 102, 103 ; principal cause, 103 ; another cause, 104 ; remedy, 104 ; second, third, and fourth evils, position of commanding officers, system of payment, and conduct of messes, 102, 103, 106 ; remedy in the hands of Government, 107 ; fifth evil, absence of confidence between officers and sepoys, 103, 108 ; sixth evil, the caste system, 103, 108 ; its working and effects, 109 ; the Bombay system, 110 ; one great excellence of the Bombay sepoy, 110 ; comparison of the Bengal and Bombay sepoys, 111 ; remedy for the defect, 112 ; seventh evil, the bad system of promotion, 103, 112 ; its effects on the private soldier, 112 ; equally baneful with the native officer, 113 ; difference under a proper system, 113 ; maintenance of the semblance of an army wonderful under the Bengal system, 115 ; eighth evil, want of discipline, 103, 115 ; guard-mounting in Bengal, 115 ; remedy for the evils apparent, 117 ;—source of greatest danger to our Indian empire, 229.
- Army rifle,** description of best, 275.
- Articles of war,** injurious to irregular cavalry, 158.
- Artillery, horse, and cavalry charges,** 228 ; bullock, in the Kutchee hills, 305, 311, 315 ; proposed establishment and pay for, 437.
- Asia, Central,** great commercial road of, to the ocean, 46, 379.
- Asiatics, desiderata in dealings with,** 2, 102, 103, 415, 416, 424, 426.
- Assamees, property in,** 139, 173 ; prices of, 144, 172 ; rules respecting, in the Sind Horse, 171.
- Assessment on land, in the North-West Provinces,** 55-57 ; in Sind, 59 ; in the Frontier District of Sind, 367.
- Audit department, the, working of,** 219.

## B.

- Baggage Corps,** 193 ; camp supplies, 193 ; importance of their proper management, 193 ; rule to be observed respecting prices, 193 ; origin of the idea of a camel baggage corps, 194 ; establishment maintained, 194 ; period of its existence, and cost, 194 ; cost of commissariat arrangements, 195 ; men of the corps soldiers as well as camel-men, 195 ; result of this arrangement, 196 ; the corps useless for object contemplated, 197 ; circumstances under which alone such a corps could be maintained, 197 ; Bengal commissariat perfect, 199, 201 ; cause of Colonel Monson's retreat, 199 ; cost of the camel baggage corps experiment, 200 ; cause for its existence so long, 201 ; evils of the present carriage system, 201 ; scheme proposed, 202 ; benefits of such a system, 202 ; how success may be commanded, 202.
- Bagh, in Kutchce,** mission to the Khan of Kheiat at, 334.
- Balls, leaden, Jacob's rifle,** 233, 253, 270, 271 ; Minié, 241, 274 ; cannon, 245, 259 ; zinc-pointed, 255 ; iron-pointed, 255, 258, 275.
- Ball, rifle, explanation of difference between the Minié and Jacob,** 280 ; the Minié ball, 280 ; rifle and powder

- best adapted to it, 280, 281; the Jacob ball, 281; charge and barrel best for it, 281, 282; advantages of short barrels, 282; sizes of rifles, 283.
- Band instruments, military, 148.
- Banks, regimental, 155.
- Batta, field, recommended to be abolished, 202.
- Batteries, horse and bullock, 305.
- Beebruck Khan, head of the Boogtee tribe, 306, 309.
- Bejar Khan, and the predatory tribes on the frontier of Sind, 289, 295, 331; his surrender, 314.
- Bell, Mr., and the predatory tribes on the frontier of Sind, 287, 296.
- Beloochee horsemen, cowardices of, 298; scouts, 358, 360.
- Beloochees, fights with, 298, 299, 301, 310, 343, 358, 360; a ruse by, 303; treachery, 307; settlement at Janadeyra, 318, 321; plundering excursions, 321, 322; disarmed and set to work, 324, 325; leaders slain at the action of Zemanea, 345; as recruits for our armies, 371.
- Beloochistan, wild tribes of, 287; invasion of, by Persia, 375; disposition towards the British, 379.
- Belooch Khan, the head of the Doombek-tee tribe, 288, 297.
- Bengal, army of, its defects and indiscipline, 101; compared with that of Bombay, 117.
- Billamora, Major, and proceedings on the frontier of Upper Sind, 297, 298, 302, 307, 309; field force order by, on the conclusion of the campaign, 326; thanked by the Brigadier commanding in Upper Sind, 327.
- Blood-feuds, measures adopted respecting, in Upper Sind 363, 365, 366.
- Board, military, its attributes, 219.
- Boian, the pass of, the grand natural outlet to the ocean of the commerce of Central Asia, 46; road through it, 379; proposed arrangements for a British force above it, 385, 393.
- Bombay, army of, compared with that of Bengal, 117; supplies from, for the Persian expedition, 413; efficiency of its commissariat arrangements, 413.
- Boogtees, of Kutchee, 288, 306, 394; fights with, 151 *note*, 308, 310, 311, 325, 343; proclaimed outlaws, 318, 319, 338; successful incursions across the British border, 319, 321; signal punishment, 325, 338, 341, 360; surrender of the chiefs, 325; final disposal of the tribe, 326.
- Boordeeka, 357, 360.
- Boordee tribe, marauding propensities of, 318, 322.
- Borderer, attempt by a, to raise a rebellion, and its results, xv. *note*.
- Border, the, of Upper-Sind, protective measures for, 356-362.
- Brahmins, their influence in the Bengal army, 109; in the Bombay army, 110, 119.
- Brahooees, as recruits for our armies, 371; their characteristics, 372, 374.
- Breeches, leather, *vs.* cloth pantaloons, 227.
- Bridges, methods of constructing, 35, 36; pavements to, 35; preservation of roadways of, 35; in Upper Sind, 357.
- Brigade, orders, 327; establishment and salaries recommended for officers of, 435.
- British, the, secret of their rule in India, 1; contrast of races, 1, 427; natives grateful to benefactors, 1; mistrustful of equals, but submissive to superiors, 2; basis of British power, 2; how it may be firmly established, 2, 3, 16, 427; how hopeless and vicious, 2; England powerless in evil, 2;—proceedings in the hills north of Kutchee, 287; position in India, 377, 397.
- Brown, Captain Lewis, of Kahun, and proceedings in Kutchee, 296, 300, 304, 309.
- Brown, Mr. E. J., and his mission to the Khan of Khelat, at Bagh, 333; escape from robbers, 333; description of Kutchee by, 334; directions respecting the treatment of Boogtee marauders, 338.
- Bunder Abbas, 402, 404.
- Bunds, protection of, by contracts, 76; public expenditure on them unsatisfactory, 76; they should be watched and guarded, 76; contracts for their maintenance should be invited, 76; rules relative to their preservation, 77.
- Bunyaa, their relations with cultivators, 70; their connection with robbers in Upper Sind, 359.
- Burke, Edmund, an authority for non-interference with market prices, 24.
- Bushire, 402; as summer quarters for troops, 408, 411; should be retained by the British, 410; water supplies at, 411; as a point embarkation, 415.

## C

- "Calcutta Review," remarks on an article in, entitled "Hints on Irregular Cavalry, &c.," 135.
- Camel Baggage Corps, 194.
- Campaign, first, in the hills north of Kutchee, 287; appendix to the memoir, 326.
- Camp supplies, 193.
- Canals, clearing of, 26; to the Indus, from Kurrachee, 40; effect of removing dams from, 79; excavation of, by robber tribes, 324, 355.
- Candidates, for enlistment, in the Nizam's service, 141; for the Sind Irregular Horse, 180, 221; for the Indian army generally, 221; education of, for the Indian services, 434.
- Cannon, rifled, ranges of, 245, 258; shot and shell for, 245, 258, 275.
- Carriage, remarks on the supply of, 84; plan adopted at Jacobabad, 84; interference with market rates condemned, 85; first effects of the withdrawal of restraint, 85; no remedy but conforming to natural laws, 86; instance, 87; the only wise principle to be established, 87; troops should always be ready to move, 88; effect of such a healthy system, 88; different workings of the systems under discussion, 89; difference of cost, 89.
- Case for army rifle, with apparatus, 275.
- Caste, the bane of the Indian army, 103, 108-117; has no real connection with religion, 220.
- Cavalry, for transport by sea to the Persian Gulf, 406; should be complete, 406; native regular cavalry best for such service, 406; European cavalry in the way in Persia, 407; a source of weakness, 407.
- Cavalry, native, best men for, 133, 142; the 3rd Bombay Light Cavalry in Persia, 134; Bengal and Sind Irregulars, 135; men of the Nizam's service, 144, 161; rates of pay of, 147; the Bombay army, 147; debt ruinous to, 146, 150, 157; arms for irregulars, 151; Skinner's horse and the Brahocees, 152; Sind Horse at the fight of the Zemanee, 151 *note*, 343; Bengal irregulars, on the Sind frontier, 185; swords, 224.
- Caucasus, the, Russia in, 375, 405.
- Chancery, the Indian court of, 38.
- Chapman, Lieutenant, canal proposed and planned by, in Sind, 45.
- Character, European, should be upheld in India, 2, 3; influence of personal character, 16; of Englishmen deteriorating in India, 102-117, 421, 422, 440.
- Charges, horse artillery and cavalry, 228; of cavalry irresistible, 230.
- Chinnee creek, reclaiming of, 40.
- Christianity in India, 8, 423.
- Chuttur, the town of, in Kutchee, 288, 291.
- Civilisation, advance of, amongst robber tribes, 4, 818, 321, 324, 363.
- Clarke, Lieutenant, and his horsemen in the Kutchee hills, 299, 302, 308.
- Clibborn, Major, at Nuffosk, 315.
- College, proposed, for candidates for the Indian service, 434.
- Commissariat, how to be maintained efficient on service, 193; cost for moving troops, 195; perfection of arrangements in Bengal, 199, 201; effects of defectiveness, 199; efficiency of the Bombay establishment, 413.
- Commissions, military, as courts of civil judicature, 83; re-hearings of trials, 83; the trials a mere pretence, 83; a great desideratum, 83.
- Committee, proceedings of, on pattern army rifle, 248.
- Communication, overland, with India, 404.
- Companies, flank, and sizing, bad in principle, 222.
- Confessions, to policemen, 83; should be discouraged, 84; the magistrate alone competent to receive them, 84.
- Constantinople, Russian schemes towards, 377.
- Contracts, for repairs of roads, 37; ferries, 41; protection of bunds, 76; canal-digging, 80.
- Copland's Med. Dict., quotations from, 205.
- Corry, Lieutenant, and campaigning in Upper Sind, 293, 294.
- Cossacks, Afghans proposed for the work of, 381.
- Courts martial, European forms of, unsuitable for the native army, 125, 129, 158; injurious to irregular cavalry, 158; unknown in the Sind Horse, 158.
- Cotton, Sir W., his opinion of the Sind Irregular Horse, 187.
- Courts of justice, military commissions as, 83; proper courts one of the greatest wants, 83.
- Crimea, the withdrawal of the British from, 375.
- Cromwell's Ironsides, an English sili-dar corps, 97, 187.

Cultivation, increased, followed by more abundant rain in the desert, 80; instance in proof, 80.  
 Customs dues, 52.

## D

Dadur, Skinner's Horse at, 152; railway from, to the sea, 380.  
 Dams, effect of removing, 79; projecting of off-shoots from canals, 79; determination to remove them, 79; fears entertained by landholders, 79; results of the measure, 79.  
 Deen Mahomed Kyheeree, repulse of marauders at Kundrahee by, 346.  
 Desert, the, taxation of, 78; its produce, 78; main object in dealing with the tribes of, 73; effects of increased cultivation in, 80; mistakes respecting its breadth, 335 *note*.  
 Detachments, frontier, of the Sind Horse, strength of, in 1847, 356; plan for the relief of, 361.  
 Deyra, the chief town of the Boogtees, 288; expedition to, 305; description of the place, 306; taken possession of, 309.  
 Dil Morad-ke-Ghuree, outpost of, 361.  
 Discipline, in the Bombay army, 111, 117, 118; want of in Bengal army, 115, 118; essential for its maintenance, 184, 188; effects of the seniority system on, 211; example of the working of a sound system, 448.  
 Disease, malignant, amongst horses, 181.  
 Districts, the frontier, of Sind, proceedings in, 287, 317; principles of procedure, 349; summary of arrangements made, 353; protective military systems, 356; disarming of the population, 358, 362; dealings with marauders, 364; standing orders for frontier posts, 367; assessment of land, 367.  
 Division, officers and pay proposed for a, 433.  
 Doombkee tribe, of Kutchee, 288, 365, 394; their towns, 288, 291; fight with them, 299; their settlement at Janadeyra, 318, 321, 352.  
 Dost Mahomed, horsemen of, at the battle of Goojerat, 373; his friendliness to the British, 378.  
 Dress of soldiers and sepoy, 100, 115, 128, 132, 164.  
 Dues, customs and pier, 52; pier fees should be abolished, 52; duty on machinery and goods, 52.

Dundas, Sir H., on guard-mounting, 116; on the Sind Horse, 184; despatch from, respecting the destruction of Boogtee robbers by a detachment of the Sind Irregular Horse, 340.  
 Durya Khan, chief of the Jekraneees, 291; his surrender to politicals in Upper Sind, 314.  
 Dust-storms, of Eastern Kutchee, 292.

## E.

Education, in engineering, &c., objects of, 54; proposed college for candidates for the Indian service, 434.  
 Elevations, scales of, for the sights of Jacob's rifles, 278.  
 Eley and Brothers, recommended as cap and tube-makers, 278.  
 Empire, Indian, 299.  
 Enayut Shah, of Shahpoor, 291.  
 Enfield rifle, the, and Minié ball, 282.  
 Engineer corps, the proposed organisation of, 438.  
 Engineering, 54; limiting of normal class scholars to Government employ. 54; objects in maintaining the institutions, 54; scholars in the districts, 55.  
 England, powerless in evil, 2; her export to counterbalance the revenue drawn from India, 15; Indian officers in, 207; what Arkwright has done for her, 234; work before her in India, 419, 421.  
 Euphrates, valley of the, and Russian policy, 403.  
 Examinations, 9; objections to our competitive examinations, 9; to civil service tests, 10; to the one test for all appointments in India, 11; a knowledge of the language widely different from a passed examination in the vernacular, 11; no need for such passing, 13; system of selection must be adopted, 14, 423.  
 Expeditions, into Eastern Beloochistan, 287, 292, 294, 304; to Persia, 401, 403.

## F.

Fairs, proclamations of, 50, 223.  
 Fees, at ferries, 41; for accommodation to travellers and traders, 49, 50; for the use of piers, 52; on grazing-lands, 71, 73.  
 Ferries, public, 41; farming of, an evil, 41; licensing an improvement,

41; perfect freedom the best plan, 42; experiment of freedom, 42; result, 42; ferry contracts, 42; approaches to ferries, 43.

Field force, frontier, proposed for the Bolan Pass, 387.

Flotilla, Indus, 53.

Forbes, Major J., and Bombay cavalry in Persia, 134.

Forces, natural, alone important, 8; simile for present proceedings, 3: the most powerful forces, 439-445.

Forests, conservancy of, 53; Government agency should cease, 54.

Fortifications, unnecessary in general, in India, 222; none on the frontier of Sind, 362.

Forts, destruction of, on the frontier of Sind, 354.

France, benefits of our alliance with, 376.

Frontier detachments, state of, in Sind, 185, 353-356.

Frontier, the north-west, of India, papers relating to, 52, 287, 317, 349, 375.

Frontier trade returns, 52.

Frontier tribes, 4, 287, 317, 325, 349, 356, 371-374, 388.

Fund, military, its effects on the army, and on society, 203; what it really is, 204.

Funds, regimental, 149; assamee, 171; military, 203.

Furloughs, effects of, on Indian society, 204; existing rules out of date and unfair, 204; a physiological fact, 204; authority for it, 205; effects of present regulations on English society, 207; sabbatical system recommended, 207; benefits of such an institution, 208.

G.

Garden and Son, directions to, for a saddle, 232; in connection with rifle practice, 262.

General orders, 335, 337. (

Ghizree Creek, 41.

Gibbard, Captain, trial of rifles by, 278.

Goldney, Captain P., and notice respecting Boogtee marauders, 338.

Goojerat, incident of the battle of, 373.

Goorka, the, as material for a native army, 133, 214.

Gordon, Brigadier, order by, on relinquishing command of the troops in Upper Sind, 327.

Goree Naree, 358.

Green, Colonel, reports by, on rifle practice, 270, 272.

Green, Lieutenant, rifle practice by, at Jacobabad, 264, 265.

Griffins, and griffinism, 104, 105.

Guffoor Mahomed, Jemedar, and the Sind Horse, in a fight with Boogtee robbers, 337.

Guides, Belooch, on the frontier of Upper Sind, 358, 367.

## II.

Hancock, Colonel, report by, on Jacob's rifle and rifle-balls, 271.

Hassan-ke-Ghuree, spies at, 358.

Head-quarters, fixed, for regiments, 96, 134, 169, 213, 437.

Herat, designs of Russia and Persia on, 376; as an English fortress, 377.

Hill tracts, pastoral, management of, 71; chiefly valuable as grazing-lands, 71; statistics desirable, 72; the people not to be compelled to resort to agriculture, 72; staple wealth of the districts, 72; best method of dealing with the inhabitants, 73; results, 73.

Hindoo Khoosh, the, in connection with the security of India from invasion, 377.

Hindoostanee, passing in, 11, 423.

Hindoostanees, the best material for native soldiers, 133, 214, 220; contrasted with Affghans, &c., as soldiers, 372; at the battle of Goojerat, 373.

Hoodoo, escape of Boogtee robbers at, 320.

Horse fairs, opinion on, 223; effects of proclamations of, 223.

Horses, compensation for, to irregular cavalry, 164; neglect of, 165; casting of, 167; unprecedented mortality amongst, 161; remarks on the purchase of, for military purposes, 214; Government agency injurious, 215, 223; cost, 215; plan recommended, 216; stud-bred, of India, worst of all, 217; a great mistake, 217; selection of breeders, 217; merits of different breeds, 218; property in, amongst the Belooch border tribes of Sind, 323.

## I

India, natives of, incapable of self-government, 1, 426; grateful, 1; mistrustful, 2; appreciate fairness



- and honesty, 2; ideas of their rights, 426.
- Indian empire, source of greatest danger to, 229.
- India, north-west frontier of, 287, 317, 349, 375; suggestions towards its permanent defence, 375, 401; British errors in Turkey, 376; the Persian quarrel, 375; Russian policy in the East, 375, 390; furtherance of her designs on India, 375-385; the present our time for action, 377; advantages of arrangements proposed, 377; Herat as an English fortress, 377; present position of the British in India, 378; opportunity for bettering it, 378; great routes into India, 378; disposition towards the British of the Affghans and Beloochees, 378, 379; the Bolan Pass, 379; the Khyber Pass, 379; Quetta as a position for a large force, 379; subsidy of the Affghans, 380, 381; raising of auxiliaries, 380; how to render invasion impossible, 379, 380; line of conduct to be observed in dealing with the Affghans, 381; presence of a British force necessary, 383; difference between present and former proceedings in Affghania, 383; Russian advance, 384; present frontier arrangements and remedy, 385; memorandum of proposed arrangements, 385; administration of the frontier district, 386; officers, 386; arrangements at Quetta, 387; frontier field force, 387; relations with Khelat, 388; advantages of an establishment at Quetta, 389; Khelat frontier stations, 389; real enemy of the British in Persia, 390; insufficiency of operations on the sea-board, 390, 402, 409; Persia and her Russian advisers, 390; Quetta should be occupied permanently, 391; the danger of delay, 391; Affghania during the war, and at the present time, 392; the question of posting a force at Quetta discussed, 393; communication with Sind, 393; the tribes of the country, 393; plunderers of Northern Sind and the Bolan, 394; country between Quetta and Sind, 394; principles to be applied in the proposed advance, 395; cost of troops, 395; arrangements for accommodation and provision, 395; commercial result of such establishment, 397; a financial view, 397; position of the "red line," 397; consequences of a war in India with a European invader, 398.
- India, observations on the present condition of, 419; recent occurrences long foreseen, 419, 421; causes of defects, 419; the work England has to perform, 419, 421; ability of the English to accomplish it, 420; confidence, and the forces in India sufficient, 420; opinion of the Persian field force, 420; its military power, 420; degradation of the European mind in Bengal, 421, 422; cry of the people of India and our reply, 422; our only opponents, 422; the supposed "props" of the falling empire, 423; the real props, 423; theory advocated, 423, 424; applicable in all circumstances, 424; example, 424; Asiatics and "passed" men, 424.
- India, reorganization scheme for its civil and military administration, 425-439; preliminary observations, 425; faults in the state of the native army, and their causes, 425; native idea of the rights of the subject, 426; our conduct towards the people, 426; regulations and articles of war, 427; absurdity and effects of the present system, 428; advantages of the proposed organization, 429; essentials to its successful working, 429; obvious objection, and remedy, 430; principles of universal application, 431; the sepoy and his officer, 431; proposed scheme, 431; general arrangements, 432; the "unemployed list," 432; establishment of European officers for an army, 433; pay, 433; leave, 433; funds, 434; civil service, 434; education of candidates, 434; number and pay of officers for a native regiment, &c., 434, 435; powers of commanding officers, 436; establishment and pay of officers for a European regiment, 437; artillery and engineer officers, 437; ordnance department, 437; appointments other than military, 438.
- India, reply to some observations on the proposed reorganization scheme for, 439; sum total of the objections, 439; stock of power for the work in India, 439; defects in applying it, 439; reply to objections to change of system, 440; evils of present system, 440; what the system should be, 441; two important objects to be accomplished by proposed organization, 442; first effects of the new system, 443; simile for administrative machinery, 443; successful application

of proposed principles, 444; the most powerful forces, 444.

India, secret of British rule in, 1; character of the natives, 2; general stock of power for government, 14, 439; native army of, 124; the north-west frontier of, 287; how to secure from invasion, 378-381; consequences of a war in, with a European invader, 398; scheme for the reorganization of its civil and military administration, 425-439.

Indus flotilla, the, beyond the sphere of the State's functions, 53; arrangements desirable, 54.

Indus, the, canal to, from Kurrachee, 40; railway to, 41.

Infantry, European, invaluable, 407; establishment and pay proposed for a native regiment, 435; for Europeans, 437.

Influence, moral, exertion of, amongst rude tribes, for securing labourers, 80; instance of the canal through the desert to Khyree Ghuree, 81; mode of procedure adopted in this case, 81; workmen employed, 81; how induced to labour, 81; the same principles of action recommended in future operations, 82.

Islam Khan, Boogtee, 306, 359.

J.

Jacobabad, rifle practice-ground at, 237; experiments on rifles at, 239; shell practice at, with 8-gauge rifles, 241; reports of rifle practice at, in 1854-55, 263; condition when first visited, 353.

Jacob, Captain (General), on the deterioration of the Bombay army, 123, 212; on the silidaree system of the Sind Horse, 141; on arms, 151, 223, 224, 233, 275; on baggage and animals, 190; reports on his rifle and rifle balls, 263-268, 273; his expeditions north of Kutchee, 293, 294, 296, 301, 304; settlement by, of the Doombkees and Jekraneees, at Janadeyra, 318; appointed to command the frontier, 320; measures adopted, 321; order, by, relative to the Moharrum, 448

Jalk, or Julluck, on the Khelat frontier, 389.

Janadeyra, settlement of robber tribes at 318, 356.

Janee, Belooch robber chief, 303; his surrender, 314.

Jan Mahomed Kyheeree, at the fight of the Zemanee, 344, 346.

Jekraneees of Kutchee, 287, 394; their towns, 288, 291; settlement of at Janadeyra, 318, 322-326, 356; surprise after a plundering excursion, 323; disarmed and set to work, 324, 358.

Jummal Khan, Doombkee chief, 317.

Jutts, tribe of, 292.

## K.

Kahun, the chief town of the Murree tribe, 288; expedition to 304, 311.

Kahur tribe, of the Bolan Pass, 394.

Kandahar, designs of Russia on, 376, 391.

Karoon, valley of the, and Russian policy, 403; should be annexed by the British, 405, 409.

Karrack, island of, the best place in the Persian Gulf for troops, 411, 412; water at, 411, 412; the best position for the British Resident in the Persian Gulf, 414.

Kars, effects of its fall on Persia and India, 375.

Kateychee-ke-Ghuree, difficulties of the country around, 312.

Khangur, state of the country around in 1847, 321, 353, 355.

Khelat, the Khan of, and his feudatories, 289, 330; manifesto of Sir C. Napier on his invasion of the Khan's territories, 330; relations with the British, 378, 380; resources, 388.

Khoords, the tribe of, ready to serve the British, 405.

Khyber Pass, the, in its relation to the security of India, 379.

Kyree Ghuree, canal at, 81; protection of the frontier from, 356.

Kirman, in Persia, 402.

Koonree, in Upper Sind, fight near, 344.

Kosah tribe, the, marauding propensities of, 318.

Kotree, as a site for a railway terminus, 44.

Kumber, guarding the frontier to, 360.

Kudranee, attack on, by Boogtees, 346.

Kurrachee, requirements of, as a port, 40; railway to the Indus from, 41.

Kusmore, frontier arrangements at, 357, 360.

Kutchee, memoir of the first campaign in the hills north of, 287; insecurity of the route to Afghanistan, 297;

positions of the tribes of Kutchee, 287; the Doombkees and Jekranees, 287; heads of the tribes, 288; principal towns, 288; dust-storms, 292; range of thermometer in Sind in the hot season of 1839, 293; strength of detachment first despatched, 293; the first day's march, 294; intention abandoned, 294; the second expedition, 294; progress of the force, 296; first encounter with the enemy, 298; want of cavalry, 297; surprise and pursuit of the Doombkees, 299; march on Ooch, 300; description of the place, 300; the country around, 301; fight with the enemy, 302; ruse of the Beloochees, 303; return to Pooljee, 303; expedition into the Murree and Boogtee Hills, 304; arrangements, 304; "beef" horse batteries, 305; unopposed advance of the troops, 305; the chief of the Boogtees, 306; description of the town of Deyra, 306; hostile preparations, 306; proceedings at Kahun, 307; demonstration by the enemy, 308; Deyra occupied, 309; annoyances by the enemy, 309; decisive victory of the British, 310; march on Kahun, 311; skirmish in the Murrow valley, 311; difficulties *en route*, 312; occupation of Kahun, 313; preparations for a return, 314; the first view of "Nuffoosk," 314; surrender of the robber chiefs, 314; the return, 315; Clibborn's disaster, 315; march over "Surtoff" to Pooljee, 316; secret of Major Billamore's success, 316; beneficial effects of the campaign, 316; total strength of the detachments, 317;—subsequent proceedings to the close of 1847, 317;—field order by Major Billamore on the breaking up of the field force in 1830, 326; brigade order by Brigadier Gordon, on relinquishing command of the troops in Upper Sind, 327; farewell letter from Captain Outram to Lieutenant Jacob, 328;—manifesto by the Governor of Sind on invading the Khelat territories, 330; tribes of the country, and their proceedings, 330; Beejar Khan Doombkee and his doings, 331; Shere Mahomed, ex-Ameer of Sind, 332; proceedings of and with the Khan of Khelat, 332; Mr. Brown's escape from robbers, 333; report of the state of the country, 334; punishment of the robbers determined on, 338;—Sir C. Napier on the discipline and courage of the

Sind Horse, 335; attack and capture of Shahpoor, 336;—desperate fight with robbers, 337; outlawry of the Boogtees, 338; Government notification on the destruction of the Boogtees by the Sind Horse, 339; despatch from the commanding officer in Sind on the same subject, 340; letter from Major Jacob, forwarding the report of the action, 342; Lieut. Merewether's report, 343; general order by the Commander-in-Chief, 348.

Kuzistan, the district of, should be annexed to the British empire, 404, 409; to abandon it an error, 409; importance of its possession, 410.

Kyheerees their repulse of marauders, 346; bravery of, 347.

## L.

Labour forced, abolition of, advocated, 18; absolute freedom the rule for market prices, 18; effects of such a rule, 19; similar principles advantageous for labour, 19; present state of affairs, 19; remedy, 20; profit by the arrangement general, 21.

Labour forced, abolition of, in Sind: minute on objections, 21, the freest market the cheapest, 21, 25; increased demand enhances the value of labour, 21; inducement to immigration, 21; importation of labourers, 22; labour how kept out of the market, 22; remedy, 22; the slave and freeman contrasted, 22, 25; error respecting rates of payment, 23; Sind capable of yielding ten times the present revenue, 23; payments to inhabitants and foreigners, 23; truest economy for Government, 24; authority for the axiom, 24; attempt to force labour criminal, 24; position of the labourer, 24; his rights, 24; freedom, in its effects, 25; a corps of Sindhee labourers desirable for public works, 26.

Labour, forced, abolition of, in Sind, 26; statistics of canal-clearances, 27; question at issue, 27; its natural laws, 27; arguments on both sides, 28; forced labour should be prohibited, 29; rules proposed, 29; the system a perpetuated abuse, 31; requisites for the introduction of a healthy system, 32; notice issued, 33.

Labour rates, calculation of, in certain districts, 34; mode of procedure and results, 34.

Lahree, description of the town of, in Kutchee, 289.

Land, titles to, and leases of, 59; misapprehensions of instructions, 59; excessive taxation of cultivators in consequence, 60; intentions of Government, 60; propositions for adjustment of claims, &c., 61; rules for leasing waste lands, unclaimed, 61; for lands lying waste, but claimed, wholly or in part, 63; for lands claimed, and under crop or lying fallow, 65; for the protection of tax-payers from fraudulent claims, 69; liberty to villagers in the employment of labour and capital, 70; circumstances beyond the province of Government interference, 70; assessment on lands on the frontier of Sind, 367.

Languages, effects of our examinations in, 11; should officers unable to pass be removed? 17; no time should be fixed for passing in, 17; operation of the proposed rule, 17;—a supposed prop to our Indian empire, 423.

Larkhana, settlement of Boogtee tribes on lands near, 325; communication with, 355.

Leases, of forests, to private parties, 54; of land, 59.

Libel, remedies for, 7.

Liebig, example from his "Letters," 52.

## M.

Macanlay, application of remarks of: to the Sind Horse, 187; to the present condition of India, 422.

Mahomedan, order relative to the Mohurram, 448.

Mahomed Hussun, wuzeer of Beejar Khan, Doombkee, 289;

Malcolm, Sir John, an authority on the subject of the native army of India, 124, 128, 130, 134; his opinion of the 5th Regt. Bombay N. L., 296; criticism of certain of his remarks, 422.

Manton, John, and Son, their guns and rifle balls, 237, 247, 254.

Marauders, mistaken leniency towards, 364; instance in point, 364; legitimate object of punishment, 364; principles of action adopted with the tribes of Upper Sind, 365; the old state of things, 365; feelings of parties affected, 366; recommendation, 366.

Marauders on the Sind frontier, 287;

Doombkees and Jekranees, 287, 318, 330, 352; Boogteea, 306, 314, 319, 325, 330, 333, 338; Murrees, 312; Kowahs and Boordees, 318; Muzzarees, 322, 366.

Markets and market rates, effects of regulations on, 5, 18, 19, 50, 84.

Maxims, 2, 8, 360, 396.

Meeanee, incident at the battle of, 227.

Meerpoor, outpost of, 356.

Mehrab Khan, of Kutchee, 289.

Merewether, Lieutenant, and the Sind Horse, at the flight of the Zemanee, 151 note, 325, 343-348.

Messes, defects in the system of, in Bengal, 103.

Military board and audit department, 219.

Military commissions, as courts of civil judicature, 83.

Military fund, 203.

Minie ball, a failure, 241; original and improved, 241, 275; best barrel and powder for, 281, 282.

Minie rifle, defects of, 228.

Missionaries, non-interference with, 8; should be wholly unconnected with the State, 8; official countenance of, dangerous, 8; maxim of government with respect to religion, 8; State religion injudicious, 9;—opinion respecting them, 423.

Moharukpoor, outpost of, on the Sind frontier, 356.

Mohumra, 411; a deadly locality, 412; stationing of troops there an error, 412; sickness on board the shipping at, 412.

Mohurram, the, order relative to the Mahomedan festival of, 448; the circumstances under which the order was issued, 448; its objects and effects, 448; its success proof of the excellence of the system of discipline adopted, 448; the order, 448; the commanding officer and religious ceremonies, 449; the officers and men and their position, 449; prohibition of noisy processions, &c., 449.

Moonson, Colonel, causes of his retreat, 199.

Moostung, produce of the valley of, in Afghanistan, 396.

Moral being, 2; maxim to be inculcated, 2, 8; source of rank in the universe, 2; rule for conduct towards rude people, 2; results of such procedure, 3; our real nature alone worth thinking on, 7, 8;—moral influence, 80; sign of weakness, 414; rules for conduct towards orientals, 415, 416.

Murree Hills, the, expedition into, 304, 312.  
 Murrees, of Kutchee, 288, 312.  
 Murrow Valley, the, skirmish in, 311.  
 Mussulmans, of Hindoostan, as material for the native army, 133, 214, 220, 372.  
 Mutineers, sepoy, and their officers, 220; first step of mutineers, 220; how they should be dealt with, 220.  
 Mutiny Act, the, injurious to the army of England, 99; objectionable in the Indian army, 126.  
 Mutiny, at Shikarpoor, xv *note*; normal condition of the Bengal army, 117, 124.  
 Muzzaree tribe, of Beloochees, 322, 366.  
 Muzzurdaun river, the, in Kutchee, 300.

## N

Nanarck, in connection with proposed operations in Persia, 408.  
 Napier Sir C., on the marching of troops, 89; his opinion of the Sind Irregular Horse, 187, 335, 337; overreached by Belooch robber tribes, 303; state of the Sind frontier up to his arrival in the country, 328 *note*; manifesto issued on his invasion of the Khelat territories, 330; error in his figures, 335; his mistake respecting the breadth of the desert between Khanghur and Och, 336 *note*; his directions regarding the treatment of Boogtee marauders, 338.  
 Napier, Sir W., in error respecting the width of the desert between Khanghur and Och, 336 *note*; his mistake respecting the Sind Irregular Horse, 337 *note*.  
 Noorwah canal, the, clearing of, by Jekranees, 324.  
 Nooskee, on the Khelat frontier, 389.  
 Nuffosk, the pass of, first visit to, 314.

## O

Officers, commanding, test for appointment as, 10; their want of power, 102, 106, 121; true position of, 125, 136; qualities necessary in, 126, 135; powers desirable for, 159; should be selected, and entrusted with full powers, 163; daily orderly-room by, 209.  
 Officers, European, should not be wasted, 3, 14; consequences of ren-

dering them "cheap," 3, 15; their character should be raised in native estimation, 3; their energies and moral influence the sole return for the revenues of India, 15; power of personal character, 16; should unpassed officers be removed? 17; failure after fair trial should involve removal, 17; subalterns and the military fund, 203; Indian officers in England, 206; new furlough regulations proposed for, 207; qualifications of staff officers, 222; establishment and salaries proposed in a scheme for the reorganisation of the Indian services, 433-438.

Officers, native, abilities of, 13, 222; system for promotion of, 113, 119; cause of their inefficiency in Bengal, 119; of irregular cavalry really officers, 158; more required for the Sind Horse, 183; vices of the seniority system of promotion, 211.

Officers, settlement, duties, &c. of, 61.  
 Officials, incompetent, non-removal of, 18; why allowed to remain, and consequences, 18; superior shrinking from duty unfit to rule, 18; practical resemblance, 18.

Officials, native: village accountants, 73; policemen, 83.

Och, in Kutchee, description of, 300.  
 Orderly-room, should be daily held by every commanding officer, 209; good effects of such an arrangement, 210.

Orders, general, not adapted for regulation of markets, 5, 84; removal of a prohibitory order, 230; precautions in an enemy's country, 230; field force orders, in Persia and in Upper Sind, 326; brigade orders, Upper Sind, 327; general orders by Sir C. Napier, 335, 336, 337; standing, for the frontier posts of Sind, 367; order relative to the Mohurrun, 448.

Organisation, the, of the armies of England, its true principles, 93; of the armies of Bengal and Bombay, 101-123; of the native army of India in general, 124; of the Sind Horse, 170; of the Camel Baggage Corps, 194; scheme for the reorganisation of the civil and military administration of India, 425-439; reply to objections to the scheme, 439.

Oriental, the, characteristics of, 2; how commanded, 415, 416; the school of smooth words, 416.

Outposts, on the frontier of Sind, 356; standing orders for, 367.

Outram, Captain (Major-General Sir J.), on the state of the Sind frontier in 1842, 328.

## P

Pantaloons, cloths, *vs.* leather breeches, for mounted men, 227.

Pathans, character of, 133; as recruits for our armies, 371.

Patrols, border, in Sind, 357, 358, 359, 367.

Pay, system of drawing, in Bengal, 103, 106; of the native army, should be increased, 132, 147, 156, 160, 175, 182; plan suggested, 202; proposal respecting, in a scheme for the reorganisation of the Indian administration, 425, 433, 435, 437.

Peacocke, Lieutenant, and proceedings in the Kutchee Hills, 307.

People, free, contrasted with the slave, 22, 25; remarks on the arming of free men, 93.

Persia, effect on, of the fall of Kars, 375; Russian policy in, 375, 384, 390, 392, 403; British demonstrations on the seaboard, 390, 402; designs of, on Herat and Kandahar, 390, 391; papers relating to the recent war with, 401; Russian advice to, 404.

Persian war, the, papers relating to, 401; its policy, 401; what may and should be done, 402; the expedition a great error, 403; annexation of the valleys of the Karoon and Euphrates recommended, 403, 405; description of cavalry best adapted for the expedition, 406; military requirements, 407; remarks on holding our own ground after victory, 408; Kuzistan should be permanently occupied, 409; water supplies at Bushire and Karrack, 411; Mohumra, Bushire, and Carrack, as summer quarters for troops, 411; insalubrity of Mohumra, 411, 412; supplies from Bombay, 413; supplies from the valley of the Euphrates, 413; employment for the troops, 414; concealment of the condition of the Indian army unwise, 414; arrangements recommended before leaving Persia, 414; Bushire as a point of embarkation, 415.

Peshawur, a proper place for a fortress, 222.

Pesheen, the valley of, in Afghanistan, 379, 396.

Findarees, of the Indus, 334.

Plans and estimates *vs.* a road and

canal, 38; instance of too many plans and estimates, and no work done, 38; consequences, 39; description of work required, 39; amount of money wasted on experiments, 39.

Plunder, disposal of, in Sind, 359.

Point and cut: the cut more effective than the point, 225; best swords for foot and horseback, 225; cutting powers of weapons of the Sind Irregular Horse and of Belooch warriors, 227.

Policy, of the Persian war, 401, 403; Russian, 375, 394, 390, 392, 403.

Pooljee, description of the town of, in Kutchee, 291, 297; proceedings of the Khan of Khelat at, 332.

Presidency, a fourth, recommended for India, 432.

Press, liberty of the, 6; how to command public praise, 6; what we are alone worth thinking on, 6; public servants and publicity, 6; the press and its supporters, 6; it never wilfully misleads the public, 7; three remedies for libel, 7; press gagging, and its consequences, 7; how calumny may be averted, 7; laws of the moral and physical worlds, 8; maxim, 8; perfect freedom is perfect law, 8.

Prince, native, advice to a, 369; arrangements necessary for friendly relations, 370; internal administration, 370; aid afforded, 370; simile, 371; benefits from attention to advice given, 371.

Prize property, 221; right of conquest over private property, 221.

Processions, prohibition of noisy, 448.

Promotion, Bengal system of, 113-115, 211.

Property in assamees, 139, 174; prize, 221; personal, 221.

Provinces, North-West, the, revenue system of, 55.

Punchayeta, preferable to courts martial in native regiments, 158; of the Sind Irregular Horse, 158.

Punjaub, the, in connection with a Sind railway, 47.

## Q

Quetta, as an advanced British post, 379; proposed arrangements for a British force at, 385; permanent occupation recommended, 391; certain commercial result, 397.

## R.

- Rahmut, a famous Belooch leader, 303; his surrender to political officers, 314.
- Railway, to connect the Indus with Kurrachee, 43; terms of the contract, 43; why Hyderabad should be neglected, 43; Kotree unsuitable as a terminus, 44; railway merely to connect Kurrachee with the river must prove a failure, 44; best project for water communication, 45; benefits derivable from a canal, 45; natural commercial road from Central Asia to the ocean, 46; country from Dadur to Sehwan favourable for a railway, 47; Sehwan the proper point for a river terminus, 47; advantages of a line from Kurrachee to Sehwan, 47; wisest course of proceeding, 48.
- Raitt, Captain, and campaigning in Kutchee, 296, 304, 307, 310.
- Rank, and pay, proposed, for the Indian services, 433, 435, 437, 438.
- Recruits, and recruiting, 96, 109, 133, 371; security for good conduct, 447; object in demanding security, 447; advantages of the system, 447; effects of recent events in a sildar corps, 447.
- Religion, State interference in, unjust and impolitic, 8; mischievous, 8; State religion incompatible with security of empire, 9.
- Reorganisation, proposed, of the civil and military administration of India, 425-439; reply to objections, 439.
- Resident, British, in the Persian Gulf, station for, 414; what he should be, 414.
- Revenue settlement, what it really is, 57; essence of a really good collector, 57; the people overtaxed, 58; advice, 58, 59.
- Revenue system, of the North-West Provinces, 55; remarks on the coparcenary system, 55; inconsistent to introduce it into Sind, 55; objections and suggestions, 56; probable effects of its introduction, 57.
- Rifles, memoranda on, in their application to the purposes of war, 233; importance of good tools, in peace and war, 234; what spinning machinery has done for England, 234; arms of English soldiers, 234; attention to improvement of rifled fire-arms, 234; pattern rifled prepared, 235; powder, 235; description of the rifle, 236; ranges and effects, 236, 237; extent and cost of experiments, 237; practice-ground, 237; distances of targets, 237; what may be accomplished with such arms, 238, 244; proceedings at Jacobabad, 239; defects of the two-grooved rifle, 239; the four-grooved rifle, 239; reason for its rejection by authority, 240; experiments to determine the best shaped ball, 240, 252, 273; conical ball, 240; defects of original Minié ball, 241; improved Minié ball, 241; form of ball finally adopted, 243; its range, 243; merits of percussion rifle shells of the same shape, 243; particulars respecting the construction of shells, 243, 244; ranges of rifled cannon, 245; 32-gauge shells, and cannon shot, 245, 274; powder used in the experiments, 245; particulars of the shell practice at Jacobabad, 247; proceedings of a committee of inquiry, 248; description of rifle submitted, 248; object with which the piece was made, 248; groove-making, 249; result of the inquiry, 250; rifles used, and how, 250; comparison of methods of firing, 251; sights, 252; further experiments with rifles and balls, 253; effects of increased charges of powder on leaden balls, 253; remedies attempted, 253; description of ball necessary, 254, 255; illustrations of shapes of balls before and after firing, 254; rifle ball with zinc or iron point, 255; mode of rifling adopted with "Lancaster" guns, 260; trial of zinc balls, 255; error in reports of Enfield rifle practice, 256; real facts, and proof, 257; iron-pointed balls, 258; greased patch, 258; best methods of preparing and carrying rifle ammunition, 258; cannon and cannon-shot, 259, 274; "Lancaster" guns, 260; their liability to burst, 260; concluding observations on the twist 261; grooves, 261; patches, 261; rifled cannon and cannon-shot, 262; information on rifle practice, 262; —reports of rifle practice at Jacobabad in 1854-55, 263-268; report by the Adjutant General Bombay army on Jacob's rifle and rifle balls, 269; description of rifle used, 269; result, 270; rifle shells, 270; gentlemen present at the practice, 270, 271; Jacob's rifle shells and bullets recommended to special attention, 271; report of rifle practice at Bombay, 272; rifle practice

at Kurrachee, 273; result of the practice, 274; penetration of Jacob's iron-pointed rifle balls, 275; experiments at Kurrachee, 275.

Rifle, Jacob's, 235, 269, 275; memoranda on, 233; description of best, for the army, 275; scales of elevations for sights, 278; proportions recommended for general purposes, 279; best sizes, 283.

Road, commercial, of Central Asia, 46, 379.

Roads, repairs of, by contracts, 37; annual repairs, 37; defects of the system, 37, 38; contracts for long periods preferable, 38; constructed all over Upper Sind, 358.

Robbers, border, checks on, 358; mistaken leniency towards, and its effects, 364.

Rojaun, outpost of, 356.

Rule, British, in India, secret of, 1.

Rules, military, on high caste men, baseless, 220.

Russia, working of our military code in the recent war with, 100; policy in Persia and the East, 375, 384, 389, 391, 403; advice to Persia respecting the British expedition, 404.

## S.

Saddle, directions for a, 232; object in view, 233.

Salaries, civil, reduction of, 14; officers underpaid, and results, 14; English energy and morality, 15; influence of character, 15; desiderata, 16; proposed military salaries, 433, 435, 437, 438.

Scabbards, wooden, 226.

Scheme, for the reorganisation of the administration of India, 419-424.

Science, political, related to all science, 51; false political economy, 51; land revenue and taxes on trade, 51; essential for thoroughly understanding any science, 51; example, and authority for it, 52.

Scott, Captain, rifle practice by, 273.

Scouts and spies, on the frontier of Upper Sind, 358, 359.

Secret, of British rule in India, 1.

Security, for the good conduct of recruits, 447.

Seewajie, true descendants of his mountain rats, 296.

Schwan, as a site for a railway terminus, 47.

Selection *vs.* examination, 9; objections to our competitive examina-

tions, 9; embryo statesmen and clever clerks, 10; civil service tests, 10; effects of the examinations in native languages, 11, 423; objections to the present test for appointments, 11; how a knowledge of the people is to be acquired, 12; the best security for fitness, 13, 423; secret of opposition to a system of selection, 13; English talent in India for administrative requirements, 13; selection must be adopted, 14, 423; English officers the general stock of power for government, 14.

Seniority system, vices of the, and its unavoidable consequences, 211; ruinous to discipline, 212; commanding officers, 212; drill-masters, 213; principles recommended, 213.

Sepoys, their caste, *vs.* discipline, 109; of Bombay and Bengal, 110-117; promotion in, 112; Bengal sepoy on guard, 115; the raw material, 117, 431; relations with commanding officers, 125, 426; gratitude, 127; a "regular" in full dress, 129; the best men for the army, 133, 214, 220; how mutineers should be dealt with, 220; what sepoy should be in the field, 231; employment of, in Persia, 413.

Service, readiness for, 89, 180.

Shahpoor, description of the village of, in Kutchee, 292, outposts of, 356.

Shaik Ally, Russaidar, at the flight of the Zemanee, 345, 346, 347.

Shaw, Lieutenant Colonel, despatch from, respecting the destruction of Boogtee robbers, 342.

Shawl, the valley of, in Afghanistan, its capabilities for the support of troops, 395, 396.

Shells, Jacob's rifle, 243, 244, 271, 275-278; 32-gauge recommended, 283; for rifle cannon, 275.

Shera Beg, Boogtee, 314 *note*.

Shera Mahomed, night attack by, 222; his proceedings on the frontier of Sind, 332.

Shikarpoor, mutiny at, *xv note*; range of thermometer at, in 1839, 293; country around in 1847, 356.

Shot, cannon, 244, 259.

Silidar corps, compensation to, 164; regulations of 1849 objectionable, 164; illustration of the systems of Bengal and Sind, 165; compensation to be avoided as a rule, 166; exceptions, 167; pay should be liberal, 167; casting of horses, 168.

Silidar horse, remarks on, 135; condition of the Bengal irregulars, 135;



- qualifications of commanders, 135, 136; native prejudice, 136; appointment and powers of commanding officers, 136, 137, 157, 160; discipline of irregular cavalry, 139; assamees, or silidarees, 139; silidars and bargheers, 140; three-horse silidars, 142; five-assamee russaldars, 142; six-horse silidars, 143; rule for promotion, 143; interference with bargheers injurious, 143; prices of assamees, 144; vacancies, 145; besetting sin of the Bengal irregular cavalry, 146; sons of native officers as bargheers, 146; pay, 147; denominations of ranks, 147; the russaldar major, 148; kettle-drums and trumpets, 148; regimental funds, 149; system with the Sind Horse, 149; indebtedness of Bengal irregulars, 150; arms, 151; Sind Horse carbines, 151; story of the Brahocees and Skinner's Horse, 152; uniform, 153; supply of clothing, 153; accoutrements, 154; marching of irregulars, 154; regimental bazars, 155; regimental banks, 155; a horseman in debt ruined as a soldier, 156, 157; courts martial, 158; punchayets, 158; silidars and their horses; 159; pensions, 160; standards, 160; sword exercise, 160; riding-schools, 160; hint respecting bargheer and silidar corps, 161; coat of regular and irregular cavalry of Bombay, 161; proposed silidar cavalry, 162; requisites to ensure success to the scheme, 163; security for the good conduct of recruits, 447.
- Silidar rifle corps, infantry, organisation of, 168; the only difficulty, 168; description of men required, 168; regimental arrangements, 168, 169; additional arm recommended for the Sind Horse, 169; capabilities of such a force, 169.
- Similes, 3, 7, 18, 95, 99, 100, 350, 371, 376, 424, 431, 443, 444.
- Sind Horse, carriage arrangements of, 189; minute penned after a review of the corps, 189; baggage and animals required by each regiment, 189; readiness for service, 190; essence of the strength of the silidar system, with reference to carriage, 191; causes of the success of the carriage arrangements, 192.
- Sind Horse, the, celerity of their movements, 89, 150, 191; strength of the irregulars, 123; assamees, 139, 144, 170; regimental fund, 149; penalty for indebtedness, 146, 156; arms, 151; fight of the Zeman e, 151 *note*, 325, 343; dress, 153; accoutrements, 153; bazar, 155; pay, 156; punchayets, 158; horses, 159, 181; standards, 160; drill, 161; cost of each man, 161; volunteers, 163; punishment for neglect of horses, 166; compensation for horses, 167, 168; a troop of horse artillery recommended for each regiment, 169; system of promotion, 213; incidents at the battle of Meeanee, 227; nucleus of the corps, 298; fights with marauders, 322, 325, 336, 337, 339, 343, 345; Sir C. Napier on the courage and discipline of the corps, 337; mistake of Sir W. Napier regarding it, 337 *note*; outposts and detachments on the frontier, 355; at the battle of Goojerat, 373.
- Sind Horse, the, memoranda on the constitution of, as exemplifying the silidar principle, 170; transfer of men, 170; silidaree system first adopted, 170; new rules introduced, 171; results, 172; prices of assamees, 173; property in assamees necessary, 174; best system of silidar arrangements, 175; pay, 177; the regiment not an irregular corps at all, 177; result of the peculiar training of the corps, 177-179; native officers, 179; constant endeavour in the organisation of the corps, 179, 186; disadvantages under which it labours, 180; secret of success, 181; instance of extraordinary expenses, 181; present rate of pay insufficient, 182; advantages to the State from extra disbursement, 183; more native officers required, 183; change of designation desirable, and deserved, 184; condition of the frontier while guarded by Bengal irregular cavalry, 185; when guarded by the Sind Horse at the time of the Cabool disasters, 185; state of affairs since 1847, 185, 186; present condition and spirit of the corps, 187; requisite for the maintenance of its character, 188.
- Sind, labour abundant in, 22; capable of yielding ten times its present revenue, 23; forced labour abolished, 26, 33; canals, 26, 38; railways, 41, 43; commercial road of Central Asia, 46; flotilla and forest, 53; titles to land, and leases, 59; the Thurr or desert district, 73, 80; bunds, 76; dams, 79; the Khyree Ghuree canal, 81; courts of justice, 83; supply of carriage, 84; Sind Horse, 169, 189;

- Camel Baggage Corps, 193; campaigns on the frontier, 287-317.
- Sind, the North-West Frontier of, campaign on, in 1839, 287; subsequent proceedings to the close of 1847, 317; arrangements effected on the close of the first campaign, 317; position of the troops, 318; successful incursions of marauding tribes, 319; state of the frontier on the arrival of the Sind Horse, 320; measures adopted by Major Jacob, 321; discovery of unsuspected robbers, 322; predatory rendezvous, a surprise, 323; the Jekranees, 324; result of measures taken with the "lootoos," 324; power of the Boogtees broken in a single fight, 325; flight and final surrender of the chiefs, 325;—principles of procedure, 349; measures, offensive and defensive, 349; grounds of action, 349; state of the frontier in 1847, 351; first year's proceedings, 351; result, 352; anticipations, 352;—summary of arrangements made, 353; population of Khanghur on first arrival, 353; condition of the troops, 353; preliminary proceedings, 354; difficulties encountered and overcome, 355; results, 355; improvements effected, 355;—military system introduced for its protection, 356; outposts and detachments in 1847, 356; general arrangements, 356, 357; new system adopted, 358; discovery of relations existing between the mauraunders and Bunyas, 359; signal punishment of a robber tribe, 360; further proceedings, 361; greatest physical difficulty, 362; fortifications, 362;—disarming the population, 358, 362; possession of arms allowed under certain conditions, 363; aggression and retaliation, 363;—standing orders for frontier posts, 367;—assessment of land, 367; benefits under proposed arrangements, 368; assessment should be stationary, 369.
- Slavery, *vs.* freedom, 21-26; first effects of emancipation, 85.
- Sizing, and flank companies, bad in principle, 222.
- Soldiers, European and native, on field service, 231, 232; conduct of English portion of the force, 231, 232; of the native regiments, 231; bearing towards, and impression left with, the inhabitants, 232; beneficial results of such behaviour, 232.
- Soldiers, obedience of, 214.
- Staff appointments, present longing after, 124; corps in India misnamed, 132; qualifications of staff officers, 222; establishment and salaries proposed for the general staff of the army, 435.
- Statistics—*Civil*: robber tribes, 4; examinations, 9; labour, 18, 21, 26, 33; means of communication, 35, 37, 38, 40, 41, 43, 80; trade, 50, 52, 214, 223; Indus flotilla and forests, 53; education, 54; revenue systems, 55, 57; land, 59, 61, 63, 65; bunds, 76; tanks, 78; dams, 79; courts of law, 83; police, 83; carriage, 84;—*Military*: the Bengal army, 101-117; Bengal and Bombay systems, 117; native army of India, 124; the "regular" system, 129; cavalry, 135-164; compensation, 164; sildar rifle corps, 168; Sind Horse, 170; carriage arrangements, 189; baggage corps, 193; the military fund, 203; furlough regulations, 204; orderly-rooms, 209; system of promotion, 211; head quarters, 213; horses, 214-219; the military board and audit departments, 219; high caste rules, 220; mutineers, 220; commanding officers and candidates for enlistment, 221; prize property, 221; fortifications, 222; companies and sizing, 222; staff officers, 222; arms, 223, 224, 225, 228, 279, 280; horse fairs, 228; dress, 227; charges, 228, 230; troops in an enemy's country, 230, 231; saddles, 232; recruits, 96, 109, 133, 371, 447;—*North-West Frontier of India*: campaigning in the hills, 287-317, 326; procedure with the predatory tribes, 349; protective arrangements, 353, 356, 362, 364, 367, 375, 385; assessment of districts, 367; negotiations, 369;—*Persian War*: its policy, 401, 409; valleys of the Karoon and Euphrates, 403, 410; transport of troops, 406; requirements, 407; water supplies, 411; stations for troops, 411, 412; supplies from Bombay, 413;—*Present Condition of India*, 419; reorganisation of the civil and military administration, 425-431.
- Sukkur, in the hot season of 1839, 293.
- Sungseela, in Kutchee, 306.
- Supplies, camp, 193; from Bombay, for the Persian expedition, 413; from the valley of the Euphrates, 413.
- Surtiff, first passage of, 316.
- Swimburn and Son, of Birmingham, and information on rifle practice, 262; recommended as gun-makers, 278, 283.

Swords, cavalry, best description for natives, 224; edges and points, 224; curved cutting blades, 225, 226; straight swords, 225; instances of the powers of cutting swords, 227.

## T.

Tank-digging, 78; object contemplated in the example given, 78; success of the experiment, 78.

Taxes, on water, 26; on trade, 50; on land, 60; on cattle, 72; on the desert, 73.

Telegraph, line recommended for Sind, 41.

Teywaugh river, the, in Upper Sind, defeats of marauders at, 299, 344.

Thatcher, Captain, trial of rifles by, 273.

Thool, a rendezvous for marauders, 323.

Tools, good, do not make bad workmen, 228; closing with foes, 228; defects of the Minié rifle or ball, 228; Jacob's v. the English army rifle, 229.

Toork Ali, Boogtee chief, surrender of, 314; settlement at Janadeyra, 318.

Trade, interference with, opposed to the laws of political economy, 5; destructive to British reputation, 5; adjustment of markets, 6; non-interference should be the rule, 6, 50; fairs, 50; impetus to trade, 51; frontier returns, 52; trade in horses, 214, 223; with robber tribes, 359.

Travellers, bungalows and serais for, 49; of the greatest advantage, 49; free accommodation eventually most profitable, 49; imposition of fees unwise, 50.

Tribes, predatory, chief requisite for the control of, 4; source of power of the border marauder, 4; results of a few years' just administration in a frontier district, 4; guiding principles, 5; contrast of two systems of dealing, 185; campaign against, on the North-West Frontier of Sind, 287; intrigues with Zemindars, 323; connection with Sind Bunyas, 359; procedure on

the North-West Frontier of Sind, 349.

Trower, Captain, on the qualifications of commanders of irregular cavalry, 135; on the denominations of different ranks, 147.

Tructnee, fight with Boogtees, 310.

Trukkee, proceedings with the Doombkees, after their surrender at, 317.

## U.

Uniforms of English soldiers, 100; of the sepoy of the line, 129; of the Sind Irregular Horse, 154.

Universe, the, rank in, 2.

## W.

War, Persian, 401.

Watering-places in the hills of Kutchee, 301, 358.

Water, want of, on the frontier of Sind, 362.

Wellington, the Duke of, on the causes of Colonel Monson's retreat, 199.

Wheel-carriages, introduction of superior description considered, 36; native carts, 37.

Wiseman, Lieutenant, and campaigning in Kutchee, 312.

Witton and Daw, and information on rifle practice, 262; recommended as gun-makers, 278.

Wullee Mahomed Chandia, Sindian chief, 334.

## Z.

Zamane, fight of the, 151 *note*, 339-348; Lieutenant Merewether's report of the action, 343; strength of the combatants, 343; the fight, 344; the slain, 345; casualties in the Sind Horse, 346; conduct of the native officers and men in action, 346.

Zemindars, supply of labour by, 20, 31; relations with cultivators, 59; understanding with marauders, 323; assessment of land in the Sind Frontier district, 367.

LONDON:  
PRINTED BY SMITH, ELDER AND CO.,  
LITTLE GREEN ARBOUR COURT.

65, Cornhill, London, March, 1858.

## NEW AND STANDARD WORKS

PUBLISHED BY

SMITH, ELDER & Co.

---

WORKS ON INDIA AND THE EAST.

---

### *Indian Scenes and Characters,*

SKETCHED FROM LIFE BY

PRINCE ALEXIS SOLTYKOFF.

*Sixteen Plates in Tinted Lithography, with Descriptions. Colomnier Folio,  
Half-bound. (Nearly Ready.)*

*The Defence of Lucknow:* a DIARY recording the  
Daily Events of the Siege from 31st May to 25th  
September, 1857. By a STAFF-OFFICER.

*Small post 8vo., price Half-a-Crown, with Plan of the Residency.*

"This diary is intrinsically valuable; it  
deserves to pass from hand to hand, and is  
not to be laid down until the last line has  
been read."—*Leader.*

"It has a special interest, inasmuch as  
it gives a full account of the mining and  
countermining, upon the result of which the  
fate of the garrison especially depended."—  
*Examiner.*

*Views and Opinions of Brigadier-General  
Jacob, C.B.* Collected and Edited by Captain LEWIS  
PELLY, Late Political Secretary Persian Expeditionary  
Force.

*Demy 8vo., price 12s. cloth.*

*Tracts on the Native Army of India.* By  
Brigadier-General JACOB, C.B. *The First Complete  
Edition, including New Matter never before Published.*

*8vo., price 2s. 6d.*

*Rifle Practice.* By Brigadier-General JACOB, C.B.

*Fourth Edition, 8vo., price 2s.*

WORKS ON INDIA AND THE EAST—*continued.**Narrative of the Mission from the Governor-General of India to the Court of Ava in 1855. With Notices of the Country, Government, and People. By CAPTAIN HENRY YULE, Bengal Engineers.**Imperial 8vo., with 24 Plates (12 coloured), 50 Woodcuts, and 4 Maps. Elegantly bound in cloth, with gilt edges, price 2l. 12s. 6d.*

"A stately volume in gorgeous golden covers. Such a book is in our times a rarity. Large, massive, and beautiful in itself, it is illustrated by a sprinkling of elegant wood-cuts, and by a series of admirable tinted lithographs. . . . Captain Yule secures at once an eager reception of his story. The grand merit of the work is his own; he wrote the graphic and informing narrative; he executed the principal drawings of palaces, temples, groups, landscapes, and city vistas, bringing to the accomplishment of the task a degree of learning, of critical sagacity, and descriptive power, seldom united even in the most distinguished of travellers. . . . We have read it with curiosity and gratification, as a fresh, full, and luminous report upon

the condition of one of the most interesting divisions of Asia beyond the Ganges."—*Athenæum*, Feb. 20th, 1858.

"Captain Yule has brought to his narrative a knowledge of many things, which is the main help to observation. In all that regards structure and execution, his profession as an engineer makes him an adept; he has a taste in architecture, art, and the cognate sciences, as well as much information on the history and religion of the Burmese. . . . His description of these things, especially of the antiquities, are not only curious in themselves, but for the speculations they open up as to origin of the Burmese style and the splendour of the empire centuries ago."—*Spectator*, Feb. 20th, 1858.

*Suggestions Towards the Future Government of India. By HARRIET MARTINEAU.**Second Edition. Demy 8vo., price 5s. cloth.*

"As the work of an honest able writer, these Suggestions are well worthy of attention, and no doubt they will generally be duly appreciated."—*Observer*.

*British Rule in India. By HARRIET MARTINEAU.**Price 2s. 6d. cloth.*

"A good compendium of a great subject."—*National Review*. "A succinct and comprehensive volume."—*Leader*.

*Tiger Shooting in India.*

By LIEUTENANT WILLIAM RICE, 25th Bombay N. I.

*Super Royal 8vo. With Twelve Plates in Chromo-lithography. 21s. cloth.*

"These adventures, told in handsome large print, with spirited chromo-lithographs to illustrate them, make the volume before us as pleasant reading as any record of sporting achievements we have ever taken in hand."—*Athenæum*.

"A remarkably pleasant book of adventures during several seasons of large game

hunting in Rajpootana. The twelve chromo-lithographs are very valuable accessories to the narrative; they have wonderful spirit and freshness."—*Globe*.

"A good volume of wild sport, abounding in adventure, and handsomely illustrated with coloured plates from spirited designs by the author."—*Examiner*.

*The Life of Mahomet and History of Islam to the Era of the Hegira. By WILLIAM MUIR, Esq., Bengal Civil Service.**Two Volumes 8vo., price 32s. cloth.*

"The most perfect life of Mahomet in the English language, or perhaps in any other. . . . The work is at once learned and interesting,

and it cannot fail to be eagerly perused by all persons having any pretensions to historical knowledge."—*Observer*.

WORKS ON INDIA AND THE EAST—*continued.**The Autobiography of Lutfullah, a Mohamadan Gentleman, with an Account of his Visit to England.*  
Edited by E. B. EASTWICK, Esq.*Second Edition, Post 8vo, price 10s. 6d., cloth.*

"We have read this book with wonder and delight. Memoirs of a live Moslem gentleman are a novelty in our letters. . . . Lutfullah's story will aid, in its degree, to some sort of understanding of the Indian insurrection."—*Athenæum.*

"Read fifty volumes of travel, and a thousand imitations of the oriental novel, and you will not get the flavour of Eastern life and thought, or the zest of its romance, so perfectly as in Lutfullah's book. It is readable, instructive, and entertaining."—*Leader.*

"As an autobiography the book is very curious. It bears the strongest resemblance to *Gil Blas* of anything we have ever read."—*Spectator.*

"Everyone who is interested in the present state of matters in India should read Lutfullah's own account of himself and his people, as well as their peculiar and general feeling towards the Feringees."—*Globe.*

"A treasure as well as a rarity in literature."—*Eclectic Review.*

*The Life and Correspondence of Sir John Malcolm, G.C.B.* By JOHN WILLIAM KAYE.*Two Volumes, 8vo. With Portrait. Price 36s. cloth.*

"The biography is replete with interest and information, deserving to be perused by the student of Indian history, and sure to recommend itself to the general reader."—*Athenæum.*

"One of the most interesting of the recent biographies of our great Indian statesman."—*National Review.*

"This book deserves to participate in the popularity which it was the good fortune of Sir John Malcolm to enjoy."—*Edinburgh Review.*

"Mr. Kaye has used his materials well, and has written an interesting narrative, copiously illustrated with valuable documents."—*Examiner.*

*Life and Correspondence of Lord Metcalfe.*

By JOHN WILLIAM KAYE.

*New and Cheap Edition, in 2 Vols., Small Post 8vo, with Portrait, price 12s. cloth.*  
(Just ready.)*Papers of the late Lord Metcalfe.*

Selected and Edited by J. W. KAYE.

*Demy 8vo, price 16s. cloth.*

"We commend this volume to all persons who like to study state papers, in which the practical sense of a man of the world is joined

to the speculative sagacity of a philosophical statesman. No Indian library should be without it."—*Press.*

*The Commerce of India.* By B. A. IRVING, Esq.,  
Author of "The Theory and Practice of Caste."*Post 8vo, price 7s. 6d. cloth.**Review of the Measures adopted in India for the Improved Culture of Cotton.* By Dr. FORBES ROYLE.  
*8vo, 2s. 6d. cloth.**The Fibrous Plants of India fitted for Cordage, Clothing, and Paper.* By Dr. FORBES ROYLE. *8vo, price 12s. cloth.*

## 'WORKS ON INDIA AND THE EAST—continued.

*On the Culture and Commerce of Cotton in India.* By Dr. FORBES ROYLE. 8vo, price 18s. cloth.

*The Productive Resources of India.* By Dr. FORBES ROYLE. Super royal 8vo, price 14s. cloth.

*The English in Western India ; being the Early History of the Factory at Surat, of Bombay.* By PHILIP ANDERSON, A.M.

*Second Edition, 8vo, price 14s. cloth.*

"Quaint, curious, and amusing, this volume describes, from old manuscripts and obscure books, the life of English merchants in an Indian Factory. It contains fresh and amusing

gossip, all bearing on events and characters of historical importance."—*Athenaeum*.

"A book of permanent value."—*Guardian*.

*Life in Ancient India.* By MRS. SPEIR.

*With Sixty Illustrations by G. SCHARF. 8vo, price 15s., elegantly bound in cloth, gilt edges.*

"We should in vain seek for any other treatise which, in so short a space, gives so well-connected an account of the early period of Indian history."—*Daily News*.

"Whoever desires to have the best, the completest, and the most popular view of what

Oriental scholars have made known to us respecting Ancient India must peruse the work of Mrs. Speir ; in which he will find the story told in clear, correct, and unaffected English. The book is admirably got up."—*Examiner*.

*The Cauvery, Kistnah, and Godavery : being a Report on the Works constructed on those Rivers, for the Irrigation of Provinces in the Presidency of Madras.* By R. BAIRD SMITH, F.G.S., Lt.-Col. Bengal Engineers, &c., &c.

*In demy 8vo, with 19 Plans, price 28s. cloth.*

"A most curious and interesting work."—*Economist*.

*The Bhilsa Topes ; or, Buddhist Monuments of Central India.* By MAJOR CUNNINGHAM.

*One Volume, 8vo, with Thirty-three Plates, price 30s. cloth.*

"Of the Topes opened in various parts of India none have yielded so rich a harvest of important information as those of Bhilsa, opened by Major Cunningham and Lieut. Maisey ; and

which are described, with an abundance of highly curious graphic illustrations, in this most interesting book."—*Examiner*.

*The Chinese and their Rebellions.*

By THOMAS TAYLOR MEADOWS.

*One Thick Volume, 8vo, with Maps, price 18s. cloth.*

"Mr. Meadows' book is the work of a learned, conscientious, and observant person, and really important in many respects."—*Times*.

"Mr. Meadows has produced a work which

deserves to be studied by all who would gain a true appreciation of Chinese character. Information is sown broad-cast through every page."—*Athenaeum*.



WORKS ON INDIA AND THE EAST—*continued.*

*A Sketch of Assam; with some Account of the Hill Tribes.* Coloured Plates, 8vo, price 14s. cloth.

*Butler's Travels and Adventures in Assam.* One Volume 8vo, with Plates, price 12s. cloth

*Dr. Wilson on Infanticide in Western India.* Demy 8vo, price 12s.

*Rev. James Coley's Journal of the Sutlej Campaign.* Fcap. 8vo, price 4s. cloth.

*Crawford's Grammar and Dictionary of the Malay Language.* 2 vols. 8vo, price 36s. cloth.

*Roberts's Indian Exchange Tables.* 8vo. Second Edition, enlarged, price 10s. 6d. cloth.

*Waring on Abscess in the Liver.* 8vo, price 3s. 6d.

*Laurie's Second Burmese War—Rangoon.* Post 8vo, with Plates, price 10s. 6d. cloth.

*Laurie's Pegu.* Post 8vo, price 14s. cloth.

*Boyd's Turkish Interpreter: a Grammar of the Turkish Language.* 8vo, price 12s.

*Bridgnell's Indian Commercial Tables.* Royal 8vo, price 21s., half-bound.

*The Bombay Quarterly Review.* Nos. 1 to 9 at 5s. 10 and 11, price 5s. each.

*Baillie's Land Tax of India. According to the Mookummudan Law.* 8vo, price 6s. cloth.

*Baillie's Mookummudan Law of Sale.* 8vo, price 14s. cloth.

*Irving's Theory and Practice of Caste.* 8vo, price 5s. cloth.

*Gingell's Ceremonial Usages of the Chinese.* Imperial 8vo, price 9s. cloth.

## WORKS OF MR. RUSKIN.

*The Political Economy of Art. Price 2s. 6d. cloth.*

"A most able, eloquent, and well-timed work. We hail it with satisfaction, thinking it calculated to do much practical good, and we cordially recommend it to our readers."—*Witness.*

"Mr. Ruskin's chief purpose is to treat the artist's power, and the art itself, as items of the world's wealth, and to show how these may be best evolved, produced, accumulated, and distributed."—*Athenæum.*

"We never quit Mr. Ruskin without being the better for what he has told us, and we therefore recommend this little volume, like all his other works, to the perusal of our readers."—*Economist.*

"This book, daring, as it is, glances keenly at principles, of which some are among the articles of ancient codes, while others are evolving slowly to the light."—*Leader.*

*The Elements of Drawing.*

*Second Edition. Crown 8vo. With Illustrations drawn by the Author. Price 7s. 6d., cloth.*

"The rules are clearly and fully laid down; and the earlier exercises always conducive to the end by simple and unembarrassing means.

To be entertaining is a great gift in a writer. This gift Mr. Ruskin possesses pre-eminently. The whole volume is full of liveliness."—*Spectator.*

"We close this book with a feeling that, though nothing supercedes a master, yet that no student of art should launch forth without this work as a compass."—*Athenæum.*

"It will be found not only an invaluable acquisition to the student, but agreeable and

instructive reading for any one who wishes to refine his perceptions of natural scenery, and of its worthiest artistic representations."—*Economist.*

"The rules and illustrations will be found to be unusually concise, pertinent, and available. . . . Original as this treatise is, it cannot fail to be at once instructive and suggestive."—*Literary Gazette.*

"The most useful and practical book on the subject which has ever come under our notice."—*Press.*

*Modern Painters, Vol. IV. On Mountain Beauty.*

*Imperial 8vo, with Thirty-five Illustrations engraved on Steel, and 115 Woodcuts, drawn by the Author, price 2l. 10s. cloth.*

"Considered as an illustrated volume, this is the most remarkable which Mr. Ruskin has yet issued. The plates and woodcuts are profuse, and include numerous drawings of mountain form by the author, which prove Mr. Ruskin to be essentially an artist. He is an unique man, both among artists and writers."—*Spectator.*

"The present volume of Mr. Ruskin's elaborate work treats chiefly of mountain

scenery, and discusses at length the principles involved in the pleasure we derive from mountains and their pictorial representation. The singular beauty of his style, the hearty sympathy with all forms of natural loveliness, the profusion of his illustrations, and above all the earnest denunciation of cant, form irresistible attractions. High thoughts, clothed in eloquent language, are the characteristics of Mr. Ruskin's productions."—*Daily News.*

*Modern Painters, Vol. III. Of Many Things.*

*With Eighteen Illustrations drawn by the Author, and engraved on Steel, price 38s. cloth.*

"Every one who cares about nature, or poetry, or the story of human development—every one who has a tinge of literature or philosophy, will find something that is for him in this volume."—*Westminster Review.*

"Mr. Ruskin is in possession of a clear and penetrating mind; he is undeniably practical in his fundamental ideas; full of the deepest reverence for all that appears to him beautiful and holy. His style is, as usual, clear, bold,

racy. Mr. Ruskin is one of the first writers of the day."—*Economist.*

"The present volume, viewed as a literary achievement, is the highest and most striking evidence of the author's abilities that has yet been published."—*Leader.*

"All, it is to be hoped, will read the book for themselves. They will find it well worth a careful perusal."—*Saturday Review.*

WORKS OF MR. RUSKIN—*continued.**Modern Painters. Vols. I. and II.*

*Imp. 8vo., Vol. I., 5th Edit., 18s. cloth. Vol. II., 4th Edit., 10s. 6d. cloth.*

"Mr. Ruskin's work will send the painter more than ever to the study of nature; will train men who have always been delighted spectators of nature, to be also attentive observers. Our critics will learn to admire, and mere admirers will learn how to criticise: thus a public will be educated."—*Blackwood's Magazine.*

"A generous and impassioned review of the works of living painters. A hearty and earnest work, full of deep thought, and developing great and striking truths in art."—*British Quarterly Review.*

"A very extraordinary and delightful book, full of truth and goodness, of power and beauty."—*North British Review.*

*The Stones of Venice.*

*Complete in Three Volumes, Imperial 8vo, with Fifty-three Plates and numerous Woodcuts, drawn by the Author. Price 5l. 15s. 6d., cloth.*

EACH VOLUME MAY BE HAD SEPARATELY.

**VOL. I. THE FOUNDATIONS, with 21 Plates, price 2l. 2s.**

**VOL. II. THE SEA STORIES, with 20 Plates, price 2l. 2s.**

**VOL. III. THE FALL, with 12 Plates, price 1l. 11s. 6d.**

"This book is one which, perhaps, no other man could have written, and one for which the world ought to be and will be thankful. It is in the highest degree eloquent, acute, stimulating to thought, and fertile in suggestion. It will, we are convinced, elevate taste and intellect, raise the tone of moral feeling, kindle benevolence towards men, and increase the love and fear of God."—*Times.*

"The 'Stones of Venice' is the production"

of an earnest, religious, progressive, and informed mind. The author of this essay on architecture has condensed into it a poetic apprehension, the fruit of awe of God, and delight in nature; a knowledge, love, and just estimate of art; a holding fast to fact and repudiation of hearsay; an historic breadth, and a fearless challenge of existing social problems, whose union we know not where to find paralleled."—*Spectator.*

*The Seven Lamps of Architecture.*

*Second Edition, with Fourteen Plates drawn by the Author. Imperial 8vo, price 1l. 1s. cloth.*

"By the 'Seven Lamps of Architecture,' we understand Mr. Ruskin to mean the seven fundamental and cardinal laws, the observance of and obedience to which are indispensable to the architect, who would deserve the name. The politician, the moralist, the divine, will find in it ample store of instructive matter, as well as the artist. The author of this work belongs to a class of thinkers of whom we have too few amongst us."—*Examiner.*

"Mr. Ruskin's book bears so unmistakably the marks of keen and accurate observation, of a true and subtle judgment and refined sense of beauty, joined with so much earnestness, so noble a sense of the purposes and business of art, and such a command of rich and glowing language, that it cannot but tell powerfully in producing a more religious view of the uses of architecture, and a deeper insight into its artistic principles."—*Guardian.*

*Lectures on Architecture and Painting.*

*With Fourteen Cuts, drawn by the Author. Second Edition. Crown 8vo, price 8s. 6d. cloth.*

"Mr. Ruskin's lectures—eloquent, graphic, and impassioned—exposing and ridiculing some of the vices of our present system of building, and exciting his hearers by strong motives of duty and pleasure to attend to architecture—are very successful."—*Economist.*

"We conceive it to be impossible that any intelligent persons could listen to the lectures, however they might differ from the judgments asserted, and from the general propositions laid down, without an elevating influence and an aroused enthusiasm."—*Spectator.*

## NEW PUBLICATIONS.

*Captivity of Russian Princesses in the Caucasus: including a Seven Months' Residence in Shamil's Seraglio, in the Years 1854-5.* Translated from the Russian, by H. S. EDWARDS.

With an authentic Portrait of Shamil, a Plan of his House, and a Map.  
Post 8vo, price 10s. 6d. cloth.

"A book than which there are few novels more interesting. It is a romance of the Caucasus. The account of life in the house of Shamil is full and very entertaining; and of Shamil himself we see much."—*Examiner*.

"The story is certainly one of the most curious we have read; it contains the best popular notice of the social polity of Shamil and the manners of his people."—*Leader*.

"The narrative is well worth reading."—*Athenæum*.

*Esmond.* By W. M. THACKERAY, ESQ.

A New Edition in One Volume, Crown 8vo, price 6s. cloth.

"Apart from its special merits "*Esmond*" must be read just now as an introduction to "*The Virginians*." It is quite impossible fully to understand and enjoy the latter story without a good knowledge of "*Esmond*." The two first numbers of "*The Virginians*" abound with references which can only be properly appreciated by those who have the previous history of the *Esmond* family fresh in their recollection. The new tale is in the strictest sense the sequel of the old, not only intro-

ducing the same characters, but continuing their history at a later period."—*Leader*.

"Mr. Thackeray has selected for his hero a very noble type of the cavalier softening into the man of the eighteenth century, and for his heroine one of the sweetest women that ever breathed from canvas or from book since Raffaele painted and Shakspeare wrote. The style is manly, clear, terse, and vigorous, reflecting every mood—pathetic, graphic, or sarcastic—of the writer."—*Spectator*.

*The Principles of Agriculture; especially Tropical.* By P. LOVELL PHILLIPS, M.D.

Demy 8vo, price 7s. 6d. cloth.

"This volume should be in every farmhouse, and it would pay a landlord to present it to his tenants."—*Critic*.

"This treatise contains nearly all that is known of the science of agriculture."—*Observer*.

*Religion in Common Life.* By WILLIAM ELLIS.

Post 8vo, price 7s. 6d. cloth.

"A book addressed to young people of the upper ten thousand upon social duties. Mr. Ellis has sound views, and his style is simple and clear."—*Examiner*.

"Lessons in Political Economy for young

people by a skillful hand; a clear knowledge is imparted, and sensible views are worked out to demonstration. We cordially recommend this work to all who are interested in the education of the young."—*Economist*.

*Victoria, and the Australian Gold Mines, in 1857; with Notes on the Overland Route.* By WILLIAM WESTGARTH.

Post 8vo, with Maps, price 10s. 6d., cloth.

"Mr. Westgarth has produced a reliable and readable book well stocked with information, and pleasantly interspersed with incidents of travel and views of colonial life. It is clear, sensible, and suggestive."—*Athenæum*.

"A lively account of the most wonderful bit of colonial experience that the world's history has furnished."—*Examiner*.

"We think Mr. Westgarth's book much the best which has appeared on Australia since the great crisis in its history."—*Saturday Review*.

"A rational, vigorous, illustrative report upon the progress of the greatest colony in Australia."—*Leader*.

"The volume contains a large amount of statistical and practical information relating to Victoria."—*Spectator*.

"To those who refer to these pages for solid and guiding information, they will prove most valuable."—*Globe*.

"The best book on the subject."—*Critic*.

NEW PUBLICATIONS—*continued.**The Life of Charlotte Brontë.*

Author of "JANE EYRE," "SHIRLEY," "VILLETTE," &c.  
By MRS. GASKELL, Author of "North and South," &c.

*Third Edition, Revised, Two Volumes, Post 8vo, with a Portrait of Miss Brontë and a View of Haworth Church and Parsonage. Price 24s. cloth.*

"We regard the record as a monument of courage and endurance, of suffering and triumph. All the secrets of the literary workmanship of the authoress of 'Jane Eyre' are unfolded in the course of this extraordinary narrative."—*Times*.

"Mrs. Gaskell has produced one of the best biographies of a woman by a woman which we can recall to mind."—*Athenæum*.

"Mrs. Gaskell's 'Life of Charlotte Brontë' has placed her on a level with the best biographers of any country."—*Globe*.

"This work cannot fail to be of the deepest interest; and it has a special interest for female readers."—*Economist*.

"The whole strange and pathetic story of the Brontë family is faithfully told in Mrs. Gaskell's memoir."—*Critic*.

*The Sea Officer's Manual; being a Compendium of the Duties of a Commander; First, Second, Third, and Fourth Officer; Officer of the Watch; and Midshipman in the Mercantile Navy.* By CAPTAIN A. PARISH, of the East India Merchant Service.

*Small Post 8vo, price 5s. cloth.*

"A very lucid and compendious manual. We would recommend youths intent upon a seafaring life to study it."—*Athenæum*.

"A little book that ought to be in great request among young seamen."—*Examiner*.

*Third Series of Sermons.*

By the late REV. FRED. W. ROBERTSON, A.M., Incumbent of Trinity Chapel, Brighton.

*Second Edition, Post 8vo, with Portrait, price 9s. cloth.*

FIRST SERIES—*Third Edition, Post 8vo, price 9s. cloth.*

SECOND SERIES—*Third Edition, price 9s. cloth.*

"Very beautiful in feeling and occasionally striking and forcible in conception to a remarkable degree."—*Guardian*.

"Mr. Robertson, of Brighton, is a name familiar to most of us, and honoured by all to whom it is familiar."—*Globe*.

"These sermons are full of thought and beauty. There is not a sermon in the series that does not furnish evidence of originality without extravagance, of discrimination without tediousness, and of piety without cant or conventionalism."—*British Quarterly*.

*Antiquities of Kertch, and Researches in the Cimærian Bosphorus.* By DUNCAN McPHERSON, M.D., of the Madras Army, F.R.G.S., M.A.I., Inspector-General of Hospitals, Turkish Contingent.

*Imperial Quarto, with Fourteen Plates and numerous Illustrations, including Eight Coloured Fac-Similes of Relics of Antique Art, price Two Guineas.*

"It is a volume which deserves the careful attention of every student of classical antiquity. No one can fail to be pleased with a volume which has so much to attract the eye and to gratify the love of beauty and elegance in

design. The volume is got up with great care and taste, and forms one of the handsomest works that have recently issued from the English Press."—*Saturday Review*.

## RECENT WORKS.

*Annals of British Legislation, a Classified Summary of Parliamentary Papers.* Edited by PROFESSOR LEONE LEVL.

THE TWENTY-FIRST PART IS JUST ISSUED.

"A series that, if it be always managed as it is now by Professor Levl, will last as long as there remains a legislature in Great Britain."—*Examiner*.

"It would not be easy to over-estimate the utility of Professor Levl's serial. It has the

merit of being an excellent idea zealously carried out."—*Athenæum*.

"We cannot imagine a more truly valuable and nationally important work than this. It is impossible to over-estimate its usefulness."—*Civil Service Gazette*.

*Life and Sermons of Tauler.*

Translated by MISS SUSANNA WINKWORTH. With a Preface by the REV. CHARLES KINGSLEY.

*Small 4to, Printed on Tinted Paper, and bound in antique style, with red edges, suitable for a Present. Price 15s.*

*A Visit to Salt Lake; being a Journey across the Plains to the Mormon Settlements at Utah.* By WILLIAM CHANDLESS.

*Post 8vo, with a Map, price 9s. cloth.*

*The Political Life of Sir Robert Peel.*

By THOMAS DOUBLEDAY.

*Two Volumes, Crown 8vo, price 30s. cloth.*

*The European Revolutions of 1848.*

By EDWARD CAYLEY.

*Two Volumes, Crown 8vo, price 18s. cloth.*

*Signs of the Times; or, The Dangers to Religious Liberty in the Present Day.* By the CHEVALIER BUNSEN. Translated by Miss SUSANNA WINKWORTH.

*One Volume, 8vo, price 16s. cloth.*

*Stories and Sketches.* By JAMES PAYN.

*Post 8vo, Price 8s. 6d. cloth.*

*Stoney's Residence in Tasmania.*

*Demy 8vo, with Plates, Cuts, and a Map, price 14s. cloth.*

*The Court of Henry VIII.: being a Selection of the Despatches of SEBASTIAN GIUSTINIAN, Venetian Ambassador, 1515-1519.* Translated by RAWDON BROWN.

*Two Vols., crown 8vo, price 21s. cloth.*

*Sight-seeing in Germany and the Tyrol, in the Autumn of 1855.* By SIR JOHN FORBES, Author of "A Physician's Holiday," &c.

*Post 8vo, with Map and View, price 10s. 6d. cloth.*

RECENT WORKS—*continued.*

*Conolly on the Treatment of the Insane.*

*Demy 8vo, price 14s. cloth.*

*Hopkins's Handbook of Average.*

*8vo, price 12s. 6d. cloth.*

*Morice's Hand-Book of British Maritime Law.*

*8vo, price 5s., cloth.*

*Adams's History and Topography of the Isle of Wight.*

*Quarto, 25 Steel Plates, cloth, gilt edges, price 2l. 2s.*

*Waring's Manual of Therapeutics.*

*Fcap. 8vo, price 12s. 6d. cloth.*

*Vogel on Disorders of the Blood.*

Translated by CHUNDER COOMAR DEY.

*8vo, price 7s. 6d. cloth.*

*Duncan's Campaign with the Turks in Asia.*

*Two Vols., post 8vo, price 21s. cloth.*

*Ross's Account of Red River Settlement.*

*One Volume, post 8vo, price 10s. 6d. cloth.*

*Ross's Fur Hunters of the Far West.*

*Two Volumes, post 8vo. With Map and Plate. 21s. cloth.*

*Russo-Turkish Campaigns of 1828-9.*

By COLONEL CHESNEY, R.A., D.C.L., F.R.S.

*Third Edition. Post 8vo, with Maps, price 12s. cloth.*

*Thomson's Military Forces and Institutions of Great Britain.*

*8vo, price 15s. cloth.*

*The Militiaman at Home and Abroad; being the History of a Militia Regiment.*

*With Two Etchings, by JOHN LEECH. Post 8vo, price 9s. cloth.*

*Levi's Manual of the Mercantile Law of Great Britain and Ireland.*

*8vo, price 12s. cloth.*

*Thomson's Laws of War Affecting Commerce and Shipping.*

*Second Edition, greatly enlarged. 8vo, price 4s. 6d. boards.*

### NEW CHEAP SERIES OF POPULAR WORKS.

In Small Post 8vo, with large Type, on good Paper, and neat cloth binding.

*British Rule in India.* By HARRIET MARTINEAU.

Price 2s. 6d., cloth.

*The Political Economy of Art.* By JOHN  
RUSKIN, M.A. Price 2s. 6d. cloth.

TO BE FOLLOWED BY

*Lectures on the English Humourists of the 18th  
Century.* By W. M. THACKERAY, Author of "Vanity  
Fair," "The Newcomes," &c.

*The Town; its Memorable Characters and  
Events.* By LEIGH HUNT.

With 45 Cuts.

### CHEAP SERIES OF POPULAR FICTIONS.

Well printed, in large type, on good paper, and strongly  
bound in cloth.

*Jane Eyre.* By CURRER BELL.

*New Edition. Small Post 8vo, price 2s. 6d. cloth.*

"Jane Eyre" is a remarkable production. Freshness and originality, truth and passion, singular felicity in the description of natural scenery, and in the analysis of human thought, enable this tale to stand boldly out from the mass, and to assume its own place in the bright field of romantic literature."—*Times*.

*Shirley.* By CURRER BELL.

*New Edition. Small Post 8vo, price 2s. 6d. cloth.*

"The peculiar power which was so greatly admired in 'Jane Eyre' is not absent from this book. It possesses deep interest, and an irresistible grasp of reality. There are scenes which, for strength and delicacy of emotion, are not transcended in the range of English fiction."—*Examiner*.

*Villette.* By CURRER BELL.

*New Edition. Small Post 8vo, price 2s. 6d. cloth.*

"This novel amply sustains the fame of the author of 'Jane Eyre' and 'Shirley' as an original and powerful writer."—*Examiner*.

*Wuthering Heights and Agnes Grey.* By ELLIS  
and ACTON BELL. With Memoir by Currer Bell.

(Just ready.)

TO BE FOLLOWED BY

*A Lost Love.* By ASHFORD OWEN.



## NEW NOVELS.

(TO BE HAD AT ALL LIBRARIES).

*Gaston Bligh.* By L. S. LAVENU, Author of  
"Erlesmere." 2 vols.

*The Three Chances.* By the Author of "The Fair  
Carew." 3 vols.

"The authoress has a mind that thoroughly appreciates the humorous in life and character."—*Globe*.

"Some of the characters and romantic situations are strongly marked and peculiarly original. . . . It is the great merit of the

authoress that the personages of her tale are human and real."—*Leader*.

"This novel is of a more solid texture than most of its contemporaries. It is full of good sense, good thought, and good writing."—*Statesman*.

*The White House by the Sea: a Love Story.*

By M. BETHAM-EDWARDS. 2 vols.

"The narrative and scenes exhibit feminine spirit and quiet truth of delineation."—*Spec-tator*.

"A tale of English domestic life. The writing is very good, graceful, and unaffected; it pleases without startling. In the dialogue,

people do not harangue, but talk, and talk naturally."—*Critic*.

"A novel made up of love, pure and simple, in the form of an autobiography."—*Leader*.

*Riverston.* By GEORGIANA M. CRAIK. 3 vols.

"A production of mark, and qualified to interest old as well as young."—*Leader*.

"An admirable and in every way genuine work of art."—*Critic*.

"It is highly moral in its tone and character, as well as deeply interesting."—*Morning Herald*.

"No reader will take up this novel without finding his sympathy excited."—*Observer*.

*The Professor.* By CURRER BELL. 2 vols.

*The Noble Traytour. A Chronicle.* 3 vols.

*Farina; a Legend of Cologne.*

By GEORGE MEREDITH, Author of "The Shaving of Shagpüt." 1 vol. Post 8vo, 10s. 6d. cloth.

*Below the Surface: a Story of English Country Life.* 3 vols.

*The Roua Pass; or, Englishmen in the Highlands.* By ERICK MACKENZIE. 3 vols.

*Kathie Brande: The Fireside History of a Quiet Life.* By HOLME LEE, Author of "Gilbert Massenger," "Thorney Hall," &c. 2 vols.

*Friends of Bohemia; or, Phases of London Life.* By E. M. WHITTY, Author of "The Governing Classes." 2 vols., post 8vo.

*Lucian Playfair.* By THOMAS MACKERN. 3 vols.

## NOVELS FORTHCOMING.

*The Moors and the Fens.* By F. G. TRAFFORD.  
3 vols. (Now Ready.)

*The Cruellest Wrong of All.* 1 vol.

*Maud Skillicorne's Penance.* 2 vols.

*My Lady.* 2 vols.

*An Old Debt.* 2 vols.

*A New Fiction.* By HOLME LEE, Author of "Kathie Brande," &c.

## NEW BOOKS FOR YOUNG READERS.

*Uncle Jack, the Fault Killer.*

*With Four Illustrations. Price 3s. cloth.*

*Willie's Birthday; showing how a Little Boy did what he Liked, and how he Enjoyed it.*

*With Four Illustrations. Price 2s. 6d., cloth.*

*Willie's Rest: a Sunday Story.*

*With Four Illustrations. Price 2s. 6d. cloth.*

*Round the Fire: Six Stories for Young Readers.*

*Square 16mo, with Four Illustrations, price 3s. cloth.*

*The King of the Golden River; or, the Black Brothers.* By JOHN RUSKIN, M.A.

*Third Edition, with 22 Illustrations by RICHARD DOYLE. Price 2s. 6d.*

*The Rose and the Ring; or the History of Prince Giglio and Prince Bulbo.* By MR. M. A. TITMARSH.

*With 58 Cuts drawn by the Author. 3rd Edition, price 5s.*

## MISCELLANEOUS.

*Elementary Works on Social Economy.* Uniform in foolscap 8vo, half-bound.

I.—OUTLINES OF SOCIAL ECONOMY. 1s. 6d.

II.—PROGRESSIVE LESSONS IN SOCIAL SCIENCE. 1s. 6d.

III.—INTRODUCTION TO THE SOCIAL SCIENCES. 2s.

IV.—OUTLINES OF THE UNDERSTANDING. 2s.

V.—WHAT AM I? WHERE AM I? WHAT OUGHT I TO DO? &c. 1s. sewed.

*Swainson's Lectures on New Zealand.* Crown 8vo, price 2s. 6d. cloth.

*Swainson's Account of Auckland.* Post 8vo, with a view, price 6s. cloth.

*Playford's Hints for Investing Money.* Second Edition, post 8vo, price 2s. 6d. cloth.

*Sir John Forbes's Memorandums in Ireland.* Two Vols., post 8vo, price 1l. 1s. cloth.

*Leigh Hunt's Men, Women, and Books.* Two Vols., price 10s. cloth.

———— *Table Talk.* 3s. 6d. cloth.

———— *Wit and Humour.* 5s. cloth.

———— *Jar of Honey.* 5s. cloth.

*Sir John Herschel's Astronomical Observations made at the Cape of Good Hope.* 4to, with plates, price 4l. 4s. cloth.

*Darwin's Geological Observations on Coral Reefs, Volcanic Islands, and on South America.* With maps, plates, and woodcuts, 10s. 6d. cloth.

*Levi's Commercial Law of the World.* Two Vols., royal 4to, price 6l. cloth.

*Juvenile Delinquency.* By M. HILL and C. F. CORNWALLIS. Post 8vo, price 6s. cloth.

*Doubleday's True Law of Population.* Third Edition, 8vo, 10s. cloth.

*McCann's Argentine Provinces, &c.* Two Vols., post 8vo, with illustrations, price 24s. cloth.

*Rowcroft's Tales of the Colonies.* Fifth Edit. 6s. cloth.

*Goethe's Conversations with Eckermann.* Translated by JOHN OXENFORD. Two Vols., post 8vo, 10s. cloth.

*Kavanagh's Women of Christianity Exemplary for Piety and Charity.* Post 8vo, with Portraits, price 12s., in embossed cloth, gilt edges.

## POETRY.

*The Six Legends of King Goldenstar.* By the late ANNA BRADSTREET. Fcap. 8vo, price 5s.

*England in Time of War.* By SYDNEY DOBELL, Author of "Balder," "The Roman," &c. Crown 8vo, 5s. cloth.

"That Mr. Dobell is a poet, 'England in time of War' bears witness in many single lines, and in two or three short poems."—*Athenæum*.

*The Cruel Sister, AND OTHER POEMS.* Fcap. 8vo, 4s. cl.

"There are traces of power, and the versification displays freedom and skill."—*Guardian*.

*Poems of Past Years.* By Sir ARTHUR HALLAM ELTON, Bart., M.P. Fcap. 8vo, 3s. cloth.

"A refined, scholarly, and gentlemanly mind is apparent all through this volume."—*Leader*.

*Poems.* By Mrs. FRANK P. FELLOWS. Fcap. 8vo, 3s. cl.

"There is easy simplicity in the diction, and elegant naturalness in the thought."—*Spectator*.

*Lota, AND OTHER POEMS.* By DEVON HARRIS. Fcap. 8vo, 4s. cloth.

"Displaying high poetic genius and power."—*Electio Review*.

*Poetry from Life.* By C. M. K. Fcap. 8vo, cl. gilt, 5s.

"Elegant verses. The author has a pleasing fancy and a refined mind."—*Economist*.

*Poems.* By WALTER R. CASSELS. Fcap. 8vo, price 3s. 6d. cloth.

"Mr. Cassels has deep poetical feeling, and gives promise of real excellence. His poems are written sometimes with a strength of expression by no means common."—*Guardian*.

*Garlands of Verse.* By THOMAS LEIGH. Fcap. 8vo, price 5s. cloth.

"One of the best things in the 'Garlands of Verse' is an Ode to Toil. There, as elsewhere, there is excellent feeling."—*Examiner*.

*Balder.* By SYDNEY DOBELL. Crown 8vo, 7s. 6d. cloth.

"The writer has fine qualities; his level of thought is lofty, and his passion for the beautiful has the truth of instinct."—*Athenæum*.

*Poems.* By WILLIAM BELL SCOTT. Fcap. 8vo, 5s. cl.

"Mr. Scott has poetical feeling, keen observation, deep thought, and command of language."—*Spectator*.

*Poems.* By MARY MAYNARD. Fcap. 8vo, 4s. cloth.

"We have rarely met with a volume of poems displaying so large an amount of power, blended with so much delicacy of feeling and grace of expression."—*Church of England Quarterly*.

*Poems.* By CURRER, ELLIS, and ACTON BELL. Fcap. 8vo, 4s. cloth.

*Select Odes of Horace.* In English Lyrics. By J. T. BLACK. Fcap. 8vo, price 4s. cloth.