

~~955~~ <sup>no</sup> <sub>6/6</sub>

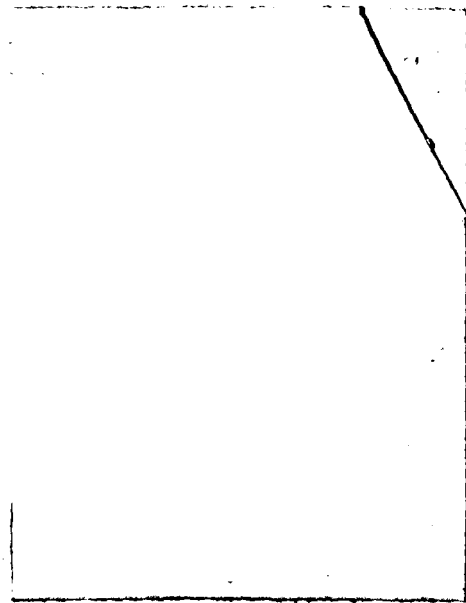

330.942

9655

**SERVANTS OF INDIA SOCIETY'S LIBRARY  
POONA 4.**

**FOR INTERNAL CIRCULATION**

**To be returned on or before the last date stamped below**

--	--	--

**Dhananjayrao Gadgil Library**



**GIPE-PUNE-009555**

**AN INTRODUCTION TO THE  
INDUSTRIAL HISTORY OF ENGLAND**

L 9555

AN INTRODUCTION TO THE  
INDUSTRIAL HISTORY  
OF ENGLAND

BY

ABBOTT PAYSON USHER PH.D.

ASSISTANT PROFESSOR OF ECONOMICS  
CORNELL UNIVERSITY

LONDON

GEORGE G. HARRAP & CO. LTD.

2 & 3 PORTSMOUTH STREET KINGSWAY W.C.



TO THE MEMORY  
OF  
MY BROTHER  
ALBERT MORSE USHER, 107th U.S. INFANTRY  
WOUNDED, OCTOBER 17, 1918  
IN THE BATTLES FOR THE HINDENBURG LINE  
DIED AT CAMIERS, OCTOBER 28, 1918

X9.3.N2

F1

9555

*Published February 1921*

---

*Printed at THE BALLANTYNE PRESS  
SPOTTISWOODE, BALLANTYNE & CO. LTD.  
Colchester, London & Eton, England*

L 9555

## PREFACE

THE present volume has been planned and written with a view to the needs of students beginning work in economic history. For this reason matters have been included that do not lie strictly within the field of industrial history, notably the chapters dealing with agrarian questions. These problems could hardly be deemed essential to the understanding of the development of industry in the literal sense, but such material is ordinarily included in the introductory courses in economic history even if the course is described as "industrial history." This slight inconsistency in nomenclature tends to create some confusion between the scope of the term "industrial history" and "economic history" in general. It is not, of course, serious, but it is perhaps better that these terms should be used with some care in the titles of books. Strictly speaking, industrial history is of no more than co-ordinate importance with agrarian history and commercial history, though the problems of these phases of economic history are relatively more difficult and ill-suited to the capacities of an elementary class. The emphasis currently laid upon industrial history is thus thoroughly justified upon pedagogical grounds, but it would be unfortunate to allow the expediency of this course to obscure the just proportions between the different phases of the general field.

The space devoted to the first three chapters may seem disproportionate to some, but it is believed that the text of the chapters will sufficiently explain their place in the book. If it should be desired to confine attention more exclusively to England, it would not be necessary for a class to read the first two chapters, though the characterization of the forms of industrial organization (pp. 4-17) should in that case be presented by the teacher. It is believed that these chapters will prove particularly useful in courses given with especial reference to work in sociology and economics as distinct from

purely descriptive history. The slight departure from the narrowly nationalistic point of view that usually dominates the writing of economic history makes the present volume a comprehensive survey of the general problems of industrial history.

The references for reading in connection with the text represent personal experience with classes, and it is believed that no books are recommended for use with classes that are not within the compass of ordinary students. An attempt has been made to suggest reading along the line of all the varied interests presented by the subject, so that each student may have opportunity to give expression to his personal tastes. Pains have been taken to make the lists sufficiently inclusive to bring the student in touch with all the critical studies of primary importance, and as most of the works contain bibliographies it would not be difficult to get in touch with the literature on each subject.

In addition to the obligations to writers which are acknowledged in the text or in the notes, the author is greatly indebted to his colleagues at Cornell University, most especially to Professor A. A. Young, without whose encouragement and advice this book would not have been written. Professor W. F. Willcox, Professor C. H. Hull, and Mr. R. A. Campbell have given me the benefit of their advice on many points which involved some departure from conventional views. I wish also to express my obligations to Professor E. F. Gay, whose teaching was instrumental in the formulation of the problems that have since then claimed my best attention. While it is not my intention to imply that he is in any way responsible for views expressed in the present volume, my work has been a direct outcome of the stimulus of his teaching.

ABBOTT PAYSON USHER

# CONTENTS

## CHAPTER I

### FORMS OF INDUSTRIAL ORGANIZATION

- I. Socialists and industrial history: Concentration of attention on the forms of industrial organization — The socialistic characterization of typical forms: household industry, craft industry, the factory system — Criticism of the interpretation of the history of antiquity by historians . . . . . 1
- II. Typical forms of industrial organization: Undiversified household industry distinguished by the absence of specialized skill — Probably a more primitive form than is usually assumed — Artificiality of the classification of industry in the patriarchal household with slaves as "household" industry — Craft industry distinguished by specialized skill, its presence indicated most clearly by the existence of distinguishable crafts in a given locality — Wage-work and craft-work not distinct stages in evolution — Disintegration of the process of manufacture by the development of crafts — The "putting-out system" a means of integration — Various terms used to describe this form of organization — The essence of the system lay in the ownership of materials by capitalists: in early forms, raw materials only; in later forms, all the instruments of production — Work was done in the home subject to no supervision — The factory distinguished by disciplined coordination — Concentration of operatives was a means to this end rather than an end in itself — The factory, as a form, antedates the Industrial Revolution — Administrative definitions of "factories" have been artificial — Difficulty of classifying the "sweat-shop" . . . . . 3
- III. Commerce and industry: The degree of industrial specialization is determined by the extent of the market — The market is subject to social as well as to territorial limitations; social limitations especially important in the early period — Industrial specialization concerned in large measure with the wants of the wealthy — The Industrial Revolution resulted in the breaking-down of the social limitations of the market and the standardization of both production and consumption — The expansion of the market in the earlier periods was primarily territorial; best indicated by the growth of geographical knowledge . . . . . 18

## CHAPTER II

### THE RISE OF THE CRAFTS IN ANTIQUITY

- I. The dawn of history not to be identified with the beginnings of social organization: early life dominated by the city — The beginnings of

industrial history not coincident with the first stages of any schematic or logical arrangement of forms of industrial organization — The city life of antiquity: its social elements; the mass of urban population — Distinctive features of city life in the middle ages and in modern times — Similarities in industrial organization in antiquity and the middle ages . . . . .	24
II. Egypt: Ambiguity of pictorial evidence — A list of crafts from the Twelfth Dynasty — Other indications of the number of crafts — Status of artisans . . . . .	30
III. Mesopotamia: Economic conditions in the early period — References to artisans in the Code of Hammurabi — The temples as business houses — Difficulty of classifying their industrial operations — Apprenticeship and craft organization — Distinctions necessary between forms of organization and the scale of industrial life . . . . .	34
IV. Greece: Various interpretations of the economic development of the Greeks in the semi-historic period — Commerce usually the basis of highly specialized industry — Leaf's conception of the Trojan War — Correlation of the view with the industrial history of Greece — Economic mechanism not a measure of artistic accomplishment — Comparison of economic conditions in antiquity with eighteenth-century Prussia — The degree of industrial specialization in the sixth century B.C. — Rapid growth in the fifth and fourth centuries — The "factory system" — Socialistic interpretations — Slavery in antiquity . . . . .	38
V. Rome and Constantinople: Roman collegia — The list of crafts — Crafts at Constantinople — Evidences of craft guilds . . . . .	47

## CHAPTER III

## CRAFTS AND CRAFT GILDS IN MEDIEVAL FRANCE

I. Roman influences in Gaul — Probable degree of survivals in the organization of industry — Basic crafts persisted — Conditions on the great estates, the "gynceum" — Lists of the craftsmen gathered around monastic establishments: Saint Riquier, in the ninth century; Saint Vincent at Le Mans, in the eleventh century — Difficulties of classifying industrial aggregations of partially unfree artisans . . . . .	52
II. The rise of the "Third Estate": its importance in social and economic history; — The prosperity of France indicated by the growth of population: estimates for Paris, 1292 and 1328; France in 1328 — Nature of the evidence of industrial specialization — Three groups of crafts: merchandizing crafts; crafts occupied with purely local concerns; crafts concerned with export industry — List of crafts at Paris late in the eleventh century — Numbers in the different occupational groups at Paris in 1292 and 1300 — Classification of crafts according to the numbers of craftsmen registered on the tax-rolls — The dis-	

CONTENTS

integration of industry — Relations between producers and consumers: not happily described as direct contact — Necessity of recognizing the social stratification of the market — Beginnings of capitalistic control of the industrial process — Wage-earners, but no wage-earning class — Crafts whose members were regularly employed by other crafts . . . . . 57

III. Members of the specialized industrial household — Apprentices and apprenticeship — Journeymen and masters — Conditions of becoming a master in the early period — The free craft: a purely spontaneous growth — The sworn craft or gild, a privileged body created by authority — The transition from the free craft to the gild at Paris — The wardens of the gild — Essentially administrative functions of the gilds at Paris — Special conditions affecting the growth of crafts closely associated with the Royal Household — History of the carpenters — Craft statutes as evidence — The more usual regulations — Early Parisian regulations of apprenticeship — Position of the journeyman — Ease of becoming a master — The master-piece not required in the early period — Inspection of goods and processes of production . . . . . 72

CHAPTER IV

THE POPULATION OF ENGLAND: 1086-1700

I. Early estimates of population based upon numbers of families, or property-holders — Uncertainty as to the proportion of the total population to those enumerated — Omissions — Importance of ascertaining the general movement of population — Estimates for England and for France — One hundred persons per square mile probably normal density of population for Europe prior to the Industrial Revolution — England relatively under-populated — Relativity of the conception of normal density: influence of rice culture in India, of the Industrial Revolution in Europe . . . . . 87

II. Estimates of Seebohm and Gasquet for the population of England prior to the Black Death — The subsidy rolls — Figures for five counties compared with the figures for 1377 — Changes in the relative density of population — The westward movement — Its significance . . . . . 92

III. Size of villages in Derby and Essex in 1086 — Population of towns in 1377 — Essentially rural population indicated by the evidence from the Subsidy Rolls — The growth of London . . . . . 102

CHAPTER V

VILLAGE AND MANOR

I. Persistence of superficial aspects of village life — Aristocracy and the village — Primitive land tenures an expression of economic needs . . . . . 109

- II. Scattered farms and villages: Modes of settlement: scattered farms; the enclosed village; the open-field village — Field arrangements of a typical open-field village — Methods of agriculture — Divisions of the fields into strips — Village organization — Racial explanations of these three modes of settlement — Economic interpretations suggested by Siberian conditions — The economic factors underlying a transition from individual farms to the open-field village — Complexity of conditions in Europe before and during the great migrations . . . . . 112
- III. The common people and the magnates: Aristocracy ultimately the predominant force in medieval rural organization — Relation of a landed aristocracy to the village — Possibility of a survival of the rural organization of the Roman period — Factors in the natural growth of an aristocracy — Influence of the Norman Conquest — Proportions of the different classes as shown by *Domesday Book* — The manor as an administrative and legal conception — Divergent types revealed by the Domesday Survey . . . . . 120
- IV. The organization of the manor in the thirteenth and fourteenth centuries: The general aspect of a manor — Week works and boon days — Services rendered by crofters — The officers of the manor — Village officials — Destruction of the economic independence of the manor by the development of local markets — Stages in this process . . . . . 127
- V. The end of villeinage in England: The influence of commutation of labor services upon tenure — Complexity of motives underlying commutation — Chronology of the movement — The new yeomanry of England . . . . . 131

## CHAPTER VI

## THE TRADERS AND THE TOWNS

- I. Schmoller's conception of the "town economy" — An unduly literal interpretation of the sources — Formalism and legal fictions — Enfranchisement of trade by means of special privileges — Medieval trade territorially extensive but of relatively small volume — Its needs not inadequately met by the complex legal status of trade and traders . . . . . 134
- II. Fairs and the Law Merchant: Fairs and markets — Some fairs especially important for wholesale and for foreign trade — European cycles of fairs — Possible fair cycle in England — Essential and ancillary business at the fairs — Tariffs, tolls, and "free trade" — Enfranchisement conferred by the charters was legal rather than fiscal — Pie-powder courts: their procedure and the Law Merchant — Special franchises of continental merchants in England . . . . . 137
- III. Associations of merchants: Organization of resident alien merchants — Origins of the Teutonic Hanse — Activities of the Hansards —

## CONTENTS

xi

- The Steelyard — Privileges of the Hanse — The *Carta Mercatoria* — Purveyance, or prise — Struggle to maintain the privileges granted by the *Carta Mercatoria* — Decline of the Hansards — Merchants of the Staple — Purpose of the Staple — Its location — Origin of the company — Control of the trade in wool — Rise of the Merchant Adventurers — The cloth trade — Struggle with the Hansards . . . 146
- IV. Township and borough: Distinction between the legal and the economic aspects of urban life — Differentiation between urban and rural life — Military factors in the growth of boroughs — Administrative factors — Economic and legal developments in the thirteenth century — Significance of the late emergence of incorporated towns in connection with Schmoller's theory — The Gild Merchant — Political decentralization and cosmopolitanism . . . . . 158

## CHAPTER VII

### THE DEVELOPMENT OF GILDS IN ENGLAND

- I. The word "gild" — Three types of gild — French terminology — Brentano's theory — Probably no fraternal element in the craft gild, no direct connection with the modern trade union . . . . . 165
- II. Religious gilds: References to religious gilds at an early date; little information until 1389 — Functions and membership of religious gilds — Officers, rules, and customs . . . . . 168
- III. The Gild Merchant: Religious elements in the gild merchant — Relations with the crafts; craft gilds — Gild merchant and municipality — Essential privileges — Non-resident membership — The sharing of purchases — Officers and meetings . . . . . 171
- IV. The Craft gilds: Religious gilds composed of members of a single craft — Crafts chartered by the King — Crafts deriving their authority from the municipality — Crafts at Norwich in 1415 . . . . . 176
- V. Relation of different types of gild to each other: The gild merchant most powerful when the other types were relatively less prominent — Religious gilds developed contemporaneously with other craft organizations — Confusion of functions and aims — Associations of crafts for ceremonial observances — Occupational statistics — Predominance of small crafts — Craft gilds probably a less conspicuous feature of social life than religious gilds . . . . . 181
- VI. The religious gilds and the crown: The gilds and the Statute of Mortmain — Acquisition of charters from the King — The grant to the Tailors of Salisbury — Confiscation of gild property in 1547 — Not directly a cause of the decline of the craft gilds — Wage-earners and employers — Companies formed by the employing classes . . . . . 187
- VII. The Statute of Apprentices: Purposes of the statute — Distinctions between the various crafts — Obligation to follow some calling — The wage-fixing clauses . . . . . 191



## CHAPTER VIII

## THE WOOLEN INDUSTRIES: 1450-1750

- I. Development of technique in the woolen industry — Types of wool and of woolen fabrics — Fundamental processes of the woolen and worsted industries — Characteristic features of woollens and worsteds — Growth of the worsted industry in England . . . . . 195
- II. The division of labor in the woolen industry — Growth of specialization of tasks — Subordination of dyeing and fulling — Proportions of workers in the worsted industry — Acquisition of capitalistic control by the mercantile class — Spinning not a specialized occupation in the modern sense — Relation of industry to agriculture . . . . . 201
- III. Geography of the woolen industries — Effect of the diffusion of industry upon the towns — The Weaver's Act — Anti-capitalistic purpose of the statute — Importance of the exemptions — Changes in the industries after 1550 . . . . . 209
- IV. The scale of manufacture: 1395-96 — The putting-out system at Colchester — The larger and the smaller masters — Importance of the putting-out system about 1450 — Descriptions of the system in the late sixteenth century — Divergent forms — Persistence of these conditions until the early nineteenth century — Sporadic tendencies toward the factory system . . . . . 215

## CHAPTER IX

## THE ENCLOSURE MOVEMENT AND LAND REFORM

- I. The meaning of "enclosure" — Its effect upon agricultural methods — The Midland system — Change in the characteristic size of farms — Social consequences of the change — Sequence of these changes — Continuity of the enclosure movement — Uncertainty of purpose in the early stages . . . . . 225
- II. Enclosure of waste — Legal problems involved in enclosure of the open fields — Rights of common pasture — Enclosure by agreement — The duty of a steward — Early enclosures partial — Creation of precedents for enclosure by act of Parliament — Theory of the Enclosure Acts — Dangers to small proprietors — Lord Thurlow's criticism of Parliamentary procedure — Essential difficulties in determining questions of right and title — The problem of common pastures — Social consequences of enclosing them — Protests at the close of the eighteenth century . . . . . 232
- III. Early attempts to correct the mistakes of the Enclosure Acts — Allotments and small holdings — Experiments of landowners with allotments — Early legislation — The Act of 1882 — Need of compulsion — The Act of 1887 — The small-holdings movement — Peasant proprietorship — Defects of the Act of 1892 — The Act of 1907 . . . . . 240

## CONTENTS

xiii

### CHAPTER X

#### THE INDUSTRIAL REVOLUTION

Origin of the phrase "Industrial Revolution" — Social importance of the period compared with other transition periods — Early consciousness of the social transformation among English writers — Difficulty of characterizing the movement — Identification of the movement with the great inventions an error — Toynbee's emphasis upon the rise of the *laissez-faire* policy — Socialistic emphasis upon capitalism and the rise of the factory system — Inadequacy of any single formula — Relative independence of the causative factors underlying the changes in the textile and in the metal trades — Genesis of the new cotton industry — The fuel problem and the metal trades — Probable rank of various industrial groups in 1700 — Effect of the Industrial Revolution upon the rank of different groups . . . . . 247

Statistics of industrial groupings: England in 1851; Prussia in 1855; British India in 1901 — These figures probably indicative of conditions that had long prevailed — Statistics for the early twentieth century reveal the full influence of the Industrial Revolution — Change in the relative importance in industry and agriculture — Tables for British India in 1901; France in 1866; the German Empire in 1895 and 1907; France, in 1901 and 1906; England and Wales in 1811, 1821, 1891, and 1901 — Primary factors in industrial location in the old and in the new order — Humidity and cotton spinning — Mineral deposits — Problems of commercial availability — Influence of the Industrial Revolution upon population — Gregory King's forecast, 1693 — Actual growth of population in England . . . . . 257

Chronology of the Industrial Revolution: Stages in the development of inventions — Significance to the individual inventor of the technical equipment of society — Invention in the larger sense a social accomplishment . . . . . 271

### CHAPTER XI

#### THE EAST INDIA COMPANY AND THE VESTED INTERESTS

The English and Dutch Companies for trade with the East Indies — The novelty of Indian cottons — Development of the trade — Limitation of the expansion of English trade in the Spice Islands — Establishments on the continent of India — Distress in the woolen and silk industries — Agitation for protection — The Act of 1696-97, to prohibit the wearing of East Indian goods — Contrast between the French and English policies of protection — Relation of the commercial issue to party politics in England — The East India Company the focus of discussions of commercial policy throughout the seventeenth century — Thomas Mun's defense of the Company — The place of the balance-of-trade doctrine in the controversy — Ne-

negotiations of 1713 with France — Complexity of the political issue — The Calico Act of 1721 — Exceptions made in favor of the existing cotton industry — Discrepancy between the expectations of the woolen manufacturers and the results of the protective legisla- tion . . . . .	276
---	-----

## CHAPTER XII

## THE NEW COTTON INDUSTRY

I. The relation of invention to the rise of the cotton industry — The process of spinning — Carding machines — Continuous and inter- mittent processes of spinning — The throstle, its limitations — Grades of yarn — Wyatt's claims as an inventor — Probable relations be- tween Wyatt and Paul — Paul's spinning patent of 1758 — Com- mercial ventures of Wyatt and Paul — Generality of interest in the problem of mechanical spinning — Arkwright's early career — Work on the spinning machine — The patent suits — The jenny — Cromp- ton's mule; its accomplishments, immediately and ultimately; its in- fluence upon the industry — Development of the power-loom . . . . .	287
II. The expansion of the cotton industry: Statistics of consumption of raw cotton — Values of merchandise exported — Values of goods consumed at home and of exports compared with similar statistics of woolens and linens — Relative importance of the different branches of the textile manufacture — The influence of the spinning inven- tions upon the costs of yarn, 1779-1832 — Comparison of labor costs of mule spinning with labor costs in India . . . . .	302

## CHAPTER XIII

## THE REORGANIZATION OF THE METAL TRADES

I. A new fuel and a new furnace: The change of fuel not an adequate in- dex of the character of the transformation of the metal trades — Sub- stitution of the indirect for the direct process — Malleable iron, cast iron, steel — Persistence of the direct process due to mechanical limitations — Unsatisfactory results of the direct process — Types of furnace — Transformation of the high bloomery furnace into the modern blast furnace — Dudley's experiments — The Darbys at Colebrookdale — Perfection of a coke-burning furnace — Need of blast — Smeaton's blast pump . . . . .	314
II. James Watt and the steam engine: The Newcomen engine — Watt's training and profession — Scientific study of heat and the Newcomen engine — His inspiration — Change in the character of the engine as result of Watt's condensing chamber — Mechanical difficulties en- countered in building engines — Causes of these difficulties — Im- portance of the development of the lathe — The slide rest . . . . .	324
III. The metallurgical problems of the iron industry: Difficulty of elimi- nating carbon — The reverberatory furnace — Onions' description of	

## CONTENTS

xv

- his method of puddling — Uncertainty of the nature of Cort's contribution — Development of the rolling mill — New products . . . 329
- IV. Sir Henry Bessemer: Special significance of his career — Early training and inventions — The bronze powder scheme — Necessity for secrecy — The capacity of machine-makers tested by the mode of awarding contracts for the machines — Importance of the achievement indicated by their success in executing the contracts — Further experimentation — Genesis of the steel project — Original purpose — Decarburization by means of a blast of air — Development of the converter — Announcement of the new process — Disappointments — Importance of non-phosphorus-bearing ores — The Thomas and Gilchrist patent — Its influence upon the geography of the European iron industry . . . . . 334

### CHAPTER XIV

#### THE RISE OF THE MODERN FACTORY SYSTEM

- I. The definition of a factory: The factory presumed by early writers to be dependent upon machinery — Aggregation of workers and factory discipline — Irksomeness of discipline — Early experimentation with the factory system — Reasons for the late development — Factories without machinery . . . . . 346
- II. Legal obstacles to the establishment of the factory system: Elizabethan legislation — Breakdown of the system of apprenticeship — The knit stocking industry — Troubles in the West Riding — The attempt to apply the Statute of Apprentices — The Woolen Inquiry and the Report of 1806 . . . . . 352
- III. The rise and progress of the factory system: The earliest factories — Development of factories in the cotton industry at the close of the eighteenth century — Conditions in the woolen industry — Factories and the factory population in 1816 — Abnormal proportion of women and children — Probable explanation — Changes in the worsted industry — Pauper apprenticeship — Attempts at regulation — Likelihood of misjudging the progress of the factory system — Proportions of the industrial population in factories at various dates — The occupational returns of 1901 . . . . . 355
- IV. Artisans and machinery: Influence of the transition upon the workers less certain than frequently supposed — Little evidence of hardship among skilled artisans — Importance of the introduction of unskilled labor in the textile trades — Various causes of distress — Machinery an emancipating force . . . . . 363

### CHAPTER XV

#### THE RISE OF COLLECTIVE BARGAINING

- I. The wage-fixing clauses of the Statute of Apprentices — Uncertainty of the extent of their application — Journeymen's organizations in

- London: 1667 and 1696 — Weavers' clubs in the West of England about 1727 — Webb's interpretation of the Act of 1756 — Evidence of collective bargaining — The Spitalfields riots — "Subscription societies" — The Spitalfields Act: 1773 — Mode of administration — Later history of the act — Wages regulated according to the price of bread — The ribbon manufacture at Coventry — The big purl time — The list of 1813 — Organizations of the weavers to resist depression of wages — Difficulty of enforcing the list of 1816 — Petition for an extension of the Spitalfields Act — Repeal of the act — Wage lists at Coventry . . . . . 367
- II. The Combination Laws: Difficulty of estimating the importance of the Combination Laws of 1799 and 1800 — Not generally enforced — Probable purpose of the Act of 1799 — The conception of status — The Act of 1800 — The doctrine of conspiracy . . . . . 377
- III. The Laws of 1824 and 1825: Francis Place — Beginning of the agitation for repeal of the Combination Laws — Contact with Hume and M'Culloch — The Committee of 1824 — Preparation of the text of the acts — Anticipations of Place — Immediate results of repeal — The Committee of 1825 — Differences between the Acts of 1824 and 1825 — New importance given to the doctrine of conspiracy — Difficulties of unionists — The Act of 1871; a satisfactory but legally ambiguous position . . . . . 380

## CHAPTER XVI

## THE PROTECTION OF HEALTH AND WELFARE BY THE STATE

- I. Obstacles to reform and the reformers: New social problems and the unreformed constitution — Difficulty of creating a central administration in a Parliamentary system — The ideal of local self-government — Development of the agitations for social regulation and for free trade — A. A. Cooper, the seventh Earl of Shaftesbury — Edwin Chadwick . . . . . 387
- II. Sanitation: Sewers and methods of removing waste in the early nineteenth century — Conditions in the poorer districts: Liverpool — Chadwick's conception of the modern system — Investigations by the Poor Law Commissioners — The Public Health Act of 1848 — Failure of the first Board of Health — Accomplishments of the period 1854-71 — The legislation of 1871 — Unfortunate policy in the departmental organization of the Local Government Board — The Ministry of Health Act: 1919 . . . . . 395
- III. Housing: Importance of housing to public health — Shaftesbury's act — The Torrens Act: 1868 — The Cross Act: 1875 — Subsequent development of the building code — Relative failure of the reconstructive aspects of this legislation — The new housing problem . . . . . 403
- IV. Factory legislation: Unwillingness of Parliament to legislate di-

## CONTENTS

xvii

- rectly with reference to adult men except in "dangerous trades" — Laissez-faire doctrines unimportant in the history of factory legislation — Necessity of correlation between the spread of the factory system and the development of factory legislation — Nature of opposition to factory legislation in Parliament — Acts prior to 1833 — The agitation begun in 1831 — The Act of 1833 — Regulation of hours — Extension of the factory code to other industries by the Acts of 1867 and 1878 — Unsatisfactory character of the statistics collected by the factory inspectors — Dangerous trades . . . 407
- V. The relief of destitution: The Elizabethan Poor Law — The Law of Settlement: 1662 — Increase in the amount of destitution in the late eighteenth century — Causes — Depression following the Napoleonic Wars — Abandonment of Cholesbury to the poor — The mixed workhouse and out-relief — Abuse of the Poor Law by landlords and farmers — Chadwick's proposals — Inadequacy of the Poor Law of 1834 — The Royal Commission of 1909 . . . 415
- VI. Social insurance: Relation of insurance to the relief of destitution — Variety of contingencies to be met — Possibilities of shifting the burden of providing for disability — Insurance a superior form of provision for distress — Liability of employers under the common law — The Compensation Act — Hostility of workingmen's organizations — Insurance against sickness and disability — Unemployment — Old Age — Probable accomplishments of this legislation . . . 422

## CHAPTER XVII

### THE DEVELOPMENT OF THE RAILWAY

- I. Early private tram lines — Lines projected by canal companies as common carriers — Richard Trevithick and the non-condensing engine — Steam-driven coaches on the highways — Development of the tram lines by the collieries in the Newcastle field — George Stephenson — Relation of northern experiments with the locomotive to Trevithick's work — Stephenson's experiments with the resistances created by grades — The Stockton and Darlington Railway — Examination of different methods of steam traction by the promoters of the Liverpool and Manchester project — Stephenson's plan for the line — The locomotive contest — The "Rocket" . . . 431
- II. Growth of the railway system: 1830-46: Predominance of local interests in early projects — Through traffic — Beginnings of amalgamation — The Midland Counties lines — Formation of the Midland Railway: 1844 — The Great Western — Its broad gauge . . . 443
- III. The rise of competition: 1846-73: Competitive traffic regions — Beginnings of the East Coast Route — The London and North Western connection with Scotland — The London-York projects — The Great Northern — The rate war — The Octuple agreement — Schemes for amalgamations in 1853 — The issue before Cardwell's committee . . .

- Effect of its decisions upon the development of the Midland Railway  
 — The attitude of the Midland towards third-class passengers . . . 448

## CHAPTER XVIII

## THE GOVERNMENT AND THE RAILWAYS

Costs of railway construction — Parliamentary costs — The general character of Parliamentary procedure — Provisions of the early charters — Beginnings of regulation — The Act of 1845 — Provision for non-discriminatory rates — Attempts to provide administrative supervision — The Railway Commission of 1873 — Careful discrimination of the Committee of 1853 in stating the advantages of the policy of maintaining competition — Report of the Departmental Committee of 1911 — Likelihood of nationalization of the railways . . . . . 459

Status of pooling agreements — Methods of rate-making — Growth of opposition among the traders — Agitation for a general revision of rates — The Act of 1888 and the new rates — Uncompromising attitude of the railways — The Act of 1894 — Reasonable rates — Declining rates of dividends — Growth of combination among railways . . . . . 468

## CHAPTER XIX

## COMBINATIONS AND MONOPOLIES

- I. Relatively late date of the combination movement in Great Britain — Significance of studying the causes of differences in the progress of the movement in different countries; — Character and location of the mineral resources of Great Britain — Monopolistic control of the Newcastle coal trade before the development of rail competition — Relation of iron deposits to monopoly — Dependence of Great Britain upon foreign markets . . . . . 475
- II. Temporary and permanent combinations — Vertical and horizontal combinations — A vertical combination in the shipbuilding industry — Advantages of such integration — Combinations in the thread industry . . . . . 479
- III. Interpretations of the combination movement by socialists and radicals — The conservative view . . . . . 493

## CHAPTER XX

## INCOMES, WAGES, AND SOCIAL UNREST

- I. Material well-being: Reduced death-rates the best evidence we have of improved living conditions — Effect of social changes upon different classes — General rates of wages unsatisfactory — Differentiation between the skilled and the unskilled — Unskilled workers close to the poverty line — Bowley's estimates of wages during the nine-

CONTENTS

xix

teenth century — Relative changes in incomes above and below £160 per year — Giffen's evidence of the increase of the smaller incomes — The problem of large fortunes — Chiozza Money's indictment of the existing social order — Difficulties in interpreting the statistics of the concentration of wealth . . . . . 499

II. Chartism: Intellectual basis of chartism — Development of the program by a group of London artisans — The Charter — The revolutionary tendencies of northern agitators — The influence of the Birmingham group — Collapse of the movement . . . . . 512

III. The unions and the socialists: The ideal of a national "Trades Union" — Owen's influence — The Grand National Consolidated Trades Union — The Dorchester Laborers — The National Association of the United Trades — The Amalgamated Society of Engineers — It becomes the model union — Parliamentary activities — Growth of the Independent Labour Party . . . . . 518

SELECTED REFERENCES . . . . . i

INDEX . . . . . xix



## MAPS

Relative Densities of Population, 1086 . . . . .	95
Relative Densities of Population, 1377 . . . . .	96
Relative Densities of Population, 1570 . . . . .	97
Relative Densities of Population, 1600 . . . . .	98
Relative Densities of Population, 1700 . . . . .	99
Sketch of the Enclosure Map of Stow, Lincolnshire, 1804 . . . . .	112
Map locating the Important Surveys and Terriers referred to in "Gray's English Field Systems" . . . . .	117
The Plan of a Manor . . . . .	127
The Great Fairs and Staple Ports . . . . .	139
The Hanse . . . . .	148
Rural Areas identified with the Woolen Industries about 1550 . . . . .	210
Competitive Railway Systems, 1843 . . . . .	445
Competitive Railway Systems, 1853 . . . . .	453
Competitive Railway Systems, 1885 . . . . .	455

## FIGURES

1. The Throstle . . . . .	289
2. Paul's Spinning Machine, 1758 . . . . .	293
3. Improved Model of Hargreaves's Spinning Jenny . . . . .	298
4. Crompton's Mule . . . . .	299
5. Osmund Furnace . . . . .	316
6. Furnace with Water-Blowing Apparatus . . . . .	317
7. Detail of Water-Blowing Apparatus . . . . .	318
8. A Norwegian Bloomery Furnace . . . . .	319
9. Blast Furnace . . . . .	322
10. Developed Cylindrical Blowing Engine . . . . .	323
11. Apparatus used by Watt in Experiments to demonstrate the Advantages of a Separate Condensing Chamber . . . . .	326
12. Section of an Engine set up by Watt at Chacewater in Corn- wall, 1777 . . . . .	327
13. The Reverberatory Furnace . . . . .	329
14. Purnell's Rolls . . . . .	332
15. A Modern Rolling Mill for the Production of Rails . . . . .	333
16. Bessemer Converting Vessel . . . . .	342
17. Vertical Section of the Bessemer Converter . . . . .	343

## GRAPHS

I. Imports of Raw Cotton and Exports of Manufactures, 1700-1800 . . . . .	304
II. Imports of Raw Cotton and Exports of Manufactures, 1801-1881 . . . . .	306
III. Relative Values of Textile Products, consumed at Home and exported . . . . .	307
IV. Percentages of Raw Materials used in the Textile Trades, 1798 to 1882 . . . . .	309
V. Selling Price of Cotton Yarn, Number 40, and Cost of Raw Cotton, 1779-1882 . . . . .	311
VI. Selling Price of Cotton Yarn, Number 100, and Cost of Raw Cotton, 1779-1882 . . . . .	311
VII. Labor Costs of Spinning per Pound of Yarn . . . . .	312

# AN INTRODUCTION TO THE INDUSTRIAL HISTORY OF ENGLAND

## CHAPTER I

### FORMS OF INDUSTRIAL ORGANIZATION

#### I. SOCIALISTS AND INDUSTRIAL HISTORY

WHEN the German socialist Rodbertus began his studies of the history of industry, it soon became evident that some considerable degree of continuity of development could be found. Forms of industrial organization appeared in various places which could be arranged in logical sequence; beginning with simple forms and passing with minute gradations to the highly complex forms of modern industrial society. The socialists were profoundly interested in the non-capitalistic forms of organization and in the slow emergence of distinct classes of capitalists and wage-earners. An economic interpretation of history began to develop which was profoundly influenced by the socialists though not confined to them. Many of the features of industrial history that appealed to them were the obvious superficial generalizations that would appeal to any casual investigator. <sup>Beginnings of industrial history</sup> The logical progression of these forms of industrial organization made the schemes particularly attractive to persons with theoretical interests. Generalizations have thus become current in economic writing that are largely due to socialistic writers; they represent, however, a superficial interpretation of history that possesses all the attractions of a plausible and simple account. The views are not obviously distorted by socialistic doctrine, but they are the basis of some unfortunate conclusions and they are so misleading that they cannot serve as a guide to further critical study of industrial problems.

The course of industrial history was sketched by these

writers somewhat as follows. In Greece and Rome, industrial development was dominated by slavery and confined to the household. Some large-scale production was made possible by the aggregation of considerable numbers of slaves in the patriarchal household, but even in such cases the industrial establishment was merely a part of the household. Little material equipment was used. Production was directly dependent upon labor. The power of the director of industrial enterprise was derived from his ownership of men. This system disappeared after the fall of Rome, and when industry became important in the towns of the middle ages the free artisan was the basis of the development. The artisan was economically independent and the strength of his material position made possible the successful struggle for political privileges and freedom that marks the rise of the Third Estate. This period of industrial freedom was tenderly idealized by the socialists, and, by one of those strange paradoxes, the middle ages, which were stigmatized in agrarian history as a period of hideous oppression, were characterized as the golden age of industrial development. The artisan was a skilled master of his craft, possessed of sufficient freedom of expression to give full scope to that "instinct of workmanship" that makes work a pleasure. He owned his material equipment and sold his product directly to the consumer. There were no capitalists to exploit workman or consumer; no employers, no middlemen.

The development of the trader created an opportunity for the capitalist. The formation of a mercantile class soon resulted in the subordination of the artisan to the merchant; the merchant supplied the raw materials, employed the artisan to perform the skilled craft-work, and sold the product to the consumer. Distinctions thus arose between the workers and the directors of industrial enterprise. The establishment of the factory system completed the transition from the non-capitalistic to the capitalistic system and reduced the artisan to the status of the modern wage-earner, without proprietary rights

**The merchant  
becomes a capi-  
talist employer**

n the industrial process and without any vital economic freedom. The attitude of the socialists is adequately conveyed by the phrase "wage slavery" so frequently used by them.

This interpretation of industrial history is based on half-truths: there is an undue sharpening of many antitheses, and many details are excluded that are fundamental. These weaknesses from the point of view of critical scholarship have been a source of strength in propaganda. The socialistic interpretation is not only easy to understand; it is the only interpretation that is easy to understand. The Greeks had an old saying, "Hard is the good"; hard also is devotion to truth. {It is notably difficult to secure any adequate approximation to the whole truth. Merely because of its simplicity, this interpretation, in the main socialistic in origin and tenor, has gained wide currency in economic literature until its shortcomings are overcome by mere force of iteration. Bücher's writings, in particular, have given wide currency to the generalizations that originated with Rodbertus, and the brilliant descriptions of Bücher's *Industrial Evolution* have apparently established them in the scientific literature of the subject. The destructive criticism of Edouard Meyer and other historians of antiquity has made little impression, though the interpretation of Bücher has been shown to be palpably wrong. The extraordinary vitality of these erroneous interpretations thus creates critical problems that cannot be avoided even in a general sketch of industrial history.

Superficiality of  
the socialistic  
view

## II. THE TYPICAL FORMS OF INDUSTRIAL ORGANIZATION

In the description of industrial growth there are two distinct problems, which are significantly related, though by no means identical. There is need of careful description of the forms of industrial organization which succeed each other. There is need also of study of the conditions that produce this progression from the simpler to the more complex forms. It is peculiarly unfortunate to assume that the main task is completed when certain forms have been arranged in a logical sequence.

The general designations of the typical forms need not be modified; the following forms can be distinguished: household industry, wage-work, craft-work, the putting-out system, the factory system. Many refinements, however, should be added to the characterization of these types.

The simplest of these types is household industry, or more specifically undiversified household industry. This stage of industrial development precedes any specialization of industry into crafts. Logically, in the pure type, each household would provide for its own industrial wants. No products would be exchanged in such a society. Productive effort would be directed solely to the satisfaction of the wants of the household. The logical requirements of the definition of this most primitive industrial form make it somewhat unreal. There is some truth in the implication that primitive peoples engage in few activities that are not designed to satisfy their personal wants. There is no elaborate division of labor and no skilled industrial craftsmanship. At the same time one must guard against extremes. Among the most primitive peoples this complete self-sufficiency is qualified in a variety of ways, which are of great significance in indicating the process of transition to a more elaborate ordering of society.

Mr. Hilton-Simpson, in writing of the peoples of the Kasai, says of one of the tribes of negroes living in the plains south of the great Congo forest:

The chief of the second village of Makasu appeared by no means anxious for us to leave at once, so we willingly settled down to spend a few days in his village, where we could enjoy a splendid opportunity of studying the daily life of a people among whom European influence has not yet begun to be felt. Every village between the Loange and the Kasai appears to be entirely self-supporting; every man manufactures his own garments, weaving the cloth from palm fiber in the same way as do the Bushongo; accompanied by his dogs, he participates in hunting expeditions, supplying his family with meat from his share of the game, and the Bashilele hunters are far superior to their kinsmen around the Mushenge; he makes his own bows, bowstrings, and

the shafts for his arrows, while he forms and decorates with carving the cups from which he drinks his palm wine; his wives cultivate sufficient land to supply the family needs with cassava; his children tend his chickens and goats. In fact the only things which a man must buy, being unable to make them for himself, are iron objects, such as arrow- and spear-heads, knives and bracelets, all of which are the work of the village blacksmith, who is paid for them in meat, fowls, foodstuffs, or palm cloth.<sup>1</sup>

This village blacksmith seems to be only an exception, something that can be neglected in generalization, and yet if one makes comparison of the relative significance of this iron work to other industrial work actually performed, it will readily appear that the proportion of industrial need actually satisfied by this village smith was far from being inconsiderable. It is quite true that these natives provided largely for their own wants, but it is no less true that we find in their village life the beginnings of specialized craft-work. Most of the industrial field was dominated by household industry of the purest type, but in the metal trades we find craftsmen and the beginnings of diversified industry. Any European would inevitably be primarily impressed by the relative self-sufficiency of the villagers, but that is not the only important conclusion to be drawn from a study of their village life. In studying industrial history it is necessary to recognize that no one form of organization really dominates social life at any particular period.

The household  
not entirely  
self-sufficient

Among the bushmen of Australia somewhat different qualifications of self-sufficiency appear. The making of boomerangs and other implements involved some degree of skill. The older men of the tribe naturally possessed more skill than the younger men in this carving and wood-working; the old men were likewise less fitted to endure the hardships of long expeditions. A variety of wares, — yellow ochre for body painting, whetstones, and a narcotic herb, — were usually obtained by tribal expeditions which involved much danger and hardship. A ceremonial friendship could be estab-

<sup>1</sup> Hilton-Simpson, M. W.: *Land and Peoples of the Kasai* (London, 1911), 331.

lished between two men by virtue of which the older man would produce certain manufactured products to exchange for the products of the expedition. There was thus some division of labor among the men of the tribe, though it was not as marked as the division of labor among the metal-using tribes of Central Africa.

A more important qualification of the self-sufficiency of the primitive industrial household appears in the fairly considerable exchanges that take place at times between different tribes. The extent of this intertribal trade among primitive peoples seems to depend more upon certain external circumstances than upon the grade of culture. Peoples living on waterways of various kinds do more trading than inland peoples like the Australian bushmen. A striking instance of the importance of intertribal trade among genuinely primitive people is afforded by conditions in British New Guinea. These people represent a low grade of culture, and, at the time the observations were made, had been scarcely affected by European influences. There are many tribes of natives inhabiting the small islands at the southerly tip of New Guinea, and various tribes scattered at intervals along the coast of New Guinea. Among these tribes there are marked specializations. Some tribes made quantities of pottery for exchanges with other tribes; others made stone axes for actual or ceremonial use. One island tribe specialized in dugout canoes. These products circulated throughout an extensive area, and there can be no doubt of the extent of the trade or of the deliberate character of the production of these various wares for the general market.

Curiously enough there was some specialization between industrial products and foodstuffs. Some portions of the trading area raised pigs and yams with which to buy shell jewelry and pottery. Certain areas in the Gulf of Papua produced large quantities of sago which were exchanged for shell jewelry and pottery. This trade was carried on annually, and sufficient sago was brought back by the pottery-making villages to insure them an abundance of food for the rest of the season. As much

Geographical  
division of  
labor



as two or three hundred tons of sago might be brought back by the annual expedition. This specialization of industrial work is possible without any genuine development of crafts; the industries are pursued locally because the raw materials are not generally available, no special skill is displayed in the product. Each household of each village would be engaged in the local specialty, and at times the form of the trade indicated that each household of one village traded with a household of the other village. It is thus thoroughly justifiable to distinguish a period of industrial development that precedes the appearance of specialized crafts, but it is not wholly sound to describe such a primitive society in terms of unqualified self-sufficiency. There was some trade even in the most primitive times.

The importance of trade under such conditions can best be appreciated if we think of frontier conditions that are roughly familiar to us all. In many frontier <sup>The frontier household</sup> communities there is no diversified industry.

The crude textiles used are produced at home, and, to the casual traveler, it may seem that each household is really self-sufficient. Such backwoods communities, however, may be absolutely dependent upon distant markets for their tools and firearms, and perhaps for a wider range of commodities. The settlement is perhaps engaged in some extractive industry or in fur-hunting, all with reference to the demand of the distant market. In truth, the outlying hamlet which seems so independent is really as much a part of the entire industrial community as the metropolitan city.

Even when qualifications are admitted, it is difficult to find characteristic illustrations of this undiversified household industry, and it would seem that industry be- <sup>The crafts developed early</sup> comes specialized into the various handicrafts at a very early cultural stage. The evidence of early culture collected by anthropologists discloses primitive peoples which are for the most part possessed of some craft-skill. Only among the most backward of these undeveloped races do we find the degree of self-sufficiency that coincides with this notion of the pure household industry. The peoples that

emerge into the field of knowledge at the dawn of history had likewise acquired some craft-skill. Not all the crafts that ultimately arise were to be found in these societies. The process of craft specialization is gradual; industrial pursuits are withdrawn from the household one by one, and in these early periods of history the number of occupations carried on by craftsmen of the town or village is small. The earlier writers have been disposed to characterize such social conditions in terms of the self-sufficiency that was being nibbled away; the entire truth of the situation would seem to be better expressed by describing such conditions in terms of the progression towards a new ordering of social life. In this sense the outstanding feature of early economic life is the rise of the handicrafts.

Rodbertus and Bücher have endeavored to give an extended meaning to the conception of household industry.

**Industrial slaves** They recognize a secondary form in which the natural monogamic family is enlarged by the addition of slaves. It is beyond doubt that large numbers were used as an industrial force by the heads of many households in the ancient world. It was possible even to develop production on a considerable scale, and we know of numbers of establishments in the various trades that must have presented the superficial aspects of small factories. Assuming that most of the operatives in such establishments were slaves, Rodbertus and Bücher did not hesitate to classify them as industrial households.

Beloch, Meyer, and other historians of antiquity have shown that the number of slaves was seriously overestimated

**Importance of slavery in antiquity** by Rodbertus and Bücher. The free artisan was a larger factor in industrial life than was at first supposed. It is therefore difficult to

form an exact notion of the relations between masters and workmen in the shops and establishments of the ancient world. There were some slave establishments, but there were many enterprises that relied upon free labor, and on the whole it would seem better to admit the presence of small factories than to attempt to obscure the existence of some

large-scale production by an adroit definition of terms. The classification of the socialists is indefensible also in respect to the purpose of this production. They are constrained to affirm that the operations of the household were designed to meet the needs of the household as <sup>Production for</sup> <sub>a market</sub> distinct from being production for the market. Now it is, of course, true that the household of classical antiquity was more largely self-centered than the modern household, but it is not true that these great slave establishments were concerned with producing goods for consumption on the estate. Pottery, metals, and textiles of the higher grade were all widely distributed throughout the ancient world, and this trade was no mere incidental feature of Græco-Roman industrial life. The production of the craftsmen of the ancient world was undertaken with reference to markets, and in no small measure for distant markets. It is therefore doubly misleading to characterize the industrial forms of classical antiquity as household industry. Occupations were rapidly becoming distinct crafts and thus being withdrawn from the sphere of undiversified household work. These changes were largely a result of the gradual expansion of commerce in the Mediterranean world. None of the implications of the simplest industrial category correspond to conditions in the ancient world.

The notion of a craft occupation may present some little difficulty because among primitive peoples it is not uncommon to find industries practiced by the entire population of certain localities. Such speciali- <sup>Craft-industry</sup> zation represents progress toward craft-work, but it would seem wise to consider such diversification a preliminary stage in the general division of labor. Similarly the division of labor between men and women must be regarded as antecedent to the development of genuine crafts. The development of specialized craft-skill is clearly evident only in cases of specialization in particular localities; in its lowest form this specialization appears in the village blacksmith or other such artisan charged with the performance of all the work of that character done in the village. Such artisans were

common in the Greek villages at an early period; they were thought of as servants or slaves of the entire village. The rise of the crafts is soon indicated, however, by the existence of some considerable number of independent crafts in particular towns and villages. The list of recognized crafts is thus evidence that industry has reached the craft stage and also the basis for detailed study of the gradual diversification of industry that is the chief feature of the history of the earlier portion of the handicraft period. It is of moment to ascer-

**The crafts emerged slowly** tain the probable order of emergence of the crafts, for some of the misconceptions of early industrial history are due to the assumption that the relative importance of the different crafts and occupations has always been the same. References in classical literature to the spinning and weaving done by the women in the household convey the impression that nearly everything of importance was done in the house. The significance of the village blacksmith is lost on the casual reader because the smith work does not seem as important as the textile work, but it is not to be assumed that the crafts emerge from the household in the order of the intrinsic importance of the various occupations.

The older writers have distinguished two types of craft-workers: wage-workers and craft-workers. The distinction **Wage-work and craft-work** turns upon the mode of payment for the work. If the raw material is owned by the consumer, the craftsman is really employed by him to perform a certain amount of skilled labor for a wage. The craftsman does not make any article to be sold in the market; he merely sells his services. He is a wage-earner, though there is no specialized employer. If the raw material is owned by the craftsman, he must produce wares to be sold in the market, and he can secure a return for his labor only through the price of the finished product.

Logically these forms may be arranged in sequence; wage-work may be regarded as a lower form of industry than craft work, but there is no historical **are not different stages in development** justification for this logical assumption that these forms represent different stages in development. They are

alternative forms that emerge in different crafts. Rarely, if ever, could one expect to find a craft which was at first practiced according to the form of wage-work and then at a later date according to the form of craft-work. It will be observed that some crafts are of such a nature that they can be most effectively remunerated by a wage payment. The building trades, for instance, are primarily concerned with the performance of certain skilled services for the benefit of a consumer. The raw materials can be most readily furnished by the consumer, unless society is sufficiently diversified to maintain capitalist contractors. In the portions of Europe which were well supplied with building stone, the material used was characteristically gotten out in the immediate locality, usually on land belonging to the person for whose benefit the building was to be erected. The stone-masons employed would be expected to get out their stone. If some general quarry were used, the stone would probably be procured by the consumer. The raw materials of other crafts were such that they could most suitably be procured by the craftsman himself. The textile workers were likely to secure their own raw materials. A few crafts might well work according to both systems. The candle-makers, for instance, might produce candles for a general market by making up raw materials purchased by them. They might also go out to some house or establishment to work up into candles a stock of grease that had been accumulated there. At Paris, the candle-makers were subjected to specific regulations as to the quality of grease they might use when manufacturing for the general market, though they were allowed to make up any kind of grease for a particular individual if the work was done on his premises. It would seem that the distinction between these different forms of payment for craft service is not of great importance.

There are two distinct stages in the development of the crafts which are of primary importance. In the earlier stages of industrial specialization, the crafts emerge as occupations which produce a finished product, or at least a salable product. Cloth,

Stages in the  
growth of  
craft-industry

for instance, can be used without being bleached or dyed, and it is fairly certain that "grey" cloth was used extensively in the ancient and medieval periods. It may be that a weaver would sell the grey cloth to a prospective consumer, and thus he would not strictly speaking deal in a finished product. We cannot be sure whether weavers preceded dyers or dyers preceded weavers as persons exercising distinct crafts. It would seem likely, however, that some persons would find a regular and distinct occupation in bleaching and dyeing crude home-spuns appreciably before weaving became a specialized occupation. The dyers took the product of undiversified household industry and gave the cloth a finish that made it substantially a new product. Such a craft would represent more or less exactly the notions commonly held of craft-industry. A single craft, represented always by a particular workman, stands between the "raw product" and the consumer. There is no middleman, no intermediate processes of production and sale.

Such a simple situation cannot long persist; the development of craft differentiation tends to disintegrate the process of production into its essential stages, and finally each phase of the transformation of the primary raw material becomes the basis of a separate craft. Thus in the textile trades, we ultimately find distinct crafts of wool-combers, weavers, fullers, dyers, and drapers. Spinning never became a craft-operation in the legitimate sense of the word; it was a subsidiary employment of women and children that required no specialized skill. The production of textiles thus came to be the work of a group of crafts, so that some of the workers never came in contact with the consumer. The direct contact with the consumer that is so strongly emphasized in descriptions of craft-industry does not apply to the later stages of craft-development. The disintegration of the process of production required at least successive sales of partly finished goods. Combers might sell combed wool to weavers, weavers would sell grey cloth to fullers or dyers, fullers and dyers would sell finished cloth to the drapers who undertook to sell the cloth in the distant market that

was usually contemplated. A considerable division of labor might thus develop without breaking down the independence of the craftsmen. In this second period of craft-diversification each craft was a link in a chain of correlated crafts. Sufficient differentiation to give rise to many of these phenomena undoubtedly existed at a relatively early period in the development of craft-industry. The notion of direct contact between producer and consumer cannot be regarded as characteristic of the chief period of craft-industry. The simplicity of industrial life during the craft period, too, has been seriously exaggerated. The multiplicity of special crafts gave rise at an early date to all these loose coordinations of groups of crafts that are so hard for us to appreciate.

The recognition of this second stage of craft-development is particularly important because it furnishes the basis for the beginnings of capitalistic control of industry. The formation of a considerable group of crafts in a single industry brought with it certain technical advantages from specialization of skill, but there were certain economic disadvantages as long as the crafts remained entirely independent. The successive buying and selling of partly finished products were sheer waste of energy. There was also no possibility of exercising any supervision over the process of production. These disadvantages could be overcome if some one bought the primary raw material at the outset and then hired the various craftsmen to perform their craft-work for wages. A capitalist employer of this type was necessary to prevent specialization from degenerating into disorder. The tendency toward disintegration was thus offset by a tendency towards integration: there was disintegration in the technique of production followed speedily by integration of control.

The general industrial system by which this control was exercised passes under a great variety of names. It has been called the "domestic system," because the workmen are generally able to pursue their craft in their homes. This term presents an antithesis to the factory system, but it fails to suggest any distinction between this form and the craft sys-

tem. Until the factory appeared the household was the scene of nearly all industrial labor; the fact that the work was done at home is thus of no distinctive significance. The phrase "commission system" has also been used, but such a term suggests a relation between principle and agent that is meaningless in this particular phase of industrial history. The term "putting-out system" is neither euphonious nor elegant, but it has the merit of describing the salient characteristics of this type of industrial organization, and it suggests the features that distinguish this type both from the craft forms that precede it and from the factory system that follows. The employer owns the materials and gives them out to various craft-workers who carry the goods through a process or group of processes. The goods are then returned to the employer, and, if they are not yet finished, they are passed on to other workmen. The employer must needs be a capitalist: he owns the materials during the process of production and advances wages to the craftsmen. At times the employer may own tools or other equipment used in production. Instances occur in the nineteenth century in which the employer owned the cottages used by the workmen; the cottages were prepared for the weavers or other craftsmen and rented completely equipped. Not infrequently part of the work was done in workshops belonging to the capitalist employer and under immediate supervision. This was most commonly the case with reference to some of the finishing processes of the woolen manufacture.

The putting-out system is by nature highly elastic, admitting of many gradations of capitalistic control of the process of production, and corresponding variety in the degree to which the disintegration of industry into separate crafts is remedied by centralized direction. The scale of production, too, might vary within wide limits. Many establishments in the woolen industry organized on this system employed a thousand hands, and though the number of employees was of course somewhat increased by the absence of power machinery the scale of the undertaking was really considerable.

**Its advantages  
and historical  
importance**



The variety of detail possible in this system enables us to appreciate clearly all the phases of the long transition from craft-work to the factory, and the minuteness of the changes affords interesting illustrations of the continuity of industrial development. At no point is there an abrupt transition from the old to the new.

In the main, the putting-out system merely brought a number of workmen under a moderate degree of supervision and direction. The establishment was the loosest possible aggregation of workers. The development of this form does not ordinarily bring with it any increase in the division of labor. It was primarily an antidote for excessive disintegration. In the eighteenth century, however, new tendencies can be perceived in some English industries. Weaving, as practiced by the craftsmen of the old school, comprised three distinct operations or tasks: preparation of the warp; the placing of the warp on the beam of the loom; and the throwing of the shuttle through the warp. The preparation of the warp and the setting-up of the loom required much skill, though neither task required as much time as the throwing of the shuttle. Concentration of skilled workmen on the preparatory tasks would thus make it possible to delegate the laborious work with the shuttle to inferior workmen, or even to unskilled beginners. A considerable dilution of skilled workers was thus possible.

These tendencies were not merely local, nor were they confined to a single industry, though we know more about the woolen industry. These beginnings of a horizontal division of labor, the splitting-up of the old crafts into their component processes are the first evidences of a transition to a new system of organization in which the workmen were to be more than mere aggregations of units. The increased subdivision of processes of production made it more necessary than in the past to work out carefully the correlation between the various groups of workmen. More supervision became necessary because the workman was not always a master of his craft. The employer thus became by force of circumstance a disciplinarian, interested in every

detail of the process of production. The advantages to be secured through the organization of team-play among the workmen and through more careful study of the pace of the entire productive process could become really significant only through an increase of discipline and drilling that would be impossible as long as the workers remained in their homes. The concentration of the whole body of employees was indispensable: properly speaking it was not an end in itself, but merely a means to an end. It is the most notable visible difference between the establishment organized under the putting-out system and the factory, but it is not in fact the essential feature of the factory system. The gathering together of operatives in one place would not properly make a factory any more than the collection of a large body of men makes an army. Until there is some plan for the increased coördination of the workmen, some increase in the division of labor, and new disciplinary measures to give effect to the closer ordering of the productive process, there is no real advantage in collecting the operatives into a single workshop.

There were advantages in this new organization that were sufficiently great to induce the proprietor of the establishment to adopt the new system, without assuming any change in the technical equipment of industry. The change to the factory system could take place before the introduction of machinery, as far as the employer was concerned. This industrial transformation, however, is distinct from all the phases of development that precede it in being bitterly opposed by the workmen. They did not like the rigid discipline of the new régime; the liberty of the craft-work in their homes was not significantly qualified by the supervision exercised by the capitalist employer, and they were loath to give up their personal liberty. The establishment of the factory system was undoubtedly delayed by the unwillingness of the workmen to accept the conditions of employment that it imposed, and the introduction of the new system thus turned upon the pressure of competition between the old equipment and the power machinery that

began to affect industry at the close of the eighteenth century. The factory that came into being in the early nineteenth century thus differed from the putting-out system in three respects: the greater measure of coördination in the process of production; the massing of the operatives in one establishment; the introduction of machinery.

Strict classification of industrial forms thus leads to a number of divergences from popular and legal usage. The "workshops" of English statutes and the "sweat-shops" that are currently distinguished from "factories" would probably fall within the meaning of the term "factory," as defined above. The legal definition of the factory inadequate It is commonly recognized that the distinction between "factories" and "workshops" is wholly arbitrary and unfortunate. An industrial establishment does not change its character significantly by reason of employing a fiftieth hand; if numbers can possess any importance from the standpoint of classification they are most likely to mean something when the establishments are small. The numbers five and six used in German and French industrial statistics are probably connected with real differences in the character of the establishment, but once the size of the establishment has grown beyond such narrow limits further classification by numbers can have no functional significance. The attempt to distinguish workshops as places in which no power machinery was used was perhaps more significant, but no more justifiable on scientific grounds. These distinctions have proved to have been unwise from the administrative point of view. There were no sufficient grounds for subjecting such establishments to different restrictions.

The sweat-shop presents a more difficult problem of classification, and it may seem extravagant to propose to classify the majority of sweat-shops as factories; the conclusion is, however, irresistible. Sweat-shops The sweat-shop is the abode of the proprietor in most cases, but many of the employees live elsewhere. Furthermore, the work is done under supervision of a taskmaster; the employees constitute a team of workers of various degrees of skill engaged in the

series of tasks necessary to complete some industrial operation; there is an elaborate division of labor and definite pace for the work. The establishment represents a type of factory in which the economic advantages are derived from this severe driving of the laborers as a team. The fact that the proprietor of the sweat-shop contracts to do certain work for another business man is of indifference in classifying the establishment. The work of that business man is "put-out" in a sense, but the manner of the putting-out is entirely different from the delegation of work in the putting-out system. When the capitalist employer of the early days gave out work he was dealing with people who were to perform the work in their homes at their own convenience; the fact that they did the work most literally at their convenience was one of the most serious difficulties the employer had to contend with. He could never be sure of getting work out on time. The essential feature of the putting-out system is this absence of any disciplinary power; the capitalist was an employer of labor, but he was not a boss.

are not survivals of the putting-out system

The position of the sweat-shop is not happily defined in terms of the putting-out of work: the work that is given out is comparable to work let out by firms that do not care to make all their accessories; it represents a contract between establishments rather than a contract between a capitalist employer and a craftsman living in his own home. The sweat-shop can thus be compared to the manufacturing firm that makes some small specialty, not itself of use to consumers but fundamental to many manufacturers. It is a small factory, representing the system at its worst. It is a "morbid survival," to use Hobson's phrase; but it is not a survival from any remote past. We see in this form the early type of the factory without machinery, exempt from all regulation.

### III. COMMERCE AND INDUSTRY

It will be observed that the development of the various industrial forms is merely an outcome of the progressive division of labor. Each form is related to particular degrees

of industrial specialization. The forms are not in themselves good or bad; they are adaptations to the circumstances created by the gradual specialization of work. The central fact is not the series of successive industrial forms, but the division of labor, ever more and more elaborately articulated. The seeming continuity of industrial development is wholly due to this dominant fact. The complexities of the actual chronology of industrial history are all lost to view because of the compelling logical movement of this progressive division of labor with its related industrial forms. It is desirable, however, to keep these complexities of actual chronology clearly in mind, for they constitute the main problem of industrial history.

The advantages of the division of labor are so widely realized that it is not necessary to comment on the cause or the variety of forms in which they appear. But it would seem that men were slow to appreciate the economic advantages of this specialization of effort. Why has the development of industrial forms been so slow? Why do the highly specialized types of industrial society emerge so late? The general answer to these fundamental questions is furnished by the axiom of Adam Smith: the extent of the market defines the profitable limits of the division of labor. The village blacksmith must needs be somewhat of a Jack-of-all-Trades because no one of his activities would, in that village, afford him a livelihood. He must needs be a worker in iron, a wagon-maker, a joiner, and not infrequently he used to be called upon as a dentist. The handloom weaver was also a gardener, and at harvest time he might hire out as a general farm laborer.

The principle of Adam Smith is well known, but there is frequent tendency to forget that the market for industrial products is no simple matter. The market is subject to social and territorial limitations. It may consist of a clientele spread through a wide area, but confined to a single class, or again it may consist of all classes of persons living within a relatively circumscribed area. The limitations of the market from the terri-

Industrial  
specialization

limited by  
the market

Territorial and  
social limita-  
tions

torial point of view have always been keenly felt, the social limitations of the market have not been as generally perceived, though they are of special importance in connection with industrial history. In the middle ages, markets for industrial products were small by reason of social rather than territorial limitations. It was easier to sell the high-grade broadcloth of England in the Near East or in the East Indies than to sell such goods to the peasants or shopkeepers of the county. Until the Industrial Revolution it was easier to extend the market for manufactures by selling through a wider area than to increase the market by offering the goods to the poorer classes of the community.

The foreign or distant market has thus played a more prominent part in industrial history than the domestic market. Some have been disposed to believe that difficulties of transportation prevented the sale of goods over large areas until a fairly recent period, but this is a serious error. Transportation was slow, and the volume of goods handled was small in comparison with modern traffic; but such comparisons are misleading. Manufactured commodities were sent great distances both in classical and medieval days, and, when water transport was available, bulky commodities like grain and oil could profitably be shipped. The limitations of the market were an outcome of the inequalities of the distribution of wealth which placed the purchasing power of the community primarily in the hands of the landed aristocracy, so that the market for many industrial products was the luxurious demand of the wealthy. Much industry was therefore concerned with a class that was concentrated in the larger towns during the Græco-Roman period, though the towns were themselves scattered throughout the Mediterranean world. In the middle ages the aristocracy was even more widely diffused through an area that had been enlarged by the development of northern Europe.

The commodities used by the common people were not all produced in the home either in classical or in medieval times; nevertheless, these needs were not sufficiently consid-

erable to afford a basis for the development of highly specialized industry. Such wants could be gratified by a few local craftsmen. There was a notable interchange of products between artisans and small farmers. The urban craftsman became dependent upon the foodstuffs produced by the small farmers and among these lower classes a genuine money economy sprang up at a relatively early date. The artisans sold their goods or services for money to the aristocrats or to the farmers of the neighborhood; with money they purchased their supplies in the market. It is the life of these humbler classes in society that creates the appearance of intense local self-sufficiency which many writers declare to be characteristic of the economic life of these early periods. The cosmopolitanism in the life of the upper classes is quite as characteristic, however, and the difference between modern life and the life of these remote periods really lies in the strange dualism of social organization in ancient and medieval times; certain aspects of society being dominated by the narrowest local influences, other aspects less definitely centralized than at the present time.

The insistence upon local self-sufficiency is thus justifiable in a measure, but it must not be presented as the whole truth of the matter, and with reference to industrial history it is peculiarly disastrous to neglect the cosmopolitan life of the upper classes, for such influences were all-important in determining the more highly specialized industrial developments.

Not until the Industrial Revolution does the intensive exploitation of the needs of all classes in the community become the dominant fact in industrial specialization. When methods of production were primarily dependent upon hand work, the high costs and tendency to emphasize distinctiveness of product inevitably restricted the sale to the wealthy. Large-scale production with a mechanical technique made it possible to offer to all wares that had formerly been the prerogative of the wealthy. Consumption became more standardized; the

manufacturer realized that it was more profitable to sell relatively cheap wares to the entire community than to sell distinctive products to persons of great wealth.

The expansion of the market for industrial products has thus been a highly complex development; sometimes social, sometimes territorial. German writers have made much use of the phrase "world market" in writing of recent developments, implying and frequently declaring that the "market" was less broad in the earlier periods. All highly developed industrial districts have been dependent upon a world market, in the territorial sense of the word. There has always been a world market, and at the same time the territorial extent of the market has been periodically enlarged — the world has grown larger. There is a tendency to forget the significance of the terminology established in geography. We are all familiar with phrases like "the Homeric World," "the World of Herodotus," "the Ptolemaic World," and yet we forget that the growth of geographical knowledge is closely related to the expansion of commerce. In the study of industrial history these various phases in the territorial expansion of the Western world are absolutely vital.

The slow growth of industry prior to the ninth century B.C. was largely conditioned by the narrow limitations of the area of significant social contacts. The rise of the maritime development of the Phœnician and Greek cities resulted in a great extension of the civilized world. The entire eastern end of the Mediterranean began to show evidence of a systematic geographical division of labor. The production of grain, oil, and metals was somewhat specialized as well as the production of industrial products. The multiplication of the crafts in the Greek cities and colonies was a reflection of this extension of Mediterranean commerce. Medieval industry developed under the influence of a somewhat different complex of commercial factors. The newly acquired importance of northern Europe gave added emphasis to the geographical division of labor: there were climatic differences between the Near East and



northern Europe that did not exist between the countries of the Mediterranean. Export industries became increasingly important in the middle ages because they were essential to the trade between northern Europe and the Near East, or Levant. There was an increase in the dependence upon export trade as well as an increase in the area within the scope of the general commercial system. These conditions afforded medieval industry a broader commercial background, and, although the forms of craft-industry predominated as during the major portion of the classical period, there were significant differences in the number of crafts and in the degree of industrial specialization.

The Industrial Revolution was in part an outcome of the commercial expansion to India and the Spice Islands. New markets were opened up and new wares were introduced into Europe. The inventions were in many cases a deliberate attempt to take advantage of the industrial opportunities created by this commercial growth, although the changes in the metal trades cannot be directly associated with the growth of commerce. With this single exception each great period of industrial change has been closely related to periods of commercial expansion. Industry has developed, therefore, as a result of circumstances affecting the life of the community as a whole and not primarily by reason of any spontaneous tendency confined to the industrial field. The factors that have dominated industrial growth are economic rather than technological. Industry reacts to general social changes, and is seldom an initial cause of change.

## CHAPTER II

### THE RISE OF THE CRAFTS IN ANTIQUITY

#### I

THE beginnings of the records of Western civilization are closely associated with the beginnings of urban life. The rapid growth of our knowledge of the life of prehistoric men should save us from the error of identifying the dawn of history with the beginnings of organized social life, and for that reason we should not be unduly surprised to find revealed, both in Egypt and Mesopotamia, a social structure already far removed from the primitive conditions that can still be studied among the backward races of Australasia and the equatorial forests of Africa. Between these primitive conditions revealed by anthropological research and the social life of the early Egyptians and Sumerians there is a gap which cannot be bridged. Social history does not begin at the beginning of social life, and there is great danger that the institutions of these early societies be misinterpreted because of an unwarranted assumption that they must needs represent in actual forms the conditions that should logically be found at the beginnings of social life. Despite the brilliance of Bücher's work and the keenness of his sense of historical development, evidence is constantly forced upon our attention that he could not free himself from the disposition to describe the dawn of history as if it were the origin of organized social life.

The political arrangements and religious beliefs are so different from our own that the changes seem immeasurably great, — so great that we readily think of the Egyptians and Sumerians as primitive peoples, scarcely civilized. So common was this view a generation ago that the archeological discoveries of recent years have been a real shock to our historical consciousness. The discovery of the Code of Hammurabi, dating from about two thousand years before Christ,

has been the most notable single revelation of this hitherto unknown world, but this is only one of many discoveries, and, although the mass of our knowledge is still small, we can form tentative opinions about the social life of these peoples of the Near East.

The most noteworthy feature of these early records is the unmistakable evidence of developed urban life. The tiny villages of primitive society had long been out-<sup>Records and</sup>grown, and some significant concentration of <sup>city life</sup> population had taken place. Among the Greeks, this transition to urban life took place within a period which was within the historical era, and the literature and legends of the race constitute a fragmentary and uncertain record which has historical value, though it can hardly be called a historical record. Even among the Greeks we have scarce anything in the nature of a formal record until urban life had become an established feature of their society. When a people has not advanced beyond primitive village life there is little likelihood that it will leave any records. Even in the period following the fall of Rome, when social life was by no means primitive, the decadence of urban life and the predominantly rural character of the settlements of the Teutonic invaders created conditions so unfavorable to the making of records that the term "dark ages" is fairly descriptive. The study of the beginnings of industrial organization is thus profoundly affected by the defects of historical records. When some conscious record is made, the details of daily life appear only by chance, in references that were not designed to describe industrial conditions systematically, so that our knowledge is at best incomplete. According to the caprice of record-making, we begin to learn something of industry in the Western world at a stage that is already far advanced.

The most difficult problems in the early history of industry center around the period of decadence in urban life. There is an interval between the decline of the <sup>The</sup> towns of the Roman Empire and the rise of the "dark ages" medieval towns which seems to be a real break in the continuity of industrial history. For several centuries there

seems to be a positive regression, and the rise of the towns in the middle ages seems to be without substantial connection with the urban life of the ancient world. The "dark ages," however, were not as complete a break with the past as is frequently assumed. On the other hand, it is an error to presume that the towns of the middle ages are a mere revival of the older urban forms. There were profound differences both in social and in political organization, and these divergences were of great moment with reference to the development of industry and commerce.

The cities of the classical world were, in the main, aristocratic residence cities; there were tradesmen and artisans, but they constituted an inferior class, usually deprived of any political rights. Trade was tolerated, its advantages surreptitiously enjoyed, but never recognized as a worthy pursuit for persons of birth. The medieval towns were primarily industrial and commercial. The aristocracy, lay and ecclesiastical, became definitely identified with the land, and, except for casual visits, ceased to reside in the towns. The townsmen constituted a distinct class, possessing privileges of real significance in all the medieval kingdoms. In many instances they achieved substantial independence. These political differences reflect different relations to the land that are of great economic importance. In the classical world there were agrarian problems, but there was no opposition between urban and rural interests. The class endowed with significant rights was so completely identified with both town and country that no fundamental opposition of interest was conceivable. The aristocrats of the ancient world lived primarily in the city, but drew their revenues from agriculture or mining. Their household consisted of a mass of blood relatives, slaves, and dependents, who divided their time between the town house and the country house. Urban concentration was thus determined more largely by social and political purposes than by economic factors.

The growth of cities in the ancient world was thus somewhat capricious, dependent upon military power quite as

much as upon commercial advantage. At times trade degenerated into an organized system of collecting tribute, ceasing to be in any sense a matter of reciprocal advantage. These military and political aspects of classical civilization appear most clearly in the later history of Rome, notably in the last century of the Republic and under the Empire. Toward the close, the predatory motives underlying this civilization were unblushingly revealed. Rome became a great commercial center, but the movement was almost entirely inward. The flow of goods toward Rome was balanced by the flow of legionaries to the provinces. In all this system of exploitation, Rome was inventing nothing: merely practicing with full knowledge the lessons learned from the other great peoples of the Mediterranean world, Carthaginians, Greeks, and Egyptians. All had contributed something toward the upbuilding of the Empire that revealed the best and the worst that antiquity could produce.

Antiquity produced brilliant cities and notable civilizations; but they lacked foundation. Industrial development was inevitably a part of the premature brilliance of these luxury-loving cultures. The rapid growth of urban centers under the stimulus of social and political factors fostered industry. It is therefore peculiarly unfortunate that Bücher and earlier writers should have attempted to classify the industries of classical antiquity as primitive types, definitely inferior to the medieval types. The peculiar characteristics of classical culture are most clearly revealed in the relation of industry to agriculture and in the predacious exploitation of distant provinces for the benefit of military aristocracies. The great market for industrial products was furnished by the wealthy aristocrats, so that industry was primarily concerned with catering to their wants.

The simplest measure of the intensity of these political forces is afforded by the meager statistics of population. The studies of Beloch give the following results for the fifth century B.C.: Athens, including the Piræus, a total population of about 120,000;

The military basis of the ancient world

Extent of the urban movement

Syracuse, 115,000; Corinth, 90,000; Sparta, Argos, Megalopolis, Akragas, Taras, Thebes, Sidon, and Tyre, 40,000 to 50,000 each. The number of slaves is largely a matter of conjecture, but occasional references form the basis of the conventional estimate of one third of the total population, slightly more perhaps in some of the notable industrial cities, slightly less in other cities. These figures represent approximately the position of the Greek cities during the period of their greatest prosperity, and the figures are particularly noteworthy in comparison with Rome, as the purely military elements were less obtrusive in Greece than in other portions of the ancient world. Commercial conditions were more important and in some cases predominant. The importation of food products, which was essential to all the larger cities, was balanced by an industrial export, so that Greek commerce was a pretty genuine exchange of commodities.

Beloch estimates the total population of Rome, for the year 5 B.C., at 850,000 or 875,000. Estimates for the early

Rome at the  
height of her  
power

Empire place the population at about 1,000,000.

This concentration was certainly not a result of purely economic forces, and the measures necessary to assure an adequate supply of food speak eloquently of the significance of political factors. Under the early Empire Rome imported between 6,000,000 and 7,500,000 bushels of grain annually, from Egypt, the Crimea, Sicily, Sardinia, and Africa. Much of this importation was definitely a tribute to Rome's military supremacy.

The rise of the medieval towns marks the beginning of a great change in the relative importance of political and economic forces in social life.

Trade and the  
medieval towns

Despite all the barriers to intercourse there was a great increase in the degree of economic freedom. Industry was free to the extent of being conducted almost exclusively by free artisans, and commerce was free in the sense of being a genuine exchange of goods. The rise of the towns in the middle ages is thus not merely an important episode in the history of political freedom, but also an important chapter in the history of economic freedom. The achievement of political in-

dependence was made possible by the close identification of the feudal aristocracy with the land. Feudal society thus tended to become divided between the rural interests of the nobility and the urban interests of the Third Estate. Town and country were opposed to each other politically, and were held together by the most casual economic relations.

The modern period is characterized by the development of a close integration between rural and urban life. The city becomes a focal point of all economic forces; Function of the a distributing point for industrial products go- modern city ing to the rural districts and a concentration point for agricultural products and minerals coming from the country. The function of the city becomes purely economic, and its growth correspondingly dependent upon its convenience for commercial and industrial purposes. The modern city serves a large region instead of a mere rural suburb; it possesses a "hinterland" that comprises an organized complex of rural and industrial centers.

There is thus some measure of continuity in the growth of relations between town and country throughout the history of the Western world. In the ancient world the rural districts had no independent organization; they were merely tributary to the towns. In the medieval period town and country were substantially independent; each had its definite place in the feudal order, and, though some contact was maintained, each remained in its own sphere. In the modern period, town and country have become an organic whole with reciprocal functions and interests. The continuity of growth is not at all times clearly apparent, and it is most obscure in the field of industrial history.

No striking differences in industrial forms distinguish classical and medieval industry. The number of crafts varies at different times, and in different places; great Ancient and medieval conditions were comparable changes take place in the relative importance of the various crafts. There are changes in the scale of industrial enterprise; growth also in the markets, from small local and foreign markets which constitute the reliance of a few craftsmen to large foreign markets which

become the basis of great export industries. There is likewise an increase in the number of towns possessing noteworthy industries. Much development during antiquity and the middle ages is concerned with the diffusion of industries and types of organization which emerge at a very early date. The legal status of the artisan and the general social and political position of the class as a whole undergo many changes. In short, the aspect of industrial life that is least influenced by historical changes is the form of organization. There are many variations, but the predominant types, during antiquity and the middle ages, are wage-work and craft-work.

## II. EGYPT

The interpretation of Egyptian records presents many difficulties. The pictorial representations on the monuments exhibit considerable numbers of craft operations, even in the early period of the Old Empire, but it is not easy to determine the status of these artisans or their relation to possible employers or customers. Much work was done in the establishments of the royal household, the great landowners, and the temples. It is essential to know whether the workmen employed were substantially slaves permanently attached to the household, or whether they enjoyed some measure of independence, working in part for casual consumers. Our knowledge of the details of craft processes is more accurate than our knowledge of the forms of industrial organization. We must needs depend upon inferences for most of our opinions about the civil status of artisans and the manner of the remuneration.

The most important single source of information is a description of the disadvantages of all forms of manual labor, written by a scribe of the Twelfth Dynasty (2000-1788 B.C.) in order to encourage young men to undergo the arduous preparation required by the profession.<sup>1</sup> There is thus an

<sup>1</sup> The document is translated entire by G. Maspero in his work *Du Genre Epistolaire chez les Egyptiens de l'Epoque Pharonique* (Paris, 1872), 48-73. Considerable portions are translated into English in his *Dawn of Civilization* (New York, 1894), I, 311-14. The texts are slightly different. The translation given here is in part original.



evident implication that a young man of the middle class might at his own pleasure adopt any one of these various modes of gaining a livelihood. Not all the crafts of which pictorial representation exists are mentioned in the scribe's enumeration, so that it may be a presentation of the careers open to a young man of the middle class:

I have seen violence . . . therefore apply your heart to letters . . . I have beheld those who are engaged in manual work . . . and, in truth, there is no occupation above that of letters . . . The crafts in it is the most important of all the crafts. It is not a <sup>early Egypt</sup> vain thing . . . he who applies himself to this profession from his youth up, gains honor. . . . He is sent on missions. He who does not take up this profession will be clad in sackcloth.

I have never seen a blacksmith on an embassy, nor a smelter sent on a mission, but I have seen the smith at his work — at the mouth of the furnace of his forge — his fingers as rugged as the hide of a crocodile, and stinking more than fish spawn.

Has the worker with metals more leisure than the man with the hoe? . . . His field is the block of wood under his hand, his tools are of metal. . . . At night the laborer is free, the artisan's hands are still busy — for at night he works with his torch.

The stone-cutter who seeks his living by working in all kinds of durable stones . . . when at last he has earned something and his two arms are worn out, he stops. But if at sunrise he remains sitting, his legs are tied to his back.<sup>1</sup>

The barber who shaves until the evening . . . only when he is eating can he lower his arm. . . . He runs from house to house seeking custom; He wears out his arms to fill his belly, for like the bee he eats in proportion to his toil.

I will tell you of the mason. Sickness threatens him continually for he is exposed to all the winds — while the bunch of lotus flowers (which is fixed) on the (completed) houses is still far out of his reach. I direct his arms in the work. His clothes are in disorder. . . . (He consumes himself, for he has no other bread than his fingers.) (*sic!*) He washes only once a day. He must humble himself in order to please.

The weaver within doors is worse off there than a woman; squatting, his knees against his chest, he gets no breath of fresh air. If he slackens work for as much as a day he is bound like the lotus in the swamp, and it is by giving bread to the doorkeeper that he sees a ray of light.

The armorer is put to great trouble when he sets out for distant

<sup>1</sup> Allusion to a common mode of punishment.

lands, he must pay much for his pack mules. He must pay much for their keep while on the road. Scarcely does he reach home once more than he must leave again.

The messenger leaving for distant lands wills his property to his children, for he fears wild beasts and the Asiatics. And what happens when he is once again in Egypt? Scarcely does he reach home once more than he must leave again. If he goes, his sorrow is a burden to him, and all his happiness is gone.

The dyer's fingers reek, and the smell is like rotten fish. His eyes are heavy with fatigue, and his hand does not stop. He passes his time cutting up rags. . . . He has a hatred of garments.

The shoemaker is very unfortunate. He begs ceaselessly. His health is the health of spoiled fish. He gnaws his leather.

The laundry-man washing by the riverside is a neighbor of the crocodile. While he beats the dirt out in the water his hand does not stop. It is forsooth no easy trade that I describe to you, no craft agreeable above all others. His food is laid with his clothes, and no part of his body is clean. He is as wretched as a woman. When I see him in his misery I bewail his lot, for he passes his time with his beating stick in his hand. When I bring him clothes to be washed, he is told, "If you are slow in bringing them back, you will be slapped on both cheeks."

The baker makes dough, and subjects the loaves to the fire; while his head is inside the oven, his son holds him by the legs: if he slips from the hands of his son, he falls into the flames.

Other workmen are described in the enumeration, such as the boatman, the husbandman, the market-gardener, the farmer, the fowler, and the fisherman. These, however, are not industrial pursuits, though they are an indication of the degree of the division of labor that is associated with the rise of crafts in industry. When the list of crafts is completed from other references, the number and character of the crafts of the period would bear comparison with conditions in the smaller towns of the early middle ages. Some of these craftsmen seem to be engaged in wage-work, rendering services for remuneration of some sort: the barber, the mason, the stone-cutter, the laundry-man, the messenger, and the like. Others make articles for a market.

Trade among  
artisans

There is a grave relief of the Fifth Dynasty,<sup>1</sup> depicting a market scene which shows various craftsmen

<sup>1</sup> The Sakkara relief; see Maspero, *Dawn of Civilization*, I, 322-23.

disposing of their wares among themselves and to the fellows who have come in from the suburbs with garden produce, game, and fish. The trade is by barter. The craftsmen indicated are: glassbead-makers, makers of fans and blowers for fires, shoemakers, metal-workers (a man with fish-hooks), and a perfumer. Some craftsmen at least devoted time to the preparation of wares for sale to their fellows and the country people. In the daily life of the humbler citizens, at least, the essential features of pure craft-work are clearly evident at the dawn of Egyptian history.

Artisans were employed in three ways: on the estates of some great landlord, royal or noble; in the workshops of the temples; and on their own account. The royal household derived most of its income from services and tools rendered as a tax or tribute by the various artisans and agriculturalists. The pictures of workmen bringing goods to the royal storehouses, thus, should not be interpreted as evidence that the workmen were permanently attached to the household. Some considerable portion of the output would be required by the King, but much of their time was at their own disposal. The work done for the temples might be arranged for in a variety of ways; it is conceivable that some artisans should be permanently attached to the service of the temple, and slaves were, of course, employed. Much of the work, however, was probably done by artisans hired for the occasion by those directing the work of the temple. The tomb of Rekhmire (Eighteenth Dynasty) depicts the operations of large numbers of craftsmen employed on work for the temple. Workers in leather, wood, stone, gold, silver, and copper are represented. The brickmakers in the building scenes are definitely stated to be captives; the other craftsmen are apparently freemen. There are two scenes suggesting payment; in one scene the workmen with their wives and children file by the officials at the storehouse and receive grain, oil, and clothing; in the other scene there are scribes and overseers for each group of workmen, and with each group of supervisors there is one man with a money bag. There is

therefore some slight reason to assume that the workmen were paid a portion of their wages in money, though the man with the purse may be a purely symbolic figure. That the workmen received some portion of their wages in kind is altogether probable, but such use was made of gold and copper rings as to make some issue of currency equally probable.

The list of crafts in early Egypt is interesting because it is evident that the crafts do not appear in the order of their importance in the field of consumption. The textile crafts are first represented by the dyers. Weavers are mentioned in the enumeration of the scribe, but it is generally held that weaving remained the work of women in the households until the Twentieth Dynasty. The word translated "weaver" in the manuscript of the scribe is doubtful and it seems likely that it was at least uncommon to find a man whose sole occupation was weaving.

### III. MESOPOTAMIA

The increase of our knowledge of the history of Mesopotamia in the early pre-Christian era is still proceeding so rapidly that no account of political or social life can be more than tentative. The process of deciphering the clay tablets, also, presents difficulties that are of special moment in the study of industrial development. The designations of various kinds of artificers and workmen are uncertain, and there are considerable differences of opinion as to the correct translation of many terms. The publications of texts afford only a partial knowledge of the matters involved, and though the records at our disposal are peculiarly specific, our knowledge of the substance is vague and uncertain. Contracts, receipts, accounts, lists of officials and servants are all precise, with the precision of legal documents, but it is difficult to translate these records without interpreting them in the light of our own institutions. Furthermore, the actual mass of material is small relative to the needs of the student of social life, and at best we have only a glimpse of the economic arrangements of these Mesopotamian peoples.

## THE RISE OF THE CRAFTS IN ANTIQUITY 35

In general, industrial arts were less diversified than in Egypt; there was less work done in wood, in the metals, and in leather. The woolen industry was by Industry and commerce far the most important of the entire group of occupations if we judge by the references in available sources. The early development of systems of weights and measures, however, and the use of the precious metals as money resulted in the abandonment of pure barter at an early date. There was also a caravan trade with the coast, so that the general aspect of Mesopotamian life is more nearly comparable to modern life than the relatively passive economic system of Egypt. The activity of commercial life brings us rather closer to these peoples than to other peoples of antiquity.

The abundant materials from the reign of Hammurabi (2143-2097 B.C.) afford us references to the following crafts: brick-makers (?), tailors, carpenters, masons, The list of crafts branders, surgeons, builders of houses, boat-builders, metal-workers, and weavers. In the code of Hammurabi there are several articles dealing with the sale of beer, or some similar kind of alcoholic drink, but there is no indication of a distinct group of brewers. Tablets of the seventh century B.C. add to this list, spinners, dyers, washermen, bakers, harness-makers, jewelers, potters, wood-carvers, and specialized workers in the various metals.

The status of artisans is somewhat uncertain, because the statements about wages and the hire of artisans cannot be assumed to refer to the hire of free artisans. Slaves were kept, and were systematically farmed out for hire, the proceeds being paid to the master. At the same time there is little doubt but that there were important classes of free artisans, who worked for hire for various individuals, for the King, and for temples.

The temples were, as in Egypt, business institutions of great importance. They possessed large estates which produced grain and wool. These supplies exceeded The temples their own needs, and became the basis of commercial activity. The wool was sold at times to artisans;

more frequently, artisans were hired to work the raw material up into cloth. This system was of great antiquity. It is clearly indicated by tablets dating between 2700 and 2580 B.C., and continued without essential change until the seventh century. In one of the earliest temple records on this subject, we find one hundred and ninety-one women set to work in the "weaving-house" on the supplies belonging to the temple. These women were paid wages. Both wool and metal were given out to artisans to be worked up at home. The temples were among the most important centers of the trade in wool and woolens.

Such establishments cannot be brought within the scope of any single classification; least of all can such establishments be classified as large households, in accordance with Bücher's scheme, because their production was designed to be sold in a distant market. It is not wise to endeavor to describe these usages as a single system. There was undoubtedly some genuine wage-work, illustrated by the turning over of bronze to a free metal-worker to be made into a doorkey. The issue of a formal receipt for the bronze turned over suggests that the work was done outside the temple grounds, without supervision. When artisans came to the temple and brought raw materials, we may have an indication of craft-work undertaken with a view to sale to fellow townsmen. The supplies of raw wool collected by the temple constituted the most readily available surplus and were thus naturally the basis for this trade. There is therefore a presumption, at least, in favor of the existence of some craft-work. The situation of the women employed on the premises of the temple seems to present strong analogies to a rudimentary factory, and yet it is hardly wise to apply the term without some qualifying adjective. The general aspect of industrial life is too rudimentary to make it desirable to apply any of the modern terms, unless it is clearly recognized that a "putting-out system" or a "factory" can exist in so simple a form as not to be out of keeping with conditions that in general represent the beginnings of craft-industry.

The important revelations of the sources consist in the

clear evidence afforded of production for the relatively distant markets of the Syrian coast towns and Egypt; the evidence of the existence of professionalized crafts; and the indication that the artisans were substantially free men working for wages.

"If an artisan take a son for adoption," says the Code of Hammurabi (sections 188-189), "and teach him his handicraft, one may not bring claim for him. If he do not teach him his handicraft, that son may return to his father's house." Such provisions intimate the existence of a system of apprenticeship for the transmission of craft-knowledge, but one must remember that the full significance of this as of other practices depends in part upon the numbers of persons involved. By the seventh century B.C. there is unmistakable evidence that the members of the various crafts were congregated in special quarters of the towns, as in Egypt. There were also certain officers with authority over the crafts. The translation of the titles are uncertain and the functions of the officials are unknown. Maspero is inclined to attribute administrative functions to the officials of the Egyptian crafts, but such a supposition reflects medieval analogies rather than contemporary evidence. Writing of the Assyrian officials, Johns inclines to a military interpretation. This would still bear analogy to the obligation of the medieval craftsmen to do watch and ward duty in the city, but such a supposition would not imply the existence of organized craft guilds. That some organization of the members of the crafts began to emerge in the late period is highly probable, with reference both to Egypt and to the cities of Mesopotamia, but we cannot be sure of the nature of the arrangements.

The existence of manufacture for export, of traces of craft organization, even rudimentary establishments for large-scale production, none of these facts should close our eyes to the infancy of organized industry. The types appear, but the scale of all these phenomena is small. Exportation was infrequent, and of

Status of  
artisans

Possible craft  
organization

Craft special-  
ization merely  
beginning

small volume. Crafts were present, but, for the most part, only the most moderate skill was required and some of the differentiation was based on varying degrees of physical fitness rather than upon definite professional skill. A lame man would be as effective as a smith as a man with two good legs; hence in Greek mythology Hephaistos the smith is lame. Edouard Meyer suggests also that Homer is represented as blind, because blind men so characteristically became singers. The singer was naturally thought of as being blind. These suggestions are, of course, pure conjecture, and they are drawn from Greek sources, but if these notions have any validity they would have more than a narrowly local application. They serve a real purpose if they emphasize the slight basis of craft differentiation in these early periods. The processes were in most cases simple, well within the capacities of the more adaptable workers without great preliminary training. The greater abundance of evidence makes it easier to find illustrations for these suppositions in the history of Greek industry, but the qualifications are perhaps even more important for the interpretation of the industrial development of the Egyptian and Mesopotamia peoples.

#### IV. GREECE

The rise of Greek civilization takes place within the general limits of the historic period, so that we catch glimpses of the development considerably before culture had reached the stage of conscious record-making. There is a semi-historic period, of which we gain some knowledge from archeology and poetic literature. These materials, however, are so difficult of interpretation that every possible view is championed by some scholar or scholars. Some say that the Greeks of this period were wholly devoted to agriculture, feared the sea, and therefore engaged in commerce only in the most casual way. Others are convinced that the Greeks were engaged in active commerce with Egypt and the Syrian coast at least a couple of centuries before the Trojan War. Some declare that the

Divergent  
views of early  
Greek devel-  
opment



Greeks merely absorbed various notable features of the culture of Egypt; others reduce the borrowing from Egypt to an inconsiderable minimum. Judgment based on the scant evidence in our possession is little more than a reflection of preconceived notions as to what is probable.

In general there is probably a disposition to underestimate the significance of trade among undeveloped peoples. The presumptions of naïve thought are comprehensively stated in the scheme of development in List's *National System of Political Economy*. The stages of economic evolution are characterized thus: savagery, pastoral culture, agriculture, agriculture combined with manufactures, agriculture combined with manufacture and commerce. Trade is thus made to appear as the climax or final result of a long economic evolution. The widespread disposition to exaggerate the difficulties of transportation confirms the presumption that is dormant in nearly all naïve economic thinking. The wide appeal of Bücher's views depended in no small measure upon the adroit formulation of all these naïve presumptions with all the paraphernalia of erudite scholarship. The study of primitive peoples, together with what we know of the ancient world, shows us that commerce plays an important part even in primitive life. Instead of evolving successively, commerce and industry must needs develop simultaneously, and though there are many reciprocal influences it is most likely that commerce is the conditioning factor in industrial development. This is designed to be the thesis of the present work, and it is hoped that it will be possible to show that the character of industrial development has been at all times a reflection of the commercial background, and that the great changes in industrial organization are the outcome of changes in commercial conditions which promote growth of population, concentration of population, or both gross increase and greater concentration. Certain aspects of the Industrial Revolution have closed our eyes to these larger relations between industry and commerce.

We can therefore approach these ambiguous indications

of the nature of early Greek development with a presumption in favor of what we may call the commercial theory. This seems, moreover, to be in accord with modern tendencies of critical scholarship. It is obviously desirable to avoid extremes, and it is above all necessary to avoid building elaborate theories of development upon single bits of archeological or literary evidence. Mr. Walter Leaf's studies of the *Iliad* bring to the subject the monographic spirit, and though much must be regarded as mere conjecture the conclusions are significant. His thesis may be stated briefly. The Trojan War seems to him to have been the outcome of economic rather than romantic causes. He regards the enterprise as an attempt on the part of the Greeks to destroy a powerful town which shut them out of the Dardanelles and the Black Sea. He endeavors to show that Troy had been a trading station at which the Greeks met the peoples of the Black Sea under Trojan auspices. Tiring of the payment of tribute and the inconveniences of such indirect methods, the Greeks at last banded together in the great military enterprise. Mr. Leaf brings this view forward with due modesty. Nothing can really be proved. But we can at least recognize the consistency of such an interpretation with the economic conditions of the early period of Greek development.

The industrial growth of the sixth and fifth centuries B.C. was in large measure dependent upon the extensive carrying trade that sprang up in the period following the Trojan War. If we include the Phœnician traders, as we should in any study of antiquity, we could say with truth that the brilliant civilization of the Græco-Roman world was based on the spirit of adventure shown by these navigators whose energies brought all the peoples of the Mediterranean world into close contact. The diversity of products was stimulating to industry, as the diversities of culture were stimulating to literature and art.

The study of the economic development of Greece and Rome has produced an antagonism between students of history and students of literature and art that is extremely

unfortunate. It seems at times as if the students of classical culture resented the conclusions of certain historical studies as being an attempt to depreciate the cultural significance of the achievements of the classical period. There can be no legitimate cause for such alarm. The material concerns of life with which the economist is busied must ever be a means to an end, and not an end in itself. No civilization can be justly appraised in terms of its economic mechanism. At best, economic organization is merely a way of attending to the daily need of material things, and no particular type of mechanism can be deemed a measure of the artistic and spiritual achievements of a people. High artistic accomplishment is not only possible when life is relatively simple, but perhaps more likely to occur. It may be that our elaborate material civilization is a positive hindrance to the attainment of the higher purposes of life.

Classic simplicity and culture

The low standards of artistic achievement in the early Victorian age may really be due to the displacement of the old craft methods by the technique of the Industrial Revolution. Production for the masses is likely to result in the subordination of refinement in execution and design to cheapness. Production of articles of luxury for a wealthy leisure class is by necessity characterized by elegance in conception and execution. The idealization of the medieval craft-workers has made us familiar with these divergent tendencies between artistry of production and cheapness of production, and yet there seems to be some obstacle to the application of these principles to the achievements of the craftsmen of Greece and Rome.

The notable parallels between the classic period and the medieval period are neither willingly nor clearly recognized. In Francotte's excellent study of the industrial development of Greece there is no comparison with the middle ages. He compares Athens with the Manchester and Birmingham of the late nineteenth century: the port of Delos with quays two hundred and fifty meters long is compared with our modern ports with kilo-

Parallels between antiquity and the middle ages

meters of quays. Industry and commerce compare unfavorably with the industry and commerce of Europe since the Industrial Revolution, but if we seek a basis of comparison with conditions definitely prior to the Industrial Revolution the results are different. Germany did not begin to feel the influence of the newer development of industry and commerce until the latter half of the nineteenth century.

At the close of the eighteenth century Prussia still displayed the salient features of medievalism. There were within Prussian boundaries, 1016 places classified as towns or cities. Berlin alone had more than 100,000 inhabitants (153,000), being therefore slightly larger than Athens in the time of Pericles. There were three towns with more than 50,000: Warsaw, 64,000; Breslau, 60,000; Königsberg, 56,000. Syracuse and Corinth were considerably larger than these second-class towns of Prussia. At the most prosperous period of Grecian development they had respectively 110,000 and 90,000 inhabitants. Six towns of Greece are mentioned by Beloch as having between 40,000 and 50,000 inhabitants. Fourteen Prussian towns had slightly more than 10,000 inhabitants; Dantzic, Magdeburg, Elbing, Stettin, Potsdam, Erfurt, Posen, Halberstadt, Halle, Münster, Hildesheim, Emden, Brandenburg, and Frankfurt-am-Main. Of the remaining 998 cities, 502 had a population of more than 1000 and less than 3000. This distribution of population is characteristically medieval, and such statistics as we have from the classical period reveal conditions that are roughly comparable. Rome, at the height of her prosperity, was larger than any medieval town; but with that exception the distribution of population in the classical period bears significant comparison with the distribution of population in the middle ages.

There is so close a relationship between industry and population, that the similarities underlying urban life lead directly to a presumption in favor of notable similarities in industrial development. With reference to economic conditions, the medieval period has more in common with classical antiquity than with modern times. The Industrial Revolu-

tion marks a transformation of social conditions which separates the modern period distinctively from both the earlier periods. Despite our intellectual and artistic heritage from the classical period, we can interpret the scant evidence bearing on the social life of Greece and Rome only in terms of our knowledge of the middle ages. The so-called "dark ages" constitute perhaps an interlude, but there is no profound change in the general character of economic arrangements; merely the ebb and flow that constitute the movement of all historical growth.

There is enough material to enable us to distinguish some of the periods in the industrial development of the Grecian world. The four or five centuries between the fall of Troy and the early sixth century B.C. are marked by the establishment of the commercial power of the Greeks. Industry responded slowly. The crafts began to emerge, but they were not very clearly differentiated. Metal-workers are mentioned. The smith's forge, like the country stores and smithies of the small towns of our own times, was a resort for the idlers and gossips of the village. There is no indication of specialized work in metals, least of all clear specialization in the preparation of different objects. There were potters, but no specialization of tasks; the vases and other vessels were relatively simple. The builders did everything needful in connection with building houses. They could also build ships. The same word is applied also to makers of household furniture, of ploughs, and objects of horn and ivory. Leather-workers did everything connected with leather, tanning as well as shield-making. These workers were free to the extent of not being the slaves of any one person, but they did not enjoy all the rights of peasants. The craftsmen were employees working for the village as a whole.

Between the sixth and fourth centuries B.C. the specialization of crafts developed rapidly. "In the larger towns," says Xenophon in the *Cyropædia* (VIII, 2), "where many people have similar wants, a single craft is a means of livelihood. Frequently, the craftsman

Rise of craft-  
industry in  
Greece

Specialization  
by processes

does not practice the entire craft: one makes men's shoes, another makes women's shoes; one lives by sewing shoes, another by cutting leather; one cuts out tunics, another devotes himself exclusively to assembling the parts." In the metal industries there were distinct crafts for making each of the pieces of armor and for the different weapons. Helmets, breastplates, plumes, shields, lances, and the like were turned out by different craftsmen. In the making of pottery there was definite division of labor into the fundamental processes: the forming of the vessels on the wheel, the firing and the painting. The dictionaries of antiquities afford some indications of a fairly comprehensive list of crafts, but references are so scattered as to date and locality that it is scarcely safe to endeavor to draw up a list of crafts for any particular period or any single town. We can be sure that craft specialization was far advanced in the Greek period, but we cannot attempt any precise statement.

The third and second centuries B.C. are marked by the decadence of some of the Greek towns, but these changes were the outcome of the loss of political prestige and the consequent loss of some of the artificial advantages that were derived in industry and commerce from the abuse of political power. Such changes, however, effect only particular towns and not the Græco-Roman world as a whole. There was no break in the general course of industrial development.

One of the notable features of the industrial growth of the larger Greek towns is the "factory system." Establishments of twenty or thirty persons existed in several branches of industry. The craftsmen in these undertakings were usually slaves, who worked under the supervision of the owner or his agent. At times the entire group was farmed out to some contractor. Francotte cites a number of cases recorded in Athenian wills. One Conon left two establishments: one of textile workers, one of druggists. Timarchus left a number of industrial slaves: nine shoemakers, a female weaver, a maker of fancy objects, and two gangs of silver miners. The father of Demosthenes left two workshops: one of knife-makers, with a personnel of

thirty-two or three persons; one of bed-makers, with a personnel of twenty. The vase-painting establishments were of about the same type; between ten and twenty workmen were usually employed, and, although such subjects were rarely chosen for vase-painting, we have a representation of a vase manufactory with eight workmen. All the processes are shown and the general aspect of the workrooms. Separate rooms were required for firing, shaping, and painting. Some portions of the work were done out of doors under canvas shelters, but most of the operations were by necessity done in definite workshops. The methods of signing the vases distinguish between the proprietor and the vase painter responsible for the decorations. These signatures afford clear evidence that this most important industry was not entirely dominated by slave labor. In a number of <sup>Some free</sup> cases the same person is designated as being <sup>artisans</sup> both proprietor and painter. One Athenian painter, Euphronius, rose from being a painter in establishments belonging to others to the proprietorship of an establishment of his own. Such at least is the story that can be read from a number of inscriptions and signatures.

Bücher classified these establishments as cases of "household industry," a household whose membership had been enlarged by the addition of slaves, but still in legal form a household. This is more misleading than helpful. Some free industry existed side by side with these slave establishments, and all were producing goods for sale in the market; at times a local market and at times an export market. The workrooms were not a portion of the dwelling-house; in many cases, at least, they seem to have been specialized quarters exclusively devoted to industry. Francotte still hesitates to apply the term "factory." He fears that the reader will assume the existence of conditions such as <sup>Unwillingness</sup> followed the Industrial Revolution. All these <sup>to recognize</sup> discussions are a reflection of the unfortunate <sup>these factories</sup> modes of thought suggested by Rodbertus and Bücher. The character of industrial life is only partially indicated by the forms of organization. The progress of economic evolution

is not entirely a matter of developing certain forms, even if one were to assume that there were no differences to be observed beyond the bare facts of the most general classification. The industrial life of a period can be appraised and described only as a complex of elements. The degree of specialization of crafts must be considered; the extent of the horizontal division of labor, if any; the scale of production and the character of the market; lastly, the forms of organization.

We have been too much inclined to suppose that factories and the factory system are the distinctive and exclusive feature of the Industrial Revolution, forgetting that small factories had emerged at various times and places throughout the period which we think of as dominated by craft industry. There is no reason to feel that there is anything abnormal in the emergence of various small factories in the classical period. Nor is there any reason for hesitating to admit frankly that these sporadic tendencies toward the factory system were rather more conspicuous in classical than in medieval times. The putting-out system dominates the middle ages in the more elaborately developed industries. From the employer's point of view it would doubtless have been more convenient to have his people collected in a workshop, but the development toward the factory was checked. The free workmen of the middle ages disliked the restraints of the factory, and the crafts, composed in large measure of small masters, were able to exert sufficient political pressure to suppress the sporadic attempts to bring workmen together in factories. The significant struggle of the English crafts against these tendencies will be treated in a subsequent chapter.<sup>1</sup> It must needs suffice here to call attention to the fact. Slavery and the absence of any significant craft organization left the employers of the classical period free to organize these small factories, and it is perhaps more significant to recognize this tendency and its causes than to endeavor to obscure the real facts. The existence of these factories does not indicate a departure from the general conditions of craft industry. This degree of capitalistic control,

<sup>1</sup> *Infra*, chapter VIII, § III.



which can be expressed either in the factory or in the putting-out system, is a characteristic feature of the later forms of handicraft industry.

It would be highly desirable to be able to reach a definite conclusion with reference to the relative importance of slaves to freemen in industry. It is unfortunately impossible. Using practically the same <sup>Slavery in</sup> <sup>Greece</sup> general figures from the classical sources, Francotte and Edouard Meyer reach opposite conclusions. A neutral reading of this controversial literature leaves the general impression that the defenders of free labor have the better case. Industry as a whole was not decisively dominated either by free or by slave labor. With the exception of the extractive industries, in Greece free labor at least held its own. The competition of the industrial slaves of the aristocrats was serious but the freeman could none the less live by his craft. Slavery afforded the wealthy an opportunity to participate in the profits of industrial enterprise without loss of caste. Despite competition the two systems could exist side by side without destroying each other; their existence was not exclusively dependent upon their advantages as methods of producing their wares. The free artisan was perhaps a foreigner, excluded from full civil rights; an inconspicuous factor in political and social life, but economically important. In many cities of the ancient world the commerce and industry of the locality was really in the hands of these foreigners; the participation of the aristocrats in business enterprise was somewhat incidental. The casual references in literature are an uncertain index of the proportionate importance of these two elements in business life, as literature was predominantly occupied with the doings of the aristocrats. Other materials are too meager to afford clear evidence of the proportionate importance of these diverse elements in the community.

#### V. ROME AND CONSTANTINOPLE

For the last century of the Republic and the period of the Empire considerable information is furnished by inscriptions.

These materials are unsatisfactory in many respects, but in careful hands they reveal many aspects of the organization of the artisans of Rome. It has frequently been presumed that some significant connection existed between the craft

Roman "collegia" — associations of craftsmen in ancient Rome.

The studies of Waltzing show that the comparisons are misleading and unreal. These Roman organizations assumed a number of fairly distinct forms, but in no case is there justification for any significant comparison with the institutions of the middle ages. The societies for the celebration of funeral rites are similar in many respects to the fraternities or religious guilds of the medieval period, but such societies should be carefully distinguished from craft guilds. The Roman "collegia" seem to have had few distinctively economic functions. They were not comprehensive groupings of all artisans exercising particular crafts. Neither skill nor apprenticeship was an essential condition of entry. The members of the society do not seem to have exercised any of the supervisory powers that are the distinctive feature of the craft organizations of the middle ages.

The inscriptions, however, enable us to gain considerable insight into the degree of industrial specialization at Rome.

The list of crafts      The following crafts are mentioned in the inscriptions from which Waltzing prepared his list of corporations at Rome. The crafts have been grouped under the general classifications to facilitate economic analysis:

*Food, and industries connected with food:*

Measurers of grain, workers in public granaries, perfumers and spicers, butchers, inn-keepers, confectioners, cooks, hay-merchants, fruit-sellers, merchants of vegetables, bakers, grain merchants, millers, cattle merchants, merchants of salt meats, wine-sellers, oil merchants, pastry-cooks, fishermen, fish-merchants, salt merchants, pork merchants, shopkeepers.

*Textiles:*

Dyers, fullers, linen merchants, embroiderers, workmen's blouse-makers, tailors.

*Leather:*

Shoemakers, women's shoemakers, tanners, furriers.

*Metals:*

Smiths (bronze), ring-makers, silversmiths, goldsmiths, gold-beaters, money-changers, blacksmiths, sellers of silver vases, mirror-makers.

*Wood and manufactures of wood:*

Joiners and furniture-makers, wood merchants, shipbuilders, carpenters, joiners.

*Stone, clay and building:*

Lime-burners, ditch-diggers, lime-porters, builders, potters, sculptors, stone-sawyers, masons, wreckers of buildings.

*Transport:*

Shippers, muleteers, boatmen of the Tiber, "curatores navium," patrons of lighters on the Tiber.

*Artists, gymnasts, etc.:*

Musicians (horns), horn-players, mimes, poets and actors, lute-players, wild-beast chasers, gladiators.

*Miscellaneous:*

Porters, wreath-makers, jailers, ivory-carvers, wholesalers, bathhouse-keepers, masseurs, barbers, doctors, pavers, merchants of pigments, makers of dice.

The small number of crafts engaged in leather-working and in textiles is noteworthy. There was considerable diversification in the metal trades and elaborate specialization in the preparation of food. Without knowledge of the relative numbers of persons occupied in these crafts, it is hardly justifiable to assume that the textile and leather groups were relatively less important, but there is strong presumption in favor of such a conclusion. The preparation of clothing and leather goods was primarily the work of members of each household. Little specialized skill was required and only the very poor resorted to the markets for the common textiles or leather goods. The list of crafts concerned with the preparation of food products is very impressive, and comparison with the lists of crafts for Paris in the eleventh and thirteenth centuries would suggest that elaborate specialization appears earlier in this general group than in any other.

At Constantinople, toward the close of the ninth century A.D., conditions were more nearly comparable to medieval conditions. The regulations made by the Prefect of the city for the government of the crafts exhibit many features that are definitely analogous to conditions at Paris in the eleventh and thirteenth centuries. The primary civil authority in Constantinople was exercised by an official appointed directly by the Emperor, as the Prefect of Paris was appointed by the King. The Prefect of Constantinople had complete jurisdiction over industrial and commercial matters and issued strict regulations. Some of the crafts at Constantinople had no autonomous powers at all; some seem to have been in the way of acquiring a small measure of autonomy in the enforcement of the rules and customs of the craft. The perfumers were instructed to prevent the preparation or sale of defective or inferior wares "by mutual oversight over each other." The spicers were charged with the supervision of all wares of their craft, in order to prevent the making of hoards, whether by members of the craft or by others. Similar functions were delegated to the chief merchants of pork products. These various functions of supervision are comparable to the "view of the craft" that became the characteristic privilege of the more powerful medieval craft guilds. It would seem that administrative functions were in process of development at Constantinople. The fundamental background can hardly have been very different from the conditions at Rome under the Empire, and thus we may well believe that guilds similar in most features to the medieval guilds might develop in the Roman world, though we have no evidence that the process of development was continued to that point except at Constantinople. The book of the Prefect at Constantinople is therefore an indication that the conditions favorable to the growth of craft guild organization might normally be expected to appear in the course of the industrial development of any large town. This particular form of craft organization should not be associated uniquely with medieval conditions, nor should it be presumed to be merely

THE RISE OF THE CRAFTS IN ANTIQUITY 51

copied from some Roman or Eastern model. When the degree of craft specialization had become considerable, it was perfectly natural that the administrative officers should delegate certain functions of supervision that could best be discharged by persons acquainted with the technique of the craft. The guild can best be regarded as a spontaneous outgrowth of industrial conditions.

CHAPTER III  
CRAFTS AND CRAFT GILDS IN MEDIEVAL FRANCE

I

THE break-up of the Roman Empire was followed by different results in the various European provinces. In England and in Germany the Teutonic influences speedily became predominant. In Italy there was a marked decline, as soon as the provinces ceased to send their tribute in money and in kind. In France the disappearance of the administrative framework of the Empire left many aspects of social life unchanged. The Roman cities of southern France maintained themselves after a fashion and the commercial life that had developed was not destroyed. The Teutonic tribes entering Gaul brought with them many new political conceptions, but the economic life of the Roman province was accepted by them and many elements of Roman culture were adopted. France became by force of circumstances one of the closest bonds between the old Roman civilization and the new Teutonic civilization that was rapidly assuming significant form. The relative continuity of social growth is a notable feature of the history of France; elsewhere in the north of Europe the break with the institutions of the Empire was so complete that the Roman background exerted little or no direct influence upon the course of development.

Much of the controversy that has existed among scholars as to the relative importance of Roman and Teutonic institutions would seem to be resolved by frank recognition of the diversities of development in different portions of Europe. There were many elements of Roman agrarian and industrial institutions that could be harmonized with the usages of the invaders. Roman customs could easily be incorporated with the Teutonic modes of life without making the final result essentially different from results achieved in provinces where

Roman influences were negligible. The condition of the un-free tillers of the soil displays most notably the possibilities of reaching substantially the same results from both Roman and Teutonic backgrounds. The existence of Roman influences in certain sections thus does not even create a presumption in favor of similar influences elsewhere. The French writers who find Roman influences in France are therefore quite as trustworthy as the German writers who deny the existence of similar influences in Germany and in England.

With reference to commerce and industry the situation is somewhat different, because France and Italy were more important both before and after the fall of Rome. There was more urban concentration, more commerce, and a more highly diversified industrial life. Many of these economic activities survived the tumult of the invasions. The administrative regulations of the Empire disappeared almost entirely, most particularly the corporate organization of the crafts, but the crafts themselves survived. The commercial and industrial life of Roman Gaul exerted a notable influence upon the economic development of the Teutonic kingdoms that established themselves during the invasions. This persistence of Roman influences in France is of more than local significance. Industry and commerce affect larger areas than the localities in which they are primarily concentrated. At the least one must include the entire market area in studies of their influence, and, as England and Germany were partly dependent upon France for the sale of their raw products and for some of the manufactured articles, the industrial development of France in the "dark ages" is part of the general history of Europe. The commercial and industrial system that finally took definite form in the medieval period was an outgrowth of the commercial importance of Roman Gaul.

The precise extent of direct Roman influences can scarcely be determined. Flach believes that many of the old Roman corporations became "confréries" — associations of craftsmen for the common celebration of religious festivals and of masses for the souls of comrades. Fagniez, too,

believes that some survivals of the Roman organizations may have persisted throughout the period of the greatest disorders, becoming one of several elements in the growth of the newer institutions that emerge into the light of historical knowledge in the twelfth and thirteenth centuries.

In the study of industrial development an undue share of attention has been given to the administrative organization of craft-workers. There is a disposition to forget that the fact of primary economic significance is the occupational specialization. The division of labor into the crafts must needs precede the formation of administrative bodies based on the crafts. It is therefore not merely possible, but inevitable, that there should be periods in which handicrafts exist as specific professions despite the absence of corporations of the Roman type or guilds of the medieval type. There is no clear evidence of corporate organization of the crafts in Greece, neither is there any definite indication of craft organization in the interval between the sixth century A.D. and the twelfth century. But in both periods there was active growth, though conditions were widely different in each case. A certain measure of superficial decay must needs have followed the break-up of the Roman Empire. The domination of Rome had forced a premature industrial growth that could not be maintained. In Roman Gaul, for instance, there were eight imperial establishments engaged in the making of weapons. The artisans were technically free, but they were subject to a definite obligation to pursue that craft under the given conditions, so that they enjoyed only a much qualified freedom. Their product was their contribution to the State. With the passing of the Empire all such forced industrial effort would inevitably pass into channels more in accord with the genuine needs of the community. The flow of commerce toward Rome declined, but inasmuch as it had never been a genuine reciprocal trade, it was hardly a retrograde movement. Changes occurred in the industries which ministered primarily to the wealthy city dwellers of the Empire. The overthrow of that particular group of parasites naturally



caused some decline in the industries which ministered to them. Fewer objects of luxury were made, and the old refinements of execution disappeared. The market had changed. Certain arts were lost or neglected. The transition from the restraints and compulsions of the Roman system to the freer régime of the middle ages involved destruction as well as construction. The fundamental specializations of occupations seem to have maintained themselves.

The craftsmen were sheltered during the period of greatest disorder in the monasteries and on the great rural estates of the feudal lords. A small number of artisans maintained themselves unattached, but they <sup>Persistence</sup> <sub>of crafts</sub> must have been exceptional, like the small freeholders in agriculture. There were such freemen, but they were not numerous nor characteristic of the age.

On the great estates the craft-workers were relatively numerous, but they were serfs. They were nevertheless better off than the slaves of the old Roman system. They could not be slain with impunity, though the offense of murder was punished primarily by the graduated fines common to all early Teutonic law. The wergilds of artisans varied according to the character of the craft. For the murder of a goldsmith one paid one hundred and fifty sous, while the worker in iron was valued at fifty sous. A carpenter was appraised at forty sous, a plain laborer or swine-herd at thirty sous. Some of the industrial work on the domains was done by the artisans in their cottages; much, however, was done in general workshops. The women in particular were gathered together in a special group of buildings called the "gynceum." These were similar in all <sup>The</sup> respects to the establishments of the Græco-<sup>"gynceum"</sup> Roman world for the utilization of the women on the great estates, though men were seldom employed in them by the lords of the early Teutonic kingdoms. It was presumed that the gynceum would be managed in all respects by the wife of the lord, but there are references to laxity of management. As many as forty women were employed at times, but references are too scanty to admit of statements as to the

characteristic size of these establishments. The work consisted primarily of textile manufacture; weaving, dyeing, and the making of garments. These were used by the household in part, but there was frequently, if not usually, some surplus for sale in the market. With reference to men, the domains were probably significant only as an asylum for the metal-workers, the masons, carpenters, and such craftsmen.

The great refuges for the artisans were the monasteries and episcopal establishments. These frequently became aggregations of people that bore all outward semblance to a small town. The Abbey of Saint Riquier in the ninth century was the nucleus of twenty-five hundred houses, which would indicate a population of more than ten thousand souls. A portion of the settlement was given over to the artisans, who were grouped in streets. The enumeration includes: wholesale merchants, smiths, shield-makers, saddlers, bakers, shoemakers, butchers, fullers, furriers, wine merchants, beer-sellers. Each of these crafts was obliged to furnish wares to the Abbey, but it was a group obligation and the quantities of material indicated leave it fairly certain that the artisans could dispose freely of much of their time. The cartulary of Saint Vincent at Le Mans mentions artisans rather more frequently than other cartularies, so that the list of crafts referred to in the eleventh century represents perhaps the higher developments of handicraft industry around monastic foundations. The following crafts are mentioned: merchants, carpenters, weavers, various kinds of workers in gold and silver, tailors, shoemakers, butchers, bakers, wax-makers, smiths, drapers, furriers, linen merchants, leather merchants, salt merchants, glass-setters. It is noteworthy that weavers and tailors seldom appear in the earlier enumerations of the craftsmen that are partially free. The textile industries were largely in the hands of women in the earlier period, as is shown by the Polyptique of the Abbey of Saint Germain des Prés (close of the eighth century). Linen and serge were made in the general workshops of the abbey (the gynceum) and in the cottages of the serfs whose wives were required to furnish stipulated quantities of cloth. As in the

Crafts in the  
ninth century

classical period, the textile industries were slow to become established as specialized occupations for men.

It may be noted in passing that the classification of these monastic and feudal establishments presents the same difficulties as the large establishments of the classical period. They are a part of a patriarchal household or of a feudal household, but it is misleading to classify them as "household industries" because the product was sold in distant markets. Except perhaps for small differences in the quantities of goods produced, these early medieval establishments differed in no essential respect from the "factories" based on slave labor during the classical period. This tendency toward the aggregation of unfree industrial workers is, however, to be distinguished from any tendencies toward the aggregation of free workers. The motives are different. Free laborers will be brought together only under the influence of some consciousness of economic advantages to be derived from the organization of the work in hand. The aggregation of unfree laborers is more largely determined by the servile status of the laborer than by profit-seeking. With rare exceptions, these groups were indeed mere aggregations of women; no real organization of work was achieved by bringing them together. They worked side by side perhaps in a large room, but the work could doubtless have been as efficiently done in the cottages of the workers.

We know less of the free craftsmen of the eighth, ninth, and tenth centuries than we know of the same class in the Græco-Roman period. In the feudal hierarchy they had no place, and consequently they are seldom mentioned in the scant records of the period.

## II

The eleventh century marks the beginning of a new epoch in the development of industry: distinguished by the political emancipation of the artisan and a great increase Rise of towns in the degree of occupational specialization. The rise of the free towns is the political expression of the new status acquired by the commercial and industrial classes.

Throughout the classical period and in the centuries immediately following the Teutonic invasions, industry and commerce had occupied an inferior place in the social order. Persons of social consequence were excluded from the direct practice of such occupations, though it was not a derogation of their caste to maintain groups of servile artisans as slaves or serfs. The commercial and industrial classes were more or less completely deprived of legal rights. The *metic*, or stranger, that controlled the commercial enterprise of the Greek cities, was tolerated and allowed some privileges, but he was definitely excluded from citizenship. The foreigner at Rome enjoyed a larger measure of legal rights, being subject to a legal system that afforded more scope for individual initiative than the laws pertaining to citizens. Finally, indeed, these legal differences disappeared at Rome, but much of the old prejudice survived. It was respectable to be a great landowner, or a venial official, but it was not conceivable that a person of consequence should be directly engaged in commerce and industry.

The rise of the medieval towns composed primarily of merchants and artisans, permanently altered the social standing of these groups. They too became a distinct caste. They occupied a position that was inferior socially to that of the noble, the ecclesiastic, or the public officials, but they soon became economically and politically of coördinate importance. In the complex struggles between kings, barons, and the Church, the Third Estate occupied a position of strategic importance. They were courted by both kings and nobles. During the classical period, this class was politically subordinate to the landed aristocracy resident in the towns; they now became an independent political factor. The urban centers became a focus of industrial and commercial interests. Down to the Industrial Revolution the structure of commercial and industrial life was dominated by the institutions that took form in the long period that began in the eleventh century.

This period of urban growth was one of especial prosperity for France; some writers even have said that France has never

been more prosperous than at the beginning of the fourteenth century when the new order had become definitely established. The figures that we have for the population of France lend plausibility to this view. It is estimated that there were about twenty or twenty-two millions of people living within the territorial limits of France as they stood in 1914. There was no considerable growth of population until the eighteenth century; the vicissitudes of pestilence and wars prevented any consistent increase. Paris, according to an enumeration of 1292, had a population of slightly more than 200,000; and in 1328, the usual calculations indicate 274,000. Relatively to other portions of Europe France must have occupied a singularly favorable position. It is likely that she enjoyed a degree of material prosperity that was equaled only in isolated portions of Europe. The Low Countries and parts of Italy shared in this material development, but no large country was as favorably situated. The advance in economic organization can thus be most advantageously studied in France, and most especially in Paris, its largest city.

It is a piece of rare good fortune that we have a fairly accurate measure of the growth of occupational specialization during the period. There is an enumeration of the occupations pursued at Paris during the latter half of the eleventh century in the *Dictionary of Jean Garlande*. Toward the close of the thirteenth century we have two sources of information: the *Book of the Crafts*, a record of the customs of the crafts made at the instance of Etienne Boileau, Provost of Paris, 1258-70; and the tax-rolls of Paris, for the years 1292 and 1300, which give the occupations of most of the persons enumerated. All these records are less accurate than we might wish, particularly the *Dictionary of Jean Garlande*, but the combined evidence of the *Book of the Crafts* and the tax-rolls must give us a well-nigh comprehensive survey of the industrial organization for that period. Thirty-seven occupations are described by Jean Garlande, one hundred crafts are enumerated in the *Book of the Crafts*, and two hundred and twenty-five industrial and commercial

occupations are mentioned in the tax-rolls of 1292. The tax-roll mentions all occupations, but it will be wise to confine our attention to industrial and commercial occupations, excluding, for instance, porters, boatmen, public officials, and the like. Many of the occupations listed occur only once or twice, so that the number of important occupations is not inconsistent with the number of organized crafts enumerated in the *Book of the Crafts*. The number of occupations organized as crafts, however, must have been somewhat more than one hundred. Occupations with less than ten persons were frequently so organized, and there were one hundred and thirty-four occupations listed in 1292 as having more than five persons. The *Book of the Crafts* does not purport to be a comprehensive enumeration of crafts, and several occupations were combined in one craft in a number of cases. A number of occupations listed in the roll of 1292, but not mentioned in the *Book of the Crafts*, received statutes as crafts early in the following century. It is thus certain that occupational specialization proceeded faster than the development of crafts with customs or statutes.

In any study of medieval crafts it is necessary to include two groups of occupations which stand somewhat outside the industrial field: the retail and wholesale merchants, and the persons engaged in the preparation of foodstuffs. Study of the merchandizing crafts is of especial importance, as they serve as a measure of many changes in the market that would otherwise escape our attention. The existence of such crafts emphasizes the importance of distant markets, and in the presence of such tangible evidence of elaborately organized trade, it is difficult to understand the tenacity with which many writers insist upon the mythical direct contact between the medieval craftsman and the consumer. In every large town there were three groups of crafts; those occupied with purely local concerns, butchers, bakers, candle-makers, brewers, and the like; those engaged in production with reference to a distant as well as the local market — the various textile crafts, the leather workers, and the metal-work-

The tradesmen

Crafts and town life

ers fall within this group; finally, there were merchandising crafts, a few definitely concerned with the wholesale trade, mostly, however, engaged in retail trade. The drapers were wholesale dealers in woolens; the mercers, wholesale dealers in silks and wares from Italy; the spicers, or grocers as they came to be called later, dealt in spices, drugs, oils, and other wares. The scope of the trade proper to these three great wholesale crafts was constantly enlarged, but the original division of business was roughly as indicated and the extensions of later years were a natural outcome of these original lines of demarcation. The development of these crafts and of their powers constitutes an important chapter in commercial history.

The crafts occupied solely with local needs appear almost everywhere, and usually rose to positions of power and affluence. The crafts of butchers and bakers were usually composed of wealthy men, and in many towns acquired a significant place in municipal politics. The merchandising crafts were also present in most towns, and always important. The crafts that represented the export industries varied, of course, in different regions: metal <sup>Regional</sup> industries were most highly developed in Ger- <sup>specialization</sup> many, Italy, and parts of Spain; the preparation of the finer grades of leather was originally a specialty of the Spanish towns, but these processes of tanning spread northward rapidly and gained a strong position in France; the woolen industry was the predominant export industry in northern France, the Low Countries, and later in England. In the woolen industry regional specialization was carried to great lengths; the weavers of each town confined their attention to a single type of cloth, or at the most to a few types. The different types of cloth were thus designated at the outset by the name of the town in which they were made, and these names persisted long after the diffusion of the industry had spread the manufacture to other towns and countries.

## THE CRAFTS OF PARIS: LATE ELEVENTH CENTURY

*After the Dictionary of Jean Garlande**Foods, and the Preparation of Food:*

- (a) Raw materials:  
(none)
- (b) Intermediate products:  
(none)
- (c) Finished products:  
Bakers, pastry-cooks, makers of meat-pies, poultry-cooks.
- (d) Merchandising crafts:  
Bakers selling their own product, sellers of cakes and wafers, sellers of cakes and pastry, sellers of fruit, sellers of wine.

*Leather:*

- (a) Raw materials:  
Tanners, furriers.
- (b) Intermediate products:  
Lorimers (makers of the metal fixtures for harness). *See below.*
- (c) Finished products:  
Workers in cordovan leather (shoemakers), gloves, saddlers, shield-makers, cobblers, belt-makers.
- (d) Merchandising crafts:  
Retailers of caps, girths, belts, and purses, retailers of shoes.

*Metals:*

- (a) Raw materials:  
Blacksmiths, goldsmiths.
- (b) Intermediate products:  
Lorimers, cutlers, buckle-makers.
- (c) Finished products:  
Sword-grinders, bell-founders, goblet-menders, broach-makers.
- (d) Sellers of pins, razors, soap, mirrors, etc.

*Textiles:*

- (a) Raw materials:  
(none)
- (b) Intermediate products:  
Weavers (women).
- (c) Finished products:  
Dyers, fullers, cap-makers.
- (d) Merchandising crafts:  
Drapers, retailers of cloaks, etc.



In the list of crafts given by Jean Garlande the retailing crafts and crafts occupied with local needs predominate. There were criers of wine, of cakes, and of wafers; persons who circulated in the streets selling their wares or urging the advantages of particular wine-shops upon the passers. Most retailing, however, was not itinerant. Selling was done in shops or stalls; fruit, cakes, and pastry could all be purchased in such fashion, as also a variety of manufactured articles. Pins, soap, mirrors and razors were the specialty of one class of sellers; cloaks, undergarments, caps, girths, belts, purses, and shoes were to be had of various other retailers. The preparation of food occupied a small group of crafts. The butchers are not mentioned, but they must have existed as a distinct occupation, as we have references to them in charters of the following century which speak of them as having been long in existence. Some writers even believe that the butchers of Paris maintained some sort of organization throughout the period between the fall of Rome and the twelfth century.

The degree of specialization in the leather, textile, and metal industries was not great. There is little reason to suppose that any leather goods found their way <sup>Leather-</sup> out of Paris at this time, but a notable import <sup>working</sup> trade is indicated. The tanners prepared only the coarser kinds of leather; the types tanned with oak bark, grades of leather that were used only in heavy goods. The finer grades of oil-tanned leathers were all imported at this time. Originating in Spain and associated with Cordova, these leathers were called "corduan," and the workers in such leathers were thus dubbed "corduanners," a word which was crudely reproduced in English as "cordwainer." This craft later specialized in shoemaking, but at this time the Parisian workmen made all types of fine leather goods. It is interesting to note the early distinction between the cobbler, who repaired shoes, and the makers of new shoes. The metal-workers were chiefly engaged in the finishing crafts, the materials being imported in an advanced stage of manufacture.

The textile crafts enumerated represent primarily the finishing processes. Specialized women weavers are mentioned, but it is fairly certain that the chief textile *Textile workers* crafts were concerned with fulling and dyeing. The drapers, at this time, can hardly have been occupied with anything but their proper business of wholesaling. Inasmuch as cloth became later the most important industrial export of Paris, this tardy development of weaving as a distinct occupation for men speaks eloquently of the slow growth of industry up to the eleventh century. The importance of the weavers at the close of the thirteenth century shows how great a change took place in the intervening period.

The tax-rolls of 1292 and 1300 enable us to form some opinion of the relative importance of the various occupational groups. The striking feature of the figures is the clear evidence that the textile and clothing group had only recently become coördinate in importance with the leather and food groups.

NUMBERS OF PERSONS EMPLOYED IN THE VARIOUS INDUSTRIAL GROUPS  
PARIS, 1292 AND 1300

<i>Group</i>	<i>Number of persons, 1292</i>	<i>Per cent of total</i>	<i>Number of persons 1300</i>
Foods and food products.....	956	20.94	(not comparable)
Leather.....	933	20.44	1223
Metals.....	606	13.27	729
Textiles.....	251		632
Clothing.....	667		811
Together.....	918	20.11	1243
Wood.....	340	7.45	289
Building trades.....	194	4.25	225
Ecclesiastical ornaments.....	77	1.69	83
Miscellaneous.....	541	11.85	(not comparable)
	4565	100.00	

The increase in the numbers of persons reported in the leather and textile trades in 1300 is partly due to the difference in the character of the taxes imposed. The taxes of 1300 fell upon the poorest artisans to a greater extent than did the taxes of 1292. The lists are thus somewhat short of being comprehensive; conclusions must thus be subject to qualification, but it would seem likely that there had been some change in the occupational groupings. The period was one of rapid growth in the population of Paris; at least such is the conclusion reached by students of population, but their computations being based upon these tax-rolls must be subject to the same elements of error as our industrial statistics.

CLASSIFICATION OF OCCUPATIONS ACCORDING TO SIZE: TAX-ROLLS OF 1292 AND 1300

	<i>Less than 5 persons</i>	5-9	10-19	20-39	40-59	60-99	100-199	200 or over
1292	91	40	34	31	11	11	5	2
1300	224	35	31	30	8	7	8	4

In 1292, 225 occupations were enumerated; in 1300, 348; the difference is largely due to the inclusion in the lists of 1300 of a large number of occupations practiced by one, two, or three persons. The most notable change occurs among the weavers of whom 82 were enumerated in 1292 and 360 in 1300. The increase was greatest in the textile and leather groups, and it is for this reason that there is reason to suppose that there was some actual growth even in so short a period.

The classification of the crafts according to groups and stages of production is perhaps more interesting than statistics of numbers. The elaborate division of labor that existed can be shown in no other way, and the notion of the craftsman as maker of a finished product is so widespread that emphasis upon the disintegration of the process of production is highly desirable. Marx appre-

ciated the importance of this tendency toward a disintegration of the industrial processes into their essential stages, but he does not seem to have realized how early the change took place. One must, of course, recognize that the development of occupational specialization in Paris was greater than in the smaller towns, but when all allowance has been made for the diversities of chronology in different places, it would seem that one were justified in saying that the beginning of the great economic development that was associated with the growth of the towns was most significantly marked by a notable increase in the process of industrial disintegration.

#### OCCUPATIONS AT PARIS IN 1300

##### *Foods, foodstuffs, and by-products:*

###### (a) Raw materials:

Sellers of wheat, measurers of grain, sellers of flour, sellers of oats, of hay, of forage-stuff.

Butchers, skinners, measurers of wine.

###### (b) Intermediate products:

Millers, oven-tenders, tripe-sellers.

###### (c) Finished products:

Bakers (bread), bakers of various kinds of fancy cakes (oublers, fougiers, gastelliers), pudding-makers.

Brewers, cooks, poultry-cooks, fried-food sellers, sauce-makers, candle-makers, soap-makers.

###### (d) Merchandising crafts:

Bakers selling their own product, regraters of bread and other foods, innkeepers (two kinds, ostellers, taverniers), wholesalers of wine.

Sellers of garlic, of salt, of spices, of herbs, of fruit, of mustard, of milk, of cheese, of oil, of fish, of herring.

##### *Leather and articles made of leather:*

###### (a) Raw materials:

Tanners in oil, tanners in bark, tanners of sheepskins, parchment-makers, furriers.

###### (b) Intermediate products:

Leather painters. (See also the lorimers and nail-makers under the metal trades, and the saddle-bow-makers under wood.)

###### (c) Finished products:

Saddlers, harness-makers, two kinds of shoemakers (corduanners — high-grade shoes; savetonniers — cheap shoes), cobblers, glove-makers, belt-makers, purse-makers.

- (d) Merchandising crafts:  
None dealing exclusively in leather goods.

*Metals:*

- (a) Raw materials and heavy work:  
Horse-shoers, blacksmiths, silversmiths, goldsmiths, tin-smiths, coppersmiths, refiners of gold and silver, gold-thread-makers, gold-beaters, workers in hammered copper and tin.
- (b) Intermediate products:  
Makers of plain nails, makers of fancy nails, bolt-makers, button-makers, iron-buckle-makers, brass-buckle-makers, ring-makers, lorimers.
- (c) Finished products:  
Cutlers, makers of knife-handles, shears-makers, ornaments of swords, scabbard-makers, chain-makers, fancy-chain-makers, fish-hook-makers, pin-makers, locksmiths, spur-makers.
- (d) Persons rendering services directly to the consumer:  
Grinders of knives, grinders and mounters of swords.
- (e) Makers of weapons and armor:  
Makers of bows, arrows, and cross-bows, arrow-makers, armorers (both of men and horses), makers of two kinds of cuirass, of chain mail, of metal plates, shield-makers (linen, leather, copper), helmet-makers.

*Textiles:*

- (a) Sellers of raw materials:  
Wool merchants, hemp merchants, flax merchants.
- (b) Preparation of raw materials:  
Wool-combing and spinning (mentioned in two or three places), spinners of silk (two kinds, à grands fuseaux, à petits fuseaux).
- (c) Intermediate products:  
Weavers of woolens, of linen, of canvas, of tapestry (two kinds, tapis sarrasinois, tapis nostrez), weavers of silk ribbons, weavers of silk kerchiefs.
- (d) Finishing processes:  
Dyers, calenderers, fullers, shearmen.
- (e) Merchandising crafts:  
Drapers (sellers of both domestic and imported cloth), sellers of imported canvas, mercers (sellers of silks).

*Clothing and garment-making:*

- (a) Raw materials (other than textiles):  
Sellers of felt, of plumes.
- (b) Intermediate products:  
Sewers (male and female), lace-makers.

## (c) Finished products:

Tailors, breeches-makers, trousers-makers, eleven different kinds of headdress-makers, each a distinct occupation.

## (d) Merchandising crafts:

Friperers (dealers in second-hand clothes), mercers.

*Wood and manufactures of wood:*

## (a) Dealers in unwrought wood:

Sellers of firewood, sellers of charcoal.

## (b) General wood-workers:

Carpenters, turners.

## (c) Makers of specialties:

Coopers (two kinds — of barrels with wooden hoops, of barrels with iron hoops), wagon-makers, wheel- and plough-wrights, makers of writing-tables, trunk-makers, makers of jewel-caskets, makers of croquet-mallets, makers of altars.

## (d) Merchandising crafts:

Sellers of wooden vessels.

*Building trades:*

Markers of stones for cutting, cutters of stone, mortar-men (mortelliers), masons, plasterers, slaters, tilers, tile-makers.

*Ecclesiastical-ornament makers:*

Chasuble makers, sculptors of images, painters of images, bead-makers (several kinds are distinguished).

*Personal service and miscellaneous:*

Barbers, bath-house keepers, launderers (men and women), surgeon doctors (men and women), fencing-masters, money-changers, brokers.

Bushel-basket-makers, basket-makers, ash merchants, straw-sellers, wax-workers, lute-makers, cut-glass workers, glaziers, potters (clay, copper, and tin, each a special group), dice-makers.

Lantern-makers (horn), dealers in horn, comb-makers.

Jewelers, makers of drinking-cup de luxe (usually of agate).

Illuminators of manuscripts, scribes (copyists), book-binders, book-sellers.

The relation of these highly specialized crafts to each other varied in the different occupational groups; in some cases the product really passed through the hands of the **Craftsmen and consumers** whole group of crafts; in some cases the specialization was associated with household work. In the group of

crafts concerned with wheat and wheat products, we find retail wheat-sellers, flour-sellers, millers, oven-tenders, and bakers of various types of things. But the wheat merchant did not sell crude wheat to the millers, nor did the millers sell exclusively to flour merchants; least of all did the bakers buy of wheat merchants or depend upon peddlers and retailers to sell their bread. The bakers of bread bought crude wheat in the neighborhood and had it ground on their account. They baked and sold their own product. The poorest classes were largely dependent upon the bakers for their supply of bread, but only the poorest people bought bread. Those who were better off bought wheat or flour. If wheat were bought they must needs have it ground at their expense; there was more waiting; some considerable stock had to be kept on hand. These different crafts thus dealt with families of various degrees of wealth. The establishments of the nobility and the Church were usually supplied with grain and provisions directly from their estates, without recourse to the markets of Paris or the neighboring towns. Within the households of the magnates, however, the division of labor was quite as elaborate as in the community at large, except for the merchandising functions. The variety of fine pastry-cooks listed reflects the desire of citizens of easy circumstances to have some of the good things enjoyed by the wealthy. The bourgeois who could hardly buy bread without some loss of caste could properly enough buy fruit pasties and fancy cakes. There were thus many degrees of directness of connection between production and consumption. The very poor were served by the relatively indirect processes of food production, the very rich were maintained almost directly by the service of their establishment.

The dependence of the wealthy upon the labor of free artisans is most conspicuous in other occupational groups. In leather, metals, textiles, and clothing much <sup>Luxuries</sup> craft-work was dominated by the desires of the wealthy. Saddles and harness were elaborately tooled and adorned. There were two distinct grades of shoes, and the better grades made from cordovan leather furnished employ-

ment for the larger number of workmen. Gloves, belts, and purses were for the most part articles of luxury. Among the metal-workers, the goldsmiths were one of the most important crafts, and there were several other crafts that specialized in objects of luxury. The most striking single illustration of specialization in the production of luxuries is the presence of eleven different crafts concerned with the making of head-dresses. There were two main groups, hats or caps, and kerchiefs.

Nearly all of the finished leather and textile products passed successively through the stages of production suggested by the occupational divisions. The **Increased specialization** change that took place in these branches of manufacture between the eleventh century and the close of the thirteenth century is notable. In the eleventh century most leather was imported; at the close of the thirteenth century, nearly all kinds were produced locally, though it is hardly to be presumed that the entire demand was supplied by the local production. Saddlers and harness-makers were partially dependent also upon the products of wood- and metal-workers. Saddle-bows were made by a separate craft, and the metal parts of saddles and bridles were made by the wealthy craft of lorimers. Both of these products involved three stages of production, and in the thirteenth century the consumer rarely came in contact with all the craft-workers concerned.

The inferences that can be drawn from materials in the *Book of the Crafts* indicate that leather was purchased **Saddlers and lorimers** right from the tanners and curriers by the crafts engaged in subsequent processes of production, but the saddlers seem to have had saddle-bows made for them by hired craftsmen, and the lorimers frequently employed leather-workers to set their bits and finishings in the harness. The harness-makers objected to this, but it was doubtless a persistent feature of the industry. Thus, in one case the craft concerned with finishing the product undertook supervision of some of the intermediate stages, and in the other, craftsmen concerned with an intermediate product



had the finishing done for them. The lorimers sold some finished products and some intermediate products. The complexities of medieval industrial conditions were due to the variety of ways in which this slight measure of general supervision could be maintained. The degree of disintegration suggested by the specialization of occupations was never an established fact. Some craftsmen hired out to members of other crafts, but without the close and permanent contracts that would create the relations that we associate with the terms "employer" and "employee." It was wage-work, but wage-work for a producer. The distinction may not seem very significant, but it is really of moment in any study of the development of the wage-earning class. At this time there were wage-earners, but no class of wage-earners: none were permanently or exclusively wage-earners; there were alternatives of employment that do not exist when the distinctions between employer and employee are sharply drawn.

One entire occupational group, the oven-tenders, including ninety-four names on the roll of 1292, must have been employed by various kinds of bakers, and though they may have had opportunities to become <sup>Wage-earners</sup> bakers themselves, there is no clear reference that would warrant such an assumption. In the textile trades, the fullers and shearmen were primarily employed by other craftsmen. They were sometimes employed by weavers, sometimes by dyers, conditions in the woolen industry at Paris at this time were highly unstable. Some weavers had acquired considerable means and occupied themselves wholly with the giving-out of work to fullers, shearmen, and dyers. Much dyeing was done on their own premises, too, despite the protests of the dyers, whose only consolation was the concession of exclusive right to dye with woad for the various blues. The drapers, originally cloth merchants, also began to concern themselves with manufacture, giving out work to weavers and others. There was thus some <sup>Capitalists</sup> small degree of integration in this as in other industries. It is an indication that the beginnings of capital-

istic control reach far back into the past, to a period that is not usually thought of as capitalistic in any sense. But if the term is used with minute discrimination, the high degree of disintegration is in itself an indication that the fundamental conditions of capitalistic industry were present. The scale of business enterprise was small, so that the problems of capitalistic control were not conspicuous, perhaps not even recognizable, if one insists upon associating the notion of capital with the scale of production that is dominant to-day. From the standpoint of analysis, however, it is wise to distinguish differences in kind from differences in degree. Capitalistic control had appeared in Paris by the close of the thirteenth century, though to a slight and uncertain extent. The outlines of a putting-out system can be seen in a number of industries, though without the definiteness of subordination of the various crafts that characterizes the putting-out system as it existed at the eve of the Industrial Revolution.

### III

Apart from the casual assistance rendered by wife and daughters, the master craftsman had assistants of two classes; **Journeyman** apprentices, young men or boys learning the **and apprentices** trade; journeymen, young men who had completed their apprenticeship, but for one reason or another had not yet become established masters. These distinctions, based primarily upon the degree of maturity and training of the workman, must be very old; and although these subordinate classes of persons were ultimately affected by the corporate privileges acquired by the master craftsmen, it would be an error to suppose that these lower ranks of workmen were in any sense created by the statutes of the crafts. These subordinate positions in the industrial world were a natural and inevitable outcome of the fundamental conditions of handicraft industry. Work was done almost entirely in the house of the master: shops, such as they were, being hardly more than a room or other portion of the dwelling given over exclusively to craft-work. In the ordinary course of things, craft knowledge was transmitted from father to son, and,

unless some special arrangement were made, craft knowledge could scarcely be secured in any other way. The narrow hereditary succession, however, was not followed very strictly during the middle ages. There was a deal of free choice of occupation, and there are suggestions that somewhat similar conditions prevailed during the classical period among free artisans.

When a boy desired to take up a craft other than that of his father, it could be arranged after the manner of an adoption. In becoming an apprentice the boy ac- Status of the apprentice quired by necessity many of the elements of the status of the man's son: the contract of apprenticeship was in fact an instrument which provided for a qualified adoption — adoption for a period of years. The long periods of apprenticeship and the early age at which boys were apprenticed reflect this aspect of the arrangement. The boy was turned over to the master at twelve years, or the like, and was expected to serve him faithfully for the prescribed interval. The master was under obligation to supply all his wants, and to teach him the craft. It was presumed that the master would get enough work out of the boy to afford him reasonable compensation for his pains, and all too frequently the apprentices were a lucrative source of cheap labor. It is very difficult to determine the actual scale of industrial enterprise during the middle ages, because the apprentice was a notable source of gain, if he was used definitely as a helper instead of being taught the craft. Many masters secured considerable numbers of apprentices and established shops which would perhaps bear comparison with the "factories" of the classical period. The attempts to limit the number of apprentices, that are notable in the gild statutes, were in part due to some desire to protect the apprentice. If there were many, none of them were likely to learn much. The maintenance of a small scale of production was thus at once a measure of protection to the small masters, to the apprentices, and to the standards of workmanship. The master had authority to apply corporal punishment. Many contracts of apprenticeship, also, make special mention of

the master's wife, bringing out the sense in which the apprentice was received into the family.

The position of the journeyman undergoes many changes in the course of gild development. In the early period there was no artificial barrier to prevent the journeyman from becoming a master. His position differed from that of a master primarily in two respects: he had little money and no home. These two qualifications, money and a home, were essential to the position of a master, and of the two the latter was the more important. The master must needs have a wife and a home because both journeymen and apprentices must needs have board and lodging provided. Besides, there must be some place for a shop. The household was the industrial unit, and for that reason, if for no other, the unmarried workman was inevitably obliged to attach himself to some established household until such time as marriage opened the way to having an establishment of his own. In this earlier period the journeyman had every reasonable expectation of becoming a master. The wages he received above his bed and board would usually enable him to marry and set up shop in a couple of years. If he had money and could marry sooner there was nothing to prevent him from becoming a master.

In all these statements it has been assumed that the craft consisted primarily of men. There were several crafts in Paris that were composed almost entirely of women. This was unusual, however, and became even less usual later. When women were admitted to membership in a craft their position differed in no respect from that of the men. Widows frequently carried on their husbands' business, and a small number of women were to be found on the rolls of the crafts at all times. This occasional presence of women does not constitute a special problem.

All the fundamental aspects of craft industry emerged in France before the members of the craft acquired the privileges that made them gilds. The gild was a political and administrative organization of the

craft. The discussion of the origins of the craft guilds is obscured by the ambiguity of the term and the persistent tendency of many writers to minimize the importance of the unorganized groups of craft-workers which were notably developed in the early period in the French towns and remained a significant feature of life in the provinces until a very late period. For a variety of reasons the free craft (*métier libre*) was more significant in France than in Germany or England, and as France was if anything the leading industrial country of the medieval period, it is perhaps justifiable to stress these divergences of national history. The relative importance of free and chartered crafts is obviously of moment in any discussions of origins, and it must be clear that the origin of the chartered craft, or gild, presents a historical problem that differs in many respects from the problems connected with the rise of the free crafts. There can be little serious question of Roman or primitive Teutonic elements in the statutes and charters of the privileged guilds that begin to appear in the twelfth century. The charters or statutes were granted by authorities that had no connections with the remote past, and their purposes were so obviously spontaneous that no distant origins can be significantly called in question. If, on the other hand, attention is concentrated on the craft groups, which certainly persisted throughout the period of the invasions, one must needs hesitate before denying the possible significance of Roman survivals or of Teutonic fraternal organizations.

The free craft was a voluntary association of individual craftsmen, without legal authority of any kind. The hierarchy of masters, journeymen, and apprentices might exist: there might be a considerable body <sup>The free craft</sup> of customs and usages. But the officers of the free craft, if there were any, had no authority to enforce the customs of the craft. Such institutions must needs have been a spontaneous growth. No single, mechanical account of their origin can be adequate, but it is part of the spontaneity of growth that many elements of the past should be incorporated in the new order, though given different meanings in

the new combination. Such organizations doubtless represent the fusion of many elements. One must anticipate likewise many diversities of form and divergent purposes. The early history of craft organization is thus dominated by tendencies toward spontaneous variation rather than by definiteness of form, though the forms which ultimately develop become even excessively rigid and fixed. It is for this reason unsatisfactory to take refuge in the easy solution of perplexities by refusing to consider anything but gild charters and statutes. The purposes that underlie these charters can be understood only in terms of the vague voluntary organization that preceded them.

The history of Paris affords special opportunities for observing the transition from the free craft to the privileged craft with statutes. The *Book of the Crafts*, made at the instance of Etienne Boileau, the Provost of Paris, is not a collection of statutes; it was designed to be no more than a record of customs, though the process of record-making did in most cases give a somewhat different significance to the usages recorded. The preparation of the record is in itself evidence of consciousness of the need of some change. The authority to enforce regulations was vested in the Provost of Paris, an official whose jurisdiction included both civil and criminal offenses. The *Book* was designed to facilitate the regulation of the crafts, and it was to this end that the members of each craft were called to the town hall and required to state the customs of their craft. In the course of proceedings provision was made for the appointment of wardens in a number of crafts in which no wardens had previously existed. Such officers were charged with the enforcement of the rules of the craft, and the emergence of a group of sworn wardens is the most indicative evidence of the transition from the vague organization of the free craft to the more strictly ordered gild or sworn craft (*métier juré*). The wardens were charged with the exercise of a portion of the authority of the Provost; service was an obligation that was in a measure burdensome to the individuals named, but the right to elect

Acquisition of  
privileges

The sworn  
craft

wardens was a privilege that might mean much to a craft, as it practically transferred to the members of the craft as a body the administrative authority of the Provost. Certain monopolistic features were inevitably associated with this autonomy of administration, so that the attempt to use members of the craft as assistants in the administration of craft rules led gradually to the creation of privileged bodies with appreciable grants of administrative power.

The entire process of development is suggested by the diversity of conditions that is recorded in the *Book of the Crafts*. In the case of twenty-five crafts no reference is made to wardens. In some cases <sup>Wardens</sup> reference is made to "prud-hommes" and, as the term is used both in a general sense and in the technical sense of "warden," these references may be to wardens whose appointment or election was so well established by custom that no detailed reference was made. The majority of crafts in this group of twenty-five, however, were very small, according to the numbers given in the tax-roll of 1292. There were eight master wire-drawers enumerated in the tax-roll, divided into two crafts, drawers of iron wire and drawers of brass wire. When called before the Provost to state their customs, the drawers of brass wire petitioned to be exempted from the burden of having wardens. There were few masters and they were all very poor. It was suggested that the Provost have all the masters swear to observe the customs of the craft. In a few cases there were important crafts that had no wardens, but it would seem unwise to draw such cases in question. Our information may be defective, or there may have been some special reason that made it advisable for the Provost to supervise the craft directly.

In most cases the technical character of the regulations made it essential for the Provost to utilize the craft knowledge of the masters. Thus the more considerable crafts all have wardens: in twenty-nine <sup>Choice of</sup> <sup>wardens</sup> crafts, appointed at the pleasure of the Provost; in two or three cases, appointed by the Provost, with the approval of the craft; in seventeen crafts, freely elected by the craft.

There is no evident basis for the discrimination between the crafts. On the whole, the older and more important crafts were allowed to elect their wardens, but there were exceptions. The brewers, the regraters of bread, the dyers, and the sword-grinders were all old crafts of some considerable importance, but they had appointed wardens. Apparently there was not a little caprice manifested in the grants of privilege, as in the enforcement of many general regulations. Keeping the city watch was a general obligation, which craftsmen must needs share with other citizens, but a number of crafts were entirely exempt, and the number of excuses that might be given varied considerably among the crafts. The fiscal obligations of the crafts varied capriciously. The medieval administrator had no conception of uniformity of rule, nor any consciousness that administration of justice without respect of persons was either desirable or attainable. There were few privileges that might not be had for a consideration, and craft privileges were at various periods a lucrative source of revenue to the Government. There is little reason, however, to suppose that there was much downright buying of privileges in Paris at the close of the thirteenth century.

Conditions among the crafts noted above represent the significance of political and administrative factors in the transformation of free crafts into privileged guilds.

**Feudal influences** There is, however, a group of crafts closely associated with the royal household which developed under notably different conditions. Eberstadt, E. Bourgeois, and some other writers have been moved by these and similar circumstances in some other towns to call attention to the importance of the feudal background. Eberstadt, who has become most closely associated with this theory, unfortunately writes with little caution and tends to overstate his case. Bourgeois is more careful, and presents the so-called feudal view of the origin of crafts in its most acceptable form.

The large establishments of the great lords sheltered many craftsmen and became the scene of further specialization of occupations at a fairly early date. The service of the kitchen



was elaborately organized for reasons that are obvious. The establishment required much craft service of smiths, garment-makers, shoemakers, masons, and builders. The crafts which were earliest to emerge, and many that persisted through the period of disorder, found shelter in the households of feudal lords. Both at Paris and at Blois there is clear evidence that the development of a number of crafts was profoundly influenced by the presence of the royal household.

The crafts  
of the feudal  
household

The royal  
household

The situation is no doubt exceptional in some respects, but it is at least indicative of the variety of administrative arrangements that makes it so difficult to generalize about any aspect of medieval law or custom. The former dependence of these crafts upon the royal household survived in two respects; there was an obligation to pay special fees to the King, or to some persons designated by the King, and there was more or less complete subjection to the supervisory authority of some official of the royal household.

The King's marshal had complete jurisdiction over the many iron-working crafts that developed out of the plain forge work; blacksmiths, hook- and hasp-makers, helmet-makers, gimlet-makers, edge-tool-makers, locksmiths and cutlers were all obliged to purchase of the Marshal the right to exercise the craft. After the general admission fee had been paid there was a special fee to be paid for the right to work at home, and another fee for the right to work away from home. The King's Marshal appointed six wardens to enforce the customs of these crafts. Any infringements were punished by fines which were paid to the Marshal. In case of refusal to obey the orders of the Marshal, the offender might be forbidden to exercise his craft, and in case of persistence in disobedience the Marshal might tear down the offender's forge. The cutlers and locksmiths were obliged to pay fees to the Marshal for the right to exercise their craft, but they were under the general authority of the Provost of Paris. The bakers were subject to the authority of the Chief Bread-Maker (Grand Pannétier), though they had the right to elect twelve wardens and seem to have enjoyed some

measure of autonomy. The King's Cook had jurisdiction over the freshwater fishermen. A special group of fishermen, however, were subject to the discretion of one Guerin Dubois, "to whose ancestors Philip the King gave this right." The said Dubois sold the right to fish in the waters described for such prices as he chose. The old-clothes merchants were subject to the discretion of the Maître Chambrier, who seems to have been Chief Groom of the Bedchamber. Leatherworkers, both shoemakers and saddlers, were under the authority of the King's Chamberlain, though the proceeds collected from the sale of permits to exercise the craft were divided between the Chamberlain and the Count of Eu. The revenue from a group of five other leather-working crafts went to a private individual "who had been given the crafts" by the King. Masons and plasterers were supervised by the Master Mason who was appointed by the King to hold office during pleasure. The masons were not obliged to pay any fees, but they enjoyed no autonomy.

The wood-working crafts, at the time of Etienne Boileau, were under the authority of the King's Master Carpenter.

**The carpenters** In 1313 general complaints prepared by the craftsmen against the Master Carpenter resulted in a hearing at the Parlement (court of administrative and civil law) and in the suppression of the office. The authority over the crafts passed naturally to the Provost of Paris and in the course of the century several of the wood-working crafts received statutes. The general craft of carpentry, confined at last to a much-narrowed scope of work by the process of subdivision, finally received statutes toward the close of the fifteenth century. The incident is significant because it illustrates all stages of the process of transition from a craft sheltered and dominated by the royal household to a craft with privileges which made it largely autonomous.

Although the craft guilds of the later middle ages came to have a fairly definite form, it would be a mistake to suppose that this was in any respect an indication or an outcome of a common origin. The guild privileges developed in many

ways. Such generality of form as came to exist was primarily due to the pressure of the economic needs of an industrial and commercial life that presented many fundamental elements of similarity despite the diversities of political forms in national and municipal life. There was a tendency to make similar regulations, and the attainment of common ends led to the creation of devices which were similar in general outline. The technical processes were largely similar, the conditions of merchandising were substantially the same in all countries. The larger outlines of craft life were thus common to the crafts of all the larger European cities, and, as our knowledge is frequently incomplete, we tend to see only these general features. Close contact with the problems of medieval industry will usually force upon one's attention the persistent variety of medieval arrangements; much of this diversity is no doubt mere difference in detail, but there is sufficient variation to make one cautious of generalization.

Diversities  
of gild  
development

The character of craft life is depicted with some clearness of outline in the statutes and customs of the crafts, though the picture is in many respects more nearly akin to a photographic negative than to the finished print. Many aspirations are expressed in these documents which show by sheer dint of repetition that the intention was not wholly realized. Masters kept more apprentices than they should. Shoddy and fraudulent work were common at all times and in all towns. It was difficult to confine the various crafts to the tasks and work which properly speaking belonged to them. One is inclined to believe that the idyllic pictures of medieval industrial life are based on reading craft statutes and customs as literal records of what was done. It is necessary to remember that we are dealing with a period whose profession of faith was eloquent, though its practice of virtue was qualified by all too human weakness.

Ideal and  
actual craft life

Craft statutes are concerned with three kinds of matters: definitions of the civil obligations of the members, definitions of the status of the different classes of workers, and regulations of a technical industrial

Content of  
craft statutes

character. The civil obligations of members of a craft involved various matters of fees: fees due the King or municipality with reference to the exercise of the craft; fees connected with the sale of the manufactured wares or the purchase of raw materials. The keeping of the city watch was likewise the subject of many clauses, especially the matter of excuses. Some crafts were entirely exempted, but in all cases certain excuses were a valid means of escape from duty on any particular night. The old-clothes merchants recited a long list of proper excuses, when they came before Boileau: age, the condition of the wife, their annual bleeding, or absence from the city of which notice had been given. They went on to say that the wardens ought to accept excuses when sent in by a neighbor or journeyman, but they required all excuses to be delivered by the wife in person "whether beautiful or homely, young or old, strong or weak. And it is wholly shameful and improper for a woman to come and wait around at the Châtelet until the hour of guard mount, requiring her return home through the streets of a city like Paris, with her son or daughter, or perhaps with no escort at all."

The definition of the status of the different members of the craft included, in general, statement of the conditions of apprenticeship, the mutual obligations of apprentices and master, the rights and duties of journeymen, and the qualifications required of masters. Regulations of this class became very detailed in the late period in all countries. In early statutes or customs there are few regulations. The general tenor of the regulations of apprenticeship in the *Book of the Crafts* seems to favor the apprentice. The restrictions seem designed to insure honest instruction in the craft. To this end it is provided that no new master shall take an apprentice during the first year; that the widow of a deceased master shall take no apprentice, though she may continue to exercise the craft. The restrictions on numbers are expressly declared to be designed to insure good teaching, as a master could not give any significant attention to many apprentices. The weavers required that proposals for apprenticeship be submitted to the

Development  
of regulations  
of status:  
apprentices

wardens, who might refuse to allow the contract to be concluded, if in their judgment the master was not capable of discharging all his obligations. The minimum duration of apprenticeship was usually fixed at six years, though as many as eleven years were required in some crafts. In a few crafts only three years were required. The statutes of the goldsmiths provided that apprenticeship should end when the individual was capable of earning one hundred sous per year in excess of his board, but this is an isolated case. Fagniez says that, to his knowledge, it is the only case in which the length of the period of apprenticeship was dependent upon the proficiency of the apprentice. One must remember that, for the most part, sons of masters were not required to comply with the provisions of apprenticeship. The regulations applied in their rigor only to persons not born to the craft.

The status of the journeyman at the close of the thirteenth century was not rigidly defined. The constant references in the *Book of the Crafts* to the direct promotion of apprentices to the grade of master show that <sup>Journeyman</sup> the transitory status of journeyman was not universally observed. Even in the later period, sons of masters could dispense with the term of service as journeymen, and, at this time, the practice seems to have been general. Lack of funds must have been the chief factor in forcing workmen to serve a term as journeymen. The journeyman was not supposed to hire himself out to any but masters of the craft, and it was irregular for him to work on his own account. When he lived with the master it would be obviously difficult for him to work outside the shop without detection, but when he found his own lodgings many opportunities for independent work presented themselves, especially when there was much wage-work in the craft that could be done on the premises of the customer. The obligation to work for a master thus constituted the most distinctive feature of the status of the journeyman. Frequently, the journeyman was not supposed to participate in any way in the sale of wares at the weekly market, but that restriction was not universal.

The conditions of becoming a master at the time of Étienne Boileau were hedged about with few formalities. Most of the customs say that any one may become a master "who knows the craft and has the where-withal." The requirement of adequate means to support the obligations of the master was perhaps more rigidly enforced than at a later date. The hose-makers reported that thirty-five of their number had fallen into poverty and become journeymen. It may be that the statement merely means that they had been obliged to hire themselves out to other masters of the craft, and so were working as if they were journeymen. One must needs assume that they went into the shops of other masters, not even having the means to do work at their own homes. Later, the terms "master" and "journeyman" implied a definite status. The master could not cease to be a master, even if he became poor. Doubtless, at this early period the terms were hardly more than descriptive phrases. There is no evidence of any formal ceremony of admission to the grade of master. The special test of craft skill, the masterpiece, is mentioned only once in the *Book of the Crafts*, and in that single case in no technical connection. Apparently the masters were examined or made to swear that they knew the craft, and of the two modes of inquiry the latter seems to have been the more common. This would not have led to the admission of unskilled workers. The elaboration of the later requirements for the mastership was not necessary from the point of view of testing craft skill. The attempt to limit the number of craft-workers by complicated conditions of admission to mastership was one of the most arbitrary of the various monopolistic practices of which the privileged crafts were guilty. In the crafts that still remained subject to direct royal authority, certain fees had to be paid, and all masters were frequently required to swear that they would observe the statutes of the craft.

The oldest portion of the customs of the crafts is that concerned with the regulations of the technical processes of the craft and its relation to other crafts. The first objects of these regulations were to prevent care-

Masters

Unfair  
competition

less workmanship and unfair competition. In the crafts whose market was purely local bad workmanship injured the consumer, and at times injured the honest workmen by enabling their unscrupulous neighbor to undersell them with inferior goods. Frauds in manufacture were more serious in the crafts which were devoted to the export trade, because all the goods were marked with the name of the town and sold as such. The goods of individual masters were only incompletely distinguished at best. A number of dishonest masters could thus injure the trade of the town as a whole, and there was a disheartening amount of dishonesty. The inspection of goods with which the wardens were charged was therefore a matter of great importance. The craft statutes endeavored to create standards of manufacture. The raw materials that should be used were definitely stated. The use of inferior materials was prohibited. In crafts which required close attention to the work, night work was forbidden.

With the increase of occupational specialization the delimitation of the activities proper to each craft became important. The cobblers were thus prohibited from making new shoes. Dyers were not allowed to do any fulling, and it was only as a concession that the woolen weavers were allowed to dye in other colors than blue. The old-clothes dealers were allowed to mend old garments, but were not supposed to compete with the tailors in the making of new garments. Specialization had been carried far enough by the close of the thirteenth century to require some of these niceties in the delimitation of spheres of activity, but this type of difficulty became much more pronounced later.

There are some traces of an element of communism. Masters were at times required to share advantageous purchases with each other. Such regulations, however, were rare.

In the records of the customs of particular crafts there is much caprice. The early records are particularly erratic and incomplete. Much of this lack of system in the writing-down of customs was due no doubt to the casual manner in which most of these records were made. Usually some spe-

cific occasion required the making of the record, and, as is natural, the matters of moment with reference to the current events exercised an undue influence on the character of the record. The caprice of external events, too, exerted a great influence upon the date at which privileges were granted to crafts. Many aspects of craft life and craft development, therefore, admit of no satisfactory explanation. Forms of organization were seldom rigidly defined, and the growth is systematic only in a very general sense.



CHAPTER IV  
THE POPULATION OF ENGLAND: 1086-1700

I

OUR knowledge of population during the middle ages is incomplete and unsatisfactory. There were no comprehensive enumerations of population for any entire country until the beginnings of census work toward the close of the eighteenth century. In particular towns and in some provinces enumerations were made at various times, and in France a comprehensive enumeration was attempted toward the close of the seventeenth century, but these enterprises were not carried out with much statistical precision, so that the results are hardly superior to the estimates obtained by other means. Estimates of population are based on two types of material: enumerations of families, property-holders, or adults for purposes of taxation; and the registers of births, marriages, and deaths. Both of these sources are subject to errors of omission and to errors in estimating the proportion of the enumerated population to the total number of persons. The proportions of families, adults over fourteen, marriages, births, and deaths to the total population are all constants within a small margin of uncertainty, but the range of possible variation is sufficient to exert a significant influence upon results. If the families in a rural community are comprehensively enumerated, the population could nowadays be estimated at about four and one half times the number of families, but it is not entirely safe to assume that this proportion would be true of a medieval population. The ecclesiastics were then more numerous and would not be represented in the count of families. It is also more than possible that more servants were kept than at the present time. The most serious element of difficulty, however, is the likelihood of omissions. The lists available for the earlier medieval period are tax-lists, so that there would be

motives enough for omissions of many kinds. The very poor were frequently omitted entirely because the tax would not fall upon them directly. Some of the well-to-do were frequently able to keep their names off the rolls, or were for some reason exempt. It is not possible to secure<sup>1</sup> any accurate knowledge of the absolute numbers of the population.

For the more general purposes of the economist it is sufficient to secure some conception of the relative changes in the mass and density of population. It is important to know whether there was a steady growth throughout the period or mere fluctuations attributable to the vicissitudes of war and disease. Our experience of the growth of population during the nineteenth century has made us prone to assume that a progressive increase of population is the normal condition of a European country, but it is not at all clear that Europe has differed as widely from Eastern countries as is frequently supposed, and there seems reason to believe that the movement of population in England presents a marked contrast to the general changes of population on the continent of Europe during the period. In England there seems to have been more of a steady growth of population; in France, population has fluctuated, tending to approximate what we may call the normal density for the country, though frequently below that figure because of various calamities. These at least are the conclusions that may be drawn from the figures presented in Tables I and II, and there is no ground for supposing that there is sufficient error in the figures to impair the validity of the general conclusion.

It will be observed that the population of France reached a mean density of about one hundred persons to the square mile early in the fourteenth century. Pestilence and wars reduced the population, but it tended to recover. The figures for 1581 are not very satisfactory, but those for 1700 and 1715 suggest pretty clearly that such decrease of population as occurred during the period following 1328 can legitimately be ascribed to calamities. The decrease between 1700 and 1715 is known to be due to the dearth of 1709-10 and the

THE POPULATION OF ENGLAND: 1086-1700 89

TABLE I  
THE POPULATION OF ENGLAND: 1086-1801

*Total number of persons and mean density per square mile*

<i>Date</i>	<i>Total persons</i>	<i>Mean density</i>
1086.....	1,800,000	35.38
1327.....	2,225,000	43.73
1377.....	2,500,000	49.14
1570.....	3,882,000	76.31
1600.....	4,460,000	87.67
1630.....	5,225,000	102.70
1670.....	5,395,000	106.00
1700.....	5,653,000	111.10
1750.....	6,066,000	119.20
1801.....	8,331,000	163.70

TABLE II  
THE POPULATION OF FRANCE TO 1789

*Total number of persons and mean density per square mile (the boundaries of 1871-1914 are assumed)*

<i>Date</i>	<i>Total Persons</i>	<i>Mean density</i>
Prior to Roman conquest.....	6,700,000	32.35
Ninth century.....	5,500,000	26.55
1328.....	22,000,000	106.20
1581.....	20,000,000	96.60
1700.....	21,136,000	102.00
1715.....	18,000,000	86.90
1770.....	24,500,000	116.00
1789.....	26,000,000	125.00

losses in the military campaigns of the period. A population of about one hundred persons to the square mile would represent the normal possibilities of adequate maintenance in view of the agricultural technique of the period. Assuming the crops and methods of culture characteristic of the middle ages, a population of that degree of density could provide for its essential needs without relying upon any systematic importation of grain or other foods. Knowing as we do that few regions of Europe were regularly importing food, this assumption is wholly in accord with medieval conditions. Industrial development was primarily dependent upon agricultural resources. Industry flourished upon the basis afforded by a local agricultural surplus,

and was thus definitely subordinate in importance to agriculture. When the Industrial Revolution introduced changes in technique which made it possible to develop great concentration of population in the proximity of mineral deposits, densities of population greater than one hundred per square mile began to appear in notable sections of England and Europe. Until the Industrial Revolution this figure of one hundred persons to the square mile represents about the normal density for Europe. The Low Countries were perhaps an exception to this statement, as they received appreciable quantities of grain from the Baltic countries.

The figures for the mean density of population in England show that the agricultural resources of England were not fully utilized until the seventeenth century, and that England was relatively under-populated until the eve of the Industrial Revolution. The continuity of growth of population in England is thus due to this emergence of significantly new factors in economic development when the limits possible under the old technique had been reached. The beginning of dependence upon the importation of grain shortly after 1750 affords striking confirmation of the substantial accuracy of the estimates of normal density. Some improvement was taking place in agricultural technique, but even such added possibilities did not make it possible to maintain a population of much more than one hundred to the square mile. France remained substantially self-sufficing in the production of food, and the mean density of population shows no increase such as took place in England. The increase of population in France could be explained by the remarkable improvements in the technique of agriculture.

It must be remembered that this conception of normal density is purely relative; a fact emphatically suggested by comparison between Europe and the Orient, especially rice-producing countries. Statistics are available for British India, and, though there are many elements of uncertainty, it is fairly clear that the great density of population in the most fertile provinces, six

Medieval  
England under-  
populated

Normal  
densities in  
the Orient

hundred to the square mile, is not to be attributed solely or even primarily to a low standard of living. Good arable land constitutes a somewhat larger proportion of the total area than is usual in Europe, and this is of course of importance. The great factor in the high density of population, however, is the dependence upon rice. Rice responds more significantly than wheat to intensive culture. Wheat yields between 530 and 1800 pounds per acre, according to the cultural system: rice yields between 820 and 4500 pounds per acre. The food value of rice is perhaps slightly lower than that of wheat, but a rice-growing region can nevertheless maintain a greater density of population than a wheat-growing region. The proportion is indicated roughly by the quantity of land that can be effectively cultivated by one man and his <sup>Peasant</sup> team. In medieval Europe it was assumed that <sup>holdings</sup> a peasant cultivator needed about thirty acres for independent maintenance of himself and his family. In British India, in the province of Bengal, between five and ten acres are sufficient to occupy the peasant and his family, not in market-gardening, but in staple agriculture. The specialized agriculture now practiced in Europe makes it difficult to institute comparisons with modern conditions, but Europe has become so dependent upon the importation of food that her own agricultural resources are no longer a measure of the density of her population. Under the influence of the Industrial Revolution the factors determining the growth of population have become so complex that it is scarcely possible to assign any precise limits to the density of population that may be achieved even in large areas.

The figures upon which the estimates of population are based are rather more satisfactory for England than for France. The English figures are in each case based upon some approximately comprehensive enumeration. The figures for France are based on enumerations, but <sup>Deficiencies</sup> none of them are as comprehensive as those <sup>of the French</sup> available for England. The estimates for 1328 in <sup>figures</sup> France are probably the most reliable figures we have for that country until the enumerations of the "Intendants" in 1700.

This is particularly fortunate, as it is rather more important to know the population at periods of greatest prosperity than in periods of distress. An enumeration of hearths was made in 1328 with reference to the levy of an armed force; the figures are comprehensive for the royal domains and thus include a large portion of the kingdom, but the population of the estates of the nobility must be assumed to have been proportionate. As the lands of the royal domain were fairly well scattered throughout the kingdom there can be little objection to projecting these figures into the non-enumerated portions of France. The chief difficulty is to determine the probable proportion between hearths and the total population; the very conservative writers multiply by four, others by four and one half or five, according to their temper. French material is so largely based on the number of hearths or families that we have no definite means of testing probable proportions by different types of enumeration, as is possible in England. The figures for France prior to 1328 are highly speculative, and the estimate for 1581 is an expression of opinion rather than a statistical result, but the general course of development does not seem to be open to much doubt. We cannot be certain of the precise figures, but we can feel confident that France was about as densely populated in the early fourteenth century as she was at any time prior to the late eighteenth century. The land of France was fully settled and utilized when the medieval civilization was at its height.

## II

The movement of population in England has been obscured by the relative uncertainty that has existed with reference to the population prior to the Black Death. In *Domesday Book* and in the roll of the poll-tax of 1377 we have for those dates much more accurate data than exist for France, but there were no collected data for the years immediately preceding the Black Death. Some writers, notably Seebohm and Gasquet, declared that England had enjoyed great prosperity prior to the great pes-

tilence. The later visitations were sufficient in their minds to prevent any considerable increase of population between 1349 and 1377, so they were disposed to regard the figures for 1377 as indicative of the population immediately after the Black Death. It has generally been assumed that the population was decreased by one half or one third during the course of the pestilence, so that this would indicate a population of four or five millions in the years immediately preceding the pestilence. If this were true the general course of the growth of population in England would have been roughly comparable with the movement of population in France. A population of five millions in England would indicate a mean density of about one hundred to the square mile, and under such conditions it would be necessary to suppose that England was a maturely settled country.

The figure for 1327 given in the table above is based upon inferences drawn from the subsidy rolls of that year; or in the case of one county the year 1332. A sub- Subsidy rolls, 1327sidy was levied in 1327 in all or nearly all the counties, and many of the rolls for the counties are extant. These materials have attracted little attention from students of population, partly because there are no summarized results and partly because the lists are lists of property-holders rather than householders. It must be confessed that the basis is not as satisfactory as might be desired, but upon careful examination it would seem that there are no more omissions from these lists than from the other lists that are the basis of estimates of population. Furthermore, careful studies by Powell of the subsidies levied in Suffolk in 1283 afford some definite indication of the proportion between the total population and the number of persons enumerated in the subsidy rolls. The multiple six, used in the tables, is derived from this source.

The poll-tax lists which are available for 1377 and for portions of England in 1381 are subject to many omissions. They purport to enumerate the entire adult Defects of the Poll-tax lists population over fourteen years of age, but it is still necessary to compute the probable number of children

and some allowance must be made for adults not enumerated. Large numbers escaped enumeration in 1381; "escaped" is the appropriate term, as it is presumed that they took to the woods during the enumeration. As much as one fifth is added by some writers in computing from the lists of 1377 merely on account of omissions. It would seem defensible, therefore, to use the subsidy rolls of the early fourteenth century despite the fact that they do not purport to be absolutely comprehensive enumerations of adults or householders. The subsidy was a tax on property from which only the very poor were exempt; the returns are thus comparable to the returns of the Domesday Survey. Figures from five counties, enumerated in Table III, indicate a population that constituted only seventy per cent of the population of the same counties in 1377. These counties are reasonably representative, as they are well scattered and present many diversities of condition. They contained about one tenth of the population of England in 1377. Comparison with the figures from *Domesday Book* and from some other subsidy rolls shows that the population was not growing consistently. The changes in Worcestershire are especially notable. There were 50,000 persons in the county in 1280, as compared with 27,000 in 1086 and 28,000 in 1327. The estimate for 1327. These figures would not support the contention that the population of England was at its maximum just prior to the Black Death, and it is very difficult to find any grounds for assuming a population of four or five millions.

TABLE III  
CHANGES IN POPULATION: 1086, 1280, 1327, 1377

County	1086	1280-1296	1301	1327	1377
Leicester.....	40,632			26,826	50,760
Staffords.....	19,068		(1332)	21,712	35,982
Somerset.....	82,584			62,814	87,072
Sussex.....	62,460	41,244		43,278	58,310
Worcester.....	27,750	50,898		28,098	25,758
York, North Riding.....			55,332	182,728	257,882 53,097



THE POPULATION OF ENGLAND: 1086-1700 95

If the figures are interpreted without prejudice, they would indicate that the population in 1327 was somewhat less considerable than in 1377, probably not as much as thirty per cent short, but definitely less than two and one half millions. The figure 2,225,000 is designed to present this opinion in round numbers, and, though it is hypothetical, it is not much more of a guess than any of the other figures.



These considerations would perhaps require some modification of the views currently expressed about the mortality from the Black Death. The epidemic may perhaps have been somewhat less general or the mortality somewhat less great. At all events, the recuperation from the ravages of the disease must have been much more rapid than has been assumed by Cunningham, Seeböhm, and Gasquet. The suggestions

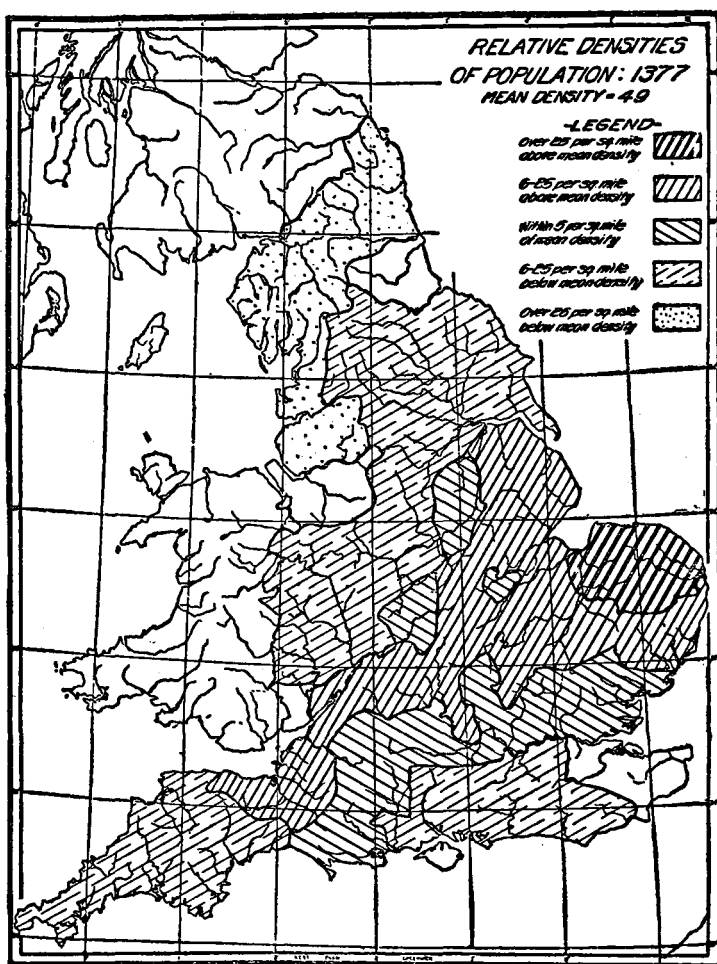

THE POPULATION OF ENGLAND: 1086-1700 97

of the material in the subsidy rolls lead to about the same conclusions as those reached by Thorold Rogers from calculations based upon the food-supply. It would seem, therefore, that we have grounds for saying that the movement of population in England was distinctively different from the movement of population in France.

The study of relative changes of population in the various



Importance of county density maps

counties is fully as significant as the study of totals for England as a whole. In some respects there is less likelihood of distortion of results by reason of general statistical errors, for we have no grounds for supposing that errors were localized by counties. Furthermore, a considerable margin is afforded by the mode of presentation that must be adopted in studying density fig-



THE POPULATION OF ENGLAND: 1086-1700 99

ures by counties. In some cases small differences might throw a particular county into a higher class or lower class. The figures for York in 1086 are low because of the devastation of the county shortly before the survey. Durham is set down for what would seem to be a very excessive figure in 1570. With these exceptions there is no ground for assuming that the figures for any particular county are seriously defective.



The maps showing the relative density of population have been shaded to represent the relation of the density in particular counties to the mean density of population in England as a whole. It is thus possible to compare the conditions at the various dates. Changes in relative density can be studied apart from the general growth of population. Counties whose population was not more than five persons per square mile above or below the mean density for all England constitute the basic group, representing approximately the mean density. As this group of counties is to serve primarily as a basis the range of variation has been made small. Deviation from this mean density is indicated in four groups: more than twenty-five persons per square mile above the mean; between six and twenty-five persons more than the mean density; between six and twenty-five persons per square mile less than the mean density; and more than twenty-five persons less than the mean density. The total range of variation thus indicated is on the whole greater than would be found in a maturely settled country prior to the Industrial Revolution.

The maps reveal a fairly definite movement of population westward and northward. At the time of the Domesday Survey, the population was most dense in the eastern counties. There was a great belt of midland counties in which the density exceeded the mean density for England, and on the frontiers of Scotland and Wales very low densities. Some of the border counties were not enumerated at all, but allowance has been made for their population in calculating the mean density. The relative concentration in the eastern counties gradually disappears; population does not decline absolutely, but the growth in those counties is not as rapid. By 1600 the population had become fairly well distributed throughout England. In no county was there a population that exceeded the mean density by more than twenty-five persons to the square mile; the counties showing such excess over the mean density in 1570 had passed the mark by very small margins, and there is considerable reason to doubt the figure for Durham in 1570. The

map for 1600 thus indicates the close of the first phase of the development of settlement in England; there was <sup>Equalizing</sup> a mean density of 87 persons to the square mile <sup>tendencies</sup> and population was rather evenly diffused. In the seventeenth century the beginnings of the modern massing of the population are evident. The metropolitan area of London began to show up conspicuously, and Worcestershire marks the beginnings of the manufacturing districts of the west. Lancashire shows a high density, but not as much above the mean for all England as in 1600. The map for this period is probably typical for a maturely settled country prior to the Industrial Revolution. There is a clear distinction between counties whose interests were purely agricultural, and the counties combining agriculture with manufactures. Norfolk, Gloucestershire, Wilts, and Devon were the principal textile counties. Worcestershire combined textiles and metals. The textile industries of Suffolk, Essex, and Kent had declined and they had become more largely agricultural counties.

The changes that are suggested by these maps can hardly be explained except in terms of the migration and differential growth that would naturally be seen in the <sup>Meaning of</sup> transition from a sparsely settled frontier to a <sup>the maps</sup> maturely settled country in which the relative density of settlement is closely adapted to the agricultural and industrial advantages of the various portions of the total area. The massing of population in 1086 represented a preliminary stage in settlement in which the coasts were more densely settled because of their proximity to the influences of the Continent. Immigration from the Continent affected these counties more than the midlands and new industrial processes thus established themselves in these counties earlier than elsewhere. The map of 1086 can thus be explained by the history of settlement. The map of 1700, on the other hand, represents the relative advantages of the different sections of England. The study of the density of population by counties tends to confirm the conclusions suggested by the study of total population and mean density. We may reasonably con-

ceive England to have been sparsely populated in the middle ages, much less densely populated than the Low Countries and France. England, to use Mackinder's apt phrase, was a frontier province of Europe.

England was acted upon by a diversity of European influences, and for this reason the history of England must be studied with a European background. Many English institutions were imported from the Continent. In economic concerns England was likewise a passive subject. Her industrial and commercial life in this early period was dominated by Continental influences. The woolen industry developed under the stimulus of the French and Flemish technique. New methods and products were in no case introduced by the English industries of this period. The progress of manufacture thus follows the advance in Europe after an interval that is at times considerable. Not until 1700 was the general position of English industries wholly comparable as regards technique with the similar industries on the Continent.

The Industrial Revolution thus brought about a great change in the relative positions of England and the Continental countries. England ceased to be a mere frontier province and became the leading exponent of Western civilization, both in the initiation of new technique and in the dissemination of European influences in the Orient and in the New World.

### III

The period prior to the Industrial Revolution also presents a marked contrast with modern conditions with respect to the relative proportions of urban to rural population. In the early period towns were small and in general the population was widely scattered in villages and hamlets. Dispersion was characteristic of this period, just as concentration is characteristic of the modern period. There is thus a difference in the relation of the population to the soil as well as some difference in the actual mass of the population. Although the population of France in



the nineteenth century was not very much greater than in the early fourteenth century, the aspect of the countryside was different. A different form of social organization had grown up which emphasized the town, and especially the great metropolis, at the expense of the small rural communes. We are so familiar with the more elaborately organized massing of the population that we are slow to realize how large a population can be maintained when widely dispersed. This is a feature of medieval life that is particularly difficult for us to reconstruct imaginatively.

There is sufficient evidence in the Domesday Survey to enable us to form fairly definite impressions of the size of settlements, but the statistics have not as yet been tabulated for any considerable number of counties. Professor Vinogradoff has worked over the surveys of Derbyshire and Essex, which are fairly typical counties. Derbyshire <sup>Two counties</sup> showed a density that was only slightly under <sup>in 1086</sup> the mean density for England, while Essex was one of the most densely populated counties. The counties also represent somewhat different types of settlement in other respects.

The two counties [says Vinogradoff] may be taken as interesting examples of the repartition of population in the midlands and in the southern counties. At the same time the Danish element is strongly represented in Derbyshire without being predominant there, while Essex, though substantially akin to Hertfordshire and Sussex, yet has many features in common with the East Anglian settlement, and especially Suffolk, from which it is divided by the slight demarcation line of the Stour. In regard to the soil and contour of the country, the two shires in question present marked contrast; hills and dales are characteristic of Derbyshire, plains and marshes of Essex.

Turning to the northern county, we naturally find a population more scattered, and concentrated as a rule into smaller groups. It is true that in some cases a rural organization described under one name in *Domesday* may in truth have consisted of several members only loosely connected with each other. But although this element of uncertainty cannot be eliminated, it is not unreasonable to assume that the single place name points to a nucleated settlement of some sort, as the record is careful to notice over and over again the subdivision of rural units. . . .

The best way seems to be to group the settlements according to the number of villein and soc-man households assigned to them. The villeins and soc-men were the principal classes of rural tenantry, and held among them the regular shares of the field holdings, while bordarii and cotters came in as small tenants of a few acres or of cottages; and had better be left aside in a review of the main features of the village settlements.<sup>1</sup>

The number of households of villeins and soc-men would represent roughly one sixth of the total population. Vinogradoff suggests grouping settlements of 2 to 5 households (under thirty persons), 6 to 11 households (36 to 66 persons), and over 12 households (over 72 persons). These groupings may seem to emphasize unduly the very small settlements, but there were so few that were larger that separate classification would scarcely be necessary. In Derbyshire there were only 6 or 7 villages of 30 or more households, so that the classification as a large village of any settlement having more than 12 households is definitely justifiable. In Essex, there were 19 villages with 40 or more households: one village had 143 households, the other 18 ranged in size between 40 and 80, few of them having more than 60 households. The proportions of the total population living within these various types of settlement were as follows:

	<i>Derby</i>	<i>Essex</i>
	<i>per cent</i>	<i>per cent</i>
Hamlets, 2-5 households.....	9	9.4
Small villages, 6-11 households.....	35	16.9
Large villages, over 12 households.....	57	73.1
	91	99.0

The portion of the population of Derby that was not classified cannot be assumed to be distributed in larger units; the impossibility of making the classification complete is due merely to the difficulty of placing the unclassified entries within the designated groups. "Boroughs" are omitted, but, as will be seen later, the Domesday borough was not distinguishable from the villages in respect to size. With rare exceptions there was no urban population: no groupings

<sup>1</sup> Vinogradoff, P., *English Society in the Eleventh Century*, 269.

of population sufficiently large or dependent upon commerce and industry as distinct from agriculture to admit of separate classification. The population was exclusively rural.

The subsidy rolls of the early fourteenth century afford further evidence of the relation of population to the soil. The classifications must be changed slightly, if the division into groups is to bear any relation to the relative numbers of villages of the various sizes. The <sup>Villages in 1327</sup> somewhat larger figures, however, cannot be assumed to indicate that the settlements were as large as indicated. In the tax-rolls we seem to be dealing with areas rather than with final units of settlement, and at times two or three villages are explicitly grouped. Casual phrases, too, suggest that various scattered farms were included in the enumeration under the caption of a neighboring village. We may be sure that the settlements were not larger. But even when all these allowances have been made, it seems clear that there were more large villages, villages of two or three hundred inhabitants, than at the time of the Domesday Survey. At this period the boroughs were becoming distinct types of settlement, but were not significantly larger than some of the villages. In the County of Somerset 17 places were described as boroughs, ranging in size from 11 households to 63 households. Only 3 boroughs had more than <sup>Boroughs</sup> 60 households. There were 13 villages with more than 60 households, 1 having 176 and another 103 households. In Staffordshire, there were 3 boroughs, having 55, 56, and 57 households respectively: there were no villages in the county of more than 47 households, and only 3 having more than 40. In Sussex and Worcestershire, there were villages that were as large or larger than boroughs, though in Worcestershire the City of Worcester was the largest place in the county. In 1280, at a period of great prosperity, it had a population of about 1800 persons, though no village had more than 1500 persons. The poll-tax returns for 1377 afford the first comprehensive indications of the emergence of towns that are distinctive units of settlement. The list of towns,

however, shows pretty clearly that the urban movement was just beginning.

POPULATION OF THE TOWNS LISTED ON THE ROLL OF THE POLL TAX OF 1377

(One third of the enumerated population is added to represent children, and one fifth of that total is added to cover possible omissions.)

London.....	37,302	Kingston-on-Hull.....	2,491
York.....	11,597	Ipswich.....	2,410
Bristol.....	10,152	Northampton.....	2,362
Plymouth.....	7,738	Nottingham.....	2,313
Coventry.....	7,706	Winchester.....	2,304
Norwich.....	6,322	Stamford.....	1,948
Lincoln.....	5,458	Newark.....	1,884
Salisbury.....	5,161	Ludlow.....	1,874
Lynn.....	5,002	Wells.....	1,874
Colchester.....	4,728	Southampton.....	1,843
Beverley.....	4,260	Derby.....	1,672
Newcastle.....	4,234	Lichfield.....	1,538
Canterbury.....	4,128	Chichester.....	1,389
Bury St. Edmunds.....	3,907	Boston.....	1,302
Oxford.....	3,770	Carlisle.....	1,084
Gloucester.....	3,582	Rochester.....	912
Leicester.....	3,361	Bath.....	912
Shrewsbury.....	3,331	Dartmouth.....	808
Yarmouth.....	3,105		
Hereford.....	3,044	9 towns over.....	5,000
Ely.....	2,857	11 towns.....	3,000-4,999
Cambridge.....	2,857	19 towns.....	1,000-2,999
Exeter.....	2,496	3 towns under.....	1,000
Worcester.....	2,491		

The predominantly rural character of fourteenth-century England is suggested by the following tables:

TABLE IV  
NUMBER OF SETTLEMENTS: 1327 AND 1332

County	Under 20 names	20-39 names	40-59 names	Over 60 names	Boroughs
Leicester.....	279	43	1	..	1
Staffords.....	218	46	3	..	3
Somerset.....	402	138	20	13	17
Sussex.....	179	117	21	8	6
Worcester.....	110	58	23	6	5
					<i>Manors</i>
York, North Riding, 1301.....	349	102	13	7	109

THE POPULATION OF ENGLAND: 1086-1700 107

TABLE V  
PROPORTIONS OF THE TOTAL POPULATION INHABITING EACH OF THE  
VARIOUS GROUPS OF SETTLEMENTS: 1327, 1332, AND 1301

County	Per cent in villages of				Per cent	
	Under 20 names	20-39 names	40-59 names	Over 60 names	In boroughs	Not specified
Leicester . . . .	66.98	21.74	0.92	..	10.36	..
Staffords . . . .	62.88	29.15	3.24	..	4.37	..
Somerset . . . .	39.64	35.08	9.23	9.93	4.91	1.21
Sussex . . . . .	32.31	42.85	13.13	8.69	3.02	..
Worcester . . . .	26.14	32.58	23.81	10.04	7.43	..
York, North Riding, 1301	43.29	28.31	6.89	4.22		17.29

If we assume that the total population is about six times the number of names on these subsidy rolls, it will be seen that the bulk of the population lived in villages of less than 300 inhabitants, and in some counties two thirds of the population lived in villages of less than 120 inhabitants. It is unfortunate that there has not been more study of the sources of information available to us. The statistics are not minutely accurate, and yet they present a more vivid picture of the general basis of medieval life than any other kind of information we possess. It would probably be possible to work out specifically the regions of small hamlets and large villages, and these differences in the size of settlements would have some relation to forms of village organization and methods of agriculture. Despite the amount of work that has been done on medieval records we may still feel that there are many important social data still to be gathered.

These figures for London are given, as the best obtainable. The growth of the seventeenth century is somewhat exaggerated by the inclusion of outlying parishes in the statistics. This is in itself an indication of the growing consciousness of the existence of a metropolitan area distinct from the City of London in its strict legal sense. The area for which figures are given after the beginning of the seventeenth century is the registration area of births and

## ESTIMATED POPULATION OF LONDON \*

1348-49.....	under 50,000
1377.....	43,700
1400-1500.....	40,000-50,000
1532-35.....	62,400
1563.....	93,276
1580.....	123,034
1593-95.....	152,478
1605.....	224,275
1622.....	272,207
1634.....	339,824
1661.....	460,000
1682.....	669,000
18th century.....	about 700,000
1801 (census).....	864,000

\* Creighton, C.: "The Population of Old London," *Blackwood's Magazine*, vol. 149, pp. 484, 486, 495. It is unfortunate that Creighton makes no attempt to correlate the materials from the bills of mortality with the gradual changes in the limits within which such information was collected. These limits were extended with especial rapidity in the years 1631-61. The multiplicity of areas that might be called London is thus a serious source of confusion at an early stage of genuine metropolitan growth. The expansion of the seventeenth century is in considerable measure expansion of the area identified with London.

deaths, usually described as the area within the Bills of Mortality. Little attempt has been made to study all the elements involved in the growth of the general urban area, and, as these problems would require much critical study and no little erudition, it would be out of place to include such a study in the present sketch. Some general conception of the growth of London is, however, of great importance. It will be evident that the growth of London was very slow until somewhat after 1500. The sixteenth and seventeenth centuries were characterized by a notable increase in population, and this period of growth was brought to a close about 1700 by the difficulty of dealing with the sanitary problems of urban life. The plague was a persistent feature in the life of the city and a large factor in its death-rate. There was no possibility of growth by natural increase; the general level of population was maintained by the influx of people from the country. London and Paris were, at this period, about equal in size, Paris being perhaps slightly larger. Both cities failed to make any significant growth during the greater part of the eighteenth century. The increase in the size of London revealed by the census of 1801 is presumed to have been the result of the last ten or fifteen years.

## CHAPTER V VILLAGE AND MANOR

### I

SYMPATHETIC appreciation of the life of the medieval period is impossible unless the rights and duties of the villager are clearly understood. The daily round of his duties and the legal definition of his relations to his neighbors are both of moment. Furthermore, we must not forget that during the major portion of the period the life of the villager was affected by the presence of a personage of some degree of social and political consequence. The "big house," as it is frequently called to-day by the English peasantry, was not a part of the village in any accurate sense of the word, but the life of the village was very definitely concerned with the "big house" and its master. The superficial appearance of rural life changes very slowly and there are still in England some few villages which would present to the casual observer most of the features of rural England in the thirteenth century. The crops would be different; farm implements would be better; food more varied; clothing profoundly changed; but the aspect of the village fields, the village street, and the "big house" would all be substantially as they were in the thirteenth century. The "shell" of the old English village can still be seen, though the legal framework of society has been completely transformed. In the few archaic villages that still exist the ancient system of farming is perhaps more nearly discernible than the legal and social relations among the villagers.

The present position of the aristocracy in England is of course a heritage from the remote past, and the critics of aristocratic institutions, therefore, find much to deplore in the ancient system that created this division of society into classes. Some have written bitterly of the titled personages that kept the land in "fetters," refusing to allow their fellow-

men to raise food on land which they themselves put to no higher use than the breeding of pheasants. Many problems of agrarian history have thus become so inextricably interwoven with the social problems of the present day that it is difficult to approach the past with the dispassionate detachment that is most favorable to a just understanding of history.

Those whose interest has been centered around the growth of free institutions have also contributed prejudices which color interpretations of the rural life of the middle ages. There are suspicions that the villager was originally free and that he lost his freedom by reason of the unjust use of political power and economic advantages. The slow process by which the villager acquired his freedom is followed with interest, but there is little sympathy for the system of social organization which is regarded as the means of depriving the villager of freedom. Many writers who find little to criticize in the institutions of the present day, thus find grounds for believing that the middle ages were a peculiarly dismal and unfavorable period. It is as difficult to pass judgment upon the medieval rural life as it is to appreciate justly the position of the negroes in the South before the Civil War. At their worst, these systems of organization were no doubt a curse to all concerned: slave and master, villein and lord, alike. At their best, and perhaps even generally, these institutions were not inconsistent with some measure of material well-being. It is doubtful if we can say more of the social institutions of our own time. Modern industrialism at its worst can create miseries which can scarcely be surpassed, though many are pleased to believe that there are opportunities for the development of personality that did not exist in earlier periods. An uncharitable critic, however, can paint a sufficiently dismal picture of our own day. Whether or no there is real improvement in the social conditions under which the mass of the people lives, it is at least certain that our understanding of the past is not promoted by attempts to discover evils and find grounds for the condemnation of long historical periods.

Judgment of  
the old order

not a primary  
purpose of  
history



The study of these bygone methods of agriculture and these obsolete English land tenures is gradually becoming part of a larger sociological study which includes not merely the more primitive periods of European development, but also the conditions which now exist among many peoples in the most sparsely settled portions of the world, most notably in Africa. The history of village life in India is also a portion of this more general study of primitive methods of agriculture and land-holding. The broader view of the sociologist tends to emphasize what the jurists and constitutional historians were prone to forget. These various primitive and archaic customs are not merely an historical stepping-stone to modern land law; they were methods of organizing rural life that had a significant relation to the economic needs of a sparse population. The laws and customs which we find so difficult to understand were the expression of vital economic needs, and it is not entirely clear yet that the opening-up of large areas of new land can be accomplished better under the principles of modern European law. Many changes in agrarian methods and many diversities in the form of settlement are due to changing relations of the population to the land. The legal organization of village life is thus only part of the problem and the merits of a particular method of legal organization cannot be judged except in relation to economic conditions. It is suggestive in this connection to remember the experience of the French in Algeria. It seemed to the administration in 1850-60 that it would be wise to clear away the obscurities and uncertainties of Moslem land tenures, which like medieval tenures rested on use rather than exclusive ownership. The precise conceptions of modern land law were thus substituted for these vague notions of use. It might well seem that such a policy was an enlightened furtherance of social progress. Events proved that it was a mistake. It has turned out to be economically disadvantageous; it has undermined native agriculture and concentrated land in the hands of Europeans, leaving the natives impoverished. In northern Nigeria the British ad-

Sociology and  
land tenures

Tenure related  
to economic  
conditions

ministration is pursuing the opposite policy. Recent laws provide that no rights in land shall be recognized that are not established in the native customs. No one, least of all a European, is allowed to buy land. The necessity of following such a policy suggests a vital relation between primitive land tenures and the needs of primitive life. It is implied also that legal forms are not an end in themselves. The elaborately sophisticated notions of modern law are not absolutely better than primitive notions. The legal framework of society must be adapted to the economic conditions of the time.

## II. SCATTERED FARMS AND VILLAGES

A rural population may be settled on the land in one or more of three forms. The people may live in scattered farms;

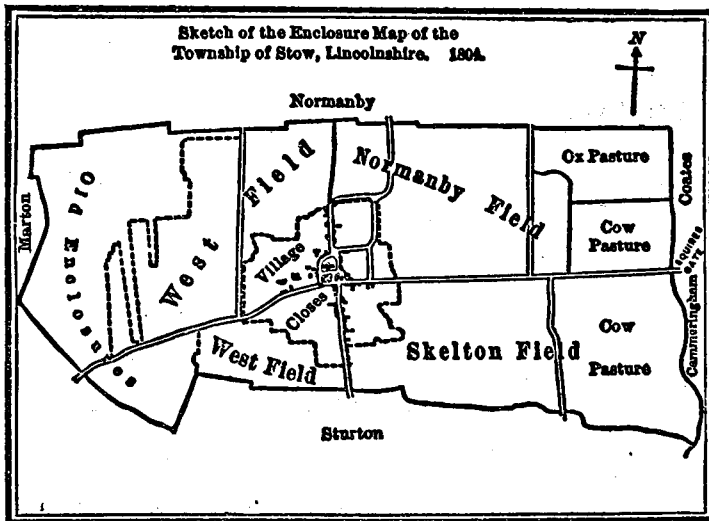

in villages surrounded by enclosed fields and individual farms; or in villages surrounded by fields not divided into permanent individual holdings. In this last case the land was cultivated by the entire village in accordance with certain general rules and arrangements. The more perplexing historical and constitutional problems are concerned with this third form of settlement and its agricultural methods.

In the enclosed village the land would be cultivated by the individual villagers each according to his taste and disposition. The fields of each villager would be separated from the untilled land and from other <sup>Enclosed and open-field villages</sup> arable fields by permanent fences. In the open-field village, the land would lie in large masses unobstructed by any but the most temporary kinds of fence, divided into large units for each particular season. The enclosure map of the Parish of Stow illustrates the general features of this arrangement. There is a considerable area devoted to the village with its houses and gardens, and we may presume that this general area was separated from the outlying fields by permanent fences or hedges. The area designated as "old enclosures" was also divided into separate lots. These fields were cultivated without reference to the general agricultural arrangements of the village. At the other end of the village there were areas reserved for pasture; special grazing-land was set apart for the plough oxen in order to assure them ample forage at a short distance from the village. The arable land of the village thus lay in four irregular fields. There are grounds for believing that there were only two fields in the early period, designated respectively as "east" and "west" fields, and in those days we must presume that there was relatively more cow pasture and no enclosures at the westerly end of the village. The changes in the arrangement of the fields that can thus be deduced from the late map were the outcome of attempts to improve the system of village agriculture. If there were only two fields <sup>The two-field system</sup> one half the land of the village would lie idle each year, for medieval agriculture was based upon an alternation of cropping and fallowing. In the early period, the large masses of arable were devoted to wheat, and as long as no other crops were grown the resting of the land in alternate years was economically profitable.

The precise nature of the benefits of a fallow year is not well understood. It is now held that the decom- <sup>Fallowing</sup> position of the great mass of roots left in the soil by the cereal crops produces conditions that are un-

favorable to the growth of the same crop in the following year. It is not now deemed likely that the fertility of the soil is really impaired in any way that would admit of recovery during the fallow year, though the weathering in the interval is undoubtedly beneficial. Experiments conducted at Rothamstead for a series of years resulted in a production of slightly more than twelve bushels of wheat per acre when wheat was grown continuously, whereas eighteen bushels were grown per acre when an alternation of wheat and fallow was practiced.<sup>1</sup> These yields were larger than the medieval yields, as modern methods of cultivation were used, but one must presume that the proportionate importance of fallowing is roughly indicated. Under the three-field system the usual yield of wheat was eight or nine bushels per acre; proportionately less would be raised under the two-field system or under continuous cropping. In southern Russia and in parts of the United States farmers are content to harvest seven or eight bushels of wheat per acre, and an appreciably smaller yield must have been secured under continuous cropping in medieval Europe. Fallowing increased the crop so significantly that it became almost universal in the middle ages. At first an alternation of wheat and fallow was practiced; soon, further modification was made to economize the arable area. It was discovered that satisfactory crops of the other cereals could be grown immediately after a crop of wheat, and by this means the fallow was reduced to one year in three. One third of the arable only need lie idle. Somewhat less wheat would be grown, but there would be a crop of rye, oats, or barley. The change from the two-field system to the three-field system was probably made at an early date, for no general change in agricultural methods was necessary. No new crops were really introduced. Nothing need be done but rearrange the arable fields.

The three-field system

The division of the arable into two or three fields, which were left fallow every second or third year, made it necessary for each villager to have land in each field, and, though the

<sup>1</sup> Hall, A. D.: *The Book of Rothamstead Experiments* (New York, 1905), 65.

reason is not clear, the parcels of land used by the villagers were not compact masses even within the <sup>Allotments</sup> fields. Each field was divided into small strips <sup>to villagers</sup> containing at the most an acre or an acre and a half, seldom less than a quarter of an acre. Normally, the strips were long and narrow, but the shape of the strips was largely determined by the method of ploughing which was necessarily related to all the details of the configuration of the land. These small strips were divided among the villagers partly with reference to equal division of all the kinds of soil among all, partly with reference to coöperative ploughing. In the early period the strips of the villagers were intermingled so that no one would possess contiguous strips. If a villager maintained himself and his family entirely by agriculture he would require about thirty acres of arable land: his holding would consist of twenty-five or thirty strips scattered around in the two or three fields. The strips were divided from each other by ridges of unploughed turf, and the furrows were turned in toward the center of the strip so that the strips were pretty distinctly set off from each other.

The work of the village required some organization, because the dates of ploughing and harvesting were of importance to all. The cattle were usually turned in <sup>village agri-</sup> upon the stubble after the harvest, and it was <sup>culture</sup> therefore essential that no one should delay this use of the fields by neglecting to get in his crops with the others. Ploughing and planting were subject to similar limitations. In order to avoid wasting land in lanes and roadways, no permanent provision was made for access to the fields. Certain strips were designated to serve as means of access, and they were therefore ploughed last. It was equally necessary to harvest them first in the fall. Crops, ploughing, planting, harvesting, were thus all subject to some rough organization for the village as a whole. Ploughs and plough teams were owned jointly and used coöperatively. The village constituted a community in a more organic sense than the modern village, but one must avoid confusing this organization of agriculture with what we think of to-day as communism.

There was no community of goods in the medieval village; both land and crops were subject to the control of individuals and were capable of being accumulated. The nature of the rights over the land were different from the property rights familiar to us, but there was an exclusive right to use certain quantities of land which makes it impossible to compare this medieval system with any type of socialistic communism.

Medieval England exhibited all three forms of settlement. Scattered farms were the characteristic forms in some of the  
**Forms of settlement**      infertile regions; and even in the fertile sections, there were usually some farms lying interspersed among the villages. Hamlets or small villages which possessed no organized two- or three-field system were the characteristic feature of the northern counties, and predominated likewise in Wales and Scotland. Larger villages without field systems were found in the eastern counties. Organized field systems were the predominant feature of village life in the midlands.

The explanation of these different modes of settlement has been largely based in the past upon the racial aspects of the  
**Various explanations** - settlement of Britain. The scattered farm is identified with surviving Celts; the open-field villages with their field systems are identified with Teutonic elements; and the absence of field systems in the eastern counties is explained by survival of Roman forms of rural organization. This identification of the mode of settlement with racial customs has so long commanded the allegiance of constitutional historians that it is hardly fitting to do more than urge the claims of explanations that are economic rather than cultural and legal. Study of conditions in Siberia by Russian scholars has shown that the highly organized open-field village can develop naturally out of scattered farms, which tend to predominate when the country is first settled by casual colonists. The development of village life creates scarcities of arable land and meadows which make it desirable to restrict individual caprice and greed. We are thus in a position to assert that these different forms of village life are

not exclusively of racial origin, though the character of the Teutonic migrations in Europe undoubtedly adds racial and cultural elements to the history of settlement in western Europe. Furthermore, the emphasis upon the underlying economic factors by these Russian scholars affords explanations of many features of medieval life that would otherwise have no meaning to us at the present day.

The transition from the settlement in scattered farms to the open-field village, or village community, is brought about primarily by increase of population. Different methods of



using land become necessary because land becomes *relatively* scarce. The significance of increasing population and of relative scarcities of land must be considered with reference to each type of land. In primitive times little attempt is made to transform nature. The meadows are the only source of hay, because they alone present sufficiently favorable conditions to the growth of grasses to maintain a continuous crop. Forests are not cut clear and the land prepared for the plough until all the unforested land has been occupied, and the search for such unforested land has been a notable feature of the migrations and settlement of western Europe. If the population is sparse there will be meadow and arable for all. Each settler can appropriate such land as he needs. Land is substantially a free good.

On the non-appropriated meadows the unrestricted right to cut grass produces, with increase of population, disastrous results. As the number of cutters increases, competition arises, and each tries to commence cutting earlier than the others; this diminishes the crop, because no one waits until it is fully ripe. All lose by this, and the community, to prevent it, forbids the cutting of grass before a certain date. . . . The next stage in the regulation of meadows has already an equalizing character. In Siberia, among the Kirgizes, the Cossacks, etc. the preventive measures are followed by a limitation of the number of cutters each family may employ. . . . Finally, the community allots to those who have not enough grass, parts of the meadows occupied by others.<sup>1</sup>

In the case of appropriated arable land the process is more complicated. At the outset each settler is free to occupy such land as he can. Despite the seeming equality of opportunity inequalities soon arise. With a large family more land can be occupied and used. The possession of a few more draught animals enables a man to bring much more land under cultivation. Small differences in nomad wealth thus become translated into large differences in landed possessions. Class conflicts arise between the rich peasants and the poor, which may at times

<sup>1</sup> Lewinski: *Origin of Property in Land*, p. 33.



result in violence. Once the poor become relatively numerous and suitable plough land becomes scarce, the original freedom of occupation is restricted. Because arable land is more necessary than meadow, pasture, or forest, it is provided that no one shall have the right to make such use of the land if some villager is ready and willing to plough the land. "It is forbidden to offer resistance to the plough." This regulation is likely to destroy the scattered farms, as their pastures and meadows are broken up for arable. Presently restrictions are placed upon the number of years that land may be left fallow. After a stated interval an occupier loses all exclusive rights of use, and the land may be ploughed by any villager. Actual allotments of land to the poor are at first made from the estates of those who die without heirs, or from the property of those who refuse to pay the village taxes. Annual allotment of the land is reached only at a late date.

The stages of development which Lewinski traces among the peasants of Siberia would doubtless represent the unhindered operation of economic forces. At the time of the first contacts between the Romans and the Germanic tribes the annual allotment of village lands was common among many villages, though not universal. The passages in Tacitus which refer to settlements in scattered farms have been the subject of much controversy, and, in the opinion of some, cast doubt upon the description of the practice of allotments in chapter twenty-six. It is peculiarly unfortunate that the text is so corrupt that no undoubted reading can be given for this latter chapter, but the account of Tacitus becomes much more plausible in all respects if we do not look upon this matter of agriculture as a definitely racial custom. If we anticipate some diversity of practice, as would be natural among tribes whose economic conditions were somewhat different, the difficulties of the text of Tacitus would largely disappear. It would seem in fact that the Germanic tribes were at that time at a stage of development in village organization roughly comparable to that of the various tribes in Siberia at the close of the past century. The open-field village was coming to

Customs of  
the Germanic  
tribes

be the characteristic feature of rural life, but many scattered farms existed, and many villages were really in an intermediate stage of development. The pressure of population that is deemed to be a motive in the migrations of the Teutonic tribes would be consistent with such a development of organized village life based on the relative scarcity of land. In so far as the migration involved entire tribes, there would be every reason to suppose that the forms of village organization would not be greatly changed even though the villagers were to find a relative abundance of land available. The mode of social organization would survive despite the removal of the economic pressure that had been the cause of its development. The different modes of village life of Celts, Germans, and Romans were due to the different economic circumstances of their life prior to the great migrations. The relegation of the Celts to the infertile districts tended to perpetuate modes of settlement adapted to the needs of a sparse population. Little concentration of population was possible, so that no elaborate forms of village life developed until a late period. The Celts continued to live in scattered farms and hamlets, not so much because they were Celts as because they were poor people living in an inhospitable country. The Germans brought the habits of organized village life to the fertile sections of France and England and the development of rural life that had begun in Germany continued without serious interruption.

Racial differences

### III. THE COMMON PEOPLE AND THE MAGNATES

The forms of village organization are not in themselves an indication of the general structure of rural society. Society might be essentially democratic or essentially aristocratic, or there might be significant changes in the degree of social stratification. The legal details of village life would naturally be somewhat different in these various circumstances, but it is not necessary to assume that there would be any profound changes in the system of agriculture or in the superficial aspects of village life. By the twelfth and thirteenth centuries aristocracy had become a funda-

The aristocracy

mental feature of English life. The magnates were occupied with military and administrative functions. They were maintained partly by the produce of landed estates exploited in their behalf by the villagers, partly by produce turned over to them by the villagers. The existence of a class of magnates thus presupposes a servile class or classes; some persons entirely deprived of personal liberty, others enjoying a qualified freedom.

The social organization of Britain, as of Gaul, during the Roman occupation was predominantly aristocratic. Rural life was dominated by the great landed proprietors whose estates (villas) were tilled by classes The Roman system of unfree tenants. The estate was divided into two portions: a domain exploited directly by slaves under the supervision of the agents and stewards of the proprietor, and a portion let out to tenant farmers (*coloni*) for rents payable in money or in kind. Both of these classes of unfree tenants exhibit many varieties of condition: there were various degrees of personal freedom among the slaves as among the tenant farmers. There were slaves who enjoyed no freedom of action at all, mere members of the gangs of ten which were the usual unit in the working of the estate. There were other slaves who were entrusted with a small holding and a cottage, so that they enjoyed much personal liberty in the details of their work and in their family life. The tenant farmers were free in the legal sense of the word, but they were bound to the soil. They were not allowed to leave the estate, nor permitted to marry any one dependent upon another lord or master. The obligations of the tenant farmers were variable in many details: the amount of rent due the proprietor varied, as also the mode of payment. Some tenants, who had brought new land into cultivation, were required merely to continue to cultivate their holding. Other tenants were obliged to pay significant rents.

Some elements of Roman life undoubtedly survived the Germanic invasions. The sites and names of Extensive survival unlikely many modern French villages are a survival from Roman times. Roman land measures and field ar-

rangements left traces in both Gaul and Britain. But there are grave doubts of any general survival of the aristocratic structure of rural life. The history of the invasions and the conditions subsequent to them present an infinite variety of detail, so that no general statements can wisely be made; it would seem likely, however, that the rural aristocracy of Roman times disappeared largely if not completely, and it is equally probable that no Germanic aristocracy succeeded immediately to such a dominant position in social life. Germanic society was not lacking in social classifications even at the time of the invasions, but the proportion of freemen was large and the actual differences in wealth much less considerable than in the Roman society that was destroyed. The invasions no doubt increased in some measure the power and economic importance of the leaders, but it is unlikely that the magnates among the invaders acquired complete predominance in any short period of time. The aristocratic structure of society in the twelfth and thirteenth centuries must be traced primarily to the influences at work in political and social life among the Germanic peoples. The aristocratic forms of the later period were not borrowed from the Romans; despite many resemblances, they were the product of spontaneous growth.

The need of military protection was of great moment in giving larger importance to the magnates, and the incursions

**Growth of  
a military  
aristocracy**

of the Danes exerted a profound influence upon the development of Anglo-Saxon institutions.

The increasing solidarity of political organization was also a factor of great importance. The formation of a strong monarchy practically required the development of an aristocracy possessed of administrative as well as military functions. The magnates thus became the chief bond between the rural village and the larger social life of the kingdom. The aristocracy was a means of securing some measure of centralization in a social structure whose essential principles seemed to be excessive decentralization. The change in the character of social life is concretely expressed by the gradual decline of dependence upon the group of kins-

men and a corresponding increase in the reliance upon the protection of some noble patron or lord. There were many motives underlying the acceptance of qualified freedom by peasants who were originally free of all obligations to an aristocracy; poverty, loss of blood kindred by violence, displacements caused by Danish incursions, might all lead to the willing acceptance of the protection of a lord. We have not sufficient information to trace these social changes in any detail, but it is fairly clear that the growth of dependence upon the magnates was of mutual advantage; a gain to the peasant as well as a source of power to the lord.

The drift toward manorial organization was greatly stimulated by the changes brought about by the Norman Conquest, so that we cannot be sure how far back we can wisely carry the manor as we come to know <sup>The origin of the manor</sup> it immediately after the Conquest. It is certain, however, that the structure of society in the eleventh century is not wholly the work of the Normans. The mass of material furnished by the Domesday Survey tends to give conditions at the close of the eleventh century a somewhat disproportionate place in history, and the slow development of the Saxon period is just beginning to be fully appreciated. *Domesday Book*, however, affords abundant evidence of the existence of the main features of the aristocratic society that reached the height of its power in the thirteenth century. The enumeration of the population was not comprehensive but it seems to have been designed to include the heads of families and servants attached to the households of persons of consequence. The results of the enumeration must show approximately the proportions of the different classes of society.

In England as a whole, society had thus become notably aristocratic: the mass of the population were unfree, and, though the tenant farmers are presumed to have held sufficient land to guarantee some measure <sup>Dependent classes</sup> of economic independence, they were none the less required to make some contribution to the affluence and magnificence of the great feudal establishments. The crofters (*bordarii* and

PER CENT OF PERSONS ENUMERATED IN EACH CLASS TO THE TOTAL  
POPULATION ENUMERATED IN DOMESDAY BOOK: 1086\*

	<i>Per cent</i>
<b>Base tenures —</b>	
Serfs ( <i>servi</i> ).....	9.
Crofters ( <i>bordarii and cottarii</i> ).....	31.5
Tenant farmers ( <i>villani</i> ).....	38.
Total base tenures.....	78.5
<b>Honorable tenures —</b>	
Yeoman farmers (soc-men and freemen).....	12.
Tenants in chief and mesne lords.....	3.5
Enumerated persons not included in the above classification.....	6.
	100.0

\*Inman: *Feudal Statistics*, 2.

*cottarii*) were persons who had some land, five or ten acres at the most, but not enough to occupy their full time nor to provide sufficiently for their families. They worked on the lord's estate and received pay in kind. The dependence of these servile classes upon the lord was real, but it is not necessary to presume that their economic condition was intolerable. The yeoman farmers had at least sufficient land to afford their family adequate provision, they were all economically independent; the freemen were in addition legally independent, looking to the King's courts for justice; the socmen were required to attend some manorial court and thus subject to the payment of certain legal fees to a manorial lord.

In this aristocratic system that was growing up the unit of rural organization was the manor: a person might hold several manors, and the ecclesiastical corporations held large numbers of them, but in such cases the manors retained their administrative and legal individuality. Ordinarily the manor consisted of a residence and farm utilized by the lord of the manor, together with a mass of peasant holdings. There was usually an organized village, but the village need not be exclusively inhabited by persons depending on the manor. The holdings of freemen might be intermingled in the village fields with the strips belonging to the lord's farm and the strips held by the lord's tenants. The complexities of the legal organization of rural life are in large measure due to the lack of precise correlation

of the various categories. Fiscal terminology does not quite correspond to legal terminology, and legal terminology does not entirely correspond to the groupings of the population in villages and hamlets. This lack of correspondence between the various aspects of social organization leads to no little diversity of meanings in connection with the term manor. "The prevalent meaning," says Vinogradoff, "is that of an estate or district of which the central house is the hall." It would seem that an attempt had been made in the Saxon period to substitute estates of four or five hides (presumed to be equivalent to 480 to 600 acres) held by thanes for a quantity of small freehold tenements. The revenue presumed to be derived from such an estate would correspond to property units that were used in calculating military obligations. The conception of the manor was thus influenced by fiscal and military policies which made it desirable to create appearances of uniformity which did not exist.

Actual manors, as they appear in *Domesday*, do not often conform to these averages, and present a variety of different types which must be examined separately if we want to form an opinion as to the character and origins of **Principal types** manorial institutions. They may be arranged very roughly in the following five classes; with a good many subdivisions and intermediate shades between them. The grouping would be somewhat as follows: the manor as a capitalistic organization, an economic center surrounded by peasant holdings supporting it; the manor as an administrative center of scattered and more or less independent settlements; the soke, a center of jurisdictional and tributary organization; royal manors; small estates exploited directly by their masters or rustics.<sup>1</sup>

These types will perhaps be more readily perceived if some of the descriptions in *Domesday Book* are given. An example of the capitalistic manor may be found in Bedfordshire, the manor of Segenehou. Two fifths of this manor, four hides, was reckoned as the lord's farm; assuming the ploughlands to be 120 acres, this would mean a demesne farm of 480 acres. The rest of the manor, 720 acres, was occupied by tenants: 24 villein households, 4 crofter households, and

<sup>1</sup> Vinogradoff, P.: *English Society in the Eleventh Century*, 311.

3 serfs. Formerly, there had been one soc-man on the manor, holding 60 acres, but he had disappeared. The medium-sized manors were usually of this type, and in such cases there was real interdependence between the lord's farm and the peasant holdings. In the very large estates, belonging to the wealthiest magnates and to monastic houses, the home farm tends to become entirely subordinate to the peasant holdings. The revenue of such an estate was derived from tribute and from assignments to the lord of portions of the produce of the peasants.

When the manor was merely an administrative organization this subordination of the lord's farm to the peasant holdings was even more marked. A royal Administrative manors manor of Mansfield, Notts, is fairly representative. This consisted of a central manor with outlying portions. The central portion consisted of a demesne farm and peasant holdings, but barely one tenth of the total area lay in the lord's farm. There were, besides, twenty-seven settlements attached to the manor for purposes of taxation, and in none of these outlying portions was there any land that constituted a demesne farm. "We are clearly in a district of scattered homesteads," says Vinogradoff, "inhabited by small farmers paying dues to the central court at Mansfield, and possibly performing some services for it." When the manor became primarily a center of political and legal obligations this relationship between the central nucleus and the appendages was strikingly emphasized. Thus, the manor of Bolingbroke in Lincolnshire had a demesne farm of 240 acres, subordinate holdings in the immediate locality for 12 soc-men, 12 villeins, and 8 crofters; as an economic center, it was only of moderate size. Its jurisdiction extended over 17 places and 529 soc-men were under obligation to attend the manorial court. The income from the manor must therefore have been derived chiefly from fines collected in the court. The royal manors exhibit all these features, but also some special features, but these matters are hardly of moment in an introductory survey of rural organization. The very small manors are likewise a problem for the erudite.



IV. THE ORGANIZATION OF THE MANOR IN THE THIRTEENTH AND FOURTEENTH CENTURIES

The general aspect of the typical manor is presented in the representative plan shown below. The common fields, com-

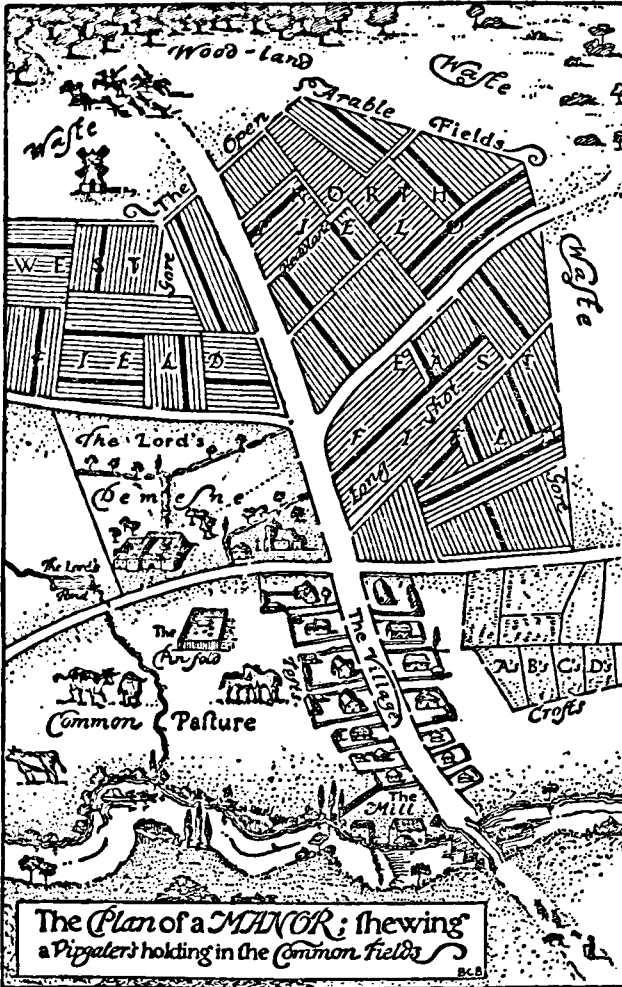

mon pasture, and waste were the persistent features of the rural landscape. The demesne farm would not, in the early period, consist of a solid block of land; it lay in strips in the common fields intermingled with the holdings of the peasants. Later it was brought together in the compact mass represented in the map. The separation of the village from the cottages of the crofters is wholly typical, and the manorial mill likewise. The wind-mill that stands by itself in the waste cannot readily be brought within the scope of normal manorial organization. The lord of the manor had the right to compel the tenants of the estate to use his mill, but he seldom indulged in the luxury of two mills and never long permitted any one to infringe upon his monopoly of milling.

The economic organization of the manor was designed to provide for the exploitation of the lord's farm by the labor services rendered by the tenants. For purposes of definition of the obligations of the tenants the labor services were divided into two main classes: the week works, an obligation to work two or three days each week under the supervision of the lord's bailiff; the boon days, supplementary services rendered chiefly in connection with ploughing and harvesting. Villeins were required to render service of both types, and freemen were usually supposed to grant the lord certain boon days. In addition to these services various kinds of work were required of cottagers; blacksmithing, carpenter work, holding the lord's plough, herding the sheep, were characteristically the tasks of persons not engaged in tilling a thirty-acre holding: one may look upon the cottagers, or crofters, as servants who have been given some measure of personal independence or as villagers who have lost their economic independence. It is probably more correct to look upon these cottagers as a class of servants living in independent houses, though some of them become relatively independent village craftsmen.

The various classes of dependents on the estates of manorial lords were graded into a hierarchy with reference to the degree of subjection to the lord's pleasure. The cottagers

were presumed to be under obligation to render such service as they were bidden to perform; their full time <sup>Obligations</sup> was their lord's, though it is likely that they <sup>of tenants</sup> were left considerable opportunity to work small garden plots. The villeins were under obligation to render definitely limited services. The stigma of villeinage attached to the uncertainty of each day's work; the villein was never able to know what the morrow would bring forth, he must needs perform the task set him by the officers of the lord, provided that the quantity of work required did not exceed the conditions defined by his tenure. The freeman, under obligation to furnish merely certain boon works, escaped the taint of servile dependence upon the orders of the lord. The burden of the general farm-work thus fell upon the tenant farmers, persons holding twenty or thirty acres by some form of unfree tenure. Serfdom was not a prominent feature of English village life, so that references to the position of serfs are not abundant. It would seem that the distinctive feature of serfdom lay in the character of the tenure rather than the size of the holding.

The supervision of these labor services was a considerable task so that certain administrative officers were essential. The affairs of the lord were in the hands of two <sup>Officials of</sup> officers, the steward and the bailiff. The stew- <sup>the lord</sup> ard was charged with legal and financial business: he held the manor court, or leet, attended to all matters connected with the tenures of the villagers and their financial obligations to the lord. The steward also supervised the market, if the lord had the privilege of holding market. There was always the mill to manage. The steward exercised some supervision over the general arrangement of the fields of the demesne farm, but he was not concerned with any details of farm management. The management of the farm was in the hands of the bailiff and the hayward: the former had charge of general arrangements of culture; the latter, oversight of the woods, cereal crops, and meadows. The hayward's functions were thus pretty extensive. The organization of harvesting was his work. The supervision of fences around the

arable to keep cattle out during the growing season, and the impounding of stray cattle, also fell to his lot.

Coördinate in importance with these officers of the lord was the village reeve. He was elected by the villagers to direct the general agricultural operations of the village, and all details concerning the management of the fields. The bailiff was supposed to keep an eye upon the reeve, but in actual fact the reeve was quite as important as the bailiff from the point of view of village life. The village constable was also elected by the villagers, and the inspection of bread was carried out by persons chosen by the villagers assembled in the court leet. There were thus some elements of democracy in the organization of the manor.

The legal organization of the manor implies that each manor was a substantially independent unit of social life, and, in the early period, this may have been generally true. The growth of commerce, however, and the increase in the concentration of wealth led to the grouping of manors and ultimately subordinated the manor to commercial contacts with the market that destroyed the close interdependence between the household of the manorial lord and the labor services of the tenants.

By the thirteenth century there were three classes of manors: manors which were essentially independent, manors which belonged to a monastic house thus forming part of a large group which sent their products to the monastery, manors which belonged to some great noble or bishop who would find it convenient to perambulate the country with his household to consume on each manor the surplus available for his maintenance. In this last type the manor was merely a source of income for a non-resident-magnate. It was sound feudal theory that each lord should live on the proceeds of his estates, and for a time this was literally done. The tenants were under obligation to render services in carting and hauling so that the products of the demesne farm could be concentrated in some central place. In so far as the manors were the property of monastic houses, it was essential that the produce should thus be sent to the

central establishment. Perambulation of the group of manors was somewhat more economical, but both of these methods of collecting the revenues were inconvenient. The possessions of individual proprietors were widely scattered, and it was really less convenient to collect the rents in kind than to collect them in money with which supplies could be purchased at the nearest market. The period 1250-1500 is marked by a gradual transition toward conversion of labor dues into money rents, and toward an abandonment of the demesne farm. It became more profitable to let out the demesne farm. The surplus grain of each village came gradually to be sold in the nearest market and the great households became purchasers in the market. The connection between non-resident lords and their manors thus became more exclusively financial, and the villagers became more nearly tenant farmers whose only obligation to their lord was the payment of a money rent. The rise of the local market thus tended to destroy the characteristic economic features of the manor almost as soon as the legal features of the manor began to assume definite outline. Before 1500 the manor ceased to be of any vital significance in the economic organization of England, though the court leet long remained a notable feature of village life.

#### V. THE END OF VILLEINAGE IN ENGLAND

The transition from labor services and payments in kind to payment of rents in money, that proved to be a primary cause of the decline of the manorial economy, exerted a profound influence upon the status of the tenant farmers. The distinction between free tenure and villein tenure was greatly diminished even by a moderate commutation of labor services into money dues, and when all obligations had been translated into money the only remaining difference lay in the nature of the record of the title to the holding. A freeholder theoretically held his own title-deeds; the transformed villein could at best show nothing more than a copy of the records of the court leet. His tenure was no longer subject to the lord's will, but from a

Commutation

The rise of  
the free  
peasantry

legal point of view it was in many ways inferior to a freehold title. The last vestiges of this copyhold tenure have not yet been entirely swept away, though the legislation of the late nineteenth century leaves little but the name.

The study of the passing of villeinage is still far from complete. In the past it has been approached almost exclusively from the point of view of the villein. The researches of Professor Gras in the field of market organization have disclosed motives that are so definitely advantageous to the lord that it would seem likely that the transformation was less exclusively a conquest of freedom by the villeins than has been assumed. The history of the rise out of villeinage would thus seem to be more than a chapter in the struggle for liberty in which the privileged classes are presumed to play merely an obstructive rôle. It is wholly probable that there should be much friction in a period of re-definition of obligations. The lord would watch his revenues with solicitude; the villagers would similarly try to utilize the occasion to pare down their obligations. The attempt to convert somewhat uncertain rights to service into precise equivalents in money must inevitably have created much difficulty, and no little tension; and yet, on the whole, both lord and tenant found a vital interest in the transition to a system of money payments.

Studies in the manorial records have thrown some light upon the chronology of the movement. It appears that little

**Influence of  
the Black  
Death**

progress had been made toward the new order prior to the Black Death, and it seems equally certain that the disorganization of rural life by that pestilence exerted a profound influence upon the organization of the manor. Many tenants died of the plague, and many bailiffs. It was less easy to maintain the old customs. Sometimes the demesne was diminished in extent because it was difficult to keep it under cultivation as a unit. Sometimes it was necessary to attract new tenants by making more favorable leases. For many reasons commutation became increasingly common in the generation following the Black Death. The relation of the peasant rising in 1381 to

the rise out of villeinage is as yet uncertain. The social background is still a matter of controversy, as well as the details of the revolt. By 1400, however, commutation of rents was more common than the exaction of the old labor services, and toward the latter part of the fifteenth century the old system was exceptional.

The social position of the villeins thus became substantially similar to that of the small freeholders, the independent peasant proprietors who are usually spoken of as the forty-shilling free-holders, or yeomen. The <sup>Yeomen</sup> aristocratic structure of society persisted, but the power of the aristocracy was tempered by the presence of this large number of peasant cultivators who had become substantially, if not technically, independent. Nearly half of the rural population must have been included in this class of yeomen farmers, as augmented by the emancipation of the villeins from their precarious services. Many other rustics who did not have sufficient land to afford them full maintenance were rendered independent by the returns from craft work. The artisans in town and country must have constituted a numerous class, and there is perhaps ground for presuming that between one half and two thirds of the population were economically independent. There were wage-earners both in the crafts and in agriculture, but it was unusual for any to remain wage-earners permanently. The social ladder was intact, and the diligent might reasonably expect to achieve independence in agriculture or in industry.

## CHAPTER VI THE TRADERS AND THE TOWNS

### I

THE interpretation of the economic history of the middle ages has been dominated in great measure by the conception of the "town economy" developed by Schmoller, Ashley, Bücher, and other writers of that generation.

Each town [says Schmoller, in his famous essay on the Mercantile System], and especially each of the larger towns, seeks to shut itself up to itself as an economic whole, and at the same time, in its relation to the outside world, to extend the sphere of its influence, both economic and political, as far as possible. It is not without significance that, during a considerable period of ancient and medieval history, all complete political structures were city states, in which political and economic life, local economic selfishness and political patriotism, political conflict and economic rivalry, all coincided. The economic policy of the German towns of the middle ages, and their economic institutions, have played a controlling part in German life down to the seventeenth and eighteenth centuries; they project themselves, so to speak, in so many directions, into our own time, that we must pause a moment to speak of them more at length.

Not only separate jurisdiction, but also the right of holding a market, of collecting tolls, and of coining money, were, from early times, the privileges of growing urban communities. This exceptional position was strengthened by the abolition of payments and services in kind, as well as by the principle that "town air makes free"; and finally, by the conquest of the right of self-government and legislation by the town council. Each separate town felt itself to be a privileged community, gaining right after right by struggles kept up for hundreds of years, and forcing its way into one political and economical position after another. . . .

Market rights, toll rights, and mile rights are the weapons with which the town creates for itself both revenue and a municipal policy. The soul of that policy is the putting of fellow citizens at an advantage, and of competitors from the outside at a disadvantage. The whole complicated system of regulations as to markets and forestalling is nothing but a



contrivance so to regulate supply and demand between the townsman who buys and the countryman who sells, that the former may find himself in a position as favorable as possible, the latter as unfavorable as possible, in the business of bargaining. . . . The whole well-rounded law as to strangers or "foreigners" was an instrument wherewith to destroy, or, at all events, to diminish the superiority of richer and more skilful competitors from outside. Except during a fair, the foreigner was excluded from all retail trade, allowed to remain only a certain time and prohibited from lending money to or entering into partnership with a burgess. . . . In short, the town market formed a complete system of currency, credit, trade, tolls, and finance, shut up in itself and managed as a united whole and on a settled plan; a system which found its center of gravity exclusively in its local interests, which carried on the struggle for economic advantages with its collective forces, and which prospered in proportion as the reins were firmly held by prudent and energetic merchants and patricians able to grasp the whole situation.<sup>1</sup>

This interpretation of municipal policy contains many brilliant half-truths; the various aspects of political and economic policy cited in proof of the inter-pretation are indeed a faithful reflection of the <sup>Superficiality</sup> <sub>of the idea</sub> ordinances and the provisions of the charters. But these provisions have been read literally in a narrow legal spirit. Little care has been taken to seek the vital significance of these regulations in the economic and political life of the medieval period. The sinister influence of municipal authority in the later period has been reflected back to the earlier period in which these institutions arose.

Literal interpretation of the legal documents of the middle ages is peculiarly dangerous. It was a period of intense formalism: a formalism so rigid that few rules could be carried out to the letter. Furthermore, the emphasis on form rather than content created an attitude of mind that was particularly open to legal fictions and evasions of many kinds. The political organization of the general community was highly complex: there were many overlapping jurisdictions, interwoven in such a manner that acts prohibited in one set of regulations were protected and guaranteed by regulations of a coördinate jurisdiction. The difficulty of visualizing

<sup>1</sup> Schmoller, G.: *The Mercantile System* (New York, 1910), 6 ff.

the entire structure of this social organization tempts us to isolate the problems that are most nearly comparable to our own, and, while this method leads to results, it seldom furnishes an accurate representation of medieval life. The municipal constitutions tended, in practically all portions of medieval Europe, to raise obstacles to commercial development, but the traders found a larger freedom than would have been possible within the limits of the municipal constitutions in the fairs, in the special privileges obtained by great trading companies, and in the development of a Law Merchant enforced by special courts. Writers upon constitutional history have been constantly aware of this vigorous development of mercantile privileges, but to them these privileges and arrangements are exceptions; exceptions because the municipal organization is presumed to be the primary legal background. The merits of the legal question need not be argued at length, but it would seem safe to say that these different masses of law and privilege were at least of coördinate importance during the medieval period.

It is difficult for us to realize that trade could flourish upon the basis of such a mass of special privileges as were characteristic of the middle ages, and it would indeed be impossible to maintain the continuity of trade or to transact the volume of business that characterizes modern commerce. It is essential to remember that medieval trade was after all comparatively small in volume; confined to a small number of commodities in any given region, and periodic rather than continuous. The great staple commodities found a market that was spatially extensive. From a very early date the various countries of western Europe and the Mediterranean world were engaged in systematic trade. The territorial extent of the market for most products is frequently underestimated. Textile districts, woolens, linens, and silks; metal districts; leather districts; regions producing spices, drugs, and dye-stuffs became distinct as early as the twelfth century, and this geographical division of labor became the basis of an active

The enfranchisement of trade

Adequacy of the privileges

commerce that was as truly "world-commerce" as the commerce of to-day. The known world was smaller, but the commerce of the time included practically all parts of the known world. This trade was not in any vital sense dependent upon rights of trading in the towns as municipalities. The fairs were the primary basis of the distribution of these basic commodities throughout Europe, and these fairs, organized with more or less elaboration, constituted a vast trading community that was international in structure as in its legal rules and procedure. The trading community

The fair charters were thus the guarantees of commercial freedom, just as the municipal charters were the bulwarks of political freedom. Little by little the bond of union between trade and the towns became closer, and, in the end, the special franchises of the traders became a part of the municipal constitution. The nature and degree of this assimilation of these two types of franchises differed widely in the various European countries. In France and in England the municipal constitution came to be relatively favorable to the trader, and the older, more special organization of commerce receded into the background. In Germany, most especially in Prussia, municipal selfishness maintained itself longer as a substantial fact, so that the fairs remained an essential feature of commercial life down to modern times.

The constitutional history of municipalities is thus distinct from the economic history of the organization of commerce and the growth of commercial towns. It is particularly necessary to avoid identifying the rise of municipal freedom with the rise of commercial freedom. These developments were closely related and each exerted important influences upon the other, but for a long period these matters can best be treated as distinct episodes in the development of urban life.

## II. FAIRS AND THE LAW MERCHANT

The fair is not sharply distinguished from the market, though its functions and organization are different in many respects. The German phrase "Jahrmarkt" indicates the

close association of the underlying ideas: the fair was a kind of market held at less frequent intervals and **Markets and fairs** for the purpose of transacting a different kind of business. The market was concerned with supplying the necessities of life, serving primarily as a bond between town and country. It was the basis of such interchange of primary products as was necessary among specialized craft-workers and the agricultural members of the community. Even in small towns and villages the market was held each week. The fair was a similar organization designed to maintain some connection between the town or village and the outside world. As the dependence upon such trading connections was slight it was usually possible to meet these needs by holding one fair each year. The fair was usually associated with some church festival of general or local importance. Easter week, Saint John's Day, Trinity, and All Saints were common dates for fairs. The feast of the patron saint of the town or monastery was the most usual choice when the date was based upon purely local considerations.

Fairs of purely local significance seldom lasted more than one day, and the majority of fairs were of this type. It is **Their number** not always possible to distinguish grants of fairs from grants of the right to hold a market, for it was usual to combine the right to hold an annual fair with the right to hold a market. The Committee on Market Rights and Tolls reported the following numbers of grants: for the thirteenth century 3300; for the fourteenth century 1560 for the fifteenth century down to 1482, 100; a total of 4960 fairs and markets granted and probably existing at the close of the fifteenth century. The kingdom was thus provided with a very substantial mechanism for the maintenance of commercial contacts. The trader was by necessity of the case a traveler, in most instances accomplishing a fairly definite circuit each year, for the generous distribution of fairs throughout the year made it possible to arrange reasonably continuous circuits.

The fair, however, was not merely a basis for the retail distribution of the primary imports: the wholesale trade in the

great staples of foreign commerce was likewise carried on in fairs. Particular fairs came to be frequented by the foreign merchants and the itinerant retailers. At times the rise of fairs to peculiar importance was due to genuinely important economic factors, such as the location of the town with reference to trade routes or its relation to the more important manufacturing districts, but in many instances relatively trivial circumstances were suffi-

The great fairs



cient to occasion a notable gathering of traders. Many of the famous fairs of Europe were thus held in places of no especial importance otherwise. When such gatherings of traders appeared at a fair the period was usually extended, first to two or three days, then to a week, and finally perhaps to a month.

The foreign traders attending such fairs, like the retailers frequenting fairs of lesser import, were disposed to arrange a circuit which would enable them to come in contact with all the regions producing the goods sought by them, so that the fairs which become prominent in connection with the wholesale trade of Europe tend to fall into more or less definite cycles. This tendency is most clearly apparent in Continental Europe, where the fairs of Champagne and of Flanders constitute two closely organized groups of fairs. There were six fairs in each group, distributed throughout the year. As the manufacturers attending the various fairs came from somewhat different areas, the wholesale market was relatively comprehensive as regards area and approximately continuous as regards time.

In England, the cycle of wholesale fairs was not so definitely organized: the fairs were not subject to any common administrative regulations, as was the case with the fairs of Champagne, and as we have no knowledge of the credit organization of the English fairs we cannot be certain that the most distinctive features of a fair cycle were present. The more important fairs, however, succeeded each other in a convenient sequence and the arrangements made by the royal treasury indicate the presence at these fairs of a substantially identical group of traders. By letters patent of November 16, 1240, the bailiffs of Winchester were ordered to make known to all merchants "the provision of the King and Council that the King's prizes<sup>1</sup> from merchants shall be paid at four terms of the year, to wit, prizes due at the fair of Northampton in the fair of St. Ives; prizes due in the latter, at the fair of Boston; prizes in the latter, in the fair of Winchester; and those due in the

<sup>1</sup> See *infra*, 151.

latter, in the fair of Northampton.”<sup>1</sup> The group of fairs mentioned presents the following sequence: the fair of Saint Ives, eight days beginning Easter Monday; the fair of Boston, eight days beginning with the feast of Saint John the Baptist, June 25 to July 2; the fair at Winchester (Saint Giles’s Fair) August 31 to September 15; the fair of Northampton, November 17 to 25. Other evidence shows that the merchants usually attended the fair at Lynn, immediately following the fair at Boston, and a fair at Stamford is mentioned as important, though perhaps not equally important. In so far as debts contracted at one fair could be paid at a subsequent fair, this English fair cycle closely resembles the Continental fairs. The King, at least, received goods and money due at one fair at a subsequent fair.

In picturesque accounts of fairs there is a tendency to emphasize the variety of goods displayed for sale, and one frequently carries away the impression that the *Business of fairs, and particularly the great wholesale fairs, a fair* were devoted to trading in all the goods known to the period. Distinction should be made between the classes of goods whose purchase and sale were the main purpose of the fair, and the classes of goods in which incidental trading was inevitable. The gathering of any great crowd of traders would require more than the usual activity of trade in food, especially cooked foods. Butchers, bakers, and all classes of cooks were thus a prominent feature of any fair. Possible disparities between the volume of goods brought to the fair and purchased there would inevitably require many merchants to add to their train of pack-animals. Dealing in horses, mules, and their equipment was therefore an incidental feature of every considerable fair. The assemblage of traders, furthermore, created a demand for more or less craft-work; blacksmiths, saddlers, harness-makers, barbers, tailors, and the like would all find special opportunities for custom. Carpenters would be in demand to put up and take down the light wooden booths that were used during the fair. The incidental work of the fair would thus be representative of

<sup>1</sup> *Cal. Pat. Rolls* 1232-47, 239.

the normal life of the community. All this business must properly be distinguished from the main business of the fair. These English fairs were especially devoted to the trade in wool, cloth, and hides. Foreign goods were exchanged for these products: wines from Gascony; spices, drugs, and dyes, coming by way of the sea or from France and Flanders; wax, linen, German wines, and other characteristic products from the Hanseatic towns of the Baltic. But the exchange of products does not seem to have been as elaborately organized in England as it was on the Continent.

Sympathetic understanding of the relation of fairs to medieval trade is made particularly difficult by the obtrusiveness of the dues levied on merchandise entering or leaving the fair, and by various restrictions on trading. The **Tolls and dues** *laissez-faire* thought of the nineteenth century made all these features seem excessively restrictive. Kitchin expresses this view characteristically in speaking of Saint Giles's Fair at Winchester:

The regulations of the fair were on every hand arbitrary and oppressive; and, if it relieved the city of Royal exactions, it at the same time destroyed its independence; all trade was forbidden in the city and in the "seven league circuit"; no man might buy or sell aught except at the fair; the Civic Authorities had no jurisdiction, even over their own citizens; nor indeed could any lord of a manor hold his Court-baron within the circuit of the seven leagues, except by special leave from the Pavillion Court. The tolls taken at the gates of the Fair were a considerable burden on traders and buyers and were levied on Englishmen or foreigners alike.<sup>1</sup>

These presumptions in favor of free trade tend to create prejudices against the whole structure of medieval commerce.

**The freedom of the fair** It seems to be burdened with excessive dues and cramped by unnecessary regulations. In looking for the frank economic freedom that is assumed by the modern thinker to be necessary, we frequently fail to appreciate the extent of the legal enfranchisement that was guaranteed by the fair. "At fairs and markets," says Lipson, "full freedom of traffic was accorded indifferently to alien

<sup>1</sup> Kitchin: *A Charter of Edward III*, 21.



and to native, to burgess and to stranger; and it was this policy of free trade and the open door which attracted traders and afforded scope for the unrestricted play of commercial forces." In the context this passage could hardly be misunderstood by any one familiar with the constitutional history of the medieval period, but the phrases "free trade" and "the open door" are singularly infelicitous because they suggest that the freedom guaranteed by the fair was fiscal and economic rather than legal.

We can know little of the actual burden of customs and tolls during the medieval period. The multiplicity of dues and the obtrusive methods of collection would seem to make it inevitable that the burden of indirect taxation was greater than it is to-day, but one must remember that the less obtrusive burdens of modern customs are none the less real because less consciously felt. In the middle ages the larger portion of public revenue, such as it was, came from direct taxes on land and incomes from land. Much medieval trade was carried on under special licenses, and evasion of customs was easier than it is now. Although the burden of indirect taxes was undoubtedly considerable, we do not really know whether it was greater or less than it is to-day. The fair was certainly not primarily a mechanism for lightening fiscal burdens.

The essential feature of the fair was the creation of a special court in which all parties, of whatsoever extraction, should have equal rights. In the other courts a citizen of a foreign country, or even a resident of another locality in the kingdom, would have no rights. <sup>The fair court</sup> The law of the land was indeed as narrow in spirit and letter as has been represented by writers who represent the medieval period as dominated by intense localism, manifested characteristically in the conception of an essentially exclusive municipality. The notion of the town economy is a legitimate interpretation of the developed municipal constitution. If there had been no other legal arrangements, trade would have been impossible. The notable feature of the fair, therefore, was the creation of a special court, which lasted throughout the fair, and, for the

time being, supplanted the other local courts. At Winchester the fair courts were charged with all legal business of the fair, the town, and a circuit of seven leagues within which trading was prohibited during the fair. In this manner the legal disabilities of aliens and non-residents were completely overcome. The suspension of the municipal constitution during the period of the fair at Winchester is symbolic. As Kitchin says, the civic authorities did not have jurisdiction over their own citizens during the fair: the policy of municipal selfishness of the town was nullified by the freedom of the fair.

These fair courts administered a different kind of law. Local courts, whether in England or on the Continent, were charged with the administration of a body of law that was essentially formal. Pleadings must needs follow definite forms and errors of form were absolutely fatal. The omission or misplacement of a word would prevent a person from securing legal relief. Customary law, too, was relatively rigid. The number of writs that might be issued by the local courts was limited, and if anything arose that created a new problem it was practically impossible to secure relief. The fair courts, which came to be called "Pie-Powder Courts," were the lowest courts in the legal hierarchy, but they administered a kind of law that gives them a notable place in legal history. Procedure was designed to be informal; the substance of the case was regarded as more important than the form of the pleadings. It was intended to make procedure sufficiently simple to enable merchants to dispense with lawyers. This complete informality of procedure was not always achieved, but in a measure the law enforced by these courts was administered by merchants without special legal training. In the decision of cases the judge was presumed to be guided by his conception of what was just and fair. Because merchants were primarily concerned with contracts, the Law Merchant was particularly rich in cases concerning the enforcement of contracts, and when the various types of commercial paper began to appear, they were recognized soonest in this special body of law de-

The Law  
Merchant

veloped with reference to the needs of the mercantile community. The Law Merchant and its special courts thus enabled the merchant to do business, although the ordinary courts and the general body of law were wholly inconsistent with the existence of the very mobile trader that was typical of the period. Trade and traders stood outside the general legal framework of society.

The special merchants court, the "Pie-Powder Court," originated in the fairs, but courts administering the Law Merchant came to be established in many towns. In the English boroughs the distinction between the mercantile jurisdiction and the ordinary jurisdiction was not always well drawn; at times one court administered two kinds of law, at other times there were two courts with distinct series of records. In the earlier stages of this development the borough court could administer the Law Merchant only during the period of the fair, but this restriction was ultimately removed, and cases under the Law Merchant could be heard at any time. These extensions of the jurisdiction of the courts of towns and boroughs thus resulted in a significant extension of the legal enfranchisement of strangers. Many privileges of the fair became essentially continuous, so that much trading could be done at all times. These possibilities must have tended to restrict the importance of the great fairs by giving the wholesale trader sufficient legal freedom to make him relatively independent of the privileges associated with the fairs. It is possible that the early decay of the great international fairs in England was due in a measure to the development of other and better methods of handling the wholesale trade. In this respect, at all events, there seem to be differences in the mechanism of trading in England and in Continental Europe that are as yet ill-understood.

The relations between England and the Continent were peculiar in a number of respects. The Kings of England possessed territorial rights in France which made them grant special privileges to merchants who were in a sense strangers, but none the less their subjects.

*Extension of  
the Law  
Merchant*

*Charters to  
alien merchants*

Thus a charter of Edward I to the wine merchants of Aquitaine (August 13, 1302) placed them under the special protection of the King "in England and elsewhere within his power." He gave them the right to "trade in gross in the cities, boroughs, and merchant towns either with natives or inhabitants of the said realm or with foreigners, strangers, or with private persons."

The said merchant vintners may lodge in the cities and towns where they will, and tarry with their goods at the pleasure of the owners of the inns or houses. All contracts made by the said vintners with any person shall be good, so that neither merchant can recede therefrom, when once earnest money has been paid. . . . All bailiffs and ministers of the fairs of the cities, boroughs, and merchant towns shall do speedy justice from day to day without delay, if they complain to them of wrongs, vexations, or touching debts or other pleas, and the justice shall be according to the Law Merchant; if there be found any default in the said bailiffs or ministers, whereby any of the said vintners have experienced delay, even though the vintner has recovered his losses against the principal party, nevertheless the said bailiff or minister shall be punishable by the King, and this punishment is granted as a favor to the said merchant vintners to hasten the doing of justice to them.<sup>1</sup>

By the "Carta Mercatoria" it was provided that there should be a special judge in London to hear pleas of alien merchants, if the sheriffs fail to do speedy justice. The foreigner thus came to have many rights by reason of the complexity of jurisdictions which it is so hard for us to understand to-day. We are accustomed to a legal system that administers the same law to all parties; in the middle ages each class in the community enjoyed some special privileges and was subject to a somewhat different set of legal arrangements.

### III. ASSOCIATIONS OF MERCHANTS

The merchants coming to England from foreign parts sometimes came as purely individual traders; but the traders coming from the Baltic towns, a particularly important and numerous group, began at an early date to form associations

<sup>1</sup> *Cal. Charter Rolls*, III, 29-30.

which were designed to protect the individual merchants during their residence in England. They formed a "hanse" — an association of merchants recognized by the State. At a later period, and in France during the early period, these associations were called "companies," but they were not companies in any modern sense of the word. Privileges and real estate were held as corporate property, but trading was always strictly individual, even when the intrusion of fraternal elements into the association gave rise to the obligation to share advantageous bargains with fellow members. In medieval England there were three associations of merchants of fundamental importance: the Hansards, <sup>Trading</sup> from the German and Baltic towns; the Mer- <sup>associations</sup> chants of the Staple, merchants, mostly native Englishmen, trading in wool to the Low Countries; and the Merchant Adventurers, English merchants, who began in the fifteenth century to compete with the Hansards for the control of English trade with the Baltic. A fundamental feature of all these associations, whether of foreign or of native merchants, was the acquisition of rights and privileges designed to overcome the restrictive features of municipal and even national regulations of commerce. Commerce could thrive only under a régime of special privilege, and these great mercantile associations held as a cherished corporate possession the more important franchises granted to trade and traders.

The origin of the association of Germanic merchants is obscure. The earliest references to an organization reveal the existence of an association substantially <sup>The Hanse</sup> similar to a merchant gild located at London and composed exclusively of foreigners, primarily merchants from Cologne. In 1157 specific reference to a house belonging to these merchants appears in the patents by which they were guaranteed the protection of the King. Their persons and their property were thus assured of legal safeguards: they were under obligation to pay various duties and were charged with repairing the Bishop's Gate. In many ways, therefore, their position was comparable to that of native citizens of London. The growth of the municipality tended

to sharpen the distinction that existed between these privileged foreigners and the citizens, for the foreigners did not participate, as such, in the rights of self-government that were gradually acquired by the citizens, though citizenship was not incompatible with membership in the Hanse and a number of Hansards rose to prominence in the government of the City. In this early period, when both foreigner and native born were subject to royal judicial and administra-



tive officers, there were few essential differences in civil rights. It is important to note that the Hanse privileges were based on royal grants which were later recognized by the Mayor and Burgesses of London. The agreement of 1282, however, seems to indicate some subordination of the Hanse merchants to the City. The merchants of the Hanse were governed by an alderman, who held court independently of the jurisdiction of the City, but it was provided that he should be a person enjoying <sup>Privileges</sup> the freedom of the City, in other words, a citizen of London. He was also required to take oath before the Mayor and Burgesses of the City.

The establishment of the merchants of Cologne proved to be the nucleus of a larger group. Merchants from the Baltic ports, notably Hamburg and Lübeck, appeared in London. At first there were many jealousies. In 1266 and 1267 merchants from these towns gained recognition as independent associations, but these separatist tendencies were subsequently overcome and a general association of German merchants was formed. The agreement above mentioned is usually assumed to indicate the disappearance of the independent organizations, as only one association is referred to. Right to maintain permanent establishments in the provinces had also been acquired; the first stations were <sup>Stations of</sup> at Ipswich, Yarmouth, Lynn, and Boston, and <sup>the Hanse</sup> though they enjoyed some measure of independence they were subordinate to the establishment at London. A merchant could not become a member of a provincial establishment nor enjoy its privileges unless he were a member of the London Hanse.

Details of organization varied considerably during the existence of the association, so that it is not possible to give any general sketch of the system of organization. The Alderman of the German Merchants at London was presumed to act as spokesman and as defender of all German merchants in England, but in practice his control of the provincial associations was not very great. Both at London and in the provincial stations there were a considerable number of Ger-

mans in permanent residence, and the civic and judicial functions of the association were of course largely exercised by them. There were some merchants whose business kept them traveling between the countries, but the general tendency was to establish partnerships embracing permanent residents both in Germany and in England.

The activities of the Hansards were not confined to the towns in which they had permanent establishments. They traded in many towns, at many fairs, and were active in the country districts, buying both cloth and wool. They claimed the right to engage in retail as well as in wholesale trade throughout the kingdom. The claims were persistently opposed by native merchants, but the Hansards retained a significant hold on the trade of the kingdom until their expulsion. In the early period the imports consisted chiefly of furs, tar, and salt fish; the exports, of wool, leather, and cloth. The extent of the trade increased notably. All the tar products, iron ore, steel, copper, wood and manufactures of wood, grain, flour, flax, linen yarn, silks, malt, beer, wines, woad, and drugs, came to be regularly imported. The list of exports was not similarly extended.

The establishment of the Hanse acquired the name "Steel-yard" in the fifteenth century. The association had increased its holdings of real estate and enlarged its warehouses and living accommodations so that it was possible to house all members in buildings owned by the corporate group. The growing hostility of the citizens and traders of London was perhaps a contributory factor. At all events, the separateness of the Hanseatic jurisdiction was more and more sharply emphasized and the older individual freedom of the merchants gave way to a system of living that brought into prominence the fraternal and communal elements that had always been latent in the idea of the association. The hostility of the City inevitably forced the Hanseatic merchants into closer dependence upon each other.

Among the privileges of the Hanse in the early period were



special exemptions from the payment of customs duties. The liberal policy of Edward I toward foreign merchants was embodied in a group of documents: <sup>Fiscal privileges</sup> some grants of privileges were addressed to particular groups of merchants, such as the wine merchants of the Duchy of Aquitaine and the Hansards; there was also a grant of essentially similar privileges to merchants of all nationalities in the "Carta Mercatoria" of February, 1303. The privileges claimed by the Hansards are presumed by many to have been founded on the general grants of this "Carta Mercatoria," as the special charter cited by Hubert Hall <sup>1</sup> seems to have been overlooked. These documents, like most medieval grants of privilege, were definitely reciprocal agreements: in exchange for certain franchises the King received certain financial considerations. The alien merchants received assurance of personal security, guarantees of certain commercial privileges, and legal rights. In return, they agreed to pay certain additional import duties. According to these arrangements the aliens were subject to the payment of duties which were perhaps fairly heavy, but absolutely certain.

The native merchant was not under any obligation to pay duties, but he was obliged to sell his goods to royal agents whenever the goods were needed, or alleged to <sup>Prise</sup> be needed, by the royal household or the military establishment. This exercise of the feudal obligation of purveyance, or "prise," amounted in fact to obligatory sale to the King at such price as the King's agents were pleased to name. The prices set were usually low so that resale at a profit was possible and usual. It was thus in reality a tax that was capricious in its incidence, and also a method of making the Crown an unfair competitor in trade. This right of prise was a source of revenue to the Crown in any case; if the purchase were actually used by the royal household or for state purposes, those needs were supplied for much less than the normal market price, if the goods were subsequently resold, the royal treasury was the beneficiary of the commercial transaction.

<sup>1</sup> Hall: *Customs Revenue*, I, 24.

As long as these rights of prise were maintained the native merchants were constantly menaced by the possibility of royal exactions that might well be heavier than any definite customs duties. The establishment of formal import duties with reference to alien importers was thus relatively favorable to the alien merchants, despite the fiscal burdens involved. The civil and legal rights acquired were worth the price. The King, too, gained; he could not exercise the right of prise over aliens.

In the "Carta Mercatoria" alien merchants were assured personal security; they were given the right to reside in cities, boroughs, or merchant towns; they were exempt from the payment of various municipal taxes; the obligations of all contracts were guaranteed; judicial officers of cities, towns, and fairs were required to render prompt justice to all merchants, according to the Law Merchant; they were guaranteed freedom from all prises or delays due to prisage. The commercial privileges of the charter were especially significant with reference to the development of the trade of the Hansards: aliens were given the right to engage freely in wholesale trade with natives and with foreigners, and in the retail trade in mercery. The term "mercery" is conveniently vague. At all times a somewhat artificial classification of goods, the list of merceries tended to increase in each successive generation, both in England and on the Continent. Some of the textiles, most small manufactured articles, and various drugs fell within the scope of the term "mercery" at various times, and these were the wares which were most frequently retailed by wealthy merchants engaged simultaneously in wholesale trade.

The privileges of the "Carta Mercatoria" were subsequently withdrawn from the general body of merchants, so that the special grants that had been made at that time became singularly important, as they maintained the régime of privilege for the Hansards and some other small groups of merchants. The Hansards were obliged to defend their privileges on a number of occasions, but they seem on the whole to have succeeded in maintaining their claim to exemp-

tion from any duties not provided for in the schedules of the grants of 1303. This principle was definitely acknowledged by the Crown in 1354, but toward the close of the century the needs of the treasury resulted in new demands on the part of the Crown which the Hansards were not able to resist. At that time increased burdens placed on native merchants had created notable preferences in favor of the Hansards. The interminable negotiations over these fiscal matters are obscure and tiresome, but the fact that alien merchants actually enjoyed preferences to the disadvantage of the native merchants is of substantial importance.

The late fourteenth century, characterized by these fiscal struggles with the Crown, marks the culmination of the commercial importance of the Hanseatic merchants. The organization was important throughout the fifteenth and sixteenth centuries, but it was gradually losing ground, in England as in Germany. Political disorder was a cause of decay in Germany. In England competition with English merchants was the principal factor, though of course the growing importance of the English trading community was furthered by the weakness of the Hanseatic League in Germany and the Baltic regions.

The appearance of the Merchants of the Staple is the first indication of an organized attempt of native merchants to secure some share in the wholesale trade that had remained in the hands of aliens until the late thirteenth century. The Staple, as the term is used in English history, was the town or group of towns designated by the King as sole exporting points for wool and wool fells. This concentration of the export trade in wool seemed desirable from the fiscal point of view. If the movement of wool followed a definite course in the process of exportation it was much easier to be sure that the export duties would not be evaded. The town or towns designated as Staple ports might be in England or on the Continent: if English ports were designated it was practically necessary to designate a number of places conveniently situated with reference to the various

centers of wool production; if a Continental town were chosen a single town would suffice, as the trade could be more easily concentrated. For this reason, doubtless, a Continental Staple port was favored. During the period 1285-1392, there was no Staple at all for seven years; for thirty years, not consecutive, the Staple was in various English towns; for the remaining seventy years, the Staple was at Calais or some town in the Low Countries. Throughout this period the location of the Staple was highly uncertain, but for the century and a half that followed, until 1558, the Staple remained at Calais.

The body of merchants that ultimately came to be known as "Merchants of the Staple" did not acquire charter rights until the fourteenth century. The development of this organization is obscure.

There were certain merchants of the realm, both native and foreign, whom the king was accustomed to call to consult with him in his council concerning loans, customs and subsidies, grants of wool and other matters touching their trade and the king's need. These were probably the richest and most influential of the wool merchants. When Parliament gave the king a grant of wool, he negotiated with these merchants for the sale of it to them outright, at other times he arranged with them for a certain part of the proceeds, after they had sold it in the continental market. They were habitually spoken of as the "king's merchants" or the "merchants of the realm." When they had the king's wool to sell, they were obliged to take it to the market which he had established; and it was because of injury done to them and through them to the king, by not attending the same market, that the other merchants were compelled to go there also. Those merchants of the realm who sold the king's wool formed, then, the nucleus of the famous English Company known in later times as The Mayor, Constables and Fellowship of the Staple; and out of their organization grew the organization of the Staple.

It is obvious from the charter that the merchants already had some slight degree of organization. The whole body of the "merchants of the realm" constituted a *communitas*; they were evidently in the habit of acting together, and they had a *major*. We know that the charter did not create the office of mayor, since a few months before it was given, a "mayor of the merchants of the realm" had been sent on a diplomatic errand to the count of Flanders. The

charter also mentions a council of these same merchants with which the mayor was to act in cases of infringement upon the rights granted. There is no indication whether the council was a new institution or whether it had existed before.

It was these special "merchants of the realm" whom the king chose to sell his wool, who first attended the Staple. The center about which they were organized was the king; they were primarily the "king's merchants." But after 1313 the other wool merchants also went to the Staple. The records begin to speak of the "Merchants of the Staple." The Staple became the center about which they were organized, and with this change there gradually came a change in the title of the mayor to "Mayor of the Merchants of the Staple," or simply "Mayor of the Staple."<sup>1</sup>

These merchants constituted a distinct body from the citizens of any town in which the Staple was held. "They dwelt by themselves in certain streets or houses Their special status set apart for them: they elected their own officers, who governed them according to royal ordinances, who judged them according to the Law Merchant, not according to the Common Law."<sup>2</sup> This company of merchants were an important factor in the commerce of England until the exportation of wool was prohibited in the seventeenth century. With the passing of the export trade in raw wool the company ceased to possess commercial importance, but the existence of a moderate amount of property gave the company an unwarranted length of life, for the organization still exists as a sort of endowed club.

The Company of Merchant Adventurers owes its origin to the same general circumstances that had earlier created associations of alien merchants in England. Civil The Merchant Adventurers disabilities in towns, uncertainties of legal status, and absence of any national organization for the protection of subjects in foreign parts made it necessary that there should be some organization capable of dealing with foreign states and of acting as the corporate recipient of franchises and privileges. The Company of Merchant Adventurers, however, came into great prominence only toward the

<sup>1</sup> Jenckes, A. L.: *The Origin, the Organization and the Location of the Staple of England*, 13-14.

<sup>2</sup> *Ibid.*, 15.

close of the fifteenth century, and the period of its commercial significance extends through the seventeenth century.

English traders who were actively engaged in commerce with the Low Countries began to receive grants of privileges in the thirteenth century, and seventeenth-century writers, who were very anxious to carry the origins of the company far back into the past, declared that these grants were the basis of the Company and Fellowship of Merchant Adventurers. But these grants were made to Englishmen generally and not to any specific group of traders. The origins of the company are obscure. There were some administrative officers before the membership in the organization was rigidly defined. Persons trading in cloth and other goods to the Low Countries were evidently presumed to be members of the organization by fact of being English traders. Membership implied nothing more than subordination to the jurisdiction of the Governor, which was primarily in the interest of the individual trader. When the administrative business increased in volume, fines came to be levied to meet the necessary expenses; in theory, these were an obligation upon all English merchants engaged in trade in the commodities which had become the affair of this group of merchants. The goods handled were in general the exports not covered by the regulations of the Staple; primarily, therefore, undyed cloth. The years of the fourteenth century, in which there was no Staple on the Continent, proved to be especially significant in the development of more formality of organization among the cloth traders who had followed, as it were, in the wake of the Staple, securing a certain amount of protection to which they were not technically entitled. Grants made in 1359, by reason of the removal of the Staple from Bruges, are in a measure the most specific beginning of the formal organization of the company. A charter of 1462 recognizes the obligation of all English traders in the Low Countries to pay fines to the organization, and in 1505 a more specific charter established a society with a strong central administration.

The sixteenth century was marked by the struggle of the

Merchant Adventurers with the Staplers and the Hansards. The gradual decline of the wool trade and the rise of the woolen industries in England gave increasing importance to the cloth trade. With the change in the relative importance of these branches of trade many Merchants of the Staple turned from their privileged trade to the cloth trade. The Merchant Adventurers declared that they had a monopoly of the cloth trade. It was not their intention to exclude the Staplers from the trade, but merely to secure the fines from their membership. The Crown did not sustain the claims of the Merchant Adventurers, but seventy-three Staplers joined the company. One must regard the Merchant Adventurers of this period, therefore, as an inclusive monopoly, expressing with some formality the spirit of the early grants of privilege — the inclusion in the organization of all English merchants actually engaged in the cloth trade with the Continent. In the seventeenth century the membership roll of the company had become subject to many restrictive measures. Apprenticeship was required, and a variety of exclusive features were embodied in the rules. The determined attack on the company as a monopoly begins in the seventeenth century and continues with no significant interruption until the monopoly was abolished in 1688.

The struggle between the Merchant Adventurers and the Hansards is an intricate episode that involves much detail of Continental commerce and politics. The Merchant Adventurers were eager to exclude the Hansards from England, and the Hansards equally intent upon a restriction of the rights of the Merchant Adventurers in Germany. The Merchant Adventurers were relatively successful, though there were elements of compromise in the general settlement. The Hansards were allowed to maintain themselves at London in the Steelyard, and in return the Merchant Adventurers received valuable privileges at Hamburg. The trade of the Hansards, however, declined steadily after the middle of the sixteenth century and they ceased to be an important factor in the trade of England.

## IV. TOWNSHIP AND BOROUGH

The economic and constitutional problems that are associated with the development of urban life are in many ways distinct. The lawyer is peculiarly concerned with the growth of the municipal corporation; the economist should properly be interested in the differentiation of urban and rural communities. These problems are related, but they are not identical. Three types of urban community were ultimately recognized in medieval English law: the city, the borough, and the market town. The city was a privileged jurisdiction which was also the seat of a bishop. The borough was a privileged town, enjoying rights of a vaguely determined character which ultimately led to its recognition as a corporation. The market town was an urban area devoid of any distinctive legal privileges, for the existence of a market was not in itself an evidence of the urban character of the settlement. The economist should therefore be occupied with the conditions affecting the development of a somewhat larger number of places than the lawyer, whose boroughs are only a single class of urban settlement. Furthermore, boroughs were in some cases so small that they do not differ from villages except in their possession of privileges. The development of the municipal corporation is thus only a portion of the general subject of the growth of urban life.

We are hardly in a position to trace all the stages in the gradual differentiation of urban from rural communities, but we can perhaps describe the points of departure and define roughly the outstanding features of a community that has become urban. There might be a disposition to assume that the distinction between the urban and the rural community should turn upon the degree of concentration of population. This simple basis of distinction encounters serious difficulties of fact. Periods of undoubted importance in the development of the relations between town and country were not distinguished by sufficient growth of population to afford much presumption in favor



of a theory which places primary emphasis upon the mere number of people living in the settlement. In the time of Edward the Confessor there were 400 houses in Cambridge; in 1279, there were 534 houses. In the meantime great changes had taken place in the legal and economic relations between Cambridge and the county — changes that could hardly be explained by the increased importance of Cambridge as a center of population.

Cambridge was not a particularly large town, but it was fairly representative. In the Saxon period there was at least one town in each county, though some coun- <sup>The military</sup> ties possessed two or more. These towns, how- <sup>theory</sup> ever, should not be characterized as urban settlements. The Saxon county seats and many if not most of the Saxon towns were aggregations of people for the purpose of maintaining a military stronghold. The rural communities of the county were presumed to contribute to the maintenance of the walls by money payment or labor services, and in many instances this obligation assumed the form of maintaining a house in town. The tenant of the house was presumed to perform certain defined duties with reference to the repair of the walls. The population of the town was thus drawn from all parts of the county. The motives underlying this aggregation of population were not economic but military, and for this reason it cannot unreservedly be called an urban settlement.

The fundamental economic problem is to explain how the inhabitants of these towns gained a living. The towns were surrounded by fields which were organized for agriculture after the manner of the fields surrounding the villages of the countryside. Until population passed a certain point there is no difficulty in presuming that the burgesses who maintained the walls of the town were primarily engaged in agriculture. They were thus scarcely distinguishable from the villagers of the county. But not all the inhabitants of the towns and boroughs could live on the product <sup>Artisans and</sup> of agriculture. Various artisans and traders <sup>traders</sup> are discernible, just as in the villages. Each village main-

tained a few artisans who were more or less completely dependent upon their craft-labor. Now if a village were required to send some one to reside in the county seat to repair walls, it is entirely conceivable that artisans should be selected in preference to others, or that persons selected should become artisans. There would be little or no inconvenience in the concentration of certain types of village artisans at the county seat or borough, and there were some advantages. During the Saxon period trading was prohibited outside of the boroughs. The publicity of the town and its assemblages of people made it easier to secure proper witnesses to transactions. Under such circumstances industry might well become somewhat concentrated in the towns without requiring us to presume that there were any economic motives underlying such a location of the craftsmen of the community. In so far as burgesses were sent up by lords of manors there would be even greater likelihood that the choice would fall upon the artisans of the estate rather than upon the agriculturalists. The mixed condition of the population of the early borough is illustrated by a statement about the Borough of Buckingham in the Domesday Survey. There were twenty-six burgesses on the King's demesne who held eight carucates of land, and twenty-six burgesses "contributed by various lords" who owned no land. The burgesses on the royal demesne had sufficient land to maintain themselves and their families by farming; the others had no visible means of support unless we assume them to be artisans.

The beginnings of concentration of population, in England at least, were not wholly an outcome of economic factors. The interests of a rural community widely scattered over the land were not the initial factor in setting off certain settlements differing in size and legal organization from the rural villages. The towns owed their origins in many cases to military necessities, in other instances to administrative convenience. The borough, in so far as it was a county seat, was not merely a fortress, but the "moot-stow," or meeting-place, for the county. This func-

County seats

tion made special administrative organization desirable. It was better that the borough, as county seat, should not be part of any of the administrative divisions of the county — the hundreds.

The borough [says Maitland] is a vill which is a hundred; or it is a vill which has an organization similar to that of a hundred. The idea is familiar to us; it is in our classical book. Perhaps it is too familiar, for is there not here a new departure in the history of institutions? We are to have a "tun," a vill, with a jurisdictional organ, with a moot that can speak law. Ought we not to ask what thought lies behind this vill that is a hundred? Will it be fantastic to compare small beginnings with a great achievement?

The city of Washington is not in any of the united states of North America. Why not? Because it is the "moot-stow" of the great republic. The *civitas* (city) of Cambridge is not in any of the hundreds. Why not? Because it is the county's town, the moot-stow, fortress, and port of the republic of Cambridgeshire.<sup>1</sup>

Towns came into being for many reasons, and it would seem that the economic advantage and functions of the urban as distinct from the rural community were among the later reasons for these aggregations. <sup>The problem</sup> of people. The economist must, therefore, seek to discover if possible when people came to live in towns because it was economically advantageous, and not by reason of political obligation or administrative convenience. In an age that leaves scant record of its doings, it is perhaps more than we should expect to be able to accomplish. It is difficult at all times to ascertain motives, and particularly in the middle ages. But it is important to recognize problems even if solutions are not forthcoming.

The period that elapses between the Norman Conquest and the thirteenth century was not marked by any notable changes in the population of boroughs and towns, so far as we know, but the changes that were taking place in the character of town life and the growth of commerce and industry may well furnish grounds for presuming that the economic advantages of town life were beginning to be consciously felt in England.

<sup>1</sup> Maitland, F. W.: *Township and Borough*, 41.

We are not obliged to suppose that the balance of motives was identical in all towns, much less that motives were identical in all countries. The relatively sparse Growth of towns population of England will probably explain the differences that may be noted between England and the Continent. Furthermore, we must realize that there were economic factors underlying the growth of the larger towns that were not present in the life of the smaller towns. With all these qualifications we may regard the thirteenth century as the period that marks the undoubted rise to importance of the economic basis of urban life. Changes took place in the character of the privileges and rights of towns. Changes occurred in the volume of trade which occasioned significant development of fairs and markets. Lastly, the woolen industry rose into prominence as a specialized industrial occupation. One must presume that these changes were closely related, and it would seem safe to say that the economic factors in town life became at this time a predominant factor in their growth.

The constitutional development toward the incorporated town is therefore roughly contemporaneous with the change The idea of a corporation in the character of the urban unit that was an outcome of the increased importance of the economic factors in town life. Elements of corporate personality begin to emerge in the thirteenth century. The idea was not at that time familiar to English jurists, however, and though there were many features of municipal organization that implied the existence of corporate personality, the documents do not recognize this fact in any formal statement. In the following century the corporate idea begins to appear in occasional charters, though the form of the grant was not as explicit as the form inaugurated by the charter granted the town of Hull in 1437. The towns did not become full-fledged corporations until a relatively late period. They were not "complete political structures," to use Schmoller's phrase, until the general character of medieval life was fairly well fixed. Much of the commercial structure of the middle ages had taken definite form before the municipi-

pal constitution was sufficiently developed to admit of much consistent policy. The town was not so completely "isolated" in its economic relations as Schmoller declared, and the period of its political power coincided with the declining prosperity of the late fourteenth and fifteenth centuries.

In England, at least, there seems to have been an intermediate period between the rise of the town as an urban settlement in the twelfth century and the acquisition of complete corporate privileges in the fourteenth and fifteenth centuries. In this interval the gild merchant was of vital significance. It was an institution which existed in conjunction with the municipality without ever being entirely identified with the town either in its membership or its official staff. Although the gild merchant is a trading organization that possessed much importance in the municipalities it can be studied most advantageously in connection with the other types of English gilds. Its existence and importance afford further evidence of the tendency already mentioned to organize the trading community independently of the municipalities. The group of persons living in the town were not all subject to the same jurisdiction. The town as an urban center was distinct from the municipality, and it is for this reason that the municipal charters may obscure the commercial organization of the period if they are literally interpreted.

The medieval town differed from the cities of the ancient world most notably in the greater dependence upon the economic bases of urban life. Adventitious political and administrative elements, which had contributed largely to the beginnings of town life, sank into the background. Towns which possessed no economic advantages lost their importance and were distinguishable from villages only by their privileges. The increased emphasis upon trade and industry made the town much more than a mere county seat — fortress and moot-stow for the little rural communities of the vicinity. The general urban movement of the thirteenth and fourteenth centuries was part of the commercial development of western

International  
importance of  
towns

Europe. The towns became part of the economy of the entire body of Christian states, and each town thus became a point of contact between its immediate neighborhood and the outside world. The urban communities became the means of promoting the economic interdependence of the European world.

Social life of the medieval period is perplexing because it seems to involve a paradox: it is at once intensely local and intensely cosmopolitan. Institutions, particularly institutions concerned with the administration of law, were highly localized. There was a maximum degree of legal decentralization. Society thus seems to be divided into tiny autonomous units: villages, manors, towns, and privileged ecclesiastical bodies. But despite this appearance of minute subdivision the spirit and essence of medieval life was cosmopolitan. Christendom was a cultural unit, and despite obstacles that loom large to our eyes, there were strong currents of trade and much travel. This general cosmopolitan movement was organized about the towns, and, whatever the appearances, it is well to remember that all the towns found their ultimate prosperity in maintaining communications between the outside world and the little rural communities in their immediate neighborhood.

## CHAPTER VII THE DEVELOPMENT OF GILDS IN ENGLAND

### I

THE interest of modern readers in the craft guilds of the middle ages has created special associations between the general term "gild" and this particular form of gild.

A number of writers, including Professor W. J. Ashley, have given added currency to such a specialization of meaning by using the phrase "gild system" to describe the form of industrial organization which is more precisely described as the craft or handicraft system. This laxity of usage has been peculiarly unfortunate because it adds to the obscurities and complexities of a subject that is beset with the difficulties that come from ambiguities of terminology and misleading connotations. The word "gild," or "guild,"<sup>1</sup> is derived from not less than three roots, and possesses, therefore, even at the outset, a wide range of meanings, some of which have no significant relation to each other. The first of these roots was used in the sense of payment, compensation, offering, sacrifice, worship, idol. The second root expressed the notion of combined or collective action, a meeting. The third root was associated with the idea of a banquet. The word was thus not clearly specialized in the meaning of an association and might refer with obvious propriety to a number of different kinds of societies.

The disposition of the earlier Teutonic writers to trace all guilds to a common Teutonic origin was not unnatural, but one cannot help feeling that this unduly literal scholarship added gratuitous difficulties to the problems connected with these different types of association. Three distinct types of society might be described as guilds: as-

<sup>1</sup> The *New English Dictionary* prefers the spelling "guild," but the tendency in economic writing seems to favor the shorter form "gild." Gross, Cunningham, Ashley, Brentano, Lipson, and Unwin all use the form "gild."

sociations for charitable and religious purposes; associations for commercial or social purposes; and associations designed to share with the municipal authority the supervision of fellow-craftsmen. In England and in Germany these associations were all called *gilds*, though there were usually elements in the name of the society that would be sufficient to indicate the general purpose of the association. Religious associations were usually placed under the patronage of some saint, or connected with the celebration of some religious festival. *Gilds of Corpus Christi*, of the Holy Trinity, of the Blessed Virgin, were to be found in many towns. Some of these religious titles appear in connection with associations that were not exclusively religious in character, for merchant and craft *gilds* were sometimes so closely identified with religious observances that the religious element appeared in the title. In such cases it would seem that there might be grounds for searching for specific evidence of the actual purposes of the *gild*.

All writers have recognized that these three types are somewhat distinct, but many have insisted that the growth of these different forms of association is dominated by some common principle. This thesis was given wide currency by Professor Brentano's essay on the "Origin and Development of *Gilds*," and later writers in dealing with English problems have found it difficult to emancipate themselves from the influences of the misleading suggestions of the old Anglo-Saxon term. The French terminology is different, and French distinctions among these various forms of association. The religious association is designated by a special term both in Latin and in French (*fraternitas-confrérie*). The merchant *gild* for some reason as yet unexplained has left little trace in the history of French commerce. A derivative from the root "*gild*" appears in French terminology in this connection. The craft *gild* is designated by the term "*métier*," the general term for craft. It is therefore necessary to distinguish in French between the organized and unorganized crafts, and thus we have the "*métier libre*" —



a mere group of unorganized craftsmen distinguished from the "métier juré," the chartered craft whose members swear to observe the statutes of the organization. The confrérie, or religious fraternity, plays about the same rôle in France as the religious "gild" in England.

There may have been significant differences in the development of the gild merchant in France, but we can at least affirm that such associations existed. The craft gilds in France and in England also exhibit differences of form. The most notable difference in the history of gilds in the two countries is that in France these forms appear more clearly to be different kinds of associations. The members of these societies were drawn from a single class, and in many cases the same people belonged to two societies or gilds; the different forms thus exerted curious reciprocal influences upon each other, as they were all a part of the daily life of a fairly definite group. The close relations of the different forms of gild to each other cannot be effectively studied, however, unless the larger differences of form and purpose are carefully distinguished.

In commenting upon the statutes of three Anglo-Saxon gilds, Professor Brentano says:

The essence of the manifold regulations of the statutes of these three gilds appears to be the brotherly banding together into close unions between man and man, sometimes even es-  
Brentano's  
tablished and fortified by oath, for the purpose of thesis  
mutual help and support. This essential characteristic is found in all the Gilds of every age, from those first known to us in detail, to their descendants of the present day, the Trade Unions. According to the variety of wants and interests at various times, the aims, arrangements, and rules of these unions have also varied.<sup>1</sup>

This statement errs in two respects: in attributing a fraternal purpose to the craft gild, and in alleging a direct connection between these early associations among artisans and the modern trade union.

The fact that a single term was applied to a variety of organizations in the middle ages can hardly be taken as evi-

<sup>1</sup> Brentano, L.: *The Origin and Development of Gilds*, 3.

dence of a common purpose, and it happens that there is fairly definite evidence that there was no clear fraternal element in the craft gild of the pure type.

Misplaced  
emphasis

In the course of development in England the religious and industrial organizations of craftsmen frequently became one society rather than two parallel organizations of the same persons. To that extent a fraternal element crept into the craft organizations, but it would be an exaggeration to suppose that the craft gild was in general a kind of fraternity. Both on the Continent and in England the religious society and the administrative organization of the craft were distinct; they were different organizations of essentially the same group of men. Although the modern trade union is not comparable to the craft gild, the relation between workingmen's benefit societies and the trade union is substantially similar to the relation that existed between the religious fraternity and the craft gild. These various kinds of gilds are not merely variations from a common type, but essentially different organizations, owing their origin to widely different circumstances and having notably different functions and purposes.

## II. THE RELIGIOUS GILDS

Scattered evidence of religious organizations begins to appear in the Saxon period, but no considerable mass of evidence about such bodies is available until the late fourteenth century. In 1389 the King ordered an inquiry into the property and regulations of these gilds. Each gild was thus required to make some statement of its purposes and of the property in its possession. A large number of the replies of the gilds are still extant. These documents comprise the primary source of knowledge of such gilds. Many of the gilds had doubtless been in existence a long time, but it is seldom possible to trace their history into the remote past. We cannot even be certain that the religious gild of that period was substantially similar to the earlier organizations to which references exist. It would seem, however, that certain common purposes were present in all such associations.

## THE DEVELOPMENT OF GILDS IN ENGLAND 169

The guilds were formed primarily to insure the celebration of masses for the souls of deceased members. This general purpose naturally included the funeral ceremonies, and in some cases an appropriate funeral was guaranteed to members. In order to assure the saying of the masses, the gild was usually endowed with property whose revenue was applied to the payment of gild chaplains. Because this property was really devoted to religious purposes it became a matter of real concern to discover the amount of gild property. The inquiry of 1389 was inspired by royal jealousy of ecclesiastical endowments, and soon afterward the general statute of mortmain was declared to be applicable to gild property. The growth of the religious guilds was thus restricted, and at the time of the Reformation these guilds were technically dissolved, though they were in many instances able to reorganize under new names with new charters.

Although the celebration of religious services was the general and primary function, the activities of the guilds were not confined to such things. Schools were frequently maintained by the guilds and one of the colleges at Cambridge was endowed by the gild of Saint Mary and Corpus Christi. Relief was usually given to brothers or sisters who were in distress through sickness or poverty.

These religious fraternities were usually composed of a number of people worshiping in the same church. In many cases a number of members of a single craft might be prominent in the gild, for the craftsmen were usually grouped in one or more districts of the town and would thus naturally worship at the same church. But even in these cases the craft was not really the basis of the organization. Persons not of the craft would be included, and women were more freely admitted to these guilds than to the craft associations. Nor should one suppose that these guilds were composed exclusively of artisans. The rolls of the Guilds of Saint Mary and Corpus Christi at Cambridge contain many names that have no occupational designation with them; the proper inference from such silence is

of course uncertain, but it is not unlikely that such persons would have been merchants or persons whose income was derived from land.

There is no certain basis of information as to the usual number of members, but lists of founders or charter members are in most cases short, seldom more than ten or a dozen names. Thus:

In the 17th year of King Edward the Third, Ralph Capeleyn, Bailiff; William Double, Fishmonger; Roger Clonyill, chandler; Henry Boseworth, Vintner; Stephen Lucas, Stockfishmonger; and others of the better sort of the parish of St. Magnus near London Bridge. . . commenced and caused to be sung an anthem of our Lady called *Salve Regina* at every vesper, and ordained candles to burn at the time of the said anthem in honour and reverence of the five principal joys of our Lady, and to excite the people to devotion. . . . Whereupon several other good people of the same parish seeing the great seemliness of this service and devotion proffered to be aiders and partners in sustaining the lights and anthem, by paying each person every week a half penny, and soon after . . . they commenced to find a chaplain to sing in the said church for all benefactors of the light and anthem.<sup>1</sup>

Once established the gild was likely to grow to considerable proportions.

These gilds elected their own officers, usually a warden and alderman, at times a clerk, or treasurer, and a summoner.

**Organization** These officials were presumed to exercise the necessary administrative functions and in addition to adjust disputes among the members of the gild. New rules and regulations were made in the general meetings of the gild as a whole. These business meetings should be distinguished from the general assemblies of the members at funerals or church service, and likewise from the feasts held each year. At all these occasions, however, the members of most London gilds and of various gilds in other towns appeared in a distinctive costume or livery. This costume was made at the direction of the wardens and paid for by members at cost. If complete it consisted of both hood and gown, but sometimes the hood was allowed to suffice.

<sup>1</sup> Cited, Unwin, G.: *Guilds and Companies of London*, 115.

## THE DEVELOPMENT OF GILDS IN ENGLAND · 171

There is reference at times to the secrets of the guilds, and there are many indications that the authorities at all times distrusted these religious organizations, fearing apparently that other purposes were concealed beneath these professions of religious zeal and charitable intentions. In the early times, too, the Church distrusted them. In the fourteenth century the religious guilds of London, locally known as the parish guilds, seem to have had covert political significance. But of these matters there is no proof.

### III. THE GILD MERCHANT

The gild merchant presents a most complex array of problems: there are certain elements of kinship with the religious guilds; some powers were exercised that were later the peculiar privilege of the craft guilds; and some of the general concerns of the town were administered by the gild merchant with a measure of autonomy difficult of comprehension to modern minds. The gild merchant was frequently dedicated to some patron saint, or associated with some church festival, and the pious observances of the simple religious guilds were maintained. The fraternal elements are also conspicuous. Sick members were frequently cared for; members who fell into poverty were given a small stipend, and if a member were imprisoned the officers of the gild were in many cases required to procure his deliverance if possible. These features of the gild merchant owed their origin to the circumstances that led to the rise of the religious guilds.

The relation to the craft guilds is a matter of greater importance. It would seem that the gild merchant exercised a general supervision over the crafts, substantially similar to the supervision that was later exercised separately by the individual crafts. The very important inspection of all manufactured goods sold was in the early period exercised by the general gild merchant. Bad workmanship was punished. Rules were laid down with reference to the exercise of various crafts. It would seem, therefore, that the craft guilds were in a sense subsidiary organizations, designed to discharge more completely

and adequately powers which required a detailed knowledge of the craft not readily acquired by outsiders. In some instances this splitting-off of the larger crafts from the general gild merchant can be traced in detail. Weavers or other craftsmen would meet surreptitiously in the gild rooms to make rules for themselves, thus assuming to act with the authority of the entire gild. But although there are instances of this sort, it would seem that in general the crafts received their grants of authority directly from the municipality or from the King. The process of specialization of function within the gild merchant, if it actually occurred, was obscured by this reference to the ultimate administrative authorities. For the most part, the relationship between the gild merchant and the craft gild in England was not very close.

The craft organizations have been presumed by some to represent some measure of opposition between the wealthy merchants and the less well-to-do artisans. In some of the German cities there were serious class conflicts between these groups, and the craft guilds rose to power on the ruins of the older institution. In England there is little evidence of any general struggle between the artisans and the merchants, and it is hardly likely that the formation of the craft guilds was merely due to specialization of functions within the larger association.

The larger importance of the gild merchant historically lies in the close relation between it and the municipality. This has been the subject of much controversy, but the researches of Gross have shown that the earlier writers were guilty of generalizing from insufficient evidence on a subject that is ill-adapted to any generalization at all. Gross says:

“Any complete generalization upon the constitutional history of the towns is impossible for this reason, that their history does not start from one point or proceed by the same stages.” Though all the boroughs had much in common, and the constitutions of many were modelled after the same exemplar, each had a separate life, developing a personality of its own; nor had Parliament yet begun

## THE DEVELOPMENT OF GILDS IN ENGLAND 173

to legislate away these individual peculiarities. While, then, the general principles laid down in this chapter touching the non-identity of gild and borough will apply in most cases, there were doubtless local variations, ranging from practically complete amalgamation of the two elements to the other extreme of open antagonism.<sup>1</sup>

The gild merchant was an important but subsidiary part of the administrative machinery of the borough. It was subordinated to the town magistrates, but enjoyed a greater degree of autonomy than any modern department of municipal government. Functions of the gild merchant

The general administration of the borough was in the hands of the borough assembly. This assembly elected both administrative and judicial officers, who thus executed both civil and criminal law. The gild merchant was charged with the regulation of trade, the supervision of the crafts, and with certain judicial or quasi-judicial functions with reference to commercial matters, primarily disputes among members of the gild.

The essential privilege of the gild was the monopoly of trade within the town. In the letter of the law this monopoly was absolute and its enforcement would seem to suggest the policy of municipal selfishness Monopoly of trade which is the basis of the old idea of a "town economy." The monopoly of trade was, however, less restrictive in fact than would appear on the surface of the regulations. The clause, "so that no one who is not of the gild may trade in the said town, except with the consent of the burgesses," seems categorical: the actual significance of the monopoly was in fact qualified by the admission of non-residents to the privileges of the gild, and by the Its actual significance extension of privileges of wholesale trading to non-members upon the payment of certain duties. The actual rigidity of the gild monopoly thus turns entirely upon the proportion of resident to non-resident members, a subject upon which we are not well informed. In Dublin, between 1225 and 1250 about one half the free citizens were non-residents, so far as

<sup>1</sup> Gross, Charles: *The Gild Merchant*, 1, 72-73.

may be judged from the place names that follow the names of the citizens, and in the list of one hundred and ninety-one persons admitted to the gild merchant of Dublin in 1226, ninety-six were non-residents. The records of Leicester reveal a large non-resident membership in the gild merchant, and there is no reason to believe that these towns were exceptional. Unfortunately we have few lists of members of the gild merchant, and little work has been done on the lists we have. Still it is clear that we must not assume membership to be confined to residents.

The resident population of a town was not identical with either the municipal corporation or the gild merchant.

**Membership inclusive** Neither of these bodies were local bodies in the sense that we would naturally suppose from our modern conceptions of citizenship and towns. Persons living in the vicinity and persons living in privileged jurisdictions within the town were freely admitted to membership in the gild merchant, though they were usually excluded from citizenship. The necessities of trade made it essential to adopt a relatively broad policy, and the differences between the body of citizens and the body of members of the gild merchant amounted to an enfranchisement of commerce. Members of religious houses were by necessity excluded from citizenship even if the order was physically situate in the town, but these monastic houses were important commercially both by reason of the quantities of wool at their disposal and by reason of their purchase of raw materials and manufactures. The country gentry, too, might well find it convenient to possess trading privileges in the neighboring town. Merchants with definite trading interests in a small group of towns would find it specially advantageous to be members of the gild merchant in each of the towns in which they had commercial concerns. The gild merchant was thus an extension of facilities for trading rather than a restrictive feature; it supplemented the markets and the fairs.

There were restrictions upon the complete freedom of trade. Casual merchants could not come to a town when no fair was in progress and sell their wares in competition with



the merchants who were regularly doing business in the place. Many incidents can be found of determined Actual restrictions on trade opposition to such sporadic trading by aliens or foreigners. The payment of dues required of non-members is also a matter that requires some care in interpretation. The dues were in most instances seignorial or royal dues from which the gild as a whole had secured exemption by paying an annual sum into the royal treasury. This sum was doubtless smaller than a sum representing an exact capitalization of the dues chargeable. By paying a lump sum the gild members reduced the fiscal burden and escaped many exactions to which they would otherwise have been subject, but there was some justice in requiring non-members to pay dues, inasmuch as they did not contribute to the general payment to the royal treasury.

It will be evident that the extent and nature of the commercial monopoly exercised by the gild merchant can easily be misunderstood. Generalization is hazardous, whether with reference to particular towns or to particular periods. These strictures upon the theory of exclusiveness are not designed to be generalizations, but merely indications of the dangers of interpreting literally these various terms which have in all cases taken on new meanings in our modern life. The gild had a monopoly of trade, but it was in fact an inclusive monopoly. Both town and gild have left record of a policy of the closed door; but it is easy to forget that pains were taken to get everybody inside before the door was closed.

The right to participate in the bargains of fellow-gildsmen is indicative of the inclusive character of the gild monopoly. The ordinances of the gild merchant at South- Sharing of bargains ampton provide "that a gildsman shall have a share in all the merchandise which another gildsman buys, if he is on the spot where the merchandise is bought." At Berwick even those who were not present at the transaction were allowed to share, provided that they paid the buyer twelve pence for profit. "This privilege," says Lipson, "was intended to foster equality, and protect the poor from falling

into the hands of the few. It embodied the principle that every burgher should have a share in the trade sufficient for the maintenance of himself and his family." The gild at times engaged in joint purchases. In a number of towns the trade in specified articles was restricted to the officers of the gild in their official capacity. The profits were turned into a common purse. Aliens were at times required to make tender of their entire cargo to the gild as a whole, and were thus subjected to many delays and restrictions. It was an attempt to promote the interests of gild members mingled with jealousy and ill-will toward the alien and foreigner.

The organization of the gild merchant was similar to that of most gilds. The primary source of authority was the general assembly of all the members. For administrative purposes an alderman and assistants were elected. There were from two to four assistants designated by names that varied in the different towns: stewards, *échevins*, and wardens were the terms most used. There were at times subordinate officials: farthingmen, level-lookers, gildans, heyners, tasters, cup-bearers, ushers, door-keepers, a dean, clerks, a treasurer, a marshal, sergeants, collectors, bailiffs, and provosts. The functions of these minor officials are not wholly certain. The meetings were called "gilds," or "morning talks." They were held annually, semi-annually, or quarterly, for the purpose of admitting new members, inflicting penalties for failure to observe the statutes, or making new ordinances. Both at these regular meetings and on special occasions there was much eating and drinking: "drinkings with spiced cake bread and sundry wines, the cups serving merrily about the house."

#### IV. THE CRAFT GILDS

The study of the conditions at Paris at the close of the thirteenth century was designed to suggest that the essential feature of a craft gild was the right to elect wardens to exercise the "view" of the craft. The craft gild, according to this interpretation, is to be conceived as a body of craftsmen possessed of some meas-

ure of autonomous power. The organization would become a definite part of the municipal administration, exercising powers that would otherwise be within the province of the municipality. This conception is in general applicable to English conditions, but there are subordinate forms of guilds which might easily be a source of confusion.

Associations of craftsmen are found which are not craft guilds in any technical sense, notably religious guilds composed primarily of members of a single craft. Religious guilds can usually be distinguished from Other associations of craftsmen true craft guilds by their more inclusive membership and their fraternal and spiritual purposes. More serious confusion can arise with reference to organizations of craftsmen that received charters from the King. Grants of privilege from the King were not uncommon in the early period, and after the Reformation they become particularly important. It may seem pedantic to distinguish these two types of grant of power, but it will be evident that the King could grant privileges that could not be secured from a municipality. A town could grant the "view" of the craft in that town, the King could grant the "view" of the craft in the kingdom as a whole. Royal grants frequently carried exemptions from supervision by the municipal authorities. Such grants were usually made to alien craftsmen settling in England, and in such cases the grant included two distinct sets of privileges. The King alone could grant authority to hold property in a corporate capacity, so that the craft guild could not become an endowed corporation without a royal grant. After the Reformation this power became particularly desirable and many of the crafts sought royal charters and paid good prices for them. The history of organizations of craftsmen in England is thus complex to a degree, and many of these forms cannot be adequately described as guilds; in the later period the term "company" was usually applied.

Apart from the royal charters granted to groups of aliens, which begin to appear in the fourteenth cen- Chartered organizations tury, there are instances of a significant exercise of the royal prerogative in behalf of native artisans. The

history of London affords the clearest evidence of the character and purport of these early grants, though these cases are not unique by any means. The Bakers, the Fishmongers, and the Weavers of London obtained privileges from the King, so that they formed definite jurisdictions before the founding of the municipality in 1191. All three of these groups of artisans stood outside the municipal constitution. Closely associated with these groups of artisans were similar bodies that are designated as the "adulterine" guilds. They seem to have been organized after the same general manner, though they had no royal grant of privilege, or at least no recognized grant. These organizations, particularly in London, exerted a profound influence upon the municipal institutions that took form soon afterward.

There were thus three distinct types of craft organization designated casually as guilds: religious guilds of craftsmen; autonomous crafts, possessed of no general political or jurisdictional privileges; craft organizations chartered by the King having perhaps the right to hold property, the right to supervise the craft throughout a considerable area, and possibly the right to hold court independently of the municipal authority. The presence of these variant forms makes it essential to form some judgment of the purposes and importance of each, and for this reason the suggestions to be derived from comparisons with French conditions would seem to be of special importance.

The autonomous craft guild charged by the municipality with the supervision of the craft in that town was typical in the sense that such an organization tended to become established in the crafts that were sufficiently large to make such organization practicable. In the smaller towns, and with reference to the less important crafts, such organizations emerge at a late period, but with the exception of colonies of aliens such organizations tended to become the basis of the administrative control of industry. When royal incorporation of native craftsmen became common in the sixteenth century, the purposes of the organization were altered in a number of respects so that the frequent

designation of these later associations as "companies" indicates a change in character as well as a change in name.

The tendencies and ideals of municipal administration are illustrated by the project for the reorganization of the crafts at Norwich that is sketched in the "Composition" of 1415 and embodied in the ordinances of 1449. The "Composition" of 1415 was a compromise between the general body of citizens and a small group that seemed to be on the verge of acquiring oligarchic powers. In order to prevent the government of the city from falling into the hands of this oligarchy, the form of government was altered in a number of respects. The specific provision for a larger measure of craft autonomy may have had some definite relation to local political conditions, but the scheme sketched in 1415 is so largely the embodiment of common ideals that it would seem that we are chiefly indebted to the crisis in municipal politics for the record rather than for the ideals expressed.

It is ordained that each craft in the City shall freely and yearly choose of each craft within itself two masters for the year coming, the which two masters shall be presented by bill Regulations written to the Mayor by the men of the same craft. at Norwich The which masters at a certain day . . . shall be charged to make good and true search in the craft of all defaults in the craft. . . . And all the defaults that they find in the craft shall be well and truly presented to the Mayor without concealment. And the defaults so presented . . . shall be judged and fines imposed according to the gravity of the offense. One half of the fine shall be paid to the sheriffs and one half to the masters of the craft. . . . And if there be any craft that needeth to be searched and will not have a search, the Mayor shall send for the craft and charge them to choose two masters within its members. And if they will not choose and present the names within eight days next following then it shall be lawful to the Mayor . . . to choose two members of the craft and to give them charge to make good and true search in the manner aforesaid.<sup>1</sup>

The powers of the wardens are more specifically described in the general ordinance of 1449:

Which wardens and the said persons assigned and named for the common council of the craft . . . shall have full power, author-

<sup>1</sup> Hudson, W., and Tingey, J. C.: *Select Records of Norwich*, I, 105.

ity, and jurisdiction to judge defaults found by the wardens and impose fines, and also to provide, make, and ordain all manner of lawful ordenances, constitutions, acts, and penalties, and the acts, ordenances, and constitutions, where they be hard, grievous, or defective to remedy, reform, and amend as often as seemeth to them expedient. Providing always that such acts, constitutions, ordinances, and penalties, made or to be made, be not put into execution until the Mayor and Aldermen or the most part of them have overseen it and examined it, and, until by the assent of the Common Council of the city, it is confirmed, enacted, and enrolled in the chamber of the city.<sup>1</sup>

The ordinance then proceeded to make arrangements for the problem presented by crafts which were too small to have an entirely independent organization. It is implied that many disorders and abuses had been common in the past because such small crafts were not supervised. It was accordingly provided that all small crafts should be united to larger, but related, crafts for the purposes of administration. Thus, the smiths should have joined to them the bladesmiths, locksmiths, and lorimers. Some element of autonomy, however, was provided for all crafts: the search of the craft was in all cases to be in the hands of some member; if there were seven or more persons in the craft the warden should be elected; if less than seven, a warden was to be appointed by the Mayor. Search of the craft was presumed to be made once every three months or oftener.

This arrangement, though primarily administrative, reveals an intrusion of other than administrative elements. The purposes of these unions of small crafts with larger ones seems to have been religious and spectacular. The crafts or unions of crafts had special uniforms or liveries which were to be worn by all members when they assembled at meetings for business or worship, and, most particularly, when they marched or rode in the processions at the inauguration of the Mayor, or on the feast days that were celebrated by pageants. On such occasions it was desirable to maintain groupings that would insure a more equable distribution of the financial

<sup>1</sup> Hudson, W., and Tingey, J. C.: *op. cit.*, II, 280.

burdens of the pageants. Religious purposes, therefore, tended to complicate the social organization of the craftsmen by creating associations which overlapped, and by rendering uncertain the relations between the fraternities and the organizations whose functions were primarily administrative.

#### V. RELATION OF DIFFERENT TYPES OF GILD TO EACH OTHER

The validity of the distinctions suggested between these three types of gild is qualified by the lack of fixity of form that is characteristic of all medieval institutions. There were, indeed, the differences of purpose that have been suggested, but these purposes did not exclude each other. It is thus difficult to determine in many cases whether there are two or more distinct organizations, or merely one organization with two or more distinct purposes.

In general, the gild merchant assumed its most characteristic form in the early period of commercial and municipal development. In the smaller towns this development was itself relatively late chronologically, <sup>Rise and decline of the gild merchant</sup> so that the transformations of the gild merchant cannot be associated with specific periods and dates. The association that originally exercised significant influence over the regulation of commerce and industry was shorn of its powers by the development of the municipality and by the increased specialization of the crafts. The name survived in many cases for several generations after the institution had become a mere shadow without substantial power. At times this old tradition expressed itself in a banquet or in some ceremonial observance like the Corpus Christi procession; at times it became a mere formula inherited from a dead past and repeated without any clear notion of its meaning. "The fourteenth century," says Gross, "may in general be called the period of gradual transition. In the fifteenth century the transition was completed. In this, and in the following centuries the term 'Gilda Mercatoria' became less and less frequent."

The religious gilds as definitely distinct institutions were

likewise characteristic of the earlier period, but the history of this element of medieval life presents more complexities than the gild merchant, for the motives of such organizations persisted unchanged for a long time, certainly down to the Reformation. There was therefore a vigorous development of fraternal organizations during the period of the development of the craft gilds, and in many cases the craft gilds absorbed many of the motives and purposes of the fraternal organization. In the larger towns the important crafts possessed either two distinct associations that were essentially parallel or a single organization that exercised all the functions of both. In the case of the smaller crafts the purposes were more likely to be kept distinct. The view of the craft could wisely be entrusted to wardens of the craft even if the group were small; at Norwich, a craft of seven masters was not considered too small to be given some measure of autonomy, and in Paris the hearings before Étienne Boileau showed that there was no hesitation in organizing the small crafts.

The functions of the religious fraternity, however, could not be effectively performed if the number of members sank to such small proportions. The financial responsibilities for a chapel or chantry and the appropriate celebration of the various religious pageants required a considerable endowment or notable contributions or both. Of the eight religious gilds in Cambridge making returns in 1389 five cannot be specifically connected with the crafts or with the artisan population. One of the three remaining gilds was founded by a group of skinnners, and provision was made that the chief official should always be a skinner. It would seem to be implied that members of other crafts might be admitted, even though the fraternity was in a measure identified with the skinnners. The two other gilds were clearly composed of groups of artisans. The Gild of Saint Katherine in the church of Saint Andrew contained in its list of founders an ironmonger, a baker, a currier, a chaloner, a piper, and a wool-comber. The Gild of Saint Mary in the church of Saint Botolph includes among its founders a fuller, a skinner, a

Parallel development of religious and craft gilds

Fraternities and craft gilds



cordwainer, and a tailor. These guilds were primarily fraternal organizations for the celebration of masses and the relief of indigent brothers and sisters. It was apparently necessary for the smaller groups of craftsmen to combine in one association.

The influence of pageantry upon the crafts can be seen in the combinations among the craftsmen of Norwich for the purpose of participating in the Corpus Christi procession. Saint Luke's Gild, composed of <sup>Pageantry</sup> the pewterers, brasiers, bell-founders, plumbers, glasers, and painters was at the first entirely responsible for the production of the pageants, although it is not known when it introduced them. In 1527 the gild petitioned that it be relieved by assigning to each craft in the city the production of one pageant for the procession. This request was granted and twelve pageants were assigned to various crafts and groups of crafts. Only a few years before, an arrangement had been made to amalgamate with some existing fraternity the crafts "that had no vows" — that is, no provision for common religious ceremonies — so that the systematic organization of religious life and pageantry went hand in hand.

The religious organizations of the fourteenth and fifteenth centuries were practically obliged to adopt a liberal policy of inclusiveness in the choice of members. They <sup>Occupational statistics</sup> were rarely a parallel organization to the craft guilds because the crafts were for the most part very small groups. Statistics of occupations are infrequent, as may well be supposed, but there are fortunately occasional figures which afford at least a basis for surmises pending the accumulation of a broader mass of material for statistical study. It is hard to believe that the meager results, as yet available in print, could not be significantly supplemented by careful utilization of the full resources of the manuscript records. The best evidence is furnished by the tax-rolls, which usually give the occupations of artisans. At this period surnames were not universal and the designation by occupation was frequently necessary as a means of identification. In the

subsidy roll for Cambridge in 1314-15 we find entries like the following: "Walter the Barber," "John the Girdler," "Alan the Skinner," etc. Such entries are fairly certain evidence as to the occupation. When the article drops out it is perhaps hazardous to assume that we are not dealing with a real surname instead of an occupational designation. Thus, "Walter Faver" may be "Walter the Smith"; "John Sherman" may be a "Shearman"; but the reality of doubts is indicated by the entry, "Robert Hatter, Shearman." However, there is reason to suppose that the occupation would be given if it had ceased to correspond with the name. The most serious source of error probably lies in the incompleteness of enumeration of the relatively poor people who were in many cases artisans. Comparison of the tax-rolls for Colchester in 1296 and 1300 or for Paris at the same date will indicate the possibilities of under-counting. In Paris, in 1296, only 225 occupations were listed; in 1300, 348 were listed, and the number of occupations in which fewer than five persons were employed had changed from 91 in 1296 to 224 in 1300. The evidence from these rolls, therefore, cannot be assumed to represent comprehensive enumerations, and should be presumed to be somewhat of an under-statement both of the relative size of the groups and the numbers of occupations represented.

RELATIVE SIZE OF THE OCCUPATIONAL GROUPS IN FIVE ENGLISH TOWNS \*

Town	Date	Number of crafts having					
		1 person	2-4 persons	5-9 persons	10-19 persons	20-39 persons	Over 40
Cambridge.....	1314-15	36	12	2	..	..	..
Colchester.....	1300	23	6	6	3	..	..
Leicester.....	1269-70	22	20	5	1	..	..
	1336	25	21	1	1	..	..
	1376	(reference to five crafts only)			3	2	..
Oxford.....	1381	29	26	18	9	3	1
Dublin.....	1225-50	34	15	6	2	..	..

\* Prepared from the records of the various towns.

The combination of a number of closely contemporary rolls would probably eliminate some of the errors, though it makes it possible to over-count. The figures for Dublin are taken from a list of free citizens for the period 1225-50, so that there are many elements of error: inclusion of persons not living at the same time; omissions of residents who were not citizens. If the returns from Dublin were not relatively consistent with the other figures they could hardly be accepted as even an approximate indication, but the relative consistency of both sets of figures would seem to lend added credibility to both.

Leicester, Cambridge, and Colchester were small towns of about two thousand inhabitants; Oxford had a population of five and a half thousand, if the academic and ecclesiastical population is included. It is unfortunate that such figures cannot be obtained for one of the larger industrial towns, and for this reason the figures given for Paris in the earlier chapter are helpful. The striking feature of all these enumerations is the large number of very small crafts, crafts with less than five persons recorded.

There is no printed enumeration for Norwich that would permit of a similar survey of occupations, but the numbers of occupations and the numbers of organized crafts <sup>Numbers</sup> suggest substantially the same general condition. <sup>of crafts</sup> One hundred and forty-seven different crafts are mentioned in the records of Norwich during the last half of the thirteenth century. As much as a century and a half later, only sixty-three crafts were enumerated in the lists of those participating in the Corpus Christi procession. The town had grown some in population, but not a great deal, and there is certainly no ground for supposing that the number of distinct occupations had decreased, though it is quite likely that the entire one hundred and forty-seven occupations were not exercised at any given time. One must infer that most of the crafts were very small, consisting of less than <sup>Preponderance</sup> five persons; perhaps it would be better to say <sup>of small crafts</sup> masters or journeymen. It is further notable that at Norwich the sixty-three crafts in the procession were not all or-

ganized as guilds. They participated in that affair under thirty-two banners and there is reason to suppose that the number of guilds was somewhat less. In Paris, in 1300, out of 348 distinct occupations hardly more than a hundred were organized as craft guilds. At London, toward the close of the thirteenth century, ninety-eight distinct occupations are mentioned in the records. In 1316, there were thirty-six recognized craft guilds. It would seem, therefore, that the rather more complete details available for the smaller towns are really an indication of a general condition. The crafts were for the most part small, and large numbers of them were not organized into guilds.

RELATIVE OCCUPATIONAL DIFFERENTIATION AND NUMBERS OF CRAFT GUILDS IN VARIOUS TOWNS

<i>Town</i>	<i>Date</i>	<i>Number of occupations</i>	<i>Number of crafts</i>	<i>Number of craft guilds</i>	<i>Probable population</i>
Beverley...	1390	..	38	..	4,200
	1510	..	37	..	..
Cambridge.	1314-15	50	..	..	2,800
Colchester.	1301	38	..	..	2,000
	1377-99	..	41	..	4,728
Leicester...	1196-1225	40	..	..	2,000
	1269-70	49	..	..	..
	1336	48	..	..	..
London....	1275-89	98	..	..	30,000-40,000
	1316	..	..	36	30,000-40,000
	1353	..	..	50	30,000-40,000
	1422	..	..	89-112	30,000-40,000
	16th century	..	..	157	30,000-40,000
Norwich...	1250-1300	147	..	..	5,000
	1440	..	..	16	6,000
	1446	..	..	24	..
	1449	..	63	(32)	..
	1543	..	73	(21)	..
Oxford....	1381	84	..	..	4,000-5,000
Salisbury...	1420	..	36	19	..
Paris.....	1276	..	97	71	200,000
	1296	224	..	..	..
	1300	348	..	..	..
St. Omer...	1300	..	50	25	..

The organization of artisans for the typical purpose of exercising the view of the craft played a relatively less conspicuous part in the social life of any towns that were as small as the majority of English towns, and the fraternal organizations of a religious and charitable character were relatively more conspicuous. Religious organizations relatively conspicuous. The wide range in numbers of members among the crafts of the larger towns created distinctions within the general mass of artisans. Only a portion of the artisan population was organized in craft guilds and only a few of these attained significant power by reason of numbers or wealth. The acquisition of power in the municipality by a small group of crafts was thus far from being a victory of "democracy" in any modern sense. The groups of craft guilds that rose to special eminence in Paris, London, Norwich, and many other towns of England and Europe were all too frequently imbued with the spirit of the commercial or feudal oligarchy that they supplanted.

A few particulars concerning a number of towns have been reduced to tabular form, partly to convey information, partly to suggest the inadequacy of our knowledge of many vital facts concerning these associations in the medieval period.

#### VI. THE RELIGIOUS GILDS AND THE CROWN

The development of the religious guilds was profoundly influenced by national legislation. In the earlier period they frequently received endowments for the saying of masses, so that they began to acquire considerable amounts of property like all other institutions connected with religion. Endowments. This dedication of property to devotional purposes became a subject of royal concern because of its withdrawal from the taxable resources of the Government. The inquiry of 1389, to which reference has already been made, was the outcome of this solicitude, and in 1391 it was announced that the property held by the religious guilds was subject to the prohibitions and restrictions of the Statute of Mortmain. If this act were strictly interpreted it would render it impossible for the religious guilds to continue

as voluntary associations, and it is probable that there is a connection between this decision and the increasing frequency of the granting of royal charters to such bodies, most particularly in London, but also in the provincial towns. Gilds which possessed much property would be practically forced to secure a royal charter or license.

This change in the character of the religious fraternity was of great importance to the other forms of craft organizations.

**Incorporation**      The relations between the fraternity and the craft gild were transformed. When the administrative organization was clothed with various powers by the municipality, it was obviously more important than a voluntary association for the celebration of masses. The acquisition of corporate character by the wealthy fraternities in the late fourteenth and early fifteenth centuries reversed the relative importance of these two types of organization. The privilege of holding property was valuable; the general corporate privileges conferred by the King were more important than any rights that the municipality could confer. These bodies were originally organized for religious and social purposes, but when the fraternity was fairly well identified with a particular craft the economic functions were soon absorbed by the corporation. The corporation was able to exercise the supervisory functions of the craft gild rather more adequately than the gild under municipal authority. The religious fraternity had always exercised some disciplinary authority over its members that was not confined to mere craft matters; the prestige of the officers of the corporation was if anything greater than that of the wardens elected or appointed to exercise merely the view of the craft.

The character of the powers conferred by these royal charters is illustrated by the grant made to the Tailors of Salisbury by Edward IV (1 Ed. IV). The King granted "to all the men of the craft of Tailors in the city aforesaid, . . . to be one body and commonalty perpetual. And also he hath granted to them to begin, make, found, ordain and stable of new, a perpetual fraternity or gild of brethren and sisters. . . .

Also he hath granted that the same men of the craft, every year of themselves [i.e. out of their number] to choose two wardens to oversee and govern the craft Commonalty and Gild as aforesaid, and also all goods, chattels and possessions of the same, for evermore. . . . And that the same wardens and Commonalty have succession everlasting and a common seal, for the needs of the said Community." <sup>1</sup>

The primary motive of such a grant was the reorganization of the religious fraternity to make it conform to the laws relating to the holding of property, but in the granting of the charter of incorporation much was accomplished that was not deliberately intended. The grant of power to the wardens included the view of the craft that they already possessed by delegation of authority from the municipality. It was not uncommon in the middle ages to get grants confirmed by various authorities; it was thus wholly in accord with medieval notions of the proper course of action to include in the enumeration of powers desired of the King these powers that had originally been received from the town. The process of incorporation thus tended to obscure the relatively slight distinctions that existed between the fraternity and the craft gild.

Not all the religious gilds secured charters. The expense of obtaining such a grant would be prohibitory to any but the wealthy organizations, and it thus came about that the distinctions which had long existed <sup>Rich and poor</sup> between the rich and the poor craftsmen and their societies were accentuated by the addition of powers to the gilds of the rich. The new kind of association added to the existing variety of gilds a type that became the visible evidence of the chasm that was opening up between the rich and the poor.

All forms of gilds began to be transformed in the fifteenth century, and most of these changes were carried to their conclusions in the first half of the following century. The Reformation did away with the older forms of fraternal

<sup>1</sup> Haaskins, C.: *Ancient Trade Guilds and Companies of Salisbury* (Salisbury, 1912), 118-19.

organization, and the economic changes reduced the older type of craft gild to a position of such subordinate importance that it ceased to be a significant feature of industrial life.

**The confiscation of endowments** The endowments of the fraternities were finally confiscated by Edward VI under authority of the Statute of 1547. Such a step had been contemplated by Henry VIII, but nothing was done beyond making an inquiry into the number of religious organizations and the amount of their property. The Statute of Edward VI provided that all property formerly devoted to religious purposes should come at once into the possession of the King, but it was ordered that all grammar schools formerly maintained by such institutions should be assured the payment of an annual stipend from the revenue of the property confiscated. Whatever the intent of the act, its consequences were unfortunate, for the great rise in prices, even then consciously felt, soon rendered these fixed salaries wholly insufficient to maintain the schools in their original condition. Much might have been done for popular education by the endowment of the existing schools with the property of the gilds and chantries.

This confiscatory statute has frequently been alleged to be the cause of the altered position of the craft gilds, but such a **Secular functions permitted** view fails to take adequate account of the distinctions between the two types of organization. The statute, though obscure in many respects, does distinguish between the secular craft gilds and the religious organizations. It does not prohibit or dissolve organizations that existed for purely secular purposes. The craft gilds were thus not directly affected by the statute. In so far as the functions of the craft gild had come to be exercised by an incorporated fraternity, it would of course be somewhat affected, though it would seem that the craft organization could continue, shorn of its property-holding powers.

The altered position of the craft gilds must be attributed **Decline of the craft gilds** to a variety of elements, partly economic and partly political. There was at this time a movement of population away from the incorporated towns: the



movement was not precisely a rural exodus, for many villages grew to considerable proportions; it would seem to have been in part an attempt to escape from restrictions imposed upon industry and commerce by the older municipalities. There was doubtless some increase in the proportion of artisans among the rural population. These changes resulted in a distinct increase in the number of artisans not formally organized in guilds.

In the large towns the distinctions between an employing and a wage-earning class was becoming significantly established. The wealthier masters in some crafts became employers of considerable numbers of journeymen or small masters. Certain crafts, also, were in general composed of well-to-do masters who employed the less wealthy masters of other crafts. The employing classes, particularly in London, secured corporate charters during this period and organized associations which were different in a number of respects from the old craft guilds. The wage-earning classes were at times excluded entirely, at times admitted to membership of an inferior order. The distinction between the two classes of members was in most cases emphasized by the livery or uniform of the company; only <sup>The livery</sup> the controlling members were allowed to wear the livery, which thus became a symbol of power and affluence. Even when the old craft guild survived, its meaning was changed. The relation to the employing master became relatively more important than the right to elect wardens to view the craft, and at times the view of the craft came to be exercised by the officers of the craft of employers. Ultimately, new organizations of workmen began to appear, disguised at times as fraternal associations, but in purpose more nearly akin to the modern trade union.

## VII. THE STATUTE OF APPRENTICES

The economic changes are reflected in the increased solicitude of the Government with reference to industry, and though much legislation was merely a record of good intentions, some of the statutes exerted a significant influence

upon social and industrial life. The Statute of Apprentices (1563) was unquestionably the most notable embodiment of the policies that dominated industrial life until the Industrial Revolution was far advanced. It was in a measure a codification of older statutes which had been imperfectly administered, and the dominant purpose seems

**Purposes** to have been to prevent change rather than to make innovations. In fact, however, the statute made a number of important innovations. It was hoped that the statute would check the decline of the corporate towns, provide for more adequate training of village artisans, assure a more considerable supply of agricultural labor, and afford some guarantee that wages would be adjusted to the "advancement of prices of all things belonging to said servants and laborers." Few social concerns were not in some measure affected by this great codification of industrial and social legislation.

Thirty-two crafts, including all the more important and frequent occupations, are enumerated in the articles referring to the length of term for which such craftsmen should be hired. These crafts were later designated as crafts to be taught in corporate and market towns to the sons of freeholders. The mercers, drapers, goldsmiths, ironmongers, and clothiers were forbidden to take any person as apprentice whose father or mother was not possessed of a forty-shilling freehold. These were crafts whose masters were characteristically employers so that this distinction is significant. In another article twenty-one crafts are enumerated which were allowed to be taught either in towns or in the country; all of these crafts were to be open to persons whose parents had no property at all.

There are thus implications that a wage-earning class was already established: it is assumed by the statute that the **Wage-earners and wages** larger proportion of artisans work for hire, and it is for this reason that the regulation of the wages of town artisans became a matter of solicitude. The wages of agricultural laborers and of certain "artificers" had long been regulated by justices of the peace, but these "arti-

ficers" seem to have been the masons, smiths, carpenters, and the like who were recognized as being a distinctly rural group. The artisans of the towns had not been included in earlier statutes, partly because their interests were presumed to be in charge of the municipality, but partly because they had not been mere wage-earners. The statute must have tended to accentuate the changes that were taking place because the status of the various classes was so specifically defined. The conditions of entrance into the crafts practiced in towns amounted to a real restriction.

Every person was ordered to adopt a definite profession or calling. Excepting persons owning property, persons of gentle birth, and scholars, every one must needs choose between the sea, the crafts, and agriculture. Any person failing to make a decision could be required to work at agriculture. Freedom of movement was likewise curtailed: no person might leave the town or parish in which he had been employed unless he obtained a formal testimonial from appropriate authorities or from two householders. These restrictions destroyed the conditions that had made craft autonomy possible in the earlier period. In so far as craft organizations continued to exist they were mere shadows of what they had been formerly.

The wage-fixing clauses constitute perhaps the most famous portion of the statute and their place in the history of the centuries that followed shows how great a <sup>Wage-fixing</sup> change had taken place in the position of the craftsmen. The intent of these clauses, however, was other than might be supposed. The provisions were designed to assure the payment of not merely a living wage, but an equivalent of the wages that had prevailed before the rise in prices. The clauses were not intended to guarantee an improvement in the relative well-being of the artisan, but to protect him in his existing state against the unfavorable effects of the price revolution. The justices of the peace were presumed to ascertain the cost of maintaining the appropriate standards of life and to regulate wages accordingly. The notions underlying the statute were in some respects similar to the thought

expressed by the phrase a "living wage," but there was no implication that the artisan had not been getting an appropriate living.

There has been much controversy over the history of these wage-fixing provisions, and the results are as yet too inconclusive to admit of final judgment of the matter. It is evident, however, that the earlier writers were wrong in asserting that the powers of the statute were not exercised at all. There are a number of wage-assessments in print and the list is constantly increasing. It should be observed that most of these lists apply to rural workmen rather than to the craftsmen of the towns, and there is considerable ground for supposing that the act was devoid of real significance in so far as it related to the urban craftsmen. The more technical character of the crafts made the problem of wage-regulation too complex for the quality of statecraft represented at quarter sessions. The failure of the assessments made by the Gloucestershire justices for weaving seems to have been typical of such attempts.

## CHAPTER VIII

### THE WOOLEN INDUSTRIES: 1450-1750

#### I

In many industries the technical transformations of the period of the Industrial Revolution obscure the considerable advances in technique that were made during the earlier period. In the woolen industries the chief improvements in the character of the goods, as distinct from processes of manufacture, took place prior to the Industrial Revolution. At that time the process of manufacture was somewhat cheapened, but the character of the goods was not notably transformed. The development in this industry, or group of industries, therefore falls into two distinct periods: in the earlier, there was a great technical advance that is most clearly apparent in the character of the fabrics made; in the later, the changes were primarily concerned with the organization of the industry as a business enterprise and with its mechanical equipment. The history of the woolen industries thus requires that some attention be given to purely technical matters.

There are in general two classes of wools, short staple wools and long staple wools, and the larger differences in the fabrics produced were originally due to these differences in the nature of the raw material. The average length of staple of various types of wool is given below.

#### AVERAGE LENGTH OF STAPLE OF VARIOUS WOOLS

Merino.....	2.25-2.5 inches
Fine cross-bred.....	3 "
Alpaca.....	7.5 "
Mohair.....	8 "
Lincolnshire.....	10.5 "

These differences in length of staple are so closely associated with the other properties of wool that they serve as the basis of classification, though the difference in length is not in

itself the most significant of the differences. The short staple wool is finer, more curly, and possesses greater felting properties. The long staple wool is more nearly like hair, possessing the peculiar felting property in such moderate measure that its use is limited to types of goods in which little felting is desired. Both types of wool are native to England: the short staple being characteristic of the South Down sheep, the long staple of the Lincolnshire sheep. The fleece of the English South Down is inferior to the fleece of the Merino, and this difference in the quality of the native wool supply probably exerted a notable influence upon the early history of the English woollen industries. The English-grown wool was less well adapted to the making of the finer grades of cloth so that the English industry suffered in a variety of ways from the competition of the French and Flemish weavers who found the fine Spanish wool readily available. In the eighteenth century the Merino sheep were

**Merinos**

brought from Spain to England and Germany. The English wools were considerably improved by judicious cross-breeding with Merino stock, but the fleece still remains slightly inferior, as is indicated by the difference in staple. Pure-bred Merinos cannot be successfully maintained in England. The best Merino wool now comes from Saxony, the climate there having proved to be somewhat more favorable than the climate of Spain. England had always produced the finest long staple wool, so that the improvement of the Leicestershire stock in the eighteenth century by careful selection has merely emphasized a difference that has always existed. The advantages of proximity to the supply of raw material are not decisive, however, and though this long staple wool is particularly fitted for the worsted manufacture, that industry was relatively slow in establishing itself in England. The location of the different branches of the manufacture in England, however, seems to be related to the character of the local supplies of wool. The south and west became identified with woolens; the eastern counties and later the West Riding of York became identified with the worsteds.

These distinct types of woollen goods were originally based on these different types of raw wool, but the difference in the goods is primarily an outcome of different methods of manufacture. Woolen cloths, <sup>Woolens</sup> originally prepared from the short staple wools, are shrunk and felted until the weave pattern is largely lost. The finish of the cloth is dependent upon this felting process and the subsequent raising of the nap to produce a soft, velvety surface. Large patterns in different colors of yarn will appear in the finished goods, though in vaguer outline because of the blurring of the lines of the weave in the felting process. All these goods shrink considerably in the finishing, being usually reduced about one third both in length and breadth. As a rule woollen goods contain a greater weight of wool per square yard than worsted goods that are not felted, and as the weight of yarn is likely to vary within the same general range, the differences in weight of woolens and worsteds are roughly correlated to the degree to which the woolens have been shrunk. The higher grades of woolens made in the fifteenth and sixteenth centuries weighed about one and one half pounds per square yard.<sup>1</sup>

<sup>1</sup> The types of woolens indicated in the statutes cannot be compared directly with the modern types, as the designations are based on color and place of manufacture. The Statute of 1551-52 (5 & 6 Ed. VI, c. 6) enumerates the following types:

	Wt. per lin- ear yd. (lbs.)	Wt. per sq. yd. (lbs.)
<b>Broadcloths (one and three quarters yards wide) —</b>		
Kent, Sussex, Reading .....	3	1.71
Worcesters, long cloths .....	2.7	1.54
Worcesters, short cloths .....	2.4	1.37
<b>Colored long and short cloths —</b>		
Suffolk, Norfolk, Essex, long .....	2.6	1.48
Suffolk, Norfolk, Essex, short .....	2.5	1.42
<b>Whites and reds —</b>		
Wilt, Gloucester, Somerset .....	2.2	1.37
<b>Plunketts (blues of various shades) —</b>		
Wilt, Gloucester, Somerset .....	2.5	1.42
Taunton and Bridgewater .....	2.6	1.48
Northern cloths .....	1.7	.87
<b>Narrow cloths (one yard wide) —</b>		
Taunton and Bridgewater .....	1.3	1.3
<b>Kersies (made of long staple wool and hence worsteds) —</b>		
Broads, one and three quarters yards wide, ordinaries, sorting, Devonshire dozens .....	1.1-1.2	.62
Checks, one yard wide .....	1.2	1.2
<b>Frieze, three quarters of a yard wide —</b>		
Welch .....	1.3	2.32
Manchester .....	1.3	2.32
<b>Cottons, three quarters of a yard wide —</b>		
Welch .....	.95	1.69
Manchester, Lancashire and Cheshire .....	.99	1.7
Penystoues, or Forest Whites, one and five eighths of a yard wide ...	2.1	1.36

There was no general difference between the broad and the long cloths. The frieses were coarse cloths that had a nap on one side only. Cottons were a mixture of wool and coarse cotton.

Worsteded were woven from yarns prepared from long staple wool, and were not subjected to the shrinking and felting process. The low felting properties of the long staple wools thus rendered them peculiarly suitable for such fabrics. The worsteds could be finished with reference to weave patterns, for the harder surface of the cloth and the absence of any considerable nap made the weave pattern very conspicuous. Twilled serges, various "pepper-and-salt" effects, and the whole range of fancy weaves characteristic of modern worsted suitings are thus a direct result of the emphasis upon the weave pattern as distinct from the felted nap distinctive of the woolens, commonly called "broad cloths" even to-day. The worsted goods were lighter and on the whole cheaper than corresponding grades of woolens, and, little by little, the worsteds have driven the woolens from the market. The appearance formerly distinctive of woolens can now be produced in worsteds, so that relatively few true woolen types are seen in the market at the present time. This is the outcome of a long historical process.

The woolens are the older type, so far as we know. Worsteds do not appear in England until the thirteenth and fourteenth centuries, and hardly more than a century earlier on the Continent. Despite increasing competition with the worsteds, the true types of woolens maintained themselves until the period of the Industrial Revolution, but the decline of the industry in the nineteenth century was relatively rapid.

The development of the woolen and worsted industries is difficult to trace in detail because the names of the goods are far from stable. Old names cannot with certainty be identified with modern types. There is reason to believe that the more important types of woolen goods had become fixed at an early date, perhaps as early as the beginning of the fourteenth century. But there was much technical improvement of the processes of finishing. The textiles preserved in museums afford some means of studying these changes, but there seems to have been little systematic study of this aspect of industrial history.



The progress of the worsted industry can be followed with more success, though it is not possible to interpret all the details without more study of the fabrics themselves. Worsteds were first made on the <sup>Rise of the worsted industry</sup> Continent, in France and in Flanders, but the variety of fabrics seems to have been small in the twelfth and thirteenth centuries. Some coarse cloths may have been made of long combing wool in England independently of foreign influence. The kerseys, so frequently enumerated in the statutes, would seem to be worsteds in that sense, and the *Draper's Dictionary* cites evidence to show that these goods were really a kind of serge. It has generally been supposed, however, that the development of the industry was the result of the initiative of Continental weavers, and to the best of our present knowledge the new types of worsteds were first brought out on the Continent and introduced into England by immigrants. The introduction of the manufacture is associated with two distinct waves of immigration: the earlier immigrants, coming at the beginning of the fourteenth century, brought with them the fundamental types, says, serges, bombazines, and tiretaines; the second group of immigrants, who appear first toward the close of the fifteenth century, introduced a number of specialties which competed more keenly with the woolens than the other types of worsteds. Many of these goods were mixed with silk.

The goods introduced at the time of the second great immigration of Continental weavers are usually called the "New Drapery," and it would seem that the <sup>The "New Drapery":</sup> term is substantially accurate, though there is much confusion in the statutes and in the references of contemporaries. The enumeration of the new drapery in the Statute of 1565 includes some of the older types, notably says, stamens, and kerseys, while various other references would restrict the term to a much narrower group of fabrics. There is thus uncertainty as to whether the term should cover all worsteds or merely those types introduced in the late fifteenth and early sixteenth centuries. The period marks a new stage in the development of the worsted manufacture in England,

at all events, and the number of new fabrics is in itself evidence of the general character of the change even though the various fabrics cannot be certainly identified. The characteristic features of worsteds were more definitely brought out, and the advantages were vigorously exploited by increasing skill in the preparation of fancy yarns. The scope of the industry was further extended by active imitation of French fabrics in the late seventeenth century. At that time there was no appreciable immigration, but the increase in the industry was comparable to the developments in the earlier periods of expansion. The extent of the change can be roughly measured by comparison of lists of worsted fabrics for 1578 and 1739.

#### WORSTED FABRICS: 1578

From a list in the Burghley Papers designed to serve as a basis for calculating export duties\*

	Length (yds.)	Width (yds.)	Weight of piece (lbs.)	Weight per linear yard (lbs.)	Weight per square yard (lbs.)
Bays, double. . . . .	34	2	44	1.3	.65
“ middle. . . . .	34	1.75	24	.7	.46
“ single. . . . .	34	1.75	24	.7	.46
Rasse, or. . . . .	24	1.5	42	1.7	1.16
Staminett. . . . .	22	..	32	1.4	
Serge, French. . . . .	23	..	20	.86	

\* James: *Worsted Manufacture*, 118. Figures for width are from other sources; chiefly, scattered references in the Victorian County Histories.

	Length (yds.)	Weight of piece (lbs.)	Weight per yard (lbs.)
Sayes, Flanders. . . . .	27	16	.59
Narrow Worsteds. . . . .	15	7	.46
Norwich grograines. . . . .	14	5	.36
Mockadoes, double. . . . .	14	4	.28
“ single. . . . .	14	3	.21
“ tuft. . . . .	14	6	.42
Plommetts. . . . .	14	4	.28
Carells. . . . .	14	4	.28
Fustians of Naples. . . . .	14	6	.42
Blanketts or Spanish rugs. . . . .	..	10	..

Knit Hose.  
Bombazines }  
Motley } made in England at this time, but not enumerated.  
Russels }

WORSTED FABRICS: 1739  
(Contemporary pamphlet)\*  
*Of combing wool entire*

Bays	Cadis	Calimancoes, Plain
Borsleys	Serge	Calimancoes, Flowered
†Shalloons	†Sagathees	Damasks
Spanish Crapes	†Duroys	Russetts
Buring Crapes	†Durations	Everlastings
†Tamys	Ranters	Cantiloons
†Purnellows	Buntins	Worsted plush
Satanetts	Bolting Cloths	Quarter diamond
Harrateens	Swathing Bands	Bird's-Eye diamond
Cheney's	†Serge Denim	
Grogram	Cambletts	
Paragon		

\* James: *Worsted Manufacture*, 227. † Denotes fabrics then of recent introduction.

*Of combing wool and carding wool mixed*  
(Warp of combing wool, woof of carding wool)

Bays	Druggetts, Plain	Swan Skin
Broad Rash	Druggetts, Porded	Swincoe Bays .
Clothiers Serge	Flannel	Perpetuanas
German Serge	Long Ells	

*Of long wool, silk, mohair, and Cotton*

Norwich Crapes	Spanish Poplins	Alapeens
Silk Druggetts	Venetian Poplins	Anterines
Hair Plush	Hair Camblet	Silk Satanetts
Bombazines		

II

In the latter part of the seventeenth century and in the early eighteenth century we find some indications of the relative numbers of persons engaged in the different operations of the woollen industries. Some of the figures were prepared by pamphleteers who were endeavoring to show the importance of the industry as a source of employment to the poor, so that there is some possibility of exaggeration; the interest of the figures, however, does not depend upon minute accuracy. We are chiefly concerned with the larger features of the statistics, the proportions among spinners, weavers, and finishers, and the relation between what we may call the main processes or tasks and subsidiary processes. It would seem that even these crude figures throw some light upon the growth of the division of labor in the industry and make it easier to

understand the transition from medieval conditions to the factory system.

PROPORTIONS OF WORKERS IN THE WOOLEN INDUSTRY

	<i>Persons needed to keep 20 looms busy, Scotland: 1681*</i>	<i>Persons needed to make one piece of medley cloth: 1683†</i>	<i>Persons needed to work up one pack of wool into broad cloth: 1737 ‡</i>
Sorters.....	24 boys	2	1
Pickers.....	12 women	1	..
Scriblers.....	20 boys	..	4
SPINNERS.....	100 men	6	30
	<hr/> 156 hands	<hr/> 9 hands	<hr/> 35 hands
Winding.....	4 men	..	4
Dressers.....	12	..	..
Setting handles.....	2	..	..
WEAVERS.....	40	3	8
	<hr/> 58 hands	<hr/> 3 hands	<hr/> 12 hands
Burlers.....	12	..	4
FULLERS.....	2	1	5
Shearmen.....	..	1	..
	<hr/> 14 hands	<hr/> 2 hands	<hr/> 9 hands

\* Scottish Hist. Soc.: *Cloth Manufactory at New Mills*, xxxvii.

† Eden: *State of the Poor*, i, 221; James: *Worsted Manufacture*, 218.

‡ V. C. H.: *Gloucester*, ii, 160.

It is unfortunate that these estimates do not include any figures for the dyers. The medley cloth was probably used in its natural color, so that no dyers would be used, and the dyeing of the broad cloth was done after it had passed through the hands of the London merchants. The statement with reference to the broad-cloth manufacture was exclusively occupied with the persons employed by the west of England clothiers. The condition of the English industry was always somewhat exceptional: short of being wholly representative, because a large part of the cloth exported was sent out wholly or partially unfinished. Some of the Flemish and Italian towns made a specialty of dyeing and finishing.

The woolen industry was divided into four primary occupations: the preparation of the yarn, which was chiefly concerned with spinning; the weaving of the cloth; the physical

manipulation of the cloth, shrinking, picking of burrs, shearing, stretching, and pressing; the dyeing. Each <sup>Stages in</sup> of these primary tasks was ultimately sub-<sup>manufacture</sup> divided, but these subdivisions were slow to appear for reasons that will be obvious from an inspection of the table. The work necessary to prepare wool for spinning required proportionately few hands, so that specialization of these tasks was not usual until the industry came to be organized on a large scale. The tasks subordinate to weaving were probably fairly well specialized at an early date, though we hear little of them as distinct occupations. Much of such work could be done by children and was undoubtedly done by the apprentices or the children of the weaver. The processes associated with fulling were by necessity the work of adults; fulling, rowing, and shearing was men's work, burling — picking knots and burrs out of the cloth — was done by women as soon as it became a separate occupation. These various finishing operations became distinguished at an early date. There is a rough consistency in the proportions of persons in the three accounts given: about three times as many persons are engaged in preparing yarn as in weaving, and the labor employed in fulling and its ancillary tasks is slightly less than the labor employed in weaving. If these facts represent to any degree the fundamental proportions <sup>Spinning in</sup> of labor in the industry, some interesting light <sup>the early</sup> is thrown upon the numbers of persons enrolled <sup>period</sup> in the various crafts in the early period. Our most complete information is from Paris, but there is no reason to suppose that conditions there were not entirely representative of the maximum degree of industrial specialization for that period.

PROPORTIONS OF TEXTILE WORKERS IN THE PARIS TAX-ROLLS:  
1292 AND 1300

	1292	1300
Combers.....		
Spinners.....		
Weavers.....	82	360
Fullers.....	24	43
Dyers.....	15	33
		f

The very large number of weavers and the absence of a specialized class of spinners shows clearly that the weavers were either having the yarn prepared in their own households or were buying yarn from persons who did not regard spinning as their main occupation. It is most likely that the separation between weaving and spinning took place very early; we have vague allusions which seem to indicate that there was an appreciable trade in yarn between different regions of northern France and between England and the Continent. It is entirely possible that Paris should have drawn much yarn from the neighboring countryside. The women on the farms were the primary source of labor for spinning. We hear little of this aspect of the industry in the materials concerned with crafts and craft organization because this labor was almost entirely unorganized, but from an economic point of view it is important to recognize the existence of this group of workers and it is our misfortune to be without any account of the manner in which the industry was supplied with yarn in the early period. It is quite possible that there was more capitalistic control of these early processes than we suspect.

It will be observed also that there is a disproportion between the number of weavers and the number of persons engaged in finishing, very striking in the figures for 1300. This admits, however, of a simple explanation. There is strong reason to presume that much unfinished cloth was used in this early period. If this presumption is well founded, it would perhaps explain why the finishing crafts, which emerged as distinct occupations before weaving, play such an unimportant rôle in the development of capitalistic control. The trade in finished cloth expanded much less rapidly than the trade in crude cloth. The industry as a whole grew much more rapidly in the thirteenth and fourteenth centuries than the finishing departments. The crafts of fullers and dyers thus grew less rapidly in numbers and in wealth, and relatively to other textile crafts their prestige declined. This is particularly noticeable in the case of the dyers of Paris,

The subordination of the fullers was furthered by the character of the occupation. The work was disagreeable and in the early period involved little capital. The cloth was placed in a long trough with fuller's earth, soap, or other cleansing and shrinking agents. <sup>Fulling</sup> Whatever the composition of the mixture, it was never inviting. The fullers, with little or no clothing to hamper them, then proceeded to tread these mixtures into the cloth. Because of this feature of the occupation, they were frequently called "walkers." In so far as any pressure was applied to the cloth in the early period it was merely the pressure of the fuller's treading. Jean de Garlande says that the fullers worked naked, and that they were a low, disorderly group of men. After the cloth was shrunk, it was stretched with ropes and pulleys — the process called "rowing" — and then dried on the grass. The fullers also went over the cloth with weaver's teazels to raise the nap, though this work ultimately became the work of a separate group of workers called "burlers." Fulling thus involved much crude manual work, some of which was so disagreeable that the occupation was confined to a particularly low order of artisans. Before weaving became a specialized occupation much cloth was doubtless finished off by fullers on behalf of persons who had done the weaving themselves. The craft was therefore accustomed to the system of wage-work and, though not exclusively dominated by such a system, it was easy and natural for them to fall into the way of working for weavers or drapers instead of for householders.

Capitalistic domination of fulling was also promoted by the introduction of machinery. The dates of these improvements are uncertain, and we have no adequate <sup>New</sup> descriptions of the machines, but we have indi- <sup>appliances</sup> cations of the general types. The first change came with the introduction of a hinged beam worked by hand, to dispense with treading out the cloth. An upright post was set up at the side of the fulling-trough. A heavy mallet was then attached to the upper end of the post with a hinge. The head of the mallet would describe an arc, and would deliver

a considerable blow on the cloth in the trough, beating it up against the side of the post. The fuller worked the mallet and passed the cloth along the trough under its blows. The cloth could thus be subjected to more pressure than could be secured by mere treading. At an uncertain date, not later than the sixteenth century, a modification of these fulling mills was introduced which made it possible to apply water-power. The hammer beam became a kind of trip-hammer worked by a water wheel. The necessity of running water for scouring and washing invited such an application of power, and this machine was sufficiently within the compass of sixteenth-century mechanics to make it fairly certain that the so-called "tucking mills" were pretty generally introduced during the sixteenth century. The other process that fell within the province of the fuller, burling, was similarly brought within the scope of machinery. The weavers' teazels were set on large drums which were turned by power, sometimes water-power, sometimes power derived from winches. These devices were called "gig mills."

The subordination of the dyers to the capitalists was less complete. There were greater opportunities for independent work. In some towns the dyers constituted an important group because they finished cloth that was woven on the farms and in the villages of the countryside, or even cloth that was imported from a great distance. However, much dyeing was done on the premises of the capitalist employers by journeymen or master dyers who were hired for wages. A small number of workmen could handle the output of a large number of weavers and the concentration made for efficiency.

The worsted industry differed from the woolen industry in some of the proportions among the various workers. More spinners were employed proportionately to the weavers and fewer persons were necessary in the finishing stages. As spinning was relatively unskilled labor it is obvious that the worsted industry could use a lower grade of labor than the woolen industry. Its competitive strength thus lay in the greater economy of raw material



and its greater reliance upon cheap labor. When one considers that worsteds offered a greater variety of fabrics at distinctly lower prices it is hardly surprising that the woolen industry lost ground steadily, beginning at least as early as the sixteenth century.

PROPORTIONS OF WORKERS IN THE WORSTED INDUSTRY <sup>1</sup>

	<i>Numbers of persons employed</i>		
	<i>Per pack of 240 lbs., 17th cent.</i>	<i>Per 100 weavers, or 12,000 lbs. wool</i>	<i>? 1738</i>
Sorters.....	..	4	..
Pickers.....	..	10	..
Combers.....	7	20	6
SPINNERS.....	250	900	120
	<u>257 hands</u>	<u>934 hands</u>	<u>126 hands</u>
Throwers or doublers.....	20	54	10
Thread-makers.....	..	4	..
Bobbin-winders.....	..	12	..
Back-throw winders.....	..	12	..
Quill boys.....	..	50	..
Warpers.....	..	5	..
WEAVERS.....	25	100	22
	<u>45 hands</u>	<u>237 hands</u>	<u>32 hands</u>
DYERS.....	..	6	..
Pressers.....	..	6	..

<sup>1</sup> James: *Worsted Industry*, 211, 218.

The preparation of the yarn required four times as many hands as the work of the weaving department, and half of the work of the weaving department could be done by persons without much strength or skill. Little work remained to be done when the cloth was taken from the loom. Conditions within the industry were thus notably different from the conditions in the woolen industry. The worsted weaver was relatively more important socially and the yarn-making more of an independent business. The separate organization of the preparation of worsted yarns might have been due to these general features of the industry, but in England, at least, it is more likely that the control of yarn-making by a separate group of capitalists was more

Worsted yarn  
manufacture

largely due to the fact that the working-up of the English wool into worsted yarn became established on a larger scale than the weaving of worsteds. The supply of long combing wool was large and for a long time the wool-growers remained dependent upon a foreign market. It became possible, however, to get the spinning done in England long before there were enough worsted weavers to utilize the entire English supply.

There were differences between the two branches of the woolen industry, but the development of capitalistic control followed the same general course. Integrated **Drapers and clothiers** control was secured primarily through the efforts of the mercantile class. The detailed reasons for the predominance of this class varied somewhat in different localities and in the different industries, but the drapers or clothiers became the employing group except in a portion of the eastern counties where the control of the supply of worsted yarn fell into the hands of a group of wool brokers who came to be called "master combers." The position of the mercantile groups was probably stronger in England than it was on the Continent.

In these statements about spinners one must remember that they were not specialized industrial workers. Spinning was a by-employment, a casual source of revenue to households whose main concern was agriculture. If we assume that spinning employed between one half and two thirds of the persons connected with the textile manufacture, the dependence of industry upon agriculture will be readily **Industry and agriculture** apparent. The industrial population was not distinct from the agricultural population even in the eighteenth century, and the large numbers of persons alleged to be concerned with the textile industry are probably to be explained in this way. A pamphleteer of 1679 declares that 700,000 persons were at that time connected with and dependent upon the woolen industry. A writer of similar caliber in 1741 arrives at a total of 964,000. These figures, of course, seem impossibly large in comparison with modern figures and there is exaggeration in them, no doubt, but the

totals must have been large simply because so large a proportion of the total population was more or less casually connected with the industry.

No comparison can be made between such conditions and those familiar to us. Occupational statistics of agriculture and industry mean nothing at that time because the distinction was not sharp enough to admit of statistical separation. Even the skilled weavers did farm-work during the harvest, and more or less gardening at all times. In the counties which produced coarse cloth, weaving and agriculture were joint occupations. In sections that were prosperous the artisans who were most highly specialized consumed the agricultural surplus on the spot and utilized the spare time of those more directly at work on the land. When the soil was stubborn the scant living offered by the land was eked out by patient work at the spindle and loom in the evenings and during the winter. The textile industries had thus become specialized to a degree, but they did not become independent of agriculture or the household until after the Industrial Revolution.

### III

The geography of the industry in 1550 is represented approximately by the map, which is based as far as may be on specific references in the statutes and documents of a similar character. The difficulty in representing the location of the manufacture lies in the danger of shading large areas on the basis of general references, and in the likelihood, on the other hand, of undue emphasis upon weaving and finishing. The industry passed through three stages of territorial diffusion. In the earliest period, before the twelfth and thirteenth centuries, there was much weaving of homespuns in all the country districts. Coarse cloths designed for personal use were thus made, though in some counties there was a surplus for export. Such weaving was not really a specialized craft-industry. Beginning in the twelfth century specialized craft-weaving became established in the trading centers and in the larger towns. Most of these settle-

ments were incorporated during the period, so that weaving as craft was definitely associated with the towns. As early as the middle of the fifteenth century in Suffolk, somewhat later in other counties, the industry began to spread to the smaller settlements, some of them fairly considerable in population, perhaps, but not possessed of corporate privileges. Villagers took up weaving, too, in a more systematic fashion; a very easy transition in those counties connected

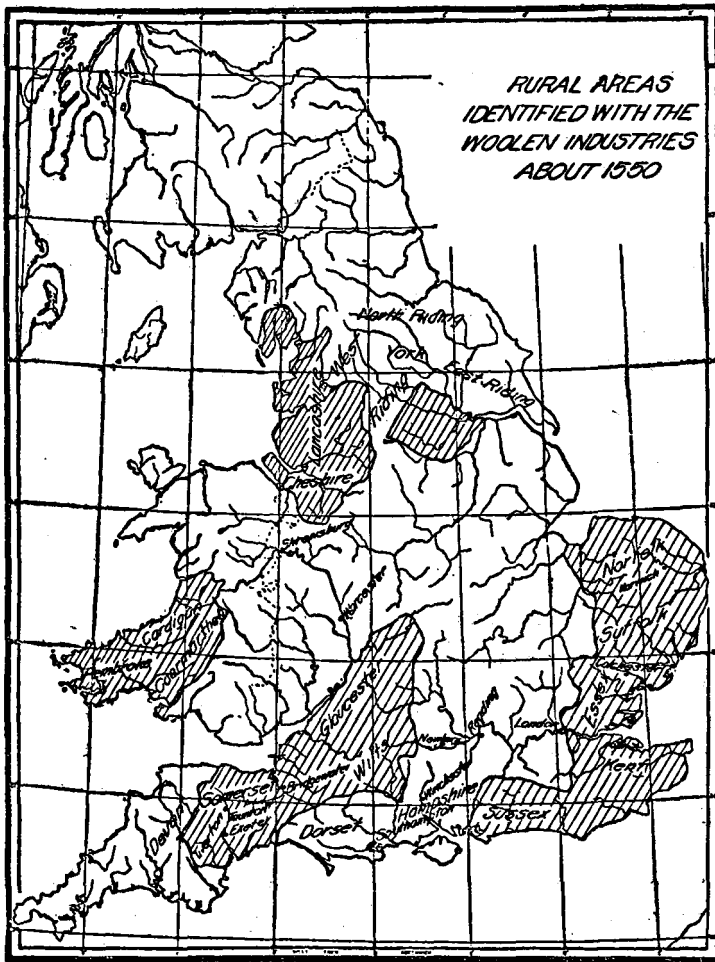

with the export of homespuns. The growth of the industry required much more spinning to be done in the country, and there were advantages in the close association of the various branches of the industry.

The shaded portions of the map are intended to be restricted to those counties and parts of counties in which industry was definitely spread through the country districts. There are two types of industrial development represented. The Welsh counties, Pembroke, Caermarthen, and Cardigan, manufactured frieses that were sold to drapers from Shrewsbury before being finished. The drapers had them finished. This represents a development of the old cottage Location of the cottage industry weaving for personal consumption into an export industry. The same is true in general of the northern counties, Cheshire, Lancashire, and the West Riding of York. The shaded portions of the eastern and western counties were the seat of the broad cloth manufacture in the Broad-cloth districts main, though some portions of these regions were concerned chiefly with the making of kerseys. There is scarcely sufficient evidence for the state of the industry in the counties of Norfolk, Kent, and Sussex, but there seems to be ground for presuming that the industry was spreading outside the towns. In Hampshire, Dorset, Berkshire, and Worcester there was much weaving and finishing done, but almost exclusively in the towns. All three stages in the growth of the industry are thus represented in some part of England in 1550.

The development of the country industry was in a measure unfavorable to the weavers of the large towns. They were obliged to compete with the country weavers, Cheap labor and this competition was the more severe because the country weavers were not working wholly on their own account. Most of them were weaving yarns given out to them by the clothiers of the towns. These clothiers had thus begun to develop the supply of cheap labor found in the country districts. The town weaver thus found that the cloth merchant was becoming a manufacturer who competed with him instead of buying his cloth or hiring him to do his weaving.

The weavers of the towns, being organized in gilds or other associations, were able to bring pressure to bear on Parliament, and in 1555 the Weaver's Act was passed which was designed to afford them relief. It was provided that no clothier, outside of a city, borough, market town, or town corporate, should have more than one loom, or receive any profit from the letting of looms, or let any house in which looms are set up. That no woolen weaver outside city or town should have more than two looms. That no weaver should have a fulling mill, or act as a fuller or dyer. That no fuller or dyer should have any loom. That persons taking up the occupation of clothier should have no weaving done for them outside cities and towns. That weavers outside cities or towns should not have more than two apprentices. That no one should be a weaver unless he had served seven years as an apprentice.

This statute, if enforced, would have well-nigh put an end to the capitalistic developments that had become established. The industry would have remained in that state of disintegration characteristic of the earliest stages of craft development. The clothier was permitted forsooth to have one loom, but that would have been small consolation. The market towns were included within the area open to industry, but this also was a trifling concession. The act was never really enforced to its full extent. Appended to the original act as a separate schedule, perhaps therefore an amendment, there is a proviso exempting all the northern counties from all the prohibitions of the statute. In these counties, York, Northumberland, Cumberland, and Westmoreland, there was much cottage spinning and weaving, primarily but not exclusively for personal consumption. In the West Riding of York the weavers were producing goods for export. The apprenticeship provisions would have worked great hardships in these districts, and they were consequently exempted. Other exemptions followed shortly which ultimately removed from the application of the statute most of the country districts in which the industry was established. In 1557-58 exemp-

tions designed to cover cottage industry were extended to Durham and Cornwall. In the more important clothing districts, in which capitalistic methods were established, all existing establishments and practices were to be allowed despite the prohibitions, and in certain specified districts new establishments might be set up by persons who had served an apprenticeship as clothier. The districts specified in the amending act were: the counties of Suffolk and Kent, the town of Godalmine, in Surrey, and the towns or villages near or adjoining the Water of Stroude in the County of Gloucester. Clothiers were required to serve an apprenticeship in the future, but those who had not served an apprenticeship were not required to abandon their business. These provisions were included in a long statute on the cloth manufacture, so that it would seem that the adroitness of the capitalists in matters of high politics was considerable, to say the least. Portions of Essex were exempted in 1558-59, and in 1575 the exemptions were extended to practically the entire west of England clothing district.

This last statute was a straightforward piece of legislation. The other acts were not very specific, a general formula was provided, but there was no detailed description of either the current practices of the clothiers or of the practices which should be accounted lawful. The Statute of 1575, however, contained a substantial statement of the condition of the industry in these counties. The preambles of statutes are, on the whole, untrustworthy evidence, but in this case there is sufficient contemporary material of other kinds to confirm the general outline of this description.

Forasmuch as divers and sundry persons have hertofore of long time used and exercised the Feate and Mystery of cloth-making in the Counties of Somerset, Wiltshire, and Gloucester, <sup>The putting-</sup> and have at great costs and charges planted them- <sup>out system</sup> selves and their dwelling houses dispersedly throughout the said counties, and neither in Cities, Boroughs, Towns Corporate or Market Towns, as might and may serve most conveniently for the use and exercise of the said Feat and Mystery, namely about the Rivers of Fromewater, Kingswoodwater, the Rivers of Avon, Willibourne, and Salisbury bournes, and Stroud water, in the said coun-

ties of Somerset, Wiltshire, and Gloucester and the branches of the same waters; And also for that the said places and waters are very good and apt for Clothing, together with the great number of Fulling Mills and other workhouses therto adjoining maintained only by the Cloth-making in the Villages and Parishes thereabouts: And forasmuch also as a great multitude of poor people as Weavers, Tuckers, Spinsters, and the like, have of long time heretofore and at this present, do inhabit and dwell near unto the said places and waters, by means of the great Clothmaking there, heretofore and now used, and have been only relieved and sustained by the same; and also for that great inconvenience might ensue within the said counties of Somerset, Wiltshire, and Gloucester, in removing and placing of such a multitude in or within any City, Borough, Town Corporate, or Market Town, according to the meaning of the said act [i.e., of 1555] . . .

The body of the statute provided that the prohibitions of the Weaver's Act with reference to the fulling and weaving of woolen cloth should be repealed in so far as they applied to the counties of Somerset, Wiltshire, and Gloucester. Clothiers in these counties, however, were forbidden to make cloth "except in such houses and places" as were devoted to the cloth manufacture for the ten years prior to 1555. Clothiers in the future should not hold more than twenty acres of land, and clothiers now engaged in this occupation should not add to their present holdings, subject to a fine of six shillings eight pence per acre per year for land held contrary to the statute.

After 1550 there was a tendency toward the concentration of the woolen industry in the exempted districts of the eastern and western counties, but this was partly an outcome of natural economic forces. The exemptions to the Act of 1555 are so numerous that one must needs assume that all the important districts were ultimately included in the exemptions. The vested interest argument that led to the Act of 1555 was equally potent in nullifying it: wherever important changes were likely to be forced by its provisions, the prohibitions were raised. The Act of 1555 might thus result in fixing the existing situation, but it is hardly likely that the location of the industry was significantly changed.

The conditions of the time also tended toward stabilizing



the industry in existing locations. The rise of the "New Drapery" at this time subjected the woolen industry to pressure that became increasingly important. The industry seems also to have been affected by foreign competition, if contemporary opinion may be trusted. The Spanish trade was accounted the cause of a decline in the early seventeenth century. The introduction of the East Indian cottons and silks in the middle of the seventeenth century added to the difficulties of the industry. The influence was felt by the entire range of industries based on wool, but most keenly by the woolen industry. The New <sup>Stagnation</sup> Drapery stood up to the competition better. The woolen industry was thus subjected to various kinds of strain from the beginning of the seventeenth century. It is likely that it ceased to expand at that time, and it is certain that its growth was less rapid than the growth of the worsted industry. It is difficult to date these changes accurately with the information available, but it is at least plausible to suppose that the expansion of the industry which carried it into the country districts of the west in the early sixteenth century marks the climax of the development of the old drapery — the woolen manufacture in its narrow sense. The restrictive legislation thus came at a time when the industry was already at its highest point.

In Suffolk, Essex, and portions of the west of England the decline of the woolen industry was obscured by a transfer to worsted goods. In these counties particular towns or localities lost ground, though the industrial character of the county as a whole was not profoundly affected. In other districts no new textile manufacture came in to replace the woolen industry. Kent, Sussex, Hampshire, and Berkshire seem to have suffered severely, though some woolen manufacture lingered in these counties until the close of the eighteenth century.

#### IV

The Weaver's Act and the other legislation of the period afford unmistakable evidence of the existence of a putting-

out system of considerable proportions. Conditions would seem to imply that this capitalistic control was not new at that time, and various items of evidence indicate the existence of the system a century or a century and a half earlier. Aulnagers' accounts for 1395 and 1396 suggest much. The aulnager was the official measurer of cloth charged with the duty of inspecting cloth as to width and length to insure compliance with the statutes. His duties would thus bring him in touch with the entire industry, and his accounts should afford a clear indication of relative conditions.

RELATIVE SCALE OF THE CLOTH MANUFACTURE: 1395-1396

<i>District</i>	<i>No. of pieces of cloth inspected</i>	<i>No. of persons responsible for manufacture</i>	<i>Average number of pieces per person</i>
Suffolk.....	733 (broad)	120	6
Romsey.....	30-46 (dozens)	4	7.5-11.5
Coggeshall.....	1200 (narrow)	9	133.3
Braintree.....	2400 (narrow)	8	300
Barnstaple.....	3685 (broad)	11	335

If we may assume these figures to be at all characteristic it is safe to say that the putting-out system was established on a considerable scale in portions of the west of England clothing district and in some towns of Essex. The dozens produced in Romsey were short, so that the scale of manufacture is really about the same as that for broad cloths in Suffolk. The fact that the manufactures in Essex, Coggeshall, and Braintree, were working on narrow cloths also reduces the significance of the figures. These cloths were one yard wide as compared with the yard and three quarters width of the broad cloths. In terms of value of output, therefore, the manufacture in the west of England was organized on an appreciably larger scale.

Detailed evidence of the character of the putting-out system in particular places is not available until a much later date. Some of the earliest evidence is from Colchester. The trade ordinances of 1411 provided that no weaver should be compelled to take any merchandise or victuals for wages

against his will. This may indicate a putting-out system, but one cannot be certain. Other ordinances, made at Colchester in 1452, are more specific. They prescribe certain weights for the wool given out by weavers to combers and spinners.

If these references are interpreted in the light of subsequent information we may conclude that two forms of putting-out were practiced at Colchester. There <sup>Colchester</sup> were clothiers or drapers who gave out yarn to poor weavers. There were also wealthier weavers who put out raw wool to be worked up into yarn. There is no reason to presume that both systems did not exist thus side by side. The existence of the putting-out system is compatible with great diversities of organization even in a single locality. The richer weavers here continued the traditions of pure craft-work, so that it would seem that the craft-form existed despite the development of the newer capitalistic form. This was probably characteristic of the eastern counties, and is well illustrated by the aulnagers' accounts already cited. The average output of the Suffolk manufacturer was six pieces, but there were seven or eight of the hundred and twenty listed who made a score or more pieces each. The smaller master weavers thus made about five pieces, and the larger manufacturers made twenty or twenty-five. The richer weavers, who thus retained their independence, became capitalists in a measure, enlisting the services of women who did combing and spinning in their homes for a piece wage. The poorer weavers became the employees of the clothiers.

Pure craft-work could not long maintain itself. The craftsmen in each industry moved up or down the scale soon after the industry reached the maximum degree of disintegration. This instability of the pure <sup>Craft independence soon lost</sup> craft stage is not adequately emphasized by Bücher and his followers, nor is the brief duration of such arrangements fully appreciated by those who like to think of the middle ages as the golden age of the artisan. Independent craft-work was a short-lived form of organization

in the industries of major importance, and, even if the extent of capitalistic supervision was moderate, the rise of capitalism in this mild form was none the less an important social transformation. Indefiniteness of outline and paucity of information have tended to obscure both the early date at which the putting-out system became established and the extent to which such arrangements dominated the chief industrial districts.

The Statute of 1464-65 is our best source of information as to the extent of this system in the fifteenth century. This was a truck act, to use the modern expression, and while it is not very specific in its terms it implies clearly that the entire woolen industry was dominated by the putting-out system. Complete description is not possible until the close of the sixteenth century. The researches of Unwin in connection with the *Victorian County History of Suffolk* have brought to light much new material, and, though the system was not established as early in that county as elsewhere, conditions in the late sixteenth century must have been fairly representative.

The first stage . . . was the purchase of the wool after shearing. This might be made by the manufacturing clothier direct from the Suffolk wool grower, but for a century before this period the inter-brokers' intervention of the middleman or broker had been becoming more and more necessary. As the industry expanded the wool grower and clothier frequently found themselves in different counties, and had no time to seek each other out. Even when they were within reach of each other, capital was needed to tide over the period of waiting. In some cases this was furnished by the wealthier wool growers or clothiers themselves, but the capital of the majority of either class was not large, and the demand upon it was greatest at sheep-shearing time. The broker, therefore, who bargained for the wool beforehand, collected it and supplied it on credit or held it over till it was wanted, supplied an indispensable link between the small producers of wool and of cloth. . . .

Coming next to the clothier, into whose hands the wool directly or indirectly passed, we have to do with a class of the most varied status. Some of its members were large employers of labor and at the same time merchants upon an extensive scale; others only contrived to keep themselves above the

level of the laboring class by dint of constant alertness and thrift and the possession of a minimum of capital. A petition of clothiers was presented to the government in 1585 against the activities of licensed brokers, complaining that as their own capital was not great they had to buy at second, third, and fourth hand in the latter end of the year at excessive prices. Of 166 names appended to this document, representing nine or ten counties, forty-one were those of Suffolk clothiers. No other county in the list (Norfolk was not included) furnished more than half that number; and no doubt the petitioners, in spite of protestations of poverty, were the representatives of a more numerous class. In the hands of these capitalists, small or great, lay the control and direction of the manufacture, with the exception of the finishing processes which were often carried out after the cloth had been disposed of to the merchant.

Although some undyed cloth was made in Suffolk, the greater part seems to have been dyed blue in the wool, whilst a smaller portion was further dyed violet, purple, or green after it had been woven. . . .

The carding and spinning were mostly done by women and children in their cottage homes all over the countryside. "The custom of the country is," says another petition of Carding and Suffolk clothiers in 1575, "to carry our wool out to spinning carding and spinning and put it to divers and sundry spinners who have in their houses divers and sundry children and servants that do card and spin the same wool. Some of them card upon new cards and some upon old cards and some spin hard yarn and some soft . . . by reason whereof our cloth falleth out in some places broad and some narrow contrary to our mind and greatly to our disprofit." . . . Although the preparation of yarn was chiefly carried on in the villages and smaller towns, it also continued to find occupation for a considerable amount of semi-pauperized labor in the larger towns. Spinning indeed was the main resource of those whose duty it became, under the New Poor Law, to find work for the unemployed, and in institutions such as Christ's Hospital, Ipswich (founded 1595), children were set to card and spin wool from their tenderest years. . . .

The spinners, who never seem to have possessed any organization of their own, were very liable to oppression on the part of their employers, not only through low wages, but also through payment in kind and the exaction of arbitrary fines. It is not surprising, therefore, to find them frequently accused of keeping back part of the wool given out to them and of making up the weight by the addition of oil and moisture to the yarn. The natural connexion of these two evils found recognition in a Bill presented to the Parliament of 1593, which while imposing fresh penalties on frauds

in spinning and weaving, proposed at the same time to raise the wages of spinners and weavers by a third. The Bill failed to pass, but the regulation of wages in the interest of the spinners continued to be a problem of poor law administration during the next half century.

The yarn woven in the country districts was collected by riders sent out by the clothiers and delivered to the weavers. The weaver, though he too was dependent on the clothier for employment, was not in so helpless a position as the spinners. The power of his organization in the town, though weakened, was not destroyed. The line between the clothier and the weaver was, at first, not sharply drawn. The more prosperous among the weavers gradually developed into clothiers, and Suffolk was one of the counties in which this tendency was allowed to have free play, since it was exempted from the operation of the statutes forbidding clothiers to set up outside the market towns. But although a master weaver here and there might rise in the world, the majority were sinking into the position of wage earners. A petition of weavers of Ipswich, Hadleigh, Lavenham, Bergholt, and other towns in 1539 states that the clothiers have their own looms and weavers and fullers in their own houses, so that the master weavers are rendered destitute. "For the rich men, the clothiers, be concluded and agreed among themselves to hold and pay one price for weaving, which price is too little to sustain households upon, working night and day, holy day and week day, and many weavers are therefore reduced to the position of servants." As a rule, however, the weaving continued to be done in the weavers' houses, although perhaps in some cases the loom was the property of the employer. Elaborate regulations both by Parliament and by the local authorities were to insure that the right weight of yarn should be delivered by the clothier, and that none of it should be wasted or stolen by the weaver. The fuller, who next took over the cloth, was also employed by the clothier. It would be a natural thing for a fuller with a little spare capital to set up a loom in his house, and no doubt he did so, as we find it forbidden in later ordinances, just as we find the weavers and shearmen prosecuted for setting up as clothiers.

When the cloth was woven and fulled the clothier might have it finished by the local shearman, but he more often seems to have disposed of it to the merchant. The two chief markets for the Suffolk clothier were London and Ipswich. A good deal of Suffolk cloth was bought by the London clothworkers to finish, and some was bought by the London merchants ready finished for export.<sup>1</sup>

<sup>1</sup> George Unwin, in the *V.C.H. Suffolk*, II, 257-59.

There are no concrete statements to indicate the scale of these clothiers' operations until 1618. Reyce, in the *Breviary of Suffolk*, written in that year, says:

It is reckoned that he which maketh ordinarily twenty broad-cloths every week cannot set as few a work as five hundred persons, for by the time his wool is come home and is sorted Scale of saymed, what with breakers, dyers, wood-setters, manufacture wringers, spinners, weavers, burlers, shearmen, and carriers, besides his own large family, the number will soon be accomplished. Some there be that weekly set more at work, but of this number there are not many.<sup>1</sup>

There is sufficient evidence to show that this system was common in the woolen districts of Essex, and throughout the western counties. In all essential details the system was in vogue in the west of England in 1806, and, as Wide vogue of this system the clothing industry had died out in the eastern counties by that time, the Woolen Report calls the system the "West of England Clothier System." In so far as this is regarded as a definite system, its distinctive feature consists in the precise extent of the domination of the industry by the clothier; his control extended at least to both preparation of the yarn and weaving of the cloth, together with incidental dyeing of yarn or cloth. If the finishing were done before the cloth was sold it was done under the supervision of the clothier. Thus we can say that all the work done on the wool up to the time of its reaching the wholesale merchant was controlled by the clothier.

Toward the close of the sixteenth century and in the early decades of the following century, there were two other forms of the putting-out system; one common in the west, the other in the worsted districts of the eastern counties. In these cases the industry was divided into two sections, spinning and weaving being separately organized. In the western counties there were many poor people "that will not spin to the clothier for small wages: but have stock enough to set themselves on work, and do weekly buy their wool in the market by very small parcels according to their use, and

<sup>1</sup> *V.C.H. Suffolk*, II, 262.

weekly return it in yarn, and make good profit thereof, having the benefit both of their labor and of their merchandise, and live exceeding well. These yarn makers are so many in number that it is supposed by men of judgment that more than half the cloth that is made in Wilts, Gloucester, and Somersetshire is made by means of these yarn makers and

**Poor clothiers** poor clothiers that depend weekly upon the wool chapmen which serves them weekly with wools either for money or for credit.”<sup>1</sup> The poor clothiers referred to were men whose means were not great enough to enable them to dominate the entire industry. The large clothiers controlled only about half the woolen manufacture of the west.

In the eastern counties there was also a place for the poorer clothiers, but it was largely in the worsted industry, in which the preparation of the yarn was a special business. The division of the worsted industry, however, was not entirely due to relative wealth or poverty of clothiers, weavers, and spinners. There had long been an export trade in worsted yarn from the eastern counties to the Continent. Spinning thus came to be organized upon a relatively larger scale than weaving, weaving being definitely of subordinate importance

**Master combers** until the seventeenth century. A group of master combers appeared in the eastern counties: persons who bought wool, put it out to combers and spinners, and sold the yarn in London or to exporters. Worsted weaving was done primarily in the towns by master weavers of small means. They were dependent in a measure upon the supply of yarn produced by the master combers, but they frequently bought wool on their own account and put it out to be spun. There was therefore little capitalistic control of weaving. This system persisted, or rather acquired sharper definition, and is described in the Woolen Report of 1806 as the “Master Comber System of Norfolk.” In the earlier period the system seems to have been more widely diffused throughout the eastern counties.

<sup>1</sup> Extracts from a document in S.P.D. Jac. I, 1615, printed by Unwin, *Industrial Organization*, 234-35.



This great development of putting-out involved not only the establishment of a network embracing many cottage workers, but also implied the creation of quite considerable central workshops to handle the business. Each large putting-out establishment thus resulted in the creation of something that strongly resembles a small factory. The line dividing the putting-out system from the factory is at all times vague and must have been particularly vague at this time. It is thus entirely natural that there should have been some experimentation with the factory system. The number of concrete instances known to us is small, but the fact is beyond question. The most notable of these early adventurers was John Winchcombe, Early factories familiarly called "Jack of Newbury" and duly celebrated in prose and verse. The metrical version of his story confines itself to so many round numbers that it would seem unwise to presume accuracy in details. There may be some element of legend in the numbers. The numbers given are as follows:

200 weavers
200 quill boys
100 women carding wool
200 girls spinning
150 children picking
50 shearmen
80 rowers
40 dyers
20 fullers
<hr/> 1040 persons employed

These proportions are hardly in accord with the indications cited previously. The force of weavers and quill boys is apparently excessive. Such, however, is the legend, and whatever the precise extent of the establishment, there can be little doubt but that Jack of Newbury was indeed experimenting with the factory system in the early years of the reign of Henry VIII. Leland the antiquarian speaks of one Stump, a clothier, who leased the Abbey of Malmesbury "to be full of looms and to weave cloth." Later the same person is reputed to have leased an Abbey near Oxford agreeing to employ two thousand persons "to succor the city of Oxford."

Ashley has inferred from the legislation of the middle of the sixteenth century that there was a significant tendency toward the factory system. It is difficult to see the grounds for this inference, though there can be no doubt that there were sporadic experiments. The putting-out system had disadvantages which must have been keenly realized by the clothiers, but there was at that time no clear financial advantage to be secured by collecting the employees in factories. The putting-out system remained the dominant form of industrial organization in both England and on the Continent until the Industrial Revolution. There was rather more experimentation with the factory in France than in England, perhaps because the experiments began somewhat later — in the seventeenth century. But on the whole the factory was not an undoubted success. Some of the French establishments maintained themselves, but they were not independent of state subsidies. The tapestry manufacture at the Gobelins<sup>1</sup> is the best known of these seventeenth-century factories, but there were other tapestry manufactures and two or three cloth-making establishments. The latter failed after various vicissitudes. In the eighteenth century paper mills were established in the Rhone Valley which were undoubtedly factories in every sense of the word. But these isolated cases were not destined to exert any profound influence upon the general forms of industrial organization. At the same time these early experiments are sufficiently important to force us to recognize that factories were not a novelty, first introduced at the time of the Industrial Revolution. It was a form that was well known, though it had not proved to be economically profitable on any extensive scale. Fuller knowledge of the forms of organization prevalent during the seventeenth and eighteenth centuries will probably destroy all claims for the novelty of the factories that emerge as a direct result of the changes brought about by the Industrial Revolution.

Weakness  
of the factory  
movement

<sup>1</sup>

*Indus.*

## CHAPTER IX

### THE ENCLOSURE MOVEMENT AND LAND REFORM

#### I

THE enclosure movement was the transformation of the methods of agriculture and field arrangements which substituted for the open fields of the medieval period the hedged and ditched fields of modern Eng-<sup>Enclosure</sup>land. The land of individual proprietors under the new arrangement was concentrated in the solid blocks of territory that characterize the modern farmstead. The enclosure is thus closely associated with the break-up of the open fields, and one tends to think of enclosed fields as always succeeding the older open fields; this, however, is not strictly true. It is now recognized that the open-field system never prevailed systematically in the eastern counties, and it has always been known that enclosures were frequently formed by clearing forest land or heath that had formerly been used for pasture. Hedged and ditched fields might thus originate in a variety of ways, and, in so far as they represented the original mode of settlement or an improvement of land that was regarded as "waste," enclosed fields cannot properly be associated with the enclosure movement.

The changes described by the term "enclosure movement" include three kinds or degrees of rearrangement of fields: the scattered strips belonging to the demesne farm might be brought together in solid blocks and <sup>Various forms</sup> enclosed; portions of the common pasture might be enclosed either by the lord of the manor or by certain villagers; the open fields, or portions of them, might be divided among the existing owners in solid blocks instead of scattered strips. The variety of forms of enclosure constitutes one of the difficulties in tracing the history of these changes. The transformation ultimately involved a complete abandonment of the old agricultural technique, but the change was not

sudden even in particular localities. The earlier enclosures were partial; they included portions of improved waste, lands belonging to the demesne farm, parts of the open fields. Considerable enclosure was possible without change in the general arrangements of village agriculture, and, as the initiative was taken by lords of manors and the richer landowners, the life of the village as a whole was not seriously affected until the movement was far advanced.

The purposes of enclosure were economic: the new field arrangements made it possible for the proprietors to adopt better methods of agriculture. More diversity in cropping and in rotations was possible, and ultimately a new combination of arable agriculture with grazing was developed. This system of agriculture is usually called the "Midland System," as it is particularly suited to the types of soil that prevail throughout the Midlands. There is thus a rough correspondence between the area that is most appropriate to this mode of culture and the area that was characterized by the open fields.

The land will hold a crop of artificial grass for six or seven years without notable deterioration, so that it is possible to pursue a system of culture in which there is an alternation between arable and grass. The farm would be divided into portions of approximately equal size; six or seven of these fields would always lie under grass, three fields would lie under cereal crops. In the spring the field that had lain longest under grass would be ploughed and planted with oats, the field that had grown oats the previous year would be ploughed two or three times and planted with wheat, and the field that had borne its crop of wheat would be ploughed in the fall after the harvest and seeded with barley and grass in the spring. The grass in the fields lying under grass was applied to the grazing of dairy cattle, with some cows and sheep being fattened for slaughter. "All together," says Marshall, "a beautifully simple system of management, and, being prosecuted on large farms, and by wealthy and spirited farmers, becomes a singularly interesting subject of study."

## ENCLOSURE MOVEMENT AND LAND REFORM 227

It will readily be seen that such a system of farming must needs be carried on with relatively large farms. There must be a constant proportion between the amount of land under grass and under arable crops: assuming a six-year period under grass, the farm must consist of not less than nine units, one third being constantly under cereals. The ultimate size of the profitable farm was determined jointly by considerations of economy in arable agriculture and in dairying. There were many local variations because of differences in soil or differences in the correlation between grazing and cereal culture. Experience with this system resulted, however, in the establishment of farms varying in size between two and three hundred acres. The virgate holding of the yeoman or villein consisted of thirty acres on the average, and it is customary to think of this as the small holding, the twenty or thirty-odd acres that are needed to maintain a single family. The type of farm that was established by the enclosure movement was thus relatively large, and farming became "capitalistic"; much of the product was raised for a market.

The change in the type of farm had certain social consequences. Yeomen farming declined. The farmer became more largely an employer of labor; he and his family still shared the work of the farm, but they were assisted by hired laborers who were likely for the most part to remain in that position. The increase in the size of the profitable farm made it more and more difficult for the hired laborer to acquire sufficient means to become the owner or lessee of a farm; the demarcation between classes of society in the village thus became more nearly permanent and what is called the social ladder was broken. The social aspects of these different systems of rural life have received much attention. It is frequently asserted that it is peculiarly desirable to have a large class of peasant proprietors, who work their own farm without more than casual hired labor. This may be true from a purely social point of view and if the discussion were confined to merely social arrangements the advocates of peasant proprietors would have a very strong case.

The agrarian problems, however, present many other considerations. The profitable size of farm must needs be determined by the predominant mode of culture, and the most appropriate mode of culture changes with variations in the complex of economic conditions that can be briefly called the conditions of marketing. Increase of population, improvements in transportation, changes in crops, better knowledge of agriculture and of the relation of various methods to differences in soil — all these changes will inevitably produce changes in methods of culture and corresponding changes in the size of farms. Growth of scientific knowledge of agriculture points clearly to the conclusion that there is no ideal system. The best system is that one most carefully adjusted to all the circumstances of soil and market.

The development of agriculture is thus likely to bring more diversity of method, and, even in the middle ages, there was more diversity than was formerly supposed. The open-field arrangements were capable of many diversities, though the changes were not great enough to lead to significant differences in the size of the average holding. From the purely agrarian point of view there can be no presumption in favor of the small holdings of peasant proprietors. Under some conditions small farms are best, under different conditions, large farms are best. One may therefore doubt the expediency of any social arrangement that would require the adoption of methods of agriculture that were economically unprofitable, and it is certainly unsound to criticize the general character of a change that resulted in a more intelligent adaptation of culture to differences in soils and market conditions.

The change in the methods of farming was both a cause and a result of the enclosure movement. It was the purpose of enclosure, but the purpose could not be accomplished until the open fields had been enclosed. The change in the size of farms preceded or followed enclosure, but the transfers of property were not directly a result, except in certain cases to be mentioned presently. The actual enclosure award was designed to give each owner

precisely the same amount of land, or at least land of equivalent value; in so far as enclosure led to concentration of landholding the small proprietors must needs be bought out before or after the award. No generalization can be suggested. In the early period, however, there is reason to suppose that the large proprietors gave much earnest attention to the purchase of land with a view to subsequent enclosure. Parcels of land adjoining their own would be bought at every opportunity, and at times pressure was brought to bear to induce owners to sell. In the period of enclosure by act of Parliament it would seem that there was less attempt to buy land prior to enclosure. Much land changed hands immediately after the enclosure awards, and this feature of the later movement was undoubtedly unfortunate. Land was sold not so much because the owner really wanted to sell, but because the details of the award left him land that he was not in a position to utilize effectively. A different policy in the details of the awards might well have diminished the extent of these transfers. But with all due allowance for the unfortunate results of the policy adopted, one must presume that the larger mass of transfers of property Causes of transfers were the outcome of genuine economic causes, a result of an undoubted decline in the profits of yeoman farming that began at least as early as the seventeenth century.

Until the last few years it was customary to divide the enclosure movement into two fairly distinct portions separated by an interval of at least a century. It was Continuity of enclosure presumed that the movement which attracted so much attention at the beginning of the sixteenth century came to an end toward the close of the reign of Elizabeth, and that there was little enclosure during the seventeenth century. A second period of enclosure was notable after the middle of the eighteenth century, when enclosure by act of Parliament became common. It is becoming clear that the movement continued without any great diminution in intensity throughout the seventeenth century. For reasons which we do not yet understand, the evidence of these en-

closures is scanty, but the extent of the movement is no longer subject to serious doubt despite the difficulty of exact statistical statement. Apparently these enclosures were done privately after purchase of titles, so that little record has been left, no record comparable to those created by the process of enclosure by act of Parliament, and no records similar to the results of the inquiries of the early sixteenth century. There was little public criticism of enclosure during the seventeenth century and the movement thus dropped out of sight.

Despite the vigorous criticism that was directed against enclosure in the sixteenth century, there is no ground for presuming that the actual extent of enclosure was large. Professor Gay says that not more than nine per cent of the total area was enclosed in any one county. The average for the midlands was about five per cent. The criticisms of contemporaries were justified in many respects, but it would be a mistake to suppose that the social problems of enclosure involved at that time any large area of land in any single portion of England. The extent of enclosure between 1600 and 1758 is problematical, but very detailed studies of the land-tax assessments for the County of Oxford present results which are probably characteristic. The county is fairly representative for the midlands generally. In this county, 37 per cent of the arable area was enclosed ultimately by act of Parliament; 53.6 per cent was enclosed prior to 1758. With an allowance of 9 per cent for enclosures prior to 1600 more than 40 per cent of the arable area would be left unaccounted for except by enclosures between 1600 and 1758. In Oxfordshire, at least, it is safe to say that as much land was enclosed between 1600 and 1758 as subsequent to 1758.

The period that intervened between the early movement and the parliamentary enclosure was thus characterized by an amount of enclosing that bears significant comparison with the later movement. But less than one third of the townships of the county were entirely enclosed in 1758. In this period as in the sixteenth century



the operations were carried out by lords of manors or by various proprietors who were able to reach a private agreement for the division of lands which had come into their hands. These operations thus resulted in a considerable amount of enclosure without destroying entirely the open fields and commons. The effect of such enterprises was thus less serious upon society as a whole. The lands of the larger proprietors were separated from the lands of the small proprietors, but this would not interfere in any way with the methods of agriculture and mode of living followed by the small proprietors of the village. The more important social consequences of enclosure would be confined to the comprehensive enclosure of all the lands of the village. It is this feature of the enclosures brought about by act of Parliament that gives the movement such special importance in the period subsequent to 1750. The private acts passed between 1750 and 1845 resulted in the enclosure of nearly <sup>Destruction of</sup> all the open fields, <sup>the open fields</sup> then remaining in England. These statutes completed the rearrangement of the field systems that had been begun in the closing years of the fifteenth century.

The special importance of enclosure in the midlands seems to warrant the special emphasis that has been placed upon the system of culture practiced there. But it should be recognized that all the new systems of agriculture were developed by practical experience so that there is a certain exaggeration in the implication that the desire to pursue particular methods was the consciously felt purpose behind the enclosing activities of the earlier period. In the late fifteenth century the enclosed land was pri- <sup>Pasture and</sup> marily devoted to sheep pasture; <sup>arable</sup> Professor Gay believes that as much as eighty or ninety per cent was devoted to pasture. Twenty years later much more land was devoted to arable agriculture.

The detailed history of the movement at this period is obscure, but it would seem that these changes indicate much uncertainty of purpose. It may be that the midland system was a compromise between the desire to secure the grazing

land that was particularly profitable for sheep-raising and the necessity of having enough grain to maintain the population. The dearths that were a feature of the sixteenth century may well have been a result of a disproportion in the amounts of land devoted respectively to pasture and tillage.

**New systems slowly established** The correlation of these two purposes of English agriculture was accomplished in part by the midland system and in part by the introduction of the root crops. These new crops took their place in the rotation systems that developed and afforded additional facilities for the rearing of stock that were of great moment. The new agriculture thus provided for some measure of combination of arable agriculture and stock-raising, but the result was achieved only by much experimentation with no higher ideal in view than the maximum net revenue from the land.

## II

The simplest form of enclosure was what is termed enclosure of "waste"; "waste" land was unimproved land, usually woodland or marsh. Such land was used in a degree for pasture of swine, especially beech forest, and the villagers had certain rights in the use of woods with reference to collecting fallen branches or the cutting of small firewood. The lord of the manor was thus under obligations to the peasantry; and, though he was in a measure possessor of such "waste" land, he could not do what he chose with it. His action was restricted by the rights of the villagers and he was not allowed to improve such land for his own benefit if the pasturage of the peasantry would be unduly curtailed. Subject to this qualification the lord of the manor might enclose such waste as he chose.

Land that had become a part of the general possessions of the village, whether as open arable fields or as common pasture, might not be enclosed without the consent of all the owners. Obviously the collective owners must be deemed to have a right to rearrange their holdings. They would have the right to choose between an

arrangement in scattered strips and a similar amount of land in solid blocks. The open fields were subject to certain grazing rights in the fall after the harvest, but it must needs be within the power of the collective owners to renounce these grazing rights over each other's land. It was usually presumed that the villagers would have cattle in proportion to the extent of their holdings, so that the larger proprietors would have relatively more cattle. This was not the case. The poorer villagers had a disproportionate number of cattle, and they would thus lose more by the renunciation of grazing rights. For this cause as for others it was usually difficult to bring the smaller proprietors to any agreement for the enclosing of lands.

Enclosure by agreement was usually the result of a deal between the larger proprietors of the village. If by the natural course of events the strips in a given field came into the hands of the lord of the Enclosure by agreement manor and one or two of the wealthier villagers, they could agree to rearrange their holdings so that each would have contiguous strips, and, as the land was no longer subject to redistribution, there was then no obstacle to the enclosure of the respective portions of land. It can be readily imagined that events were not always allowed to follow their natural course. If some one or two recalcitrant small proprietors still had strips in this field that was the subject of interest to the lord of the manor, it was quite possible that various kinds of pressure might be brought to bear to induce them to sell. "A steward," writes a contemporary (Edward Lawrence, *Duty of a Steward to his Lord*)

should not forget to make the best enquiry into the disposition of any freeholders within or near any of his lordship's Manors to sell their lands, that he may use his best endeavors to purchase them at as reasonable price as may be for his Preparations Lord's advantage. . . . Especially in such manors where improvements are to be made by enclosing commons and common fields. If the freeholders cannot all be persuaded to sell, yet at least an agreement for enclosing should be pushed forward by the steward. The steward should endeavor to lay all the small farms, let to the poor, indigent people, to the great ones. But it is unwise to unite

farms all at once on account of the odium and the increase of the poor rates. It is more reasonable and popular to stay until such farms fall in by death. To facilitate this, noblemen and gentlemen should endeavor to convert copyhold for lives to leasehold for lives.<sup>1</sup>

The recommendations of this handbook for stewards are in no respect unseemly, involve no downright injustice to the peasantry, though they clearly favored the ungenerous policy of changing the more secure to less secure tenures.

The opportunities for the abuse of power were large; pressure could be exerted upon tenants who held land under the more precarious tenures, a peasant's substance could be jeopardized by lawsuits, and many could be intimidated by threats of lawsuits. Misfortunes could be utilized to the lord's advantage. These practices could hardly be carried out on any great scale in a particular locality, but a peasant who was the unfortunate possessor of land that was strategically situated with reference to his lord's farm might well find himself in a thoroughly unpleasant position. Large acts of injustice to a class could hardly be done in such a complex manner, but many acts of individual injustice were undoubtedly committed.

The method of accomplishing these earlier enclosures was thus likely to confine them to portions of the village land.

Unanimous consent is difficult to obtain if any considerable number of persons are concerned. The possibility of a more expeditious procedure was not at first perceived. In 1606-07 an act of Parliament was passed providing for the enclosure of waste in certain manors of Herefordshire. The act was carefully restricted and seems to have been associated with special circumstances which prevented its being drawn in consequence as a precedent. An act of 1664 provided for the enclosure of portions of the Forest of Dean and parts of the New Forest, but this again seemed to present a special case. In the reign of Anne there were two enclosure acts, in 1709 and 1713, both providing for the parting and enclosing of common fields. These acts may

<sup>1</sup> Slater, G.: *English Peasantry and the Enclosure of the Common Fields*, 153.

thus be regarded as the beginning of the use of the act of Parliament as a means of carrying out a project for enclosure. Sixteen acts were passed in the reign of George I, and two hundred and twenty-six in the following reign. The precedent was thus rapidly established in the early eighteenth century and by 1750 this device was bringing the open fields to an end.

The act of Parliament was a means of accomplishing enclosure without unanimous consent. The rights of the minority were deemed to be inconsistent with <sup>Theory of the</sup> the general interest and their refusal to reach <sup>enclosure acts</sup> an agreement was rendered of no avail by the vote of Parliament that public welfare would be best served by the enclosure. In theory there can scarcely be any objection to the basis of the enclosure acts, and yet it was a theory that could be abused. Parliament was largely in the hands of the landed gentry so that the interests of the various classes were not likely to receive impartial and disinterested consideration.

The consent of the owners of four fifths of the land was required. The small owners were thus at a disadvantage because they were voting as owners rather than individuals, and in addition to this they were subject to all the forms of pressure that were in the power of the lord. The enclosures of the period were the work of the large proprietors. They reached a tentative agreement among them- <sup>Actual</sup> selves, chose the attorney, and thus defined the <sup>procedure</sup> general character of the project before they even called a meeting of all the proprietors. The small holders had little or no weight in determining the clauses of the act. One must not forget the sinister influence of legal expenses to the small holder. In order to protect the property rights of all, elaborate legal formalities were requisite. The expenses must needs be borne by the property and when the amount of property involved was small the legal fees might well exhaust the major part of the estate. Even with the best of intentions it would have been difficult to do full justice to the small holders, and Parliament was not organized

sufficiently well to give effect to any clear policy on these matters. Each act was a separate affair, assigned to a special committee that might be conscientious or corrupt. Procedure before private bill committees was not carefully standardized. Members were irregular in attendance and careless in voting. The protection that the committee was presumed to afford the persons concerned, the guarantee of fair treatment, was not made effective. The poor peasant proprietors were at the mercy of the commissioners, and indirectly at the mercy of their wealthy neighbors.

These details of the preparation of the enclosure acts have received little attention in recent times and received even less attention in the eighteenth century. A speech of Lord Thurlow in the House of Lords is therefore of great significance. The speech is given in indirect discourse in the *Parliamentary History* as follows:

Abuses in Parliament  
 His Lordship next turned his attention to the mode in which private bills were permitted to make their way through both houses, and that in matters where property was concerned, to the great injury of many, if not the total ruin of some private families: many proofs of this evil had come to his knowledge as a member of the other house, and not a few in his professional career. He did not recollect the twentieth part of them, but he could not forbear mentioning a few. Through his profession he had learned that there was a family of the name of Gardiner, in Wales, which had been stripped of its whole property by the compendious and certain operation of a private bill (enclosure). This surely must have proceeded from a criminal inattention. He believed he might point to one source of the evil, he meant the facility, or rather rapidity, with which private bills were hurried through Committees of the other House, where it was not infrequent to decide upon the merits of a bill which would affect the property and interests of persons inhabiting a district of several miles in extent, in less time than it took him to determine the propriety of issuing an order for a few pounds.<sup>1</sup>

This speech evoked replies from various members of the Lords, but the utmost extent of the criticism of the facts presented was the general declaration that serious cases of

<sup>1</sup> *The Parliamentary History of England from the earliest period to the year 1803* (London, 1814), xxii, 59.

## ENCLOSURE MOVEMENT AND LAND REFORM 237

injustice were infrequent. No evidence was presented to meet the main charge of Lord Thurlow, that procedure in committee was scandalously lax.

The opportunities for differences of opinion in the interpretation of proprietary rights were very great. The rights of common were particularly involved, and at <sup>Problems</sup> times there might be serious difficulty in the <sup>of title</sup> proof of claims to arable. The proposal to enclose made it essential to discover the precise nature of all titles to real property, and, inasmuch as many titles were defective, the canvass of rights in the strict sense would be to the disadvantage of existing holders. These discrepancies between rights enjoyed and rights possessed by clear title were most serious with reference to the use of the common pastures. The cottagers had long been accustomed to put more cattle out to pasture than they were strictly entitled to send out. The wealthier villagers made relatively less use of these commons than was usual in the period in which the strict legal rights were defined. Forage crops were more largely used than in the early period, and the rich usually had some enclosed fields which they were able to use exclusively. Toward the close of the eighteenth century, therefore, there had come to be a wide divergence between the rights of common and the use of the commons. Strict insistence upon the letter of the law would amount to substantial dispossession of the poorer members of the village, and unfortunately there was a disposition to adopt the narrowly legal interpretation of the rights of property that were to be recognized in the award.

Apart from this matter of determination of titles, one other aspect of enclosure was a serious menace to the well-being of the poor. It was not essential to the larger purposes of enclosure that the common fields be entirely broken up. At least portions of the common pastures might have been left unenclosed, without in any respect defeating the objects of enclosure. It was not necessary to assume that all proprietary rights, whatever their nature or extent, <sup>Grazing rights</sup> must be converted into terms of arable land. The policy adopted was on the whole more favorable to the

wealthy, but it is not clear that this view was adopted with any deliberate disregard of the larger problems of statesmanship.

The general mistakes of policy were probably the result of indifference rather than consciously selfish class interest. The growing dislike of the old open-field system with its commons might well lead to the disposition to do away with the whole tangle of rights. Enclosure was regarded as a great improvement in agricultural method, and, as the common pastures were one of the least successful features of the system from a technical point of view, it is not surprising that at the outset, scarcely any one advocated the retention of commons, in whole or in part. The commons afforded scant forage at the best; they were merely wild pastures; they were frequently, if not usually, overcrowded, so that no beast could secure a full ration. The comparison with the enclosed pastures that existed were wholly to the disadvantage of the commons, and one might well argue that the interests of society required that the land should be utilized in the most effective way.

The social consequences of the destruction of all the commons were not foreseen in any large manner. It was well understood that enclosure might result in an increase in the poor-rates, but each locality was disposed to assume that this situation would be temporary. Those who were dislodged by the change would ultimately be absorbed in other occupations or other regions. In a measure this was true, but the poorer members of the open-field village suffered a real social displacement. The classes that constituted the chief source of supply of hired labor were uprooted from the soil which had formerly afforded them partial maintenance. As cottagers or squatters with a small garden and a cow, these people were not wholly dependent upon their wages as hired laborers. Continuous employment was not essential. The enclosures deprived them of the commons and thus made it impossible for them to keep a cow. The expense of enclosure was likely to consume the greater part of the garden, even if it had been possible for them to

A calamitous  
mistake



prove title. This class of cottagers thus tended to become an agricultural "proletariat," entirely dependent upon wages, and so poor that they would be dependent upon continuous employment.

The loss of all rights of pasturage was particularly serious. In many districts it became practically impossible for the poor to get milk even if they had the means. <sup>Milk or tea</sup>  
The only dairy herds were those of the wealthy.

The profits of a retail distribution of milk were small, and the notion of doing such a thing relatively new. Many owners of herds simply refused to peddle milk, and in such communities it was not possible to buy it. By force of circumstances tea became the staple drink of the poor; even young children were put on a diet of tea. The effect upon the health of the population can scarcely be imagined, and these unfortunate results of enclosure contributed some of the darkest features of a period that must be regarded as peculiarly distressing from the point of view of social well-being.

When Parliamentary enclosure had already made extensive inroads upon the open fields and commons, a few writers called attention to the unfortunate effects that <sup>Young's</sup>  
would result from a comprehensive enclosure. <sup>proposal</sup>

Arthur Young, in a pamphlet of 1801, advocated the reservation of sufficient common pasture to assure pasturage for the cattle of cottagers and squatters. Such land or right of pasturage was to be inalienable, a definite appurtenance of the cottage. When land was not available for this purpose he recommended that it be leased by the parish. There can be no doubt but that these problems could have been met easily at the time of enclosure had there been sufficient foresight. In a few cases a truly enlightened policy was actually followed; but, in the main, the narrow view was taken. This was probably one of the most calamitous errors of social policy in the legislation of the period; more unfortunate even than the policy adopted toward the poor, because this failure to appreciate the position of the cottagers was in large measure responsible for the great increase in poverty that marks the close of the eighteenth century and the early nineteenth century.

## III

In the course of the last century some attempt was made to correct the mistakes made in the enclosure acts. The pastures could not easily be restored; at all events little attempt appears with reference to the establishment of small areas of common pasture. In later enclosure acts portions of the common pastures or lands have been reserved for public use, but parks and playgrounds have usually been the object contemplated in these reservations. The village has become an annex of the industrial town and breathing-space for humans has become more important than grazing-land. But it has been possible to get the farm laborer back to the land by giving him a garden plot and some reasonable hope of securing a small holding if he should desire it.

In this connection it is necessary to recognize that there is a fundamental distinction between the "allotment" or garden plot, and the "small holding." The garden is merely supplementary to some other occupation, a resource for the hired agricultural laborer, or for artisans and shopkeepers. The small holding is presumed to furnish occupation and maintenance to the holder and his family, and, ordinarily, all the work of the holding would be done by them. Allotments are therefore relatively small, ranging from one quarter of an acre to ten acres. The smallest allotments would thus be mere kitchen gardens barely sufficient to supply the green vegetables for the family, and not requiring enough work to more than fill the spare hours of a man pretty steadily employed. The larger plots, ranging between five and ten acres, would doubtless be the main occupation of the holder, other work being subordinate and casual. Under modern conditions such a holding would probably be devoted in part to raising some specialty for the market. There would be no sharp distinction between the allotment and the small holding beyond the relative degree of dependence or independence upon other employment. In the best market-gardening districts ten acres, or even less, might well occupy a man's full time; in other re-

gions, a much larger area would be necessary to occupy and maintain the family. The distinction is therefore based upon the economic results of operation rather than upon any mere number of acres. But both phases of this back-to-the-land movement are intimately related; if the hired man has a garden he has some opportunity of improving his position, gradually increasing the size of his plot until he becomes practically if not completely independent of other occupation.

Allotments were so closely related to the welfare of the agricultural laborers that their importance was recognized almost as soon as the problem was created. <sup>Early</sup> Some of the landed gentry made experiments <sup>allotments</sup> with allotments on their estates. These private philanthropies began at least as early as 1770. The motives were in part selfish, as it was recognized that the laborers were less likely to become a charge upon the parish if they had this means of supplementing their wages. At the same time one must regard these attempts as evidence of genuine solicitude for the welfare of the laboring population, and as an indication of the quality of statesmanship displayed by the leaders of the aristocracy. In 1798 a society was founded for "Bettering the Condition and Increasing the Comforts of the Poor"; its main project was the encouragement of this allotment policy. In 1806 some provision was made for the laboring poor in the enclosure act for Great Somerford (Wilts); and in the period following the Napoleonic wars Lord Lansdowne carried out a project on certain of his estates at Calne with such success that the same policy was greatly extended on his properties. Neighboring landowners followed his example, and nearly one hundred acres were devoted to such purposes in the vicinity.

The Poor-Laws of 1818 and 1831-32 empowered parish authorities to enclose waste lands and let them to the poor in portions of not less than one rood nor more than <sup>Public activities</sup> one acre. The new Poor-Law of 1834 and the general Enclosure Act of 1845 made some provision for such allotments, but the chief progress was the result of private initiative. These acts were permissive rather than compul-

sory and were therefore significant in those districts only that were dominated by well-intentioned landlords. During the decade, 1830-40, the Laborer's Friend Society was active in this propaganda, disseminating information and urging landlords to adopt this policy. The society established seventy-four hundred allotments on its own responsibility; usually renting the land and subletting to the laborers. In the period between 1843 and 1868 there was a great extension of allotments, though there were many regions in which the policy made no real headway.

The first general act wholly devoted to this problem was the Statute of 1882, but this act should be regarded as a cul-

Acts of 1882  
and 1887

mination of the movement rather than the beginning of reform. Hasbach even says that the problem of the agricultural laborer was largely solved in the period 1830-80; meaning, no doubt, that allotments had become the rule rather than the exception. The statute was necessary to meet the needs of districts in which the obstinacy of particular landlords stood in the way of adequate provision for the needs of the agricultural laborers and artisans. The Act of 1882 was for this reason a failure. It was merely permissive, and the movement had already progressed as far as was possible under a permissive policy.

The compulsory  
principle

The compulsory principle was introduced in 1887; landlords were required to sell or lease land needed for these purposes. The statute marks the beginning of a new phase in the social legislation of Great Britain. For the first time, members of the aristocracy were compelled to recognize the superiority of the needs of the community in which they lived over their vested interests. Many had always felt these higher obligations, but it was becoming increasingly clear that the reorganization of England could not be accomplished by the spontaneous activities of the best elements of the aristocracy. The principle of compulsion that was applied to this small problem has been gradually applied in a constantly widening field, and the notion of the superior claims of the general social interest has thus become embodied in much important legislation.

The opponents of these reforms have been disposed at times to declare that the acts were unnecessary because the demand for allotments does not seem to be very great. The officials charged with the administration of the acts are less inclined to measure the importance of the acts by the mere quantity of land affected. In the case of allotments, particularly, the extent of the movement subsequent to the statute is no real index of the need of the act. It is fairly evident that the main work of reform had taken place prior to the compulsory statute; its work was the completion of a reform already far advanced. The Act of 1887, too, was not wholly suited to the needs of the problem. The procedure was complex and there were opportunities for the exertion of an unfortunate pressure upon the laborers. Landlords who were definitely opposed to the policy could still exert a repressive influence that might even stifle all appearance of demand for allotments when a genuine demand really existed.

The small-holdings movement presents a more complex problem of policy. There is a difficult question connected with the appropriate size of the profitable unit of exploitation. The desirability of allotments was undoubted; the expediency of the small holding was highly questionable until the beginnings of the great changes in the organization of English agriculture that were the result of foreign competition. After 1880 wheat-raising became much less profitable because of the opening of the American markets and the greater severity of competition with southern Russia. The large farm devoted to grazing and wheat-raising was no longer the best unit of exploitation: crops and methods must needs be changed. The development of highly specialized farming and of market-gardening altered the economic conditions that had dominated English agriculture for more than a century: the small holding, that had been without clear advantage, became a significant possibility on many types of soil. The small-holdings problem is thus an agrarian rather than a social question. Some legal problems are involved, because there was not enough mobil-

with the study of the demand for small holdings in the several counties, and the consideration of the extent to which such demand can be practically satisfied. If it is felt desirable to proceed in any district, the County Council is informed and requested to prepare a plan. In case nothing is done within a specified time, a scheme would be prepared by the commissioners. The plans must be approved by the Board of Agriculture in either case. It is thus possible to overcome local opposition. Land requisite under such a plan might be hired, or bought; and, in event of local opposition, land might be acquired by compulsory process.

It is still too early to appraise the results of this act. The commissioners feel that there is a *bona-fide* demand for land, though many point to the statistics of applications as evidence that the demand is trivial. It would seem that much deference is still shown to the large landholders, so that there are many who lack courage to apply. It may well prove to be a less far-reaching reform than was anticipated by the earlier advocates; one might even feel some certainty on this score, and yet it is a significant reform, both on its own account and as part of the general reform of landholding in Great Britain.

## CHAPTER X

### THE INDUSTRIAL REVOLUTION

THE great transformation of industry that became noticeable in England toward the close of the eighteenth century was characterized by Blanqui in 1837 as the *Blanqui's characterization* Industrial Revolution with the intention of *characterization* attributing to it an importance co-ordinate with the French Revolution. "Industrial conditions," says Blanqui, "were more profoundly transformed than the French Revolution," says Blanqui, "were beginnings of social life." It is evident that he desired to explain the difference in the outlook of the nineteenth century in France, the Industrial Revolution in England, each in its own way contributing to a break with the past so complete that it is difficult for us to reconstruct the social life of the old régime. Although Blanqui's conception of this movement is superficial in some respects, his appreciation of its epoch-making significance is just, remarkable even, when one considers that he was writing while the transformation was still in progress and benefiting while the very characteristic features of the change had revealed themselves. It is not possible for us to-day to add anything material to his statement.

The renaissance of urban life in the eleventh and twelfth centuries had brought about a great industrial transformation. The division of labor was carried *Other social transformations* much farther than it had been carried in the ancient world. Some genuine reciprocity had been carried in the ancient world. the rural districts had sprung up. Differentiation between employers and wage-earners appeared in the larger industrial centers. That period marks the beginning of a new stage in industrial history, but medieval conditions were after all similar to conditions in antiquity. The differences were quantitative, and even the quantitative differences

resources of the newly reformed Parliament seemed utterly inadequate to cope with the social reorganization that would be necessary. The change is reflected in somewhat higher coloring in Carlyle's *Past and Present*, and there is a similar drawing-back from what seems like chaos and disorder, from an impending plutocracy that seemed worse even than a well-ordered aristocracy. There were, of course, many who looked only toward the conquest of nature by the machines, but the magnitude of the event seems really to be more completely appreciated by those who felt the new social problems so keenly that their tone is pessimistic.

Both in France and in England the magnitude of the event was soon perceived, but the nature of the transformation was very inadequately understood and some of these <sup>Misleading</sup> misunderstandings are closely associated with <sup>connotations</sup> the phrase "Industrial Revolution." The term has captured the imagination, and despite misleading connotations it will doubtless hold its place in the literature of the subject, but interpretation becomes more and more necessary. The earlier writers were so powerfully impressed by the inventions in the textile industries and the development of the steam engine that they usually referred to the inventions as the prime cause of the great changes. The great inventions become more or less completely identified with the Industrial Revolution. Blanqui in France, and Gaskell in England, both thought of the movement primarily in terms of the great inventions, and this view has found its way into many secondary books. The view is stated in its usual form by Gibbins. "The change," he says, "... was sudden and violent. The great inventions were all made in a comparatively short space of time. . . . In a little more than twenty years all the great inventions of Watt, Arkwright, and Boulton had been completed, steam had been applied to the new looms, and the modern factory system had begun." This <sup>an</sup> conception of the Industrial Revolution exhibits all <sup>ings</sup> higher forms of historical inaccuracy. The movement <sup>is not</sup> sudden and violent: the inventions were an effect <sup>and</sup> not a cause: and the enumeration of the inventions <sup>is</sup>



characteristically the most revolutionary of the textile inventions — Crompton's mule.

Arnold Toynbee developed another conception of the movement in the *Lectures on the Industrial Revolution*, which were published after his death. Industrial development and the changes in commercial policy were both carefully described, but the rise of the liberal economic thought seems to have had the chief claim on his attention. The Industrial Revolution was thus conceived to be more largely a change in economic thought than in industrial organization. The inventions and the growth of the factory system were made incidental to the new outlook in theory and in commercial policy. Toynbee's efforts must command much sympathy, for they unquestionably gave wider significance to the movement, but it is unfortunate that so much emphasis was placed on the rise of the *laissez-faire* theory. The events of the last quarter-century have carried us all so far from the older notions of unrestrained individualism that few of us would care to represent the "system of individual freedom" as the foremost feature of the Industrial Revolution. The views of Toynbee dominate Cunningham's *Growth of English Industry and Commerce*, but such problems are not felicitously handled by Cunningham. The fine judgment shown in the treatment of problems of research and minute scholarship does not appear in such generalizations as find their way into the text.

The view of the Industrial Revolution that has occupied the largest place in recent writing seems to have drawn some inspiration at least from the writings of Karl Marx. This view is in a measure an outgrowth of the earliest interpretations of the movement, but, instead of stressing the mechanical inventions, emphasis is laid upon the factory system and the growth of capitalistic organization of industry. This characterization of the movement would be wholly adequate if the older generalizations about industrial development were sound. If it were true that there was capitalistic industry in the earlier periods; if workmen had even hardly ever, been collected in small factories, —

these characterizations would be commandingly significant. The facts are otherwise. There was a steady growth toward capitalistic industry based on free labor throughout the middle ages, and, in the classical period, slavery had opened up other modes of capitalistic domination. The capitalist became more important at the time of the Industrial Revolution, and the lines between the employing and the wage-earning classes were more sharply drawn, but the phenomena were not new. Even the factory was not new. The experiments of the Tudor period in England and of the reign of Louis XIV in France had not been successful in any large sense, but they showed that there was disposition to organize industry in that manner. What was new toward the close of the eighteenth century was not the factory, but the conditions destined to make the factory a dominant form of organization. To emphasize the factory only is thus to leave out the most notable fact of the situation.

No single formula can adequately describe the complexity of forces and reactions that gave the movement its profound significance. There were changes in the relation between industry and agriculture, readjustments in the textile trades brought about by the rise of the cotton industry, technical developments in the metal industries which gave the whole group of metal trades a more important place in industrial society. None of these transformations were sudden: there were many reciprocal influences, so that particular inventions were at once cause and effect. The development of a mechanical technique was of the utmost importance in both textile and metal industries, but the older writers simplified unduly when they ascribed such exclusive importance to single inventions. It is well known to-day that no great mechanical achievement is the result of a single invention, though some brilliant conceptions will frequently direct endeavor so fruitfully into certain channels that we think currently in terms of the controlling patent or invention. But every great accomplishment is really the achievement of a group of inventors, and es  
 consists of a series of inventions. In the period of the

A broader view

Industry

trial Revolution mechanical achievement was relatively slower than it is to-day. The struggle of inventors was more desperate, and relatively less fruitful in results. It is therefore peculiarly important to think in terms of protracted mechanical endeavor when studying the rise of the modern mechanical technique of the textile and metal industries.

The inventive efforts of the period were stimulated by commercial changes and by the realization of the importance of mineral deposits whose significance had been well-nigh overlooked. Commercial changes were relatively more important in creating the new cotton industry: the iron and coal deposits were the direct incentive to the fundamental metallic inventions. In seeking so-called primary causes for the Industrial Revolution one may conceivably choose any one of three: the mechanical achievement; the commercial changes; or physiographic factors that were in a sense the basis of both the commercial change and the development of the mineral industries. It is wiser, perhaps, to abandon the search for a single cause, recognizing that the interplay of factors was in reality essential. The commercial changes that underlay the industrial transformation were not specifically associated with England; they might have stimulated industrial development in France. The intensity and importance of the changes in England were due to the unusual conjunction of factors making for change in a number of related industries. All the factors favorable to change were present in England, and the conjunction of factors did not occur in any other country.

The development of trade with India had brought to Europe the fine cotton fabrics that had been known casually to the ancient world, but almost entirely unknown to the middle ages. These cottons appealed strongly to the consuming public and made their way rapidly. The woolen, linen, and silk industries all suffered in the competition with these new fabrics and attempts were made to restrict the use of cottons by protective legislation. The restriction was carried farther in England than

on the Continent, and, though some measure of success was obtained at first, the failure was the more complete in the end. The protective barrier erected for the benefit of the woolen industry fostered the growth of a domestic cotton industry which found an element of advantage in the climate of which no one had been aware. The cotton industry was thus a new industry in every sense, and because it was new it was wholly free from the restrictive influences of craft customs and legislative regulation. It was free to adopt any forms of organization that might be convenient and suitable. The growth of the cotton industry was the occasion of many changes in the textile trades: changes in the relative importance of the various textile products, changes in the forms of organization, and changes in the technique of production.

The changes in the metal industries were largely the outcome of the attempt to use coal as fuel. The forests were being seriously depleted by the demand for <sup>The metal</sup> charcoal, and early in the seventeenth century <sup>industries</sup> it was clearly recognized that the iron industries must needs decline unless other fuel were found and made available. There was coal in abundance. At some of the iron workings coal was bedded with the iron and was a necessary but unimportant by-product. There was thus a strong incentive to use coal. The early experiments of Dudl y were a direct outcome of such circumstances. The difficulties were great: mechanical and metallurgical. Successful utilization of coal would be possible only in an entirely transformed iron industry; an industry with much more mechanical equipment and more exact metallurgical knowledge. The great achievements of the Industrial Revolution were made possible by several generations of patient endeavor in the metal industries, and this portion of the story of the movement has been least adequately treated in the general accounts. There has been a disposition to regard these matters as excessively technical for general treatment in economic history, but this transformation of the metal industry is of fundamental importance and it seems unwise to omit the salient features of the development.

As a result of these changes the metal industries became much more significant than they had been for centuries.

The new position of the metal industries The full effects of the change have appeared only in the last half of the nineteenth century, but they are undoubtedly a result and should be

regarded as a part of the Industrial Revolution. In 1700 the metal industries were of very subordinate importance in all European countries. The textile group was by far the most significant of the general groups now utilized in classification, and among the textiles the woolen industries (i.e., both woolen and worsted) were far in the lead. The cotton industry was of subordinate importance, almost negligible. The leather industries were probably more important than metals in France and in England, and though in Germany the metals were in all probability a greater factor in general industrial development we have no grounds for supposing that metals outranked leather even in Germany. The relative position of the different industries in 1700 represents the culmination of the general factors in industrial development that became notable in the twelfth and thirteenth centuries. Throughout the long period of five centuries the textile industries had grown in importance as specialized occupations. All three branches of the old textile trades had shared in the prosperity, though in many ways the woolen industry had undergone the most considerable transformation. The development of the silk industry was, however, a notable feature of economic growth in Italy and France; comparable in magnitude and character of technical advance to the development of the woolen industries in northern France, Flanders, and England. The Industrial Revolution brought a twofold dislocation: the rise of the new cotton industry resulted in the subordination of all the other branches of the textile manufacture to cottons — cotton was king; the reorganization of the metal trades gave them an entirely new place in the social order, raising them from a relatively low rank to substantially coördinate importance with the textile trades. The changes in the textile trades took place very early in the course of the general movement, the rise of the metal trades to their

new position took place only in the latter half of the nineteenth century.

Statistical evidence of these occupational changes is naturally difficult to secure. Attention has already been called to the absence of a sharp distinction between the industrial and the agricultural population, and <sup>Statistical</sup> ~~difficulties~~ for that reason alone no complete comparison could be instituted. Furthermore, there are no enumerations of population for the period prior to the Industrial Revolution. Statistical demonstration is thus confined to the comparative method, a means of reaching judgments that is somewhat unsatisfactory and subject to many elements of error, but nevertheless a more adequate basis for opinion than mere guess-work. Occupational statistics are available for Great Britain quite early in the nineteenth century, but the classifications in the earlier decades are not satisfactory and the enumerations were not very accurate. The figures for 1851 are the earliest figures that are thoroughly available. The grouping of the population had <sup>England in 1851</sup> been affected by the Industrial Revolution at that time. The new cotton industry was well established and some of the newer occupations in the metal trades were beginning to be important, but it is possible that the relative position of textiles and metals had not been greatly changed at that time, though it is certain that metals were a more important group then than they had been for two centuries or more.

The figures for Prussia in 1855 are perhaps more characteristic of the groupings of the people prior to the Industrial Revolution. At that time scarce any great <sup>Prussia in 1855</sup> changes had taken place in Germany, conditions were not very different from what they had been for at least a century, and with reference to such a matter as the relative importance of different occupational groups it would seem almost safe to assume that conditions in 1855 were representative of the period following the Thirty Years War. In so far as it is wise to include non-European countries in the comparison, the results of the census of occupations in British India are particularly significant. British India in 1901 was

still predominantly an agricultural country. The proportions of industrial to agricultural population must bear very close comparison with the proportions for England and the continent of Europe in the seventeenth and early eighteenth centuries. The density of population in India was greater than in Europe, but we have no grounds for supposing that conditions were not comparable: the normal density of population for India is considerably greater than the normal density for Europe; both countries were utilizing all their resources and there is therefore a very direct ground for drawing a comparison between Europe in the seventeenth and eighteenth centuries and India at the present time.

The subordinate position of the metal trades is clearly apparent in all three countries. Conditions in Germany and Salient features of the tables in British India probably represent some of the variations in occupational groupings that are likely to be found in different places or in different stages of what we will term the "medieval" or intermediate industrial order. The large number of persons engaged in the preparation of food and drink in India would seem to represent a condition that must be most characteristic of the earlier stages of development even in this intermediate period of industrial growth. One is tempted to draw comparisons with the large number of persons enumerated among the crafts engaged in the preparation of food on the Paris tax-rolls of 1296. The three groups, foods, leather, and textiles, were of about coördinate importance, each constituting twenty per cent of the total number of persons enumerated. It would thus seem that the crafts occupied with food and drink are among the most important in the earlier stages of craft specialization. The importance of the groups concerned with leather and wood in Germany is doubtless highly characteristic of occupational groupings in medieval Europe. The relatively large number of persons not specifically classified is the outcome of the large number of subsidiary employments that cannot be brought within the modern classifications. Many persons were concerned with performing various personal services, and, though these peo-

## THE INDUSTRIAL REVOLUTION

257

### OCCUPATIONAL GROUPINGS IN ENGLAND AND GERMANY: 1851 AND 1855\*

Group	England, 1851		Prussia, 1855	
	Thousands of persons	Per cent of total	Thousands of persons	Per cent of total
Textiles and clothing. . . . .	1,720	35.78	417	34.41
Food †. . . . .	378	7.86	81	6.68
Mines. . . . .	355	7.38	..	..
Leather. . . . .	332	6.90	173	14.27
Metals. . . . .	323	6.70	113	9.32
Clay, stone, etc. (building inc.)	287	5.97	113	9.32
Wood-working. . . . .	166	3.45	191	15.77
Paper and printing. . . . .	50	1.04	..	..
Chemicals. . . . .	30	.62	..	..
All other occupations. . . . .	1,168	24.29	124	10.23
<b>Totals. . . . .</b>	<b>4,808</b>	<b>100.00</b>	<b>1,212</b>	<b>100.00</b>

\* The figures for England are from the Census for 1851, *Population Tables*, vol. II, part I, p. c. The figures for Prussia are from Dieterici, *Statistik des preussischen Staats* (Berlin, 1861), 400. The states covered by the enumeration are: Prussia, Posen, Brandenburg, Pomerania, Silesia, Saxony, Westphalia, and the Rhine Provinces.

† This heading refers in all tables to the preparation of food products, drinks, and tobacco. It excludes all agricultural work.

### BRITISH INDIA: 1901\*

Group	Thousands of persons	Per cent of total
Textiles, etc. . . . .	11,214	21.41
Food, etc. . . . .	16,753	31.99
Leather. . . . .	3,241	6.19
Metals and precious stones. . . . .	3,710	7.09
Clay, stone, and building. . . . .	3,722	7.11
Wood, cane, leaves. . . . .	3,790	7.24
Light, firing, forage. . . . .	1,461	2.79
Drugs, gums, dyes. . . . .	455	.86
Learned and artistic professions. . . . .	4,923	9.40
General labor. . . . .	3,100	5.92
<b>Totals. . . . .</b>	<b>52,379</b>	<b>100.00</b>

\* *Imperial Gazetteer of India* (Oxford, 1907), I, 499.

ple do not constitute an important class at the present time, they were relatively important in the earlier period. Persons engaged in the manufacture of wares that are composed of mixed materials are difficult to classify, and, as these tables have been prepared from unclassified lists of craftsmen, it has seemed safer to include under the general head-



ings only those craftsmen whose relation to the occupational group was unmistakable.

The occupational groupings at the beginning of the twentieth century show the full measure of the changes brought about by the Industrial Revolution. The Census of Production in the United Kingdom taken for the year 1907 reveals an iron industry of fully coördinate importance with the textile group. The net value of the product is somewhat greater, the average number of persons employed somewhat smaller. In Germany somewhat less complete statistics point to similar conclusions. The metal trades seem to be of coördinate importance with the textiles. In the United States the census of 1909 reveals an iron industry that was leading the entire field in respect both to values of product and numbers of persons employed. The new industrial order thus represents an entirely different grouping of the industrial population.

These changes in the relative importance of the different industries were accompanied by a general increase in the numerical importance of industrial occupations as a whole. Prior to the Industrial Revolution

OCCUPATIONAL GROUPINGS IN THE UNITED KINGDOM: 1907\*

Group	Cost of materials (millions of pounds sterling)	Net output (millions of pounds sterling)	Per cent of total output	No. of persons (thousands)	Per cent of total persons
Food, drink, and tobacco.....	197	89.5	12.51	463	6.64
Textiles and clothing..	293	141.9	19.95	2,009	28.79
All metals.....	293	164.8	23.16	1,653	23.67
Timber.....	24	21.4	3.02	239	3.42
Leather.....	26	8.6	1.22	84	1.20
Paper and printing....	26	33.6	4.73	325	4.65
Chemicals.....	53	21.5	3.03	127	1.82
Clay, stone, and building.....	49	60.4	8.49	725	10.40
Mines and quarries....	28	119.5	16.80	965	13.83
Miscellaneous.....	3	4.4	.63	46	.65
Public utilities.....	30	45.9	6.46	342	4.90
Totals.....	1,028	712.1	100.00	6,984	100.00

\* Census of Production, final figures, Commons Papers, 1912-13 (Cd. 6320), col. 1, 21.

## THE INDUSTRIAL REVOLUTION

259

### OCCUPATIONAL GROUPINGS IN GERMANY: 1907 \*

Groups	Thousands of persons	Per cent of total
Foods, etc. ....	1,239	11.73
Textiles and clothing .....	2,393	22.65
All metals .....	2,057	19.47
Wood, manufacturers of wood, and by-products.	864	8.18
Leather .....	206	1.95
Paper and printing .....	438	4.15
Chemicals, etc. ....	172	1.63
Stone and earth (includes "Quarries") .....	770	7.29
Building .....	1,563	14.80
Mines .....	860	8.15
<b>Totals .....</b>	<b>10,562</b>	<b>100.00</b>

\* *Statistik des Deutschen Reichs*, Band 213, 1. Gewerbl. Betriebsstatistik, 4-5.

### OCCUPATIONAL GROUPINGS IN THE UNITED STATES: 1909 \*

Group	No of persons (thousands)	Per cent	Cost of materials (millions of dollars)	Value of product (millions of dollars)	Per cent of total	Per cent added by manufacture
Foods .....	411	6.2	3,187	3,937	19.0	19.0
Textiles .....	1,437	21.7	1,741	3,054	14.8	43.0
All metals .....	1,779	27.0	3,213	5,399	26.1	..
Lumber .....	907	13.7	714	1,582	7.7	54.8
Leather .....	309	4.7	689	992	4.8	32.5
Paper and printing .....	415	6.3	451	1,179	5.7	61.7
Liquors .....	77	1.2	186	674	3.3	72.4
Chemicals .....	237	3.6	857	1,430	6.9	39.4
Stone, clay, and glass .....	342	5.2	183	531	2.6	65.4
Tobacco .....	166	2.5	177	416	2.0	57.5
Miscellaneous .....	528	8.0	748	1,470	7.1	49.1
<b>Totals .....</b>	<b>6,615</b>	<b>100.0</b>	<b>12,142</b>	<b>20,672</b>	<b>100.0</b>	<b>..</b>

\* Census of 1910, VIII, 53, Table 7.

industry employed a much smaller proportion of the population than agriculture. The conditions suggested by the figures for British India and for France in 1866 probably represent the extremes: it is hardly likely that agriculture furnished employment to more than 64 to 65 per cent of the population of any maturely developed section of Europe prior to the Industrial Revolution; it is equally probable that the agricultural population did not fall below 50 per cent. France was at all times possessed of important export industries, but

## INDUSTRIAL HISTORY OF ENGLAND

## OCCUPATIONAL DIVISIONS OF THE POPULATION

## A. Countries not significantly influenced by the Industrial Revolution

## BRITISH INDIA: 1901 \*

Group	Thousands of persons	Per cent
Administration and defense .....	5,607	1.90
Agriculture.....	191,691	64.98
Personal, household, and sanitary service....	10,707	3.63
Care of animals.....	3,976	1.32
Earthworks and general labor.....	17,953	6.07
Trade and commerce.....	7,725	2.61
Industry.....	51,642	17.49
Miscellaneous.....	5,911	2.00
Totals.....	295,222	100.00

\* *Imperial Gazetteer of India* (Oxford, 1907), I. 499.

## FRANCE: 1866 \*

Group	Thousands of persons	Per cent
Fishing, agriculture, and forestry.....	7,231	52.2
Industry.....	4,647	33.6
Commerce.....	972	7.0
Liberal professions.....	999	7.2
Totals.....	13,849	100.0

\* *Résultats Statistiques du Recensement Général de la Population effectué le 4 Mars, 1906* (Paris, 1910), tome I, II<sup>e</sup> partie, p. 57.

## B. Countries in which the influence of the Industrial Revolution appears in a moderate degree only

## THE GERMAN EMPIRE: 1895 AND 1907 \*

Group	Thousands of persons		Per cent	
	1895	1907	1895	1907
Agriculture.....	18,501	17,681	38.78	31.72
Industry.....	20,253	26,386	42.45	47.33
Commerce.....	5,966	8,278	12.54	14.84
Personal service and artistic professions.....	886	792	1.85	1.41
Free professions and public service.....	2,098	2,626	4.38	4.70
Totals.....	47,704	55,763	100.00	100.00

\* *Statistisches Jahrbuch für das Deutsche Reich* (1914), 14-15.

# THE INDUSTRIAL REVOLUTION

261

## FRANCE: 1901 AND 1906 \*

Group	Thousands of persons		Per cent	
	1901	1906	1901	1906
Fishing and agriculture.....	8,244	8,855	44.0	44.8
Industry .....	6,993	7,224	37.3	36.5
Commerce .....	1,881	2,068	10.1	10.5
Liberal professions.....	1,621	1,626	8.6	8.2
<b>Totals.....</b>	<b>18,739</b>	<b>19,773</b>	<b>100.0</b>	<b>100.0</b>

\* *Résumé Statistiques* (Paris, 1910), tome I, II<sup>e</sup> partie, p. 57.

*Notes.* The figures for the United States are not easily comparable as the unskilled laborers are not sufficiently well classified. Many engaged in agriculture or industry appear under the general heading "Domestic and Personal Service."

### C. Great Britain, representing the most extreme effects of the Industrial Revolution

#### GREAT BRITAIN: 1811 AND 1821 \*

Group	Thousands of families		Per cent	
	1811	1821	1811	1821
Agriculture.....	895	978	35	33
Industry.....	1129	1350	44	46
All other.....	519	612	21	21
<b>Totals.....</b>	<b>2543</b>	<b>2940</b>	<b>100</b>	<b>100</b>

\* *Census of Great Britain, 1851, Population Tables, vol. II, part I, p. lix.*

#### ENGLAND AND WALES: 1891 AND 1901\*

Group	Thousands of persons		Per cent	
	1891	1901	1891	1901
Professional class.....	926	972	7.15	6.78
Domestic service .....	1,900	1,994	14.76	13.91
Commerce.....	1,399	1,858	10.80	12.97
Agriculture and fishing.....	1,336	1,152	10.33	8.04
Industry .....	7,336	8,350	56.96	58.30
<b>Totals.....</b>	<b>12,897</b>	<b>14,326</b>	<b>100.00</b>	<b>100.08</b>

\* Hobson, J. A.: *Evolution of Modern Capitalism*, 284.

the proportions shown for 1866 probably represent as high a proportion of industrial workers as can be presumed for the preceding century. Even in the most highly developed industrial sections, agriculture was thus the chief interest and employment of the people. Directly or indirectly, national wealth was dependent upon agricultural resources.

Leading medieval industries with their specialized industrial population were dependent upon an agricultural surplus.

**The basis of national prosperity**

Much industry was really a by-employment, used by persons whose chief occupation was agriculture to supplement their income from the land. Even when industry was a definitely specialized occupation, the artisans were obliged to live as close as possible to the farms which produced the necessities of life. No distinction could be drawn between industrial and agricultural resources. The extractive industries were of definitely secondary importance. The mineral resources of England were thus of casual significance only throughout the middle ages. The fertility of France, on the other hand, was the basis of a great industrial development. In the middle ages, France was the most highly developed portion of Europe, and economically the most prosperous. Some of the Italian Republics enjoyed a high degree of prosperity, but this was not shared by Italy as a whole, for reasons that were partly political and partly economic. The cities of the Low Countries enjoyed periods of great prosperity, but in so far as this well-being had a solid foundation it rested upon the agricultural wealth of the country, and the easy access to the surplus grain supplies of the countries of the Baltic.

The rise of the new metal industry during the Industrial Revolution completely transformed the relation between industry and agriculture. Industrial development came to be dependent upon mineral resources and climate. Industry was set free from

**Mineral resources and climate**

its dependence upon agriculture, both as to the details of location and as to the extent of possible development. Industrial wealth became, for the first time, antithetical to agricultural wealth. The significance of mineral resources will

be readily apparent to all, and this aspect of the migration of industry from southern and eastern England to the north of England and to Scotland was soon appreciated. The coalbeds of the West Riding of Yorkshire, Lancashire, and the midlands afforded the power which was so necessary to the new industrial technique. The significance of climate was fully appreciated only at a relatively late date. The older types of mill with stone walls, wooden floors, and relatively little ventilation minimized the difficulties of a technical nature. The workmen knew that moisture was favorable to spinning and they secured a measure of empirical success by diligent use of a plain watering-can. The evaporation of water from the floor of the room is wholly adequate from the standpoint of spinning and weaving, though it is neither agreeable nor healthy for the operatives. There was little exact study of the relation of humidity to spinning and weaving until the latter part of the nineteenth century. The new steel construction had made the problem urgent, and attempts to reduce bronchial and pulmonary diseases had stimulated exact keeping of humidity records.

The difficulties that arise from low humidity appear most obviously in the development of free electricity in the rooms of the factory. A somewhat extreme case is Humidity in cotton spinning cited with reference to a factory at Glasgow. "The accumulation of electricity in one room in particular, in which was a large cast-iron lathe, shears, and other machinery driven with great velocity by belts, was so great, that it was necessary, in order to protect the workmen from unpleasant shocks, to connect the machinery with copper wire with the iron columns of the building, and then when a break in the wire was made at a quarter of an inch, the succession of sparks was very rapid." "I have seen mills of recent construction," says Dobson, "especially fireproof mills, where every shaft, column, and beam of the fabric of the mill was charged with electricity to such a degree that cotton fiber stood out from the ironwork to the distance of at least three inches, radially to the center of electric attraction." The electricity is usually developed by the friction

between belting and pulleys and drums. The effect on the manufacture is twofold; the product is inferior, and the costs of manufacture are greatly increased. Electricity is developed chiefly when the atmosphere is dry, so that relatively high humidity offers a solution for most of these difficulties.

Careful tests made by Mr. Dobson of yarns spun at 31 per cent relative humidity and at 50 per cent relative humidity revealed a difference of five pounds in the tensile strength of the latter. Number 40 yarn spun at 31 per cent humidity tested 45.66 pounds, similar yarn spun at 50 per cent humidity tested 50.66 pounds. The mechanical qualities of the yarns are also affected by humidity. Yarn spun under relatively unfavorable conditions is less even in size, and has more loose fibers attached to it. Much fiber is also thrown off by the machines as waste, and when conditions are distinctly unfavorable as to humidity the amount of waste literally clogs the machine. An American firm, for instance, found that it was impossible to use in their mill a machine that could be operated successfully in England. Low humidity thus results in positive breakdown of machinery unless the speed and character of the work are modified. Climate thus becomes a decisive factor in the development of the modern textile industry. Only the coarser grades of stuff, whether cotton or woolen, can be made when climatic conditions are unfavorable. The finer grades of yarn and cloth are being made more and more largely in those districts whose climate is favorable, and there is reason to believe that to-day climate is at least of coördinate importance with power in determining the location of the major textile districts of the world.

Some writers are inclined to doubt the importance of climate, on the ground that artificial humidification presents a complete solution. It would seem that the place of artificial humidification might easily be misunderstood. Even when general conditions are favorable, some artificial humidification is desirable, if not actually necessary. One might even say that there has long been some attempt at artificial humidification in the more impor-

tant textile districts. In so far as there is novelty it lies in the attempt to control this factor with scientific accuracy and certainty. The use of the watering-can is as old as the spinning industry in Lancashire. In the districts favored by climate, more significant results are possible with humidification than in unfavorable districts even with the best apparatus. The difference in climate would thus seem to be one of the most nearly permanent bases of industrial location.

Although the subject is rather technical, the following passage from Mr. Dobson's study will perhaps be of interest:

In making a comparison between one district and another, as regards its capabilities for manufacturing, there are several points which must be carefully weighed in all cases: the Comparison of first being the question of mean temperature, the various regions second, the extreme range of temperature to which it is subject, and the third the weight of aqueous vapor per cubic foot of atmosphere. I append a table of statistics with regard to the foregoing conditions, and will endeavor to deduce the comparative values for the purpose of manufacturing — say cotton spinning, in each case. I have taken official meteorological records of twelve parts of the world — the 10th, 11th, and 12th being respectively, Boston (Mass.), Bolton (Lancashire), and the district near Lille. I will proceed to show why, and to what degree, each is favored by its climatic peculiarities for this particular industry. I have given in each case the monthly maximum and minimum temperature, and the mean monthly maximum and minimum of relative humidity, and, also, the calculated annual mean. The latter is of little value as a factor in the problem, as, of course, extremes of conditions of humidity would not affect the annual mean; although one condition or the other, or both, might be very prejudicial to the working of the fiber. And I may state as a principle, that the less the range of temperature, and the more regular the degree of humidity, the better the conditions. Thus, for instance take the contrast between Boston and Bolton. I find the highest mean monthly humidity in Boston to be 85 per cent, against Bolton, 93.1 per cent; the lowest monthly mean 66 per cent, against one of 69 per cent. Moreover, comparing the annual mean humidity, Boston has 74.5 per cent, while Bolton has 81.9 per cent, the contrast showing an immense advantage in favor of Bolton. Again, take the range of temperature — in Bolton it is 62.8 degrees, whilst in Boston it is 92 degrees. When the temperature in Boston is minus one degree, the absolute amount of vapor in suspension would be practically



nil — about half a grain per cubic foot of air; consequently when the air is heated sufficiently to allow of spinning operations it would be absolutely necessary, even for considerations of health alone, to impart artificial humidity. The climatic conditions of the district near Lille will be seen to more nearly resemble those of Bolton.<sup>1</sup>

Mineral resources, unlike climate, are a singularly capricious basis of industrial location, and some discussion of the subject is perhaps desirable, lest it be supposed that these newer considerations in industrial development impose a rigid determination upon the world. Apart from the changes that must always turn upon the gradual diffusion of technique, the metal trades introduce many elements of industrial instability. The economic significance of deposits depends upon conditions of utilization. Deposits that are absolutely unworkable under particular conditions may become of incalculable value by reason of minute changes in processes of reduction and utilization. Similarly, deposits that have been valuable in a given period may cease to be of practical significance because richer deposits are opened up or made available. All of these possibilities are illustrated by the history of the iron trade in the nineteenth century. English ore-beds are in most cases moderate in extent and richness, but numerous and peculiarly available because of the proximity of the coal. The immense ore deposits of Lorraine and Luxemburg were well known but were of low grade and contained enough phosphorus to render them almost valueless. The basic modification of the Bessemer process made it possible to utilize these deposits. Simultaneously, extraordinarily rich deposits of pure Bessemer ore were discovered in the Lake Superior district of the United States. These two deposits of ore dominate the industrial world to-day. The industrial prestige of England has been destroyed by the rise of Germany and the United States. The dislocations in the metal industries have occasioned real disturbances of the general political and economic equilibrium.

There is no reason to suppose that other generations may

<sup>1</sup> Dobson, B. A.: *Humidity in Cotton Spinning* (Manchester, 1901), 15-16.

THE RELATION OF CLIMATE TO THE TEXTILE MANUFACTURE

	Temperature (degrees Fahrenheit)					Humidity (per cent)							
	Annual mean	Monthly maximum	Number of month	Monthly minimum	Number of month	Annual mean	Highest monthly mean	Number of month	Lowest monthly mean	Number of month	Annual maximum at 10 a.m. June/July and 4 p.m.	Annual mean/all	
1. Bombay, India.....	79.5	84.7	5	73.1	1	75	86	4, 5	64	12	73-70	74.23	} Humidity too low, and range too wide Favorable Maximum temperature too high
2. Madras, India.....	81.8	87.2	4, 5	75.5	1	78	84	5	72	1	77-61	49.34	
3. Adelaide, Australia.	63.0	112.0	1	34.7	7	59	84	8	30	2	..	20.44	
4. Madagascar.....	73.4	94.0	1	59.0	7	81	83	5, 9	80	3	..	145.34	
5. Ichang, China.....	63.5	107.2	7, 11	22.0	2, 12	73	82	4, 12	78	6	..	44.60	
6. Chicago, Ill.....	48.8	90.0	7	-11.0	2	75	80	11	63	8	78-72	34.95	} Excessive range of temperature, low mean humidity and wide diurnal variation
7. New Orleans, La....	68.8	95.0	7	32.0	2	78.5	91	12	58	5	84-73	48.45	
8. New York City.....	53.5	90.0	8	2.0	2	75.5	82	9	68	3, 4	77-74	58.68	} Daily and annual range of humidity excessive
9. Salt Lake, Utah.....	52.7	102.0	7	5.0	1	49.5	76	2	17	7	66-43	18.46	
10. Boston, Mass.....	50.7	91.0	5	- 1.0	2	74.5	85	9	66	12	75-74	39.82	} Probably the most unfavorable of all parts of the earth for cotton spinning See text
11. Bolton, Lancaster...	46.3	55.0	8	31.9	12	81.9	98.1	2	69	5	82-82	42.24	
12. Lille, France.....	48.8	71.4	7	23.3	1	84.3	93	12	78	5	..	26.31	

not witness dislocations fully as startling. There are vast deposits of ore in Newfoundland, rich in iron but at present unavailable because of the presence of titanitic acid. A discovery, somewhat similar in general character to the discovery of Thomas and Gilchrist, would produce important disturbances in the iron and steel trade. The ore deposits of the Western world are coming to be fairly well known; there is to-day some measure of certainty, but economic availability depends upon many factors that are wholly uncertain. Sudden displacements of industry are thus characteristic of the world created by the Industrial Revolution. There is less stability in the present economic system than there was in the system based on agriculture that was supplanted.

These disturbances of the economic equilibrium are comparable to some of the caprices of commercial development during the middle ages and in the sixteenth and seventeenth centuries. Purely political factors were in many cases sufficient to divert and concentrate in particular localities a stream of commerce that was rather small in volume and consequently capable of finding adequate facilities in any one of many localities. The instabilities of Italian commercial and industrial growth may be traced to such sources; alternations of prosperity and decay in the Low Countries may also be ascribed to political factors. The present relation between economic and political factors is the reverse. The economic change exerts an influence upon the balance of political power. Thus, the Industrial Revolution was a factor, not necessarily the sole factor, in the loss of prestige by France in the course of the nineteenth century. Economic changes were a factor in the imperial prestige of England in the latter half of the century. The economic rejuvenation of Germany has been of importance in connection with the disturbances of the balance of power in Europe. The achievement of political stability will be a matter of great difficulty as long as the underlying economic basis of political power is subject to such momentous changes as have taken place in the last generation.

The emancipation of industry from close dependence upon a local surplus of food products has resulted in greater concentration of population. The increased opportunities for industrial employment created new <sup>Population</sup> opportunities for agriculture. The importation of food products became essential to some regions. They were able to draw from a more remote frontier. Growth of population in Europe and in England has thus been accompanied by proportionate growth in the frontier countries. The industrial and the agricultural population became separated territorially, and, by this new division of labor, expansion was possible of which no one dreamed at the beginning of the nineteenth century. The dismal forebodings of the Malthusians seem very remote to us, and it is equally difficult for us to appreciate Liebig's feeling that the application of scientific theory to agriculture would be of inestimable humanitarian worth by reason of freeing the world from the prospect of indefinitely increasing pressure upon food-supply. We have become so accustomed to rapid growth of population that we cannot enter into the older point of view without determined effort.

The calculations of Gregory King (1693) may therefore serve a useful purpose, presenting the best judgment of the time upon the existing population of England and his expectation of increase. <sup>A forecast: 1693</sup>

THE POPULATION OF ENGLAND, ITS HISTORY AND ITS FUTURE —  
GREGORY KING: 1693

	<i>Persons</i>
1300.....	2,860,000
1400.....	3,300,000
1500.....	3,840,000
1600.....	4,620,000
1700.....	5,550,000
1800.....	6,420,000
1900.....	7,350,000
2000.....	8,280,000
2100.....	9,205,000
2200.....	10,115,000
2300.....	11,000,000

## THE POPULATION OF ENGLAND AND WALES: 1700-1911

<i>Estimates based on the baptismal registers*</i>		<i>Census returns</i>	
	<i>Persons</i>		<i>Persons</i>
1700	5,475,000	1801	8,892,000
1710	5,240,000	1811	10,164,000
1720	5,565,000	1821	12,000,000
1730	5,796,000	1831	13,896,000
1740	6,064,000	1841	15,914,000
1750	6,467,000	1851	17,927,000
1760	6,736,000	1861	20,066,000
1770	7,428,000	1871	22,712,000
1780	7,953,000	1881	25,974,000
1790	8,675,000	1891	29,002,000
1800	9,168,000	1901	32,527,000
		1911	36,070,000

\* *Abstract of the Answers and Returns (Census 1821), Preliminary Observations, xxix.* The figures differ somewhat from figures published in 1831.

It will be observed that King's estimate of the population for 1700 is slightly larger than the estimate made later by the census authorities in 1821, but the discrepancy is not large considering the uncertainty attending all such computations. King's rate of increase was based on English figures for a century or more, and while his materials were defective to the last degree we should hardly be warranted in declaring his forecasts foolish. He expected the population to be almost stationary. The population of France has been in fact about as nearly stationary as he anticipated. The disturbing factor in his calculations was not an error in the probable rate of increase, other things remaining the same. This was one of the many instances in which things refused to remain the same. The normal density of population for the essentially agricultural civilization of the intermediate period and the older expectations of increase ceased to have any vital significance for the world created by the Industrial Revolution. The expansion of Europe, in population as in influence, was one of the most unexpected events of history, and these forces were most remarkably manifested in England. The economic changes that made this growth possible effected a complete transformation in the outlook upon life. The sense of the limitation of human

activities by nature that cast a positive gloom over the early nineteenth century has disappeared, and at the outbreak of the Great War the confidence in human powers and the sense of mastery over nature had reached a climax.

The Industrial Revolution was thus a revolution in every sense of the word, except that of suddenness of transition. But the extraordinary character of the trans-  
The Industrial Revolution not sudden  
 formation must in itself be sufficient to convince one that such changes in the matters of daily life could not take place suddenly. Particular machines can be brought to public attention within a brief space of time; the form of industrial organization can be changed, though that would inevitably require a longer period. But the Industrial Revolution was more than any such formula could possibly imply. The "Great Inventions" were merely a stage in a long development of a new mechanical technique, neither the beginning of the new order nor its culmination. The rise of the modern factory system was only one of many results of mechanical change, industrial dislocation, and commercial development. The abandonment of the idea that the Industrial Revolution was sudden involves a considerable readjustment of chronology for the entire movement. The study must be carried farther back into the past and continued down nearer to the present time. The establishment of even approximate limits is obviously difficult.

There is a growing disposition to carry the beginnings of the movement back to 1700, treating the date as an approximate round number. The date is wholly satisfactory except for the metal trades, in which the abortive experiments of Dudley are pretty clearly the beginning of the story. This case illustrates the difficulty of finding the beginnings of a change in industrial technique. There are many beginnings, many meanings of new, many degrees of novelty in invention.

Patent law is by necessity constrained to assume that an invention can be exclusively the work of an individual; the historian who gives heed to all the facts must needs admit that most achievements are not the work of a single indi-

vidual. There is a difference between an invention and a mechanical achievement; the latter phrase implies that the affair is practically useful. Now, an individual can certainly invent something that is distinctly new, but it is rare that any single individual can compass a notable mechanical achievement by methods that are wholly, or even primarily new. The larger achievements are the result of endeavors exerted over a perceptible period of time, usually by successive inventors. In the early days of mechanical endeavor, this preliminary struggle is particularly long. The entire process of invention may be divided into three stages, which have a certain degree of logical and dramatic sequence. The beginning of every mechanical achievement must be a matter of pure conception. Before any contrivance can be made it must exist more or less completely in the mind of its inventor. The conception becomes entirely real when a small experimental model can be built, but any one familiar with the history of any inventive achievement knows how great may be the difficulty of converting the model into a practicable device of commercial importance. Many details of construction that are of no moment in connection with the model may offer almost insuperable obstacles to the building of full-sized machines. Both aeroplane and automobile were seriously handicapped at the outset by the inadequacy of the motor available. There was enough power to demonstrate the possibilities, but not enough to insure reliability. Watt found it possible to build a model of his condensing engine because all the parts could be made of the softer metals and with considerable accuracy. Smeaton, a contemporary engineer who was shown the model, said that it was wonderfully perfect, but declared that it could never be built, and Watt's long struggles in the machine shop testify eloquently to the keen appreciation of Smeaton for the difficulties of engine-building. Cylinders could not be made of sufficient accuracy of bore to work effectively, and every detail from piston packings to valve construction presented an individual problem. The period of struggle with details of con-

Stages in  
inventive  
achievement

Practical  
difficulties

struction must needs be present in every mechanical achievement: present in some degree before the full consequences of the invention can be realized. At times the interval may be short, and the struggle not very difficult: Whitney's cotton gin and Crompton's mule afford illustrations of machines that became economically significant almost immediately, but even in these cases it was some time before the machine reached a stable form.

When the technical difficulties have been overcome the full measure of the importance of the original conception is really achieved, and with this stage of development the <sup>Commercial</sup> great financial rewards are usually associated. <sup>success</sup>

The inventors who win great wealth are, in most instances, inventors who have participated in the last stages of the long chain of correlated inventions so that they really receive a reward for the work of their predecessors as well as for their own work. Arkwright's conversion of a model spinning machine into a commercial success which made him wealthy furnishes a perfect illustration of the possibilities of deriving benefits pretty directly from the efforts of others. In many cases the connection might be less direct, and might be more nearly free from all suggestion of unscrupulous exploitation of other people's ideas.

The commercial value of an invention depends largely upon the ease with which the idea can be utilized. The most brilliant conception is of little immediate use if <sup>Rewards of</sup> it is wellnigh impossible to embody it in an <sup>inventors</sup> actual machine. The commercial availability of an invention is thus measured in no small degree by the effort required to make the conception a reality. If it is possible for an inventor to make drawings of his machine, having ready at hand firms of machine-builders capable of executing the designs, the inventor is benefited directly by all the mechanical achievement of a century or more of struggle. His innovation can become immediately useful on a large scale. The devices perfected by Professor Pupin to facilitate long-distance telephoning probably brought their inventor larger rewards than the original inventors of the telephone secured;



and though it seems illogical that the subordinate invention should yield larger returns than the principal invention it should not be a cause for surprise. The commercial value of inventions thus depends in part upon the technical equipment of society. The individual working in comparative isolation may conceive great things and struggle patiently toward their accomplishment, but the final accomplishment must involve more than the efforts of detached individuals. The conception may be, indeed, the work of the individual, but the accomplishment is the work of society in its organized entirety.

The history of the Industrial Revolution is therefore something more than a chronicle of various individual inventive achievements; it is a record of the development of a new quality of technical equipment, and the mechanical technique was acquired slowly and painfully with the same successive stages of effort that appear with reference to each single invention. There is thus a period of conceptions, a period of struggle, and a period of achievement. The early eighteenth century was in general a time of conceptions, experiments that were important, but for the most part devoid of large commercial significance. It was so in the metal trades, and in the textile trades; new things were done, but no great results were achieved. The late eighteenth century and the early nineteenth century was the period of struggle. The biographies of the inventors of this generation are closely similar. Most of them are poor, and few achieve even financial competence. The daily incident of their lives is the struggle to realize great ideas with woefully inadequate means, financially and technically. Beginning perhaps with the decade of the thirties financial returns become more usual, and in Sir Henry Bessemer we find one of the first inventors to acquire a truly large fortune. The latter half of the nineteenth century is thus the culminating achievement of the century or more of effort that preceded, and though the fortunes of the inventors of the period are due in part to their qualities as individuals, they are also in part attributable to

Cumulative  
effort

Social or indi-  
vidual accom-  
plishment

the general equipment of society that has been so laboriously created.

Treatment of the Industrial Revolution has frequently slighted both its beginning and its end; there is a great temptation to presume that the struggles with the new technique are alone worthy of serious attention. It is easy to neglect the early period because we know relatively little about it, and because it is not always interesting to bother with unsuccessful inventions. The closing years of the nineteenth century, on the other hand, seemed to be more nearly related to the future than to the past, until the Great War made us realize that we have been living through the close of a great period in history.

It is quite unconventional to suggest that the period of the Industrial Revolution should include the whole of the nineteenth century, but there seems to be warrant <sup>The close of</sup> for it in many respects. <sup>the period</sup> At least some portion of this generation of great achievements must needs be included in the history of the Industrial Revolution if the narrative of the movement is to have any fitting climax and conclusion. This dating is thus defensible on artistic grounds. It is also defensible on scholarly grounds. The change in the relative importance of the metal trades is most certainly a feature of the Industrial Revolution. It is thus reasonable to conceive the movement as incomplete and unfinished until this change has taken place, and, as has been shown already by the statistics of occupations, the metal trades do not become fully coördinate in importance with the textiles until the close of the last century. Both of these reasons are relatively independent of the occurrence of the War, so that we may feel some assurance in presuming that the outbreak of the War will serve naturally as the line of demarcation in economic as in political history.

## CHAPTER XI

### THE EAST INDIA COMPANY AND THE VESTED INTERESTS

THE companies formed in England and in Holland to trade with India ultimately had larger significance than the somewhat similar company of the Portuguese, because both English and Dutch became connected with different portions of India. The Dutch and the English became interested first in the islands of the Javanese archipelago and the English later became interested in the easterly coast of continental India, a connection made peculiarly important because of its relation to the textile manufactures. It thus happened that a trade undertaken with reference to spices came to have a profound influence upon European habits of consumption and upon European industries. The textiles were in the main cottons, but there were also types of silks that had not been manufactured in medieval Europe. The history of the East India Company is therefore a peculiarly important chapter in industrial history because it brought about the changes in the textile markets that were a fundamental feature of the Industrial Revolution.

During the medieval period cotton and cotton goods were known in Europe, but not generally used. Cotton was cultivated in Spain by the Moors and some manufactures of cotton were developed by them, but apart from their enterprises little cotton was grown within the boundaries of Europe and little was imported. The Venetians and Genoese brought small quantities of cotton to Europe which was made into coarse fabrics, usually mixed with linen. It was this cotton manufacture that spread north from Italy into Switzerland and Austria, but at no time did this type of textile become a significant competitor of either linen or silks. Cotton manufacture of this general type existed in England from an early date, but few details of the history of this industry are known to us. These fabrics were used only by the poorer classes of the population.

The types of cotton goods now familiar to us were produced in India early in the Christian era, and became known to Europe by repute. They were described by Marco Polo and other travelers, but did not enter into commerce.

The determination of the approximate date of the significant introduction of these fine cotton goods into Europe is of considerable moment with reference to the influence of the East India Company's com-<sup>Indian cottons</sup>merce upon English industry. The purpose of the earlier Indian voyages is a matter of special interest. The ships carried out general cargoes of British and foreign goods and brought back spices. Trade was largely confined to the Spice Islands. In 1608 trade with continental India began. The natives of the Spice Islands were not particularly eager for English goods, but were particularly anxious to get Indian textiles. The English agents at Bantam wrote home: "that the cloths and calicoes imported from Cambaya were in great request and if the factories could be furnished with them they could be profitably exchanged for pepper and finer spices: the factors therefore recommended that a trade should be attempted at Surat and Cambaya; that two ships should be employed to purchase goods at those ports to be sent for sale to Bantam and the Moluccas, which would increase the general profit of the annual voyages."<sup>1</sup>

These recommendations met with the approval of the Governors and in 1609 the ships sent out were instructed to buy raw silk, fine book calicoes, indigo, cloths, and pepper. In September, 1612, the first English factory was established on the coast at Surat, apparently to give more stability to the trade between the coast and the Spice Islands. The textiles secured on the continent were used primarily as trade goods in the Islands, though consignments were sent home. The continuance of this system was interrupted by the struggle with the Dutch for supremacy in the Spice Islands. The Dutch claimed exclusive rights of trade. They had secured points of strategic importance, and, backed by significant military force, they proposed to expel the English from the Islands.

<sup>1</sup> Bruce: *Annals*, 1, 156.

The Dutch projects culminated in the massacre at Amboyna in 1623. The small English trading post was raided and all the persons found there executed shortly after on trumped-up charges. It was alleged that they were conspiring against their Dutch neighbors. The necessities of European politics obliged the Dutch Government to make promises of appropriate reparation. Nothing was actually done until the time of Cromwell, but the Dutch were forced to abandon their monopolistic claims and recognize the existing situation in the Islands.

These events made it clear to the East India Company that there would be little opportunity of expansion in the Spice Islands, and, while it is difficult to be certain of official motives, the establishments on the east coast seem to have acquired a new importance after 1630. The trade begun at Surat in 1612 was slow to develop on account of the difficulties of transport from the interior, and the famine of 1630 made it impossible to secure cottons at advantageous prices. East-coast goods could still be procured and the factories established there came to play a greater part in the operations of the company. The correspondence of the company and its agents shows that there was coming to be a real demand for Indian cottons, and though indigo continued to be the chief importation from the continent of India the textiles came to be something more than a superior kind of ballast.<sup>1</sup>

The first symptoms of distress in the woolen and silk industries of England appear about the time of the Restoration, and, allowing for the slackness of the East Indian trade prior to the grant of Cromwell's charter to the company, this pressure would be essentially consistent with the development of the trade of the company. The nature of the competition that affected the established industries was not immediately understood, and the pamphlet literature of the period affords ample evi-

<sup>1</sup> The records of the English factories in India, now available in print for the first half of the seventeenth century, make it possible to trace the development of this early trade in textiles in detail. Foster, W.: *The English Factories in India* (Oxford, 1933-15); 9 vols.

dence that the consciousness of trouble preceded appreciation of the underlying cause by a comfortable margin. The woolen interest was prompted to demand protection, but even the petitioners were very uncertain as to what the industry was to be protected from.

The first indication of clear understanding of the menace of the East Indian commerce appears in a pamphlet of 1678, *The Ancient Trades Decayed and Repaired Again*.

This loosely reasoned pamphlet contains a passage which refers to the changes in consumption: "Instead of green say," the author writes, "that was wont to be used for children's frocks, is now used painted and Indian stained and striped calicos; instead of perpetuana or shalloon to line men's coats with is used sometimes a glazed calico and sometimes a bengal." A few years later, in polemics between Sir Josiah Child and the Turkey Company, the whole situation was further discussed and the relation of the East Indian trade to the pressure on the English textile industries clearly recognized by both sides. One may conclude that the vogue of the East Indian fabrics, cottons as well as silks, had become definitely established at least as early as 1680, though the more voluminous pamphlet literature is at least a decade later.

The agitation for protection was carried on somewhat separately by the silk and the woolen interests; and of the two groups the silk weavers were the most active in the early period. The protests against the im-  
Diagnosis  
Petitions for protection  
 portation of silks and calicoes by the East India Company were submitted to Parliament in November, 1680, and, though there was some debate, nothing was done. This petition of the silk weavers, however, marks the beginning of the protective policy that dominated English commerce and industry until the establishment of free trade principles in the middle of the nineteenth century. In 1696-97, a bill was introduced to prohibit the wearing of all East Indian and Persian wrought silks, bengals, dyed, printed, and stained calicoes. From this date the industrial interests were actively devoted to the advocacy of protective policies.

It will be observed that this protective system was founded on principles that were in nearly all respects different from the principles governing the policies of Colbert.

**Vested interests** The French statesman was eager to foster new industries. Parliament in England was accessible to almost any suggestion that an established industry was endangered. The English protective system, therefore, was specifically designed to maintain vested interests: it was directed against the great transformation of habits of consumption brought about by the trade with India.

Somewhat has been made of the relation of these policies to party politics. Professor Ashley has shown that the protective policy was established by the Whigs, and that the Tories, or at least some of them, advocated free trade. The tendencies of party politics admit of relatively simple explanation. The charter of the East India Company represented an exercise of the royal prerogative of which Parliament was always jealous. The charter could be defended only upon the constitutional assumptions of the Tories. The merchants interested in the company were originally Whigs and remained Whigs until after the Restoration, though at all times the company had been obliged to defend itself by appeal to the more extended theories of royal prerogative. The company had always been dependent upon royal favor. Josiah Child perceived the intimate dependence of the company upon the predominance of Tory influences and at his suggestion the politics of the company were definitely changed, though not without a serious conflict among the directors. In the latter part of the seventeenth century, therefore, the Tories were the supporters of the East India Company and the Whigs its opponents. This alignment of parties, however, was more largely due to personal and constitutional considerations than to any conscious thought of the merits of free trade and protection.

The problem of commercial policy had occupied a conspicuous place in political discussion throughout the seventeenth century, and, in a casual way, the doctrines associated

with the mercantile theory appeared in the discussion. The narrow formulation of mercantilism by Adam Smith has effectively concealed the actual complexity of motives that underlay discussions of policy in this period. Consideration of the East Indian trade involved all the larger problems of commercial policy, and with a few exceptions the polemical literature connected with the East India Company covered the entire discussion.

Some of the notable mercantilistic fallacies were closely associated with some incidental features of the trade of the company. This is particularly true of the <sup>Export of</sup> alleged identification of money with wealth by <sup>bullion</sup> mercantilistic writers. The East India Company did indeed export considerable quantities of coin and bullion, and this export of bullion was the subject of much criticism during the first half of the century. Malynes's pamphlet, *The Canker of England's Commonwealth* (1601), presents this criticism. The same ideas appeared in a number of later pamphlets, none of them quite as famous as the first. This objection, however, was decisively answered by Thomas Mun, whose reply contained a significant analysis of the mechanism of international payments. The form of presentation is unfortunate, as systematic exposition was subordinated to the polemical necessities of the moment, but all the essential features of the modern theory were embodied in Mun's statement.

Mun's first pamphlet appeared in 1621; in 1628 he wrote the petition and remonstrance submitted to Parliament by the company. This last document contains the essential material of the most famous of his <sup>Mun's defense</sup> writings, the pamphlet, *England's Treasure by her Foreign Trade*, which was written in its final form immediately afterward, but not published until 1664. The significant feature of Mun's writings is the clear consciousness that money is not wealth, and the recognition of the inaccuracy of the phrase "balance of trade." As in modern treatises, the movement of specie between countries is ascribed to a number of debit and credit items of which the trade balances are only one



among several. Some of the items specifically suggested by Mun are: charges for shipping services, expenses of foreign wars, remittances to foreign countries by priests and Jesuits, travelers' expenses, ambassadors' expenses, gifts to strangers, and the like. There is thus in Mun's work the same conception of a balance of indebtedness that is the basis of the modern theory of foreign exchange. We cannot be entirely certain of the impression made by these writings, but on the whole one may well question the existence of serious confusion between money and wealth in the latter part of the seventeenth century, and the doctrine of the "balance of trade" was certainly of subordinate importance in the last half of the century. It did not dominate the thought of the more important writers.

When the first effects of competition with these Indian textiles began to be felt, the writers most closely associated with the woolen interests were disposed to find the explanation of the distress in the competition with France. The pamphlet of Samuel Fortrey, *England's Interest and Improvement* (1663), is fairly typical of this view. English manufacturers were represented as being at a disadvantage with French industries and some attempt was made to prove that France was a source of trouble by casting up a balance of trade between France and England. In so far as the balance-of-trade doctrine appears in this controversy it is in connection with this allegation of danger from competition with France. When it came to be understood that the real difficulty was to be attributed to the East Indian commerce the balance-of-trade doctrine was largely abandoned by the pamphleteers, to be revived for a brief time when the commercial clauses of the Treaty of Utrecht were under discussion in 1713. The substantive protective measures were based on the alleged necessity of protecting "vested interests."

The significance of the woolen industry in the minds of contemporaries is indicated further by the importance attached to the Methuen Treaty of 1702. Portugal was presumed to be a singularly important

market for woolens, partly because Portugal was dependent upon imports for her domestic consumption and partly because of the exports of goods to the Portuguese colonies. Both France and England were anxious to secure this market, and it was felt to be a matter of first-rate importance that England should secure preferences. Accordingly, England granted preferences to Portuguese wines at a very substantial sacrifice. The Portuguese wines were always to pay one third less duty than the like quantity of French wines. British consumption, up to that time, had favored the French products; these preferences of the Methuen Treaty, however, curtailed legitimate trade in French wines and brandies, and led to the well-known smuggling trade that flourished until the early nineteenth century.

The European problem was brought up again in 1713 by the conferences upon the commercial clauses of the Treaty of Utrecht. The conclusion of the treaty with France would have required the abandonment of the policy of protecting the woolen industry.

Proposed  
treaty with  
France

The issue that was joined with reference to this measure was thus curiously interwoven with the controversy that had long centered around the East India Company. The persistent dread of French competition was a heritage from the early misunderstandings of the nature of the pressure from which the woolen industry had suffered for many years. The decision of the issue turned in no small measure upon general political considerations: The Whigs, who were incidentally protectionists, were on the whole the predominant party, and the menace of a Jacobite restoration proved to be a fundamental source of weakness to the Tories. The problems of commercial policy became a party issue when the highest stakes of politics overshadowed all minor issues. The literature on these commercial questions consequently seems barren and meaningless, for the ultimate decision was only casually affected by the merits of the discussion. The action taken undoubtedly tended to conceal the considerable amount of good free-trade thought to be found in the writings of the defenders of the East India Company.



In view of the general victory of the protectionists in 1703 and 1713 it may seem strange that the demands for protection against the East Indian fabrics did not meet with more success. Bills that advocated complete prohibition of all importation of East Indian goods were introduced into Parliament as early as 1697, but none of the measures passed. The company was ably defended at that time by Charles D'Avenant whose essay on the East Indian trade was inspired by the bill. The essay shows a clear perception of the general benefits of free trade, and many of the specific allegations of the woolen manufacturers were successfully answered. Although the general prohibition was not approved, some concession was made to the silk manufacturers, partial protection being afforded by the Acts of 1697 and 1700. In all probability the tenderness with which the East India Company was handled was chiefly due to the large sums of money that had been lent to the Government. The intimate financial relations between the Government and the company are probably the real explanation of the incomplete success of the protectionist group.

The agitation of the woolen interests continued and began to assume an acute phase in 1719. This finally resulted in the passage of the Calico Act of 1721, "an act to preserve and encourage the woolen and silk manufactures and for the more satisfactory employment of the poor, by prohibiting the use and wear of all printed, painted, flowered or dyed calicoes in apparel, household stuffs, furniture or otherwise" after December 25, 1722. This act made it unlawful for any person to use or wear any calicoes under penalty of forfeiting £5 to the informer and paying a fine of £20. Merchants were not allowed to sell any calicoes, or any furniture upholstered with calicoes. There were some exceptions, but it is not easy to appreciate their exact nature.

The extension of the act to goods partially made of cotton was of serious moment to such cotton manufacture as then existed in England. Somewhat later, when the native cotton industry began to assume larger proportions, an attempt was

Successful re-  
sistance of  
the company

The Calico Act

made to enforce the act against the domestic production of cotton goods. This resulted in appeal to Parliament by the cotton manufacturers, and, as they also constituted a "vested interest," they secured relief. The Manchester The Manchester Act Act was passed in 1735, providing that the Calico Act should not be interpreted to prevent the wearing or use of any stuff of linen yarn and cotton wool manufactured and printed or painted with any color or colors. This statute covered the coarser fabrics that had long been made in England. There were thus exemptions to cover some of the Indian products and the domestic goods which were constantly being improved under the stimulus of the new demands.

The protective system was thus developed with the explicit purpose of maintaining the woolen industries, but in accomplishing this end the home market was so Expectations and results thoroughly protected against competition with British India that significant opportunities were created for a native cotton industry. These opportunities were emphasized by the exemptions. A calico printing industry became established in England at an early date. The importation of white goods seems to have been possible at all times. East Indian yarn was imported, and muslins, neck-cloths, and other exempted goods were manufactured in England. Although the detailed history of this drastic statute is uncertain, and the effect of its prohibitions qualified by smuggling, there can be no doubt but that these protective measures were ultimately more significant to the infant cotton industry than to the "vested interests" of the woolen manufacture.

There are few instances in history of so great a discrepancy between expectations and results. The politicians at the beginning of the eighteenth century were very anxious to further the commercial advantage of England as against France. They presumed that this could be done only by protecting the woolen industry from the joint competition of France and the East Indian trade. The industrial supremacy did in fact pass from France to England in the course of the

century, but in an entirely unexpected manner. The development of the cotton industry in England under the shelter of protection was an event of the first magnitude, and, though the annals of invention generally distract our attention from these matters of commercial policy, the significance of protection to the growing cotton industry cannot be overlooked. The Calico Act was not repealed until 1774, when it actually began to stand in the way of the expansion of the English cotton industry. It is a strange coincidence that Crompton's invention should have followed so closely. The mule made it possible for the English manufacturers to compete with East India, not merely in printing and finishing, but in spinning all grades of yarn. The industry was thus freed and made independent of a protecting influence only when it had attained a definite mechanical superiority.

It would be too much to say that the cotton industry was created by protection, but the cotton industry was certainly the outcome of a demand for cottons created by the East Indian trade which was partially obstructed by protective measures. If the demand for cottons could have been continuously gratified by importation from India it is hard to believe that the English cotton industry could have made as favorable a growth. Protective measures were thus a part of a highly complex situation. The woolen industries gained some temporary relief from competition with cottons, but in the end the domestic cotton industry was able to compete more keenly and disastrously than any foreign industry could have done. We are probably only now witnessing the final readjustments of the textile trades to the changes that began in the seventeenth century with the introduction of the East Indian cottons into Europe.

## CHAPTER XII THE NEW COTTON INDUSTRY

### I

THE changes in the habits of consumption that followed the introduction of East Indian cottons into Europe laid the foundations of a new cotton industry, but the development of an industry capable of dominating all branches of the cotton trade was made possible only by a complete technical transformation of the old hand processes of manufacture. The inventions were not the original cause of the changes in the industry, but they were essential to the full realization of the new opportunities. The commanding success of some of the inventions and the obscurity of the early history of the first attempts to apply mechanism to this industry have fostered the natural disposition to presume that the achievement of mechanical technique was accomplished without any considerable struggle. It is frequently suggested or implied that the history of the Great Inventions differs in this respect from the ordinary course of mechanical development. But this is an error. Inventions in the cotton industry as in other fields of enterprise were achieved only after appreciable efforts and the full significance of the new devices was realized only after a considerable number of complementary inventions had been applied to the perfection of the original machines. The early machines were a great advance over hand processes, but for more than a generation important mechanical improvements were made in their construction and operation. The transformation of the industry was not really sudden and violent as was alleged by the earlier writers on the Industrial Revolution.

The first successes of inventors were with spinning machinery, and the entire process of spinning was brought within the scope of machinery long before weaving by the power loom was at all practical. Spinning

ning had become specialized into three stages before the introduction of machines. The cleansed cotton fibers were carded and reduced to an orderly parallel arrangement in a ribbon or sliver. The sliver was then formed into a loosely twisted strand, so weak that further drawing and twisting was necessary before it could be used in weaving. The intermediate product was termed "rovings" to distinguish it from the finished yarn. The process of spinning, though lengthy and somewhat specialized, involved only two types of operations: the carding of the cotton fibers, and the drawing and twisting that was repeated several times in the course of preparing yarn or thread.

The development of carding machines was the work of the inventors of spinning machines, and there is a rough identity in certain of the mechanical principles used. **Carding machines** All the machines utilized cylindrical rollers, but the form and character of the rolls were by necessity adapted to the somewhat different purposes to which they were applied. The problems of carding were in general relatively simple, though the details of the process admitted of much refinement in the technical details.

Spinning involved a number of serious problems, and two distinct types of machines were ultimately produced which were possessed of such varied merits that both types have always been employed in the industry. The bobbin and fly frame system of the throstle proved to be particularly well adapted to the preparation of rovings, so that the intermediate processes have been dominated by this type of machine. The coarser yarns can also be spun with this type of machine, but the finer yarns can be spun only on the mule.

These two spinning machines are based on essentially different principles. Throstle spinning is usually termed the **Continuous and intermittent spinning** continuous process; mule spinning, the intermittent process. On the throstle all phases of the process proceed simultaneously and continuously: drawing, twisting, and reeling on the bobbins. The mule forms the thread during the run of the carriage away from the rolls, accomplishing the drawing and twisting at the

same time, but the reeling of the finished yarn upon the bobbin is accomplished during the return of the carriage toward the rolls, so that actual spinning is intermittent.

The continuous process was first to be developed. It represents in many ways a particularly brilliant mechanical accomplishment, for it departs in all its details from the processes of spinning on the hand wheel. The essential feature of this process is the accomplishment of the drawing-out of the sliver or roving by

passing it through a series of rollers revolving at different speeds. The adjoining sectional view of Arkwright's spinning frame illustrates the arrangement of the machine in a somewhat improved form. There are four pairs of rollers, *A A*. The upper rolls are kept in contact with the lower rolls by the weights, *B B*, and, supposing the rolls numbered from left to right, the second, third, and fourth pairs each revolve more rapidly than the preceding pair. The sliver or roving was thus drawn out in the course of its passage through the rolls to a degree of fineness that could be regulated by variations in the speed of the rolls. Leaving the

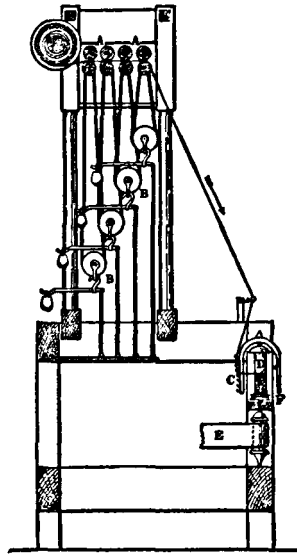

FIG. 1. THE THROSTLE

rolls, the sliver or roving passed downward to the flyer and bobbin receiving the twist necessary to form it into yarn by reason of the rotation of the flyer, *C*. The finished yarn was reeled upon the bobbin, *D*, by reason of a difference in speed between the flyer and the bobbin. It is possible to accomplish this part of the process either by driving the bobbin faster than the flyer and thus drawing the yarn from the flyer to the bobbin, or by driving the flyer faster than the



bobbin so that the yarn would be deposited upon the bobbin. It will be obvious that the machine will either produce rovings from slivers of carded cotton, or finished yarn from rovings.

The distinctive feature of the throstle lies in the successive accomplishment of drawing and twisting. This results in subjecting the sliver or roving to its chief strain and tension before it has received the twist which imparts strength. It was thus found to be especially desirable to pass the cotton successively through several machines so that some twisting was done before all the drawing was accomplished. The specialization that already existed between the preparation of rovings and the finishing of the yarn was thus gradually carried farther, and the quality of yarn considerably improved by better management of the machines. But even

*Its limitations* when the throstle is most carefully used, it is incapable of producing the finer grades of yarn. It is not possible entirely to avoid the effects of performing the drawing independently of and prior to the twisting.

Yarn is graded in terms of the number of hanks per pound. The hank represents a standard length so that differences in weight are in fact indices of the fineness of the yarn. The number of hanks per pound is technically called the "count" of the yarn. Now the throstle is effective for counts up to forty, though there is some competition between the mule and the throstle in spinning forties. The mule, on the other hand, now produces counts for general commerce as high as three hundred and fifty, and for exhibition purposes some very extraordinary achievements have been accomplished.

The first use of rollers in spinning was the joint work of two men, Wyatt and Paul, whose separate contributions to *Wyatt's claims* the inventions cannot now be very successfully ascertained. It is alleged by Wyatt's son, in testimony given as late as 1817, that his father was the real inventor of the process. "In the year 1730," he says, "living then at Litchfield, my father first conceived the project and prepared to carry it into effect, and in the year 1733, by a model of about two feet square, in a small building near

Sutton Coldfield without a single witness, was spun the first thread without the intervention of human fingers. . . . The cotton wool had been carded in the common way and was passed between two cylinders from whence the bobbin drew it by means of two distaffs." Wyatt, himself, in two letters, claims credit for the invention, but not sole credit. He says, in 1741, "the engine owed the condition it was thus in to the superintendency of John Wyatt." In another letter he says, "I am the person who was the principal agent in compiling the spinning engine." According to his account, hopes of securing financial support induced him to enter into partnership with Lewis Paul, a foreigner more capable of making promises than of carrying them out. It is implied that Paul secured so great an ascendancy over Wyatt that the patent finally taken out in 1758 stood in Paul's name. The acquisition of patent rights in this machine and the invention of other machines by Paul constitute a serious obstacle to the claims made by Wyatt and his son.

The relations between Wyatt and Paul are most adequately revealed by Paul's will and the letters addressed to him by various correspondents. From this evidence it is possible to reconstruct a fairly plausible account of the relations between the two men. Paul was an inventor of small means engaged, when we first hear of him, in the manufacture and sale of an instrument for pinking crepes and tammies for burying cloths. Wyatt was a carpenter, who did some work for Paul on the spinning machine. Wyatt was apparently better supplied with funds than Paul, for the latter became indebted to him for £800. In the fall of 1741 Wyatt was working on the carding machine more or less under the direction of Paul, though he made a number of suggestions and improvements. The following spring Wyatt found himself in need of money and made a determined attempt to force Paul to pay his debts. The bills were put into the hands of an attorney, but Paul was practically bankrupt. Wyatt recognized the necessity of compromise. In a letter of March, 1742, he says, "The money is what I want, or at least what would please me best at present, but to be

Relations  
with Paul

plain, I am in some doubt of having money from Mr. Paul, and, if spindles must at last be my share, I would be willing to have as many as would attach my sole attending." Wyatt was given three hundred spindles. The papers going with them suggest that the work of designing the machine was essentially Paul's. The deed for the spindles was accompanied by a covenant in which Paul agreed "to turn over the plans for erecting the spindles, which he, Lewis Paul, hath gone by, and to give Wyatt, his agent or his workman, such further instructions for the erecting, making, and perfecting of the said machines as shall be requisite and needful."

It is fairly clear that the initial impulse came from Paul, although it is possible that many suggestions were made by Wyatt in the course of executing Paul's designs. It is by no means inconceivable that a craftsman of Wyatt's caliber should have an exaggerated notion of the importance of his contributions, and such presumptions would cover most of the discrepancies in the various accounts.

In August, 1748, Paul took out a patent for a carding machine, and in 1758 a second patent for a spinning machine, which is accompanied by fairly complete drawings. It is a reasonable presumption that this spinning machine was no more than a development of the earlier machine on which Wyatt and Paul were working in the thirties. The wording of the text of the earlier patent indicates no essential difference in principle, so that the specifications of 1758 may be regarded as representative of the earliest device for combining rolls with the flyer and bobbin. It will be observed that the drawings are incomplete. The rolls and flyer which are shown in profile give the essential mechanical features of the machine, but there is no indication of the method for feeding the sliver or roving into the rolls.

The general form of the machine, too, makes it difficult to imagine precisely how this might be accomplished. So far as one can judge by the drawings, the functions of the rolls were different from their later functions in the developed throstle. There was only one pair of rollers, so that the drawing-out of the roving was accomplished by

tension between the rolls and the flyer, instead of being the work of different pairs of rolls. The motion of the flyer thus accomplished the double task of drawing and twisting the roving. The separation of the drawing and twisting which

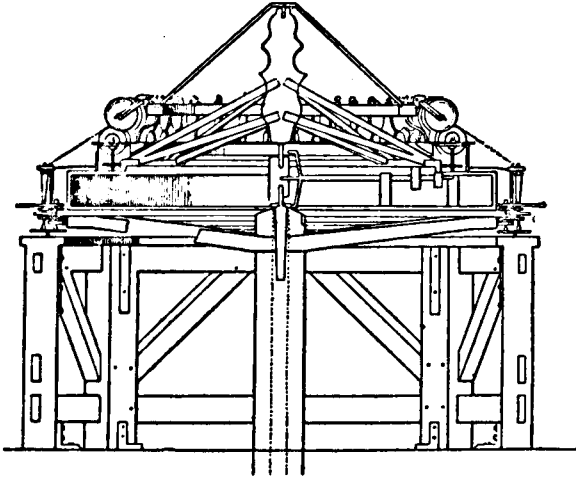

FIG. 2. PAUL'S SPINNING MACHINE, 1758

became characteristic of this general type of machine does not appear in this early form. The description of the process, as "spinning by rollers," used by Paul, is not accurate.

In Arkwright's machine there were at least two pairs of rolls revolving at different speeds so that the drawing-out of the roving was accomplished between the rolls; the partially finished yarn was thus subjected to no appreciable tension between the rolls and the flyer. Without more positive evidence we can only surmise, but it would seem likely that the commercial failure of Paul's machine was due to the excessive strain placed upon the roving by his neglect of the possibility of accomplishing the drawing-out process by means of rolls. At the same time it is no more than just to his memory to say that he conceived the general principles of spinning by machinery.

In 1741 a mill was erected at Birmingham, supplied with motive power by a winch worked by two asses. Ten girls were employed. This establishment was not supported with sufficient funds and was abandoned in 1743. A larger establishment was set up at Northampton with access to water-power. These works had two hundred and fifty spindles and employed fifty hands. They were financed by Mr. Cave, the friend of Dr. Johnson, and to the best of our knowledge these works were operated for twenty or thirty years. There are reasons to believe that Arkwright actually saw this mill at Northampton, but it is not possible to prove either the nature or the extent of Arkwright's familiarity with Paul's accomplishment.

Before Arkwright's perfection of the water-frame other inventors worked on the spinning problem. The Society of Arts offered prizes for a spinning machine, and a number of machines were submitted to its committee between 1761 and 1767. Most of these projects were of no substantial significance, but the efforts of one Highs (Hayes) were of real importance. At the trial of the patent cases in 1785 Highs declared that he made rollers for the spinning of cotton in 1767, two years before Arkwright's patent was taken out. He did not follow up his invention for want of money. It was represented only by a model which had been made for him by a clock-maker named Kay. This clock-maker called Arkwright's attention to the matter, and his knowledge of the model of Highs seems to have been the beginning of the water-frame, if not the actual basis of the design.

Arkwright had been brought up to the trade of a barber. He had little or no education, but seems to have been aggressive and alert. Discovery of a chemical process for dyeing hair led to the abandonment of the general practice of his craft for the allied occupation of wig-making. Much of his time was spent in collecting hair at county fairs. He alleges that the years following 1761 were spent in experiments with spinning machinery, but there is more reason to believe that he continued his wig-making

until 1767 when he fell in with Kay at Warrington. Kay told him of Highs's machine and agreed to make a model.

Arkwright abandoned his former business and set to work on the spinning problem, apparently as much from the point of view of a business man as an inventor. As Kay was unable to make all the parts, the services of a smith and a watch-toolmaker were secured. Arkwright went to his old home, Preston, to raise money for the undertaking. He succeeded in interesting a liquor-dealer named Smalley, and a demonstration was given in the parlor of the Free Grammar School. Smalley was much impressed, but fear of rioting induced them to move to Nottingham. Through Smalley's influence funds were obtained from local bankers, but their support was withdrawn when unexpected difficulties delayed the perfection of the machine. However, this support was not withdrawn until Arkwright and his project had been commended to the attention of Need and Strutt, machine-makers. Strutt was a mechanic, so that his study of the model resulted in a number of helpful suggestions. The machine was finished and patented in 1769.

A mill was set up at Nottingham driven by horse-power, but water-power was found to be more practicable and a larger mill was established at Cromford in 1771. Three years later, after an expenditure of £12,000, some profits began to be realized. The mill became fairly successful, but other manufacturers refused to buy yarn of Arkwright, and it proved to be necessary to find means of using the product of the mill. The partners began the manufacture of stockings and turned later to the weaving of calicoes. Their rivals complained to the excise officials on the ground that these calicoes were made in contravention of the Calico Act. A considerable stock of goods accumulated and the partners went to Parliament for relief, securing the repeal of the act despite the strong lobby run by the Lancashire manufacturers. Although Arkwright could hardly be called the inventor of the spinning machine, he must be recognized as the founder of the modern English cotton industry.

The neighboring manufacturers began to build and use the machines; all the Arkwright machines, carding, drawing, and roving machines as well as the spinning frame. **Patent suits** Arkwright finally brought nine suits, and the manufacturers formed an association to defend the cases, one of which was selected for trial. The defense of the manufacturers was that the specifications were so obscure that there was a manifest effort to withhold knowledge of the machine. Mechanics were produced who swore that the machine could not be built from the specifications in the patent. Both judge and jury agreed upon setting the patent aside (1781). The case was brought up again upon appeal. The Chief Justice of the Court of Common Pleas expressed an opinion that was favorable to the sufficiency of the specifications. The manufacturers joined again in the prosecution of the case, which was finally argued before a special jury in June, 1785. In this trial it was contended that the invention was not the work of Arkwright: that the idea was not original with him, and that the invention itself was not really his work. Failure to disclose the invention in his specifications was also alleged. It was at this trial that Higs was brought in as a witness. The manufacturers succeeded in establishing their case to the satisfaction of the jury, and the patents were thrown open.-

The use of the new machines was undoubtedly extended by this additional facility afforded to all alike. The effect of **The patents voided** the opening of the patents was relatively greater than it would be to-day in any industry because scarce any of these machines were at that time the object of special engineering designs or of particular craft skill in construction. The water-frames as then used could be built by carpenters and blacksmiths, and it was this ease of setting them up that had been a cause of Arkwright's difficulties. A manufacturer who succeeded in enticing away some one or two of Arkwright's workmen could produce machines that would be substantially the equivalent of the originals.

The water-frame was a mechanical means of doing what had long been done — spinning relatively coarse yarns for the

manufacture of calicoes. The yarn was sufficiently strong to enable the weavers to dispense with the linen warps that had been used, but on the whole the novelty of Arkwright's accomplishment lay in the application of machinery to the work that was then being done by hand. The development of the intermittent process of spinning which culminated in the invention of the mule really introduced a new product. In 1763 muslins began to be manufactured in England by Joseph Shaw of Bolton. This manufacture was wholly dependent upon importations of yarn from India, but despite this handicap the industry made some substantial progress.

There was available at this time for the purpose of spinning by the intermittent process only the small machine introduced by Hargreaves, usually known as the "jenny." It was little more than an enlargement of the conventional hand wheel, but it enabled a single workman to run a number of spindles instead of one only. The machine was in no wise automatic and involved so much attention that it was not a great extension of the power of the spinner. The accompanying cut shows the jenny in its improved form. There is a box (4-4) beneath which contains rovings: a carriage (5-5) with a movable clasp bar (16) capable of holding firmly the rovings which pass through it to the spindles (3-3). The spindles are rotated by means of the large wheel (*B-B*).

The jenny was worked by one person, who took up his position in front of the frame. The rovings were then drawn between the "clove" of clasp bars of the carriage, and attached to the spindles, the carriage having first been placed in position for commencing work that was at the end of its traverse, nearest the spindles. The bottom bar having been lowered, the carriage was drawn away from its position, until a proper quantity of rove to form one "draw," or length of yarn, had been given out, which was regulated by a mark on the side of the frame. The lower bar was then raised, the rove held, and the spindles set in motion by the spinner turning the wheel, *B*, at the same time commencing to draw the carriage further out from its position near the spindles. Thus the attenuation and twisting of the rove went on simultaneously, until the requisite degree of fineness was attained, when the outward traverse of the carriage was stopped, the spindles being kept in operation for



a short time longer, in order to impart sufficient twist to the thread. In the yarns intended for warps this was much more than for wefts, in which the same degree of strength was not required. When this twisting had been completed, the carriage was slightly backed, the guide or faller wire, 12, was gently brought down upon the threads,

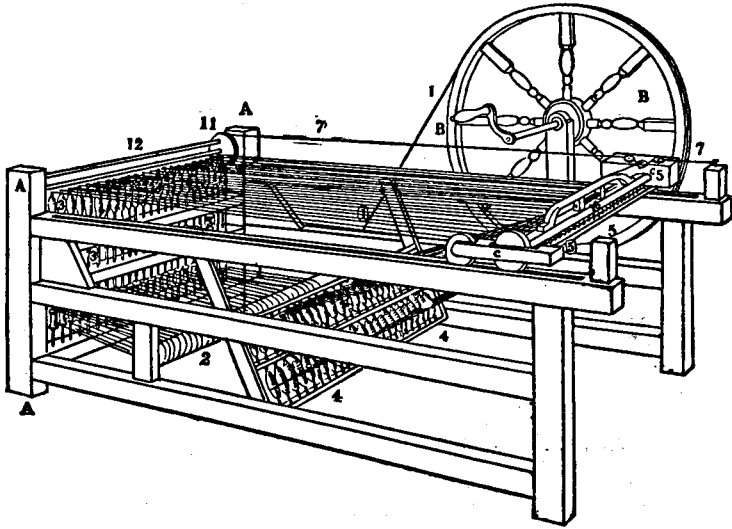

FIG. 3. IMPROVED MODEL OF HARGREAVES'S SPINNING JENNY

by means of the cord, 7, depressing them to the required level: the wheel, B, was then turned slowly round, causing the spindles to wind up the thread as the carriage returned to its first position.<sup>1</sup>

Crompton, who developed this machine into the present mule, was brought up as a jenny spinner. Work on his invention was begun about 1774 and experimentation continued for about five years. He finally produced what was at first known as the "hall-in-the-wood" machine or "muslin wheel." The name "mule" was given it later because it combined features of both the jenny and the water-frame. The mule differed from the jenny in two respects: the place of the clasp was taken by two pairs of rollers, and the spindles were placed upon the carriage. The rollers were apparently inspired by the water-frame, though

<sup>1</sup> Marsden, R.: *Cotton Spinning* (London, 1886), 205.

they served a different purpose. They were feed rollers rather than drawing rollers. The annexed cut shows a side view of the machine greatly simplified. The rovings at *A* are drawn off by the rolls and in that manner fed into the machine. If we imagine the process to begin with the carriage near the rolls at *L*, the carriage would then recede from the rolls at a rate of speed proportioned to the speed of the rolls. A certain amount of roving was thus drawn in. While the carriage is retreating

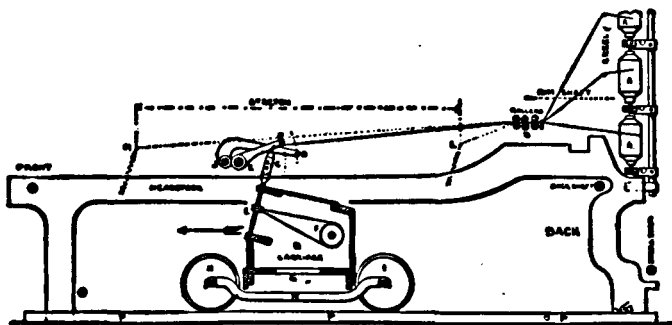

FIG. 4. CROMPTON'S MULE

from the rolls its speed is sufficiently great to subject the roving to some tension at the same time that the roving is being twisted. Shortly before the carriage reaches the limit of its run, the rollers stop so that the process of drawing out the roving is completed after the yarn has been otherwise finished. At this stage the yarn is capable of bearing considerable tension and therefore fine yarns could be produced. When the carriage reaches the full limit of its run, the spindles are given a reverse motion so that the completed yarn is reeled up as the carriage returns toward the rolls.

In the original mules these various phases of the process required the constant attention of the operative. The self-actor accomplished these operations automatically, and the delicate mechanisms required to perform them make it one of the most remarkable of all the early mechanical inventions.

Crompton's first machine was built of wood and carried

only twenty or thirty spindles, but with these machines he was able to spin yarn to the count of sixty, a degree of fineness that equaled the East Indian yarns usually imported. The product was rapidly improved and the best East Indian yarns surpassed. By 1790 Robert Owen was able to produce counts as high as two hundred and fifty and three hundred, though it was not customary then to produce such yarn for general commerce.<sup>1</sup> In 1851 samples were spun for exhibition purposes that would be graded as seven hundreds. The mule thus exceeded all possible accomplishments of the human hand. The finest products of the Indian spinners were introduced into general commerce and yarns could be produced that surpassed the utmost known to men. The mule thus achieved a distinction that is within the scope of few inventions, and it must certainly be deemed the most remarkable of the textile inventions. Its development, too, was fundamental to the establishment of all branches of the cotton manufacture in England and Europe. But for this machine Europe would have always been dependent upon India for yarn and goods, excepting only the coarse grades. The future of the cotton industry was thus profoundly influenced by this invention, though the use of the water-frame in preparing rovings makes it impossible to ascribe the great changes that took place to either invention exclusively.

Crompton received but little benefit financially from his invention. The workmen in the vicinity had long known of his experiments, and he was threatened with violence soon after the completion of his mule. He felt that there was no choice but to destroy the machine or make it public. No attempt was made to secure any patents, but the original machine was sold to a number of manufacturers to be used as a model in the building of others. They took the machine, but Crompton never received the sums of money promised by them. In 1812 the pressure of necessity moved him to apply to Parliament for a pension and on recommendation of the committee a grant of £5000 was made.

<sup>1</sup> Podmore, F.: *Life of Robert Owen*, I, 47.

The last of the textile inventions was the power loom. This was the work of a clergyman whose attention was called to the problem in an entirely casual manner by a manufacturer. A friend engaged in the industry happened to remark to Cartwright upon the disproportion that had come about between weaving and spinning by reason of the spinning inventions. The influence of the remark is described by Cartwright as follows:

It struck me that as plain weaving can only be three movements which were to follow one another in succession, there would be little difficulty in producing them and repeating them. Full of these ideas I immediately employed a carpenter and a smith to carry them into effect. As soon as the machine was finished, I got a weaver to put in a warp which was of such material as sail cloths are usually made of. To my great delight, a piece of cloth, such as it was, was the product. The reed fell with the weight of at least half a hundred weight and the springs which threw the shuttle were strong enough to have thrown a Congreave rocket. In short, it required the strength of two powerful men to work the machine at a slow rate and only then a short time. I then secured what I thought was a most valuable property by a patent on April 4, 1785. This being done, I condescended to see how other people wove, and you will guess my astonishment when I compared their easy modes of operation with mine. It was not until 1787 that I completed my invention and took out my first weaving patent.

An attempt was made to set up a factory with power looms at Doncaster, but the concern was not successful. In 1790 a Manchester firm with a license from Cartwright set up a weaving factory and spent much money in attempting to improve the power loom. They met with little success and the undertaking was finally abandoned after the destruction of the first mill by a fire.

The chief defect of the early loom was the absence of any mechanical contrivance to dress the warp as it unrolled from the beam. The difficulty was overcome in part by dressing the warp before it was wound on the beam at all; a loom with such an attachment was brought out by the firm of Radcliffe and Ross. The invention was really the work of an employee, William Johnson, a dissipated weaver of volatile temperament, brilliant in conception, but

lacking in the concentration required to give effect to his ideas. Radcliffe was very anxious to develop weaving to check the exportation of cotton yarn which was beginning to be considerable. His experiments began in January, 1802, and the machine was patented in 1803-04. Three patents were taken out by Horrocks in the years 1803, 1805, and 1813. His loom was compact and strong; it was finally made an efficient machine and became ultimately the basis of the modern power loom. Horrocks himself, however, failed and sank into poverty. The idea was developed by Sharp and Roberts, machine-builders, who placed a much-improved model of the Horrocks loom on the market in 1822. This machine was a commercial success; the first loom really capable of competing with the hand industry. The significance of the invention is shown by the immediate increase in the number of power looms in use.

## NUMBERS OF POWER LOOMS

	1813	1820	1829	1833
England.....	2,400	12,150	45,500	85,000
Scotland.....	?	2,000	10,000	15,000

It will be observed that no considerable use was made of the power loom before 1820, and that the use of the loom developed rather rapidly in the decade following the introduction of the Sharp and Roberts loom of 1822. The power loom, however, did not attain even approximately its modern form until 1841. Kenworthy and Bullough of Blackburn then brought out their improved loom equipped with self-acting temple, stop, and taking up motion. The labor of weaving was reduced by nearly one half and a greater quantity of high grade cloth was produced.

## II

The relation of the development of machinery to the growth of the industry is most clearly shown by the statistics that are available, despite their many deficiencies. The incompleteness and uncertainty of much of this information makes it impossible to reach certain conclusions with refer-

ence to many matters of detail, but the larger facts in the expansion of the industry appear in such striking fashion as to admit of little reasonable doubt.

The older writers were inclined to date the expansion of the industry from the period of the great inventions, representing this expansion as a result of the development of mechanical processes. Presumptions against such a view are suggested by the history of the development of the trade in cotton goods, but without some means of determining the quantitative changes and the rates of expansion at different periods, these presumptions could scarcely suffice to establish the larger outlines of the history of the industry. Graphs I and II present the rates of expansion in the industry, as measured by the consumption of raw cotton and the value of merchandise exported. The supply of raw materials is imported so that the figures for the quantities imported afford a fairly accurate idea of the quantitative expansion of the entire industry. The figures for the values of goods exported are obviously subject to elements of error that do not exist in statistics of the weight of imports, but the importance of the export trade in finished goods makes such figures an interesting supplement to the other series.

The graphs have been plotted upon a logarithmic scale in the vertical dimension in order to represent the rates of expansion as distinct from the absolute quantitative increase. The more usual arithmetic scale is sufficiently representative when the absolute quantities compared do not vary greatly, but no helpful comparisons can be made by such a scale when the differences between the largest numbers and the smallest numbers are as great as in these series of figures. The exports of manufactures increased one thousand-fold between 1710 and 1800: under such conditions an increase in the early years of the century that would represent a doubling of exports could scarce be perceived if compared with the large volume of exportation at the close of the period. For the purposes of studying the chronology of the industry, the rates of

growth are more important than changes in the absolute volume of production or exportation.

Graph I indicates that the expansion of the industry began about 1740. Machines were not significantly applied to the industry until the decade of the

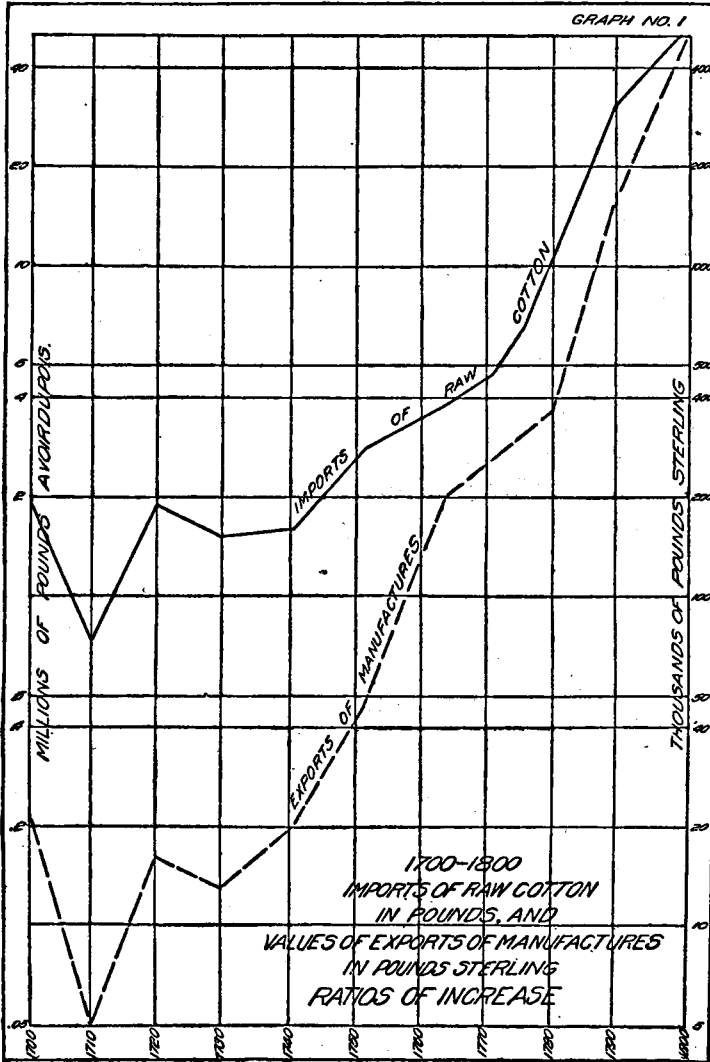

seventies, but the industry had already by that time undergone a great expansion. The rate of growth between 1740 and 1770 was greater in the export trade, than in the industry as a whole: imports of raw cotton trebled, exports increased tenfold. These rates of expansion were somewhat less considerable than in the next three decades, but the difference is not as great as might be supposed. We tend to compare absolute volumes as distinct from rates of change.

We may therefore say with some confidence that the inventions were a result of expansion in the industry as well as a cause of further growth. They were a response to a definite and consciously felt opportunity.

Graph II is interesting in connection with the discussions as to the proper termination of what we may call the "period" of the Industrial Revolution. Unless <sup>Graph II</sup> the term is used in the very narrow sense of the period of the Great Inventions, there is no justification in

## I. FIGURES FOR GRAPHS I AND II

## IMPORTS OF RAW COTTON AND EXPORTS OF MANUFACTURES\*

	<i>Cotton imported</i> (millions of pounds)	<i>Exports of manufactures</i> (thousands of pounds sterling)
1701 .....	1.9	23
1710 .....	.7	5
1720 .....	1.9	16
1730 .....	1.5	13
1741 .....	1.6	20
1751 .....	2.9	45
1764 .....	3.8	200
1766 .....	..	220
1771 (average 5 years).....	4.7	..
1776 (average 5 years).....	6.7	..
1780 .....	..	355
1785 .....	18.4	..
1787 .....	..	1,101
1790 .....	31.4	1,662
1800 .....	56.0	5,406
1811 .....	91.6	..
1821 .....	129.0	16,000
1831 .....	280.5	17,200
1841 .....	489.9	23,400
1851 .....	760.1	30,000
1861 .....	1,261.4	46,800
1862 .....	533.1	36,700
1871 .....	1,676.1	72,800
1881 .....	1,676.1	79,000
1884 .....	1,791.6	72,700

\* Baines: *History of the Cotton Manufacture*, 108, and Ellison, T.: *Cotton Trade of Great Britain*, Appendix, Tables 1 and 2.



relatively early dates that have frequently been suggested. It would seem that there would be some purpose in conceiv-

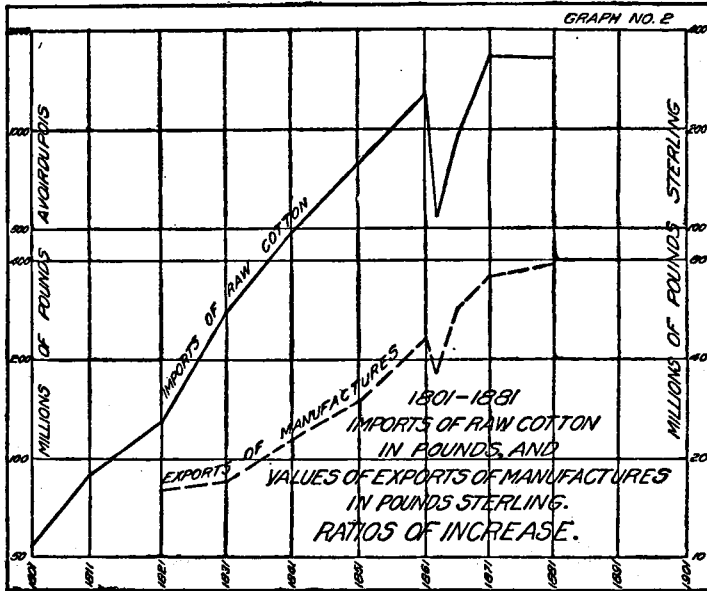

ing the period of the movement as the entire interval between the old order and the establishment of a fairly stable relationship of the different aspects of industry under the new order. We are here concerned with the textile trades alone, but it is perfectly evident that the cotton industry was expanding at substantially the same rate as in the preceding decades until 1871. Since that time the more important changes have taken place in the metal trades, but it must be evident that there can be no question of any stability in the textile trades until the last decades of the century.

The expansion of the cotton trade during the greater part of the nineteenth century was due jointly to the continued improvement of the fundamental machines and to the displacement of the other textiles. The changes in the costs of spinning are presented in subsequent graphs, but unfortunately it is not possible to make any

simple statement with reference to the costs of weaving. The elements of the comparison are too complex because the goods are not so completely standardized. The changes in the relative position of the various textile industries are indicated by Graphs III and IV. In Graph III the rates of growth of the industries are shown in so far as the changes can be expressed by the values of goods consumed at home or exported. This also is a ratio chart drawn to a logarithmic scale, so that the comparison should be made primarily

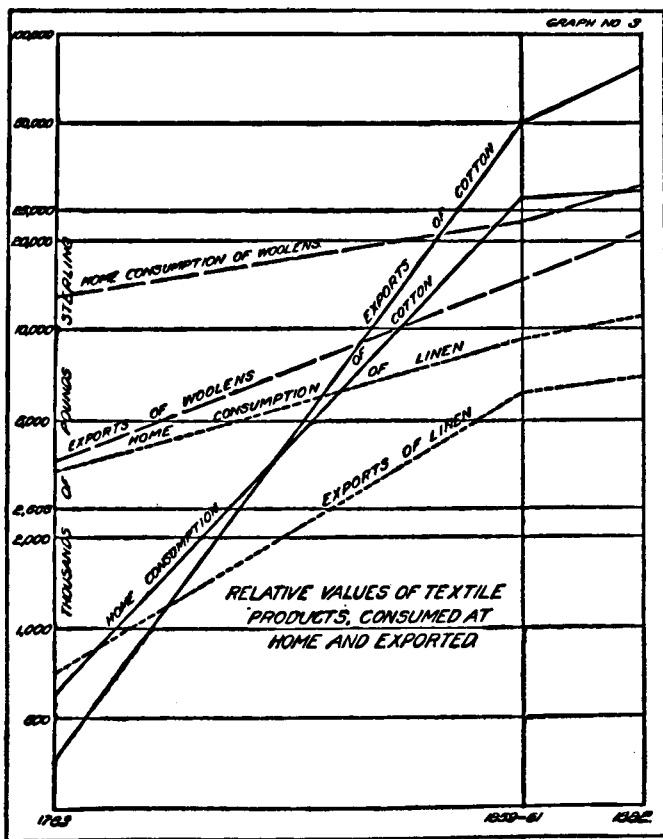

## II. FIGURES FOR GRAPH III

## RELATIVE POSITION OF THE BRITISH TEXTILE INDUSTRIES \*

	<i>Values in thousands of pounds sterling</i>		
		<i>Exports</i>	<i>Home consumption</i>
1783 .....	Woolen	3,700	13,100
	Cotton	360	600
	Linen	700	3,300
1859-61.....	Woolen	15,041	24,959
	Cotton	49,000	28,000
	Linen	6,119	9,381
1882 .....	Woolen	21,377	31,623
	Cotton	76,000	30,000
	Linen	6,907	11,093

\* Ellison, T.: *Cotton Trade of Great Britain*, 118, 124 ff.

between the degrees of inclination of the various lines. It is unfortunate that no figures were available for the long period between 1783 and 1859, and especially so in view of the fact that this period was the time of greatest change in the relative position of the industries.

The cotton industry displays a rapid expansion; the linen industry shows some growth especially in the export trade; but the woolen industry makes no notable expansion except in the export trade. These rates of growth may be correlated with the growth of population. When the population of a country is increasing as rapidly as that of England in the early nineteenth century some growth of essential industries is to be expected. The very slow growth of the woolen industry therefore indicates a condition that must have been disheartening to the woolen manufacturers. The change is perhaps concealed in part by changes in the character of the goods. It became necessary to abandon the manufacture of the most expensive wools and to give more attention to cheaper grades. The actual quantities of goods produced probably increased more rapidly than the values. However, it is not possible to evade the general conclusion that the cotton industry rose rapidly to a position of preëminence among the textile trades.

This appears in a different group of figures in Graph IV, a comparison of the relative amounts of raw material used, pound for pound. The comparison seems rather crude, but it avoids certain elements of error involved in figures of

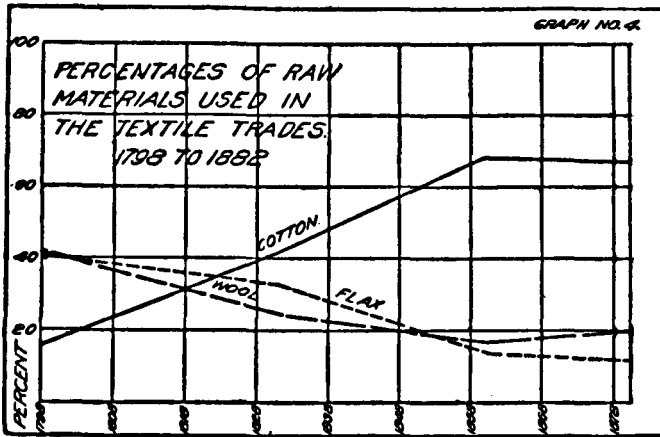

III. FIGURES FOR GRAPH IV

PROPORTIONS OF NEW MATERIALS CONSUMED BY THE VARIOUS TEXTILE INDUSTRIES \*

	Cotton	Wool	Flax	Total
1798-1800.....	16.08	42.15	41.77	100
1829-31.....	41.47	25.48	33.05	100
1859-61.....	68.40	17.42	14.18	100
1880-82.....	66.35	20.90	12.75	100

\* Ellison, T.: *Cotton Trade of Great Britain*, 120.

values. The figures have been reduced to percentages. It may be observed further that there are figures available for the years 1829-31, so that the material is in that respect more satisfactory than the material embodied in the preceding graph. The inclusion of these additional figures in the series, however, does not change the general aspect of the lines. The growth of the cotton industry proceeded without

interruption or much change in rate, from the close of the eighteenth century to the mid-nineteenth. It became more definitely dominant than any of the industries had been in the earlier period. The position of flax and wool here indicates that the change in the basis of comparison results in slight differences. They seem to be nearly coördinate in importance in 1798, though in the preceding graph the woolen industry was palpably the more important.

Graphs V and VI show the changes in the prices of raw cotton and of the two grades of yarn that became characteristic of the new industry. The arithmetic scale has been used in these graphs as absolute comparisons are essential. These figures are somewhat conjectural, being computations by Ellison from the best data available for the years mentioned.

## IV. FIGURES FOR GRAPHS V AND VI

## PRICES AND COSTS IN MAKING NUMBER 40 YARN

	Selling price		Cost of cotton		Labor and capital	
	shillings	pence	shillings	pence	shillings	pence
1779.....	16	0	2	0	14	0
1784.....	10	11	2	0	8	11
1799.....	7	6	3	4	4	2
1812.....	2	6	1	6	1	0
1830.....	1	2½	0	7½	0	6½
1860.....	0	11½	0	6½	0	4½
1882.....	0	10½	0	7½	0	3½

## PRICES AND COSTS IN MAKING NUMBER 100 YARN\*

	Selling price		Cost of cotton		Labor and capital	
	shillings	pence	shillings	pence	shillings	pence
1779.....	38	0	4	0	34	0
1784.....	19	0	3	6	15	6
1799.....	7	2	3	0	4	2
1812.....	5	2	2	4	2	10
1830.....	3	4½	1	1½	2	2½
1860.....	2	4	0	11	1	5
1882.....	1	10	0	9½	1	0½

\* Ellison, T.: *Cotton Trade of Great Britain*, 61.

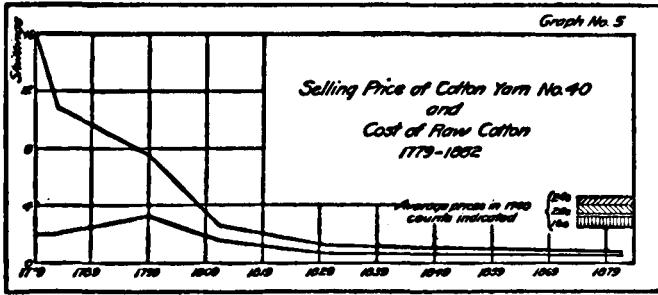

The high cost of cotton in 1799 in the figures for Number 40 yarn does not seem wholly consistent with the figures given in the other table. The prices quoted for 1799 in the former instance are presumed to reflect war conditions, but it is not

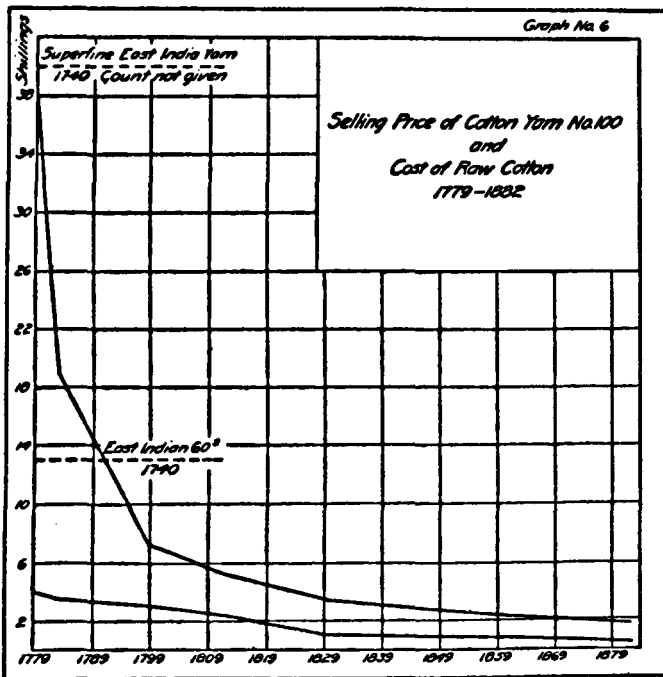

very plausible to suppose higher costs for the coarse than for the fine yarns. For that year Number 40 is quoted higher than Number 100. With reference to the dating of

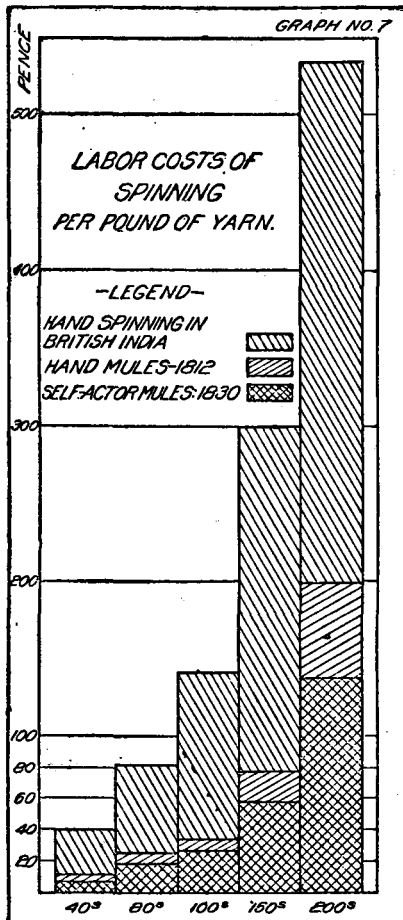

the changes in the industry these details of costs are not as significant as the relation of the prices of these counts of yarn to the prices of the counts used before the introduction of machines.

The prices of grades of yarn that were used in the earlier period, for the purposes that were substantially the same as those to which these counts were applied, are noted on the graphs. Neither forties nor one hundreds were commonly used prior to the introduction of machinery. Twenty-fours, twenties, and sixteens are mentioned in connections which seem to suggest that they occupied the place in the trade that later came to be dominated by the

forties, but weft spun at Manchester about 1760 was graded between fives and sixteens. The first effect of the introduction of machinery, therefore, was not so much to reduce the costs of the ultimate products as to improve the character of the goods. The displacement came earlier in the fine

## V. FIGURES FOR GRAPH VII

COSTS OF LABOR PER POUND OF YARN. HAND MULES, 1812; SELF-ACTORS, 1830; AND HAND SPINNERS IN INDIA\*

Counts of yarn	1812 (pence)	1830 (pence)	India (pence)
40.....	12	7½	40
80.....	26	19½	82½
100.....	34	26½	143
150.....	78	59	300
200.....	200	138	535

\* Schultze-Gaevernitz: *The Cotton Trade in Great Britain*, 43.

yarn trade, if we may trust the figures presented, and there would seem to be no grounds for doubting this conclusion. It is wholly consistent with the general characteristics of the product of the mule. The greatest changes in the prices of the high counts took place before 1800, whereas the greatest changes in the prices of the lower counts took place between 1800 and 1829. The influence of the inventions upon the prices of the product was thus much less sudden than is frequently supposed.

The absolute differences in the costs of production are also shown by Graph VII. It will be observed that the introduction of the self-actor mule did not result in any startling reductions in the costs of produc- <sup>Costs in Eng-</sup>land and India ing the lower counts, although large economies were realized in the production of one hundred and fifties and two hundreds. The more interesting comparison lies between the costs in India and in England. The mule could produce one hundreds cheaper than the Indian hand-spinners produced forties; one hundred and fifties, cheaper than the hand-spinners could spin eighties; two hundreds, cheaper than the Indians could produce one hundreds. Furthermore, the costs of producing the higher counts by hand will be seen to be substantially prohibitive. It is thus the distinction of the new cotton industry that it brought to the masses of the people better goods than even the rich had been able to afford in the earlier period.



## CHAPTER XIII

### THE REORGANIZATION OF THE METAL TRADES

#### I. A NEW FUEL AND A NEW FURNACE

THE development of the iron and steel industries in England is usually associated with the change from charcoal fuel to coal and coal products. In some of the industrial histories the change of fuel is alleged to be the primary change. This is a serious misconception. The fuel was, indeed, changed, but the change in the fuel was only a part of a general transformation of the technique of ore reduction and of methods of preparing the various classes of iron products. The changes in technique embraced a comprehensive transformation of nearly all the mechanical and metallurgical aspects of these processes. It is fairly certain that the attempt to use coal products as fuel was the stimulus to many of the changes, but it was not the sole stimulus, and the transformation is very inadequately described in terms of the change in fuel.

In the broadest sense the transformation of the industry was a substitution of indirect processes for direct processes. There was an increased specialization which carried with it important technical advantages. The introduction of coke as the primary fuel was an essential feature of the change, but great mechanical improvements were no less necessary. The direct process gets its name from the production of malleable iron as an immediate result of the process of smelting. Malleable or wrought iron is iron that is nearly, if not entirely, pure. It is free from carbon and from other substances that might impair the toughness which is the distinctive feature of this product. When iron is combined with a high percentage of carbon it is known as cast iron. It is said to be impossible for iron to contain much more than five or six per cent of carbon, but

more than two per cent is sufficient to make iron brittle and undesirable for purposes requiring great tensile strength.

Steel is a combination of iron with relatively moderate percentages of carbon. There is, therefore, a wide range in the qualities and properties of steel, because minute variations in the proportion of carbon occasion great transformations in the physical properties of <sup>Steel</sup> the metal. Some types of iron begin to exhibit characteristics of steel when the carbon content rises above 0.3 per cent, but most types of iron fail to exhibit these properties until there is at least 0.6 per cent carbon: the types of steel most frequently used contain between 1.0 and 1.5 per cent carbon. Two per cent of carbon seems to be the limit between steel and cast iron. In the modern industry the varieties of steel have been increased by the addition of minute proportions of the rarer metals, titanium, vanadium, and the like. The difficulty of producing steel lies in the control of the carbon content, and, though steel was undoubtedly known as early as any of the iron products, it is only within the last centuries that the deliberate production of steel was at all successful.

The indirect process is so called because the product of smelting is cast iron. This cast iron is ill suited for many uses. Medieval cannon, various kinds of ornamental work, and much kitchen-ware came to <sup>The indirect process</sup> be made of cast iron at an early date, but the uses of cast iron are strictly limited. It is necessary to subject cast iron to further processes to eliminate the carbon and silica and convert the preliminary product into wrought iron or steel. Processes of smelting which result in the production of cast iron are termed indirect processes, because the production of cast iron is not the ultimate purpose.

The primitive iron industry and the iron industries of western Europe down to the period of the Industrial Revolution generally utilized direct processes, and <sup>The direct process</sup> even when the ironmasters of Europe began to get cast iron in their furnaces, it was produced for specific purposes and was not as a rule the basis for subsidiary refin-

ing processes. One may say, therefore, with little exaggeration that the indirect processes were not used prior to the Industrial Revolution. This long predominance of the direct process is to be attributed to the small size of the furnaces used in early times and above all to the limited possibilities of producing an artificial blast. These furnaces were wasteful because the relatively low temperatures obtainable were not sufficient to separate all the metallic iron from the ore. It was because of these low temperatures, too, that the product of these furnaces was characteristically extracted in a solid mass: red hot but not a liquid. Any furnace will produce cast iron when the temperature obtained is sufficiently high to melt the iron. Cast iron is therefore drawn off as a liquid; run into beds of sand to form the "pigs" of commerce.

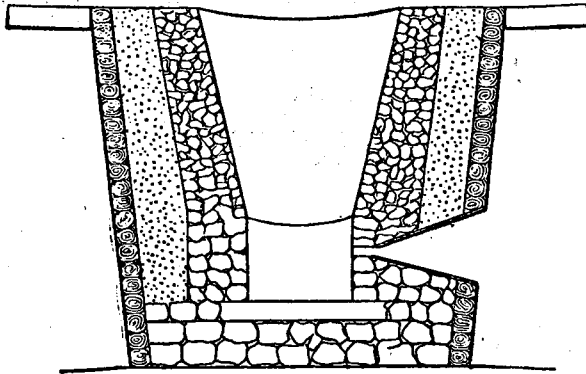

FIG. 5. OSMUND FURNACE. VERTICAL SECTION THROUGH THE TWYER. (From Swedenborg's plate)

This furnace was ordinarily about 12 feet high. The lump of iron produced in smelting was withdrawn through an opening at one side (not shown in the cut) which was filled with loose stones during the firing. Not more than 1.5 tons of iron could be made weekly, and in working up the "osmund" or "bloom" there was a loss of from 33 to 50 per cent.

The irregular shaped mass, or bloom, extracted from early furnaces was seldom homogeneous. It was likely to consist of a shell of steel and a core of pure malleable iron. The selection of steel for tools and cutlery was therefore a task requiring nice discretion, and the careful testing of swords

and other such apparatus was a particularly wise bit of caution on the part of any buyer. The defects of early steel products were due to the uncertainties of producing steel. It was not possible to produce any particular grade at will nor was it possible to produce any considerable mass of even quality. The steel industry of the middle ages was wholly empirical. All these uncertainties were overcome when production became indirect. Economies were also realized, as a result of the larger size of the furnaces.

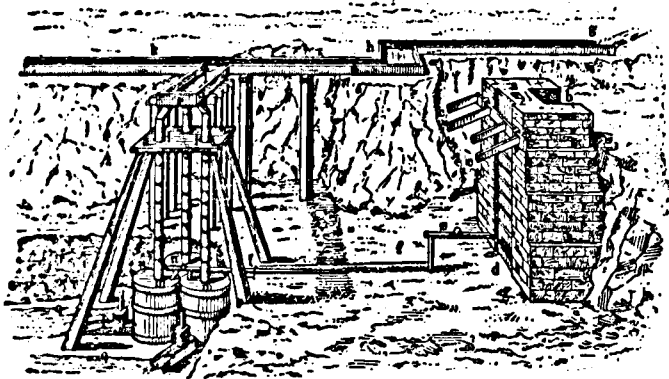

FIG. 6. FURNACE WITH WATER-BLOWING APPARATUS  
(Dauphiné, eighteenth century)

The construction of the furnace differs in some particulars from that of the more famous Catalan furnace, but the mechanism for blowing is based upon the Catalan principle.

The low open-hearth furnace maintained itself in Sweden for a long time, and the annexed cut of the Swedish furnace is fairly typical of the highest development of this most primitive type. In Catalonia special kinds of blowing apparatus were developed which made it possible to achieve higher temperatures despite the small open hearth, so that the effect of the furnace became significantly different. Small quantities of steel could be produced.

The small water-powers that were available in Spain led to the perfection of a blast created by a small stream of water falling intermittently down a pipe. (See Fig. 7.) There is

a series of holes near the top of the pipe; the flow of water being checked, air flows in which is carried down by the water that is immediately admitted. The excess water

flows off from the bottom of the lower tank and the air in the enclosed space above is driven with some considerable force through the vent, or tuyère, which leads to the furnace. This was probably the best device for creating a blast known to the middle ages, and the superiority of the Spanish steel products was largely due to the temperatures obtainable in this water-blown furnace.

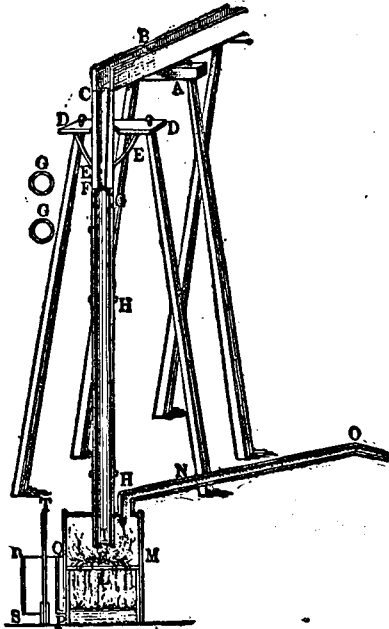

FIG. 7. DETAIL OF WATER-BLOWING APPARATUS (*Dauphiné*)

The pipe *HH* is 27 feet high and 1 foot 4 inches in diameter. The reservoir *M* is 6 feet high and 6 feet in diameter. Outflow of superfluous water is provided for by the chamber *QRS*, and the blast is carried to the furnace by the tuyère *NO*.

The first great improvements in smelting furnaces were made in Germany. The height of the furnace was increased and the shape altered. The opening at the top was made narrow and the

greatest diameter of the furnace placed about halfway between the top and the bottom. The furnace was fed from the top so that the metal was kept in contact with the fuel for a longer time. The increased height tended to increase the draft, and the greater capacity of the furnace made it easier to achieve high temperatures. This form, known in England as the bloomery or high bloomery furnace, produced either cast iron or wrought iron, according to the details of the firing. Apparently, however, cast iron was not produced

unless it was intended to be used without refining. The German ironmasters were on the verge of introducing the indirect process, but did not actually abandon the direct process when wrought iron was desired.

As long as charcoal was used as fuel

Effect of using coke  
 this double use of the high bloomery furnace was wholly feasible. The attempt to use coal, or rather coke, for fuel made it increasingly difficult to avoid getting cast iron as the product. The change in fuel, therefore, exerted a notable pressure toward the introduction of the systematic use of the indirect processes and thus the development of the indirect methods was substantially an English achievement. The scarcity

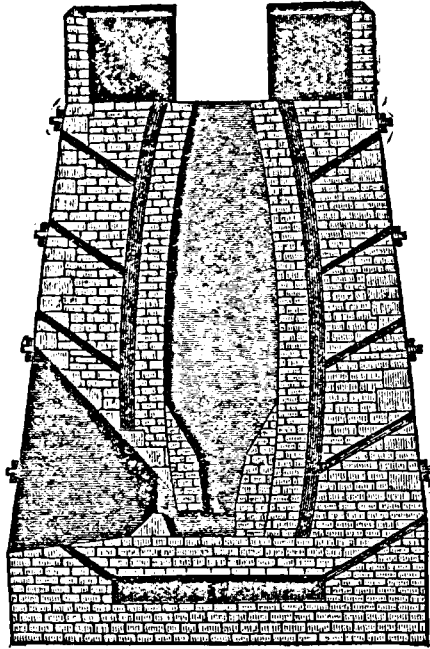

FIG. 8. A NORWEGIAN BLOOMERY FURNACE  
 (Eighteenth century)

Total height of furnace, 30 feet. The product averaged 19 to 20 tons weekly, but only two thirds of this amount was recoverable as malleable iron.

of timber for the preparation of charcoal became a serious problem by the sixteenth century. There were a number of statutes prohibiting further cutting of timber for use in iron furnaces and some statutes prohibiting the establishment of smelting works. Despite these measures the iron industry continued to expand throughout the early part of the seventeenth century, but a decline set in at that time which continued until 1740 when the introduction of coke as fuel

arrested the decline. The transformation of the industry was thus a necessity which became increasingly imperious.

The earliest developments were the results of Dudley's experiments in the seventeenth century. His first trials

**Dudley's experiments** were made in 1619 when he took control of his father's foundry after graduating from Oxford.

Wood was scarce, and there was plenty of coal. The foundry was located on a coal-field, the coal and iron being bedded together so that it had been necessary in the past to produce a certain amount of coal in getting out the iron ore. With the second blast he produced iron at the unsatisfactory rate of three tons a week. He wrote at once to his father, directing him to secure a patent, and the first patent was issued in 1622. In the following year floods ruined the works, to the joy of the neighboring ironmasters whose works had escaped. Dudley's neighbors claimed that his iron was of inferior grade and the matter was brought before the King and Parliament. A test was instituted and, though Dudley succeeded, the following Parliament abolished all his patents. They were subsequently renewed, but the charcoal ironmasters drove him out of Worcester County. He moved to Himley in Staffordshire and made pig iron there, but had no means of converting it into wrought iron and was obliged to sell it to the charcoal ironmasters. Another furnace was set up by him at Hascobridge. His bellows were larger and he produced seven tons per week. A riot was finally organized, his apparatus was destroyed, and he was forced to desist. In 1660 Dudley petitioned for a new patent, but even then he was unable to rival the charcoal furnace in output. The details of his process are not accurately known. We do not know in what form he used coal, whether raw or as coke; and we do not know the character of his blowing apparatus. There is reason to doubt the commercial success of his undertaking even at his period of greatest prosperity. After his death nothing further was done for a considerable period. It seems likely that coke-making became more common and that its applications were better known, but it was not applied directly to smelting.

The development of this new process as a commercial undertaking was largely the work of the Darbys, of whom there were three generations. At their works <sup>The Darbys</sup> at Coalbrookdale were initiated the fundamental features of the modern iron industry. The first Abraham Darby proposed to undertake the making of kitchen-ware. As the processes then known in England were ill-adapted to the purpose, he made a trip to Holland in 1706 where he mastered the process of making castings in sand. Upon his return in 1708, he took out a patent, but his partners refused to embark more capital in the business and he was obliged to set up independent works at Coalbrookdale in Shropshire. He began to use charcoal for fuel, but the scarcity of wood forced him to experiment with coke. Apparently the coke was used only for roasting the ore preparatory to smelting. It was difficult to produce a strong enough blast to get the necessary heat from coke and some of the ore was left unmelted.

Abraham Darby, the second, assumed control of the works about 1730, and, as the supplies of charcoal were fast failing, he determined to apply coke to the entire process. His experiments took place some time <sup>Success with coke</sup> between 1730 and 1735, and a moderate degree of success was obtained. The blast apparatus was apparently not significantly changed. It was produced by a pair of bellows coupled and worked by a water wheel. He got additional power through the use of an old Newcomen engine to pump the water from a lower to the higher level. He then leased additional properties and erected seven furnaces with five fire engines to run water wheels. In 1754 the first of these new furnaces was blown in, and in December, 1756, the work of the furnace was declared to be "at the top pinnacle of prosperity, twenty to twenty-two tons a week, and sold off as soon as made at profit enough." These experiments of Abraham Darby, however, were a beginning of many things rather than the end of a transformation.

The furnace was a commercial success, but left much to be desired in its mechanical aspects. The leather bellows



which had been more or less efficient when charcoal was used were barely adequate at the best under the new conditions, and tantalizingly imperfect. There was an obvious need of better blowing machinery and significant improvement was possible only under a new principle. The main problem, however, centered around the conversion of pig

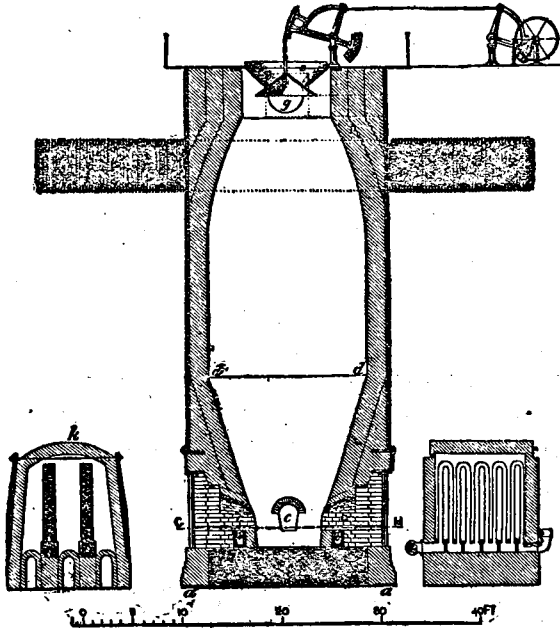

FIG. 9. BLAST FURNACE (*Ebbw Vale, Monmouthshire, 1850-60*)

Vertical section, with sections of stoves for heating the blast. Height of furnace, 53 feet. The product of a blast furnace varies according to the size, shape, and details of management. Percy gives records of a furnace (about 1860) that produced at times 150 tons of gray iron weekly, averaging 135 tons; but these figures seem to be higher than the average for that time.

iron into wrought iron; there was some knowledge of the methods of refining, but there were no processes that could be applied on a large scale.

The blowing apparatus was perfected by John Smeaton in 1760. His work was done largely at the Carron Works in Scotland. These were the first works in Scotland to use coke as fuel, but their success

was moderate and the proprietors were becoming discouraged. They were on the point of returning to charcoal when Smeaton completed his compressed air pump. The first pump consisted of four iron cylinders, four feet six inches in diameter, fitted with pistons having a stroke of about four feet six inches. The machine was driven by water-power and produced an almost constant blast with a pressure of two to three atmospheres. The furnace which had formerly yielded ten to twelve tons now produced forty.

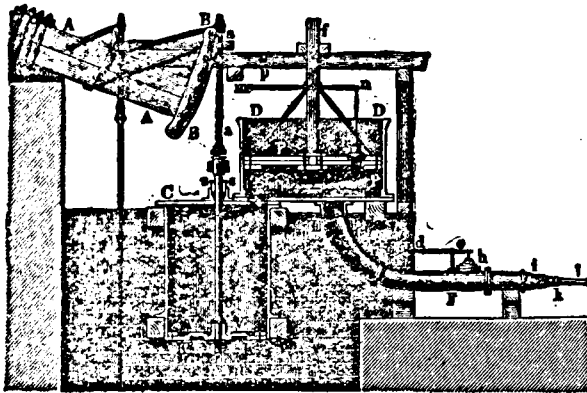

FIG. 10. DEVELOPED CYLINDRICAL BLOWING ENGINE

This new principle in blowing was rapidly extended throughout the iron industry. Steam engines were applied in a number of cases to driving the pump though water-power was most advantageous.

The perfection of the steam engine was inspired in part by these new demands upon it, and in part by the increased development of pumps generally. The Newcomen engine was used increasingly in the iron industry, but in most cases it was not possible to apply the engine directly to the air pumps. The engine was used to pump water to drive wheels that worked the blowing cylinders.

## II. JAMES WATT AND THE STEAM ENGINE

The story of Watt's engine is not directly a part of the history of the iron industry, but the invention is more closely related to this mechanical development in the iron trade than it is to any other single episode. Watt's engine was definitely the outcome of an attempt to improve the Newcomen's engine Newcomen engine, and the essential principles of his invention are most readily understood when approached from that point of view. The Newcomen engine was first patented in 1705. It was, properly speaking, an atmospheric engine rather than a steam engine. The motive power really came from the difference between the pressure of the air on the upper side of the piston and the partial vacuum produced in the cylinder by the condensation of the steam. Steam was therefore an incidental mechanism, a means of producing a rather incomplete vacuum. The engine worked at very low pressure. The pistons were large. In the later period they sometimes reached six feet in diameter, and they were usually four or five feet in diameter. Newcomen's first engine made six or eight strokes per minute, and his later improved model as many as ten or twelve. The engine was considerably modified after the first patents, but by 1718 had acquired a standard form which it held for many years. The engines were badly proportioned, however, and were frequently unsafe. Smeaton revised many details, improved their proportions, and increased their efficiency very notably.

Watt was brought up as a tool-maker: in the phraseology of the time a "mathematical instrument-maker," in our own terminology a maker of scientific apparatus for astronomical and physical experiments. He set up Watt's studies his shop within the university precincts at Glasgow and found much of his trade in repairing apparatus for the college laboratories. His attention was directed to the steam engine as early as 1759 by a student in the university, Robinson. He had made some study of chemistry and became interested in the problems of heat. His work with

Dr. Black led to the discovery of latent heat, and these interests determined the character of his approach to the problem of the steam engine.

Setting to work in 1763 to repair a model of Newcomen's engine belonging to the college, he made a systematic study of its problems. After experiments he came to the conclusion that about three fourths of the heat supplied to the engine was wasted. This appalling waste was due to the alternate heating and cooling of the cylinder.

The essential idea of his invention was a simple reaction from this realization of the wastefulness of Newcomen's engine. He says (1765): "I had gone to take <sup>conception of</sup> a walk on a fine Sabbath afternoon. I had <sup>the engine</sup> entered the Green and passed the old washing house. I was thinking of the engine at the time. I had gone as far as the herd's house when the idea came into my mind that as steam was an elastic body it would rush into a vacuum, and if a connection were made between the cylinder and an exhausting vessel it would rush into it and might there be condensed without cooling the cylinder."<sup>1</sup> This notion of a separate condensing chamber was the germ of an entirely different machine. The initial proposal was merely to save wasting heat by alternately heating and cooling the cylinder. The ultimate result was to apply steam alternately to the different sides of the piston head thus converting the old atmospheric engine into a genuine steam engine. The live steam acting on the piston head would usually be at a pressure of several atmospheres and the partial vacuum on the other side of the piston head was, if anything, more complete than in the Newcomen engine, so that Watt's engine was immensely more powerful as well as being more economical in heat and fuel.

The valve structure of Watt's original machine seems crude and imperfect to us to-day, but we can easily fail to understand the brilliance of Watt's conception and above all is it easy to lose sight of the extraordinary advance mechanically. The best indication of the quality of Watt's

<sup>1</sup> Thurston, R. H.: *History of the Growth of the Steam Engine*, 87.

work is the comment made by Smeaton when he first saw the engine at work. "It is," he said, "a very remarkable invention, but notwithstanding its excellence it can never be brought into general use because of the difficulty of getting its parts manufactured with sufficient precision."<sup>1</sup> The truth of this comment was painfully borne out by Watt's subsequent experience. In letters written during the work on the engine, Watt writes:

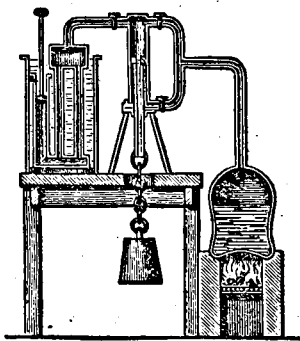

FIG. 11. APPARATUS USED BY WATT IN EXPERIMENTS TO DEMONSTRATE THE ADVANTAGES OF A SEPARATE CONDENSING CHAMBER

"You ask what is the principal hindrance in creating engines? It is always the smith work." Some of the first cylinders cast for him were one eighth of an inch wider at one end than at the other, and in one cylinder of eighteen inches diameter there was an error of three eighths of an inch.

The description of the trials adds some significant details. In connection with the first trials, Watt writes to Dr. Small, September 20, 1769:

The trial has not been decisive, but I am still allowed to flatter myself with hopes. . . . The adjusting and fitting all the parts together took longer time than we thought of, but after much close labor we got it brought to trial about a fortnight ago. After the air was pumped out, the piston of the cylinder descended about two feet and stopped there, being unwilling to go any further. Steam was admitted and it descended. On the second trial, it came down only a few inches. I thought the bucket of the pump was in fault. The water being let off, and the bucket drawn the leather was then found to be flyped, that is, turned up at the edge. On examining the piston of the cylinder, the pasteboard used for leather there was torn. It was conjectured that the jacket hole might not be in the center of the cylinder, and that we endeavored to rectify, three ply of pasteboard was put on the piston instead of one. A double leather was put on the bucket and we again

<sup>1</sup> Smiles, S.: *Industrial Biography*, 180. The original reference is in indirect discourse.

set to work. . . . After some strokes the piston failed and oil came through the condenser. The piston being drawn, cork was put on in the same manner as the pasteboard. The oil pump was examined and the passage through which it should discharge its oil found too small. . . . On putting in the cork the piston in descending did not apply itself to the cylinder in one place on one side. On examination the cylinder was found to be oval in that place either from some inaccuracy in making or from some injury in setting it up. . . . The leather of the bucket was lengthened. The piston was changed for two-ply of pasteboard sewed together. The pump then threw good water. The engine went as well as ever, but always waited a little at the top.<sup>1</sup>

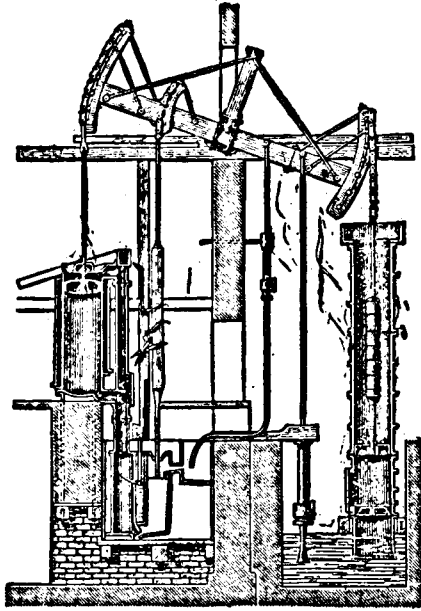

FIG. 12. SECTION OF AN ENGINE SET UP BY WATT AT CHACEWATER IN CORNWALL, 1777  
 Embodying various improvements over the first model of the engine.

The difficulties in building the machine led to the partnership with Boulton. Watt desired to set up a complete machine shop for building the engines so that they could train their own workmen and develop tools for the purpose. It was therefore wholly in accord with Smeaton's prophecy that Watt found it quite as necessary to devote his brilliant energy to building the engine as to inventing it. Even at the best, the engine of the period fell far short of realizing the merits of the design.

<sup>1</sup> Muirhead: *Watt's Mechanical Inventions*, I, 66-67.

It was a matter of the utmost difficulty to set an engine to work, and sometimes a matter of equal difficulty to keep it going. **Persistent trouble** Though fitted by competent workmen it often would not go at all. Then the foreman of the factory at which it was made was sent for, and he would almost live beside the engine for a month or more, and, after easing her here and screwing her up there, putting in a new part, and altering an old one, packing the piston and tightening the valves, the machine would at length be got to work.

We have heard of a piece of machinery of the old school the wheels of which, when set to work, made such a clatter that the owner feared that the engine would fall to pieces. The foreman at last gave it up in despair saying: "I believe we better leave the cogs to settle their differences with one another. They will grind themselves right in time." <sup>1</sup>

The defectiveness of these machines is to be attributed in the main to the inadequacy of tool-making equipment. All **Tools** these matters are substantially dependent upon the character of the lathes available for use. The lathe in its early form was no more than a device for turning the work. The tools had to be held against the work by the workman, and scarce any one could achieve significant accuracy when the harder metals were involved. Metal- and wood-working were both at a very low ebb, and England was far behind France in these respects. The improvement of the lathe, however, was achieved independently in England.

In 1794 Maudsley developed the slide rest which became the beginning of notable departures in tool-making and metal-working. The slide rest was merely a device for holding the tool against the work, but its significance could scarcely be overestimated. "It is not saying too much," **The slide rest** says Naysmith, "to state that its influence in improving and extending the use of machinery has been as great as that produced by the improvement of the steam engine. How could we have good steam engines, if we had no means of boring a true cylinder or turning a true piston rod, or planing a valve face?" The lathe was

<sup>1</sup> Smiles, S.: *Industrial Biography*, 181, and note.

brought to some measure of efficiency by improvements of Clement and assumed stable form by 1818.

The details of the tool-making inventions are so technical that general description is scarcely possible, but the progress of mechanical development cannot be adequately appreciated unless the date and significance of these highly technical inventions are clearly recognized. Watt's desperate struggle with his invention was wholly due to the absence of such facilities, and the rapid mechanical development of the nineteenth century was made possible by these subsidiary inventions.

### III. THE METALLURGICAL PROBLEMS OF THE IRON INDUSTRY

The introduction of remodeled furnaces and the new fuel resulted in the systematic production of pig iron. The industry thus faced an intricate metallurgical problem: eco-

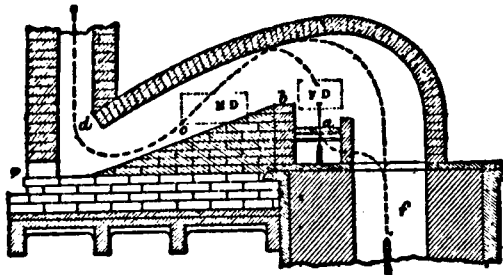

FIG. 13. THE REVERBERATORY FURNACE

nomical conversion of pigs into wrought iron or steel. There was no chemical knowledge at all sufficient for the solution of these problems. The accomplishments were therefore slow and hesitant. The conversion of pig iron into other forms required reheating, and as the iron already contained too much carbon, it was out of the question to bring the metal again into direct contact with the fuel. The elimination of the carbon could be brought about only by some form of combustion, most readily produced by stirring the



molten cast iron in a shallow furnace over which were passed the heated gases from the fire. The reverberatory furnace

**The reverberatory furnace** was used as early as 1766, when it was patented by the brothers Thomas and George Cranage.

The process of puddling was occasionally used at Coalbrookdale, but not generally introduced. The Cranages do not seem to have developed puddling. In 1783 Peter Onions patented a reverberatory furnace and a puddling process. The specifications contain an unusually complete description of the process:

There are two furnaces used in this operation or invention, to wit, a common furnace, in which the iron ore or metal is put and there smelted or melted, and another furnace which is made of stone and brick and other materials, as usual, and fit to resist the force of fire, and bound with iron work and well annealed, and into which the fluid iron or metal is received from the common furnace or smelting blast in its hot liquid state, and when so received is worked or refined as follows: A quantity or stream of cold water must then be run or be put into the cistern or trough under the ash grate of the refining furnace, and the doors thereof closed and luted with sand or lome, and the fire place filled with fuel of pit-coal, coaks, or wood charcoal, from time to time as occasion requires, and then the common bellows, cylinder or usual machine for blowing or pumping air into the space below the ash grate through the tubes, is begun to be worked, and the fire excited by the air until the cavity is sufficiently heated, and then the hot liquid iron metal is taken and carried in iron ladles from the above common furnace and poured into the refining furnace through an iron door or apperture raised by a lever; then the said apperture is stopped, and the blast of air and

**Puddling** the fire used until the metal becomes less fluid and thickens into a kind of paste, which the workman, by opening the door, turns and stirs with a bar or other iron instrument or tool, and then closes the apperture again, and must apply the blast of air and fire until there is a ferment in the metal: and if no ferment ensues, then he must turn or convey the blast of cold air through the tube upon the matter, which will excite a kind of ferment or scoriification in the matter or metal; and as the workman stirs or turns the metal it will discharge or separate a portion of scoria or cinder from it, and then the particles of iron will adhere and separate from the scoria, which particles the workman must collect or gather into a mass or lump, and then shut the door and heat the mass until the same become of a white color, and then take

or convey out of the furnace, with a bar of iron or tongs, the said mass or lump to the forge hammer, and there by repeated blows, squeeze or beat out the remaining scoria or cinder, when a mass of malleable iron will be formed into an octagonal or other bar called a loop, which bar may be then or at any time heated in a fire, and worked by the workman and the forge hammer into rods and bars of iron, for various purposes.<sup>1</sup> . . .

This description covers all the essential features of the process that is usually associated with the name of Henry Cort, and it is not easy to discover now precisely what was the original contribution of <sup>Henry Cort</sup> the various individuals. Cort's refining or reverberatory furnace differed from that of Onions in a number of details, so that one may perhaps assume that in this case, as in many others, the bare abstract idea of the process was the least original feature of the invention. The great difficulties seem to have been encountered in the perfection of the details of the process, and in this respect there can be no doubt of the significance of Cort's work. It was due to his energy that this process became a commercially important method of refining pig iron.

The next stage of the process of refining was also notably transformed though not invented by Cort. The iron taken from the puddling furnace had to be worked <sup>Rolling mills</sup> under the hammer partly to clear it of certain residual scoria and cinder, partly to shape it for further use. This work, especially the shaping of the malleable iron, has come to be done by rolling mills: series of notched and grooved rollers which impart to the hot metal the shape of the space left between the rolls. The use of rolls of this type for the shaping of metal was suggested as early as 1728, but the moderate mechanical equipment of the time confined the use of such apparatus to the preparation of small pieces, such as bolts and bars. The use of rolling mills thus developed gradually. The final extension of the process to the welding of composite bars and the shaping of all types of material was the work of Purnell and Cort.

<sup>1</sup> *British Patents*, vol. 14, no. 1370.

Until these mills were introduced nothing could be accomplished that was not within the scope of hammering. The trip-hammer was an established feature of the industry, but its limitations were very considerable. The rolling mills

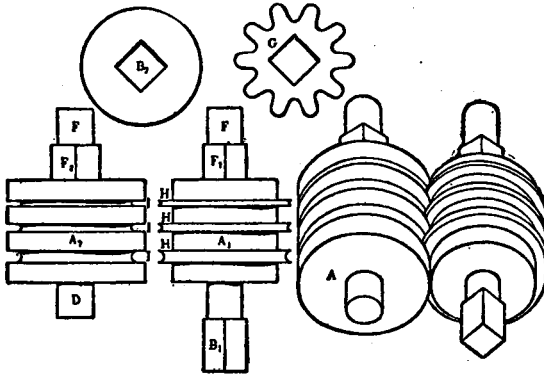
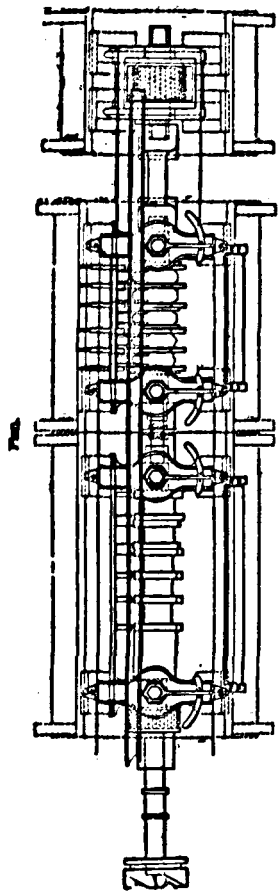

FIG. 14. PURNELL'S ROLLS

introduced a number of new products. In the first place it was possible to work up iron bars of varying composition, relatively hard grades of iron or steel for the wearing surfaces while pure wrought iron was put in the center of the bar to increase its tensile strength. Structural use of iron in the half century that followed was largely dependent upon the increased delicacy of manipulation thus made possible.

The most unique product of the rolling mill, however, was its simplest product, sheet iron. The use of plain rolls set at varying degrees of closeness made it possible to produce large sheets of malleable iron. This led to the construction of tanks, boilers, and iron ships, and all these developments followed very rapidly upon the introduction of the rolling mill. The first iron vessel was a canal-boat, built in July, 1787, by John Wilkinson of Birmingham. This boat was seventy feet long and six feet eight inches wide. It was made of plates five sixteenths of an inch thick. Stem and stern posts were of wood. There was a good deal of canal-boat building at that time, and it may be that we are not well informed as to all the details of these early experiments.



Scale of 1" = 10' 0"

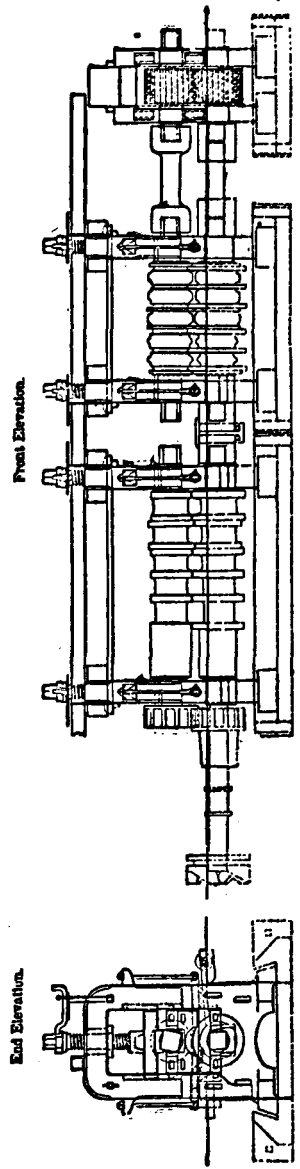

FIG. 15. A MODERN ROLLING MILL FOR THE PRODUCTION OF RAILS

Richard Trevithick developed many applications in the use of tanks and boilers. Strangely enough people hesitated to use iron tanks for containing drinking water. About 1808 accidental discovery that water standing in an old boiler had no unpleasant taste or smell led to an extensive development in the use of iron for the construction of storage tanks on shipboard.

The use of iron in shipbuilding is advantageous because of its greater strength and also because it increases the carrying capacity of the vessel, bulk for bulk. The hull of a wooden vessel weighs about 55 per cent of its total displacement; the hull of an iron vessel, about 35 per cent; and of a steel vessel, only 25 per cent.

#### IV. SIR HENRY BESSEMER

The career of Henry Bessemer is significant in two respects. His career as a whole represents the culmination of the changes wrought by the Industrial Revolution. He is one of the first inventors to achieve great wealth. This aspect of his career is therefore of significance in tracing the general industrial change, and in studying the relation of improved social technique to individual qualities. Bessemer typifies the period of achievement as dramatically as Watt and Crompton represent the unremunerated struggle of the early period. Crompton received nothing for his invention until a Parliamentary pension was granted him late in life. Watt achieved a modest competence. Bessemer made several fortunes.

Bessemer was born in 1813 in a small town in Hertfordshire. His father was a manufacturer of gold chains which were executed with steel dies. The boy was given opportunities for a good deal of mechanical work. He received some training in lathe and shop work, and did amateur work of various kinds. His chief interest at this time was moulding and the making of castings of fragile things. The development of some of this work led him to the discovery that the embossed stamps used by the Government Revenue Department might easily be counterfeited, and he was at

much pains to instruct the Government in means to prevent it. The Government utilized his process and his knight-hood was conferred on him nearly a generation later in recognition of this assistance for which he had never received any adequate financial compensation. This work on the Government stamps was the first of his adventures in London, the beginning of an attempt at earning a living by invention.

It would be somewhat of an exaggeration to suggest that Bessemer deliberately embarked upon a career of professional invention, but while the design was never consciously formulated in his mind the de- <sup>Early projects</sup> scription of what he actually did can hardly be expressed in other terms. His mind was full of schemes: economical methods of sawing plumbago and compressing the dust to make lead pencils, type-casting by machinery, a type-setting machine, a method for embossing velvet by a cylindrical press. These were the more important schemes which filled the year 1838. The velvet embossing proved to be a success and might have constituted a permanent employment, but Bessemer's mind was too fertile in new schemes to limit his attention to any single business.

Shortly after the embossing of velvet was successfully accomplished Bessemer had occasion to do a little gilt lettering for his sister. She had asked him to decorate the cover of an album of sketches, and his attention was attracted to the character of the stuff sold him in the shops for this purpose. He bought this gilt powder at a price which would be consistent with the price of gold, but Bessemer suspected its genuineness and was moved to apply the acid test which revealed the fact that this gilt powder was mere <sup>Bronze powder</sup> bronze. The discovery challenged his attention. It seemed so particularly worth while to know how one might convert brass into a substance having the value of gold. It seemed almost like the transmutation of metals. He discovered by a careful search in the British Museum that the bronze powder was manufactured by a most laborious hand process. Little sheets of bronze were hammered

out between gold-beaters' skins, and the bronze leaf thus obtained was subsequently pulverized.

Now it seemed to Bessemer that there could be no great difficulty in preparing bronze powder by mechanical means. He proposed to himself to rule thin sheets of bronze in a cross-hatched pattern so that there would be a large number of little particles standing on end. These would then be shaved off with a knife and there would be a bronze powder. Experiments revealed the fact that bronze powder could be obtained, but it was wholly unlike the bronze powder of commerce; there was no brilliance, none of the gilt quality. The failure of this attempt seemed complete, but his attention was called to the value of microscopic examination in a wholly accidental fashion and he was moved to compare under the microscope the bronze powder of commerce with his bronze dust. His powder was really a mass of crude little shavings, bright on one side and hopelessly dull on the other.

This gave him a sufficient start and the process was transformed and developed with a view to obtaining this slightly different result. The character of these new features is not wholly revealed in the autobiography. The process was deliberately kept secret. When the plans were perfected, Bessemer decided that the process was too simple to be adequately protected by patent, and consequently resolved to secure the benefits of his invention by absolute secrecy. This involved the maintenance of secrecy in getting the machinery built as well as secrecy in the operation of the works. To guarantee secrecy during the building of the machinery it was necessary to award the contracts for the various machines to a number of firms, giving each firm a contract for the parts of several machines and thus withholding all knowledge of the purpose for which these various parts were to be used. This was, of course, a very severe test for the various machine shops. It is very rare that a shop is required to rely entirely upon drawings, and there is usually opportunity to test the accuracy of the work done by partial

A mechanical process

A test of machine shops

or complete assembling of the machine. Bessemer had drawn out his machine in complete detail and the various shops were charged with executing the designs.

To insure secrecy of operation the machinery was designed to be completely automatic. There would be nothing to do but feed the machines and take away the product. The factory could thus be operated with an engineer and Bessemer's brothers-in-law; and the engineer was not to know any secrets. The boiler-room was separated from the business part of the factory by a brick wall with no opening except what was indispensable for the transmission of power. The freight entrance was provided with double locks and door, a kind of air chamber in fact to which the draymen were admitted only after the inside door had been carefully locked and from which they were carefully excluded before that inside door was ever opened. For forty years no one other than the three men ever crossed the threshold of that factory. The machinery was designed furthermore with reference to being set up by these three men without further assistance and this required a number of special features in design for the heavier castings.

In 1843 the various parts were delivered at the outer door and the machines assembled by Bessemer and his brothers-in-law; the power was gotten up, and finally turned on. The results were rather different from those that characterized the assembling of early steam engines in the days of Watt. These machines whose entire plan had been known only to the inventor had been so carefully executed that there was no significant change to be made in any respect. The process was a complete success mechanically and economically. At a cost of about twenty-five cents a product was secured that would sell for very nearly five dollars. The only obstacle to complete domination of the market was sufficient knowledge of sundry metallurgical details that would be necessary to produce the different colors of gilding powders. Bessemer proceeded to place his product through a broker at a little less than the cost of production in Germany where the hand-made



powder came from. He was personally waited upon by representatives of the German trade, and it was intimated that such severe competition could mean nothing but disaster to all. Bessemer failed to see any imminent disaster and refused to put the price any higher.

The German trade was practically killed, but before the Germans abandoned all hope an attempt was made to learn the secret. An agent came from Nürnberg and attempted to study the in-going and out-going employees and employers at the factory. His embarrassment was the failure to see any employees, but he finally pitched upon the engineer and endeavored to secure information from him. The engineer promptly informed Bessemer of these attempts and at Bessemer's suggestion agreed to arrange a meeting between the German agent and Mr. Bessemer himself. At the appointed time Bessemer in tasteful workingman's attire met the agent in a neighboring ale-house, and, for a consideration, imparted some very wonderful information on the subject of bronze powder-making. This information was of such a remarkable character that when Mr. Bessemer happened to pass through Nürnberg a good many years later he was waited upon during the first evening of his stay by a representative of the Police Department. He was told that the authorities would assume no responsibility for his personal safety unless he were willing to be escorted by a bodyguard of gendarmes. So Mr. Bessemer and his party saw the sights of Nürnberg under escort.

The bronze powder establishment indicates to a remarkable extent the technical advance in machine-building that took place between 1800 and 1840. In 1800 the designs could not have been executed. The possibility of meeting such a test even with relatively simple machinery is the first decisive indication of the approaching maturity of the mechanical technique which is the characteristic feature of modern industrial developments. The achievement of such technical results, too, was profoundly significant to inventors. Unless something

startlingly new were done it was no longer necessary for an inventor to wear out his life building his machine. The profits of invention were thus brought more nearly within reach of the inventor who began to feel the economic advantage of improvements in machinery which in the old days was seldom if ever realized by the inventors themselves, and even if some gains were forthcoming as was the case with Arkwright it was never the full measure of the mechanical value of the inventions. Before the inventor could achieve significant success it was essential that the society around him should be able to execute and utilize new ideas. No great mechanical achievements were possible until the general mechanical capacity of the age had attained significant standards of accuracy and versatility.

The significance to the inventor of delegating the execution of designs must be fully evident. Until the effort of building a machine can be transferred to other shoulders, further invention is practically impossible. <sup>A rich inventor</sup> The powers of an inventor can thus be given a more adequate expression in conjunction with significant technical capacities in society at large, and this was the case with Bessemer. The bronze powder establishment afforded him more than a comfortable maintenance, and he straightway created laboratories and drafting-rooms for the development of new ideas. The enumeration of all his projects would be tedious. A good many matters were studied that led to no particular conclusion, particularly problems connected with glass-making. Bessemer came upon a number of important ideas, but developed none of them. In connection with the Crystal Palace Exhibition of 1851 a prize was offered for a new type of cane-sugar press. Bessemer was interested in the project and turned in a machine which won the competition. The affair does not seem to have engaged his attention for very long and the idea of the machine is essentially simple, but it reduced the weight of the sugar press to an extraordinary degree and increased its effectiveness in the extraction of juice. The press is still used, though it is not now the most common form of press.

In 1853 he began some experiments with projectiles. He proposed to develop a rifled projectile to be discharged from smooth-bore guns. Instead of establishing the rotation of the projectile by rifling on the barrel of the gun he proposed to accomplish the same object by the action of the gases on slots cut in the bottom of the projectile according to the principles of the whirligig water fountain. By properly designed slots the tangential force of the escaping gases would set up the desired rotary motion. To demonstrate this principle Bessemer prepared a dummy projectile that would fit the ordinary water tumbler so that he could demonstrate his new idea at dinner parties. It proved impossible to interest the British ordnance authorities in this project, but he arranged for a meeting with the officers of the French army and in December, 1854, a test was made at Versailles. Some projectiles prepared by Bessemer were shot from ordinary cannon with results wholly in accord with Bessemer's statements. The French officials, however, declared that such departures in artillery were not then feasible as the cast-iron guns were not strong enough to stand the higher charges used.

This suggested to Mr. Bessemer the desirability of improving the quality of iron and steel. At that time there was no steel suitable for structural purposes. Crucible steel of very high grade could be prepared and the less reliable kinds of steel from which crucible steel was prepared were attainable, though at high cost. Steel cost two hundred and fifty to three hundred dollars per ton. He set out in his experiments with the principle of adding carbon by the fusion of small quantities of crucible steel with malleable iron in a reverberatory furnace. His chief problem was to secure a sufficient degree of heat. In order to raise the temperature in the furnace a hot-air blast was turned in to assist in the combustion of gases that usually escaped. This general process is in substantial outline the open-hearth process usually known as the Siemens-Martin process. Bessemer patented the process and the originality of his work can scarcely be contested, though he abandoned

this line of development when the idea of decarburization was suggested.

The fundamental suggestion for his converter came to him incidentally. A hole in the furnace had been stopped with a piece of pig iron and he observed that it was very completely free of carbon after a considerable heating of the furnace. These tendencies had been observed by others in connection with the use of hot-air blasts, but no particular consequences drawn from them. It then occurred to him that he could accomplish more than mere production of steel from malleable iron and he now set to work to produce malleable iron from pig iron without puddling or rolling. He proposed to accomplish this by internal combustion. The principle is precisely the same as that of puddling, though Bessemer proposed a very much more intense kind of internal combustion, a process sufficiently vigorous to dispense with all stirring by hand. The first experiments were conducted in crucibles that were heated externally and after some moderate success he set to work to create a sufficiently powerful blast to develop internal combustion adequate to maintaining the metal in its liquid state.

An experiment was tried with results equivalent to the eruption of a small volcano. The violence far surpassed anything that Bessemer had expected. The results, however, were merely typical of what is happening now in thousands of Bessemer converters. Shortly after the blast is turned on there is a tremendous shower of sparks produced by the combustion of the silicon. This is the impurity that used to be hammered out of the iron at the forge. After an interval, the violence of the display abates and finally ceases. An interval of relative quiescence is followed by a more considerable display of fireworks. The metal in the converter boils violently with explosions and there is a great display of sparks. This display is the result of internal combustion of the carbon and when it ceases the air blast is promptly shut off. The product is pure malleable iron. The first trials produced

an ingot weighing about seven hundred pounds, purer than could be produced by puddling.

These experiments were concluded in August, 1856, and

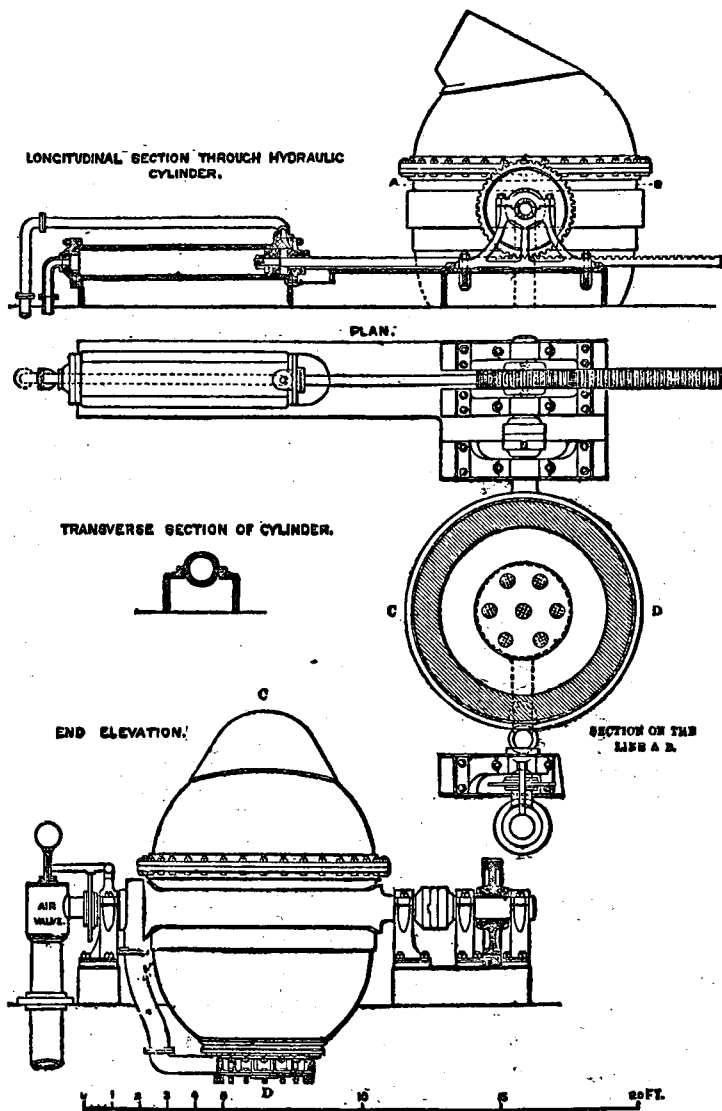

FIG. 16. BESSEMER CONVERTING VESSEL

shortly afterwards Bessemer read a paper on his process at the meeting of the British Association for the Public an-  
Advancement of Science. The paper was re- nouncement ceived with great excitement and many ironmasters applied at once for rights to utilize the process. Presently complaints began to come in. Various ironmasters declared that the process was a fraud and would not work. They spoke of Bessemer with real bitterness and the attitude of the iron trade changed from one of uncritical praise to equally uncritical hostility. Bessemer repeated his tests with the same results. It then occurred to him that there might be some difference in the results obtained with different kinds of pig iron.

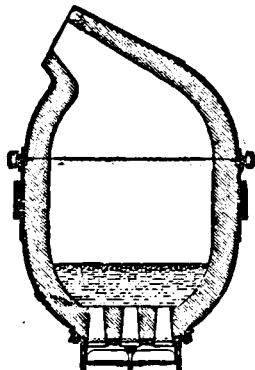

FIG. 17. VERTICAL SECTION OF THE BESSEMER CONVERTER

The experiments when tried with British pig iron produced significantly different results from the earlier experiment in which Bessemer had used the finest Limitations of  
the process Swedish pig iron and it was discovered that the presence of phosphorus in some of the British ores made them wholly unsuitable for this particular process in the production of either malleable iron or steel. Strangely enough many of these English ores were capable of producing good puddled iron, but Bessemer recognized that the commercial use of his process would attach special value to non-phosphorus-bearing ores, and, with the aid of a group of friends, concessions in non-phosphorus-bearing ore-beds in both England and Spain were at once obtained. With proper pig iron, malleable iron or steel could be produced for about thirty-five dollars a ton. The development of the process, however, required a great deal of application. All the details — form of converter, lining, production of blast, and the like — required careful development, and Bessemer said later that if he had known as much about the iron busi-

ness when he began as he came to know shortly, he would scarcely have had the courage to attempt the project at all. The details of the converter were not perfected until 1859. In the intervening period experiments were tried out with a great many different forms and types, but the converter of 1859 was substantially the modern form.

The announcement that the Bessemer process was restricted to ores free from phosphorus at once challenged the attention of the iron trade. There were significant deposits of phosphorus-bearing ore in England in the Cleveland district and most German ores were phosphorus-bearing ores. After the announcement of the Bessemer process the price of pig iron prepared from Bessemer ores was double that of phosphorus-bearing pig iron. Under these circumstances there was a great premium set upon any development that would modify other ores or processes so as to render them suitable for use in the converter. There was deliberate experimentation. One of the leading metallurgists of the time said in 1872 that he had made over a thousand experiments to remove the phosphorus.

In 1878 at a meeting of the Iron and Steel Institute Mr. Bell read a paper proposing a method for the removal of phosphorus. The process had not been perfected and proved to be incapable of complete success, but the paper called forth statements of a simultaneous discovery of an adequate process from Mr. Snelus and Messrs. Thomas and Gilchrist. Mr. Thomas had set to work from the point of view of pure chemistry. The phosphorus was present in the ore as an acid and it was his conviction that the phosphorus could be made to combine with lime or manganese. The difficulty was largely to give the lime sufficient hardness to make it a practical lining for the converter. After laboratory experiments on a small scale he joined forces in 1875 with a cousin, P. C. Gilchrist, who was a chemist at an iron-works in Wales. Tentative trials were made for a year and a half. In June, 1877, the director of the Blaenavon Works gave them facilities for experiments on a larger scale. The process of preparing the basic lining was perfected.

## THE REORGANIZATION OF THE METAL TRADES 345

In the winter of that same year patents were taken out and a paper prepared for a meeting of the Iron and Steel Institute at Paris in February, 1878, but the paper was scarcely noticed. The discovery was announced to the manager of some of the Cleveland iron-works and further experiments were made. A public demonstration was given April 4, 1879, which attracted great attention. Ironmasters came to Middlesborough from Belgium, France, Prussia, Austria, and the United States. <sup>The basic process</sup> Shortly after this there was a meeting of the Iron and Steel Institute at London in which the young chemists read a paper and discussion was held. After the meeting, Middlesborough was again besieged and the process again studied. The process was perfected in its mechanical details as early as 1881; simultaneously, in England and on the Continent. Patent rights were purchased by German firms and some attempts were made to manufacture by the process outside of the patent. The validity of the patents was attacked, but successfully defended and under that patent the iron and steel industry assumed its present form.

The most dramatic consequence of this technical development was the bringing into the market of the great masses of the Lorraine ores; up to that time practically valueless. By reason of the successful development of this process they attained commercial significance and the immense quantity of them at once rendered them the most important single source of iron in Continental Europe. This immense supply of iron became the basis of the development of the iron industries of Germany and resulted in the displacements between Great Britain and Germany that have had such serious political consequences.



## CHAPTER XIV

### THE RISE OF THE MODERN FACTORY SYSTEM

#### I. THE DEFINITION OF A FACTORY

DESCRIPTION of the genesis of the modern factory is difficult because all historical accounts are so profoundly influenced by the definition of the factory. Accounts that may seem to differ in important details represent merely different conceptions of the thing described. It would seem desirable that the matter be approached from a purely historical point of view, without the prejudices created by elaborately formulated notions of the factory. It is of course impossible to avoid definition even in a purely historical account, but if the ideal of historical investigation is achieved these definitions will be an interpretation of events that occurred rather than an artificial form or mould into which events have been crowded with Procrustean indifference to the adaptability of the events to the mould.

The preconceived notions that are most likely to cause confusion appear both in popular conceptions of the factory and in some special writing. These views are Common definitions therefore peculiarly dangerous. The presence of machinery in the factory and the relatively large scale of production both seem to be highly characteristic features, so that it is not strange to find these elements emphasized as the fundamental features of the factory. The early English factory acts; Dr. Ure, a sympathetic observer; and Marx, a most bitter critic were united in the opinion that machinery made the factory. It became necessary to distinguish the tool from the machine, but though there were difficulties they did not seem insuperable. This was largely in accord with the opinions of the average citizen. In the words of Marx, the instruments of labor employed the workman; instead of being the foundation of the industrial process the workman became an incidental feature of the productive

system, his numbers determined by the needs of the machines, his skill subordinated to the ingenuity of the new contrivance. Ure describes the factory in less forceful language, "a vast automaton, composed of various mechanical and intellectual organs, acting in uninterrupted concert for the production of a common object, all of them being subordinate to a self-regulated moving force." Legislative definitions and census enumerations generally define the factory in terms of numbers; it is of course freely recognized that such definitions are somewhat artificial, but it is none the less easy to assume that the essential feature of the factory consists in the number of hands employed.

The other aspect of the factory has also been the basis of distinctions from the outset: the factory workers are gathered together in buildings or rooms wholly devoted to their work; the establishment does not serve <sup>Numbers and discipline</sup> as a home for either employer or employee. The aggregation of workers created new problems of discipline. When work was done in the household no regularity of hours was necessary. The craft-worker enjoyed considerable freedom as to the manner and time of doing such work as was necessary for his support. Even when the putting-out system had become elaborately organized it was not possible to exert much pressure on the workers as to the time of finishing the work allotted to them. The aggregation of the workers in factories made it possible to improve the timing of the productive process; the work could be made to flow along without interruptions; no group of workers need be obliged to wait for the group engaged on the earlier stages of the work. The division of labor that existed under the putting-out system could thus be more effectively carried out, but on one condition — the subjection of the whole body of workmen to a systematic schedule.

The organization of factories thus gave a different meaning to the relation between the capitalist employer and the workman. The dependence of the worker <sup>Capitalism not new</sup> on the capitalist was not increased; under the putting-out system every possible degree of dependence

existed: at an early date it became common for the capitalist to own the machines or tools, and in the later phases of this system the capitalists owned the entire establishment. The Hand-Loom Weavers' Commissioners reported that a firm at Newark, Notts, employed about one hundred weavers in cottages; "the system is for the manufacturer to build cottages adapted for weavers, and filled up with looms, and to let these cottages at a moderate weekly rental: every weaver taking a house and not having a family sublet portions of the cottage." The gathering together of such cottage workers into a factory involved only one change; the introduction of discipline. The capitalist employer became a supervisor of every detail of the work; without any change in the general character of the wage contract, the employer acquired new powers which were of great social significance. He acquired authority which was irksome to the men and almost certain to become the source of much friction.

It is doubtless possible to exaggerate the extent of the increased authority of the employer under the factory system; the small master of the earlier periods undoubtedly exercised some supervision over his journeymen and apprentices, but in theory his authority was that of a parent or fellow-workman, and it seems likely that in actual practice supervision amounted to nothing that would imply a different relation between master and journeyman. The capitalist employer of the putting-out system certainly exercised no powers of supervision. It was therefore an essentially new thing for the capitalist to be a disciplinarian.

The irksomeness of discipline to the workmen would seem to explain the slow development of the factory system. Experimentation with the factory system begins in England as early as the sixteenth century and in France in the seventeenth century, if the presence of power machinery is not made the essential test of the factory. The relative failure of these early attempts is curiously puzzling. In England actual legislation in the interest

New powers

Hostility of  
the men

of the older system must have played some part in preventing a significant development of factories, but the usual futility of legislation to check a powerful social tendency makes one hesitate to account for the late development of factories solely, or even primarily, by reason of antagonistic legislation. Toward the close of the seventeenth century the restrictive legislation was still in force, but there were developments toward the factory even in those trades and areas that were included within the restrictive laws. Furthermore, there was little legislative restriction in France, and yet the sporadic experiments with the factory system led to no large change in industrial organization. Factories became permanently established only when there were special features which overcame the social and economic drawbacks.

Although we cannot be certain, there is reason to believe that the factory system did not afford a significant margin of profit as compared with the putting-out system until machinery became relatively elaborate. The factory thus held out little hope of special profits to the capitalist in the early period, and, as it was bitterly opposed by the men, there was no general tendency to substitute the factory for the organization of cottage industry under the putting-out system. Unfortunately, we cannot determine the relative importance of these two factors in the post-<sup>Slow growth</sup>ponement of the factory development; but the late evidence makes it clear that factories developed slowly even after they had become profitable to the capitalist. This was notably the case with weaving factories; the handloom weavers could not be induced to forsake the freedom of the old system under which they had enjoyed more independence even than farm laborers.

Speaking of the conditions in Coventry, the special commissioner writes:

With all its usual distress and degradation, the trade of single hand weaving (requiring a minimum of strength and skill) offers half the liberty of savage life, for which the un instructed man is almost tempted to sacrifice half the enjoyments of the civilized.

Thus, there is a well known feeling among the farm laborers, the brick-layers, and other ordinary artisans in this district, that it is very hard on them to be turned out at early hours every day instead of being able to take what hours they please, like the ribbon weaver, and like him, take *saint* Monday,<sup>1</sup> and *saint* Tuesday too if they choose. Precisely the counterpart of these feelings is also found in the other sex. Notwithstanding the wretched state in which, until recently, the trade had long been, it was impossible for respectable families to procure domestic servants. There is the greatest difficulty in prevailing upon parents to let their children come to service. The young women look down with scorn upon it, and prefer the liberty of the Monday and Saturday, the exemption from confinement, and the little finery, with the liberty to wear it, which the loom furnishes them.

From all sections of England there came similar testimony. The great attraction of hand-loom weaving was the degree of freedom enjoyed, the weavers refusing to leave their cottages for the factory even when the factory offered higher wages. It would seem that the discipline of the factory was not merely a distinguishing feature, but an obstacle to the introduction of the system. Machinery became important in the development of the system because its introduction ultimately forced the workman to accept the discipline of the factory. As long as there was some measure of freedom of choice between cottage and factory the workman preferred the cottage. The general development of the factory thus required the existence of commanding economic advantages, advantages so great as to destroy any real freedom of choice on the part of the worker. The development of the factory is thus closely associated with the introduction of machinery, but it would inevitably distort one's conception of the rise of the system if the use of machinery were made the characteristic test of the existence of a factory. Machinery made the factory a successful and general form of organization, but there can be a factory "without machinery."

The factory "without machinery" was not as conspicuous

<sup>1</sup> Monday was usually devoted to getting new work from the capitalist employer, so that no craft-work was done.

in the earlier phases of the movement as it became later; the logical order of development does not coincide with the chronological growth of the new system. <sup>Factories with-</sup> <sup>out machinery</sup> Before power-loom weaving became significantly established, many manufacturers collected hand-loom weavers in factories, so that the transition in this branch of the textile trades took place just before the introduction of the new machinery. The development of what is known in the reports as the "shop loom" was accompanied by an increase in the division of labor which separated the operations requiring skill from the work that demanded little special training. The work of the old craft-weaver included three distinct operations; winding or quilling, the initial preparation of the warp; the putting of the warp on the loom beam; the actual weaving, or passing of the shuttle through the warp. The two preparatory processes required considerable skill, the work with the shuttle demanded little more than reasonable ingenuity.

There is abundant testimony in the reports of the Hand-Loom Weavers' Commission to show that the weavers most frequently referred to were practically un- <sup>Unskilled labor-</sup> <sup>ers as weavers</sup> skilled laborers. One manufacturer declared that an apt person who had never seen a loom would be able to figure out the nature of the operation in the course of an hour without any help, and, with a week of practice, might become a perfect journeyman worker. These lower-grade workmen were given prepared warps, and, although there is no documentary proof, one would suppose that this development led soon to the gathering together of workers in the shops or factories of the capitalist employer. There were obvious advantages: the master would know the nature of the work in process, he would be better able to check the output of the individual weaver, and in most cases the weaver would have better equipment than if left to his own resources.

In Gloucestershire, the shop looms were introduced in the course of a strike. The master weavers, presuming that the manufacturers were wholly dependent upon them, went out

in a body; the manufacturers then hired the journeymen formerly employed by the master weavers and set them to work on looms set up on the premises. The master weavers were left almost entirely without work. In 1840 there were 824 looms actively employed and 230 idle looms in the 43 weaving factories of the country. The total number of hand-looms is not given, but the major portion of the hand-looms must have been in the factories. In the Coventry ribbon district there were 545 hand-looms in factories, 1264 hand-looms employed by capitalists outside the factories, and 121 looms in the hands of independent masters. At Norwich, 656 hand-looms were in factories out of a total of 3398 for the district as a whole. The same system was in use in the woolen district in the west of England, though no figures are available. The power-looms were beginning to appear in these districts, but in 1840 the power-loom was not beyond the experimental stage in the woolen industries.

## II. LEGAL OBSTACLES TO THE ESTABLISHMENT OF THE FACTORY SYSTEM

The legislation of the Elizabethan period was designed to prevent the growth of factories; several features of the notable statutes would technically interfere with the establishment of factories; each craft was to be the exclusive occupation of persons trained in the craft; persons engaged in finishing operations were forbidden to have looms, and *vice versa*; further extension of the industry in the country districts was forbidden; the number of apprentices was limited. Of all these restrictions the limitation of the number of apprentices was perhaps most important in the late seventeenth century. The tendencies toward the factory system manifested themselves chiefly in the increase in the number of unskilled workers who would be called apprentices, though their relation to the master was essentially different from that of the apprentice of the earlier period.

The national system of apprenticeship that was estab-

## THE RISE OF THE MODERN FACTORY SYSTEM 353

lished by the Statute of 1563 began to lose its force in the following century. The disorders of the civil <sup>Regulations</sup> wars were a great blow to the old organization <sup>relaxed</sup> of industry and trade. The number of artisans was greatly reduced and it was necessary to relax many of the provisions of the statutes. After the Restoration an attempt was made to revive all the features of the system of strictly regulated industry, but it was too late. The trades were too largely dependent upon the workmen who had never served a real apprenticeship; legal fictions were introduced. For a period the illegal workmen were fined, sometimes after indictment, sometimes periodically assessed small sums to buy off indictment. Toward the close of the seventeenth century the status of illegal workmen was further improved. A man was to be accounted master of his craft if he had exercised it for seven years, so that an illegal workman who escaped indictment for seven years became a fully established craftsman. The guilds and companies still maintained their rules, but the enforcement of the rules was becoming increasingly difficult. The compulsive elements in the system were largely gone by the beginning of the eighteenth century. The old legislation thus ceased to be an effective obstacle to the concentration of workmen just at the time that it was coming to be profitable. Young persons and unskilled hands could be collected by employers despite the opposition of the adult workers who still adhered to the older rules.

The history of the knit-stocking industry affords the best illustration of this type of development. The introduction of the stocking-frame made it possible to utilize <sup>Knit-stocking</sup> a lower grade of labor, and this new labor force <sup>industry</sup> was brought into the industry under the guise of apprentices, Capitalist employers utilized such hands in preference to the journeymen and small masters who had been trained to the craft. The journeymen demanded that the limitations of numbers be enforced. The courts recognized the justice of their request; the Statute of Apprentices was applicable to the craft, but the masters (i.e., the capitalist employers) did



nothing to enforce the law. Frame-breaking began in 1710, and, despite heavy penalties, continued sporadically throughout the century. In all probability certain rudimentary forms of the factory became established in the industry at an early date, though they did not secure exclusive control of the industry as a whole.

A more determined attempt to secure the enforcement of the old rules was made by the woolen weavers of the Leeds district toward the close of the century. The **Trouble at Leeds** factory system began to appear in this district about 1796; the capitalists employed women, children, and some journeymen who had served no apprenticeship. The cloth made in this region was sold at the Leeds Cloth Hall, and until 1796 no cloth was admitted that was not made by a master weaver who had served seven years' apprenticeship. In that year the trustees of the Hall voted to admit cloth made by any one who had worked five years at the trade; shortly after, any one was allowed to sell cloth at the Hall. The craft-weavers were thus forced to compete with the new system of manufacture. They formed an association for the protection of their interests which was called the Institution. This organization was maintained despite the Combination Laws.

The weavers were not quick to understand the merits of their case. The capitalists were guilty of illegal practices, but no suits were brought until 1802-03. The **Prosecution, inquiry, and repeal** initiative was then taken by men in the west of England. The master manufacturers were sued for infringement of the Statute of Apprentices. They replied by having a bill introduced into Parliament providing for the suspension of all restrictive legislation pending inquiry. The small masters of the Leeds district joined in the opposition to this bill, but the bill was passed. The organization of the journeymen was improved and funds were collected to present the case to Parliament. The master manufacturers withdrew and formed a separate organization. The continuance of the annual acts suspending the restrictive legislation created much antagonism among the journey-

## THE RISE OF THE MODERN FACTORY SYSTEM 355

men and in 1805 there was some violence. In the following year the Select Committee on the Woolen Trade reported in favor of a repeal of the regulative legislation, and in 1813 and 1814 the old legislation was repealed.

The opposition of the journeymen had thus accomplished nothing more than the clearing of the statute book of the obsolete laws. The factories that had already begun to appear could now develop without fear of legal interference of any kind. The repeal of these old laws was defended by the manufacturers on the grounds of a *laissez-faire* policy, but one should avoid assuming that Parliament thereby adopted the policy. The laws were obsolete and their repeal was desirable on such grounds. Parliament, however, had already passed the first act to regulate conditions in factories and was soon to proceed further with such legislation; it would thus be unfortunate to regard the *ex-parte* defense of a measure by the manufacturers as an indication of a policy maturely and deliberately adopted by Parliament.

### III. THE RISE AND PROGRESS OF THE FACTORY SYSTEM

The history of experimentation with the factory system in the eighteenth century is still obscure; we have many scraps of information, but no grounds for believing that our information is at all comprehensive. The disposition to associate factories with establishments using power machinery tends to distract attention from instances of factories which were not based on any tools or mechanism other than the old hand-machines. Silk mills Cooke-Taylor is disposed to regard the silk throwing mill of John Lombe (1719) as the "first" factory in modern England. The mill was a new departure and it is likely that it does mark the beginning of factories in the silk industry. After that date some silk throwing was probably done in such mills. A mill established in 1753 was still running in 1816, and at the beginning of the nineteenth century there were in all eight or ten silk mills. It is likely that enough finishers were collected in establishments of the drapers and clothiers to constitute "factories." Without careful research it is not

safe to make many categorical statements about the earliest factories. There was a considerable establishment in Yorkshire for making alum in the early seventeenth century, and various paper mills were set up in the latter half of that century. Potteries are not sufficiently described to admit of certain classification.

The movement that ultimately transformed the organization of the textile industries did not begin until after 1770, when the development of carding and spinning machinery gave an impulse to the systematic establishment of factories. These factories appeared first in the cotton industry, but shortly after in the woolen and worsted industries. Factories based on power machinery were largely confined to these preparatory processes and to the printing of calicoes. The weaving of textiles and the finishing of the woolens were not affected for a considerable interval, not significantly until after 1830. It is thus possible to distinguish two periods in the development of the factory system in the textile trades: in the earlier period the factories were supplementary to the older putting-out system that maintained itself in weaving; in the later period, the factory gradually became the predominant mode of organization in the textile trades and ultimately the predominant form of industrial organization. The length of the period of transition is easily underestimated.

Arkwright's first spinning mill was established in 1771; in 1780 there were about twenty water-frame spinning mills in England. The failure of Arkwright in the defense of the patents led to a considerable increase in the use of the frames, and it is said that there were one hundred and fifty water-frame mills in operation in 1790. The development of factories in the woolen industries seems to have been largely subsequent to 1790, though it is difficult to be certain of the probable date of the establishment of weaving factories in the west of England based on hand-loom. There were several types of factory; some devoted to preparatory processes, carding, slubbing, and spinning; some devoted to weaving on hand-loom; some devoted to finishing the cloth on

Beginnings in  
the other tex-  
tile industries

gig mills and shearing frames. Coöperative or joint-stock mills for finishing became very common in the West Riding of Yorkshire, enabling the small master weavers to compete successfully with the larger manufacturers. But the number of factories in the woolen industries does not seem to have been very great at the time of the <sup>Early</sup> <sup>inquiries</sup> Woolen Report of 1806; there was much uncertainty as to the proper definition of a factory, but even with due allowance for such elements of error there is no ground for supposing that the new system was more than barely launched.

The earliest statistics with reference to factories appear in the Report on Children in Factories made in 1816. These figures are incomplete in many respects; they do not pretend to include all the factories, and the classifications according to age and sex are not uniform; yet, with all these shortcomings, these figures afford notable evidence of the general composition of the factory population. About half the mills in England were reported and apparently all the Scotch mills except the cotton mills at New Lanark. The statements are sworn statements and thus represent the situation in the mills to the best knowledge and belief of the owners and managers. In some cases only approximations are given, but as a rule the figures submitted were prepared for the committee with some care. There is evident purpose on the part of the committee to secure statements from all sections in which factories existed, and under such circumstances one may feel confident that the figures are fairly representative.

The striking feature of these statistics is the large number of women and children employed. Adult male workers were predominantly employed outside the factory, and their absence appears in the low proportions of males in factories compared with the industry as a whole. The best wholly contemporary comparison that is possible is in the woolen industry of the west of England. We have a careful statement of the numbers of hours' labor of men, women, and children required to produce a piece of broad cloth, at various dates between 1781

and 1828; we have also a statement of the proportions of persons employed in twenty-eight woolen mills in Wiltshire. Between 1805 and 1820 the labor of a man was supposed to constitute 37.2 per cent of the labor in the industry, hour for hour. In the mills reported in 1816 adult males (over 18) constituted 27 per cent of the labor force. The proportion of males in the mills was thus considerably below the proportion for the industry as a whole.

RELATIVE LENGTH OF TIME SPENT BY MEN, WOMEN, AND CHILDREN IN THE MANUFACTURE OF FINE BROAD CLOTH \*

<i>Period</i>	<i>Men</i>	<i>Women</i>	<i>Children</i>	<i>Total</i>
1781-1796.....	31.79	25.28	42.93	100
1796-1805.....	40.50	20.10	39.40	100
1805-1820.....	37.20	21.20	41.5	100
1828.....	39.9	18.6	41.5	100

\* Report on Hand-Loom Weavers (1840). Part II, 439-41.

With reference to the other industries it is not possible to draw an accurate comparison, as we have no statistics for the industry as a whole at this early date. The later figures from the reports of the factory inspectors, however, probably afford a basis for rough comparison. The figures for the woolen industry covering the period between 1796 and 1828 show no profound change in the proportions between men, women, and children; it would seem likely that similar constancy of proportions would appear in the other industries.

The first introduction of machinery resulted in a noteworthy change in the proportions of men, women, and children, but after this the proportions fluctuated within relatively narrow limits. In the period between 1835 and 1895 the proportion of adult males in cotton factories was never lower than 24.1 per cent nor higher than 28.8 per cent; it would therefore seem likely that these proportions represent the normal conditions of the industry. The cotton industry became a factory industry much earlier than the other textiles, and there is nothing improbable in the assumption that the proportions in factories

were normal as early as 1835. In 1816 the adult males in the Scotch mills constituted only 17.7 per cent of the total number of employees, and in a group of six mills in Nottinghamshire 18.54 per cent. The other English figures do not distinguish between males and females over eighteen.

The relatively low proportion of adult males is probably due to two factors; the late extension of the factory system to the branches of the industry that were the chief field for the employment of males, and the indisposition of the males to enter the factories. <sup>Why the men remained outside</sup>

These two factors exerted considerable influence on each other. The late development of factories in weaving was admittedly due in no small measure to the restlessness of the hand-loom weavers. It was not possible to bring them into the factories until the improvement of the power-loom drove the hand-loom from the field, and in some branches of the textile industries the hand-loom held its own until 1850 and even later.

The worsted industry was one of the last to be brought under the factory system, and the gradual entry of the men into the factories is clearly indicated by the changing proportions of adult males. In 1835, only 10.7 per cent of the factory hands were males over eighteen; in 1856, 20.6 per cent were adult males, and after 1885 the proportion rose to 25 per cent. These changes can hardly represent changes in the general proportions in the industry at large, and as we know that the factory system was only gradually being extended to this particular industry it is likely that these changes are a rough measure of the transition to the factory. The outstanding feature of the earlier phases of the factory movement was thus the relatively <sup>Social problems</sup> large measure of dependence upon women and children as a labor force. When the factory was concerned primarily with the preparatory processes, the number of adult males necessary was small. In the earliest period the number of very young children was considerable. Appreciable numbers of children under ten were employed. The social problems created by the factory were thus rendered peculiarly

acute, because the persons first gathered into the factories were those least able to make any effective protest.

The initial problem of the factory owner was to recruit a labor force, and, as children were desirable, it was possible for him to utilize the laws providing for the apprenticeship of pauper children. These laws went back to the days of Henry VIII. It was provided that vagrant children should be arrested and bound as apprentices; sons of vagrants might be apprenticed until the age of twenty-four, daughters to the age of twenty. These provisions were continued without much change until the Reform of the Poor-Law in 1834. These indentures were similar to the indentures for ordinary industrial apprentices, but the overseer of the poor stood in place of the parent, and the payment of a small fee might easily acquire a somewhat different meaning in the case of pauper children.

The theory of pauper apprenticeship was sound, but in practice the device was hardly more than a method of unloading the children upon some person willing to take a chance of getting enough work out of them to pay for their keep. All pretence of obligation to teach them a trade was abandoned at an early date. When the law of settlement of 1691 raised obstacles to the free movement of the indigent classes a regular traffic in apprentices sprang up which continued without much diminution until the close of the eighteenth century. Some attempts were made to regulate this traffic in 1767 and again in 1778, but these acts were mere palliatives. When the cotton factories were established in Lancashire, Yorkshire, and Scotland they were at first filled with pauper apprentices from London and other large towns. At London a register was kept and part of the fee was withheld to be paid only at the conclusion of the period of apprenticeship, but this was no guarantee of good treatment. In Owen's mills at New Lanark, some care was taken of the welfare of the apprentices, but the extent of these humanitarian efforts does not seem very considerable in comparison with modern standards. Unfortunately we have no means of determin-

ing the precise extent of such apprenticeship, nor the date of its substantial disappearance in the factories. It was declining in the early years of the nineteenth century, and was probably of subordinate importance in the recruiting of the labor force after 1816. The conditions of child labor in general were sufficiently bad to make it needless to distinguish between the "free" children and the paupers.

The social problems of the factory had reached forbidding proportions long before the factory became the characteristic form of industrial organization, and, be- The reports of inspectors cause of the attention given these matters in Parliament and in public agitation, there is real danger of misjudging the progress of the movement toward the factory system. This danger is increased by the character of statistical material available for the study of the industrial population. The factory inspectors' reports begin in 1835, and after 1838 these reports become trustworthy and comprehensive for the regulated establishments. They constitute a continuous series of figures to the present time, organized with reference to classifications that are essentially in accord with modern problems. It is therefore tempting to confine studies of the industrial population to these figures, despite the fact that they do not include the entire population and despite changes in factory legislation which gave the inquiries a wider and wider scope. Occupational statistics are published by the Census Office and in a measure these figures afford some indication of the relative numbers of persons employed outside the factories, but the classifications do not always coincide exactly with those of the factory return. The census does not distinguish between persons employed in factories and persons employed at home, except in 1901, so that the only comparison that can be made is between the totals reported in the factory return and the totals reported by the census enumerators.

In 1841 the census reported 377,000 persons in the cotton industry as compared with 259,000 persons reported by the factory inspectors in 1838. About 70 per cent (68.7 per cent) of the cotton operatives were thus employed in factories



at that time. The woolen and linen operatives were about evenly divided between the factories and various forms of employment in their homes. Only 40 per cent of the silk workers were employed in factories at that time. No fundamental change had taken place in 1851; there were more factories in the cotton industry than in other textile employments, and in the other trades nearly one half the workers were in non-regulated establishments. The factory legislation defined the factory in such a way that we may well suppose that certain establishments were not regulated, though they were factories in all essential features, and yet it would seem likely that the factory was merely one of several forms of industrial organization. It was attracting the most earnest attention of the people, but it was not at that time a predominant form.

By 1871 the factory had become the characteristic form of organization in both the leading textile trades. Eighty-eight per cent of the persons enumerated by the census in the cotton industry were employed in factories; seventy-eight per cent of the persons employed on woolen goods were in factories, and the factory inspectors actually reported more persons in the worsted industry than were enumerated by the census. The silk and linen industries were declining in importance both relatively and absolutely, so that the somewhat smaller proportion of factory workers in those trades can hardly be drawn in consequence. The factory had also become the predominant form of organization in the metal trades; seventy-five per cent of the persons enumerated by the census were in factories. In the clothing trades and in the leather trades the factory system had made little progress. The tailors and milliners were still outside the factories; likewise the boot- and shoemakers, the saddlers, the goldsmiths, the watch-makers, and the cutlers.

The extension of the factory system to the lesser industries took place in the following generation. The careful occupational enumeration of 1901 shows the final triumph of the factory. The enumeration dis-

tinguishes persons working in factories and persons working at home. This is in many respects a more satisfactory distinction than the numerical distinctions common in France and Germany. Persons working at home, whether for an employer or on their own account, are certainly not factory workers, and at the present time it is probable that any establishments outside the home should be included in the classification of factories. The clothing trades have been least dominated by the factory, but even in that group, seventy per cent of all the workers are employed in factories. In the other groups only a small residuum is still employed at home; in textiles, 1.9 per cent; in metals, 2.82 per cent; in the precious metals, 9.3 per cent; wood-working, 7.26 per cent; skins and leather, 10.54 per cent. In all probability small numbers of workers will always be able to maintain their independence in these various trades; in some trades more easily than in others, but to a certain extent in all trades. At the same time it must be evident that this survival of domestic employment is quantitatively unimportant. The factory has not made its way quite as rapidly in Europe as in England, but the home worker is becoming the exception in the major European countries.

#### IV. ARTISANS AND MACHINERY

It is customary to associate the distress among the artisans in the early nineteenth century with the introduction of machinery and the rise of the factory system. "Pains of transition" The violence that was not infrequently directed against machines would seem to lend color to this view, and the conception of the Industrial Revolution as a sudden and violent change would make it seem logically necessary that there should be pains of transition. The distress of the early years of the century is undeniable, but it would seem that the causes of the distress were much more complex than the conventional views would lead one to suppose. The development of the factory system and the introduction of new machinery were both very gradual. Some of the most notable mechanical achievements probably exerted no

pressure upon the workman; the spinning inventions, the steam engine, and the steel inventions created opportunities for employment that had not previously existed. The energetic individual, of the humblest extraction, thus found openings that were unrivaled in dramatic possibilities. It is hard to believe that the individual of significant resourcefulness did not find abundant chances for betterment.

The case of the craft-worker — the skilled workman brought up to a craft that required years of training — was undoubtedly different. But the effect of the great transformation on these workers was by no means a mere displacement of men by machines. In the textile trades, craft-skill could easily be transferred from one class of goods to another. The weaver could work on cottons, woolens, or silks, and there is clear ground for supposing that the more highly skilled workmen did change from one type of goods to another. Even at the period of greatest distress among the hand-loom weavers, the skilled workers were able to earn satisfactory wages, and the work requiring both strength and skill was well paid.

The difficulty in analyzing the conditions in the textile trades is largely created by the introduction into the industry of a large number of unskilled persons.

The unskilled workers. The early years of the century were characterized by periods of great expansion and prosperity. The demand for labor was keen; the increased specialization in the process of production and the relaxation of the old laws of apprenticeship made it possible to utilize a grade of labor that had not formerly been used in these trades. Many Irish came over to England and became weavers. Persons who had never seen a loom came to the textile districts and established themselves as weavers. When the periods of expansion came to an end the trades were overcrowded. New ideas with reference to the payment of wages resulted in wage reductions, as well as in lack of employment. The attractions of cottage industry prevented these hands, or many of them, from transferring to other employments. After 1840 the development of power-loom weaving made

the over-supply of unskilled weavers a serious matter, but even then the machines did not supplant trained craft-workers in the sense that might be inferred from many accounts.

It must be remembered, furthermore, that these were years of distress in the agricultural districts also, and that the condition of the agricultural laborer was <sup>Other causes</sup> equally desperate. It is unfortunate that the <sup>of distress</sup> entire social question has not been studied as a whole. The inquiries of the Poor-Law Commissioners suggest other explanations for the distress among the working classes. Great displacements of population took place in this period. The northerly counties of the present manufacturing district grew rapidly in population, the older industrial districts barely held their own or actually lost ground. The agricultural counties lost also. Much migration was necessary, but the poor-laws presented every possible obstacle to migration of the working classes. The law of settlement tended to immobilize the population. There might be work enough to occupy the poor of a parish, but they could not take the job unless it could be held without acquiring residence in the other parish. The unfortunate effect of such regulations at a time of great social change can hardly be imagined. The inquiry of 1833-34 revealed the <sup>The poor-laws</sup> fact that a number of parishes had been abandoned to the poor by the owners of property. The rates had increased portentously and in some instances the property-owners simply abandoned the parish. Such conditions were not the result of industrial or agrarian changes; they were merely the result of unfortunate social legislation, and it is extremely difficult to know the extent to which the ills of the period can be justly ascribed to bad laws. It is difficult to believe that the distress of the time was in any sense a *necessary* outcome of industrial change. Proper regulation of the purely social problems of the factories and the factory towns would inevitably follow the emergence of new problems by a more or less considerable interval, but it is hard to find concrete evidence to support the conclusion

that economic distress, "pain of transition," was a necessary feature of the Industrial Revolution.

The modern industrial system, however, has changed the position of the artisan. In a sense there is little place for the artisan of the old type. Modern industry does not need mere acquired manual dexterity, but rather capacity to accept responsibilities. The well-paid worker of the present time is paid for a different kind of qualities. In the old system acquired skill was paid for. Today, essential human qualities are paid for; powers and capacities that can be improved by training, but not in any real sense created by training. Modern industry has its great rewards for the *man*. The introduction of machinery has not made men slaves; it has emancipated them and placed the emphasis upon the fundamental character of the individual. It must be confessed that modern conditions reveal an immense mass of irresponsibility and great deficiencies in human qualities. The old distinctions between the skilled and the unskilled might better be abandoned for distinctions between the responsible and the irresponsible.

Machinery  
and the man

CHAPTER XV  
THE RISE OF COLLECTIVE BARGAINING

I

COLLECTIVE determination of wages must be associated with the attempts at administrative participation in the regulation of wages by various groups of magistrates; by the municipal officials in part, and in part also by the county officials, the latter acting under The Statute of Apprentices the Statute of Apprentices of 1563. The wage clauses of this famous statute have been the subject of a deal of controversy, and it is not yet clear that all of the controversial points have been settled; but the larger outlines of the subject are now fairly evident, the purposes of the statute roughly known, and its success at least partially understood. Memoranda in Lord Burleigh's papers indicate definitely that the wage clauses were designed to afford a means of adjusting the wages of laborers to the rising scale of prices which was exerting such serious influence on the welfare of the lower classes. The mechanism of the statute was not new. Handbooks prepared for justices of the peace indicate that some administrative intervention in wage contracts was well established in law and custom, but the establishment of rates of wages by justices of the peace as conceived in the Statute of Apprentices involved some new elements or at least new purposes.

Even if wages had been in the past somewhat regulated in proportion to the prices of grain, the results of adjusting wages to the price of grain would have been very different at the close of the sixteenth century. Increase of money wages projected The rise in prices meant that the maintenance of the old principle would bring about a significant increase in the money wages of all classes of artisans. The accomplishment of the purpose of the Statute of Apprentices in the period immediately following its enactment must

remain at least doubtful, and it would seem that there is a presumption against the view that it was in fact a means of bringing about a general increase in money wages. The statute remained, however, a possible recourse in labor disputes and as actually administered tended to provide for a form of compulsory arbitration. This much at least is true, that even in the early period and most particularly in the eighteenth century the wage contract was not a purely individual contract. The laborers were not organized in elaborate associations, but the individual wage-earner was not obliged to bargain with his employer as an isolated individual.

There is little adequate evidence of what was taking place among wage-earners in industry in the seventeenth and eighteenth centuries, but a number of instances are suggestive. Some instances of wage disputes in London toward the close of the seventeenth century have been brought to notice by Unwin. There are references in the records of Parliament

**Important episodes** to conditions among the wage-earners in the cloth districts of the west of England in the early eighteenth century. We have fairly adequate evidence for the silk industry of London during the late eighteenth century, and some casual evidence with reference to other industrial wage-earners. In all these cases there was organization among the wage-earners and some organized attempt at the determination of rates of wages. The legal rights of the wage-earners were uncertain and the spirit of much of the negotiation very different from the spirit of modern unionism, but in the larger sense of the word, one must regard these episodes as indicative of tendencies toward collective action.

In the fall of 1667 the journeymen felt-makers of London appealed to the aldermen against the wardens of the gild.

**The London felt-makers** The journeymen had become a substantially permanent class of wage-earners employed by the masters of the gild. Under such circumstances there was no real provision for protection of their rights and interests. Appeal to the municipal authorities was the only

solution. The aldermen in this instance proposed to amend the gild statutes; wage-lists were to be made each year by the wardens of the gild and submitted to the aldermen of the city. This arrangement was obviously in the interests of the wardens and designed to prevent the journeymen from forcing increases of wages by concerted action. There is thus an intimation at least of collective action among the journeymen. In the latter part of the century much more definite evidence of the activities of the journeymen is available. In 1696 the felt-makers' gild drew up a scale of wages for the journeymen with the provision that if the journeymen did not accept the masters might employ journeymen from out of town. The journeymen struck and forced a compromise. The revised wage-list was presented to the aldermen and agreed to. It will be observed that the municipal authorities were summoned to give added sanction to an agreement that had already been reached between the wage-earners and their employers.

In the west of England the situation was different because gild organization was not important in the industry. A witness testifying before Parliament said:

The weavers have many clubs in several places in the west of England, particularly at Exeter, where they make by-laws some of which he has seen, which by-laws are among Weavers' clubs other things to appoint places of meeting, fix their <sup>in the west</sup> officers, make allowances to traveling workmen, and ascertain their wages. Several weavers have brought home their work and durst not go on to serve their master for fear of other weavers of the club who have deterred them therefrom, and he believes that one of the occasions of the late riots that have happened has been that the masters have refused to raise the workmen's wages to what prices they please. He was present at a great mob in the town of Crediton (Devonshire) consisting of weavers and others concerned in the weaving manufacture who were headed by a captain and threatened their masters if they refused to raise their wages. They carried about with them a chain of serge cut off from a loom and declared that they would do the like to the pieces of serge of other masters. When the constables had seized some of the ring leaders and had brought them before two justices of the peace the mob bursting into the house, insulted the justices, threw stones at them, forced them to fly and rescued the prisoners.



Another witness said that the weavers complained of paying them in truck, but he "believes that this is not the cause of the rioting because they usually begin in the spring when there is the greatest demand for goods and the most plenty of work. He has known weavers who would willingly have worked for him at the wages he gave, but the club threatened if they did so to pull them out of the house and coolstaff them, upon which he was forced to pay them the prices demanded to save his work from being cut."<sup>1</sup>

The remedy proposed was an assessment of wages under the Statute of Apprentices. The list was published, but was never enforced. The masters objected on the ground that it was not sufficiently detailed.

Similar difficulties occurred in 1756 and an act was passed providing for the assessment of wages by justices of the peace. A wage assessment for Gloucestershire was made, but protests were received from the master clothiers and the Act of 1756 was repealed. Sidney Webb declares that this statute marks the beginning of a policy of "administrative nihilism" based on the notion of absolute freedom of contract. This, however, would seem to be an untenable interpretation of the statute. There seems to be no adequate grounds for supposing that the repeal of the act implied anything more than a return to existing customs and the existing customs suggest that there was much collective action between the clothiers and the weavers.

In connection with the petition of the clothiers one William Dallaway testified that he had never heard of any rate for wages being made by the justices of the peace before 1727 when a rate was made of which he had seen an attested copy, but the rate was never complied with to his knowledge. Continuing his testimony he declared that he had been in business for ten years and had never varied in his prices. The rates were settled according to his belief by "some clothiers and some weavers." Others testified to substantially similar facts,

The Act  
of 1756

Customs in  
Gloucester-  
shire

<sup>1</sup> *Commons Journals*, xx, 648, 1-2 April, 1726.

and it would seem that there must have been some measure of collective action prior to 1756. It would be wholly warrantable to suppose that reference to administrative authority was due to a desire to make the rates more binding. There would seem to be no grounds for assuming that the absence of statutory enactment would disturb existing customs. In other industries at least there is clear evidence that no policy of administrative nihilism was adopted, and in short there is adequate reason for believing that the tendency toward collective bargaining clearly apparent in the first half of the eighteenth century continued without serious interruption throughout the latter half of the century.

The unrest which had become a serious problem in the woolen industry seems to have attracted little more public attention, but in the silk industry and most particularly among the silk weavers of London at Spitalfields <sup>riots</sup> there was serious trouble throughout the years 1765-70. The difficulties were partly due to pressure created by competition with French silks, and rioting, which was serious in May, 1765, was finally brought to an end by the imposition of protective duties. The trade, however, continued to be disturbed partly by reductions of wages, partly by certain dislocations in the industry. The introduction of a new type of ribbon loom caused significant trouble. Throughout 1768 there was sporadic trouble, violence was done to the property of master weavers, and some cases of violence to persons are recorded. We are very ill-informed about the details of these matters; the evidence available comes largely from the Annual Register whose accounts are tantalizingly brief. In August, 1769, it is stated that the handkerchief weavers had taken up a subscription of sixpence on every loom to support their cause against the masters. One of the master weavers, "that paid satisfactory prices, insisted notwithstanding that his men should not belong to the subscription society and not pay such sixpence, and armed his people to defend their looms against the body. The club, determined to support the plan they had on foot, assembled

themselves to compel said master's men to pay the subscription. There ensued a bloody fray in which many of both sides were wounded. Work was cut out of fifty looms belonging to the master weaver above mentioned and shortly after out of a hundred other looms."

Further evidence of the organization of the men is afforded by the incident in September when an attempt was made to arrest an entire meeting. An officer with a party of soldiers invested an ale-house in Spitalfields "where a number of riotous weavers, commonly called cutters, were assembled to collect contributions from their bretheren toward supporting themselves in idleness in order to distress their masters and oblige them to advance their wages." The raid resulted in an armed fight; the soldiers were finally obliged to fire upon the weavers of whom they killed two and captured four.

The ultimate result of this period of violence was the Spitalfields Act of 1773, passed at the request of all the manufacturers in hopes of bringing about better relations with the men. The act provided that the wages of journeymen weavers within the limits of London should be settled by the mayor and aldermen, and in all places in the county of Middlesex by the justices of the peace. The authorities were to issue wage-lists, however, only upon application. Any wage-list established by them was to be printed three times in any two daily newspapers published in London or Westminster. The list would then be compulsory upon both weavers and journeymen. Master weavers paying more or less wages would be fined £50, the proceeds of such fines being distributed among distressed journeymen. Journeymen weavers, who should ask or take greater or less wages, or enter into combinations to raise them, or assemble to petition on the subject of them in numbers of more than ten, *except when going to the magistrates*, were subjected to a fine of forty shillings. This act was subsequently extended to apply to all aspects of the trade including mixed goods and to women as well as to men.

The Spital-  
fields Act:  
1773

The text of the statute might seem to imply that the wages were actually declared by the magistrates. The exception in the clause relating to journeymen not observing the act shows that some form of organized activity on the part of the men was contemplated. We have adequate indication of the actual methods of administration employed in the testimony taken before the Lords Committee in 1823 with regard to the effect of the statute. Mr. Hale testified:

A committee of masters generally met a committee of journeymen, perhaps three or four or five on each side, and, after they have argued the matter, they come to an agreement as to what they think should be a fair price for labor. It is then taken before a magistrate who ratifies it and it becomes by law a fixed price until altered by subsequent agreement. If we cannot come to an agreement we go before the magistrates at Quarter Sessions. We each of us take witnesses on each side and after mutual deliberation and viewing the measure in all its consequences on both sides the magistrates determine it. Of two instances of disagreement, in one case the magistrates decided in favor of the employers and in one case in favor of the workmen.

The continuity of administration is significantly indicated by the testimony of Mr. Buckeridge. "He had been engaged in the trade upwards of fifty years, first as an operative weaver, later as a master." He says:

I have assisted in forming all of the list prices that have been made since 1784; a general one in 1795, another in 1800, in 1802, in 1804, an explanatory one in 1805, and the last, a general one, in 1806, and then, by the desires of the masters and the men, the masters in particular, compiled the present book of prices.

Mr. Buckeridge thought the act had been a success, preventing either weavers or masters from taking an undue advantage of the other.

The statute was thus a device for collective bargaining with magisterial supervision which was designed primarily to insure observance of the lists, but it is important to recognize that the magistrates looked upon the facts of the case more largely with reference to

maintaining a definite status than with reference to possible increases in wages. According to evidence brought out both in 1818 and 1823 the principle followed was "to fix prices so as to afford the journeyman if he can get full work the income of other like skilled craftsmen calculated by the price of bread." The statute was thus an embodiment of the policy represented by the Statute of Laborers which despite its alleged intent had become a means of maintaining a status rather than a means of sharing in the benefits of possible progress.

We must remember that the problem of wage determination did not at that time raise the issue of sharing in the gains of an improving technique. There had been no change in technique sufficiently great to create the presumption of a real increase in social well-being, and, although changes were beginning to take place at the close of the eighteenth century, public opinion was slow to realize the magnitude of the transformation then in process. The notion of a status to be maintained remained the predominant feature in public opinion until after the Napoleonic wars.

The significance, and even the emergence, of new ideas is clearly indicated by the sequel to the history of the wage regulation in London afforded by the conditions at Coventry. The ribbon manufacture became established at Coventry soon after the prohibition of the importation of foreign silks in 1766.<sup>1</sup> The trade increased slowly and without any great change until the period of the Napoleonic wars. In this early period the organization of the trade was simple and conditions were not unlike those prevailing among agricultural laborers. The price of weaving remained unaltered for many years and any reductions in the prices paid would have been of all measures the measure last contemplated by the manufacturer. The old relations between the employer and the employed had apparently established a public opinion as to

<sup>1</sup> The history of the trade is told in the Report of the Assistant Commissioner to the Royal Committee on Hand-Loom Weavers.

Eighteenth-century wage problems

Ribbon manufacture at Coventry

their relative position and comforts which kept the price of labor unaffected by the excess of hands. The larger portion of the trade was generally out of employment several months of each year, but no reduction was attempted in the prices paid for weaving.

The first departure from the old system was at the big purl time which commenced in 1812. This was a period of great expansion due to the sudden and great demand for ribbons with large purl edges. The demand for goods was so great that the persons ordinarily employed in the industry could not supply the trade and many hands were called in from other trades. The masters began to bid against each other for workmen, offering high prices without any regard to the old customs. The men found conditions favorable, and early in 1813 the single hand-<sup>Collective</sup> workers as a body petitioned the masters for <sup>action by</sup> higher wages. The petition was granted and a list prepared which was signed by all the principal masters of Coventry. The list was printed: the first printed list of wages known in the Coventry trade. <sup>the men</sup>

These conditions continued until the end of the war. The return of the soldiers and the general disturbance of trade completely disorganized conditions at Coventry. The putting-out system gave place to the factory system, and, at times, power machinery was substituted for hand-loom. These changes were indirectly results of a great expansion following 1812, for at that time the manufacturers began to set up looms in their shops.

The depression of the period 1816-20 resulted in further experiments with collective bargaining. In 1816 the frame-weavers assembled and organized as "The City of Coventry Weavers' Provident Union for Trade and Burial." The purpose, according to the constitution, was to assist persons who were out of work or compelled to receive half-pay. The price of labor, however, was very unstable, and, after a series of reductions, meetings were held by both masters and men and deputations were appointed by each side in September, 1816, to prepare a list. The list was not maintained for a

fortnight, and a meeting of the deputations from each side was again held, and after deliberation the list was sent up to London to be registered in the Court of Chancery, it being supposed that the agreement would be legally binding on all who had signed. This, however, was of no avail. Other expedients were adopted likewise without results, until finally the weavers determined to petition Parliament for an extension of the Spitalfields Act to Coventry.

The petition was submitted early in 1818 and a committee appointed to consider the subject. The presentation of this petition is a curious indication of how little the workmen realized the changes that had taken place in public opinion since the Spitalfields Acts were passed. To them the statute was merely a means of giving validity to mutual agreements that were difficult to enforce. The relation of the statute to the old ideals of rigidly defined status was lost sight of. In the evidence given before the Parliamentary committee these other aspects of the statute quickly came to light and the inquiry resulted in making clear to all that the statute was no longer adapted to the needs of the time, not so much because there was not still need of collective action, but because the mechanism of the statute was ill-adapted to the increased complexity of the problem. The Coventry petition was denied. The action of the committee led to dissatisfaction in London. The masters felt that the justices were favoring the men because great concessions could be forced from them before the magistrates. The London masters petitioned in 1823 for a repeal of the statute and in 1824 the act was repealed.

After the failure of the petition of 1818 the Coventry journeymen and masters resumed their efforts at list-making. In 1819 a list was framed that lasted after a fashion for two years. Then there was no general list until 1826, when a list was framed that was partially successful and not wholly abandoned until 1828. A list made in 1829 was a complete failure. In 1831 the persistent under-paying by some firms forced the others to protest and finally resulted in a

general reduction of wages. This led to a strike. There was some violence and much unrest. Committees of manufacturers and weavers came together to revise the list. The masters made a resolution to pay by the piece and not by the day, and finally voted to establish "a permanent committee of twenty manufacturers to watch over the general interests of the trade and adopt such measures as they conceive will prevent encroachments on the part of any manufacturers or any infringement of the spirit of these resolutions by which temporary conditions may be obtained to the injury of the trade generally." The committee made its first report in 1832. The difficulties of maintaining the lists were serious, but the later developments in the trade were based on this foundation.

These episodes in the silk trade are sharper in outline than somewhat similar episodes in the Frame-Work Knitting industry and in the woolen industry. The organization of the workmen in both of these industries was less exclusively an attempt to make wage-lists. In both cases attempts were made to enforce the Statute of Apprentices against the employers whose factories were really contrary to the provisions of the old statute. The chief result of that aspect of these agitations was the inquiry of 1806 and the subsequent repeal of the Statute of Apprentices in 1813. These associations, however, did at times become involved in pure wage controversies. The unwillingness of Parliament and the courts to coöperate in giving effect to the Statute of Apprentices might seem to indicate an attitude of undue favoritism, but it must be remembered that the famous statute was not only obsolete, but rapidly becoming a serious obstacle to vital changes.

## II. THE COMBINATION LAWS

In view of the continuity of growth toward collective bargaining in the silk trades and the frequency of the organization on many other trades, it is peculiarly difficult to estimate accurately the significance of the Combination Laws of 1799 and 1800. These drastic statutes would, if literally



interpreted, prevent any notable development of collective action and it would thus seem that the presumption must be against their literal interpretation.

Enforcement  
of the Combi-  
nation Laws

Furthermore, it was asserted by the clerk of Hume's committee in 1824 that the Act of 1800 "had been in general a dead letter upon those artisans upon whom it was intended to have an effect, namely the shoemakers, printers, paper-makers, shipbuilders, tailors, etc., who have had their regular societies and houses of call as though no such act was in existence. In fact it would be almost impossible for many of these trades to be carried on without such societies which are in general sick and relief societies, and the roads and parishes would be pestered with these traveling trades, who travel for want of employment, were it not for their societies who relieve tramps."

The Statute of 1799 seems to indicate in its detail that the intention of the framers was to insist upon notions of status

Purposes  
of the Act  
of 1799

in order to prevent the dislocations in industry which were likely to be the result of attempts to improve conditions. The act included a clause directed against the employers so that there would seem to be a fairly strong case in favor of these ultra-conservative aspects of the statute. In section 15<sup>1</sup> it is provided that nothing shall be construed to extend or repeal the powers given to the justices of the peace in existing statutes touching combinations of manufacturers, journeymen, or workmen, or for settling disputes between masters and their journeymen, or the rate of wages to be paid to such journeymen. This clause would seem to be a guarantee for the maintenance of conditions as they had existed throughout the eighteenth century. The other clauses of the statute which have attracted more attention are directed toward the newer practices. The objection seems to be not to the collective character of the action, but to the unreasonable desire to change established conditions of status on the part of either masters or men.

The first section has a very sinister sound if not viewed

<sup>1</sup> The wording is slightly condensed.

from the standpoint of this problem of public opinion. "All contracts previously made between journeymen, manufacturers, or other workmen for obtaining an advance of wages, lessening or altering their usual hours of work, decreasing the quantity of their work, preventing or hindering any persons from hiring whom they choose, controlling or in any way affecting any person or persons carrying on any manufacture, trade, or business, shall henceforth be illegal, null, and void." The animus of this section is the absence of registration of these acts before the magistrate.

The very famous prohibition of combinations in section 3 is an unavoidable consequence of reasoning based on conceptions of status. If no member of society had legitimate right to expect significant improvement in material welfare an attempt to secure a higher standard of living by means of the strike must necessarily be regarded as a seditious and wicked thing. We have become so habituated to expectations of improved standards of living that it is hard for us to recognize that such expectations were sincerely regarded with apprehension. In a measure the statute was an attempt to strengthen the hands of the magistrates in the enforcement of wage-lists based upon existing standards of living. It was designed to make it easier to compel journeymen "to work for reasonable wages," and in view of the customs of the period there can be little doubt as to the meaning of the word "reasonable" in this statute.

The Statute of 1800 adds no significant prohibition to the earlier statute, though some of its clauses would remove any possible doubt as to the illegality of any association of working-men. Societies for the collection of funds for the benefit of fellow-workmen were definitely forbidden. This particular prohibition contains some elements of panic growing out of the dread inspired by the French Revolution. It was feared that some of the workmen's societies possessed political significance. These fears were probably ill-founded, but their existence is none the less an explanation of the drastic character of the later statute. This portion of the statute was certainly not enforced.

The Statutes of 1799 and 1800 were only part of the legal basis for the restraint of the associations among working-men and the theory of conspiracy was probably more important than the Combination Laws themselves because the penalties were rather more severe. The prosecution for conspiracy rested on certain very old statutes, a statute of Edward I (1305), and a statute of Edward VI (1549), both embodying the notion that certain kinds of associations could be deemed conspiracies. The earlier of these statutes was not very clearly applicable to the problems arising among wage-earners. The statute of Edward VI, however, was pretty directly aimed at craftsmen. The primary purpose of that statute, however, was to prevent the increase of prices to consumers. The craftsman of that time was more nearly a producer than a wage-earner, but that statute contained certain general clauses against combinations to raise wages. Both of these statutes had been forgotten, but were discovered early in the nineteenth century by energetic lawyers employed by the manufacturers, and this new departure gave the situation of the wage-earner a much more desperate appearance. These doctrines are usually thought of as common-law doctrines, though they rest in large measure upon statutes.

### III. THE LAWS OF 1824 AND 1825

The disadvantageous position of the wage-earner in this period was remedied largely through the activities of a master tailor named Francis Place. He had achieved a very considerable success in business, and, despite serious handicaps, had educated himself. He had been in contact with nearly all the radical elements in the intellectual life of England, including the very scholarly group associated with Bentham. He also maintained a vital interest in political concerns throughout his career, and, after attracting attention by organizing the artisan vote in the Borough of Westminster, exerted a significant influence upon the politics of his locality. Because he was self-educated, he was more active as a thinker than he was successful in ex-

pressing opinions in literary form. In making strength out of weakness he developed a peculiar talent for organizing agitations in which his direct action was scarcely evident. In modern political language he would be termed a "master lobbyist."

The library in the rear of the tailor shop of this eccentric character was the center of the most practical radical undertakings of that quarter-century. The library was unique in many respects. It was in part a <sup>His library</sup> collection of Parliamentary papers at a time when such evidence received little if any attention. There was also a collection of materials connected with working-men's associations of all kinds; clippings from newspapers concerned with working-men's affairs, and summaries of cases in which working-men had been prosecuted. In so far as this collection was concerned with the Combination Laws it was the result of activities deliberately begun in 1814.

In 1814 [he says] I began to work seriously to procure a repeal of the laws against combinations of workmen, but for a long time made no favorable progress. As often as any dispute arose between master and men or when any law proceedings were had and reported in the newspapers I interfered sometimes with the masters, sometimes with the men, very generally as far as I could by means of some one or more of the newspapers and sometimes by acting as a pacificator, always pushing for one purpose, the repeal of the laws. I wrote a great many letters to trade societies in London and as often as I heard of any dispute respecting the Combination Laws in the country I wrote to some of the parties, stated my purpose and requested information.

In 1818 he abandoned his business to his son and devoted all his time to agitation. A small newspaper called *The Gorgon* was subsidized by Bentham and Place and distributed among the trade societies. This <sup>Agitation on the Combination Laws</sup> proved to be the means of enlisting the interest of Mr. Joseph Hume, a member of Parliament of Place's temperament, a professional agitator, an indefatigable advocate of reforms to which Parliament as a whole was indifferent. Place supplied Mr. Hume with much information and most particularly with a mass of manuscript which was

transmitted by Hume to M'Culloch, who embodied the program of the radicals in a notable article published in the *Edinburgh Review* in 1823.

The agitation was brought into Parliament rather unexpectedly. Hume himself seemed unable to make much progress in Parliamentary agitation, but the matter was brought up by other people and it was agreed that a committee be appointed in the following session (1824) to inquire into the entire problem. Provision was made for the appointing of the committee February 24, 1824, and at first it was scarcely possible to get twenty-one members of Parliament sufficiently interested to sit as members. Within three days it had attracted so much attention that members of Parliament were scheming to get appointed to it and it finally consisted of forty-eight members. The success of this committee and its popularity were largely due to the elaborately prepared mass of evidence brought before it by the energy of Place.

Deputations were sent up by the working-people from all over England, and Place opened his house to them.

I had all the town and country delegates under my care; I heard the story which every one of these men had to tell; I examined and cross-examined, took down the particulars of each case and then arranged the matter as briefs for Mr. Hume, and, as a rule, for the guidance of the witnesses a copy was given to each. . . . The workmen were not easily managed; it required great care and pains and patience not to shock their prejudices so as to prevent them doing their duty before the committee; they were filled with false notions, all attributing their distress to wrong causes which I in this stage of the business dared not attempt to remove.<sup>1</sup>

When the committee's work was done, the problem of getting the bills through the Houses of Parliament required similar delicacy and manipulation. "I had still one fear," says Place, "namely of speech-making. I was quite certain that if the bills came under discussion in the House they would be lost. Mr. Hume had the good sense to see this and wholly to refrain from speaking on

<sup>1</sup> All these citations are from the chapter in Wallas's *Life of Place*.

them." The details of drafting were largely dominated by Hume and Place. They prepared the draft of the bill, but a barrister went over the manuscript and gave Place other apprehensions, but fortunately the barrister felt that his duty was done once the bills were printed and thereafter gave himself no further concern about them. "We now got them into our hands," says Place, "altered them as we liked, had manuscript copies made and presented them to the House. No inquiry was made as to who drew the bills. They were found to contain all that was needful, and with some assiduity in seeing members to induce them not to speak on the several readings, they passed the House of Commons almost without notice within, or of the newspapers without." The scheme was nearly wrecked in the Lords by Lord Lauderdale, who perceived that the bills had not been properly printed, and if pressure had not been brought to bear upon him the case would have been lost, but he was finally persuaded to hold his tongue and the three statutes were passed: An Act to Repeal the Laws Relating to Combinations of Workmen; An Act to codify and Amend the Laws Relative to the Arbitration of Disputes between Masters and Workmen; and An Act to Repeal the Laws Relative to Artisans Going Abroad.

The anticipations of the radicals with reference to the repeal of the Combination Laws were rather different than one might suppose. In the writings of Place in particular there is little evidence of an appreciation <sup>Expectations of Place</sup> of the importance of organized collective bargaining. Place felt that the organizations of the workmen were largely defensive measures against the tyranny of the law, and it was his opinion that the repeal of the obnoxious laws would diminish concerted action among the laborers. He seems to have doubted the possibility of any great increase of wages. He believed that wages were at times unduly held down by the masters with the assistance of the repressive legislation, but he was too deeply imbued with the theory of Malthus to believe in the possibility of great material improvement in the condition of the wage-earners through the wage contract. He believed, however, that the repeal of the laws

would promote better relations between the masters and their men, doing away with demonstrations of violence against the masters and against machinery. "Combinations," Place wrote, in 1825, "will soon cease to exist. Men have been kept together for long periods only by oppression of the laws, these being repealed, combinations will lose the matter which cements them into masses and they will fall to pieces. All will be as orderly as even a Quaker could desire. He knows nothing of the working people who could suppose that when left at liberty to act for themselves, without being driven into permanent associations by the oppression of the laws, they will continue to contribute money for distant and doubtful experiments, for uncertain and precarious benefits." This strange misconception of the vitality of workingmen's associations must undoubtedly be attributed to the erroneous theories of the radical group which led them to assume that improvement would be possible only through a reduction in the relative numbers of the wage-earning classes.

The accomplishment of 1824 was too complete. The existing laws were swept off the statute books. The period **Results of repeal** happened to be one of industrial stringency and the workmen utilized their newly acquired liberty to engage in strikes and boycotts on such a scale that the employers were induced to believe that immediate restoration of the old laws was essential. The employers prepared to duplicate the achievements of Hume and Place. A committee was to be secured which was to serve as a vehicle for putting their bill through the House in a similarly expeditious manner. The Government itself selected the members for the committee which was regarded as a purely formal preliminary to the introduction of the drastic bill prepared by the employers.

The activities of Hume made it necessary to appoint him to the committee and a campaign organized by Place made **A new committee** it possible for him to outwit the employers. The committee at first refused to take evidence from working-men, but the motion for the committee had been injudiciously worded and it proved impossible to ex-

clude working-men. The matter was forced on the attention of the committee by a carefully organized campaign; petitions drafted by Place were sent up in great numbers from all parts of the country. Workmen were kept in the passages leading to the committee rooms. Others were stationed on the roads leading to the Houses of Parliament. Great masses of evidence were introduced: the allegations of the employers were shown to be false and the committee was finally induced to report against the employers' bill.

The bill finally enacted differed only in moderate degree from the statute of the previous year. The essential guarantees were embodied in the Statute of 1825, but <sup>The Act</sup> the new act did not give working-men the com- <sup>of 1825</sup> plete immunity from prosecution that had led to the great increase in strikes. Under the new statute certain kinds of acts were designated as unlawful if undertaken by combinations of working-men. It was unlawful to enter into a combination "to induce another to depart from his service before the end of his term," or to use violence or threats toward another on account of his not conforming to the rules and regulations made by any union. It was likewise unlawful for a combination of working-men to urge any one to refuse work that was offered. Under the Statute of 1824 the unions would have been protected in attempts to introduce the "closed-shop" principle; the new statute gave the men guarantees for the open shop, but specifically forbade the doing of things that would be essential to the closed-shop policy.

The Statute of 1824 had guaranteed immunity from prosecution "under Common or Statute Law," the new statute omitted all reference to the common law. <sup>Omissions</sup> Workmen could therefore be prosecuted for conspiracy if the purposes of the combination were not restricted to the determination of the rates of wages and the hours of work. Because all statutes against combination were repealed this prosecution would necessarily rest upon common-law doctrines, so that the provisions of this statute set up a sharper distinction between statute and common-law prosecutions than had previously existed.



Prosecutions for conspiracy became a serious menace to the members and leaders of unions. The trial of the five Glasgow cotton spinners in 1837 and of the officers of the friendly Society of the Journeyman Steam Engine Workers in 1846, tended to emphasize the importance of this offense. The hostile tendency of judicial interpretation was further indicated by the opinion given by Justice Crompton in 1856. All combinations, he declared, which tended directly to impede and interfere with the free course of trade were not only illegal, but criminal. The qualifications embodied in the Act of 1825 were thus a very serious matter to the unions. Some of the tendencies of interpretation were checked by the Statute of 1859, which defined more closely the offenses of molestation and obstruction, but a new doctrine then appeared — the interpretation of the agreement between the workmen as a conspiracy in restraint of trade, so that the constitution of a union would be classified as a non-enforceable contract. This theory struck at the integrity of all workingmen's societies that were in any way connected with activities designed to improve conditions of employment; the societies found it difficult to protect their funds, as officers could not be sued for embezzlement. The position of the unions was thus wholly unsatisfactory until the Act of 1871 gave them an assured status.

The Act of 1871 provided for the registration of trade unions, and, when registered, gave the union the right to hold small amounts of property. Trustees had the right to defend the property of the union in court, and officers of the union were bound to render account of all funds. A registered trade union thus possessed some of the privileges of a corporation without being incorporated. This anomalous position was desired by the friends of the unions: full corporate capacity was not deemed desirable, as it might open the way to suit by some member excluded from working contrary to the interests of the union. The Act of 1871 thus afforded the unions means of organizing for the accomplishment of the purposes that were made legal in 1825.

CHAPTER XVI  
THE PROTECTION OF HEALTH AND WELFARE  
BY THE STATE

I. OBSTACLES TO REFORM AND THE REFORMERS

THE difficulties that beset the history of all problems of state policy appear in a peculiarly intense form with reference to the development of the regulative legis- <sup>Miscon-</sup>lation that now governs the life of the working <sup>ceptions</sup> classes, protecting them from vicious exploitation by landlords and employers. The disposition to assume that Parliament adopted a systematic and thorough-going policy of *laissez-faire* at the beginning of the nineteenth century tends to distort the early history of this entire mass of legislation. Delay that was due to the inadequacy of governmental machinery is frequently attributed to positive unwillingness to take any steps in this direction, and the fumbling uncertainty of the first statutes is assumed to be exclusively due to the desire of employers to retain unfettered control of their business, although it is admitted by all that Parliament did not possess the information requisite. Actual knowledge of conditions in the factories and towns was deficient, and likewise scientific knowledge of the principles that should properly constitute the basis of regulative legislation.

Villages had grown into towns, and towns of five or six thousand inhabitants had suddenly become towns of twenty, thirty, or forty thousand. These new towns <sup>New con-</sup>were scandalously constructed: the buildings <sup>ditions</sup>were unsubstantial and provisions for sanitation were almost entirely neglected. Even the rudimentary provision for drainage then practiced in the older towns was not made. There was much overcrowding. Houses were huddled together, back to back, and then filled with tenants from cellar to garret. The workers, who lived under these debilitating conditions when "at home," were collected in factories or

mines for thirteen, fourteen, or fifteen hours per day. Before the rise of the factory it had been customary to work more or less regularly from daylight until dark, and in most crafts night work was not actually prohibited. When the factories were established the long hours of work were carried over to the new system without any realization of the crucial importance of the regularity imposed by the discipline of the factory.

The condition of the manufacturing population between 1815 and 1840, both in factories and in their own houses, was probably more unfavorable to the health and well-being of the people than at any period before or since. The actual extent of these evils can hardly be exaggerated; but it would seem unfortunate to represent them as the result of a deliberate policy. The neglect of regulative measures was not the result of a *policy* of non-interference in the sense that might readily be conveyed by much writing of the Fabians and persons of kindred sympathies. The unreformed constitution of England was ill-adapted to these new problems of administration. It had no means of carrying out a policy of regulation other than the local officials of parish, county, or town. There was no central administrative system. The old regulative legislation concerning the working classes had been administered by the justices of the peace or by special officials appointed in the parishes. The existing mechanism of local government was thus scarcely adequate for more than the simplest problems of a rural community.

The development of an effective administrative regulation of industry and of social conditions was slow because it was necessary not merely to secure the adoption of new policies, but to create an administrative system capable of giving effect to the new ideas.

The obstacle to reform was in part the inertia of opinion with reference to problems of social policy that were distressingly new, and in part the genuine difficulty of creating an administrative system that should be adequately coordinated with the mechanism of Parliamentary government. Any student

of the institutional history of France under the Third Republic will appreciate the extreme difficulty of securing proper correlation between the legislative and administrative branches of the Government. There is an inherent incompatibility between administration of a centralized type and the fundamental ideas of Parliamentary government. Administrative departments cannot be independent of Parliamentary control, and at times it is well-nigh impossible to conduct efficient departments subject to the incessant meddling of Parliament. If one is willing to recognize the reality of these constitutional problems, there is justification for regarding the history of the nineteenth century as a period of definite and persistent growth toward effective central control of matters pertaining to the welfare of society in general, with particular emphasis upon the welfare of the lower classes. Much yet remains to be done, but it is possible now to perceive the larger outlines of a centralized administrative system.

The resistance to this accomplishment has been serious, and it would be undesirable to convey an impression that might cause it to be minimized, but, at the same time, it is important to recognize clearly the nature of the resistance. There was much casual reference in Parliamentary debate to the catchwords of the *laissez-faire* policy, but these references appear on both sides of the house, and <sup>Empiricism</sup> there is a disposition among many students of <sup>dominant</sup> social legislation to attach small importance to these alleged principles. Scarce any of the major enactments were advocated or opposed on well-defined issues of principle. Substantive legislation was at all times frankly empirical: particular evils were dealt with in such measure as they were brought to the attention of Parliament. It would thus seem that the principles of *laissez-faire* were, of all obstacles, the least important. Ignorance of the facts and lack of proper administrative officers were, on the other hand, fundamental. The chief difficulty in opinion lay in the bias of Englishmen, both members of Parliament and the squirearchy, against central government.

This view was most energetically expressed by the group of idealists who developed a cult of a political philosophy from studies in Anglo-Saxon law. They declared that the essence of English polity lay in the rights of local self-government. They opposed administrative centralization both as a bad policy and as an unconstitutional encroachment upon the rights of Englishmen. Toulmin Smith became the leader of this group, and his book *Local Government and Centralization* affords a significant opportunity to appreciate the extent to which old traditions became an obstacle to reform even when they did not become the basis of a consciously adopted political ideal.

It was genuinely difficult to induce Parliament to create official positions that might result in a real control over local authorities or local funds. The reforms of the poor-laws proposed in 1832-33 by the commission of inquiry were radically amended, in fact wrecked, by the unwillingness of Parliament to delegate sufficient authority to central officials. The factory inspectors appointed under the Act of 1833 are usually regarded as the first agents of a centralized administrative service: the beginning of the invasion of the sphere of authority long guaranteed to local officials. The social transformation brought about by the Industrial Revolution created problems that required a complete reorganization of the government. The reform of the House of Commons as a legislative body is well known. The development of a central administrative system is less consciously recognized as a feature of the past century.

The development of this administrative organization was the result of pressure brought to bear upon Parliament from the outside. The advocates of increased central authority used much the same methods as were followed by the advocates of *laissez-faire* policies in the field of commerce and fiscal legislation. The two movements really proceeded simultaneously in their earlier developments, though the free-trade agitation achieved conspicuous results more rapidly.

England was indeed fortunate [says Redlich] in the almost simultaneous success of two very different, but not necessarily conflicting modes of thought. The first is the Manchester School, usually associated with the names of Mr. Cobden, and Mr. Bright and with the repeal of the Corn Laws in 1846. The second is the philanthropic or socialistic school, usually associated with the name of Lord Shaftesbury and with the introduction of factory legislation. . . . Public Health Legislation and Chadwick's labors may therefore be regarded, not only as a natural development of the work of local authorities from their early duties of keeping the peace, maintaining the roads or supporting the poor, but also as symptomatic of a more general movement for extending the sphere of internal administration and of multiplying the supervisory powers and positive duties of the State in relation to its citizens.<sup>1</sup>

Although Shaftesbury and Chadwick were closely associated in a common cause, and at one time colleagues on the Board of Health, their purposes and ideals were <sup>Shaftesbury</sup> widely different. Anthony Ashley Cooper, later the seventh Earl of Shaftesbury, was a member of a historic family whose members had been conspicuous in government and society for a century and a half. He had the capacities and the opportunity for the political career that was open to members of the aristocracy, but he soon withdrew from the official positions which would have led by natural sequence to ministerial responsibility. He was inclined to devote himself to astronomy, and, if it had not been for certain coincidences, the scientific bent of his mind might have gained permanent ascendancy. It so happened, however, that his attention was directed at the critical juncture to the problems of lunacy and ultimately to the factory question. The provision of better care for the insane was the beginning of his philanthropic work, but he had not at that time made any decision as to his life-work. The larger issue was presented to him by the invitation to undertake the direction of the Factory Bill in the House of Commons. He then realized that identification with the movement for reform would enlist him in a cause which would require his best energies and entail the sacrifice of not a few connections with his own class. The task that was assumed at the time was

<sup>1</sup> Redlich, J.: *English Local Government* (London, 1903), I, 136.

consciously recognized by him as the beginning of a life-work.

The character of his contribution to the reform movement reflects in great measure the circumstances of this decision.

**His attitude toward reform** With Shaftesbury reform was not a matter of principles, but a recognition of specific evils by a quickened social conscience. His work was empirical. A diligent and fearless investigator of concrete evils, he was conscious of no political principle in the abstract sense of the term, but he was convinced that any government was morally responsible for the continuance of preventable evil that had once been brought to its attention. His distinction lay in the untiring energy with which the social condition of the laboring classes was studied, and in the warm-hearted sympathy that enabled him to establish vital personal friendships with people of a class that was far removed from that of his birth.

Edwin Chadwick was of middle-class origin, and unlike Shaftesbury, was uncompromising in the advocacy of a definite principle in the work of social reform.

**Chadwick** Chadwick contemplated a career in law, but devoted a portion of his energies to the writing of review articles. His attention was drawn to problems of public health by an allegation of one of the Government actuaries that the expectation of life had not increased among the members of the middle class despite the improvement of the general conditions of living. The subject was at first studied with the detached interest given to mere stuff for an article. "But as the labor progressed a new train of reasoning came into his mind, which in the end developed into what he called the 'sanitary idea,' that is to say, the idea that a man could, by getting at first principles, and by arriving at causes which affect health, mould life altogether into its natural cast, and beat what had hitherto been accepted as fate, by getting behind fate itself and suppressing the forces which led up to it at their prime source."<sup>1</sup>

<sup>1</sup> Richardson: *The Health of Nations; a Review of the Works of Edwin Chadwick*, I, xxvii.

This essay appeared in the *Westminster Review* in April, 1828, under the title "Life Assurance," and was followed the next year by articles in the *London Review* entitled "Preventive Police" and "Public Charities of France." These three articles contained the essential principles of a definite administrative policy based upon the example of France and Germany. Energetic central control of matters pertaining to the public health was recommended in hopes of significantly increasing the expectation of life of all classes of the community. These articles brought Chadwick more prominently to the attention of the circle of the philosophic radicals; Bentham, James, and John Stuart Mill. It is doubtful, however, if these ideas would have become more than a personal opinion had not official position brought Chadwick into daily contact with the problems involved. He was admitted to the bar and was not indisposed to devote himself to the general practice of law when the constitution of the Commission on the Poor-Laws led to his being offered the position of Assistant Commissioner. After some hesitation he accepted and for twenty-two years was actively concerned as investigator and administrator in the reorganization of poor-relief, factory inquiries, and the development of systematic protection of the health of the public. Although he usually held offices that were technically subordinate, he exerted a controlling influence upon legislative and administrative policy. The sharply defined conceptions that he brought to his task proved to be an obstacle to his permanent enjoyment of official position. It was politically impossible to give full effect to his ideals of administration. He desired a greater measure of central authority than public sentiment was prepared for, and this, together with an unconciliatory attitude, forced him to retire from public life. The Board of Health, organized in 1848 largely as a result of his influence, became so unpopular that it was discontinued in 1854 and Chadwick was sacrificed to popular clamor.

In the common judgment of the time [says Sir John Simon] it was he who upset the coach. As the credit of having originated



the Board of Health had been due to him, so to him was ascribed, with every depreciative term, the policy which had brought it to an end; and Mr. Chadwick bore in those days the distinction which has been many a reformer's crown of laurel, that he was among the best abused men of his time. . . . In the earlier stages of Mr. Chadwick's career, when the essence of his work was to force public attention to the broad facts and consequences of a great public neglect, it mattered comparatively little whether, among his eminent qualifications, he possessed the quality of judicial patience; but in his subsequent position of authority, demands for the exercise of that virtue were great and constant, and Mr. Chadwick seems not to have been gifted with the quality in degree sufficient for administrative success. . . . He perhaps did not sufficiently recognize that the case was one in which deliberate national consents had to be obtained, and in which therefore no real, no permanent, success could be won, except in proportion as the people and their representative bodies should have made way in a necessarily gradual process of education. He could not have advisedly thought it possible to snatch his verdict, and to revolutionize national habits by surprise; but he probably hoped to achieve in a few years the results which not ten times his few years could see achieved; and where others on all sides were hanging back, his ardour seemed ready to undertake the work of all. . . . Mr. Chadwick, beyond any man of his time, knew what large additions of human misery were accruing day by day under the then almost universal prevalence of sanitary neglect, and the indignation which he was entitled to feel at the spectacle of so much needless human suffering is a not ignoble excuse for such signs of overeagerness as he may have shown.<sup>1</sup>

This judgment by a successor in the work of sanitary reform reflects more completely than any statement by an official person the conviction of the reality of the obstacles to reform that lay in the mere inertia of common opinion. Furthermore, the experience of the generations that followed has shown that this devotion to the old traditions of local self-government was not without meaning, and, though it is not always possible to respect the tradition, it is none the less assured that central control is not a remedy for many types of difficulty. Sir John Simon felt convinced that Chadwick underestimated the value of the coöperation of local authorities, and there

Significance  
of Chadwick's  
failures

<sup>1</sup> Simon, Sir John: *English Sanitary Institutions*, 231.

was an element of exaggeration in some of Chadwick's views, but despite extravagances in detail Chadwick's faith in the superiority of central administration has been justified.

## II. SANITATION

The sanitary condition of the towns of the United Kingdom at the beginning of the nineteenth century showed no essential or systematic improvement over the conditions that had prevailed for a century or more. There were beginnings of a new order, indeed, but by reason of deficiencies in technical knowledge and the absence of systematic and comprehensive application of what little was known, the "improvements" resulted at times in intensification of the old evil. Sewers had existed in the larger cities for a long period, but these drains were designed <sup>Sewers</sup> to care for surface water only, a function that was discharged imperfectly enough because of the inadequacy or absence of pavements in the city streets. In many towns uncovered ditches were the only provision made for surface drainage, and in some cases the authorities were satisfied that they had done all that was requisite when they had improved the courses of small brooks or streams that seemed to be well located.

The waste from houses, under these circumstances, was by necessity turned into cesspools, the details of whose construction was largely left to individuals. The <sup>House</sup> results can be imagined. Conveniences were of <sup>waste</sup> the most primitive description. Toward the close of the eighteenth century, water-closets were gradually introduced, but imperfections of design made them less effective than they might have been, and their chief value from the point of view of public sanitation was destroyed by the absence of any general system for the removal of waste from houses in streams of running water. At the close of the eighteenth century the public sewers began to be connected with private houses, but there was no notion of creating a general system of public sewers for the removal of waste. While Medical Officer of the City of London (1848-51), Dr. John Simon suc-

ceeded in abolishing the private cesspool within the limits of the "City," but it was "still almost universal in the metropolis, . . . and in mansions of the West End [was] regarded as equally sacred with the wine cellar." At its best, the older system is not incompatible with public health, and as now administered in many Continental cities it is free from the evils that were responsible for the fevers that destroyed the lives of so many and lowered the standards of health of the entire community.

The evils of the early nineteenth century were primarily due to the inadequacy of the means for the removal of waste in the poorer quarters of the towns. A great mass of material was collected in 1840-42 by the Poor-Law Commissioners, most of it being a reiteration of identical abuses, inadequacies, and neglect. From Liverpool, Dr. Duncan reported:

The sewerage of Liverpool was so very imperfect, that about ten years ago a local act was procured, appointing commissioners with power to levy a rate on the parish for the construction of sewers. Under that act, which expires next year, about £100,000 have been expended in the formation of sewers along the main streets, but many of these are still unsewered: and with regard to the streets inhabited by the working classes, I believe that the great majority are without sewers, and that where they do exist they are of a very imperfect kind unless the ground has a natural inclination, therefore the surface water and fluid refuse of every kind stagnate in the street, and add especially in hot weather their pestilential influence to that of the more solid filth already mentioned. With regard to the courts, I doubt whether there is a single court in Liverpool which communicates with the street by an underground drain, the only means afforded for carrying off the fluid dirt being a narrow, open, shallow gutter which sometimes exists, but even this is very generally choked up with stagnant filth.

There can be no doubt that the emanations from this pestilential surface, in connexion with other causes, are a frequent source of fever among the inhabitants of these undrained localities. I may mention two instances in corroboration of this assertion: in consequence of finding that not less than sixty-three cases of fever had occurred in one year in Union Court, Banastre Street (containing twelve houses), I visited the

court in order to ascertain, if possible, their origin, and I found the whole court inundated with fluid filth which had oozed through the walls from two adjoining ash-pits and cesspools, and which had no means of escape in consequence of the court being below the level of the street and having no drain. . . . The house nearest the ash-pit had been untenanted for nearly three years in consequence of the filthy matter oozing up through the floor, and the occupants of the adjoining houses were unable to take their meals without previously closing the doors and windows.<sup>1</sup> . . .

The remedy for these evils was to be found in the development of the more economical system of removal of waste by means of a continuous flow of running water through properly constructed and ventilated sewers. Chadwick was convinced that such a system of sewage removal would be cheaper in the end than any system dependent upon the emptying of private cesspools by any form of hand labor or by mechanical devices. The initial costs would of course be high, but the moderate daily charge would in his opinion more than warrant the great outlay. The use of glazed earthenware conduits in establishing connections between houses and the main sewers constituted an important technical detail, rendering these smaller conduits entirely inoffensive and sanitary.

The inadequacy of existing methods of caring for these problems was first brought generally to the attention of the public by the Poor-Law Commissioners in the report previously cited. The officers in charge of relief discovered that fevers and other preventable diseases were among the most frequent causes of destitution among adults that were in general able-bodied. The premature death of the bread-winners or long-continued debility would inevitably bring an entire family upon the rates. These cases of destitution were clearly due to the general conditions of life, which were forced upon the poor by no choice of their own. It was an unescapable hazard. Reports made in 1838 and 1839 by the Medical Officers for the Metropolis were communicated to the Ministers, and, in

<sup>1</sup> *Report from the Poor-Law Commissioners on an Inquiry into the Sanitary Condition of the Labouring Population of Great Britain* (London, 1842), 31.

August, 1839, the Poor-Law Commission was ordered to use its agencies and staff in making an inquiry into the sanitary conditions affecting the laboring classes throughout the United Kingdom. The Commission collected detailed reports from its medical officers and from its inspectors. In 1842 a general report, largely the work of Chadwick, was submitted to the Government.

Although it is hardly likely that the conclusions of Chadwick's report were doubted, a Royal Commission was appointed in 1843 to consider the same subject. The Commission soon came to regard Mr. Chadwick as a colleague working with them confidentially, and at no stage in their proceedings was there any exhibition of a contentious spirit between the Royal Commissioners and the Poor-Law Board. Mr. Chadwick, in fact, informed personal friends that he accompanied several of the commissioners on their tours of inspection and actually drafted the first report as well as the recommendations of the second. Chadwick's report and the reports of this Commission made a deep impression upon the public mind so that there was no question of the need of legislation. A bill was introduced in 1845, but political exigencies delayed the passage of general public health legislation until 1848.

The Public Health Act of 1848 made less generous provision for the needs of the time than the reception of the reports would lead one to anticipate. A General Board of Health was established, but the opposition forced the Government to limit its existence to five years, a device which gave factious opposition an unfortunately strong point of vantage in attacking the Board. Local Boards of Health might be set up in towns of more than three thousand inhabitants, in places showing an annual mortality in excess of twenty-three deaths per thousand. The General Board was given power to require the locality to acquire the sanitary powers provided in the act for Local Boards. The duties of the General Board consisted primarily in the supervision and control of the Local Boards. The greatest deficiency in the act lay in the inadequacy of provi-

sion for expert assistance: no provision was made for permanent officials possessed of training in medicine or civil engineering. Two years later the need for medical assistance was met by attaching a salaried medical officer to the Central Office of the Board, but the engineering profession was never adequately represented. The Board was required to consult particular engineers with reference to each proposal, and, as the engineers consulted in this manner must needs be engaged in private practice, there were opportunities for an engineer to secure in official position knowledge that would be of advantage to him in his private capacity. The members of the profession came to feel that the preferments of the Board created an unfair competition in the profession, so that the full influence of the professional group was soon directed against the Board.

The Board possessed sufficient authority to make itself thoroughly hated by the local authorities, who were indifferent to the health of the public, without having any means of requiring these local officials to <sup>Opposition</sup> make use of the powers that they could be obliged to acquire. The natural tendency of this relation between central and local government was not tempered by Chadwick's distrust of local agencies, so that the unpopularity of the Board grew rapidly to serious proportions. As the Board was not directly associated with any ministerial position it was without defense in Parliament. In the beginning the attack was a personal attack upon Chadwick rather than upon the idea of a General Board of Health, and it seemed likely that the Board could be saved by sacrificing Chadwick to his enemies. The temporary character of the provision for the Board, however, prevented the realization of these hopes. The old Board was allowed to lapse, though its more important duties and powers were shortly after provided for by an annual act. This temporizing with the opposition was in the end responsible for a confusion of administrative jurisdictions which ultimately did serious injury to the cause of sanitary reform, and the history of this legislation thus illustrates to a remarkable degree the power of petty selfish interests to

thwart well-conceived designs for reform despite deep convictions of the need of reform measures on the part of many active agencies.

Despite the partial reconstitution of the Board of Health in 1858 under the Local Government Act of that year, the period from 1854 to 1871 can best be regarded as a sort of interim characterized rather by the development of the technique of supervision and administrative control than by actual administrative work. Chadwick had been guided more largely by abstract principles than by technical knowledge. The medical fraternity and especially a number of its members who held various official posts furnished in these years a mass of technical knowledge concerning the prevalence of disease, and the causes of endemic and epidemic diseases. They began to form a body of statistical knowledge and to develop a technique in the collection and interpretation of statistics that was fundamental in health administration. The officials of the census coöperated in giving such form to the publications of that department as would be most illuminating in the study of mortality and its causes. Consciousness of the imperfections of knowledge as well as lack of adequate powers directed the attention of those most concerned with the work toward the laying of foundations for the future. The defective organization of the service was for these reasons no calamity during these years; but it is difficult to regard the legislation of 1872-75 with similar complacency. It was then high time that the hopes of the preceding years should be fulfilled, and it was no longer possible to excuse further delay on grounds of ignorance of the proper means to secure the desired end.

The known deficiencies of the local authorities in carrying out sanitary reforms resulted in the appointment of a Royal Commission in 1868 to investigate conditions and to recommend new legislation. The report emphasized the utter inadequacy of laws that merely created opportunities for the acquisition of powers by local authorities, and the ineffective administration of powers acquired

was likewise pointed out. The Commissioners were disposed to believe that there were too many local bodies possessed of similar or overlapping powers. The closely related jurisdictions of health and poor-law authorities presented, in fact, many instances of ill-defined correlation. The existing central authority was deemed to be unduly diffused among officials associated with different departments of the Government. The Privy Council, the Local Government Act Office, the Poor-Law Board, the Board of Trade, and the Home Office, all participated in the supervision of matters closely related to the public health. The Commission therefore recommended the consolidation of all these related functions in one office, whose political head should have a seat in Parliament. It was suggested that the Health Department and the Poor-Law Administration should have separate permanent secretaries and thus be maintained as independent departments in actual administration, although they were under one political head. There was nothing unstatesmanlike in this recommendation, and if it had been carried out to the letter much good might have been done.

The text of the Act of 1871, however, was not very specific with reference to the departmental organization of the office, and Mr. Stansfeld, the chief of the new office, <sup>The new</sup> took more authority into his own hand than <sup>officers</sup> was contemplated by the Commission. He had formerly been connected with the Poor-Law Board, and upon his appointment proceeded to fill nearly all the places under his direction with persons selected from his old department. The intentions of the Commission were thus disappointed: instead of a Health Department and a Poor-Law Department responsible to a single political head, the President of the Local Government Board, there was in fact a Poor-Law Administration charged with the supervision of the entire mass of sanitary legislation.

This substantial suppression of a distinct Public Health Office was made possible by the administra- <sup>A calamitous</sup> tive confusion that followed the discontinuance <sup>mistake</sup> of the first Board of Health. There was no group of per-



manent officials sufficiently organized to resist this disastrous intrusion of purely personal questions into the large problems of administrative organization. The medical staff that had gradually grown up in the purlieus of the Central Government was not associated with the new department in any permanent or helpful way. Although the administration of the office required expert medical assistance of the highest quality, no appointments were made from the medical fraternity, and existing officials were given the most limited opportunities of making themselves useful. The same disregard of professional medical assistance characterized the appointments of the local authorities, whose action was, in large measure, a reflection of the influence of the central office. The administration of public health legislation thus fell into the hands of a group of poor-law officials most of whom were without medical training.

The laws relating to public health were revised and codified by the Statute of 1875; so all the external appearance of final achievement was given to the legislation of the period. The details of correlation between central and local authorities had been worked out, and the development of grants from the revenues of the Central Government in aid of local rates had removed the chief complaint of local interests. They could no longer plead in extenuation of their conduct an inability to provide financially for the schemes of improvement imposed upon them by the central health authorities. These were, indeed, substantial accomplishments, but it is none the less important to recognize that opportunities were lost of creating an administrative jurisdiction that would have been better able to accomplish the primary ends of social improvements in these directions. The high death-rates that shocked the early investigators are still to be found in many districts, and it is still common to find portions of cities with annual death-rates of over thirty-five per thousand, as compared with a general death-rate of nineteen or twenty per thousand for England and Wales.

One cannot feel that the legislation of the years 1871-75 |

was in any adequate sense a fulfillment of the preparatory work of reform that had been accomplished with distinction under the direction of Chadwick in the forties and under the leadership of the most public-spirited members of the medical fraternity in the years following the retirement of Chadwick from office. The progress in combating preventable disease has been slower than might have been anticipated. The shortcomings of the work of 1871 were peculiarly unfortunate because the departmental organization became sufficiently fixed at that time to render further reform especially difficult. There has been in recent years considerable agitation for a Public Health Office, and, with the beginnings of a general reconstruction of the Cabinet following the armistice of November 11, 1918, this has been one of the first reforms to be enacted into law. The Ministry of Health Act of 1919 provides for the appointment of a minister and the transfer to him of most of the functions of the President of the Local Government Board. It will be his duty "to take all steps that may be desirable to secure the effective carrying out and coördination of measures conducive to the health of the people," including the prevention and cure of disease, the collection and preparation of information and statistics, and the training of persons engaged in health service. It is now believed that this minister will have authority over the administration of the poor laws, and some concern is felt in many circles lest the old system be entirely supplanted and transformed. It is possible, however, that subsequent legislation will make definite provision for the care of the poor.

### III. HOUSING

The health of the population is no less intimately dependent on the general condition of its house accommodations than upon the general sanitary arrangements for the care of streets and the disposal of waste. The explanation of the persistence of high death-rates in urban districts is to be found in the multiplicity of possible causes of premature death. A satisfactory state of public health can hardly be secured until all preventable menace to life is removed. The

housing problem is doubly difficult because it has increased in complexity with the progress of the urban movement, and the general tendency toward greater concentration has created untoward conditions of congestion more rapidly than the legislative and administrative reforms could suppress the old evils.

Attention was first drawn to this aspect of social reform by Shaftesbury (then Lord Ashley) in 1851, and it was his unique experience to superintend the passage of the bill through both Houses of Parliament, as his succession to the earldom took place in the interval between the adoption of the bill in the Commons and its presentation in the Lords. The act was permissive only, enabling local authorities to erect model cottages or tenements. The first considerable attempt to grapple with the problem came in 1867-68, when the Torrens Bill was introduced. This was directed against individual buildings that were unfit for human habitation. The bill contained provision for the condemnation of buildings upon reports by the medical officer of the locality and by engineers. The local authority was then under obligation to recommend suitable repairs if there was any possibility of putting the building into shape. If this were impossible, or if the owner failed to execute the repairs within a specified time, an order for the demolition of the building could be issued. Provision was made also for the erection of a suitable building to replace the condemned structure, but this clause failed to pass, and no such powers were conferred upon the local authorities until 1879. Procedure under the Torrens Act (Artisans and Laborers Dwellings Act, 1868) was complex and many of the legal provisions were obscure. The act consequently failed to accomplish all that had been anticipated.

It should be observed that the machinery of this act, as of other housing acts, was to be set in motion primarily by the reports of the medical officers of the various local areas, so that the inadequacy of the medical inspection provided by the Local Government Act of 1871 was responsible in part for the small number of condemnations of buildings. Medi-

cal officers engaged in private practice, holding a public position at the pleasure of a local authority, were not free to exert themselves on behalf of the public in ways which might conflict with the private interests of their patients and employers. Much good was accomplished under the statute, but it did not become the basis of systematic reforms in all urban districts as had been hoped.

The Act of 1875, introduced at the instance of Mr. R. A. Cross, endeavored to deal with the other serious aspect of urban housing: the congested area, rendered <sup>Congested</sup> unfit for habitation, not by overt structural de- <sup>areas</sup>fects of particular houses, but by the arrangement of the streets and houses in the entire district. Narrow streets, courts, longer passages that were prevented from becoming a thoroughfare by the closing of one end by perhaps no more than a single house, — all these slum conditions would remain a serious menace even if the individual buildings should pass inspection. Under this act certain portions of London were remodeled. Streets were widened and additional entrances were provided for inner blocks.

Since the passage of this act no fundamentally new principle has been incorporated in housing legislation, unless one were to interpret in such light the provisions for the preparation of systematic plans for the development of urban areas on which no buildings at all had been erected at the time of the preparation of the plan. The numerous enactments since 1875 have been predominantly legal and administrative: several amending acts, 1879, 1880, 1882, and 1885; comprehensive amendment and codification in 1890; and further amending acts in 1900, 1909, and 1912. These <sup>Recent</sup> acts have been directed toward the simplifica- <sup>statutes</sup>tion of procedure and have made the obligations of the local authorities imperative in many instances in which they were formerly permissive. But despite the intentions of the central authorities, various interests are sufficiently powerful to prevent the granting of vital powers. It was suggested, for instance, that a clause be included in the Town Planning Act of 1909 providing that once in five years a complete survey

should be made, under the direction of Borough or County Councils, of all houses below a certain assessed value. Such comprehensive surveys are an essential basis for any entirely adequate reform, but the clause was rejected and in scarcely any districts have such surveys been made. The attitude of the Central Government is indicated by the report of the Land Inquiry Committee appointed by Mr. Lloyd George, when Chancellor of the Exchequer in 1912.

Laws embodying a consistent policy have been placed on the statute book; sometimes by one party, sometimes by the other. The issue has never been a party question. Curiously enough there is abundant consciousness on the part of members of Parliament that the statutes are not effectively administered, and there has been not a little tendency to put the blame on the landlords. Much responsibility should rest on their shoulders, for the local authorities have represented propertied interests and have constituted a last bulwark of aristocratic privilege. There has been little opposition to the writing of these laws into the statute book, because many of those interested knew that large reforms could be thwarted, just as they knew that small reforms were politically expedient. This legislation thus constitutes a part of that opposition between class interests of which Parliament is gradually becoming the theater of conflict.

The present housing crisis is partly due to these essentially restrictive laws, and partly due to the influence of the methods of assessing real estate. Provision for the condemnation of buildings and definition of building standards gradually reduced the rate of new building. Land costs remained high because it was easy to hold land for speculative increases in value as long as unimproved land was assessed at purely nominal figures. It has thus come about that there is an actual dearth of housing accommodation throughout the greater part of the United Kingdom. Knowledge of the fact does not allay the class feeling that was already sufficiently well defined. Together with the land question with which it is inextricably associ-

ated, this housing question is one of the most serious issues between Conservatives, Radicals, and Socialists. The actual dearth of accommodation gives color to the assertion that private initiative has failed, so that public endeavor is a necessity. The criticisms of the Socialists and Radicals are undoubtedly sound in most of their details, and yet one is inclined to doubt the necessity of the conclusion that "private initiative" has failed. However, it is difficult to form opinions about such matters at a distance from the localities concerned, and it is entirely possible that there is no significant hope of enlisting the activities of a group of private capitalists other than that which has in fact failed to meet an urgent public need.

#### IV. FACTORY LEGISLATION

Regulations of conditions of employment in factories fall into three groups: regulations designed to protect women and children; regulations designed to assure reasonable safety, with reference to machinery and especially with reference to certain occupational dangers in what are classed as "dangerous trades"; regulations of hours of employment and other conditions for adult men. Direct regulations of this third class have been avoided in English legislation, as in this country, though there is no possible doubt of the competence of Parliament to make such regulations. It was hoped that the famous Ten Hours Act of 1847 would in fact constitute a regulation of the hours for adult men as well as for women and children, but means were found of maintaining the hours of the men, and the act was for a while practically nullified with reference to the protected classes for whose benefit it was designed. In 1850 the definition of the limits of the legal working day actually resulted in a restriction of the hours worked by adult men, and there can be no question of the intention of the framers of the act to accomplish that end. But Parliament has not been willing to legislate specifically for men except with reference to "dangerous trades"; there is a feeling that the principle of individualism should be maintained, in form if not in

Principles of  
legislation

fact. This disposition is due in part to the desire to find the essential legal basis of these curtailments of individual freedom in the doctrine of the police power, and to the intention of keeping the laws within the most certain aspects of that authority of the State. The Factory Code of to-day thus concerns itself with women, "young persons," and specific occupational dangers. This legislation has been consciously founded on the police power from the outset, and though its development has at times been slow it has progressed on the whole as rapidly as conditions of administrative control and knowledge of evils made legislation practical.

At the outset, some trace of *laissez-faire* doctrine may be seen in the disposition to limit administrative interference to the protected classes, but the validity of the *Laissez-faire* non-interference theory was quickly disposed of in the debates of the forties, and in the general history of factory legislation the argument from *laissez-faire* principles was not important. The question of principle was well argued by Lord Howick in the debates on the Factory Act of 1844:

I contend [he says] that you altogether misapply the maxim of leaving industry to itself when you use it as an argument against regulations of which the object is, not to increase the productive power of the country, or to take the fruits of a man's labor and give it to another, but, on the contrary, to guard the laborer against himself, and the community from evils against which the mere pursuit of wealth affords us no security. . . . There is an important distinction which has not been sufficiently adverted to in these debates, between restrictions imposed upon industry with the visionary hope of increasing the nation's wealth, or with the unjust design of taxing one class for the benefit of another, and those of which the aim is to guard against evils, moral or physical, which it is apprehended that the absence of such precautions might entail upon the people.<sup>1</sup>

In suggesting that the principle of regulation of industry according to the doctrine of the police power was adopted at an early date, it is not designed to minimize the importance of the ten hours movement nor to give an impression that

<sup>1</sup> Cited in Hutchins and Harrison: *History of Factory Legislation*, 93.

there were no obstacles to be overcome. It does seem desirable, however, to point out that all estimates of the relation of legislation to the difficulties created by social change require that there should be some correlation maintained between the progress of the new problem on the one hand and the progress of legislation on the other hand. In the history of factory legislation this correlation has not been carefully worked out, and there are many difficulties in tracing the actual progress of the factory movement. Regulation of industry in the homes of workers was very nearly if not entirely impractical, so that the precise dating of the progress toward the factory system becomes a crucial matter in the judgment of the growth of the Factory Code. It would seem that the extent and character of the early factory movement has been frequently misjudged by the writers that are most severe in their strictures upon the slow development of factory legislation. Judgment of the ten hours movement involves a somewhat different issue. It is not clear that the leaders in Parliament were swayed by personal interests in the matter. While there were members who held intense convictions on both sides of the question, the leaders and apparently a majority of the House regarded it as a matter which could not be proved either way. Contemporary judgment of a positive character was based on sentiment or self-interest; many stood aside. The ultimate passage of the Ten Hours Act illustrates the susceptibility of Parliament to any persistent pressure. For the most part Parliament is not an obstacle by reason of its principles, but by reason of its inertia. The achievement of this particular reform was particularly difficult because the case could not be presented with much appeal to persons who were inclined to yield only to arguments which seemed to be certain and definite. The situation was comparable with the present issue of the eight-hour day. Despite the possibilities afforded by studies of industrial fatigue, according to a technique that is now well understood, we do not now know what limits of working hours are really desirable. Many are inclined to suspect the



sincerity of the demand for "short" hours, and it is not yet possible to define the limits that would secure maximum efficiency.

The early Factory Acts, including under the phrase all acts passed prior to 1833, were designed to remedy the flagrant evils that were the outcome of the peculiar dependence of the early factories upon child labor.

Early acts

There was no clear evidence of any consciousness of a general obligation to care for the public health, but merely a recognition of certain special obligations. The condition of pauper apprentices made obvious claims upon the attention of Parliament, for these pauper children were really wards of the State. The Act of 1802, which bore the title, "Health and Morals of Apprentices Act," is therefore a regulation of factory conditions in a somewhat incidental manner. It is not an act that called in question the police power in the sense that became important with reference to the general factory legislation, and it can hardly be considered to be the beginning of the Factory Code. Its provisions could not be applied to what were called free children, children sent in for the day by their parents. For the apprentices working hours were restricted to twelve per day. Night work was gradually to be discontinued, and to cease entirely by June, 1804. All apprentices were to be instructed in reading, writing, and arithmetic, and each child was to receive one suit of clothes per year. Factories should be white-washed periodically, and should be properly ventilated. Separate sleeping-apartments were to be provided for the two sexes.

Dependence upon pauper labor became inconsiderable in the course of the decade following the Act of 1802, and with reference to children as a class most of the older evils were increasingly conspicuous. The investigation of the conditions of child labor in factories (1816) marks the true beginning of a conscious responsibility on the part of the State for those of its subjects who were unable to protect their own interests. The Act of 1819, which

Act of 1819

was the result of the investigation, was less drastic than the bill originally introduced, but the essential principle was written into the statutes. The act applied to cotton mills only. Children under nine years were not to be employed at all, and those under sixteen were restricted to twelve working hours. The allowance of an hour and a half for meals limited the gross time of attendance at the factory to thirteen and one half hours. The administration of the act was entrusted to the justices of the peace who were presumed to appoint certain of their number to be inspectors. The administrative details designed to give effect to these provisions were somewhat amended in 1825, 1829, and in 1831, but the actual content of the acts was not significantly changed.

The need of more comprehensive handling of the new problems was brought to the attention of Parliament by the introduction of a bill by M. T. Sadler in 1831. The manufacturers urged the appointment of a Select Committee of the House of Commons, hoping to secure recommendations that were more acceptable to them than the provisions of Sadler's measure. The results of the hearings in London were a disappointment to them, however, and they moved for a Royal Commission of investigation clothed with authority to proceed to the factory districts and study the problem on the ground. The reformers and the operatives distrusted this committee at first, feeling that its composition had been unduly influenced by the manufacturers, but the presence of Edwin Chadwick on the committee was a guarantee that the interests of the public would receive adequate attention. The report of the committee insisted upon the need of reform, though the details of the recommendations were not identical with those of the earlier proposals.

The Act of 1833, which followed, marks the beginning of a new phase in factory legislation. The great departure lay in the provision for more efficient administration The Act of 1833 of the laws. The supervision of factories was put in the hands of itinerant inspectors, responsible to the Home Office. Their powers were coördinate with those of

the justices of the peace, who were unfortunately allowed to exercise a joint control over factory conditions which for a time nullified the efforts of the inspectors. The appointment of the inspectors, however, was of the greatest importance, for their systematic tours of inspection afforded means of securing information of the greatest value in the elaboration of the Factory Code.

The regulations formerly applied to persons under sixteen were applied in the act to all under eighteen. Employment of children under nine years was prohibited except in silk mills, and between the ages of nine and thirteen only half-time was allowed. The age limits of young persons and children thus assumed permanent form. The working hours of young persons were limited to twelve, and it was subsequently admitted by Sir James Graham in 1844 that the Government presumed that these limitations would in fact apply to all operatives, men as well as women. The failure of the act to achieve this end was due to the omission of sufficient restrictions to prevent the employment of protected persons under complex and evasive relay systems, which complied literally with the statute, though they were wholly contrary to its intent.

These difficulties were met by the Act of 1844. The twelve-hour day prescribed for protected persons was to be deemed to begin as soon as any protected person began work. Hours of work and meal hours were to be regulated by some public clock. The act further provided for the inclusion of all women in the class of protected persons, and hence subject to the same regulations as young persons between the ages of thirteen and eighteen. For the first time also regulations were made to insure the safety of operatives. The employment of young persons to clean and oil machinery while in motion was prohibited, and it was required that the more dangerous types of machines should be encased in protective coverings. Interference by the magistrates with the work of the factory inspectors was brought to an end by the withdrawal of all their powers. The hands of the inspectors were strengthened in a number of respects.

The hours of work for protected persons were limited to ten hours by the Act of 1847, and its effective application was secured in 1850 by the restriction of the time of employment to the period between 6 A.M. and 6 P.M. With this addition the chief outlines of the Factory Code assumed permanent form. The accomplishments of the next generation lay in the regulation of dangerous trades and in the extension of the system of regulation to factories in all branches of industry.

It would be interesting to correlate the extension of the Factory Acts in 1867 and 1878 with the medical knowledge of occupational diseases on the one hand, and <sup>Extension</sup> with the spread of the factory system on the <sup>of principles</sup> other hand. It is the impression of the writer that the rapidity of the development of the factory system is frequently exaggerated, but without specific studies of the various industries no conclusions can safely be drawn. The terminology of the period is terribly confused. The word "factory" is used ordinarily in a much more restricted meaning than is now common among economists. The statutes adopt formal definitions based upon the use of power, or upon the number of operatives. Popular usage at that time seems to have reflected these definitions.

In the hosiery and lace trades the term "warehouse" was used to designate an establishment that seems to be a factory in all essential respects. Power was introduced in hosiery-making in 1846, and, in 1852, 3800 steam-worked frames were known to be in use. To what extent the essential features of a factory system appeared in the industry prior to the use of power, we are not now in a position to state. In some trades, notably in calico printing, the establishment of the factory system must have preceded significant regulation by a considerable interval. It is thus unlikely that any single generalization would apply to all the industries that were brought within the view of the factory inspectors by the acts of the period 1867-78. However, it seems likely that small workshops were common if not predominant in a large part of the industrial field even then, and one may perhaps infer

that such shops had given place to factories in other portions of the field within a decade or two. The fact that we learn more about the factories that existed in the earlier period may close our eyes to the existence of other forms of industrial organization. The factory made its way slowly in the textile trades in which it was first introduced, so that it does not seem unwarrantable to wonder how rapidly it gained a hold upon the other branches of industry.

The most significant feature of the policy underlying the extension of the field of regulation was the inclusion of "workshops" in the Act of 1867. This admirable proposal made an end of the essentially artificial position adopted by the earlier legislation, by which the application of State regulation was made to depend wholly upon the form of organization. It is, however, unfortunate that no provision was made for the classification of the statistics collected by the inspectors. The classifications used follow the requirements of the statutes without any reference to the statistical and economic questions that might be answered by careful analysis of the figures. We are unable to use what would otherwise be the most important source of information on the subject. None of the returns distinguish between women over eighteen years old and those between the ages of thirteen and eighteen. The early returns of the total numbers of persons in factories are unrepresentative because the inspectors had no jurisdiction over some industries in which factories existed. The later returns of totals are unrepresentative because they include many persons who were employed in workshops. The transition from the workshop to the factory in the general industrial field is thus obscured in this important mass of statistical information. By 1871 the factory inspectors were reporting nearly the entire industrial population, but that fact should not lead one to suppose that all the persons enumerated were actually employed in "factories," the heading of the return to the contrary notwithstanding.

The regulation of dangerous trades was begun by the Act of 1864. The statute was directed against the pottery and

Defects of the  
inspectors'  
returns

match trades, which used white lead and phosphorus, and also against various trades in which grinding and polishing developed dust which caused serious lung troubles. The provisions were too general to secure significant results, but the technique of this legislation was further developed in the Acts of 1878 and 1883. The introduction of fans to remove dust, special regulations with reference to meals, and added facilities for personal cleanliness indicated the principal remedies that can be taken. There has been a constant increase in the effectiveness of the regulation of these dangerous trades. The humidity of cotton factories was regulated by the Act of 1889, and in 1898 attention was given to india-rubber works, wool sorting, lead works, and other trades presenting serious occupational risks." The list of trades certified as dangerous is now too long to be given in full, and at present it is within the power of the Secretary of State at the Home Office to issue an order certifying particular trades to be dangerous. Parliamentary action is thus no longer necessary.

The entire mass of factory legislation was amended and consolidated in 1901, so that it now stands as a systematic code.

#### V. THE RELIEF OF DESTITUTION

Provision for the relief of destitution was part of the comprehensive legislative schemes of the Elizabethan period. The conception of status that appears so strikingly in the Statute of Apprentices placed a definite obligation upon the State to guarantee its members what would to-day be called a "national minimum." Any person who failed to secure adequate maintenance in the calling which it was his duty to pursue had the right to receive from the State such assistance as was needed by him or his family. In general it was the intention of the Statute of Apprentices to secure this end by the adjustment of wages to the price of food, but, if these adaptations failed, the individual had a definite claim upon the parish in which he resided. It was not presumed that able-bodied persons should remain

idle, and provision was made for the setting of the poor to work. These workhouses, however, were in intent at least different from the institutions of the nineteenth century: the modern workhouse is designed to be in a measure a penalty, a place of detention whose regulations are mildly unpleasant; the early workhouses were designed to afford an opportunity — jobs for the jobless.

These conceptions were further defined by the legislation of the Stuart period, notably the Laws of Settlement and Removal of 1662. The obligation of the parish to maintain its resident poor required some definition of conditions of obtaining residence, as the burden of relief became in many cases considerable. The Laws of Settlement placed the primary obligation upon the parish in which the individual was born, unless he had acquired a new residence by uninterrupted dwelling in another parish for a year. The possibility of transferring burdens to another parish, however, by shipping off persons on the verge of destitution, resulted in the grant of authority to parish officials to refuse to admit to their parish any persons likely to become a public charge. Although this provision was eminently reasonable from the standpoint of the parishes, it was calamitous to the wage-earners. The skepticism of parish authorities with reference to capacity to earn one's living became a serious obstacle to any movement of the laboring population in search of work. The class of unskilled workers became immobilized in the parishes of their birth. The fear that they would become public charges prevented them from seeking work in any large area and contributed largely to their ultimate destitution. No aspect of parish administration of relief was more disastrous than this artificial interference with the normal circulation of the laboring classes.

The last half of the eighteenth century and the early decades of the nineteenth witnessed a great increase in the amount of destitution in England. The causes of this progressive degradation of the wage-earning classes were highly complex. The unfortunate consequences of the Enclosure Acts must undoubtedly be ac-

counted the most important initial factor in this untoward social change. The agricultural laborer was deprived of the small plots of ground used for gardening and lost his rights to the use of the old common pastures which were broken up into individual parcels of property and generally withdrawn from grazing. The laborer became entirely dependent upon his wages, and at the customary rates these wages were scarcely adequate to the entire needs of the family. The garden patch, the pig, and the cow had long constituted the margin between sufficiency and insufficiency. It must be admitted, however, that the problem created by the defective aspects of enclosure legislation was intensified by the unwise policies of poor-relief adopted in many parishes and by the immobility imposed upon the laboring population by the laws of settlement.

Economic conditions were by no means unfavorable in all the counties of England, but under the existing laws it was impossible for the excess of laborers in one *immobil-* county to flow freely to another county to take *ities* advantage of the new opportunities presented there. There was, of course, some migration to the northern counties, both from the other portions of England and from Ireland, but these migratory movements were less considerable than was desirable and were somewhat restricted with reference to particular classes of the population. A situation that was serious in the extreme was thus terribly intensified by a system of relief that pauperized the lower classes with extraordinary rapidity and completeness.

The wars of the Napoleonic period added to the distress. There were years of extreme depression in agriculture and much localized distress among the artisans. The close of the wars brought no immediate relief. The period from 1815 to 1819 was one of great pressure for all classes of the population, and of course the severity of the hardships was most palpable among the lowest classes. Destitution increased to portentous degrees. Some extreme cases were discovered by the Committee of 1832 which show that at the worst an absolute limit was reached. At Cholesbury, Bucks, the



rates increased until the parish was abandoned. In 1801 the rates were £10, 11s., and there was one pauper. In 1816 the rates were £99, 4s.; in 1831, £150, 5s.; in 1832, £367. At that point the process of collection came to an end. Land-lords gave up their rents, farmers their tenancies, the clergyman his glebe and tithes. The propertied persons actually decamped, leaving the parish to the poor. The clergyman, who remained, wrestled with the problem as best he could, securing temporary relief from neighboring parishes. He proposed to divide the land of the parish among the poor, and it was his hope "that at the expiration of two years, the parish in the interval receiving rates in aid, the whole of the poor would be able and willing to support themselves." There were wide variations in the amount of poverty, but there can be little doubt that these were among the darkest years of English social history.

Some of this distress, notably distress among the handloom weavers, is frequently associated with the transformation of industry by the mechanical inventions, and comment upon this theory has already been made elsewhere. In suggesting other explanations it is not designed to exclude entirely all influences of general social change, but it would seem that abundant explanation can be found in the lack of sound statesmanship shown in the Enclosure Acts and in the systems of relief then existing. It is highly repugnant to the writer to presume that such distress can be a necessary accompaniment of social changes. Some problems were perhaps too difficult to be successfully handled at that time, but the worst of the evils were certainly due to causes within the significant control of British statesmen. No iron law of wages, no Malthusian principle of population, no smug theory of necessary "pains of transition" can diminish the responsibility of British statesmen for the conditions that prevailed. There were attenuating circumstances, no doubt, but the location of the general responsibility can hardly be questioned. The unreformed Parliament has a great place in history, but there were certain kinds of problems that it was ill-fitted to deal

Abandonment  
of a parish

Bad states-  
manship re-  
sponsible

with. The basis for a great democratic legislative body was afforded by its precedents, but the full development of these powers in a truly democratic spirit was reserved to a later age, in which there was more reality of democratic control.

The modes of relief prevalent in the period prior to the reform of 1834 were numerous. Each locality was a law unto itself, so that there was no uniformity. The <sup>Systems</sup> outstanding features of administration were the <sup>of relief</sup> workhouse and various systems of relief given to persons who lived in their own homes. The workhouse was devoted to an indiscriminate housing of orphan children, invalids, and old persons. The administration of the workhouses left much to be desired, but the chief pauperizing elements in relief administration lay in the so-called "out-relief" given to persons living in their own homes. Applicants for relief were sometimes freed wholly or in part from the expense of obtaining house or room. Large amounts of money were also disbursed directly to the paupers. Doles were given at times without imposing any obligations to work upon the applicant: in some cases the applicant was desired to shift for himself without bothering the parish authorities; in other cases the recipient was required to attend roll-call several times during the day, or to remain unmistakably idle in a designated spot. By the allowance system the applicant for relief was employed at the rates of wages current in the district and then given such additional sum of money as might be needed to bring his total income up to a given standard. Under the roundsman system the parish undertook responsibility for the maintenance of the laborers, but it was presumed that the parish therefore acquired right to their time and effort. The pauper labor was sold at auction to the farmers of the neighborhood, and the parish made up the difference between the price offered and a living wage. The form of a wage payment was thus preserved. Other systems were to be found in some places, but they cannot be distinguished from the systems described unless all the details are given.

By astute use of these systems landlords were able to make

the parish responsible for the rents of their houses, farmers were able to make their neighbors contribute to the wages of their laborers, and dwellers in some parishes were able to shift to other shoulders the burden of maintaining a supply of cheap labor. It is scarcely possible to imagine the effect of the system upon the poor. All sense of responsibility for self-maintenance was lost, and the sentiment that might be presumed to exist among members of the same family gave way to a rapacious desire to utilize the claims of parents and children as a means of extorting more money from the "Guardians" of the poor.

The evils of the old systems were thoroughly studied by the Commission of 1832; significant proposals for reform were submitted to Parliament, but it proved to be impossible to carry the entire reform scheme through both Houses. The Law of 1834 embodied merely a fragment of the reform actually recommended by the Commission. The proposals for reform were largely the work of Edwin Chadwick, who was able to bring his colleagues on the Commission to his point of view, though he could not convert Parliament. He desired to create new administrative areas, much larger than the existing parishes, and the local authorities thus constituted were to be subject to the supervision and control of a strong central office. The Law of Settlement was to be abolished or radically amended. The principle of classification was to be introduced: the destitute should be grouped in classes; children, the aged and infirm, the sick, and the able-bodied adults. Each class should be granted the type of relief most appropriate to its needs in a separate building. Relief of the able-bodied was to be made less eligible than self-maintenance by means of the labor test. It was strongly urged that no relief should be given except in a well-regulated workhouse, and the conception of a workhouse was altered in a number of particulars. There was to be sufficient discipline to make it something other than a poor man's club, and the diet was to be nourishing without being attractive.

Of all these ideas two only made a real impression upon

contemporary thought. The enlargement of the administrative area was seen to be essential, and the notion that poor-relief should be less satisfactory than self-maintenance was warmly espoused. All could understand that the terrible curse of the old poor-law was its pauperization. Less sentiment and more reason was recommended, and it was possible to spread the ideal of a discriminating and somewhat niggardly charity. There was sound sense in these recommendations, but the high statesmanship lay in the other features of Chadwick's plan. Chadwick, however, was practically alone in advocating a centralized and classified system of relief, and despite his years of service with the Poor-Law Board it proved to be impossible to lift the administration of the Poor-Law to a higher plane than was embodied in the idea of the "workhouse" test. Some slight progress was made toward classification, but in general the evils of the mixed workhouse were tolerated without much clear consciousness that they were evil.

The appointment of the Royal Commission on the Poor-Law in 1909 was an indication that the time had come for important reforms, but the sharp division of opinion revealed by the reports of the majority and minority probably constitutes an obstacle to thoroughgoing reorganization of the Poor-Law Administration. The attitude of the Government to the report leads one to believe that the appointment of the Commission was designed rather to satisfy certain radical elements than to prepare the way for new legislation as is usual in such cases. No general legislation has been submitted to Parliament in connection with the report. The Mental Deficiency Act of 1913 embodies certain aspects of the recommendations. The Relief Regulation Order of 1911, the Boarding-Out Order of 1911, and the Classification Order of 1914 are admittedly inspired by the majority report. These administrative orders represent the extent of attempts on the part of the Government to give effect to the results of the inquiry. The minority of the Commission was controlled by the Fabians under the leadership of Mrs. Webb. Their report, written by her, is one of

the most elaborate of any of the proposals for concrete reforms that have come from that source.

The report of the majority falls into two distinct divisions: recommendations for reorganization of the entire adminis-

**Majority**                    administrative mechanism for relief of destitution; rec-  
**recommenda-**                    ommendations for the application of the aspects  
**tions**                         of Chadwick's plan of 1834 that were unaccepta-

ble at that time. The desirability of giving some out-relief is recognized, but careful supervision of such cases is clearly necessary and the best means of assuring discreet administration of out-relief were sketched. The discontinuance of the mixed workhouse was strongly urged. Various systems for dealing with children were suggested. For the aged, the mentally deficient, and the sick special institutional treatment was recommended, and as it would be impossible for individual Poor-Law Unions to provide proper facilities, it was proposed that they should combine for these purposes. In so far as these recommendations can be accomplished without changes in the general administrative organization of the present department they have been adopted by the Board. But there is no disposition to introduce legislation contemplating the administrative reorganization that is undoubtedly desirable. At the outbreak of the War it seemed that the question had been indefinitely postponed. It is now certain that the years of reconstruction will make this matter a live issue.

## VI. SOCIAL INSURANCE

The term "social insurance" is loosely applied to a wide group of measures designed to distribute the burdens of disabilities due to industrial accidents, sickness, unemployment, disability, and death. It has long been recognized that the direct occasion of much pauperism is to be found in contingencies that are by nature insurable, and it is thus obvious that a certain measure of pauperism can be prevented

**Anticipations**                    or met by forms of provision that are less humili-  
   ating to the individual and more just in their  
apportionment of burdens in society at large. The more op-

timistic collectivists anticipate such complete provision for the contingencies of life that there will be no need of continuing present methods of direct relief of destitution. Poverty is likened by such reformers to a preventable disease that can be entirely overcome if proper measures are taken. It is not altogether clear, however, that relief of distress by means of insurance methods is in all instances more economical and preferable to direct relief out of poor-rates.

The different contingencies that must needs be met present widely different opportunities for the distribution of the burden of the disability. The dangers of accident <sup>Accidents</sup> in industry, agriculture, or domestic employment can be made a burden upon the industry in general, and at the present time there is little disposition to question the wisdom of placing definitely upon the employer the immediate burden of occupational accidents, with the understanding that the increased cost of doing business can be transmitted to consumers of the goods in higher prices. The burden of a hazardous occupation thus falls upon the entire body of consumers of the article instead of crushing the individual workman and his dependents and ultimately increasing the tax-rate in the locality.

In other cases it is not possible or desirable entirely to relieve the individual and the taxpayers of all burdens. Sickness, permanent disability, old age, and death <sup>Other contingencies essentially different</sup> are all insurable contingencies, but there is no ground for making them charges upon the occupation as distinct from charges upon the individual and the taxpayers. It is obviously impractical to require persons to make provision for an uncertain future when their means are insufficient to satisfy all the legitimate needs of the present. Providence is a virtue which the poor cannot wisely practice. Contributions toward insurance by the poor, and even by artisans who are well above the poverty line, cannot be required on any large scale. It is perhaps desirable that some nominal contribution should be expected of them, but it is inconceivable that the cost of insurance should be borne by those whose economic independence is most jeopardized

by sickness, premature disability, and old age. The charge must needs fall largely upon the community either as consumers or as taxpayers, and it seems desirable that the burden should become a direct obligation of the State.

In so far as social insurance is financed from the public treasury it differs only in form and in name from the relief destitution by the Poor-Law authorities. In all countries, it has been found that the relief of the sick, the infirm, and the aged constituted a large part of the problem. The elaboration of insurance legislation is really a form of the policy of classification recommended by Chadwick in 1832 as the sound basis for any system of poor-relief. The insurance legislation would free the recipient from the legal disabilities usually attached to the receipt of poor-relief. The insurance stipend, too, would assume the form of a purely contractual payment as distinct from a charitable dole.

In practice, it is likely that insurance against sickness and disability reaches a wider range of need than poor-relief, and that each case would be more adequately provided for. Insurance is thus a method of guaranteeing a superior type of provision for distress of certain kinds. Insurance against old age has as yet remained distinctly inferior to the provision made by the relieving authorities under the poor-laws. The pensions are small and the age at which pensions begin is high. Some income is assumed, both by the size of the stipend and the age at which it commences. Such insurance can hardly prevent particular individuals from coming on the poor-rates; it adds a little to the income of people who would not come on the rates and probably saves them from much hardship.

The burden of industrial risk was placed by the common law upon the workman. The employer was responsible only for the most direct personal negligence, so that in large enterprises in which the workmen seldom came into any direct relations with the employer there was scarcely any opportunity for showing that the employer

was personally at fault. The injustice of this legal theory was remedied in part by the Act of 1880 which made the employer liable for all accidents caused by defective works or machinery or by the negligence of persons in his employ. Such provision for recovery of damages was inadequate in theory and in practice. The calamity is not mitigated by establishing the fact of negligence on the part of the individual injured, and there is certainly little purpose in paying to lawyers money that would suffice to set the injured party on his feet.

The defects of the modified common-law system were recognized at an early date and there were attempts made in the early nineties to apply the general principle of the Compensation Laws. There was opposition, especially in the House of Lords; but strangely enough the Conservatives in 1897 passed a genuine compensation law, though the Liberals had not been able to secure the Lords' assent to a much less thoroughgoing measure. The Law of 1897 was somewhat limited in scope, and the benefits provided were not as liberal as they have subsequently become, but the essential principle of compensation was embodied in the act. It was no longer necessary for the workman to prove neglect on the part of the employer, but merely the fact of injury in the course of his employment. In 1900 the law was amended to include common and agricultural laborers; and in 1906 provision was made for the application of the principles of the act to clerks, domestic servants, and sailors.

In event of death the sum of three years' wages is paid to the dependents, but not more than £300 nor less than £150. If there are no direct dependents the employer is responsible merely for funeral expenses not exceeding £10. In event of disability exceeding one week, half the average weekly wage must be paid, but not more than £1. If the disability becomes permanent, the same rate of compensation is paid during life. The Act of 1907 makes somewhat more liberal provision in a number of administrative details.



The English legislation does not require the employer to insure himself against the risk of accident nor does it provide for any special supervision of the private corporations that undertake the business of industrial insurance. The employers are allowed to utilize the existing Friendly Societies, but most insurance is now carried by private companies.

**Existing difficulties** The expenses of management of this insurance legislation are high, and more is consumed in legal fees than is desirable. The persistence of the older laws creates a number of legal problems that give rise to an unfortunate amount of litigation. The leaders of the working-men are not friendly to this legislation, as it seems to compete with their Friendly Societies and Trade Unions. The strength of unionism was in part based on the prospect of the benefits offered by the societies, so that this facilitation of recovery of damages seemed to threaten the existence of organized labor. Official opinion in the labor world is thus apparently inconsistent with the best interests of the class.

The hostility of the working-men's organizations was more pronounced with reference to the National Insurance **Health insurance** Act of 1911 which made provision for insurance against sickness. The political difficulty was clearly foreseen by the sponsors of the statute, and an attempt was made to conciliate labor by utilizing existing Friendly Societies and other benefit associations. But this device was only partially successful despite the fact that the working-men's societies had enrolled scarcely more than a quarter of the industrial population. The new act makes insurance against sickness and disablement compulsory upon all workers between the ages of sixteen and sixty-five. The scheme is contributory: men pay fourpence weekly, women threepence; employers, threepence for each worker; and the State two ninths of the benefits payable to men and one fourth of the benefits payable to women. The employer is responsible for the payment of his contribution and for the deduction of the worker's contribution from wages.<sup>1</sup>

<sup>1</sup> The schedules of contributions are really more complex than this summary would suggest.

## PROTECTION OF HEALTH BY THE STATE 427

Benefits are paid out through some approved society or through the Post-Office. The benefits include: provision for medical attendance and treatment in a sanatorium if necessary; the payment of a weekly sum for not more than twenty-six weeks as a sick benefit, or during the continuance of incapacity as a disability benefit; and a maternity benefit of thirty shillings. Some reductions are made in the case of unmarried persons without dependents. The calculations of actuaries gave reason to anticipate that the contributions required in the act would produce a surplus of ten per cent over the costs of management and the primary obligations with reference to benefits; it is intended to apply this surplus to what are classified in the act as additional benefits: free medical attendance for dependents of the insured; payments to distressed members; increase of sickness and disablement benefits in all cases or in the cases of married men; allowances to the insured during convalescence; the building and maintenance of convalescent homes; payment of pensions or superannuation allowances; extension of the maternity benefit.

The act provided also for insurance against unemployment, supplementing the Labor Exchanges Act of 1909 by introducing out-of-work benefits in a select list of trades: building, construction of works, ship-building, mechanical engineering, iron-founding, construction of vehicles, and saw-milling. Unemployment insurance With reference to these trades insurance is compulsory: both the employers and their men contribute twopence halfpenny each week, and the State adds an amount equal to one third the total contribution of both combined. Persons under eighteen contribute one penny only each week and the other contributors in like proportion. No benefits are to be paid during the first week of unemployment, nor for unemployment resulting from a strike in the trade in which the insured is engaged. The workmen receive seven shillings per week when out of work, but no benefits shall be paid for more than fifteen weeks in any one year nor in excess of the proportion of one week's benefit for each five weeks of contributions.

Provision for voluntary insurance against old age has existed in Great Britain since 1833. The National Debt

**Old age** Office at that time made arrangements to sell annuities of not more than twenty pounds on one life. The amounts allowed have since been increased, and in 1864 the Postal Savings Bank offered similar opportunities. These facilities were used in a small way by the middle class, but in so far as insurance was taken out most of it was taken through private companies or friendly societies. The passage of the German Insurance Law in 1884 attracted attention to the subject, and in the years that followed attempts were made to secure the passage of similar legislation. A Parliamentary Commission reported that the administrative difficulties were insuperable, and for a time the issue was not brought up in Parliament, though some advocates of the policy continued to keep it before the public. In 1900 a departmental commission reported favorably upon the subject and suggested the general outlines of the present statute, but the project did not become law until 1908.

No contributions are required from the prospective recipients of pensions, the entire burden being assumed by the State. All persons of seventy years of age, who  
**The Pension Law** for twenty years have been British subjects and not in receipt of poor-relief, are entitled to a pension if their income does not exceed £31 10s. The amount of the pension varies with the income: ranging from five shillings per week for persons with incomes not exceeding £21, to one shilling for persons with incomes exceeding £28 17s. 6d., but less than £31 10s. It is the intention of the act that the aggregate income of the pensioner shall not exceed thirteen shillings per week.

It is early to judge of the effect of this statute, but it seems scarcely possible that it should be of much significance in reducing the burden of poor-relief. The exclusion from the benefits of the law of all persons who have been in receipt of poor-relief will probably exclude from the sphere of operation of the act many of those members of the poorer classes who come upon the rates in old age. Furthermore, the rela-

tively small stipend makes it merely supplementary in character. The act will doubtless be productive of much good, but its benefits will accrue to an essentially different class than those who become public charges. As it stands, the statute will contribute little toward the abolition of poverty.

It may seem ungracious to call attention to the deficiencies of this legislation, but it must be remembered that these laws were defended in Germany as a different way of making provision for poor-relief, and it was actually declared that the expenditure for poor-relief would diminish. Optimists in England and the United States have cherished hopes that such measures would lead to <sup>Probable</sup> <sub>results</sub> the abolition of poverty, though they have never encouraged the belief that the adoption of such legislation would reduce the burden of the poor-rates and thus justify in part the great expenditure incurred. There has been no reduction in the burden of the poor-rates in Germany, and it does not seem likely that there will be any diminution in the amount of relief that will have to be provided in England. These new forms of provision for distress will, for a long time at least, be an increase in public burdens. They are an expression of increased consciousness of the urgency of the social problem, and this attitude of mind leads to dissatisfaction with the old standards of relief. It therefore becomes an interesting financial problem; how far can these new measures be carried without imposing excessive burdens upon the community?

Those who believe that it will be possible to provide adequately for the needs of all have called attention to the fact that a *pro-rata* division of the national income <sup>Can poverty</sup> <sub>be abolished?</sub> would furnish each family with the necessities of life. The probable cost of these various insurance schemes affords a different basis for speculating about the power of the community to make provision for the needs of all its members in such fashion as would abolish poverty. Complete computations have probably not been made upon the generous scale that would be necessary, but the actuarial experience gained in preparing the existing legislation would

hardly encourage the view that the abolition of poverty is within the scope of any system of taxation that is now conceivable.

The sanitary idea as conceived by Chadwick must be accepted as the fundamental ideal of protective legislation: our health legislation must seek to overcome fate and give the individual a chance to accomplish the full span of life. Preventable causes of disaster, whether physical or economic, must be forestalled as far as may be; but it would seem that we lose all consciousness of human limitations when we require of ourselves the actual accomplishment of all that we must strive to attain.

## CHAPTER XVII

### THE DEVELOPMENT OF THE RAILWAY

#### I. GENESIS OF THE RAILWAY

THE modern railway unites two elements of mechanical technique that developed independently for considerable periods: the prepared roadbed appears in its simplest form in the tram lines that began to be laid down in the collieries as early as the seventeenth century; the mechanical tractive power developed naturally as one of the applications of the steam engine. The earlier development of the stationary engine resulted in the use of the cable system of transmitting power at the outset, but the successful application of the non-condensing engine to the problems of the locomotive soon made the modern railway possible. The intimate connection between these two features was not quickly perceived. The inventors of the locomotive were slow to see the importance of a prepared roadbed with rails: the proprietors of the tram lines were equally slow to see the need of steam tractive power. It is thus possible to distinguish three separate inventive achievements: the invention of the tram line with rails, the invention of the locomotive, and the invention of the "railway."

Although tram lines were used in all the mining sections of England the Newcastle coal-fields took the initiative in the principal innovations. The collieries were near the coast so that little outlay of capital was necessary to make experiments in improvements of transportation to the wharves. Each mine usually attended to the transportation of its own coal to the port. Under such circumstances the resourceful proprietor enjoyed an opportunity that was unusual. The first improvements were made in 1630, when plank roads were laid for the coal cars at one of the collieries. The enterprise was not immediately successful, but in 1676 the system of plank ways was in general

use throughout the district. Large sums were paid for rights of way. It is not certain that any of these early tram lines used cross-ties to bind the rails or planks together; in most cases, the lines for each wheel were wholly independent. Beginning in 1738, experimentation with various devices to protect the planks with metal became common, and toward the close of the century something like the modern rail had been developed. The earliest devices were mere strips of iron attached rather imperfectly to the ways. In 1767 the

**Iron rails** iron works at Coalbrookdale cast some rails with flanges to keep the wheels on the track. At collieries belonging to the Duke of Norfolk at Sheffield flanged rails were laid on wooden cross-ties in 1776, but workmen tore up the road and forced the inventor to flee for his life. The modern combination of a flanged wheel with an edge rail was first worked out in Leicestershire, by William Jessup, but this system was not generally introduced at that time.

The canal companies were the first to build tram lines designed to serve as common carriers, a number of lines being projected to connect the canals with mines or towns that might add to the traffic. These **Common carriers** feeders to the canals were the first tram lines to receive Parliamentary authorization; their charters are thus the first charters of a type strictly comparable to the instruments of incorporation granted the early railways. The earliest grant is of 1776, to the Trent and Mersey Navigation Company, with reference to lines projected in Staffordshire. Other grants were made in 1792, 1793, and 1802; in all, about a half a dozen lines. A few independent tram lines were projected early in the nineteenth century: notably the Wandsworth-Croydon line (1801) designed to serve London, and the Croydon-Reigate line (1803). These lines were not financially successful, and if it were not for their place in the history of railway legislation they would scarce be worthy of mention. They represent a phase in the development of the tram line, however, and their history shows clearly that such roads had little hope of success without motor traction.

The application of the steam locomotive to the tram line was, in the first instance, the work of Richard Trevithick. He must be regarded as the real inventor of both <sup>The loco-</sup> locomotive and railway, despite the failure of <sup>motive</sup> his work to introduce either of these inventions into general use. As a matter of fact, his use of the locomotive on rails was incidental and he did not perceive the vital need of the prepared way. It may be that fuller consciousness of this would have come had he remained at the iron works at Pen-y-darran, but other ventures called him elsewhere and monopolized his attention. It would perhaps be an accurate account of the matter to say that the development of the railway and its locomotive was crowded out of his eventful life by the completion of other projects of less difficulty and greater immediate prospectiveness.

None of the commandingly great inventions was less truly the work of one man than the locomotive. The two types of steam engine are closely enough related to make <sup>Non-condens-</sup> the development of the non-condensing engine <sup>ing engines</sup> a logical outcome of the condensing engine as built by Watt. In fact, one of Watt's workmen, Murdock, made various experiments with a model for a non-condensing engine shortly after Watt's engine was effectively brought before the public. Watt discouraged this attempt with apparent sincerity. He could not believe that it would be possible to construct boilers of sufficient strength to resist the high pressures that would be essential to such a machine. Watt's engines seldom developed steam pressure more than sufficient to offset the atmospheric pressure; their actual working power was due to the partial vacuum created behind the piston head by the condensation of steam. The effective pressure per square inch on the piston head was thus very small, perhaps eight or ten pounds; large pistons were almost essential to the requirements of power. These low pressures taxed the early boilers to the limit of safety, and, in great measure, the development of the high-pressure non-condensing engine was a result of the perfection in the handling of sheet iron. Trevithick was one of the pioneers in the use of iron tanks, and



one is tempted to believe that his work with the non-condensing engine was largely based on his faith in the strength of his sheet-iron boilers. His early engines developed steam pressures of fifty or sixty pounds to the square inch, and, as there was no attempt to create a vacuum on the off-side of the piston head, the effective working pressure would be about thirty-five or forty-five pounds to the square inch. The size of the piston could thus be greatly reduced and the entire machine was more than correspondingly reduced in bulk, as no condensing chamber was necessary. The compactness of this type of engine was essential to the development of a locomotive. The slow perfection of the type was due to the lack of faith in boilers and the difficulties of producing sufficiently high pressure to make the engine practical.

The incredulity of the members of the profession is well illustrated by a letter written by Trevithick from Coalbrookdale in 1802. He was working there with a non-condensing pumping engine:

**Trevithick's experiments**

The engineers at this place all said it was impossible for so small a cylinder to lift water to the top of the pumps, and degraded the principle, though at the same time they spoke highly in favor of the simple and well-contrived engine. They say it is a supernatural engine, for it will work without either fire or water, and swore that all the engineers hitherto are the biggest fools in creation. They are constantly calling on me, for they all say they would never believe it unless they saw it. . . . After they had seen the water at the pump head, they said it was possible, but that the boiler would not maintain its steam at that pressure for five minutes: but after a short time they went off, with a solid countenance and a silent tongue.<sup>1</sup>

As usual in such cases there was some truth on both sides: Trevithick's faith in his new engine was fully warranted, but the difficulties that loomed large in the minds of his fellow-engineers were a serious obstacle to the use of this type of engine for as much as twenty years.

Trevithick's first locomotive was built in 1801 at Camborne. It was defective in a number of details, and though it would run short distances it was incapable of any continu-

<sup>1</sup> Trevithick, F.: *Life of Richard Trevithick*, I, 153.

ous performance. This machine was designed to run on the highways, as were most of his early models. <sup>Early loco-</sup> Patents were taken out in 1802. The details <sup>motives</sup> are not very clearly specified, but it seems evident that it was intended to use the exhaust steam in creating a forced draft. This is the most important single detail in the early engines, for this use of the exhaust steam and the use of a tubular boiler were the ultimate means of overcoming the difficulties of raising sufficient steam pressure to make the machine wholly practical and economical. It was possible to make locomotives that would go long before it was possible to make machines that could really compete with horses.

Several road locomotives were built by Trevithick. One was run ninety miles over the roads to Plymouth under its own steam. Most of these machines were exhibited at London, and thus gained considerable publicity. The "Catch me who can," 1808, was run on a circular track at London, but it was designed as a road locomotive. In February, 1804, Trevithick tried out a tram locomotive at the iron works of Pen-y-darran:

The engine with water included is about five tons. . . . The steam that is discharged from the engine is turned up the chimney about three feet above the fire, and when the engine works forty strokes per minute not the smallest particle of steam appears out of the top of the chimney. . . . The fire burns much better when the steam goes up the chimney than when the engine is idle. Yesterday, we proceeded on our journey with the engine; we carried ten tons of iron, five wagons, and seventy men. It is above nine miles which we performed in four hours and five minutes. We had to cut down some trees and remove some large rocks out of the road. The engine while working went nearly five miles per hour.

This account is so complete that it is impossible to deny that Trevithick accomplished all the essential tasks of applying the steam engine to a railway, and yet his work did not result directly in the building of railways. He put a locomotive on rails, but he had no realization of any economies to be derived from a carefully prepared roadbed, with rails and a specially planned series of grades. He shared the impression

that was common at that time, supposing that the future of the new tractor was on the highways.

In the developments that followed his early experiments attention was given primarily to the building of steam carriages to take the place of the stage-coaches. **Motor carriages** In the decade of the twenties there were several steam carriages sufficiently perfected to operate on the roads with appreciable continuity. Gurney built a steam coach in 1827 that operated in the vicinity of London for two years. On one trip he made eighty-five miles in ten hours, including all stops, and he frequently attained twenty or thirty miles an hour for short distances. A line was operated by steam power in the Epping Forest for a short time, but the roads proved to be too rough. Steam coaches were also operated regularly between London and Stratford, and between Cheltenham and Gloucester. Proprietors of coach-lines became apprehensive, and at their instance an investigation was made by Parliament. The report of the Parliamentary committee in 1831 affords the best indication of contemporary opinion that could well be desired. One must remember that this is subsequent to the opening of the Liverpool and Manchester Railway. The committee reported that "the substitution of inanimate for animal power, in draught on the common roads, is one of the most important improvements in the means of internal communication." Its practicability was declared to be "fully established," and the committee ventured to predict that its introduction would "take place more or less rapidly, in proportion as the attention of scientific men shall be drawn, by public encouragement, to further improvement." They felt that the success of the new system had been retarded by prejudice, adverse interests and prohibitory tolls.<sup>1</sup>

The concentration of attention in the south upon this aspect of motor transport left the discovery of the **Colliery problems** real significance of rails to the engineers of the collieries of the Newcastle district. They took the lead in

<sup>1</sup> Cited by Thurston, R. H.: *The Growth of the Steam Engine* (New York, 1902), 170.

applying power to the tram line for precisely the same reasons that had forced them to apply the tram line to their peculiarly difficult problem of transportation. None of these engineers were in any true sense inventors of locomotives; at best they were inventors of certain parts or features of the machine, but they were the real inventors of the railroad. In the group of men that contributed to this new departure George Stephenson is the commanding figure, but it should always be remembered that he was not working alone. He owed much to some of his early contemporaries. The circumstances of his profession brought him in touch with the more energetic of the engine-builders of the north, and his work with the locomotive was clearly inspired by their successes and failures. His greatest talent lay in doing more perfectly, and with clearer consciousness of the mechanical problems involved, the things that had been done and were being done by his fellow-engineers. He was a self-made man of great ingenuity; resourceful but intensely practical. His accomplishments, especially the earlier accomplishments, were all in the course of the day's work.

The locomotive came to the north soon after Trevithick's first models were completed. According to some accounts, the engine built by Blakett at Wylam Colliery Experiments at the coal mines in 1804 was put together with the assistance of Trevithick's plans. Other accounts deny any direct connection with Trevithick. It is difficult to be certain of the details, but it would be most creditable to the intelligence of the northern mechanics to assume that they were working independently, for if they really had any of Trevithick's designs they failed to understand the most important features of them. The early northern designers were slow to perceive the importance of the use of the exhaust steam, and incredulous on the matter of smooth wheels. They found it hard to believe that there would be enough friction to give the wheels a grip on the track. It may be that heavy grades were partly responsible for the persistent use of rack rails in the early power lines, but there was some failure to understand principles.

When Stephenson addressed himself to the problem Blenkinsop had built a rack-rail locomotive that worked effectively, Hedley had patented a smooth-wheeled locomotive, and many collieries were using stationary engines to draw cars up inclined planes with cables. The tram lines were being divided into sections; fairly level reaches were operated with horses, the inclined planes by cable. Stephenson was in charge of the engineering work at the Killingworth Colliery, and in 1813 he induced the proprietor to apply steam traction. In the following year an engine was completed after the Blenkinsop design. The machine was defective in many respects and Stephenson at once set to work to improve it. A machine was turned out in 1815 which was wholly practical. The model was used for several years and some of the machines remained in use for a generation. It was at this point that Stephenson began to diverge from his predecessors. He undertook a scientific study of the entire problem of mechanical transportation.

The first fruit of these studies was a new type of rail, which was patented in 1816 and immediately put into use at the colliery. Then in 1818 were performed the truly epoch-making series of experiments on the resistances<sup>1</sup> to which carriages were exposed on

<sup>1</sup> It may be of interest to study in connection with these conclusions of Stephenson a table of resistances that embodies the results of modern experiments. In modern practice it is usual to avoid grades of more than two per cent, though railroads in the United States have frequently tolerated higher grades, even up to six per cent. In England there are few severe grades; Stephenson's principles having been accepted by the engineering profession.

Per cent	Rate of grade, Feet per mile	Total resistance— Pounds per ton
Level	.....	8
0.2	10.56	12
0.4	21.12	16
0.6	31.68	20
0.8	42.24	24
1.0	52.80	28
1.2	63.36	32
...	.....	..
2.0	105.6	48
3.0	158.4	68
4.0	211.2	88
5.0	264.0	108
6.0	316.8	128

(Wallington: *Economics of the Location of Railroads* (1887), 669.)

railways. These experiments led Stephenson to conclude that it was essential to reduce rolling resistance to a minimum, and that a grade of one per cent was sufficient to reduce the working efficiency of the locomotive by fifty per cent.

This fact [writes the son] called my father's attention to the question of gradients in future locomotive lines. He then became convinced of the vital importance, in an economical point of view, of reducing the country through which a railway was intended to pass to as near a level as possible. This originated in his mind the distinctive character of railway works, as distinguished from all other roads: for in railroads he contemplated that large sums could wisely be expended in perforating barriers of hills with long tunnels, and in raising low ground with the excess cut down from the high ground. In proportion as these views fixed themselves upon his mind, and were corroborated by his daily experience, he became more and more convinced of the hopelessness of applying steam to common roads.

This statement by Robert was written long after the crucial experiments were made, but the incidents of his father's career show that the importance of the experiments were fully appreciated by him at once. The obstacles to be overcome in the development of the railway were due to the feebleness of the locomotives of the time and to the indisposition of the mine-owners to make the outlay of capital that would be required to grade the roadbed according to Stephenson's ideas. The period 1815-25 was characterized by a notable extension of the use of engines working inclined planes by cables. Locomotives were frequently used on level stretches, but seldom constituted the main source of tractive power.

The Stockton and Darlington Railway is technically the first steam railway designed to serve as a common carrier, but its accomplishments were not sufficiently striking to indicate the future of the new method of transportation. In its general mechanism and methods of operation it differed in no important respect from the tram lines operated by the collieries of the region. It was owned by a group of mine-owners and was, in its main purpose, a colliery tram line. The coal-miners in the Bishop Auckland

Valley began discussing a scheme of improved transportation to the coast as early as 1768; they thought of a canal at that time, and the canal scheme came to life from time to time during the next half-century. In 1810 a tram line was suggested. The canal project was revived in May, 1818, and a public meeting held at Stockton. Some people from Darlington became interested, and, after consultation with engineers, the scheme was converted into a tram-line project. Surveys were made, and a bill for a charter was introduced into Parliament. Opposition from the Duke of Cleveland delayed the passage of the bill, but it was carried in 1820.

Late in the following year Stephenson was consulted by the promoters of the line; they were then thinking of a line operated by horses. Stephenson urged them to  
Stephenson's first railway operate by steam. He was appointed engineer to the company in September, 1822, and immediately set to work on a careful survey of the proposed route. He suggested a new line, shorter by three miles and less difficult in its grades. In view of Stephenson's ideas it would seem that this was the first attempt to locate a railway according to the general principles that are now commonplace, but some of the grades actually embodied in the line were too severe to be operated by locomotives, so that one must assume that Stephenson was not successful in his attempt to convert the promoters to the new conception of the railway. The planes were operated by stationary engines, the rest of the line by locomotives, and in addition concessions were granted for the operation of passenger coaches drawn by horses. The line thus exhibited all the uncertainties then existing with reference to the future of the railway. The road was opened September 27, 1825. The ceremonies consisted chiefly of the display of the first train, the details of the exhibition reflecting the contemporary attitude toward the locomotive. For a considerable distance the train was preceded by a man on horseback who was supposed to keep people off the line, and Stephenson caused much astonishment by ordering the horseman out of the way and speeding up his engine to a rate of twelve miles per hour.

Shortly after this a project was launched for a railway between Liverpool and Manchester. The promoters were uncertain as to the merits of stationary engines and locomotives; they were inclined on the whole to regard the stationary engine and cable the more efficient system, but the great initial outlay made them hesitate to install such an equipment over the relatively long line. The whole matter was thus carefully canvassed. A committee was appointed to visit all the tram lines then using power. Various engineers were consulted. The decision was in favor of the locomotive.

The Liverpool  
and Manches-  
ter project

If the quantity of goods be very small or very uncertain, it would require no calculation to determine that the locomotive system is the cheaper, because by it you increase the power by an increase in the number of the engines, and can always proportion the power to the demand, while upon the stationary system it is necessary first to form an estimate of the probable trade and then at once to establish a line of engines, ropes, etc., from end to end.<sup>1</sup>

It was therefore proposed that the main line should be worked by locomotives, supplemented by two fixed engines at the hill just outside of Liverpool. Stephenson was appointed engineer, and, as conditions were more favorable than in the case of colliery roads, he urged strongly against any dependence upon stationary engines. It was his plan to carry out as carefully as possible the theory of the railway that was suggested to him by his experiments in 1818. His views prevailed, and the line as built had no grades that were impracticable for locomotives. This required a deep cutting outside of Liverpool—the Olive Mount cutting that is nearly two miles long and at places one hundred feet deep. This first true railway thus represented a courageous application of the new principles.

Stephenson did not at first propose to concern himself in any way with the locomotives. A contest had been proposed by the company calling for locomotives of not more than six tons in weight. The engines that

The locomotive  
contest

<sup>1</sup> Walker, J.: *Report to the Directors of the Liverpool and Manchester Railway* (Philadelphia, 1831), 7,



Stephenson was then building for the collieries weighed about twelve tons, and under the circumstances Stephenson did not care to compete. Mr. Booth proposed to modify the existing designs of the locomotive by making a multi-tubular boiler, and, coming to Stephenson with this suggestion, offered to combine in making a locomotive for the competition. The scheme was taken up. Robert Stephenson and Mr. Booth worked on the locomotive, while the father was busy on the engineering problems of the line. The "Rocket" embodied a number of new features: the multi-tubular boiler, an improved and perfected steam blast, and a simplification of the arrangement of the cylinders and driving-gear. The engine with water weighed only four and one half tons. It was finished well ahead of time and tried out successfully at Killingworth. Four engines were entered for the trial. Two of them never really performed at all; the third, the "Novelty," was at first the favorite among the spectators, but it broke down shortly and the "Rocket" held the field alone.

The "Rocket" A speed of twelve miles an hour was required by the conditions of the contest. The "Rocket" attained this speed on its first try-out, and later exceeded it. Thirteen tons of freight were hauled thirty-five miles in one hour and forty-eight minutes, including stops — a speed of twenty-nine miles an hour was attained. Several years afterward the "Rocket" was driven four miles in four and one half minutes.

The first train to run the whole length of the line was run from Liverpool to Manchester on June 14, 1830. The trip was made in an hour and a half, at twenty-seven miles per hour. The road was formally opened to traffic September 15, 1830. The promoters had expected to secure four hundred passengers a day, but an average of twelve hundred was almost immediately reached. The commanding success of the road put an end to all uncertainty with reference to the future of this mode of transportation, and although the road is not really the first to be built its opening marks the real beginning of the modern railway.

## II. GROWTH OF THE RAILWAY SYSTEM: 1830-1846

The railway was not at once recognized as an independent form of investment, although the Liverpool and Manchester line paid eight or nine per cent dividends from the outset. The general money market did not become interested in railway shares until 1843; in the earlier period, railways were financed by local funds. They were promoted by coal-owners or merchants who were primarily concerned with the development of new facilities of transportation in behalf of other business interests. The usual <sup>Capital for railways</sup> source of capital was the mercantile community in the towns at either end of the line; the Liverpool and Manchester project was typical of railway projects for somewhat more than a decade. The development of railways during this period was dominated by local interests, and, with the exception of the Great Western project, the lines were relatively short links which did not in any case afford uninterrupted communication between points of major importance.

Communication between Liverpool, Manchester, and London was controlled by four separate companies. Traffic from the midland cities, Derby, Nottingham, Leeds, and intermediate points, was served by <sup>Inconveniences of the short line</sup> three closely related lines, which secured connection with London by transfer to the London and Birmingham at Rugby. The actual inconvenience was not as great as might be imagined, for provision was made from the outset for the joint use of stations and in some cases for the joint use of portions of track. The stations at Birmingham and Derby were used by all the roads, though not without friction. During the period of keenest competition between the Birmingham and Derby and the Midland Counties Road a locomotive belonging to the Midland Counties Company was "captured" at Derby by the Birmingham and Derby: locomotives were shunted onto the siding in front and behind the "enemy" locomotive. Attempts were made also to deny passengers full facilities in the use of the station, but the roads were obliged by the courts to fulfill all their engage-

ments to each other. The most important instance of running powers is afforded by the Manchester and Birmingham; **Provision for** this company was authorized to construct a line **through traffic** from Manchester to Crewe, traffic from Crewe to Birmingham being handled over the line of the Grand Junction Railway. In this case the provision was an outcome of the policy of Parliament to prevent the undue duplication of facilities. There were many jealousies among these various lines, but on the whole the common interests prevailed and the facilities were used with significant reference to through traffic before actual amalgamation took place. Through passenger coaches were put into operation between London and points on the railroads of the Midland lines at an early date, and the complexities of the division of revenues from traffic led to the establishment of the Railway Clearing-House in 1842. The idea was suggested by an audit clerk on the London and Birmingham system after the analogy of the London Clearing-House. As originally constituted, the Railway Clearing-House included nine companies.

Although the roads were built as independent units they became associated in systems at an early date. The group **Early affilia-** of lines that ultimately became the London and **tions** North Western constituted a distinct group almost from the outset. The Midland Counties lines were closely associated with the London and Birmingham, but their position was somewhat ambiguous, sufficiently distinct to make them a fairly separate group from the outset. This group of lines was an outgrowth from a short coal road between Leicester and Swannington. This little road was built in 1832 in order to develop coal properties at Swannington, the facilities of the railway enabling these mines to compete on more than even terms with the mines of the Erewash Valley from which Leicester had formerly been supplied by water transport. The Leicester and Swannington line stirred the coal-owners of the Erewash Valley to activity. A road was projected to afford rail transportation for their coal, but the suggestions of certain London capitalists resulted in the expansion of the original scheme. The line

was finally built to connect Derby and Nottingham with Rugby by way of Leicester; the extension to Rugby gave the region a connection with London. The project to develop the mines of the Erewash Valley was abandoned because of a



proposed line from Derby to Leeds, so the scheme that had started as project for a coal road became the typical scheme for connections between manufacturing towns. The North

Midland, between Derby and Leeds, and the Birmingham and Derby were chartered and built at about the same time. For a short period the two roads connecting Derby with the London and Birmingham engaged in severe competition for the traffic from Leeds. Preferential rates were made by the Birmingham and Derby in favor of through traffic, but these rates were disallowed by the courts on suit by the Midland Counties line. A few months later an agreement was made to amalgamate all three lines, and in 1844 Parliamentary sanction was obtained for the formation of the Midland Railway. This was the nucleus of the first of the modern railway systems to be formed by amalgamation. The component parts of the London and North Western were united in 1846.

The development of the Great Western thus brought into existence three of the great companies which were later to compete for the London-Liverpool traffic. The Great Western, however, was not the result of amalgamations. It was somewhat similar to the other projects in so far as it was a scheme for connecting London and Bristol, but the project really went far beyond the limits of a scheme to serve purely local interests. This road was surveyed by Brunel and his influence appears not only in certain technical details of engineering, but also in the general conception of the road. In a report made to the company in 1838, Brunel sketched the destiny of the Great Western.

The Great Western Railroad [he says] broke ground in an entirely new district, in which railroads were unknown. At present, it commands this district, and has already sent forth branches which embrace nearly all that can belong to it, and it will be the fault of the company if it does not effectually and permanently secure to itself the whole trade of this portion of England, with that of South Wales, and the South of Ireland: not by a forced monopoly, which could never long resist the wants of the public, but by such attention to these wants as shall render any competition unnecessary and hopeless. Such is the position of the Great Western Railway. It could have no connection with any other of the main lines, and the principal branches likely to be made were well con-

sidered, and almost formed part of the original plan, nor can these be dependent upon any other existing lines for the traffic which they will bring to the main trunk.<sup>1</sup>

The Great Western was thus conceived as a complete system that should primarily depend upon a monopoly of traffic in an entire region. It was certainly the first of the railways to be planned in the modern spirit, with a view to what we may call commercial strategy. The ultimate extensions to Oxford and Liverpool were not foreseen by Brunel, but the domination of the west of England was part of the plan. The notion that the road was to be <sup>Broad gauge</sup> somewhat isolated induced Brunel to modify in some details the character of the engineering work. The gauge of the roads in the north, built by Stephenson, or under the influence of his ideas, was the four-foot-eight-and-one-half-inch gauge that had been taken from the tram wagons of the colliery lines. Brunel felt that this gauge was not well adapted to the needs of a railway. There was too little room between the wheels for a convenient arrangement of the parts of the locomotive, and there was not sufficient stability to make high speeds as easy of attainment. He therefore recommended a seven-foot gauge, confident that the slight additional expense involved in laying the roadbed would be recovered in economies of operation. It was difficult to secure Parliamentary authority for the gauge, and the charter as finally approved omitted all reference to the gauge. The policy was defended to the stockholders by the report cited above, and for a considerable period the argument proved to be sound. The development of contacts with the roads of the London-Liverpool traffic region, however, rendered the difference in the gauge unfortunate. The Great Western began to adapt its line to the northern gauge at an early date, at first by adding a third rail so that both gauges could be used, latterly by a complete abandonment of the broad gauge. It must be confessed that Brunel's contentions were technically sound: there were advantages in the broad

<sup>1</sup> Brunel, I.: *The Life of I. K. Brunel* (London, 1870), 105.

gauge, but it was introduced too late to be adopted generally and uniformity proved to be more important than the highest possible technical efficiency.

The development of roads up to 1846 was primarily non-competitive. Such episodes of competitive practices as appeared were incidental to the formation of the systems that become the basis of the keen struggles of the fifties. It is in this sense that the early period is purely formative, dominated by the actual building of the primary trunk lines and only incidentally affected by considerations of high strategy and politics.

### III. THE RISE OF COMPETITION: 1846-1873

Some portions of England do not afford sufficient traffic to offer opportunity to more than one railway system, so that these regions have been monopolized by particular lines from the outset. The eastern counties and the southwest are both essentially non-competitive regions. The density of traffic in the London-Liverpool district and the traffic between London and Scotland led to competition as soon as the railway network began to approach its ultimate form. Lines built for local purposes possessed significance from the point of view of through traffic, so that competition emerged where none was originally planned. The history of the lines engaged in the competitive struggle involves so many matters of general policy that it overshadows for the general student the story of the other lines whose development is primarily interesting from the technical incidents of the engineering problems involved. The economist is concerned with those aspects of the development of the railway network that throw light upon the relations between the railways, the traders, and the public.

The first great struggle between railways was the outcome of the completion of two routes to Scotland. The east coast route was first developed in its northerly section. As early as 1835-36, merchants of York, led by George Hudson, projected lines to

Completion of  
the Scotch  
connections

connect York with the Midland lines at Leeds and other lines to afford a Scottish connection. The section between York and Leeds was soon completed and the rails were extended northward by easy stages. In 1841 the rails stopped at Darlington: extension to Newcastle was authorized in the following year and opened in 1846. The Newcastle-Berwick section was opened in October, 1847; and as Scotch companies had been at work on the Edinburgh end since 1844, it was possible to offer through service from London to Edinburgh. The trip was made in thirteen hours and ten minutes; an all-rail route except for the gap caused by the delay in the completion of the bridge over the Tyne at Newcastle. Meanwhile the London and North Western interests had been at work on a west coast route, via Lancaster and Carlisle, which was finally opened for traffic in February, 1848. The first trains on this route ran on a fifteen-and-one-half-hour schedule, but by July the trains were making the journey to Edinburgh in twelve hours. In the fall the Tyne bridge was completed, but the east coast service was hampered by the dependence upon the London and North Western for connections between Rugby and London, and in this service there were discriminations in favor of the passengers and freight that were booked for Scotch points via the west coast route. The Midland lines were not likely to feel any conflict of interests with the Yorkshire lines.

The difficulties that were experienced by the Yorkshire lines in securing an adequate London connection after 1848, gave an entirely different aspect to the various London and York projects that were being considered for a direct connection between York and London. Schemes for such a line had been projected after a fashion as early as 1833; surveys were made for a line to be called the Grand Northern, with a main line from London to York via Cambridge and Gainsborough. Other schemes followed in close succession for local and through lines, but all these early schemes failed because of the lukewarm support given by the merchants of York. They felt that the main point was to get some rail



connection with London even if it were not direct, and, upon the development of the North Midland project, they were satisfied to build a link down to Leeds. Thus for a period of years, roughly 1835-45, the projects for direct connection between York and London were promoted almost exclusively by the residents of various Lincolnshire towns that were still without any rail connections; local interests were advanced for the building of a line that was most important with reference to through traffic. The local capitalists were not able to secure adequate funds to push the project through, and thus a project which was initiated quite early was late in realization. In 1844 Hudson and the Midland interests went so far as to support some competing projects for roads in Lincolnshire with the express purpose of defeating or at least delaying the building of any direct London-York line.

The attitude of these capitalists must have changed in the course of the long Parliamentary contests that grew out of the great mass of London-York projects deposited in 1844. They foresaw the conditions that became actual by 1848, and **The Great Northern** became interested in the early completion of a through line from London to York. After record-breaking hearings, one of the through projects was approved by the Commons, and, after consolidation with another similar project, was finally authorized as the Great Northern Railway in June, 1846. Portions of the line were opened for traffic in 1850, but negotiations were begun somewhat earlier with reference to rates between competing points.

The London and North Western, assisted by the Midland as a subservient ally, endeavored to exclude the Great Northern from all possible traffic and proposed arrangements **Hostile measures** which would afford minimum facilities for the handling of such traffic as involved joint activity. Branches were built into Great Northern territory, the Scotch companies associated with the London and North Western were persuaded to refuse traffic and connections, and attempts were made to induce the local east and west lines to boycott the new road. These hostile measures were

carried to extraordinary lengths: the Manchester, Sheffield, and Lincolnshire refused to exchange traffic at Retford, and at Grimsby placed blocks on the rails to prevent the Great Northern from using its running powers. At Retford, station authorities refused to supply water to the locomotives of the Great Northern. Time-tables were arranged with a view to producing a maximum degree of inconvenience to passengers using the new line. The opening of increased portions of the Great Northern line produced a wild rate war among the roads seeking passengers to the Exhibition of 1851: round-trip fares from the West Riding to London fell from fifteen shillings to ten, and then to five shillings. Finally, the Great Northern agent at Leeds declared that the Great Northern fare would be sixpence less than any fare declared by any other road.

This rate war was proceeding simultaneously with negotiations among the roads for a division of traffic and an agreement as to rates. The general principle of a traffic pool had been assumed at the outset, and it was The Gladstone award equally clear that there must be rate agreements, but matters of detail proved such an obstacle that it was necessary to call in as arbitrator the then President of the Board of Trade, W. E. Gladstone. The London and North Western had originally proposed a division of traffic on the basis of traffic then carried: the Great Northern wished the award to be based on its capacity to handle traffic when all its facilities should be complete. The award finally made was based upon somewhat arbitrary percentages, the Great Northern being awarded sixty-three per cent of the traffic of the most intensely disputed area — Lincolnshire. This Gladstone award covered only the traffic south of York. The Scotch traffic had caused somewhat less trouble so that the roads had reached an agreement privately in March, 1851. The arrangement involved eight companies and is therefore known as the "Octuple Agreement": the com- The Octuple Agreement panies included were the London and North Western, the Lancaster and Carlisle, and the Caledonian, constituting the west coast group; the North British, the

York, Newcastle and Berwick, the York and North Midland, and the Great Northern, constituting the east coast route; and the Midland, which at this time was hardly more than a connecting link between the two great competitive systems.

The Octuple Agreement was relatively unfavorable to the Great Northern; it received no share in the traffic of Glasgow, Perth, and Aberdeen, and only an unsatisfactory share of the traffic with Edinburgh, Berwick, and Newcastle. These arrangements were distinctly less amiable than the arrangements between the London and North Western and the Great Western with reference to competitive traffic. In those negotiations provision was made for charging equal rates based on the shortest or most advantageous route; in dealing with the Great Northern the directors of the London and North Western were unwilling to recognize the new line as an equal, and the agreements were merely a kind of truce which did not put an end to the attempt to destroy the traffic of the Great Northern. The London and North Western urged passengers to buy tickets to intermediate points and from such places to London, rates being arranged

**A rate war** to reduce the total fare below the level provided for in the award. There was thus little qualification of competition in this district even during the limited period of these agreements. The contest for domination of the disputed territory continued without serious interruption. The actual rate war, however, was a subordinate feature of the struggle in the years immediately following the agreements.

The primary object of both companies was to secure more complete control of the two independent lines serving Lincolnshire and the West Riding. Both of **Alliance and counter-alliance** these lines, the Manchester, Sheffield, and Lincolnshire, and the Midland had been satellites of the London and North Western, but the Great Northern did not give up hope of forming an alliance with them. Overtures were made to the Midland directors in May, 1852, proposing amalgamation with the Great Northern. The moment was

favorable, for although there had been a similar proposal from the London and North Western, proceedings from that quarter had become involved in difficulties as to the details



of the exchange of securities. The Midland directors were less favorable to the London and North Western alliance than they had ever been, and it is barely possible that the hopes of the Great Northern might have been realized if

there had been some little difference in the timing of the various propositions. The London and North Western, however, succeeded in winning the Midland over to its old allegiance and in 1853 application was made to Parliament for authority to amalgamate the two systems.

This proposal involved a truly momentous decision. If the amalgamation were permitted, the London and North Western with its allies in Scotland would have controlled all the Liverpool-London traffic, the traffic of the midlands, and would have dominated the Scotch traffic. The Caledonian proposed to amalgamate with the Edinburgh and Glasgow, so that the east coast companies would have had little chance to secure any traffic beyond Edinburgh. These proposals raised the issue between the definite acceptance of the principle of monopoly and application of the principle of competition to railways in the regions of greatest traffic density. It was acknowledged by all that there were regions in which railways must needs possess a monopoly, but this proposal of a substantial monopoly of the traffic of the greater portion of the island could not be accepted as a matter of course.

The whole matter was canvassed by a committee of the House of Commons of which Mr. Cardwell was chairman and the decision was in favor of competition among the railways. It cannot be denied that this decision exercised an important influence upon the development of the railway network of Great Britain, and it may be that the decision was unwise, but if the choice between monopoly and competition is to be criticized the matter should be considered in all its bearings and due attention given to the situation in 1853 as well as to the effect of the decision upon subsequent railway-building. The ultimate effect of the decision was the creation of the extensions of the Midland system to London and to Scotland. The Midland could not exist as an independent line between the London and North Western on one side and the Great Northern on the other side. A third competitive system was thus created by reason of the policy of Parliament.

The accomplished result may be seen by referring to the railway map for 1885; the Midland system developed connections with London, via Bedford and St. Albans; with



Liverpool, via Manchester; with Scotland, via Settle, Appleby, and Carlisle. The extension to Bristol that was made in the early period was further developed by the line to Swansea. In its final form the Midland system possessed

outlets to important points on all coasts and thus entered into competition with all the great railway systems.

The accomplishment of these results was difficult. When the proposed amalgamation of 1853 was denied by Parliament the two companies contented themselves with a secret joint-purse agreement which was not discovered until 1857. The officials of the Great Northern discovered it unexpectedly and used their knowledge to put an end to the alliance between the London and North Western and the Midland. The extension from Leicester to Hitchin via Bedford was opened in that year so that a rapprochement with the Great Northern was easy and natural. After the opening of this line the Midland enjoyed a strategic position between the rival companies on either side; it could divert considerable masses of traffic to either road, and by skillful use of this possibility the Midland was able to maintain itself through the most trying period of its existence. Both roads discriminated against the London traffic from the Midland, but each could be played off against the other so readily that neither was able to work serious injury to the Midland. Arrangement was made for the Midland to use the tracks of the Great Northern between Hitchin and London, so that Midland trains began to operate directly to London in 1858, though the traffic was frequently obstructed by discreetly contrived difficulties in the yards and terminals. Work on an independent entrance to London was begun in 1860, but the terminal at St. Pancras and the line to Bedford were not completed until 1869. The Scotch connections were still slower in development. The line to Carlisle was opened for freight in August, 1875. The lines in Scotland were not authorized until after the opening of the Carlisle line and were completed considerably later.

The gradual rise of the Midland as a competing trunk line to Liverpool and the north made the competitive struggle among the roads more complex and bitter. The rivalry between the Great Northern and the London and North Western was not diminished, though at times both roads

combined to keep the Midland out of various towns; the annals of these years thus constitute an important chapter in the history of competitive railroading.

The position of the Midland made it difficult to compete on even terms for passenger traffic, so the road finally adopted an entirely new policy toward third-class passengers which ultimately revolutionized conditions throughout the kingdom. The third-class <sup>Third-class</sup> passengers passenger had not been encouraged. Third-class passage practically amounted to the privilege of riding in an open flat-car without seats, on and among such baggage as might happen to be thrown into the car. The schedule of the train was adapted to the character of this mixed traffic, and, as may be supposed, the conditions of the journey were determined by the requirements of collecting and handling freight. A journey that involved no changes required at least twice the length of time that was necessary for the first- and second-class passengers, and if it became necessary to make connections with other trains the delays at junctions might be prolonged indefinitely. In short, third-class passage was passenger service only in respect to the fact that humans were carried; the service was precisely the same service that was rendered to cattle and miscellaneous freight. In 1844, after Parliamentary inquiry, the roads were required to run a certain number of third-class trains at a fare of a penny a mile. This afforded some guarantee that there would be trains at reasonable hours, but there was no improvement in the accommodations.

It was thus a revolutionary step when the Midland, in 1872, announced that third-class coaches would be carried on all trains beginning April 1. This policy proved to be so successful that second class was abolished in <sup>The Midland</sup> 1874, first and second classes being combined at <sup>policy</sup> fares which represented a reduction on the old first-class rates. These changes were accompanied by improvements in the character of accommodations provided for the third class, and the differences that have come to exist between conditions in England and the Continental railways are



due to this departure of the Midland Railway. The other roads were forced to adopt the new policy, though it was many years before the full results were embodied in the practice of all the railways.

## CHAPTER XVIII

### THE GOVERNMENT AND THE RAILWAYS

FOREIGN writers have frequently criticized the procedure followed in England in the grant of railway charters on the grounds of extravagant expenditure in legal fees <sup>Parliamentary</sup> and in preliminary surveys. These charges un-<sup>expenditure</sup> doubtedly increased the costs of constructing railways in Great Britain and in part explain the high costs of construction relatively to other countries. One of the reviews published in 1849 comparative figures of costs of construction which indicate the divergence among the various countries:

*Costs of Railroads per mile*<sup>1</sup>

United States.....	£5,000
Prussia.....	10,000
Austria.....	11,300
Small German States.....	19,000
Great Britain (selected lines).....	56,915

The figures for the British railways are an average for ten lines that must be fairly representative. One railroad, the Blackwall Railroad, cost £289,000 per mile, but this expenditure was due largely to the great difficulty of securing entrance to a populous city. Parliamentary expenses alone averaged between £1000 and £6000 per mile, about as much as the total cost in the United States. Land involved an average expenditure of £10,000 or £15,000. The cost of the charter and the land thus exceeded the costs of the entire investment in the Central European states.

Such expenditure can easily be made to seem extravagant, but one must be cautious in passing judgment upon these facts. When all due allowance has been made for these preliminary expenditures the actual outlay on <sup>Causes of</sup> the line is still far greater than the outlay in the <sup>high costs</sup> European states and in America. The British lines were more

<sup>1</sup> *North British Review* (1849), 584.

carefully graded and more solidly built than most lines in other countries. The principles of George Stephenson were more thoroughly carried out in Great Britain, partly perhaps because they were better understood, partly no doubt because there was promise of traffic that justified such expenditure. The history of railroads in England differs from the history of roads in other countries in many details because there was no need to stimulate traffic. In most parts of Great Britain there was such need of the railways that even the more ambitious undertakings were able to earn handsome profits from the outset. The actual earnings per mile were probably higher in the early decades than they were later when the low earnings of feeders reduced the average. British railways were not speculative ventures as they were in many countries; a charter was not merely a hope, but a valuable franchise. The extraordinary contests in Parliament cannot be understood if this fact is not keenly appreciated, and the elaborate procedure would have been wholly unnecessary if the rights involved had been less important.

At the same time one must realize that the railroads were not subjected to any special procedure in obtaining charters. Parliamentary procedure on canal bills, turnpike bills, English Ideals closures, railroads, and public utilities was a direct outcome of the deep regard of eighteenth-century English thought for property rights and vested interests of all kinds. It was a fixed principle of English legislation that no one should be deprived of his property without due process of law. Applications for privileges which might interfere with the property rights of others were thus the subject of a hearing before they were acted upon. The details of the procedure in Parliament developed rapidly at the beginning of the nineteenth century and had begun to assume definite form when railway projects came before the House.

The project passed through two distinct stages, one prior to the introduction of a bill, one subsequent to the introduction of the project into Parliament as a bill. Detailed surveys were required to be deposited at the Board of Trade

not later than the February preceding the session in which the bill was to be introduced. Notices were <sup>Parliamentary</sup> required to be sent to all landowners affected. <sup>procedure</sup>

After 1845 the Board of Trade made report on the projects submitted. A petition was then submitted to the House which really contained the text of the bill or charter. This was immediately referred to the Standing Orders Committee, a permanent committee of the House of Commons whose duty it was to ascertain if all preliminary requirements had been complied with and to secure from the promoters sufficient evidence of the significance of the project to warrant detailed examination of the scheme. This committee held a hearing, but in theory it was merely a cross-examination of the promoters and their witnesses. At times members of the committee who were hostile to the project called witnesses to testify against the project, though the hearing was not presumed to be contentious. If the Standing Orders Committee approved the preamble of the petition a bill was introduced embodying the petition presented to the House.

The bill then followed the usual Parliamentary course: three readings in each House, together with a careful scrutiny of the details of the measure in small committees of each House. There was no debate in either House in the ordinary sense of the term debate; actual consideration of the bill was delegated to the small committees which followed a quasi-judicial procedure. The promoters were under obligation to prove the expediency of their project, and all whose property rights were affected might come before the committee, personally or through counsel, to object. These hearings were the chief source of expense. At times they became unduly contentious.

The hearings on the bills concerned with London to York projects in 1845 lasted seventy days. Existing railroads whose traffic might be affected had a right to appear before the committees, so that the struggle between <sup>Hearings</sup> roads began at times before the projected competing lines were chartered. The extensive use of running powers in the early decades of English railway history was

the outcome of the unwillingness of these committees to approve projects that involved the construction of parallel lines. In this as in many other ways these committees exerted a notable influence upon the development of railroads. It is obviously impossible to pass any general judgment upon the quality of work done by these committees, but it would seem that there is abundant reason to believe that their work was not without public advantage. There was at least some conscientious effort to examine these schemes with reference to the interest of the public and of parties directly affected. Whether the results were commensurate with the cost or not can hardly be determined.

The charters granted to railways were modeled on the turnpike and canal charters of the late eighteenth century. The general form of the charter was established in 1801 by the **Early charters** charter granted to the Wandsworth and Croydon Railway, a tram line designed to carry heavy freight. The organization of the company was provided for; compensation to landowners stated; maximum tolls listed. These tolls were presumed to be paid for the privilege of hauling goods on the line by wagons and horses belonging to private individuals. The line was deemed to be a kind of turnpike, a common way provided by the company for the use of individuals. This conception of the railway persisted for a long time. The Stockton and Darlington, for instance, made no provision for the carriage of passengers. The right was leased to an individual who furnished the coaches and horses. The Liverpool and Manchester line was operated by the company exclusively, and it was soon recognized that the railroad was "by nature a monopoly." This phrase meant that the company must necessarily exercise exclusive control of all rolling stock on the line; it was an attempt to express the difference between railways and the turnpikes and canals. But no changes were made in the provisions of railway charters defining the tolls to be charged. Despite the evident intention of Parliament to regulate charges, the railways were really free to make such rates as they pleased.

The desirability of a definite policy toward the roads was clearly seen by a few individuals almost at the outset. The chief advocate of systematic regulation was <sup>Regulation</sup> James Morrison, a member of Parliament with- <sup>proposed</sup> out official position. In the session of 1836 he brought in a bill proposing that all railway charters should be subject to revision or withdrawal within a stated term of years, and that each company should make a return to the Board of Trade each year, showing the gross income, the expenditures, and the passengers and freight carried. Even this moderate proposal seemed unwise to the majority of the House and opposition was so general that the bill was withdrawn before there had been any serious debate. In 1838 provision was made for the conveyance of mail by the railways at reasonable charges; some power of compulsion was given the Government. Finally, in 1840, a committee was appointed to consider the entire question of legislative policy. The tendencies of the time were recognized, the mistakes of the past admitted, but no substantive measure of control was proposed. The committee recommended that steps be taken to insure the observance by the companies of the provisions and limitations of their charters. In the ses- <sup>The first rail-</sup> sions of 1841-42 acts were passed providing: <sup>way acts</sup> that no railway should be opened until it had been inspected by the Board of Trade; that returns should be made to the Board of Trade as to traffic, tolls, rates, and all cases of accident; that existing by-laws affecting persons not servants of the companies were to be submitted to the Board of Trade. The Board of Trade was also designated as the "guardian of the public interest," and authorized to certify to the law officers of the Crown any infraction of the interest of the public. These acts thus established the principle of regulation, but made no specific provision of importance.

The problems of the railways were too momentous to be long neglected, and further investigations in 1844 resulted in the Act of 1845 which is the substantial beginning of modern railway legislation in England. Provision was made in the act for the collection of statistical material concerning

the traffic of the railways; for the submission of by-laws to the Board of Trade for approval; for cheap third-class trains, at convenient hours; authority was given the Government to purchase the railways after twenty-one years; the profits of railways were limited to ten per cent; and the toll clauses of all existing and all future railways were fundamentally revised.

This section of the act (90) is the basis of all subsequent rate legislation, and although it embodies a policy of regulation, it was frequently referred to as the **The "Charter of Liberties"** "Charter of Liberties" because of the wide discretion given the railways.

AND WHEREAS it is expedient that the Companies should be enabled to vary the tolls upon the railways so as to accommodate them to the circumstances of the traffic, but that such power of varying should not be used for the purpose of prejudicing or favoring particular parties, or for the purpose of collusively and unfairly creating a monopoly either in the hands of the Company or of particular parties, it shall be lawful, therefore, for the Companies subject to the provisions and limitations hereinafter and in special acts contained, from time to time to alter or to vary the tolls by the special acts authorized to be taken, either upon the whole or upon any portion of the Railway as they shall think fit:

Provided that all such tolls be at all times charged equally to all persons, and after the same rate, whether per ton, per mile, or otherwise, in respect of all passengers, and of all goods or carriages of the same description, and conveyed or propelled by a like carriage or engine passing over the same portion of the line of the Railway under the same circumstances, and no reduction or advance in any such toll shall be made either directly or indirectly in favor of any particular company or person travelling upon or using the line.<sup>1</sup>

The portions of this clause that were concerned with the statement of non-discriminatory practices were not at once of much importance because there was no administrative machinery to exert constant regulative pressure upon the railways. It was for this reason that the railways long regarded the clause, as a basis for making rates according to their discretion, exempt from the wholly

**Essence of the policy**

<sup>1</sup> 8 Vict., c. 20, sec. 90.

impractical limitations embodied in the early charters. This Act of 1845, however, foreshadows the policy of the Government with reference to rates for nearly a half-century; in 1891 an attempt was made to define more precisely the rates that should be charged upon the railways, but until then the efforts of the authorities were devoted to the maintenance of non-discriminatory rates according to these principles laid down in 1845. The clause is noteworthy because it carefully distinguishes between cases of real and merely apparent discrimination; the phrase, "passing over the same portion of the line . . . under the same circumstances," was particularly happy, providing for the apparent discriminations of the long- and short-haul cases, and the equally perplexing differences between carload rates for through traffic and jobbers' rates on small shipments of similar goods from the local stations along the line. Although this is the first attempt at careful statement of a policy of non-discriminatory regulation it is superior to the clauses of our Interstate Commerce Act, both in details of drafting and in conceptions of policy.

The Act of 1845 contained no provision for any special authorities to deal with the railways, all regulative authority was vested in the Board of Trade whose functions were too diverse to admit of much effective supervision of the railways. In the following year, however, an act was <sup>The Com-</sup>passed conferring the powers of the Board upon <sup>missioners</sup> five commissioners; three salaried commissioners, and two members of Parliament debarred from receiving salary. The powers were not extended in any significant respect, but a bill introduced in 1847 proposed to create a real administrative commission. The Commissioners were to report to Parliament annually on tolls, rates, and charges, and upon the regularity or irregularity of trains; they were authorized to call for returns of traffic and to inspect the books of the companies; and they were given the right to settle disputes between companies having termini or portions of their lines in common. This bill was so vigorously opposed by the railways and by members of Parliament that it was withdrawn



before it came up for debate. The failure of the measure proved fatal to the Commission. Devoid of any characteristic functions, it languished, and in 1851 was discontinued.

For a time all regulative functions were exercised by the Board of Trade or by the ordinary courts. The justices protested against the new duties that were imposed upon them by the Acts of 1853 and 1868. Difficult

**Difficulties** questions of fact were involved which they were neither able nor willing to decide. It was not within their province, they declared, to discover whether or no a rate was "reasonable," nor to define what constituted "undue or unreasonable preference." The appointment of another Railway Commission in 1873 was thus a natural consequence

**The Commission of 1873** of the increasing numbers of cases concerned with rates and rate-making. The powers of the Commissioners were judicial rather than administrative; they were a court of final resort on all questions of fact. Their jurisdiction included both rates for transport and the terminal charges made for storage, handling at terminals, and delivery. They were authorized to determine the reasonableness of any terminal charge, and in order to exercise this power they could require the railway to state what portions of the total charge were for transportation and what portions were terminal charges. This addition to the provisions of the Act of 1854 was important as the railways had used the terminal charge as a means of evading the provisions of the earlier act.

Meanwhile, the problem of competition among the railways had assumed notable proportions. The report of the committee of 1853 has already been mentioned in connection

**Competition** with the development of the Midland Railway, but the statement of the policy sketched by the committee requires some delicate distinctions between the general notions of monopoly and competition which have become increasingly important. There had been some perception of the problem before 1853; amalgamations had been allowed in many instances among lines which constituted continuous routes and in some cases among lines that might have

competed for certain traffic; but no general policy had been adopted by Parliament. The issues were squarely joined by the proposed amalgamations of the session of 1853; the report of that year thus possesses the same basic importance with reference to competition that we have noted with reference to rates in the Act of 1845. It has long been customary to cite the Report of 1853 as an adoption of a policy of maintaining competition, and there is evident truth in the statement, but the events of recent years have given increasing prominence to the significance of the carefully qualified recognition of the need of combination under certain circumstances. The principle of competition was favored by the committee, and a notable decision made with reference to the London and North Western and the Midland, but the principle was not adopted in any doctrinaire spirit. Extremes were avoided as carefully as in the questions of rate-making.

"It is natural," say the committee, "for traders to compete where the opportunity is unlimited for new rivals to enter the field. It is quite as natural for traders to combine so soon as the whole number of competitors may be ascertained and limited"; implying that the circumstances of the railway situation would lead <sup>The policy adopted</sup> inevitably to combination. The committee did not feel that combination was contrary, on the whole, to public policy, but they feared two things: the acquisition of powers by the railways that might diminish the regulatory powers of Parliament, the development of monopolies of traffic that might be prejudicial to the public. They conceived situations in which the freedom and security of traffic should be so completely guaranteed that amalgamation would no longer threaten the public with the menace of monopoly. This foresight has since been justified. The departmental committee, reporting in 1911, says:

The effect of the limited degree of competition now existing between Railway Companies is not necessarily to public advantage. . . . Experience has shown that informal combinations . . . while less likely to be of advantage to the Companies than the more

formal and complete unions, can destroy competition as effectively, and moreover possess certain incidental disadvantages from a public point of view, from which a monopoly under a single control is free.<sup>1</sup>

Despite the general policy of maintenance of competition adopted in 1853, there has been a steady development of combinations among railways which was rapidly creating a unified railway system when the outbreak of the War resulted in the establishment of national control for the period of the War. Although this was a war measure and is in form temporary, there is little expectation of abandonment of centralized control. It is thus of some interest to trace the rise and decline of the policy of maintenance of competition, and it is certainly of moment to recognize that the policy was never intended to be applied in any extreme form. There is a greater degree of continuity of policy than might appear on the surface of railway legislation.

The willingness to recognize combinations among railways even in 1853 appears most clearly in the policy adopted toward the various kinds of arrangements between companies retaining their corporate independence. Working agreements and pools were frankly admitted to be desirable, but such arrangements were illegal unless specifically sanctioned by Parliament. By granting such powers for limited periods Parliament hoped to exercise a greater measure of control than would be possible if the companies were amalgamated. Traffic pools and working agreements were thus encouraged, and in the years that followed the field of actual competition among railways was greatly restricted.

Furthermore, there was a tendency to restrict competition to the competition of routes and facilities as distinct from differential rates. In rate-making the principle of the most favorable route was a predominant factor in the adjustments among the various roads. In addition to the Railway Clearing-House, which handled the accounting in all mat-

<sup>1</sup> Cited by Robertson, W. A.: *Combination among Railway Companies* (London, 1912), 23-24.

ters pertaining to the division of revenue from through traffic, the railways developed a number of monthly <sup>Traffic con-</sup>rate conferences to adjust various matters per- <sup>ferences</sup>taining to competitive rates and traffic. The more important of these conferences came into being between 1873 and 1881; there have been some additions since that time, but most of the regular conferences were in existence in 1881. The London and West Riding Conference handled questions concerning traffic between London and stations in the West Riding, excluding the coal traffic from South Yorkshire. The Normanton Conference dealt with rate questions in which three or more railways were interested, together with regulations concerning cartage, warehousing, and wharfage at the various towns embraced in the conference. The London, Liverpool, and Manchester Conference dealt with traffic from the Lancashire district bounded by Liverpool, Fleetwood, Preston, and Stockport. The English and Scotch Traffic Rates Conference handled all rate problems arising out of the traffic in goods and livestock between Scotland and England. The Liverpool and Manchester Districts Conference dealt with rates between Liverpool and west coast ports to Manchester. The Midland Association, the Irish and English Traffic Conference, the South of Ireland Conference, the Irish Cattle Conference exercised functions that are obvious. The Humber Conference was concerned with traffic between the east and west coast points. The activities of these conferences aroused some apprehensions among the traders, but testimony was given in 1881 in which it was denied that the railways had combined to raise rates. The result of these meetings, it was asserted, was a series of reductions.

The antagonism between the railways and the traders which continued throughout the rest of the century began in the period marked by the development of these <sup>The railways</sup> various modes of reducing the evils of competi- <sup>and the traders</sup>tive rate-making among the railways. It is difficult, perhaps impossible, to reach any judgment of the merits of the controversy, but one is tempted to conclude that many practices of the railways were misunderstood by the traders. The

methods of rate-making, that were by necessity the foundation of the rate structure that assumed form at this time, resulted inevitably in many anomalous rates. The presence of water competition or the competition of a more advantageous rail route would result in rate reductions. Rates between competitive points would thus cease to bear the normal relation to mileage, and many seemingly irrational situations might develop. The traders were prone to assume that these competitive rates represented roughly the cost of rendering the service, and they thus concluded that large margins of profit existed on all non-competitive traffic. The committee of 1881 gave much attention to the question of rates, canvassing two main subjects, prevailing methods of rate-making and the desirability of increasing the powers of the Railway Commissioners by the addition of rate-making functions. The report of the committee was indecisive. The influence brought to bear by the railways themselves was considerable. Parliamentary action was thus postponed for a few years. The complaints of the traders, however, became more and more insistent, and in 1888 the powers of the Commissioners were enlarged and provision made for a systematic regulation of rates. The principles embodied in the early charters were to be applied; the character of the rates specified were somewhat different, but the idea of defining by statute the maximum rate to be charged was frankly adopted.

Pains were taken to bring this scheme within the limits of practicality: the railways were urged to submit to the Board of Trade revised classifications of goods with schedules of rates. The Board of Trade would then consider the proposed rates and listen to any complaints lodged with them against the schedules. In theory the railways were to take the initiative; the traders were to have an opportunity to criticize; the Board of Trade was to serve as arbiter. Only in case the Board of Trade found it impossible to reach an agreement with the railways was it permitted to prepare schedules on its own initiative. The schedules prepared thus were to be introduced as a Provi-

sional Order Bill, affording additional opportunity for criticism. The act provided that companies should keep on hand for inspection and sale copies of their authorized classification and the schedule of authorized maxima, thus assuring a greater measure of publicity than had hitherto existed.

The railway companies complied with the terms of the act, though with many misgivings. Schedules of maximum rates and charges were submitted to the Board of Trade and published. Over four thousand objections were made. An inquiry was held, and, after protracted hearings of railway companies and traders, a new schedule of rates was prepared for companies having termini in London. These schedules proposed considerable reductions, establishing a maximum below the existing rate in many cases. In other cases the rates were considerably above the rates then charged by the companies. The bills containing these schedules were introduced in 1891, and in the following year similar bills were prepared with reference to the other railways.

In September, 1891, shortly after the first group of bills was passed, the managers of seventeen of the principal railways met in London to consider means of fore- Opposition of  
the railways stalling a serious reduction in revenue from these reductions. It was resolved to adopt the schedules in their entirety as actual rates, raising such rates as were below the maxima provided in the schedules. Partly as explanation and partly as defense of this action, the railways declared that it was impossible for them to do otherwise for the time being. The changes involved the recalculation of millions of rates, little time was allowed for the publication of the new rates, and under the circumstances they declared that it was impossible to get out a series of schedules of actual rates distinct from the maxima. It was implied that the use of the maxima would be merely a temporary expedient, but one may well doubt the good faith of the railways in this matter. No instructions were given station-masters to indicate that the new rates were to be merely provisional.

The action of the railways evoked cries of alarm and dismay from the traders. The latter appealed to the Board of

Trade for assistance, and the Board wrote (January 2, 1893) to the Associated Railway Companies calling their attention to the complaints, and asking if the rates then in the rate-books were to be taken as an expression of the deliberate opinion of the railway companies. The railway companies replied (January 7, 1893):

The rates now entered in the rate-books are not to be taken as final, and any rate which shall be found open to any serious objection will be reconsidered. . . . The Companies believe that many of the alleged grievances will disappear before the end of February, by which date the completed scale of rates will be inserted in the rate-books; and they are satisfied that the course they propose of immediate investigation of complaints, and the gradual revision by the goods managers, concurrently with meetings for full discussion between the traders and general managers, will best tend toward the settlement of differences.<sup>1</sup>

The traders interpreted this to mean that the companies intended to maintain the maximum rates wherever they could. Correspondence with the Board of Trade continued. The Board of Trade urged the companies to return to the rates in force prior to the new legislation, but this was more than the railways would agree to do. They insisted upon an increase of five per cent in all cases in which such an increase was within the maximum permitted, and finally in March, 1893, the railways returned to their original classification with this difference in the rates. The results were not serious. The increase in revenue from the five per cent increase was in most cases sufficient to balance the loss from reductions. Tests on the Great Western system, which were regarded as characteristic, showed a net gain of £50,000 on May 4 and of £14,000 on a selected day in August.

In January, 1894, an act was passed providing that any rate in excess of the rate charged December 31, 1892, should be considered *prima facie* unreasonable. The Railway Commissioners were given power to deal with complaints arising under the act, and, though it

<sup>1</sup> *Commons Papers*, 1893. Vol. LXXIX (c 7044). Correspondence between the Board of Trade and the Railway Companies. No. 2.

was not intended, they were undoubtedly given power to make rates. The Commissioners refused to interpret the act save in the most conservative manner: Justice Collins said, "I cannot suppose that Parliament intended to take the management of these trading companies out of the hands of the men who manage them, and to place it in the hands of the Railway Commissioners."<sup>1</sup>

The Commission did not even adopt the 1892 rate as an unqualified standard of reasonableness, it was held that special conditions could be considered, and this attitude has in large measure prevented the realization of the anticipations of the traders. The Commission has carefully avoided any rate-making experiments, and, on the whole, it is credited with having done well in administering an unfortunate piece of legislation.

In the early years of the twentieth century the revenues of the railways began to decline; operating expenses had increased, rates had not increased in proportion, <sup>Financial</sup> and the traffic of the railways had suffered from <sup>pressure</sup> the competition of electric tram lines and motors. In 1870 the proportion of operating expenses to gross receipts for all companies was forty-eight per cent. In 1890 it was fifty-four per cent, and in 1908 it was nearly sixty-four per cent.<sup>2</sup> Making such allowance as is possible for the increased capital investment in the properties, it seems fair to say that the dividends on the ordinary stock of the companies had declined from an average of four and one half per cent in the decade 1875-85, to four per cent in the decade 1885-95, and to three and one half per cent in the decade 1895-1905. In order to meet these new conditions the various railways have formed combinations to achieve economies in operation. <sup>Combination</sup> Between 1904 and 1909 the three leading west coast companies formed an alliance which put an end to any significant competition among them. The London and North Western and the Lancashire and Yorkshire had been

<sup>1</sup> J. S. McLean: "The English Railway and Canal Commission of 1888," *Quarterly Journal of Economics*, xx, 1.

<sup>2</sup> Robertson: *op. cit.*, 22.



closely associated since 1862, constituting for practical purposes one system, but the Midland Railway had long been a keenly competitive rival. In 1908 an agreement was made between the London and North Western and the Midland, which was extended in the following year to include the Lancashire and Yorkshire. A great traffic pool was formed for all competitive traffic, covering both freight and passengers and including joint use of all facilities. Stations can be used indiscriminately, by the railways themselves, by traders, and by passengers. A number of economies of operation are introduced both in the routes used for passengers and freight and in the choice of freight stations with reference to the greatest convenience in delivery. So far as the public is concerned these lines have become one system. A similar agreement has been made by the Great Northern, the Great Central, and the Great Eastern, which thus consolidates the more important east coast lines. The Scotch lines have made agreements with reference to their Clyde steamers. The Great Western and the London and South Western entered into a coöperative agreement with reference to their competitive traffic. Consolidation was therefore already far advanced when the roads were taken over by the Government at the beginning of the War. The mechanism for joint operation existed, and officials had had much experience in coöperative endeavor. Public opinion was not unfavorable to consolidation and there was much agitation for national control. Consolidation would undoubtedly bring with it an increase of governmental supervision, and this would differ only in name from governmental control. The widely current opinion that Government control of the railways has come to stay is therefore justified by many aspects of the pre-war situation.

## CHAPTER XIX COMBINATIONS AND MONOPOLIES

### I

Most writers now agree that the "trust movement" began later in Great Britain than in Germany or the United States. The country that was first to disclose most of the tendencies that are important in the Industrial Revolution was in this instance the last to reveal this notable tendency in industrial organization. In order to reach this conclusion it is necessary to conventionalize the meaning of the phrase "trust movement": what are termed "sporadic" instances must needs be excluded. The arrangements among the coal producers of the Newcastle district in the early part of the century must not be counted. The pools and amalgamations among the railways and the rate agreements among oceanic steamship lines must likewise be excluded. Some unsuccessful tendencies toward combination in the iron trade in the decade of the eighties must also be passed by in silence. When such qualifications have been made it is possible to date the combination movement from the decade of the nineties, and it is undoubtedly true that the tendency toward combination became conspicuous in industry only toward the close of the last century. The years 1899 and 1900 saw the formation of amalgamations and agreements on a scale without precedent in Great Britain. A widespread tendency toward combination thus emerges in Great Britain ten or fifteen years later than in Germany and the United States, and even then develops less portentously than in those countries.

The comparative chronology of the movement in the different countries would be of little importance if it were not for the disposition of certain writers to regard the combination movement as the forerunner of some far-reaching change in the general mode of social or-

ganization; the first intimation of the passing of a competitive order of society. The end toward which social organization is supposed to be moving is vaguely conceived, deemed by some to be nothing less than a complete realization of certain socialistic ideals while others merely assume that the State will ultimately take charge of most of the industries and productive establishments. If the late and hesitant development in Great Britain is due to something deeper than mere inertia, there may well be grounds for supposing that competition in some form or other may possess a vitality wholly unsuspected by the most enthusiastic students of monopolistic tendencies in Germany and the United States. Comparative study of the progress of this tendency makes it easier to distinguish between the fundamental conditions underlying the movement and incidental or adventitious features that have contributed to its progress.

The late emergence of combinations in Great Britain has been attributed to the individualistic character of the British business man and to the free-trade system.

Causes of late-  
ness of move-  
ment

Both explanations are inadequate. The psychology of the Englishman did not prevent the establishment of significant combinations in a number of important trades early in the nineteenth century. In this, as in other cases, professions of a particular belief have not prevented action upon a contrary principle. Professor Levy believes that the explanation is to be found primarily in the character and location of the mineral and extractive resources of Great Britain, secondarily in the free-trade policy and the features of international competition that make that policy wise in the case of England. The most important factor is the multiplicity of deposits of the various minerals and the facility with which they can reach essential portions of the market. This dispersion of resources is as notable in Great Britain as is the concentration of such resources in both Germany and the United States. The relation of

The London  
coal trade

this aspect of conditions to combination is well illustrated by the history of the London coal trade. Coal began to appear on the London market from the

mines in the Newcastle district at an early date, and this early trade came to be organized according to medieval forms with true loyalty to the medieval policy of limitation of output. When the gild came to an end in the early seventeenth century private agreements between the owners of the mines were sufficient to maintain all the essentials of the policy of limitation of production. The properties were held in a few hands and combination was easy.

The policy was successful because no other coal could profitably reach the London market. Changes in the technique of mining opened new mines in the northern fields, many of which commanded even easier access to tidewater than the older mines. Competition thus sprang up in the district among the older and the newer mines, but the results were so disastrous that a new combination was established toward the close of the eighteenth century. Production was regulated with reference to the condition of the London market, which was further dominated by a group of wholesale dealers. The Newcastle coal-owners restricted output within limits which would maintain prices at figures that assured the wholesalers in London a comfortable margin over local prices. It was in the interest of the coal-owners to have prices in London fairly well standardized as it became easier to estimate the tone of the market as to quantities. Production was adjusted in such a way as to prevent the monopoly of the dealers from becoming oppressive. The officials of the organization at Newcastle allotted production by districts, and further allotments were made to the individual mines.

This entire structure of monopoly rested upon the regional monopoly possessed by the Newcastle fields. With the development of railways and canals monopoly <sup>Basis of the</sup> ceased to be the predominant feature of the <sub>monopoly</sub> London coal trade. Sufficient coal from inland workings appeared on the market in the late thirties to subject the Newcastle Vend to severe pressure, and by 1844 conditions were so serious that prices were reduced far below the level of profitable operation for the poorer mines. After a feeble attempt to reorganize, the combination was abandoned. Since then

the London coal market has been increasingly competitive. It became the avowed policy of the railways to adjust rates in such a way as would make it possible for coal to reach the market effectively from all the important mining regions. Under these circumstances combinations to control the London market have proved to be impracticable. What is true of the London market in particular is even more true of the general national market; no single region possesses a substantial degree of monopoly of any single grade of coal, with the possible exception of the Welsh semi-bituminous fields. The combination formed to control the trade in this steam coal illustrates the close relation between the degree of concentration of the mineral deposit and opportunities for monopolistic organization. The German cartel in the Ruhr basin controls in that region sixty per cent of the total output of coal in the entire customs area. A somewhat similar degree of concentration of the production of particular grades of coal in the United States has exerted important influence upon combinations in the coal trade and in the iron industry.

Deposits of iron in the various countries present essentially the same features, though in more pronounced degree. No single British ore field produces as much as one half the total product. The Lorraine ores constitute more than eighty-five per cent of the total German output, and the Lake Superior ores a similar portion of the production of the entire United States. There are thus certain natural conditions in Germany and the United States which have favored combination in trades dependent upon the extractive industries. It will be noted, too, that the most aggressive combinations have occurred in these trades. In some cases the degree of concentration of the supplies of the raw materials has been affected by the development of the regions of the United States whose resources were not at first adequately known, but though production of oil and coal is somewhat more dispersed now than at the beginnings of the combination movement the initial situation gave the existing organizations an advantage which they have not yet lost.

The difference in the relative importance of the foreign and domestic markets must also be kept in mind in discussing the comparative chronology of the combination <sup>Marketing</sup> movement. For many industries in Germany <sup>problems</sup> and the United States the domestic market is and has been of primary importance. The later acquisition of the technique of the Industrial Revolution placed them in the position of competing with foreign countries for their own domestic markets in many trades. Great Britain, on the other hand, was primarily concerned with the foreign market, both because of the narrower quantitative limitations of her domestic market and the actual possession of foreign markets obtained at a period when commercial rivalry was less keen. These circumstances are, of course, closely related to the free-trade policy. It is important, however, to note that the conditions of international competition are at once a primary factor in the maintenance of the liberal commercial policy and the essential factor in maintaining a larger measure of industrial competition than exists in other countries. Combination is restricted to the achievement of increased efficiency in the conduct of business, for monopolistic control over prices is hardly feasible. There is less inducement to forego the satisfaction of personal control of one's establishment, and consequently much less eagerness or willingness to form combinations.

## II

Combinations may be classified with reference to the characteristics of the legal forms of the association or with reference to the relation of the association to <sup>Legal classification</sup> the entire group of industrial and commercial processes engaged in putting a particular finished product in the hands of the consumers. Differences of legal form turn primarily upon the degree of permanence sought, presenting every gradation from mere contracts between distinct firms to regulate certain matters of common concern to acts of incorporation entered into by a group of firms to form a single large corporation. The combination movement

is directed toward the integration of industry, but unless attention is concentrated exclusively upon the utmost possibilities, it is more largely concerned with the regulation of competition than with its complete suppression. The arrangement of forms in logical sequence proceeding from the least degree of regulation to the achievement of substantial monopoly is frequently supposed to be evidence of an irresistible tendency toward the logical conclusion, and there is just enough truth in this idea of a tendency toward the extreme logical conclusion to make it difficult to judge accurately the course of events. The convenience of the purely logical arrangement in the presentation of material ought not to prejudice our judgment.

The simplest form of trade agreement is the understanding with reference to the conditions of transacting business: an agreement as to the terms of credit, discounts, payment for packing and transport, and other matters incidental to the trade. In some instances these agreements are scarcely more than attempts to standardize forms of doing business comparable to the rules of Boards of Trade and marketing associations, but in some trades such conventions tend to insure open competition and to exclude rebates and special discounts.

Price associations represent the next higher degree of combination. These agreements constitute a definite qualification of competition; the group of associated dealers or traders acts concertedly in raising or reducing prices both as to the date and the extent of the price change. Sporadic action of this type is common among the smaller retail tradesmen of many localities, and periodic price-fixing is practiced by associations of producers of various raw materials. Associations for price-fixing have existed in the coal and iron trades of Great Britain since the eighties. The Cleveland Ironmasters' Association, the Midland Unmarked Bar Association, and the Fife Coal Association are illustrations of this type. Such associations usually possess some formal organization: a staff of executive officials and provision for regular meetings. At times deposits are re-

quired to constitute security for the observance of the decisions of the association, but in many instances these common decisions are mere "gentlemen's agreements" dependent upon the good-will of all concerned.

Price-fixing seems to provide a remedy for excessive competition, but in reality it leaves the cause of difficulties untouched. It is of little permanent avail to fix prices if production is unchecked, so that such agreements might well be nullified by the overstocking of the market even without any deliberate intent on the part of the members of the association to abandon the scale of prices. Attempts at price-fixing are thus peculiarly likely to be abandoned altogether or carried further by means of some arrangement for the control of production. Pools, whether of production or of receipts, are the most common device. <sup>Pools</sup>

Specific shares in production are in such cases assigned to the members of the pool, just as the shares in the output of coal were allotted to the various mines in the Newcastle district in the days of the Vend. The adjustment of the allotments presents many difficulties, even when the practice is allowed by law as in England.

The traffic pools among the competing railways in the fifties are representative of the extreme difficulty of establishing a just basis for division of trade or traffic. The Great Northern was a new line, and though it possessed a superior route for many portions of the territory it could bring forward no statistics of traffic to support its claims. The London and North Western and the other roads of the hostile alliance would recognize nothing but existing traffic as the basis for the pool. It was under such circumstances that the intervention of Mr. Gladstone was sought. The ultimate failure of that particular pool is hardly surprising when one considers the utter lack of any real friendliness among its component parts. Some of the difficulties of pooling are avoided by the pooling of the profits instead of the traffic or production.

The German cartel is a stronger organization designed primarily to secure the advantage of pooling without entirely destroying the individuality of the member firms. The essen-



tial feature is the organization of a corporation by the member firms for the purpose of selling the product and determining the policies of the associated companies; the capitalization is nominal, but the organization in all respects similar to that of a corporation doing business directly. The conduct of operations by the member firms, however, is substantially similar to the system followed by a pool. Output is limited and quotas allotted. Provision is made for divergences from the quotas. The prices are fixed. Organizations of this type have appeared in England, though they have never become common as a means to the desired end. The Central Sales Agency which formerly marketed the thread of the firms composing J. & P. Coats seems to be an organization of this type, but its methods are not sufficiently known to admit of much certainty of classification. The North-Western Salt Company (1906) and the Industrial Spirit Supply Company (1907) seem likewise to present the chief features of the cartel. The more considerable combinations in England, as in the United States, have become giant corporations in which the individuality of the constituent firms is wholly lost. Such associations, however, become by necessity permanent.

It is usually presumed that the temporary forms of combination are inherently defective both from the economic and from the legal point of view. The hostile policy of the courts and legislatures in the United States afforded further motives for the abandonment of the temporary forms here, and though there has been no actual hostility to such forms of organization in Great Britain, the fact that all contracts in restraint of trade were unenforceable made temporary combinations ineffective as a remedy for the most destructive forms of competition. It is strange that the different policy adopted in English-speaking countries has not left a palpable impress upon the history of the movement in the two countries, but in reality there is little to distinguish the history of temporary forms of combination here from the history of similar forms in England. The extent of successful evasion of the anti-pooling

**Instability of  
temporary com-  
binations**

laws in this country must have contributed toward this result. Although temporary associations have been accounted wholly futile, it is likely that some of these weaker forms of association play an inconspicuous but significant part in the trade of Great Britain. In attempting to estimate the importance of tendencies toward combination in the entire industrial field these evanescent and unstable forms may really count for more than is frequently supposed, and the fact that they do not result in permanent combination might be taken to indicate limitations to the ultimate extent of the combination movement.

Permanent associations have been organized in Great Britain as holding companies or as new corporations; the "trust" in the accurate sense of the term has <sup>Trusts</sup> been rarely used. The formation of a company to take over all the stock of the member companies presents a number of advantages. It is easier to retain any advantage to be derived from locally known brands and from the goodwill of the subsidiary companies. The former can more readily be kept in close contact with the business. As compared with the giant corporation, these aggregates held together by a holding company may display more individual resourcefulness and energy, retaining the more conspicuous features of individual ownership without its competitive burdens. The large corporation, however, is frequently <sup>The large corporation</sup> able to introduce economies in production by bringing the entire mass of properties up to the standard of the best managed and equipped, closing unessential or badly equipped plants that would have to be kept running under the other system. The characteristics of each form are thus adapted to different conditions, both of personnel and industrial technique: there is scarce any warrant for declaring one form superior to the other.

From the point of view of economics and industrial history these various legal forms are less significant than <sup>Tendencies of vertical and of horizontal combinations</sup> the direction of integration. The effects and purposes of combinations are different with respect to the direction of the tendency toward centralization

of control. The drawing together of a number of firms engaged in producing the same goods for the purpose of centralizing the control of production and sales is likely to result in an attempt to secure some measure of monopoly power. The association can scarcely be satisfied with anything short of a significant control of prices. Horizontal combination thus tends directly toward monopoly. Firms engaged in the manufacture of products which are really stages in the production of a single finished product may find a very different set of motives for combination. Such a vertical integration of industry is in large measure a positive improvement in industrial technique. It is not at all essential that there should be any acquisition of monopolistic powers to justify the formation of such associations. The ultimate result is to intensify competition in the production of the finished product.

The development of the firm of John Brown & Co., Ltd., of Sheffield indicates the characteristic features of the process of vertical combination. The firm had always **Brown & Co. of Sheffield** been self-contained for the manufacture of rolled and heavy steel products, but was dependent upon outside interests for the supplies of raw materials and for the greater part of the market for its products. They soon found it advisable to assure an unfailing supply of ore and coal by the acquisition of iron mines in Spain, Lincolnshire, and Northamptonshire, and of several collieries within a few miles of the main works at Sheffield. In 1890 it was realized that further economies in production could be secured by alliance with firms using the armor plate, marine shaftings, forgings, and castings that constituted the chief products of the Sheffield works. The establishment of new works for general shipbuilding was deemed wholly impractical, and all the essential advantages of increased scale of management could be obtained by amalgamation. Arrangements were finally made for union with the Clydebank Engineering and Shipbuilding Company, so that the combined firms were prepared to undertake every aspect of the work of shipbuilding. In order to extend operations to war vessels as well as to mer-

cantile trade the combination was extended in 1903 to include Thomas Firth & Sons, Ltd., of Sheffield, manufacturers of ordnance and projectiles. The establishment is thus qualified to undertake the manufacture of complete liners or battleships without dependence upon any outside firm for any portion of the work.

The activities of the firm and its alliances are as follows:

*Raw materials:*

IRON ORE. Spain, Lincolnshire, and Northamptonshire.

COLLIERIES. Sheffield.

LIMESTONE QUARRIES.

*Intermediate products:*

PIG IRON. Atlas Works at Sheffield.

MALLEABLE IRON. Atlas Works at Sheffield.

STEEL INGOTS.

ALL DESCRIPTIONS OF ROLLED AND HEAVY STEEL PRODUCTS.

Armor Plate, castings, forgings, ship-plates, angles, etc.

TOOL STEEL.

*Complementary finished products:*

ORDNANCE AND PROJECTILES. Norfolk and Tinsley Works, Sheffield.

Coventry Ordnance Works, Ltd.

Naval Gun Mounting Works,  
Glasgow.

Ammunition Works, Rochester.

RAILWAY MATERIAL.

MACHINERY OF VARIOUS KINDS.

*Primary finished products:*

MERCHANT VESSELS. Clydebank Engineering and Shipbuilding Works.

WAR VESSELS. (Large interests in Harland and Wolff, Belfast, Shipbuilders and Engineers.)

The development of this firm is representative of a tendency that is general within the iron and steel trade of Great Britain. There has been extensive attempt made to coordinate the various stages in the production of finished metal work so as to bring under one control raw materials, intermediate, and finished products. The circumstances that have induced this development can be classified under three heads: market considerations, process considerations, and producing considerations.

Market conditions in the iron and steel trade are complex. The markets for raw materials are particularly sensitive and unstable, and the markets for the essential intermediate products, pig iron and steel, only slightly less so. Firms producing these goods for a market are in a very precarious position, and firms dependent upon buying such goods in the open market are subject to many uncertainties in securing deliveries at proper intervals and satisfactory prices. The large capital equipment of plants in the iron and steel industry exerts pressure on the management to keep the plant running as long as it is possible to recover the specific costs of operation; all hope of earning interest on the fixed capital must frequently be abandoned. If production is in the hands of firms controlling only one stage in the industry there is grave danger that the market will become seriously overstocked with particular types of goods, for the firms producing finished products might check their production sooner than the firms turning out the basic intermediate products. Serious dislocations would also be the result of any circumstances that should stimulate production of finished products at a time of slackened output of ore or pig iron. The close correlation of the production of the products at the various stages can thus be best secured under conditions of vertical integration. For the most part the irregularities in the demand for iron and steel products are seldom general to the entire industry; there are sectional or branch depressions which might be disastrous to a highly specialized firm, though a larger establishment would find it possible to divert its activities into profitable channels, but under such conditions it is obviously desirable that the output of the basic commodities should be carefully adjusted to the specific demands of the moment.

Process considerations consist in the advantages and economies derived from the arrangement of works for the continuous performance of several processes with one heating of the ore and iron. Isolated firms carrying on these operations would be obliged to heat the metal several times; once for smelting, once for producing

malleable iron or steel, once for converting the ingots into other products. The costs of fuel are among the most considerable costs in the business, so that it is an extremely serious loss to heat the mass three times when one heating can be made to suffice. Under vertical control, the ore goes to the blast furnace, the molten pig iron is conveyed to the converters or refining furnaces while still at its full heat, and the steel ingots are drawn from the forms and sent to the rolling mills as soon as they have cooled sufficiently for the purposes of that process. These economies alone would be important enough to lead to much concentration of management, but there is further opportunity through the utilization of waste gases and heat. The gases which escape from the blast furnace can be burned in gas engines and used to produce electricity or other forms of power. Exhaust steam can be diverted into turbines and utilized. In these ways many of the great demands for power in driving the heavy machinery of the plant can be met by the conversion of products that would be entirely wasted in isolated smelting works. The rolling mills, hot blast plant, and general machinery can be entirely, or very nearly, supplied with power by the use of the heat and gas from the coke ovens and blast furnaces required to furnish the requisite mass of pig iron: a strange instance of fortuitous correlation in an industrial process.

The joint operation of these market considerations and process considerations produces an intermediate group of circumstances which can best be distinguished <sup>Economies</sup> as producing problems. Most of these matters center around the problems of management concerned with maintaining continuity of operation of the plant as a whole. The outlay in wages and fuel is not affected by small differences in the output. Costs per ton of output will thus vary according to quantity. A firm running about three quarters time reported costs, as shown on page 488.

In the case of the firm from whose books these figures were taken there was an annual saving of about £45,000 by reason of increased continuity of operation. It will be obvious that no firm could secure the regularity of deliveries of ore

19— Week of	Tons finished	Wages per ton	Fuel per ton
Feb.—.....	2364	16/10.5	2 tons .5 cwt.
Feb.—.....	2222	17/6.75	2 tons .5 cwt.

Increased cost in wages for the second week, 8.5d. per ton.  
Average wage cost for two weeks, 17s. 2.5d.  
Fuel consumed per ton, 2 tons, 0.5 cwt.

When operating full time costs were as follows:

Week of	Tons finished	Wages per ton	Fuel per ton
March—.....	3093	14/8	1 ton 10 cwt.
April—.....	3105	14/2.5	1 ton 9.75 cwt.

Average wage cost for two weeks, 14s. 5.5d.  
Average fuel consumed, 1 ton, 9.87 cwt.

Saving in wages over three quarters time.....	2s. 9.25d.	per ton
Saving in fuel.....	2s. 2d.	
General charges.....	1s.	
Total.....	5s. 11.25d.*	

\* Carter, G. R.: *The Tendency toward Industrial Combination* (London, 1913), 118.

and coal from independent producers that could easily be maintained in mines under the direct control of the firm. Complete control of the entire course of production of a group of finished products thus affords the best opportunities for securing the closely regulated flow of goods from raw materials to consumers that is well-nigh essential to success in the iron and steel industry. Unessential middlemen's costs are avoided and serious wastes of by-products eliminated.

Vertical combination at the present time is a manifestation of the integrating tendencies in industry that appear from time to time after periods of excessive specialization and disintegration. The modern phenomenon may be compared to the development of centralized control of craftsmen under the putting-out system; the essential economies were similar though not present in such striking form. Such integration does away with not a little buying and selling of intermediate products, but it does not in any accurate sense of the word restrict the area of com-

petitive trade, least of all does it tend to destroy the competitive order. The giant corporations and amalgamations in this field cannot be cited as indicative of an essential tendency toward nationalized or socialized industry, though, of course, such a structure could be raised on the foundations now existing. It should be recognized, however, that such a development would not be a logical outgrowth of tendencies now revealed.

The difficulty of generalizing with reference to the entire industrial field is well illustrated by the great divergence between the conditions in the iron and steel trade and the textile trades. In the former the tendency is toward vertical integration, in the latter there has been no tendency toward further integration since the early nine-<sup>The textile trades</sup>teenth century; in fact, there seems to be some tendency toward more definite separation between the various branches of the industry than was common in 1800. At that time it seemed as if there might be an advantage in the combination of spinning and weaving, but no such combination has taken place. The industry gives every evidence of having reached a stable position with reference to the degree of vertical integration. Spinning, weaving, and dyeing are carried on by different establishments in all the major branches of the textile trade, and there are various special phases of manufacture that are similarly carried on in particular establishments. The tendencies toward combination in these trades thus assumes the horizontal form by necessity. In the early years of the active development of combination, 1896-1900, by far the greatest number of combinations announced consisted of firms in the textile trades; in a list of thirty-one amalgamations and combinations, sixteen were concerned with textile manufacture. This numerical predominance is due in part, of course, to the relative predominance of the textile trades, but it would seem likely that it was also an indication that the problems created by extravagant competition were particularly severe.

The most spectacular success has been achieved by the firm J. & P. Coats, Ltd., and its allies. The original firm was



founded in 1826 as a purely personal business which remained in the family for three generations. In 1890 the firm reorganized as a limited liability company capitalized at £5,750,000; it then occupied a very prominent place in the manufacture of sewing cotton; but, if we can form some rough estimate from the relative investments of capital, it could scarcely have controlled more than one third of the business of the United Kingdom in sewing cottons. By the formation of the Central Thread Agency the severity of competition in the business had already been significantly reduced. Notwithstanding these developments the Coats firm inaugurated a new movement beginning in 1895 and 1896. Amalgamations were formed by the purchase of the stronger houses: Kerr & Co. of Paisley, in 1895; Clarke & Co. of Paisley, James Chadwick & Co. of Bolton, Jonas Brook & Co. of Meltham, in 1896. The reorganized corporation was capitalized at £12,000,000. The property of the company included sixteen factories, some of which were located in the United States, Canada, France, Spain, and Russia; sixty branch houses and one hundred and fifty dépôts. Since amalgamation the firm has paid dividends of twenty per cent or more, in addition to some bonuses. These achievements, too, were not the result of high prices. A statement in the Financial Supplement of the London *Times* of December 31, 1906, is favorable to the company, but apparently disinterested:

The average price of the standard length of 200 yards six cord [says the writer] has actually been 2*d.* per gross of 144 spools higher than the average price ruling during the twenty-five years preceding the amalgamation; but with larger discounts to the trade allowed since the amalgamation the price is actually less. Wages have risen considerably, as also has the fine cotton used, as well as the coal. Spool-wood — an important item — is 25 to 30 per cent dearer than formerly. In effect, then, thread costs more to make by the combination even with the economies attainable under the combination, yet the consumers (or at all events the retailers) are paying somewhat less for it than they did when it cost less to make. It is not the case that the Coats combination has forced out competitors by underselling them. . . . The combination has improved the character of

its products, while it has immensely reduced the cost of distribution. . . . What the "Combine" has done is to destroy the business of the middlemen, who stood between the thread manufacturers and the drapers and large customers. All these smaller dealers and consumers can now buy direct from the Central Agency on the same terms as the wholesale dealer.<sup>1</sup>

The success of the combination was due to the skill and judgment of the leaders both in the detailed organization of the business and in the absence of any illusions Elements of success about the value of a comprehensive amalgamation of all the firms in the industry. They were never deluded by the megalomania of promotions. None but the best organized firms were brought into the combination, although many houses were omitted; and, although it might seem that the combination was not in a position to dominate the industry because of the large capitalization of these excluded firms, the superior efficiency of the Coats firm really placed them in a position of substantial power.

In 1897 the excluded firms formed a combination of their own, organizing a holding company under the name of the English Sewing Cotton Company. Friendly Failure of the rivals relations were established with the Coats firm which took some of the stock of the English Sewing Cotton Company and entered into a pooling agreement. By the terms of the agreement both companies were to abide by the existing condition of the trade: existing proportions of trade in areas reached by both companies were to be maintained unchanged, and certain other markets were reserved to one or the other company. In the following year the English Sewing Cotton Company encouraged various firms in the United States to form a combination, and the American Thread Company was ultimately organized. The relations between the companies were close; the American Company took stock in the English Sewing Cotton Company, and the three managing directors of the latter sat on the board of the American Company. When the pooling arrangement with Coats is

<sup>1</sup> Cited by Macrosty, H. W.: *The Trust Movement in British Industry* (London, 1907), 128-29.

taken into consideration it will be seen that scarce any vestige of competition was left in this industry.

The finances of the English Company were badly managed, and in 1901 the lack of judgment and looseness of management could no longer be concealed. It appeared that excessive prices had been paid for the good-will of many of the constituent companies, promoter's profits arising out of the American Thread Company had not been kept sufficiently distinct on the books of the English Company, and the actual conduct of business was scandalously neglected. A scheme of reorganization was prepared with the assistance of one of the Coats firm, and reforms were carried out under the tutelage of Coats. The stronger combination has thus acquired a moral ascendancy over the greater part of the trade. The substance of monopoly power is in their hands with reference to the trade of the world in this highly specialized product.

Concentration has not proceeded to such lengths in other branches of the textile industry, though the number of competing firms has been greatly reduced by combination. However, it is clear that the field of competition has been significantly restricted, and there is no ground for supposing that the movement has reached a stable equilibrium. The published reports of most of these companies reveal a discouraging financial situation: some have paid no dividends, and others only the most moderate rates. The disappointment of large expectations may well have an influence upon future developments of combinations. It is scarcely possible to know whether one should anticipate further concentration or some measure of reaction.

The larger outlines of the history of combinations in the textile industries are representative of the tendencies in the other portions of the industrial field. There have been a few spectacular successes; competition has been notably restricted; temporary forms of combination have proved to be relatively unstable, and the greater mass of amalgamations have failed to realize the expectations of profit that were entertained.

Qualified suc-  
cesses elseq-  
where

## III

These tendencies toward combination are variously interpreted by radicals and conservatives. The socialists, and many with socialistic leanings that are not sufficiently pronounced to lead to definite avowal <sup>Interpretations</sup> of such doctrine, invest the whole subject with a large significance. Although Marxian doctrines are seldom mentioned, the history of these recent years is read as a fulfillment of the earlier phases of the prophecies of Karl Marx. The increase in the scale of business enterprise has taken place in at least as great a measure as he was inclined to expect. There is substantive evidence of a "tendency," and, with little recourse to theoretical demonstration, it is assumed that this tendency will by necessity proceed to the extreme logical conclusions. Combinations and monopolies thus constitute the last phase of the Industrial Revolution, representing the culmination of the forces set in motion by the Great Inventions. The existence of the evils of the competitive order and the evident dangers from private monopoly become, in the <sup>Socialistic</sup> mind of the socialist, proof that the "competitive <sup>views</sup> order" is doomed. The movement is interesting to the socialists also from another point of view: these industrial organizations afford some intimation of the ultimate character of socialized industry. "It necessitates not so much changes in organization as an alteration of the aims to which that organization is to be directed."<sup>1</sup> The concreteness of these developments has made it possible for socialists to present a view of the new society that is wholly freed from the obvious utopianism of earlier writing. The Fabians add to this element of seductiveness their patience in waiting for the new industrial day. They have a remedy for monopoly, and it is not merely a policy, but a faith in irresistible historical tendencies.

The historical interpretation of which their view is a part makes it impossible to discuss the nationalization of indus-

<sup>1</sup> Macrosty, H. W.: *Trusts and the State* (London, 1901, The Fabian Series), 237.

try merely as a policy which we are free to adopt or reject. It is essential to recognize the importance of the socialistic faith in an imperative necessity for this solution of the problem. The proper object of criticism and discussion is not the policy advocated, but the interpretation of industrial history upon which the faith is based.

It is, of course, impossible to achieve a final interpretation of any series of historical events, so that it would be un-  
 scholarly to intimate that the socialistic interpretation can be  
 disproved or another view positively estab-  
 lished in its place. It is, however, legitimate to  
 point out the possibility of another interpretation, and thus  
 throw some measure of doubt upon the dogmatic conclusions  
 of the socialistic writers.

It has been a purpose of this present study to show that the history of industry is susceptible of other than the usual socialistic interpretation, so that the entire text constitutes the primary answer to the socialistic view, but with reference to the particular issues raised by the problem of monopoly some special discussion may be in place. It would seem that the fundamental features of the socialistic interpretation are: the alleged inherent instability of the forms of industrial and commercial organization evolved during the period of the Industrial Revolution; the notion that the cause of all the trouble is the dehumanizing influence of machinery.

There has been a long struggle between two great principles [says Macrosty]. Competition came into the industrial world to free trade from feudalism, and, having done that work, played havoc with the lives of men. It called into existence the great opposing principle of association, by which a series of bulwarks against individualism has been built up in the trade union, the coöperative society, the municipality, and the central Government. Finally, competition turning against itself, has ended in combination, and private monopoly threatens to overwhelm the State by economic and political oppression. We cannot turn back the march of economic progress; for good or for evil we must now face the concentration of industry. We cannot go back to competition, but we can direct the new tendency into safe channels. In the collectivisation of industry lies the future hope of society, and it will be attained by the gradual

transfer of one branch of production after another under the control of the municipality or the Government.<sup>1</sup>

The socialistic position makes the question-begging assumption that there is no possible middle course between the most extreme freedom of competition and absolute monopoly. The present organization of society is regarded as being hopelessly unstable because it represents neither extreme; competition is by no means unregulated, monopoly is not complete. The conservative interpretation of recent events turns upon the faith in the existence of this middle course. It is deemed possible for industry to achieve some measure of stability of organization without becoming entirely monopolistic on the one hand, and without entirely losing all elements of a competitive character on the other hand. Neither monopoly nor competition appears in its absolute form; neither can entirely exclude the other. The existence of competition is not incompatible with significant elements of monopoly in price-making, and it is entirely conceivable that a society should remain in large measure competitive despite the presence of a considerable number of industries and occupations carried on under monopoly conditions.

The relativity of these terms is best illustrated, perhaps, by the trade in books and certain kinds of patented articles. The copyright or patent confers an absolute monopoly of the privilege of producing particular books or goods, and yet the book trade and the trade in many kinds of patented goods is dominated by competition. Novels, schoolbooks, books of travel, de luxe editions of various classics all sell at prices that are not determined by the individual publisher according to the principle of securing the maximum net revenue, but by the general demand for the particular class of literature concerned. The existence of the copyrights on the various books serves merely to lift the plane of competition. Such books sell for more than similar books on which the copyright has expired; it becomes possible to reward the author for his work, but the special privilege does not become the basis of a monopoly

<sup>1</sup> Macrosty, H. W.: *op. cit.* 317.

price. This is merely one of the more striking cases of the importance of the collateral competition of substitutes. There are many others, notably the various mineral waters, the different systems of artificial illumination, different routes of communication between two points, and the like.

The phenomena which we usually describe as a growth of monopoly are in a sense changes in the character of competition. At times, to be sure, the change results in a dangerous weakening of competitive control, creating not an absolute monopoly, but a measure of monopoly control that is sufficient to afford opportunities for the manipulation of prices in the interest of the proprietors of the undertaking.

The view of the socialist must be qualified in one other respect: it is not necessary to presume that competition consists solely of self-destructive rivalry in price-cutting. The reduction of prices below the level consistent with continued operation is an unrepresentative and reprehensible form of competition that confers no benefit upon the public. Such trading has never been placed by law in the category of unfair competition unless there were aggravating circumstances, but the spirit of such transactions is closely similar to prohibited practices. It is therefore unfortunate in the extreme that this type of rivalry should be so firmly fixed in the mind of the public as the characteristic form of competition. The selling at varying prices that can remain a permanent basis of trading is not sufficiently distinguished from the disastrous price-cutting that is intended by both parties to be wholly temporary. The existence of price agreements in a trade is not inconsistent with important competition in the character of the services rendered.

The socialistic doctrine of the causative importance of machinery is related to the problem of monopoly in a round-about fashion. The productivity of industry with the mature mechanical technique, together with its ownership by a relatively small class of capitalists, is made the explanation of commercial crises. There is a chronic and periodic over-production because the power of the consuming public to buy is disproportionate to the power

of society to produce. The capitalists thus defeat their own ends by withholding from the laboring classes their just share of the purchasing power of the community.

It is impossible to answer this body of doctrine in brief compass, and much of the discussion is a matter of pure theory. It may be sufficient to repeat the proposition advanced in an earlier chapter, that machinery was at once a result and a cause of some of the phenomena of the Industrial Revolution. In so far as one approaches these problems as a matter of historical narrative the development of machine technique was a result of an expanding market for new commodities. Changes in the character and extent of the market constitute the background of industrial history, and there are progressive changes in the degree of the division of labor to correspond with developments of the market. The disintegration of industry by the division of labor must needs be balanced by countervailing tendencies toward integration. The development in industrial history is for this reason not in a single direction: neither exclusively disintegration, nor exclusively integration. There is an oscillation. The combination movement represents the contemporary aspects of a set of integrating tendencies, and, if we may judge by the past, we may feel confident that these tendencies precisely will not proceed to any rigid logical conclusion. The marketing conditions in the different branches of industry are widely different, and we may presume that the measure of integration ultimately achieved will bear relation to the specific problems of each industry.

The conservative is thus inclined to approach the problems of monopoly in somewhat the frame of mind of the practical politician; he is disposed to deal with each case separately, unprejudiced by dogmatic con-<sup>The conserva-</sup>ceptions of policy. There is in his mind an indisposition to regard any single policy as a complete remedy for the troubles we now experience with monopolies. The various suggestions now current offer different prospects of attaining the desired end. The limitation of the size of corporations presents possibilities, but it is hard to regard such a proposition



as an ultimate solution of any considerable number of problems. The notion of having a limit seems good, but the practical determination of any limit would seem likely to become a penalty upon efficiency. Furthermore, if there is any correlation between the size of the corporations in a given field and the market, the limit would be by necessity elastic. It might prove to be something in the nature of the limit of note issue at the Bank of France — a limit that was increased whenever there was any prospect that it might be reached. Limitation of profits, if successful, would almost certainly diminish the stimulus to efficient management.

In English-speaking countries the control of large-scale enterprise is tending to combine three elements: publicity of accounts, public fixation of prices in certain industries, and the suppression of predatory competition by legislative and administrative regulation. The results, as yet, leave much to be desired.

Despite all our experience and thought [says Jethro Brown] the best that can be said is that we are groping our way toward sound conclusions. Some useful data we have; and some principles seem to be clearly established. But the precise significance of the data is often doubtful; and the value of established principles is limited by the fact that we have to apply them, not to an ideal world, but to a world of actual facts around us. Many things are desirable that are not practicable; much that is practicable is not desirable. I believe that, if we are to proceed on right lines, we should begin with a recognition of the difficulties before us, their complicated character, and their manifold ramifications.<sup>1</sup>

<sup>1</sup> Brown, W. Jethro: *The Prevention and Control of Monopolies* (London, 1914), 47-48.

## CHAPTER XX

### INCOMES, WAGES, AND SOCIAL UNREST

#### I. MATERIAL WELL-BEING

No question is more interesting to the average reader on economic history than the relative well-being of the lower classes at different historical periods. Many seem to feel that economic history fails to make any material contribution to knowledge unless some conclusions are possible with reference to the welfare of society. In general, no very satisfactory answer is possible. Statistical material is so scant and so different in character at different periods that no details are available. At the same time it is possible to reach some objective judgment which may serve in a measure to answer the doubts that arise as to the reality of the "progress" which we seem to find characteristic of the period of the Industrial Revolution.

Taken in their entirety the changes in the form and character of social life have resulted in real improvement in the material basis of life. The improvement is rela- <sup>Material</sup> <sub>progress</sub> tive only; we can merely say that living conditions are better than they used to be, and we can be reasonably certain that there is still opportunity for much improvement. The material change can best be measured in terms of the declining death-rates. These rates express the number of deaths per thousand persons, and, although there are some refinements of statistical method that might effect small corrections, these official figures are sufficiently correct for the purposes of such a comparison as we have in hand.

The very great decrease in mortality that is shown by these figures is perhaps the most decisive indication that can be given of the change in living conditions. The figures are somewhat more impressive in their positive form. We think more readily in terms of the expectation of life than in terms of crude mortality, but unfortunately the positive form be-

DEATH-RATES PER THOUSAND PERSONS: ENGLAND AND WALES,  
1841-50—1911

	<i>Males</i>	<i>Females</i>	<i>Children</i>		
			<i>Under 5</i>	<i>5-10</i>	<i>10-15</i>
1841-50 .....	22.2	21.0	66.0	9.0	5.3
1861-70 .....	22.3	20.4	68.6	8.0	4.5
1881-90 .....	19.7	17.6	56.8	5.3	3.0
1901-10 .....	16.4	14.4	57.7	4.3	2.5
1911 .....	15.3	13.3	43.7	3.4	2.1

comes more complex because the expectation of life changes each year. Suffice to say that several years have been added to the reasonable expectation of life. This achievement is perhaps more largely an achievement of science than of industry; the result is due to the development of preventive medicine and public-health legislation. However, these changes have been a part of the change that we think of as the Industrial Revolution; they have been an integral part of the new social order that has developed, affording the clearest indication of the new social conscience.

The question of material well-being, however, presents itself in another guise; the relative condition of the different classes as compared with each other proves more interesting to most readers than the more general matter of the condition of society as a whole. It is easily forgotten, however, that any general change must appear among the most numerous classes, so that a general social improvement, such as we find indicated by the lower death-rates, must be evidence of substantive change for the better among the lower classes. But more concretely, it is desirable to know whether wages have gone up as rapidly as incomes from property. Has the position of unskilled laborers changed for the better? Are skilled laborers relatively more numerous and better paid? Is the class of persons with moderate incomes increasing or decreasing relatively to the class of persons with very large incomes? These questions are unfor-

tunately difficult to answer. The material available is none too plentiful, and the interpretation of existing statistics presents many problems that are not yet satisfactorily solved.

It is somewhat artificial to attempt statistical statement of changes in the general rates of wages. Averages leave out many details that are of real importance. But <sup>Differences in</sup> there is a measure of reality in statements of <sup>wages</sup> average wages, because there is a perceptible tendency toward the establishment of rates of pay that are designed to be related to the strength and skill required by the occupation. Labor is not as mobile as would be necessary to give full effect to these tendencies toward equalization of wages; differences persist between occupations and between localities. The rates of wages for unskilled agricultural labor tend to be somewhat different from the rates for unskilled industrial labor. Likewise, the wages that prevail in London tend to be somewhat higher than the wages in provincial towns, differences that may be partly explained by higher costs of living in the larger towns. Studies of general rates of wages are thus most significant if we preserve some of these distinctions between groups of wage-earners. It would seem particularly important to maintain some distinction between the rates for skilled and for unskilled labor.

The differentiation between the skilled and the unskilled is sufficiently clear to influence any statistical statement of a single average wage; one could never be cer- <sup>Skilled and un-</sup>tain whether or no changes were due to circum- <sup>skilled laborers</sup>stances that really affected only one of the two classes. It is thus desirable to distinguish as carefully as possible between the wages of these two groups. Much light is thrown upon some of the important social problems involved, if this distinction is carefully maintained. The unskilled laborers are close to what is coming to be called the "poverty <sup>The "poverty</sup> line"; which is presumed to represent the <sup>line"</sup> minimum income compatible with the maintenance of full physical vigor. The most notable recent estimate of this irreducible minimum is that of Seebom Rowntree. He estimates as follows the family income necessary before the War:

	s.	d.
Expenditure on food.....	12	9
Rent and rates.....	4	0
Clothing, including boots.....	2	3
Fuel.....	1	10
Light, washing materials, furniture, etc. ....		10
	21	8 per week

The dietary assumed in this estimate "contained no butcher's meat or butter, and allowed such a luxury as tea but once a week. The only meat was bacon and very little of that. It was a dietary 'more stringent than would be given to any able-bodied pauper in any workhouse in England or Wales.' Taking the lowest coöperative store prices, he found that this dietary would cost 3s. each for the adults and 2s. 3d. each for the children per week. Thus the cost of food alone would be 12s. 9d. per week." The other estimates were based on similar presumptions of minute care in expenditure. In all probability the average family of such circumstances would not succeed in distributing its income with as much intelligence as Mr. Rowntree presumes; real needs would in many cases be sacrificed to indulgence in alcohol and tobacco or to extravagant expenditure for clothes. Such estimates are subject to many elements of error, but they possess a real significance. The unskilled laborers have been at all times very close to this line of primary poverty, and at certain periods of high prices most of the unskilled have been far below this margin. Materials exist for a careful study of the condition of the unskilled laborers in agriculture and in certain branches of industry; but as yet these materials have been very incompletely utilized.

Mr. Bowley in studies of wages in the nineteenth century has endeavored to preserve these distinctions. He has Bowley's figures studied the changes in wages of particular groups of wage-earners, so that his figures are merely representative, typical to the extent that conditions in the groups chosen were fairly typical of a larger class. The skilled laborers are represented in the table chiefly by the building trades, the unskilled town laborers being the helpers. Study of these particular classes seemed desirable because

they were least affected by the great changes of the Industrial Revolution.

TENTATIVE TABLE OF AVERAGE WEEKLY WAGES\*

	1795	1807	1824	1833	1867	1897
	s. d.	s. d.	s. d.	s. d.	s. d.	s. d.
London artisan.....	25 0	30 0	30 0	28 0	36 0	40 0
Provincial artisan.....	17 0	22 0	24 0	22 0	27 0	34 0
Town laborer.....	12 0	14 0	16 0	14 0	20 0	25 0
Agricultural laborer...	9 0	13 0	9 6	10 6	14 0	16 0

\* Bowley, A. L.: *Wages in the Nineteenth Century* (Cambridge, 1900), 70.

This tentative representation of the movement of wages is interesting in several particulars. The stress of the period 1824-33 is evident among all classes of workers, but it was especially severe for the agricultural laborers. The price of wheat was high, and wages of 9s. 6d. or 10s. 6d. must have been wholly inadequate for their maintenance. The crisis of poor-law administration correlates definitely with these indications of wages; the only periods of greater distress were some of the years of the Napoleonic wars. Further detail for the agricultural laborers is furnished by figures from Sussex, given on the following page. The agricultural laborer thus endured a relatively long period of great economic pressure in the early part of the century. Relief came partly through increased wages and partly through the fall in the prices of the essential foodstuffs, especially wheat. The greater stability of prices of wheat, after the repeal of the Corn Laws, was also a great boon to the poor. The agricultural laborer was thus a burden on the poor-rates for the greater portion of a generation.

The condition of the town laborer is less certain; without specific local study we cannot be sure whether these laborers were relatively independent of the poor-rates or not. The position of the artisans, however, seems to be fairly clear. The artisan seems to have been above the line of primary poverty throughout the period, and with the exception of a few years his economic position

Agricultural laborers pay poor

The artisans

## WEEKLY WAGES OF AGRICULTURAL LABORERS IN SUSSEX \*

	<i>Wages</i> <i>s. d.</i>	<i>Pecks of</i> <i>wheat purchasable</i>
1767-70.....	8 6	5.7
1793.....	9 6	6.0
1795.....	10 6	4.5
1813.....	13 0	4.0
1821.....	9 0	5.0
1822.....	8 0	5.6
1824.....	9 6	4.7
1827.....	10 0	5.4
1830.....	11 0	5.5
1831.....	12 0	5.8
1833.....	10 0	6.0
1834.....	10 0	7.0
1836.....	10 0	6.6
1840.....	10 0	4.8
1851.....	10 6	9.0
1860.....	11 7	7.0
1870.....	12 2	8.3
1872.....	13 4	7.3
1880.....	13 6	10.0
1885.....	13 6	13.0
1887.....	12 0	12.0
1892.....	12 0	12.7

\* Bowley: *op. cit.* 40.

seems to have grown steadily stronger, so that toward the end of the century the artisan was comfortably above the poverty line. This, indeed, seems to be the chief result of these statistical inquiries, and, as the purchasing power of money was increasing until at least 1896, the movement of real wages was in general favorable to the wage-earner. There were reductions of hours in nearly all trades, also, both those regulated by general statutes and trades which had secured the shorter hours by their own efforts. We are certainly justified in saying that the skilled laborers were receiving at the close of the century appreciably higher wages for shorter hours of work.

It is difficult to secure satisfactory evidence of the relative position of the different classes in the community to each other. The statistics available are fairly trustworthy for incomes of £160 or more, but the exemption of smaller incomes makes it essential to supplement

Returns of  
incomes

the figures for those in receipt of labor incomes of less than £160. The figures for the different classes thus come from different sources and present varying degrees of accuracy. The interpretation of the figures is also a matter of considerable difficulty, influenced in most cases by the disposition of the statistician. Thus, for the year 1907 we have estimates of total income ranging from £1,800,000,000 to £1,964,000,000, all from substantially the same figures, and the publication of the final figures for the Census of Production added another figure, £2,038,000,000. The division of the total income between the different classes is subject to a similar degree of uncertainty, and conclusions must thus be accepted with many mental reservations.

The following table has been selected from a number of estimates, including as far as may be estimates from the same source. The first set of figures were prepared by Mr. Robert Giffen; the figures for 1851, 1867, and 1881 are by Mr. L. Levi; those for 1904 and 1907 are taken from Mr. Chiozza Money's statements. An estimate by Mr. A. L. Bowley has been added to indicate the degree of uncertainty in the estimates for 1907. It should further be noted that Mr. Money is disposed to set the larger incomes at maximum figures and to estimate the smaller incomes on the most conservative basis. Giffen and Levi are more inclined to believe that the incomes of the lower classes were a very considerable proportion of the total. Thus any tendency toward error in the appended table (page 506) will probably be in favor of the larger incomes.

The increase in all classes of incomes is considerable, the rate being in excess of the rate of increase of the population, but it is noteworthy that the incomes of manual workers receiving less than £160 per year in- Conclusions creased much more rapidly than all other classes of incomes. The incomes of the clerical workers and small shopkeepers increased least of all. Studies by Robert Giffen point to a considerable increase in the class of persons in receipt of incomes of somewhat more than £160. During the period 1838-82 the amount of property probated in England in-



## DISTRIBUTION OF INCOMES IN THE UNITED KINGDOM: 1835-41—1907 \*

	<i>Giffen</i> 1835-41	<i>Levi</i> 1851	<i>Levi</i> 1867	<i>Levi</i> 1881	<i>Money</i> 1904	<i>Money</i> 1907	<i>Bowley</i> 1907
	(millions of pounds sterling)						
Above £160.....	250	272	423	577	830	909	880
Below £160, non-manual workers.....	94	132	120	143	225	232	325
manual workers.....	171	242	418	448	655	703	740
Total below £160.....	265	374	538	591	880	935	1065
Total.....	515	646	961	1168	1710	1844	1945

\* Whittaker, Sir T. P.: *Ownership, Tenure, and Taxation of Land* (London, 1914), 52.

## PERCENTAGE OF INCREASE OF EACH CLASS OF INCOME OVER THE FIGURES FOR 1835-41

	1851	1867	1881	1904	<i>Money</i> 1907	<i>Bowley</i> 1907
Above £160.....	8.8	69.2	130.8	232.0	263.6	252.0
Below £160, non-manual workers.....	40.4	27.6	52.1	139.3	157.4	150.0
manual workers....	41.5	144.5	162.0	283.1	311.2	332.8
Total below £160.	41.1	103.0	123.0	232.0	252.8	301.8
Total.....	23.5	86.6	126.8	232.0	250.3	277.6

creased from £47,000,000 to £118,000,000, but the average amount of property in each estate increased only from £2170 to £2600. The increase in wealth must thus have been rather well diffused among moderately well-to-do people. The evidence furnished by the income tax schedules seems to indicate that the number of recipients of the smaller incomes remained at least proportionate. On the whole, therefore, we have grounds for believing that the artisans and middle-class people have at least maintained their position in the community, if not actually gained in relative well-being.

In view of these general conclusions, the growth of the very large fortunes presents many perplexing problems. There seems to be little reason to doubt that there has been an extraordinary development of great incomes, and a correlative concentration in the ownership of

**INCOMES, WAGES, AND SOCIAL UNREST 507**

property. The facts have been presented in a variety of forms, and unfortunately there has been more sensationalism than scientific analysis. Mr. Chiozza Money divides the community into those who are rich, with an income of £700 or more; those who are comfortable, with incomes ranging from £160 to £700; and those in poverty, by reason of having less than £160 per year.

**DISTRIBUTION OF BRITISH INCOMES: 1908\***

	<i>Total number of persons dependent on the income</i>	<i>Income: millions of pounds sterling</i>
With more than £700.....	1,400,000	634
With more than £160 but less than £700 .....	4,100,000	275
With less than £160.....	39,000,000	935
Total.....	44,500,000	1844

\* Money, L. C.: *Riches and Poverty, 1910* (London, 1911), 50.

More than one third of the entire income of the United Kingdom is enjoyed by less than one thirtieth of its people. Elsewhere Mr. Money puts the matter in a slightly different form, using the probate returns: "Year by year, with the regularity of the seasons, about four thousand persons die leaving between them about £200,000,000 out of total estates declared to be worth about £300,000,000." A measurably similar concentration of wealth is to be found in other countries, in some apparently more, in some less than in the United Kingdom. There can be very little doubt of the essential accuracy of the facts, but we have not yet succeeded in interpreting the facts.

The designation of these different groups of recipients of incomes is a matter of vital importance. One decides the question in advance by classifying as "Poor" or in "Poverty" all who have less than £160. Question-begging terms The poverty line drawn by Mr. Rowntree assumed a yearly income of about £60, and it would seem possible for people to live in something more than "poverty" on incomes ranging between £100 and £160 annually. It would seem de-

sirable that discussions of such social problems should be dominated by some measure of uniformity in the use of such strong words as "poverty" and its related phrases. One will, of course, recognize that the conception of the middle class is vague, but for that reason any statistical studies should be scrupulously careful in the selection of group designations.

The problem is, however, more than a matter of minute details of terminology. Investigators have not always been clear in their minds as to the standards of comparison in terms of which the results were to be judged. Professor Young has given especial attention to this aspect of the problem at one of the recent meetings of the American Economic Association. He says:

What is the precise meaning of the concentration of wealth? By what standards shall we measure it? In general, I think, statisticians have been accustomed to use "concentration of wealth" and "inequality in the distribution of wealth" as loosely interchangeable terms. Now any departure from perfect equality in the distribution of wealth means *inequality*. But is *concentration* to be defined so broadly as this? Wealth might be distributed unequally, without there being any amassing or concentration of any relatively large part of it in the hands of any one group or portion of society.

**Concentration** Concentration means, then, a particular kind of inequality in distribution. And, moreover, while, statistically speaking, any perceptible degree of centralization must be deemed concentration, yet the social problem of the "concentration of wealth" is very certainly the problem of its undue or excessive concentration. But we have no definite standard of what constitutes justifiable, permissible, or normal concentration. And so the statistics are made to indicate merely the gross departure from a condition of absolute equality in distribution. One has to be on one's guard, therefore, against imputing to them a significance which possibly they may not have.

For the most part, however, equality of distribution is interpreted literally; that is, it is taken to mean absolute uniformity in the distribution of income. Thus, when a statistician throws his estimates into the familiar form that assigns a certain (large) proportion of the aggregate income to a certain (small) proportion of the families, the comparison inevitably implied is with a state of things in which 50 per cent of the families get exactly 50 per cent of the aggregate income and 10 per cent of

the families get 10 per cent of the income. And so with Dr. Lorenz's graphic device for representing the way in which such proportions depart from the line of absolutely equal distribution. So, too, with the index of concentration which Professor Corrado Gini has suggested as a substitute for Pareto's, but which increases when Pareto's decreases, and which becomes unity when one income receiver gets just as much income as another. . . . All of these ways of expressing the degree of inequality in the distribution of wealth use as a standard or reference of comparison an absolutely equal and uniform distribution.

Some or all of these measures are useful in comparing the distribution of wealth in different countries or at different periods. But none of them is of much help in forming a judgment with reference to the degree of undue or excessive concentration that may exist. The degree of departure from absolute equality, however measured or stated, must itself be referred, if not explicitly, then in some vague way, to a standard of normal or justifiable concentration. A dead level of uniformity is neither practicable nor desirable as an ideal of distributive justice.

A concrete example may give point to this consideration. Suppose that incomes in an imaginary society were distributed symmetrically around the modal or most common income, in the form of a normal frequency distribution. This distribution might represent either one of two things: (1) a normal distribution of ability and a perfect proportioning of income to ability; (2) a random or chance distribution of incomes, under the influence of complex but unbiassed forces. This second condition would be consistent with the existence of real equality of opportunity, broadly understood, coupled with the presence of a myriad of small circumstances that might deflect one towards a lower or a higher portion of the income range. Now suppose that the average family income is \$1500 and that half the families get incomes that are within \$200 of this average. Under such conditions the richer half of the families would get 58 per cent of the aggregate income and the poorer half would get 42 per cent. Increase the dispersion of the distribution somewhat, so that half of the incomes is between \$1000 and \$2000. Then 70 per cent of the aggregate income would go to the richer half of the population, and 30 per cent to the poorer half. Increase the limits between which half of the incomes fall to \$800 and \$2200, and the portion of the aggregate income assigned to the richer half of the population becomes 78 per cent, leaving 22 per cent for the poorer half.

I do not think that Dr. King's recent estimates err in the direction of underestimating the present inequality in the distribution of incomes in the United States. He assigns about 27 per cent of the

aggregate income to the poorer half of the families and 73 per cent to the richer half. But this is a slightly smaller degree of concentration than would be given by a normal frequency distribution with half the incomes falling between \$900 and \$2100. This suggests that no single or general statement of the degree of concentration can give, by itself, an adequate notion of the extent to which the existing distribution has to be deemed unsatisfactory. And instead of tabulating statistics in the misleading form of the proportions of aggregate income or property in the hands of stated proportions of the population, it is better to use a **Proper methods** simple frequency distribution, showing the relative numbers of income receivers or property owners in the different income or property classes. Such frequency distribution can be adequately described and compared, one with another, and with various ideal schemes of distribution by the use of the constants devised by Pearson for measuring their spread, skewness, and curvature. Such a handling of income statistics serves to focus attention upon the really important things, which are the upper and lower limits of the income scale and the manner in which income receivers are distributed between these limits. The *amount* of concentration, the amount of departure from a condition of uniform incomes, does not matter so much as does the particular *form* of the income distribution underlying the concentration. An identical degree of concentration may result from a fairly good and a very bad distribution of incomes.

The worst thing in the present situation is undoubtedly the extreme skewness of the income frequency curve. The mode — the most common magnitude — is very close to the lower limit of the distribution. Then the income curve descends rapidly as the higher income classes are brought under review, reaching a condition of extreme attenuation at incomes of only a few thousand dollars, but stretching on for an absurdly great distance before the maximum incomes are reached. The problem of **Our problems** poverty and the problem of great fortunes are the problems of the upper and lower limits of this income curve. But, seen rightly, the problem of great fortunes is only a part of the larger problem of the general skewness of the curve, the problem, that is, of the extremely small average differences in the incomes of persons in the lower part of the income range and the unduly rapid increase of these average differences as the view is shifted to successively higher income groups. Put concretely, that 10 per cent of the families in the country get possibly three fifths or two thirds of the aggregate income ceases to appear principally as a problem of large fortunes, when it is realized that to include the richer 10 per cent of the families, one has to go down to somewhere between the

\$1200 and \$1800 income levels. The most serious aspect of the distribution of property and incomes in this and in other countries is not the presence of a larger or smaller degree of "concentration," but the general distortion of the whole income scheme, reflecting as it undoubtedly does the presence of a high degree of inequality in the distribution of opportunity.<sup>1</sup>

The distribution of wealth in the more developed countries cannot be regarded as satisfactory at the present time, but from the historical point of view we are concerned in large measure with the relative problem: Are matters going from bad to worse? Is the direction of social change favorable or unfavorable? To these questions there is no certain answer. Our information about the distribution of wealth in the earlier period is too uncertain to admit of confident comparisons. One is tempted to believe that there were periods in which there was much less departure from a normal frequency distribution than prevails at present; much less discrepancy, too, between the larger and the smaller incomes. But one must go back to the period prior to the Reformation to find such conditions. Naturally we have no exact knowledge of such a remote period. However, we have no grounds for supposing that conditions have become significantly worse in the United Kingdom during the past century. The position of the magnate was primarily dependent upon the holding of land at the beginning of the nineteenth century, but the enclosure movement had resulted in a concentration of landholding that was very unfortunate. The great industrial fortunes of the present age are spectacular, and yet one may well doubt if the general situation has become worse. As Professor Young says, the very large fortunes are only part of the problem. Exact judgment of the changes in the distribution of wealth is not attainable. At the utmost, we are justified in doubting the accuracy of the statements of those who would have us believe that the new industrial order is responsible for all the difficult social

<sup>1</sup> Young, A. A.: "Do the Statistics of the Concentration of Wealth in the United States mean what they are commonly assumed to mean?" *American Economic Review*, Supp., VII (March, 1917), 148-52.

problems of the present day. We can declare with some confidence that these problems were not wholly created by the Industrial Revolution. It may be that it would be warranted to declare that on the whole the lower classes had gained some little ground and found themselves in a stronger economic position at the close of the century than at its beginning. Of this one must be skeptical, and it is quite essential to recognize that progress in material well-being has certainly been modest in its proportions. It should be observed, however, that even a moderate measure of improvement would be of great significance, for any change that lifted a large class of the population well above the "poverty line" must be considered highly important even if the ultimate position of the artisan class left much to be desired. Unfortunately, we can scarcely more than guess at these important questions.

Whatever may have been the actual facts, there can be no doubt but that a growing consciousness of inequality in distribution has been the basis, though perhaps not the sole basis, of the social unrest. The discontent has been most consciously felt by the skilled workers that we have called the artisan class, and it has been their belief that they have not shared proportionately in the growth of wealth that has been a result of the changes in the industrial system. From the larger social point of view it is of little moment whether their conception of the facts is sound or not; the influence of these beliefs upon the activities of the artisan class is not dependent upon the degree of accuracy of some of these allegations as to material well-being and the relative inequality in the distribution of wealth.

## II. CHARTISM

The Chartist movement, like many radical movements, is more significant as affording an indication of the tendencies of thought among the working classes than as a substantive attempt to achieve certain aims. It is interesting in its inception. The factors that

gave it such general vogue as it managed to achieve are of undoubted importance. But when the formal history of the movement begins it seems to be a very trivial incident, despite the genuine anxiety that was felt at the time by those in authority. The deeper meanings of the episode, in short, lie not in the external events of the history of the organized agitation, but rather in the vaguely felt need of a genuinely democratic constitution and the new sense of class consciousness that emerged from the propaganda. The aims were so far beyond any possible achievement that the movement assumes an appearance of futility that might easily close one's eyes to its real importance.

The intellectual background of Chartism was socialistic, and, though many of the leaders of the later period were not keenly conscious of the entire body of doctrine that was associated with the agitation, the violence of their propaganda doubtless contributed more largely to the growth of proletarian class consciousness than the sober intellectual tone characteristic of the group that gave form to the program. The many-sidedness of the entire movement and the indiscriminate rioting that occurred in the later years tend also to obscure the genuine socialistic significance of the agitation. The disturbances can easily be dismissed as if they were wholly comparable to the sporadic disturbances that had occurred with lamentable persistence throughout the preceding generation.

The Chartists always distinguished their movement from socialism. Scarce any of them were themselves originators of socialistic ideas. They felt a certain measure of antagonism to the communistic type of socialism that was most prominent in public discussion. Nevertheless, the early leaders were all deeply imbued with socialistic ideas and drew the inspiration for the movement from them; they gave a measure of concrete expression to the somewhat imperfectly conceived criticism of the Classical Economists that found its ultimate development in the writings of Marx.

The London artisans whose efforts were mainly responsible for the completion of the Chartist program cherished a



deep faith in the need of emancipating their class from all reliance upon leaders drawn from the upper classes. They did not favor revolution nor the type of class war that is so common in Continental socialism. There was much of the Englishman's deference to constitutionalism, so much, in fact, that Chartism never became whole-heartedly revolutionary. This inconsistency between abstract doctrine and the temper of the stronger leaders was a source of weakness in many respects. There was more disposition to talk about class struggle than willingness to resort to force.

The Chartist program was the work of a small group which had been continuously identified with radical agitation from the beginnings of the movement that preceded the Reform of 1832. Francis Place, William Lovett, Henry Hetherington, John Cleave, and James Watson organized a number of working-men's societies, most of which were short-lived: all were designed to serve some radical purpose. The Reform Bill had tended to consolidate opinion among the artisans. It was felt that the bill was incomplete and evasive. Their hopes were disappointed, and there was more consciousness of the need of agitation. The special importance of the opinions of the small group of leaders mentioned lay in their belief that significant reforms could be accomplished only under pressure of a working-class movement led by working-men. There was a sense that their interests had been betrayed by the middle-class leaders to whom they were accustomed to look.

The policy that thus emerged from the experience of these years was expressed in the London Working-Men's Association that was founded in the summer of 1836. It was designed "to draw into one bond of unity the intelligent and influential portion of the working classes in town and country. To seek by every legal means to place all classes of society in possession of equal political and *social* rights." In order to accomplish these ends it was proposed "to collect every kind of information pertaining to the interests of the working classes in particular and to society

Ideals of London leaders

Sense of class struggle

Aims

in general, especially statistics regarding the wages of labour, the habits and condition of the labourer, and all those causes that mainly contribute to the present state of things: to meet and communicate with each other for the purpose of digesting the information acquired." The essentially educational intent of the organizers is further indicated by their demand for a cheap daily press for the working-man, and better education for the rising generation. The membership of the society was carefully selected with a view to the exclusion of middle-class members and genuine artisans who did not clearly have some serious purpose. Despite these ideals a few middle-class members were actually admitted, but the organization was in the main true to the ideal. This London society was never large. The total of admissions to membership from June, 1836, to 1839 was only two hundred and seventy-nine, exclusive of thirty-five honorary members. It was in fact as in intent a study club. Much of the work was done in committees which reported to the general society. Early in 1837 similar societies began to be formed in the provinces, and what was at the outset a wholly spontaneous tendency came ultimately to be encouraged by "missionaries" sent out from London.

About the same time the movement took a new turn, as a result of a public meeting held at the Crown and Anchor Tavern. The meeting was worked upon by the <sup>Elements of</sup> speeches until it was finally proposed that a <sup>the charter</sup> petition be sent to Parliament urging substantial reforms of a democratic character. A petition was framed and submitted to the meeting. The preamble contains the essential reasoning of the Chartists and the prayer contains the famous six points. The Charter of the later period was merely this petition worked over into the form of a bill ready for presentation in Parliament. The reforms demanded were: the establishment of equal one-member districts for a House of Commons with a fixed number of members; universal suffrage; annual Parliaments; voting by ballot; abolition of all property qualifications for membership in Parliament; the payment of members, at £400 per year.

From this time on the Association drifted rapidly into active radical agitation, concerned for the most part with the presentation of the petition to Parliament. The leaders believed that sufficient agitation could be created in the country to secure the adoption of these reforms after the manner of the Reform Bill of 1832. In order to bring matters to a sharp issue, it was felt desirable to be able to present to the country the actual bill that was to be passed, and with this in view a committee of twelve was appointed to draft the measure. Nothing was accomplished, and after some delay Lovett

**The Charter** drafted the bill in consultation with Roebuck and Francis Place. The final draft was discussed by the committee and published May 8, 1838, as the "People's Charter." The members of Parliament associated with the group were indifferent, largely no doubt because they were fully conscious of the hopelessness of the project; this was an obstacle, but it was not keenly felt by the leaders, as they were looking forward to three years of agitation.

An organization of general scope was created toward the close of 1838, and the London Working-Men's Association ceased to be of real moment. There is reason to believe that the entire movement would have collapsed if new energy had not been infused into it from an unexpected quarter. The Poor-Law of 1834 had evoked the most violent protests

**Northern agi-  
tators** from all parts of the country. Agitation began in 1836, directed in part against the administration of the law and in part against the law itself. The leaders of this movement were violent and unscrupulous agitators, ready to adopt any doctrine or catchword that would further inflame their audiences. The agricultural and manufacturing population of Lancashire and Yorkshire had already been worked up to a dangerous pitch of excitement when the Poor-Law agitators adopted Chartism. The enfranchisement proposed by the Charter appealed to them originally as a means of securing the repeal of the hated Poor-Law; later the Poor-Law was lost sight of in the larger issue, but it seems likely that even the more violent agitators would have failed to arouse the working classes on the more abstract

issues of the Charter if their antagonism had not already been carried far in the opposition of the Poor-Law.

The final organization of the movement was the work of a group of Birmingham radicals. From this source came the idea of the monster petition and the organization of a convention of working-men's delegates that was <sup>The "People's</sup> called sometimes the "People's Parliament." <sup>Parliament"</sup>

The Birmingham group, however, were never able to secure undisputed leadership. These later years of the movement were peculiarly complex because there was never any certain leadership. The more important members of the London group remained in touch with the organization and exerted some influence, though they were unable to force their view of a purely constitutional movement upon the organization as a whole. The agitators from Lancashire and Yorkshire were likewise unable to steal the organization entirely and convert it into a frankly revolutionary agitation. The Birmingham radicals experienced similar difficulties in their attempt to dominate.

The party of violence, however, was able to exert enough influence to distract the endeavors of the constitutional group and carried their incitement to violence far <sup>Threats of</sup> enough to terrorize the authorities and many <sup>violence</sup> members of the upper classes. It may be that there was real danger, but the small hold of Chartism outside very restricted areas makes it unlikely that the movement would have become anything more than a local outbreak scarcely more organized than a casual riot. There was drilling among some of the Chartists, but the attempts at organized violence actually made would seem to indicate that the working-men were not capable of making a revolution. The Government of the day showed much discretion in dealing with the threats of violence, in their general policy, and in the choice of military officers in the disaffected areas. Ugly possibilities were met with a minimum of armed conflict.

The threats of violence throughout the first half of 1839 alienated many of the constitutional party. The convention, that was the fundamental organ of the movement, was greatly

reduced by the constant withdrawal of members who were terrified at the prospect of a revolutionary attempt with its attendant personal danger. In July, 1839, the petition was presented and lost by a vote of 235 to 46.

**Failure**

The constitutional phase of Chartism was practically dead already, so that the failure of the petition was merely the formal closing of an episode that had ceased to be significant.

Chartism was an utter failure as an organized movement, and its intellectual program had so little contact with the working-men's political thinking in the following generation that one might easily overlook the deeper aspects of the entire episode. There is a kind of prophetic foresight in the belief of the London artisans that working-men's movements must be led by working-men. Their criticism of the rank and file of their class was all too true, and the turn that events have taken in the last ten or fifteen years shows how much is involved in the two fundamental principles of the London Chartists: leadership in the hands of members of the class, and concentration of effort on political enfranchisement.

### III. THE UNIONS AND THE SOCIALISTS

It is particularly difficult to sketch the history of the so-called "Labor Movement" because the organization of the working classes is not the outcome of any single impulse, but rather the result of a group of tendencies that have been closely related in many instances and in other cases sharply opposed to each other. The lack of any central organic structure, like Parliament or a central administration, makes these endeavors much more chaotic than the general political life of a nation. A narrative history of these developments must, therefore, be accepted with qualifications. The labor writers, who are responsible for the bulk of material on the subject, are very incompletely conscious of this limitation, and in turning to the past to find materials, whether positive or negative, in support of their policies and schemes for organization there are many instances of a patronizing or even contemptuous attitude toward other phases

**Difficulties for historians**

of the movement that seem to be scarcely justified to the outsider.

Although it is possible to distinguish elements of difference in the policies and methods of organization at different periods there are also many elements common to the entire period, and many policies recur unchanged in general form, though embodied in different organizations. The members of the Independent Labor Party and the newer types of socialists are especially guilty of patronizing their antecedents. One might perhaps wisely assume that the multiplicity of things to be accomplished will, for a long time, make it impossible to achieve these ends by any single organization or any single policy.

The years that followed the repeal of the Combination Laws were dominated by attempts to secure large results in the immediate future. The characteristic aim was the formation of a "trades union"; or, to use the current <sup>The trades</sup> terminology, an amalgamation of local trade <sup>union</sup> unions in a single national society. The trades union of this early period, however, was not designed to be exclusively a craft organization. In most instances it was intended to be a comprehensive organization of all members of the working class. The Grand National Consolidated Trades Union, one of the most vigorous of these attempts, included agricultural laborers and women. The local lodge usually included members of one trade only, but provision was made for the formation of miscellaneous lodges in the small places where the individual craft would not be sufficiently large to organize independently.

The illusive hopes of large and immediate results seem to be primarily a result of Owen's influence. He was instrumental in the organization of the Grand National Consolidated Trades Union, and his ideas were an im- <sup>Robert Owen</sup> mense factor in much of the labor agitation of the period. Owen's confidence in the ease with which the entire structure of society might be transformed is one of the extraordinary aspects of his personality. Social organiza-

tion seemed to him to be a mechanical arrangement that could be changed as easily as the system of discipline in a factory. Human nature was no obstacle, for it was merely the product of environment, and, by appropriate but simple educational methods, all members of society could be made estimable and capable citizens. This sort of millennialistic faith was easily transfused into his followers, and curiously enough disappointment in particular instances did not at once result in general disillusionment. This faith in a speedy transformation of society dominated the decades of the thirties and the forties.

Although there had been attempts to organize national associations of particular trades or groups of trades prior to 1834 the Grand National Consolidated Trades Union was the first entirely comprehensive working-men's society. It was launched by Owen in January and February, 1834, at London. It was to consist of federated lodges which retained a large measure of independence, most especially in the control of their funds. The lodges were urged to provide sick, funeral, and old-age benefits for members, and there were projects for the employment of persons out on strike. The initiation rites and oaths common at that period were widely adopted. So far as is known, these rites possessed little specific importance, being wholly devoid of political bearings. The rites and paraphernalia were substantially similar to the Masonic rites; quite innocent, though there was much unreasoning fear among the upper classes. The case of the Dorsetshire laborers subsequently showed that the possibility of confusing these organizations with secret societies of the type prohibited by law was extremely unfortunate. In the attempt to appreciate these events from the point of view of the laborer, it is easy to lose sight of the grounds for apprehension on the part of the governing classes, and, because lamentable mistakes were made, we frequently fail to appreciate the regard that was really shown for the principle of individual liberty. The governments of the day were not really reactionary, though there were many moments of panic. The

handling of the Chartists and the general attitude toward the unions reveal much discretion in the use of the power of the State.

The low wages of agricultural labor had been the occasion for violence in the southern counties in 1829 and 1830: machine-breakings, rick-burnings, and hunger riots. These were put down by the use of troops. The Dorsetshire laborers The laborers organized, and were alleged to be contributing to a network of affiliated local societies. There was an increase in wages, directly or indirectly the outcome of this organization. In the village of Tolpuddle, the farmers at first granted the increase that was general throughout the county and then in 1833 reduced wages again. The laborers decided to organize. Delegates came down from the Grand National. The preparation of some of the "properties" for the initiatory rites attracted the attention of the farmers. Placards were issued warning the men that any joining the union would be sentenced to seven years' transportation, and shortly after six of the leaders were arrested. The legal grounds of the trial were certainly misunderstood by the laboring class, but the indecent haste shown at every stage of the proceedings creates a strong presumption against the sincerity and discretion of the Government. The men were arrested February 24 (1834); the trial was held March 18 and was exceedingly brief; before the 30th the men had been sent to the hulks, and by the middle of the following month the ship had sailed for Botany Bay.

The episode was made the occasion of extended agitation by the Grand National Consolidated Trades Union. Petitions were presented and public meetings held. Protests A number of craft unions not then included in the Grand National established temporary connections with it in preparation for a great procession in London on the occasion of presenting the petition to the Home Secretary. A quarter of a million of signatures had been obtained, and it is estimated that thirty thousand people took part in the procession. The Government refused to commute the sentence. The case resulted in the dropping of all oaths from



the procedure of the unions and in the abandonment of the greater part of the ritualistic forms then in use.

The protest against the conviction of the Dorsetshire laborers marks the highest point in the influence of the Grand National. Shortly after, the London Tailors organized and precipitated a strike on the issue of shorter hours. Twenty thousand men went out. The Grand National endeavored to arrange for strike pay. Levies were made on all the branches, but these produced discontent and insufficient funds. The strike pay fell to four shillings a week, and under these conditions it proved to be impossible to hold the men. The employers' conditions were accepted by the men individually as they returned to work. Other strikes in London and elsewhere met with no better fate, and by July, 1834, the Grand National began to break up. Its disappearance was concealed in a measure by its conversion in August, 1834, into the British and Foreign Consolidated Association of Industry, Humanity, and Knowledge. This society was designed to establish a New Moral World by the reconciliation of all classes. Needless to say it was Owen's work. Its activities were confined to the organization of a few futile experiments in coöperative production.

In 1845 a National Association of the United Trades for the Protection of Labor was formed. This society was National in scope, but it had lost the great expectations of the earlier associations. It undertook nothing more ambitious than some measure of assistance in trade-union struggles and the care of labor interests in the House of Commons. Provision was made for a strike fund, but no considerable amount of money was collected. The local societies were jealous of each other and of the central committee; the employers adopted a policy that favored the local units against the central body. The national organization thus found itself deprived of support and of its more significant functions. It was unable long to survive under such circumstances. Its influence was gone by 1848, and after 1851 it was wholly negligible. The passing of this association

Failures of strikes

Passing of the Grand National

Other organizations

marks the beginning of a period of disillusionment. The men gave up all hope of the magnificent achievements promised by Owen and his group. Attempts at comprehensive national organization were abandoned. The specifically craft unions which had long existed maintained themselves, but were occupied primarily with the interests of their own craft. The revolutionary spirit of the earlier period was supplanted by a notably constitutionalistic spirit. The unions proposed to act wholly within the law, though they were anxious to have the strike and its necessary incidents legalized. The desire to transform society thus gave way to the purely materialistic purposes of increasing wages and reducing the hours of labor.

The leadership in this new phase of unionism fell to a group of men in the engineering trades. The craft unions which had long existed in these trades had been losing <sup>The craft</sup> their purely local significance and acquiring <sup>unions</sup> more national importance. Amalgamations adroitly planned by Newton and Allan resulted in the absorption of a number of associations of minor importance in their own union. The appearance of association among equals was successfully preserved, but the new organization took over the constitution, the scheme of benefits, the trade policy, and even the official staff of Newton and Allan's union, the Journeymen Steam-Engine and Machine-Makers and Millwrights' Society. The result of these labors, the Amalgamated Society of Engineers, became the model of most of the national organizations among the crafts. Its constitution was copied and its policies adopted without notable change. <sup>A new model</sup> This association differed in many respects from the unions of the earlier period. It was a national society with branches, instead of being a group of local societies or lodges provided with a central committee. The power of the central organization of the Engineers was skillfully dissembled, but it was complete. The local societies were mere branches: they elected officers and went through the form of managing their funds, but in reality everything was controlled from London. The duties of officers were so mi-

nutely prescribed by the rules of the central organization that they were deprived of any vital power of initiation. The funds actually belonged to the entire society, and, though held by the branch, were administered according to general rules and subject to a complex equalization which was designed to distribute burdens and benefits impartially among all the members.

A notable feature of the Amalgamated Society of Engineers was the combination of the benefit society with the trade union. At the outset it had been primarily a benefit society; the functions of the trade union were acquired in the process of growth. Out-of-work pay stood on a par with other claims for benefits, and it gained from this association. A single fund was collected for all purposes, and, though it was later alleged that the actuarial basis of the scheme was unsound, it was a great practical success. The merits of the scheme were most obvious from the unionist point of view. The inducements of the general benefit system made it easy to collect high weekly contributions. The society was richer than any of the early unions, and the fund being specifically a general fund the entire strength of the society could be devoted to a local strike without any possible question of propriety. The inadequacy of the strike funds had been the weakness of the unions of the preceding period. It had proved to be impractical to raise an adequate fund specifically for strikes; difficult likewise to administer the fund when the balance of power lay with the local organizations. The problem was solved for the Engineers by a happy turn of historical accident. They grew into the kind of society most adapted to the needs of the time. The great vogue of the constitution of the society is probably due to this aspect of the organization.

The society also introduced a new policy with reference to admissions to membership. It was not proposed to admit all applicants, but only those who had served a regular apprenticeship. The knowledge of the craft was treated as a vested interest which it was the duty of the union to protect. The union thus became committed to the

Elements of  
success

Craft policy

modern policy of antagonism toward the "illegal" worker, or, as we would say, the scab. Its purpose became not merely the advancement of wages and shortening of hours, but likewise the closed shop.

In some of the early strikes the Amalgamated Society of Engineers was not successful, but the strength of their organization was clearly revealed by the London Builders strike late in 1858. The strike, or rather lock-out, was precipitated by a demand from the Joint Committee of the Carpenters, Masons, and Bricklayers for a nine-hour day. The request was followed by the dismissal of the man who presented the memorial. The men employed by that firm immediately struck, and the other employ- A test of strength ers with equal expedition closed their shops.

Twenty-four thousand men were thrown out of work. Contributions to a strike fund were sent in by union organizations in London and in the provinces. The sensation of these subscriptions was the grant by the Engineers of £1000 for three successive weeks. The employers were compelled to yield, though it was not possible to secure all that the men had hoped. The incident contributed to increase the influence of the Amalgamated Society and to stimulate the copying of its constitution.

While the general tendencies of unionism at this period were particularistic, means were found to secure some coördination of effort among the various societies. Trade Councils had been formed at various emergencies in the past, and during the forties and fifties permanent councils appeared in some of the provincial towns; Glasgow, Sheffield, Liverpool, and Edinburgh. A similar organization was established in London in 1861 by some of the less important unions. The larger societies soon perceived the possibilities of this organization and by 1864 had secured control. The secretaries of the larger national organizations constituted the executive committee. There was thus a body of men who possessed no direct constitutional authority to act as representatives of the general mass of union members, though they were in fact representative of large bodies of unionists and enjoyed

all the opportunities for accomplishing many things of moment to unionists in general. Parliamentary activity was not a purpose of their organizations, but no group of Englishmen can entirely ignore Parliament. As there was no other means by which union interests could be brought before Parliament the Executive Committee of the London Trades Council stepped into the breach.

The most important occasion for Parliamentary action was brought up by the adverse decision in the case of the boiler-makers in 1867. Some of the society's funds had been appropriated by one of the officials. The society sued to recover its money, when, to the astonishment of the trade-union world, the court announced that the union was an illegal society incapable of bringing suit in court. It had been known that there were difficulties involved in the status of the unions, but it had been presumed that the technical difficulty had been overcome by treating their funds as the property of a friendly society. It seemed as if the decision might well be fatal to the unions. The group dominating the Trades Council, called by Webb the "Junta," determined to summon such aid as could be secured from sympathetic members of the middle class, notably certain barristers and solicitors. This legal assistance was of the utmost moment in meeting the crisis. There had been some extremely unfortunate outbreaks of violence at Sheffield, and as the entire legal basis of unionism had been overthrown by the decision of 1867 the Government proposed to make an inquiry through a Royal Commission. The Junta with the aid of middle-class sympathizers organized a successful defense before the Royal Commission, presenting material in their testimony which did much to change the attitude of the public toward the unions.

The minority led by Frederic Harrison presented a report indicating the legal reforms that would be necessary to place the unions in a satisfactory situation. The Government at first paid no heed, but astute conduct in Parliament forced the matter on its attention, and after consenting to a formal recognition of the Unionist

Bill they brought in a temporary bill late in 1869. Permanent legislation was presented in 1870-71. The clauses concerning the legal status of the unions represented the ingenuity of Harrison and remained the law until the Taff Vale case. Harrison desired to express in law the situation that had existed prior to 1867, in which the unions enjoyed the legal protection of certain aspects of the law of corporations and societies without being subject to any of the responsibilities. It was undoubtedly a matter of grave importance to the unions, and Harrison's solution was adroit. It involved anomalies, however, which must needs have come to the fore at some time. To the outsider it is difficult to find any class prejudice directly involved in the Taff Vale case. The unions had enjoyed a peculiarly favorable situation for a generation without challenge, but their legal status contained an essential weakness: they were in fact corporate bodies with responsibilities. The old position was secured only by a *tour de force* of legal ingenuity, which was hardly capable of bearing the test of a judicial hearing. But even if the success were short-lived, unionism and the Labor movement in general owe much to the efforts of the group who defended the cause in what was undoubtedly a crisis of the first magnitude. The skill shown in meeting the Parliamentary difficulties bears comparison with the efforts of Place and his friends at the time of the repeal of the Combination Laws, though one usually hears much less of this second crisis. The patronizing attitude of many recent Labor leaders toward this period in the history of unionism seems unjustifiable and ungraceful.

The predominance of the Amalgamated Society of Engineers and its group of sister societies did not survive the generation of the first leaders. The influence of <sup>Changes in</sup> the Junta began to decline even within the life-<sup>leadership</sup> time of some of its original members. There were many elements involved in the change of leadership in the Labor movement. To the outsider, it seems as if the general movement becomes more complex, more manifold of purpose and organization. There is no longer any group of leaders that

can be treated as adequately representing the aspirations of the working class. Two aspects of the recent tendencies seem relatively new: there is impatience with the constitutionalist policy of the Junta and the Fabians and a demand for direct action; there is also a reaction from the specifically craft tendency of the preceding period and more emphasis placed upon the organization of the unskilled. These two tendencies are at times closely associated, as the advocates of direct action desire to organize the unskilled in order to promote a "general strike" against the existing framework of society.

But it is hardly possible to declare that these tendencies are essentially characteristic of the present Labor movement.

**Representation** Working-men have secured election to the House of Commons with increasing frequency; at first, under sufferance of the Liberal Party, latterly by reason of their own strength. The Labor group secured fifty members in 1906 and were sufficiently important under the special circumstances to force the Liberals to adopt important items of the Labor program. The independence of the Labor members is somewhat qualified in many cases; there is still some disposition of the Liberals to use Labor members as a decoy for working-men's votes, but a portion of the group is intellectually and politically independent. At present it is possible for one to say that the growth of working-class influence in Parliament is one of the signs of the times. The Osborne case, though apparently a blow directed against Labor, has resulted in provision for the payment of members, so that the working-man is not obliged to rely upon his union for support. If provision is made for the payment of election expenses the position of the Labor group will be still further assured. All these tendencies are a natural outgrowth of the constitutionalist policy, and it is very difficult to estimate the relative importance of the radical tendencies and the conservative features of the recent Labor movement.

Recent years have thus revealed every shade of policy in the Labor movement, from the most radical socialism looking toward a violent revolution to the most patient consti-

tutionalism. The radicals are filled with an intense enthusiasm and conviction; they are stirred by the consciousness of thinking new thoughts: and yet one wonders if their aspirations are so widely different from those of the Owenite period. Time alone can decide the relative merits of the policies of these rival groups of leaders, and until then an adequate history of these years can hardly be written. At present we are confronted with an unrivaled activity in propaganda.

The more radical propaganda is based on the discontent created by the rise in prices. The working-men are inclined to believe that these changes have been deliberately made by the capitalists in order to recover in profits the burdens imposed in the new taxation. They feel that they have been duped by the insurance legislation: given a present with a string tied to it. The antagonism founded on these beliefs was the basis for the great strikes that have threatened the security of the community during the past ten years. The leaders are quite right in maintaining that these demonstrations should not be regarded as isolated events. They represent a deliberate attack on the existing organization of society, fostered by the belief that the means exist for the payment of wages sufficient to assure a decent living to all manual workers. This temper seems to have maintained itself throughout the War, and, if it survives, England will be uncomfortably near a social revolution.

The socialists depend in part upon the appeal to current hardships, but their doctrines are of course of more general appeal. They hope to capture the entire union-ist organization, because they alone have a consistent general policy. They can appeal to the working-man during prosperity, as well as in hard times, and it is possible that they will become the leaders of the working class as a whole. The great body of unionists, however, are eminently conservative in temper, and socialistic propaganda has not as yet made a deep impression upon them. The middle-class socialism of the Fabians has failed to develop any real strength among working-men, and it is not yet clear that the more revolutionary socialists will succeed.

Elements of  
current dis-  
content

The socialists'  
aspirations



## SELECTED REFERENCES FOR CRITICAL STUDY AND FOR CLASS READING

THESE references have been restricted to the most important books as extended bibliographies are easily accessible. It has seemed best to restrict the lists to the literature that is indispensable to critical study. In most instances the references given were used in preparation of the various chapters, but no attempt has been made to include all books and documents that have been used.

It is hoped that the titles classified as collateral reading will assist in the preparation of reading assignments for classes of undergraduates. Care has been taken to avoid any assignments that are not well within the scope of the average class.

### *Bibliographies.*

Gross, Charles. *The Sources and Literature of English History. From the earliest Times to about 1485.* London, 1915.

Hall, Hubert. *A Select Bibliography for the Study, Sources, and Literature of English Medieval Economic History.* London, 1915.

Woodbury, C. J. H. *A Bibliography of the Cotton Manufacture.* Waltham, 1909.

An unusually careful special bibliography.

### *General Works of a Critical Character.*

Ashley, W. J. *An Introduction to English Economic History and Theory. The Middle Ages.* London, 1894. 2 vols.

A discriminating study of select topics that has long occupied an important place.

Cunningham, W. *The Growth of English Industry and Commerce. Vol. I, The Early and Middle Ages. Vol. II, Modern Times.* 5th Edition. Cambridge, 1910-12.

The most considerable study of the general economic history of England. A monument of patient research and of discriminating judgment based upon methods of presentation that minimize the larger sociological problems of economic history. Likely to be less useful to a student than works whose arrangement is topical, though invaluable for reference.

Lipson, E. *Introduction to the Economic History of England. Vol. I, The Middle Ages.* London, 1915.

A comprehensive survey of the important topics. Represents careful study of the materials recently made available by the publication of records and local studies.

Rogers, J. E. T. *Six Centuries of Work and Wages.* New York, 1884.

The most considerable work of a writer who brought to the subject conceptions of method which were not adopted by other English scholars. There are many suggestions, however, in his general points of view, and on many matters pertaining especially to agriculture his work is of substantial value.

Rogers, J. E. T. *The Industrial and Commercial History of England*. New York, 1892.

A series of university lectures.

— *The Economic Interpretation of History*. London, 1888.

*Briefer General Works and Texts.*

Ashley, W. J. *The Economic Organization of England*. London, 1914

Bry, G. *Histoire industrielle et économique de l'Angleterre, depuis le  
origines jusqu'à nos jours*. Paris, 1900.

Cheyney, E. P. *An Introduction to the Industrial and Social History of  
England*. New York, 1901.

Cunningham, W., and McArthur, Ellen A. *Outlines of English Indus-  
trial History*. New York, 1895.

Gibbins, H. de B. *Industry in England: Historical Outlines*. London  
1896.

Meredith, H. O. *Outlines of the Economic History of England*. London  
1908.

Price, L. L. *A Short History of English Commerce and Industry*. London  
1900.

Warner, G. T. *Landmarks in English Industrial History*. London  
1899.

## CHAPTER I

*Critical Discussions.*

Bücher, K. *Die Entwicklung der Volkswirtschaft*. 3d edition, consider-  
ably enlarged. 1900. Translation by Wickett, from the third edition  
*Industrial Evolution*.

The changes that occur in the various editions consist in the addition of  
new material. The doctrine of the book has not been revised despite the crit-  
icisms of historians, but there is a brief defense in the preface of the last edition.

Marx, K. *Das Kapital*. 1st edition, 1867. 4th edition. Hamburg,  
1890-94. Translation. *Capital, a Critical Analysis*. London, 1887.

There is no deliberate attempt to suggest a scheme of industrial stages, but  
much material is important in connection with the socialistic interpretation of  
the transition to the factory system. Especially chapters XIII, XIV, and XV  
(English edition.)

Meyer, Edouard. *Kleine Schriften zur Geschichtstheorie*. . . . Halle, 1911

A collection of essays written at various times, several of them devoted to  
criticism of Bücher's generalizations.

Rodbertus, J. K. Zur Geschichte der Römischen Tributsteuern seit  
Augustus. *Jahrbuch für National Oekonomie und Statistik*. 1861  
p. 339.

Characterizes the industrial organization of the ancient world as "house-  
hold industry" and thus furnishes the essential step towards the generalization  
popularized by Bücher.

Salvioli, G. *Le Capitalisme dans le Monde Antique*. Paris, 1906.

Criticism of Bücher with constructive interpretation.

Sombart, W. *Der Moderne Kapitalismus*. Leipzig, 1902. 2 vols.

The most considerable socialistic interpretation of industrial history. The simpler aspects of the scheme suggested are similar to Bücher's scheme, but in its entirety the generalisation is much more elaborate and complex.

Usher, A. P. Generalizations in Economic History. *American Journal of Sociology*. Vol. XXI, pp. 474-91.

Weber, M. "Agrargeschichte," in Conrad's *Handwörterbuch der Staatswissenschaften*.

An interpretative essay of substantial length, broader in scope than its title would suggest. There is much criticism of Bücher, and an attempt at constructive interpretation of the life of the ancient world.

#### *Collateral Reading.*

Bücher, *op. cit.* Chapters III and IV.

Gaskell, P. *The Manufacturing Population of England*. 1833. Introduction. (*Ibid.*, *Artizans and Machinery*, 1836. Chapter I.)

## CHAPTER II

#### *Critical Discussions.*

Breasted, J. H. *Ancient Records of Egypt*. Vol. II. Sections 246-95, 663-759.

Erman, A. *Ägypten und Ägyptisches Leben im Alterthum*. 1885-87. Translation. *Life in Ancient Egypt*. 2 vols., London, 1894.

Still useful, though seriously out of date, because it remains the only comprehensive description of social life in Egypt.

Francotte, H. *L'Industrie dans la Grèce Ancienne*. Bruxelles, 1900-01.

The most extensive of several good studies of Grecian industry.

Harper, R. F. *The Code of Hammurabi. King of Babylon about 2250 B.C.* Chicago, 1904.

King, L. W. *Letters and Inscriptions of Hammurabi*. Vol. III. English Translations. London, 1900.

Lau, R. J. *Old Babylonian Temple Records*. New York, 1906. Columbia University Oriental Series. Vol. III.

Meyer, Edouard. *Geschichte des Alterthums*. Vol. I, Parts 1 and 2, 2d edition, Stuttgart, 1907-09. Vol. I, Part 1, 3d edition, Stuttgart, 1910.

Newberry, P. E. *The Life of Rekhmara*. London, 1900.

A new edition of this important relief.

Nicole, J. *Le Livre du Préfet, ou l'Edit de l'Empereur Léon le Sage sur les Corporations de Constantinople*. Genève, 1904.

Virey, Ph. *Le Tombeau de Rekhmara. Préfet de Thèbes sous la XVIII<sup>e</sup> Dynastie*. Min. de l'ins. Pub. Mémoires de la Mission Archéologique Française au Caire. Vol. V. Fasc. I. Paris, 1889.

Waltzing, J. P. *Étude Historique sur les Corporations Professionnelles chez les Romains*. Louvain, 1895-1900. 4 vols.

Wilcken, U. *Griechische Ostraka*. Leipzig, 1899.

An account of the Egyptian institutions of the later period based upon materials furnished by Greek potsherds.

*Collateral Reading.*

There is little reading upon the specifically economic problems of these early cultures that is entirely suitable for a general class. Portions of Erman might be used, and Maspero, G., *The Struggle of the Nations*, contains an excellent chapter on Thebes at the height of its power. The most readable account of the Mesopotamian cultures is furnished by Johns, C. H. W. *Babylonian and Assyrian Laws, Contracts and Letters*. New York, 1904.

## CHAPTER III

*Critical Discussions.*

Depping, G. B. *Règlements sur les Arts et Métiers de Paris*. Paris, 1837. Collection des Documents Inédits.

The earlier of the editions of the Book of the Crafts.

Eberstadt, R. *Magisterium und Fraternalitas*. Leipzig, 1897.

A statement of the extreme feudal theory of the origin of the craft gilds.

— *Der Ursprung des Zunftwesens und die älteren Handwerkerverbänden des Mittelalters*. Leipzig, 1915.

A development of the work above mentioned.

Fagniez, G. *Études sur l'Industrie au XIII<sup>e</sup> et XIV<sup>e</sup> siècles*. Paris, 1877.

The most detailed study of early craft organization at Paris.

Flach, J. *Les Origines de l'Ancienne France*. Vol. II, Paris, 1893.

Primarily constitutional, though the treatment of the origin of the towns contains much material that is of importance to economic history.

Géraud, H. *Paris sous Philippe le Bel*. Paris, 1837. Collection des Documents Inédits.

Contains the tax-roll of 1292 and the Dictionary of Jean de Garlande.

Lespinasse, R. de, et Bonnardot, F. *Les Métiers et Corporations de Paris: XIII<sup>e</sup> siècle*. Paris, 1879. (Histoire Monumentale de la Ville de Paris.)

A later edition of the Book of the Crafts.

Levasseur, E. *Histoire des Classes Ouvrières et de l'Industrie en France avant 1789*. Paris, 1900-01. 2 vols.

A work that bears comparison with Cunningham's work on England in its discriminating scholarship and comprehensive knowledge, and relatively more readable because the method of presentation is less severely annalistic.

Martin-Saint-Léon, E. *Histoire des Corporations des Arts et Métiers*. Paris, 1909.

A standard work now available in a new edition.

*Collateral Reading.*

There is no reading available in English upon these problems of French history. Conditions of essentially similar character are presented by the history of industry in the Low Countries now adequately told by Pirenne, H. *Belgian Democracy, its early history*. (Manches-

## SELECTED REFERENCES

v

ter, 1915.) Chapters i, iv, and ix are especially recommended. This excellent book came into my hands after the present chapter had been written, and no attempt has been made to add specific references to the important confirmations of fact and method. It is particularly interesting to note the criticisms of Bücher at pp. 15 and 92-93.

A discussion of craft specialization from a different point of view from that adopted in the text may be found in Bücher, *op. cit.*, chapter VIII.

### CHAPTER IV

#### *Critical Discussions.*

The controversy over the population of England prior to the Black Death appears in the following articles in the *Fortnightly Review*. Seebohm, F. "The Black Death and its Place in History." (Vol. II, pp. 149, and 268.) Rogers, J. E. T. "England before and after the Black Death." (Vol. III, 191.) Seebohm F. "The Population of England before the Black Death." (Vol. IV, 89.) The views advanced by Seebohm have been espoused by several writers without material change in the arguments used or the figures suggested. Rogers subsequently used his materials in the lecture that appears in the volume *The Industrial and Commercial History of England*. His views have not been favorably received, and it is therefore with some diffidence that similar estimates of population have been advanced. The conclusions to be drawn from the Subsidy Rolls, however, seem to confirm this hitherto unpopular view. Detailed references to the Subsidy Rolls maybe found in the bibliographies of Gross and Hall. The relation of these tax-lists to the probable population is best indicated by the study: Powell, E. *A Suffolk Hundred in the Year 1283*. Cambridge, 1910.

Creighton, C. "The Population of Old London." *Blackwood's Edinburgh Magazine*. Vol. 149, p. 477.

A unique and important study.

Estimated Population of England and Wales, 1570-1750. Mr. Rickman. *Census of Population of Great Britain*. 1841. Introductory remarks to the three volumes, p. 43.

These estimates differ slightly from some others but they constitute the most considerable body of material available, and as they are based on the same methods throughout it was deemed wise to use them to the exclusion of other material in the preparation of the density maps published.

Hull, C. H. *The Writings of Sir William Petty*. Cambridge, 1899. 2 vols.

The introduction (pp. lxxxiv ff.) contains the most detailed study of the growth of the registration area in and about London.

Inman, A. H. *Domesday and Feudal Statistics*. London, 1900.

Levasseur, E. *La Population Française*. Paris, 1889-92. 3 vols.

The most considerable of several studies of the population of France.

#### *Collateral Reading.*

The material on this subject does not seem suitable to the needs of a class.

## CHAPTER V

*Critical Discussions.*

Gras, N. S. B. *The Evolution of the English Corn Market.* Harvard University Press, Cambridge, 1915.

An important contribution to the early history of marketing which gives an essentially new account of the decay of the manor.

Gray, H. L. *English Field Systems.* Harvard University Press, Cambridge, 1915.

A painstaking and significant study of the agricultural arrangements of the early and later medieval period, supplanting in many ways the older literature on the subject.

Hone, N. J. *The Manor and Manorial Records.* London, 1906.

A description of the general features of manorial life designed to be free from technicalities.

Kaufmann, A. *Beiträge zur Kenntniss der Feldgemeinschaft in Siberien.* Archiv für Sociale Gesetzgebung und Statistik. Vol. IX, p. 108.

The general conclusions of researches carried on for many years in connection with the publication of materials collected in Siberia. In many respects a pioneer work.

Lewinski, Jan de St. *The Origin of Property and the Formation of the Village Community.* London, 1913.

A study based on the Siberian materials, presenting no new facts though the development recognized by Kaufmann and Simkhovitch is made part of a general theory of the origin of property. It would seem that this general thesis must be regarded as a hypothesis, suggested by the Siberian evidence, but needing further confirmation before acceptance as a general principle of historical sociology.

Maitland, F. W. *Domesday Book and Beyond.* Cambridge, 1897.

A critical study of fundamental importance.

Meitzen, A. *Siedelung und Agrarwesen der West- und Ostgermanen.* Berlin, 1895.

A voluminous and careful study based upon the theory that the mode of settlement is essentially associated with "race." The work is the culmination of much German writing, and it seemed that its conclusions were irresistible until new light was thrown upon the subject by the Siberian materials.

Seebohm, Frederick. *The English Village Community.* London, 1883.

Long a standard work, now supplanted in many details by recent works, especially Gray's.

Simkhovitch, V. G. *Die Feldgemeinschaft in Russland.* Jena, 1898.

A comprehensive study of the Russian village community, both in Russia and in Siberia. Much attention is devoted to the criticism of the idealisation of the village community by socialistic writers. The institution is regarded as an essentially primitive arrangement that has already passed the term of its greatest usefulness in Russia.

— "Hay and History." *Political Science Quarterly*, 1913, vol. XXVIII, pp. 385-403.

An application of some of the principles derived from the Siberian material to conditions in medieval Europe.

## SELECTED REFERENCES

vii

Vinogradoff, P. *English Society in the Eleventh Century*. Oxford, 1908.  
A scholarly and vivid description of England at the time of the Domesday Survey.

— *The Growth of the Manor*. Oxford, 1911.

One of the most important and extended studies of this problem.

### *Collateral Reading.*

Lipson, *op. cit.*, chapters II and III.

Hone, N. J., *op. cit.*

Lewinsky, *op. cit.*

Simkhovitch, "Hay and History."

## CHAPTER VI

### *Critical Discussions.*

Ballard, A. *The Domesday Boroughs*, 1904.

Day, C. *History of Commerce*. New York, 1914.

Gross, Charles. *Select Cases on the Law Merchant*. Selden Society. London, 1908. Introduction.

Hall, H. *A History of the Customs Revenue in England*. London, 1885. 2 vols.

Huvelin, P. *Étude Historique sur le Droit des Marchés et des Foires*. Paris, 1897.

Jenckes, A. L. *The Origin, the Organization, and the Location of the Staples of England*. Philadelphia, 1908.

Kitchin, G. W. *A Charter of Edward III confirming and enlarging the Privileges of St. Giles' Fair, Winchester*. London, 1886.

Lingelbach, W. E. *The Merchant Adventurers of England. Their Laws and Ordinances*. Philadelphia, 1902.

Maitland, F. W. *Township and Borough*. Cambridge, 1898.

Mitchell, W. *Early History of the Law Merchant*. Cambridge, 1904.

Schmoller, G. *The Mercantile System*. New York, 1896. A chapter from the study, *Studien über die Wirtschaftliche Politik Friedrichs des Grossen*, 1884. Reprinted separately in *Umrisse und Untersuchungen*.

The specific purpose of the essay gave prominence to Prussian illustrative material which is somewhat unfortunate; it was intended to be a statement of a theory of the development of the modern state, but the scheme suggested is more closely related to the history of Prussia than to the history of other portions of Europe. This essay introduced the idea of the "town economy" into economic history. The publication of essentially the same ideas by Bücher in 1893 was the occasion of no little feeling.

Schultz, F. *Die Hanse und England von Edouard III bis auf Heinrich VIII's Zeit*. Berlin, 1911.

Stein, W. *Die Hanse und England*. Leipzig, 1905.

### *Collateral Reading.*

Lipson, *op. cit.*, chapters V, VI, VII.

Mitchell, *op. cit.*

## CHAPTER VII

*Critical Discussions.*

Brentano, L. *On the History and Development of Guilds and the Origin of Trade Unions.* London, 1870.

Despite the generalizations criticized in the text, Brentano's work is still useful.

Gross, Charles. *The Guild Merchant.* Oxford, 1890. 2 vols.

A fundamental study, directed against certain theories of continental writers. Primarily concerned with constitutional problems. The discussion of the economic policies of the Guild Merchant seems to be rather more literal than the notes and documents of the second volume would warrant.

Herbert, W. *The History of the Twelve Great Livery Companies of London.* London, 1834. 2 vols.

Hibbert, F. A. *Influence and Development of English Guilds.* Cambridge, 1891.

Kramer, S. *English Craft Guilds and the Government.* New York, 1905.

Unwin, G. *The Guilds and Companies of London.* London, 1908.

The best comprehensive study of the guilds of London, based on much documentary material that has recently become available in the archives and in print.

— *Industrial Organization in the Sixteenth and Seventeenth Centuries.* Oxford, 1904.

An important study in the history of the later phases of the craft organizations. The conclusions seem to be obscured by the failure to distinguish sufficiently between the constitutional and industrial aspects of craft activities.

*Collateral Reading.*

Lipson, *op. cit.*, chapter VIII.

Brentano, *op. cit.*

Unwin, *Guilds and Companies of London.*

## CHAPTER VIII

*Critical Discussions.*

Ashley, W. J. *Early History of the English Woollen Industry.* Publications of the American Economic Association, vol. II, no. 4. 1887 (*Introduction to the Economic History of England*, II, chapter III.)

Bischoff, J. *A Comprehensive History of the Woollen and Worsted Manufactures.* London, 1842.

James, J. *History of the Worsted Manufacture in England.* London, 1857

Lohmann, F. *Die Staatliche Regelung der englischen Wollindustrie vom XV<sup>ten</sup> bis zum XVIII<sup>ten</sup> Jahrhundert.* 1900.

Unwin, G. "Woollen and Worsted Industries of Suffolk." *Victorian County History of Suffolk*, vol. II, pp. 254 ff.

The most important of many local studies.

*Collateral Reading.*

Lipson, *op. cit.*, chapter IX.

Ashley, *op. cit.*

Saltzman, L. F. *English Industries in the Middle Ages.* London, 1913 Chapter VIII.



## CHAPTER IX

*Critical Discussions.*

Bradley, H. *English Enclosures*. New York, 1918.

An important study of the early enclosure movement, attributing the changes in agricultural methods to soil exhaustion rather than to the supposedly high price of wool. The study seems to be not inconsistent with the view expressed in the text, but it would perhaps explain more completely the circumstances leading to the establishment of the Midland System of mixed arable and pasture.

The views in the text were based largely upon suggestions from Gray's studies of the field systems: the field systems were deemed to be capable of more improvement of agricultural technique than Miss Bradley assumes. It was intended, however, to represent the transition as a change towards a more refined technique; so general a formulation that it has not seemed necessary to introduce any changes in a text that was complete before this excellent piece of work came into my hands.

Collings, J. *Land Reform. Occupying Ownership, Peasant Proprietary, and Rural Education*. London, 1908.

A statement of the problem by the chief advocate of small holdings.

Evershed, H. Allotments. *National Review*, vol. x, p. 25.

Description of early experiments.

Fortescue, E. Poor Men's Gardens. *The Nineteenth Century*, 1888, vol. xxiii, p. 394.

Gay, E. F. Inclosures in England in the Sixteenth Century. *Quarterly Journal of Economics*, 1903. Vol. xvii, pp. 576-97.

— and Leadham, I. S. The Inquisitions of Depopulation in 1517 and the "Domesday of Enclosures." *Transactions of the Royal Historical Society*, 1900, vol. xiv, pp. 231-303.

A discussion of the critical problems in the interpretation of the inquiries of the early sixteenth century, chiefly with reference to the proportion of enclosure devoted respectively to arable and pasture.

Gonner, E. C. K. *Common Land and Enclosure*. London, 1912.

A praiseworthy attempt to write a comprehensive history of the enclosure movement; necessarily uneven in quality.

Hasbach, W. *A History of the English Agricultural Laborer*. London, 1908.

A careful and discriminating study.

Jebb, L. *The Small Holdings of England. A Survey of various existing systems*. London, 1907.

— *The Working of the Small Holdings Act*. London, 1907.

Johnson, A. H. *The Disappearance of the Small Landowner*. 1909.

Shows by use of the land-tax assessments that the yeoman farmer disappeared nearly a century earlier than was currently supposed.

Leadham, I. S. *The Domesday of Enclosures. 1517-18*. Introduction. Royal Historical Society. 1897.

Levy, H. *Large and Small Holdings*.

Prothero, R. E. *English Farming Past and Present*. London, 1912.

## SELECTED REFERENCES

Slater, G. *The English Peasantry and the Enclosure of the Common Fields*. London, 1907.

A study of the enclosure movement, primarily in the eighteenth century. In many ways the most readable of the accounts now available.

*Collateral Reading.*

Gonner, E. C. K., *op. cit.*

Slater, G., *op. cit.*

Collings, J., *op. cit.*

Jebb, L., both books.

## CHAPTER X

*Critical Discussions.*

Ashley, W. J. *Economic Organization of England*. London, 1914. Chapter VII.

A relatively conservative account, which embodies many of the elements of interpretation criticized in the text.

Jevons, W. S. *The Coal Question*. 1st edition, London, 1865. 2nd edition, London, 1906. Chapters IX, X, XI.

The entire change is interpreted in terms of the volume of the production of coal. It would seem that this extreme emphasis upon a single source of power leads to exaggeration. Even to-day we are in position to foresee a development of other sources of power which may well invalidate certain of the conclusions of this stimulating work.

Mantoux, P. *La Révolution Industrielle au XVIII<sup>e</sup> siècle*. Paris, 1906.

The most careful study of the beginnings of the Industrial Revolution. Already long out of print.

Wood, Sir H. T. *Industrial England in the Middle of the Eighteenth Century*. London, 1910.

## CHAPTER XI

Anon. (presumed to have been edited by Defoe). *The British Merchant*. London, 1720. 3 vols.

A polemic inspired by the discussion of the commercial treaty with France projected in 1713.

Barbon, Nicholas. *A Discourse on Trade*. 1690. 1696.

Reprinted by Hollander, *Economic Reprints*.

Bruce, J. *Annals of the Honorable East India Company*. London, 1810. 3 vols.

A collection of documents that is important in connection with the development of the trade in cottons.

Child, Sir Josia. *A New Discourse on Trade*. 1681.

D'Avenant, Charles. *Essay on the East Indian Trade. Political and Commercial Writings of D'Avenant*. London, 1771. Vol. 1, p. 83.

Hewins, W. A. S. *English Trade and Finance*, chiefly in the seventeenth century. London, 1892. Chapter v. Three Commercial Treaties.

Hunter, W. W. *A History of British India*. London, 1899-1900. 2 vols.

The most complete account of the early history of the company.

Mun, Thomas. *England's Treasure by her Forraign Trade*. London, 1664. Reprint: Economic Classics, New York, 1892.

Smith, J. *Chronicon Rusticum-Commerciale, or Memoirs of Wool*. London, 1747. 2 vols.

Wright, Arnold. *Early English Adventurers in the East*. London, 1917.

Narrative of early travel in the East leading up to the East India Company and chapters from the early history of the company.

*Collateral Reading.*

Hunter, *op. cit.*, vol. II, chapter VIII.

Hewins, *op. cit.*, chapter V.

CHAPTER XII

*Critical Discussions.*

Baines, Edward, Jr. *History of the Cotton Manufacture*. London, 1835.

Still the most comprehensive account.

Chapman, S. J. *The Cotton Industry and Trade*. London, 1905.

Recent history and description of the present condition of the industry.

— *The Lancashire Cotton Industry*. Manchester, 1904.

A careful history of the rise of the factory system in the industry and of the development of organisation among the workers.

Ellison, Thomas. *The Cotton Trade of Great Britain*. London, 1886.

A study of the trade by a member of a famous Liverpool firm. The most complete study of the trade statistics.

French, G. J. *Life and Times of Samuel Crompton*. Manchester, 1860.

Contains also an appendix on the development of spinning by rollers, documents connected with the claims of Paul to the invention.

Guest, Richard. *History of the Cotton Manufacture, with a disproval of the Sir Richard Arkwright's claim to his Inventions*. 1823.

An important near contemporary account, provided with illustrations of the early machines which are the basis of most of the modern cuts.

Marsden, R. *Cotton Spinning, its development, principles, and practice*. London, 1886.

The least technical of the treatises on spinning.

Schultze-Gaevernitz, G. von. *Der Grossbetrieb: Ein Wirtschaftlicher und socialer Fortschritt: Eine Studie auf dem Gebiete der Baumwollindustrie*. 1892. Translation: *The Cotton Trade in England and on the Continent*. Manchester, 1895.

An excellent study in the rise of the factory system and certain aspects of international competition.

Taggart, W. S. *Cotton Spinning*. London, 1902. 3 vols.

A more elaborate treatise than that of Marsden, designed for technical students.

Wood, G. H. *The History of Wages in the Cotton Trade during the last Hundred Years.* London, 1910.

*Collateral Reading.*

Baines, *op. cit.*

Marsden, *op. cit.*

CHAPTER XIII

*Critical Discussions.*

Beck, L. *Die Geschichte des Eisens in technischer und kulturgeschichtlicher Beziehung.* Braunschweig, 1884-1903. 5 vols.

The most important single work on the iron industry, combining the technical and historical points of view with unusual success.

Bessemer, Sir H. *An Autobiography.* London, 1905.

A record that conveys the personality of the man as well as the external events of his career as an inventor. Absorbingly interesting.

Grantham, J. *Iron Ship-building.* London, 1868.

Jeans, W. T. *The Creators of the Age of Steel.* New York, 1884.

Biographical essays on Bessemer, Siemens, Whitworth, Brown, Thomas, and Snelus.

Muirhead, J. P. *The Origin and Progress of the Mechanical Inventions of James Watt.* London, 1854. 3 vols.

The most complete of the biographies of Watt.

Percy, J. *Metallurgy: The Art of Extracting Metals from their Ores, and of Adapting them to Various Purposes of Manufacture. Iron and Steel.* London, 1864.

A technical treatise that includes more historical material than any other treatise in English.

Scrivenor, H. *A Comprehensive History of the Iron Trade throughout the world, from the earliest records to the present.* London, 1841. Revised and enlarged, 1854.

Not very useful.

Smiles, S. *Industrial Biography: Iron Workers and Tool-makers.* London, 1863.

Important.

— *Lives of Boulton and Watt*, from the original Soho MSS. London, 1865.

Thurston, R. H. *A History of the Growth of the Steam Engine.* New York, 1902.

An account written by an engineer for the general public.

Trevithick, Francis. *Life of Richard Trevithick.* London, 1872. 2 vols.

*Collateral Reading.*

Bessemer, *op. cit.*

Jeans, *op. cit.*

Smiles, *Industrial Biography.*

## CHAPTER XIV

*Critical Discussions.*

Cilleuls, A. de. *Histoire et régime de la grande industrie en France aux XVII<sup>e</sup> et XVIII<sup>e</sup> siècles.* Paris, 1898.

Dunlop, Jocelyn, and Denman, R. D. *English Apprenticeship and Child Labour.* New York, 1912.

Gaskell, P. *The Manufacturing Population of England.* London, 1833.

Hammond, J. L., and Hammond, Barbara. *The Town Laborer.* London, 1917.

A sociological study that is strongly influenced by class consciousness. The position of the aristocracy is brought out with technical accuracy, but one is tempted to question the justice of the implications of the text. Is it strictly true that the aristocracy consciously used its position to exploit and oppress the lower classes? One must remember that much impetus towards reform came from this aristocratic class.

Martin, G. *La Grande Industrie en France sous la Règne de Louis XV.* Paris, 1901.

The most considerable of the studies of the early tendencies toward the factory system in France.

Marx, K. *Capital. A Critical Analysis of Capitalist Production.* Translated from the third German edition, Moore, S., and Aveling, E. London, 1887.

*Parliamentary Papers.*

*Two Reports of the Committee on Petitions from the Handloom Weavers in the Linen, Cotton, and Silk Manufacture.* 4 parts. 1834-35.

*Report of the Royal Commission and the Assistant Commissioners on the Condition of the Handloom Weavers.* 7 parts. 1839-41.

*Report of the Committee on the Woollen Manufacture of England, the Laws relating to it, and the Acts regulating the conduct of Masters and Workmen.* 1806.

Rousiers, P. de. *The Labour Question in Great Britain.* London, 1896.

A study of conditions among the working classes according to the methods of Le Play: observations of specific families and their histories.

Ure, A. *The Philosophy of Manufactures.* London, 1835.

Description of the introduction of machinery by one who is wholly dominated by the industrial and mechanical advantages.

*Collateral Reading.*

Dunlop, *op. cit.*

Gaskell, *op. cit.*

Hammond, *op. cit.*

De Rousiers, *op. cit.*

## CHAPTER XV

*Critical Discussions.*

Clapham, J. H. "The Spitalfields Acts. 1773-1823." *Economic Journal*, vol. 26, pp. 459-71.

Howell, G. *The Conflicts of Capital and Labour, historically and economically considered.* London, 1878.

Schloesser, H. H., and Clark, W. S. *The Legal Position of Trade Unions.* London, 1913.

Wallas, G. *Life of Francis Place, 1771-1854.* London, 1898.  
Vivid and of capital importance.

Webb, Sidney and Beatrice. *History of Trades Unionism.* London, 1894.

The first chapter only is of moment in connection with the present discussion and it is difficult to avoid feeling that this introductory chapter is considerably below the standard of the rest of the book. The interpretation of the early history of Unionism seems to be dominated by assumptions as to the policy of Parliament that are not borne out by the facts.

*Collateral Reading.*

Wallas, *op. cit.*

CHAPTER XVI

*Critical Discussions.*

Aschrott, P. F. *The English Poor Law System, Past and Present.* London, 1902.

The best brief account of the existing administrative framework. The discussion is, however, somewhat out of date, as the Report of 1909 has exerted a notable influence upon opinion though it has not resulted in much legislation.

Bosanquet, H. *The Poor Law Report of 1909.* London, 1909.

Discussion favorable to the Majority Report.

Bowstead, W. *The Law Relating to Factories and Workshops.* London, 1902.

The text of the Act of 1901 accompanied by introduction and legal commentary.

Brend, W. A. *Health and the State.* London, 1917.

Carter, J. W. *Factory and Workshop Acts.* Blackburn, 1907.

Dewsnup, E. *The Housing Problem in England; its statistics, legislation, and policy.* Manchester, 1907.

The best general statement.

Frankel, L. K., and Dawson, M. M. *Workingmen's Insurance in Europe.* New York, 1910.

Hodder, E. *Life and Work of the Seventh Earl of Shaftesbury.* London, 1891-92.

A biography written with the assistance of Shaftesbury's private papers, though the work was not undertaken at the request of the family.

Hutchins, B. L., and Harrison, A. *A History of Factory Legislation.* London, 1903.

Lovatt-Fraser, J. A. *The National Insurance Act; 1911.* London, 1912.

Mackay, Thomas. *Public Relief of the Poor.* London, 1901.

Six lectures of unusual value.

Nicholls, Sir G., and Mackay, T. *A History of the English Poor Law.* London, 1898.

The most complete historical work on the subject.

## SELECTED REFERENCES

xv

Paterson, A. *Across the Bridges, or Life by the South London Riverside*. London, 1911.

An excellent description of slum conditions by a talented and sympathetic observer.

Redlich, J. *Local Government in England*. London, 1903. 2 vols.  
*Report from the Poor Law Commissioners on an Inquiry into the Sanitary Condition of the Labouring Population of Great Britain*. London, 1842.

Richardson, B. W. *The Health of Nations. A Review of the Works of Edwin Chadwick*, with a biographical Dissertation. London, 1887. 2 vols.

Rowntree, B. S. *Poverty, a Study of a City*. London, 1901.

Simon, Sir John. *English Sanitary Institutions*. London, 1890.

*The Land. The Report of the Land Enquiry Committee*. Vol. I, Rural. Vol. II, Urban. London, 1913.

Webb, Mrs. Sidney. *The Case for the Factory Acts*. London, 1902.

Webb, Sidney and Beatrice. *English Poor Law Policy*. London, 1910.

Discussion of the problem from the point of view of the Minority Report.

— *The Prevention of Destitution*. London, 1912.

### *Collateral Reading.*

Dewsnup, *op. cit.*

Hutchins and Harrison, *op. cit.*

Simon, *op. cit.*

Mackay, T. *Public Relief of the Poor*.

Paterson, *op. cit.*

Rowntree, *op. cit.*

Webb, *Prevention of Destitution*.

## CHAPTER XVII

### *Critical Discussions.*

Brunel, I. *The Life of Isambard Kingdon Brunel*. London, 1870.

Grinling, C. H. *History of the Great Northern Railway*. London, 1898.

Jeaffreson, J. C. *Life of Robert Stephenson*. London, 1866.

Pratt, E. A. *A History of Inland Transport and Communication in England*. London, 1912.

Smiles, S. *Life of George Stephenson*. London, 1858.

Steel, W. L. *The History of the London and North-Western Railway*. London, 1914.

Thurston, R. H. *A History of the Growth of the Steam Engine*. New York, 1902.

Williams, F. S. *The Midland Railway, its Rise and its Progress*. London, 1876.

### *Collateral Reading.*

Pratt, *op. cit.*, chapters 18, 19, 20.

Thurston, *op. cit.*, chapter 4.

## CHAPTER XVIII

*Critical Discussions.*

- Ackworth, W. M. *The Railways and the Traders. A Sketch of the Railway Rates Question.* London, 1891.
- Butterworth, S. K. *The Railway and Canal Traffic Act of 1888.* London.
- Cohn, G. *Untersuchungen über die englische Eisenbahnpolitik.* Leipzig, 1874-83. 2 vols.
- Grierson, J. *Railway Rates, English and Foreign.* London, 1886.
- Pratt, E. A. *Railways and their Rates.* London, 1905.
- Stevens, E. C. *English Railways. Their Development and their Relation to the State.* London, 1915.

*Collateral Reading.*

- Pratt, *op. cit.*
- Stevens, *op. cit.*

## CHAPTER XIX

*Critical Discussions.*

- Brown, W. J. *The Prevention and Control of Monopolies.* London, 1914.  
Discussion of the policy of regulation by a lawyer with experience in control of combinations in Australasia. Conservative.
- Carter, G. R. *The Tendency toward Industrial Combination.* London, 1913.
- Hirst, F. W. *Monopolies, Cartells and Trusts.* London, 1905.  
A brief essay from the conservative point of view.
- Hobson, J. A. *Evolution of Modern Capitalism.* London, 1910.  
Moderate socialistic view. Chapters v, vii, viii, ix, xvii.
- Levy, H. *Monopoly and Competition, a Study in English Industrial Combination.* London, 1911.
- Macrosty, H. W. *The Trust Movement in British Industry.* London, 1907.  
A descriptive treatment not notably influenced by the views of the author.
- *Trusts and the State.* London, 1901.  
Propagandist literature of the Fabian Society, but moderate and persuasive.

*Collateral Reading.*

- Brown, *op. cit.*
- Levy, *op. cit.*
- Macrosty, *Trust Movement.*

## CHAPTER XX

*Critical Discussions.*

- Arnold Forster, H. O. *English Socialism of Today.* London, 1908.  
Sees a future for radical agitation only under the leadership of the Socialists.
- Bowley, A. L. *Wages in the United Kingdom in the XIXth Century.* Cambridge, 1900.  
A scholarly study by a famous statistician.



## SELECTED REFERENCES

xvii

Burgess, J. *John Burns*. Glasgow, 1911.

A biographical sketch by a hostile critic. An account of the "treason" of Burns. Affords therefore much insight into the bitterness of feeling inside the ranks of organised labor.

Cole, G. D. H. *The World of Labor*. London, 1913.

The best single study of recent conditions in the field of labor. The author has a policy, moderate in character, but it does not intrude itself into the narrative.

Gammage, R. G. *History of the Chartist Movement*. 1837-54. Newcastle, 1894.

Giffen, Sir R. *Economic Inquiries and Studies*. Vol. I, p. 382; Progress of the Working Classes in the Last Half-Century (1883).

Henderson, F. *The Labour Unrest. What it is, and what it portends*. London, no date.

Hovell, Mark. *The Chartist Movement*. Manchester, 1918.

Humphrey, A. W. *A History of Labour Representation*. London, 1912.

A study that is seemingly accurate in many minute details of candidacies and contests, but not very illuminating in its treatment of the relation of the Labour members to the Liberal whip.

Money, L. G. Chiozza. *Riches and Poverty*. 1910. London, 1911.

A study of distribution by a radical, somewhat sensational in tone, but by no means unsound in its calculations.

Rose, F. H. *The Coming Force*. Manchester, 1909.

Stamp, J. C. *British Incomes and Property*. London, 1916.

A study of the Income Tax returns with reference to their use by economists, designed to assist persons without official knowledge through the many pitfalls of the returns. Mistakes of Levi and Mallock are noted. Some constructive conclusions are reached but they are couched in a form that renders them unavailable for the purposes of the present chapter.

Watson, A. *A Great Labour Leader: the Life of Thomas Burt*. London, 1908.

A significant biography of one of the first Labour M.P.'s.

Wilson, J. *Memories of a Labour Leader*. London, 1910.

### *Collateral Reading.*

Cole, *op. cit.*

Hovell, *op. cit.*

## INDEX

- Accidents in industry, risk of, placed by insurance upon consumers, 423.
- Acquittaine, grants to wine merchants from, 151.
- Administrative nihilism, Webb's allegation of, 370.
- Administrative system, lack of a centralised, 388.
- Aggregation, of free and of unfree workers, 67.
- Agriculture, basis of prosperity in the Middle Ages, 262; capitalistic farming, 227; the midland system, 226; no ideal system, 228; relation to industry, 208, 251; relative importance of, to industry, 260-61; size of farms, 227; yeoman farming, 227.
- Algeria, French land policy in, 111.
- Aliens, charters to a. craftsmen, 177; grants of privileges to merchant a., 151.
- Alien merchants, royal privileges granted to, 146.
- Allotment, definition of, 240.
- Allotments, accomplishment of legislation on, 243; acts of 1882 and 1887, 242; compulsory provision of land for, 242; early experiments with, 241; origin of, in the village community, 118-19; provision for, in the Poor Laws, 241; to villagers in the open fields, 115.
- Amalgamated Society of Engineers, the, constitution and organisation of, 523-24; decline of its power, 527; grants during the builders' strike, 525; the model for craft unions, 523; policy of, 524.
- Amalgamation of railways, projects for, in 1853, 454.
- Amboyna, massacre at, 278.
- Ancient Trades Decayed and Repaired Again*, the, 279.
- Antiquity, parallels with the Middle Ages, 41.
- Apprentices, 72; pauper, 360; significance of the restriction of numbers of, 353.
- Apprentices, the Statute of, attempts to enforce, about 1800, 354; distinguished three groups of crafts, 192; implies the existence of a wage-earning class, 193; later significance of, 368; purposes of, 192; purpose of the wage-fixing clauses, 367; wage-fixing clauses, 193.
- Apprenticeship, 73; attempts to enforce legal provisions on, 353; decay of the system, 353; in Mesopotamia, 37; regulations of, in the *Book of the Crafts*, 82.
- Arable land, development of communal use of, 118.
- Aristocracy, the, control of land by, curtailed, 242; its demand for agricultural products, 20; development of a Germanic, 122; disappearance of Roman, 122; factors creating an, 122; the feudal, 29; indirect participation in industry, 47; its place in the medieval village, 120; position of, in the ancient city, 26; its relation to agrarian history, 109.
- Arkwright, R., development of the water frame, 295; early career, 294; manufactures stockings and calicoes, 295; his patent suits, 296; relations with Kay and Higs, 294; secures repeal of the Calico Act, 295; his water frame contrasted with Paul's machine, 293.
- Artisans, in antiquity, 8; during the dark ages, 55; in Greece, 45; obligations of, under the late Roman Empire, 54; position of, in Egypt, 33; position of, in the nineteenth century, 503; status in Mesopotamia, 35.
- Ashley, W. J., 165; conception of the town economy, 134; interpretation of sixteenth-century legislation in the woolen industry, 224.
- Aulnager, his functions and his accounts, 216.
- Ballif, duties of a manorial, 129.
- Balance of power, the, influence of economic changes on, 268.
- Balance of trade, the, use of the conception in the seventeenth century, 282.
- Basic process, for application of the converter to acid ores, 344; extension of, in the iron trade, 345.
- Beloch, discussion of slavery in antiquity, 8; estimates of population, 28, 42.
- Benefit societies, in Rome, 48. *See also* Conifère.
- Bessemer, Sir H., 274; the bronze powder episode, 335-39; criticism of, by

- English iron masters, 343; early career of, 334; experiments in middle life, 339; the steel-making inventions, 340-43.
- Black Death, the, extent of its ravages uncertain, 96; presumed effect on population, 92; relation to commutation, 132.
- Blacksmith, in early Egypt, 31; in early Greece, 43; on the Kasai, 4-5.
- Blanqui, use of the phrase "Industrial Revolution," 247.
- Blast, artificial, its influence on smelting, 316; produced by falling water, 317-18.
- Blowing machinery, Smeaton's, 322; vital importance of, 322-23.
- Board of Health, the first, 398; nature of opposition to, 399.
- Board of Trade, exercised regulatory functions over railways, 466; functions of, in connection with railways, 463; participation in the preparation of rate schedules, 470; supervision of railway projects, 461.
- Bolton, Lancashire, climate of, 265.
- Book of the Crafts*, the, 59; 60; 70; 77; regulations of apprenticeship, 82; regulations common in craft statutes, 82; status of journeymen, 83; status of masters, 84.
- Boon days, 128.
- Booth, proposed the multitubular boiler for the locomotive, 442.
- Bordarii (crofters), 123.
- Boroughs, as county seats, 160; definition of, 158; features of, 161; population of, 104-05; trade and industry in, 159.
- Boston, Mass., climate of, 265.
- Boulton, partnership with Watt, 327.
- Bourgeois, E., 78.
- Bowley, A. L., 505; studies of wages, 502.
- Brentano, L., *Origin and Development of Guilds*, 166-67; his theory of gild development, 167.
- British New Guinea, coastal trade of the natives of, 6.
- Brown and Company, Sheffield, activities of the firm, 484-85.
- Bücher, K., 217; conception of the dawn of history, 24; concept of household industry criticized, 36, 45; conception of town economy, 134; discussion of the household in antiquity, 8; *Industrial Evolution*, 3; underestimates the importance of commerce, 39.
- Bullion, export of, to India, 281.
- Burgesses, obligations of, 159-60.
- Butchers, craft of, said to have persisted at Paris since Roman times, 63.
- Calais, the staple at, 154.
- Calico Act, the, 284; repealed, 286; repealed at the instance of Arkwright, 295.
- Cambridge, 161; early history of, 159; occupational groups in, 185.
- Candle-makers, at Paris, wage and craft work, 11.
- Capital, source of, for early railways, 443.
- Capitalism, early rise of, 218.
- Capitalist employer, functions of, 13; his new functions in the factory, 16.
- Capitalistic control, beginnings of, 13; of industry at Paris, 1300, 72; its rise, in the woolen industries, 208.
- Carding machines, 288.
- Cardwell, chairman of the Committee on Railways, in 1853, 454.
- Cardwell's Committee, policy on competition adopted by, 454.
- Carlyle, T., *Past and Present*, 249.
- Carpenters, their connection with the Royal Household, 80.
- Carta Mercatoria, 146; 151; its provisions, 152.
- Cartel, the, 481-82.
- Cartwright, invention of the power loom, 301.
- Cast iron, conditions essential to its production, 316; produced in the bloomery furnace, 318.
- Centralization, opposed by Toulmin Smith and his group, 390.
- Cesspools, in early towns, 395-96.
- Chadwick, Edwin, career and characterization, 392-94; plan for reform of the Poor-Law, 420; policies unpopular, 399; proposals for improved sanitary conveniences, 397.
- Changes in population, 88.
- Charcoal, scarcity of, 319.
- Charter of Liberties, of the railways, 464.
- Charter, the People's, 516.
- Charters, hearings on the applications of railways for, 461; parliamentary expense incurred by railways for, 459; procedure for acquisition of, 460-61; provisions of early railway, 462.
- Chartism, aims of the London group, 514; the Birmingham group, 517; constitutionalist tendencies of, 514; drafting of the Charter, 516; failure of the great petition, 518; genesis of the program, 514; importance of, 512; influence of anti-poor-law agitation on, 516; London Working Men's Association, 514, 516; the petition and the six points, 515; relation to the Reform agitation of 1832, 514; socialistic background of, 513; threatened violence, 517.

- Child, Sir J., changed the politics of the East India Company, 290; defense of the East India Company, 279.
- Cholesbury, parish abandoned to the poor, 417.
- City, the ancient, 26; the modern, 29; technical meaning of, in England, 158. *See also* Towns; Urban life; Boroughs.
- Class consciousness, among London artisans, 1833-36, 514.
- Classes of society, about 1086, 123.
- Classical Economists, the, 513.
- Cleave, John, 514.
- Climate, relation of a humid climate to textile manufacture, 263; relation to textile manufacture (table), 267. *See also* Humidity.
- Cloth, market for Suffolk, 220.
- Cloth manufacture. *See* Woolen industry.
- Clothiers, activities restricted by the Weavers' Act, 212; become capitalists, 208; certain poor, 222; at Colchester, 217; as employers of weavers, 211; in the Suffolk woolen industry, 218; in the west of England, 213. *See also* Drapers.
- Coal, significance of its use in the metal trades, 314; use of, by Dudley, 320.
- Coal trade, combinations in Germany and the United States, 478.
- Coats, J. & P. Ltd., history of the firm, 489-90.
- Coke, influence on the use of the bloomery furnace, 319.
- Colchester, occupational groups in, 185; putting-out system established, 217.
- Collective bargaining, beginnings at Coventry, 374-75; in Gloucestershire, 1756, 370.
- Collegia, in Rome, 48.
- Collings, Jesse, advocates small holdings, 245.
- Cologne, 149.
- Coloni (tenant farmers), 121.
- Combination, tendency toward, 475; horizontal, in the textile trades, 489; in the thread trade, 490; vertical, advantages of, 484; vertical, advantages in the steel trade, 485-87; vertical, does not destroy competition, 488-89.
- Combination Laws, the, 377; aspirations of laborers following the repeal of, 519; the committee of 1823 on, 382.
- Combinations, among railways, 468; causes of late development of, 476; causes of, in the steel trade, 478; forms of permanent, 483; legal classification of, 479; in the Newcastle coal trade, 476-77; temporary, 482; vertical and horizontal, 483.
- Combinations of working men, the act of 1825, on, 385.
- Commerce, expansion of, 22; expansion during the Middle Ages, 22; expansion leading to the Industrial Revolution, 23; importance of, in France after the invasions, 53; relative order of emergence as compared with industry, 39; of Rome, 27.
- Commercial theory, of Greek development, 40.
- Commercial treaty, with France, proposed in 1713, 283.
- Commission system, 14. *See also* Putting-out system.
- Common carriers, development of tram lines to serve as, 432.
- Common pasture, effect of destruction of, on the diet of the poor, 239; Young's proposals, 239; contemporary dissatisfaction with, 238; consequences of their destruction, 238; policy concerning, 237.
- Common, rights of, 232.
- Communal use of arable land, 118.
- Communal use of meadow land, 118.
- Communism, traces of, among craftsmen, 85; not practiced in the village community, 115.
- Commutation, its influence upon the status of tenant farmers, 131; of manorial dues, 131; mutual advantages of, 132; progress of, 132.
- Companies, nature of companies for foreign trade, 147.
- Compensation Laws, adopted in England, 425; act of 1897, 425; amendments, 1900, 1906, 425; opposition of organized labor to, 426.
- Competition, the essence of, 496; not destroyed by vertical combination, 488; a relative term, 495; unfair, among craftsmen, 84.
- Competition among railways, disadvantages of limited, 467-68; nature and advantages of, 467; policy adopted by Cardwell's committee, 454; policy adopted in regard to, 466-67.
- Composition, the, at Norwich, 179.
- Concentration of wealth, the form more important than the amount, 510; meaning of, 508.
- Confrérie, 166; perhaps connected with Roman collegia, 63.
- Congested areas, provision for reorganization of, 405.
- Conspiracy, doctrine of, 380.
- Constable, the village, 130.
- Constantinople, autonomous crafts in, 50; Prefect of, 50.
- Consumer, seldom in direct contact with the craft producer, 12.

- Consumption, standardized, 21.
- Converter, the, genesis of Bessemer's idea, 341; limitations of the use of, 343; mode of operation of, 341.
- Copyhold tenure, 132.
- Cordwainer, 63.
- Corporate personality, development of the concept, 162.
- Corporation, the large, advantages of, 483.
- Cort, H., his inventions, 331.
- Cosmopolitanism, 21; during the Middle Ages, 164.
- Cottage industry, exemptions in the Weavers' Act in favor of, 213; woolen weaving, 211.
- Cottagers (crofters), injured by enclosure, 238; obligations of, on a manor, 128; Young's proposals in their behalf, 239.
- Cottarii. *See above*, under Cottagers.
- Cotton, use of, in medieval Europe, 276.
- Cotton industry, effect of the Industrial Revolution on, 254; growth of, in Great Britain, 303; importance of protection to, 286; protected by the Manchester Act, 285; rise of, 308-09.
- Cotton spinning, effect of humidity on, 263.
- Cotton trade, early history of, 276.
- Cottons, East Indian, compete with woolens, 215; competition with European textiles, 278; effect of their introduction in Europe, 252; effect of prohibitions against their importation, 253; introduction of, in Europe, 278; not an original purpose of the East India Companies, 277; prohibition of importation, by the Calico Act, 284; as trade goods in the islands, 277; use of, in England, 279.
- Courts, at fairs, 143.
- Coventry, labor troubles at, 374-77.
- Craft guilds, characteristics of, 74; at Constantinople, 50; feudal influences on, 78; origins of sworn crafts at Paris, 76; problems of origins, 75; Roman and Teutonic influences, 75; a spontaneous outgrowth, 50.
- Craft industry, 9.
- Craft specialization, based on physical limitations, 38.
- Craft unions. *See* Trade unions; *also* Amalgamated Society of Engineers.
- Craft work, beginnings of, 4-5; in early Egypt, 33; in Mesopotamia, 36; notion of, 10; a short-lived form, 217.
- Craft workers, relations with the consumer, 68.
- Crafts, administrative organization absent during the dark ages, 54; in antiquity and the Middle Ages, 29; autonomy at Constantinople, 50; chains of correlated, 13; chartered, 75; content of statutes of, 81; delimitations of their activities, 85; develop early, 7-8; in the eleventh century, 56; in early Egypt, 31; engaged in export trade, 61; engaged in finishing of woolens, 204; engaged in the preparation of foods, at Rome, 49; in the feudal household, 79; free, 75; groups distinguished in the Statute of Apprentices, 192; groups of, in the Middle Ages, 60; ideals not achieved, 81; importance of lists of, 10; no lists possible for early Greece, 44; lists of, at Paris in the eleventh century, 62; lists of in Rome, 48; in Mesopotamia, 35; not always organized as guilds, 187; in the ninth century, 56; numbers of, at Norwich, 185; numbers at Paris, 60; numbers of, in various English towns, 186; obligations of members of, 82; organization in antiquity, 27; organization at Rome, 48; persistence of, in the dark ages, 55; process of specialization gradual, 8; records for Paris, 59; specialization by processes in Greece, 43; stages in the development of, 11-12; subordinate importance of textile, in Rome, 49; sworn, 76; traces of communism among, 85; unions of smaller and larger crafts at Norwich, 180.
- Craftsmen, regulations of status of, 82.
- Cranege, Thomas and George, 330.
- Crofters. *See* Cottagers.
- Crompton, invention of the mule, 298; poverty of, 300; various names given his spinning machine, 298.
- Cross Act, 1875, 405.
- Crown and Anchor Tavern, the, meeting of Chartists at, 515.
- Culture of antiquity, 41.
- Cunningham, W., 96; *Growth of English Industry and Commerce*, 250.
- Danes, effect of their invasions, 122.
- Darby, relation of the family to the iron industry, 321.
- Darby, Abraham, experiments with coke, 321.
- Darby, A., 2d, success with coke as fuel, 321.
- Dark ages, the, 25; industrial conditions in, 54; persistence of crafts, 55.
- D'Avenant, C., *Essay on the East Indian Trade*, 284.
- Death rates, decline in, 499.
- Delimitation of crafts, 85.
- Density of population, normal, 89; relative changes in, among English counties, 98; significance of deviation from the mean, 100.

- Dependent classes, on a manor, 128.  
*Dictionary of Jean de Garlande*, 59.  
 Direct contact, between producer and consumer, 60, 69.  
 Direct process, in the iron industry, generality of its use in the early period, 314, 315.  
 Disintegration, of industrial processes, 12, 66.  
 Dispersion of population, characteristic of the Middle Ages, 102.  
 Distress, complex causes of, in the early nineteenth century, 364.  
 Distribution of wealth, changes in, 511; concept of normal, 509; equality of, 508; implications of normal, 509.  
 Division of labor, geographical, 6; horizontal, 15; vertical, 9; relation to industrial forms, 18.  
 Domesday Book, 125; social classifications in, 123-24; evidence of dispersion of population in, 103.  
 Domestic system, 13. *See also* Putting-out system.  
 Dorsetshire laborers, the, case of, 521.  
 Drapers, 61; as capitalists, 71; become capitalists, 208; at Paris, eleventh century, 64; of Shrewsbury, 211. *See also* Clothiers.  
*Draper's Dictionary*, the, 199.  
 Dublin, 173, 174; occupational groups in, 185.  
 Dudley, D., experiments with coal, 320; purposes of his experiments, 253.  
 Dutch, the, their struggle for the Spice Islands, 277.  
 Dyeing, a speciality of some Flemish and Italian towns, 202.  
 Dyers, early emergence of, 12; conflicts with the drapers at Paris, 71; precede weavers in Egypt, 34.  
 East India Company, its early trading policy, 277; export of bullion, 281; its first factories in India, 277; its hold upon the Government, 284; Mun's defense of its trade, 281; its politics, 280.  
 East Indian textiles, bill to prohibit the use of, 1696-97, 279.  
 Eberstadt, 78.  
 Economic equilibrium, disturbances of, 268.  
 Edward I, grants to foreign merchants, 151.  
 Edward VI, statute of, confiscating the endowments of the gilds, 190.  
 Egypt, character of records, 30; early culture of, 24.  
 Employer, authority of, in the factory, 348; early functions, 13. *See also* Capitalist employer.  
 Enclosure, by act of Parliament, 231; by agreement, 233; and changes of proprietorship, 228; continuity of, 229; effect on the diet of the poor, 239; errors of policy, 238; forms of, 225; Lord Thurlow's criticism of procedure in Parliament on, 236; meaning of, 225; partial in the early period, 230-31; policy towards commons in the acts of Parliament, 237; poorer villagers hostile to, 233; precedents for Parliamentary acts, 234; problems of title raised by, 237; procedure under act of Parliament, 235; progress of, 230; purposes of, 226; relative areas to arable and pasture, 231; rights of common an obstacle, 232; theory of Parliamentary acts for, 235; of waste, 232.  
 England, dependence upon Continental influences, 102; a frontier province of Europe, 102; growth of population in, 88; population prior to the Black Death, 92, 97; under-populated in the Middle Ages, 90.  
 English Sewing Cotton Company, financial difficulties of, 492; its pool with Coats, 491.  
 Enumerations of population, in the Middle Ages, 87; deficiencies of French figures, 91; poll-tax returns, 93; subsidy rolls, 93.  
 Evolution of industry, not merely a matter of typical forms, 45-46.  
 Factory, the, common definitions, 346-47; development checked by legislation, 352; development opposed by the workmen, 348; essential features of, 347; legislative definitions, 413; primitive forms in Greece, 44; probable dates of its introduction in various textile trades, 358-59; reasons for the slow growth of, 349; relation of machinery to, 350; rise of, in the cotton industry, 356; a rudimentary, 36; social problems of, 359; without machinery, 350.  
 Factory (trading post), at Surat, 277.  
 Factory Act, of 1802, 410; of 1819, 410; of 1833, 411; of 1844, 412; of 1847, 413; of 1864, 414; of 1867, 413-14; of 1878, 413, 415; of 1883, 415; of 1889, 415; of 1898, 415; amended and codified in 1901, 415; dangerous trades regulated, 414; early history of, 410; extension of principles, 413.  
 Factory inspectors, created by the act of 1833, 411; defects of their returns, 414; limitations of their reports, 361.  
 Factory legislation, based on the police power, 408; inquiries of 1831-33, 411.  
 Factory system, the, essential features

- of, 16; experimentation with in France, 224; growth of, 362; hostility of workmen to, 16; legal definitions inadequate, 17; in the sixteenth century woolen industry, 223; tendencies toward, in antiquity, 46.
- Factories, first tendencies toward, 355; not confined to the period of the Industrial Revolution, 46; proportions of men, women, and children in, 357; rudimentary, 57, 73. *See also* Mills.
- Fagnies, on the survival of Roman institutions, 53-54.
- Fairs, 136; business of, 141; their courts, 142, 143; cycles of, 140; devoted to wholesale trade, 138-39; dues levied, 142; freedom of, 142-43; not sharply distinguished from markets, 137; number of, 138; procedure in their courts, 144; regulations of St. Giles' Fair at Winchester, 142; trade characteristic of the English, 142.
- Fallowing, benefits from, 113; medieval use of, 114.
- Farms, scattered, 112.
- Farming. *See* Agriculture.
- Felt-makers of London, organization of journeymen, 368.
- Feudal household, crafts in, 79.
- Feudal theory of guilds, 78.
- Field system, the open, 114-15; the three, 114; the two, 113.
- Flach, J., on the survival of Roman institutions, 53.
- Foods, crafts preparing, early development of, in Rome, 49.
- Formalism, in the Middle Ages, 135.
- Forms of industrial organization, 4; craft work in the east counties, 217; putting-out system, 216; putting-out system in the west of England clothing industry, 213. *See also* Putting-out system; Factory; Factory system.
- Forms of settlement, in England, 116.
- Fortrey, S., *England's Interest and Improvement*, 282.
- Fortunes, large, the problem of, 506, 510.
- France, growth of population, 88; importance of her economic influence during the dark ages, 53; population in the fourteenth century, 59; proposed commercial treaty with, 1713, 283; Roman influences, 52; stationary population of, 270.
- Francotte, H., 41; 44; timidity in classifying industrial forms in Greece, 45.
- Fraternity. *See* Guilds, religious.
- Freeman, obligations of, to the manor, 129.
- Free trade policy, origin of, 280; Tory support of, 280.
- Free trade theory, developed by the defenders of the East India Company, 283.
- Friendship, the basis of primitive trade, 5.
- Fullers, employed by Suffolk clothiers, 220; low repute of, 205.
- Fulling, appliances for, 205-06; character of the process, 205.
- Furnace, the bloomery, 318; coke used in the bloomery, 319; low open hearth, in Sweden, 317; the reverberatory, 329-30.
- Gaskell, P., pessimism of, 248.
- Gasquet, 92; 96.
- Gay, E. F., on the extent of early enclosures, 230; judgment of the purposes of early enclosing, 231.
- Gentlemen's agreements, 481.
- Geographical division of labor, among the peoples of New Guinea, 6.
- Germanic customs, described by Tacitus, 119.
- Gibbins, H. de B., on the Industrial Revolution, 249.
- Giffen, Sir Robert, 505.
- Gig mills, 206.
- Gilchrist, P. C., partnership with Thomas, 344.
- Gild, meanings of the word, 165; types of, 165.
- Gild merchant, its alleged monopoly of trade, 173; its control of craftsmen, 171; decline of, 181; its enfranchisement of trade, 174; its functions, 173; its monopoly inclusive, 175; non-resident members, 173-74; organization, 176; its place in municipal development, 163; sharing of bargains, 175; struggles with the craft guilds in Germany, 172.
- Gilds, adulterine, 178; charter incorporating the Tailors of Salisbury, 188; craft organizations less conspicuous than religious organizations, 187; employing and wage-earning classes distinguished in, 191; French terms for the various types, 166; influence of pageantry upon, 183; membership of religious and craft organizations, 182; numbers of, in various English towns, 186; relations between religious and craft guilds, 182; relative size of religious and craft organizations, 182. *See also* Craft guilds.
- Gilds, craft, a spontaneous outgrowth, 50; become companies when chartered by the King, 177; at Constantinople, 50; essential features of, 176; at London, 178; métier in French, 167; at Norwich, 179; organized within the gild merchant, 172; position after

- the Reformation, 190; the pure type, 178; and the Reformation, 177; types of, 177-78; view of the craft, 177; wardens of, at Norwich, 179.
- Gilda, religious, 166; a charter of incorporation, 188; denied right to endowments, 187; endowments confiscated, 190; the French term, 166; influence of incorporation, 188; the inquiry of 1389, 168-69; maintained grammar schools, 190; membership of, 169; organisation, 170; purposes, 169; purposes of incorporation, 189; secure charters of incorporation, 188.
- Gini, Professor C., 509.
- Gladstone award, the, 451.
- Grand National Consolidated Trades Union, activities in the case of the Dorsetshire laborers, 521; failure in the organisation of strikes, 521; its organisation, 519-20.
- Graa, N. S. B., 132.
- Great Northern Railway, the, genesis of, 450; relations with the Midland, 456.
- Great Western Railway, the, Brunel's conception of, 446.
- Greece, free artisans in, 45; primitive factories, 44; proportions of free and slave laborers, 47; stages of industrial development in, 43; vase painters in, 45.
- Grocers, 61.
- Gross, C., 172; 181; *the Guild Merchant*, 173.
- Guild. See *Gild*.
- Gynecœum, 55; at Saint-Germain des Prés, 56.
- Hall, Hubert, 151.
- Hall-in-the-Wood machine, early name for the mule, 298.
- Hamburg, 149.
- Hammurabi, list of crafts in his reign, 35.
- Hammurabi, Code of, 24; 37.
- Hand-loom weaving, reasons for persistence of, 349-50.
- Hansards, the, origins, 147; at times citizens of London, 148.
- Hanse, the, its decline, 153; defined, 147 establishment called the Steelyard, 150; fiscal privileges of, 151; government of, 149; origins of, 147; privileges of, recognized by the City, 149, its struggle to maintain its privileges, 153; subordinate corporations, 149, trade of, 150.
- Hargreaves, description of his jenny, 297-98.
- Harrison, F., 526.
- Hasbach, 242.
- Haskins, C., *Ancient Trade Guilds and Companies of Salisbury*, 189.
- Hayward, duties of, 129.
- Health, Ministry of, 403. See Board of Health; Public Health; Local Government Act; Local Government Board.
- Health administration, development of principles of, 400.
- Health insurance, act of 1911, 426.
- Health and Morals of Apprentices Act, 1802, 410.
- Hetherington, H., 514.
- Higs, spinning inventions, 294.
- Hilton-Simpson, M. W., *The Land and Peoples of the Kasai*, 4.
- Hobson, J. A., characterization of sweatshops, 18.
- Horrocks, loom patents, 302.
- Hours for work, defined by acts of 1844, 1847, and 1850, 412-13; regulation of, 409.
- House waste, early modes of disposal, 395.
- Household, industry in the feudal, 55; the industrial unit, 74.
- Household industry, based on slave labor, 8; Bücher's concept criticized, 45; undiversified, 4; undiversified, of rare occurrence, 7; in the feudal period, 57.
- Household, royal, in Egypt, 33; influence on craft guilds, 79.
- Housing, the Cross Act, 1875, 405; difficulties of securing adequate regulation of, 404; present problem, 406; the Torrens Act, 1867-68, 404; Town Planning Act, 1909, 405.
- Hudson and Tingey, *Select Records of Norwich*, 179.
- Hull, its charter of 1437, 162.
- Hume, J., association with Place in the repeal of the Combination Laws, 381-82.
- Humidification, artificial, requisite, 264.
- Humidity, effect of, in cotton spinning, 263; effect on the strength of yarn, 264; of twelve selected regions, 265-67.
- Hutchins and Harrison, *History of Factory Legislation*, 408.
- Incomes, distribution of, in England; 506; in the United Kingdom, difficulties of estimating, 505.
- Independent Labor Party, the, 519.
- India, cost of cotton spinning in, compared with costs of mule yarn in England, 312-13.
- Indirect process of iron production, 315.
- Industry, conditioned by commerce, 39; dependence upon agriculture, 208, dependence upon agriculture in the



- Middle Ages, 262; in the feudal household, 57; present dependence upon mineral resources and climate, 262-63; relation to agriculture, 251; relative importance of industry and agriculture, 260-61.
- Industrial development, primarily a matter of industrial specialization, 54; stages of, in Greece, 43.
- Industrial evolution, not merely a matter of typical forms, 45-46.
- Industrial groups, at Paris, in 1300, 64.
- Industrial history, beginnings of systematic study of, 1; stages in, 247; socialistic interpretations of, 2.
- Industrial organization, typical forms, 4.
- Industrial Revolution, changes in industrial groupings, 258; chronology of, 271; the close of the period, 275; the close of the period in the cotton trade, 305-06; defined in terms of capitalism, 250; early English writers on, 248; its essential features, 251; Gibbins' view, 249; importance of the changes in the metal industries, 253; misleading connotations of the phrase, 249; not primarily characterized by the emergence of the factory, 46; tables showing the varying relations between industry and agriculture, 260-61; primary causes of, 252; Toynbee's view, 250.
- Industrial specialization, conditioned by commercial expansion, 22; conditioned by the market, 19.
- Instinct of workmanship, 2.
- Integration in the control of industry, at Paris, in 1300, 71.
- Interstate Commerce Act, compared with English statutes, 465.
- Invention, conditions requisite to securing large profits from, 339; stages in, 272.
- Inventions, conditions of commercial success, 273; not complete in themselves, 272; not suddenly perfected, 251; their relation to the growth of the cotton industry, 287; a result of commercial expansion in the cotton trade, 305.
- Inventors, rewards of, 273.
- Iron, cast, 314; introduction of sheet, 332; malleable, 314; products of, 314.
- Iron ships, early history of, 332.
- Jack of Newbury, his woolen factory, 223.
- Jenckes, A. L., *The Origin, the Organization and the Location of the Staple of England*, 155.
- Jenny, the, description of, 297-98.
- Journymen, 72; 74; regulations concerning, in the *Book of the Crafts*, 83.
- Journymen Steam-Engine and Machine-Makers and Millwrights' Society, 523.
- Junta, the, 526; 527; 528.
- Kasai, the, peoples of, 4.
- Kay, relations with Arkwright, 294-95.
- Kenworthy and Bullough, loom patent, 302.
- Kersies, difficulty of classification, 199.
- King, Dr., 509.
- King, G., attempted forecast of the growth of population, 269.
- King's merchants, 154. *See also* Merchants of the staple.
- 
- Labor movement, the, elements of current discontent in, 529; many-sided, 518.
- Labor representation, 528.
- Laborer, the agricultural, distress of, in the early nineteenth century, 503.
- Laborers, the Dorsetshire, case of, 521.
- Laborers, relative position of skilled and unskilled, 501.
- Laborer's Friend Society, its campaign for allotments, 242.
- Laissez-faire* theory, not a genuine obstacle to reform, 387; not of substantial importance in the development of factory legislation, 408.
- Lake Superior ores, discovery and utilization, 266.
- Land, significance of relative scarcity of, 118.
- Land policy, of England in Nigeria, 111-12; of France in Algeria, 111.
- Land tenure, related to economic conditions, 111; the Roman system, 121.
- Large scale production, in antiquity, 9; relation to standardized consumption, 21.
- Lathe, the, development of, 328.
- Law merchant, the, 136; 146; administered in fair courts, 144; application extended by the *Carta Mercatoria*, 152; in the court of the staple, 155; essence of its principles and procedure, 144; extension to municipal courts, 145.
- Lawrence, Edward, *Duty of a Steward to his Lord*, 233.
- Le Mans, crafts at, 56.
- Leaf, W., interpretation of the Trojan War, 40.
- Leeds, opposition to capitalist employers and their factories at, 354.
- Leet, the court, 129; 130; its records of land tenure, 131.
- Leicester, 174; occupational groups in, 185.
- Levi, L., 505.

- Levy, Professor**, explanation of the tendency toward combinations, 476.
- Lewinaki, Jan de St.**, 119.
- Liebig, J. von**, 269.
- Lille, France**, climate of, 266.
- Lipson, E.**, 175-76.
- List, Frederick**, *The National System of Political Economy*, 39; scheme of periodisation, 39.
- List of crafts**, analysis of, 65; Egypt, 31; importance of, 10; Mesopotamia, 35; none possible for early Greece, 44; at Paris, in the eleventh century, 62; at Rome, 48.
- Liverpool**, untoward sanitary conditions in, about 1840, 396.
- Liverpool and Manchester Railway**, the first project, 441; profits of the early years, 442-43.
- Livery**, becomes a class distinction, 191; of craftsmen, 180; of guild members, 170.
- Local Government**, influence of the old system of, 388; act of 1858, 400; act of 1871, 401.
- Locomotive**, the, contest at Liverpool, 441-42; invented by Trevithick, 433; northern designs, 437.
- London**, about equal to Paris in size in the seventeenth century, 108; area for which the population is recorded, 107-08; craft organisations at, 178; growth of, 108; the plague at, 108; relation between the City and the Hanse, 149.
- London builders**, strike of 1858, 525.
- London coal trade**, history of, 476.
- London and North Western Railway**, agreement of 1908 with the Midland, 474; amalgamations proposed in 1853 by, 454; hostility to the Great Northern, 450; joint purse agreement with the Midland, 456.
- London Working-Men's Association**, the, 514; decline of, 518.
- Lorens, Dr.**, 509.
- Lorimers**, 70.
- Lorraine ores**, development of, 345; their utilisation, 266.
- Lovett, W.**, 514; 516.
- Low Countries**, trade with, 156.
- Lübeck**, 149.
- Luxuries**, dependence of the wealthy upon specialized production of, 69; disappearance of, after the fall of Rome, 55.
- Machinery**, relation to the factory system, 16, 350; effect of its introduction upon the artisan, 363.
- Macrosty, H. W.**; *Trusts and the State*, 493; *The Trust Movement in British Industry*, 491.
- Magnates**, their place in medieval society, 121.
- Maitland, F. W.**, *Township and Borough*, 161.
- Malleable iron**, 314.
- Malthusians**, pessimism not justified by events, 269.
- Malynes, The Canker of England's Commonwealth**, 281.
- Manchester Act**, the, 285.
- Manchester, Sheffield and Lincolnshire Railway**, the strategic position of, 452.
- Manor**, the, the administrative type, 126; as a capitalistic organisation, 125; its court leet, 129, 130; essential features of, 124-25; general aspect of, 128; obligations of the tenants, 128; officers of, 129; origins of, 123; principal types found in Domesday, 125; royal, 126; varying degrees of its economic independence, 130.
- Manufacture**, for export, in antiquity, 37.
- Market**, difference between fairs and markets, 138; in the Vth Dynasty of Egypt, 32; production for, in antiquity, 9; territorial and social limitations, 19; for Mesopotamian industry, 37; the world, 22.
- Marketing conditions**, relation of, to combinations, 479.
- Marsden, R.**, *Cotton Spinning*, 298.
- Marshall, A.**, 226.
- Marx, K.**, 513; on the tendency toward combinations, 493; view of the Industrial Revolution, 250.
- Master Combers**, capitalists, 208; in the worsted districts, 222.
- Master craftsman**, 72; conditions of becoming a, 74.
- Masterpiece**, an isolated reference in the *Book of the Crafts*, 84.
- Masters**, definition of status in the *Book of the Crafts*, 84.
- Maudsley**, 328.
- Maximum tolls**; provided for in early railway charters, 462.
- Meadows**, development of communal use of, 118.
- Mercantile class**, the, source of the employing class, 2.
- Mercantilism**, fallacies associated with, 281.
- Mercers**, 61.
- Merchery**, 152.
- Merchandizing crafts**, 60.
- Merchant Adventurers**, 155; charters of 1462 and 1505, 156; origin of, 156; struggle with the Hansards, 157; trade of the company, 157.
- Merchants of the Staple**, 153; organiza-

- tion and government, 155; origin of the company, 154.
- Merino sheep, spread of the stock, 196.
- Mesopotamia, character of records, 34; early culture of, 24.
- Metal industries, abrupt changes in, 266; factors in their transformation, 253; position before and after the Industrial Revolution, 254.
- Metal trades, character of their transformation, 314.
- Methuen treaty, purpose of, 282.
- Matics, 58.
- Métier, juré, 167; libre, 166.
- Meyer, Edouard, 3; discussion of slavery in antiquity, 8.
- Midland Railway, agreement of 1908 with the London and North Western, 474; alliance with the London and North Western, 452; effect of the decision of 1853 upon, 454; extensions to London and Scotland, 454; final form of, 455; genesis of, 444-46; joint purse agreement with the London and North Western, 456; the London terminal opened, 456; policy towards third-class passengers, 457; Scotch connections developed, 456; traffic difficulties, 1857-68, 456.
- Midland system (of agriculture), description of, 226.
- Milk, poor unable to obtain, 239.
- Mill, Arkwright's cotton, 295.
- Mills, first cotton spinning in, 294.
- Mineral deposits, significance of concentration of, in Germany and the United States, 476; significance of dispersion of, in Great Britain, 476.
- Mineral resources, availability affected by technique, 266.
- Ministry of Health Act, 1919, 403.
- Money, Chiosza; 505, 507.
- Monopoly, alleged transition from, to socialization, 493; conservative attitude towards, 497; of London coal trade by the Newcastle area, 477; never absolute, 495; railways found to be "by nature a m.," 462; tendencies in legislative control of, 498.
- Monopoly, Welsh, of steam coal, 478.
- Moors, use of cotton, 276.
- Morning talks, 176.
- Morrison, J., proposed regulation of railways, 1836; 463.
- Mortmain, statute of, applied to the religious gilds, 187.
- Muirhead, *Watt's Mechanical Inventions*, 327.
- Mule, the, accomplishments of, 300; description of, 298-99; its importance, 300.
- Mun, T., *England's Treasure by her Foreign Trade*, 281.
- Municipal constitution, the, an obstacle to trade, 136.
- Muslin wheel, early name for the mule, 298.
- Muslims, beginnings of the manufacture, 297.
- Nasmyth, comment on the slide rest; 328.
- National Association of United Trades, formation and decline of, 522.
- National minimum, guaranteed by Elizabethan statutes, 415.
- Negligence, common-law doctrine of, 424.
- New drapery, as competitor of woollens, 215; meaning of the term, 199.
- New Lanark, policy at, 360.
- Newcastle coal trade, combinations in, 477.
- Nigeria, English land policy in, 111-12.
- Non-discriminatory practices among railways, definition of, 464.
- Normal density of population, 89; in the orient, 90; relative only, 90.
- Norman Conquest, its effect on the growth of the manor, 123.
- Norwich, craft organization at, 179; numbers of crafts at, 185.
- Obligations of craftsmen, 82.
- Occupations, at Paris, in 1300, 66; at Paris, classified according to size, 65; statistics of, in medieval England, 183.
- Occupational specialization, at Paris, 60.
- Occupational statistics, for British India, in 1901, 255-56; general features of industrial groupings, 1850-55, 259; Germany, in 1907, 259; not significant prior to the Industrial Revolution, 209; recent figures, 258; tables, England and Prussia, 1851 and 1855, British India, 1901, 257; tables showing the relations between industry and agriculture, 260-61; United Kingdom, 1907, 258; United States, 1909, 259.
- Octuple agreement, 451.
- Old age insurance, 428.
- Onions, P., puddling patent, 330.
- Open fields, grazing rights over, 233; relation to enclosure, 225.
- Osborne case, the, 528.
- Owen, R., 523; his ideals, 519; mills at New Lanark, 360.
- Ownership, not always preferable to tenures based on use, 111.
- Oxford, occupational groups in, 185.
- Oxfordshire, extent of seventeenth-century enclosure, 230.

- Pageantry, its influence on gild life, 183.
- Pains of transition, 363; not responsible for distress in the early nineteenth century, 418.
- Paper mills, early factories in the Rhone Valley, 224.
- Pareto, 509.
- Paris, industrial groups, in 1300, 64; occupations in 1300, 66; transition from the free to the sworn craft at, 76.
- Parliament, the People's, 517; acts for enclosure, 234.
- Parliamentary, expenses of railway companies, 559; procedure in grant of charters, 460-61; trains, 457.
- Parliamentary History of England, The*, 236.
- Passenger traffic, accommodations for third class, 457; policy of the Midland Railway, 457.
- Paul, L., 290; covenant with Wyatt, 292; defects of his spinning machine, 292; patents of 1748 and 1758, 292; relations with Wyatt, 291; his spinning machine compared with the water frame, 293.
- Pauperism, growth of, 416.
- Pearson, 510.
- Peasant holdings, average acreage, 91.
- Peasant proprietorship, advocated, 244; not always best, 228; Young's view, 244.
- Pen-y-darvan, Trevithick's locomotive trials at, 435.
- Phosphorus, elimination of, by the basic process, 344; importance of its presence in iron ore, 343.
- Pie-powder courts, 144; jurisdiction gradually merged with municipal courts, 145.
- Pig iron, conversion of, 329.
- Place, F., 514; 516; agitation against the Combination Laws, 381; early career, 380; expectation of the results of repeal of the Combination Laws, 383.
- Plague, the, limited the growth of London, 108.
- Podmore, F., *Life of Robert Owen*, 300.
- Police power, the basis of factory legislation, 408.
- Poll-tax returns, defects of, as enumerations of the population, 93.
- Pools, among railways, 481; purpose of, 481.
- Poor-Law, the Elisabethan, 415.
- Poor-Laws, allotment policy of, 241; a cause of much distress, 365; Chadwick's plan for the reform of, 420; defective administration of, 1750-1830, 417; inquiry of 1909, 421; Majority report, 1909, 422; out-relief, prior to 1834, 419; recent reforms, 421; re-
- forms of 1834, 420; systems of relief prior to 1834, 419; a parish abandoned to the poor, 418; protests against the law of 1834, 516.
- Population, in ancient cities, 27-28; of boroughs in 1086 and 1327, 104-05; changes in the mass of, during the Middle Ages, 88; concentration of, in towns, 160; deficiencies of French enumerations of, 91; deviations from the mean density of, 100; differences in growth of, in England and in France, 88; dispersion of, in the Middle Ages, 102; dispersion of, in 1086, 103-04; effect of an increase in, on the form of settlement, 117; of England about 1327, 93-95; in England and Wales, 1700-1911, 270; of France, in the fourteenth century, 59; King's estimates of, 269; increase of, subsequent to the Industrial Revolution, 269; an index of prosperity, 59; of London and of Paris, 108; medieval enumerations, 87; movement of, in England, 100; proportions of, living in various sizes of settlements, 104; Prussian towns in the eighteenth century compared with ancient Greek cities, 42; Rogers' estimates of, for England prior to the Black Death, 97; stationary in France, 270; of towns in 1377, 106.
- Poverty, likened to a preventable disease, 423; Mr. Money's use of the term, 507.
- Poverty line, the, artisans now above, 512; Rowntree's definition of, 501.
- Power loom, description of Cartwright's, 301; perfection of, 301-02; number in use at various dates, 302.
- Predatory civilisations, 27.
- Prefect, of Constantinople, regulates crafts, 50.
- Price associations, 480.
- Price-fixing, a remedy for excessive competition, 481.
- Prise, 151.
- Producer, not usually in direct contact with the consumer even during the craft stage, 12, 60, 68.
- Progress, the reality of, 499.
- Proletariat, formation of an agricultural, 239.
- Proportions of the population in various sizes of settlements, 104.
- Proprietary rights, in open field villages, 237.
- Protection, demand for, by the woolen interest, 279; the vested interest principle in England, 280.
- Protective policy, beginnings of, 279.
- Provost of Paris, supervisor of industry, 76.

- Prussia, cities of, in the eighteenth century compared with antiquity, 42; occupational groups in 1855, 257.
- Public Health, codification of laws, 1875, 402; inquiry of 1868, 400; statute of 1848, 398.
- Public Health Office, practically suppressed in 1871, 401.
- Puddling, contributions by Cort uncertain, 331; description of, 330; early history of, 330.
- Purnell, development of a rolling mill, 331-32.
- Putting-out system, the, beginnings of, in the woolen industry, 216; at Colchester, 217; economically superior to the factory system in the early period, 224; essential features of, 14-15; extent of capitalistic control in, 347; not represented by sweat-shops, 18; various forms in the woolen industries, 221; in the west of England clothing district, 213; in the woolen industry, 218.
- Race, alleged to be a factor in settlement, 120.
- Radcliffe, loom patents, 302.
- Rails, development of, 432.
- Railway, the, essential elements of, 431; the Great Western's broad gauge, 447; Stephenson's conception of, 439; the Stockton and Darlington project, 439.
- Railway Clearing House, the, 468.
- Railway Commissioners, first provision for, 1846, 465; functions of, 466; provision for, in 1873, 466.
- Railway legislation, beginnings of, 463.
- Railways, beginnings of the struggle between the Great Northern and the London and North Western, 450; their charter of liberties, 464; competitive traffic areas, 448; completion of the Scotch connections, 448-49; costs of construction in various countries, 459; early development dominated by local interests, 443; early development non-competitive, 448; early provision for through traffic, 444; first regulatory acts, 463; the first trunk line, 446; the Gladstone award, 451; high costs of construction in England, 459-60; hostility of traders to, 469; likelihood of Government control or supervision of, 474; London and York projects, 449; by nature a monopoly, 462; the Octuple agreement, 451; opposition to Parliamentary declaration of rates, 471; recent combinations among, 468, 473; recent financial pressure upon, 473; regulation proposed in 1836, 463; relations between, in early years, 443; significance of the Great Northern Railway, 450; source of capital for early railways, 443; traffic conferences among, 469.
- Rates, railway, adjusted by traffic conferences, 469; definition of unreasonable, 472; demands for Parliamentary regulation of, 470; power of railways to vary, 464; provision for maximum, 470; schedules of 1893, 472.
- Ratio charts, special uses of, 303.
- Redlich, J., *English Local Government*, 391.
- Reeve, the, functions of the village, 130.
- Reform, social, general causes of slow progress of, 387.
- Reform, two schools of, 390.
- Reform Bill, disappointment of artisans over, 514.
- Report from the Poor-Law Commissioners on an Inquiry into the Sanitary Condition of the Labouring Population of Great Britain*, 397.
- Reyce, *Breviary of Suffolk*, 221.
- Richardson, *The Health of Nations, a Review of the Works of Edwin Chadwick*, 392-93.
- Robertson, W. A., *Combination among Railway Companies*, 468.
- Rocket, the, success of, 442.
- Rodbertus, 1, 3; discussion of the household in antiquity, 8.
- Rogers, Thorold, 97.
- Rolling mills, Cort's development of, 331; Purnell's, 331-32.
- Roman influences, in Gaul, 52.
- Roman institutions, survival of, in France, 53.
- Roman land system, essentially aristocratic, 121.
- Rome, collegia, 48.
- Rowing (fulling), nature of the process, 205.
- Royal Household, influence on the craft guilds, 70.
- Ruhr Basin, importance of its coal to the German cartel, 478.
- Saint Riquier, Abbey of, as nucleus of a settlement, 56.
- Scab, the, attitude of the Amalgamated Society of Engineers towards, 525.
- Schmoller, G., 162-63; conception of town economy, 134.
- Schools, endowments of guilds not transferred to, 190.
- Scotland, rail connections with, 248-49.
- Scribe, of the XIIth Dynasty, description of craftsmen, 30-31.
- Seebohm, F., 92; 96.
- Self-sufficiency, incomplete on the fron-

- tier, 7; local, 21; municipal, 134; not unqualified in the primitive household, 4-6; qualified by inter-tribal trade, 6; qualified on the manor, 130.
- Serfs, not numerous on manors, 129.
- Settlement, Celtic forms of, 116; development of various forms in Siberia, 116-17; forms of, 112; forms of, in England, 116; racial theories of, 116; Roman forms, 116.
- Settlement and Removal, law of, 1662, 416.
- Settlements, characteristic sizes of, about 1086, 104; characteristic sizes, about 1327, 105; combination of racial and economic factors determining forms of, 120.
- Sewage removal, Chadwick's proposals for the improvement of, 397.
- Sewers, defective, in Liverpool in 1840, 396; defects of early, 395.
- Shaftesbury, the seventh Earl of, characterisation, 391.
- Sharp and Roberts, loom patents, 302.
- Sheep, important breeds of, 196.
- Sheet iron, introduction of, 332.
- Shop looms, 351; numbers of, 352.
- Siberia, development of land systems in, 118; forms of settlement, 116-17.
- Silks, East Indian, importation prohibited, 1697 and 1700, 284. *See also* East Indian textiles.
- Silk mills, early history of, 355.
- Simon, Sir John, abolished the private cesspool in the City of London, 395-96; characterisation of Chadwick, 393-94; criticism of Chadwick's attitude toward local authorities, 394.
- Size of farm, profitable a. relative to market conditions, 228.
- Slaves, attached to villas, 121; in Egypt, 33; in Greek factories, 44; number of, in antiquity, 8, 28; proportions of freemen and slaves, in Greece, 47.
- Small holdings, acts of 1892 and 1907, 245; advocated by Jesse Collings, 245; agitation for, 243; definition of, 240; extent of present need of, 246.
- Small holdings Commissioners, duties of, 245.
- Smeaton, J., comment on Watt's engine, 272, 326; blowing engine, 322.
- Smiles, S., *Industrial Biography*, 328.
- Soc-men, of an administrative manor, 126. *See also* Yeomen.
- Social insurance, 422; Health Insurance Act of 1911, 426; old age, 428; probable results of, 429; some contingencies not genuinely insurable, 423; unemployment, 427.
- Social ladder, the, break in, 227.
- Socialism, an influence in the recent labor movement, 528; relation to Chartism, 513.
- Socialists, current aspirations of, 529; interests of, in economic history, 1.
- Socialistic, interpretation of industrial history, 2, 3, 494; views on combinations, 493.
- Sociology, adopts a new point of view in agrarian history, 111.
- Southampton, 175.
- Specialisation, among leather workers at Paris, 70; degree of, at Paris, in the eleventh century, 63; of crafts, in early Greece, 43; in industry, conditioned by the market, 19; of industry, by regions, 61; of occupations, 57.
- Spice Islands, the, early importance of, 277; the struggle for, 277.
- Spinners, working on their own wool, 221.
- Spinning, continuous and intermittent processes, 288; deficiencies of, in cottages, 219; an occupation for the poor, 219; organisation of, uncertain in the early period, 203; process of, 288; by use of rollers, 290; use of rollers not really accomplished by Paul, 293.
- Spitalfields Act, 1773, its application, 373; a form of compulsory arbitration, 373; petition for its extension to Coventry, 376; provisions of, 372.
- Spitalfields riots, 371.
- Squatters. *See* Cottagers.
- Standing orders, committee on, 461.
- Staple, length of, of various wools, 195.
- Staple, the, at Calais, 154; location of, 154; meaning of the term, 153. *See also* Merchants of the staple.
- Status of craftsmen, defined, 82.
- Steam coaches, on the highways, 436.
- Steam engine, the, defects of, in the early days, 328; Newcomen's, 323; the non-condensing type, 434; principle of Newcomen's, 324; Watt's conception of, 325; Watt's difficulties in making, 326.
- Steel, costs about 1850, 340; early processes and their limitations, 340; produced by the direct process, 316.
- Steel trade, the, conditions tending to monopoly in, 478.
- Steelyard, the, establishment of the  $\odot$  Hanse at London, 150.
- Stephenson, George, conception of the nature of railway works, 439; early career, 438; experiments on grade resistance, 438; his principles of railway construction adopted in England, 460.
- Stephenson, Robert, joins with Booth in building the Rocket, 442.

- Steward, duties of a manorial, 129.
- Stockton and Darlington Railway, 439-40; provisions for passenger traffic, 462.
- Strangers, medieval laws for, 135.
- Struggles of inventors, in early stages of the Industrial Revolution, 272.
- Stump, his factory near Oxford, 223.
- Subsidy rolls, afford evidence of population, about 1327, 93.
- Suffolk, putting-out system in, 218.
- Surnames, derived from occupations, 183.
- Sweat-shops, classification of, 17.
- Tacitus, Germania of, 119.
- Taff Vale case, 527.
- Tailors of Salisbury, the, charter of, 188.
- Tapestry, manufacture at the Gobelins, 224.
- Tax rolls, as basis for occupational statistics, 183.
- Tea, becomes a staple for the poor, 239.
- Temples, work in, in Egypt, 33; work in, in Mesopotamia, 35-36.
- Ten Hours Act, 409.
- Tenants, obligations to cart produce, 130; obligations of, on a manor, 128.
- Tenant farmers, of the Roman Empire, 121; status changed by the commutation of labor dues, 131; status of the *villani* about 1086.
- Tenure of land, adapted to economic conditions, 111; sociological definition of the problem, 111.
- Teutonic customs, during the invasions, 119.
- Teutonic invasions, not incompatible with the survival of Roman institutions, 52.
- Textile crafts, at Paris, in the eleventh century, 64; subordinate importance of, in Rome, 49.
- Textile industries, dependence upon humidity, 263; dislocations occurring during the Industrial Revolution, 254; general changes in, 254; relative growth of, during the Industrial Revolution, 307-08.
- Textile trades, changes in, during the Industrial Revolution, 252; no recent tendency toward vertical integration, 439.
- Third Estate, the, 29; rise of, 2, 58.
- Thomas, development of the basic process, 344.
- Throstle, the, limitations of, 290; its principle, 288; sectional-view of, 289.
- Thurlow, Lord, criticism of procedure on enclosure bills, 236.
- Thurston, R. H., *The History and Growth of the Steam Engine*, 325, 436.
- Tool-making machinery, importance of, 328.
- Torrens Act, 1867-68, the, 404.
- Town, distinguished from city and borough, 158; distinguished from rural settlements, 158.
- Town and country, relations in different periods, 29.
- Town economy, the, described, 134; as embodied in the gild merchant, 173; superficiality of the conception, 135.
- Town Planning Act, 1909, 405.
- Towns, acquire corporate privileges, 162; growth of, 162; military theory of their origin, 159; rise of, 58; in the Saxon period, 159.
- Toynbee, A., *Lectures on the Industrial Revolution*, 250.
- Trade, associations for foreign, 147; characteristic of English fairs, 142; with continental India, 277; crafts engaged in, 60; development of, in finished and in unfinished cloth, 204; on the East Coast of India, 278; among Egyptian artisans, 32; enfranchisement of medieval, 136; foreign, 20; of Greeks and Phœnicians, 40; hindered by municipal law, 136; local, 21; with Low Countries, 156; in the Middle Ages, 28; in primitive society, 6; in woolen yarn, 204. *See also* Market.
- Trade agreements, 430.
- Trade unions, based on crafts, 523; Royal Commission of 1868 on, 526; status of, in 1871, 386; status presumed under the statute of 1871, 527.
- Trader, the, as capitalist, 2.
- Trades Councils, genesis of, 525; Parliamentary activities of, 526.
- Trades Union, a, notion of, 519.
- Tradesmen, 60.
- Traffic conferences, 469.
- Tram lines, as common carriers, 432; in the northern collieries, 431.
- Transformations, great social, 247.
- Transportation, not an obstacle to distant trade in early times, 20.
- Trevithick, R., experiments with the non-condensing engine, 434; his first locomotive, 434-35; his use of sheet iron, 334.
- Trojan War, the, Leaf's interpretation of, 40.
- Trust, rare in England, 483.
- Trust Movement, the, definition of, 475; beginnings of, in Great Britain, 475.
- Tucking mills, 206.
- Unemployment insurance, act of 1909, 427.
- Unfair competition, among craftsmen, 84.

- Unrest, the present social, basis of, 512.
- Unwin, G., *Industrial Organization in the Sixteenth and Seventeenth Centuries*, 222; *Guilds and Companies of London*, 170; in the *Victorian County History, Suffolk*, 218.
- Urban Concentration, in antiquity, 27; Prussia and Greece compared, 42.
- Urban development, beginnings of, in the eleventh century, 58.
- Urban life, rise of, among the Greeks, 26; at the dawn of history, 24.
- Urban settlements, beginnings of, in England, 158; forms of, 158.
- Use, land tenures based on, 111.
- Vase painters, in Greece, 45.
- Vertical integration, not present in the textile trades, 489.
- Veeted interests, protection of, in England, 280.
- Victorian County History, Suffolk*, 218.
- View of the craft, the, at Constantinople, 60; importance of, 177.
- Villa, the, probably did not survive the invasions, 121; its organisation, 121.
- Village, agriculture of the medieval, 115; enclosed, 112; officers elected by, 130; the open-field, 112.
- Villages, predominantly small, in 1327, 107; size about 1086, 104.
- Village blacksmith, the, 9; in Greece, 43; on the Kasai, 4-5.
- Village community, the, evolution of, 117; origin of allotments, 118.
- Villagers, allotments of, in the open fields, 115.
- Villein, the, obligations of, 128; acquisition of freedom by, 132.
- Vinogradoff, P., 103.
- Vintners, privileges acquired by, 146.
- Wage-earners, in the Middle Ages, 71.
- Wage-earning class, implied by the Statute of Apprentices, 192.
- Wage-fixing, provision for, in the Statute of Apprentices, 193.
- Wage work, among the early Egyptians, 32; in Mesopotamia, 36; notion of, 10.
- Wages, important differences in, 501; importance of discovering relative changes in, 500.
- Walker, J., *Report to the Directors of the Liverpool and Manchester Railway*, 441.
- Wardens, functions of, 76; modes of choice, at Paris, 77.
- Waste, enclosure of, 225, 232.
- Water frame, the, compared with Paul's machine, 293; patent declared void, 296; story of the invention, 295. *See also*, Throstle.
- Watson, J., 514.
- Watt, J., conception of the steam engine, 325; description of the first trials of the engine, 326; early career, 324; struggles of, 272; partnership with Boulton, 327.
- Wealth, distribution of, in England, 506.
- Weavers, position in the Suffolk woolen industry, 220; position of worsted, 222; probably emerge later than dyers, 12.
- Weaver's Act, the, exceptions, 212-13; provisions, 212.
- Weaver's clubs, Spitalfields, 371; in the west of England, 1727, 369.
- Weaving, as a cottage industry, 211; degrees of skill required, 351; diffusion of in the rural districts, 211; rates for, 370; in towns, 209-10.
- Weaving house, the, of early Mesopotamian temples, 36.
- Week works, 128.
- West of England Clothier System, 221.
- Wool, classification of, 195; exported by the Hanse, 150; exported through staple ports, 153; properties of, 196; purchased by poor people to spin, 221; put out by the Suffolk clothier, 219.
- Woolen industry, broad-cloth districts exempted from the Weaver's Act, 213; its concern with the Methuen treaty, 282; cottage weaving exempted from the Weaver's Act, 213; its decline in the East Counties, 215; essential processes of manufacture, 202-03; finishing not notably developed in England, 202; location of the broad-cloth manufacture, 211; market for Suffolk cloth, 220; position of spinners in Suffolk, 219; position of weavers in Suffolk, 220; proportions of workers, 202; protected against the competition of cottons, 253; scale of, 216; scale of, in Suffolk, 221; stabilized after 1555, 214; suffered from competition in the seventeenth century, 215; weaving in cottages, 211; weaving in towns, 211; numbers of persons occupied in, 1679 and 1741, 208.
- Woolen Report*, the, 1806, 221, 222.
- Woolens, characteristics of, 197; chronology of their history, 198; competition with worsteds, 198; types of, 1551-52, 197.
- Workhouse, the, original conception of, 416; the mixed, prior to 1834, 419.
- Workingmen's Friendly Societies, the,



- Roman collegia similar to, 48. *See also* Confrérie.
- Workshops, 17; regulated under the act of 1867, 414.
- World commerce, in the Middle Ages, 137.
- Worsteds, characteristics of, 198; rise of the industry, 199; types of, 1578 and 1739, 200-01.
- Worsted industry, its competitive strength, 206; master combers, 222; organization of, 222; proportions of workers, 207.
- Wrought iron, produced in the bloomery furnace, 318.
- Wyatt, J., his claims to the spinning invention, 290; covenant with Paul, 292; relations with Paul, 291.
- Xenophon, description of craft industry, 43.
- Yarn, export of worsted, 222; grades of cotton, 290; strength of cotton, under variant humidity conditions, 264; worsted, its manufacture specialized, 207-08; East Indians, imported, 285; labor costs of producing, in England and in India, 312-13; prices and costs of cotton, 312-13; production of, by cottagers in the west of England, 222.
- Yeoman, definition of, about 1086, 124; extended meaning of the term after 1400, 133.
- Yeoman farming, 227.
- Young, Professor A. A., 511; on the concentration of wealth, 508.

Recently Published

# THE REAL WEALTH OF NATIONS

OR

A NEW CIVILIZATION  
AND ITS ECONOMIC FOUNDATIONS

By JOHN S. HECHT

Fellow of the Royal Economic Society

358 pages. Size  $8\frac{3}{4} \times 5\frac{5}{8}$  inches. 15s. net

## Extracts from Press Notices

### *The Economic Review*

"This remarkable book deserves the attention of all students of social reform. Mr Hecht has brought a fresh and vigorous mind to his great subject, and if politics ever cease to be mainly an affair of vote-catching, his work will have its influence in shaping the future destinies of the country."

### *The Times*

"A slight inspection of Mr Hecht's argument shows that he is entitled to the claim of originality. . . . In Chapter X there are remarks well worth reading as to the remuneration of unskilled labour and the evils and perils incident to thinking in terms of money."

### *Review of Reviews*

"The author propounds a new theory of economics that, whatever else one may say of it, is at least clear and courageous."

### *Stock Exchange Gazette*

"Mr Hecht has written a very thoughtful book . . . not a haphazard collection of thoughts arising from contemplation of current industrial conditions. It is a well-planned treatise commencing at fundamentals and gradually developing its arguments, tracing them along various branches towards such conclusions as may be applied to present problems. The book is easily readable, at times fascinating."

### *The National Outlook*

"Mr Hecht's book is a distinct contribution to the great national problem of Reconstruction. . . . I doubt if any recent work on economics will eventually have the status which will be conceded to this one."

### *Journal of Education*

"This is an original book, remarkably free from convention, and obviously the product of much independent thought."

### *Liverpool Post*

"The author writes well and to the point and with evident knowledge of his subject. . . . Altogether we find it a provocative book."

## ECONOMICS, SOCIOLOGY, &c.

### COAL, IRON, AND WAR

[Just ready

By EDWIN C. ECKEL. Demy 8vo, 390 pages, 12s. 6d. net.

A study in Industrialism past and future. Among the subjects discussed are: The Material Bases of Civilization—The Growth of Germany—The Development of America—The Struggle of the Nations—The Factors of Industrial Evolution—The Rise and Fall of Prices—The Share of the Worker—The Forms and Future of Progress.

### WHY MEN STRIKE

[Just ready

By SAMUEL CROWTHER. Crown 8vo, 256 pages, 7s. 6d. net.

A comprehensive analysis of the present situation, this book makes some startling suggestions. Apart from its other aspects, it is a study of thrift and how it may be used.

### A HISTORY OF LABOUR

[In preparation

By GILBERT STONE, B.A., LL.B. Demy 8vo, about 550 pages, 21s. net.

A history of British Labour from earliest times to the present day. Chapters are devoted to the Labour movements on the Continent and in America.

### POLITICAL ECONOMY

By CHARLES GIDE, Professor of Political Economy in the University of Paris. Authorized Translation, by C. H. M. ARCHIBALD, M.A. Fourth Impression. Demy 8vo, 720 pages, 15s. net.

From the third French edition. The book is independent of the same author's *Principles*, and is designed for more advanced students.

### A HISTORY OF ECONOMIC DOCTRINES

From the Time of the Physiocrats to the Present Day. By CHARLES GIDE, University of Paris, and CHARLES RIST, University of Montpellier. Translated from the Second Edition by R. RICHARDS, B.A., University College, Bangor. Third Impression. Demy 8vo, 700 pages, 15s. net.

### PRINCIPLES OF POLITICAL ECONOMY

By C. GIDE, Professor of Political Economy in the University of Paris. Translated from the Eighth Edition by C. W. A. VEDITZ. Demy 8vo, 700 pages, 15s. net.

### A DIGEST OF GIDE'S "PRINCIPLES OF POLITICAL ECONOMY"

From the Translation of Prof. VEDITZ. By H. M. DESAI, B.A. Cr. 8vo, 224 pages, 6s. net.

### THE STATE

[New Edition

Historical and Political Politics. By WOODROW WILSON, LL.D. Revised Edition, by Prof. ED. ELLIOT. Cr. 8vo, 560 pages, 15s. net. The original edition still in print, 15s. net.

### INTERNATIONAL LAW

By GEORGE GRAFTON WILSON, Ph.D., and GEORGE FOX TUCKER, Ph.D. Fifth Edition, enlarged. Demy 8vo, 525 pages, 12s. 6d. net.

### THE BEGINNERS' HISTORY OF PHILOSOPHY

By Prof. HERBERT E. CUSHMAN, M.A., Ph.D., Tuft's College. Vol. I. Classical and Medieval, 428 pages. Vol. II. Modern, 400 pages. Crown 8vo, Illustrated, 10s. 6d. net each.

CL 500  
2003-04