

Government of India

INDIAN WATERWAYS EXPERIMENT STATION, POONA

Director:

Rao Bahadur D. V. JOGLEKAR, B.E.

RESEARCH PUBLICATION No. 10
**ANNUAL REPORT (TECHNICAL) OF
WORK DONE**

DURING THE YEAR 1945

AND

INDEX FOR 1937 TO 1945

BY

Rao Bahadur D. V. JOGLEKAR, B.E.,

Director,

AND

STAFF AT KHADAKWASLA.



POONA

PRINTED AT THE ISRAELI PRESS, POONA

1948

**List of Research Publications of the Central Waterways, Irrigation
and Navigation Research Station, Poona, available for Sale
with the Manager of Publications, Delhi, and Agents.**

Symbol No.	Research Publica- tion No.	Subject.	Price.			Year of Publica- tion.
			Rs.	A.	P.	
IHR. 1.38	1	Annual Report of work done during 1937-38 by C. C. Inglis, A. R. Thomas, Rao Sahib D. V. Joglekar and staff at Khadakvasla.	7	8	0	1939
IHR. 1.39	2	Annual Report of work done during 1938-39 by same authors as in 1.	7	8	0	1940
IHR. 2 ...	3	Note on the theory, design and construction of Gibb Modules which, without moving parts, give a constant discharge within working limits irrespective of variations in upstream and downstream water levels by C. C. Inglis, and Rao Sahib D. V. Joglekar.	3	0	0	1941
IHR. 1.40	4	Annual Report of work done during 1939-40 by C. C. Inglis, A. R. Thomas, Rao Sahib D. V. Joglekar and staff at Khadakvasla.	7	8	0	1941
IHR. 1.41	5	Annual Report (Technical) of work done during the year 1940-41 and Index for 1937-41 by C. C. Inglis, A. R. Thomas, Rao Sahib D. V. Joglekar and staff at Khadakvasla.	7	8	0	1942
IHR. 1.42	6	Annual Report (Technical) of work done during the year 1941-42 by C. C. Inglis, J. S. Reid, Rao Bahadur D. V. Joglekar and staff at Khadakvasla.	7	8	0	1944
IHR. 1.43	7	Annual Report (Technical) of work done during the year 1942-43 by C. C. Inglis, J. S. Reid, Rao Bahadur D. V. Joglekar and staff at Khadakvasla.	7	8	0	1945
IWE. 1.43	8	Annual Report (Technical) of work done during the year 1943 by C. C. Inglis, Rao Bahadur D. V. Joglekar and staff at Khadakvasla.	7	8	0	1945
IWE. 1.44	9	Annual Report (Technical) of work done during the year 1944 and Index for 1940-44 by Sir Claude Inglis, Rao Bahadur D. V. Joglekar and staff at Khadakvasla.	7	8	0	1945
IWE. 1.45	10	Annual Report (Technical) of work done during the year 1945 and Index for 1937 to 1945 by Rao Bahadur D. V. Joglekar and staff at Khadakvasla.	25	0	0	1948
IWE. 1.46	11	Annual Report (Technical) of work done during the year 1946 by K. K. Framji, Rao Bahadur D. V. Joglekar and staff at Khadakvasla.	7	8	0	1947

TABLE OF CONTENTS

SUBJECT OF INVESTIGATION	Paragraph	Page
PART I—INTRODUCTION		
1. Staff and their activities	... 1	1
2. Model Experiments	... 2	4
3. Publications during the year	... 3	4
PART—II		
III FIELD RESULTS OF MEASURES ADOPTED AFTER MODEL EXPERIMENTS"		
1. Measures taken to control erosion of the left bank of the Rupnarain upstream of the Bengal Nagpur Railway Bridge at Kolaghat by means of a deflecting groyne.	... 4	5
2. Training of the Malaprabha River to protect the left bank and abutment of the M. & S. Railway Bridge No. 8 at Hole-Alur on the Hotgi-Gadag line.	... 5	7
3. Protection of retaining walls from scour by means of repelling spurs—(Baluchistan) (advice without model experiments)	... 6	8
4. Methods followed in fixing model scale ratios and overcoming model limitations, based on experience gained at the Indian Waterways Experiment Station, Poona.	... 21	88
PART III—SPECIFIC EXPERIMENTS		
"IV RIVER BEHAVIOUR AND CONTROL."		
<i>"(ii) Scour".</i>		
1. Experiments in connection with dissipation of energy downstream of Lower Sind Barrage (2400 ft. upstream of site B near Hajipur).	... 7	10
2. Causes of accretion of the river bed at Sukkur Barrage and how to reduce rate of rise—Part II.	... 15	59
<i>"(iv) Tidal action".</i>		
Training the Hooghly River at Dunbar Cotton Mill with a by-pass channel.	... 8	11
<i>"(v) Flood control".</i>		
1. Experiments with a vertically-exaggerated model (1/400, 1/66) of the Mahanadi and its branches at Cuttack (Orissa).	... 9	19
<i>(vi) Local Training.</i>		
1. Training of Luni River to prevent it damaging the Jodhpur Railway line	... 12	36
2. Training of the Jumna River at Delhi Gate Pumping Station with pitched embankment on the right bank.	... 13	43

SUBJECT OF INVESTIGATION	Paragraph	Page
"XV—DAMS"		
"(i) Design".		
1. Experiments to determine a suitable profile of the Lower Sind Barrage to cause minimum afflux with gates fully open. ...	10	22
2. Determination of the coefficient of discharge of the automatic gates spillway for the Tansa Dam. ...	11	29
"XIX EXCLUDERS AND EJECTORS".		
1. Design of the Lower Sind Barrage Experiments to test the design for scour and sand-exclusion from canals—Sind. ...	14	48
PART IV—BASIC EXPERIMENTS.		
"IV RIVER BEHAVIOUR AND CONTROL".		
"(ii) Scour".		
Scour downstream of rigid structures in wide channels. ...	16	67
"XV—DAMS"		
"(i) Design".		
Siphon spillways :		
Ganesh Iyer's volute siphon—Factors affecting the coefficient of discharge of ...	17	72
"XVIII THE DESIGN OF CANAL FALLS"		
Curvature of flow in the throat of a Standing Wave Flume ...	19	80
"XII RAINFALL AND RUNOFF"		
"(ii) Maximum run-off discharge.		
On sunspot intensity cycles as medium of predicting the probable dates of occurrence of river floods. ...	20	86
"XXII MISCELLANEOUS".		
Nomograms for determining commonly required hydraulic elements and constants. ...	18	78

ANNUAL REPORT (TECHNICAL) OF THE WORK DONE DURING THE YEAR 1945

PART I—INTRODUCTION

1. STAFF AND THEIR ACTIVITIES

Director : Sir Claude Inglis, C.I.E., B.A., B.A.I., MInst. C.E., M.Am.Soc.C.E., M.I.E.(I) (till 21-3-1945 when he proceeded on leave to England preparatory to retirement).

Rao Bahadur D. V. Joglekar, B.E. (from 22-3-1945).

K. K. Framji, Esq. B.A. (Bom.), B.Sc.(Lond.), A.K.C. (Lond.), M.B.E., I.S.E., (from 6-12-1945).

Deputy Director : Rao Bahadur D. V. Joglekar, B.E. (till 21-3-1945) and from 6-12-1945. The post was vacant from 22-3-1945 to 5-12-1945.

Assistant Research Officers

1. Mr. G. M. Panchang, B.A. (Hons), M.Sc. (Lond.) (for Statistics).
2. Mr. S. T. Ghotankar, M.Sc.
3. Mr. S. C. Desai, B.E.
4. Mr. J. M. Parikh, B.E. (till 28-2-1945).
5. Mr. C. V. Gole, B.E. (from 1-3-1945).

Research Assistants

1. Mr. C. V. Gole, B.E. (till 28-2-1945).
2. Mr. S. N. Mulekar, B.Sc. (Elect. and Mech.).
3. Mr. S. V. Chitale, B.E.
4. Mr. D. P. Kulkarni, B.E.
5. Mr. P. K. Kulkarni, B.Sc. (Elect. and Mech.).
6. Mr. P. M. Damle, B.Sc.
7. Mr. P. H. Wagh, B.Sc. (till 31-5-1945).

Works Assistant

Mr. N. K. R. Iyengar

Computors

Mr. S. B. Barve

Mr. S. R. Chandorkar, B.Sc.

The Khadakwasla Welfare Centre which receives some contribution from the staff and labour of this Station continued good work during the year.

At the instance of the Government of Bombay, the Director (Sir Claude Inglis) and Rao Bahadur Joglekar, Deputy Director, visited between 19th and 22nd January 1945, the areas near Surat and Broach in Gujarat, damaged by the 1944 monsoon floods in the Tapi and Nerbada rivers, for suggesting remedies to prevent similar damage in future. The Government of Bombay accepted the recommendations of the Director regarding prevention of damage to the Surat-Rander Road and the City Wall of Surat, and sanctioned an estimate amounting to Rs. 7000 for model experiments at the Indian Waterways Experiment Station for investigating measures to prevent damage to Surat City Wall by floods in the Tapi River, vide their Press Note No. 267 of 10-4-1945. Data are being collected for these model experiments.

As desired by the Government of India in the Labour Department, the Director (Sir Claude Inglis) presided over a meeting of the Chief Engineers of the Punjab and U.P. held at Delhi in the 2nd week of February 1945 for determining the

shares of each of these two Provinces in the waters of the Jumna River vis-a-vis that of the Delhi Province in connection with the Delhi Water Supply Scheme.

On 20-4-1945 Rai Bahadur A. N. Khosla, Consulting Engineer to the Government of India for Waterways, Irrigation and Navigation visited the Indian Waterways Experiment Station.

On the 13th and 14th May 1945 the Director (Rao Bahadur D. V. Joglekar) inspected the Hooghly River from Calcutta upstream up to Triveni, including the foreshores of the Anglo-India Jute Mill, Dunbar Cotton Mill and the Titaghar Jute Mill, covering a distance of 35 miles; and, on the 15th May, he inspected in company with the Consulting Engineer to the Govt. of India for Waterways, Irrigation and Navigation, the River from Calcutta to Hooghly Point, a distance of 37 miles. On the 16th May, the Director inspected the Rupnarain River at Kolaghat Bridge on the B. N. Railway in order to have an idea of the condition of the river after the 1945 freshet season. He also wanted to ascertain the effect on scour at the Bridge of the measures carried out by the Railway, based on Model Experiments done at the Indian Waterways Experiment Station.

Between 17th and 20th May 1945, the Director was at Cuttack in the Province of Orissa, from where he and the Consulting Engineer visited the following rivers and canals in that Province:

Mahanadi Central Sluices,
Birupa river,
Kendrapara Canal,
Naraj Weir,
Birnasi Gap.

On the 22nd of May 1945 the Director visited the Bengal River Research Institute at Galsi, 15 miles from Burdwan and also the Punjab Irrigation Research Institute and the Hydraulic Station at Malikpur in August.

On 11-8-1945 he visited the Pumping Station at Delhi Gate, by prior engagement with Messrs. Merz, MacLellan & Co., Consulting Engineers to the Delhi Elec. Power Authority, in connection with their proposal to construct cooling towers on the island in front of the Delhi Gate Power House. The representative of Messrs. Merz & McLellan was also present. The Director gave his opinion that it was unsafe to construct the cooling towers on the island.

From 5th to 14th October 1945 the Director was in Mysore State where he saw the following works in company with the Consulting Engineer, Waterways Irrigation & Navigation:

Ganesh Iyer's Volute Siphon Spillways at Markonahalli

Krishnarajasagar Dam and the Krishnarajasagar Hydraulic Institute,

Jog Falls and the Hirebhasgar Dam and the volute siphons under construction.

Between 9th and 15th November 1945, he was in Jodhpur State where he inspected the Railway Bridge over the Luni River on the Samdari-Raniwara Branch of the Jodhpur Railway. The left flank of this bridge was eroded during the 1944 floods and model experiments are in progress at this Station to investigate the best position of an island or islands, and other remedial measures, to centralise the flow and hold it axially, permanently.

The following are some of the prominent visitors to the Station during the year:

1. Rai Bahadur A. N. Khosla, I.S.E., Consulting Engineer to the Government of India for Waterways, Irrigation & Navigation, New Delhi.
2. Mr. Wang Shu-Fang, Public Health Engineer from China.
3. Mr. J. Shaw, Superintending Engineer, Eastern Circle, Orissa.
4. Mr. M. J. Haquami, Deputy General Manager, Nizamsagar Factory, Hyderabad, (Deccan).

5. Mr. W. X. Mascarenhas, Principal, College of Engineering, Poona.
6. Mr. W. Lawley, Superintending Engineer, North-W.F. Province.
7. Mr. M. L. Champbekar, Superintending Engineer, Project Circle, Sind.
8. Mr. C. G. Kale, Superintending Engineer, Project Circle, Bombay, Poona.
9. Mr. Dildar Husain, Superintending Engineer, Nizam P.W.D., Hyderabad (Deccan).
10. Mr. K. C. Mazumdar, Assistant Irrigation Adviser to the Government of India.
11. Mr. Andrew H. Southorn, Deputy Secretary to the Government of Madras.
12. Mr. K. N. Mathur, Asstt. Director, Scientific and Industrial Research, Delhi.
13. Mr. Kahawita, Engineer, Designs, Ceylon.
14. Mr. K. R. Gunjekar, M. A., (Cantab.), B.Sc., (Bom.), Dy. Director of Public Instruction, Bombay Province.
15. Mr. D. C. Pavate, M.A., (Cantab.), Assistant Director of Public Instruction, Bombay.

Students and Professors from the following Colleges also visited the Station during the year :—

- (1) College of Engineering, Poona.
- (2) College of Agriculture, Poona.
- (3) Engineering College, Osmania University, Hyderabad (Dn.)
- (4) College of Engineering, Bangalore.

Advice was given *without model experiments* in the following cases :

1. Scour below the bridges on the lower Jhelum Canals—main line.
2. Damage to railway embankment at mile No. 416/7 between Narasaraopet and Santamagalur (M. & S. M. Railway). Enquiries regarding the length of guide banks.
3. Protection of the Pump House of Jodhpur Railway at Balotra on the bank of the Luni River by a repelling spur.
4. Protecting the Ogilvie Bridge over the Banas river from out-flanking (Ajmer).
5. Sakri River Irrigation Scheme :
Training the river Sakri to divert Portion of the floods to the old Sakri Branch (Bihar).
6. Design of guide banks and depth of piers embedded in sand below maximum scour level (Enquiry from Bengal and Assam Railway).
7. Sindri Water Supply Scheme on the Damodar River.
8. Mr. Ganesh Iyer's Volute Siphon Spillway for the Hirebhasgar Dam—Jog Power Scheme (Mysore State).
9. Siphon Spillway design for the Neersagar Water Supply Scheme for Hubli and Dharwar (Bombay).
10. Protection of piers of the Kathore Road Bridge on the Tapti with concrete blocks (Bombay).
11. Training the Gogra river at the Inchape Railway Bridge (Bengal and Assam Railway).

Fig. 1

Fig. 1 is the map of India showing the places (a) visited by the Director (b) where advice was given without model experiments and (c) advice given with model experiments (either complete or in progress).

2. During the year 13 investigations were in progress, of which 9 were specific in character and 4 basic. 11 notes on 'Basic Problems' and 13 notes on 'Specific Problems' were written during the year.

3. The following publications were issued during the year:

(1) Research Publication No. 7—Annual Report (Tech.) of work done at the Central Irrigation and Hydrodynamic Research Station, Poona during the year 1942-43, Price Rs. 7-8-0.

(2) Research Publication No. 8—Annual Report (Tech.) of work done at the Indian Waterways Experiment Station, Poona during the year 1943, Price Rs. 7-8-0.

(3) Research Publication No. 9—Annual Report (Tech.) of work done at the Indian Waterways Experiment Station, Poona during the year 1944.

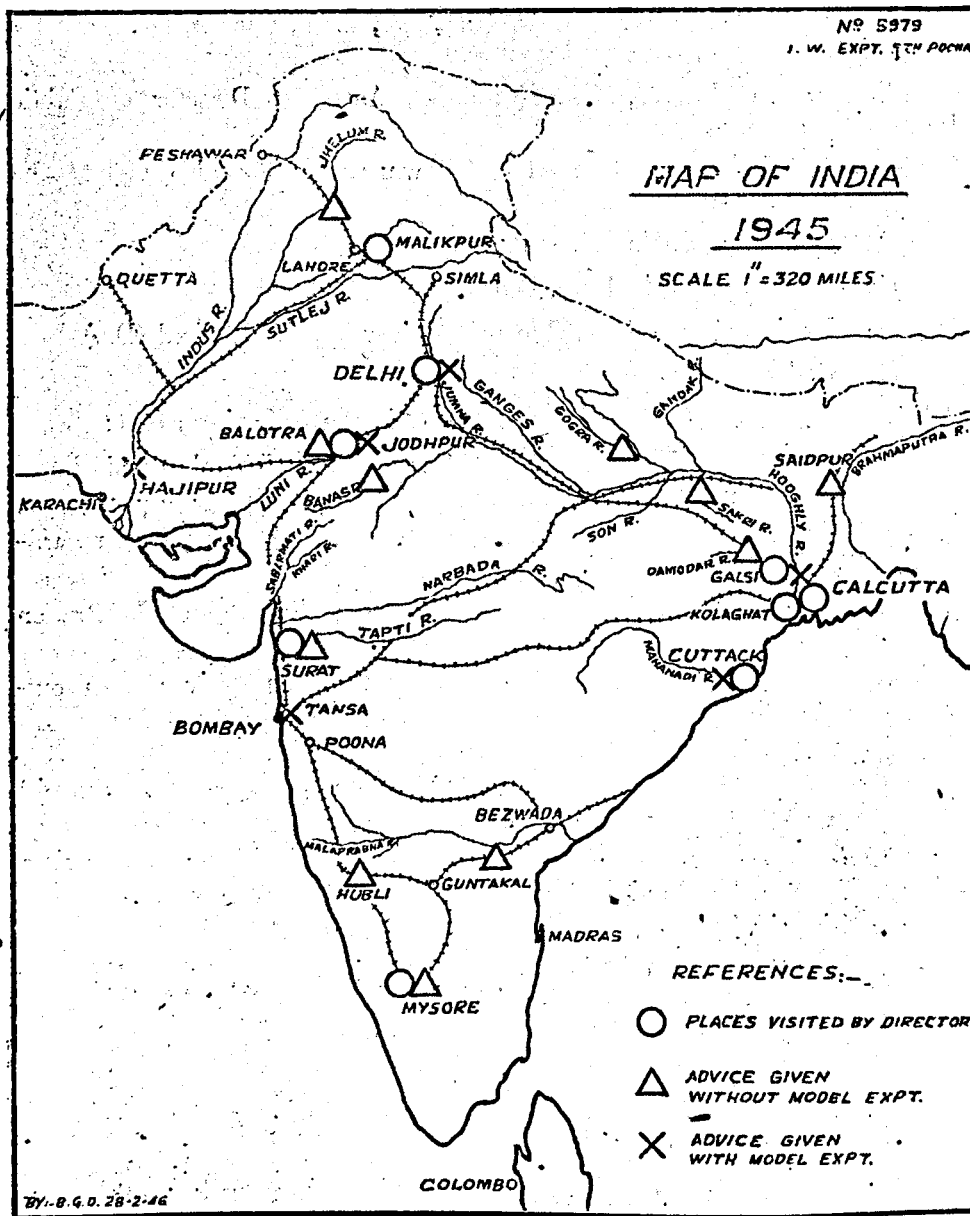

Fig. 1

PART II—1. FIELD RESULTS OF MEASURES ADOPTED
AFTER MODEL EXPERIMENTS

**4. Measures taken to control erosion of the left bank of the Rupnarain
upstream of the Bengal Nagpur Railway Bridge at Kolaghat by
means of a deflecting groyne.**

1. The model experiments carried out in 1944 and the subsequent changes in the River up to the end of 1944 caused by constructing a repelling groyne on the left bank 4,200 ft. upstream of the Bridge, have already been described.⁽¹⁾

2. The further changes which have taken place during 1945 are dealt with below. Fig. 2 is reproduced to show the changes between 1938 and 1944 prior to constructing the groyne; while Fig. 3 shows river conditions in December 1945. The magnitude of the change is brought out even more clearly on Fig. 4 which shows river cross-sections at A on Fig. 3 observed in

Fig. 2

Fig. 3

Fig. 4

April 1938
April 1943
January 1944
October 1944
and June 1945

Still later information received is that

“The western edge of the shoal on 3-2-46 appears to be still nearer to the right bank.”

3. The model did not indicate such a rapid change nor that the change would be nearly so great as has occurred, but the Director⁽²⁾ predicted:—

“From experience, combined with close observation of flow conditions in the model, that accretion would occur in the river for some distance upstream and downstream of the groyne leaving the groyne earthbound; so that in years to come people might wonder why it had been constructed.”

4. The effect of the groyne was to slow down the velocity along the left bank, so that the channel along that bank, clearly shown in Fig. 4 gradually deteriorated. As this occurred, the right bank channel gradually carried more and more water. This was greatly facilitated by there being no large freshets in the Damodar or Rupnarain during 1945, so that the river tended to shorten, and hence straighten, its course. It is probable that the shoal along the left bank will now rise higher and higher until much of it is above normal high tide level. The changes which took place between 1938 and 1942 may then be repeated; but in that case the groyne would again come into action to repel the river away towards mid-stream or the right bank. Erosion in depth is not, however, likely to occur hereafter along the left bank, because the Damodar Flood Enquiry Committee have recommended that dams should be constructed on the Damodar and Barakar Rivers to reduce the peak flood discharge from 6½ lakhs cusecs to 1 lakh cusecs. There is, of course, the possibility that the Damodar may change its course before the dams are constructed, an avulsion occurring into the Rupnarain, but this would probably take some years to develop to a dangerous extent. If, however, dams were not constructed, an avulsion would occur in time; but conditions would then be so different from those in existence to-day that the best action to take under those conditions cannot be foreseen.

5.1 Rai Bahadur Guba, Chief Engineer Bengal, questioned the statement made in the 1944 Annual Report (Tech.)—that the likely cause of the heavy erosion, since 1938, was the increase in the meander length following the increase in the discharge of the Rupnarain river—remarking:

(1) Indian Waterways Experiment Station Annual Report (Tech.) 1944, pages 18-20.

(2) Proceedings, Institution of Civil Engineers, Maritime Paper No. 3 “Training Works constructed in the Rupnarain in Bengal” February 1946, by Sir Claude Inglis, C. I. E.

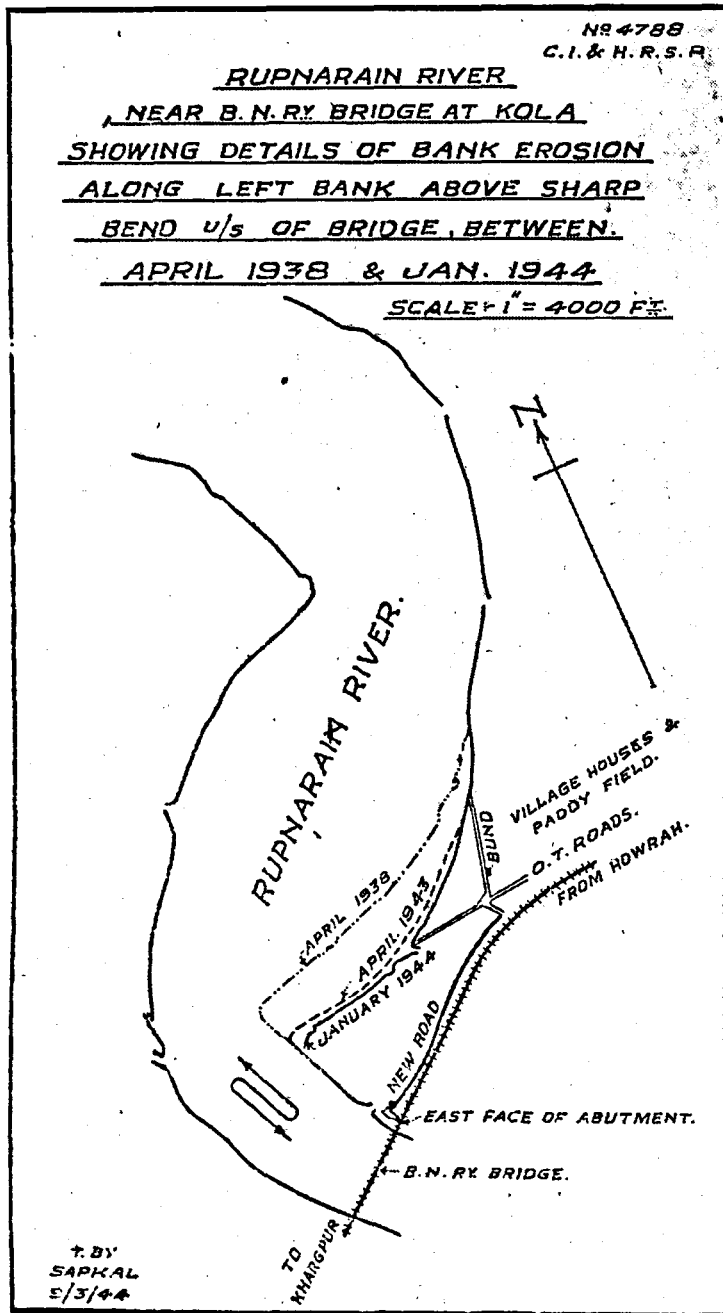

Fig. 2

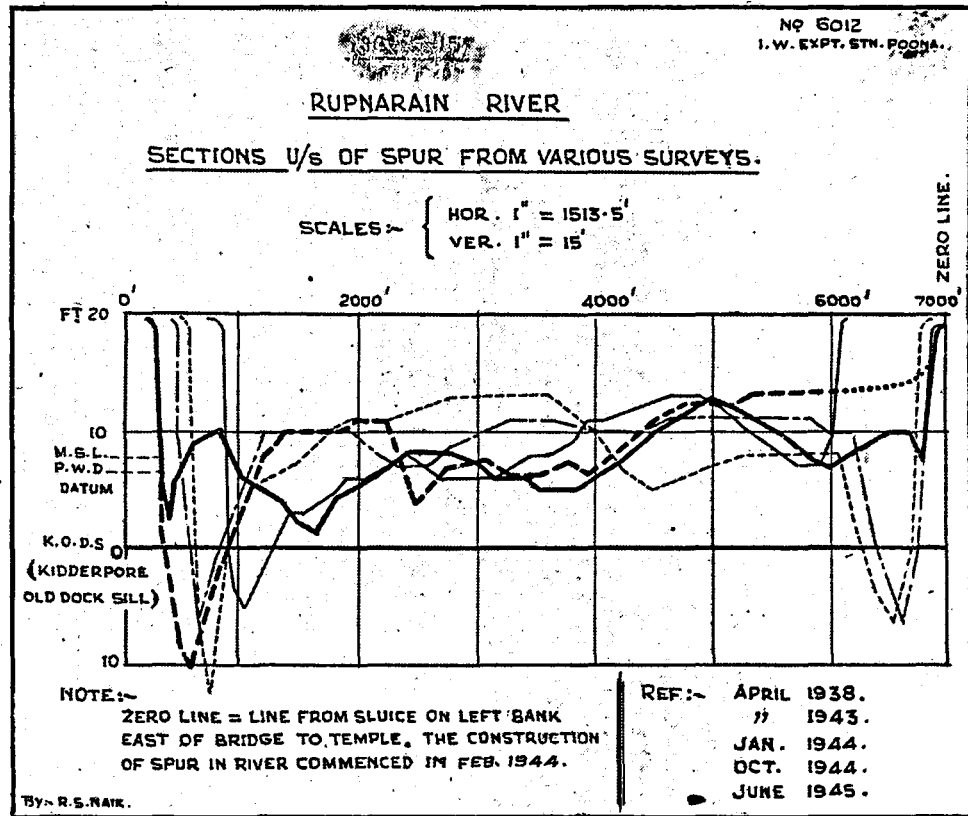
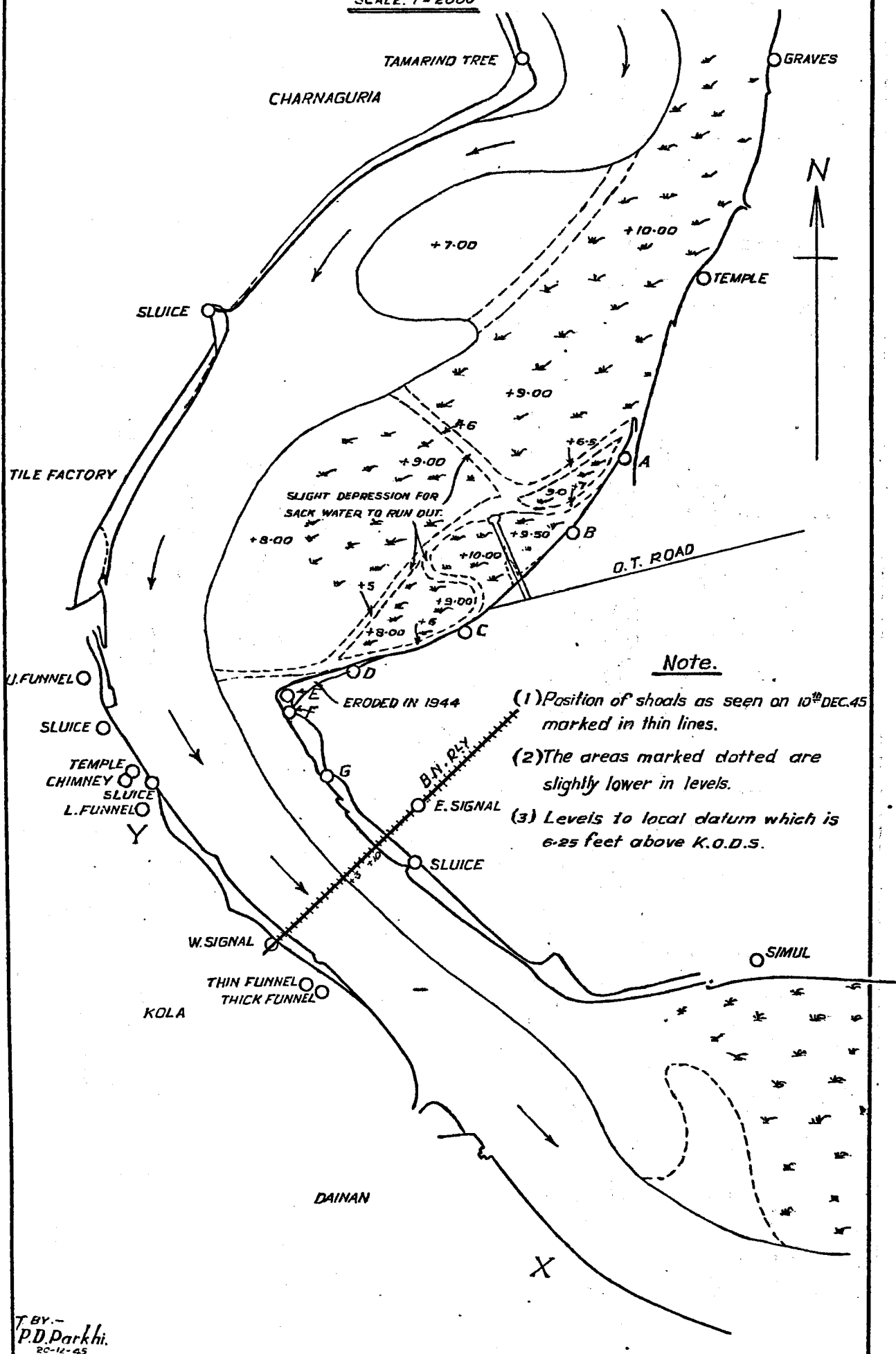

Fig. 4

FIG. 3.
RUPNARAIN RIVER
CONSTRUCTION OF SPUR.

SCALE. 1" = 2000'



Note.

- (1) Position of shoals as seen on 10th DEC. 45 marked in thin lines.
- (2) The areas marked dotted are slightly lower in levels.
- (3) Levels to local datum which is 6.25 feet above K.O.D.S.

FIG. 5 RUPNARAIN RIVER

NR 5933
I. (A) EXPT. STD.
POONA.

SCALE: 1" = 8 MILES

(a)
SURVEYED IN JANUARY TO APRIL 1938

(b)
SURVEYED IN JANUARY TO MARCH 1944

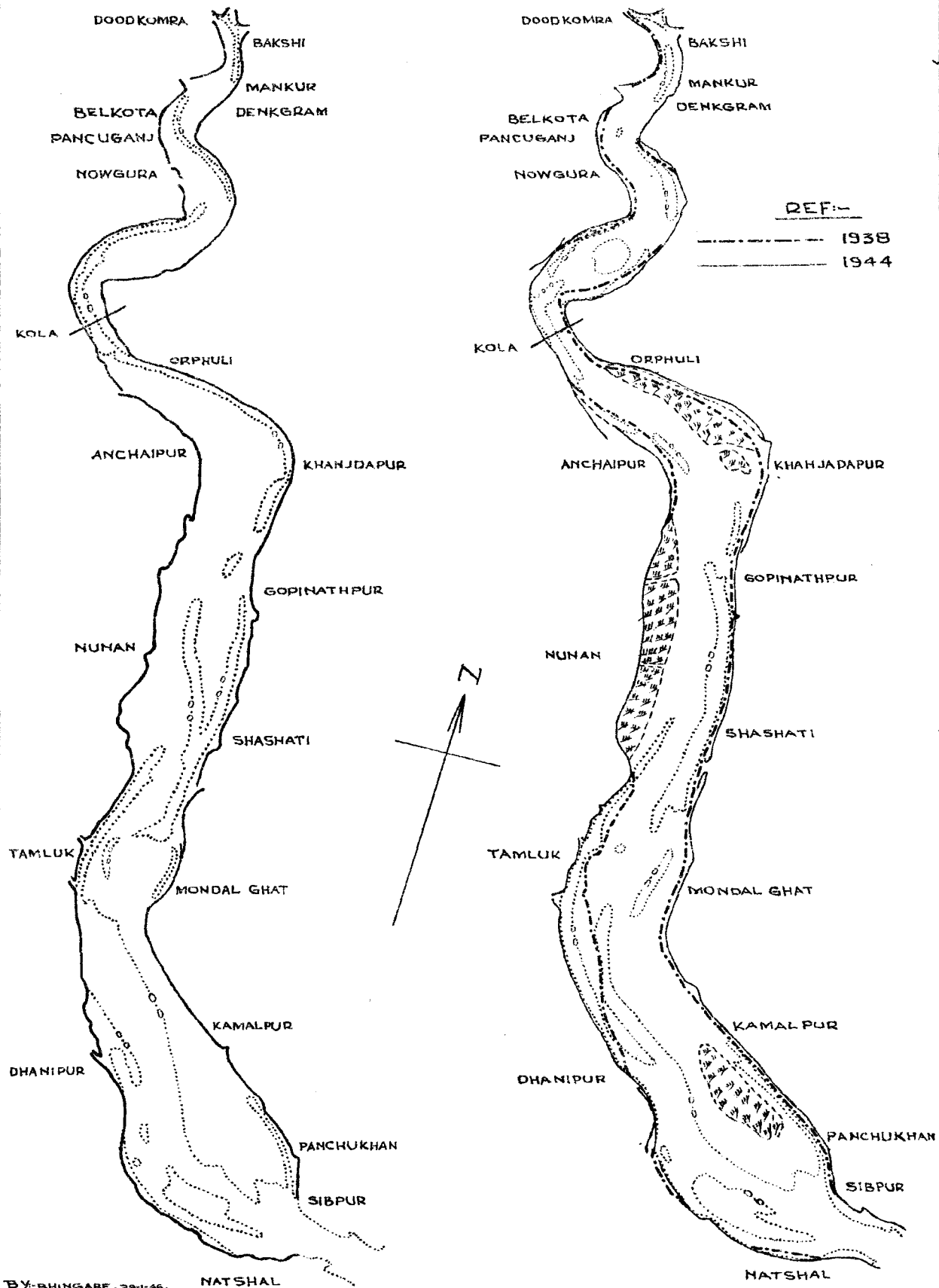

"If meander length increased in one portion of the river it should also increase in other portions".

In fact, since 1938, changes have taken place not only upstream but also downstream of the Railway Bridge as is evident by comparing fig. 5 (a) (showing the 1938 survey) with fig. 5 (b) (showing the 1944 survey with the 1938 bank line). It will be seen that the main channel which was along the left bank downstream of the Railway Bridge between Orphuli and Khanjadapur shifted towards the right bank in 1944. Similarly, there has been erosion of the right bank above and below Tamluk; and as the river is very wide downstream of Khanjadapur, large changes are not to be expected.

When this evidence is taken together with the fact that the conditions below the bridge are controlled more by tidal than by river discharges—or, at any rate, the river effect must be relatively small and must lag behind changes upstream—there is sufficient substantiation of the Station theory that the cause of the trouble was due to the meander length increasing as a consequence of the increase in the discharge of the river.

5.2 Rai Bahadur Guha has also criticised the recommendation, as a result of model experiments, to construct a retired embankment (estimated to cost Rs. 65,000), even if the spur was constructed to avoid danger of scour of the P. W. D. bund there. He has remarked :—

"But no such scour developed as anticipated, after the construction of the stone spur; on the contrary a fairly wide and high chur was formed just in front of the retired embankment recently constructed and scour was developing on the right bank about a mile or so below the stone spur. The formation of the chur above the spur and scour on the right bank were perhaps not shown in (by ?) the model".

The model showed that the P. W. D. Bund would be attacked in the initial stages of the shoal formation. So, although the Station has frequently observed that silting occurs very much more slowly than scour in models and is thus not correctly reproduced, because the relative rates of silting in model and prototype are still unknown, it was considered desirable—and very rightly too—to take no risks. Actually, it appears that shoaling took place much more quickly in the river which shifted the main flow away from the left bank and the P. W. D. bund was not attacked.

6. Conclusion.

The groyne fulfilled its immediate object with signal success, so that the main flow of the river is now nearly one mile away from the point where dangerous erosion was taking place in 1943. Nothing further will be required provided the recommendations of the Damodar Flood Enquiry Committee are acted on. These we hold to be essential, not merely to prevent an avulsion into the Rupnarain; but still more to preclude the possibility of an avulsion into the Hooghly above Calcutta.

5. Training of the Malaprabha River to protect the left Bank and Abutment of the M. & S. M. Railway Bridge No. 8 at Hole Alur on the Hotgi Gadag Line.

Having developed a cut-off a mile below the M. & S. M. Railway bridge, the Malaprabha river was trying to increase its length by eroding the banks. This bank erosion near the Railway bridge was very severe and experiments were carried out at this station to devise means to protect the left abutment and relieve it from attack.⁽¹⁾

The recommendation of cutting the right bank above the bridge was adopted in the river and the spoils were dumped in front of the left abutment. The

Fig. 6

(1) Annual Report (Tech.) for 1942-43, pages 10 to 18.

conditions obtained after one flood season showed that in the portion where the right bank was cut, the deep channel has definitely shifted to the right; and at the bridge itself, though the deep channel is along the toe of dumped material, the conditions have apparently improved; and, in course of time, it is expected that the main channel at the bridge will be safely away from the bank.

6. Protection of retaining walls from scour by means of repelling spurs (Baluchistan) (without model experiments).

In 1944, the C.R.E., South Quetta, referred a case to the Director in which retaining walls constructed to protect roads running along concave banks of nullahs were undermined and in extreme cases they collapsed.

Fig. 7

A series of submerged repelling spurs pointing 60° upstream were recommended for local protection of the retaining walls.

In 1945, the C.R.E. wrote stating that they had built several, upstream facing, spurs—which they call “shingle catchers”—and they proved most effective. In most cases the shingle bed of the nullah has already been built up level with the top of the submersible spurs.

This clearly brings out the action of repelling spurs in repelling the high velocity flow away from the bank and, thus, causing accretion of the bed.

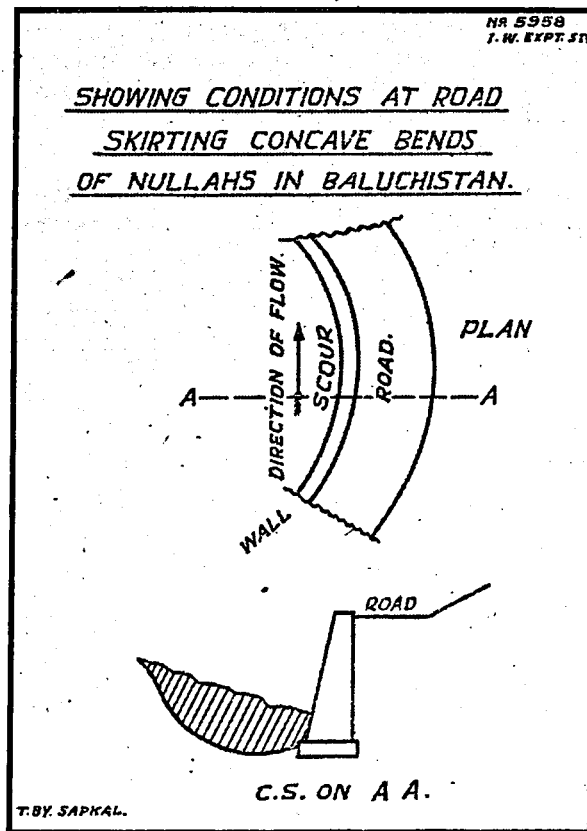

Fig. 7

M. & S. M. RY.

PROTECTION TO BRIDGE Nº. 8 ON
THE MALAPRABHA RIVER NEAR HOLE - ALUR.
PLAN SHOWING COURSE OF RIVER BEFORE & AFTER

PRELIMINARY CUT AT RIGHT BANK

MILE 30/10-15 G.D.G. - S.U.R.M. LINE

SCALE - 1" = 600 FT.

Notes

Earth filling in scour at north abutment is shown thus. 

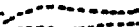
Old lowest course 1942 

Present lowest course 18-1-45 

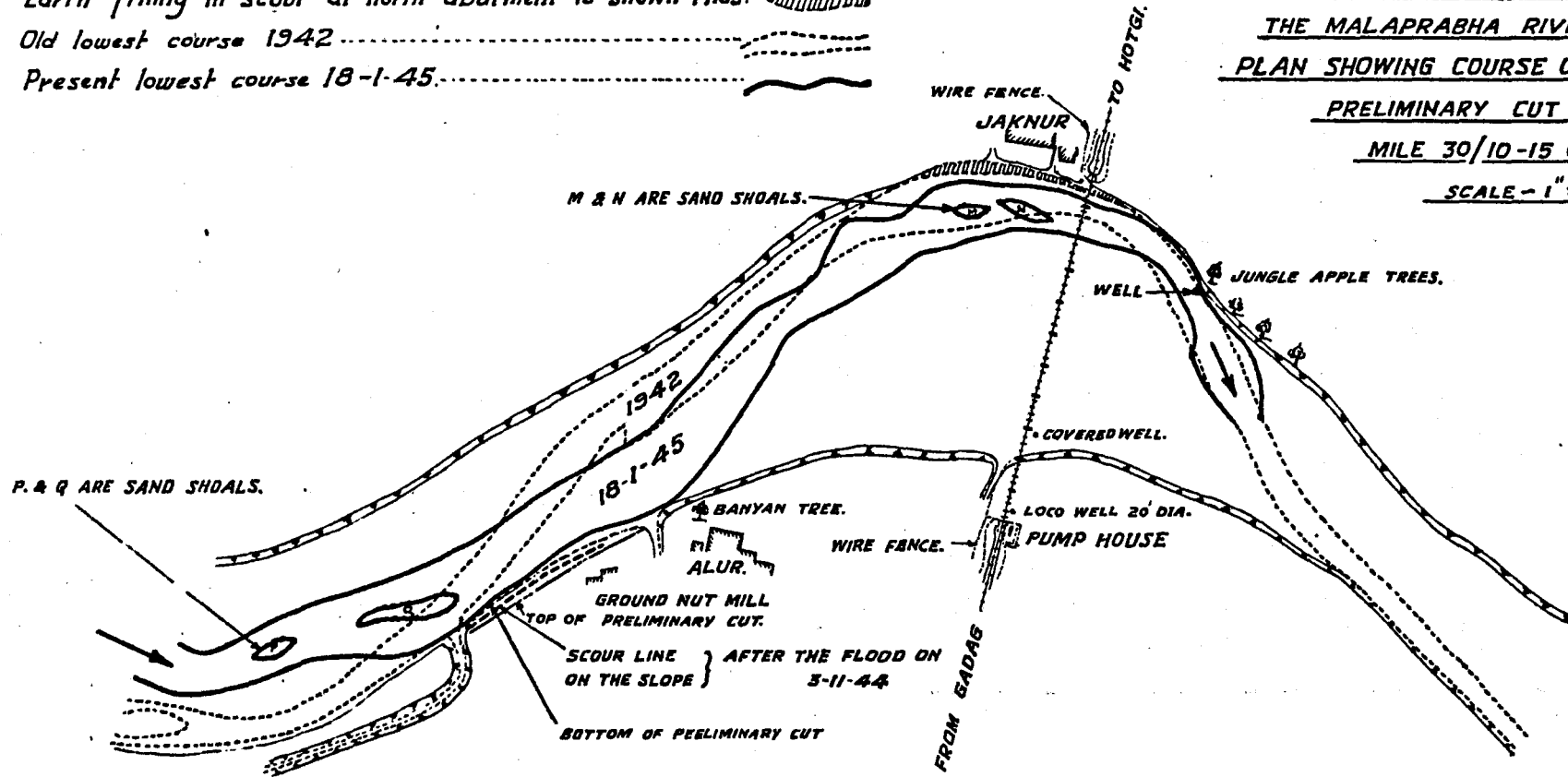

TABLE 2.
(Downstream pavement level R.L. 28.0)

Series No.	Experiments.	R. Ls. of scour observed for various discharges,						Remarks.
		200,000 cs.	300,000 cs.	400,000 cs.	450,000 cs.	500,000 cs.	550,000 cs.	
(1)	No friction blocks on the pacca pavement.	18-0	10-50	8-0	6-0	3-0	-2-0	Undermining just d/s of pavement and then a gradual slope of 1 in 4.
(2)	Two staggered rows of trapezoidal baffle blocks 5' x 3' x 2' starting 10' downstream of the toe of the glacis.	17-0	13-0	9-0	8-0	5-5	3-0	Undermining just d/s of pavement for Q = 450,000, 500,000 and 550,000 cs. and then a slope of 1 in 4.
(3)	Two staggered rows of rectangular, baffle blocks 5' x 2' x 2-5' at the toe of the downstream glacis.	17-0	13-0	9-0	8-5	5-5	3-0	No undermining d/s of pacca pavement.
(4)	Two staggered rows of rectangular, deflector blocks 5' x 2' x 2-5' at the end of the d/s pacca pavement.	18-0	19-5	15-5	13-0	10-0	8-0	No undermining downstream.
(5)	Two staggered rows of rectangular, baffle blocks 5' x 2' x 2½' starting 10' downstream of the toe of glacis and two staggered rows of rectangular, deflector blocks 5' x 2' x 2½' at the end of the pacca pavement.	24-0	23-0	19-5	15-0	15-0	13-0	No undermining but a gradual slope of 1 in 4 downstream.
(6)	Two staggered rows of trapezoidal baffle blocks 10' d/s of the toe of glacis and two staggered rows of rectangular, deflector blocks 5' x 2' x 2½' at the end of pacca pavement, as proposed in the design.	23-5	22-0	18-0	14-0	14-0	12-0	No undermining but a gradual slope of 1 in 4 downstream.

PART III.—SPECIFIC EXPERIMENTS

RIVER BEHAVIOUR AND CONTROL

(ii) *Scour*

7. Experiments in connection with dissipation of energy downstream of Lower Sind Barrage at Hajipur.

(2400 ft. upstream of site B near Hajipur)

(1) *Object of the experiments* :—

(a) To find the extent of scour downstream.

(b) To find out whether energy dissipation devices as proposed—i.e. two rows of trapezoidal, baffle blocks near the toe of the glacis and two rows of rectangular, deflector blocks at the end of pacca pavement—are satisfactory and sufficient; if not to suggest modifications.

(2) *Model* :—

These experiments were carried out in the river model—described in item 14 of this report—except that the weir portion was treated as geometrically similar to a scale of 1/50. The model below the barrage was a large scale (1/50), geometrically-similar part model, with the river curvature imposed upstream. The Barrage was reproduced down to the pacca pavement 100' long from the toe of the glacis. The concrete blocks 4' x 3' x 4' for a length of 80' and stone apron 200' long downstream of the pacca pavement were not reproduced.

(3) *Experiments*.

Table 1.

Six series of experiments were carried out (see table 1). In each series, the arrangements of blocks was changed and discharges corresponding to those ranging from 200,000 to 550,000 cusecs with an allowance of 20 per cent concentration, as assumed in the design, were run till scour ceased. The water levels maintained were pond level upstream and the minimum of the specific levels (allowing for retrogression) downstream as this would be the *worst* condition :—

TABLE 1.

Discharge	Pond Level maintained upstream	Water level maintained downstream
200,000 cusecs	60.0	45.0
300,000 "	61.0	48.0
400,000 "	61.0	50.4
450,000 "	61.0	51.5
500,000 "	61.0	52.5
550,000 "	61.0	53.3

In these experiments bed sand was injected at the rate of 0.2 parts per 1000.

(4) *Results* :—

Table 2.

Results as obtained in different series of experiments are shown in table 2.

Fig. 8 (a)

(a) Fig. 8 (a) shows the contours observed with $Q \equiv 550,000$ cusecs with no blocks on the pavement downstream. The maximum depth of scour observed was down to R. L. - 2.0. There was undermining just downstream of pavement to a depth of 7 ft.

Fig. 8 (b)

(b) Fig. 8 (b) shows the contours observed with $Q \equiv 550,000$ cusecs with two staggered rows of trapezoidal, baffle blocks (5' x 3' x 2'), starting 10' downstream of the toe of glacis and two staggered rows of rectangular, deflector blocks (5' x 2' x 2½'), at the end of the pavement as shown in fig. 9. There was no undermining downstream of the pavement and sand

Fig. 9

FIG. 8.
LOWER SIND BARRAGE
(HAJIPUR)
MODEL EXPTS. FOR PREVENTING SCOUR
D/S OF BARRAGE.
SCALE. 1" = 100'

(a)
WITHOUT BLOCKS.

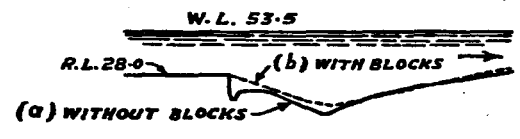
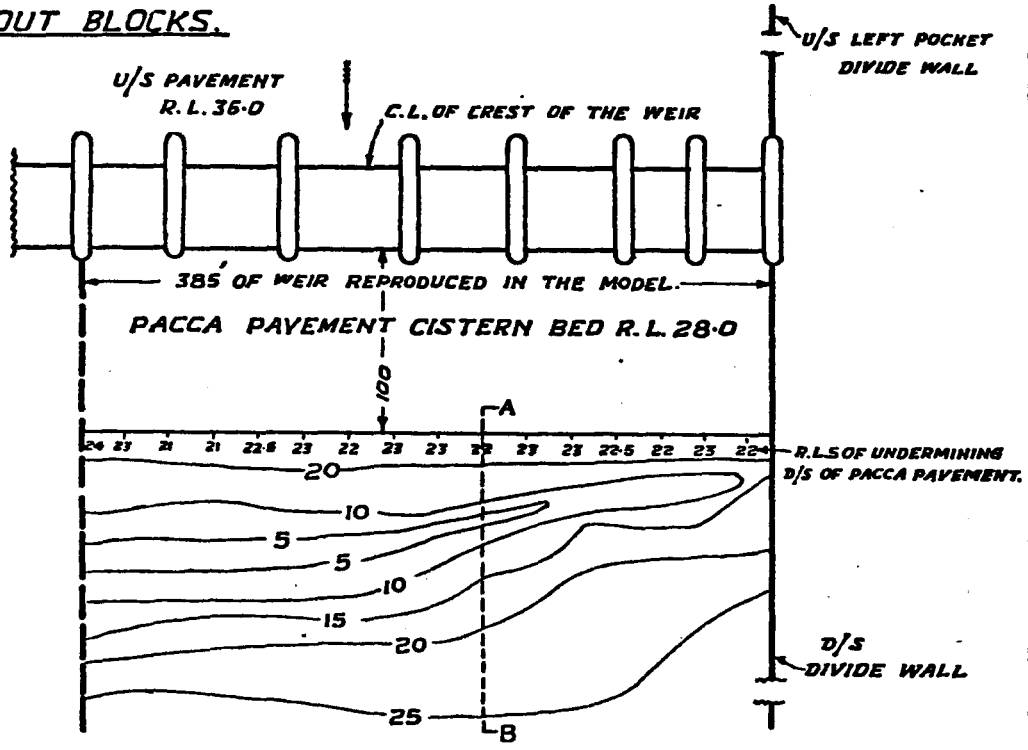

SECTION ON A.B.
SCALE - 1" = 100'

(b)
WITH BAFFLE BLOCKS AND
DEFLECTOR BLOCKS.

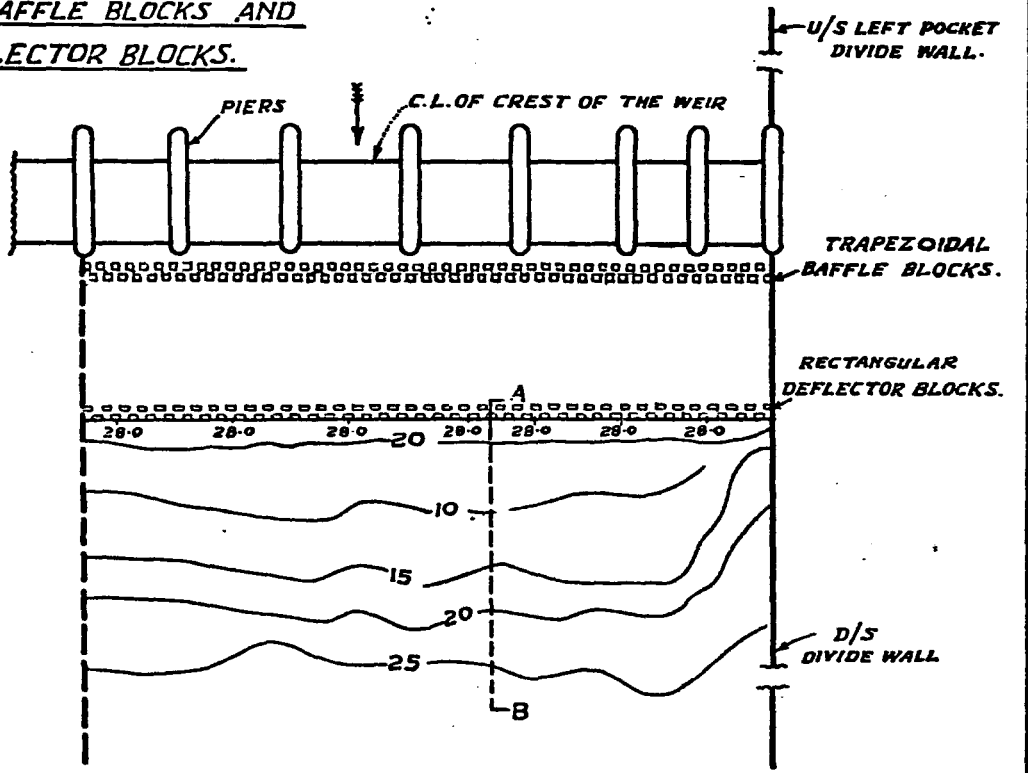

piled against the face of the curtain wall. The maximum depth of scour observed was down to R. L. 12. 0.

(c) Two staggered rows of rectangular, baffle blocks (5' x 2' x 2½') starting 10 ft. downstream of the toe of glacis and two staggered rows of rectangular, deflector blocks 5' x 2' x 2½' at the end of the pacca pavement were also equally effective in preventing undermining and R. L.s of scour obtained were same as in (b) above (see table 2.)

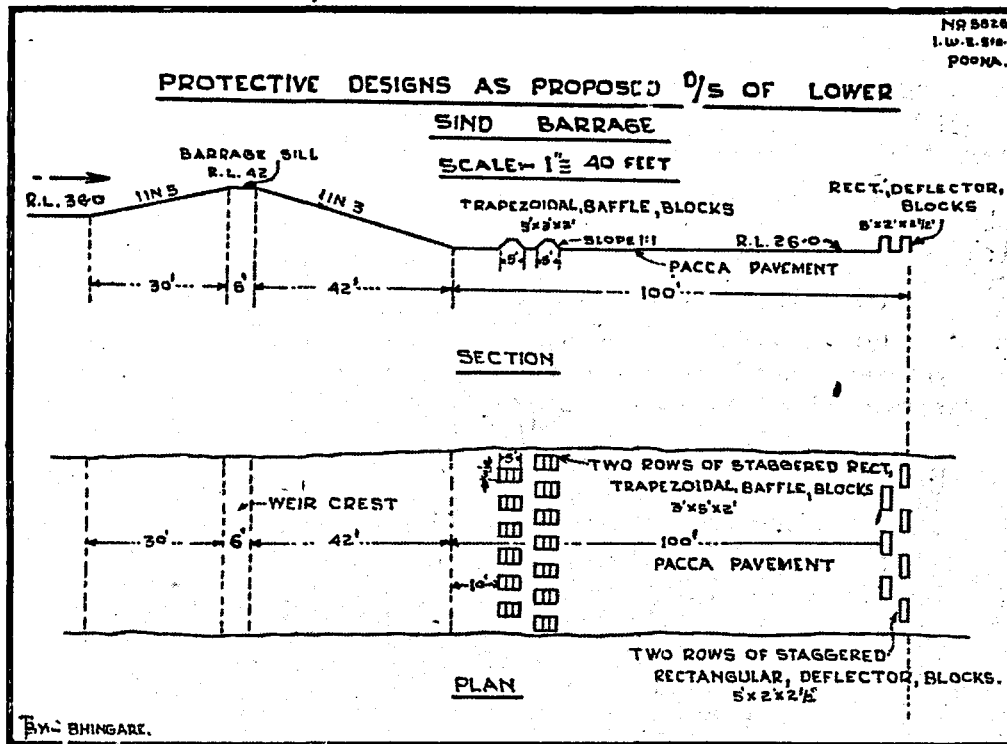

Fig. 9

Experiments thus showed that the design as proposed may be adopted. Though rectangular, baffle blocks near the toe were equally effective, trapezoidal, baffle blocks as originally designed are recommended, being streamlined.

No protection downstream of deflector blocks is necessary against dynamic action. Actually in the design, however, concrete blocks over a length of 80 ft. and a stone apron 800 ft. long are provided downstream with the object of preventing piping due to exit gradient and release of residual uplift pressure. This kacha protection will be tested on the Kotri Barrage model to see if any undesirable flow conditions arise, in the event of uneven settlement of concrete blocks and the stone apron as shown to occur below the Sarda Barrage model, described in 1940-41 Annual Report (Tech.) p. 24.

“(iv) TIDAL ACTION”.

8. Training the Hooghly River at Dunbar Cotton Mill with a by-pass channel.

Introduction.

Experiments described in 1944 Annual Report (Tech.) have shown that accretion could be made to occur in the deep scour-hole downstream of the knuckle at Dunbar Cotton Mill by driving 4 to 5 rows of piles into the bed of the river, in continuation of the projecting ledge of the knuckle and another row of piles at right angles to the bank upstream of the knuckle, to slow down the bed velocity. During this year experiments were done to see if conditions at Dunbar Mill could be improved by allowing a part of the discharge to flow

through a by-pass channel. These experiments were largely basic in character, as it was all along realized that it was impracticable to construct a by-pass channel at this place owing to the existing mills and the densely populated area. The experiments were, however, carried out with a view to obtain an insight into the fundamental causes and remedies and, thus, collect information which would be useful for treating similar cases elsewhere where such remedies are practicable. In this particular case, such a by-pass channel would be prohibitive in cost—see Appendix I; because it would have to be lined; otherwise a cut-off might develop along the by-channel with serious consequences.

On both banks of the Hooghly, there are various mills and other manufacturing concerns having their import and export jetties projecting into the river; in addition, there are several brick fields jutting out into the river. At various places the banks are pitched to prevent local erosion.

The river was inspected by the Director in May 1945 and erosion was observed on the outside of curves at the following places; the banks which are being eroded are shown hatched in figure 10.

- (1) Along the left bank upstream and downstream of Punhatti;
- (2) Severe erosion along the right bank at Ballampur, Serampur and very severe at Chatra, where in many cases walls of buildings and ghats were found severely damaged;
- (3) Severe erosion along the left bank between Nawabgunj and Palta Water Works;
- (4) along the right bank between Gondalpara and Chandranagore;
- (5) a new embayment along the right bank opposite the Anglo India Jute Mills;
- and (6) along the right bank upstream and downstream of the Victoria Jubilee bridge.

It is thus apparent that where the banks are held, the river cannot swing freely of its own accord and it then assumes the sharp curvature as is found near the Dunbar Cotton Mills. The curvatures of river banks between Damurdaha and Konnagar were analysed and it was found that the curvature of the river at Dunbar Mill was too sharp to cope with the maximum freshet discharge. The arc to chord ratio at this place was 1.5 while a cut-off occurred upstream of Bansbaria when this ratio was 2.0. Since the curvature at Dunbar Mills was apparently too acute for the discharge, it seemed feasible to improve the conditions there by allowing a part of the flow through a by-pass channel. The shape and curvature assumed by the river and the changes which occur depend on several factors, such as the dominant discharge, the proportion of flood flow which is contained within the banks and, hence, the level at which the banks are overtopped, the material in movement and its grade, the nature of banks etc. The exact relation of all these factors is only partly known; but it has been found that the radius of stable curvature varies as the square root of the dominant discharge.⁽¹⁾

In the past, it has been generally assumed that the only factor which controls cut-offs is the ratio, $\frac{\text{arc}}{\text{chord}}$; and in practice this is partly true and this ratio is useful as a simple guide; but actually another important factor causing cut-offs is "too sharp curvature for the discharge", i.e. r/\sqrt{Q} , where r is the radius of curvature and Q the maximum discharge. Table 3 shows the average value of r/\sqrt{Q} , between Thana Damurdaha in fig. 10 and Punhatti (H)—a distance of 28 miles—is 13.1, based on the maximum ebb discharge of 187,000 cs; whereas the value of the same ratio for the curvature between Damurdaha (K) and Thana Hooghly (A) when the cut-off developed and between Chandranagore and Bhadreswar is only 7.4. If the average value of $r/\sqrt{Q}=13.1$ is

(1) Annual Report (Tech.) for 1939-40, page 10.

FIG. 10
INDEX PLAN OF HOOGLHY RIVER
SHOWING SURVEY 6 MILES UPSTREAM
BANSBARIA TO CALCUTTA.
IN 1940.
Scale:- 1" = 18,000'

REFERENCE:-
EROSION OF BANK 

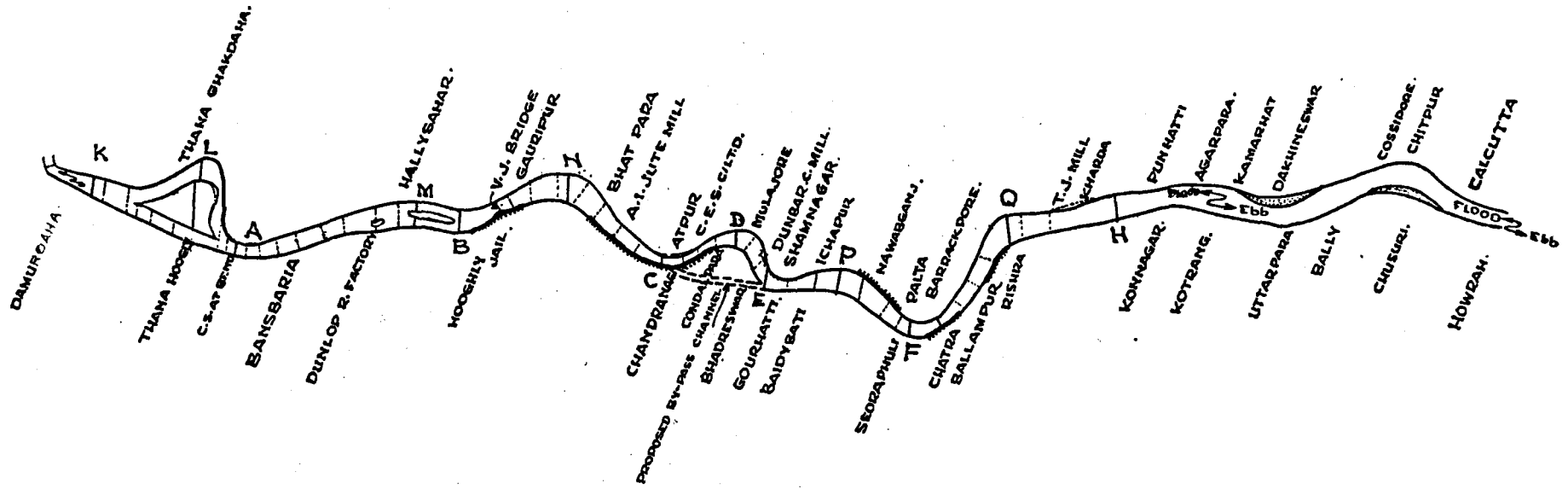

Kulkarni 12-1-46.

accepted as the natural ratio for the discharge of 187,000 cusecs for the Hooghly, it works out to 5,650 ft. as against 3,200 ft. between Chandranagore and Bhadreswar. We know from conditions in the river that the latter curvature is excessive and, in the past, has led to a cut-off at Damurdaha.

Experiments.

Experiments were first done in the rigid 1/300 : 1/60 Hooghly model, with vertical exaggeration of 5, for observing lines of flow. These are described in Part I of this note. As the by-pass channel would take off from the outside of a bend, it would draw sand-free, top water and the main river would carry the bed material; it was therefore anticipated that accretion would occur in the scour-hole downstream of the knuckle at Dunbar Cotton Mill due to reduced river discharge suitable for the curvature. The accretion could not be reproduced in the 1/300 : 1/60 model due to the large vertical exaggeration; so the experiments were repeated in a large scale, part-length, 1/125 : 1/90 scale Hooghly model, after imposing correct entry and exit conditions as obtained in the 1/300 scale model and are described in part II of this note. As the vertical exaggeration of the large model was only 1.4, it was possible to see from it whether accretion would occur in the scour-hole in the river.

PART I.—EXPERIMENTS WITH A BY-PASS CHANNEL IN 1/300 : 1/60 SCALE HOOGHLY MODEL

V sand passed through 30 mesh sieve having a mean diameter $m = 0.20$ mm. was used as bed material. The model was laid according to the 1940 survey

L scale = 1/300

D scale = 1/60

Q scale = 1/140,000

T scale = 1/39

[*Note* :—Ebb flow of the prototype was reproduced in the model; and a constant discharge of 1.34 cs \equiv 187,000 cs. was run for 12 hours in each experiment. The gauge at Konnagar was maintained \equiv 13.5 ft. above K. O. D. S. (Kidderpore Old Dock Sill).]

Experiment No. 1—After running the ebb for 12 hours, surface and bed lines of flow at Dunbar Cotton Mill were observed. Velocities at cross section 21 B were also noted. The lines of flow in this experiment were used as the standard for comparison with lines of flow of other experiments. Fig. 11.

Experiment No. 2—The model bed was readjusted according to the 1940 survey and an embankment was constructed on the right bank opposite Mulajore Mill, as shown in fig. 12. The by-pass channel shown in the same figure carried 0.18 cusecs \equiv 25,000 cs. In the lay-out of this experiment, the scour-hole downstream of the knuckle was filled up with V sand as silting was expected to occur in the river with the improved flow conditions. The surface flow concentrated at cross section 21 as in experiment 1 and the flow there was not central. The by-pass channel carried only surface water. Fig. 12

Experiment No. 3 was not satisfactory in design as two factors were changed in this experiment, viz. the embankment was removed and the discharge of the by-pass channel was increased to 50,000 cs.; and hence the results were not comparable.

In *Experiment No. 4* the by-pass channel was enlarged to carry 50,000 cusecs keeping the alignment of the embankment the same as in experiment 2. The results were still not satisfactory; so the alignment was changed in *experiment 5*.

The conditions of flow near the Dunbar Mill improved in *experiment 5*; Fig. 13. but the flow still concentrated towards the left bank at cross section 21.

In *Experiment No. 6* the scour-hole downstream of the knuckle was filled with V sand and the lines of flow and velocities at cross section 21 were

TABLE 3.
Analysis of curvature in the Hooghly river, (see fig. 10).

Curvature	Radius of curvature	Maximum freshet ebb discharge 'Q' (cs.)	r/\sqrt{Q}	Arc Chord	Meander length (ft.)	Meander belt (ft.)	Remarks
1	2	3	4	5	6	7	8
K to A (before the cut-off of 1936)	3,200	187,000	7.4	2.0	15,000	9,500	It is almost a straight reach. Dunbar Mill reach curvature.
L to M (before the cut-off of 1936)	8,000	..	18.5	1.2	25,000	11,000	
A to B	—	—	—	—	—	—	
B to C	7,000	187,000	16.2	1.25	26,000	9,500	
N to D	5,500	..	12.7	1.1	21,000	7,400	
C to E	3,200	..	7.4	1.5	12,000	6,500	
D to P	3,300	..	7.6	1.1	13,500	6,000	
E to F	9,500	..	22	1.1	18,000	5,500	
P to Q	5,400	..	12.5	1.2	24,000	11,000	
F to H	5,800	..	13.4	1.2	31,000	8,000	
Average (K - H)	5,656		13.1	—	20,611	8,267	
O to E (after by-pass)	3,200	137,000	8.6				

FIG. II, $\frac{1}{300} : \frac{1}{60}$ HOOGLHY MODEL
SHOWING LINES OF FLOW NEAR
DUNBAR GOTTON MILL IN EXPT. I.

$Q = 1.34 = 187,000 \text{ Cs.}$
WATER LEVELS AT KONNAGAR 13.5' ABOVE K.O.D.S.

SCALE: $1" = 1200' = 4'$

REFERENCES:—

- SURFACE LINES OF FLOW
- BED LINES OF FLOW

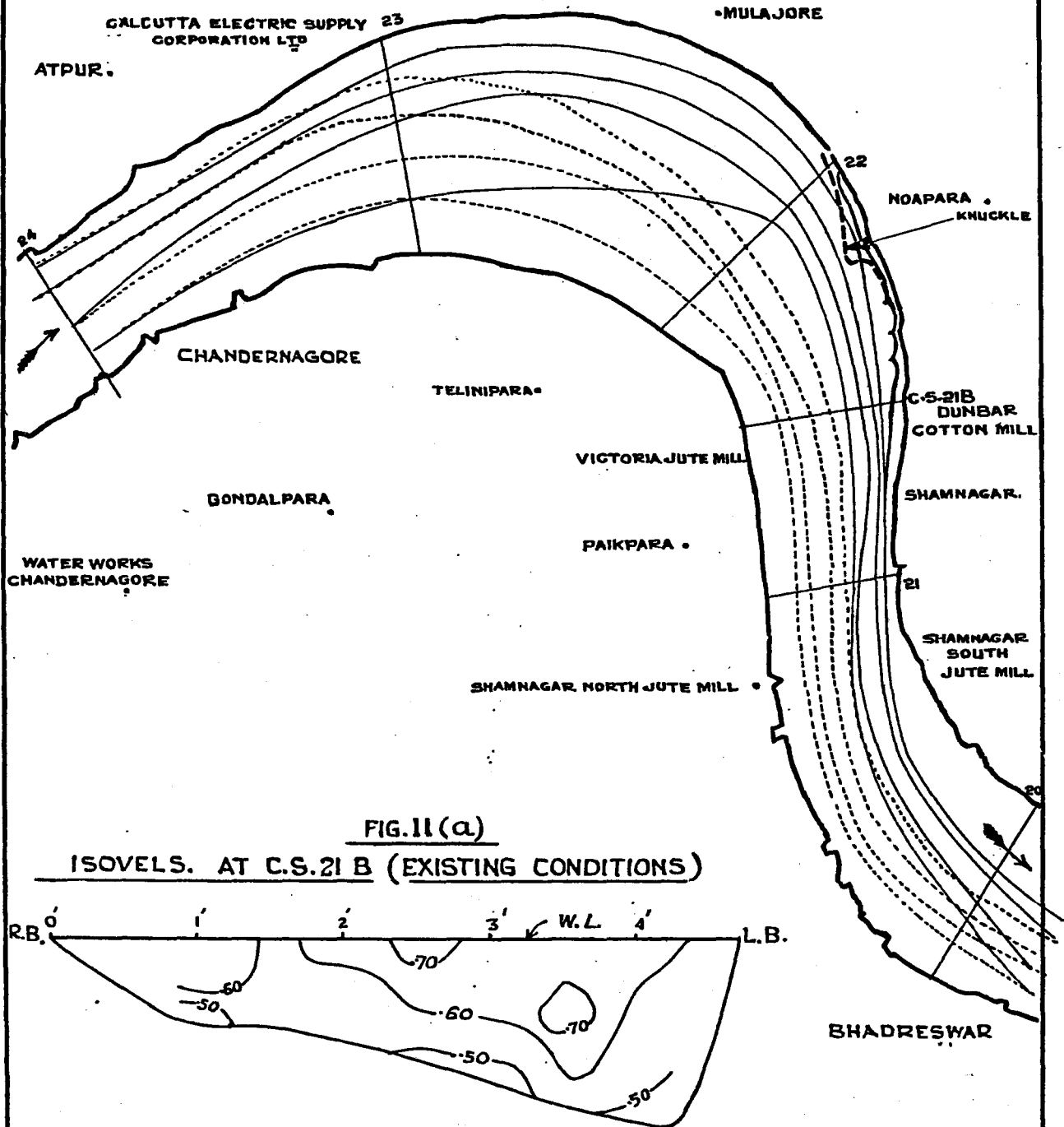

V. OBS. = .65 FT/SEC.
V. CAL. = .60 FT/SEC.

FIG. 12
 $\frac{1}{300} : \frac{1}{60}$ HOOGHLY MODEL
LINES OF FLOW NEAR DUNBAR COTTON MILL
 WITH BY-PASS CHANNEL & EMBANKMENT OF EXPT. 2.
 CONTINUOUS EBB $Q = 1.34 \approx 187,000$ Cs.
 BY-PASS CHANNEL CARRYING $\approx 25,000$ Cs.
 W.L. AT KONNAGAR 13.5 FT ABOVE K.O.D.S.
 SCALE $1'' = 4' \approx 1200'$

REFERENCES:-

- SURFACE LINES OF FLOW
- BED LINES OF FLOW
- EMBANKMENT

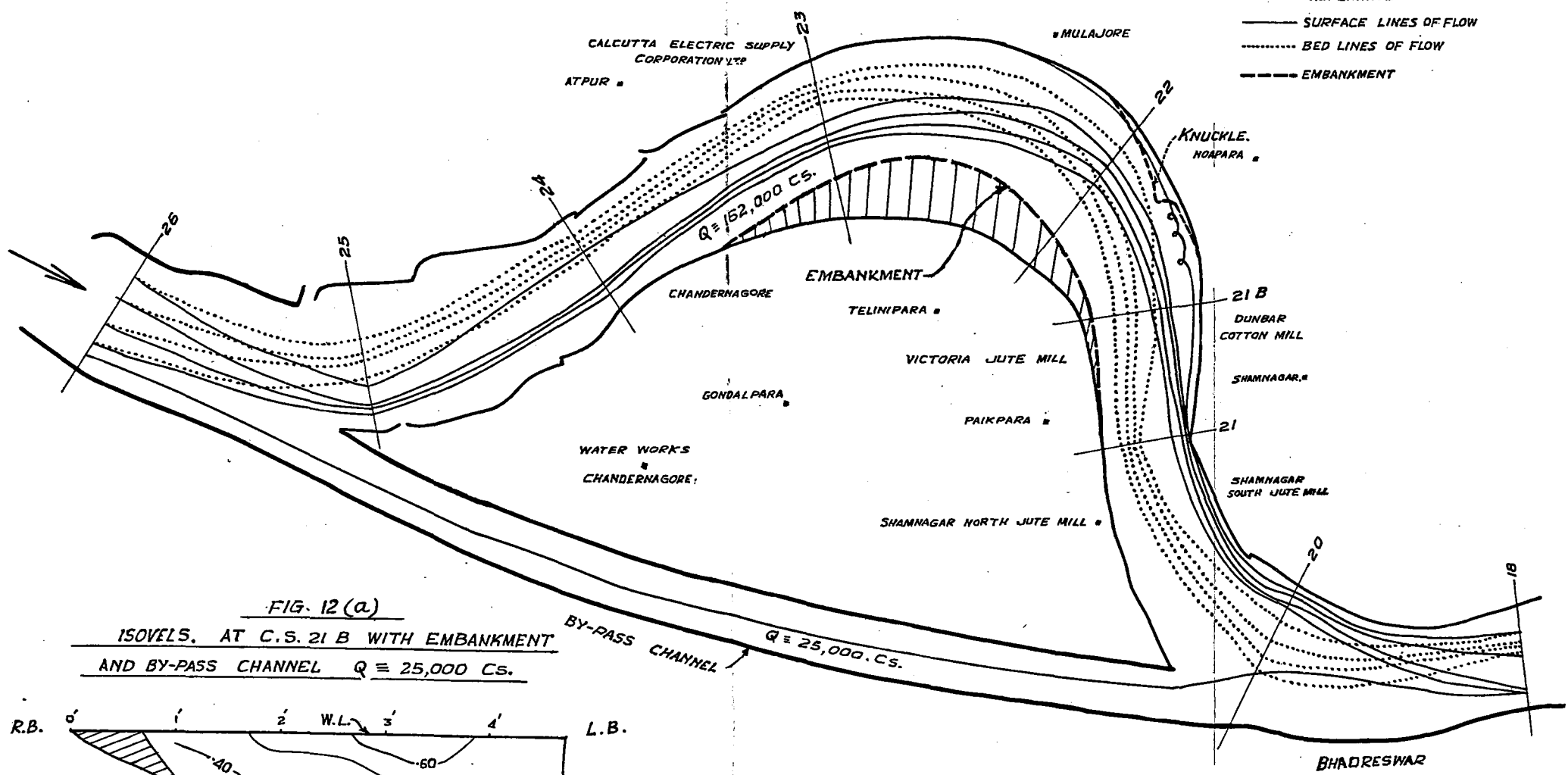
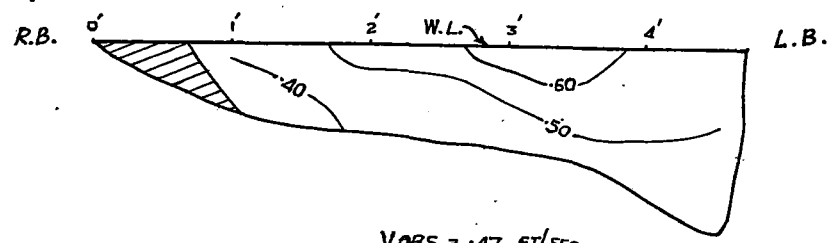

FIG. 12 (a)
 ISOVELS, AT C.S. 21 B WITH EMBANKMENT
 AND BY-PASS CHANNEL $Q \approx 25,000$ Cs.



$V_{OBS.} = .47$ FT/SEC.
 $V_{CAL.} = .45$ FT/SEC.

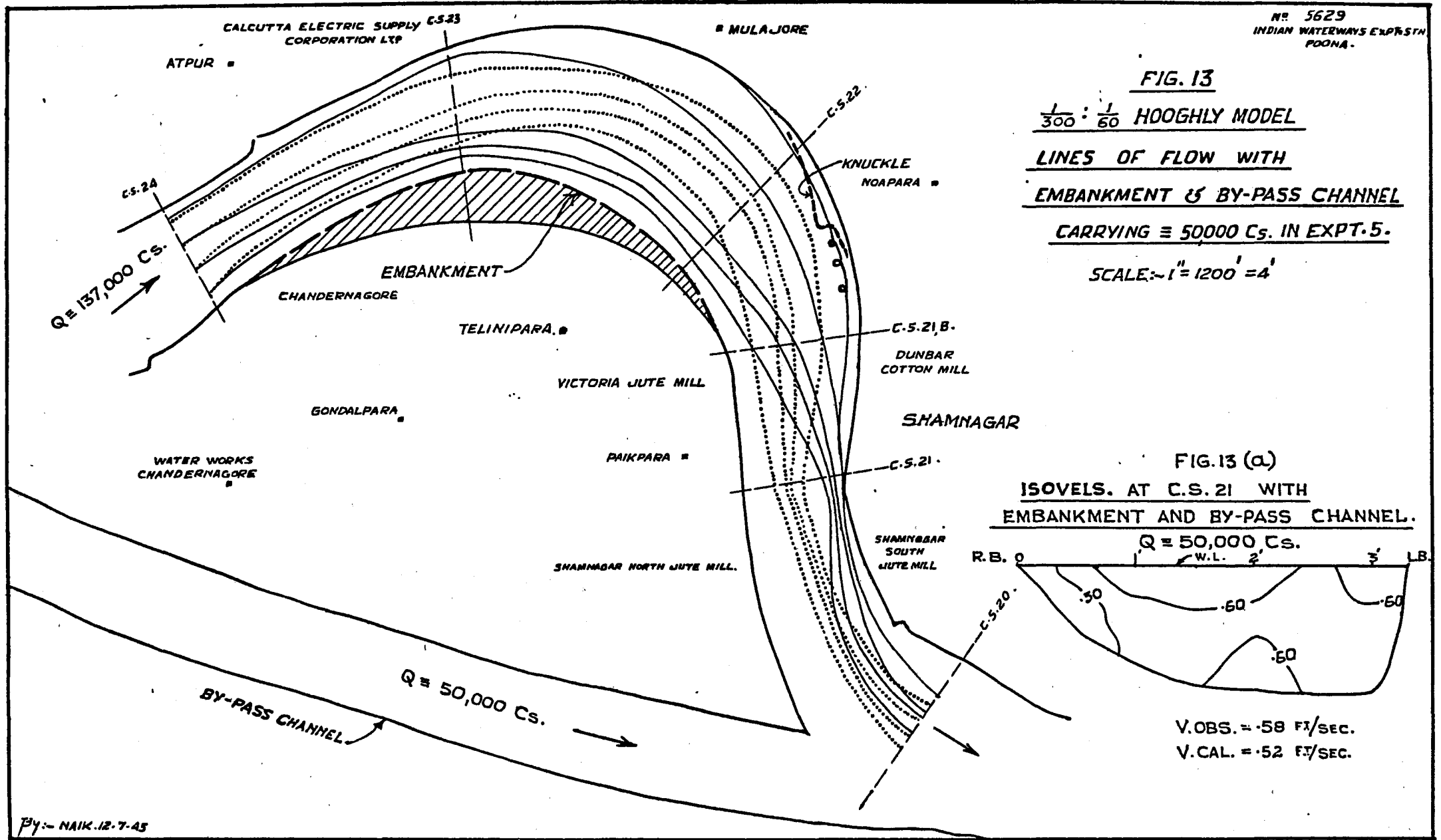

FIG. 13

$\frac{1}{300} : \frac{1}{60}$ HOOGHLY MODEL

LINES OF FLOW WITH
EMBANKMENT & BY-PASS CHANNEL

CARRYING ≈ 50000 Cs. IN EXPT. 5.

SCALE:- 1" = 1200' = 4'

FIG. 13 (a)

ISOVELS. AT C.S. 21 WITH
EMBANKMENT AND BY-PASS CHANNEL.

Q $\approx 50,000$ Cs.

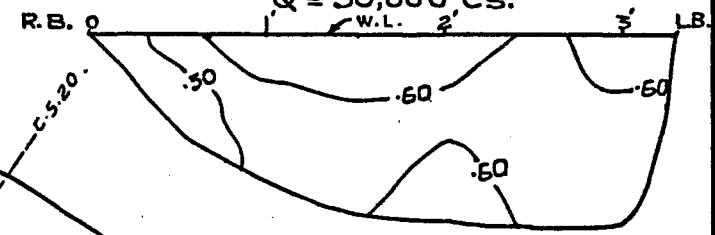

V.OBS. = .58 FT/SEC.
V.CAL. = .52 FT/SEC.

By:- NAIK.12.7.45

observed; and it was found that flow had become central, and this is what would occur in the river after accretion had taken place. The river downstream of Bhadreswar up to Ichapur is almost straight. The by-pass channel joins the main river at Bhadreswar on the outside of the curve. The model showed that the conditions with the by-pass channel were better than without it; because the flow which was previously following the right bank became central.

Fig. 14(a)
& 14(a)

Discussion of results.

In the river, under the existing conditions, the surface flow concentrates over the knuckle and persists all along the left bank; the bed water is deflected away from the bank by sub-surface water diving towards the bed. The flow in the bight is very disturbed, surface eddies and boils being prominent.

In experiment 2, with a by-pass channel carrying an equivalent discharge of 25,000 cusecs and an embankment, the concentration of flow shifted away from the knuckle, but persisted on the left bank downstream of cross section 21: and even after filling the scour-hole, there was no change in lines of flow, showing that, even under such conditions, the left bank downstream of cross section 21 would be subject to erosion, which might result in the formation of a knuckle downstream.

With a by-pass channel carrying the equivalent of 50,000 cs. the concentration of flow shifted away from the knuckle; and the flow did not persist along the left bank, as it did when the by-pass channel carried only 25,000 cusecs; but it still concentrated towards the left bank downstream *until accretion occurred in scour-hole*. (This was simulated in this model by filling the scour-hole with sand).

An embankment is desirable together with a by-pass channel as it would make it possible to reclaim a large area of land, the sale of which would help to pay for the cost of the work.

Though, to start with, there might be a tendency in the river for the flow to concentrate towards the left bank, the scour-hole would fill up fairly quickly and, thereafter, the flow would become central.

It may be noted that when the discharge in the by-pass channel was increased to 50,000 cusecs, there was still no appreciable reduction in velocities on the left bank; but when an embankment was added, the velocities on the left bank were reduced and velocities near the embankment (right bank) increased. This means, as we have always found in the past, that an embankment suitably positioned and aligned tends to pull the flow towards itself and this is true for *tidal* as well as *non-tidal* flows.

Conclusion :—

Curvature between Chandranagore and Bhadreswar seems to be suitable for a maximum ebb discharge of about 140,000 cusecs; central flow would then be obtained. This could be achieved by building a by-pass channel to carry 50,000 cusecs and constructing an embankment along the right bank.

PART II—EXPERIMENTS WITH 1/125:1/90 HOOGLHY MODEL

In the experiments described in Part I the water level at Konnagar was maintained \approx 13.5 ft. above K.O.D.S. (Kidderpore Old Dock Sill); and water level at Shamnagar without a by-pass channel was found to be equivalent to 16.5 ft. above K.O.D.S; which with a by-pass channel dropped down to 15.9 ft. above K.O.D.S.

In the large, 1/125:1/90 model the water level at Shamnagar was maintained at the equivalent of 15.9 ft. above K.O.D.S. Conditions of flow were imposed at the entrance as were obtained in the 1/300 model with a by-pass channel.

Description of the model.

The model was laid with Khadakvasla dam sand sieved through a 20 mesh screen having a mean dia. of 0.26 mm. The banks for 7 ft. upstream and 14 ft. downstream of the knuckle in the model were constructed in clay and sand layers; and the model bed and knuckle were laid according to the survey of March 1941.

Sand having a mean dia. of 0.20 mm. was injected in all the experiments at the rate of 2 cft/hour, i.e. 0.3 parts per 100.

Experiments with the 1/300 model had shown that an embankment was necessary to improve the conditions of flow; these experiments were therefore repeated in the 1/125 model to see if similar results would be obtained.

SERIES I

Experiments without embankment opposite Victoria Jute Mill and with a by-pass channel.

Experiment No. 1. In this experiment a constant discharge of 1.37 cusecs \equiv 147,000 cusecs was run with water level at Shamnagar maintained \equiv 16 ft. above K. O. D. S. The by-pass channel was assumed to carry 40,000 cusecs of ebb discharge.

The object of this experiment was to determine the minimum carrying capacity of the by-pass channel for improving flow conditions near Dunbar Mills.

This experiment consisted of two parts. In the first part the ebb flow was run continuously for 24 hours with the injection of sand. The accretion downstream of the bight was then noted and the bed contours were observed.

In the second part of the experiment, the bed in the bight was adjusted to approximately three times the accretion actually obtained; this was done to accelerate results as silting in a model is relatively very much slower⁽¹⁾. This is a normal practice at the Station—precaution being taken to prevent excess material being added.

Lines of flow were observed after 24 hours of run as is shown in Fig. 15 (a) figure 15(a).

The experiment was then continued for further 24 hours with the injection of sand. The lines of flow and bed contours were again observed after 48 hours of total run.

Fig. 15 (b) The flow persisted on the left bank and concentrated upstream of cross section 21. Eddies were visible downstream of the knuckle.

Figs. 15 (c) & (d) Bed contours were observed after 24 hours and 48 hours of run and are shown in figures 15(c) and 15(d).

Comparison of figure 15(c) and 15(d) shows that there was greater scour opposite the left bank after a longer run, as is indicated by the increased area of the 60 ft. contour.

Conclusion:—The flow conditions did not improve and the experiment showed that the by-pass channel should carry more than 40,000 cs. discharge.

Experiment No. 2—The discharge through the by-pass channel was increased to 50,000 cs, the river carrying 137,000 cs. Water level at Shamnagar was maintained = 15.9 ft. above K.O.D.S. as was observed in 1/300:1/60 Hooghly model.

(1) Annual Report (Tech.) for 1944, p. 7.

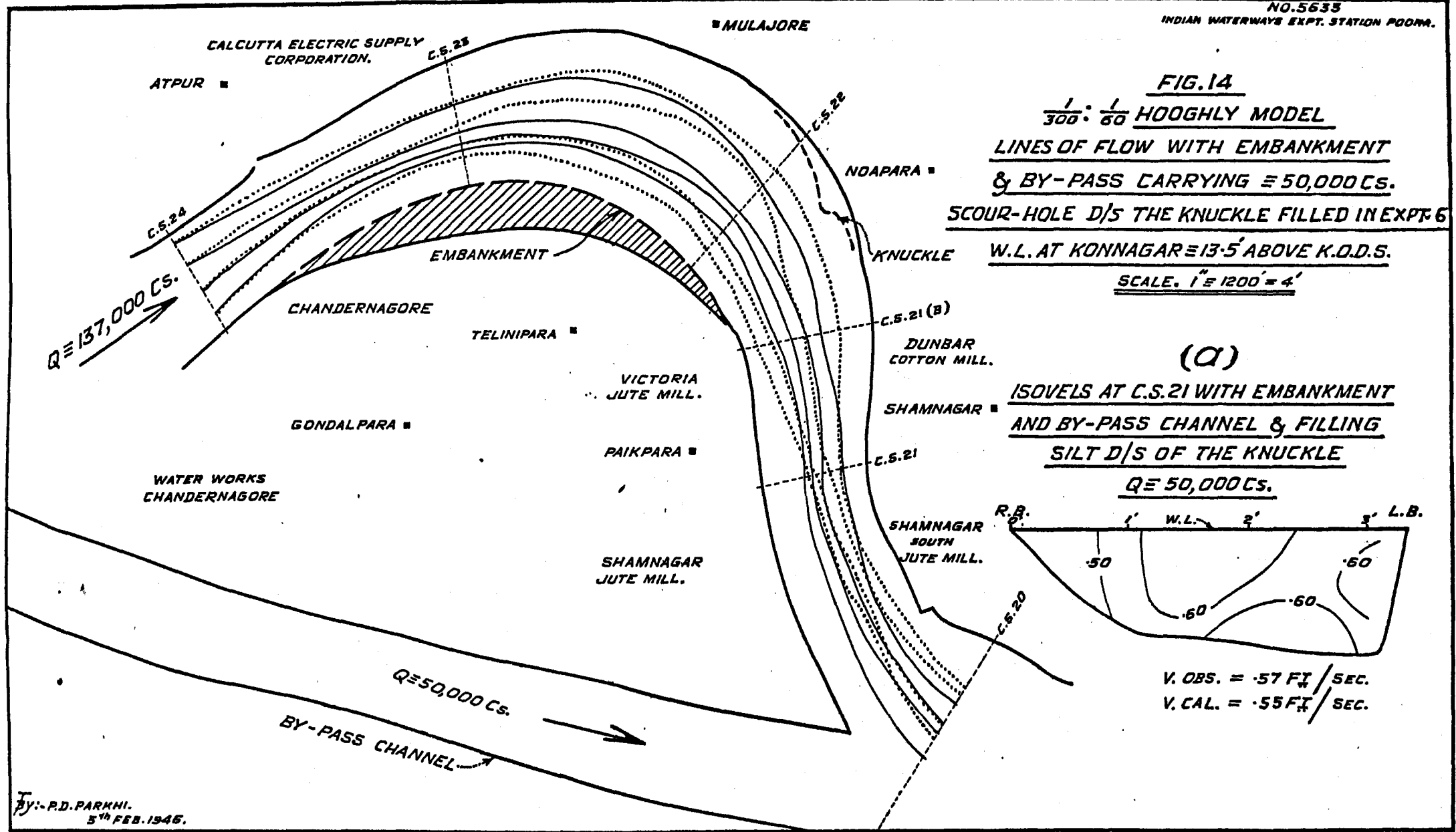

FIG.14
 $\frac{1}{300} : \frac{1}{60}$ HOOGHLY MODEL
LINES OF FLOW WITH EMBANKMENT
& BY-PASS CARRYING $\approx 50,000$ C.S.
SCOUR-HOLE D/S THE KNUCKLE FILLED IN EXPT. 6
W.L. AT KONNAGAR ≈ 13.5 ABOVE K.D.S.
SCALE. $1'' \approx 1200' = 4'$

(a)
ISOVELS AT C.S.21 WITH EMBANKMENT
AND BY-PASS CHANNEL & FILLING
SILT D/S OF THE KNUCKLE
 $Q \approx 50,000$ C.S.

R.B. 2' 1' W.L. 3' 3' L.B.
50 60 60 50

V. OBS. = .57 FT / SEC.
V. CAL. = .55 FT / SEC.

By:- P.D. PARKHI.
5th FEB. 1946.

FIG. 15 (a)-(b) SHOWING LINES OF FLOW IN

N^o 5943
Indian Waterways Expf. Stn.

SERIES : 1

1/125:1/90 HOOGHLY MODEL

Q=1.37 ≅ 147,000 Cs. CONTINUOUS EBB

WITH INJECTION (0.3 PARTS PER 1000)

W. L. AT SHAMNAGAR 16 FT. ABOVE K.O.D.S.

Q IN BY-PASS CHANNEL (NOT REPRODUCED IN MODEL) ≅ 40,000 Cs.

TOTAL Q ≅ 187,000 CUSECS.

MULAJORE

SCALE: 1" = 8' ≅ 1000 FT.

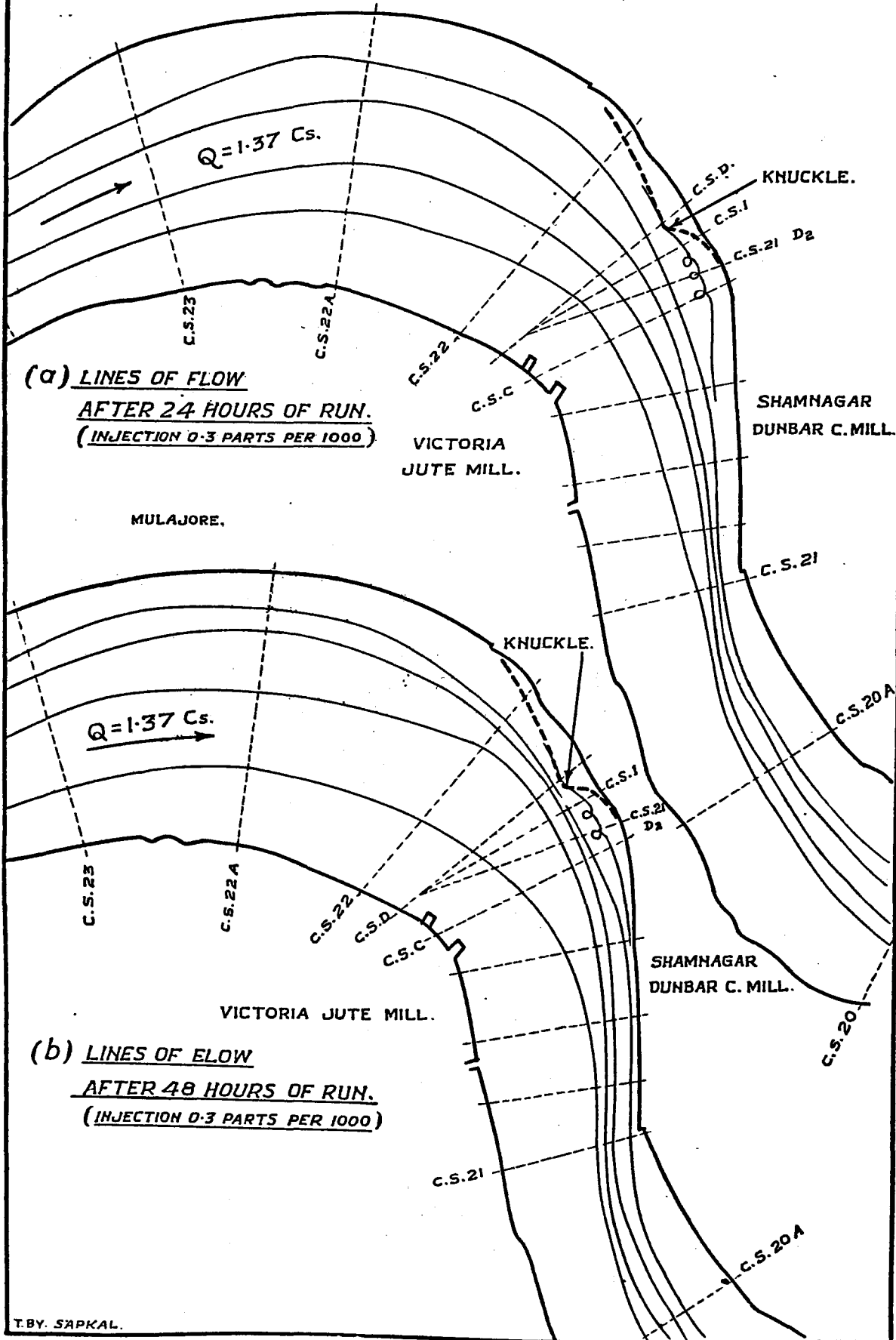

T.BY. SAPKAL.

G.P.Z.P. POONA '47

FIG. 15 (c) & (d) SHOWING BED CONTOURS IN
SERIES I 1/125:1/90 HOOGHLY MODEL CONTINUOUS EBB

Q = 1.37 Cs. \approx 147,000 Cs.

BY PASS CHANNEL (NOT REPRODUCED IN MODEL)

Q \approx 40,000 Cs., TOTAL Q \approx 187,000 Cs., W.L. AT SHAMNAGAR \approx 16' ABOVE K.O.D.S.

SCALE, 1" = 8' \approx 1000'

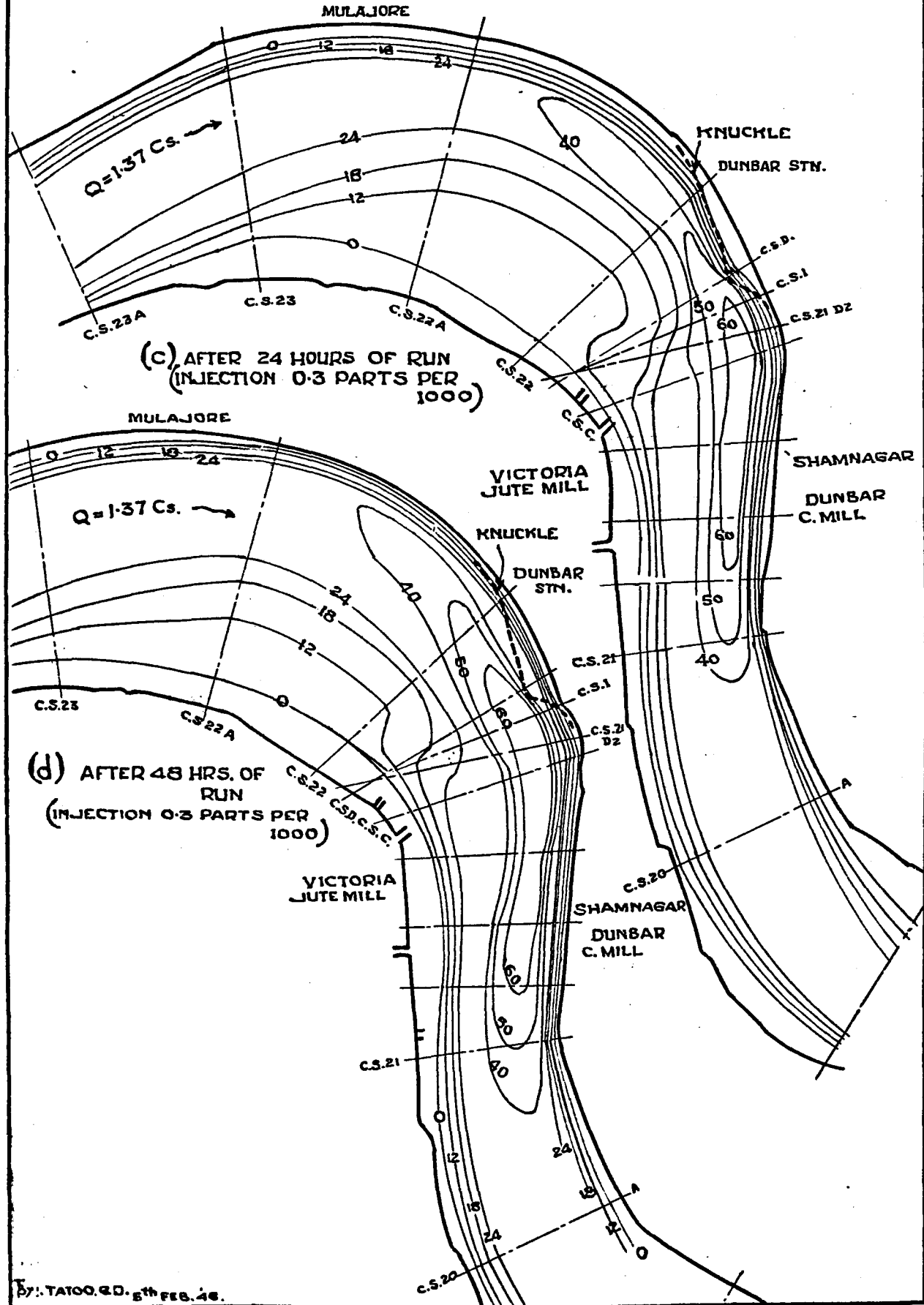

Lines of flow and bed contours were observed before and after the experiment, i.e. after 72 hours run. Comparison of figure 16 (a) and 16 (b) shows that the lines of flow shifted away from the left bank resulting in centralising the flow. The intensity of eddies downstream of the knuckle was also reduced. Fig. 16 (a)
Fig. 16 (b)

Scour occurred on the right side of the bight which extended down to cross section 21 and the 60 ft. contour also extended downstream to cross section 21. Fig. 16 (c)
Fig. 16 (d)

Soundings at cross section 21 D₂ were taken after 24 hours, 48 hours, and 72 hours of run. They show the nature of accretion in the bight after every stage of the experiment. (e)
(f)
(g)

Conclusion :—Though the flow conditions near Durbar Mills improved when the by-pass channel carried a discharge of 50,000 cusecs, scour occurred near the left bank, thus showing that the flow was not sufficiently pulled away from the left bank.

SERIES 2

Experiments with embankment opposite Victoria Jute Mill and with the by-pass channel.

The experiments described above showed that an embankment was necessary to pull the river towards the right bank. It would also reclaim valuable land which would partly pay towards the cost of the by-pass channel.

In this series of experiment a constant discharge of 1.28 cs. \equiv 137,000 cs. (i.e. the discharge in the by-pass channel \equiv 50,000 cusecs) was run. An embankment was constructed opposite Victoria Jute Mill.—see appendix 1. Fig. 17 (a)
Appendix 1

The experiment was run with injection for 24 hours and soundings in the bight were taken. It was found that accretion took place and so the experiment was continued for another 24 hours. Lines of flow were taken after 48 hours of run which showed improvement in flow condition. There was no concentration of flow anywhere and the flow, even though not fully centralised, had a tendency to shift away from the left bank. Fig. 17 (a)

Bed contours were observed after 48 hours of run. When compared to those of figure 16 (c) (Series I without embankment) they did not show appreciable scour opposite the left bank. Area enclosed by the 60 ft. contour had also considerably reduced. Fig. 17 (b)
Fig. 16 (c)

The 12 ft. and 18 ft. contours near the right bank approached towards the right bank, showing scour opposite this bank; this was the effect of the embankment which tended to pull the stream towards right bank. Soundings at cross section 21 D₂ showed accretion in the bight.

Conclusion.

The experiments, thus, showed conclusively that accretion in the scour-hole would take place when by-pass channel carried 50,000 cusecs; an embankment on right bank would tend to pull the flow towards the right bank, thus assisting the centralisation of flow in the river; this would also enable a large area of land to be reclaimed.

APPENDIX I

(a) DESIGN OF A LINED BY-PASS CHANNEL IN THE HOOGRHY FROM CHANDRANAGORE TO BHADRESWAR.

Distance from Atpur to Bhadreswar along the river course = 18,000 ft.

Difference in water level during the middle of ebb
 = (17 ft. at Atpur)
 - (15' 9" at Bhadreswar)
 = 1' 3"

∴ The slope = 1/14,400

Distance from Atpur to Bhadreswar along the by-pass-channel = 13500 ft.

$$\therefore \text{The slope} = \frac{1}{13500} = \frac{1}{10800}$$

The discharge that the by-pass channel would carry will be 50,000 cusecs out of 187,000 cusecs of ebb.

$$V = \frac{1.486}{N_m} R^{2/3} S^{1/2}$$

$$= Q/A$$

Using this relation, a section, 240' × 20', would be sufficient with a low value of $N_m = 0.103$:-

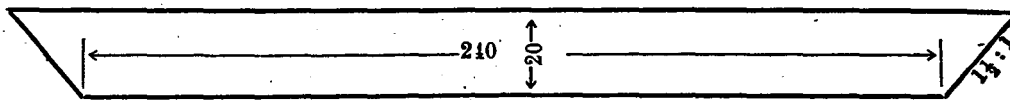

$$V = Q/A = \frac{50,000}{5400} = 9.26 \text{ ft/sec.}$$

$$R = A/P = \frac{5400}{312} = 17.31 \text{ ft.}$$

$$S = 1/10800$$

$$N_m = \frac{1.486}{9.26} (17.31)^{2/3} \frac{1}{(10800)^{1/2}}$$

$$= \frac{1.486}{9.29} \times 6.7 \times \frac{1}{103.95}$$

$$= \frac{0.1605 \times 6.7}{103.95}$$

$$= 0.01034$$

The quantity of excavation would be = 5400 × 13,500
= 72,900,000 cft.

Assuming a low rate of excavation of Rs. 30/- per 1000 cft. of soft wet soil

The total cost of excavation will be Rs. 21,87,000

To this the cost of lining will have to be added which, at Rs. 30/- per 100 sq. ft., would cost another Rs. $312 \times 13,500 \times \frac{30}{100} = \text{Rs. } 12,63,600$

(b) *The design of embankment.*

The top of embankment will be 25 ft. above K.O.D.S.

Area of land reclaimed will be 2, 100,000 sq. ft or about 50 acres.

Assuming the average depth of 10 ft. below K.O.D.S. within the reach of this proposed embankment, the quantity required for its construction will be = 2100000 × 35 = 73,500,000 cft.

This is slightly more than the quantity available from the excavation of the by-pass channel.

FIG.16 (a)&(b) SHOWING LINES OF FLOW IN

SERIES 1, $\frac{1}{125} : \frac{1}{90}$ HOOGHLY MODEL

$Q = 1.28 \approx 137,000$ C.S. CONTINUOUS EBB

WITH INJECTION (0.3 PARTS PER 1000)

W.L. AT SHAMNAGAR 15.9' ABOVE K.O.D.S.

Q IN BY-PASS CHANNEL (NOT REPRODUCED IN MODEL) $\approx 50,000$ C.S.

TOTAL $Q \approx 187,000$ C.S.

SCALE, $1'' = 8' \approx 1000'$

NO.5942
INDIAN WATERWAYS EXPT.
STATION POONA.

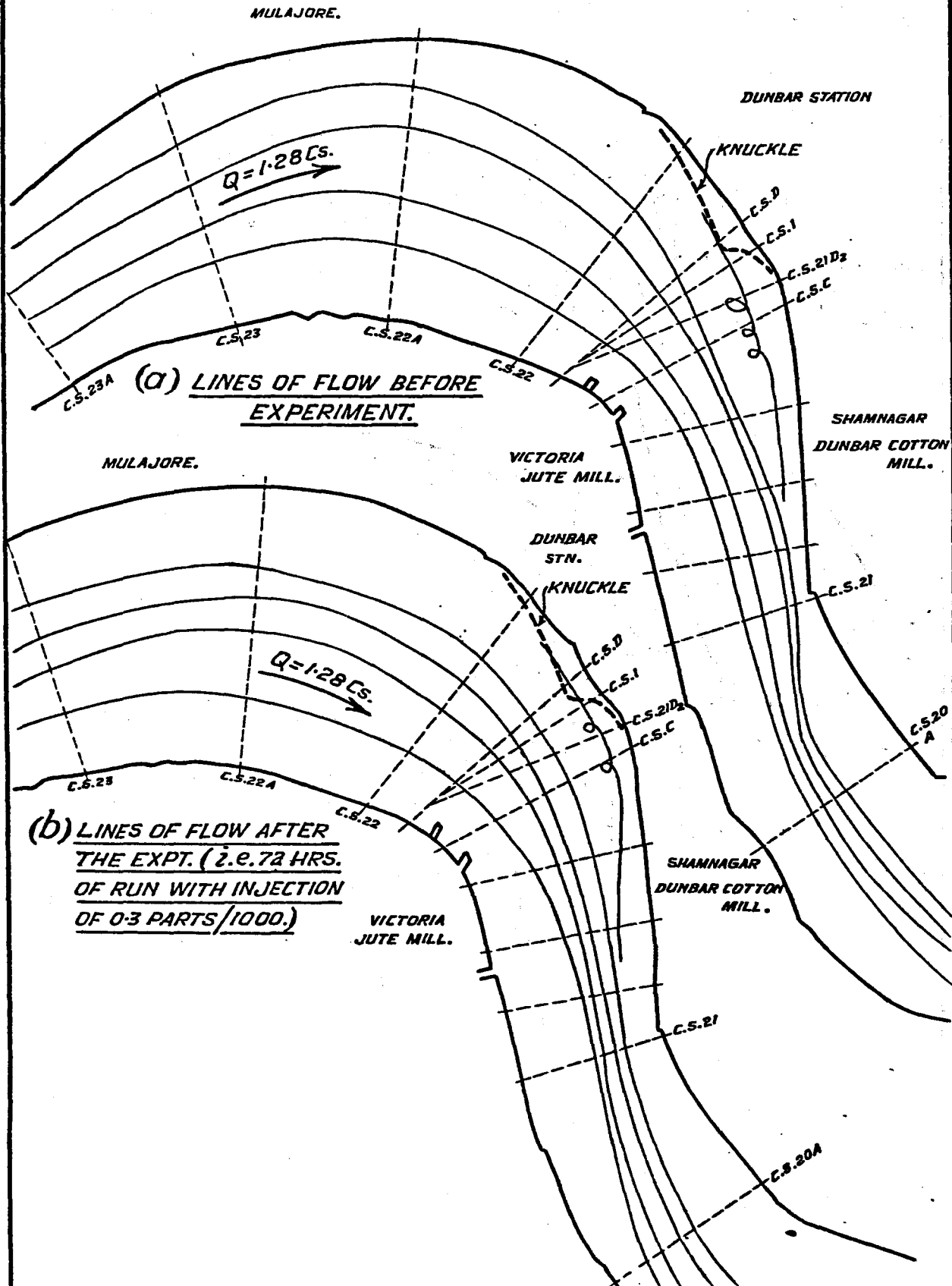

FIG:-16(c&d) BED CONTOURS IN SERIES I,
1/125:1/90 HOUGHLY MODEL. CONTINUOUS EBB.

$Q = 1.28 \text{ Cs.} \approx 137,000 \text{ Cs.}$

BY-PASS CHANNEL (NOT REPRODUCED
IN THE MODEL.)

$Q = 50,000 \text{ Cs.}$ TOTAL $Q \approx 187,000 \text{ Cs.}$ W.L. AT SHAMNAGAR $\approx 15.9 \text{ FT.}$

ABOVE K.O.D.S.

Scale:- 1" = 8 FT. $\approx 1000 \text{ FT.}$

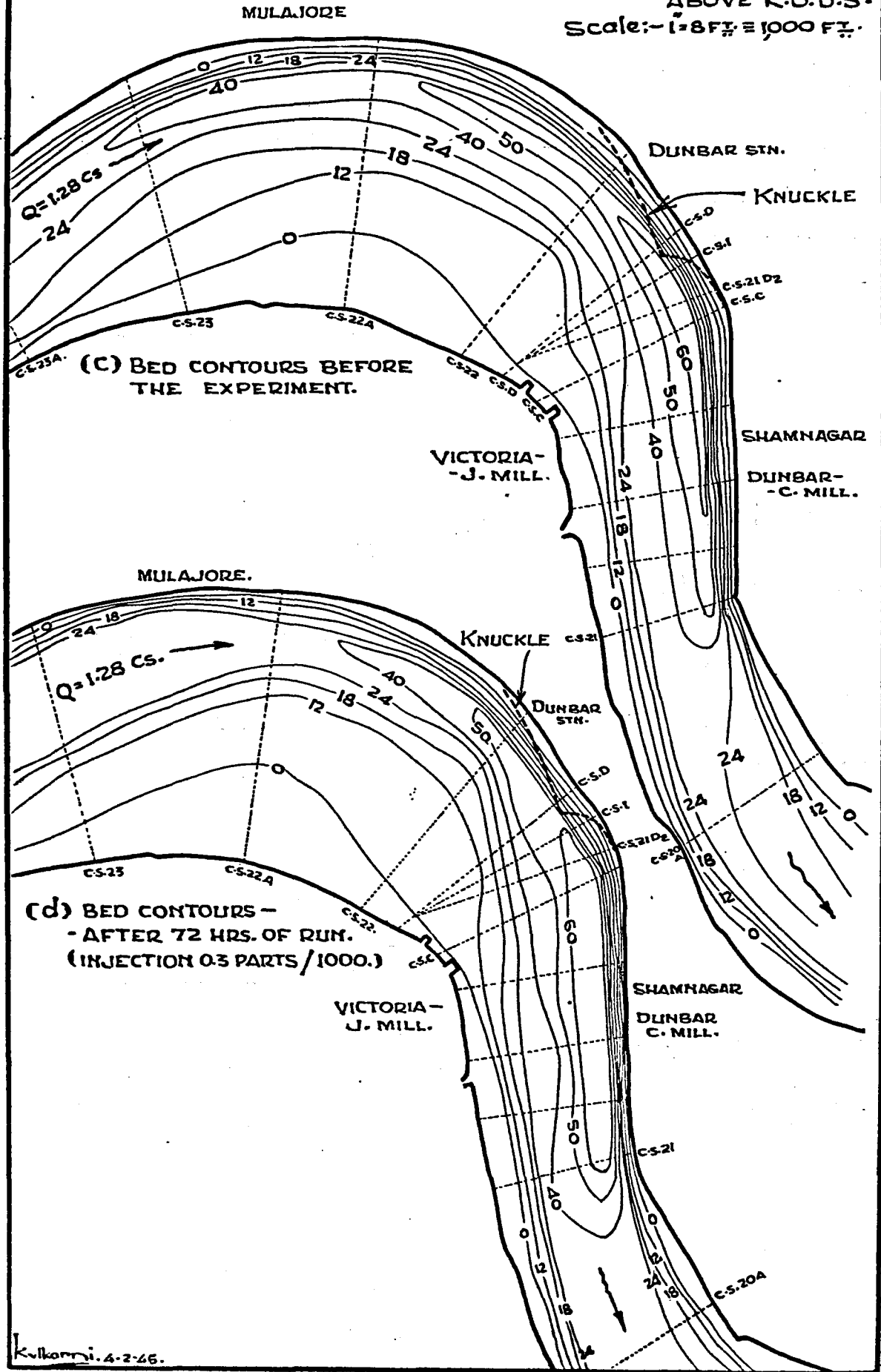

Kulkarni. 4-2-66.

FIG. 16 (e)
CROSS SECTION 21 D₂
AFTER 24 HOURS RUN.
SCALE:- HOR: 1" = 5' = 62.5 FT.
VER: 1" = 5' = 45 FT.

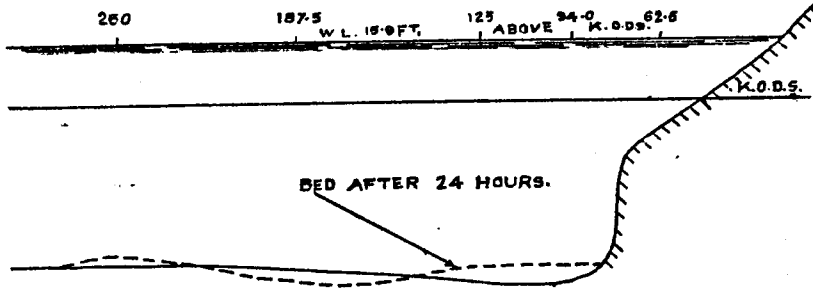

CHAINAGE.	DEPTHS BELOW K.O.S. AS OBTAINED.	DEPTHS BELOW K.O.S. AS LAID.	AMOUNT OF ACCRETION.
94	41.4	44.1	+ 2.7
125	42.3	45.9	+ 3.6
188	45.0	42.3	- 2.7
250	38.7	40.5	+ 1.8

FIG. 16 (f)
CROSS SECTION 21 D₂
AFTER 48 HOURS RUN.
SCALE:- HOR: 1" = 5' = 62.5 FT.
VER: 1" = 5' = 45 FT.

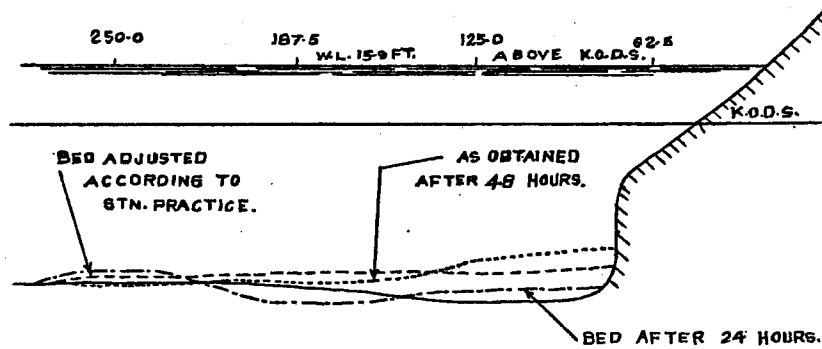

CHAINAGE.	DEPTHS BELOW K.O.S. ADJUSTED.	DEPTHS BELOW K.O.S. AS OBTAINED.	AMOUNT OF ACCRETION.
94	35.1	31.5	+ 3.6
125	36.0	33.3	+ 2.7
188	37.8	40.5	- 2.7
250	37.8	39.6	- 1.8

FIG. 16 (g)
CROSS SECTION 21 D₂
AFTER 72 HOURS RUN.
SCALE:- HOR: 1" = 5' = 62.5 FT.
VER: 1" = 5' = 45 FT.

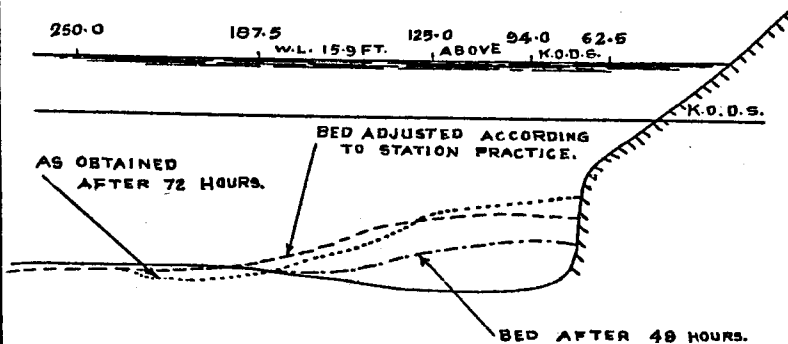

CHAINAGE.	DEPTHS BELOW K.O.S. ADJUSTED.	DEPTHS BELOW K.O.S. AS OBTAINED.	AMOUNT OF ACCRETION.
94	25.2	21.6	+ 3.6
125	26.1	25.2	+ 0.9
188	37.8	40.5	- 2.7
250	40.8	42.3	- 1.5

FIG. 17
SERIES-II
EMBANKMENT AND
BY-PASS CHANNEL (NOT REPRODUCED IN MODEL.)
 RIVER $Q = 128 \text{ CS.} \approx 137,000 \text{ CS.}$
 BY-PASS CHANNEL $Q \approx 50,000 \text{ CS.}$
 TOTAL $Q \approx 187,000 \text{ CS.}$
 W.L. AT SHAMNAGAR $\approx 16.05 \text{ FT. ABOVE K.O.D.S.}$
 SCALE: $1'' = 1000' \approx 8 \text{ FT.}$

(a)
 LINES OF FLOW
 AFTER 48 HOURS OF RUN.

(b)
 BED CONTOURS
 AFTER 48 HOURS OF RUN.

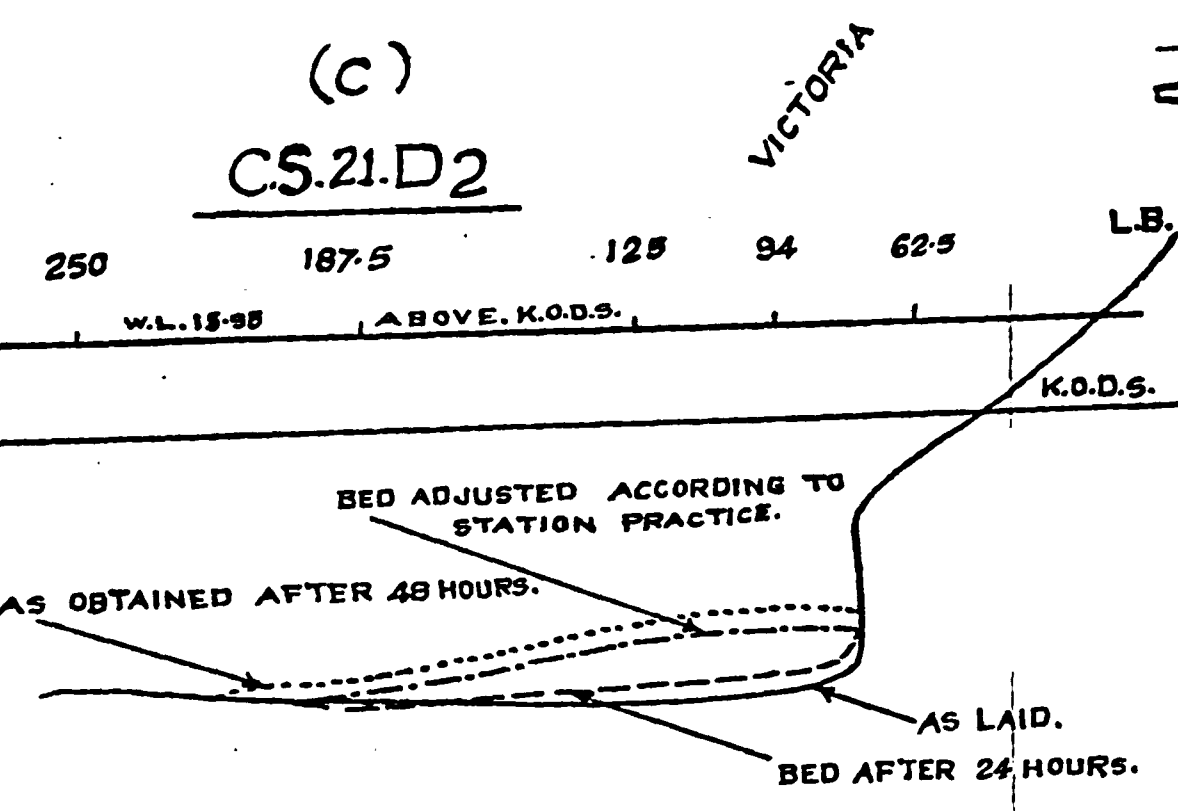
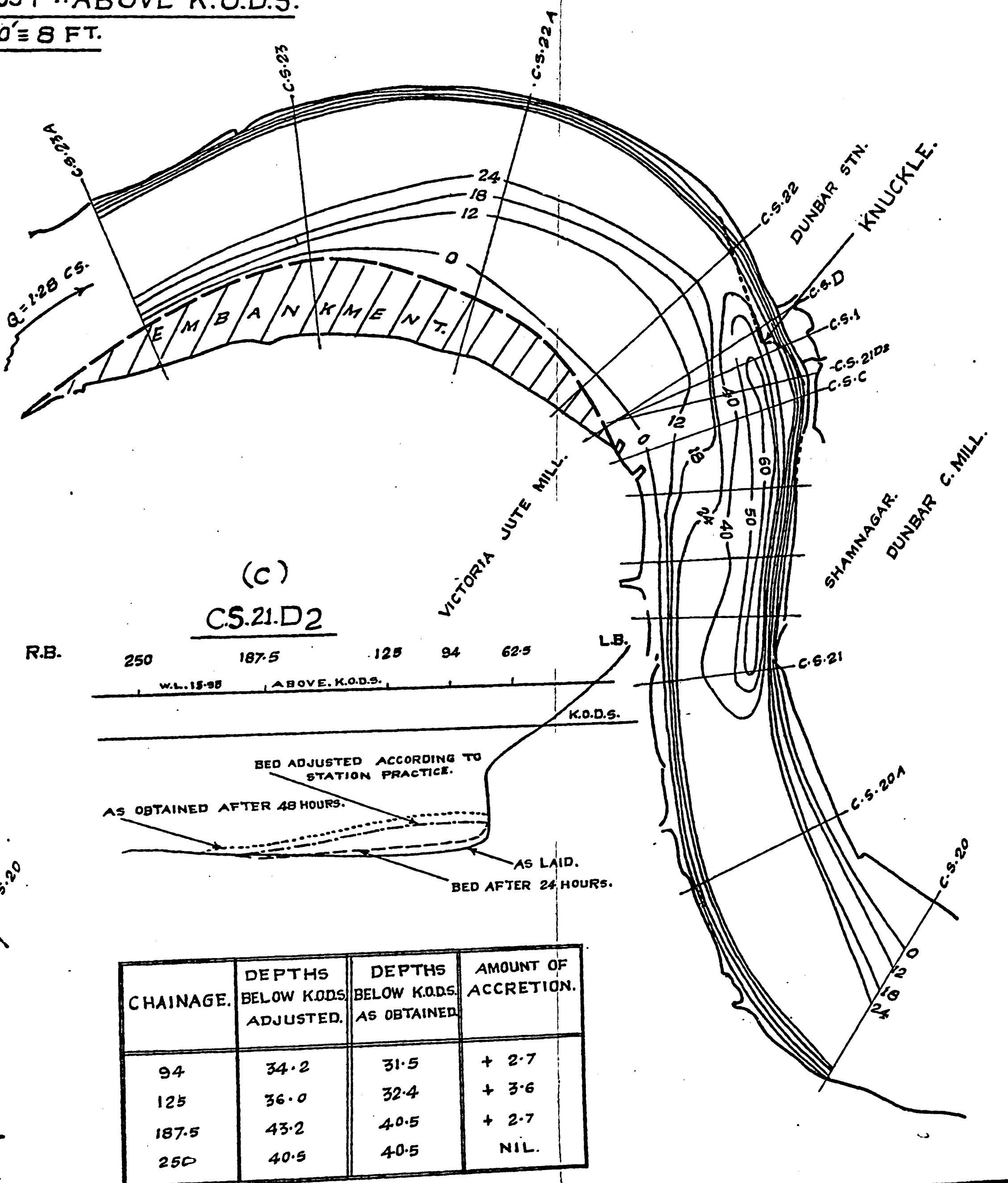
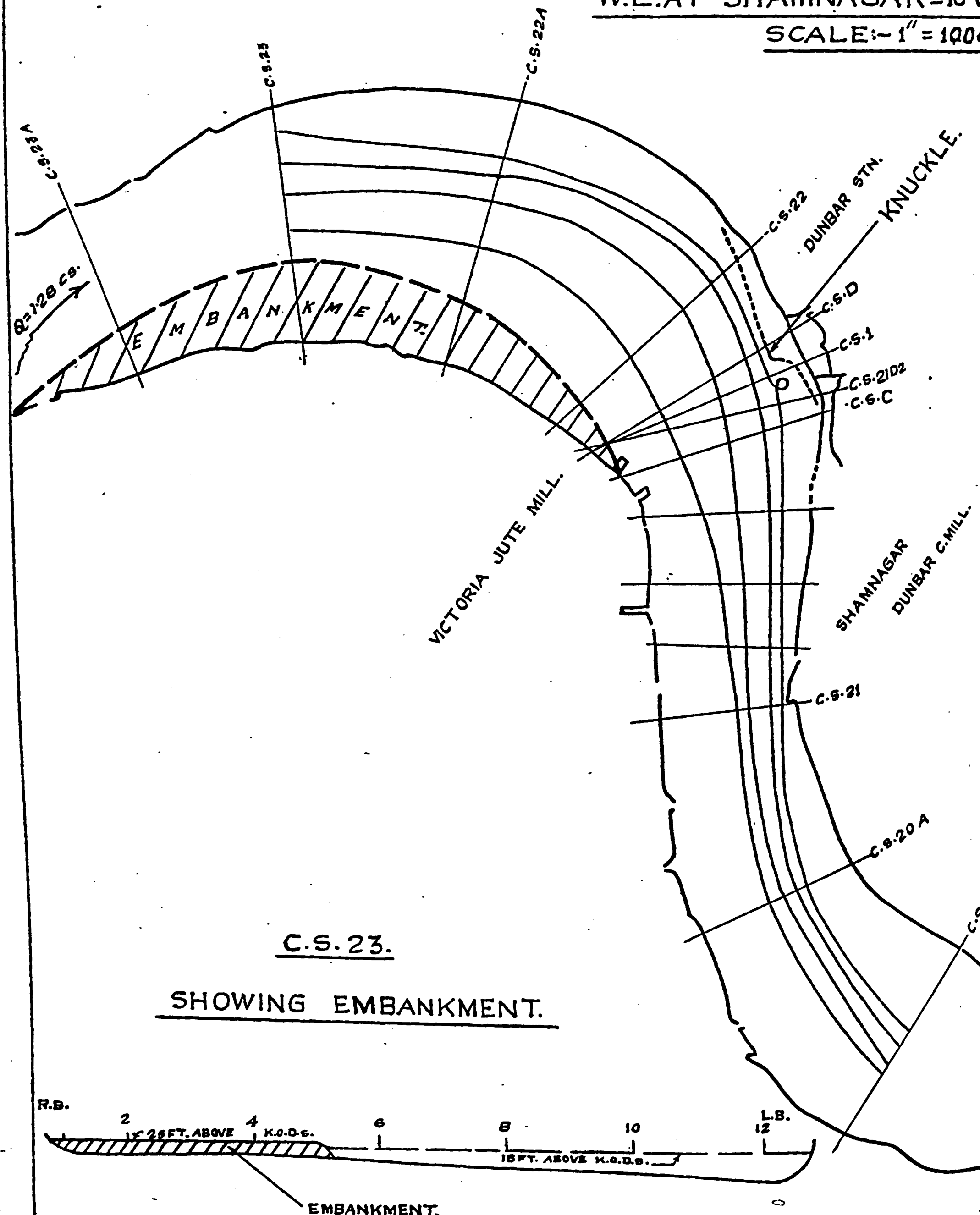

CHAINAGE.	DEPTHS BELOW K.O.D.S. ADJUSTED.	DEPTHS BELOW K.O.D.S. AS OBTAINED.	AMOUNT OF ACCRETION.
94	34.2	31.5	+ 2.7
125	36.0	32.4	+ 3.6
187.5	43.2	40.5	+ 2.7
250	40.5	40.5	NIL.

RIVER CONTROL

(i) "FLOOD CONTROL"

Experiments with a vertically-exaggerated Model (1/400, 1/66) of the Mahanadi and its branches at Cuttack (Orissa).

(1) *Introduction:—*

A preliminary note dealing with the history of the case, its diagnosis and anticipated treatment, etc. has already been published (q.v.)⁽¹⁾

Figure 18 is a plan of the Mahanadi and its group of branching rivers as they existed in 1838-42 and fig. 19 shows the condition in 1930, i.e. 62 years after the Naraj weir was constructed. It will be seen that the right bank of the Katjuri from Naraj down to the Kuakhai head has been considerably eroded with concurrent deposition of sand on the left bank. This process has been going on apparently for more than 100 years; so that though the Katjuri still flows along the revetment to the south of Cuttack, yet the main flow upstream, has been swinging more and more to the south (vide fig. 19 dotted lines).

Fig. 18
& 19

The Birnasi spill, which at one time flowed from the Mahanadi into the Katjuri, except at high flood, now flows from the Katjuri into the Mahanadi, at all flood stages, inspite of the Jobra Anicut.

These facts indicate that the crux of the problem is the deterioration of the Katjuri below Naraj; by which is meant that a much heavier load of sand is entering the Katjuri at Naraj weir than the river can carry. Water levels, unless examined over a long period, may not show up this deterioration; because water levels do not rise steadily, but by jumps at long intervals — when a critical condition is reached; further, the Banki Road Spill helps to keep down the water levels. But, the erosion of the right bank with accretion of sand on the left which is steadily taking place, is an unmistakable sign of this deterioration of the Katjuri.

To reduce this deterioration it appears necessary—

- (a) to increase the carrying capacity of the Katjuri by preventing spilling of the water out of the Katjuri on either bank above Cuttack; i. e., by stopping the Banki and Birnasi spills;
- and/or (b) to reduce sand entry into the Katjuri at Naraj weir by reducing the discharge of the Katjuri at Naraj.

(2) *Distribution of discharge in the rivers:—*

The crest of the Naraj weir is at R. L. 72.60. When the water level at Jobra falls below R. L. 67 the crest shutters are raised to maintain that level: at this stage the corresponding water level at Naraj is R. L. 71.0. It follows, therefore, that on a rising flood, initially the whole flood passes down the Mahanadi till the water level at Naraj rises to R. L. 72.6, when Katjuri begins to flow. As the river rises further, the discharge over the Naraj weir increases, till at about 6 lakhs cusecs flood above Naraj Katjuri draws 70 per cent of the flood while the Mahanadi takes only 30 per cent. As the floods rise further, the percentages tend to equalise: and with a 15 lakhs cusecs total flood, the percentage of discharge in the Katjuri is 56 per cent.

(3) *Standing wave conditions at Naraj weir:—*

When the water level upstream of the Naraj weir is at R. L. 75.28, there is a clear standing wave all across the weir. As the floods increase, the standing wave near the right end gets drowned; and the length of smooth flow when the wave is drowned goes on increasing till, at peak flood, the weir is drowned throughout its length. As the floods fall after the peak has passed, sand deposits on the weir; and the length of the clear standing wave is relatively shorter than when the flood is rising.

(1) Annual Report (Tech.) of work done during the year 1943. Pages 37 to 39.

(4) The model :—

The model extended from Goil bank to a mile below the Jobra weir. The extents of the various branches reproduced in the model were as shown by broken lines in fig. 19.

The scale ratios of the model were :

L scale = 1/400
d scale = 1/66
Q scale = 1/160,000
V. E. = 6.06

Slope exaggeration = Bed slope exaggeration = 5.00

It was not possible to reproduce correctly the standing wave conditions at the Naraj weir in the model : firstly, because for it to form, the model required a relatively bigger loss of head due to relatively greater drag ; hence less depths downstream of the weir which meant steeper slopes, which would have caused excessive bed movement. Secondly, the scour produced in the Naraj gorge was relatively elongated, and extended much too far downstream in the model. This was because the model was vertically exaggerated six times, whereas the angle of repose of bed sand was not. In addition, a very small error in water level in the model just above the Naraj weir caused a relatively large error in the distribution of discharge in the Mahanadi and Katjuri. And, finally, though Naraj weir is at the same level all across, in the model it had to be tilted to allow for longitudinal slope exaggeration.

These difficulties were overcome, so far as practicable, by making the bed upstream of the gorge semi-rigid to obtain suitable entry conditions; and the Naraj weir was given a longitudinal tilt by raising the upstream end by 0.079 ft. compared with the downstream Cuttack end. Excessive sand movement was reduced by making bed slope exaggeration ≈ 5 against vertical exaggeration = 6.06.

(5) Experiments :—

The following experiments were done, during the year, to test the qualitative effects of stopping the spills on the water levels in the Katjuri :—

Experiment 1 :—

With existing conditions: the model was run to stability with six flood cycles, each rising from 6 to 12 lakhs and falling back to 6 lakhs; in the final 7th cycle, the discharge was raised to a peak of 15 lakhs. The distribution of discharges obtained in the model compared satisfactorily with the distribution observed by Rhind in 1872.

Experiment 2 :—

With only Banki Road spill closed and a discharge cycle rising to 15 lakhs cusecs run to observe the effects of closing this spill. The Jobra gauge rose by 5" due to increased discharge through the Birnasi gap.

Experiment 3 :—

Photo 3021 With only Birnasi spill closed by an embankment on the left bank of Katjuri — photo 3021 —; the embankment ended in a spur pointing roughly 60° downstream. With 6 lakhs cusecs flood, the main high velocity surface flow followed the left bank of the Katjuri down to the nose of the groyne; from where it tended to concentrate on the Cuttack embankment at a point 1 mile below the Bellevue gauge — Fig 20 —. As the floods rose, this high velocity concentration moved towards mid-stream; and, with the embankment in position, the Bellevue gauge was in back water.

Fig. 20

Experiment 4 :—

Fig. 21 With both Banki Road and Birnasi spills closed. Fig. 21 shows the water levels at the Collectorate gauge in experiments 1 to 4. It will be seen that the afflux in experiment 3 was markedly less than in experiment 2; while in experiment 4 the afflux with 15 lakhs was nearly 4½ ft. Bellevue gauge which was masked by the bund recorded a rise of 4 feet.

NO:-5466

INDIAN WATERWAYS EXPERIMENT STATION
POONA.

FIG. 18
MAHANADI RIVER COURSE
IN 1838 - 1842
SCALE:-2"=1 Mile.

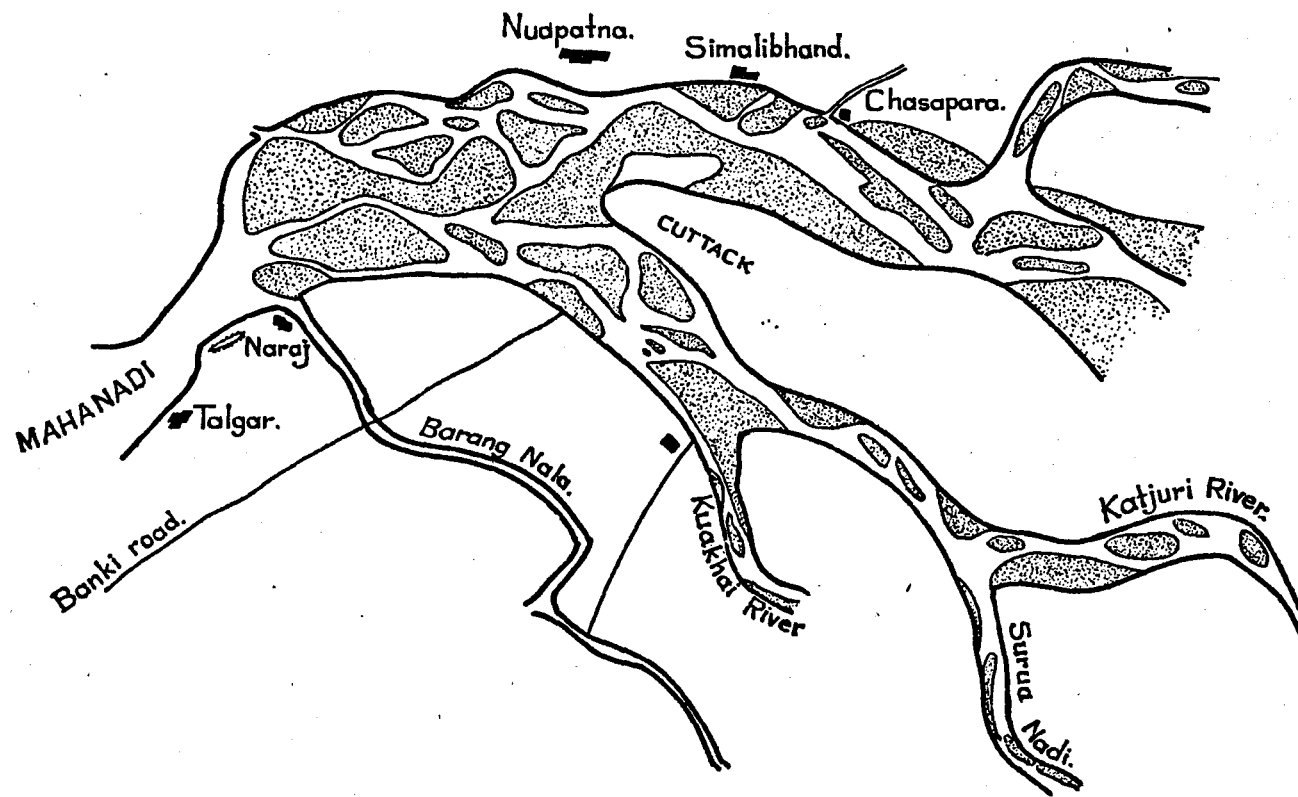

BY:- PARKHI.P.D.
23-5-45.

FIG. 19

PLAN SHOWING
MAHANADI & ITS BRANCHES
AT CUTTACK
1930

SCALE 1" = 2 MILES

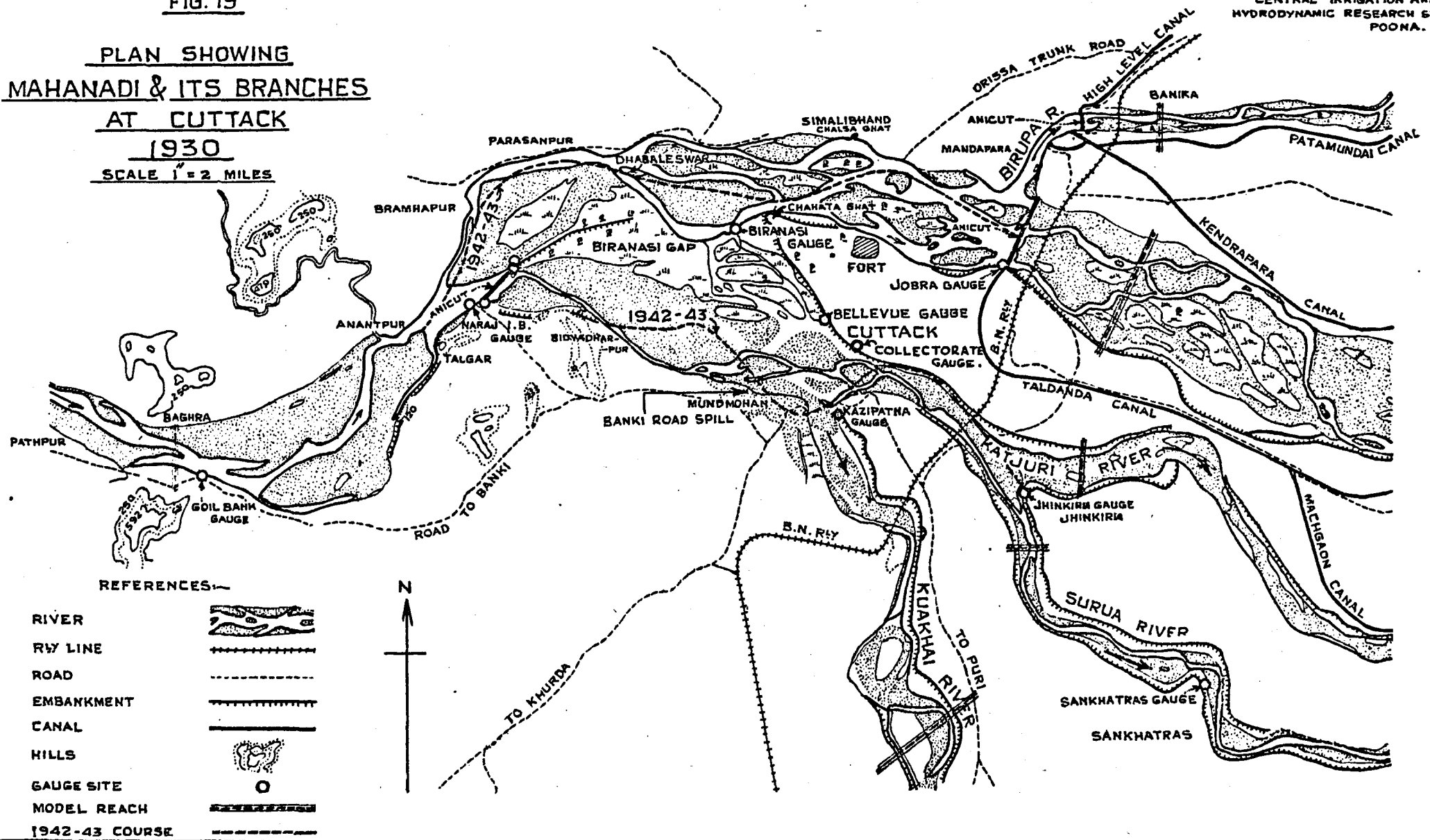

REFERENCES:-

- RIVER
- RW LINE
- ROAD
- EMBANKMENT
- CANAL
- HILLS
- GAUGE SITE
- MODEL REACH
- 1942-43 COURSE

**Experiments with 1/400, 1/60 model of the Mahanadi
and branches at Cuttack (Orissa)**

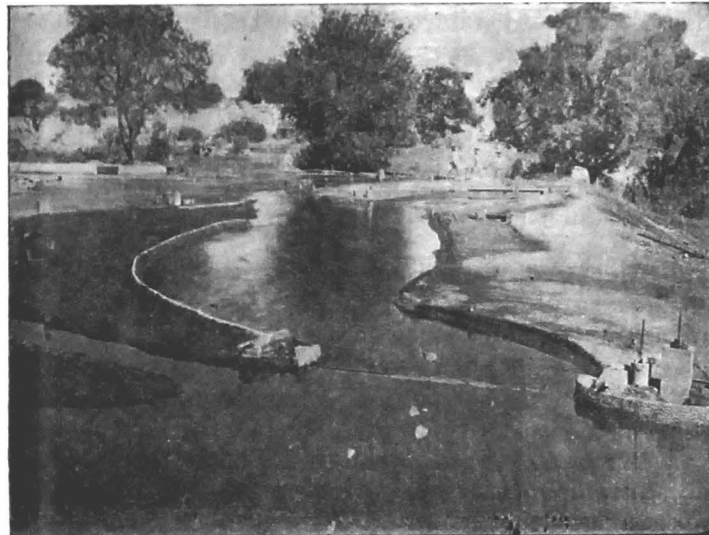

3021

Photo looking
downstream,
showing the
embankment
and spur las
tested in ex-
periment 3.

←Naraj weir.

Mahanadi→

↑
Katjuri (in foreground downstream
of Naraj weir).

Experiment 5:—

With the Banki Road and Birnasi spills closed, the waterway of the Naraj weir was reduced from the right end, so as to obtain the same water levels as at present (vide expt. 1) at the peak flood (15 lacs cusecs). This could be achieved by reducing the Naraj weir waterway by 35 per cent, thus diverting an additional 1.5 lakhs cusecs into the Mahanadi below Naraj. This, however, caused an afflux of 1.38' at the Jobra weir. As this rise in water level may be considered objectionable, a 25 per cent contraction of the Naraj waterway was tried; the Jobra gauge then recorded a rise of 8" and Katjuri gauge of 10" at the peak flood. With 12 lakhs cusecs flood, however, there was no appreciable afflux in the Katjuri.

6. Conclusions:—

(1) Experiments showed that, with a peak flood of 15 lakhs cusecs, closing off the Banki spill would cause a rise of 3.5 ft. in the Katjuri water levels; and the rise following the closing of Birnasi spill would be markedly less, viz. 1 ft. at peak flood.

(2) If an embankment ending in a spur pointing 60° downstream were constructed on the left bank of the Katjuri below Naraj weir, the river would develop a channel towards the Collectorate gauge.

(3) Before closing off any spills, it is apparently necessary to reduce the waterway of the Naraj weir so as to maintain substantially the same water level in the Katjuri as at present, at the peak flood of 15 lakhs cusecs. This would increase the discharge of the Mahanadi by 1.5 lakhs cusecs, but would cause a rise of 1.38 ft. at the Jobra gauge.

(4) If a rise in water levels of about 8" is permissible on both sides of Cuttack, the Naraj weir length would require to be reduced by 25 per cent.

10. Experiments to determine a suitable Profile of the Lower Sind Barrage to cause minimum afflux with gates fully open.

(1) Object.

The object of the experiments was to ascertain a suitable profile for the proposed Lower Sind Barrage at Hajipur. This involved the determination of the following:—

(1) What is a suitable upstream slope of the glacis? Whether any curve for the upstream slope will improve the coefficient of discharge and reduce the afflux.

(2) To determine a suitable downstream slope of the glacis.

(3) To determine the optimum combination of upstream and downstream glacis slopes.

(4) To determine the coefficient of discharge at all stages of flow.

(2) Why alterations were made in the old design.

Originally the upstream pavement level of the weir was R.L. 34, crest level R.L. 40 and cistern level R.L. 30. The length of crest (in line of flow) was 6'.

In the new design, proposed by the Project Division, Sind, the upstream R.L. was changed to 36, crest R.L. to 42, and cistern level to 28. Crest length was maintained the same.

The reasons for altering the design were summed up as follows:

"The original design suffers from the following defects:—

(i) The barrage is too loose in waterway with the result that it would remain permanently gated for all practical discharges that are likely to come.

(ii) The cistern bed level required for the undersluices to hold the standing wave would be very low, viz. R.L. 26.7, while the lowest cistern that is desirable from practical considerations and difficulties during construction should not be lower than R.L. 28."

In order to determine the coefficient of discharge and the scale effect under different conditions, experiments were carried out with geometrically-similar models to three different scales.

FIG. 20.
MAHANADI
SHOWING LINES OF FLOW WITH THE EMBANKMENT ON LEFT BANK
OF
KATJURI RIVER BELOW NARAJ & A GROVNE TESTED
IN EXPT. 3
SCALE - 1" = 8000' (PROTO) 1" = 20' (MODEL)

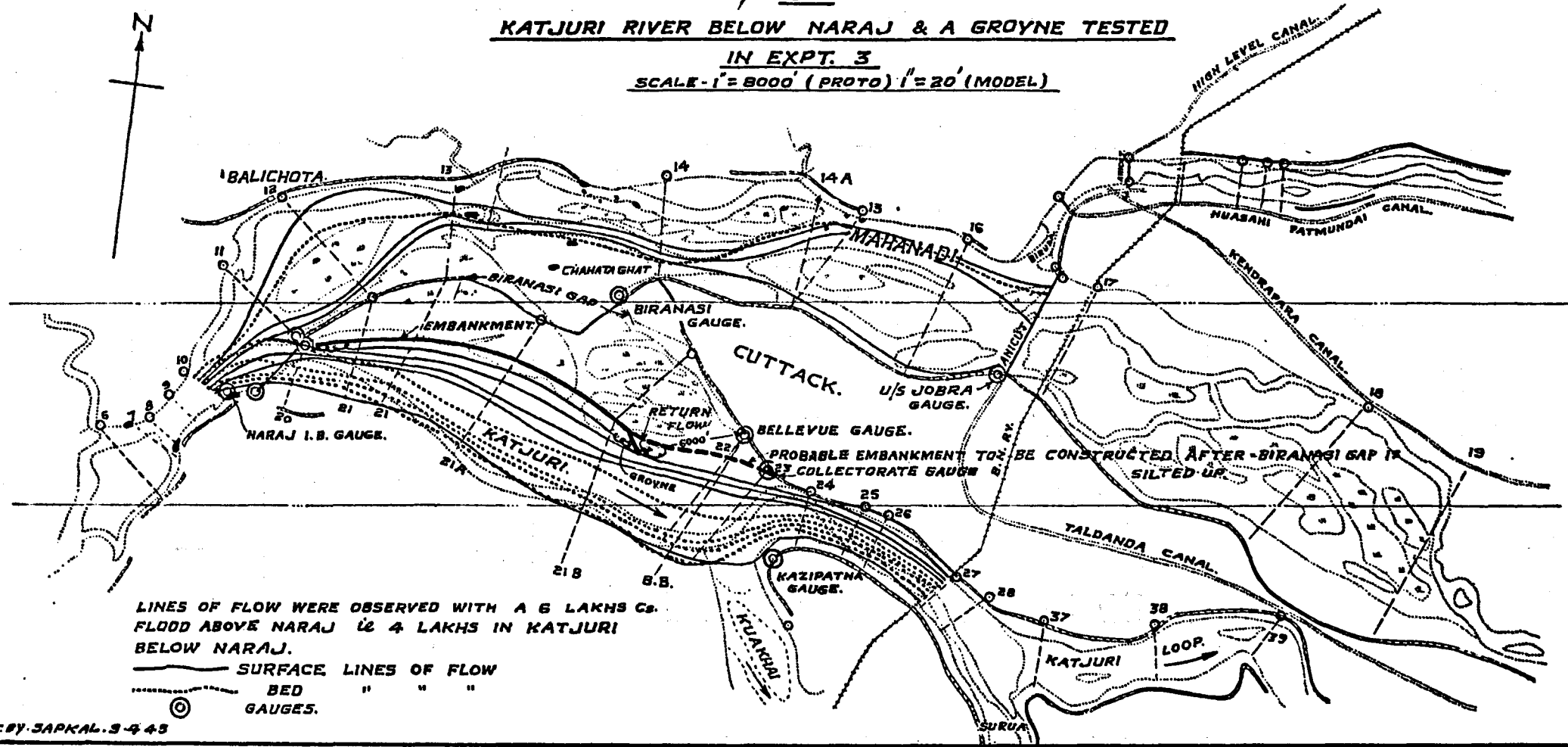

LINES OF FLOW WERE OBSERVED WITH A 6 LAKHS C.C. FLOOD ABOVE NARAJ & 4 LAKHS IN KATJURI BELOW NARAJ.
 ——— SURFACE LINES OF FLOW
 - - - - - BED " " "
 ⊙ GAUGES.

T. BY SARKAL. 3-4-43

COLLECTORATE GAUGE.

FIG. 21

NO. 5978.
I.W. EXPT. STN. POONA.
(FIG. 21. FROM A.R.T.
1945 OF I.W. E. STY.)

SHOWING W. L. OBSERVED AT
THE COLLECTORATE GAUGE ON SOUTH
SIDE OF CUTTACK.

- EXPT. WITH EXISTING CONDITIONS.
- x——— " " BANKI ROAD SPILL CLOSED.
- △——— " " BIRNASI SPILL CLOSED.
- BOTH SPILLS CLOSED.

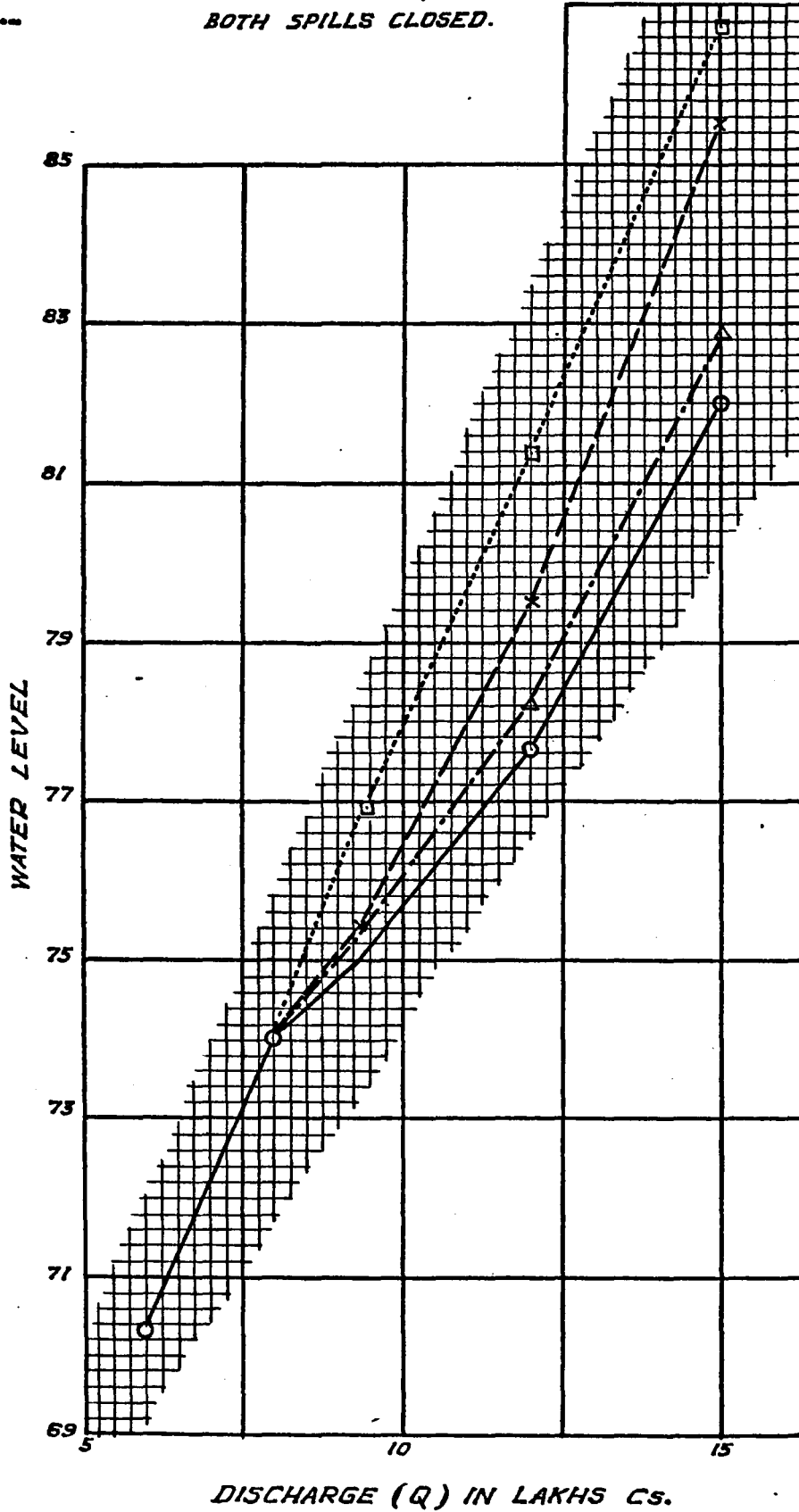

By. Parkhi
23/2/46

(3) *Description of the 1/50 geometrically-similar model.*

A 1/50 scale, geometrically-similar model of the Lower Sind Barrage weir, with smooth cement finished surface, was constructed in the 4.5' wide, right bank, parallel sided, flume. Fig. 22 shows the position of piers, bed levels, crest level and crest length. The model consisted of three spans, each of $1.2' \approx 60'$. The width of the pier was $0.14' \approx 7'$ and its overall length was $1.44' \approx 72'$. Length of crest in line of flow = $0.12' \approx 6'$. It was anticipated that the side walls would affect the distribution of velocities upstream, due to the retardation of velocity near the walls⁽¹⁾. This was reduced by literally contracting the flow, a short distance upstream as shown in Fig. 22. The effect of contraction in equalising velocity⁽²⁾ is well known. The effect of retardation of flow by the side walls between the bell-mouth and the weir, however, still remained.

Fig. 22.

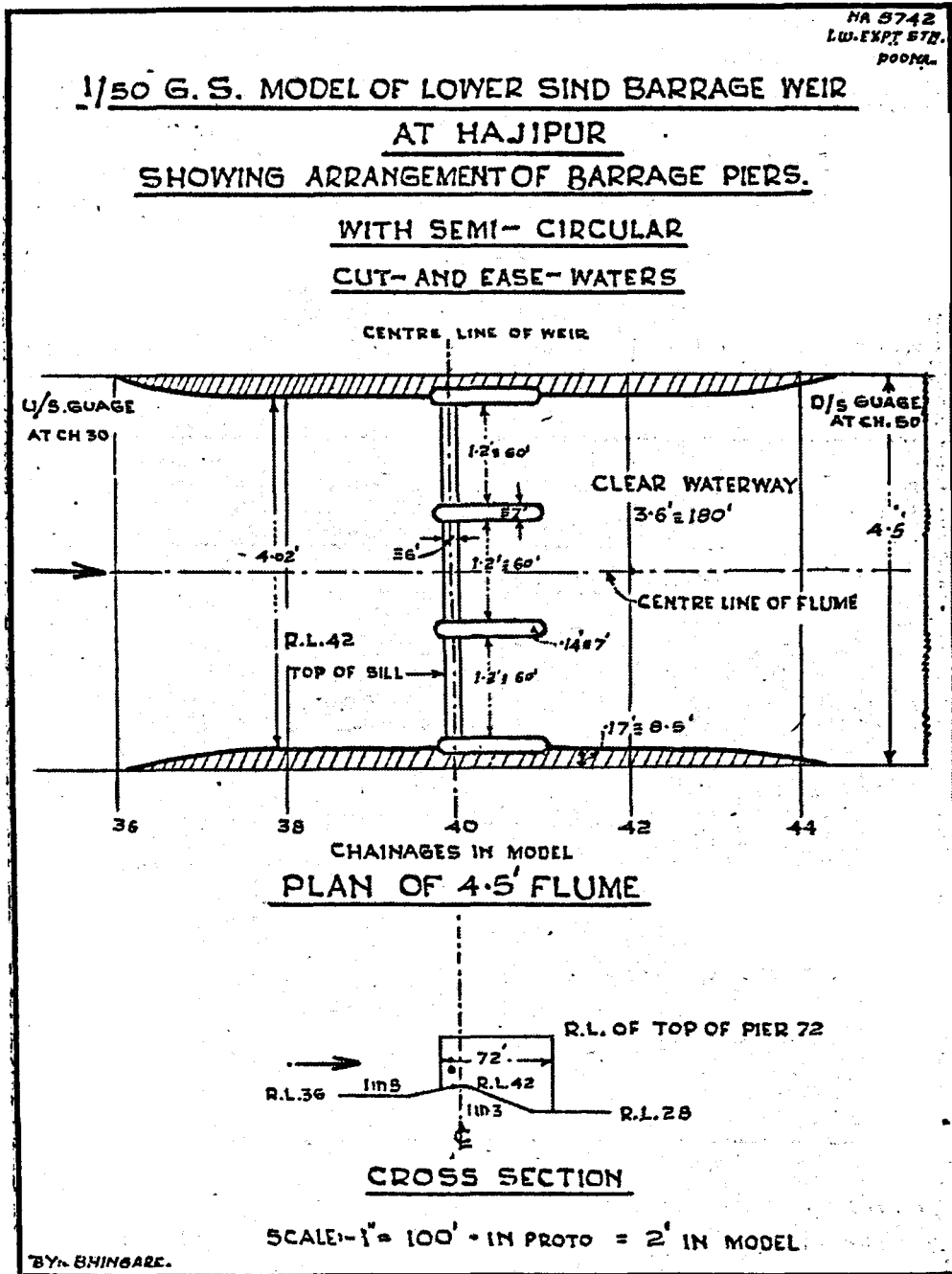

Fig. 22

(1) Annual Report (Technical) 1940-41 (P. 42, 43).

(2) H. Rouse "Fluid Mechanics for Hydraulic Engineers" 1938, p. 263.

Another anticipated effect of side walls was the retardation of velocity of flow over the wier⁽¹⁾. In order to offset the effect of this retardation in increasing the velocity away from the wall, the side walls downstream were given a very gradual divergence.

The piers were provided with semi-circular, cut-and ease-waters.

The scale ratio of the discharge intensity per running foot of the barrage was $(1/50)^{1.5}$, i. e. $1/353$, and the discharges passed through the model were equivalent to 300,350, and 420 cusecs/ft intensity in the prototype, i. e. corresponding to a total discharge of 750,000 cs., 850,000 cs., and 850,000 cs. with 20 per cent concentration in midstream, respectively; it was assumed that the canals would be closed and pocket sluices and barrage gates would be fully open after the discharge is equal to or greater than 550,000 cusecs.

Groove casting and gate recesses were reproduced to scale.

(4) Profiles tested.

The following profiles were first compared :-

- (1) 1 in 3 upstream slope and 1 in 5 downstream slope.
- (2) 1 in 5 upstream slope and 1 in 3 downstream slope.

Of these two, the latter gave better results in respect of afflux and coefficient of discharge. In the present series of experiments, therefore, tests have been carried out only with 1 in 5 upstream slope; and the results of 1 in 3 downstream slope have been compared with those obtaining with a free parabolic downstream glacis slope. The profile of the latter was shaped to the under-surface of a freely discharging jet, with a discharge corresponding to the normal maximum flood of 600,000 cs. as shown in figure 23; the toe of the glacis was given a reverse curve of $R = 11$ ft.

Fig. 23

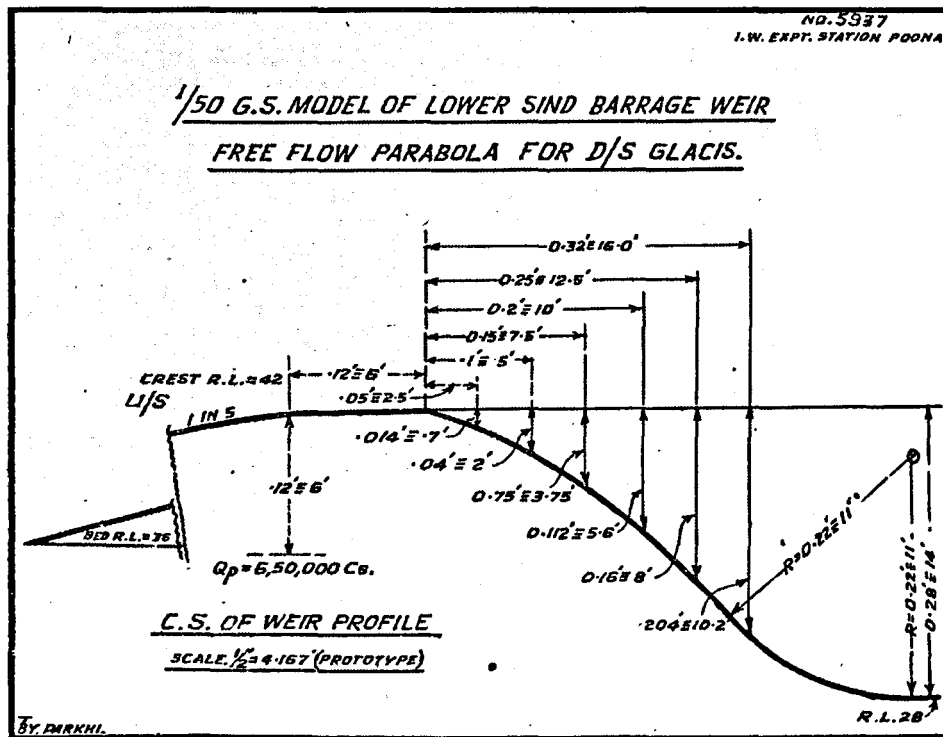

Fig. 23

(5) Weir formulas.

The discharging capacity of a weir of infinite width may be represented by the dimensionless coefficient C_1 in the equation

$$q = C_1 \sqrt{2g} D^{1.5}$$

where q = rate of discharge per ft. width and D = equivalent still pond depth

(1) Annual Report (Technical) 1940-41 (P. 42, 48).

upstream above the weir crest level. It is, however, more convenient to eliminate g by using the coefficient $C = C_1 \sqrt{2g}$ in the equation

$$q = CD^{1.5}$$

where C is *not* dimensionless. This formula has been used to find out the coefficient of discharge.

(6) Velocity head.

To obtain the true coefficient it was necessary to evaluate the equivalent head of the velocity of approach to the weir, which was added to the observed depth D_1 above the weir crest level to determine D , the total upstream energy head.

The mean velocity head on a cross section was taken as $x v^2/2g$, where x = correction factor varying with the height of the weir above the upstream bed, and v = mean velocity. An approximate value of 1.27 was assumed for x and hence the velocity head was assumed to be $1.28 v^2/64 = v^2/50$ approx. In subsequent experiments it is proposed to verify this assumption, or to obtain the values of x , and therefore of the velocity head, for various bed levels.

EXPERIMENTS WITHOUT & WITH GROOVE AND GATE RECESS FOR PIERS, SCALE 1/50.

(7) Procedure

Experiments were divided into two series. In the first, the piers were provided with neither groove casting nor gate recesses; in the second, these were introduced, to see their effect on the coefficient of discharge. Groove castings and gate recesses were found to have practically no effect with either free flow parabolic glacis or 1 in 3 downstream slope. An eddy formed in the groove but this had only a surface effect and did not affect the coefficient of discharge appreciably. Therefore, only the results obtained with the groove castings and gate recesses have been analysed below.

(8) Summary of results—

(i) *Coefficient of discharge* :- Fig. 24 shows the relationship between $C (= q/D^{1.5})$ and percentage loss of head $(= \frac{D_1 - D_3}{D_1} \times 100)$, where D_1 is the depth u/s over sill and D_3 " " " d/s " ") Fig. 24

Fig. 25 shows the curves of the comparative loss of head under the conditions specified. The following table shows the variation in the value of C , with different downstream water levels and with different discharges (with groove casting and gate recess for piers). Fig. 25

TABLE 4 (scale 1/50)

Qp	Downstream glacis slope	Range of d/s water levels +	Range of variation of C
(1)	(2)	(3)	(4)
7,50,000 cs.	1 in 3 free parabolic	R. L. 50 to 62 R. L. 50 to 62	3.17 to 2.80 3.175 to 2.61
8,50,000 cs.	1 in 3 free parabolic	R. L. 50 to 63 R. L. 50 to 63	3.18 to 2.90 3.215 to 2.69
8,50,000 with 20 per cent concentration	1 in 3 free parabolic	R. L. 50 to 67 R. L. 50 to 67	3.245 to 2.745 3.265 to 2.785
+ See note below table 7			

It is clear from this that the parabolic glacis gave only *slightly* better results than the 1 in 3 glacis.

As, however, it is likely to present constructional difficulties the small reduction in afflux due to the slightly better coefficient does not justify the adoption of the parabolic glacis in preference to the 1 in 3 glacis.

(ii) *Position of standing wave.*—Positions of the standing wave in the 1/50 geometrically-similar model for 8,50,000 cusecs discharge, and with minimum and maximum downstream water levels, are shown in photos 4018 & 4019. The wave formed well up on the glacis for the range of water levels given.

Similarly, in the 1/40 and 1/30 geometrically-similar Models the standing wave formed well up the glacis for the range of water levels tested.

(9) *Scale Effect.*

In order to determine the coefficient of discharge in the prototype by extrapolation for eliminating the scale effect, two more models to 1/40 and 1/30 scales were constructed and the whole procedure repeated. Their results are given in tables 5 & 6.

Note:—Ratio of number of piers : number of spans was maintained nearly the same in all experiments, as proposed in the prototype.

The models were two-dimensional, geometrically-similar replicas of the prototype, all dimensions being reduced in the same scale ratio except those of the surface roughness (smooth cement), which was as nearly uniform as could be obtained by hand finishing in all models.

An important feature disclosed by the experiments was that, under submerged conditions, the coefficient of discharge of a weir *decreases* with an increase of scale—instead of *increasing*, as it does due to the decreased viscous effect under free flow downstream. The reason for the smaller coefficient in the larger models under submerged conditions is that the region of return flow in the bed downstream of the weir is relatively bigger, the larger the scale⁽¹⁾: this results in less sharp a curvature of flow over the weir, a flatter pressure gradient in the direction of flow, and a lower coefficient in the larger models, despite the decreased viscous effect, which varies inversely with scale.

This is shown by the Figures 26 and 27 and tables 4, 5 and 6.

This observation is proposed to be verified in tests with widely varying scales for all degrees of submergence.

In all these experiments, submerged flow was obtained for downstream water levels exceeding R.L.50.0—which is much lower than the lowest water level expected at Hajipur for discharges > 750,000 cusecs—even allowing for retrogression.

For free flow, however, the coefficient of discharge increases with the size of the model, as shown in fig. 27(b), due to the decreased viscous effect.

Table 5 of results for 1/40 geometrically-similar Model.

Qp	Glacis slope downstream	Range of d/s water levels	Range of variation of C
(1)	(2)	(3)	(4)
7,50,000 cs.	1 : 3	R. L. 50 to 63	3.12 to 2.68
8,50,000 cs.	1 : 3	L. R. 50 to 63	3.14 to 2.85
8,50,000 cs. with 20 per cent. concentration.	1 : 3	L. R. 50 to 67	3.18 to 2.69

(1) Annual Report 1939-40, page 25.

NOTATION:-

- PERTAIN TO U/S SLOPE OF 1 IN 5 & FREE PARABOLIC GLACIS D/S
- - -△- - - " " " D/S SLOPE OF 1 IN 3.
- ALL PIERS PROVIDED WITH GATE RECESS &
GROOVE CASTING.

FIG. 24

1/50 G.S. MODEL OF LOWER SIND BARRAGE WEIR.
GRAPH SHOWING RELATIONSHIP BETWEEN 'C' THE COEFFICIENT
OF DISCHARGE IN FORMULA $Q = CD^{1.5}$ ALLOWING FOR
VELOCITY OF APPROACH AND % LOSS OF HEAD.

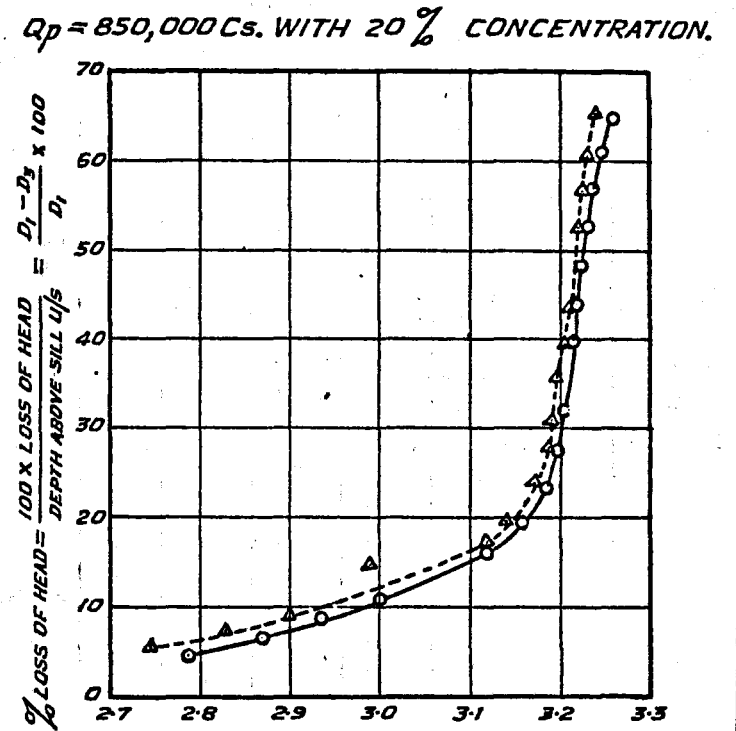
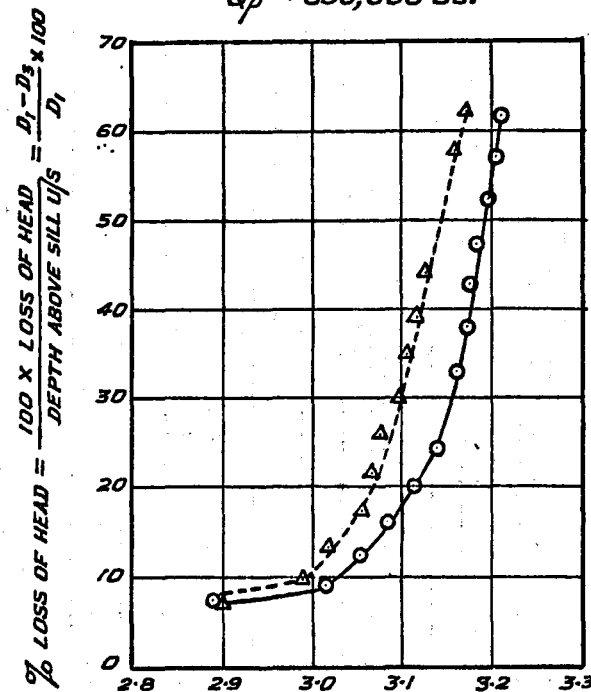
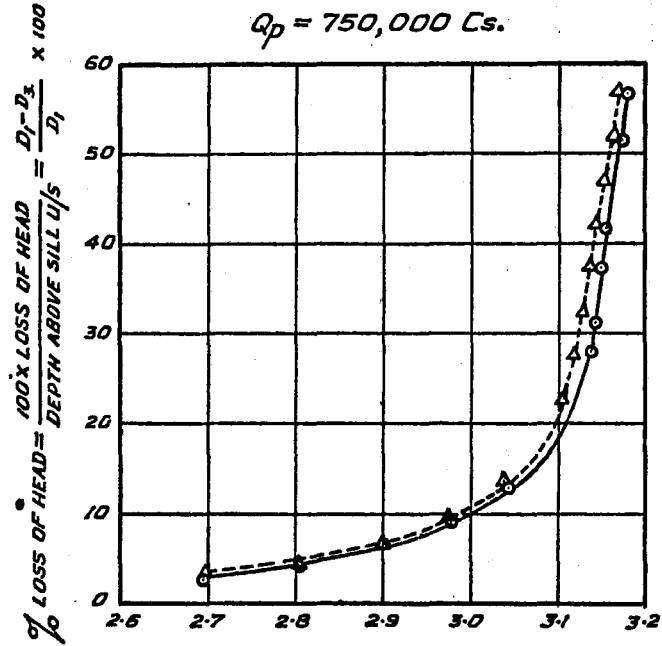

C THE COEFFICIENT OF DISCHARGE IN FORMULA $Q = CD^{1.5}$

NOTATION

○ PERTAIN TO 1/5 SLOPE OF IIN S & FREE PARABOLIC GLACIS 0/5
 △ " " " " 1/5 SLOPE OF IIN 3.

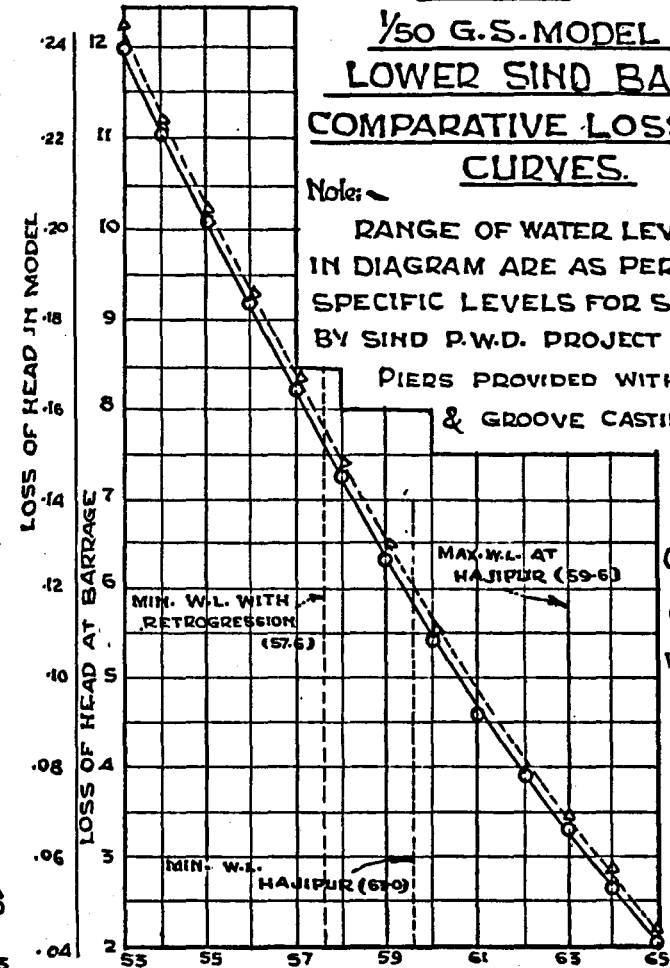
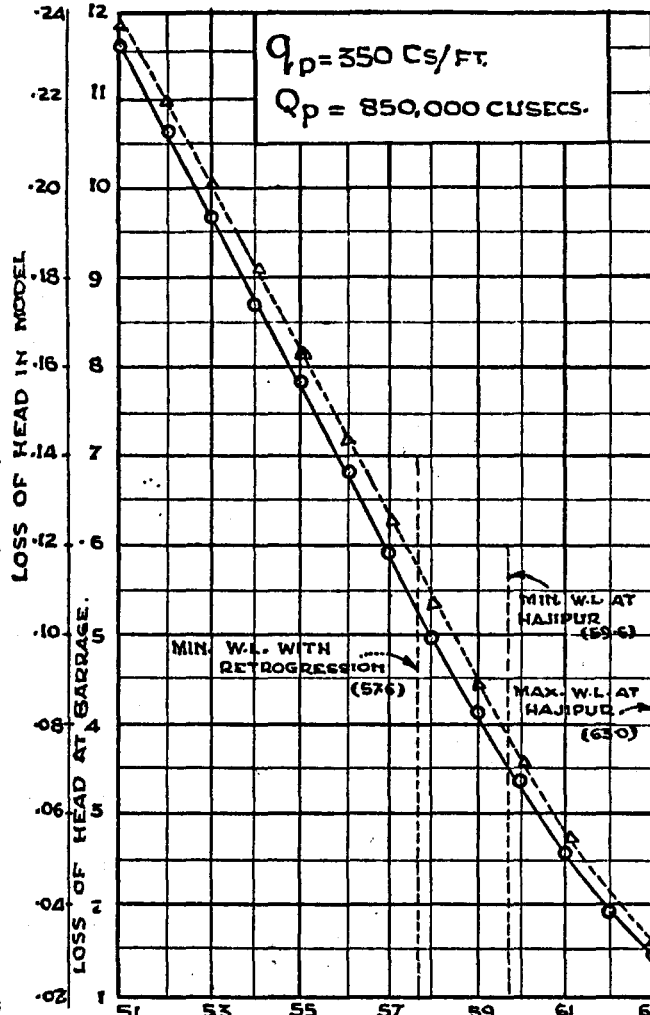
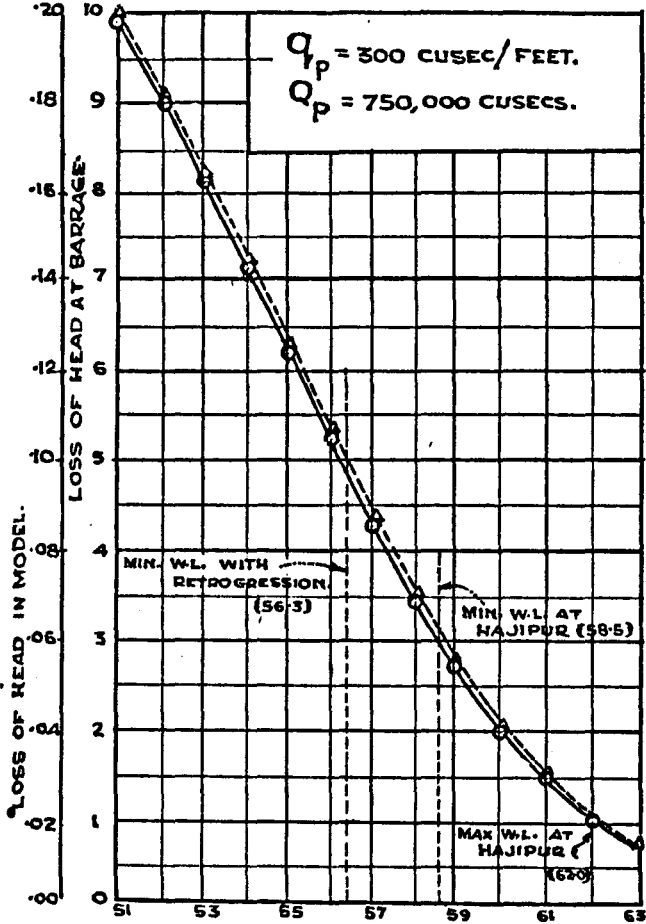

FIG.-25
 1/50 G.S. MODEL OF LOWER SIND BARRAGE.
 COMPARATIVE LOSS OF HEAD CURVES.

Note: RANGE OF WATER LEVELS SHOWN IN DIAGRAM ARE AS PER DATA OF SPECIFIC LEVELS FOR SITE B SUPPLIED BY SIND P.W.D. PROJECT DIVISION. PIERS PROVIDED WITH GATE RECESS & GROOVE CASTING.

△ D.L.S AT WHICH DOWNSTREAM WATER LEVELS WERE MAINTAINED.

Kulkarni 29/46.

FIG. 26.

G. S. MODELS OF LOWER SIND BARRAGE WEIR.
EFFECT OF DROWNING ON COEFFICIENT OF
DISCHARGE IN DIFFERENT SCALE MODELS.

REFERENCES:—

△	$\frac{1}{50}$	SCALE MODEL
⊙	$\frac{1}{40}$	" "
x	$\frac{1}{30}$	" "

U/S SLOPE 1 IN 5 & D/S SLOPE 1 IN 3

ALL PIERS PROVIDED WITH GROOVES FOR GATES

(a) $Q_p = 7,50,000$ CS.

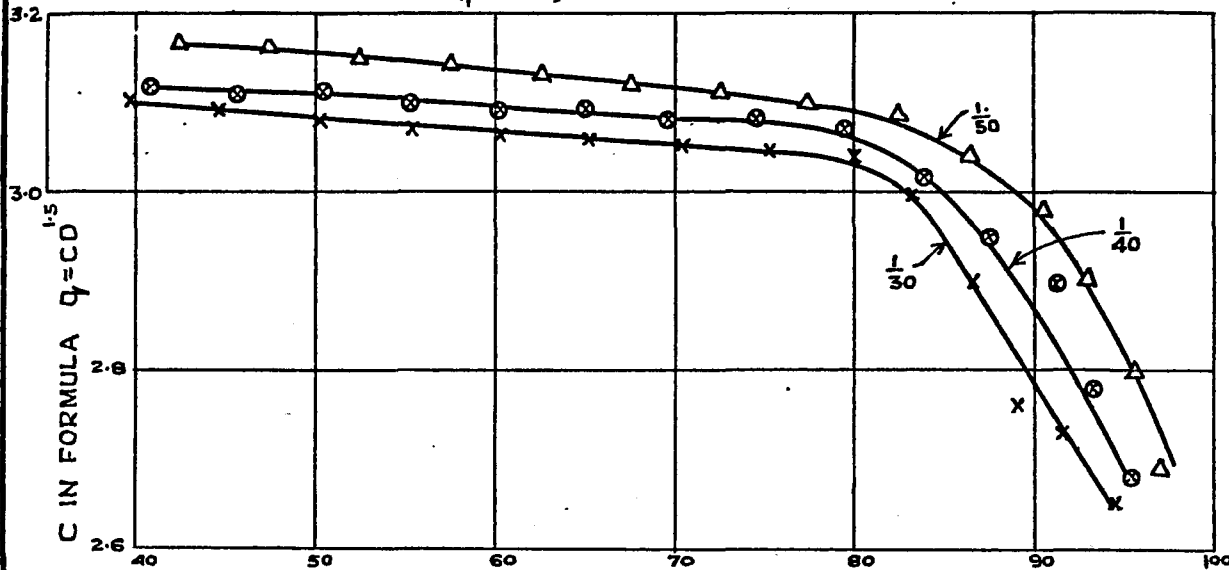

(b) $Q_p = 8,50,000$ CUSECS

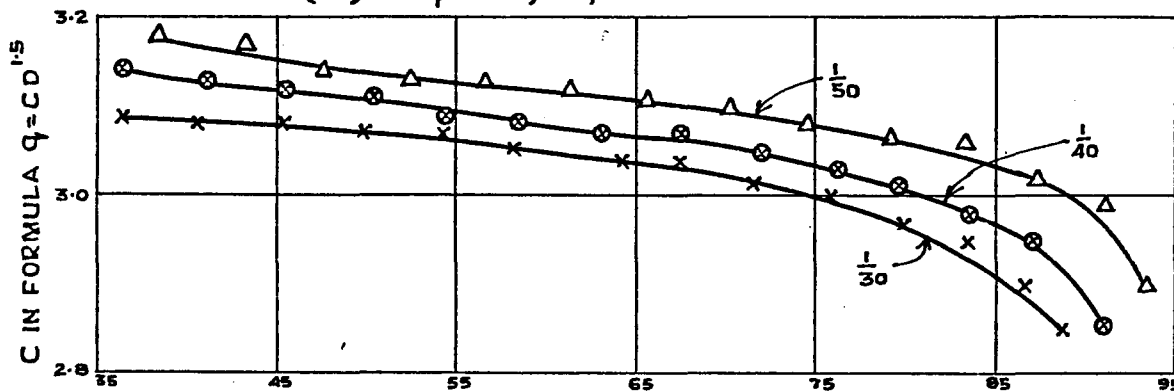

(c) $Q_p = 8,50,000$ CS. WITH 20% CONCENTRATION

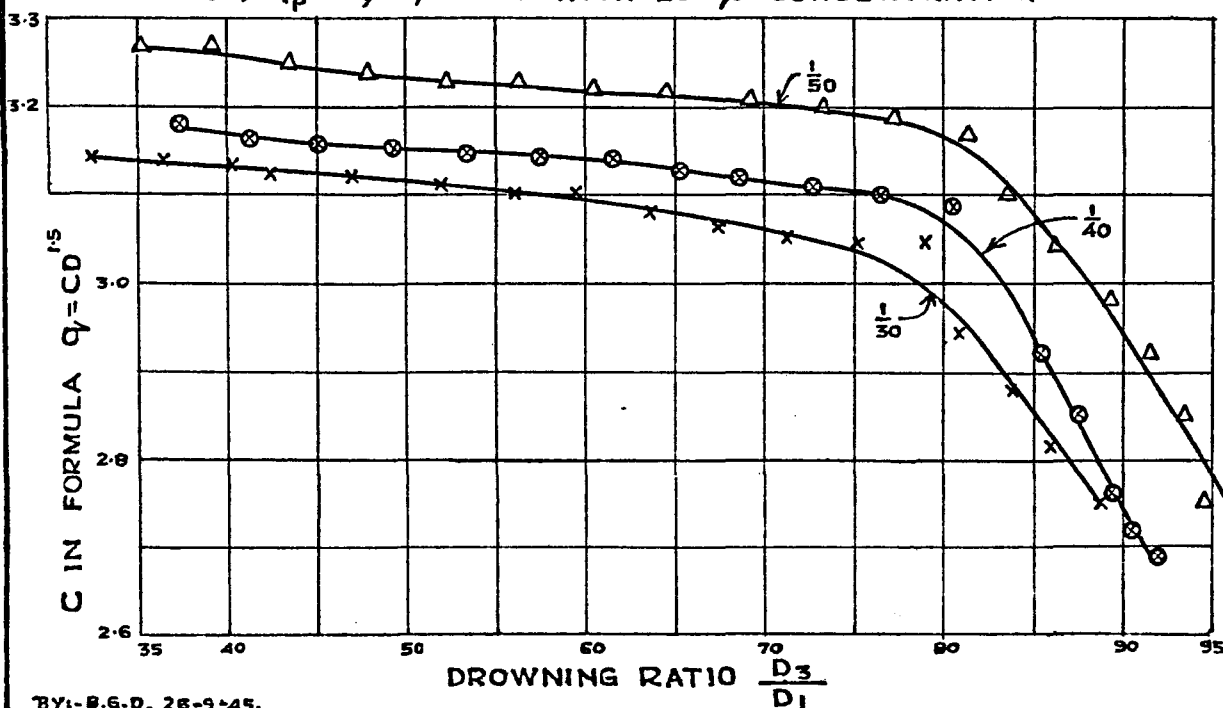

LOWER SIND BARRAGE WEIR PROFILE EXPTS.
COEFFICIENTS OF DISCHARGE WITH DIFFERENT
D/S WATER LEVELS IN MODELS OF VARIOUS SCALES.

(a) $Q_p = 7,50,000$ Cs.

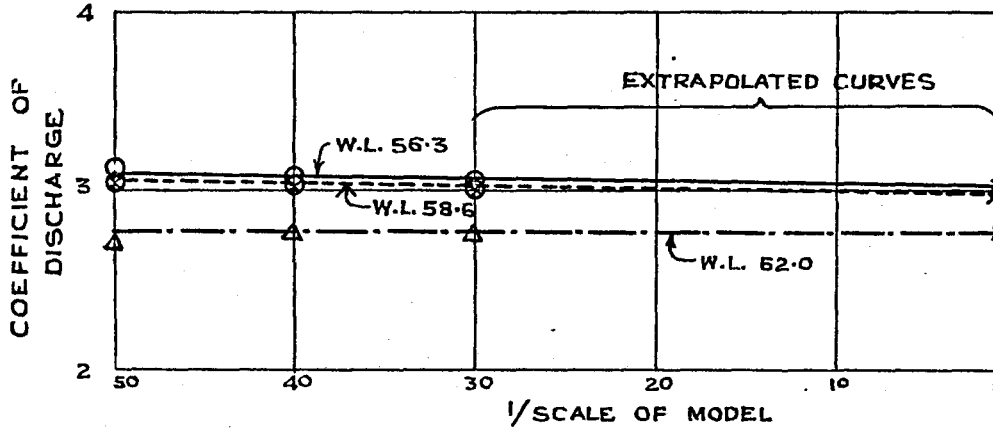

(b) $Q_p = 8,50,000$ Cs.

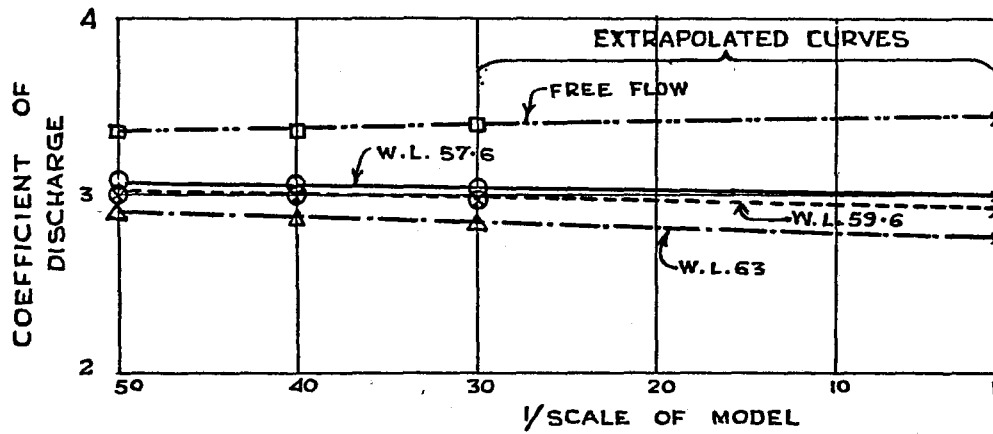

(c) $Q_p = 8,50,000$ Cs. WITH 20% CONCENTRATION.

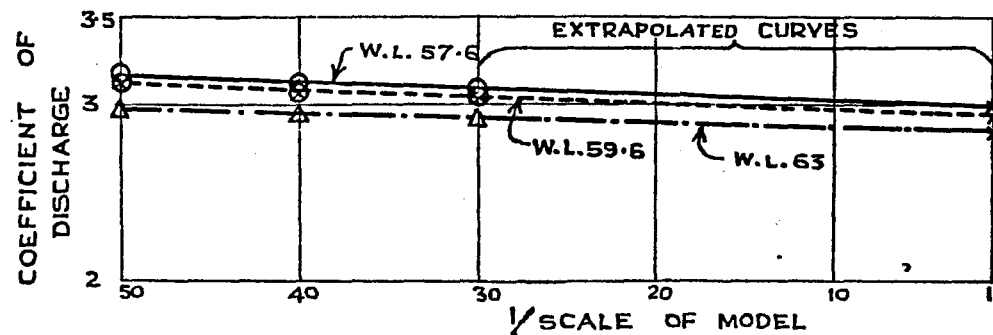

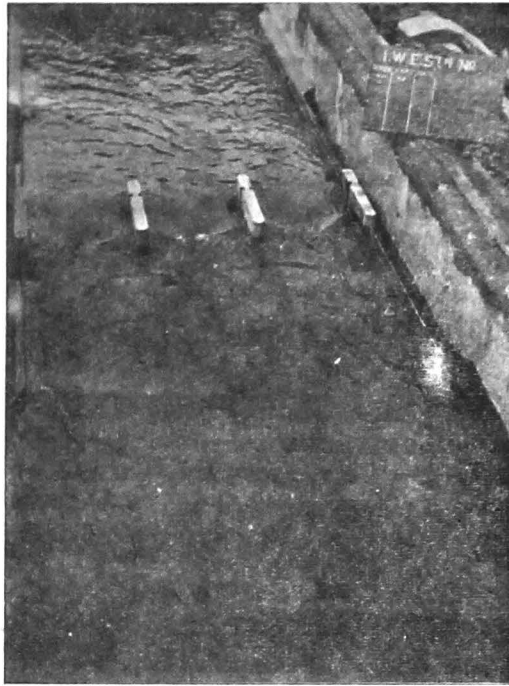

No. 4018 1/50 Lower Sind Barrage weir profile
 $Q = 8,50,000$ cusecs : D/s W. L. = 63 (Maximum W. L.)
 Upstream slope = 1:5
 Free parabolic glaucis downstream with groove
 and gate casting in piers for gates.
 Looking upstream.

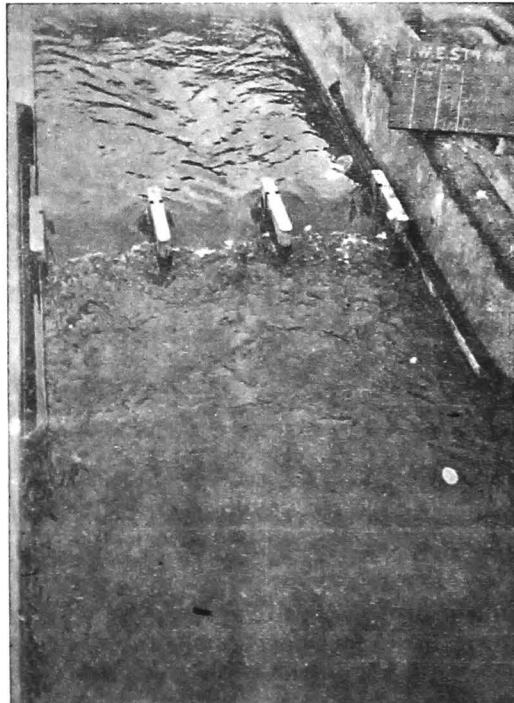

No. 4019 1/50 Lower Sind Barrage weir profile
 $Q = 8,50,000$ cusecs.
 Downstream W. L. = 59.6 (Minimum W. L.)
 Upstream slope = 1:5
 Free parabolic glaucis downstream with groove
 in piers for gates.
 Looking upstream.

TABLE 6. 1/30 geometrically-similar Model.

Qp	Glacis slope downstream	Range of d/s water levels	Range of variation of C.
(1)	(2)	(3)	(4)
7,50,000 cs.	1 : 3	R. L. 50 to 63	3.10 to 2.65
8,50,000 cs.	1 : 3	R. L. 50 to 63	3.09 to 2.64
8,50,000 cs. with 20 per cent concentration	1 : 3	R. L. 50 to 67	3.14 to 2.70

By extrapolation, the coefficients of discharge of the prototype under different conditions were obtained and these are shown in table 7. Figure 27 a, b & c show the extrapolated curves. The extrapolation is, admittedly, over too wide a range relative to the range covered by the observations.

Figure 26 a, b and c show various drowning ratios and corresponding value of C, in the three different models.

The temperature of water in all these experiments was *practically* constant.

(10) *Conclusions.*

(i) Extrapolation gives the following coefficients of discharge for various discharges and downstream water levels in the prototype.

TABLE 7

Qp	Downstream water level*	C in $q = C D^{1.5}$	Remarks
1	2	3	4
7,50,000 cs.	R. L. 56.3	3.01	Minimum water level with retrogression
	R. L. 58.3	2.99	Minimum W. L.
	R. L. 62.0	2.75	Maximum W. L.
8,50,000 cs.	R. L. 57.6	3.00	Minimum with retro.
	R. L. 59.6	2.92	Minimum W. L.
	R. L. 63.0	2.78	Maximum W. L.
8,50,000 cs. with 20 per cent concentration	R. L. 57.6	3.00	Minimum with retrogression
	R. L. 59.6	2.95	Minimum W. L.
	R. L. 63.0	2.76	Maximum W. L.

[*The *minimum* and *maximum* water levels stated in col. 3 of tables 4 to 6 were obtained from the envelope lines of the gauge discharge curves for site B near Hajipur for years 1932-43: the *maximum*, thus, does not take account of any further accretion consequent upon the construction of the Barrage; the *minimum*, however, allows for anticipated retrogression.]

Thus, the coefficient of discharge will vary from 3.0 during the period of retrogression (i.e. during the first few years after the Barrage comes into operation) to 2.76 after conditions downstream are restored and accretion begins. As further accretion occurs, the coefficient will be further reduced. Thus, with 4 ft. accretion in downstream water levels, i.e. with downstream water level = 67.0 for $Q = 850,000$ cs and with 20 per cent concentration, the extrapolated value of C is 2.66.

(ii) The free parabolic glacis gave only *slightly* better results than with 1 in 3 glacis; the latter being simpler in construction may be adopted.

(11) *Further Experiments.*

Further experiments are contemplated as indicated below :-

- (a) To determine the coefficients for lower discharges, covering the full range of water levels;
- (b) In the above experiments, the value of x in $h_v = x v^2/2g$ is assumed to be equal to 1.28. x evidently depends upon the depth of the upstream floor below the crest level⁽¹⁾. So experiments will be done to determine the values of x for various bed levels upstream, which in a river varies due to scour or silting; with submerged flow the effect of the levels of the upstream bed may be insignificant.
- (c) To see the effect of side walls on C with various water levels downstream.
- (d) To see the effect on C and the position of standing wave by raising the cistern bed level downstream of the Barrage.
- & (e) Linking up these results of C_D in flumes with those in the Kotri Barrage model to evaluate the effects of curvature of flow, uneven silting upstream and downstream etc.

11. Determination of the Coefficient of Discharge of the Automatic Gates Spillway for the Tansa Dam.

(1) *Introduction*

The waste weir of the Tansa dam is 2000' long, its crest width being 12'25". Fig. 28 shows the sectional view of the proposed automatic gates. It is proposed to install 38 automatic gates, each 50' long with 3' thick intermediate piers, making the reduced waterway 1883 ft.

Fig. 28

There will, thus, be reduction in the discharging capacity of the weir owing to—

- (a) reduction in waterway ;
- and (b) impact and frictional losses due to the piers and counter-weights.

Also, with the installation of gates the flood absorption capacity of the reservoir will be mostly lost (see appendix 1). Full provision for the disposal of the entire high flood discharge with the same H. F. L. as at present has, therefore, to be made by improving the coefficient of discharge of the automatic gate spillway. Appendix I

(2) *Object*

The experiments were designed to determine—

- 1. the discharging capacity of the existing waste weir ;
- & 2. the optimum profile of gates-cum-weir to give a suitable coefficient of discharge, so as to pass the maximum anticipated high flood discharge with cill level lowered by 2'36 ft. to R.L. 418'92, and H.F.L. 422'25'

(3) *The maximum discharge over the weir and the flood absorption capacity of the lake, with and without gates.*

The fan catchment formula⁽²⁾

$Q = 7000 A / \sqrt{A + 4}$ where $A = 52.5$ sq. miles gives a discharge of 48,700 cs.

From the data of observed maximum run-off on 30-6-41 and 2-7-41 the maximum inflow works out to 34,000 cs.

(1) C. I. & H. R Annual Report (Tech.) for 1939-40, p. 45.

(2) Indian Waterways Experiment Stn. Annual Report (Tech.) for 1943, p. 67.

As shown in Appendix 1, the existing absorption capacity of the lake is 28,100 cs. corresponding to a maximum inflow of 48,000 cs: but after the installation of gates, the absorption capacity will be negligible.

The spillway is, accordingly, proposed to be designed to pass a high flood discharge of 36,000 cusecs with H.F.L. 422.25.

(4) *Why siphon spillways could not be recommended in the present case.*

Had it not been for more or less insuperable difficulties during construction, this Station would have recommended siphon spillways—preferably Ganesh Iyer's volute siphons—because these are truly automatic in action, require practically no attention having no moving parts, have a low priming depth and give a high coefficient of discharge; unlike gates, they are leak-proof and maintain an almost constant water level over a wide range of discharge.

For the construction of siphons, however, a working period of about 3-4 months and a low water level would be necessary for the laying of the foundations of the siphons; while by 10th of February (corresponding to a working period of 3½ months) the water level only falls to R.L 410 i.e. 10 ft. below the existing crest, making installation of siphons impracticable without coffer-dams; and construction in coffer-dams is difficult because of the large height.

(5) *Scale Effect of the Model.*

A 1/10th scale geometrically-similar model of the weir without gates was constructed in the 10 ft. R. B. Channel, to find the discharging capacity of the existing weir. The weir is 130 ft. high but only the top 15 ft. were reproduced in order to have a large scale model; the effect of velocity of approach would in any case be negligible as the height reproduced was about 6 times the head over the weir.

The results of these experiments were then compared with those of 1/8th scale geometrically-similar model in a linking test.

The scale effect on the coefficient of discharge was found to be negligible (vide table 8). Hence, only the results of 1/8th scale model are described below.

TABLE 8

Q _p (cusecs)	D _p in 1/10 G. S. model. (ft.)	D _p in 1/8 G. S. model. (ft.)	C in 1/10 G. S. model.	C in 1/8 G. S. model.	Water level in prototype. R. L.	Remarks.
19,900	2.44	2.44	2.775	2.775	420.81	<i>Gate horizontal.</i>
25,000	2.83	2.83	2.80	2.80	421.20	<i>Cill R. L. 418.37.</i>
36,000	3.53	3.53	2.91	2.90	421.90	<i>Downstream Slope 1 in 5 up to 5.35 ft. from the Downstream end and then horizontal.</i>
48,000	4.16	4.16	3.02	3.01	422.53	

(6) *The model tests.*

6.1 *Model.*

The profile of the weir, as proposed to be resectioned, was reproduced to scale in the model thus: the crest was lowered from R. L. 420.18 to R. L. 418.00 for 4.75 ft. from the upstream end; then a slope of 1 in 5 maintained to a length of 0.335 ft. \approx 2.680 ft.; and, thereafter, the crest was kept horizontal for the remaining 0.668 ft. \approx 5.345 ft.

Two staggered rows of piezometers, one in the centre and the other near the pier, were provided to observe pressures above and below the gates (required in the design of the counterweight) and on the crest of the weir.

FIG. 28

NO. 5981
I.W. EXPT. STN. POONA

SECTIONAL VIEW OF THE PROPOSED
AUTOMATIC GATES FOR
TANSA DAM WASTE WEIR.

(GATES 50'-0" WIDE x 3'-1" RETENTION HEIGHT.)

SCALE: 1" = 2'

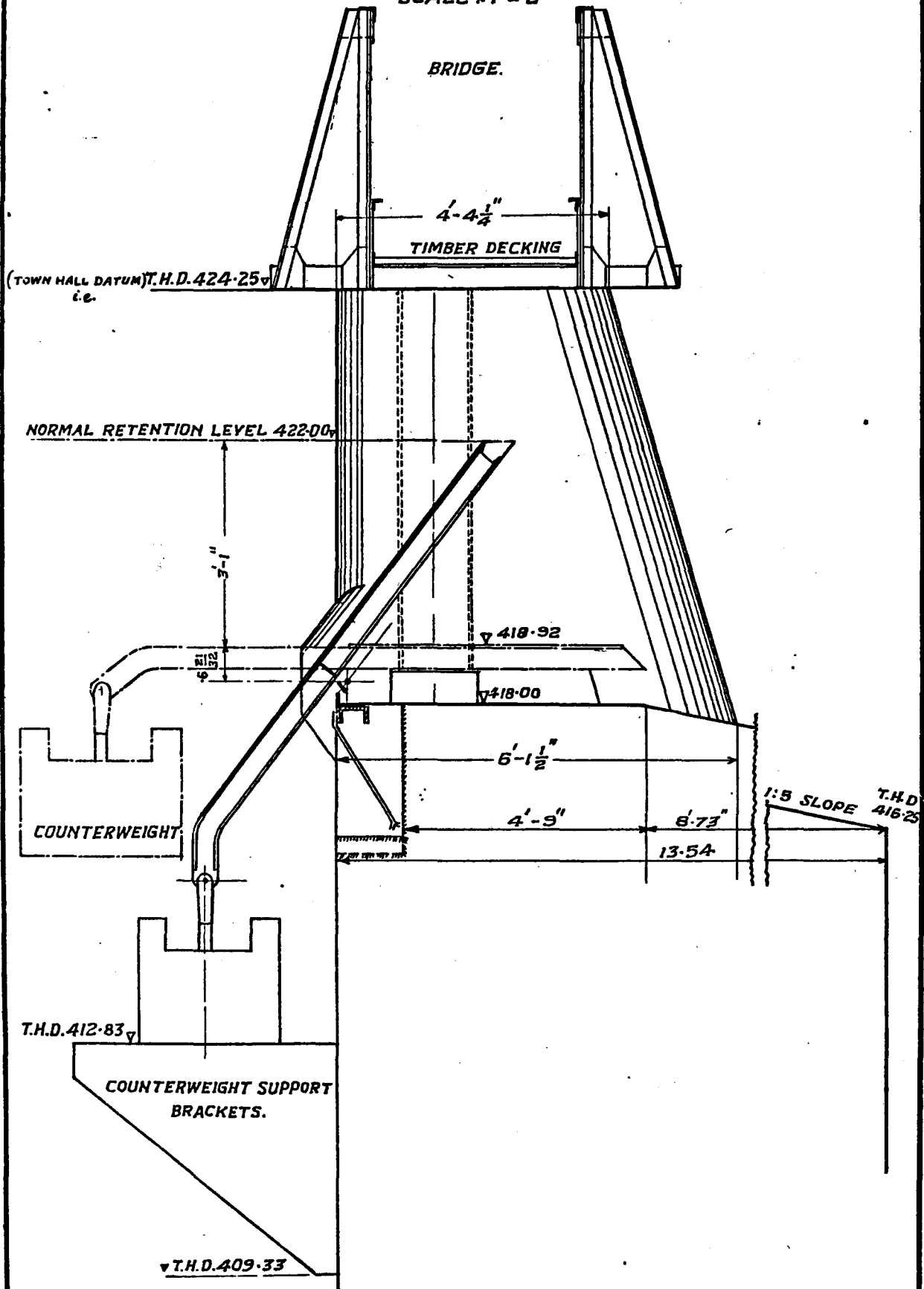

T.B.Y. SARKAL

S.A.L.A. FORM. 40.

To secure water tightness the piers were provided with projecting staunches against which the edges of the gate press and make a water-tight joint; these staunches were also reproduced to scale.

The piers were provided with 0.125 ft. \approx 1 ft. diameter air vents to allow air into the pockets below the gates when they fall flat in order to avoid harmful vibrations which would be otherwise set up by intermittent aeration.

6.2 Procedure.

The required water levels were adjusted at a distance of 6.25 ft. \approx 50 ft. upstream of the weir; and for each water level the corresponding discharge was measured on the calibrated standing wave flume provided in the channel. The coefficient of discharge for the weir was worked out from the formula $q = CD^{1.5}$

where q = discharge intensity in cusecs per ft.,

and D = upstream still pond depth including h_w , which was negligible as already stated.

Water profiles and pressures were observed corresponding to each water level; and rollers and eddies were located by woollen threads.

It was apparent that, in order to improve the coefficient of discharge to pass 36,000 cusecs at H. F. L. 422.25 with the reduced water-way, one or the other of the following expedients was necessary:—

(a) Sloping the gate and possibly also the downstream profile in order to steepen the pressure gradient and induce curvature of flow; ⁽¹⁾

(b) providing a curved upstream lip to eliminate the roller which persisted at the upstream end, thus allowing the water profile to cling to the weir and thereby induce increased velocities (see fig. 29);

Fig. 29

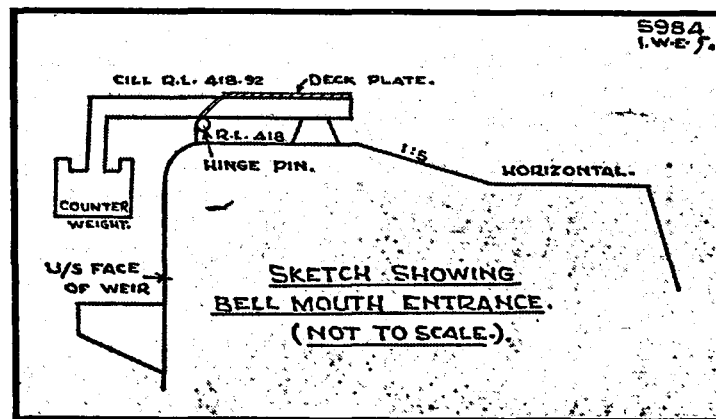

Fig. 29

(c) by streamlining the counterweight to eliminate the disturbance created by the sharp obstruction caused by it (see fig. 30).

Fig. 30

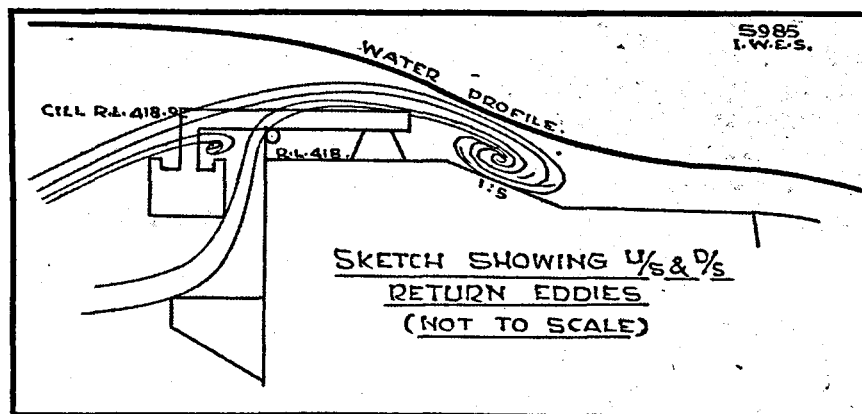

Fig. 30

(1) I. W. E. Stn. Annual Report (Tech) for 1939-40 and 1940-41.

6.3 Discussion of results.

Two series of experiments were designed:

In Series I, experiments were done with the gate profile varying but the downstream weir profile (i. e. slope 1 in 5 and then horizontal) constant; in Series II, experiments are proposed with gate profile (viz. sloping at 1 in 10) and downstream slope 1 in 10 constant, alternately with and without a step between the gate and the weir profile. Only experiments of Series I were completed during the year.

Series I.

Table 9 In *Experiment 1*, with the gates horizontal and the profile shaped as described above, C varied from 2.81 to 2.95 for water levels ranging from 422.00 to 423.29; at H. F. L. 422.25 a discharge of 32,700 cusecs only could be passed as against 36,000 cusecs required.—see table 9—. But even this showed an improvement over the coefficients with the existing profile (sill R. L. 420.18), where the maximum coefficient was of the order of 2.83. This increase in the coefficient of discharge was evidently due to the change in the form of the weir produced by the resectioning of the profile: under existing conditions the weir is broad-crested with parallel flow ($L/D = 5.27$ at H. F. L.), while with gates at R. L. 418.92 it approximates to a short-crested weir ($L/D = 1.17$ at H. F. L.).

In *Experiment 2*, the gate in the fallen position was itself kept to a slope of 1 in 20, the downstream profile being kept the same as before, viz. 1 in 5 slope and then horizontal. The coefficient of discharge varied from 2.933 to 3.0805; the corresponding flood discharge at H. F. L. being 34,222 cusecs ($C = 2.961$).

In *Experiment 3*, the gate slope was made 1 in 10 and the downstream profile kept the same as before. C varied from 3.0732 to 3.1124, being 3.0917 at H.F.L., thus providing a discharge capacity of 35,700 cusecs at H. F. L.

Fig. 30 In all these experiments, two eddies, one at the upstream end of the gate and other at the downstream end of the gate, persisted. The former was apparently due to the obstruction caused by the counterweight and the latter to the step below the gate (see fig. 30). The coefficients with the counterweight removed and with the gate horizontal (Expt. 1(a)) were compared with the results of experiment 1. The coefficient slightly improved, varying from 2.865 to 2.99 against 2.81 to 2.95 obtained in experiment 1 (see table 9).

Pressure Diagrams.

Fig. 31 These are required in the design of the counterweights for the gates. Such diagrams were prepared for all the conditions tested and a representative pressure diagram (for Experiment 3 Series I) is shown in Fig. 31. The diagrams show that:—

(a) Pressures below the gate are practically constant and smaller in value than those on the top of the gate.

(b) Pressures on the top of the gates vary, reaching the maximum at mid-gate and then again falling at the step due probably to reverse curvature at the downstream end of the gate; and falling further to a minimum value at the downstream end of the weir.

The pressures in the centre of the span were higher than those adjacent to the pier; as the latter appeared to be affected by the piers, the former would be more reliable in the design of the counterweights.

Water profiles were also observed in all cases.

7. Further experiments.

In order further to improve the coefficient of discharge it is contemplated

FIG. 31
SERIES I EXPT. 3
1/8 SCALE G.S. MODEL OF TANSA DAM WASTE WEIR
CURVES SHOWING WATER PROFILE AND
WATER PRESSURE ABOVE & BELOW THE GATES
CILL R.L. 418.92 GATES SLOPING TO 1:10

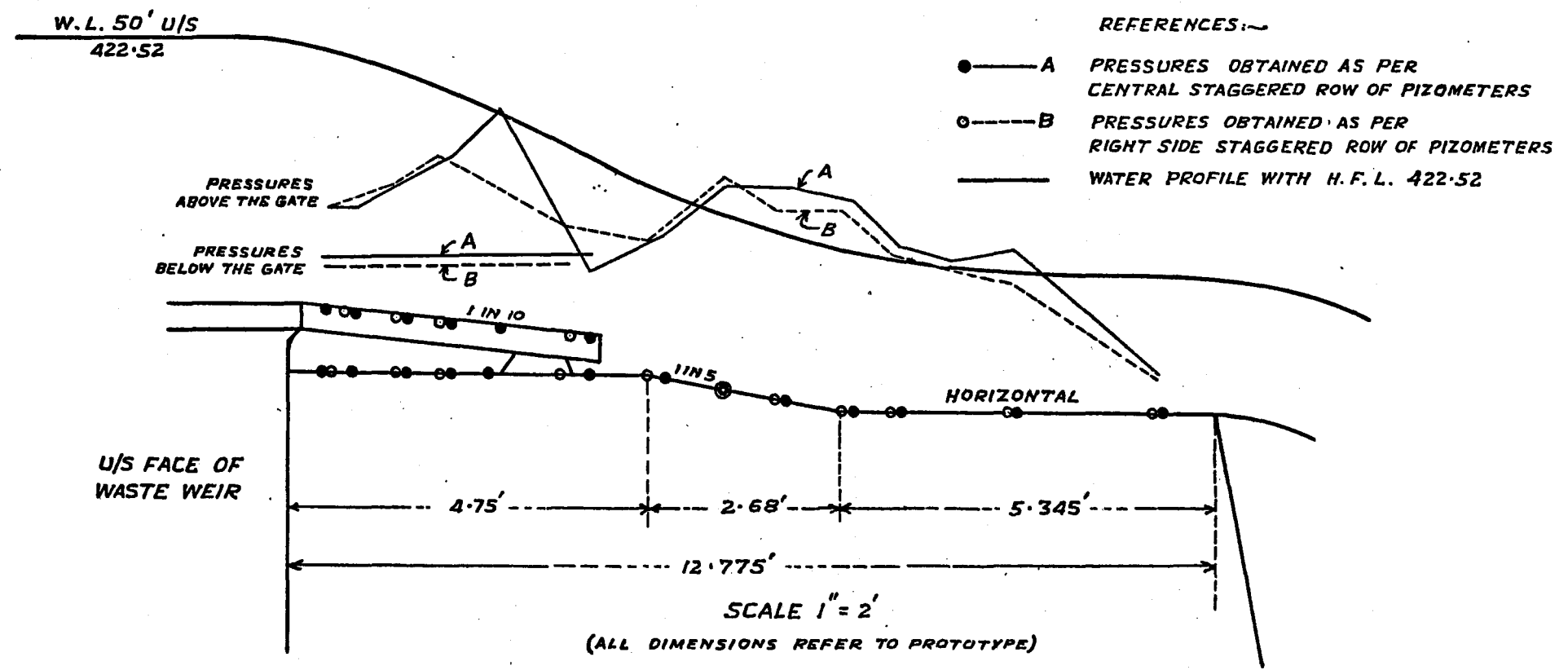

TABLE 9

Table 9 showing water levels and corresponding total discharges passed in each design. Cill R. L. 418. 92.
Total waterway 1900 ft.

Existing weir profile (1/10 G. S. model)			Gates horizontal with counterweight in position (1/8 G. S. model)			Gates sloping at 1 in 20 with counter- weight in position (1/8 G. S. model)			Gates sloping at 1 in 10 with counter- weight in position (1/8 G. S. model)			Remarks
W. L.	Q _p	O	W. L.	Q _p	O	W. L.	Q _p	O	W. L.	Q _p	O	
421.65	10,100	2.83	422.00	28,900	2.81	422.008	30,260	2.933	422.00	31,557	3.0732	It is required to pass 36,000 cs. with upstream W. L. 422.25.
422.09	15,000	2.83	422.152	31,400	2.84	422.152	32,607	2.9536	422.152	34,049	3.0839	
422.26	17,000	2.81	422.25	32,700	2.84	422.20	33,482	2.966	422.25	35,703	3.0917	
422.50	19,900	2.80	422.52	37,800	2.89	422.24	34,322	2.961	422.52	40,393	3.1124	
422.89	25,000	2.80	423.29	50,800	2.95	422.30	35,188	2.9738				
						422.544	39,346	2.9882				
						423.136	50,675	3.0805				

PART III

to do other experiments in addition to Series II, with modifications designed to eliminate—

- (a) the upstream roller by rounding the upstream end of the gate ;
and (b) the eddies caused by the counterweight by streamlining it.

APPENDIX I

1. Calculation of Time of Duration of Flood and Flood Absorption Capacity of the Tansa Lake with and without gates.

Let Q = rate of incoming discharge in cusecs.

T = Time in seconds during which the flood lasts

A = Water spread area in sq. ft. when water level is midway between F.S.L. and H.F.L.

L = Length of the weir in ft.

C = Coefficient of discharge.

H = Maximum height over the weir in ft.

Let W.L. rise by H ft. in time T .

Total incoming discharge = Absorption in the lake + Outgoing discharge.

i.e. $Q \cdot T = A \cdot H + CLH^{3/2} \times T \times m \dots (1)$, where $(m.C.L.H.^{3/2})$ is the average rate of discharge over the weir ; and m is the ratio of $Q_{\text{mean}}/Q_{\text{max}}$.

To find the average rate of discharge.

Let at any time t , q_h = outgoing discharge

& h = head over weir

then $q_h = CLh^{3/2}$

\therefore Total outgoing discharge in time T when head varies from zero to H

$$= \int_0^H q_h dh = \int_0^H CLh^{3/2} dh$$

$$= \left[\frac{2}{5} CLh^{5/2} \right]_0^H$$

$$\therefore Q_{\text{Total}} = \frac{2}{5} CLH^{5/2}$$

$$\therefore Q_{\text{mean}} = Q_{\text{Total}}/H = \frac{2}{5} CLH^{3/2}$$

$$\therefore m = Q_{\text{mean}}/Q_{\text{max}} = 0.4 *$$

Substituting this value of m in equation (1),

$$Q \cdot T = A \cdot H + 0.4 T \cdot C \cdot L \cdot H^{3/2} \dots (2)$$

Now actually in the case of Tansa reservoir

$$Q = 48,000 \text{ cs.}$$

$$A = 7.43 \text{ sq. miles}$$

$$L = 2,000 \text{ ft.}$$

$$C = 2.9$$

Note—(C in 1/10th scale geometrically-similar model = 2.83

Allowing for excess frictional loss in model,

$C = 2.9$ in the prototype)

Substituting for C in eq. (2) and dividing throughout by T

$$Q = AH/T + 0.4 \times 2.9 \times 2000 \times 2.32^{1.5}$$

$$\therefore AH/T = 39,800$$

from which $T = 12,080$ seconds

or 3 hrs and 21 minutes.

In 1941, a flood of 33,000 cs. lasted for 3 hrs. and 35 minutes; hence a discharge of 48,000 cs. may last for a smaller period and so the period worked out above appears to be on the safe side.

2. Flood absorption Capacity of Tansa dam..

Major A. Garrett⁽¹⁾ has evolved the following formulae for calculating the length of the waste weir allowing for flood-absorption capacity of the reservoir.

$$B = T i / 2 h \cdot A$$

and $l = n i / c h^{3/2}$

where

i = maximum estimated flood into the reservoir
in cft. per second.

T = Time in seconds in which such a flood may be expected
to last.

h = Difference between H.F.L. & F.S.L.

A = Area of the water spread of the reservoir in sft. when
water level is midway between F.S.L. and H.F.L.

l = length of waste weir

c = Coefficient of discharge of the weir.

The maximum influx calculated from the lake contents was 34,000 cusecs in 1941 when the lake level rose from R.L. 400 to R.L. 401 and time required for this was 1 hour and 10 minutes. An average inflow of 33,200 cusecs lasted for 3 hours and 35 minutes when the lake level rose from R.L. 399 to R.L. 402.

Assuming that the maximum estimated inflow of 48,000 cs. were to last for 3 hours and 21 minutes (i.e. 3.35 hours) with F.S.L. = 420.18 and H.F.L. = 422.50, the flood absorption capacity of the reservoir can be worked out as follows—

$$B = T i / 2 h A$$

where

$$T = 3.35 \text{ hrs.} = 12,080 \text{ seconds.}$$

$$h = 2.32 \text{ ft.}$$

$$A = 7.43 \text{ sq. miles.}$$

$$i = 48,000$$

$$\therefore B = \frac{12080 \times 48000}{2 \times 2.32 \times 7.43 \times 5280 \times 5280}$$

$$= 0.603$$

Referring to the table for values of B and n ⁽²⁾, the corresponding value of n is .385.

\therefore the discharge passing over the weir i.e.

$$n i \text{ is } .385 \times 48000 = 18,500 \text{ cusecs.}$$

Actually the model showed that with H.F.L. at R.L. 422.5, a discharge of 19,900 cs. can be passed.

Thus assuming outgoing discharge as 19,900 cs. the flood absorption capacity of the lake works out to $(48,000 - 19,900) = 28,100$ cs.

(1) Irrigation Pocket Book by Buckley (p. 325) 1925 edition.

(2) Irrigation Pocket Book by Buckley (p. 327) 1925 edition.

Flood absorption with gates.

With the installation of gates, F. S. L. will be 422 and H. F. L. 422'50. Therefore the difference between F. S. L. and H. F. L. is only 0.5'.

Assuming that the maximum estimated inflow of 48,000 cs. starts entering the lake when F. S. L. is at 422 and lasts for 3.21 hours as before, the flood absorption capacity of the reservoir will be

$$B = Ti/2hA$$

where

$$T = 12,080 \text{ seconds.}$$

$$i = 48,000 \text{ cs.}$$

$$h = 0.5 \text{ ft.}$$

$$A = 7.45 \text{ sq. miles.}$$

$$\therefore B = \frac{12,080 \times 48,000}{2 \times 0.5 \times 7.45 \times 5280 \times 5280}$$

$$= 2.782$$

Referring to the table

$$n = 0.99 \text{ to } 1$$

Assuming $n = 0.99$

\therefore the discharge passing over the weir is

$$0.99 \times 48000 = 47500 \text{ cs.}$$

i. e. the flood absorption capacity of reservoir is 500 cs. only, i. e. practically negligible.

(vi) "LOCAL TRAINING."

12. Training of Luni River to prevent it damaging Jodhpur Railway Line.

PART I : PRELIMINARY NOTE.

(1) *Introduction*(A) *Main Line between Parlu and Gole.*

Due to very heavy rainfall in the catchment, unprecedented high floods occurred, in August 1944, in the Luni river which takes off from the foot-hills of the Aravalli range near Ajmer and flows in the south-west direction through the Jodhpur State (see Fig. 32). Several breaches occurred along the main Jodhpur Railway line running parallel to the river from Luni to Gole, roughly $1\frac{1}{2}$ miles away, particularly between Parlu and Gole Stations, a distance of about 20 miles; and serious damage was caused to the railway bridge No. 3 of the Samdari-Raniwara branch crossing the river near Samdari. To prevent the recurrence of such damage, the railway authorities decided to carry out extensive works costing about twelve lakhs of rupees, and Sir Claude Inglis, the then Director of the Station, was requested to advise on the proposed works.

After inspecting the site in November 1944 and scrutinizing the available data, Sir Claude recommended raising the Railway embankment above the present high flood level by about 6 ft. allowing for a probable rise of 3' in river levels due to bunding up of the river and 3' for free-board. Model experiments were also suggested for determining the optimum river training measures for centralizing the river at the Railway bridge near Samdari.

The site was again inspected by the Director (Rao Bahadur Joglekar) in November 1945 and he confirmed Sir Claude's proposal of raising the railway embankment.

The damage to the Railway Bridges and Railway track are due to the high intensity of rainfall occurring over the catchments in a very short time, thus concentrating large floods into the rivers. The floods build up so rapidly that the river does not get time to scour its bed and water simply spills over the

Fig. 32

Index plan of the Luni river

SCALE: 1" = 15 MILES.

NOTE:-
AREA ENCLOSED BY DASH
LINE IS THE CATCHMENT-
AREA OF THE RIVER.

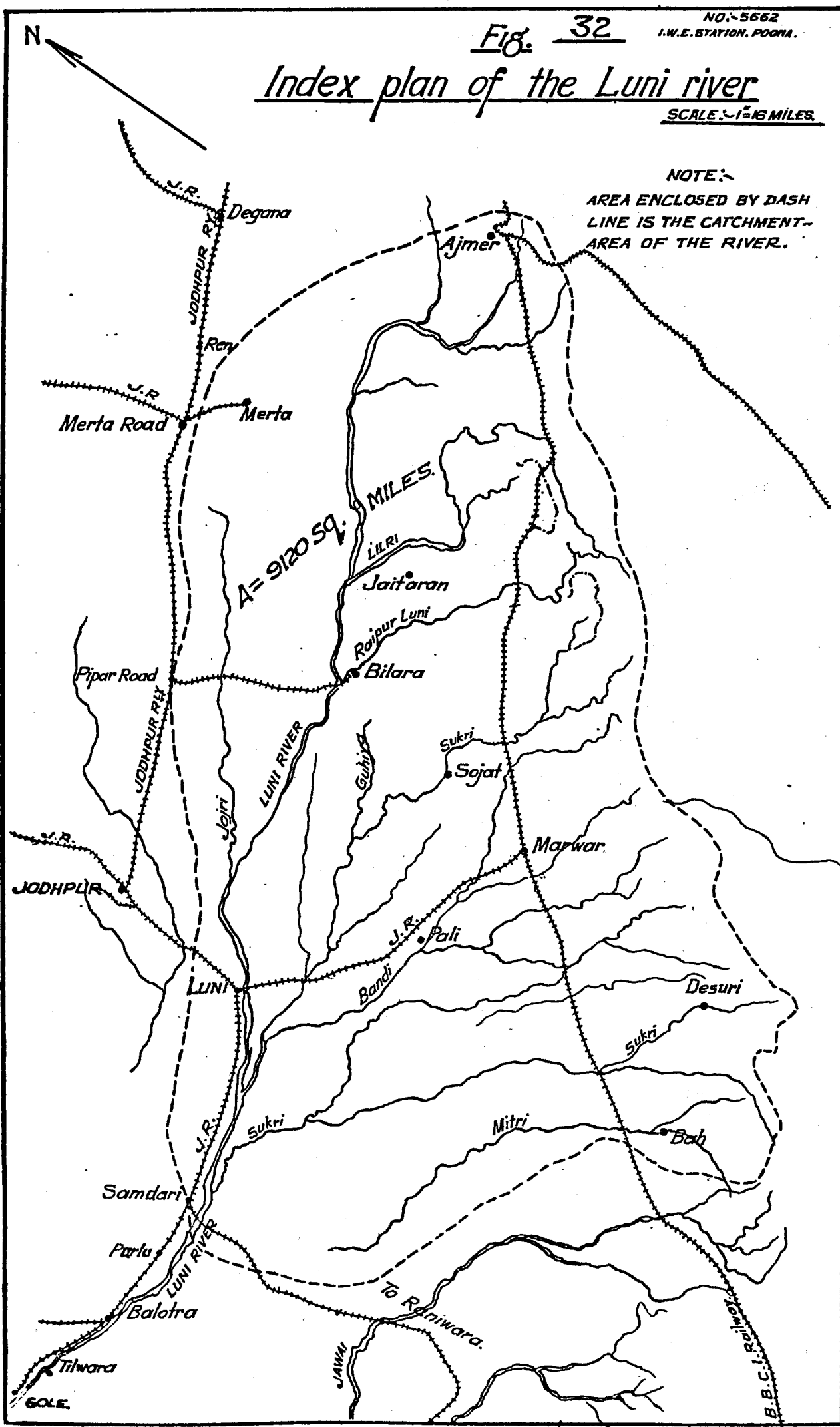

country and over the railway track. The breaches in the railway embankments are probably due to water falling over the railway track and undermining it from the downstream end; the bank then becomes very weak and eventually gives way; water also percolates through the bund due to the large head (of the order of 5 to 6 ft.) and meets the downstream 2 : 1 slope at a higher level than the toe.

There appear to be two ways to prevent damage :

(i) to have the railway track, duly protected, running along the ground level allowing the spill to go over it; in other words, there should be numerous Irish Bridges, the downstream sides of which would be protected with 1 in 3 stone pitching carried below ground level to a depth of about 3 to 4 ft ;

or (ii) to stop all the spills by raising the railway line above the H.F.L.

Other measures have been found to be ineffective in preventing breaches.

It is, however, undesirable to allow the main line—which is the link to Sind — to be submerged under water; and so the only course is to raise the formation level, as recommended by Sir Claude Inglis. On the other hand, on the relatively unimportant Samdari-Raniwara Branch it is possible to let the line be submerged occasionally during high floods, vide (i) above.

The bunding effect due to raising the line above H.F.L. will result in an increase in the present H.F.L.; on the other hand, as the floods would be contained within the railway embankment, the river will tend to scour its bed, (a) partly due to the increased discharge as a result of preventing spills, and (b) partly due to an increase in the flood discharge consequent upon a reduction in the flood absorption capacity. The net increase over the present H.F.L. is expected to be 2 ft., taking into account a natural rise in river levels of the order of 1 ft. per 100 years. Allowing a freeboard of 3 ft. the railway embankment may be raised, generally, by 5 ft. above the 1944 H.F.L. — which is the highest so far recorded — but at places where the attack is very severe, it should be raised to 6 ft. above H.F.L. The effect of the increase in afflux may extend upstream between Samdari and Parlu and some portion of this line would also have to be raised.

Repelling spurs, with their shanks connected to high local banks, wherever possible, are necessary to repel the attack of the river downstream of Balotra.

(1) Short spurs about 10 ft. long, with semi-circular heads built at suitable angles to the embankment, at intervals of about 450 ft., between stations Balotra-Tilwara on the main line, appear to have functioned well, in that they have prevented cross flow and have protected the embankment adequately; these may be constructed where the flow is small.

(2) Where the flow is large and attack severe, long repelling spurs will be necessary; these repelling spurs should be at least 100 to 150 ft long pointing 60° upstream, at intervals of about 1500 ft. The upstream side and the nose of these groynes should be provided with 2 ft. thick pitching; and grass should be planted on their downstream side. A stone apron should be provided at the nose, and continued below ground level, to a depth of about 3 to 4 ft.

An independent series of experiments were done at the Station to test the stable slopes of an embankment with a similar type of sand as in the Luni river. The angle of repose of the saturated sand was found to be 1 in 2.6'; so a 1 in 3 slope is recommended.

Indirect evidence in support of the view that rivers in the Jodhpur State tend to increase their widths rather than deepen their beds is adduced from the following facts:—

(1) The apron round the head of the Bell-bund on the left bank upstream of the Jawai Bridge No. 32 at mile 33/3 of the Samdari-Raniwara

Branch has not launched, though the action at the nose of the head during the floods was severe.

(2) Very severe bank erosion took place to the extent of 300 ft. on the right bank of the Khari River at mila 56, outflanking the Railway Bridge.

(B) *The Railway Bridge on the Samdari-Raniwara Branch over the Luni river.*

The Luni river debouches from hills near Ajmer, and collecting water on the way from various tributaries, Lilri, Raipur Luni, Sukri, Bendi etc., flows westward till Gole, where it turns southward and flows roughly straight till it meets the Arabian Sea. It is a very wide and shallow river (B/d = 500) and is mostly dry throughout the year except during short periods of the monsoon season. In years of extraordinary floods it overflows the banks, causing damage to the railway line.

The average width and depth of the river near the Samdari bridge, in flood, are 3800 ft. and 8 ft. respectively and its slope is 1 in 1500. The analysis of the bed sand samples shows that the river bed consists mainly of sand of 0.26 mm. diameter, though in places the variation in material is very large, ranging from big pebbles (mean dia. about 1") to fine sand; but, it is believed that most of the pebbles find their way into the river from the hills on the right bank.

No attempt has yet been made to measure the river discharge and so reliable discharge data are not available. Only a rough estimate could therefore be made of the 1944 flood discharge, which was the biggest flood recorded since 1917. The total sectional area of the waterway through the bridge, the breaches, and the spill through and over the railway bank, measured from Fig. 33, = 67,867 sq. ft; and, assuming arbitrary velocities in the various sections, based on the observed approximate velocity of 10 ft/sec. at the centre of the bridge, the 1944 flood discharge works out to 261,000 cusecs (see appendix I). The discharge which must have passed through the bridge before the breaches may, therefore, be assumed to be about 260,000 cs. This, approximately, agrees with a discharge of 2,46,000 cs. calculated by Manning's formula, as shown in Appendix II.

No gauges are maintained at any of the railway bridges, but gauge readings observed by the P.W.D. in 1944 on various tributaries of the Luni were available, from which hydrographs were prepared. These show that the river is flashy and that the whole flood cycle in 1944 lasted only for 16 days.

(2) *Analysis of the rainfall data.*

The data of the annual rainfall in the catchment and the figures of maximum rainfall in 24 hours for each year are available. The analysis of these shows that—

- (a) The average annual rainfall is 19"
- (b) The total rainfall and intensity in the years 1909 and 1925 were lower than in 1908 and 1926; yet the damage done during the lower rainfall years of 1909 and 1925 was considerable, while no damage has been recorded in years of higher rainfall, namely in 1908 and 1926. It, therefore, appears that there is little likelihood of any direct, significant relation between rainfall and run-off.
- (c) The rainfall distribution is non-uniform; and the variation in the annual average rainfall at any place in the catchment is very erratic. Hence, it is not accurate to work out the maximum discharge by applying any empirical formula, such as the Fan-catchment formula⁽¹⁾; besides, the absorption of the flood is very large, as the area on which water spreads is considerable.

(1) Indian Waterways Experiment Station, Annual Report (Tech.) of work done during the year 1943, page 67.

FIG. 33.

NO.-5769
I.W. EXPT. STN. POONA.

LONGITUDINAL SECTION TAKEN AFTER
1944 FLOODS FROM MILE 4 TO 7 OF —
SMR-RNV BRANCH OF THE JODHPUR RLY.

SCALE: { VER. 1"=40'
HDR. 1"=2000'

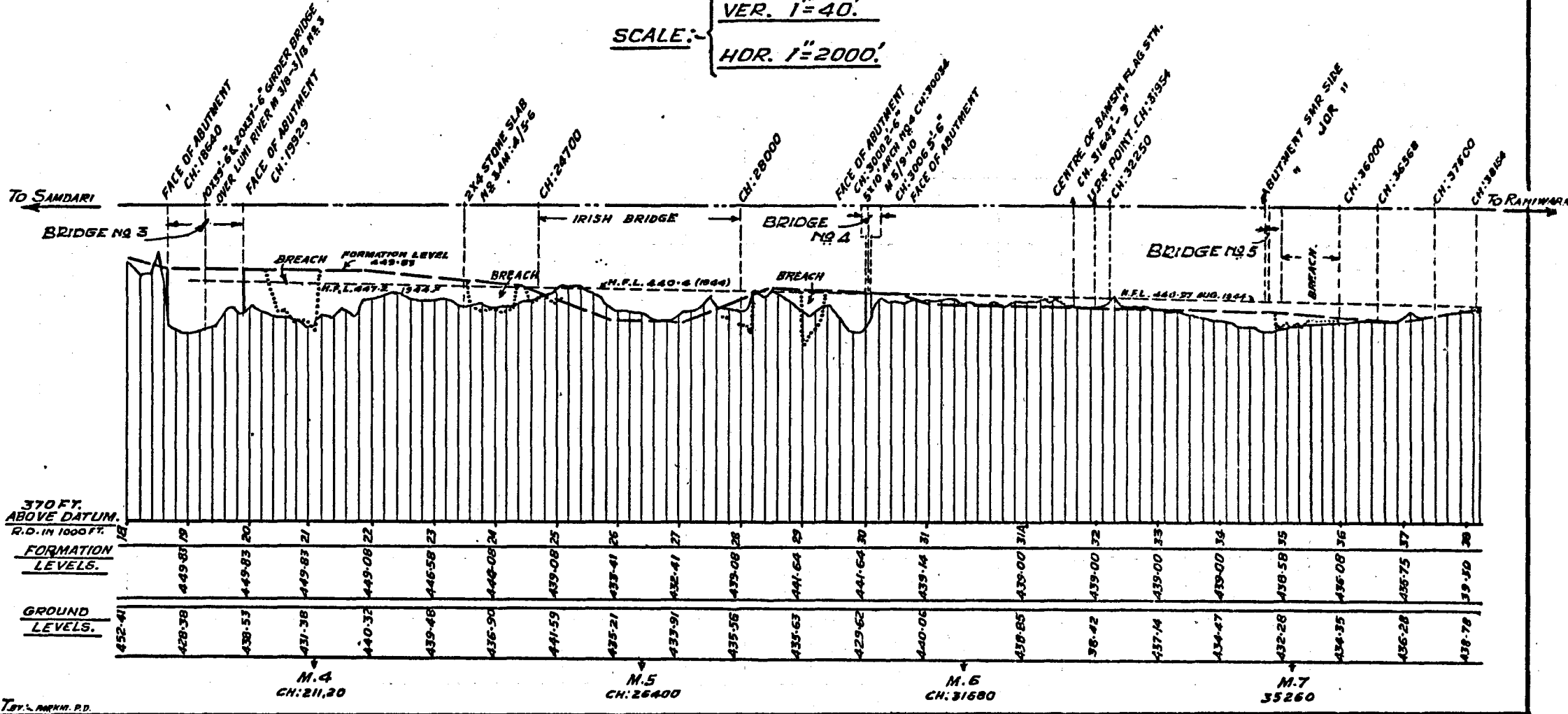

TO SANDARI

TO RAHIMNARA

370 FT. ABOVE DATUM.
R.D. IN 1000 FT.
FORMATION LEVELS.
GROUND LEVELS.

M. 4
CH: 211,20

M. 5
CH: 26400

M. 6
CH: 31680

M. 7
35260

FIG. 34.
HYDROGRAPHS
OF THE
LUNI RIVER
&
ITS TRIBUTARIES
20TH AUG. TO 7TH SEPT. 1944.

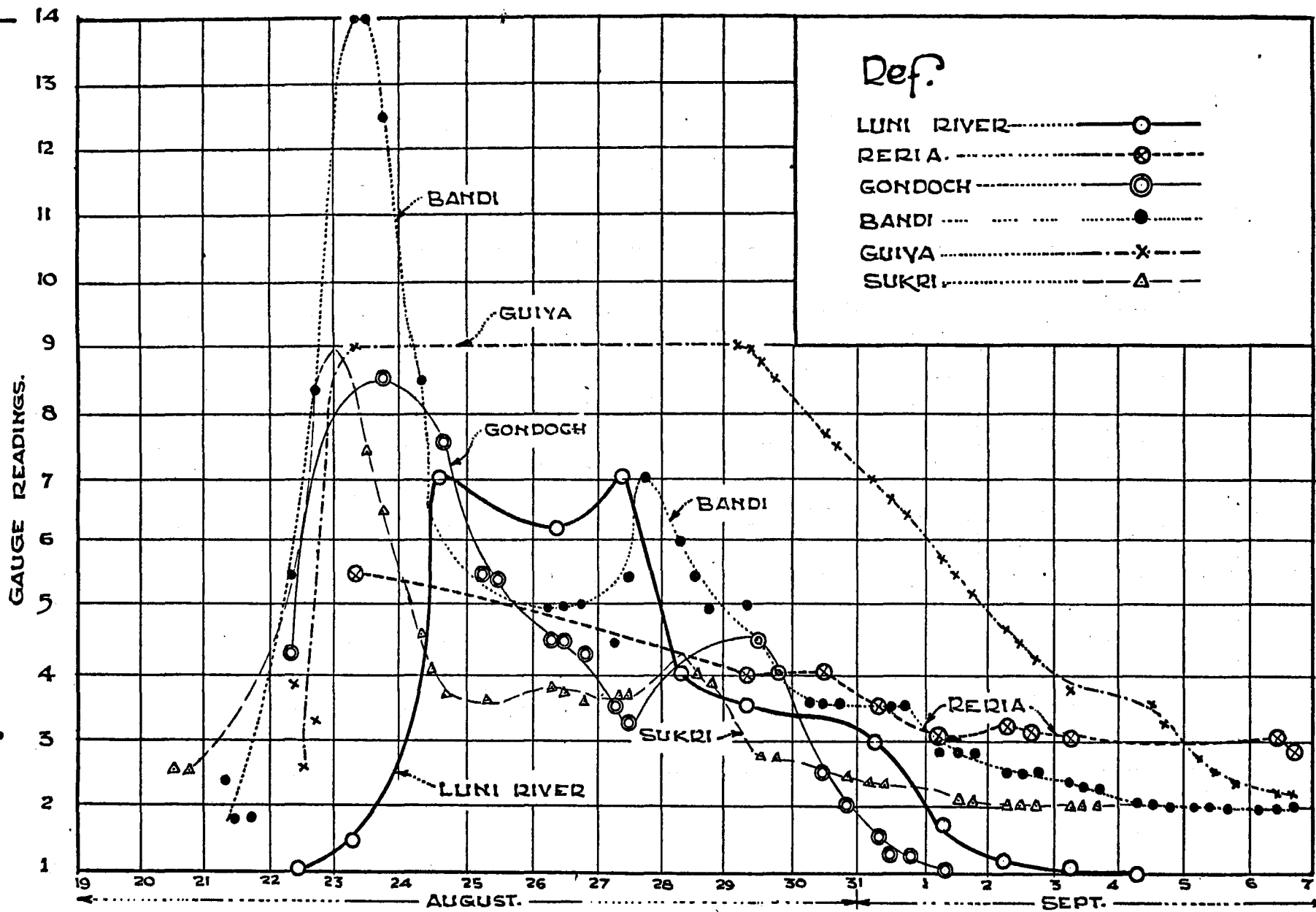

W. K. K. 10-10-45

FIG.35.
SHOWING AVERAGE RAINFALL
(OF 7 STATIONS) IN THE
CATCHMENT AREA OF LUNI RIVER.

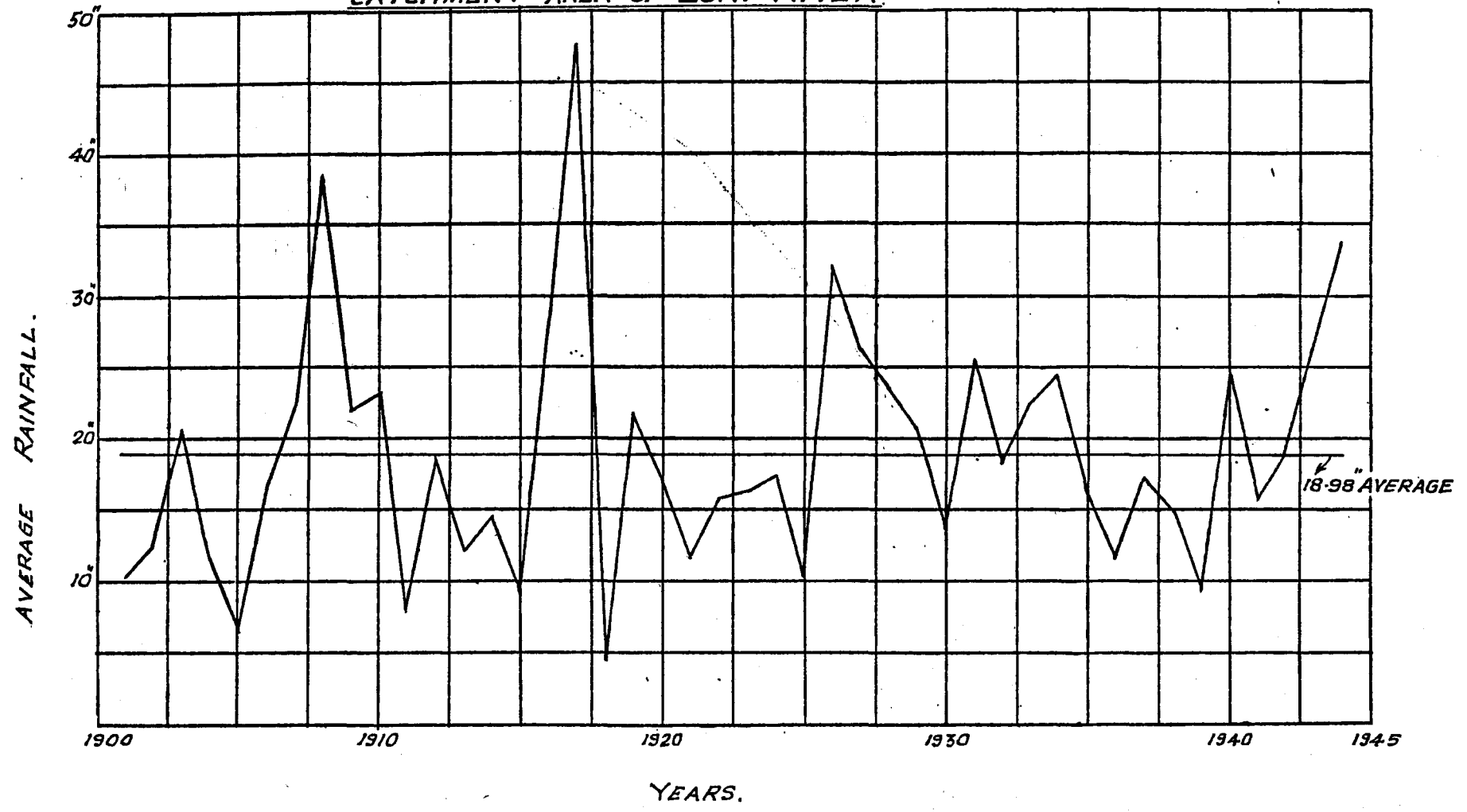

By- S.K.ATRE. 20-6-45.

(3) *The Railway Bridge :*

Figure 36 shows the bridge near Samdari. The bridge is 1295' in length and has a clear waterway of 1160' with 29 piers: while, before the construction of the bridge in 1927, the river width at the bridge site was 3100'. Thus, the present clear waterway is only 0.374 times the normal width of the river and is only 0.856 times the Lacey's minimum stable width of waterway.

Fig. 33

The level of the underside of the girders of 10 end spans on each side is R.L. 447.2 and of the middle 10 spans R.L. 446.08; the rail level is at R.L. 449.83.

The dotted and full lines showing the lines of the hard strata do not seem to be reliable as they do not tally with the results of the borings recently taken.

The river bed of 1926 (prior to the construction of the bridge) and of 1944 are shown, from which it will be seen that the river bed had scoured considerably in the 10 left end spans.

There is little possibility of the shifting and spilling of the river on the right bank as there are hillocks and rock outcrops of sand stone or resistant clay on this bank.

When the bridge was constructed, the high bank line was continuous upto A, shown in Fig. 37, and a concave guide bund (as shown in the figure) was constructed from this point to the left abutment for prevention of flooding of the low level area behind the bund. Since then the river has been gradually eroding the bank.

Fig. 37

In 1939, high floods occurred in the river, the maximum recorded water level at the bridge being R. L. 443.5. The guide bund breached at the head; and another breach occurred in the railway bank. Before the floods of 1944, this was repaired and the head of the damaged bund was strengthened by building a T head. A new retired bund was also constructed for checking the tendency of developing new channels.

Fig. 37

During the flood of 1944—the maximum recorded since 1917—the water level rose to R.L. 447.2, i. e. up to the underside of the end spans: the flow was obstructed in the middle portion, where the R. L. of the underside of the girders was 446.08. Big breaches resulted in the guide bunds and a 612' length of the railway embankment was severely damaged. Serious damage was also caused to the three end piers on the left bank, one of which—No. 29—collapsed altogether. Heavy scour took place round these piers—down to R.L. 416.13—i. e. 15' below bed level.

All the breaches have now been repaired and an apron has been provided for the protection of the guide bunds. The bridge has been raised by 2', according to Sir Claude Inglis' recommendation.

The damage to the bridge seems mainly to be due to the adverse curvature and attraction of the old guide bund and the concentration of flow under a very high afflux. The difference between the water levels upstream and downstream of the railway bank, in the 1944 floods, was approximately 6 ft. This inordinate afflux at the bridge appears to be due to a combination of circumstances, such as the insufficiency of lineal waterway, the un-uniform distribution of flow due to unfavourable entry conditions, and the nature of the river which does not readily permit the deepening of its bed.

The island near the left bank is covered with a layer of fine silt and has got a growth of tamarisk, indicating its more or less permanent nature. The island near the right bank does not appear to be as permanent. The existence of the natural islands suggests that pitched islands may be a possible solution for centralising the flow in this case.

The existing main stream of the river is from the left bank island towards the right abutment, there being a bye-channel along the left bank. On the downstream of the bridge the main channel is along the right bank; the large low level area on the left side is covered with shrubs.

The ground slope being to the south, the tendency of the river is to spill on the left bank and then flow parallel to the railway line. During the 1944 floods, the river Mithi, which normally tails off at Bharwari, 14 miles from the Railway line, was in a heavy flood. This water combined with the spill from the Luni and Sukri between Majal and Karmawas. The existing bridge No. 5 at mile 6/12 also has insufficient waterway; but instead of increasing the waterway of this bridge, it may have to be raised above H. F. L. and the adjacent Irish bridge enlarged.

As regards the spill from the Luni towards Bameni village and the railway track, the existing retired bund will have to be extended with the object of diverting the spill to the channel which crosses the line at Bridge No. 4 at mile 5/9. If this extension is not found to be feasible, the other alternative of a cut through the ridge between the Bameni village and line, together with a repelling spur, will have to be considered.

As regards measures to prevent the recurrence of damage to the Luni Bridge, the following points suggest themselves for consideration during model testing:—

(1) To provide one or two pitched islands, as necessary, upstream or downstream of the bridge, and allow them to attract and direct the flow uniformly and axially through the existing bridge. As bed scour may not be so certain in a flashy river, islands may not be sufficiently effective in time as in the case of rivers which have longer flood duration; and it may be necessary to maintain, in addition, a suitably designed guide bund to prevent any outflanking tendency.

(2) As the piers of the bridge are not founded on rock, due to scouring of the river bed locally the foundations may be endangered; hence, for this reason alone, the waterway of the bridge may have to be increased.

PART II. MODEL EXPERIMENTS

1/200 : 1/40 Luni Model Experiments.

Experiment 1: (with existing conditions).

At the start the model was laid with vertical exaggeration = 5 and slope exaggeration = 3, according to the survey made in April 1945. The model extends for 172 ft. ($\approx 6\frac{1}{2}$ miles) upstream of the bridge and 119 ft. ($\approx 4\frac{1}{2}$ miles) downstream. The bridge in the model consists of 7 spans, .925 ft. each as compared with 20 spans in the prototype. This was done in order to maintain roughly the same B/d ratio of each span in the prototype and model. Portions of guide bunds were pitched as in the river with stones of about 1/8" size. Water level at the bridge for the estimated maximum flood of 250,000 cs. was 447.2. Assuming, discharge \propto depth^{5/3}, depths for different discharges were calculated. Time scale adopted is shown in fig. 38. Equivalent depths and gauges maintained in the model for various discharges are shown below, in table 10.

Fig. 38

TABLE 10

River discharge in cusecs.	Model discharge in cusecs.	Depth of water in river in ft.	Depth of water in model in ft.	Gauge maintained at Bridge in model.	Remarks.
50,000	1.25	6.09	.1520	1.847	
100,000	2.50	9.23	.2309	1.926	
150,000	3.75	11.78	.2940	1.989	
200,000	5.00	14.00	.3500	2.045	
250,000	6.25	16.00	.4000	2.095	

FIG. 36
CROSS SECTION OF THE LUNI RIVER
AT THE BRIDGE NEAR SAMDARI.

1944.

SCALE: HOR. } 1"=120'
VER. } 1"=30'

REFERENCES:-

- APPROXIMATE LINE OF ROCK OR EARTH SUITABLE FOR FOUNDATION. (NOT RELIABLE)
- HARD STRATA AS DETERMINED BY BORINGS OF 1927-28. (NOT RELIABLE)
- BED LINE OF 1944 (AFTER FLOODS)
- " " " 1926 (PRIOR TO THE CONSTRUCTION OF THE BRIDGE)
- R.L. OF HARD ROCK AS DETERMINED BY BORINGS OF 1945

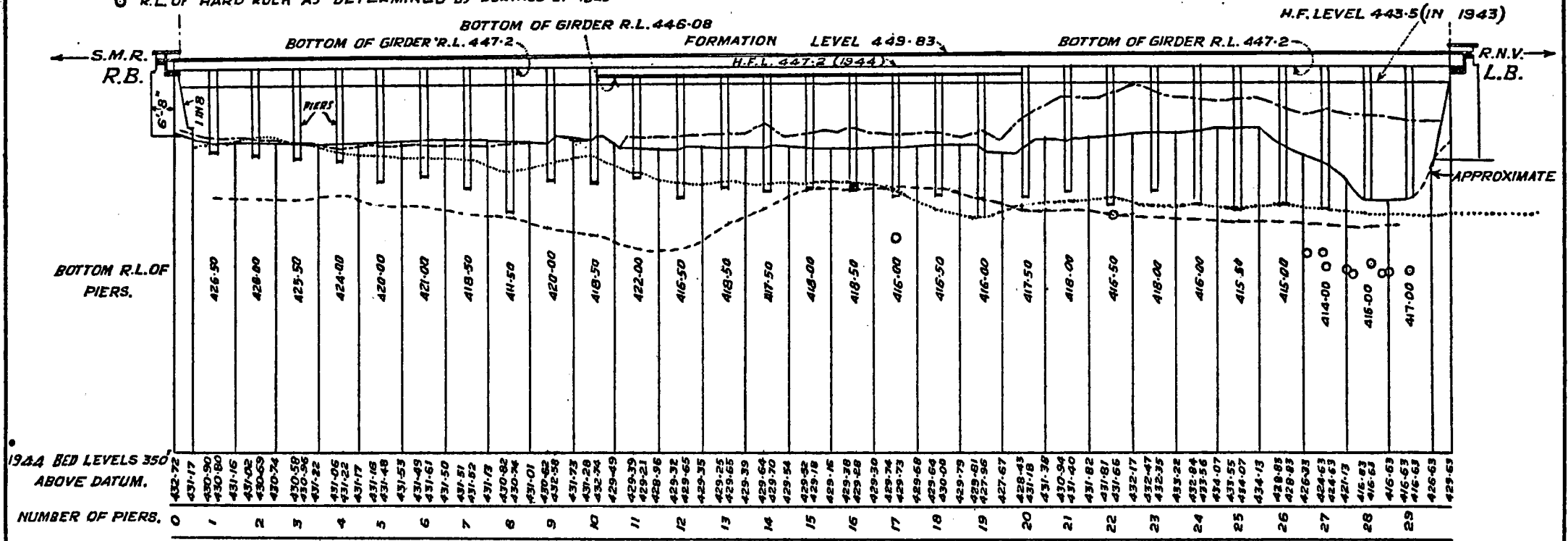

J. BY. PARKHI.
5 Oct. 45

FIG. 37

LUNI RIVER AT THE RAILWAY

5757,
I.W.E.S.H.

BRIDGE NO. 3.

Scale:- 1" = 600FT.

Ref:-

- 1927 SHOALS -----
- 1944 " -----
- 1927 RIVER BANK -----
- 1939 " " -----
- 1943 " " -----
- 1944 " " -----

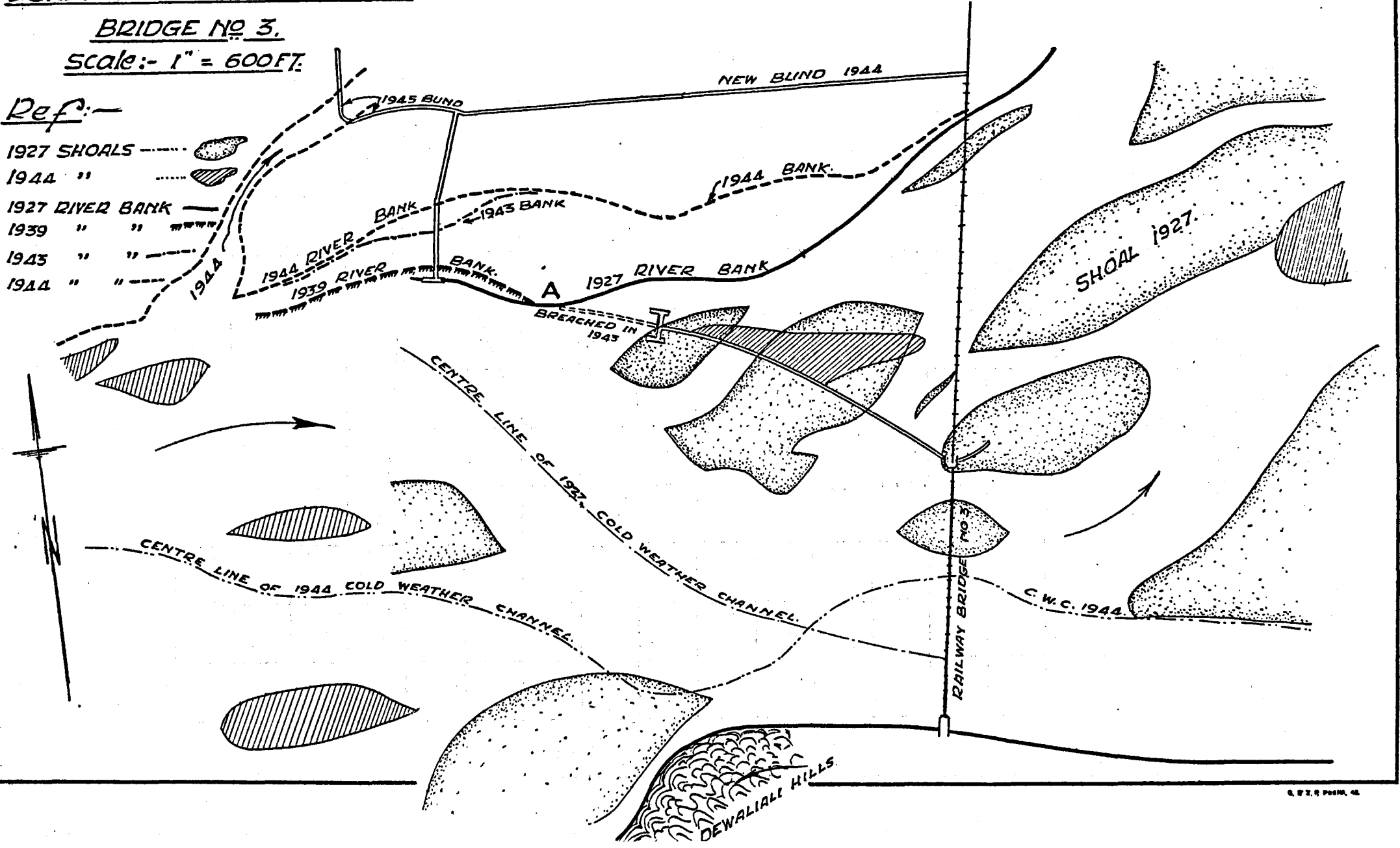
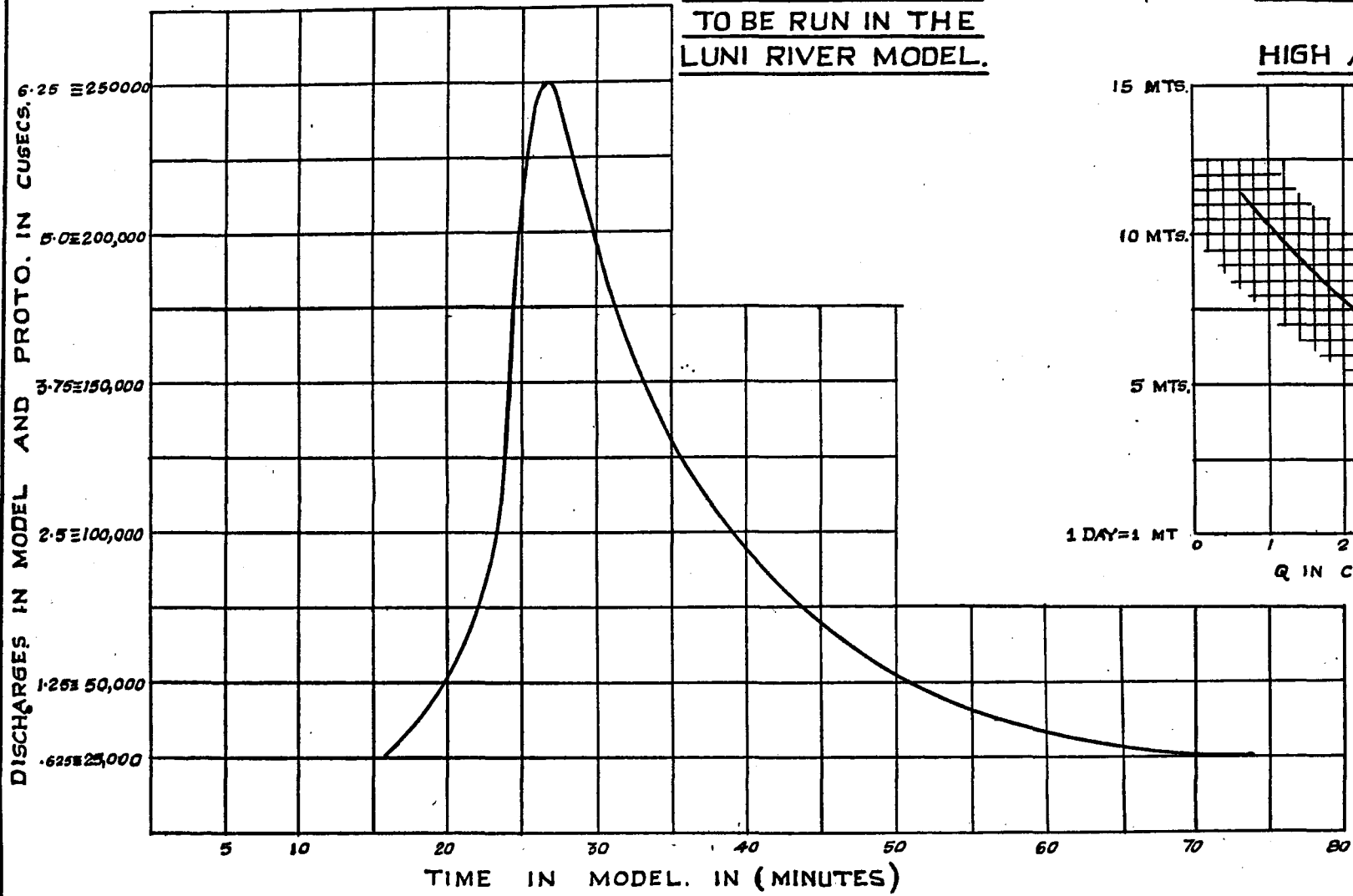
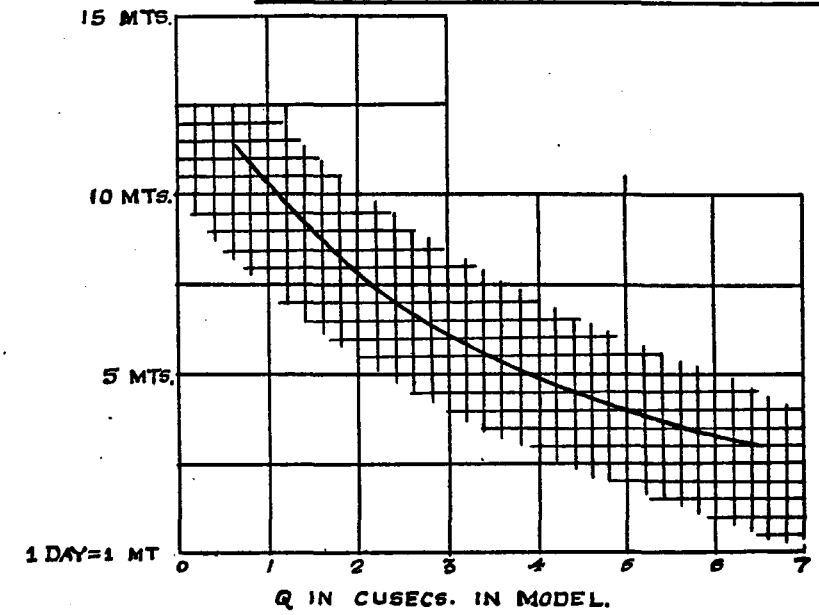

FIG. 38

DISCHARGE CYCLE
TO BE RUN IN THE
LUNI RIVER MODEL.



VARIATION OF THE TIME SCALE
FOR
HIGH AND LOW MODEL DISCHARGES.



The large value of the ratio B/d , viz. 110, and the slope of 1 ft. per 1500, indicate a heavy charge of bed material; so in the model, heavy silt charge was necessary. For the maximum discharge of 6.25 ($\approx 250,000$) cs, the charge injected was 0.6 part per 1000 by weight, as determined experimentally. For lower discharges the silt charge was made proportional to the quantity of water flowing; as the duration of discharges was small any error in this assumption would make an inappreciable difference in the results.

After running the model to stability, average slope obtained was 2.3 per 1000, giving a slope exaggeration of 3.45. Depth scale obtained was 4.85 times the longitudinal scale, as against 5.0 designed.

The centre lines of the deep channel obtained in the model and in the river were practically the same.

Afflux for the maximum discharge of 6.25 cs. $\approx 250,000$ cs. obtained in the model was .11' ≈ 4.5 ft. The difference in water level between upstream and downstream, as estimated on the river approximately by eye by a subordinate (not actually measured) is said to be 6'. Considering that no other data except H. F. L have been given (and even the high flood discharge has been estimated) it is reasonable to conclude that the model was correctly reproducing the prototype.

Bed and surface lines of flow were observed with a discharge of 2.5 cs. $\approx 100,000$ cs. Percentage discharge passing through various spans of the bridge, and through the three channels upstream (formed due to natural islands) were also measured. There was greater concentration of flow near the end spans of the bridge than in the midstream. Return flow and eddies were formed in the pocket between the bunds, and at the head of the retired bund. This caused a big scour-hole at the head of the retired bund, down to R. L. 421 in the river. This gave the depth of scour ≈ 26.6 ft. Maximum depth of scour is $2R$ where $R = .47(Q/f)^{1/3}$ according to Lacey. For $Q = 250,000$ cs. and $f = .895$ for .26 mm. sand, maximum depth would, accordingly, be 62 ft. This depth, however, cannot be expected in flashy rivers where the maximum flood occurs for a very short duration; and *particularly* not in a river such as the Luni which widens rather than deepens during floods.

Fig. 39

Fig. 40

At the old guide bund the surface water was attracted to it and the bed water was deflected away from it. Diving flow thus produced caused the bed along the bund to scour. The flow hit the pier near the left abutment at a sharp angle. This explains why the end pier near the left abutment collapsed in the 1944 flood—due to undermining of the foundations; and the 2nd pier from the left bank tilted. Below the bridge most of the flow was along the right bank.

Maximum velocity observed at the bridge was $1.64 \approx 8.2$ ft/sec. in the right end span.

At C.S. 17.5 ≈ 3500 ft. upstream of the bridge—across the natural islands—the maximum velocity was $1.1 \approx 5.5$ ft/sec. in the left and central channels.

With the maximum discharge of 6.25 $\approx 250,000$ cs. only surface lines of flow were observed: bed lines and velocities could not be observed as it would have necessitated the running of model for a longer time, which would have vitiated the results due to heavy bed scour.

Mr. Gaur the Assistant Engineer I/C of the bridge works who had been here to see the experiments was completely satisfied with the behaviour of the model in respect of reproducing the existing conditions at the prototype. Further experiments are in progress and will be included in next year's Annual Report (Tech.).

APPENDIX I

Approximate maximum flood discharge through the Luni Railway Bridge and various spills during the 1944 flood season.

Figure 33 shows the longitudinal section along the railway bank from the railway bridge No. 3 to mile 7. The cross-sectional areas of the waterways

Fig. 33

through the breaches, spills and the main bridge and 2 other small bridges were measured from this figure. Actual velocities were not observed but approximate surface velocity of 10 ft/sec. was observed at the centre of the bridge No. 3. Arbitrary velocities were therefore assumed and the discharge calculated as shown in table 11.

TABLE 11

S. No.	From	To	Area in sq. ft.	Arbitrary velocities assumed in ft/sec.	Discharge in cusecs.
1	Bridge No. 3		18510.00	7	129570
2	Ch. 20540	Ch. 21080	7203.60	4	28816
3	" 23580	" 24384	5628.00	4	22512
4	" 24495	" 24820	1300.00	2	2600
5	" 25700	" 27400	8160.00	2	16320
6	" 27520	" 27800	868.00	1	868
7	" 27810	" 27900	738.00	2	1476
8	" 27945	" 28170	2205.00	2	4410
9	" 28950	" 29300	4154.50	3	12465
10	Bridge No. 4		340.00	5	1700
11	Ch. 30600	Ch. 31028	577.80	1	578
12	" 31028	" 31200	464.40	1	464
13	" 31400	" 31000 A	2431.00	2	4862
14	" 31370 A	" 32170	352.00	2	704
15	" 32250	" 34830	1135.20	2	2270
16	Bridge No. 5		434.00	5	2170
17	Ch. 34830	Ch. 36000	5850.00	3	17550
18	" 36000	" 36568	2311.76	2	4624
19	" 36568	" 37500	4138.08	1½	6307
20	" 37500	" 38154	1066.02	1	1066
Total sectional area of waterway			67867.36		261,052 cs.

APPENDIX II

1944 flood discharge according to Manning's formula

$$V = \frac{1.486 R^{2/3} S^{1/2}}{n}$$

where

V = velocity in ft./sec.

R = Hydraulic mean depth.

S = Slope

n = Coefficient of rugosity (0.03 for rivers in bad regime).

(1) At the cross-section 4000 ft. upstream of the bridge

Area—A = 51,000 sq. ft.

S = .6 ft. per 1000

R = 8.75 ft.

$$\therefore V = \frac{1.486 \times 8.75^{2/3} \times .0006^{1/2}}{.03}$$

$$= 5.1 \text{ ft./sec.}$$

$$\therefore Q = AV = 51,000 \times 5.1 = 261,000 \text{ cusecs.}$$

(2) At the cross-section 5000 ft. downstream of the bridge

Area—A = 46,000 sq. ft.

S = .8 ft. per 1000

R = 6.88 ft.

$$\therefore V = \frac{1.486 \times 6.88^{2/3} \times .0008^{1/2}}{.03} = 5.04 \text{ ft./sec.}$$

$$\therefore Q = AV = 46,000 \times 5.04 = 232,000 \text{ cusecs.}$$

$$\therefore \text{Average discharge (Mean of (1) and (2))} = 246,500 \text{ cs.}$$

FIG. 39.
 $\frac{1}{200} : \frac{1}{40}$ LUNI MODEL
EXPERIMENT I
SURFACE & BED LINES OF FLOW
WITH $Q = 2.5 \approx 100,000$ Cs.
SCALE $1'' = 7.5' \approx 15000'$

REF. ~
—— SURFACE LINES OF FLOW
..... BED LINES OF FLOW

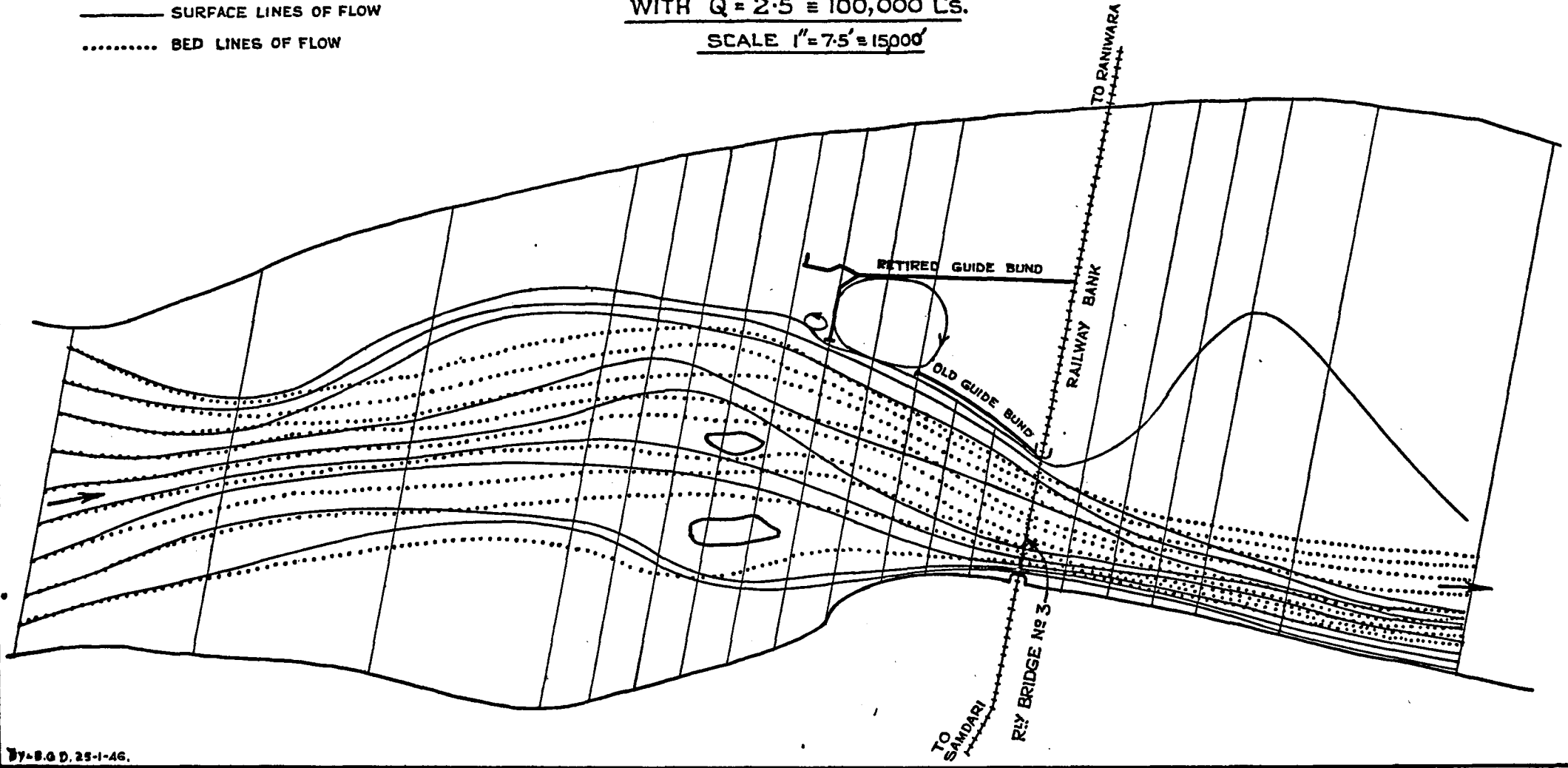

FIG. 40

EXPERIMENT. I

(WITH EXISTING CONDITIONS)

ISOTACHS AND DISCHARGE DISTRIBUTION WITH $Q \approx 2.5 \approx 100,000$ Cs.

VELOCITY SCALE: $1 \text{ FT/SEC.} \approx 5 \text{ FT/SEC.}$

No. 5932

India Waterways Expt. Stn.

RIGHT ABUTMENT.	12.35 %	19.0 %	18.0 %	16.35 %	11.10 %	7.00 %	16.20 %	LEFT ABUTMENT.	% DISCHARGE THROUGH EACH SPAN.
-----------------	---------	--------	--------	---------	---------	--------	---------	----------------	-----------------------------------

SPANS IN PROTO

POINTS SHOW BOTTOM OF
PIER FOUNDATIONS IN
PROTO

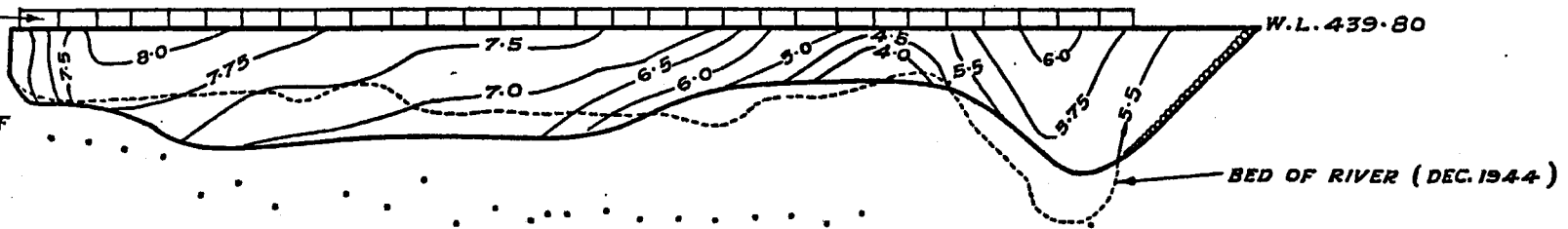

$5'' \approx 100'$ U/S OF THE BRIDGE (ONE MODEL SPAN ≈ 4.29 SPANS IN PROTO)

HOR. SCALE: $1'' = 1' \approx 200'$

VERT. SCALE: $1'' = 1/2' \approx 20'$

NOTE:- EQUIVALENT VELOCITIES ARE SHOWN

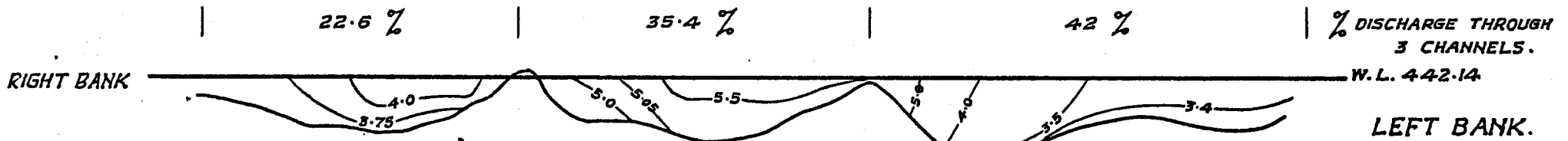

RIGHT BANK

W.L. 442.14

LEFT BANK.

AT SECTION No. 10 - 3500 FT. U/S OF BRIDGE - ACROSS THE NATURAL ISLAND.

HOR. SCALE: $1'' = 2' \approx 400'$

VERT. " $1'' = 1/2' \approx 20'$

T. BY. SAPKAL.

13. Training of Jumna at Delhi Gate Pumping Station with Pitched Embankment on the Right Bank.

1. Introduction :—

Experiments with the Barrage at Purana Killa⁽¹⁾ showed that with existing groynes, the increased depths upstream of the Barrage caused accretion of the bed in front of the Pump House inlet; thereby necessitating dredging a low-level channel to feed the pumps during the low water stage.

Experiments were, therefore, carried out to determine the measures required to improve these conditions.

2. Flow conditions in the river :—

Under existing conditions in the river, the main stream follows the left bank down to groyne 3, then gradually swings to the right, misses groyne 5, is more or less central opposite the pump house and crosses to the right bank well downstream of it. Bankful stage is reached with about 40,000 cusecs and when the discharge exceeds about 70,000 cusecs, the spill channels on right bank begin to flow.

When the most westerly channel begins to flow, it meets the main river at the upstream inlet of the pump house, where a slack return flow occurs, thus reducing the forward velocities near the Pumping Station and causing a heavy deposit of sand on a falling flood.

With the barrage, there would be accretion in the river bed which would cause the westerly channel to spill earlier and the period of slack flow would persist longer, and hence there would be a rapid deterioration in the present conditions.

3. *Experiments* :— In continuation of four experiments reported in the Annual Report (Tech.) 1944⁽²⁾ the following further experiments were done (see Fig. 42) :—

Experiment 5 :— With the groynes as existing, with a Barrage at Purana Killa, and an embankment 1875 ft. long excluding the curved head, upstream of the Pump House inlet. The curved head had a radius of 200 ft.

Experiment 6 :— Same as experiment 5, but with the nose of groyne 5 receded by 200 ft; the mid-depth point being kept correct.

Experiment 7 :— Same as experiment 6, but with the length of the proposed embankment reduced to 1275 ft, a curved head being provided as in experiment 5.

Experiment 8 :— Same as experiment 7, but with the length of the embankment increased to 1575 ft. and its alignment altered with a view to improve curvature.

Experiment 9 :— Without the Barrage at Purana Killa, i.e. existing conditions and nose of groyne 5 receded by 200 ft. as in expt. 6.

Experiment 10 :— Same as expt. 9, but with the 1575 ft. long embankment of expt. 8 added.

Experiment 11 :— Same as expt. 10, but with the embankment realigned by cutting off a portion of the projecting bank near the downstream inlet of the Pump House. Length of the embankment was 2400 ft.

Experiment 12 :— Same as expt. 11, but with the Barrage at Purana Killa.

(1) Annual Report (Tech.) for 1944, page 8.

(2) Indian Waterways Experiment Station Annual Report (Tech.) 1944, page 8.

Fig. 41

Fig. 42

4. *Procedure*:— Before starting each experiment with the Barrage at Purana Killa, the model bed was moulded to the conditions obtained in experiment 3, with injection of fine silt. To accelerate results, silting obtained in the experiment was exaggerated three times. The model channels before experiment were thus as shown in photo 3055.

Before starting experiments without the Barrage, the model bed was moulded to the 1942 river survey because to mould according to results of expt. 3 would have been to impose wrong conditions on the model.

Discharge cycles *rising* from 40,000 cusecs to 90,000 cusecs and *falling* back to 40,000 cs. were run till stability was obtained. The rate of injection of sand was .055 parts per 1000 with 40,000 cs.

5. *Discussion of experiments*:—Experiments were carried out with different lengths and alignments of embankments, on the right bank upstream of the Pumping Station, to ensure forward flow at the Pump House, at all the flood stages, and to increase the velocity near the Pumping Station by attracting the flow so that the low water channel would persist along the Pump House.

Reproducing prototype conditions in vertically-exaggerated models in such cases is difficult because action at rigid structures is geometrically-similar while the rest of the model is vertically exaggerated for reproducing curvature of flow correctly. Scour-holes round rigid structures are, therefore, usually deeper and wider than according to scale in the prototype due to the natural angle of repose; which cause relatively greater concentration of discharge at noses, tending to vitiate conditions; and results must, therefore, be adopted judiciously.

Fig. 43 Fig. 43 shows the scour-hole at the nose of groyne 5. This being relatively deep and wide caused unnatural conditions downstream, viz. the channel downstream of groyne 5 was relatively very wide and shallow. To overcome this defect, the nose of groyne 5 was receded in experiment 6 by 2/3rds its length, *the mid-depth point being kept correct*—a useful model technique.

Figs. 43 & 44 Figs. 43 and 44 show the scour-holes and the low water channels in experiments 5 and 6. It will be seen that, when the nose of groyne 5 was receded, the scour-hole was less deep and less wide, and the low water channel was well defined as in the river.

Fig. 45 The result of experiment 7, in which the length of embankment was reduced from 1875 ft. to 1275 ft., was similar to that of experiment 6.

Fig. 46 In both these experiments, the low water channel was still nearly 200 ft. away from the upstream inlet of the Pumping Station. In experiment 8, therefore, the alignment and length of the embankment were suitably modified to improve conditions. Results in respect of the low water channel were satisfactory, in that it crossed over to the right bank at the Pump house inlet as required.

Lines of flow were observed with 40,000 cs. in experiment 5, 6, and 8 from which it was seen that, in experiment 5, the high velocity surface flow was markedly concentrated at the nose of groyne 5; whereas, in experiments 6 and 8 it was well distributed and more natural than in experiment 5. In experiment 5 the tendency of the bed flow, at the nose of groyne 5, was along the edge of the scour-hole and more towards the Pump House bank than in experiments 6 or 8. This effect, which was relatively exaggerated in the model in experiment 5, was almost overcome in the following experiments by receding the nose of groyne 5.

Having obtained satisfactory low water channel conditions with the barrage, it remained to see if the same embankment would be equally effective without the barrage at Purana Killa.

Fig. 47 Experiment 9 was, therefore, carried out with the existing conditions; the results showed that (without any device to attract the flow, to the Pump House bank) the low water channel crossed over to the left bank below groyne 5, i.e. away from the Pump House as in the river, thus proving the model.

Photo 4056

FIG. 41

JUMNA RIVER AT DELHI GATE PUMPING STATION

SHOWING SURFACE FLOW CONDITIONS

U/S OF PUMPING STATION

OBSERVED IN AUGUST 1942 WITH Q = 78,000 Cs.

WATER LEVEL AT PUMPING STATION = 669.00

SCALE 1" = 1200'

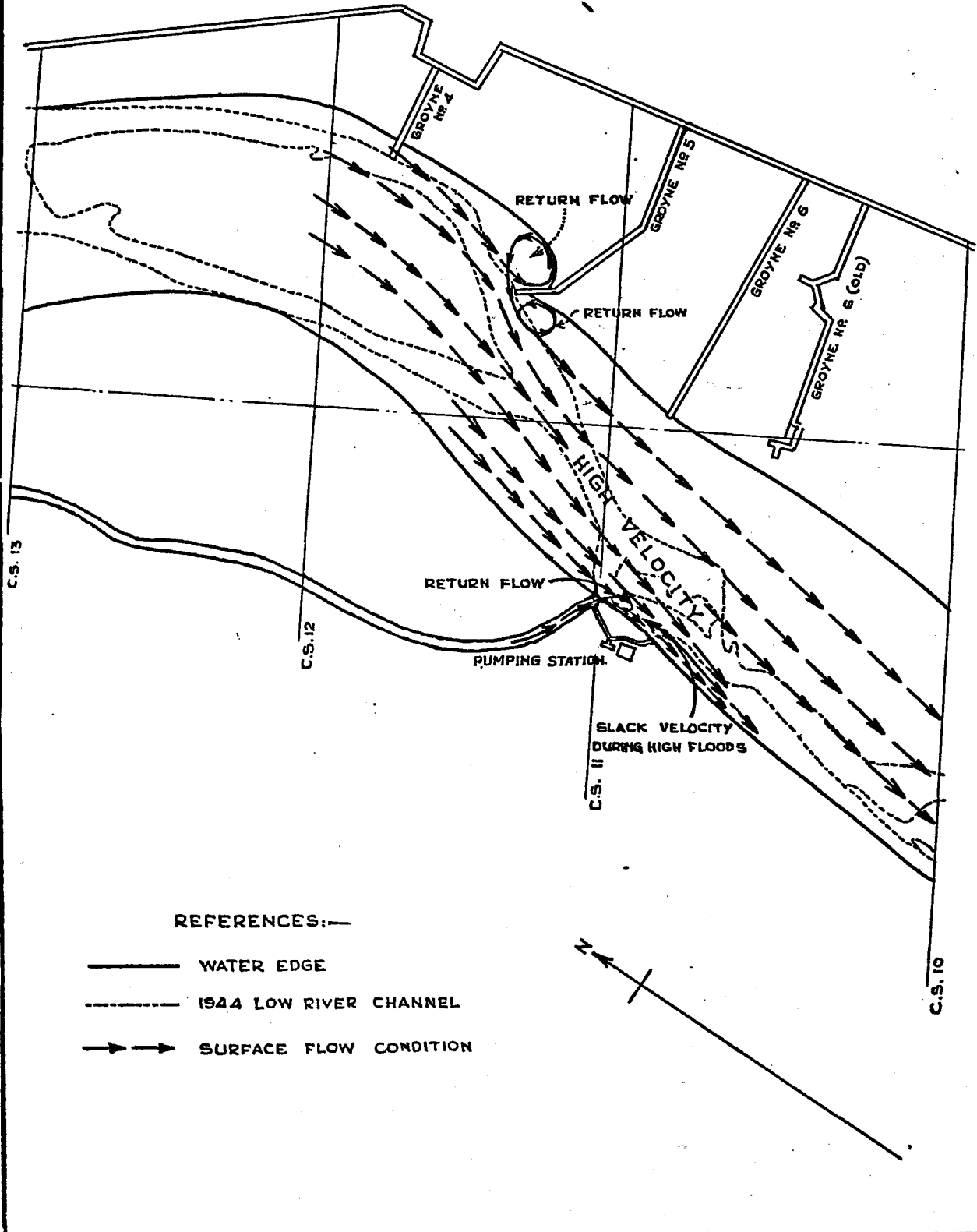

E.I. RAILWAY BRIDGE

FIG. 42

1/150 : 1/46 JUMNA MODEL EXPTS.
SHOWING THE VARIOUS ALTERNATIVES
TESTED IN EXPERIMENTS.

SCALE 1" = 1800'



- PITCHED EMBANKMENT OF EXPT. 5-6
LENGTH EXCLUDING CURVED HEAD = 1875'
- PITCHED EMBANKMENT OF EXPT. 8
LENGTH EXCLUDING CURVED HEAD = 1575'
- PITCHED EMBANKMENT OF EXPT. 7
LENGTH EXCLUDING CURVED HEAD = 1275'
- PITCHED EMBANKMENT OF EXPT. 11-12
LENGTH EXCLUDING CURVED HEAD = 2400'

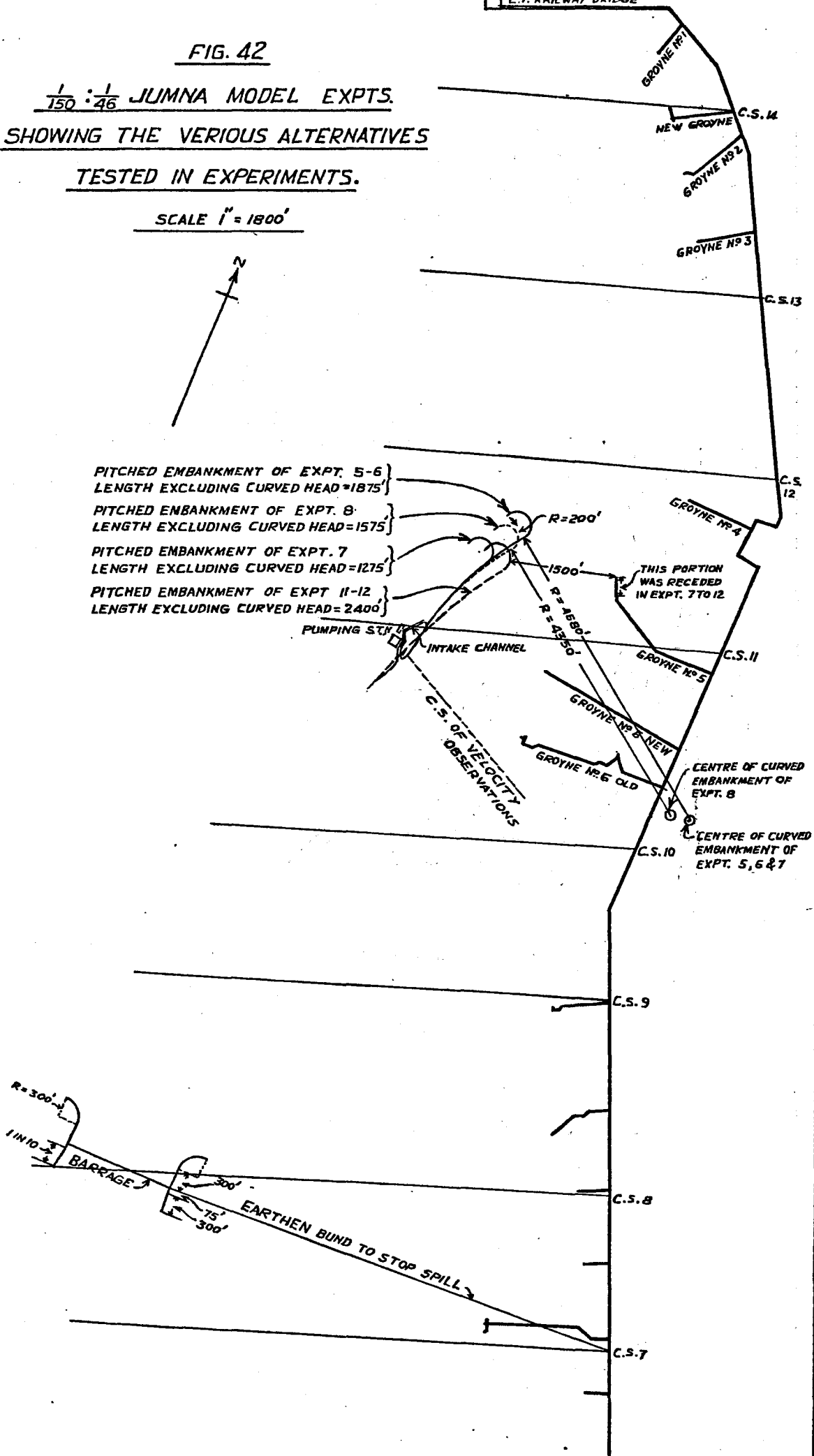

FIG. 43

1/150:1/46 JUMNA MODEL EXPTS.
SHOWING THE SCOUR PIT AT THE NOSE
OF GROYNE NO 5 IN EXPT. 5
& THE LOW WATER CHANNEL OBTAINED
AT THE END OF EXPERIMENT.

SCALE:- 1" = 8' = 1200'

REFERENCES:-

- - - - - 1944 LOW WATER CHANNEL IN THE PROTOTYPE.
- ~~~~~ LOW WATER CHANNEL AFTER EXPTS.

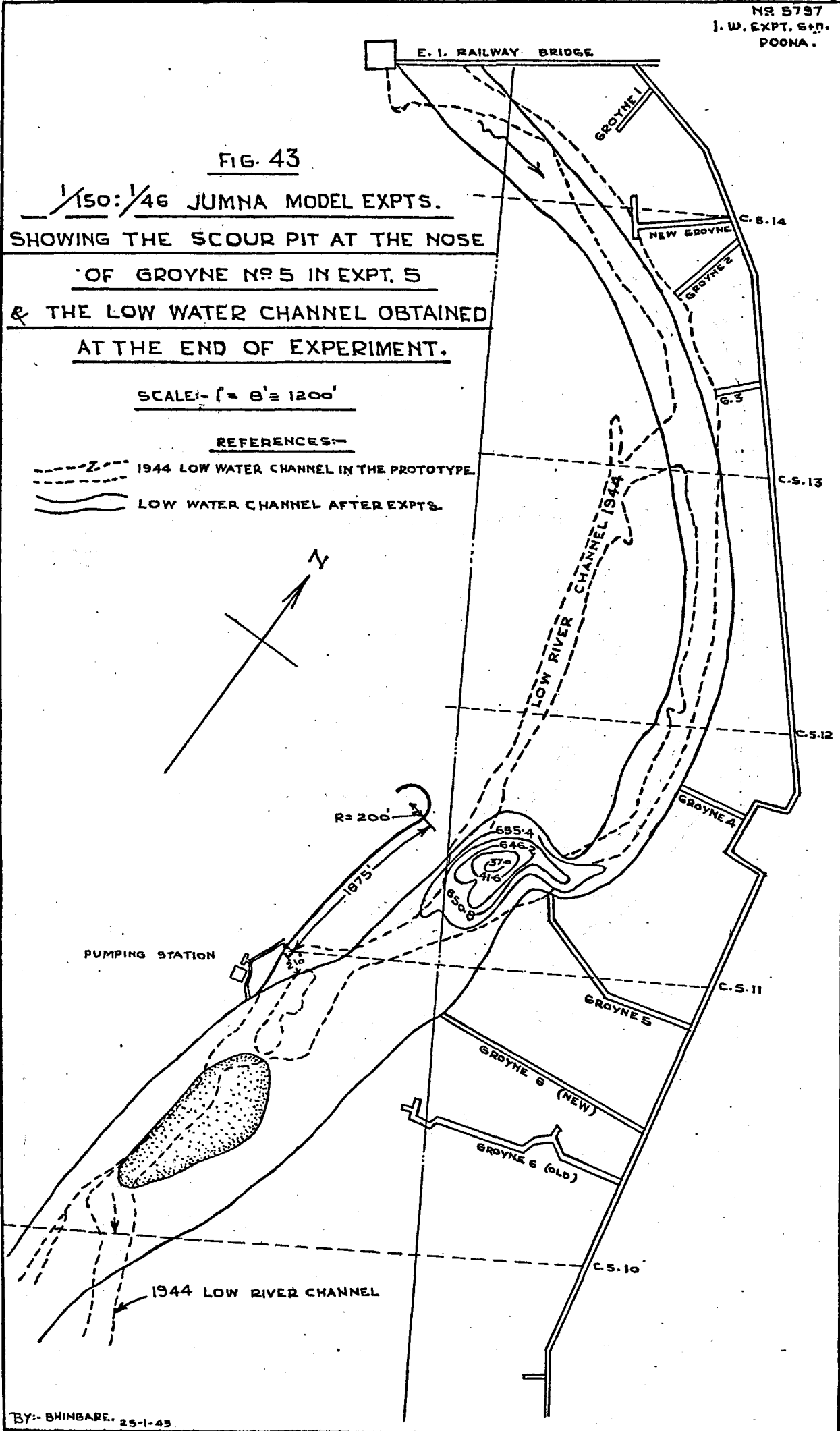
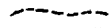



FIG. 44

$\frac{1}{150} : \frac{1}{46}$ JUMNA MODEL EXPTS.
SHOWING THE SCOUR PIT AT
THE NOSE OF GROUYNE N^o 5
IN EXPT. 6 & THE LOW
WATER CHANNEL OBTAINED
AFTER EXPERIMENT.

SCALE 1" = 8' = 1200'

REF:

-  1944 LOW WATER CHANNEL IN THE PROTOTYPE
-  LOW WATER CHANNEL AFTER EXPT.

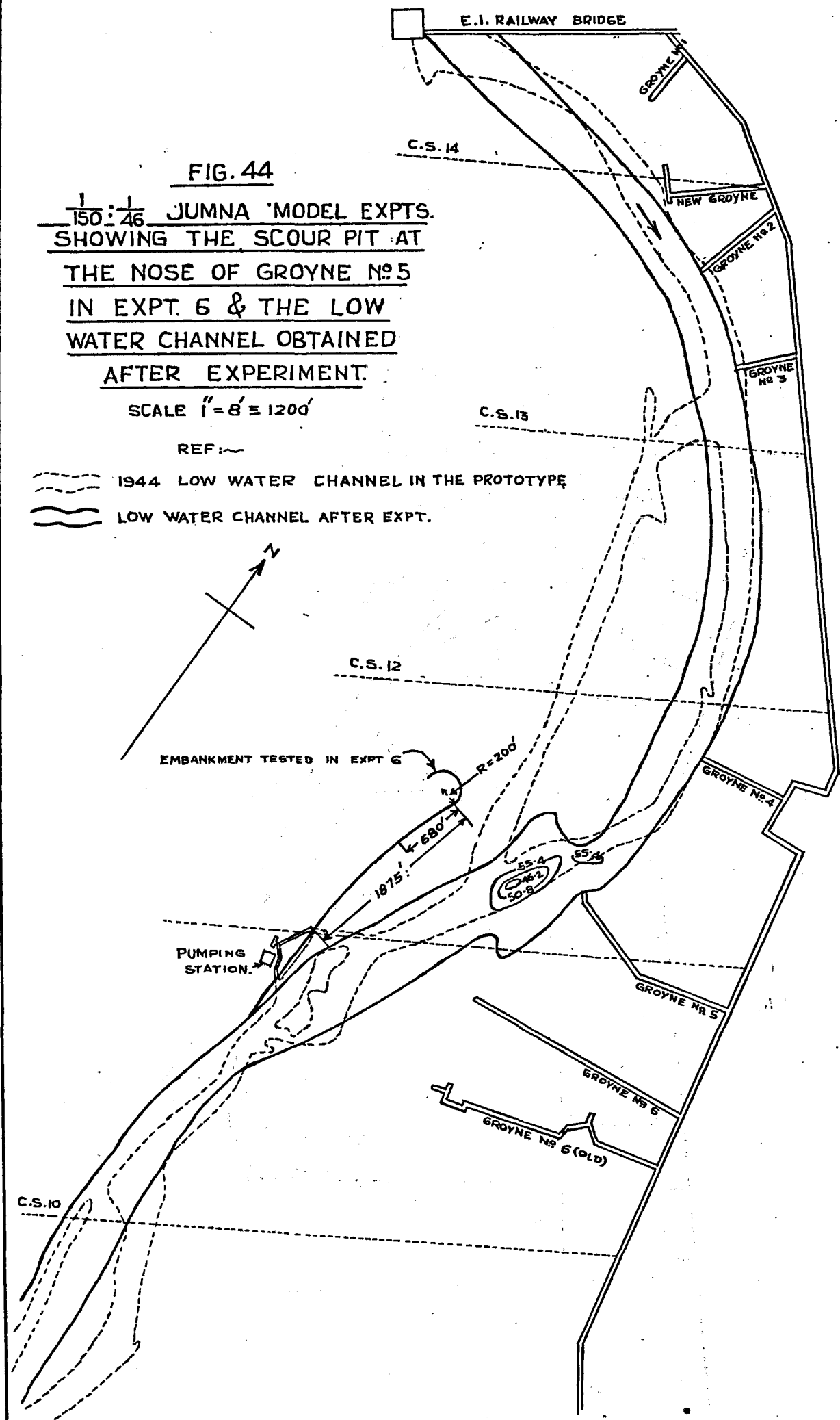
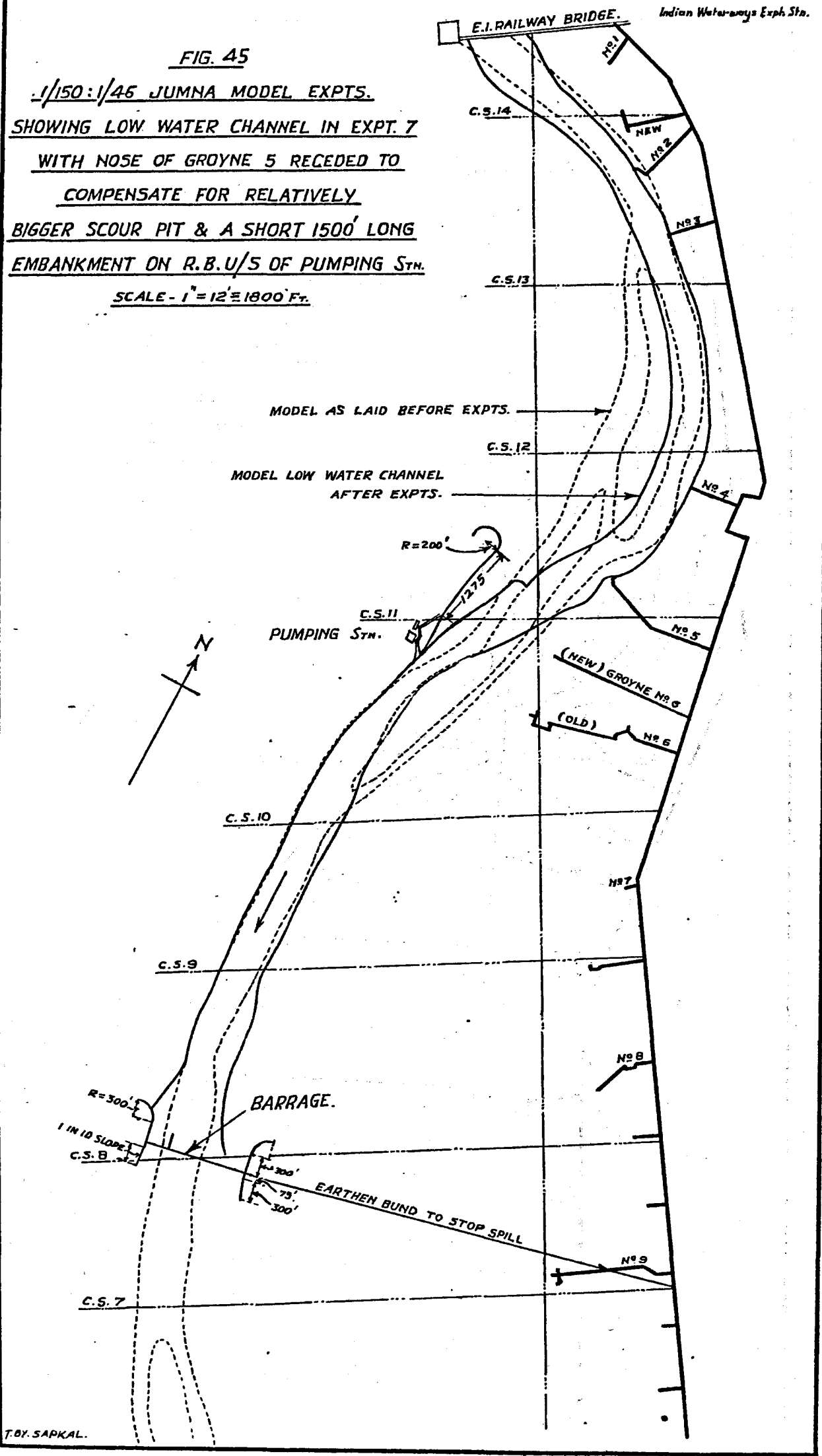

FIG. 45

1/150:1/46 JUMNA MODEL EXPTS.
SHOWING LOW WATER CHANNEL IN EXPT. 7
WITH NOSE OF GROYPNE 5 RECEDED TO
COMPENSATE FOR RELATIVELY
BIGGER SCOUR PIT & A SHORT 1500' LONG
EMBANKMENT ON R.B.U/S OF PUMPING STN.

SCALE - 1" = 12' = 1800 FT.



T. BY. SARKAL.

FIG. 46
1/150:1/46 JUMNA MODEL EXPT.
SHOWING DEEP CHANNEL OBTAINED IN
THE MODEL AFTER EXPT. 8
WITH CHANGED ALIGNMENT
OF
EMBANKMENT.
SCALE 1" = 12' = 1800 FEET.

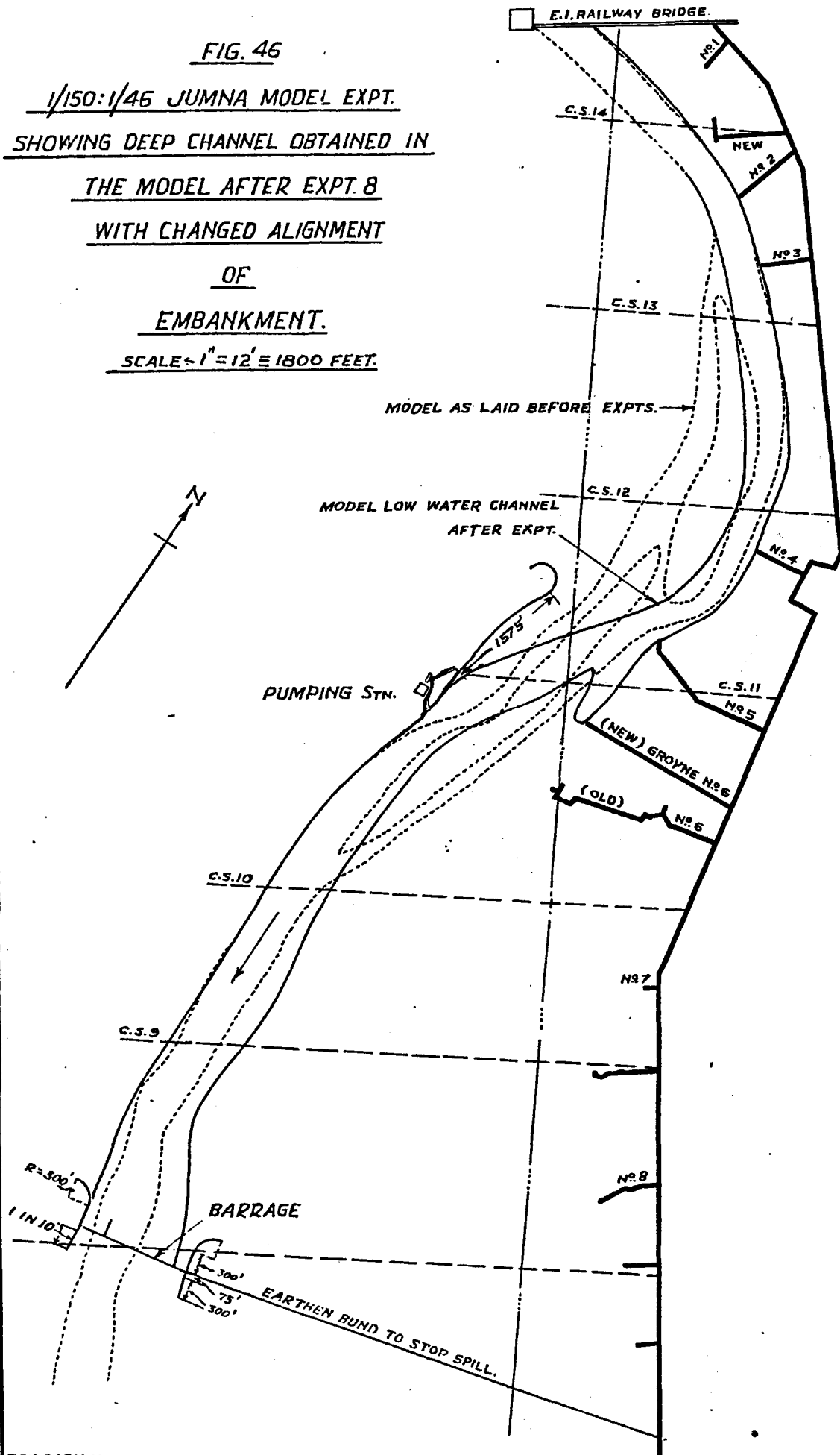

TRV. SAPHAL

FIG. 47
1/150:1/46 JUMNA MODEL EXPTS.
SHOWING LOW WATER CHANNEL IN EXPT. 9
WITH EXISTING CONDITIONS
(NOSE OF GROYPNE 5 WAS RECEDED BY 200 FT.)

SCALE 1" = 12' = 1800'

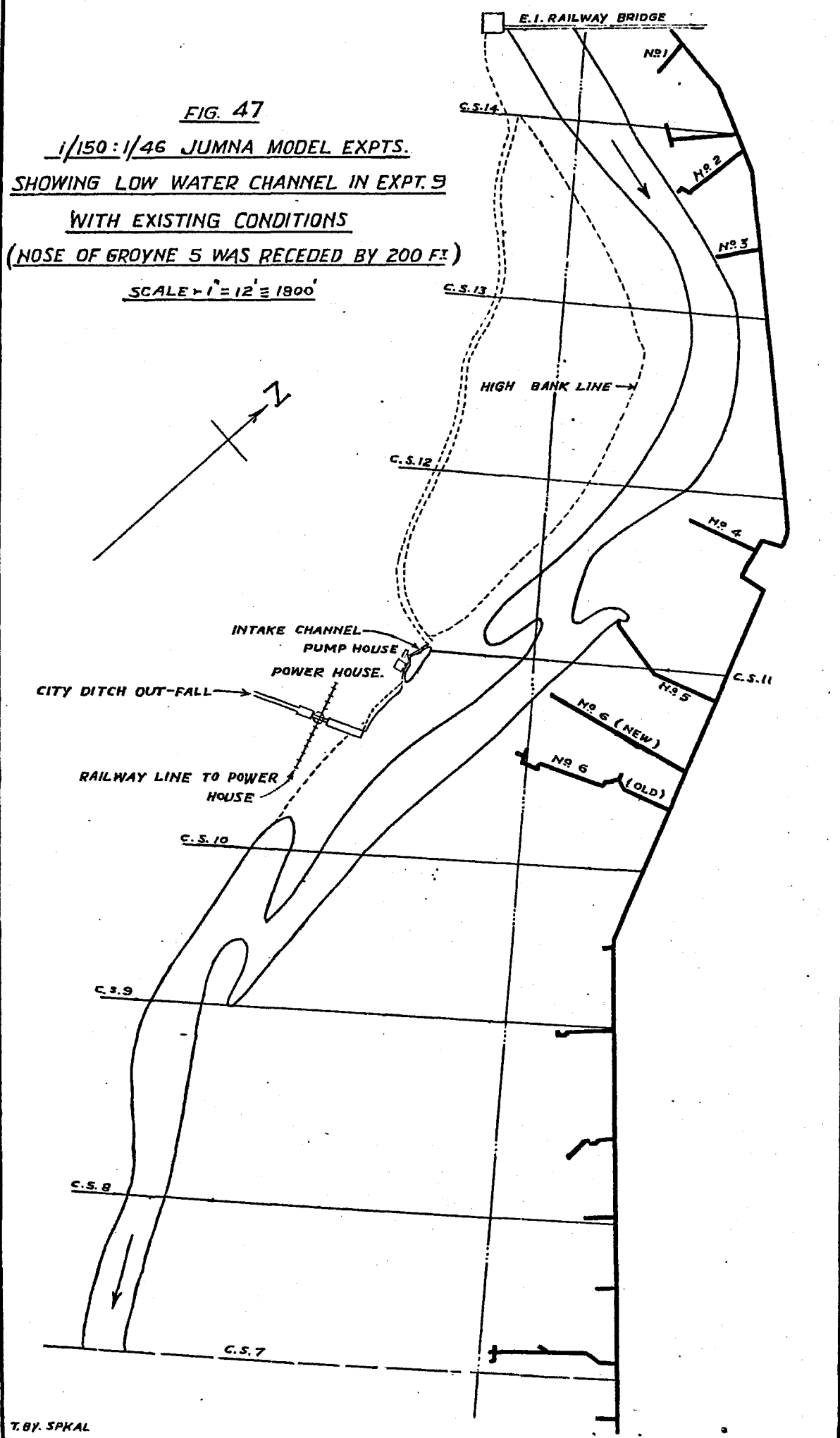

T. BY. SPKAL

1/150 : 1/46 Jumna Model Experiments

Shoal in front of
Pumping Station Bank.

Shank of
groyne 6 →
Groyne 5 →
with truncated
nose.

Shank of
groyne 4 →



← Pitched
embankment
upstream of
Pumping
Station.

Photo 3055 : Photo looking downstream from left bank above groyne 4 showing the model channels as laid before beginning experiments 5 and 6, with pitched bank on right bank upstream of Pumping Station. This photo was taken at the beginning of experiment 6 in which the nose of groyne 5 was receded.

1/150 : 1/46 Jumna Model Experiments

Shank of
groyne 6 →
Groyne 5 →

Shank of
groyne 4 →

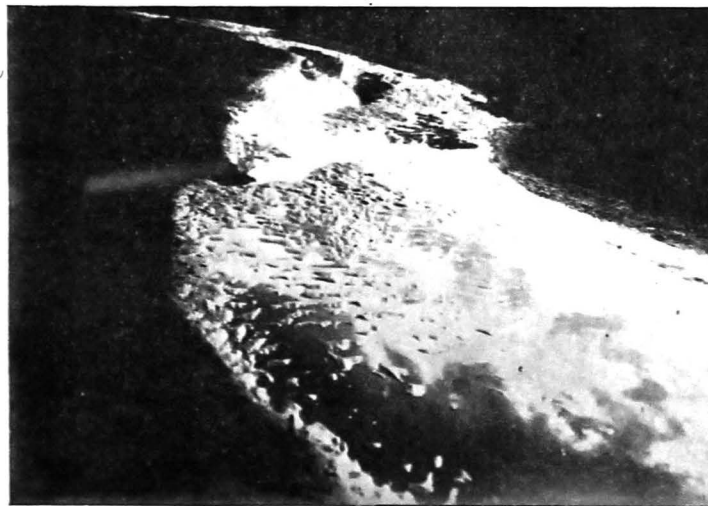

4056

Showing
low water
channel in
expt. 9
with exist-
ing condi-
tions i. e.
without
the
barrage.

Fig. 48 In experiment 10, the 1575' long embankment of experiment 8, which had given satisfactory results with the barrage, was added; but the results were not satisfactory as the low water channel was 660 ft. away from the Pump House bank.

In experiment 11, therefore, the alignment of the embankment was altered by cutting off a portion of the projecting bank in front of the Pump House, so that the embankment was concave throughout its length; it was continued downstream of the pump house till it joined the high bank. The total length of the embankment from its upstream end to the tail was 2400 ft. excluding the curved head.

Fig. 49 Results were satisfactory as the low water channel was along the Pumping Station bank as desired.
Photo 4073

Fig. 50 Having obtained satisfactory conditions without the Barrage, in order to see if the *same* embankment would be equally effective with it, the Barrage was added at Purana Killa in expt. 12 as in the first 8 experiments. The results were satisfactory as the low water channel hugged the Pumping Station bank.
Photo 4076

Fig. 49 Observation of lines of flow with 40,000 cusecs in experiment 11 showed a definite curvature effect in that almost all the bed lines were deflected away from the Pump House bank; but the high velocity surface lines hugged the bank.

Fig. 50 In experiment 12, though the curvature effect was not so apparent the bed lines being more uniformly distributed across the section; yet the velocities near the Pump House were higher than without the embankment, which led to scouring the shoal formed in front of the Pump House by the Barrage without an embankment so as to give a low water channel, as seen in fig. 50.

It is anticipated that the results would be appreciably better in the river than indicated by the model because of the inherent *limitations* of this model.

The model bed movement ceased below a discharge \cong 30,000 cusecs, whereas in the river the bed scour is said to continue with discharges down to even 5000 cusecs. Thus, at even the lower discharges, with their reduced meander length, the embankment may be expected to further assist the river tendency to scour a deep channel along its face.

6. *Effect of embankment on the distribution of velocities at a cross section 150 ft. upstream of the weir site of experiment 2 (for location of this cross section please see fig. 42):—*

Fig. 51 Fig. 51 shows the ratio of \bar{v} mean on the vertical to \bar{V} mean of the cross section plotted at each point of the cross section with $Q \cong 40,000$ cs. in experiment 9 (i. e. existing conditions) and in experiment 12 (with the Barrage and the best design of the embankment). It will be observed that the embankment caused a decrease in the velocities in the *left* half of the cross section and an increase of velocities in the *right* half, i. e. a complete reversal of velocities under existing conditions without an embankment.

Fig. 52 7. *Details of the optimum embankment:*—Fig. 52 shows the dimensions of the optimum embankment and its cross section. As the maximum water level at the Pump House is R.L. 71, the top of the embankment, with 2 : 1 side slopes, may be taken up to R.L. 73, having a free board of 2 ft. The stone pitching may be 2 ft. thick.

Launching apron:—In order to protect the toe of the embankment, a launching apron should be provided. An apron 30' wide and 4' thick would appear to be sufficient to form a 2 : 1 slope with a deep channel along the face of the embankment. (For calculations see Appendix I).

8. *Conclusion:*—

(1) A pitched embankment along the right bank at the Pumping Station as in experiment 12 would induce the river to develop a deep

FIG. 48

1/150 : 1/46 JUMNA MODEL EXPTS
SHOWING LOW WATER CHANNEL OBTAINED
IN EXPT 10, WITHOUT THE BARRAGE AT PURANA
KILLA & THE 1570' EMBANKMENT OF EXPT. 8.

SCALE - 1" = 1800'

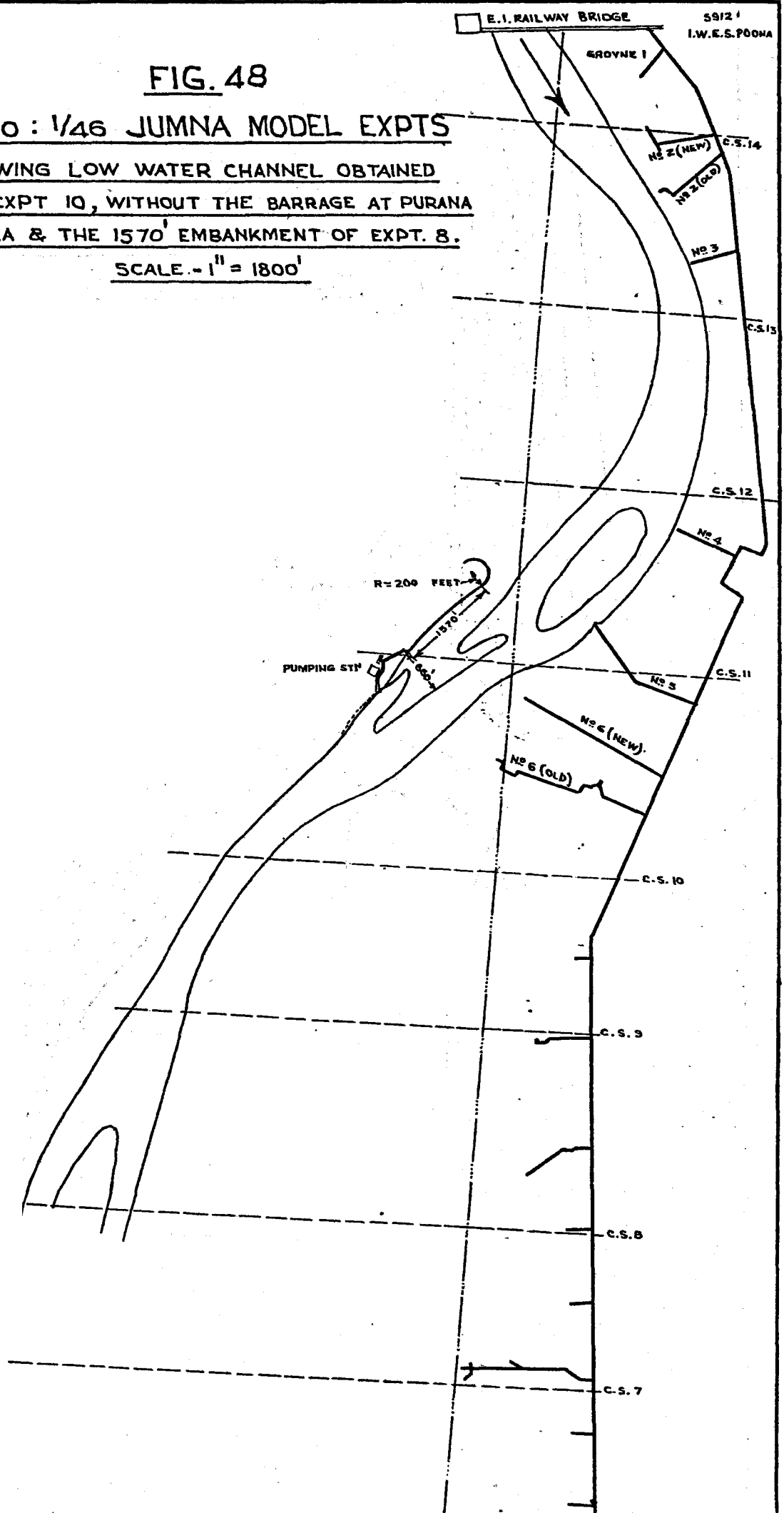



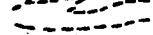

FIG. 49

1/150:1/46 JUMNA MODEL EXPTS.
SHOWING LINES OF FLOW WITH 40,000 CFS.
& LOW WATER CHANNEL OBTAINED AFTER
EXPT. II WITH EXISTING CONDITIONS
i.e. WITHOUT BARRAGE & REALIGNED
EMBANKMENT ON RIGHT BANK
AT PUMPING STATION.

SCALE: 1" = 1800'

REFERENCES:-

-  WATER EDGE.
-  SURFACE FLOW LINES.
-  BED " " "
-  LOW WATER CHANNEL.

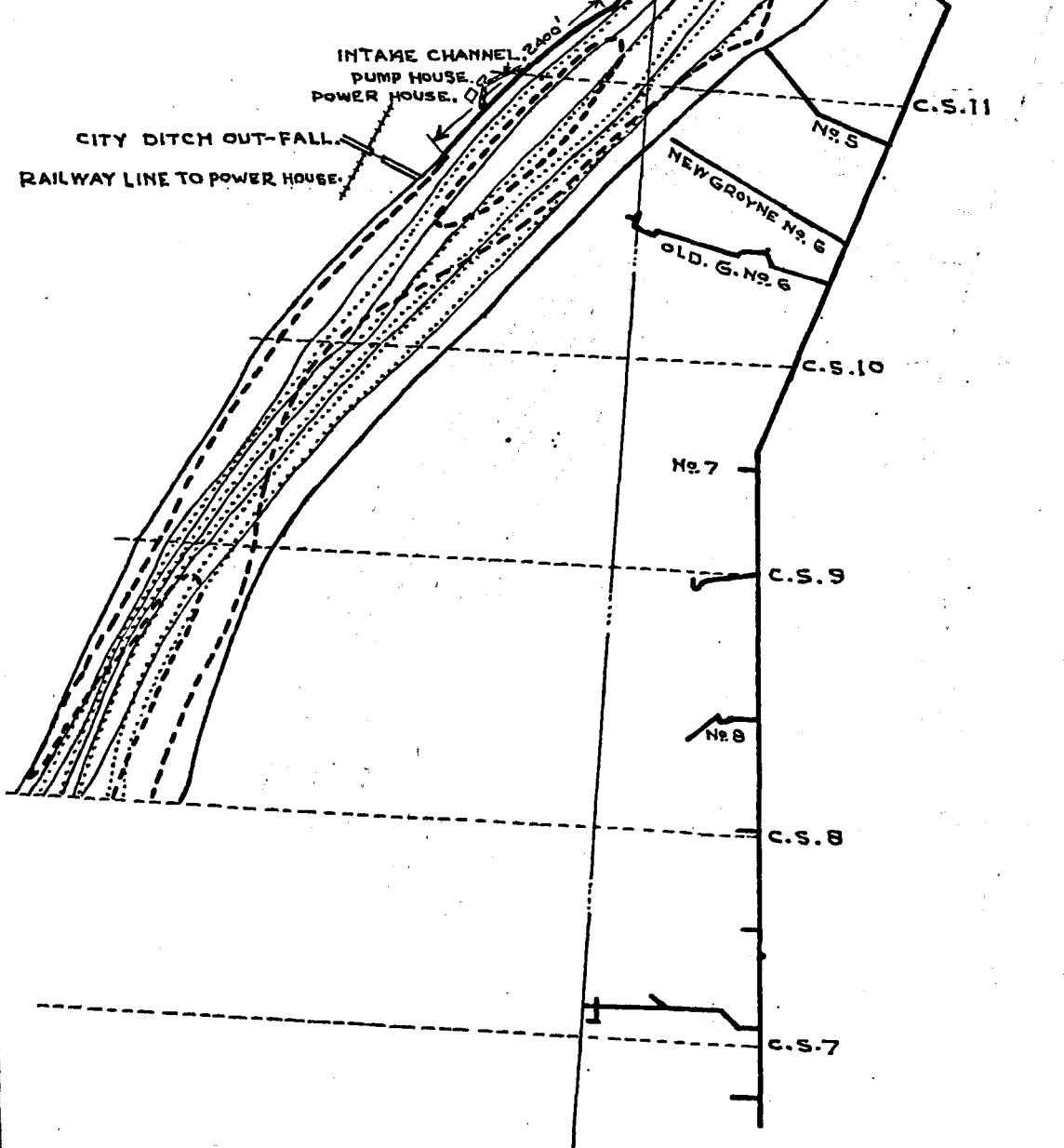





By:- BHINGARE.

FIG. 50

1/150: 1/46 JUMNA MODEL EXPTS.
SHOWING LINES OF FLOW WITH 40,000 CS.
& LOW WATER CHANNEL OBTAINED IN
THE MODEL IN EXPT. 12 WITH
BARRAGE & THE EMBANKMENT OF EXPT. 11

SCALE: 1" = 1800'

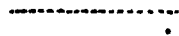
REFERENCES:-

-  WATER EDGE.
-  SURFACE FLOW LINES.
-  BED FLOW LINES.
-  LOW WATER CHANNEL.

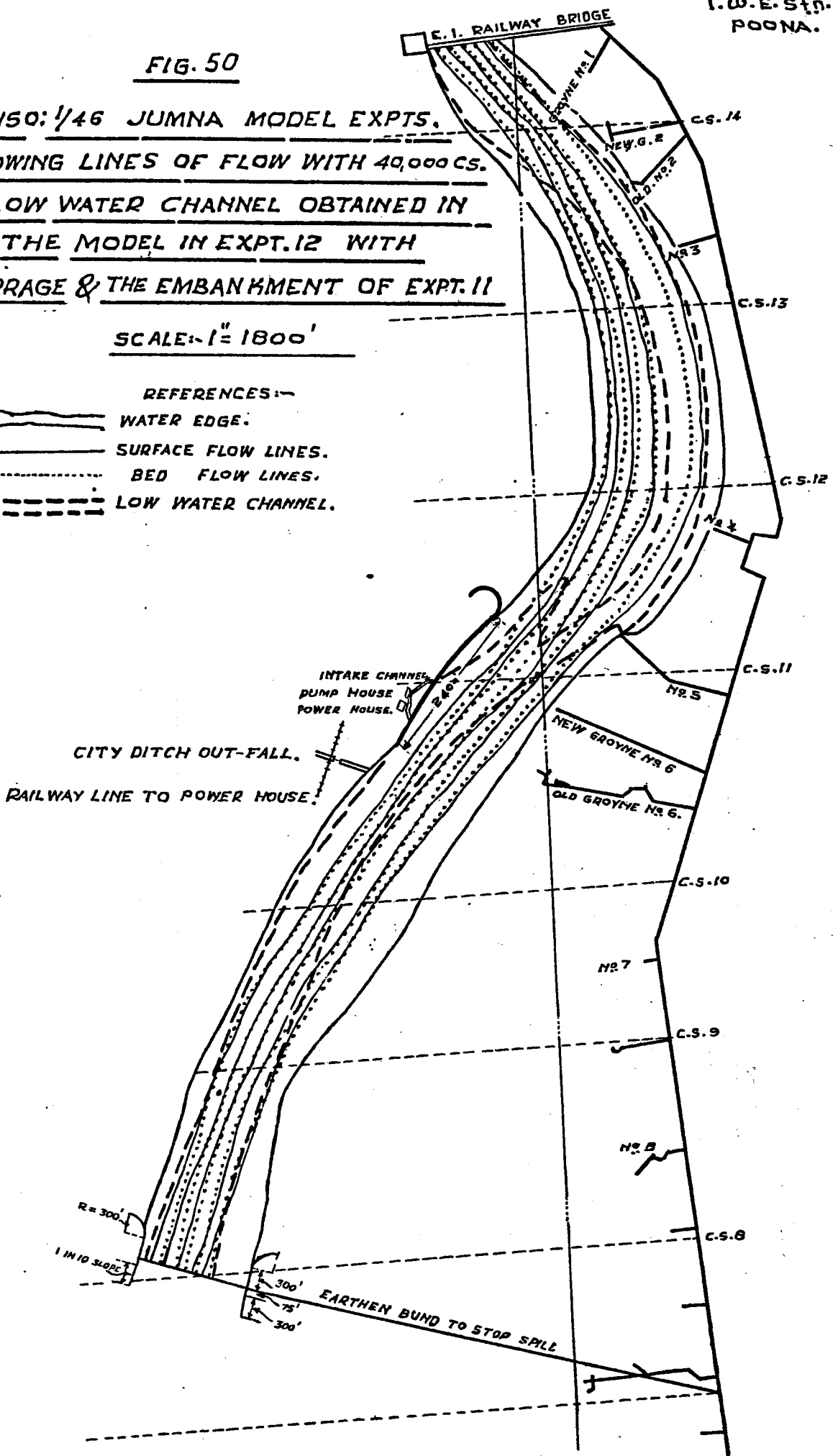

FIG. 51

1/150 1/46 JUMNA MODEL EXPERIMENTS
SHOWING THE VELOCITY DISTRIBUTION AT A C.S. 150' D/S
OF THE ALIGNMENT OF THE LOW LEVEL WEIR IN EXPT. 2.
FOR LOCATION OF C.S. (PLEASE SEE FIG 1.)

REFERENCES

- \bar{V} MEAN OF VERTICAL IN EXPT. 7 WITH EXISTING CONDITIONS.
 - - - - - \bar{V} OBSERVED OF CROSS SECTION " " EXPT. 12 WITH EMBANKMENT & BARRAGE.

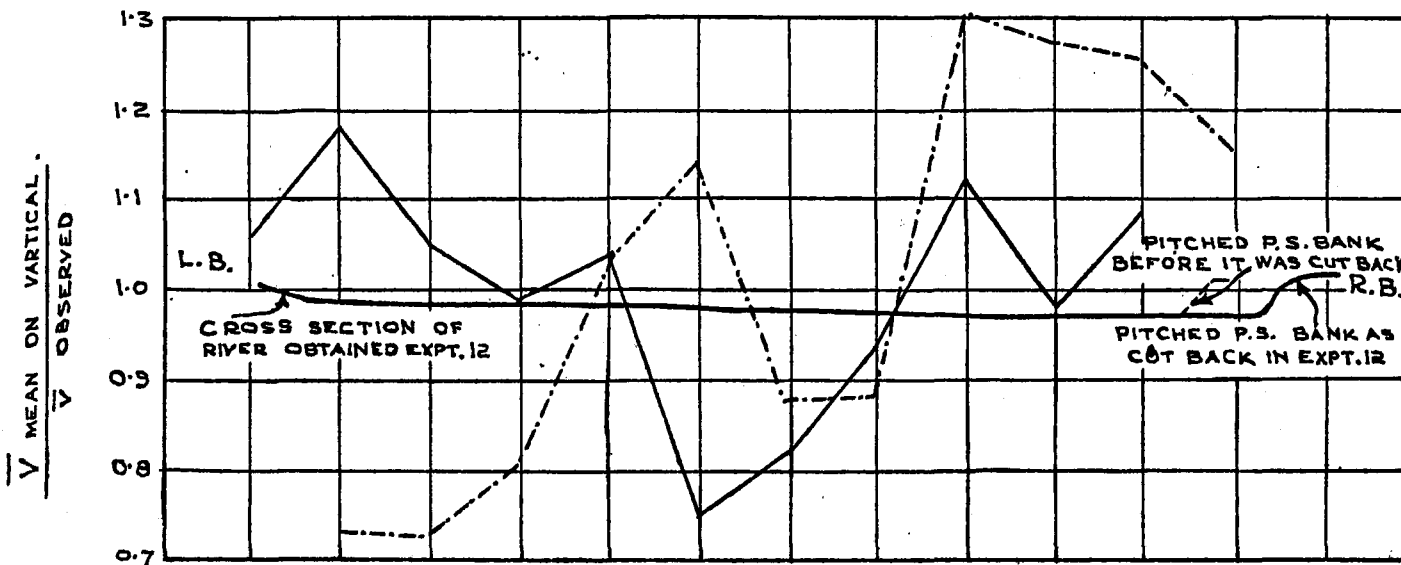
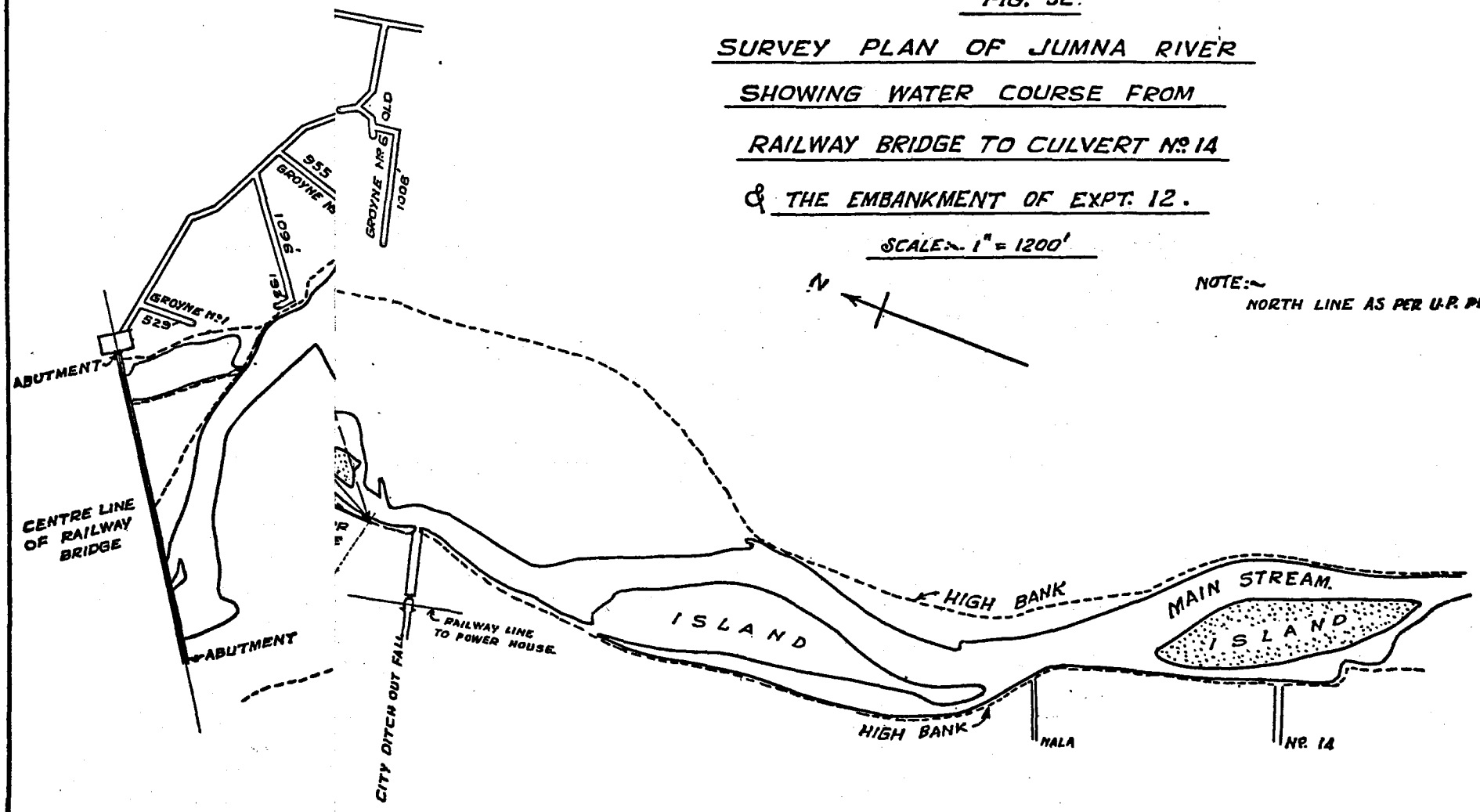

FIG. 52.
SURVEY PLAN OF JUMNA RIVER
SHOWING WATER COURSE FROM
RAILWAY BRIDGE TO CULVERT NO. 14
& THE EMBANKMENT OF EXPT. 12.

SCALE: 1" = 1200'



NOTE:~
NORTH LINE AS PER U.P. PLANS



W.P.S.C.D. 28-7-45.

1/160 : 1/46 Jumna Model Experiments

Shank of
groyne 6 →

Groyne 5 →

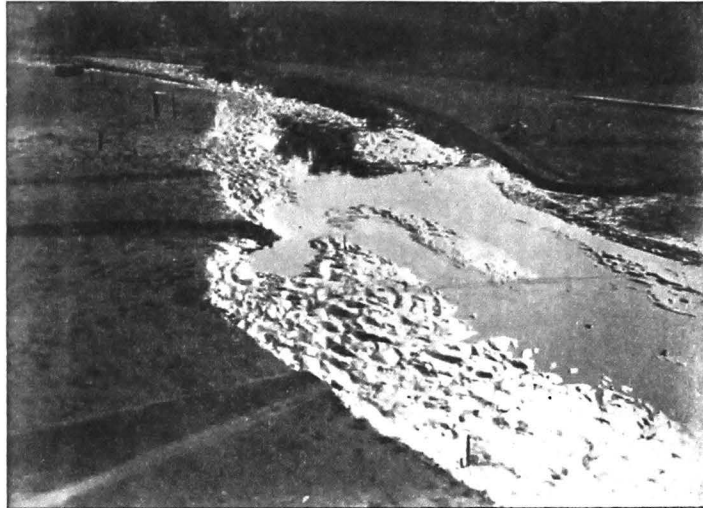
Shank of
groyne 4 →

4073 Showing low water channel in experiment 11 with realigned embankment upstream of Pumping Station and existing conditions (i. e. without Barrage).

Shank of
groyne 6 →

Groyne 5 →

Shank of
groyne 4 →

4076 Showing low water channel after experiment 12 with Barrage at Purana Killa and embankment as in experiment 11.

channel along its face, both under the present conditions and even when a Barrage is constructed at Purana Killa at some subsequent date.

(2) The upstream existing inlet of the Pump House, in case the embankment is constructed, may be altered to the position shown in fig. 52, i. e. downstream of the present inlet, because, at the downstream site, the curvature effect produced by the embankment is likely to be more pronounced.

APPENDIX I

Showing the calculation of the quantity of stone required for the falling apron to give a 2 ft. thick launched apron.

Data :—

$$Q_{\max.} = 100,000 \text{ cusecs.}$$

Water level at Pumping Station
with 100,000 cusecs = R.L. 71.00 (to G.T.S. datum)

General river bed R.L.
at the embankment site = R.L. 58.00

$$f_d = 1.76 \sqrt{m} = 1.00$$

Toe of the pitched embankment may be kept at the general river bed level at the embankment site.

$$\begin{aligned} \text{Maximum depth of scour at} \\ \text{the nose of the pitched} \\ \text{embankment} \quad \dots \quad \dots &= 1.8 D_{\text{Lacey}}^{(1)} \\ &\text{or} = 1.8 \times .47 (Q/f)^{1/3} \\ &= 39.3 \\ &= 39 \text{ ft. say.} \end{aligned}$$

$$\therefore \text{Lowest bed R.L. in scour pit} = 71 - 39 \\ = 32 \text{ R.L.}$$

i. e. 26 ft. below the proposed toe of pitched embankment.

$$\therefore \text{Length of launched apron} = \sqrt{52^2 + 26^2} \\ = 58.15 \\ = 58 \text{ ft. say.}$$

$$\therefore \text{Quantity of stone per running foot of the embankment,} \\ \text{Assuming a 2 ft. thick} \\ \text{launched apron} \quad \dots = 58 \times 2 \\ = 116 \text{ cft.}$$

$$\therefore \text{An apron 30 ft. wide will have to be } 3.87 \text{ ft. or say } 4' \text{ thick.}$$

12. EXCLUDERS AND EJECTORS

14. Design of the Lower Sind Barrage: Experiments to test the Design for Scour and Sand Exclusion from Canals—Sind.

PART I

(1) *Necessity of barrage for Lower Sind :—*

It is expected that, due to the contemplated further Punjab' withdrawals, there will be a serious lowering of the river levels in Lower Sind, particularly in the months of May and September which are crucial months for Kharif crops on the lower Sind inundation canals. In order to offset these adverse effects it is proposed to construct a barrage in the Lower Sind reach at some suitable point, with feeders on both banks to link up with the existing canal systems.

(1) Annual Report (Tech.) of work done during 1944, pages 74-81.

(2) *Selection of site for the barrage.*

The over-riding considerations in selecting the site for the barrage are:—

(a) The river course at the point must be stable to avoid costly river training works.

(b) It should give sufficiently high levels to command all the lands to be irrigated without undue heading up at the Barrage.

(c) It should be as near the command as possible to avoid unnecessarily long Feeders.

In case of a Project for Lower Sind, three alternative sites were considered:—

(1) Kotri (2) Hajipur and (3) Jherruck.

Fig. 53

The site near Kotri satisfies requirements (a) and (b) above; it would, no doubt, involve longer and costlier Feeders than a Barrage at either Jherruck or Hajipur; but, deciding where to build the Barrage on first cost instead of on all-time, general superiority would be a folly.

The site at Jherruck satisfies requirements (a) & (c); but it is too far down the river to give sufficiently high levels required in the canals.

The site at Hajipur satisfies the requirements (a) and (c), but not (b) without undue heading up which would inevitably lead to serious accretion or meandering and unfavourable sand-exclusion in time; at Hajipur again two sites are feasible:—

(1) Site C and (2) Site B.

Fig. 53

Out of these two sites at Hajipur, a Barrage at site C is cheaper as construction can be carried out there *in the dry* by enclosing within ring bunds and, thus, would be continuous and quicker and less costly than at site B, where the Barrage would have to be constructed in *cofferdams*. In order to test the feasibility of each of these sites, model tests were carried out for both the sites at the Poona Station.

(3) *Model.*

In order to test the suitability of site, a model was constructed in Sangam sand having $m = 0.18$ mm. and with horizontal and vertical scales of 1/250 and 1/50, respectively. The model extended for an equivalent of 9 miles upstream of Hajipur to 5 miles downstream of old C.S. No. 13.

Fig. 56 (b)

(4) *Experiments with the barrage at site C and conclusions.*

These experiments have already been described in the 1944 Annual Report, Fig. 54 page 55. The experiments showed that:

(a) Due to wrong convex curvature imposed by the guide banks and the central island, most of the bed material would enter the canals on both banks.

(b) There would be difficulty in regulating and controlling the supply of water in right and left bank channels.

(c) The excess discharge required to work the excluders and ejectors causes an excess load of bed sand to be drawn into the pockets; and this excess bed load has then to be ejected with a relatively small discharge (33% of the canal discharge); and this ejected escapage water with its supercharge would then be injected into the river downstream, with the inevitable result that much of the bed sand would accumulate at the outfalls, as the slope of the river in this reach is too flat to carry away this supercharge; and so dredgers would be required to remove it continuously.

(d) Once the excluder tunnels get blocked, the design would completely fail; and the Excluders would act as "includers" or "attractors" of bed sand.

(e) In order to keep a river channel along the left bank, unnatural conditions would have to be imposed which under certain conditions might lead to a very heavy charge of bed sand being drawn along the left bank and thence into the left Bank canals.

Thus, though a Barrage at site C may be more economical in first cost, it will not be permanently satisfactory as many serious difficulties will arise after the construction of the barrage.

As "head" is a valuable consideration in Sind, it is important to construct the Lower Sind Barrage at a place where sand exclusion is achieved by natural curvature rather than by means of Excluders and Ejectors, which require a minimum of 2 ft. of head. So, site C was condemned and site B near Hajipur was recommended by the Station.

(5) *Experiments without barrage at site B.*

In order to prove the model and compare results that would be obtained with the barrage at site B, the model was first run without the barrage at site B, according to a rising and falling cycle of river discharges based on observations at Kotri in 1943. The time scale as adopted is shown in Fig. 55.

Fig. 55. at Kotri in 1943. The time scale as adopted is shown in Fig. 55.

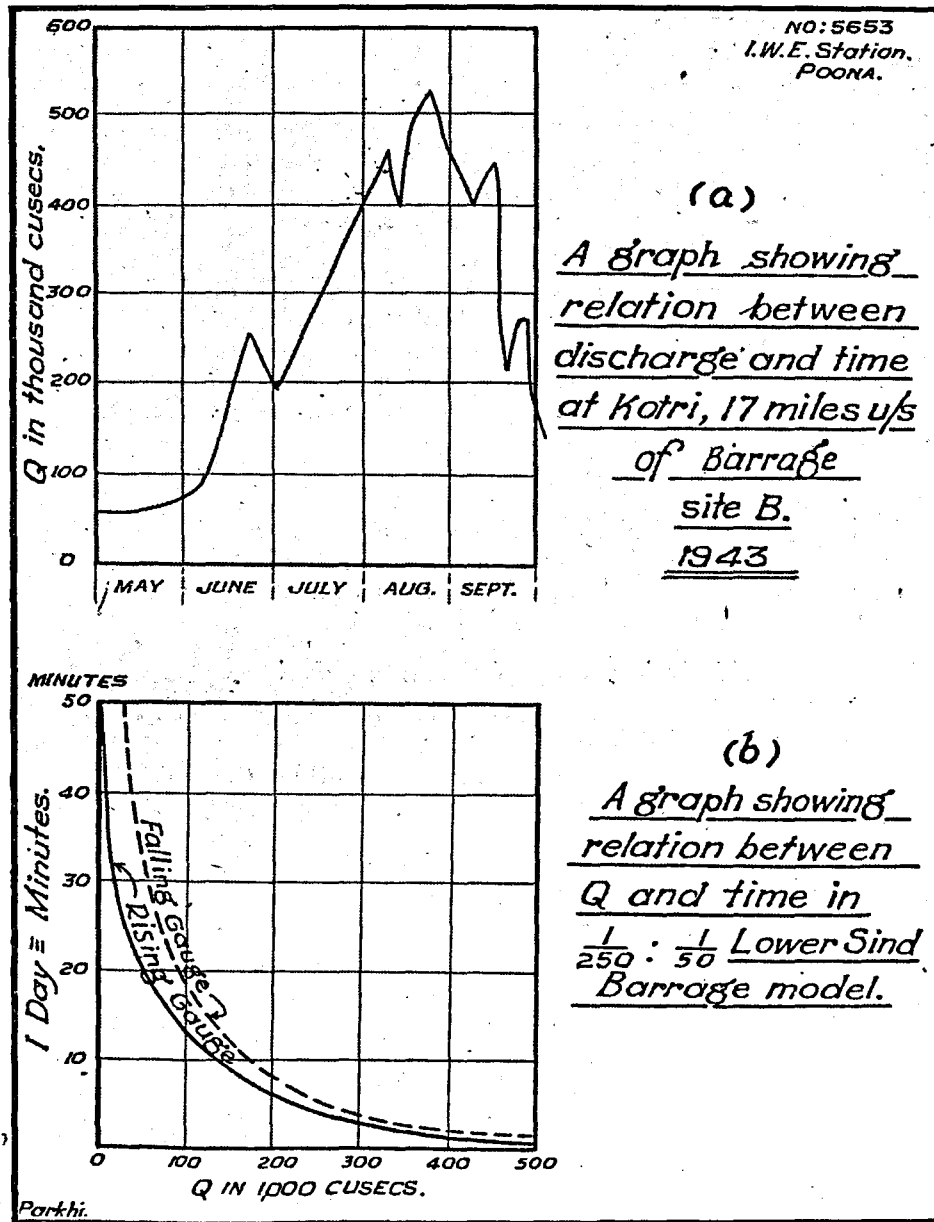

Fig. 55.

Fig. 56 (a) After running three rising and falling cycles, lines of flow were observed & 57 (a) and a ripple plan prepared to get an idea of the flow conditions.

Fig. 53

Index plan of River Indus
Showing Alternative
Positions for Lower Sind barrage
Scale:- 1" = 4 Miles.

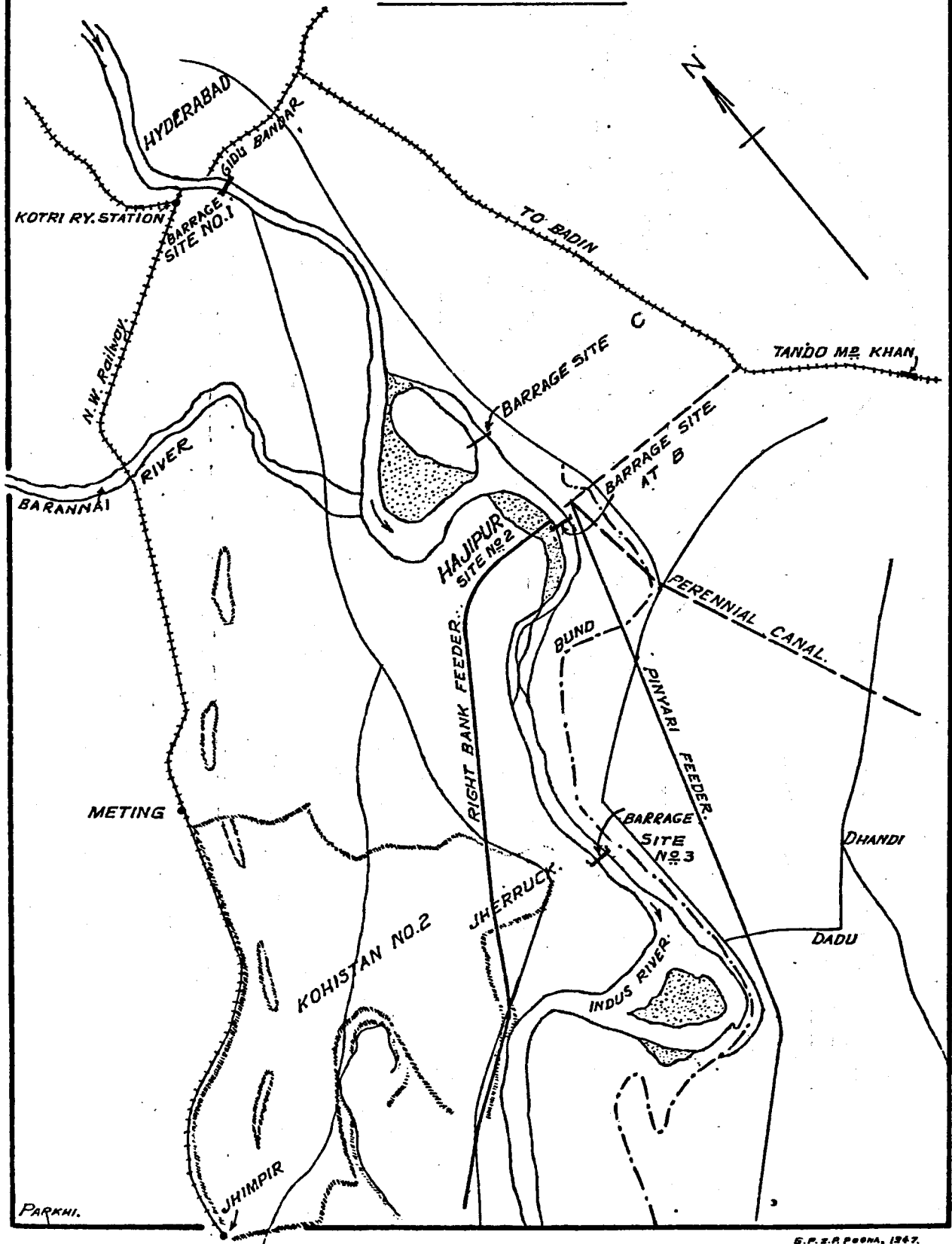
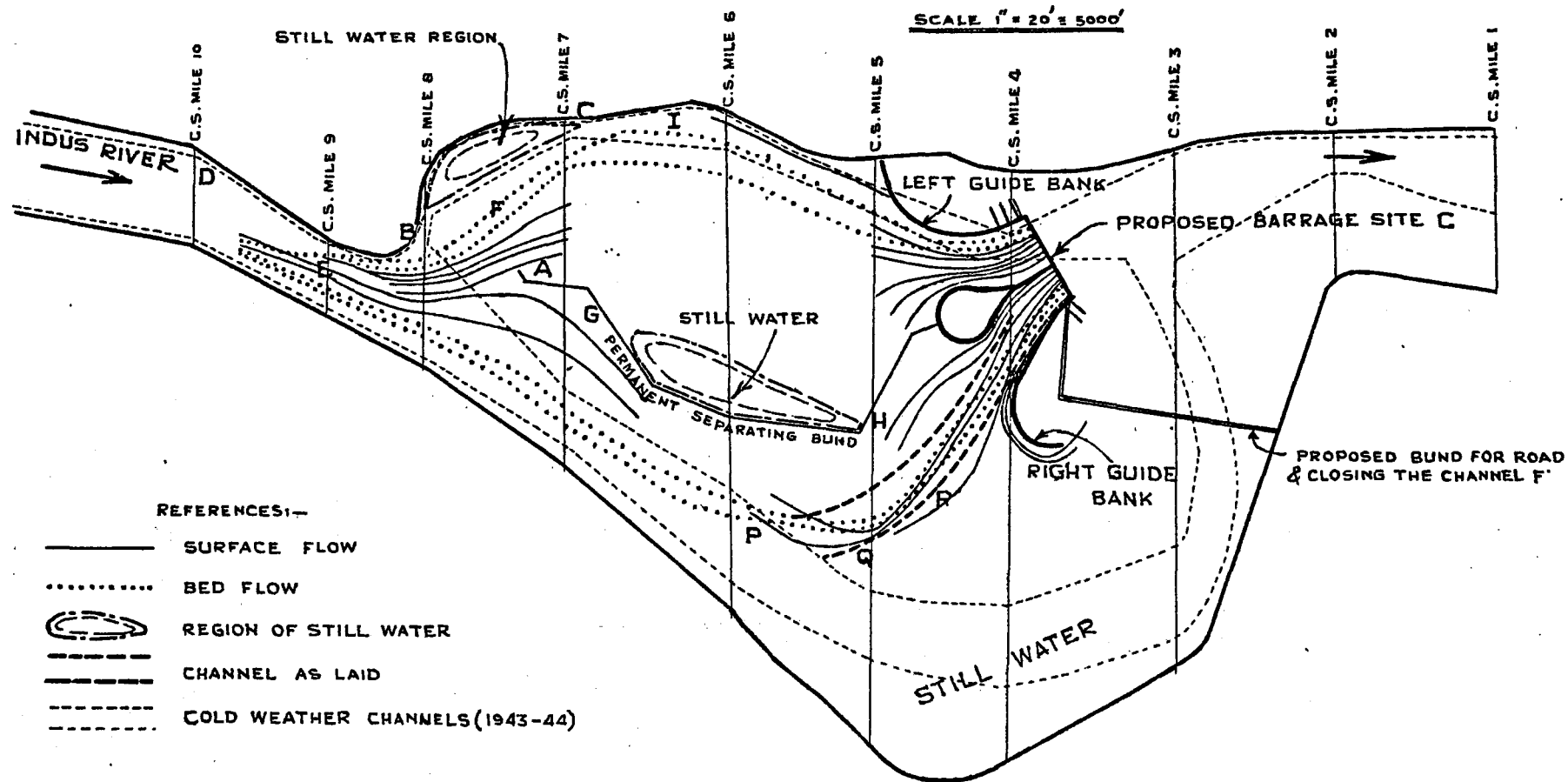

FIG. 54.

1/250 SCALE MODEL OF RIVER INDUS 6 MILES U/S &
3 MILES D/S OF PROPOSED BARRAGE SITE (C)
LINES OF FLOW OBSERVED WITH DISCHARGE \approx 400,000 CUSECS
(THE BARRAGE WAS WORKED UNDER STILL POND CONDITIONS WITH
U/S W.L. \approx 61.00 & D/S W.L. \approx 55.2)



LOWER SIND BARRAGE.

SHOWING LINES OF FLOW OBSERVED
FOR A DISCHARGE \approx 300,000 cfs.

$Q_m = 4.8$ CU SECS

Scale: $1" = 40' \approx 10,000'$

(a) WITHOUT BARRAGE

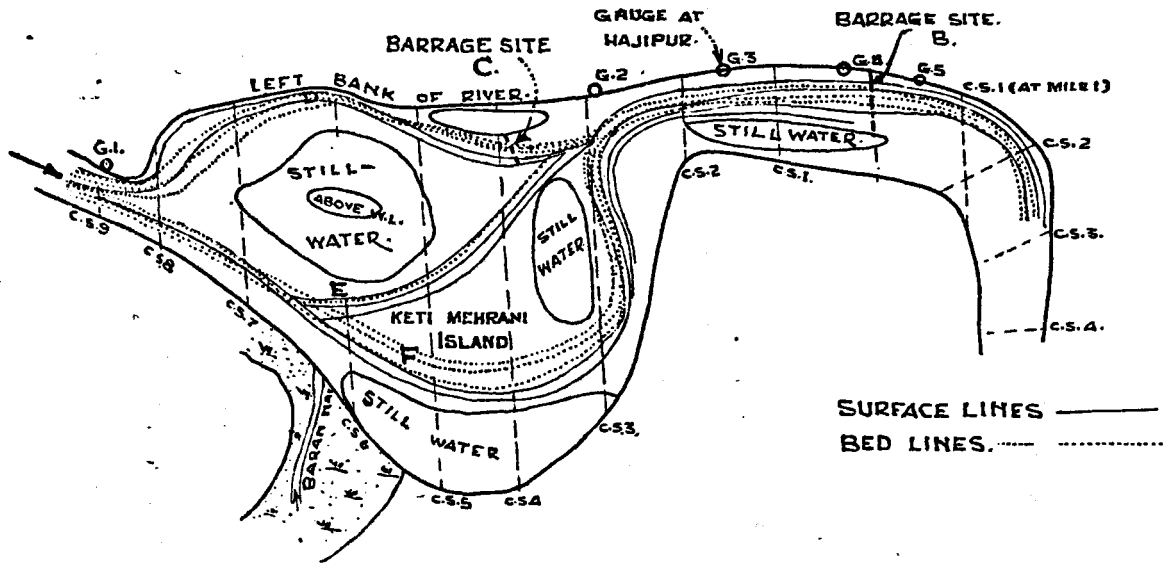

(b) WITH BARRAGE AT SITE B. (OLD C.S. 15)

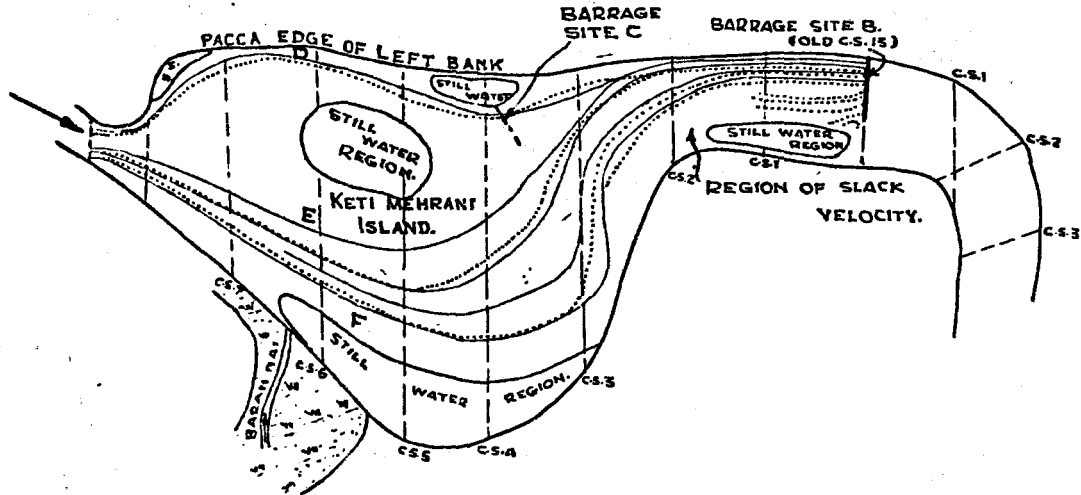

(c) OBSERVED AFTER RAISING THE SILTED PORTION.
WITH BARRAGE AT SITE B.

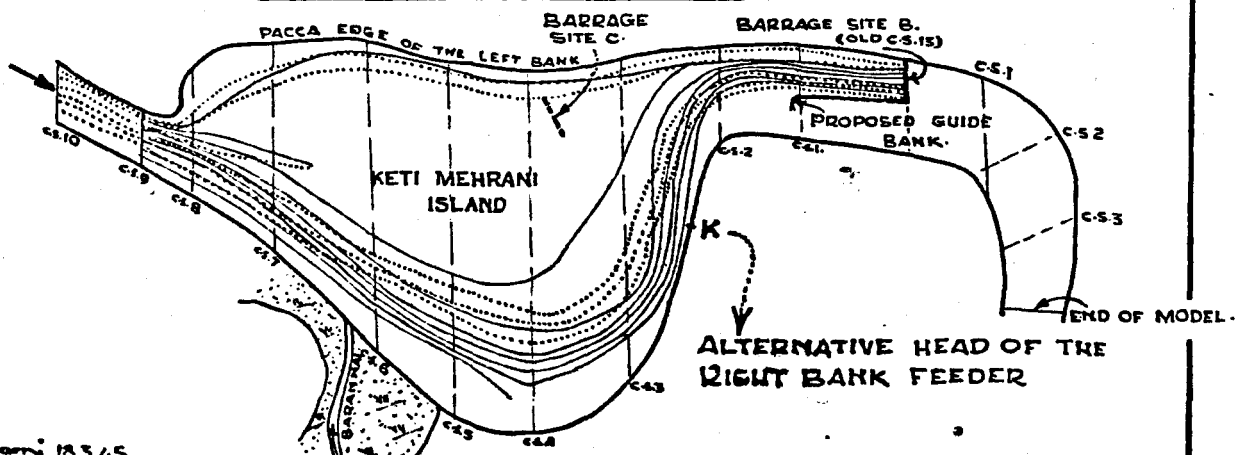

Kulbarni 18.3.45

FIG. 57.

LOWER SIND BARRAGE
SHOWING FORMATION OF RIPPLES.

SCALE 1" = 40' = 10,000'

(a)

AFTER STABLE CONDITIONS WERE OBTAINED
WITH THREE FLOOD CYCLES WITHOUT BARRAGE.

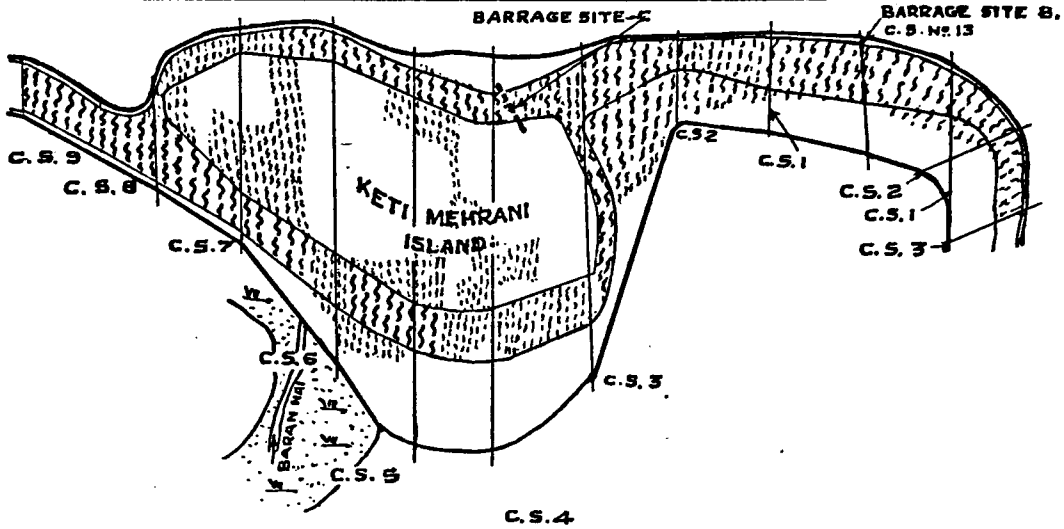

(b)

AFTER THREE FLOOD CYCLES WITH BARRAGE
AT SITE B.

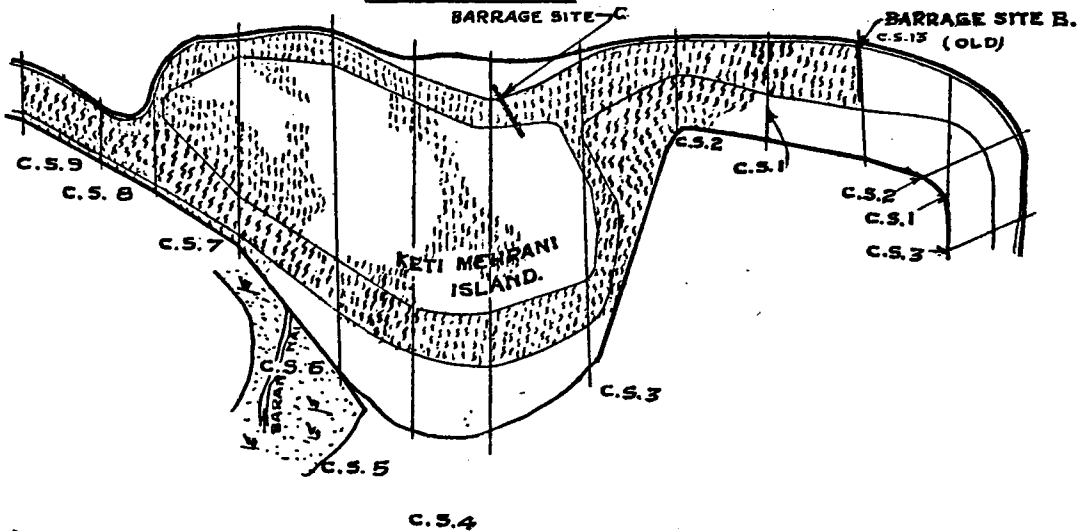



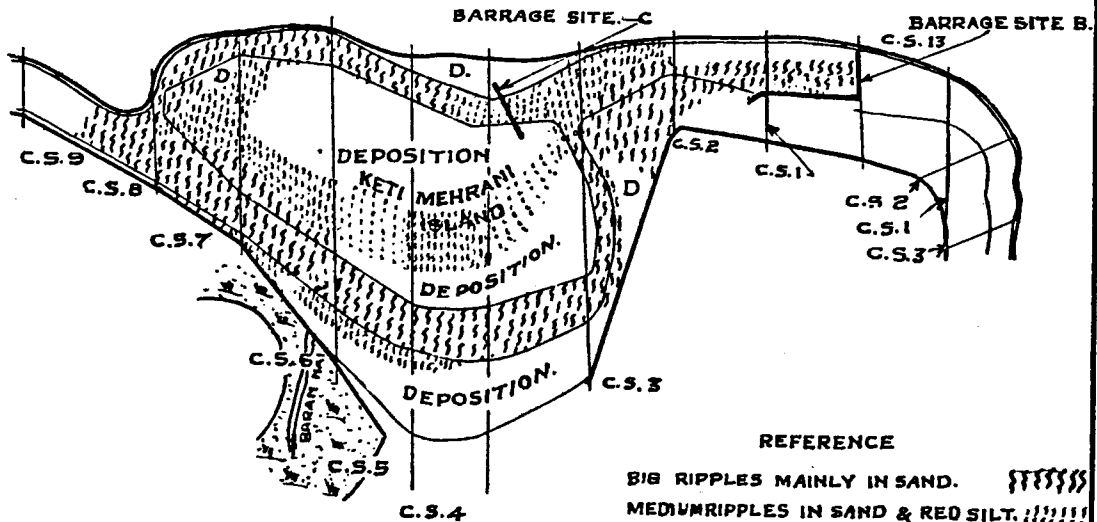

(c)

WITH THE BARRAGE AT SITE B & RIPPLES OBSERVED
AFTER RAISING THE PORTIONS WHERE SILTING OCCURRED.



REFERENCE

- BIG RIPPLES MAINLY IN SAND. 
- MEDIUM RIPPLES IN SAND & RED SILT. 
- RIPPLES IN FINE RED SILT. 
- DEPOSITION OF FINE RED SILT. D. 

The model correctly proved the flow conditions and showed three principal channels D, E and F, the percentage of discharge obtained in these channels being 30, 10, 60 respectively.

(6) *Experiments with barrage at site B.*

The barrage was then constructed at site B to test its suitability.

As it is very important to watch carefully the changes showing the effect of heading up at the barrage on the regime of the river upstream, a heavy charge of fine red silt (6 parts per 1000) was injected. The first effect of heading up was to cause a straighter flow down the river. Heavy silting took place on Ketī-Mehrani; and, after exaggerating the thickness of silt (as the process of silting in the model is slow), it was observed that the extreme right, low-level channel F redeveloped its tendency to meander still further out, which is just what has occurred upstream of Bukkur since the Sukkur Barrage has been built. Fig. 56 (b)
and 57 (b)

(7) *Conditions on the left bank :—*

Three canals have been proposed on the left bank :—

<i>Name of Canal</i>	<i>Discharge of canal without ejector</i>	<i>Discharge of canal with ejector</i>
Fuleli Feeder	16,000 Cusecs	21,300 Cusecs
Guni perennial Canal	2,600 Cusecs	4,480 Cusecs
Pinyari Feeder	16,000 Cusecs	21,300 Cusecs
	34,600 Cusecs	47,080 Cusecs

First, the left bank canals were run with discharges including escape discharges. It was observed that when the percentage in the pocket exceeded 12 to 14 per cent of the total river discharge ($\cong 300,000$ cs. when there was bed movement), upstream bed sand entered the canals, even though the curvature was favourable for the left bank canals. As this adversely twisted the naturally favourable conditions on the left bank, it was proposed not to use ejectors or excluders on the left bank (i.e. to run only 34,600 cs. instead of 47,080 cs).

The optimum width of the left pocket for this pocket discharge of 34,000 cusecs worked out to 529 ft. (8 spans of 60' with 7 piers of 7').

Next, different lengths of divide walls were tested. A divide wall = $\frac{2}{3}$ the length of the canal head regulators gave unsatisfactory results owing to the very high discharges entering the canals. The optimum length was found to be equal to the full length up to the upstream face of the first canal head regulator.

It was also observed that with the divide wall at right angles to the barrage a heavy swirling action occurred round the nose. The depth of scour was about $\cong 50'$ for $Q \cong 5,30,000$ cusecs. In order to improve conditions, a bulbous nose was tried, which, however, did not improve conditions. Similarly, a sloping nose reduced the favourable curvature⁽¹⁾ for sand exclusion, though it reduced the depth of scour to $\cong 40$ ft. A divide wall, equal in length to $0.6 l$ (where l is the length of the divide wall from the barrage up to abutment of uppermost canal) and then continued towards the pocket side on a curve of radius = 1800' for the rest of the length, reduced the swirling action and depth of scour-hole and hence was adopted.

The maximum differential head, observed across the left divide wall for $Q \cong 5,30,000$ cusecs, under still pond conditions, was 3.70 ft.

(1) Bombay (Tech.) Paper No. 52, page 31.

7 (a) *Scour at the nose of divide walls:—*

As regards the shape of the scour-hole, allowance has to be made for vertical exaggeration of the model (vert. exaggeration = 5.0.) Previous experiments of similar nature carried out at the Station have shown that the horizontal scale of scour-hole in the prototype is approximately half the horizontal scale of the river model⁽¹⁾. Fig. 58 shows the probable prototype contours of the scour hole (i. e. after allowing for a V.E. in the model scour-hole of 2.5) round the nose of the left divide wall, with still pond conditions and river discharge \cong 500,000 cusecs which will be the worst conditions for scour. It was recommended that the protection round the nose should be laid approximately according to the shape of the scour-hole.

Fig. 58

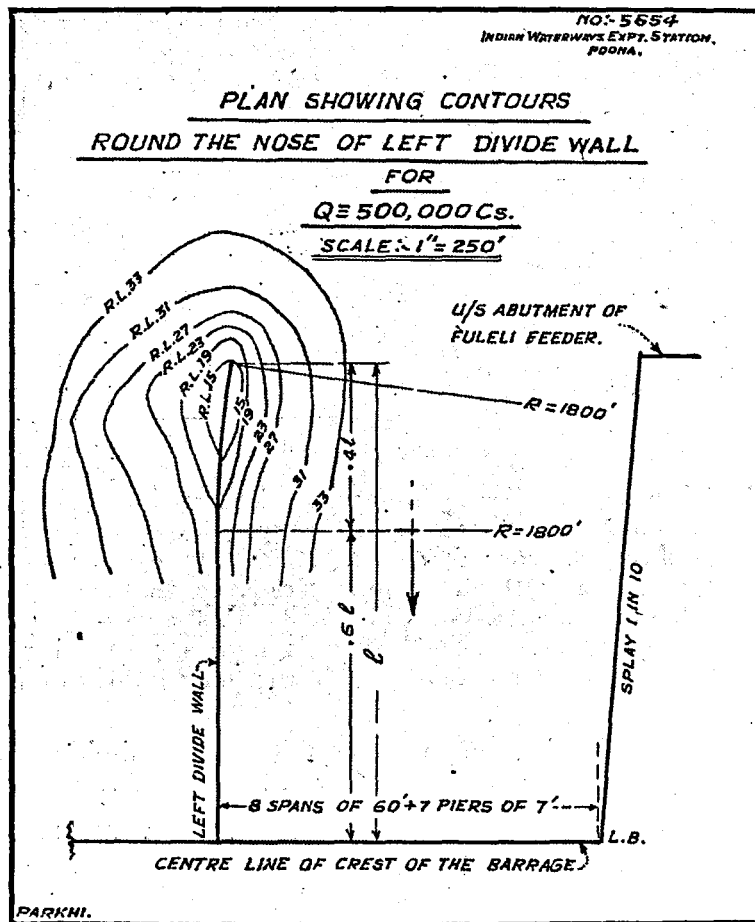

Fig. 58

(8) *Conditions on the right bank:—*

On the right bank, there is only one canal — the Kalri Baghar Feeder — with a discharge of 11000 cs. and escape of 3300 cusecs.

When a heavy charge of red silt was injected it was observed that, due to concentration of flow on the left bank, the portion near the right bank silted up; and this will be accentuated when the islands in the loop have built themselves up with silt — just as has occurred at Sukkur. At Sukkur, its adverse effects on sand exclusion from the Right Bank Canals have been remedied by means of an approach channel, recommended by the Station.

As the velocity obtained at Hajipur site B on the right bank was very low, the first device tried was a long right guide bank with a view to increase the velocity on the right end of the barrage by constriction of the river portion upstream.

(1)Page 13 of C. I. & H. R. Annual Report (Tech.) for 1940-41.

FIG. 59

1/250 : 1/50 LOWER SIND BARRAGE MODEL.
SHOWING LINES OF FLOW OBSERVED WITH
A DISCHARGE \cong 300,000 CUSECS.

U/S W.L. \cong 61.0 D/S W.L. \cong 54.00

SCALE: 1" = 8' \cong 2000 FT.

———— SURFACE LINES OF FLOW
..... BED " " "

(a) WITH LONGER GUIDE BANK.

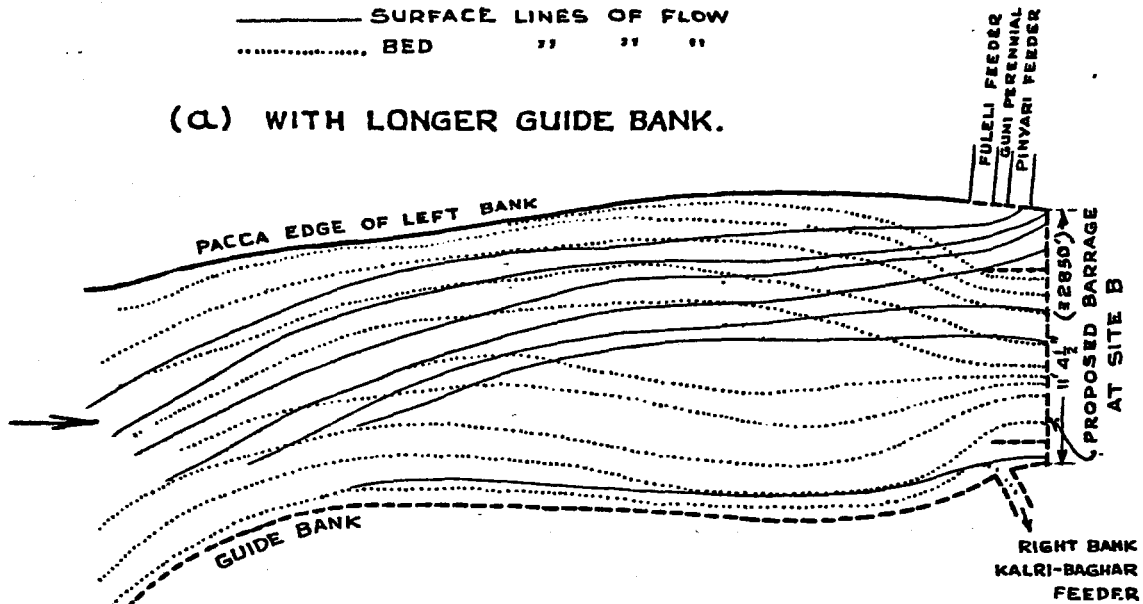

(b) WITHOUT UNDERSLUICES OUTSIDE THE
POCKET & WITH PROPOSED MEDIUM
GUIDE BANK.

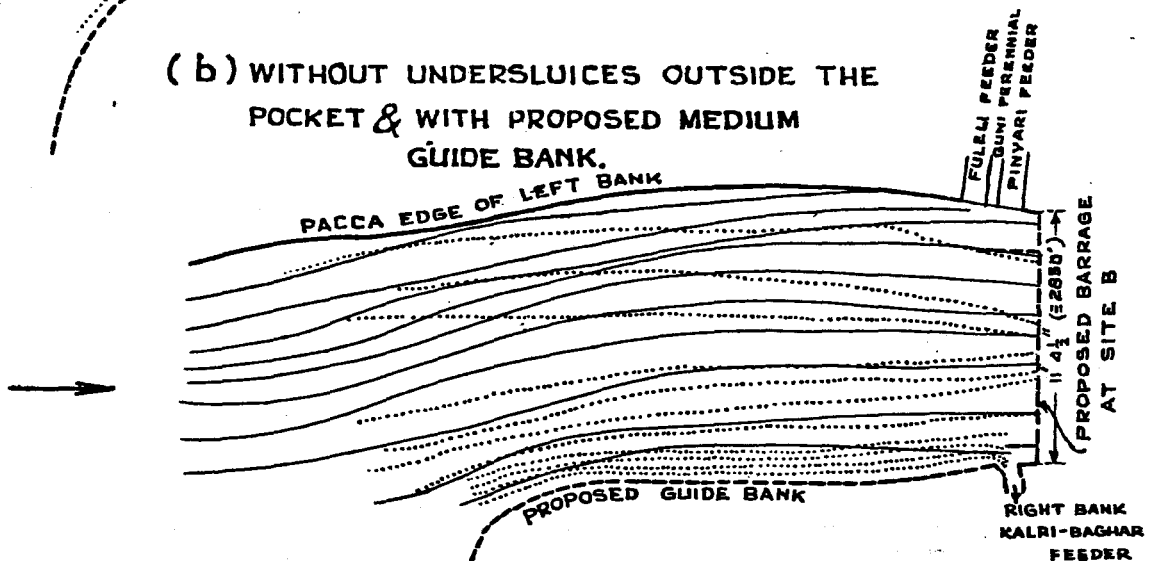

(c) WITH 4 SPANS OF UNDERSLUICES AT R.L. 40-0
OUTSIDE RIGHT POCKET WITH MEDIUM
GUIDE BANK.

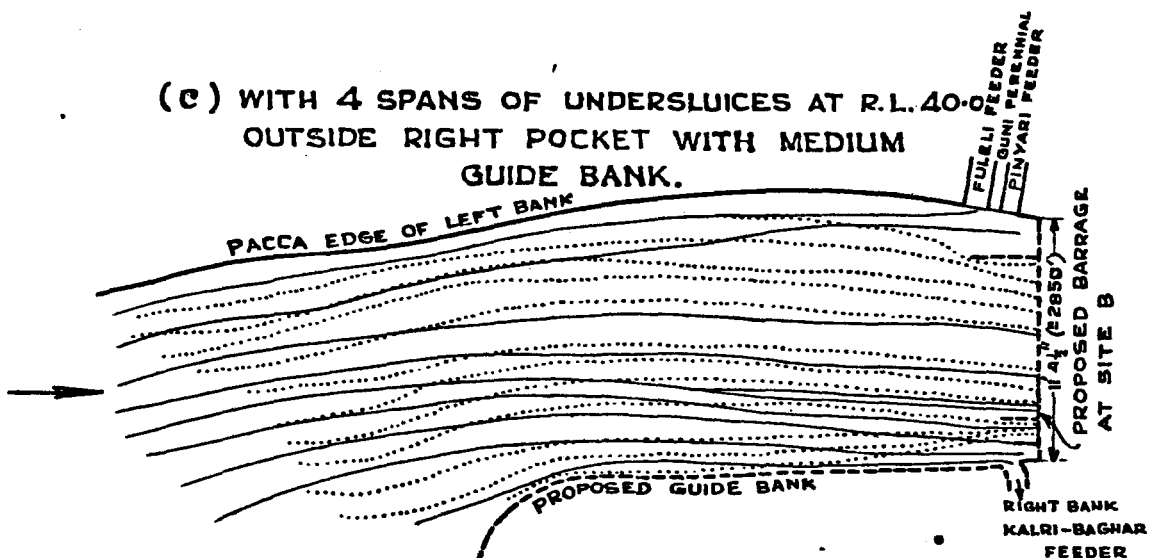

Three alternative lengths of guide banks were tested :—

- (a) A long guide bank 11000 ft. up to the gorge.
- (b) A short one of length equal to 3000'.
- (c) A medium length guide bank, 6000 long ft.

The long guide bank (a), did not give satisfactory results as water did not follow the banks. Fig. 59 (a)

The short guide bank was ineffective in getting the flow to the right bank.

The medium guide bank (c) was better in effect. Still, as is clear from the Fig. 59 (b) figure, the conditions were not satisfactory.

In order to improve the conditions, four spans outside the pocket were made to have their sills 2' lower than the barrage sills. This helped to increase the velocity near the right end of the barrage and to pull a small share of the top water. In spite of this, however, the tendency of accretion near the right bank persisted.

In order to pull a fair share of the top water on the right end, three alternative measures were next considered :

- (a) An approach channel as at Sukkur.
- (b) An island above the gorge.
- (c) A right bank groyne

Fig. 60

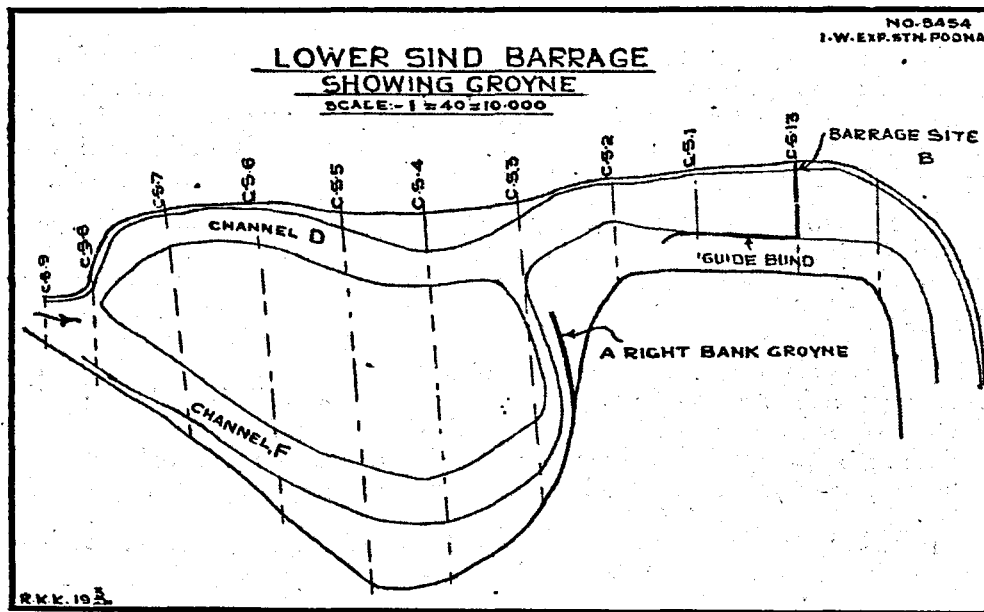

Fig. 60.

As conditions are not favourable for a right bank approach channel at Hajipur, only one of the other two alternatives is likely to be suitable.

An island was not found to be effective in pulling the flow towards the right bank; so further experiments were carried out with a right bank groyne; its optimum length was found to be 1800 ft. (for lines of flow with this groyne see fig. 61).

Fig. 61

Though the groyne pulled a share of top water, there was still some tendency of silting on the right end of the barrage. So it was recommended that an alternative head at point K may be kept ready for the Right Bank Canal; because this would be preferable on account of the additional head available and the better sand excluding property, as it takes off from the outside of the curve. Fig. 62, Fig. 61

Regulation of the barrage.

The barrage proposed at site B consisted of 42 spans arranged as under :—

- (1) 8 left pocket spans at R. L. 42.0
- (2) 30 barrage spans at R. L. 42.0
- (3) 4 right pocket spans at R. L. 42.0

The upstream pavement level was R. L. 36.0

The downstream „ „ „ R. L. 28.0

The upstream and downstream slopes were 1 in 5 and 1 in 3 respectively. The designed pond level at full supply is R. L. 61.0. The barrage is designed for a superlood discharge of 850,000 cusecs.

*Regulation for 300,000 and 3,50,000 cusecs.
(still pond conditions).*

For these discharges it was observed that on the right bank, though high velocity persists, exclusion of bed sand is not so effective, unless an equivalent set of nine gates outside the right pocket is opened more than the rest of the gates by 2.5' and 2' for 3,00,000 and 3,50,000 cusecs respectively. This increased the ratio of the velocity *outside* the pocket to the velocity *inside* the pocket and thus helped to create a favourable curvature. On the left bank, even with equal gate openings, sand is excluded due to the natural, favourable curvature of flow.

Regulations of the barrage for 4,00,000, 5,00,000 and 5,30,000 cusecs.

With these discharges the barrage was regulated, under *still pond* conditions, with all the barrage gates equally opened. But it was observed that, due to the pronounced curvature of the left bank, the scour at the nose of the Left Divide Wall was excessive; the *differential* head across this divide wall was as high as 3.70 ft. for 5,30,000 cs; and the flow in the pocket was not smooth.

In order to improve conditions, *semi-open flow* was tested in the left pocket and it was observed that (a) the pocket gates nearest to the canal head regulator have to be opened less than those furthest from the head regulator for proper exclusion of bed sand; (b) sand is scooped out from the bed of the pocket— which in the design was not protected — and a deep scour-hole is formed down to R. L. 24, pointing to the necessity of paving the pocket bed at R. L. 36.0; (c) scouring action round the nose of the left divide wall is reduced; (d) the *differential* head across the left divide wall is reduced; (e) scouring operations for flushing out the pocket will not be as frequently necessary as under *still pond* conditions; and (f) there will be less shoaling downstream of the left divide wall.

It was also observed that the right pocket could not be run under *semi-open flow* conditions for $Q < 600,000$ cusecs.

PART II

Lower Sind Barrage 2400' Upstream of Site B Near Hajipur.

- (1) *Why was it necessary to repeat the experiments with barrage at site B with a change in Plan?*

The experiments described in part I were carried out according to a plan of the river Indus received from the Project Division. In these experiments the Fig. 63 barrage was sited as shown in the plan, fig. 63.

But the Project Division later discovered a discrepancy in the plottings of Fig. 64 the survey plan supplied to the Station. As the curvature in the corrected plan, in the vicinity of the barrage, is much more pronounced than in the old one and this would have an important bearing in the results previously obtained, it was decided to repeat the experiments to test the salient features.

$\frac{1}{250} \cdot \frac{1}{50}$ LOWER SIND BARRAGE MODEL
PLAN SHOWING LINES OF FLOW FOR Q \approx 300,000 CUSECS

NO: 5489
 INDIAN WATERWAYS EXPT. STATION, POONA

WITH PROPOSED GROUYNE.
U/S POND LEVEL \approx 61.0

FIG. 61

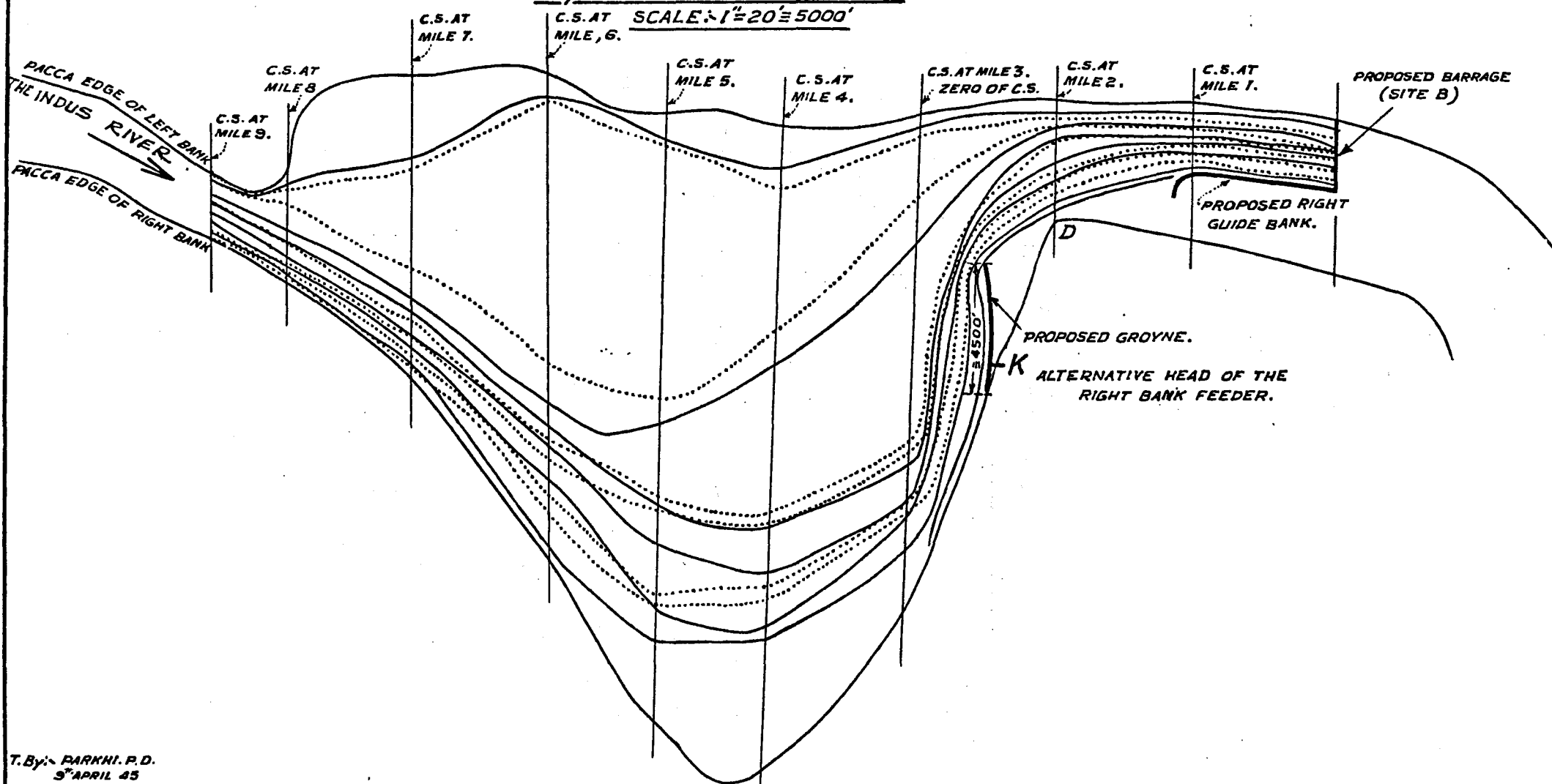

T. By: PARKHI, P.D.
 5th APRIL 45

FIG. 62

NO 5489
I. W. E. STY POONA

SHOWING CROSS SECTIONS UPSTREAM OF
BARRAGE AT SITE B

SCALES: { HOR - 1" = 4' = 1000'
VER - 1" = 1' = 50'

C.S. AT MILE 2 U/S OF BARRAGE (AT SITE B)
(LOOKING UPSTREAM)

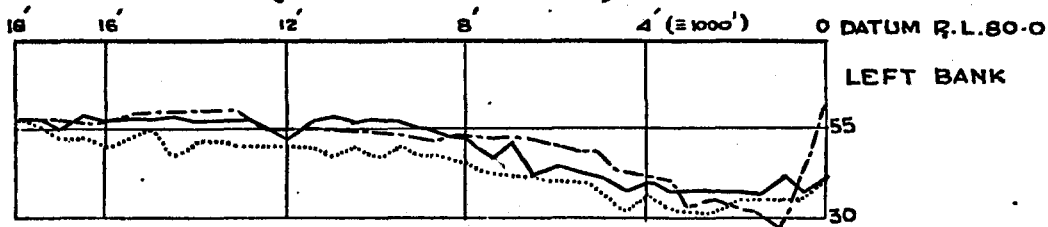

C.S. AT MILE 1½ U/S OF BARRAGE
(LOOKING UPSTREAM)

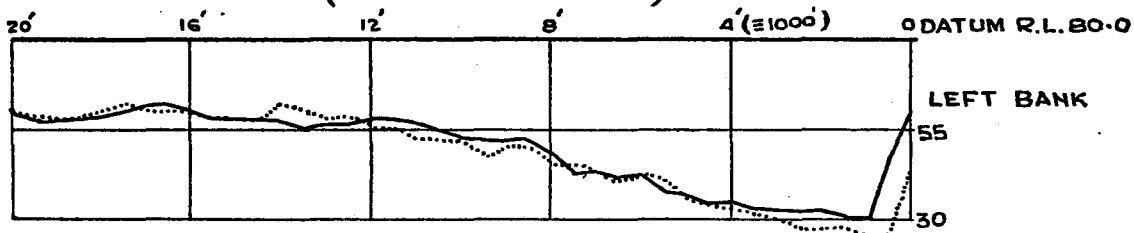

C.S. AT MILE 1 U/S OF BARRAGE
(LOOKING UPSTREAM)

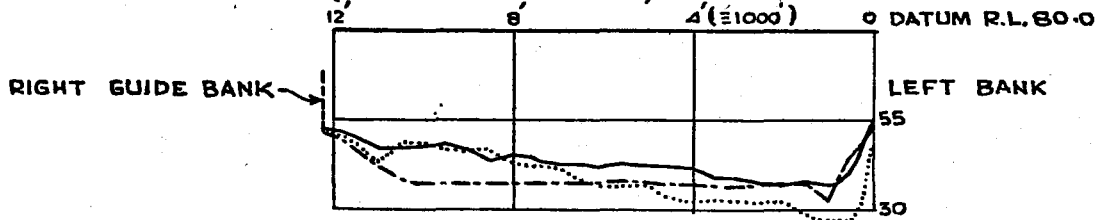

C.S. AT MILE ½ U/S OF BARRAGE
(LOOKING UPSTREAM)

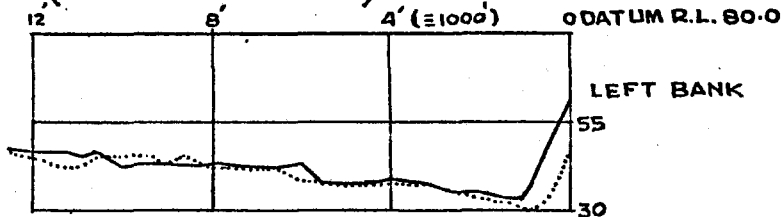

REFERENCES.—

- ORIGINAL SECTIONS OF RIVER OBSERVED IN JANUARY 1944.
- SECTIONS AS LAID WITH BARRAGE
- SECTIONS AS OBSERVED AFTER RUNNING THREE FLOOD CYCLES.

FIG. 63.
RIVER INDUS 10 MILES $\frac{4}{5}$ &
10 MILES $\frac{3}{5}$ OF THE BARRAGE
SITE B AT MILE 0

SCALE: - 1" = 10000' ± 40' (MODEL)
(INCORRECT SURVEY)

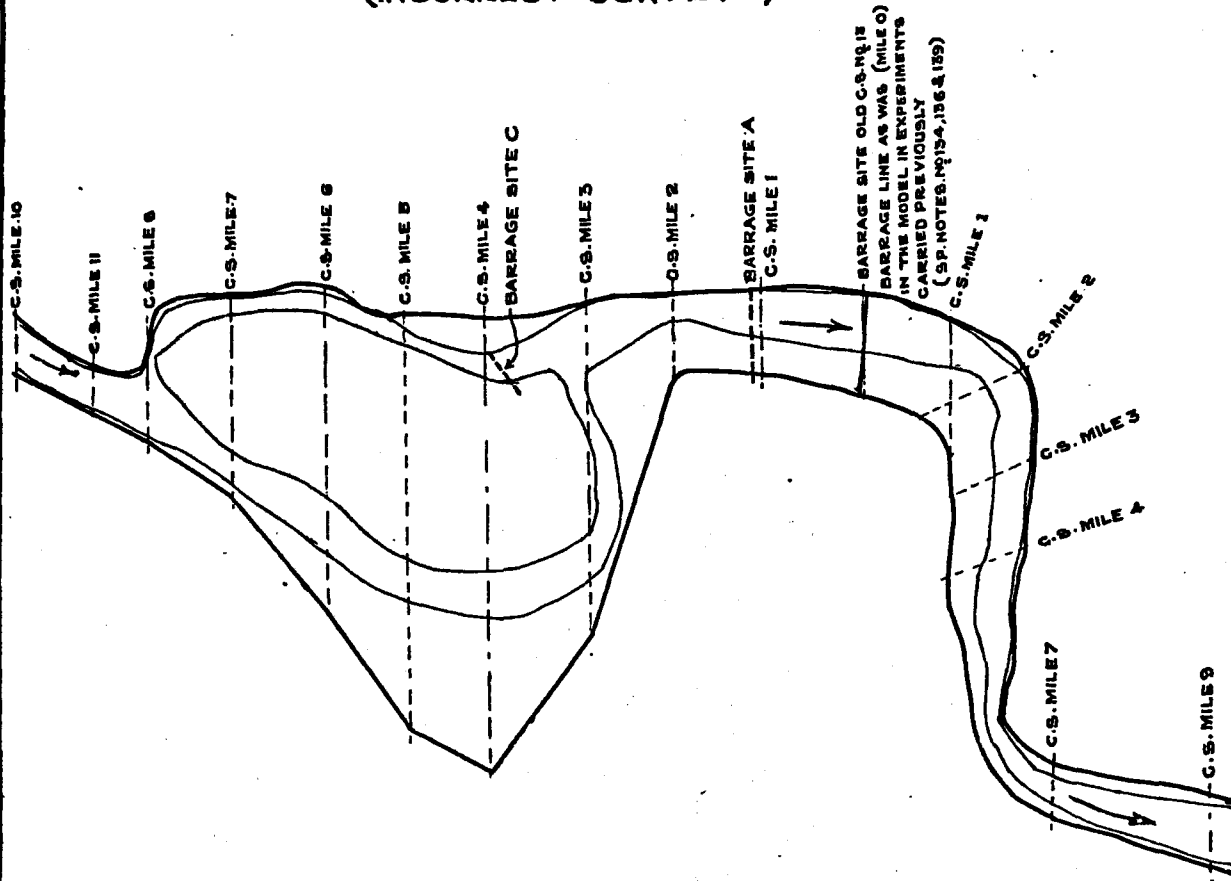
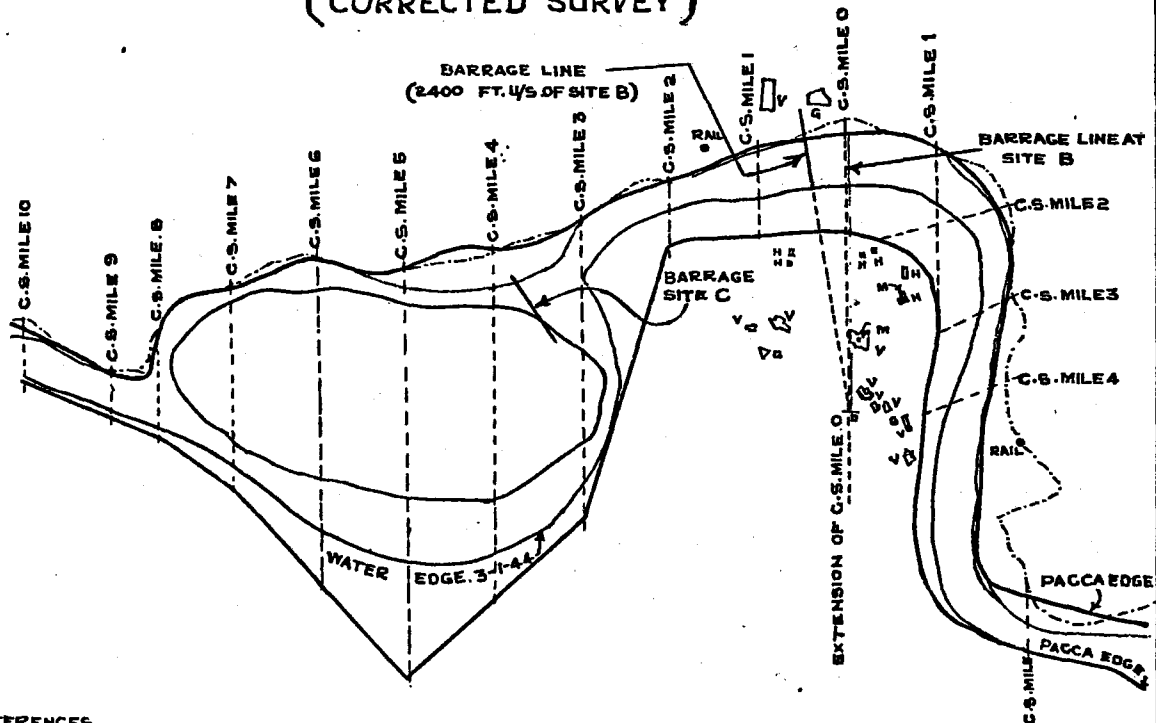

FIG. 64.
(CORRECTED SURVEY)



REFERENCES

- V = VILLAGE
- H = KUTCHA HUT
- G = GRAVE YARD
- M = MOSQUE

Another difficulty pointed out regarding siting the barrage exactly at site B (mile 0) was that it is not possible to take the left bank canals clear of the Mukams (grave yards) and the crossing of grave yards is considered highly impracticable and to be avoided as far as possible. This could be done either by shifting the barrage line 200' downstream of mile 0 or by shifting it 2400 ft. u/s of mile 0 as the left bank and right bank canals require a clear width of 1350 ft. and 600 ft. respectively.

The former was considered unsuitable as the curvature of the left bank upstream and downstream of it is rather severe and water after flowing through the barrage would have concentrated more towards the left bank downstream and the barrage would have been too near the downstream bend; so that water would not have flowed away quickly without causing damage to the left bank—which would then have to be protected heavily.

Besides, had the barrage been constructed 200 ft. d/s of c. s. mile 0, it would have been very difficult to pull the river on the right end of the barrage; scour at the nose of the left divide wall would have been severe and, therefore, heavy protection would have been required.

So it was decided to align the barrage 2400 ft. u/s of mile 0; this recommendation was accepted by Sind.

(2) *Experiments without barrage :*

In order to test the model and compare conditions with those observed previously, the model was run with a rising and falling cycle from 300,000 cusecs to 530,000 cusecs with the same time scale as before.

After running four cycles, lines of flow were observed. The model showed three distinct channels D, E and F, as before, and the percentages of discharges found in these channels were 38.7, 11.3 and 50% respectively. Fig. 65(a)

Fig. 65 (b) shows the velocity distribution on cross section X-Y, 2400 ft. upstream of cross section mile 0 and parallel to it. Fig. 65(b)
Fig. 65 (c) shows depths of bed as observed on C. S. mile 2 and C. S. 2400 ft. u/s of mile 0. Fig. 65(c)

(3) *Experiments with barrage :—*

The barrage was constructed at an equivalent of 2400 ft. upstream of cross section mile 0 so that the barrage line ran clear between the village and the graveyard on the left bank and also of the obstructions on the right bank.

The head regulator of the left bank was given a splay of 1 in 10; the barrage consisted of 42 spans arranged as under :—

- (1) 8 left pocket spans at R. L. 42.0
- (2) 26 weir spans at R. L. 42.0.
- (3) 4 weir spans just outside the right pocket at R. L. 40.0
- (4) 4 right pocket spans at R. L. 42.0

Thus, the total length of the barrage was 2844 ft., the same as before.

In order to watch the effect of heading up on the regime of the river upstream, a heavy charge of fine red silt was injected. The behaviour was the same as in experiments described in Part I, viz. Channel F persisted and the model showed that there will be a tendency of the river to meander still further towards the right bank. Fig. 66 (a) shows the lines of flow as observed. Fig. 66(a)

(4) *Conditions on the left bank :—*

The optimum length of the left divide wall, the optimum width of the left pocket, the shape and depth of the scour-hole obtained, and the differential heads across the left divide wall, were found to be the same as before.

The loss of head in the left bank canals was observed to be as follows :—

<i>Name of Canal</i>		<i>Loss of head</i>
Fuleli Feeder	≡	0.65 ft.
Pinyari Feeder	≡	0.60 ft.
Guni Perennial Canal	≡	0.50 ft.

As the barrage is shifted by 2400 ft. upstream of C. S. mile 0, the curvature effect was not so predominant as would have been had the barrage been constructed on C. S. mile 0 or as in experiments described in Part I. There was no *swirling* action as in experiments described in part I and hence the divide wall need not be curved near the nose, as recommended previously.

(5) *Conditions on the right bank of the barrage.*

Fig. 67(b) (a) In order to increase the velocity on the right side of the barrage different lengths of guide banks were tested. The details of the alignment which gave the best results are shown in Fig. 67 (b).

Fig. 66(b) (b) Fig. 66 (b) shows the velocity distribution as observed at C. S. mile 1. Velocity obtained on the right side was 0.60'/sec. ≡ 4.2 ft./sec.

(c) In order to pull additional top water, different lengths of groyne, as tested in previous experiments (part I) were again tested, but there was no appreciable change produced by the groyne in the conditions on the right end of the barrage. So a groyne need not be constructed.

Figs. 65(a) & 67(a) (d) That the barrage has a tendency to reduce the effect of sharp curvature and thus tend to equalise flow can be seen by comparing Figs. 65(a) and 67 (a). Thus, without the barrage, top water had a tendency to hit the left bank directly and thus concentrate on the left side. Whereas the barrage has the effect of bringing water round the corner of the gorge section, at mile 2, and thus drag a share of the top water on to the right side. Most of the bed material of channel F concentrates on the right side of the barrage, especially along the 9 spans just outside the right pocket. Silting took place along the Right guide Bank and as this would be accentuated in the river—due to silting in models taking place more slowly than according to the model time—scale—the Right Bank Canal may tend to silt; so, to be ready for this contingency should it occur, it would be advisable, if this design were adopted, to assume an alternative head for the canal, taking off from the right bank above the bend at point K shown in Figure 66 (a); and land should be reserved for this purpose.

Fig. 66(a)

The head at K was tested in the model: with the head at right angles to the pacca edge of the right bank, the flow conditions were not satisfactory; the head facing upstream gave sweeter and more uniform flow at the entry than when it was at right angles; Hence head at K should face upstream as shown in Fig.66 (a)

Fig. 66(a)

(6) *Right bank pocket :—*

(a) It was observed that with a divide wall equal to 2/3 the length and at right angles to the barrage, as recommended previously, sand entered the canals for Q ≡ 300,000 cusecs, even though four spans outside the pocket were at R.L. 40.0, i.e. 2 ft. lower than the barrage crest.

(b) With four spans at R.L.40.0 it was observed that these had an effect of reversing the desired curvature along the right guide bank and attracting a greater amount of bed sand, towards it from the midstream and thus would accentuate the rate of formation of sand bank along the right guide bank. It is, therefore, recommended that these spans outside the right pocket may be at R.L.42.0, i.e. at the same level as the barrage spans.

(a) LINES OF FLOW
OBSERVED FOR Q = 300,000 Cfs.
(WITHOUT BARRAGE)
SCALE. 1" = 7500'

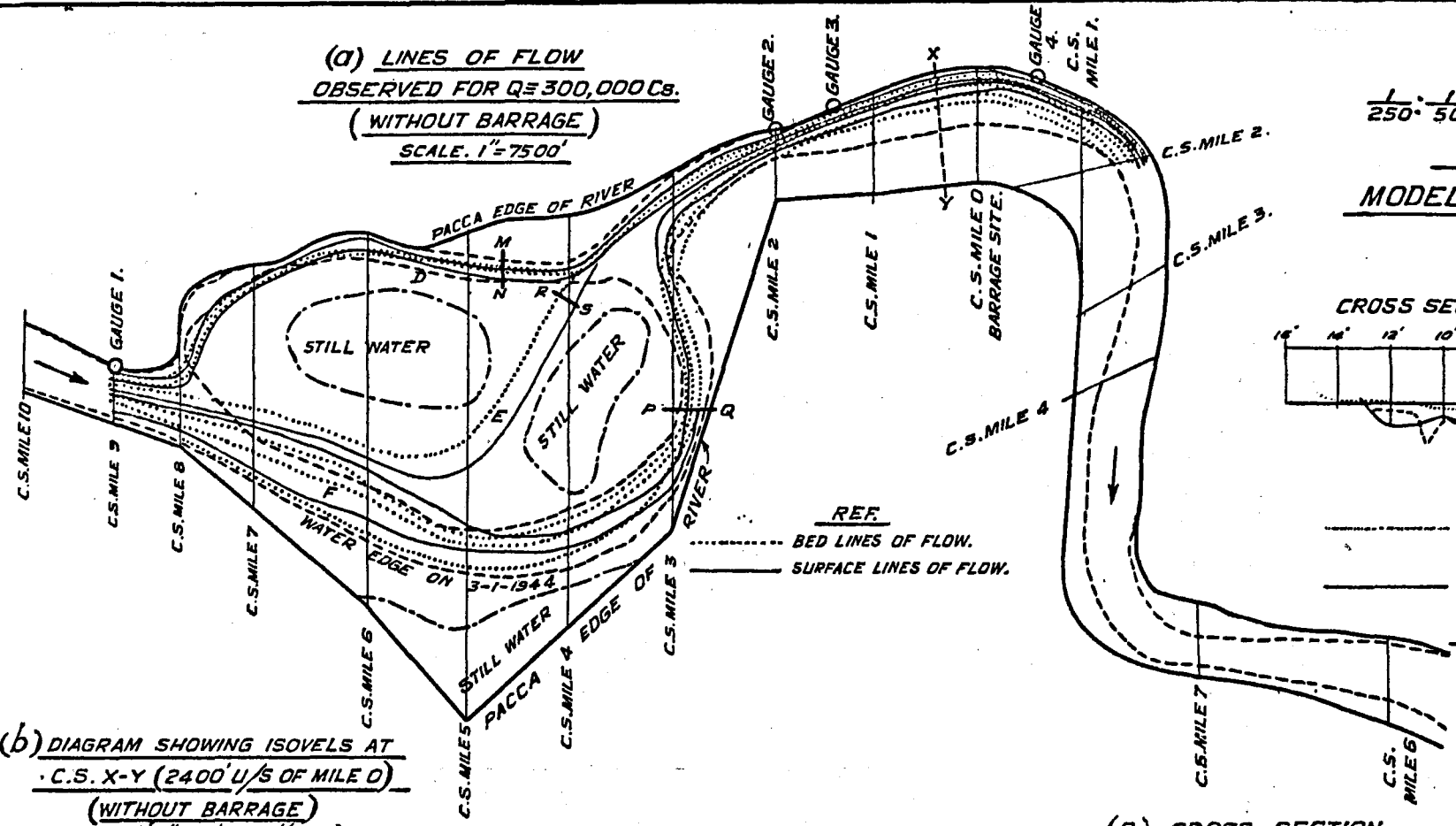
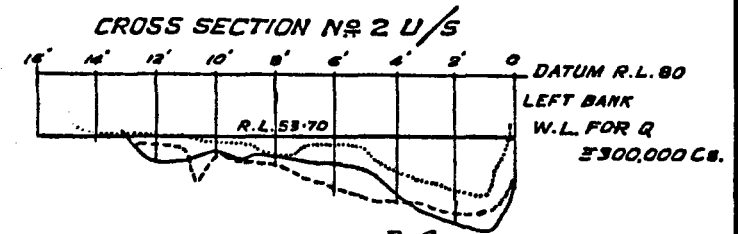
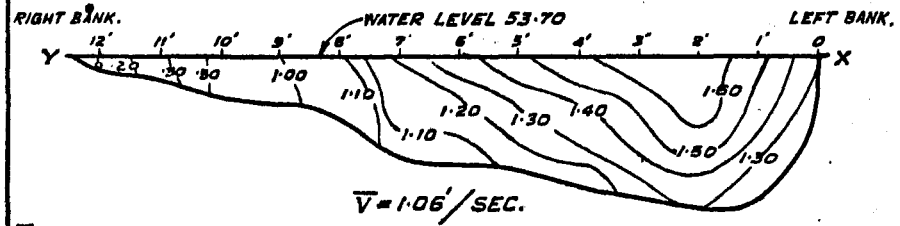

FIG. 65
 $\frac{1}{250} : \frac{1}{50}$ LOWER SIND
BARRAGE
MODEL EXPERIMENTS.



- References.
- Original C.S. of the river as observed in January 1944.
 - C.S. as observed after realigning according to correct plan. (Without barrage at site B)
 - C.S. as observed in old expts. without barrage.

(b) DIAGRAM SHOWING ISOVELS AT
C.S. X-Y (2400' U/S OF MILE 0)
(WITHOUT BARRAGE)
SCALE: $\frac{1}{2}'' = 37.5'$ (VERT.)
 $\frac{1}{2}'' = 750'$ (HOR.)



BY: P.D. PARKHI.
8-1-1946

(c) CROSS SECTION
2400' U/S OF C.S. MILE 0

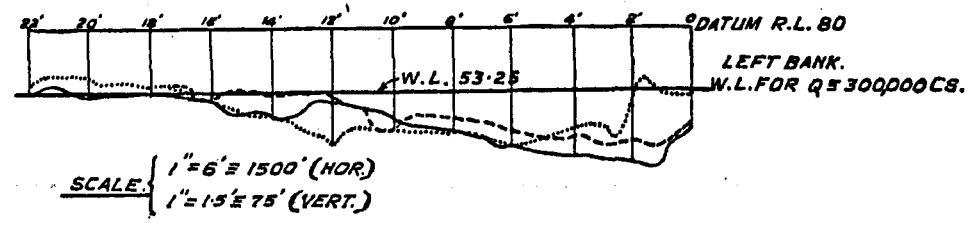

SCALE: $\frac{1}{2}'' = 1500'$ (HOR.)
 $\frac{1}{2}'' = 75'$ (VERT.)

FIG. 66 (a)

PLAN SHOWING LINES OF FLOW
 (WITH BARRAGE 2400' U/S OF SITE B.
 CORRECTED SURVEY)

FOR
 $Q = 300,000 \text{ Cs.}$
 SCALE - 1" = 7500'

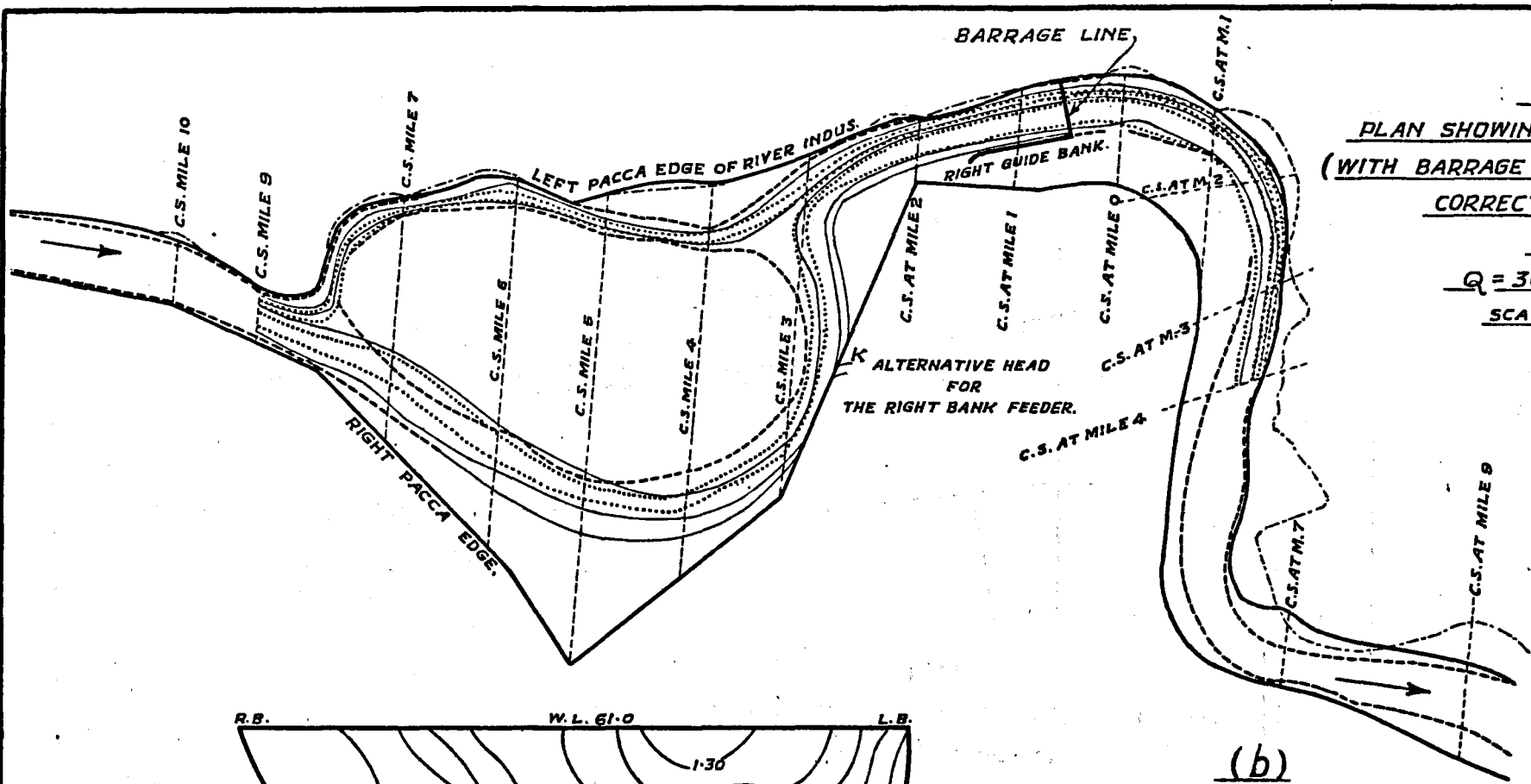

(b)

DIAGRAM SHOWING ISOVELS OF C.S. N^o 1 (U/S)
 WITH BARRAGE 2400 FT. U/S C.S. MILE 0

$Q = 4.8 \approx 300,000 \text{ Cs.}$
 U/S POND LEVEL 61.0
 D/S LEVEL 53.70

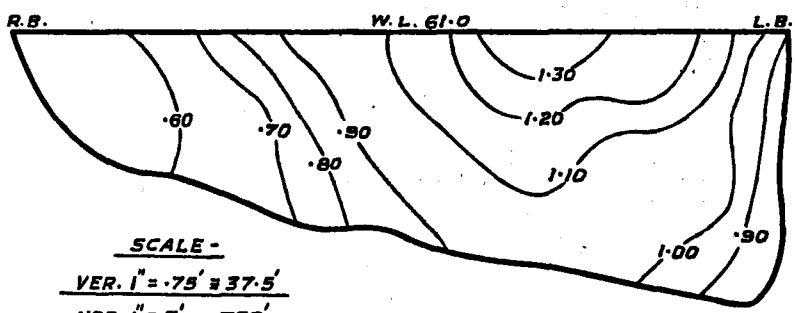

SCALE -
 VER. 1" = 75' \approx 37.5'
 HOR. 1" = 3' \approx 750'

FIG. 67. (a)
PLAN SHOWING ALIGNMENT OF
PROPOSED BARRAGE, RIGHT GUIDE BANK
& DETAILED LINES OF FLOW

WITH $Q_R \approx 300,000$ Cs.
 $Q_{R.B.C.} \approx 11,900$ Cs.
 $Q_{L.B.C.} \approx 34,600$ Cs.
 u/s W.L. ≈ 61.0
 d/s W.L. ≈ 54.0
 SCALE: $1'' = 10' \approx 2500'$

FIG. (b)
DETAIL ALIGNMENT OF RIGHT GUIDE BANK
SCALE: $1'' = 4' (\approx 1000$ FT.)

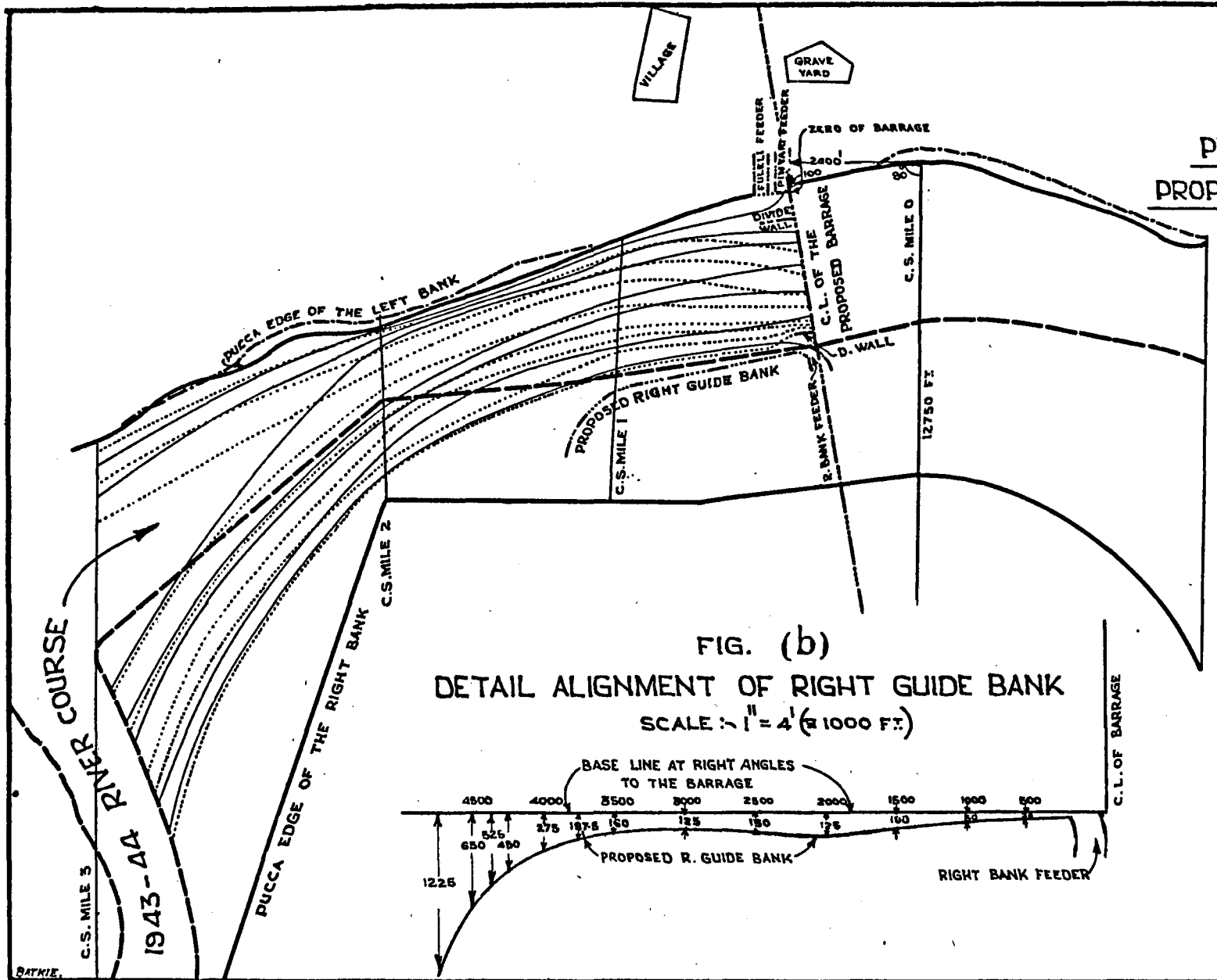
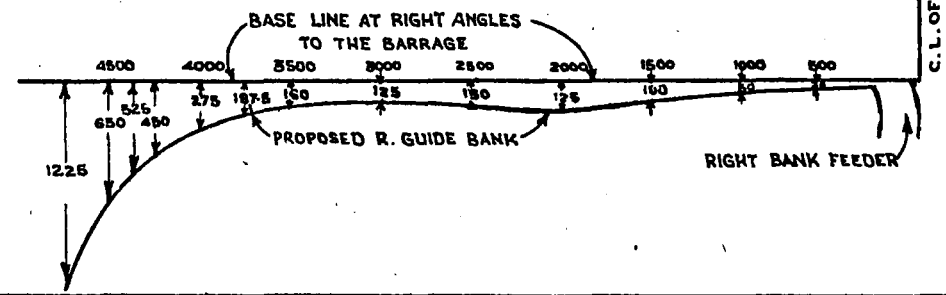

RATKIE.

(c) When a divide wall diverging with a splay of 1 in 10 and equal in length to the upstream abutment of the Kalri-Baghar Feeder was tested, sand exclusion improved.

(d) Loss of head observed in the right bank canal was ≈ 0.45 ft.

(7) Regulation of the barrage :-

(a) Regulation for 300,000 cusecs :-
(Still pond in both pockets)

As it was observed that four spans just outside the right pocket at R. L. 40 adversely distorted the conditions favourable to the right bank canal, these spans were made at R.L. 42.0. Bed sand was excluded effectively with the opening of these four gates being kept 2 ft. more than the other openings.

(b) Regulation for 350,000 cusecs.
(Still pond in both pockets)

For $Q \approx 350,000$ cusecs, sand was effectively excluded from the left bank canals and right bank feeder when all gates were equally opened.

(c) For other discharges regulation may be carried out as described in Part I.

(8) Intensity of discharges in various spans :-

(a) The intensity of discharge was found out for $Q \approx 300,000$ cusecs, the discharge passing through the barrage being 250,000 cusecs, alternatively with the four spans just outside the pocket at (i) R.L. 40.0 & (ii) 42.0.

The average intensity for this discharge works out to $\frac{250,000}{1800} = 139$ cs/ft, where 1800 ft. is the clear width of the weir portion (30 spans of 60' each).

(b) The intensity of discharge was also observed for river discharge $\approx 500,000$ cs, the discharge passing through the barrage being 450,000 cs, with the four spans at R.L. 42.0, and under 'still pond conditions in both the pockets. The average intensity in the river spans works out to $\frac{450,000}{1800} = 250$ cs/ft. The results obtained are shown in table 12.

Table 12.

TABLE 12
(All barrage gates were equally opened)

Spans of the weir portion.	River $Q \approx 300,000$ cs. (Four spans outside the right pocket at R.L. 40.0)		River $Q \approx 300,000$ cs. (Four spans outside the right pocket at R.L. 42)		River $Q \approx 500,000$ cs. (The four spans at R.L. 42.0)	
	Intensity of discharge	Percentage over or below the average intensity of 139 cs. per ft.	Intensity of discharge	Percentage over or below the average of 139 cs/ft.	Intensity of discharge	Percentage above or below the average of 250 cs/ft.
1	2	3	4	5	6	7
9-10-11	125	- 10 %	125	- 10 %	235	- 6 %
12-13-14	125	- 10 %	130	- 6.5 %	235	- 6 %
15-16-17-18-19	146	+ 5.2 %	149	+ 6.7 %	264	+ 5.6 %
20-21-22-23-24	146	+ 5.2 %	149	+ 6.7 %	266	+ 6.4 %
25-26-27-28-29	147	+ 5.8 %	149	+ 6.7 %	267	+ 6.8 %
30-31-32-33-34	145	+ 4.5 %	140	0 %	250	0 %
35-36-37-38 (4 spans outside the right pocket)	140	0 %	130	- 6.5 %	230	- 8 %

Note:- (i) + shows % of intensity of discharge above average intensity of discharge.

- " % " " " " below " " " "

(ii) The first span is taken from the left end of the barrage; spans 1 to 8 are in the left pocket 3J-42 are four spans in the right pocket.

(a) It can be seen from the table that concentration of flow occurs in 15 spans of the barrage, Nos. 15 to 29.

(b) The results also show that concentration increased near the right bank when the 4 spans outside the right pocket were at R.L. 40.0; in spite of this, conditions for sand exclusion from right bank canal became worse as water flowing in these four spans had an unfavourable curvature for the right bank canal; and, therefore, all the spans are recommended to be at the same sill level, R.L. 42.0.

(9) *Scouring operations:—*

Scouring operations were carried out for a discharge \cong 200,000 cusecs.

It is realised that, during periods when scouring operations will be practicable, river discharges exceeding one lac cusecs will generally not be available; it is, therefore, proposed to test out flow conditions for scouring operations with a river discharge \cong 1,00,000 cusecs in subsequent tests.

A discharge \cong 70,000 cusecs was passed through the left 8 spans and discharge \cong 35,000 cusecs was passed through the four right pocket spans thus the intensity of discharge Q , was equivalent to 146 cs/ft. run in both pockets. The rest of the discharge was passed through the barrage gates equally opened.

As very fine silt will be deposited in the pocket and this will be in a consolidated state, the fine red silt washed through the elutriator⁽¹⁾ having a mean dia. of 0.11 mm. was used and consolidated by a rammer and was laid as shown in fig. 68.

Fig. 68

The sill of the pocket spans was at R.L. 42.0 with upstream and downstream slopes of 1 in 5 and 1 in 3 respectively. The upstream pavement level was \cong R.L. 36.0 and downstream cistern level \cong R.L. 28.0.

Time of scour was 21 minutes \cong 3 days.

The downstream water level maintained was \cong R.L. 52.2, this being maximum water level for $Q \cong$ 200,000 (allowing for accretion downstream), as this would be the *worst* condition for sand exclusion tests. The pond level maintained was \cong R.L. 60 i.e. cut-off \cong 7.8 ft.

Observations:—

(a) When all spans were equally opened, silt near the head of the Fuleli canal was not effectively scoured away, this being due to the fact that water after flowing round the nose of the divide wall concentrated in spans 5 to 8.

(b) Even though spans 5 to 8 were kept closed and discharge concentrated through 1 to 4 spans, scouring near the Fuleli head did not improve.

(c) Scouring near the Fuleli was more or less uniform when spans 1 to 4 were opened 2 ft. more than the spans 5 to 8.

Opening of the spans 1 to 4 being \cong 12.6'

" " " " 5 to 8 being \cong 10.6'

(d) No difficulty was observed in scouring right pocket spans (opening of the right pocket spans being \cong 11.6').

(e) In the case of Sukkur barrage, the upstream and downstream slopes are 1 in 30 and 1 in 70 respectively; so, precaution has to be taken to regulate the gates very carefully in such a way that the standing wave does not form beyond the pacca pavement. This is ensured by restricting the cut-off to 5 ft at Sukkur. No such difficulty was observed with even a cut-off of 7.8 ft.

(1) Annual Report (Tech.) for 1943, P. 64.

Fig. 68
Lower Sind Barrage
(2400' u/s of mile 0)
Plan Showing Bed as laid &
As observed in the left Pocket
After scouring operations.
Time of run 21 minutes \approx 3 days
Scale: 1" = 125ft.

NOTE: BLACK FIGURES SHOW R.L.S.
OF BED AS LAID.
R.L.S OF CONTOURS ARE THOSE OF
SCOURED BED.

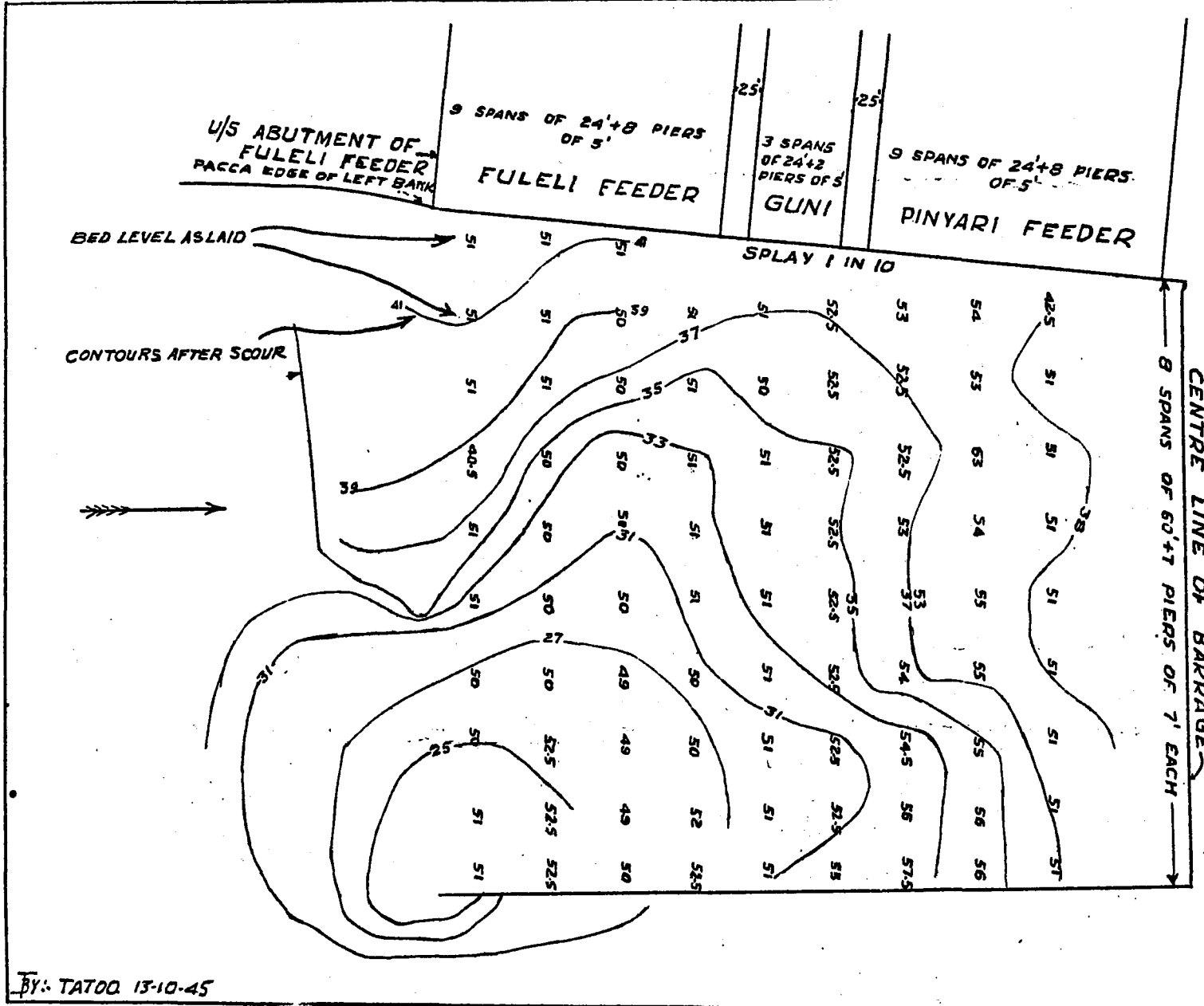

Retgression will occur during the first few years of the opening of the barrage: and, at that time, the position of the standing wave on the downstream glacis of the pocket will be the over-riding consideration for scouring operations: but as the downstream bed level in the cistern at Hajipur will be low (R.L. 28) against a high flood level of R.L. 62.2—and the glacis slope will be steep—1 in 3—, the standing wave will always form on the pavement. This may be compared with the relatively high downstream pavement level and the very flat glacis slope of 1 in 70 of the original Sukkur Barrage design, which was condemned by the Station (1) and replaced by a lower pavement with a glacis slope of 1 in 10, except downstream of pockets where the flat glacis slope had already been constructed.

The position of the Standing Wave was verified in the model, with the results shown below :

River discharge in cusecs	Maximum water level R.L.	Position of standing wave from the centre of the crest of the barrage	Minimum water level R.L.	Position of Standing wave	Minimum water level (after retrogression) R.L.	Position of standing wave
100,000	48.7	20'	44.9	27.5'	40.9	Standing wave formed just at the toe of the d/s glacis.
150,000	50.8	14.8'	47.0	23'	43.2	30'
200,000	52.2	8'	48.6	20'	45.0	28'

As it will be very difficult to unwater to a sufficiently low level to make it possible to have the downstream pavement at R.L. 28, this is another reason for changing the site for this Barrage from Hajipur to upstream of Kotri where the cistern level will be relatively higher.

15. Causes of Accretion of the River Bed at Sukkur Barrage and how to Reduce Rate of Rise

PART II

1. Introduction

Part I of this note will be found on pages 99 to 104 of Annual Report (Tech.) 1944. Mr. H.P. Mathrani had stated in his report:—

“In this case, however, accretion is more than normally rapid and has become particularly so after 1940. In my opinion this rapid accretion is due to the following causes :

(1) Location of the Barrage a short distance below a gorge resulting in sudden change of gradients upstream and downstream and deposition of silt immediately below the Barrage.

(2) The above is accentuated by the silting u/s of Barrage when the same is ponded in low river. This cause is normal and exists in case of all barrages.

(3) The deposition of silt on upstream is further accentuated by permanent closing of 10 spans and about 1 ft. higher ponding generally required above river spans to give required pond level in right bank pocket when river is low.

(4) Sudden expansion on downstream of Barrage caused by complete non-functioning of 14 spans on right side and partial functioning of 12 spans during high floods. Here it may be stated that the new right side approach channel can pass only about 48,000 cusecs in high floods. Out of this about 18,000 cusecs are drawn by right side canals and about 30,000 cusecs

(1) Bombay T.P. No. 29 (Note on “Experiments carried out with various designs of piers and sills in connection with the Lloyd Barrage at Sukkur”)

flow through spans Nos. 15 to 22. Again owing to the curvature of the outer bank there is a very sluggish flow through spans Nos. 24 to 26. Thus only spans Nos 27 to 66 function properly in high floods. This causes sudden expansion and deposition of silt on downstream.

(5) The fact that the rate of accretion has rapidly increased after 1940 i.e. after functioning of the new river works shows that the causes Nos. 3 and 4 play an important part.

1.1 Before replying to the above the following extracts from a report incorporated in the Annual Report (Tech.) 1943 pages 12-15 entitled "Technical Enquiry into the causes of Breaches in River Bunds in Sind and Steps Required to Minimise Danger of a Recurrence", will be quoted :—

Fig. 69.

"Though Bachalshah gauge (see Fig. 69) is situated downstream of Sukkur Barrage; yet it is the best Gauge for indicating conditions just above the Barrage.

Gauge readings have been observed at this Gauge since 1919.

It is situated where the river is still narrow, and is flowing nearly axially; so that variations in gauge due to curvature effect, are very small for discharges in excess of 100,000 cusecs.

The great value of Bachalshah Gauge is that it is not affected by ponding above the Barrage, as is the case at Outfall, Bukkur, and head of the Sukkur Canal.

It may be wondered why Bachalshah should indicate the effect of the Barrage on upstream conditions. The explanation is that during high floods (when there is very little heading-up at the Barrage), silt which has accumulated by deposition upstream during long periods of ponding, is scoured through the Barrage during the relatively short periods when the gates are fully open. Under these conditions, there is a supercharge of material in movement for the slope available downstream, so deposition takes place downstream of the Barrage. Consequently, though this is a measure of the rate of deterioration of the river just downstream of the Barrage; yet this deterioration affects, and hence indicates, conditions upstream of the Barrage, which cannot be obtained from upstream gauge readings except for discharges exceeding 4 lakhs—and floods of this magnitude have been a rare occurrence of recent years, and even when they have occurred, have been of short duration.

Fig. 70.

When the Barrage gates were first closed in 1932, ponding was considerable, and large quantities of silt and sand deposited several miles upstream of the Barrage, even during the early part and end of the Abkalani (flood season). Only a part of this accretion was subsequently scoured away when the gates were fully opened during the high flood period; so that the charge of material in movement through the Barrage was considerably less than previously; with consequent retrogression of water levels at Bachalshah during 1933 and 1934; but this relief was short-lived, and since 1935 the rise has been rapid.

It will be seen that a somewhat similar drop in specific discharge gauge reading occurred in 1925—which was followed by a steady rise from 1926-32. It has been suggested that this drop in 1925 might have been due to a 'good river' in 1924. This belief that a good river in one year is followed by a lower specific discharge gauge the following year is widespread; but statistical analysis did not show any such relationship and the same result was obtained when specific discharge gauges were compared with averages of 50 maximum discharges of previous years at Sukkur. It was also thought that though a single good year might not have this effect, yet a series of good years might bring out such a relationship; but no such inverse relation could be found. Hence, the temporary improvement in 1925 must have been due to some other disturbing factor. There seems to be little doubt that the

№ 5483.
I. W. EXPT. SYL. ROOMA



REDUCED FROM DRAWINGS
FROM INDUS RIVER COMMISSION
RECORD PART III & IV

FIG. 69

CHANGES IN THE COURSES OF
RIVER INDUS OVER A REACH OF 55 MILES U/S
OF SUKKUR DURING 1916-17

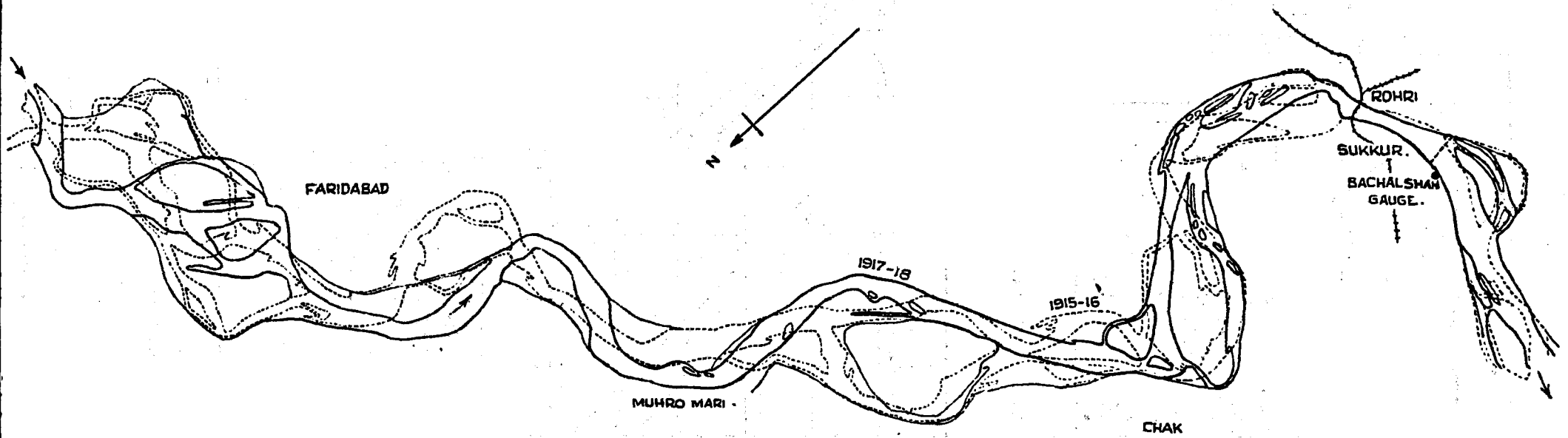
SCALE: 1" = 4 MILES.

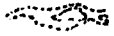

REF:-
1915-16 
1917-18 

BY: NAIK. II-4-45.

(Same as fig. 110. of 1944 report)

Nº. 6152

Indian Waterways Expt. Sfn.

FIG. 70
SPECIFIC DISCHARGE GAUGES
AT
BACHALSHAH
1919 - 1945

FITTING OF STATISTICAL TREND LINES.

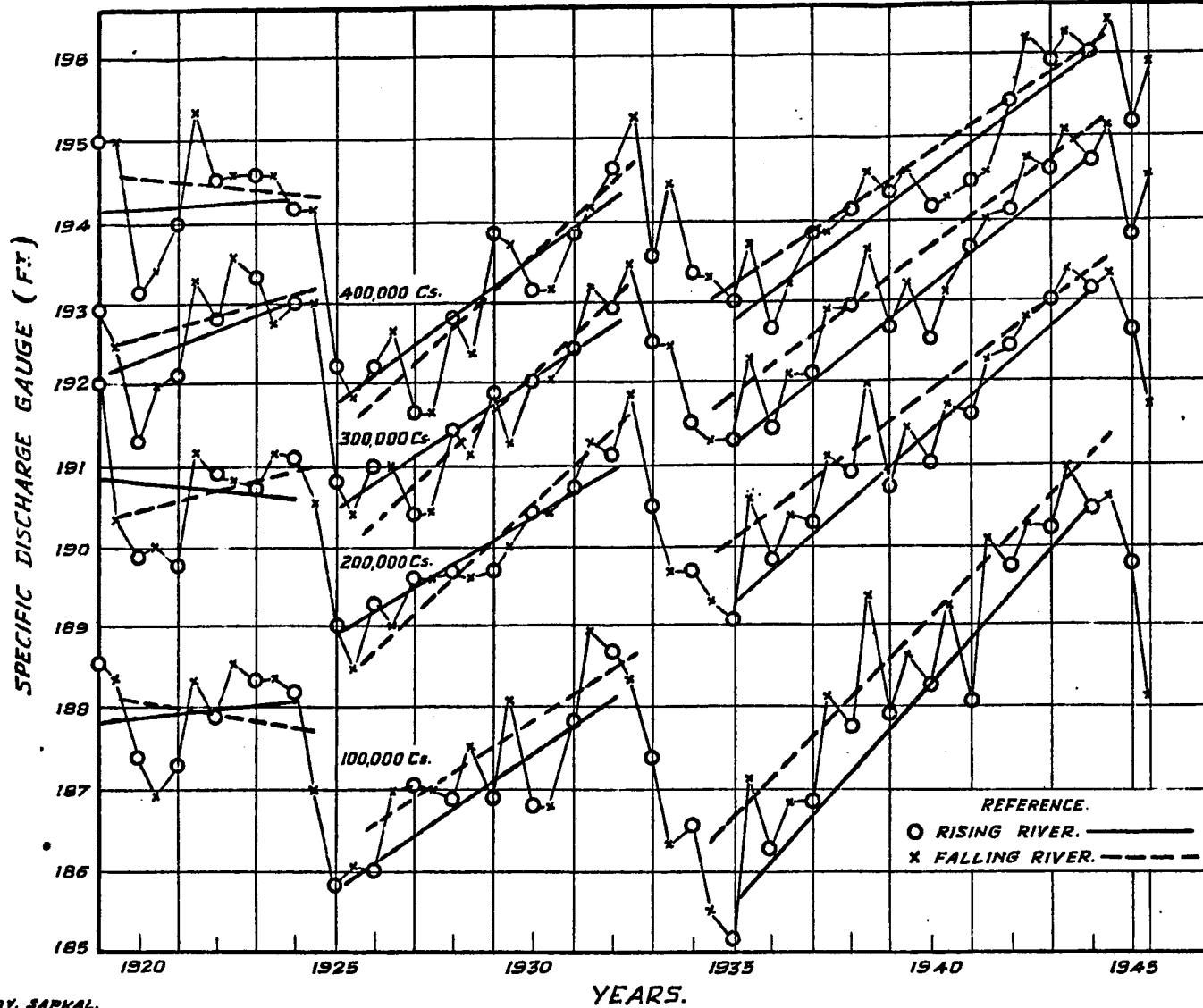

BY. SAPKAL.

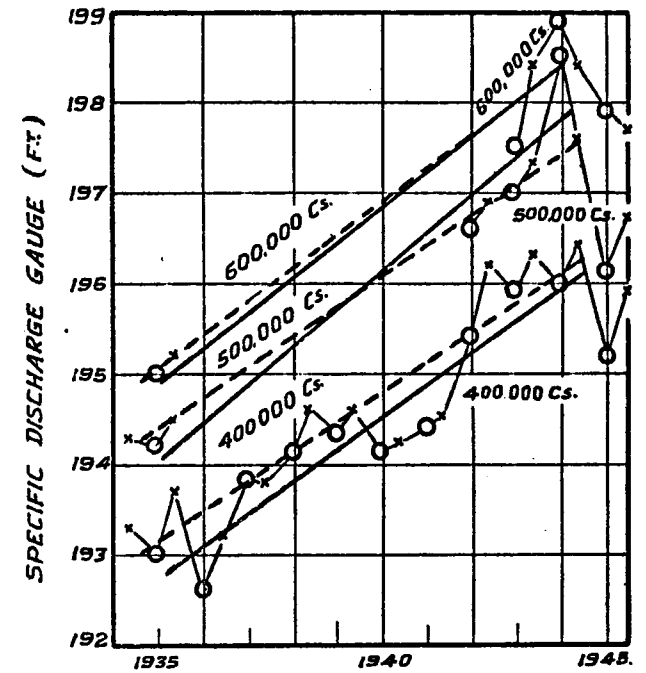

G. P. S. P. POONA. '46.

improvement in gauge resulted from the banks between Bunder and the Barrage having been faced with stone pitching. The temporary effect of this would be to cause a deep channel to form along the left, concave bank—which would persist downstream and cause a flattening of the gradient, and hence a lowering of specific discharge gauges. This is actually confirmed by river plans.

This improvement disappeared as soon as the stone facing got covered with silt, and during the period of construction of the Barrage, when large cofferdams were constructed, so that foundation work could be done in the dry, these obstructed about 1/4th of the river width, so conditions deteriorated rapidly. This was followed by marked retrogression during 1933 and 1934—after completion of the Barrage—since when the rise has been rapid. The 3 periods 1919-24, 1925-32 and 1934-44 have been dealt with statistically—vide figure 70 which shows that there was no trend between 1919 and 1924; but that the rises between 1925-32 and 1934-44 were highly significant, statistically. Fig. 70

The fall in 1925 and the subsequent rise between 1925 and 1932 is of no importance in this enquiry except to show that it had a physical significance; but the rise after completion of the Barrage is of great importance, and if water levels were to continue to rise at the same rate, the future would be very serious indeed. Fortunately, however, it is not so bad as may seem at first sight, for several reasons, two of which are:—

(1) As already explained: when the Barrage gates were first closed, much of the silt deposited in low portions of the area covered by the ponded water; and much of this deposit became permanent. This was followed by deposition of material at points from which it could be scoured when the gates were opened; but as the process continued the material already laid down above the Barrage consolidated, and we may anticipate that as the pond gradually extends further and further upstream, material subsequently deposited in reaches further from the Barrage will be less and less affected by draw-down, and hence will be less subject to scour during periods when the Barrage gates are open during high floods. Consequently, the rate of rise of water level at Bachalshah will gradually decrease;

and (2) as more and more material is deposited downstream of the Barrage—i.e. as the Gauge Readings at Bachalshah rise for specific discharges—the shorter will be the period during which water has to be headed up at the Barrage; and hence the less ponding will there be; and consequently the less deposition of silt will there be, and the longer the period during which the gates will be open to move the material downstream of Bachalshah. Consequently, for this reason also, the rate of rise of the bed at Bachalshah will gradually decrease.

As a result of these two factors, a condition must eventually be reached when the rate of rise of water levels at Bachalshah will be identical with the pre-Barrage rate of rise."

1.2 Mr. Mathrani's statements contained in para. 1 were countered in Annual Report (Tech.) 1944:—

(i) The data indicated that the steady rise of water levels after 1935 for the same specific discharges at Sukkur Barrage was mainly due to water being headed up at the Barrage after the movement of silt and sand became considerable when the discharge exceeded 200,000 cusecs. This led to deposition upstream, which was followed by a period when the discharge increased still further, so that most of the Barrage gates were opened to pass the flood. Under these conditions; the silt and sand deposited upstream was scoured through the Barrage as a super-charge, the excess being deposited downstream, thus raising the downstream water levels; and though part of this deposit was subsequently washed further downstream, this did not prevent the river downstream of the Barrage showing progressive deterioration.

(ii) As was anticipated, the bed level in the Gorge had been rising since 1935, but the rate of rise had not accelerated since the Approach Channel was constructed. The levels quoted by Mr. Mathrani for 1942 and 1943 were in fact quite wrong, being 6 ft. and 7 ft. too high respectively.

(iii) The data did not indicate any acceleration in the rate of rise after the Approach Channel was built.

(iv) Statements (3) and (4) para. 1 were shown to be inaccurate. The Barrage originally designed for 1,500,000 cusecs was now required to pass a maximum of 900,000 cusecs and the maximum recorded flood was 730,000 cusecs, so the reduced length of Barrage is ample to pass the discharge and is more than that normally provided for a similar discharge in the Punjab. So far from the waterway downstream of the Barrage being reduced unduly, the cross-section area of the river downstream of the open spans of the Barrage has become much greater since the Approach Channel was completed. Indeed the area of the whole width of the river was greater in 1944 than it had been for many years before the Approach Channel was constructed.

(v) Afflux at the Barrage when all gates were open was negligible.

(vi) Much larger fluctuations in specific discharge gauge readings occurred before the Approach Channel was constructed, for which the Approach Channel cannot be blamed.

1.3 The aim of this—part II—is to analyse the available data in greater detail in order to see whether the relative effects of various factors can be traced and, if possible, evaluated.

2. Gradients.

Mr. H. Mathrani stated:—

“The gradients upstream of Barrage have steepened very materially while those from Barrage to Bachalshah flattened up to 1942 and steepened in 1943.

Steepening of gradients upstream of Barrage denotes reduction in waterway upstream and results in increase in charge of silt. Flattening of gradient downstream increases the differences between upstream and downstream gradients, reduces silt carrying capacity downstream and causes silt to drop, which is what is actually happening”.

Here Mr. Mathrani has ‘put the cart before the horse’. The increase or decrease in slope results from, and is not the cause of, increase or decrease of charge. Actually changes in slope are going on continuously, often very rapidly, as indicated by abrupt changes in water levels relative to discharges (Fig. 71), so that steepening occurs in one part of the River and flattening in another, and vice versa; and it is unsound to jump to conclusions from single observations of slope taken at considerable intervals of time. Further more, the data, when corrected, do not bear out the statements made.

3. Progressive Reduction of Silt Charge and Load.

Table 13 Table 13 shows average discharges, silt loads, and charges (in grains per cubic ft) during 183 day flood seasons (from 1st April to the end of September).

3.1. Trends related to Time.

Fig. 72 Fig. 72 shows the variations with time of average discharges, charges, and loads—based on a 183 day season (Abkalani). All the parameters showed a gradual decline prior to ponding at the Barrage in 1932, and also a gradual decline subsequent to ponding in 1932 (the sudden drop in discharge after ponding at the Barrage was due to withdrawals for the canals), but the only statistically significant time trend was for the decrease of silt charge after ponding at the Barrage.

(Same as fig. III. of 1944 Report.)

NO: 5093
INDIAN WATERWAYS EXPT. STN.
POONA.

(FIG. III. FROM A.R.T.
1944 OF I.W.E.S.T.)

FIG. 71.

BACHALSHAH

WATER LEVEL : DISCHARGE

1943 & 1944

FROM 13-7-44 TO 12-9-44.

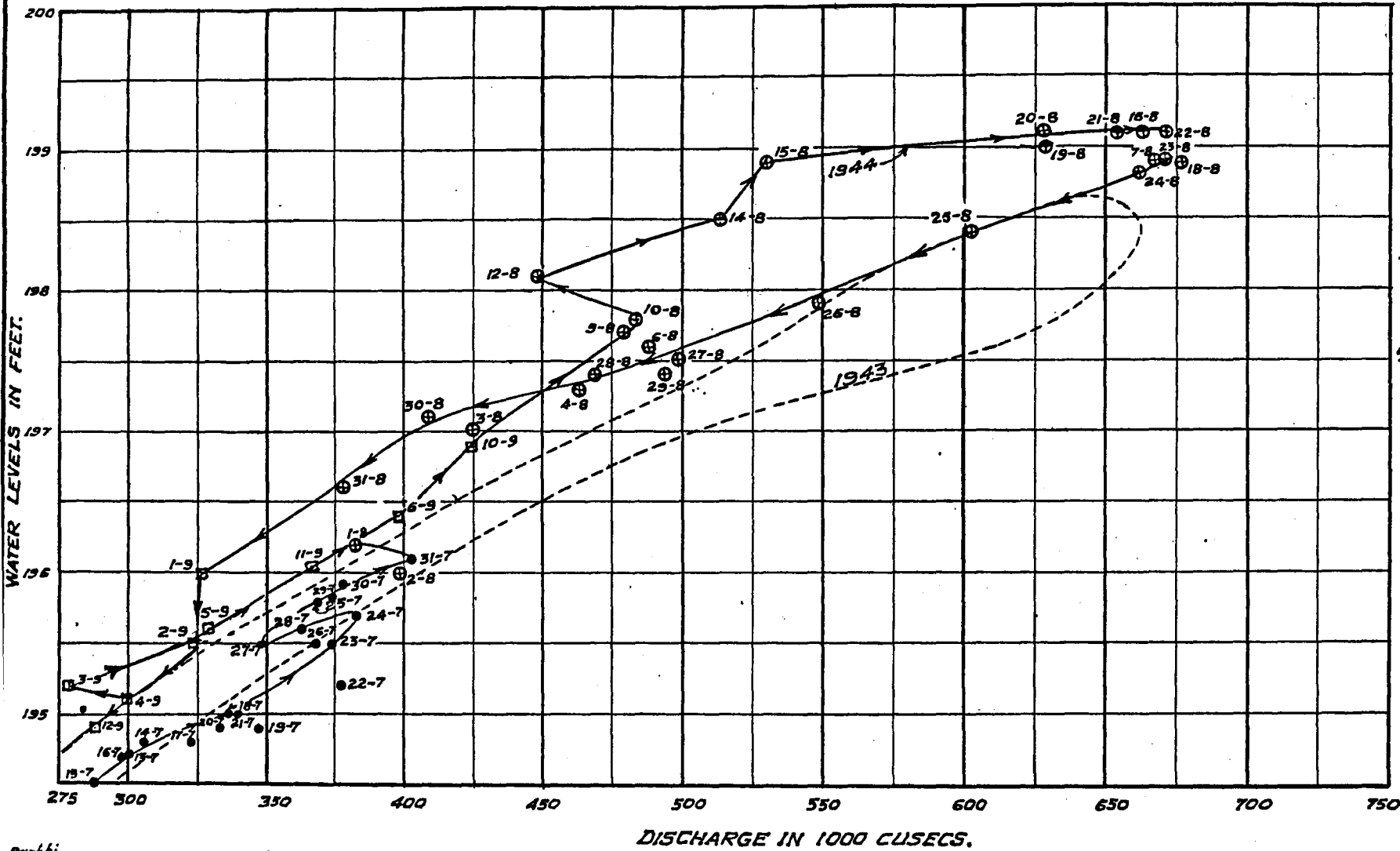

REFERENCES:~

- JULY 1944
- ⊙ AUG. "
- SEPT. "

FIG. 72

No 5494 A
I. W. E. S. POONA

VARIATION WITH TIME OF AVERAGE DISCHARGE, AVERAGE SILT LOAD, CHARGE & SP. Q GAUGE READINGS AT BACHALSHAH FOR 4 LAKH CUSECS

N. B. :—

- (1) CABLE SUSPENSION CORRECTION HAS BEEN APPLIED TO ALL DISCHARGES PRIOR TO 1924.
- (2) DISCHARGES & SILT LOAD FIGURES ARE THE TOTAL VOLUMES TRANSPORTED DURING EACH SEASONAL YEAR (i. e. 1ST OCT. TO FOLLOWING 30TH SEPT.) BUT AVERAGED FOR THE 183 (ABKALANI) DAYS OF RIVER ACTIVITY.
- (3) FIGURES FOR BACHALSHAH HAVE BEEN APPROPRIATELY REDUCED FROM THE FIGURES OBSERVED AT OUTFALL SECTION.

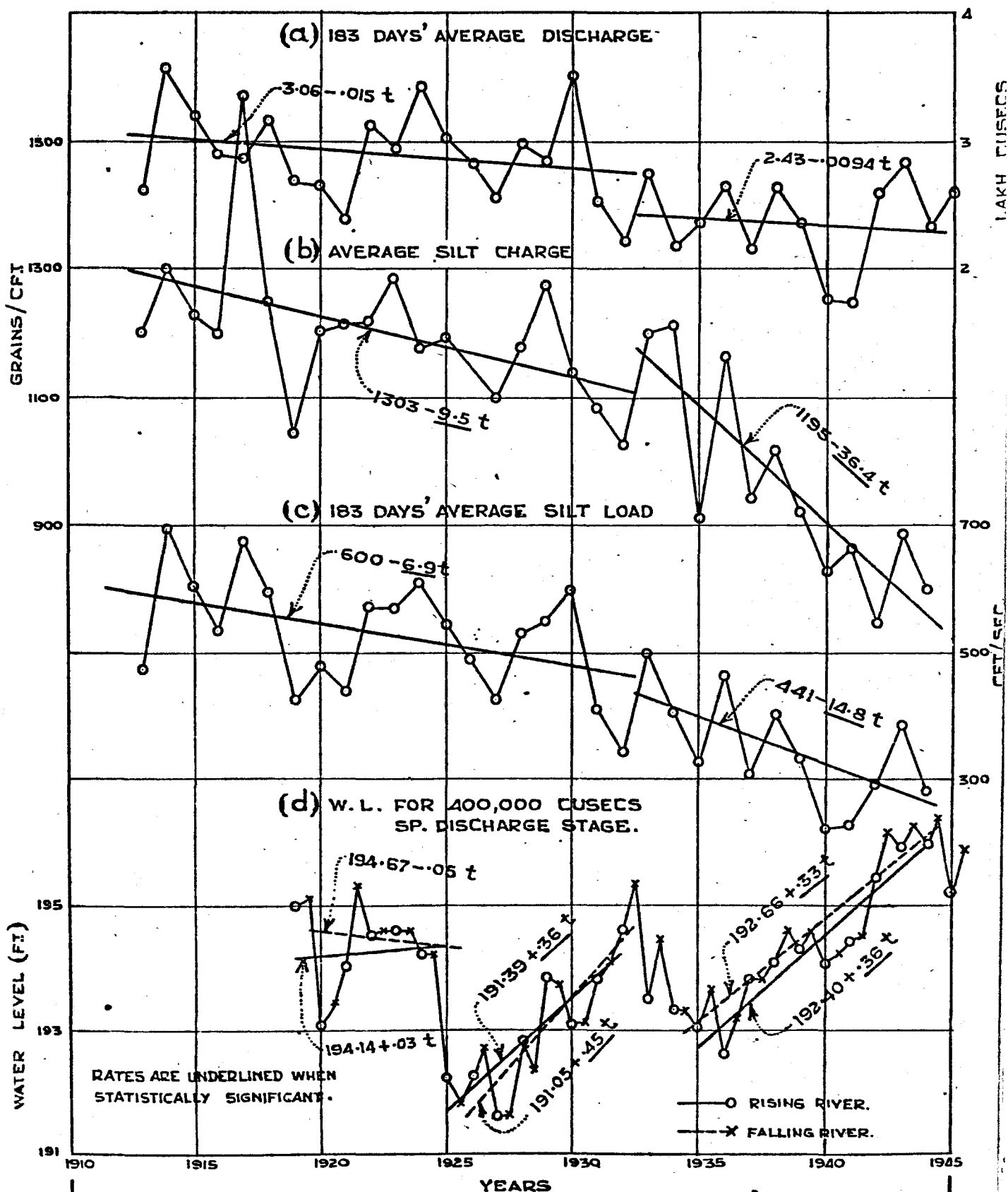

3.2. Trends relative to Discharge.

When silt load values (average for 183 days) were plotted against average discharge for the same period it was found that high degrees of association were obtained, especially for the period 1913-1932 and for sub-groupings in the period 1933-44. The relations are shown in figs 73 and 74, the former after correcting for cable suspension, the latter without correction. The correlations obtained were *similar* but were slightly higher for the uncorrected figures. Figs. 73 & 74

TABLE 13

Years	Outfall Section				Bachalshah		Average silt-charge in-grains per cft.
	Not corrected for cable suspension		Corrected for cable suspension		Discharge (cusecs)	Silt-load cft/sec.	
	Discharge (cusecs)	Silt-load (cft/sec.)	Discharge (cusecs)	Silt-load (cft/sec.)			
	1	2	3	4	5	6	
1913	289098	524	261184	473	261184	473	1206
1914	409268	802	356187	698	356187	698	1303
1915	370820	688	326246	605	326246	605	1233
1916	325962	598	290827	584	290827	584	1206
1917	318836	752	285151	673	285151	673	1569
1918	359623	679	317400	599	317400	599	1254
1919	297164	467	267700	421	267700	421	1046
1920	292399	580	263825	473	263825	473	1205
1921	263273	482	239847	439	239847	439	1217
1922	352811	646	311991	571	311991	571	1219
1923	329629	639	293736	569	293736	569	1288
1924			342956	608	342956	608	1179
1925	From 1924 onwards		301137	541	301137	541	1194
1926	current meters have		283270	489	283270	489	1149
1927	been rigidly suspended		256922	424	256922	424	1098
1928	on a metal rod. No		297685	530	297685	530	1183
1929	corrections are		285208	548	285208	548	1278
1930	therefore necessary		350508	600	350508	600	1138
1931	for these observations		252767	412	252767	412	1085
1932	From 1932 the figures		249671	386	220728	341	1029
1933	for Bachalshah are		312635	566	273247	495	1203
1934	less than those		272240	497	220063	402	1214
1935	measured at Outfall		289191	395	236891	324	909
1936	due to canal		315422	553	263307	462	1166
1937	withdrawals		268253	380	217636	308	942
1938			317819	488	262913	404	1020
1939			290825	403	238302	330	921
1940			232904	290	177934	222	828
1941			230631	299	175346	227	863
1942			307614	347	260405	294	750
1943			332452	445	285306	382	839
1944			281586	340	233475	282	802

The data for 1917 and 1942 were abnormal :—

(i) In 1917 the river changed its course upstream of the Gorge as shown in fig. 69.

(ii) In 1942 the silt load at Outfall was relatively low after the Indus breached the Mahomedabad Loop Bund upstream of the Barrage on 21-7-42 (i.e. just when the peak discharge was reached). This reduction was due to the breach drawing away a large proportion of the silt in movement down the river. The recovery in charge in 1943 and 1944 was small.

Note :—Though the charge was not observed from 16th October to 31st December 1929 and during the month of August 1935, the load carried in the river during these periods has been estimated assuming that the charge for the missing months was equal to the average charge for the same months in previous years, so the error will be small.

The scatter in the Pre-Barrage group (1913-32) was less than for the whole period 1913-44, showing that the relation governing the quantitative variations between the average discharge and the load was *very precise* prior to ponding at the Barrage. During the post-Barrage period, when the discharge in the River downstream of the Barrage was reduced considerably by canal withdrawals, the apparent scatter in the silt-load distribution became relatively great. This was to be expected; because ponding at the Barrage made a marked change in the quantity of silt and sand in movement; thus during the winter months the water, instead of being silty, was at first bottle green. The silt load during the flood seasons 1933, 1934 and 1936 was, however, similar to that during the pre-Barrage period for the same discharges, indicating that the silt load during the flood season was, at first, little affected by the Barrage, though the sand charge was markedly less; but between 1937 and 1940 a marked decrease in silt charge occurred, followed by a sudden further decrease in 1942, caused by the breach—as already explained.

At first sight, the progressive decrease in silt charge might not be expected, for it might be thought that as the water levels upstream of the Barrage rose to a new and steeper gradient, silting would become progressively less and hence the silt carried, and observed at Outfall, would increase; but though accretion has been occurring along the edge of the river, the rising water level in the river commands a greater length and area of low-lying berm behind the silted lips of the berms, so that these low areas have been flooded with silty water; and until nearly the whole width of the river berm has been silted—which will not be until the rate of rise of water levels caused by afflux at the Barrage almost ceases—the charge of silt passing down to Outfall will continue to decrease. After that, the charge will again begin to increase. The above takes into account the differences in silt (not sand) charge caused by ponding at Sukkur Barrage; but differences caused by ponding and by more water being drawn off in the Punjab have not been considered, though they may have affected the question to a small extent.

3.3. A second confirmation of the close correlation obtained between discharge and silt load was obtained by a method which is not subject to the criticism that the co-relation may be spurious and a result only of the mutual dependence of both these variables on time.

The standard method of eliminating the time effect consists first of fitting time trend lines separately to the data for the variates, discharge and silt load in this case, and then correlating the departures of the observed values of these variables from time trend lines; the resulting correlation, if any, is free from the influence of time-effect on the variables.

DATA CORRECTED FOR CABLE SUSPENSION ERRORS

PRE- & POST-BARRAGE RELATIONS BETWEEN DISCHARGE & SILT LOAD AT BACHALSHAH (PERIODS 1913-32 & 1933-45)

No. 5557

I.W. EXPT. STATION: POONA
(FIG. 73. FROM
A.R.T. 1945)

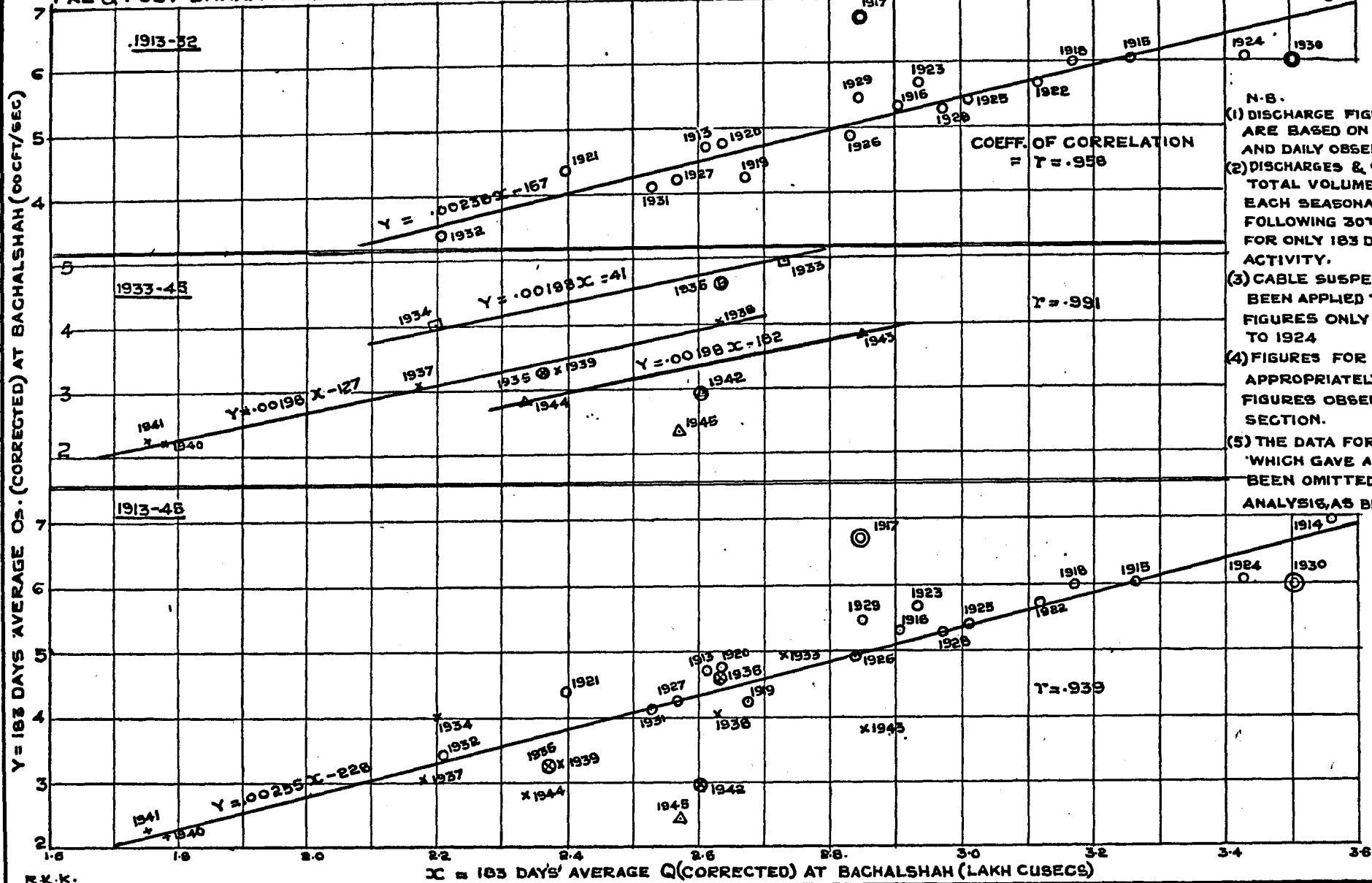

FIG. 73

N.B.

- (1) DISCHARGE FIGURES PRIOR TO JUNE 1920 ARE BASED ON BIWEEKLY OBSERVATIONS AND DAILY OBSERVATIONS THEREAFTER.
- (2) DISCHARGES & SILT LOADS ARE THE TOTAL VOLUMES TRANSPORTED DURING EACH SEASONAL YEAR (i.e. 1ST OCT. TO FOLLOWING 30TH SEPT) BUT AVERAGED FOR ONLY 183 DAYS (ABKALANI) OF RIVER ACTIVITY.
- (3) CABLE SUSPENSION CORRECTION HAS BEEN APPLIED TO SUCH AVERAGE FIGURES ONLY FOR ALL DATA PRIOR TO 1924
- (4) FIGURES FOR BACHALSHAH HAVE BEEN APPROPRIATELY REDUCED FROM THE FIGURES OBSERVED AT OUTFALL SECTION.
- (5) THE DATA FOR YEARS 1917, 30, 35, 36 & 42 WHICH GAVE ABNORMAL POINTS, HAS BEEN OMITTED FROM STATISTICAL ANALYSIS, AS BEING INCORRECT

The data for 1917 and 1942 were abnormal :—

Fig. 69

(i) In 1917 the river changed its course upstream of the Gorge as shown in fig. 69.

(ii) In 1942 the silt load at Outfall was relatively low after the Indus breached the Mahomedabad Loop Bund upstream of the Barrage on 21-7-42 (i.e. just when the peak discharge was reached). This reduction was due to the breach drawing away a large proportion of the silt in movement down the river. The recovery in charge in 1943 and 1944 was small.

Note :—Though the charge was not observed from 16th October to 31st December 1929 and during the month of August 1935, the load carried in the river during these periods has been estimated assuming that the charge for the missing months was equal to the average charge for the same months in previous years, so the error will be small.

The scatter in the Pre-Barrage group (1913-32) was less than for the whole period 1913-44, showing that the relation governing the quantitative variations between the average discharge and the load was *very precise* prior to ponding at the Barrage. During the post-Barrage period, when the discharge in the River downstream of the Barrage was reduced considerably by canal withdrawals, the apparent scatter in the silt-load distribution became relatively great. This was to be expected; because ponding at the Barrage made a marked change in the quantity of silt and sand in movement; thus during the winter months the water, instead of being silty, was at first bottle green. The silt load during the flood seasons 1933, 1934 and 1936 was, however, similar to that during the pre-Barrage period for the same discharges, indicating that the silt load during the flood season was, at first, little affected by the Barrage, though the sand charge was markedly less; but between 1937 and 1940 a marked decrease in silt charge occurred, followed by a sudden further decrease in 1942, caused by the breach—as already explained.

At first sight, the progressive decrease in silt charge might not be expected, for it might be thought that as the water levels upstream of the Barrage rose to a new and steeper gradient, silting would become progressively less and hence the silt carried, and observed at Outfall, would increase; but though accretion has been occurring along the edge of the river, the rising water level in the river commands a greater length and area of low-lying berm behind the silted lips of the berms, so that these low areas have been flooded with silty water; and until nearly the whole width of the river berm has been silted—which will not be until the rate of rise of water levels caused by afflux at the Barrage almost ceases—the charge of silt passing down to Outfall will continue to decrease. After that, the charge will again begin to increase. The above takes into account the differences in silt (not sand) charge caused by ponding at Sukkur Barrage; but differences caused by ponding and by more water being drawn off in the Punjab have not been considered, though they may have affected the question to a small extent.

3.3. A second confirmation of the close correlation obtained between discharge and silt load was obtained by a method which is not subject to the criticism that the co-relation may be spurious and a result only of the mutual dependence of both these variables on time.

The standard method of eliminating the time effect consists first of fitting time trend lines separately to the data for the variates, discharge and silt load in this case, and then correlating the departures of the observed values of these variables from time trend lines; the resulting correlation, if any, is free from the influence of time-effect on the variables.

DATA CORRECTED FOR CABLE SUSPENSION ERRORS

PRE- & POST-BARRAGE RELATIONS BETWEEN DISCHARGE & SILT LOAD AT BACHALSHAH (PERIODS 1913-32 & 1933-45)

NO. 5557
I.W. EXPT. STAN: POONA
(FIG. 73, FROM
A.R.T. 1945)

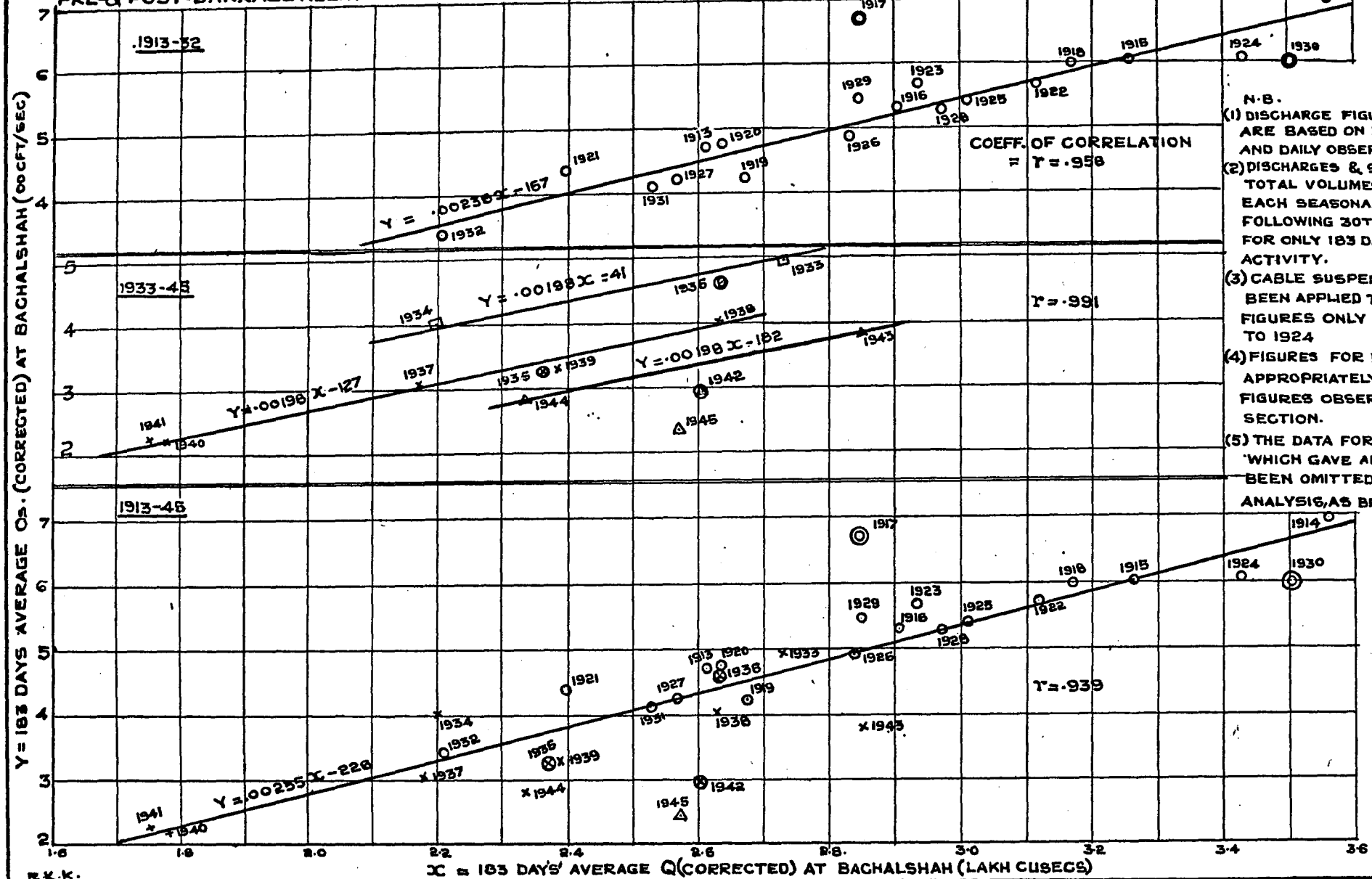
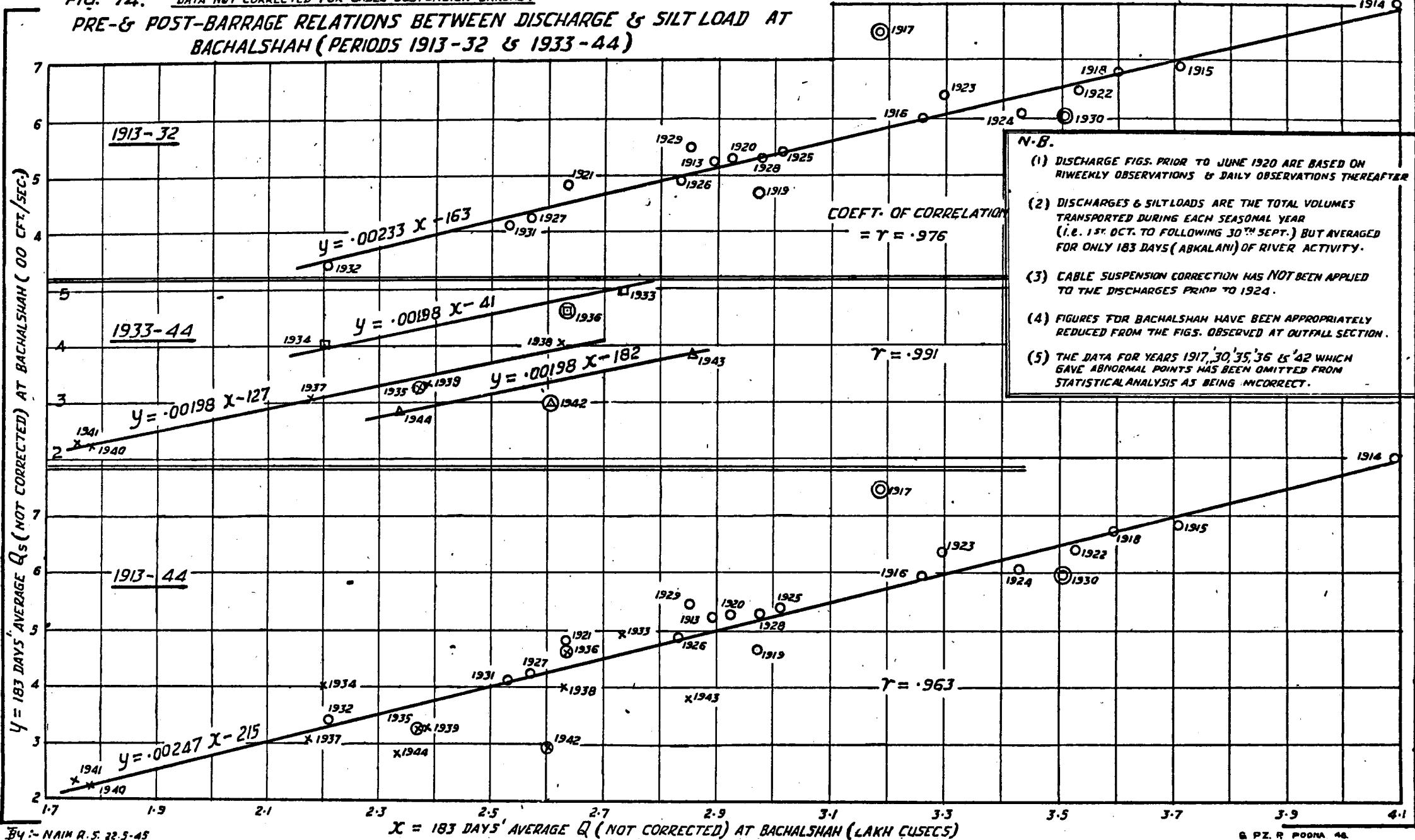

FIG. 73

- N.B.
- (1) DISCHARGE FIGURES PRIOR TO JUNE 1920 ARE BASED ON BIWEEKLY OBSERVATIONS AND DAILY OBSERVATIONS THEREAFTER.
 - (2) DISCHARGES & SILT LOADS ARE THE TOTAL VOLUMES TRANSPORTED DURING EACH SEASONAL YEAR (I.E. 1ST OCT. TO FOLLOWING 30TH. SEPT) BUT AVERAGED FOR ONLY 183 DAYS (ABKALANI) OF RIVER ACTIVITY.
 - (3) CABLE SUSPENSION CORRECTION HAS BEEN APPLIED TO SUCH AVERAGE FIGURES ONLY FOR ALL DATA PRIOR TO 1924
 - (4) FIGURES FOR BACHALSHAH HAVE BEEN APPROPRIATELY REDUCED FROM THE FIGURES OBSERVED AT OUTFALL SECTION.
 - (5) THE DATA FOR YEARS 1917, 30, 35, 36 & 42 WHICH GAVE ABNORMAL POINTS, HAS BEEN OMITTED FROM STATISTICAL ANALYSIS, AS BEING INCORRECT

R.K.K.

FIG. 74. DATA NOT CORRECTED FOR CABLE SUSPENSION ERRORS.
PRE- & POST-BARRAGE RELATIONS BETWEEN DISCHARGE & SILT LOAD AT
BACHALSHAH (PERIODS 1913-32 & 1933-44)



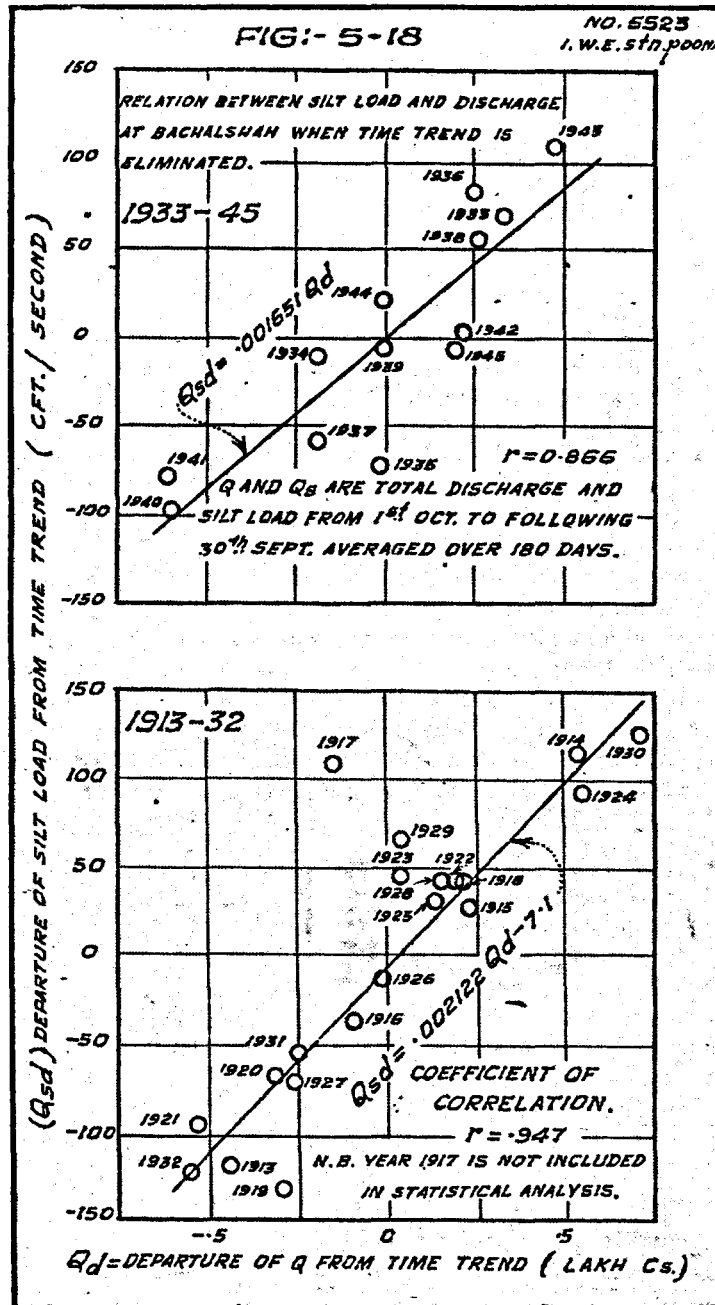

Fig. 75

This method gave an identical degree of correlation for the pre-Barrage years (1913-32), as indicated by the equal value of the correlation coefficient (= .947), as had been obtained previously from the "absolute values" without eliminating the time trend: while, for the post-Barrage years (1933-1944)—during which period the downward trend of silt-load is more marked—there is a more significant correlation obtained between the departures than between the absolute values (.8895 against .755). Thus, even during the post-Barrage period, the correlation between the discharge and silt load is confirmed to be real.

4. *Ponding, Afflux, Cut-off.*

Fig. 76 "Afflux",—known as "cut-off" in Sind—has decreased since the Approach Channel was constructed; but Fig. 76 on which curves of maximum and minimum afflux for the years 1940—44 have been drawn, show that the minimum afflux for $2\frac{1}{2}$ lakhs cusecs fell from 2 ft. to a few inches—between 1941 and 1942; and the minimum afflux for 1 lakh cusecs fell from 6 ft. in 1940 and 1941 to less than 2 ft. in 1943 and 1944; while maximum afflux was 2 ft. less in 1943 and 1944 than in 1940 and 1941. From the above, it is clear that the afflux was much greater in 1940 and 1941 than in 1943 and 1944 after the approach Channel was completed.

Fig. 77 The statement—see para 1 (3)—that "about 1 ft. higher ponding is generally required" is misleading; because the rate of deterioration depends on the amount of afflux—for reasons already explained—and fig. 77 shows that the rate of deterioration in discharge for specific gauge readings with all gates open decreased in 1942, 1943 and 44.

5. Coming now to what really matters, namely, whether anything can be done to retard deterioration in the river resulting from heading up water at the Barrage.

Obviously, the position of the Barrage cannot be altered so that such accretion as is occurring in the Gorge must continue until a new regime becomes established; *but what can and should be done is to lower the Full Supply Levels at the heads of the Rice and North Western Canals* so that afflux will cease with a discharge of say 2 lakhs cusecs, or even $1\frac{1}{2}$ lakhs cusecs in the river. When that is achieved the Barrage would cause little further accretion upstream and hence there would be no supercharge to lead to deposition downstream.

5.1. Lowering the Full Supply Levels was recommended by the Director in 1944—see p. 104 Annual Report (Tech.) 1944:—

"this accretion can be largely stopped provided the Full Supply Level in the Rice Canal is reduced by 1.5 ft. below designed Full Supply Level, to give a flatter slope. It will be necessary in order to flatten the slope to 1 in 16,000 to lower the bed at the Head by 3 ft.—thus increasing the depth by 1.5 ft. from 11.7 ft. to 13.2 ft. if the present width is retained; or to widen the canal by 22 ft. from 243 to 265 ft., making the depth 12.3 ft. by lowering the bed by 2.1 ft.

Though the bed of the Rice Canal has now scoured almost to its designed bed level; the slope in this Canal with F. S. discharge is still high. This is because coarse sand ($m = .28$ mm.)—the residue of several feet of scoured bed material—is exposed on its bed. *This concentration of coarse sand must be removed*, and the velocity reduced, before the Canal can be run with the flatter slope now rendered possible by the exclusion of most of the bed sand as a result of constructing the approach Channel. Lowering the water level at the head of the North West Canal will, however, present greater difficulties, owing to the designed bed-slope being already flat—1 in 14,000—and to the Warah Branch taking off at a high level at R.D. 83,824".

Even in the case of the North West Canal, however, the full Supply Level can be lowered by excavating the bed and flattening the slopes in the main canal and Warah Branch. At worst, a small area of high land near the head of Warah Branch will be turned into lift. This, however, would be a small loss compared to the great advantage of allowing free flow through the Barrage for discharges in excess of 2 lakhs cusecs, so as to retard or prevent further deterioration.

FIG. 76
SHOWING
MAXIMUM AND MINIMUM
AFFLUX CURVES
AT
PIERS 23 & 59

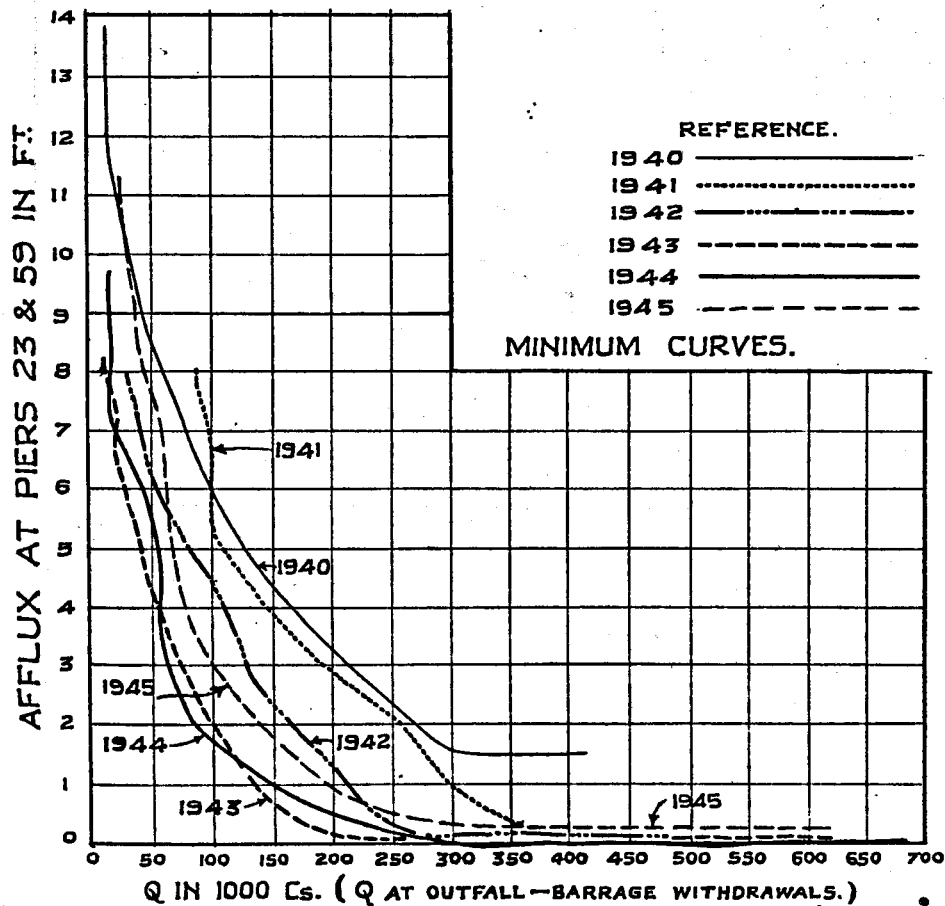
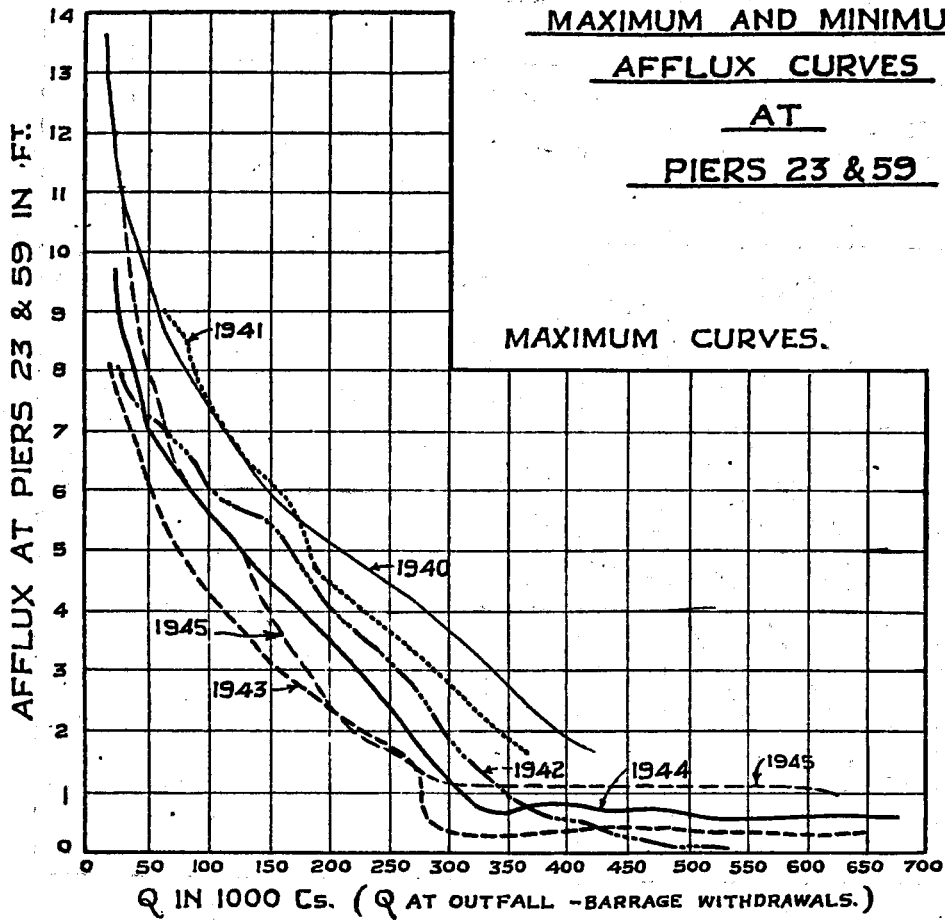

T. BY. SARKAL.

FIG. 77.

FIGURE SHOWING DISCHARGE THROUGH THE BARRAGE (WITH ALL GATES FULLY OPEN) IN 1933 TO 45 FOR SPECIFIC WATER LEVELS AT PIERS 23 & 59 D/S.

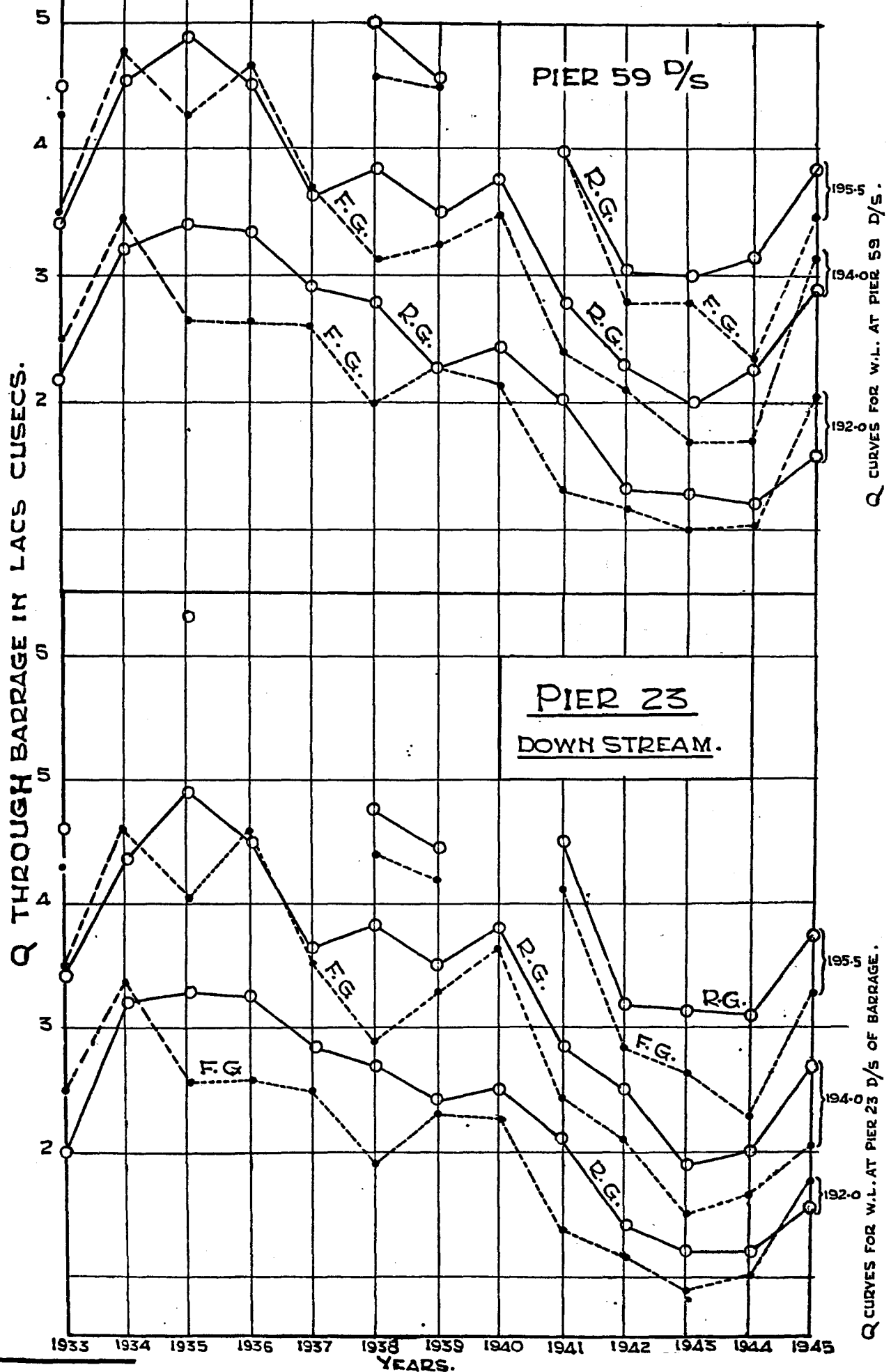

PART IV.—BASIC EXPERIMENTS

2. RIVER BEHAVIOUR AND CONTROL

“ (ii) SCOUR ”

16. Scour Downstream of Rigid Structures in Wide Channels.

1. *Introduction.*

Whenever a rigid structure, constricting the waterway is built across a natural channel, the velocity and the discharge intensity are greater than in the natural channel. So, when the water leaves the structure and flows over the bed of the natural channel, the depth of flow gradually increases downstream of the pucca floor of the structure (including a scour-hole) and then gradually decreases again till the stable depth is reached. Under such flow, ultimately a condition of equilibrium will be reached in which the scour-hole does not change, because the material thrown up from the bottom on the slope of the scour hole is thus stabilized, the excess energy acquired by water is completely dissipated and the bed velocity is adjusted to the extent that neither accretion nor scour occurs, as long as other conditions remain the same⁽¹⁾.

2. *Factors affecting downstream scour.*

The predominant factor, determining the maximum depth of scour downstream of structures like barrages and bridges over *wide* rivers⁽¹⁾ is the *discharge intensity*, the effect of sides being negligible: other important factors are the flow pattern and grade of bed material. In canals, however, bellies generally occur downstream of structures, as in the case of bridges over the Rice Canal⁽²⁾, the N.W. canal⁽³⁾, and the Rohri canal (Sind), causing return flow on the sides and jetting in the middle. The bellied sides have an appreciable effect on the maximum depth of scour reached in canals, where the width of channel is not large compared to the depth. Any mathematical analysis is thus complicated by virtue of the return flow at the sides.

3. *Object of the Experiments.*

The object of the following experiments was to obtain a correlation between the various factors such as q and V^2/d at the structure and the maximum depth of scour reached downstream of it; such a correlation would be useful in determining the depth of foundation of piers in bridges or the depth of sheet-piling, loose stone protection, etc. in barrages, and other similar problems.

4. *The Model Experiments.*

The experiments were conducted in a channel, 8.0 ft. wide, having non-erodible sides so as to reduce the side effect and, thus, approximate to conditions in wide rivers. The $\frac{\text{width}}{\text{depth}}$ ratio in the experimental channel was 10.0, and, at the outset, this was believed to be sufficient to eliminate the side effect and represent wide rivers. Other dimensions of the channel are given in Fig. 78, from which it will be seen that sufficient entry and exit lengths were provided. A geometrically-similar model of the bridge with a pavement of coarse sand of 8.0 mm. diameter representing stone pitching, formed the rigid structure. The channel upstream of the bridge was plastered. The sides of the channel downstream of the bridge were given a slope 1/2:1 and were also plastered. Sand was laid in the channel downstream of the bridge to a depth of 2.0' below the pavement level. V sand of 0.3 mm. mean dia. was used for the first five experiments and Londha sand of 0.3 mm. mean dia., which is more uniform, for the rest. Various discharges with different depths at the bridge were run, for a sufficiently long time, till stable depths in the scour-hole were obtained. Sand was not injected in the above experiments.

Fig. 78

(1) Maximum depth of scour at heads of guide banks and groynes, pier noses and d/s of bridges—See Annual Report (Tech.) for 1944 (pp. 78-83).

(2) Annual Report (Tech.) for 1942-43 (pp. 21-24).

(3) " " " for 1944 (pp. 23-25).

5. *Depth and shapes of scour-hole.*

Figs. 79 & 80 Figs. 79 and 80 show the typical contours and the shape of scour-holes obtained with a discharge of 6 cusecs but with different V^2/d . The depths at the sides in the scour-hole were generally greater than in the centre. The term ' d_s ', used in the following analysis, is obtained by dividing the maximum cross-sectional area of the scour-hole by its mean width. The ratio $\frac{\text{absolute max. depth of scour-hole}}{d_s}$ generally increased for higher values of V^2/d

Fig. 81 due to the sloping sides causing diving flow, as shown in Fig. 81.

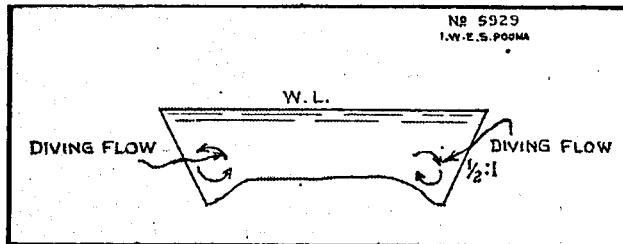

Fig. 81

The results showed that, contrary to expectations at the start, the experimental channel was not sufficiently wide to make the side effect negligible, e.g. the absolute maximum depth was as much as $1.28 d_s$ for $V^2/d = 15.2$ in expt. Table 14 7 - vide table 14, cols. 11 and 13. It is, therefore, proposed further to reduce the side-effect by using a channel of double the width.

6. *Analysis of sand samples.*

Analysis of sand samples taken before and after the experiments showed that V sand became slightly coarser for higher values of V^2/d while Londha sand did not show any appreciable increase in coarseness. V sand contains flat particles and the size distribution curve is spread over a greater range; while particles of Londha sand are more rounded and the distribution is more uniform. This may be one reason for the greater scatter in results obtained with V sand than with Londha sand. In both cases, however, the samples obtained at various cross-sections differed greatly. Usually the sand in the deepest part of the scour-hole, near the sides, was finer than at the centre, the finer particles in the centre being washed away and carried further downstream by the forward flow. The mean dia. of sand samples varied from 0.29 to 0.4 mm. for V sand and from 0.3 mm. to 0.37 mm. for Londha sand.

Increase in coarseness of V sand for higher values of V^2/d is clearly shown Fig. 82 in fig. 82.

7. *Divergence from Lacey's regime depths due to divergence in turbulence.*

In the following analysis, actual values of V^2/d and d_s are compared with Lacey's values of V^2/d and R (the latter called R_L). That the grade of sand or silt factor affects the depth of scour has been observed in the analysis of the depths of scour below bridges⁽¹⁾ and, hence, ' f ' has been introduced as a variable factor in the following tentative analysis.

According to Lacey,

$$\text{and } V_o = (Qf^2/3.8)^{1/6} \quad \dots (1)$$

$$V_o = 1.15 \sqrt{f R_L} \quad \dots (2)$$

$$\therefore R_L = 0.7305 V_o^2/f \quad \dots (2')$$

Substituting for V_o from equation (1) in equation (2'),

$$R_L = 0.7305 (Q/3.8 f)^{1/3} \quad \dots (3)$$

(1) Annual Report (Tech.) for 1944 (pp. 77-83).

FIG. 78.
SCOUR D/S OF RIGID STRUCTURES
IN A CHANNEL WITH SIDES HELD.
NOT TO SCALE.

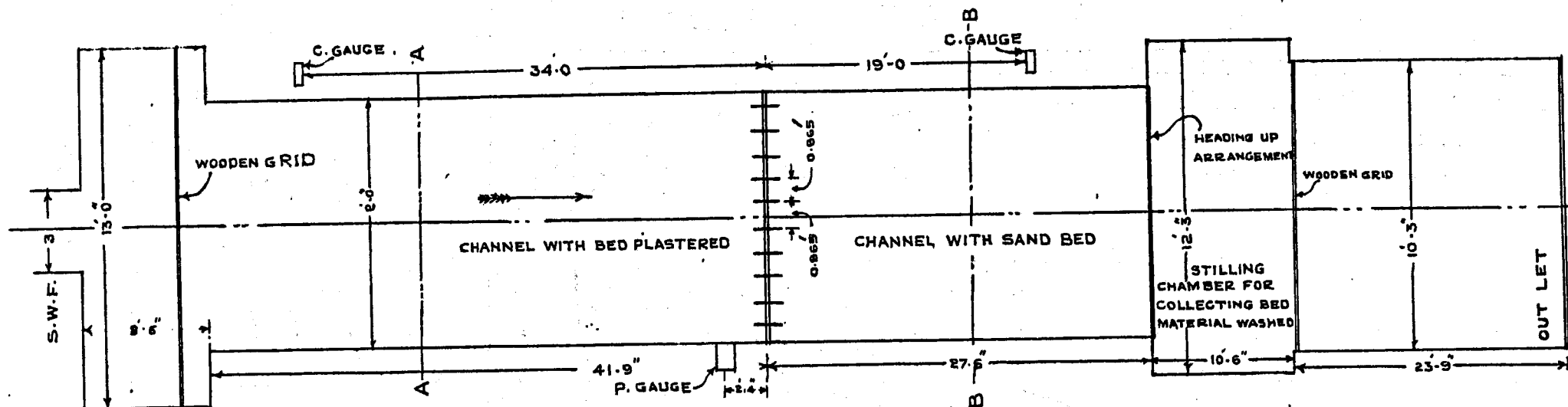

SECTION ON A A

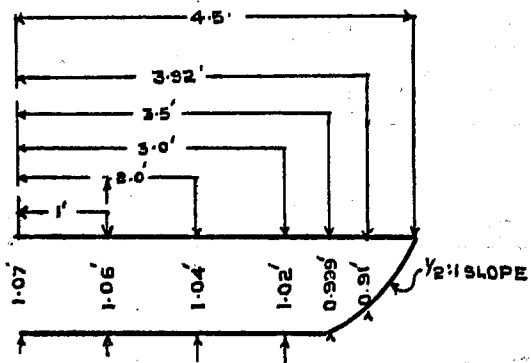

BRIDGE PIER

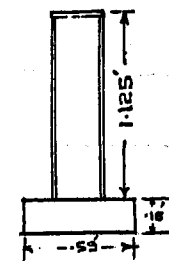

ELEVATION

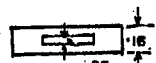

PLAN

SECTION ON B B

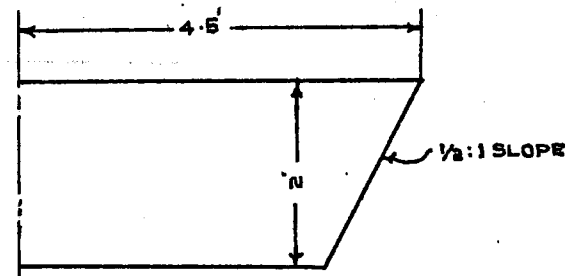

FIG. 79

**SCOUR D/S OF RIGID
 STRUCTURE IN A CHANNEL**

WITH SIDES HELD EXPT. No. 2 (V SAND)

SCALE = 1" = 2'

CONTOUR DEPTHS ARE GIVEN BELOW. WATER
 LEVEL IN FEET.

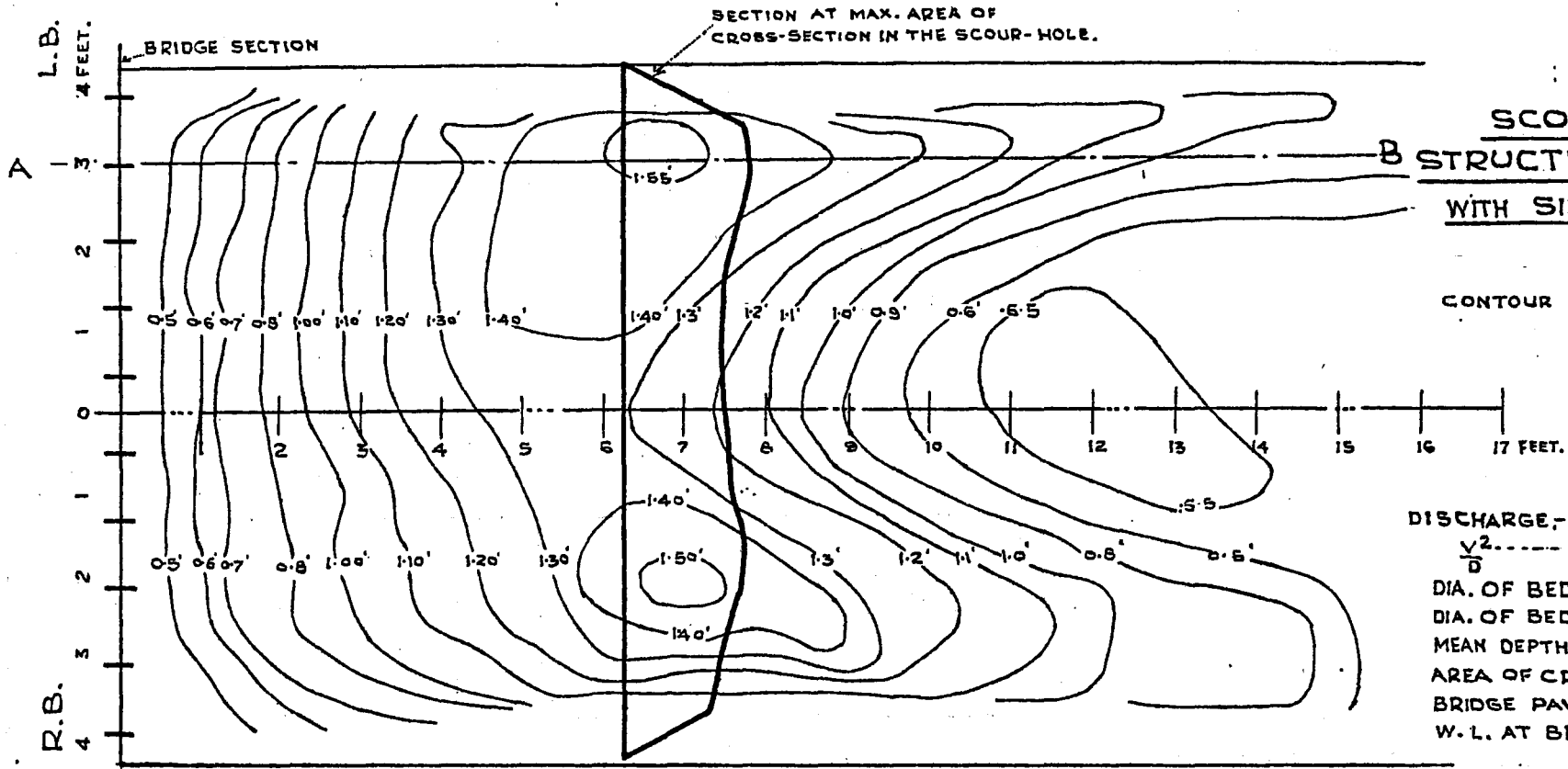

DISCHARGE	-----	6 CUSECS.
$\frac{V^2}{D}$	-----	27.7
DIA. OF BED SAND AS LAID	mm.-----	0.3
DIA. OF BED SAND AFTER EXPERIMENT	mm.-----	0.42
MEAN DEPTH OF SCOUR AT MAX.	}-----	1.325
AREA OF CROSS SECTION, FT.		
BRIDGE PAVEMENT LEVEL	-----	109.728
W. L. AT BRIDGE	-----	110.004

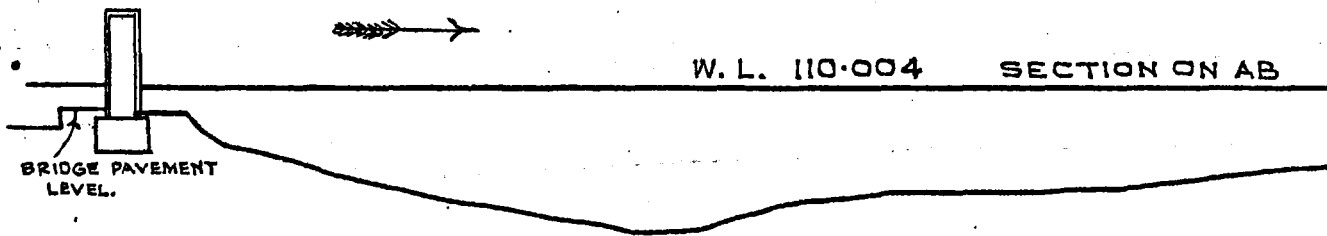

FIG. 80.

SCOUR $D/5$ OF RIGID
STRUCTURE IN A CHANNEL WITH
SIDES HELD. EXPT. NO. 3. (V SAND)
SCALE: 1" = 2'

CONTOUR DEPTHS ARE GIVEN BELOW.
WATER LEVEL IN FEET.

DISCHARGE ----- 6 CUBICS.

$\frac{V^2}{D}$ ----- 7.3

DIA. OF BED SAND AS LAID, m.m. --- 0.3

DIA. OF BED SAND AFTER EXPERIMENT, m.m. 0.36

MEAN DEPTH OF SCOUR AT MAX. } --- 0.94

AREA OF CROSS SECTION, FT. ² }

BRIDGE PAVEMENT LEVEL. ----- 109.56

W. L. AT BRIDGE. ----- 110.004

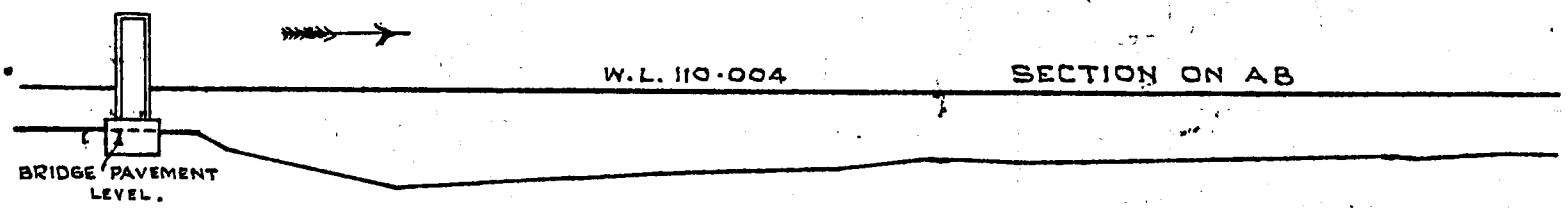
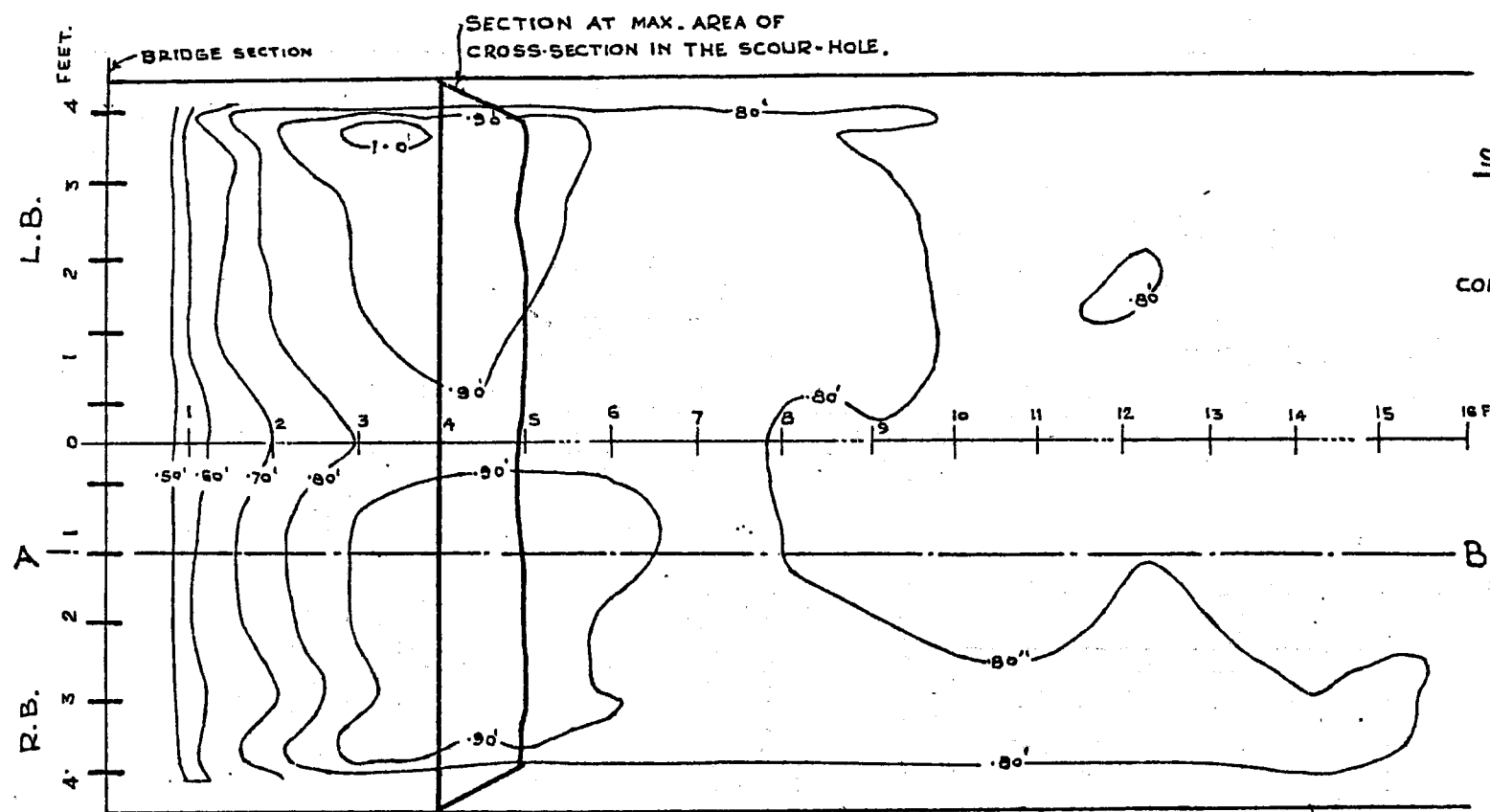

BHINGARE.

EXPERIMENT 2. (V SAND)

C.S. 6' 3" D/S OF BRIDGE NEAR LEFT BANK $m = .432$ m.m. +
 " " " " RIGHT BANK $m = .4$ m.m. O
 $Q = 6.0$ Cs. $q = .72$ Cs/F \bar{x}
 $v^2/d = 27.7$

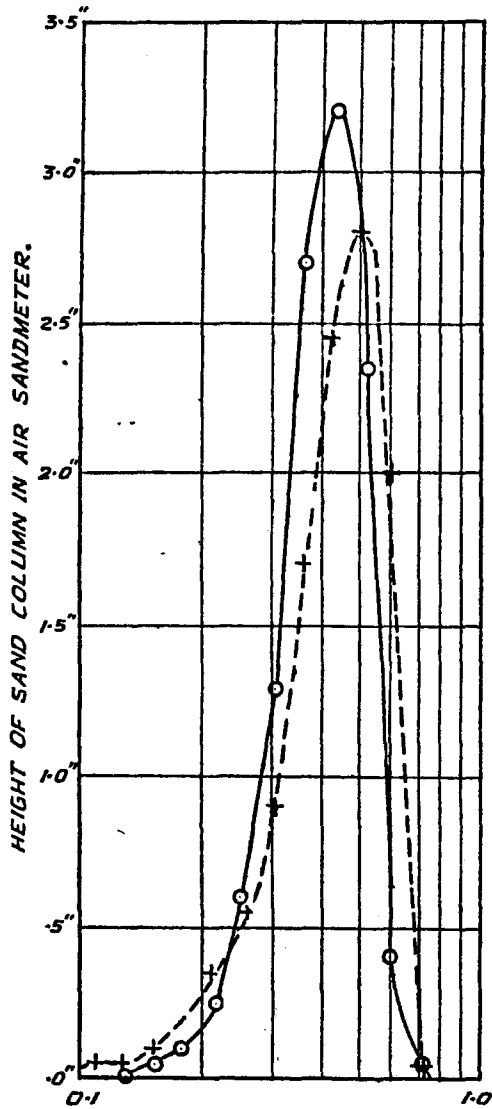

EXPERIMENT 3. (V SAND)

AT C.S. 4' NEAR RIGHT BANK $m = .36$ m.m. +
 " " " " LEFT BANK $m = .355$ m.m. O
 $Q = 6.0$ Cs. $q = .72$ Cs/F \bar{x}
 $v^2/d = 7.3$

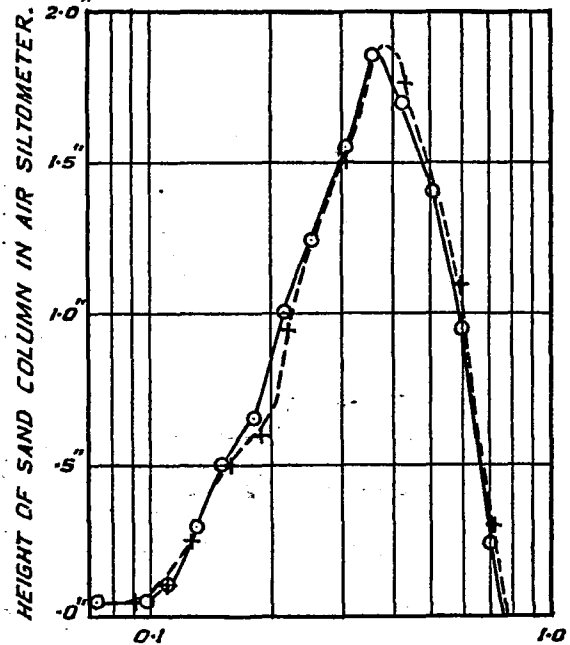

GRAIN SIZE IN MILLIMETERS C.B.I. CLASSIFICATION.

EXPERIMENT 5. (V SAND)

AT C.S. 2' NEAR RIGHT BANK $m = .33$ m.m. +
 " " " " LEFT BANK $m = .315$ m.m. O
 $Q = 6.0$ Cs. $q = .72$ Cs/F \bar{x}
 $v^2/d = 2.92$

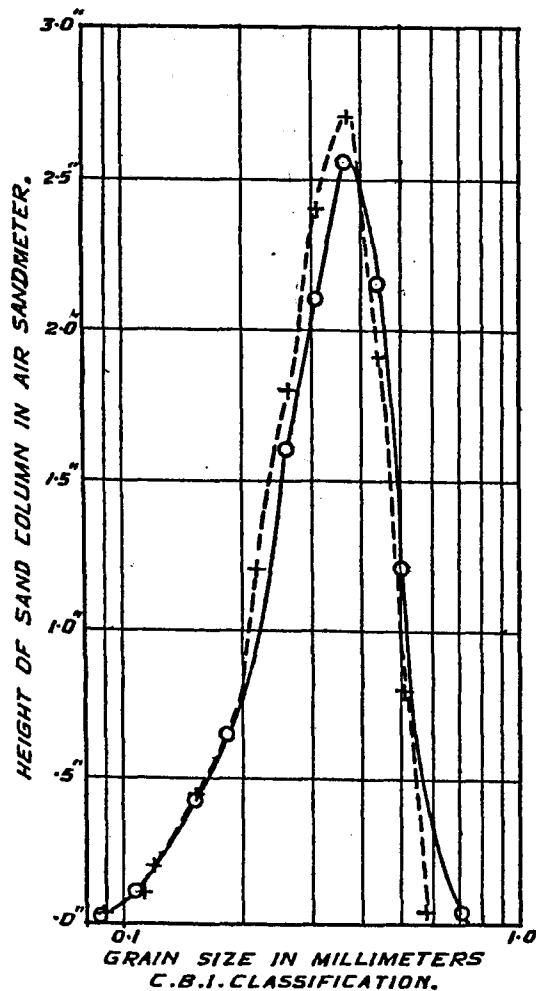

FIG. 82.
 SIZE DISTRIBUTION CURVES
 (BY AIR SAND - METER)
 OF SAND IN SCOUR-HOLES D/S OF
 THE BRIDGE IN A CHANNEL WITH
 HELD SIDES.

TABLE 14

Scour downstream of 'rigid structures' in a channel with sides held.

	Expt. No.	Q Total discharge in cusecs	q discharge per foot at Bridge section in cs.ft.	d depth of water at Bridge section in ft.	V (ft/sec.) at Bridge section	V ² /d at Bridge section	m' mean dia. of sand in mm. after expt.	f (=1.76√m)	1.32 f = $\frac{V}{V_c} \cdot \frac{V_c^2}{R_L}$	Lacey's depth $\frac{Q^2/S}{R_L} = 0.9 \frac{Q^2/S}{f^{1/3}}$	Absolute maximum depth of scour = [d _s (max.)]	d _s mean depth in ft. at the max. area of cross section in the scour-hole.	Absolute max. depth / d _s = Col. 12/Col. 13	V ² /d V _c ³ /R _L = Col. 7/Col. 10.	d _s /R _L = col. 13 / col. 11	d _s (max) / R _L = col. 12 / col. 11
1	2	3	4	5	6	7	8	9	10	11	12	13	14	15	16	17
Series No. I with V sand 0.8 mm. dia. initially.	1	6.00	0.72	0.376	2.08	11.4	0.38	1.085	1.435	0.7	1.24	1.13	1.1	7.95	1.614	1.77
	2	6.00	0.72	0.276	2.77	27.7	0.42	1.045	1.51	0.694	1.56	1.325	1.18	18.3	1.91	2.25
	3	6.00	0.72	0.444	1.81	7.3	0.36	1.018	1.395	0.71	1.05	0.94	1.11	5.23	1.325	1.48
	4	6.00	0.72	0.500	1.64	5.4	0.34	1.01	1.35	0.72	1.02	0.88	1.16	4.00	1.22	1.42
	5	6.00	0.72	0.59	1.31	2.92	0.32	1.00	1.32	0.724	0.85	0.82	1.04	2.21	1.13	1.17
Series No. II with Londha sand Mean dia 0.8 mm. initially.	6	6.0	0.72	0.376	2.08	11.4	0.32	1.00	1.32	0.724	1.45	1.15	1.26	8.6	1.59	2.00
	7	6.0	0.72	0.349	2.27	15.2	0.32	1.00	1.32	0.724	1.67	1.30	1.28	11.5	1.80	2.31
Series No. III with Londha sand 0.8 mm. mean dia. initially and increased discharge	8	8.7	1.05	0.8	1.37	2.35	0.32	1.00	1.32	0.927	1.27	1.09	1.16	1.78	1.175	1.37
	9	8.7	1.05	0.7	1.575	3.54	0.32	1.00	1.32	0.927	1.36	1.16	1.17	2.68	1.25	1.47
	10	8.7	1.05	0.63	1.74	4.8	0.32	1.00	1.32	0.927	1.47	1.255	1.08	3.64	1.35	1.59
	11	8.7	1.05	0.59	1.885	6.00	0.32	1.00	1.32	0.927	1.79	1.325	1.35	4.55	1.43	1.93
Series No. IV with Londha sand. Mean dia. 0.8 mm. initially and increased discharge	12	8.7	1.05	0.55	2.03	7.51	0.32	1.00	1.32	0.927	1.97	1.35	1.45	5.67	1.46	2.125
	13	10.5	1.265	0.8	1.65	3.4	0.32	1.00	1.32	1.05	1.53	1.36	1.13	2.58	1.30	1.46
14	10.5	1.265	0.7	1.895	5.1	0.32	1.00	1.00	1.32	1.05	1.66	1.45	1.14	3.86	1.38	1.58

PART IV

$$\text{Now } P_w = 2.67 \sqrt{Q}$$

$$\therefore q = Q/P_w = \sqrt{Q}/2.67$$

$$\therefore Q = (2.67 q)^2$$

Substituting this value of Q in equation (3),

$$\begin{aligned} R_L &= 0.7305 \frac{(2.67)^{2/3}}{(3.8 f)^{1/3}} q^{2/3} \\ &= 0.9 \frac{q^{2/3}}{f^{1/3}} \quad \dots (4) \end{aligned}$$

giving Lacey's regime depth in terms of q and f .
the ratio

$$\frac{d_s}{R_L} = \frac{\text{Mean depth of maximum section of scour-hole}}{0.9 q^{2/3} / f^{1/3}}$$

for each observation has been worked out to give a measure of the divergence from Lacey's stable depth in a wide channel.

$$\text{From equation } V_o = 1.15 \sqrt{f R_L}$$

$$V_o^2 / R_L = 1.32 f$$

V^2/gd (Froude's number) is one criterion of turbulence; and V_o^2/gR_L is the equivalent Froude's number for Lacey's regime flow; thus V_o^2/R_L is the analogous Lacey's criterion.

The ratio $\frac{V^2/d \text{ at Bridge section}}{V_o^2/R_L \text{ for particular sand dia.}}$

would, therefore, be a measure of the *divergence* from Lacey's turbulence criterion.

Table 14 Table No. 14 gives the values of $V^2/d/V_o^2/R_L$ and d_s/R_L for all experiments.

Fig. 83 (a) Fig. 83(a) shows the relationship between $V^2/d/V_o^2/R_L$ and d_s/R_L in the first five experiments with V sand.

Fig. 83 (b) Fig. 83(b) shows a similar relationship in experiments No. 6 to 14 for Londha sand.

For V sand,

$$d_s/R_L = 0.88 (V^2/d/V_o^2/R_L)^{0.27} \quad \dots \quad \dots \quad \dots (5)$$

and for Londha sand,

$$d_s/R_L = 1.03 [V^2/d/V_o^2/R_L]^{0.21} \quad \dots \quad \dots \quad \dots (6)$$

Fig. 83 (a) & (b) These relations are shown in full lines in fig 83 (a) & (b).

When $V^2/d/V_o^2/R_L = 1$, d_s/R_L should be equal to 1, and then, the constant for the equations should be unity.

The set of equations obtained by making the constants equal to unity are as under :—

For V sand

$$d_s/R_L = [V^2/d/V_o^2/R_L]^{0.21} \quad \dots \quad \dots \quad \dots (7)$$

and for Londha sand,

$$d_s/R_L = [V^2/d/V_o^2/R_L]^{0.23} \quad \dots \quad \dots \quad \dots (8)$$

FIG. 83.

SCOUR D/S OF RIGID STRUCTURE IN
A CHANNEL WITH SIDES HELD.

REFERENCES:-

- O SERIES I EXPT. NOS. 1 TO 5. 6.0 Cs. 'V' SAND.
- Δ SERIES II " " 6 TO 10. 8.7 Cs. LONDHA SAND.
- x SERIES III " " 11 TO 12. 10.5 Cs. " "
- SERIES IV " " 13 TO 14. 6.0 Cs. " "

d_s MEAN DEPTH AT MAX. AREA OF C.S.
IN THE SCOUR-HOLE.

R_L LACEY'S REGIME DEPTH $(= \frac{0.9 q^{2/3}}{f^{1/3}})$

$\frac{V^2}{d}$ AT THE BRIDGE SECTION.

$\frac{V_0^2}{R_L}$ FOR LACEY'S DEPTH OF FLOW R_L .

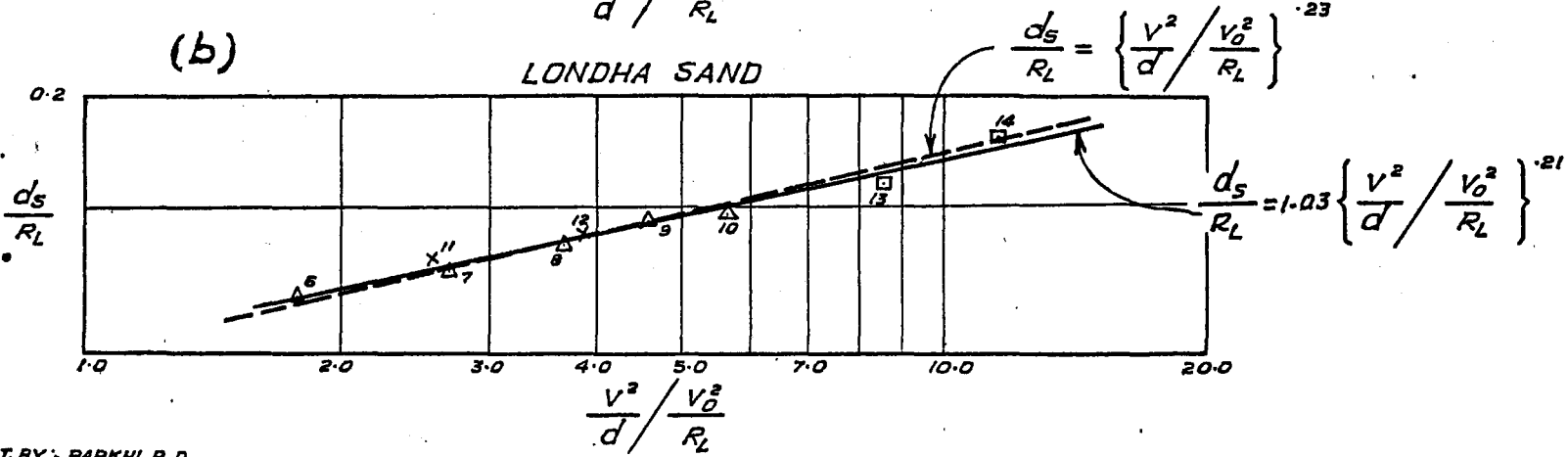
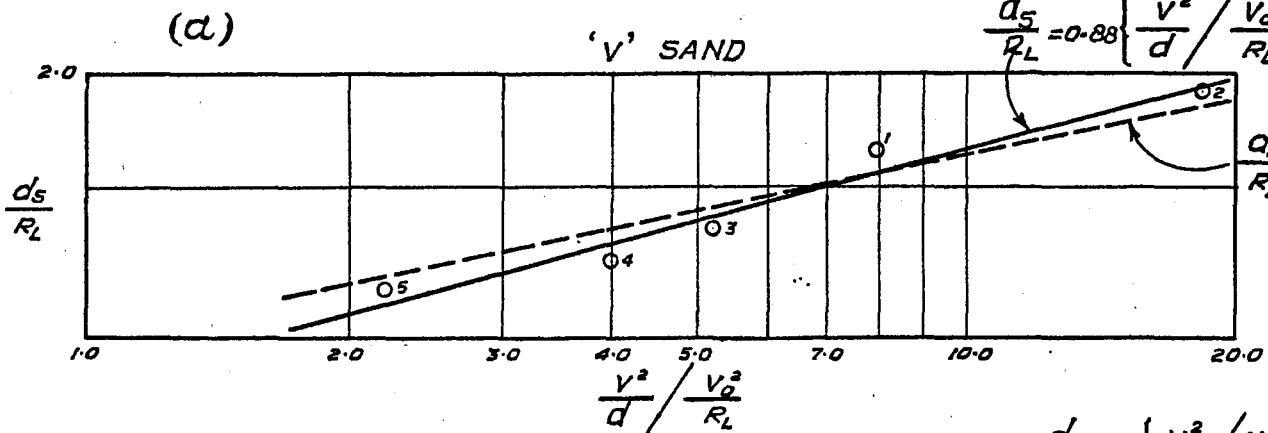

These relations are shown in dashed lines in the same figures. Results for Londha sand seem to be more satisfactory.

Thus $d_s/R_L = [V^2/d/V_o^2/R_L]^n$ is the *general* equation ... (9)

$$\therefore d_s = R_L (V^2/d)^n / (V_o^2/R_L)^n$$

But $R_L = 0.9 (q^{2/3}/f^{1/3})$ and $V_o^2/R_L = 1.32 f$

Substituting these in (9)

$$\begin{aligned} d_s &= 0.9 \frac{q^{2/3}}{f^{1/3}} \times (V^2/d/1.32 f)^n \\ &= \frac{0.9}{1.32^n} \times \frac{q^{2/3}}{f^{1/3} \times f^n} \times [V^2/d]^n \end{aligned}$$

Now $V = q/d$

$$\therefore V^2 = q^2/d^3$$

Substituting for V^2

$$d_s = 0.9/1.32^n \times q^{2/3}/f^{1/3} \times f^n \times (q^2/d^3)^n \quad \dots \quad \dots \quad (10)$$

Substituting $n = 0.23$, obtained for Londha sand in equation (10)

$$d_s = 0.545 \times \frac{q^{1.13}}{f^{0.56} \times d^{0.69}} \quad \dots \quad \dots \quad \dots \quad (11)$$

for Londha sand; and generally, for any sand—

$d_s = C \cdot q^a f^{-b} d^{-c}$, where a , b and c are indices depending on the grade and distribution of sand.

Equation (11) agrees in form with the type of equation suggested by Sir Claude Inglis $d_s = C q^m (V^2/d)^n$. Instead of the constant C depending upon the type of bed material, a separate silt factor has been introduced in equation (11).

This is suggested merely as a *tentative* relationship and the effect of f has yet to be found out by using different grades of sand; and later, if necessary, using the same grade but different distributions of sand particles, if distribution is found to affect the issue.

8. Assumptions made in the Analysis.

The following assumptions have been made in the above analysis:—

1. There should be forward flow only with no component of velocity at right angles to the axis of flow.

2. The channel is of infinite width, any boundary effect being absent. (As stated above, see para 5, this is proved unjustified and further experiments are contemplated with a channel of double the width). Further experiments are in progress.

RIVER CONTROL

(V) "FLOOD CONTROL".

17. Siphon Spillways : Ganesh Iyer's Volute Siphon— Factors affecting the Coefficient of discharge of—

Depth of floor below crest of bellmouth of siphon and clear space required between the domes of adjacent siphons.

1. Introduction and object of experiments :

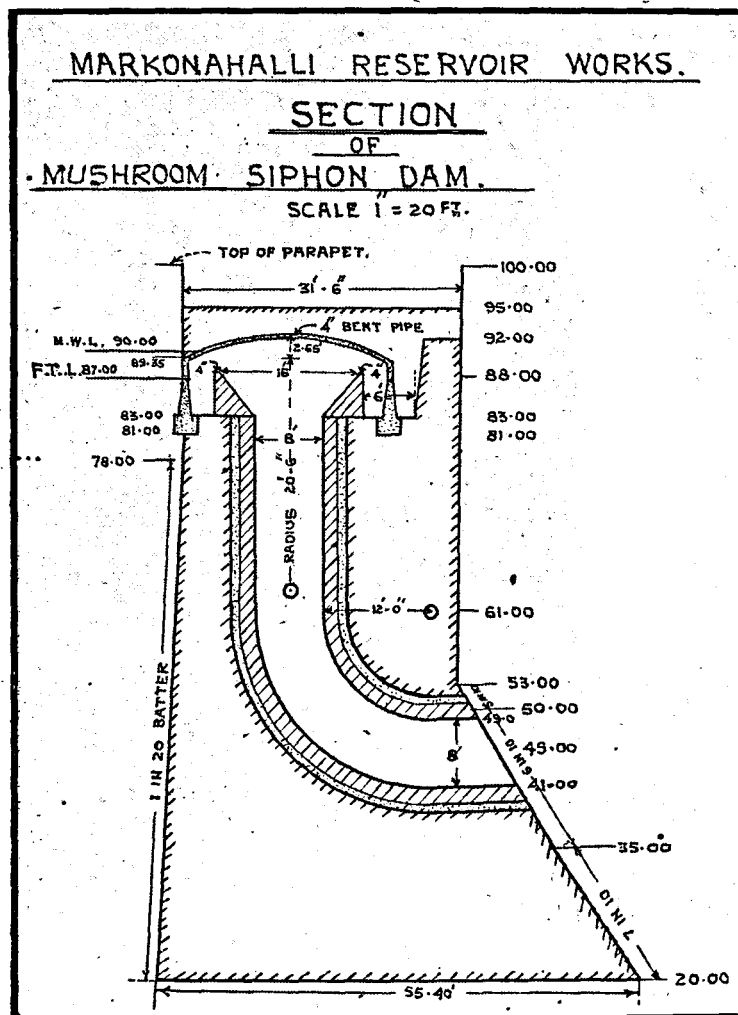

Fig. 84.

Experiments with 1/16th scale, geometrically-similar model of volute siphons at Markonahally designed by Mr. Ganesh Iyer were carried out at the Poona Station⁽¹⁾

Fig. 84 In the volute siphon design at Markonahally (see Fig. No. 84) the floor is

(1) Results given in Annual Report (Tech.) for 1942-43, pp. 27-29.

5 ft. below the crest of bellmouth and the wall on the rear side of the siphon was 2.5 ft. from the outer side of the dome. Due to the high floor level and small water way between the dome and the wall a high velocity of approach developed when the siphon was running full, and resulted in suction of air below the rim of the dome. Lowering of the floor level in model from $\cong 5.0'$ to $\cong 10.0'$ below crest of the bellmouth resulted in higher coefficient of discharge, and smoother flow conditions near the siphon. It was anticipated that with a bigger depth of flow near the siphon (floor $\cong 10'$ below crest) the clear space required between the domes of adjacent siphons could be reduced. Thus the experiments aimed at determining the extent of mutual interference between adjacent siphons and the reduction of the interference by lowering the floor level and/or increasing the depth of entrance below the water level.

2. Experiments :

Three series of experiments were done with two 1/16 scale Geometrically-similar models of Markonahally volute siphons. The clear space between the domes of the two siphons was kept $\cong 5.0'$, see fig. 85. The following alternatives were tested in each series:— Fig. 85

Series I; Series II; Series III

(1) Depth of floor below crest of bellmouth	$\cong 5'$	$\cong 10'$	$\cong 10'$
(2) Level of lower rim of dome below crest of bellmouth	$\cong 1.5'$	$\cong 1.5'$	$\cong 6.5'$
(3) Depth of flow at entrance to the dome	$\cong 3.5'$	$\cong 8.5'$	$\cong 3.5'$

3. Series I

The two siphons were first run separately and then both together. Tables 15 and 16 show the depth upstream over crest of siphon and coefficients of discharge and corresponding discharges obtained with A and B siphon respectively. Tables 15
& 16
Table 17 shows results obtained when both A and B were discharging. The depth: discharge and depth: coefficient curves are plotted in Fig. 86 (a & b). Table 17
Fig. 86
(a) & (b)
In the depth to discharge curve, the mean discharge of siphons A and B is plotted against mean depth upstream when both the siphons were discharging in combination for comparison with the individual discharge when only one was discharging at a time.

TABLE 15

Discharge coefficient of siphon A

S. No.	D Mean depth of water over sill of bellmouth in ft.	Q Discharge through siphon in cusecs	C = coefficient of discharge in $= \frac{Q}{A \sqrt{2gH}}$	Remarks	
1	.178	2.082	.770	Siphon A discharging only. Series I.	
2	.176	2.082	.771		
3	.1745	2.073	.768		
4	Expt. vitiated	—	—	h = difference in sill of bellmouth and centre of outlet of siphon = 2.72 ft.	
5	.099	2.012	.763		
6	.078	1.985	.755		
7	.071	1.985	.756		
8	.071	1.977	.753	A = Area of cross section in sq. ft. of tubular section of the siphon = .1964	
9	.062	1.969	.751		
10	.057	1.936	.756		
11	.056	1.927	.736		
12	.054	1.894	.724		
13	.052	1.886	.721		
14	.047	1.845	—		
15	.046	1.861	.712		
16	.044	1.771	.678		H = h + D
17	.041	1.788	.685		
18	.036	1.712	.657		
19	.082	1.724	.661		
20	.082	1.716	.659		

TABLE 16

Discharge coefficient of siphon B

S. No.	D Mean depth of water over sill of bellmouth in ft.	Q Discharge through siphon in cusecs	C = coefficient of discharge in $= \frac{Q}{A \sqrt{2gH}}$	Remarks
1	.327	2.200	.804	Siphon B only working. Series I.
2	.323	2.199	.804	
3	.318	2.196	.804	
4	.206	2.126	.793	h = 2.705 ft.
5	.200	2.118	.791	
6	.160	2.048	.770	A = .1964 sq. ft.
7	.121	2.036	.771	
8	Expt. vitiated	—	—	H = h + D
9	.050	1.944	.754	
10	.046	1.936	.743	
11	.043	1.882	.723	
12	.039	1.873	.722	
13	.049	1.845	.708	
14	.045	1.837	.705	
15	.049	1.833	.703	
16	.049	1.820	.698	
17	.048	1.804	.692	

FIG:- 85.

1/16TH SCALE MODEL OF VOLUTE SIPHON.

SHOWING PLAN & SECTION.

Scale:- 1" = 10' = 16'.

PLAN.

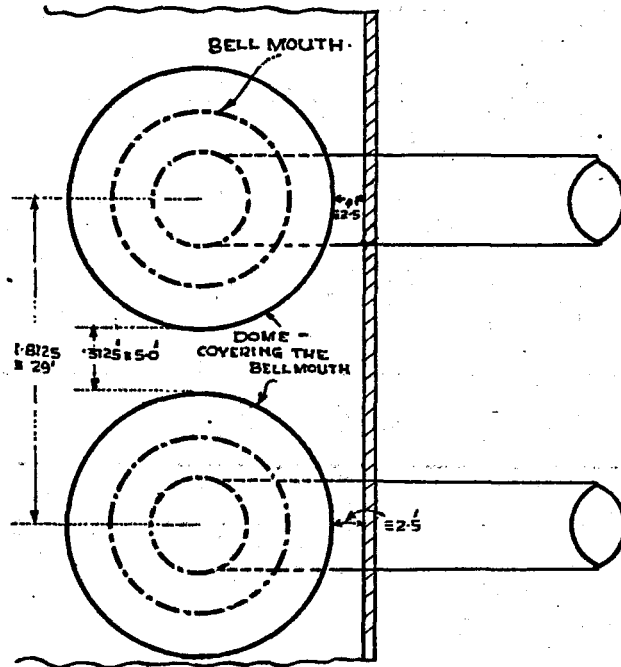

SECTION THROUGH THE SIPHON.

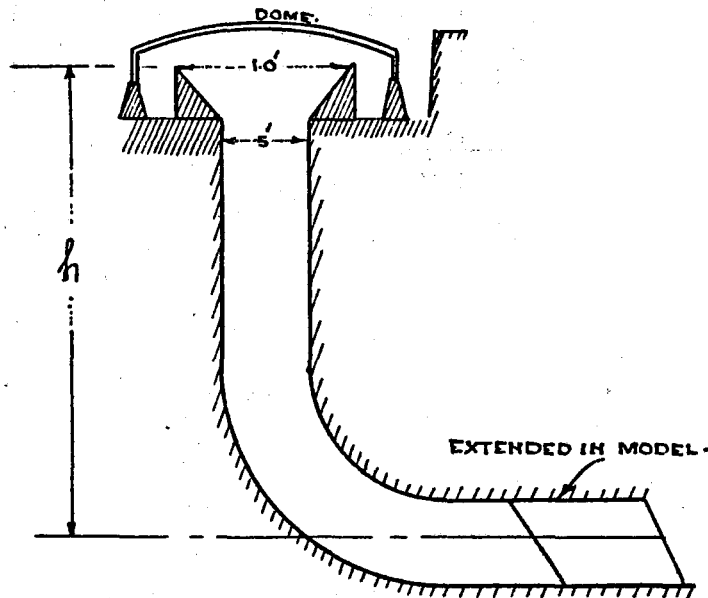

FIG. 86.

1/6 SCALE VOLUTE SIPHON
EFFECT OF INTERFERENCE.

REFERENCES.

- SIPHON A.
 - - -x- - - SIPHON B.
 - - -△- - - SIPHON A AND B.
- CLEAR SPACE BETWEEN
A & B SIPHONS $\approx 5.0'$
FLOOR LEVEL BELOW
CREST OF BELLMOUTH $\approx 5'$

(a) D:Q CURVE.

D = DEPTH U/S, OVER CREST OF BELLMOUTH OF SIPHON IN FEET.

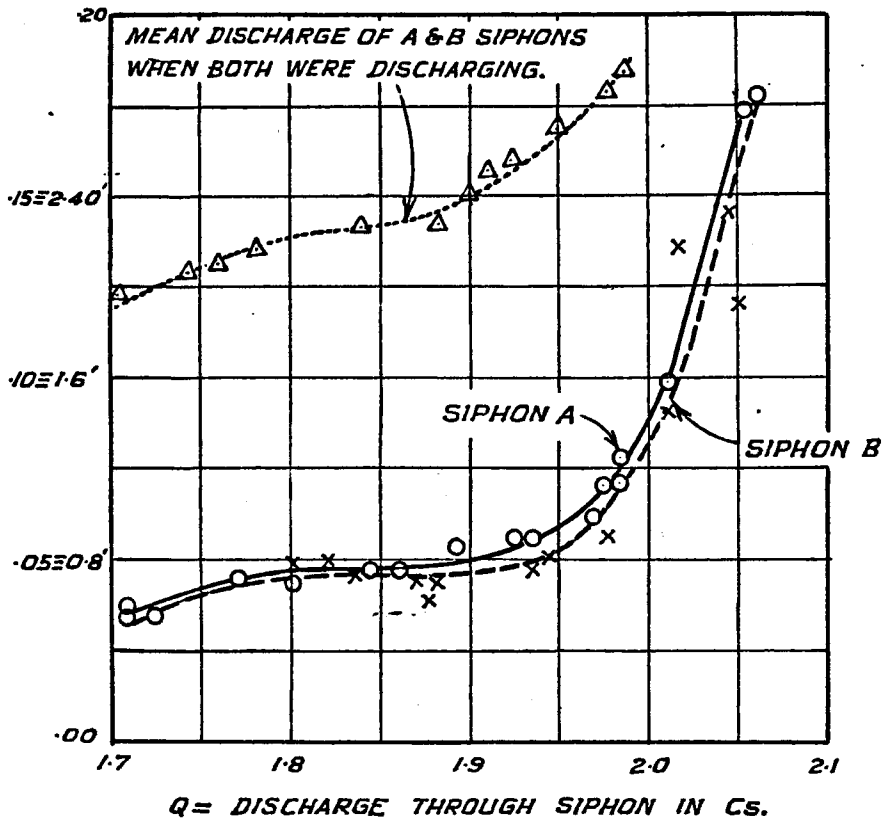

(b) D:C CURVE.

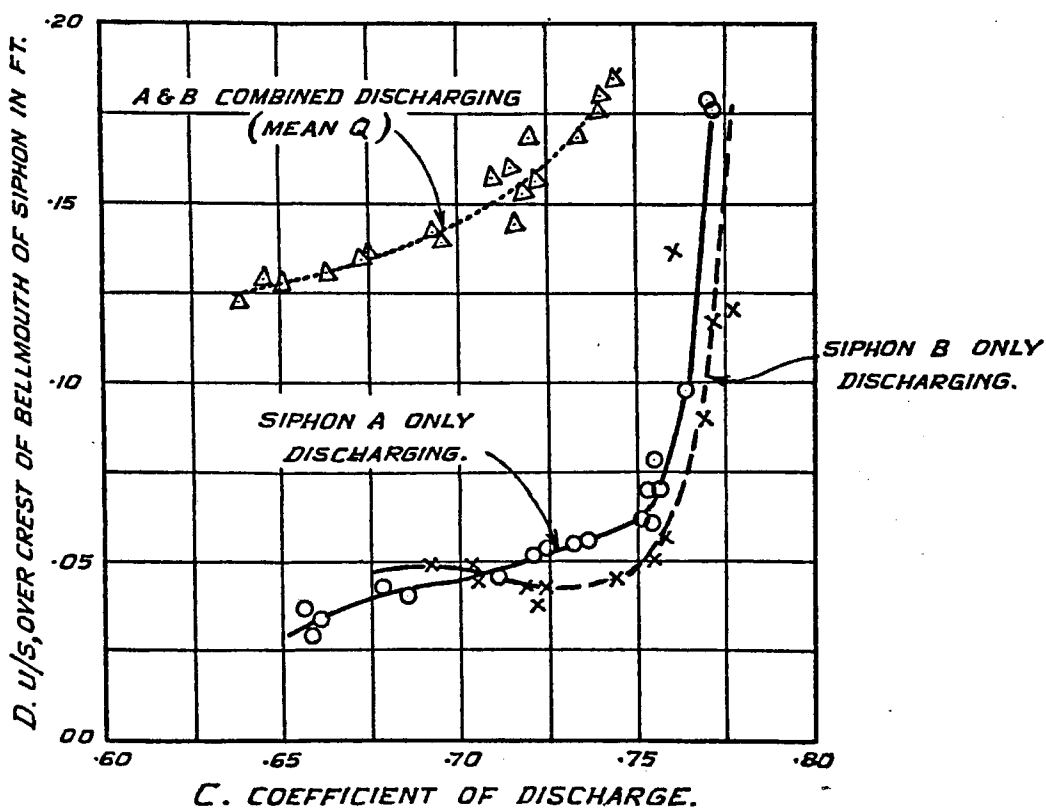

TABLE 17

Discharge coefficients of A & B siphon both discharging simultaneously.

S. No.	D mean depth of water over sill of bellmouth	Q discharge through the siphons in cusecs	C Coefficient of discharge $= \frac{Q}{A\sqrt{2gH}}$	Remarks
1	.1845	3.978	.743	Both siphons A & B discharging. Series I. h = mean difference in siphons A & B in sill of bellmouth and centre of outlet of siphons = 2.713 ft. A = Total Area of C. S. in sq. ft. of tubular section of siphons A and B. = .1964 + .1964 = .3928 sq. ft. H = h + D.
2	.1795	3.958	.740	
3	.177	3.958	.741	
4	.177	3.946	.739	
5	.169	3.894	.720	
6	.168	3.909	.733	
7	.169	3.889	.720	
8	.160	3.858	0.714	
9	.161	3.841	.728	
10	.157	3.841	.708	
11	.157	3.821	.718	
12	.156	3.846	.723	
13	.154	3.827	.719	
14	.150	3.799	.714	
15	.148	3.802	.715	
16	.142	3.680	.693	
17	.141	3.635	.694	
18	.187	3.582	.675	
19	.186	3.567	.673	
20	.131	3.531	.663	
21	.1295	2.469	.647	
22	.128	3.490	.650	
23	.122	3.423	.639	
24	.121	3.404	.635	

Table 18 shows the depths, coefficients and discharges obtained.

TABLE 18

Floor level \equiv 5.0 ft; clear space \equiv 5.0 ft; level of rim below crest of bellmouth \equiv 1.5 ft.

Depth of water u/s over crest in ft.	Discharge through siphon A in cs.	Discharge through siphon B in cs.	mean discharge when both A and B were running in cs.	C_A coefficient of discharge siphon A.	C_B coefficient of discharge siphon B.	C_{AB} for both siphons A and B.
.05' \equiv 0.80'	1.900	1.940	not observed	.720	.750	—
.10' \equiv 1.60'	2.010	2.015	1.600	.765	.770	.600
.125' \equiv 2.00'	2.027	2.034	1.725	.768	.772	.645
.15' \equiv 2.40'	2.040	2.047	1.900	.770	.774	.710
.175' \equiv 2.80'	2.055	2.062	1.965	.771	.776	.737

At 2 ft. upstream depth, i. e. at H.F.L., the coefficient of each siphon discharging singly was 0.77; while with both running together, the coefficient dropped to .65; i. e., as a result of interference, a reduction in discharge of 17.0 per cent was observed. On the other hand, with D upstream \equiv 2.8 ft., a reduction of discharge of only 4.57 per cent was observed. Apparently, with increase in depth of water the quantity of air sucked below the dome decreased and hence the discharging capacity of the siphons improved. It was, thus, clear that increasing the depth of flow would improve the coefficient.

4. Series II.

In this series, the level of the floor was lowered from \equiv 5' to \equiv 10'. Tables 19 to 21 show the depths and coefficients obtained with various discharges. With the lowered floor, the velocity of approach reduced and the flow through the siphon improved, both when the siphons were running separately or together. The D : Q and D : C curves obtained are plotted in Fig. 87 (a) and (b) Table & (b) No. 19 shows the results obtained.

TABLE 19

Discharge coefficient of siphon A.

S. No.	D = Mean depth of water over sill of bellmouth in ft.	Q discharge through siphon in cusecs.	$C = \frac{Q}{A \sqrt{2gH}}$	Remarks.
Series II				
1	.29	2.187	.8024	Siphon A only discharging. h = difference in crest of bellmouth and centre of the outlet of siphon in ft. H = total head over the siphon in ft. = h + D. A = Area of O.S. of outlet in sq. ft. = .1964.
2	.308	2.183	.7986	
3	.088	2.170	.8243	
4	.234	2.139	.7921	
5	.2225	2.139	.7936	
6	.224	2.131	.8091	
7	.148	2.100	.7893	
8	.0845	2.096	.7966	
9	.0915	2.058	.7848	
10	Expt. vitiated	—	—	
11	.0985	2.058	.7784	
12	.039	2.049	.7850	
13	.1535	.2046	.7681	
14	.030	2.015	.7784	
15	.001	1.994	.7693	

FIG. 87.

1/16 SCALE VOLUTE SIPHON
EFFECT OF INTERFERENCE.

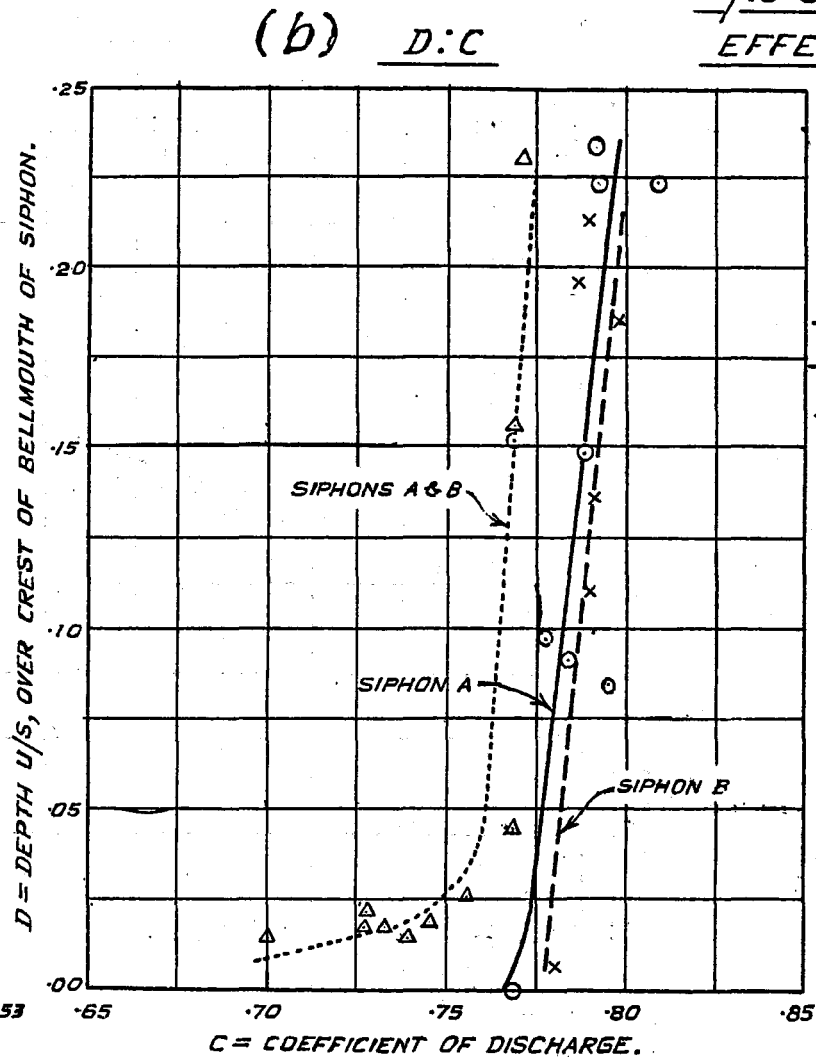
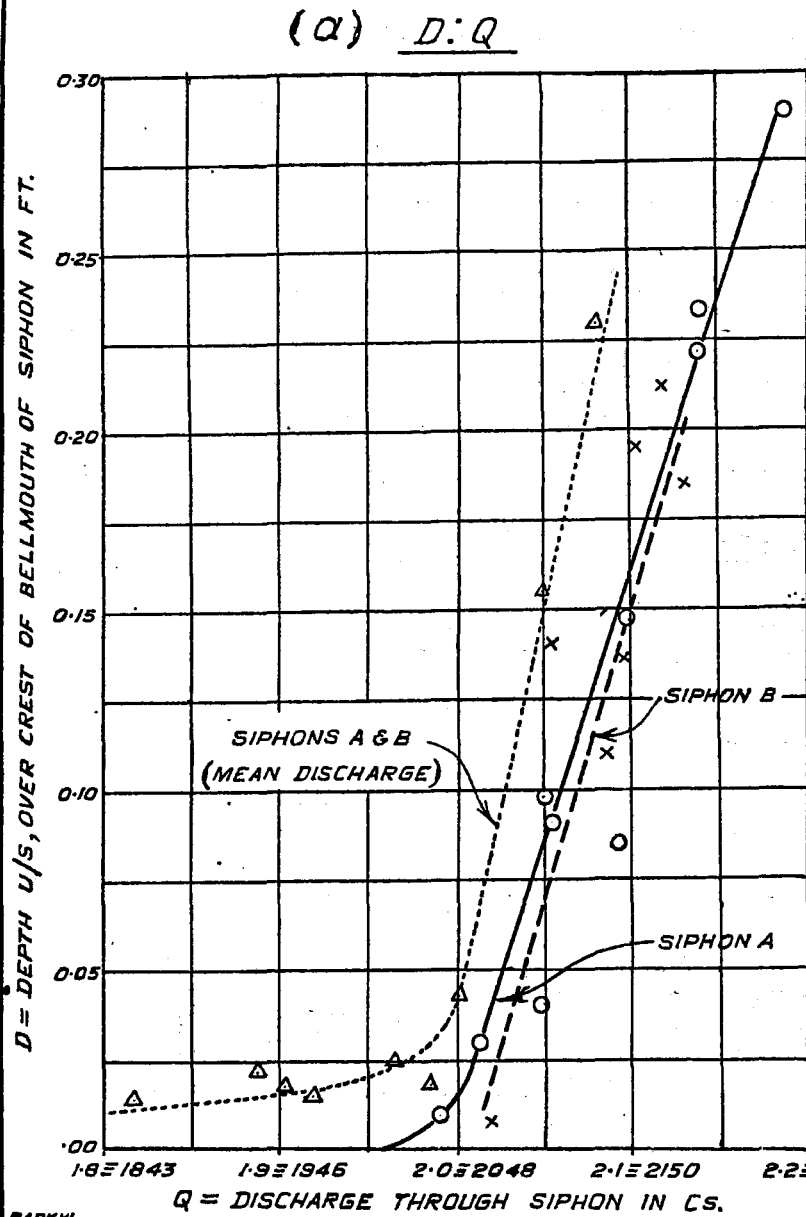

REFERENCES.

- SIPHON A.
 - ×—SIPHON B.
 - △—SIPHON A & B.
- CLEAR SPACE BETWEEN
 DOMES OF A & B SIPHONS = 5'-0".
 FLOOR LEVEL BELOW
 CREST OF BELLMOUTH = 10'.

FIG. 88.
1/16 SCALE VOLUTE SIPHON
EFFECT OF INTERFERENCE

REFERENCE :-

- O — SIPHON A
- X — SIPHON B
- Δ — SIPHON A+B

CLEAR SPACE BETWEEN DOMES OF A+B SIPHONS $\approx 5.0'$
FLOOR LEVEL BELOW CREST OF BELLMOUTH $\approx 10'$
RIM OF THE DOME LOWERED FROM $\approx 1.5'$ TO $\approx 6.5'$ BELOW CREST
(ENTRANCE DEPRESSED)

(a) D:Q CURVE

(b) D:C CURVE

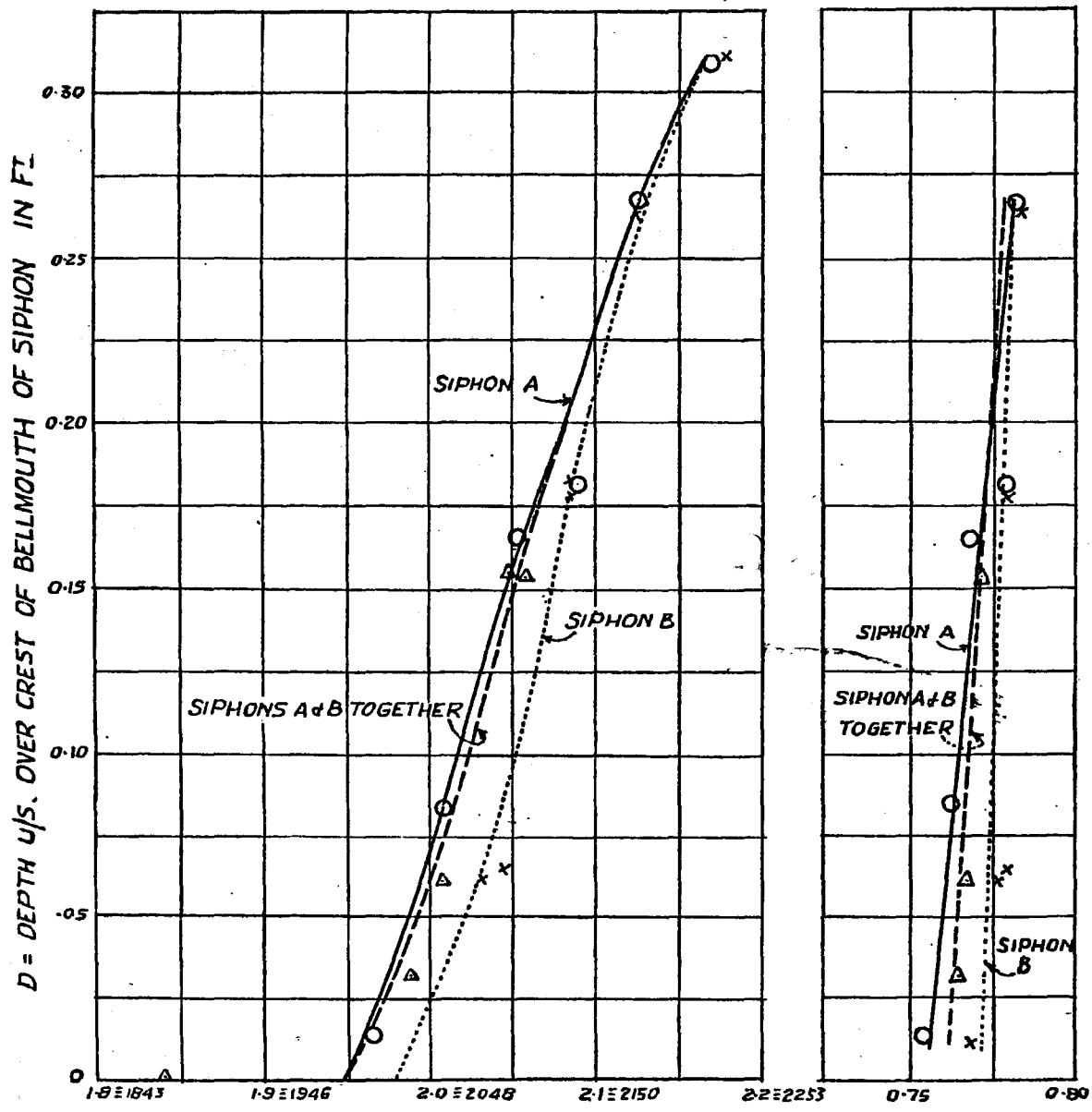

DISCHARGE THROUGH THE SIPHON IN CUSECS.

C = COEFFICIENT OF DISCHARGE.

By: TATOO, G. D.
16th JAN. 26.

FIG. 89

1/16 SCALE MODEL OF GANESH IYAR'S VOLUTE SIPHON
AT

MARKONHALLY (MYSORE)

PRESSURES IN FT OF WATER

WITH RESPECT TO ATMOSPHERIC PRESSURE.

DEPTH OF WATER U/S = 0.125 = 2.0'

HORIZONTAL PIPE EXTENDED IN MODEL BY 9" = 12'

SCALE = 1" = 0.5'

REFERENCES:-

- △ PRESSURE ON SIDE.
- " " U/S SIDE.
- × " " D/S SIDE.

PRESSURE SCALE = 1" = 1' = 16"

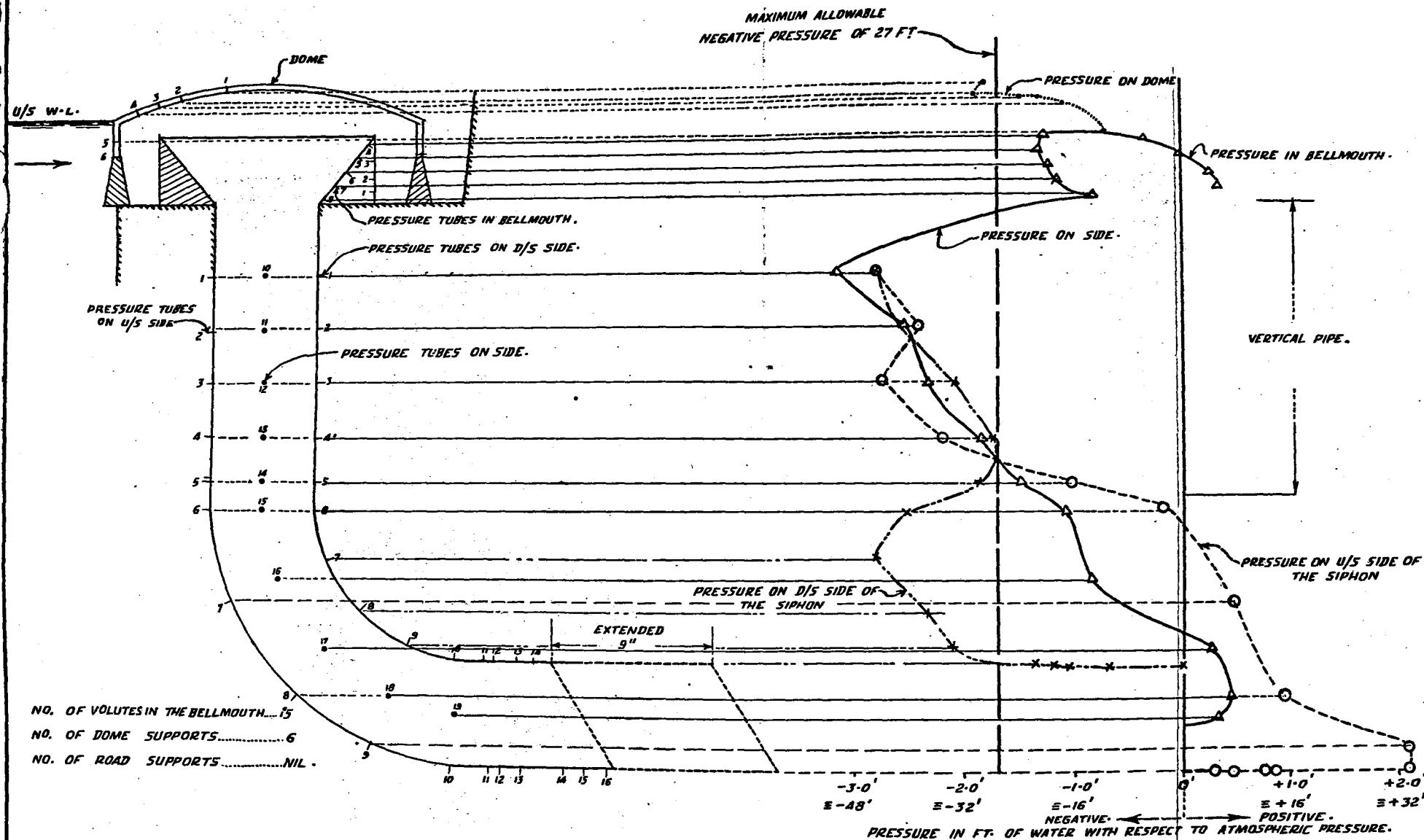

TABLE 20

Discharge coefficient of siphon B.

S. No.	D = Mean depth of water over sill of bellmouth in ft.	Q discharge through siphon in cusecs.	$C = \frac{Q}{A \sqrt{2gH}}$	Remarks
				Series II
1	.185	2.131	.7979	Siphon B discharging only.
2	.2125	2.118	.7894	
3	.195	2.102	.7859	
4	.1855	2.096	.7916	
5	.110	2.084	.7905	
6	.1415	2.054	.7739	
7	.007	2.02	.7807	

TABLE 21

Discharge coefficient of siphon A and B.

				Series III
1	.044	4.011	.7688	Siphons A & B discharging together.
2	.026	3.932	.7561	
3	.018	3.877	.7466	
4	.015	3.841	.7399	
5	.0175	3.810	.7366	
6	.0175	3.784	.7288	
7	.0215	3.778	.7269	
8	.0145	3.634	.7003	

TABLE 22

Floor level \equiv 10 ft; clear space \equiv 5.0 ft; Depth of rim below crest of bellmouth \equiv 1.5 ft.

Depth of water upstream over crest in ft.	Discharge through siphon A in cs.	Discharge through siphon B in cs.	Mean discharge when both A & B siphons were running in cs.	C_A coefficient of discharge of siphon A.	C_B coefficient of discharge of siphon B.	C_{AB} coefficient of discharge for both siphons A & B
.05 \equiv 0.8	2.020	2.040	2.000	.775	.782	.760
.10 \equiv 1.6	2.055	2.070	2.025	.782	.787	.765
.125 \equiv 2.0	2.071	2.085	2.038	.785	.789	.767
.15 \equiv 2.4	2.090	2.100	2.050	.787	.792	.768

As compared to results in series I (in which floor level was \equiv 5.0 ft. below the crest of bellmouth), the discharge of siphons A & B working separately increased by 3 per cent at depth upstream \equiv 2.0 ft. A much greater improvement was observed in the combined discharge, the percentage increase being 18.15 per cent, thus showing that the interference is reduced with increased depth of flow.

5. *Series III.*

In this series the floor level was kept \equiv 10' below the crest as in series II; but the lower rim of the dome was lowered by \equiv 6.5' thus reducing the depth of flow at entrance from 8.5 ft. to 3.5 ft. Table No. 23 shows the observed depth and coefficient with various discharges. These are plotted in Fig. 88 (a) & (b).

Table 23
Fig. 88 (a)
& (b)

TABLE 23

Floor level \equiv 10 ft; clear space \equiv 5 ft; Depth of rim below bellmouth = 6.5 ft.

Depth of water u/s over crest of siphon in ft.	Discharge through siphon A in cs.	Discharge through siphon B in cs.	Mean discharge when both A & B siphons were running in cs.	C_A Coefficient of discharge of siphon A.	C_B Coefficient of discharge of siphon B.	C_{AB} Coefficient of discharge for both siphons A & B
.05 \equiv 0.8	1.990	2.030	2.000	.762	.775	.767
.10 \equiv 1.6	2.025	2.050	2.030	.768	.777	.770
.125 \equiv 2.0	2.040	2.065	2.043	.770	.778	.772
.15 \equiv 2.4	2.056	2.074	2.060	.773	.780	.773
.175 \equiv 2.8	2.070	2.084	2.073	.775	.781	.775

As compared to the results with the higher rim level in series II, when running individually the discharge was slightly less, the average discharge (mean of siphons A and B running individually) of 2.079 cs. dropping to 2.053 cs. for $D \equiv 2$ ft. i.e. a reduction of only 1.27 per cent. The discharge coefficients were, it was observed, of the same order whether the siphons were running individually or in combination, i.e. there is little interference under these conditions.

Considering that the depth of flow at entrance to the dome was reduced by 60 per cent, the reduction in discharge is remarkably low; it will also be noted that with the depressed rim of the dome, the flow near the siphons was very smooth and small vortices which were observed to form at the rear side of the siphon in series II were less frequent and the effect of interference was not observed and therefore gave slightly higher discharge coefficient.

6. Pressure observations in the Markonahally Siphon Model.

Pressures were observed along the periphery of the siphon tube and in the dome with a depth of water over crest \equiv 2.0 ft. These are shown in fig. 89. From the model pressures it will be seen that pressure at the wall in the vertical limb below the bellmouth of the prototype siphons would be very high and would cause cavitation. Similar high pressures were observed at the downstream convex bend of the siphon.

18. Nomograms for determining commonly required hydraulic elements and constants.

In daily irrigation engineering practice, it is often necessary to ascertain whether the available data of a channel indicate that the channel is in regime; and if not, to have a measure of the degree or extent of *divergence* from regime. For this purpose it often becomes necessary to obtain values of certain hydraulic criteria and constants from given values of certain other hydraulic elements. General formulae (such as the Manning's formula) and the deservedly popular and the best available regime formulae of Lacey are a matter of daily requirement and use. To save labour and time over long and often complicated, numerical calculations nomograms have been prepared to obtain the values by eye.

As most of the hydraulic formulae are exponential in character, logarithmic scales have been used. The nomograms cannot, therefore, be read sufficiently precisely for statistical and other analysis requiring a high degree of accuracy; but they are, never the less, useful to give quick, approximate values of the

frequently required hydraulic elements and criteria and to serve as a check on values computed by elaborate calculation.

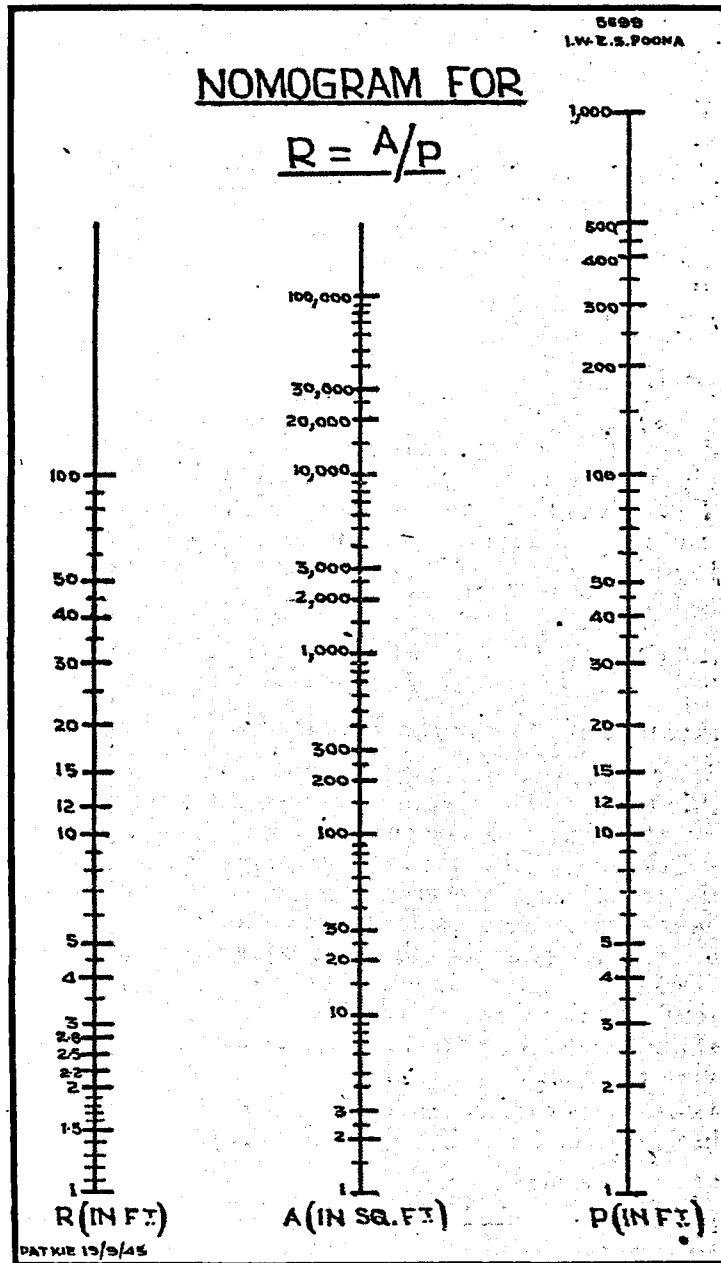

Fig. 90

The following nomograms have been prepared and are shown in figs. 90 to 100 :-

Fig. No.	Nomogram for
90	$R = \frac{A}{P}$
91	$\left\{ \begin{array}{l} S = 0.542 f_{93}^{5/3} Q^{-1/6} \\ V = 0.7937 Q^{1/6} f_{92}^{1/3} \end{array} \right.$
92	$f_{92} = 0.75 \frac{V^2}{R}$
93	$f_{93} = 193.15 R^{1/3} S^{3/8}$

Fig. No. Nomogram for

94 $f_m = \sqrt{f_{VR} f_{RS}}$

95 $f_{SV} = \sqrt{f_m f_{RS}} = 48.215 \sqrt{SV}$

96 $\frac{V}{RS}$

97 $\frac{V}{\sqrt{RS}}$

98 $\left\{ \begin{array}{l} R = 0.472 \left[\frac{Q}{f_{VR}} \right]^{1/3}, \\ \frac{f_d}{\sqrt{m}} \end{array} \right.$

99 $N_M = \frac{1.486 R^{2/3} S^{1/2}}{V}$

100 $N_L = \frac{1.346 R^{3/4} S^{1/2}}{V}$

The reading of the nomograms is generally simple and self-evident. When there are only three variables, the intersection of the straight line through the three scale lines gives the correlated values of the three variables; when, however, there are more than three variables (as in figs. 96, 97, 99 & 100) appropriate key diagrams are added on the sheet to facilitate the correct reading of the nomograms.

6. ACCURACY OF DIFFERENT METHODS OF TAKING DISCHARGES

19. Curvature of Flow in the Throat of a Standing Wave Flume

1. *Synopsis*:- The usual theory of the Standing Wave Flume assumes 'parallel flow' in the control section in the throat of two-thirds the depth over the sill. In fact, absolutely parallel flow on a horizontal bed is a physical impossibility unless the bed slope is equal to the loss of energy head due to side and internal friction the latter differing for every discharge. There must be some curvature of flow even in the throat itself besides the sharp curvature at its entry and exit. There is, however, a certain length between the sharp curvatures at entry and exit in which contraflexure of curvature occurs with nearly parallel flow. In this note, "parallel flow" therefore connotes that the stream lines have no substantial curvature, the depths of water and pressures on bed observed by means of manometer tubes being almost uniform.

This note describes experiments made to ascertain the extent of parallel flow for various discharges in a Standing Wave Flume.

2. Object of the Experiments.

The experiments described below were designed to observe, for various depths over sill:—

(i) The extent of curvature of flow at the entrance and exit of a 2' Standing Wave Flume;

(ii) length over which parallel flow occurs in the throat;

(iii) depth of "parallel flow";

and (iv) the effect of the above factors on the values of C and n in the discharge formula for a Standing Wave Flume, $Q = CBD^n$.

3. Experiments.

The experiments were carried out in a 2 ft. Standing Wave Flume. The details of construction and its principal dimensions are indicated in fig. 101. Manometer tubes were provided, for observation of pressures, in the bed and sides of the throat and expansion of the Standing Wave Flume. One side of the flume was fitted with glass to facilitate observation of lines of flow.

The notation used below is set out in Fig. 102.

The following two series of experiments were carried out in the 2' Standing Wave Flume.

FIG. 91.

NOMOGRAM FOR

$$1000 S = .542 f_{as}^{5/3} Q^{-1/6}$$

NOMOGRAM FOR

$$V = .7937 Q^{1/6} f_{va}^{1/3}$$

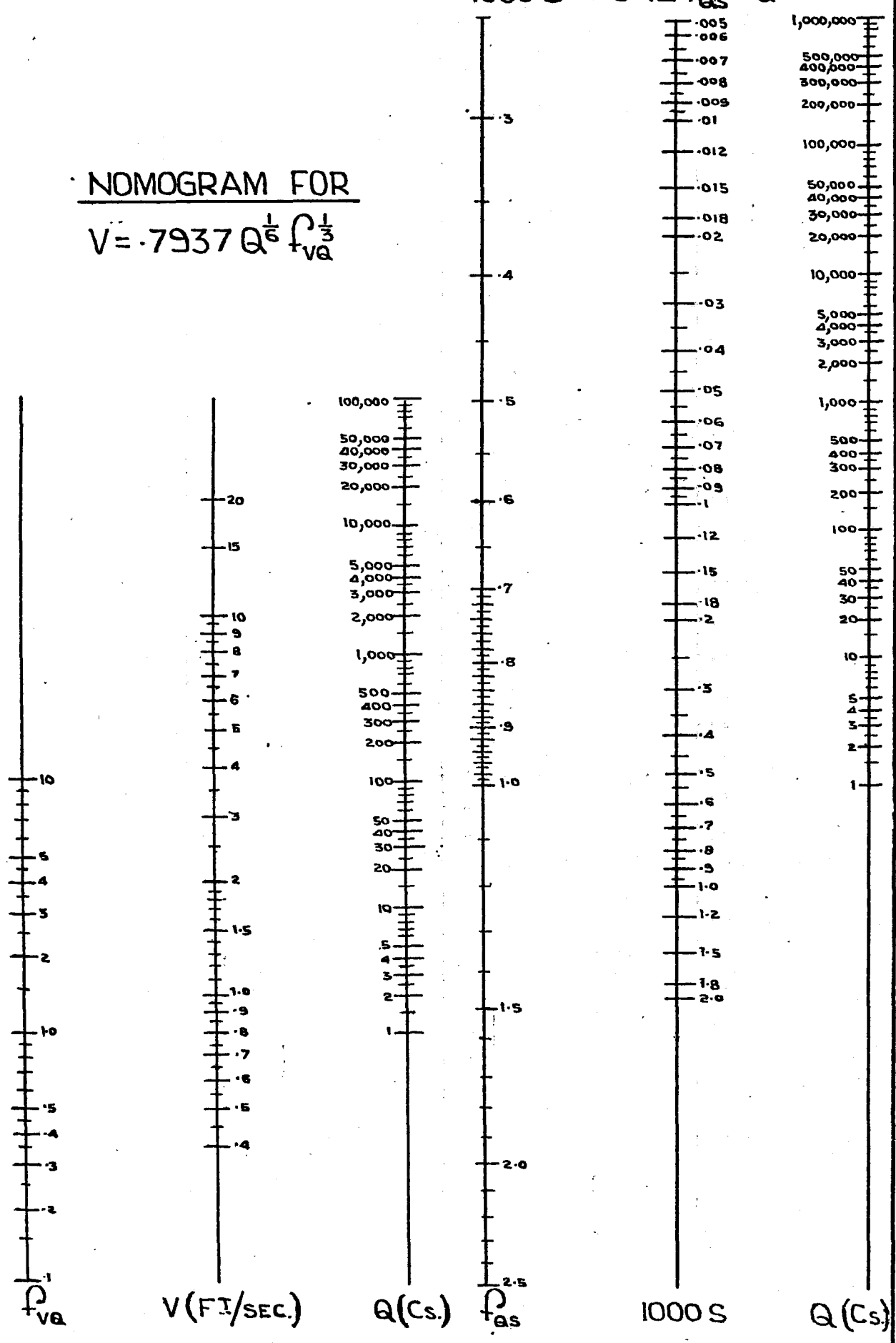

FIG. 92.
NOMOGRAM FOR

$$f_{VR} = 0.75 \frac{V^2}{R}$$

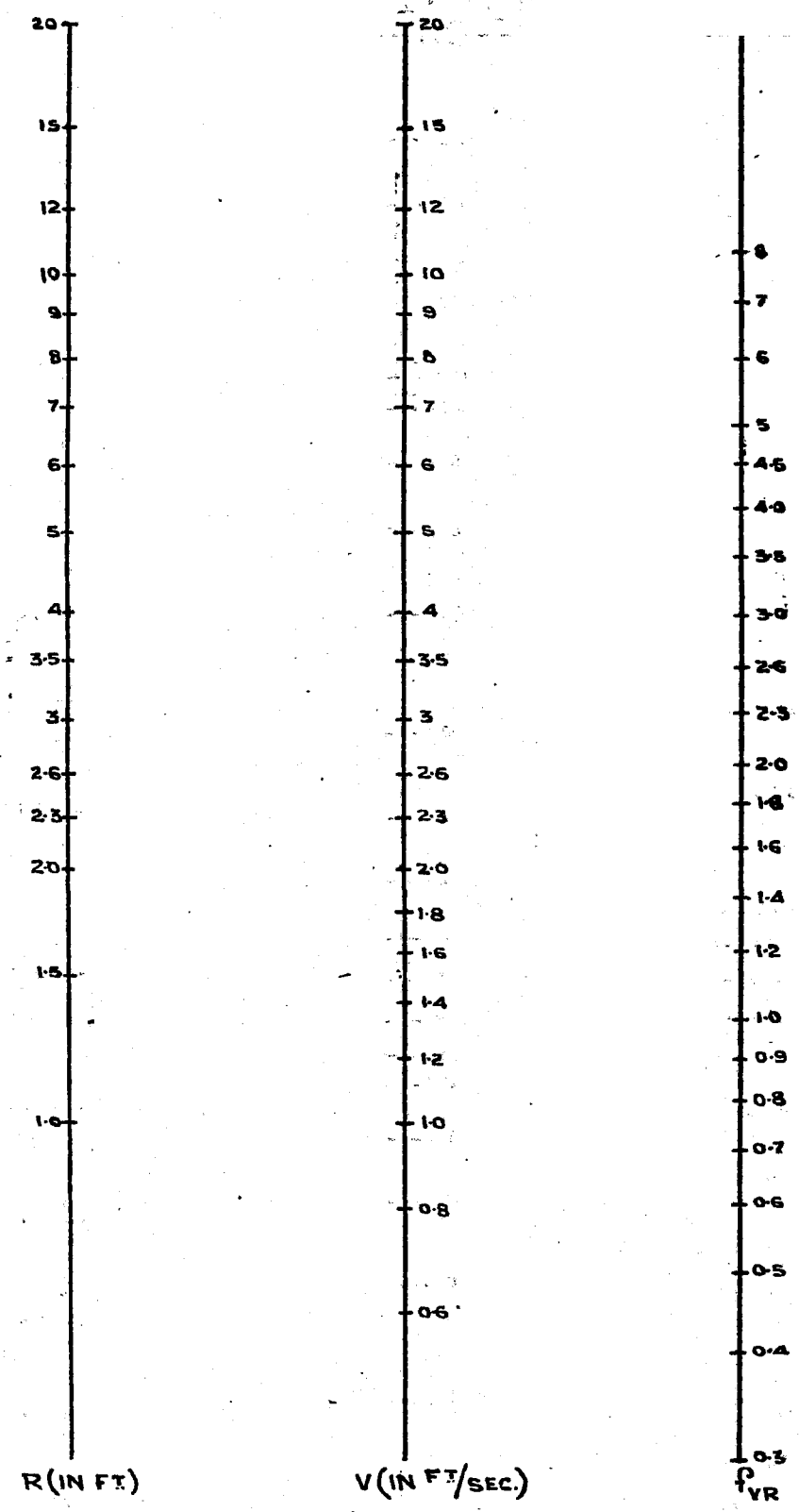
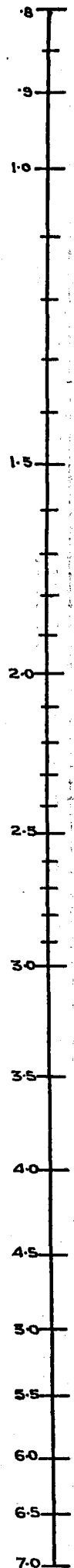

FIG. 93.

NOMOGRAM FOR

$$\frac{\rho}{RS} = 193.15 R^{\frac{1}{3}} S^{\frac{2}{3}}$$



$\frac{\rho}{RS}$

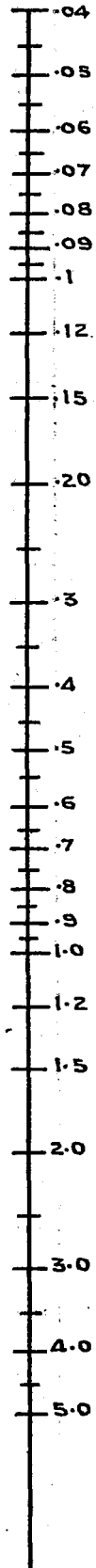

1000 S

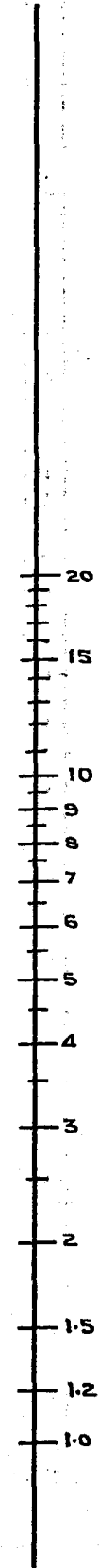

R (IN FT)

FIG:- 94. NOMOGRAM FOR $f_m = \sqrt{f_{VR} f_{RS}}$.

(THE NOMOGRAM MAY ALSO BE USED FOR READING $f_{SV} = \sqrt{f_m f_{RS}}$ BY INTERCHANGING

f_m FOR f_{VR} & f_{SV} FOR f_m .)

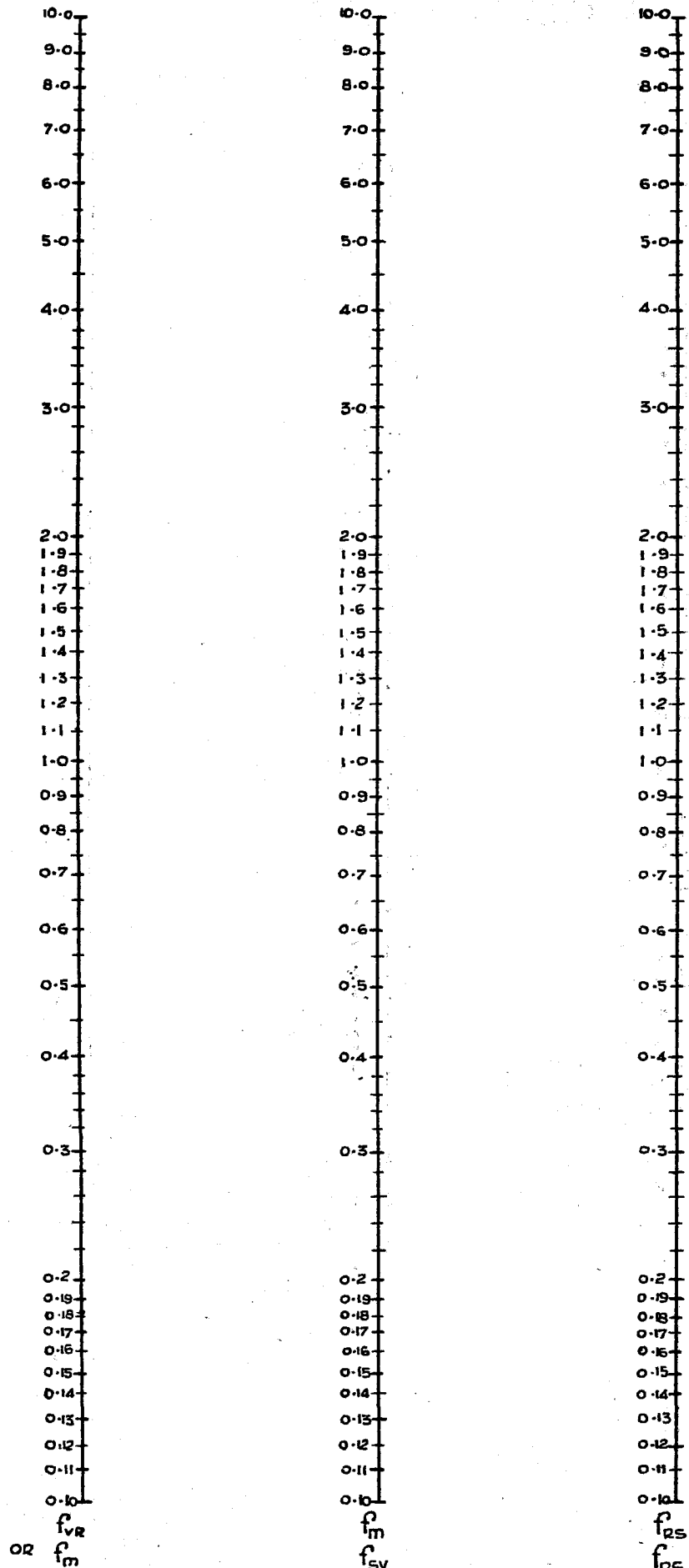

FIG. 95.

NOMOGRAM FOR $f_{SV} = 48.215\sqrt{SV} (= \sqrt{f_m f_{RS}})$

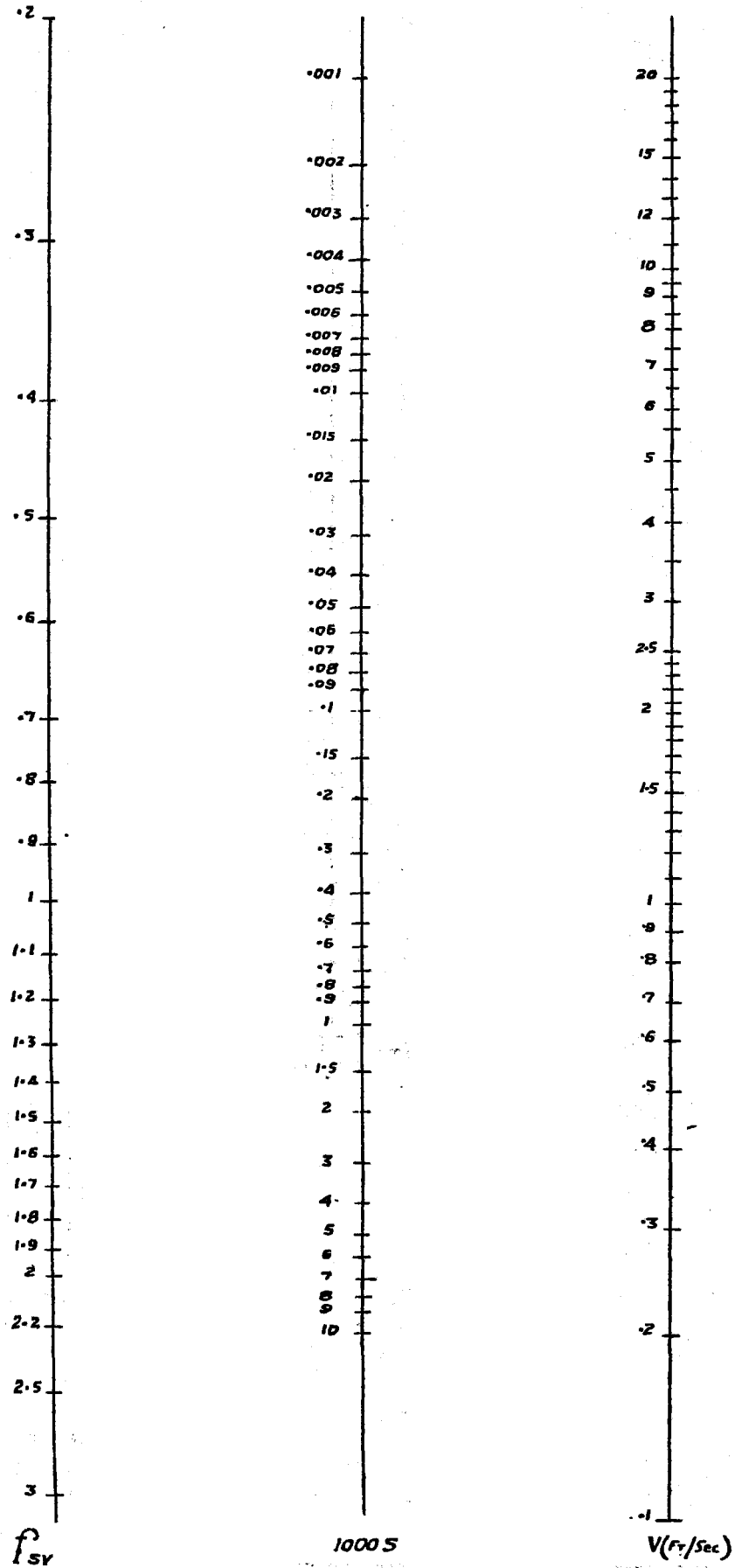
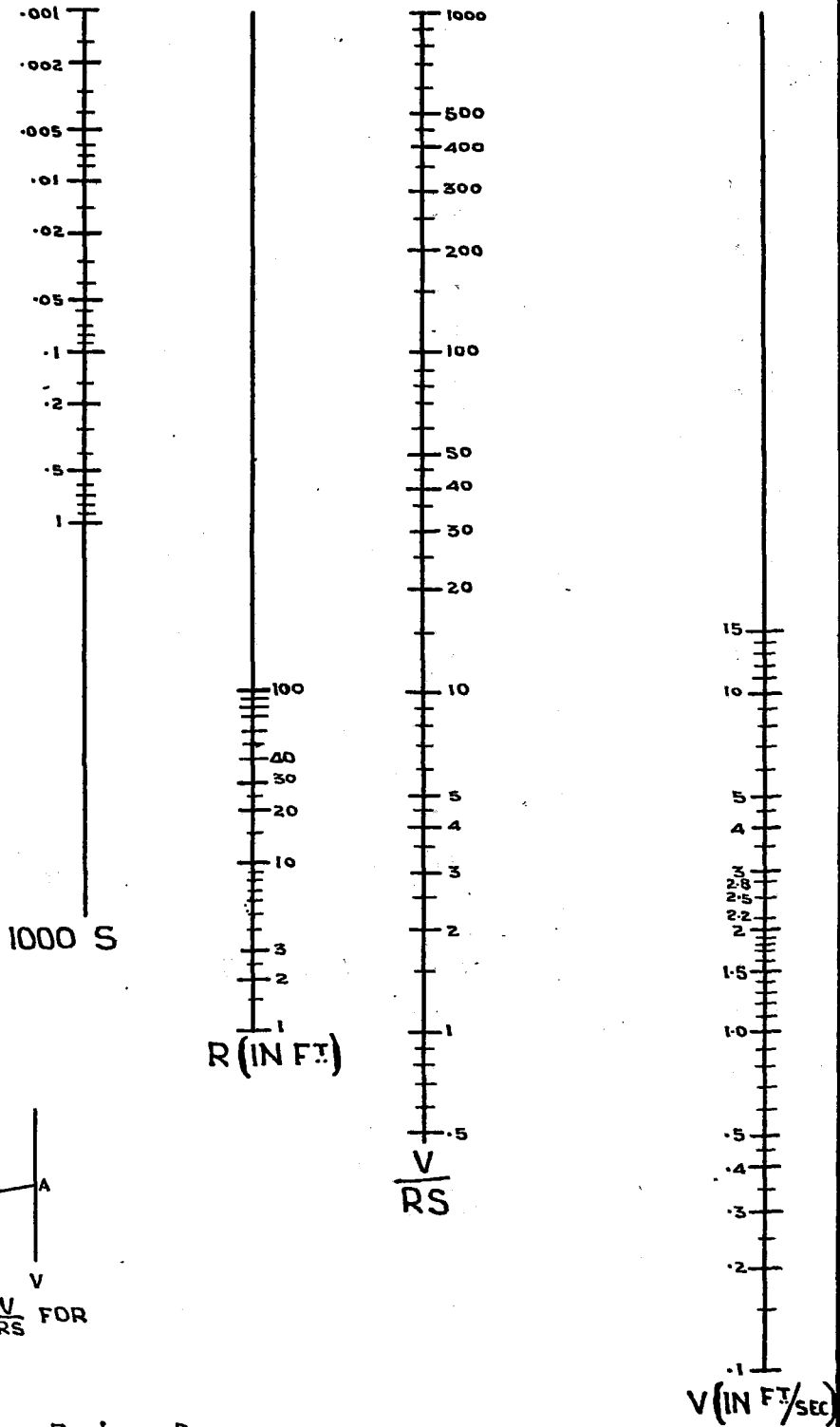

FIG. 96. NOMOGRAM FOR

$$\frac{V}{RS}$$

REFERENCE LINE



KEY

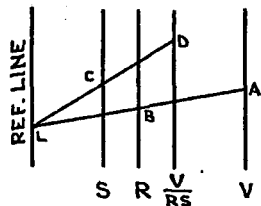

TO EVALUATE $\frac{V}{RS}$ FOR
 $V = d$
 $R = b$
 $S = c$

JOIN $V = d$ AT A TO $R = b$ AT B AND
 PRODUCE TO L ON REFERENCE LINE.
 JOIN L TO $S = c$ AT C & PRODUCE TO D.
 THE READING AT D GIVES THE VALUE OF $\frac{V}{RS}$

FIG. 97. NOMOGRAM FOR

$$\frac{V}{\sqrt{RS}}$$

REFERENCE LINE

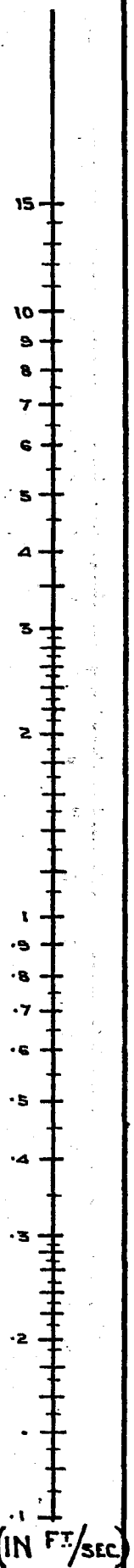
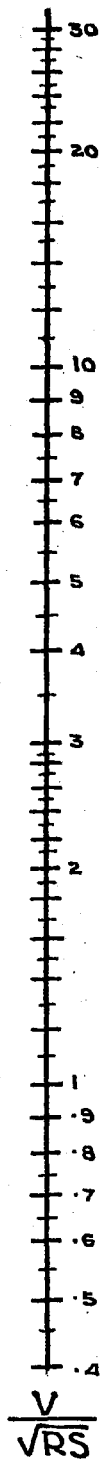
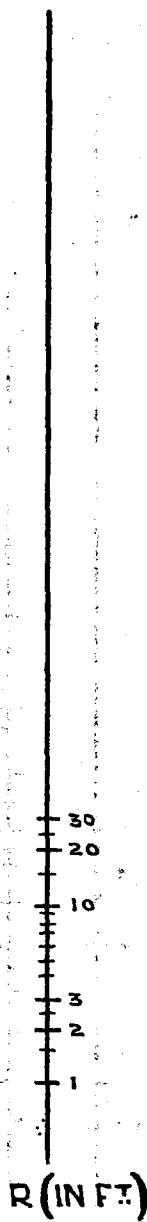
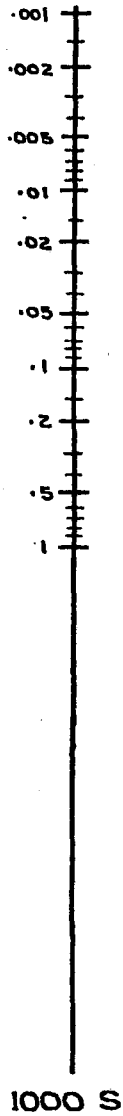

KEY

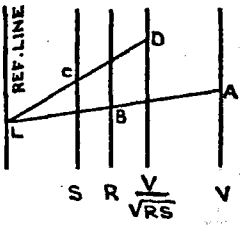

TO EVALUATE $\frac{V}{\sqrt{RS}}$ FOR
 $V = d$
 $R = b$
 $S = c$

JOIN $V = d$ AT A TO $R = b$ AT B AND
 PRODUCE TO L ON REFERENCE LINE.
 JOIN L TO $S = c$ AT C & PRODUCE TO D.

D GIVES THE VALUE OF $\frac{V}{\sqrt{RS}}$

V (IN FT./SEC.)

FIG. 98.

5739
I.W.E.S. POONA

NOMOGRAM FOR

$$\frac{f_d}{\sqrt{m}}$$

NOMOGRAM FOR

$$R = .472 \left(\frac{Q}{f_{VR}} \right)^{\frac{1}{3}}$$

OR $\log R = \frac{1}{3} \log Q - \frac{1}{3} (\log f_{VR} + .9782)$

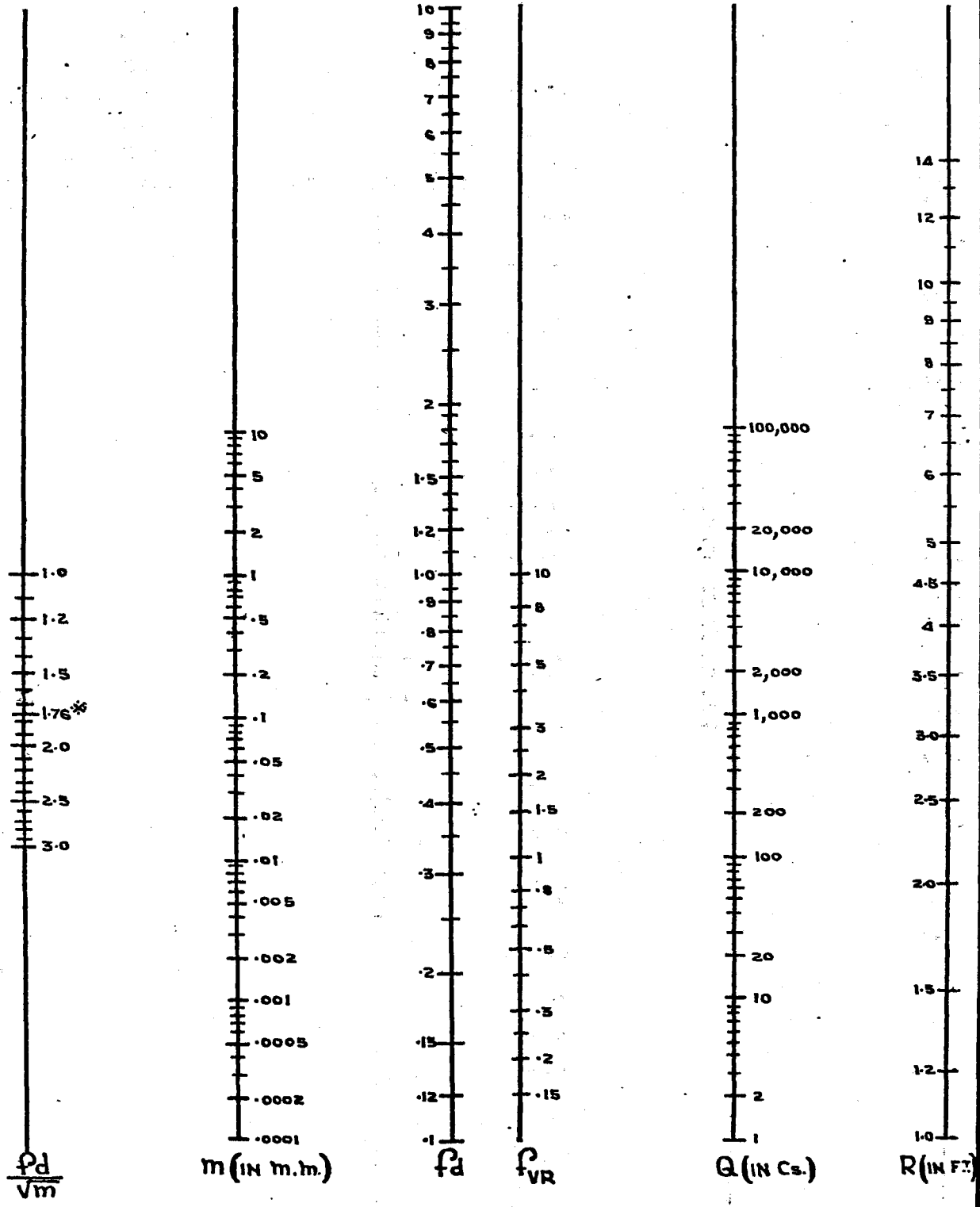

* THE VALUES OF f_d FOR $\frac{f_d}{\sqrt{m}} = 1.76$ PROVIDE LACEY'S ESTIMATES OF SILT FACTOR f_s FOR KNOWN VALUES OF THE MEAN SILT DIAMETER m .

FIG. 99
NOMOGRAM FOR

$$N_m = \frac{1.486}{V} R^{\frac{2}{3}} S^{\frac{1}{2}}$$

OR $\log N_m = \frac{2}{3} \log R + \frac{1}{2} (\log S + 0.344) - \log V$

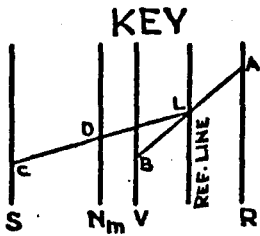

TO EVALUATE N_m FOR

$R = a$

$V = b$

$S = c$

JOIN $R = a$ AT A TO $V = b$ AT B CUTTING THE REFERENCE LINE AT L.

JOIN L TO $S = c$ AT C CUTTING THE N_m LINE AT D. THE READING AT D GIVES THE VALUE OF N_m

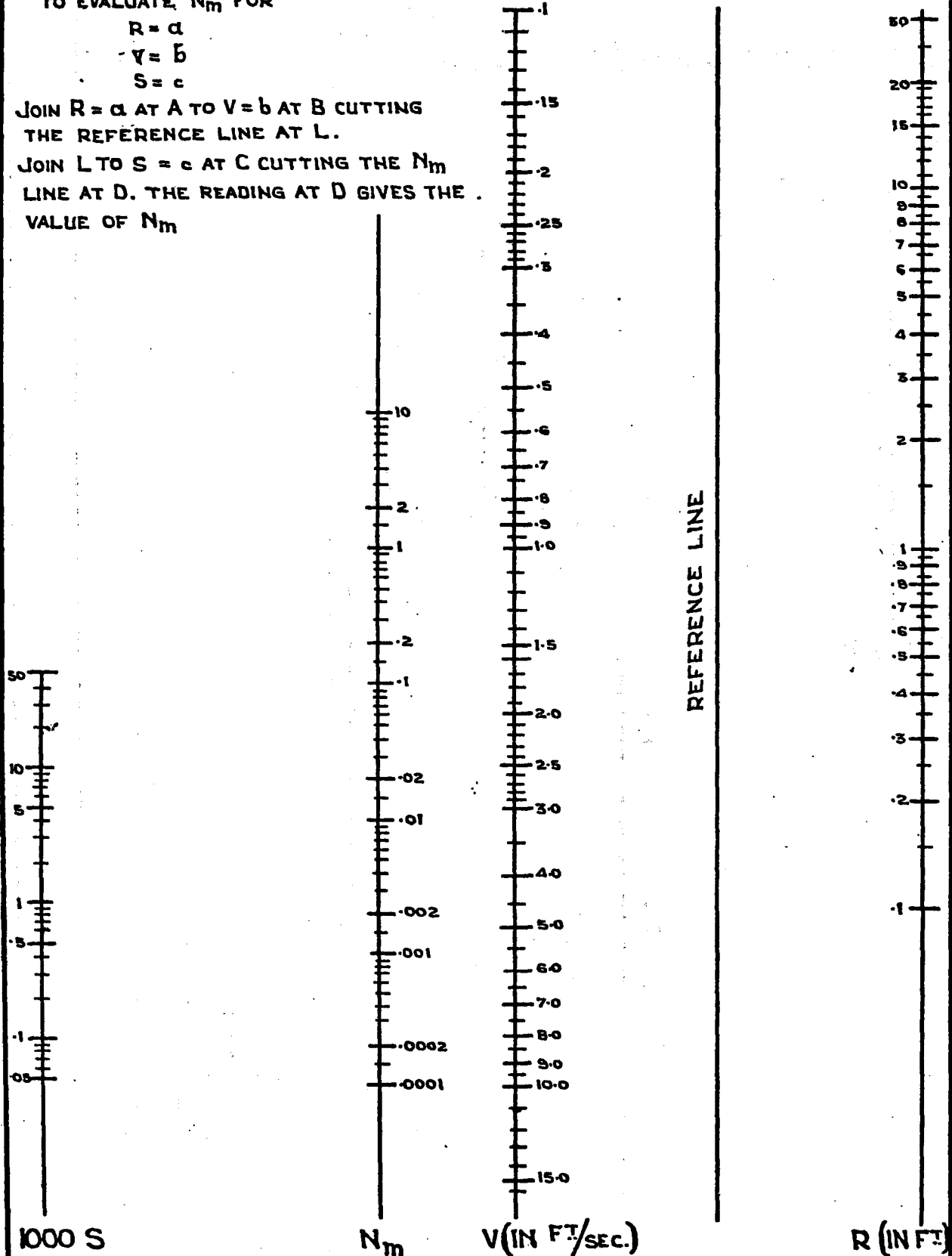
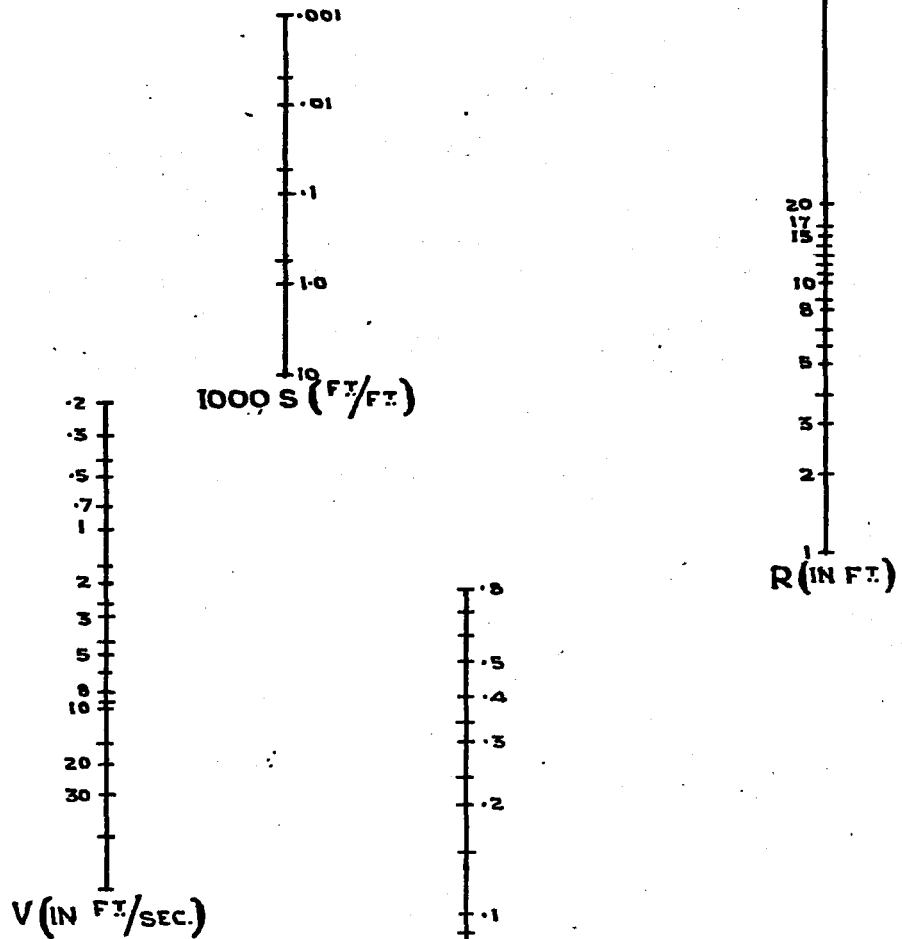

FIG. 100
NOMOGRAM FOR

$$N_L = \frac{1.346}{V} R^{\frac{3}{4}} S^{\frac{1}{2}}$$

OR $\log N_L = \frac{3}{4} \log R + \frac{1}{2} \log S - (\log V - 0.129)$

REFERENCE LINE



KEY

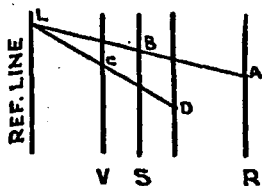

TO EVALUATE N_L FOR

- $R = a$
- $S = b$
- $V = c$

JOIN $R = a$ AT A TO $S = b$ AT B
AND PRODUCE TO L ON REF. LINE.
JOIN L TO $V = c$ AT C & PRODUCE
TO D. THE READING FOR D GIVES
THE VALUE OF N_L

FIG. 101
2 FT. STANDING WAVE FLUME.
IN
CALIBRATION CHANNEL
SCALE: 1" = 2'

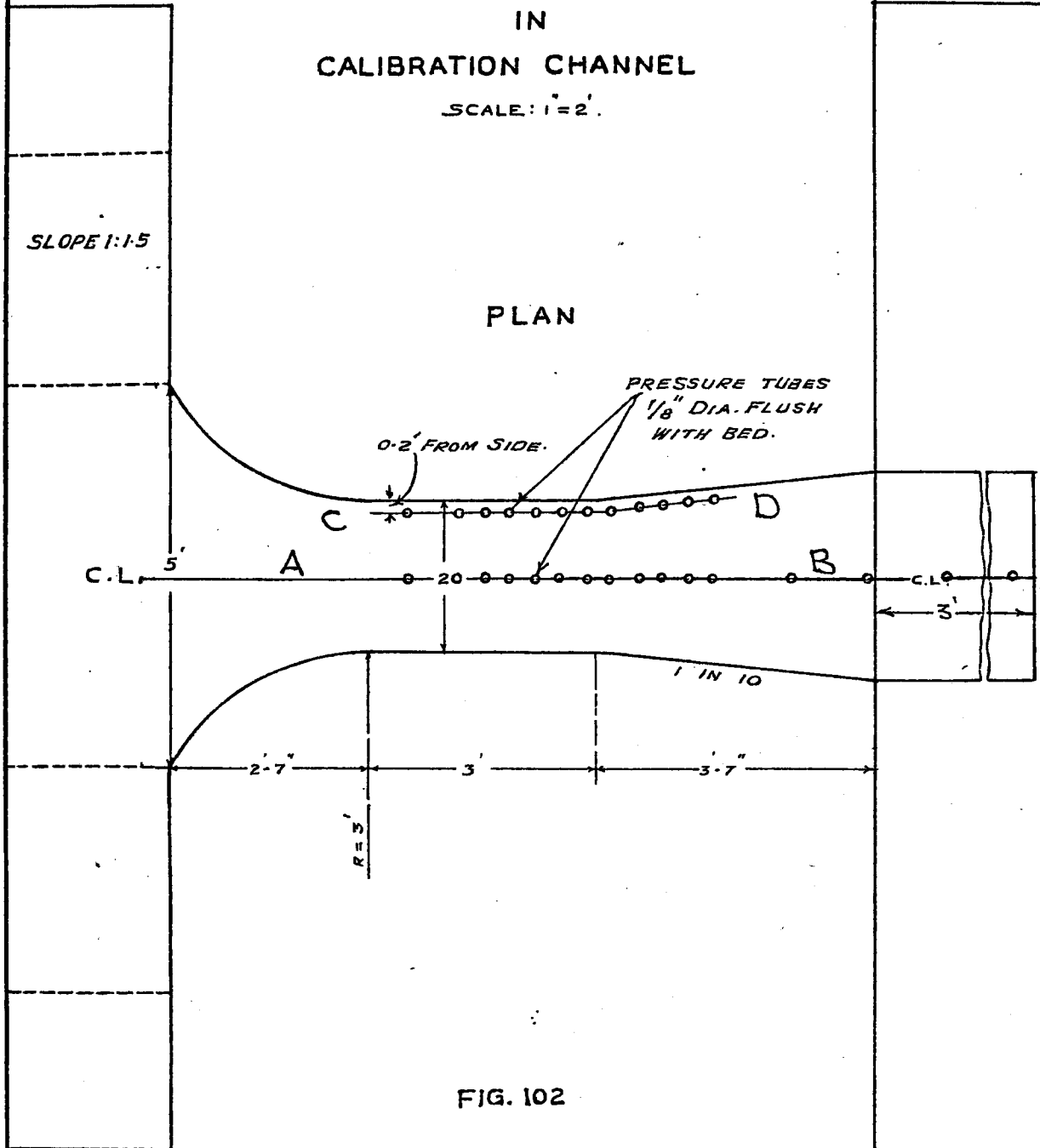
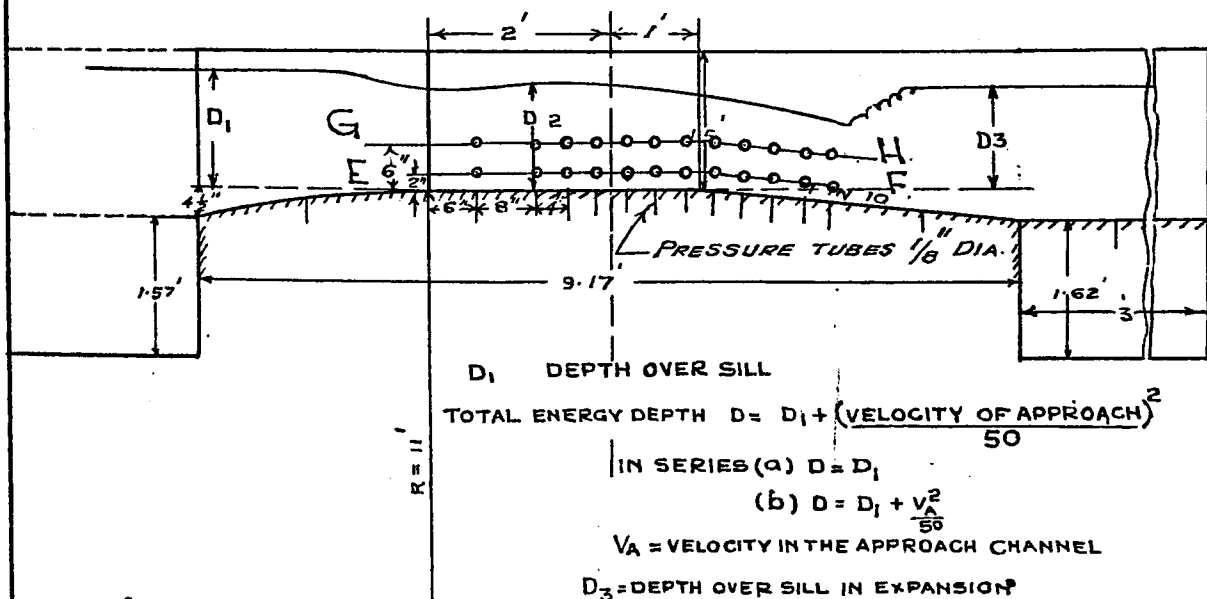

FIG. 102
LONGITUDINAL SECTION



Kobinik 23/5

Series (a):—With a stilling chamber, 20' long, 15' wide, and 1.62' deep, upstream of the Standing Wave Flume. This reduced the velocity of approach to a negligible value. Water surface profiles and pressures were observed for $D = 0.41'$, $0.807'$ and $1.2'$, with free flow and standing wave downstream.

Series (b):—With an approach channel upstream of the Standing Wave Flume as shown in Fig. 101 in dotted lines. Surface profiles and pressures were observed for $D = 0.4'$, $0.6'$, $0.8'$ and $1.2'$. The object of this series was to see the variations, if any, in the surface profiles and pressures from those observed in series (a). Fig. 101

4. Observation of lines of flow at entrance and exit.

It was at first attempted to observe the curvature of lines of flow at the entrance and end of the throat by wool thread. This method was, however, liable to errors due to high velocities and was dropped.

The alternative method of finding the direction of flow by means of a Pitot tube was tried. Fig. 103 shows the arrangement that was used. It consisted of a clamp A, for holding the pitot tube fitted into the flange B with a ball and socket joint. This allowed the pitot tube to be fixed in any position inclined to the vertical. Fig. 103

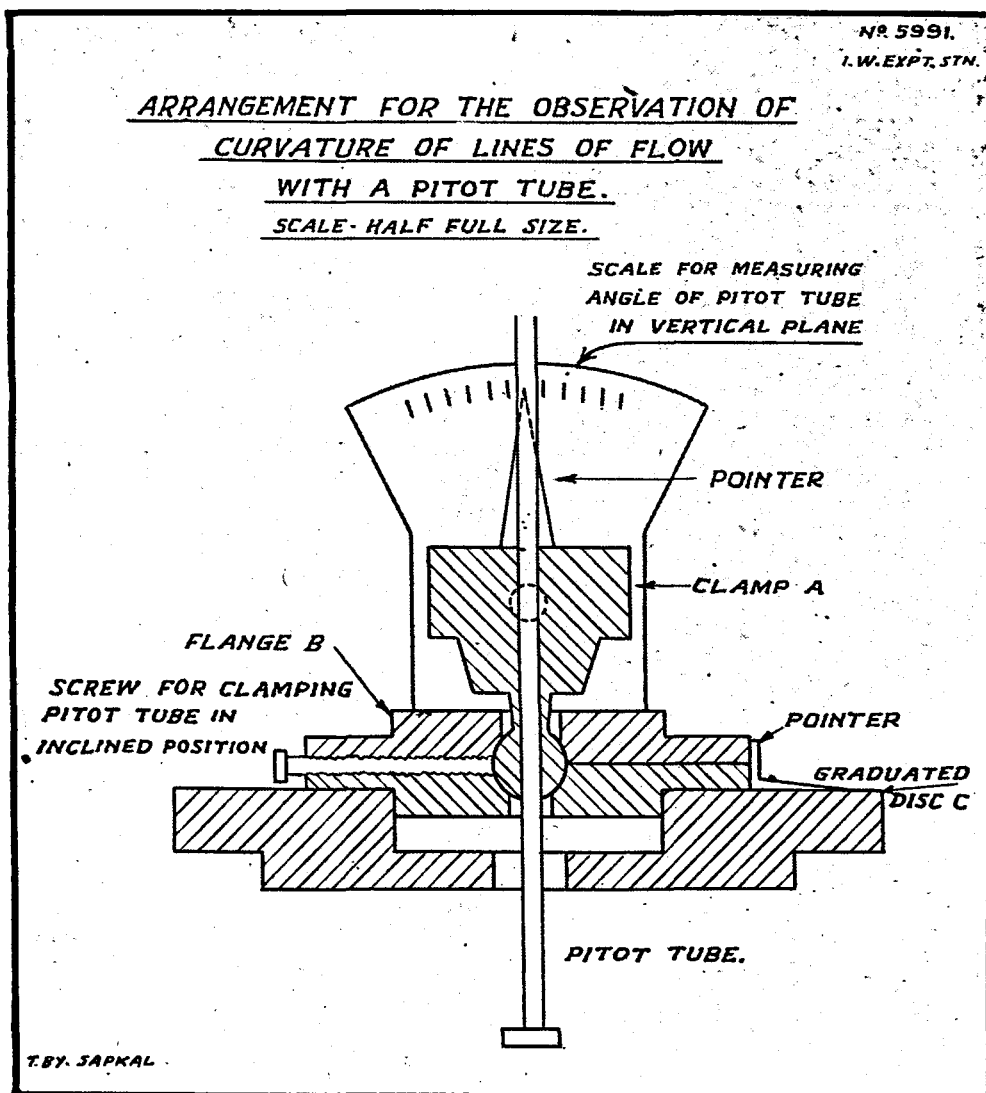

Fig. 103

[The flange B could, moreover, be rotated horizontally through any desired angle on the graduated disc C. Thus the pitot tube could be moved in any direction horizontally or vertically and the bearing and inclination observed.]

To find out the curvature of flow at a point in the Standing Wave Flume the pitot tube was kept vertical and the flange B was slowly rotated in a horizontal plane till maximum deflection in the U tube was obtained. This gave the horizontal bearing of the line of flow in relation to the centre line of the S.W.F. Keeping this angle with the centre line constant, the clamp A holding the pitot tube was tilted in the vertical plane of the line of flow till maximum deflection was again obtained. This gave the inclination of the line of flow to the vertical.

The pitot tube was sensitive enough to give a change in deflection when rotated through 1° horizontally or vertically. Due to the drop in surface profile and the inclination of the pitot tube, (while measuring the curvature of flow with the vertical), the static head on both ends of the Pitot tube is not quite the same. A correction can, however, be made by allowing for drop in profile and inclination of the pitot tube. Figs. 104 and 105 show the directions and velocities at the entrance and the middle of the throat for $D = 0.807'$.

Figs. 104 & 105

Fig. 106 & 107

Figs. 106 to 111

Figs. 106 and 107 show typical water surface profiles and pressures for $D = 0.810'$ in series (a) and for $D = 0.4'$ in series (b) respectively, for free flow and standing wave downstream.

Comparison of profiles and pressures obtained in series (a) and (b) showed that the two different upstream conditions gave nearly similar results. Fig. 108 shows water surface profiles in series (a) and (b) at the centre of the flume for $D = 0.4'$ as almost identical.

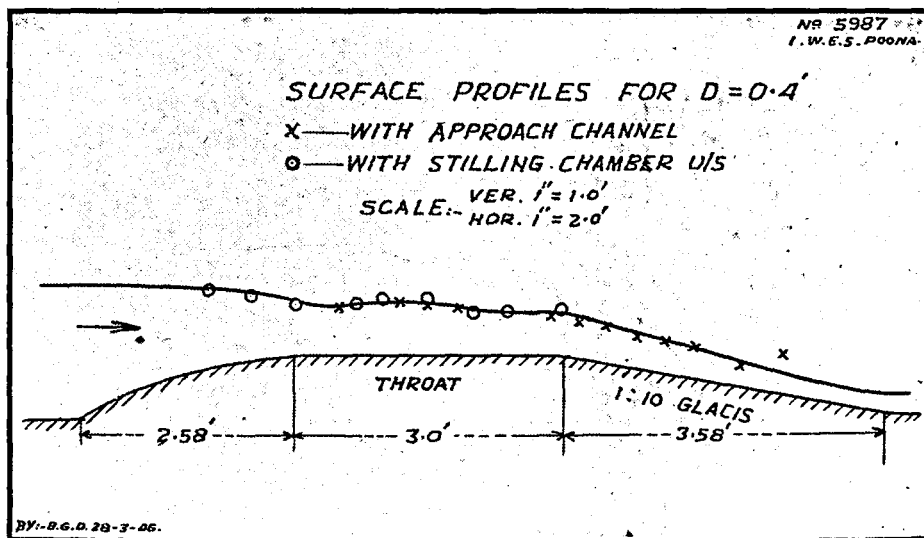

Fig. 108

For $D = 0.4'$, a characteristic hump was observed for a certain length at the entrance to the throat, (Fig 108). The reason underlying this formation of the undulatory wave has been explained by Bakhmeteff⁽¹⁾ as a "transitory" stage of flow in the state of establishing itself. An example is the entrance portion of a flume (Fig. 109). Above section (A) there lies the undisturbed level of the reservoir. Below section (B), flow is uniform. The stretch between sections (A) and (B) is the transitory part in which uniform flow establishes itself. In fig. 109 this transitory stretch presents an undulatory surface. Such is always the case when the slope of the flume is mild or to be more specific, when flow which is in process of establishing itself, is "tranquil".

Fig. 109

(1) "Hydraulics of open channels" by B. A. Bakhmeteff, Page 62.

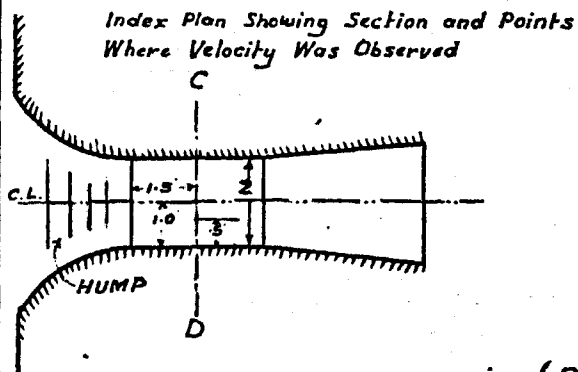
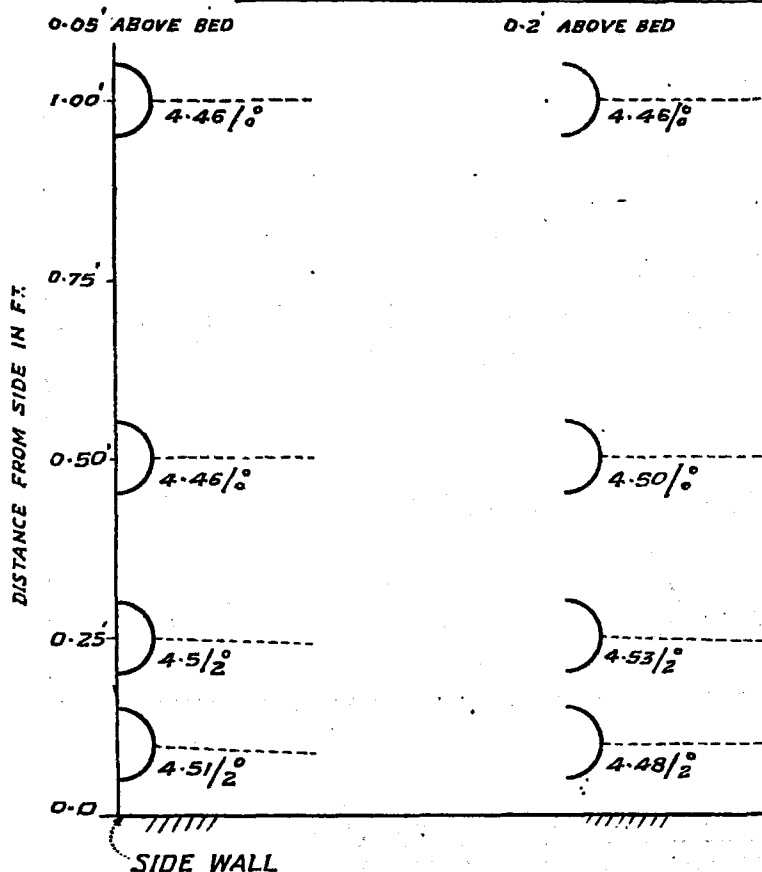

FIG. 104.

2' STANDING WAVE FLUME EXPTS.
SHOWING VELOCITIES & OPTIMUM ANGLE IN PLANE
AND ON VERTICAL AT SECTION ON C.D
(SCALE FOR VELOCITY $i=5'$)
 $D \sqrt{s} = 0.807 \text{ FT.}$

(a)

VELOCITIES WITH DIRECTION IN PLAN ON
SECTION C.D. (INDEX PLAN) AT
DIFFERENT DEPTHS ABOVE SILL OF S.W.F.



(b)

VELOCITIES WITH DIRECTION IN SECTION C.D AT
DIFFERENT DEPTHS, ON VERTICALS AT 0.1', 0.25', 0.5' & 1.0' FROM
THE SIDE, SHOWING DEVIATION FROM PARALLEL FLOW.

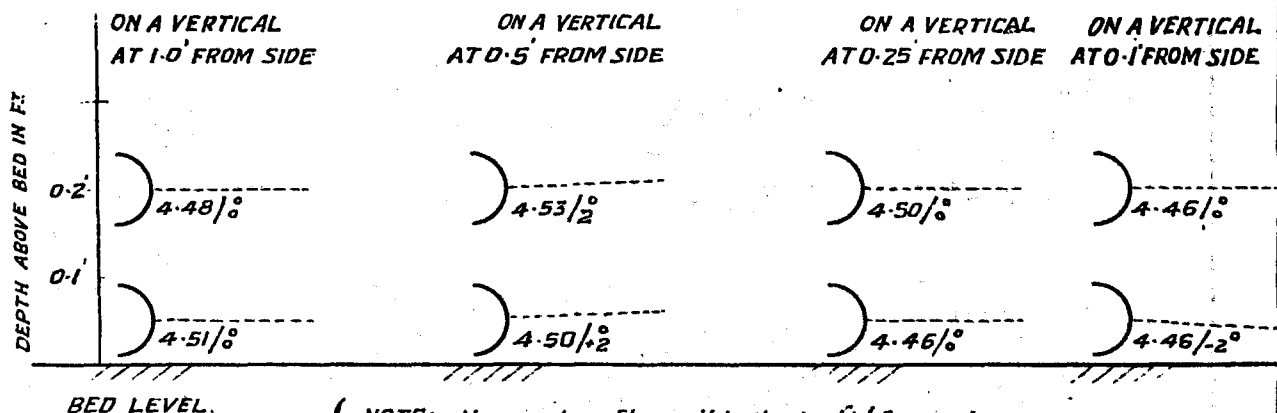

(NOTE:- Numerator Shows Velocity in Ft./Sec. and The Denominator The Angle of The Filament.)

(SERIES A) 2 FT STANDING WAVE FLUME EXPTS.

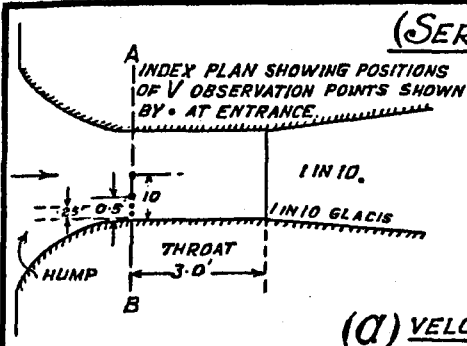

SHOWING VELOCITIES OBSERVED GIVING
OPTIMUM VELOCITY ANGLE IN PLAN &
ON VERTICAL AT SECTION ON A B.

(Scale for velocity $v = 5$ feet.)

$D U/S = 0.807'$

(a) VELOCITIES WITH DIRECTION IN PLAN ON
SECT. A B, (INDEX PLAN) AT DIFFERENT
DEPTHS ABOVE SILL OF S. W. F.

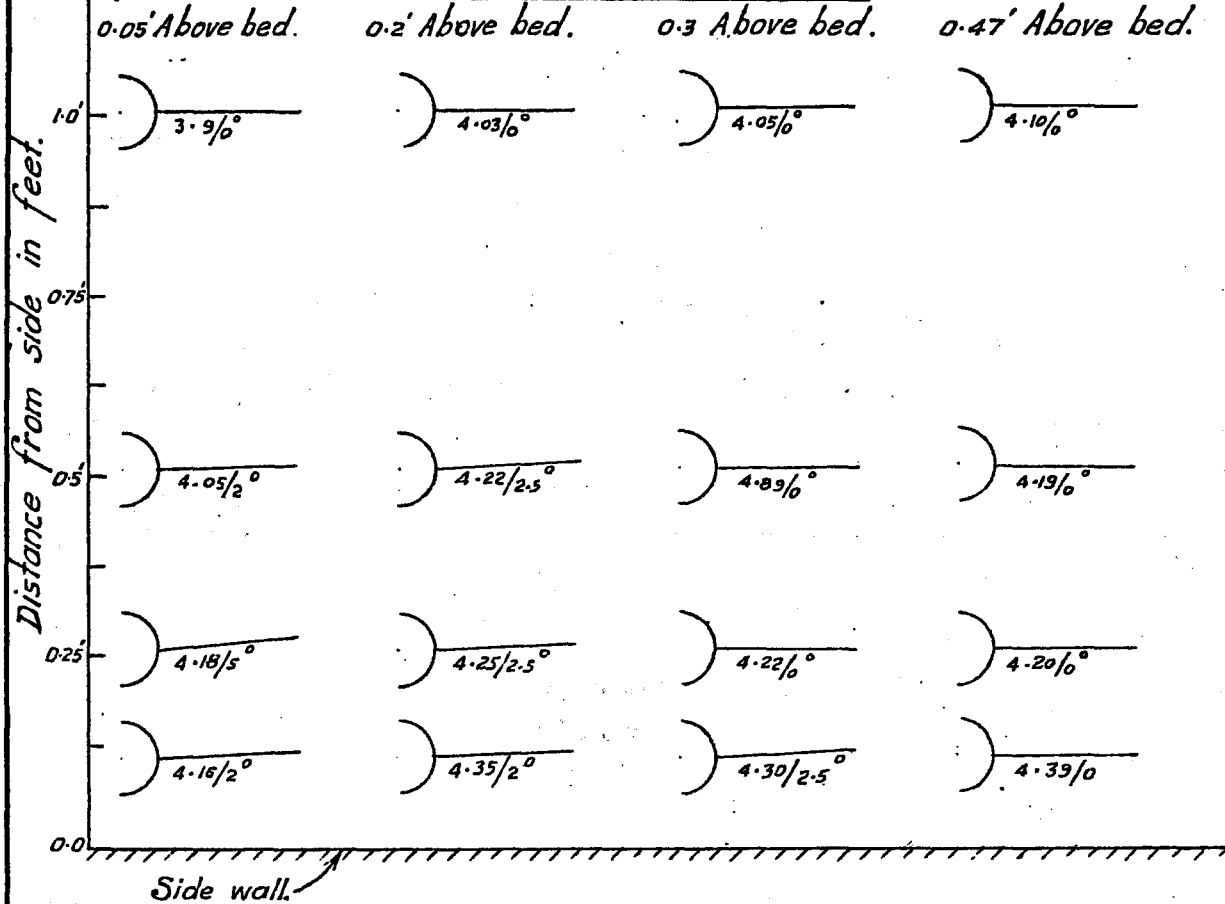

(b) VELOCITIES WITH DIRECTION IN SECT. A B. AT
DIFFERENT DEPTHS, ON VERTICALS, AT 0.1, 0.25, 0.5 & 1.0'
FROM THE SIDE, SHOWING DEVIATION FROM PARALLEL FLOW.

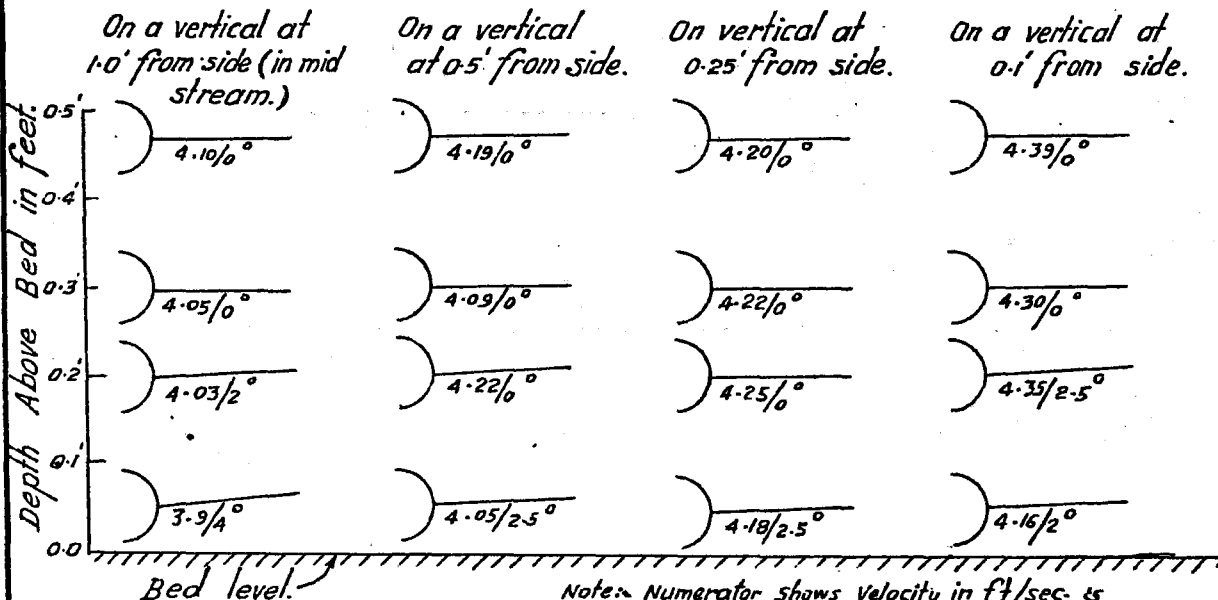

Note: Numerator shows Velocity in ft/sec. & denominator the angle of the filament.

FIG. 106.

SERIES = A

2 FT. STANDING WAVE FLUME WITH STILLING CHAMBER.
PROFILE OF WATER SURFACE AT CENTRE OF FLUME.

SCALE: HOR: 1" = 2'
VER: 1" = 0.5'

D = 0.807 FT.

FREE FLOW D/S.

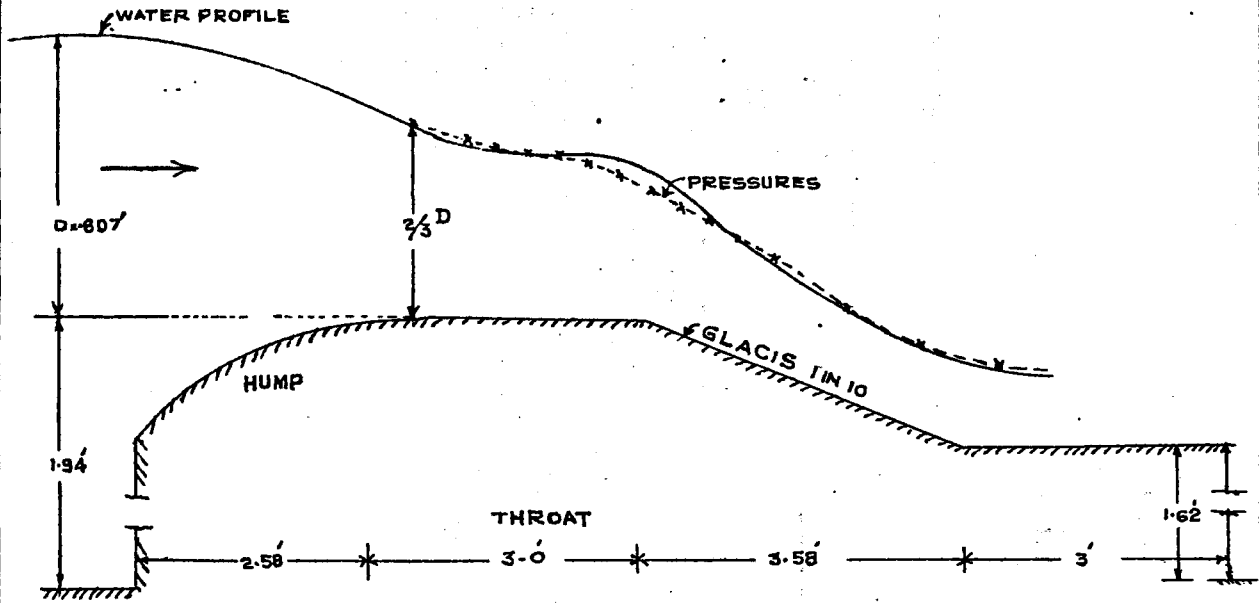

D = 0.81

$\frac{D3}{D1} = 0.7$

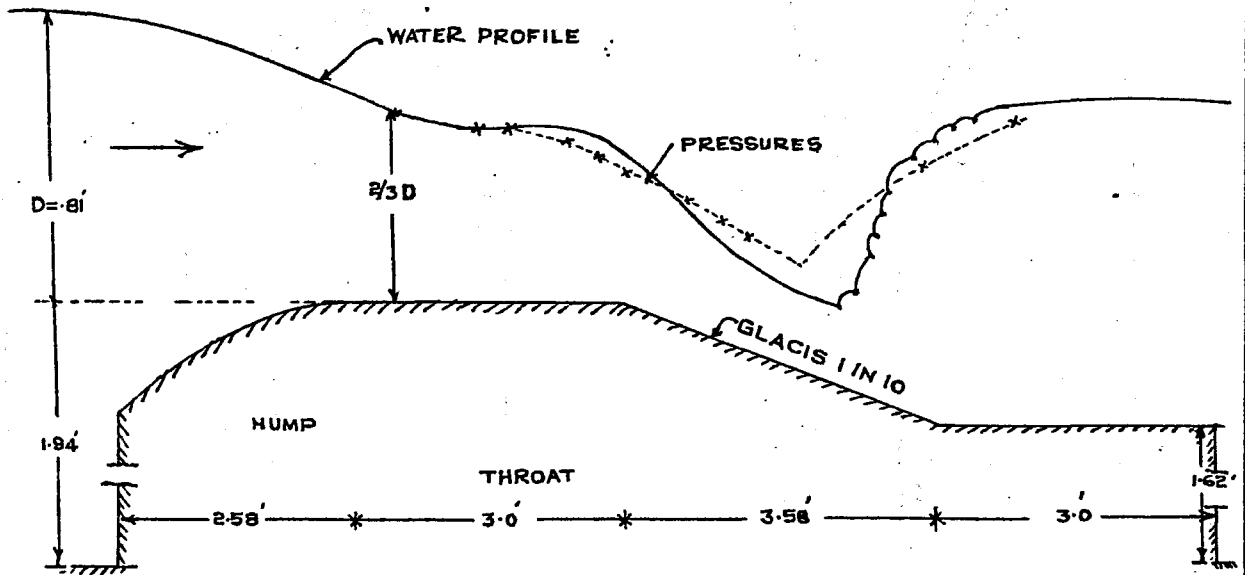

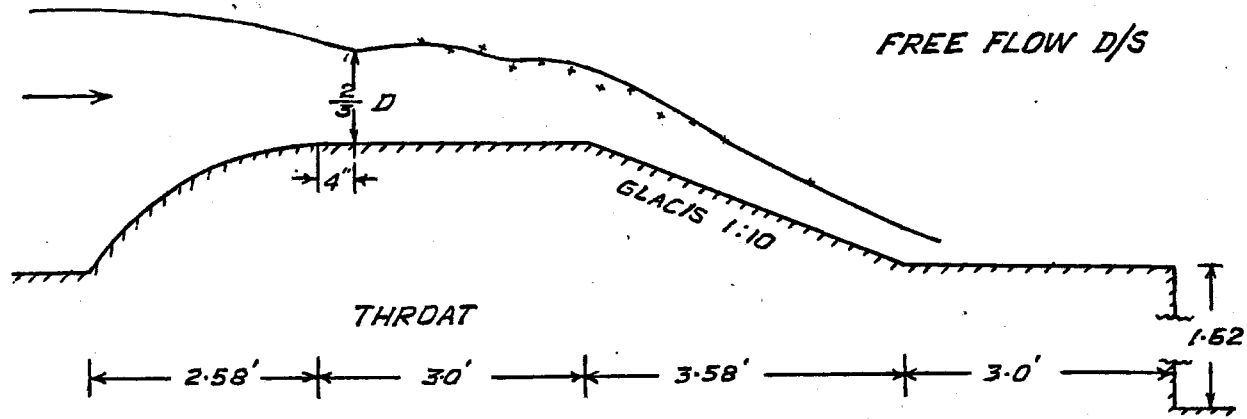

STANDING WAVE D/S

$$\frac{D_s}{D} = \frac{0.307}{0.4} = 0.77$$

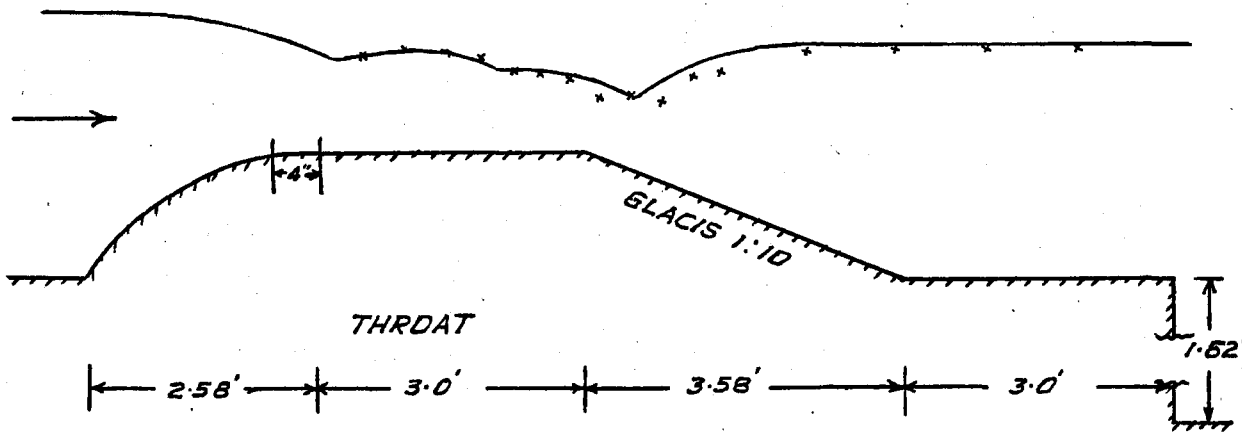

FIG. 107

SERIES b

2' STANDING WAVE FLUME WITH APPROACH CHANNEL.

PROFILE OF WATER SURFACE AND PRESSURES AT CENTRE OF FLUME

$$D = 0.4'$$

SCALE. $\left\{ \begin{array}{l} \text{HOR. } 1'' = 2' \\ \text{VER. } 1'' = 0.5' \end{array} \right.$

PRESSURES X

BY. PARDHI.

Series (a):—With a stilling chamber, 20' long, 15' wide, and 1.62' deep, upstream of the Standing Wave Flume. This reduced the velocity of approach to a negligible value. Water surface profiles and pressures were observed for $D = 0.417, 0.807$ and 1.2', with free flow and standing wave downstream.

Series (b):—With an approach channel upstream of the Standing Wave Flume as shown in Fig. 101 in dotted lines. Surface profiles and pressures were observed for $D = 0.4, 0.6, 0.8$ and 1.2'. The object of this series was to see the variations, if any, in the surface profiles and pressures from those observed in series (a).

Fig. 101

4. Observation of lines of flow at entrance and exit.

It was at first attempted to observe the curvature of lines of flow at the entrance and end of the throat by wool thread. This method was, however, liable to errors due to high velocities and was dropped.

The alternative method of finding the direction of flow by means of a Pitot tube was tried. Fig. 103 shows the arrangement that was used. It consisted of a clamp A, for holding the pitot tube fitted into the flange B with a ball and socket joint. This allowed the pitot tube to be fixed in any position inclined to the vertical.

Fig. 103

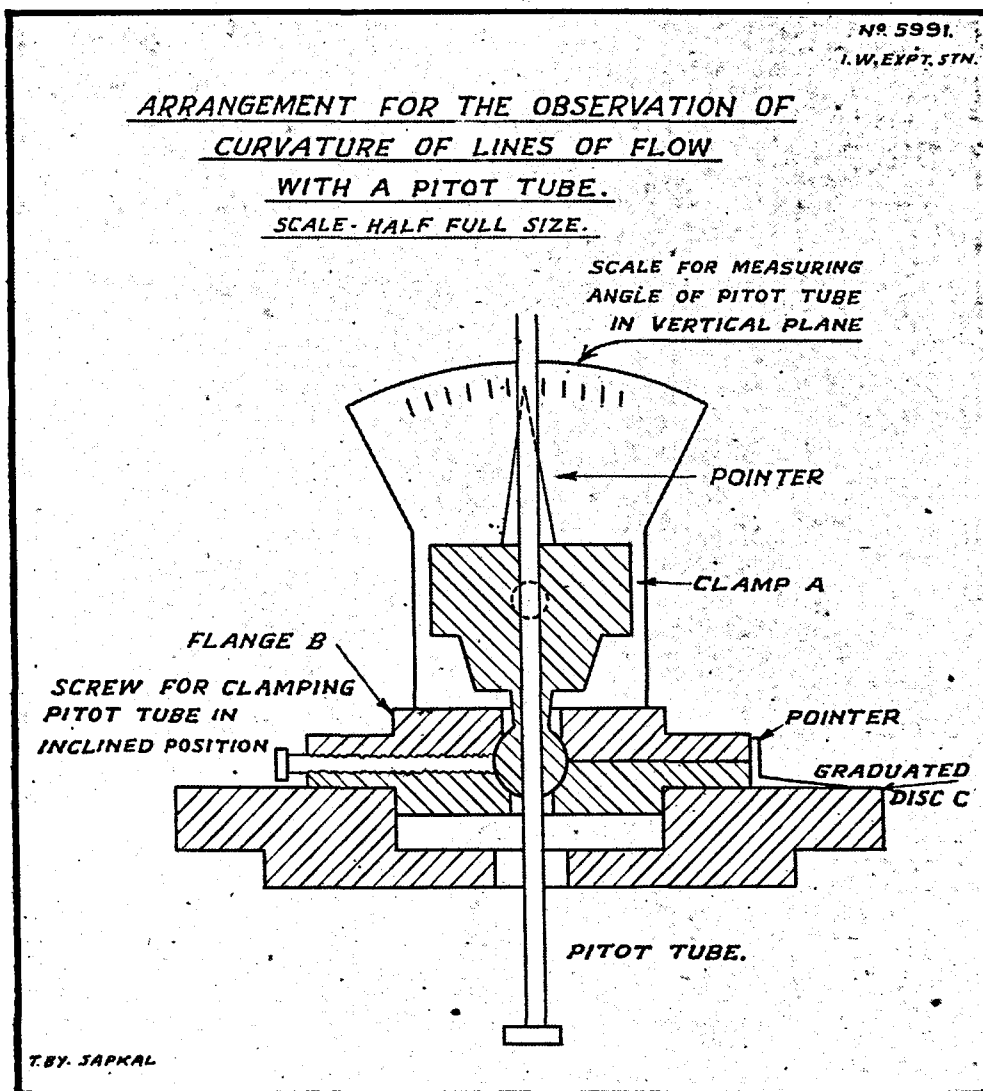

Fig. 103

[The flange B could, moreover, be rotated horizontally through any desired angle on the graduated disc C. Thus the pitot tube could be moved in any direction horizontally or vertically and the bearing and inclination observed.]

To find out the curvature of flow at a point in the Standing Wave Flume the pitot tube was kept vertical and the flange B was slowly rotated in a horizontal plane till maximum deflection in the U tube was obtained. This gave the horizontal bearing of the line of flow in relation to the centre line of the S.W.F. Keeping this angle with the centre line constant, the clamp A holding the pitot tube was tilted in the vertical plane of the line of flow till maximum deflection was again obtained. This gave the inclination of the line of flow to the vertical.

The pitot tube was sensitive enough to give a change in deflection when rotated through 1° horizontally or vertically. Due to the drop in surface profile and the inclination of the pitot tube, (while measuring the curvature of flow with the vertical), the static head on both ends of the Pitot tube is not quite the same. A correction can, however, be made by allowing for drop in profile and inclination of the pitot tube. Figs. 104 and 105 show the directions and velocities at the entrance and the middle of the throat for $D = 0.807'$.

Figs. 104 & 105

Fig. 106 & 107 Figs. 106 and 107 show typical water surface profiles and pressures for $D = 0.810'$ in series (a) and for $D = 0.4'$ in series (b) respectively, for free flow and standing wave downstream.

Figs. 106 to 111

Comparison of profiles and pressures obtained in series (a) and (b) showed that the two different upstream conditions gave nearly similar results. Fig. 108 shows water surface profiles in series (a) and (b) at the centre of the flume for $D = 0.4'$ as almost identical.

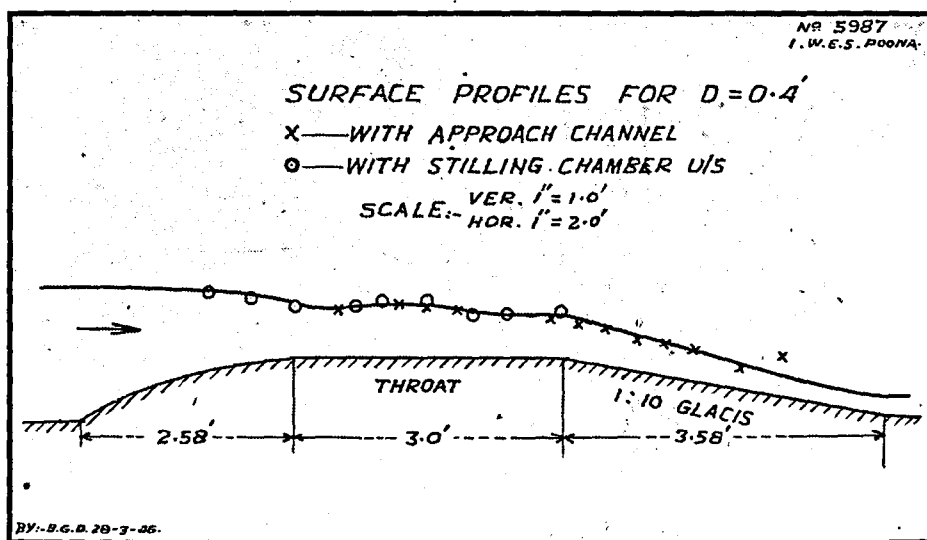

Fig. 108

For $D = 0.4'$, a characteristic hump was observed for a certain length at the entrance to the throat, (Fig 108). The reason underlying this formation of the undulatory wave has been explained by Bakhmeteff⁽¹⁾ as a "transitory" stage of flow in the state of establishing itself. An example is the entrance portion of a flume (Fig. 109). Above section (A) there lies the undisturbed level of the reservoir. Below section (B), flow is uniform. The stretch between sections (A) and (B) is the transitory part in which uniform flow establishes itself. In fig. 109 this transitory stretch presents an undulatory surface. Such is always the case when the slope of the flume is mild or to be more specific, when flow which is in process of establishing itself, is "tranquil".

Fig. 109

(1) "Hydraulics of open channels" by B. A. Bakhmeteff, Page 62.

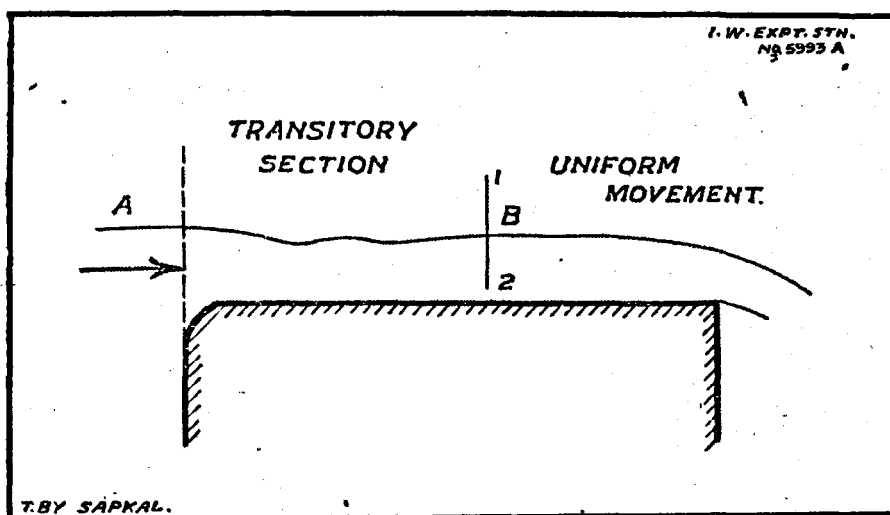

Fig. 109

In broad-crested weirs, specially, the flow is in the neighbourhood of critical depth, where the depth curve is very steep. So a large variation in depth can take place with very little change in energy of flow. When the movement in the transitory stage is rapid then there are no such undulations.

In order to see the range of D in which this transitory undulating flow occurred, an experiment was carried out in which D was slowly increased from 0.2' to 0.6'. The minimum value of D for which this peculiar hump did not occur was found to be about 0.56 ft.

5. Curvature of flow.

Pressures on the bed, at the centre of the Standing Wave Flume corresponding to various values of D are also shown in figs. 106 and 107. The pressures at the end of the throat were less than the corresponding depths of water. This negative pressure on the bed, at the end of the throat (i.e. difference between depth of water and pressure on the bed), which is a measure of the convex curvature, apparently increases for higher values of D . At the entrance to the throat there is little difference between depths of water and corresponding pressures, even for $D = 1.2'$: the curvature at the entrance of the throat is thus less pronounced.

The effects of this convex curvature at the end of the throat is to reduce the value of the critical depth at the edge, and to make the critical depth occur at a certain distance before the edge of the weir as explained by Bakhtmeteff⁽¹⁾ :

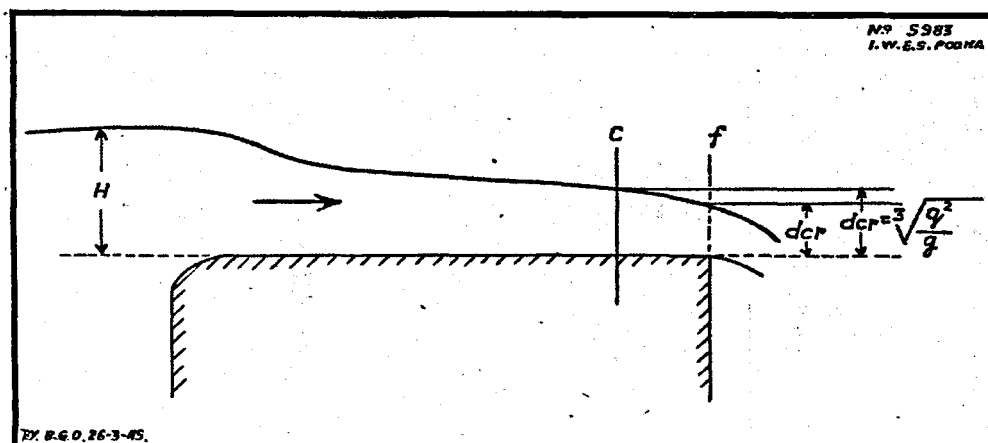

Fig. 110

(1) 'Hydraulics of Open Channels' by Bakhtmeteff, page 43.

Fig. 106 & 107

TABLE 24

2' Standing Wave Flume experiments.

Table showing actual depth of water observed on centre line at various places as compared to D upstream over sill of Standing Wave Flume.

S.No.	D Depth upstream over sill in feet.	Depth of water at entrance to the throat in feet.	$2/3 D$	Position where $2/3 D$ of flow was observed (measured below entrance section in feet.)	D_2 depth of flow over sill where flow was parallel in ft. (i.e. equal to pressure head)	Position where flow was parallel from section noted below (measured from entrance in ft.)	$\frac{D_2}{D}$	Condition of flow
1	2	3	4	5	6	7	8	9
1	0.410	0.280	0.273	0.6' & 1.6'	0.247	2.0' — 2.4'	0.603	Free flow downstream
2	0.417	0.315	0.278	1.8'	0.278	1.8' — 2.0'	0.60	Standing wave; $\frac{D_2}{D} = .8$
3	0.807	0.593	0.538	0.5'	0.462	1.8' — 2.2'	0.573	Free flow downstream
4	0.810	0.600	0.540	0.5'	0.483	1.5' — 2.2'	0.597	Standing wave; $\frac{D_2}{D} = .7$
5	1.200	0.900	0.810	0.67'	0.66	2.2'	0.542	Free flow downstream
6	1.207	0.910	0.805	0.67'	0.67	2.3' — 2.5'	0.555	Standing wave; $\frac{D_2}{D} = .83$
7	0.60	0.442	0.400	0.4'	0.362	1.2' — 2.4'	0.603	Free flow

* In all these experiments, the velocity of approach was negligible and D_1 was equal to D .

Fig. III.

2 Ft. Standing Wave Flume Expts.
Plan showing water profile contours in
the throat; free flow d/s. $D u/s = 0.817$
(all figures are for depths above sill level)

scale: HOR: 1" = 1' 0"
VER: 1" = 1' 0"

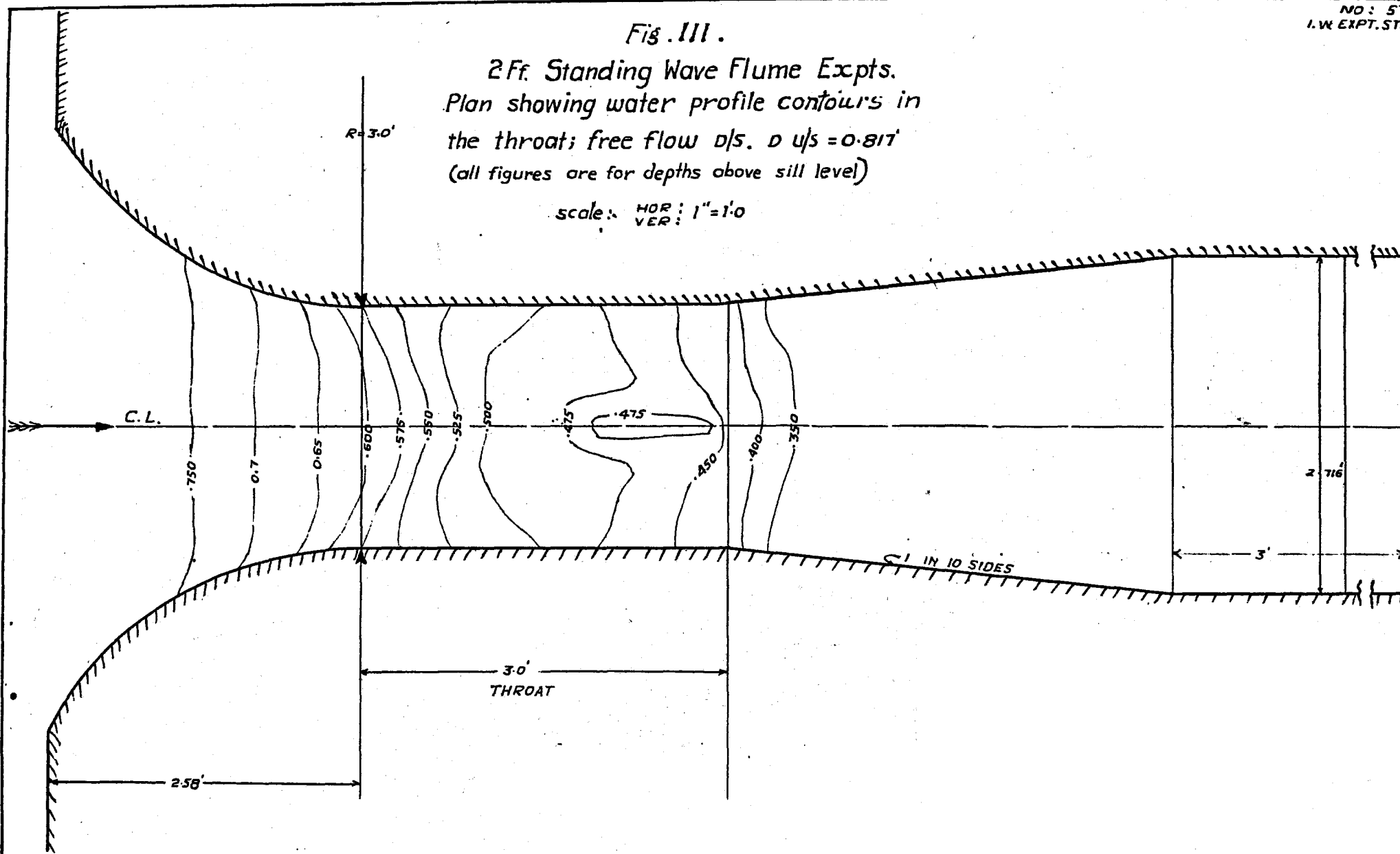

"Experiments show that in actual movement over a broad-crested weir—Fig. 110— the critical depth $d_{cr} = \sqrt[3]{q^2/g}$ is attained by the surface at a certain distance before the edge of the weir and that the depth d'_{cr} over the edge is somewhat smaller. The explanation lies in the fact that the critical depth $d_{cr} = \sqrt[3]{q^2/g}$ was determined under the assumption of parallel flow. In other words $d_{cr} = \sqrt[3]{q^2/g}$ corresponds to flow with a possible minimum content of energy in parallel flow and parallel flow only. Fig. 110

For curvilinear flow, the minimum possible content of energy, corresponding to a discharge q differs from $D_{min.} = 1.5\sqrt[3]{q^2/g}$ corresponding to a parallel flow. It is greater for concave flow and smaller for convex movement.

Also the critical depth, determined as the depth at which flow with minimum content of energy takes place is smaller than $\sqrt[3]{q^2/g}$ for convex streaming and greater than $\sqrt[3]{q^2/g}$ for concave flow."

Due to this effect of convex curvature on the critical depth, the depth D_2 in the throat was always less than the theoretical value of $2/3 D$ (compare Table 24 columns 4 & 6 of table 24). Value of ratio D_2/D (table 24, col. 8), always less than $2/3$, decreases for higher values of D due to the increased convex curvature at the end of the throat occurring at the greater depths; with a standing wave, particularly at the lower depths, the ratio has a higher value than with free flow.

6. Length of parallel flow.

Table No. 24 gives the depth, D_2 of parallel flow and the position where parallel flow was observed as compared to position where $2/3D$ (D = upstream depth over sill) was observed.

For $D = 0.6'$, the flow was parallel over a considerable length, i.e. $1.2'$. The length for which flow remained parallel decreased for higher values of D ; e.g. for $D = 1.2'$, the flow was parallel over a very short length. For depths higher than this there will not be an appreciable length of parallel flow; which is a necessary condition for the discharge formula $Q = 3.09 BD^{1.5}$ to hold true for a Standing Wave Flume. So $D = 1.2'$ seems to be the limiting depth in the $2'$ Standing Wave Flume with $3'$ length of throat. The ratio $\frac{\text{Length of throat}}{D}$ comes to be about 2.5.

7. Conclusions.

The experiments clearly showed the existence of curvature in the Standing Wave Flume—see also fig. 111.

The curvature at the end of the throat increases for higher values of D .

The length over which flow remains parallel in the throat depends upon D and decreases with increase of D .

The depth D_2 of parallel flow is always less than $2/3 D$. The ratio D_2/D decreases for higher values of D .

8. Further experiments.

The extent of curvature at the end of the throat, for a given value of D , depends upon the slope of the downstream glacis: a steeper glacis will cause greater curvature of flow. So the effect of curvature on the maximum percentage recovery of head and the discharge coefficient in a Standing Wave Flume caused by different downstream glacis slopes are proposed to be determined in a separate series of experiments.

7. RAINFALL AND RUNOFF

" (i) TOTAL VOLUME OF RUNOFF "

20. On Sunspot Intensity Cycles as a Medium of Predicting the Probable Dates of Occurrence of River Floods.

1. Introduction.

Much work has been done in the past — without much success — on cycle analysis to determine (a) the maximum extent of weather variations, e.g. temperature, rainfall etc., and (b) the approximate time intervals between such extreme variations. Quoting A. Streiff:⁽¹⁾ "So many periodicities are found as to cast doubt on their reality. Different parts of a record yield different sets of elements. These, if continued into the future, do not furnish the actual continuation of the record. Correlations, if found, are fragmentary, discontinuous, irregular. In attempting to resolve a curve into variable cycles, the problem leaves the field of rigorous mathematics, and is only solvable in an approximate way. Only those cycles which clearly are caused by the earth's motions—the diurnal and annual cycles — are of equal period, but have by no means a homogeneous amplitude. Horace Lamb states 'The problem is indeed indefinite, for the solution is possible in an infinite number of ways.'"

Even granting that the weather may be purely fortuitous or governed entirely by terrestrial causes, Shuman⁽²⁾ says, "there should be no objection to utilising the fact that a certain cycle can be derived statistically from the sunspot numbers, varying in periodicity depending upon the length of two consecutive solar cycles, and which is named the BRUCKNER CYCLE; and that also a similar cycle derived by similar processes in river runoff, rainfall, temperature, lake levels, etc., is identical in its general pattern, although varying in phase from place to place."

Taking a cue from this remark, in connection with the problem for ascertaining the worst conditions of water-supply to Bombay City, annual Sunspot Numbers⁽³⁾ data for the years 1850-1943 (which were obtained from the India Meteorological Department) have been subjected to a Bruckner⁽⁴⁾ cycle analysis to discover what indications, if any, are available of probable low years. If confirmatory evidence can be first adduced in respect of the similarity of the Bruckner cycles for sunspot numbers and for the quantitative measures of climate, e.g. precipitation, in view of the relatively longer period for which data of annual sunspot numbers is available than of, say, rainfall, such an association, if it exists, would be most valuable for examining periodicities in weather phenomena, which cannot be directly done for lack of sufficient data. There would still remain the fixing of the appropriate *phase* differences before the actual periodicity of the weather phenomena can be correctly inferred from that of the Sunspot Numbers; but this difficulty could possibly be overcome by analysing other similar data for purposes of cross-identification of the Phase differences.

(1) A. Streiff "On the Investigation of Cycles," U.S. Dept. of Agri., Monthly Weather Review (1926), p. 289.

(2) J. H. Shuman in Discussions on "Flood Stage Records of the River Nile," Proceedings of the American Society of Civil Engineers, Vols. 61 & 62.

(3) Sunspot numbers are averages of the daily numbers of spots counted on standard size photographs of the sun's disc made at a number of internationally recognized observations: Kodaikanal observatory in South India is one of them. The number of sunspots is known to have a periodicity of approximately 11 years and hence it is possible to indicate roughly the general course of the curve of frequency of sunspot numbers; but the prediction with any accuracy of the number of spots in any year is difficult.

(4) This was first discovered by Bruckner, and given by him a varying length of 25 to 50 years, its average value being set at \pm 35 years due to the fact that the cycle was compositely made up of the secular and 2 solar cycles.

FIG. 112.

CYCLE ANALYSIS BY MEANS OF
BRUCKNER'S CURVE METHOD

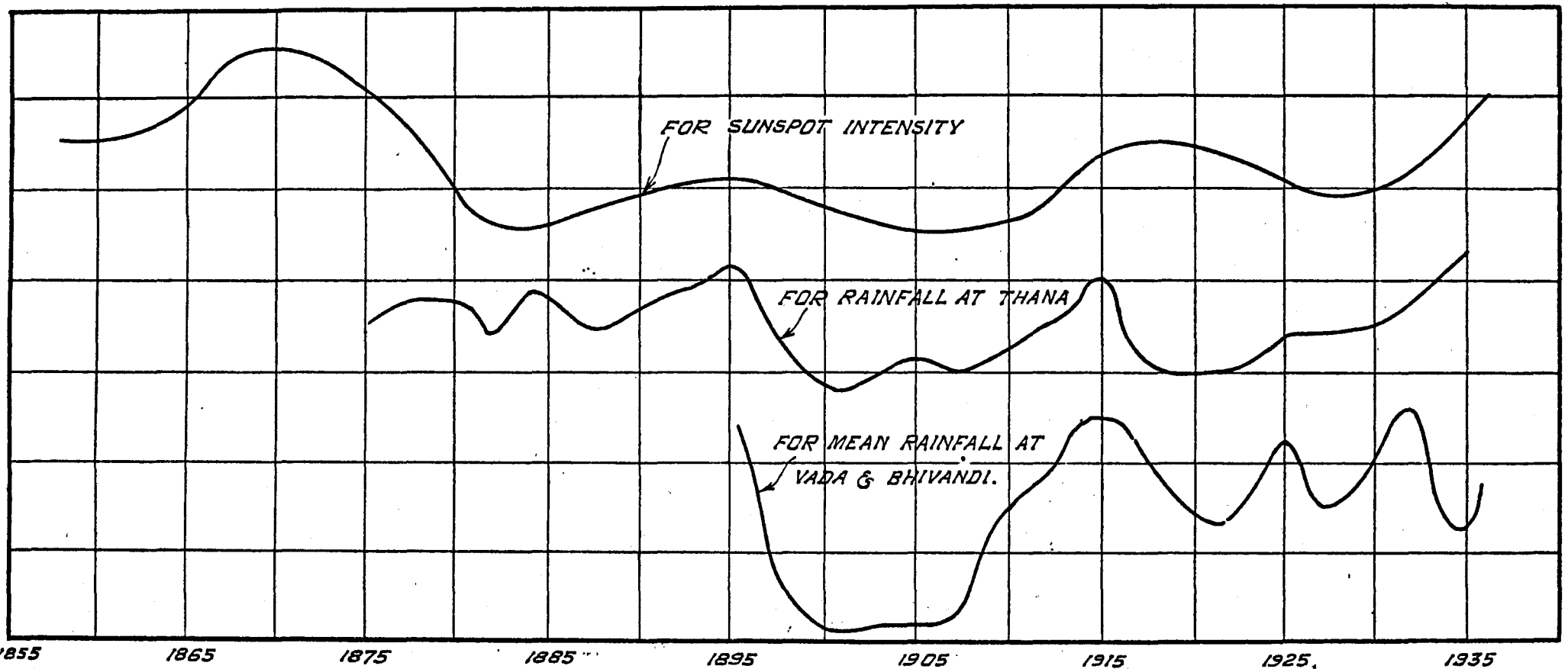

1855

1865

1875

1885

1895

1905

1915

1925

1935

By: PARHNI.
30-3-46

2. Method.

The actual method of deriving the Bruckner cycle which is, in essence, an approximate cycle analysis consists of the following steps: (i) a five year moving average (R_4) weighted with the five binomial coefficients 1, 4, 6, 4, 1 is fitted to the data of the five successive years in each group; (ii) The departures (S_1) of the observed data from the moving average figures (R_4) are then plotted against the corresponding years; (iii) a median line (M_1) is drawn through the curve for S_1 ; (iv) A plot of the points for $R_4 + M_1$ for each year will now yield what is known as the Double Wolf or the Hellman cycle; and (v) the median line of this cycle will finally give the Bruckner cycle.

3. Discussion of Bruckner Curve for Sunspot Numbers.

The Bruckner curve thus derived from the sunspot Numbers date (1850-1943) and shown on fig. 112 reveals the following features:

Fig. 112

Peaks are observed in the neighbourhood of 1869-70, 1894-95, 1917-18 and 1937-38. Troughs are observed in the vicinity of 1857-58, 1883-84, 1907-08 and 1928-29. Thus, the intervals between the peaks equal, respectively 25, 23 and 20 years: while those between the troughs equal 26, 24 and 21 years. A continuity of similar trends would indicate a trough in the neighbourhood of 1946-48. Therefore, if any correlation can be established between the periodicity for rainfall and periodicity for sunspot numbers it may be fair to expect low rainfall years during 1946-48.

2. Comparison with Bruckner Curves for rainfall near Bombay.

With this object in view, two more Bruckner curves, respectively for (i) the rainfall recorded at Thana raingauge, which has records going back to 1867, and (ii) the mean rainfall of 2 raingauge stations—Vada and Bhivandi—which bears a very high and real correlation with the monsoon runoff at Tansa—have been superimposed on the curve for sunspot numbers in fig. 112. Some degree of general resemblance is seen from the three curves. But both the rainfall curves, perhaps due to other complicating features, reveal a few more peaks and troughs, thereby making it unwise to depend on an invariable agreement between the corresponding peaks and troughs. It would not, therefore, be safe to look to variations in sunspot intensity as a guide to corresponding variations in weather phenomena.

Fig. 112

5. Conclusion

From a study of the Nile River data for 1738-1921 Shuman has also come to a similar conclusion: "The Bruckner cycle derived in the flow records of the River Nile, are just about, if not exactly, in phase with the Bruckner cycle in sunspot numbers The question arises, can any of these cycles be extended into the future, with any dependability? The answer would have to be negative, if these data were available." Shuman further concludes that extreme values in the variation of weather are not brought about suddenly, but only approached in an oscillating, pyramiding manner, culminating at the extreme values so that only values embraced in, say, not more than 200 to 300 years, are necessary for any type of analysis. "Great catastrophes", he says "such as those observed in the past did not strike from "a clear sky", but were the culminating point in a stormy period of greater intensity than normal, and which developed gradually enough so that with proper knowledge, due warning of their approach was given. The Ministry of Public Works of Egypt, in discussing the hydrology of the Nile Basin, states that these records of the flow of the river have been analysed for periodicities, and periods of small amplitude have been found. They are, however, so masked in irregularities as to be useless for forecasting purposes. A connection exists between conditions in the South Atlantic and the Nile, but up to the present it has not been possible to make a forecast of the flood which is sufficiently reliable for practical purposes. However, as the science of meteorology develops and the nature of the mechanisms producing the flood becomes known in detail, it may be possible some day to produce an accurate forecast of the nature of the flood some months in advance ...". For the same reasons, this indirect analysis cannot be used for predicting Bombay rainfall to any degree of dependability.

GENERAL.

21. Methods followed in fixing model scale ratios and overcoming model limitations, based on experience gained at the Indian Waterways Experiment Station, Poona.

by
Rao Bahadur D. V. Joglekar and
Sir Claude Inglis, C. I. E.

Contents.*Introduction.**Types of models.*

Type I. Geometrically-similar models which give geometrically-similar results.

Type II. Geometrically-similar models which do not give geometrically-similar results.

Type III. Models with mobile beds, in which 'flow pattern' is the dominant factor.

Type IV. Vertically-exaggerated models of rivers (tidal and non-tidal):

- (a) rigid;
- (b) semi-rigid;

and (c) mobile.

Type I *Geometrically-similar models which give geometrically-similar results.*

Rigid (a) Coefficients of discharge.

(b) Standing wave relations.

Semi-rigid (c) Lines of flow at off-takes.

(d) Scour downstream of falls.

Example I (a) (i) Coefficient of discharge of Standing wave flume.

(ii) Determination of the variable coefficient of the 10,595 cusecs Tando Mastikhan Fall on the Rohri Canal, Sind.

(iii) Coefficient of discharge of Nira Left Bank Canal Head Regulator.

Example I (b) (i) Position of standing wave with various discharges & different designs of sill at Sukkur Barrage.

Example I (c) (i) Design of off-take at the entrance to the right pocket from the Approach channel at Sukkur.

(ii) Lines of flow at off-takes.

Example I (d) (i) Scour downstream of flumed falls.

Types I & II combined. Siphon spillways.

Type II Geometrically-similar models which do not give geometrically-similar results.

Example II (i) High-coefficient weirs.

Type III Vertically-exaggerated models with mobile beds, in which flow pattern is the dominant factor.

Example III (i) Geometrically-similar models. Flow pattern downstream of rigid structures.

(ii) Vertically-exaggerated models: scour downstream of rigid structures.

Type IV Vertically-exaggerated models.

- (a) rigid;
- (b) semi-rigid;
- and (c) mobile.

Type IV (a) Rigid, vertically-exaggerated, models. Scale ratios of tidal models.

Example IV (a) (i) Hooghly rigid tidal models.

Type IV (b) Semi-rigid, vertically-exaggerated, models.

Example IV (b) (i) Hooghly semi-rigid tidal model (long).

Example IV (b) (ii) " " " " (short).

Example IV (b) (iii) Port of Rangoon tidal model.

Type IV (c) Vertically-exaggerated mobile models.

Method of calculating scale-ratios in vertically-exaggerated mobile river models:

(1) Introduction

(2) Selection of scale ratio

I Longitudinal scale ratios

II Latitudinal " "

III Discharge " "

VI Sand " "

V Depth " "

VI Slope " "

VII Time " "

(3) *Difficulties experienced in river model experiments due to effects caused by vertical-exaggeration.*

(i) Exaggerated scour near rigid structures.

(ii) Incorrect 'throw-off' from rigid structures.

(iii) Necessity of tilting masonry structures.

(iv) Exaggerated size of vortices caused by rigid structures.

(v) Necessity of having different scales for rigid and non-rigid portions due to excess friction losses in the rigid portion of models.

(vi) Exaggerated length of standing wave in plan.

(vii) Longitudinal distortion.

(viii) Different time scales for scour and accretion.

*Conclusions**Appendix I*

Equivalent size and specific gravity of stones and blocks in a model.

INTRODUCTION

There are few subjects concerning which so much confusion of thought exists as about the correct role of hydrodynamic models⁽¹⁾. Some engineers believe that models can always be relied on to give correct results, others that they are highly untrustworthy. Neither of these views is correct. Some types of models give results which are almost identical with those in the prototype; others give results which require correction for known errors; while the type with which we are mainly concerned—models of alluvial rivers, the banks of which are eroding—give only short-term accuracy. In complex river problems, correct interpretation depends on wide field knowledge combined with a scientific background and long experience of river model investigation. River model experimentation is not, in fact, an exact science, but an *art*.

The aim of this Note is to explain why some experiments give reliable results, while others depend to a marked extent on making correct assumptions.

The methods followed in designing models and in carrying out experiments are described in detail; and pitfalls to be avoided, and difficulties to be overcome, are explained; with suggestions as to how to mitigate inherent discrepancies. It must, however, be emphasised that no two rivers present the same problem, and that success depends mainly on correct diagnosis of the past and inspired prediction of the future.

Generally speaking, Research Stations are not consulted about cases until conditions have reached a serious stage. Drastic methods have then to be adopted to avoid a catastrophe; and that too, in a short interval of time. A single mistake would generally be fatal, so a heavy responsibility rests on those giving advice. Although it is easy to use formulas, the best we know, for working out model scale ratios *as a first approximation*; thereafter the less we think in terms of thought-numbing formulas the better.

Experiments should only be started after the model is considered to be reproducing known conditions with a high degree of approximation. This will only be attained after the model has been run for some time to allow it to adjust itself by sifting the coarse particles from the fine in different parts of the model where scour or accretion is taking place. The model also requires time to correct errors made in laying—resulting from inadequate or incorrect data. Thereafter, when the model is relaid for subsequent experiments, it should be laid for the conditions existing after the model has corrected itself.

TYPES OF MODELS.

Various types of models are described below, quoting specific examples of each type.

- Type I. Geometrically-similar models which give geometrically-similar results.
- Type II. Geometrically-similar models which do not give geometrically similar results.
- Type III. Models with a mobile bed, in which "flow pattern" is the dominating factor.
- Type IV. Vertically-exaggerated models of rivers (tidal and non-tidal):
 - (a) Rigid;
 - (b) semi-rigid;
 - and (c) mobile.

(1) "Hydrodynamic models as an aid to engineering skill" by C.C. Inglis. Presidential address, Engineering Section of the 28th Session of the Indian Science Congress, Benares 1941.

Type I. Geometrically-similar models which give geometrically-similar results.

In this type, the models are rigid and the changes in energy relations between velocity and pressure are the chief factors affecting results, requiring a similar Froude Number (V^2/gd) in model and prototype. This is easily attained in some experiments in which our aim is to determine

- (a) Coefficients of discharge,
and (b) Standing wave relations;

but *approximately* accurate results can also be obtained as regards

- (c) lines of flow at off-takes,
and (d) scour downstream of falls.

A few examples of these kinds of models will now be given; with references to more detailed information contained in Bombay P.W.D. Technical Papers and Annual Reports of the Poona Station when it was known as the Central Irrigation & Hydrodynamic Research Station; and later when renamed the Indian Waterways Experiment Station.

Coefficient of discharge of S. W. Flumes⁽¹⁾.

Standing wave flumes give geometrically-similar results provided the models are made relatively smoother than their prototypes; but there is a limit to the effect caused by making the surface smoother which occurs when the roughnesses are fully covered by the laminar layer. At this stage flow changes to smooth turbulent flow.

More generally, however, the surface of structures are sufficiently rough to produce a type of flow intermediate between smooth and rough turbulent flow, or the flow may be fully turbulent. Under such conditions the coefficient of discharge for equal roughness increases with the discharge; so the discharge coefficient tends to vary with the discharge.

TABLE 25

<i>Discharge</i>	<i>C</i>	<i>Formula</i>
2 to 10 cusecs.	$C = .97$	$q = 3 BD^{1.5}$
11 to 50 cusecs.	$C = .98$	$q = 3.03 BD^{1.5}$
51 to 500 cusecs.	$C = .99$	$q = 3.06 BD^{1.5}$
501 cusecs and above.	$C = 1$	$q = 3.09 BD^{1.5}$

From this it follows that when models are used to determine coefficients of discharge, allowance should be made for the greater loss in the model before applying results to the prototype flume.

Using Manning's formula

$$V = \frac{1.486}{N} R^{\frac{2}{3}} S^{\frac{1}{2}}$$

and assuming the same roughness in the model as in the prototype:

$$\begin{aligned} h_f \text{ (frictional loss)} &\propto LV^2 / R^{4/3} \\ &\propto \frac{(\text{scale ratio})^2}{(\text{scale ratio})^{4/3}} \\ &\propto (\text{scale ratio})^{2/3} \end{aligned}$$

In other words, the frictional loss is *not* geometrically-similar. Thus let h_f in a full scale flume with depth above throat = 10', be = .153'; h_f in 1/10 scale geometrically-similar model will be = .153/(10)^{2/3} = .033 ft. Thus D in large flume,

(1) See item 9 of I.W.E.S. Annual Report (Tech) 1944, p.84

including loss in friction = 10.153' and D in small flume, including loss in friction, 1.033'. To find C, the coefficient of discharge in the model with D = 1.033'; assuming C in prototype = 3.09,

$$\begin{aligned}
 q \text{ of model} &= \frac{q \text{ of prototype}}{\text{scale ratio}^{1.5}} \\
 &= \frac{3.09 \times (10.153)^{1.5}}{(10)^{1.5}} \\
 &= 3.16 \text{ cs/ft.} \\
 3.16 &= C_1 (1.033)^{1.5}
 \end{aligned}$$

or C_1 (of model) = 3.01 (against 3.09 of prototype).

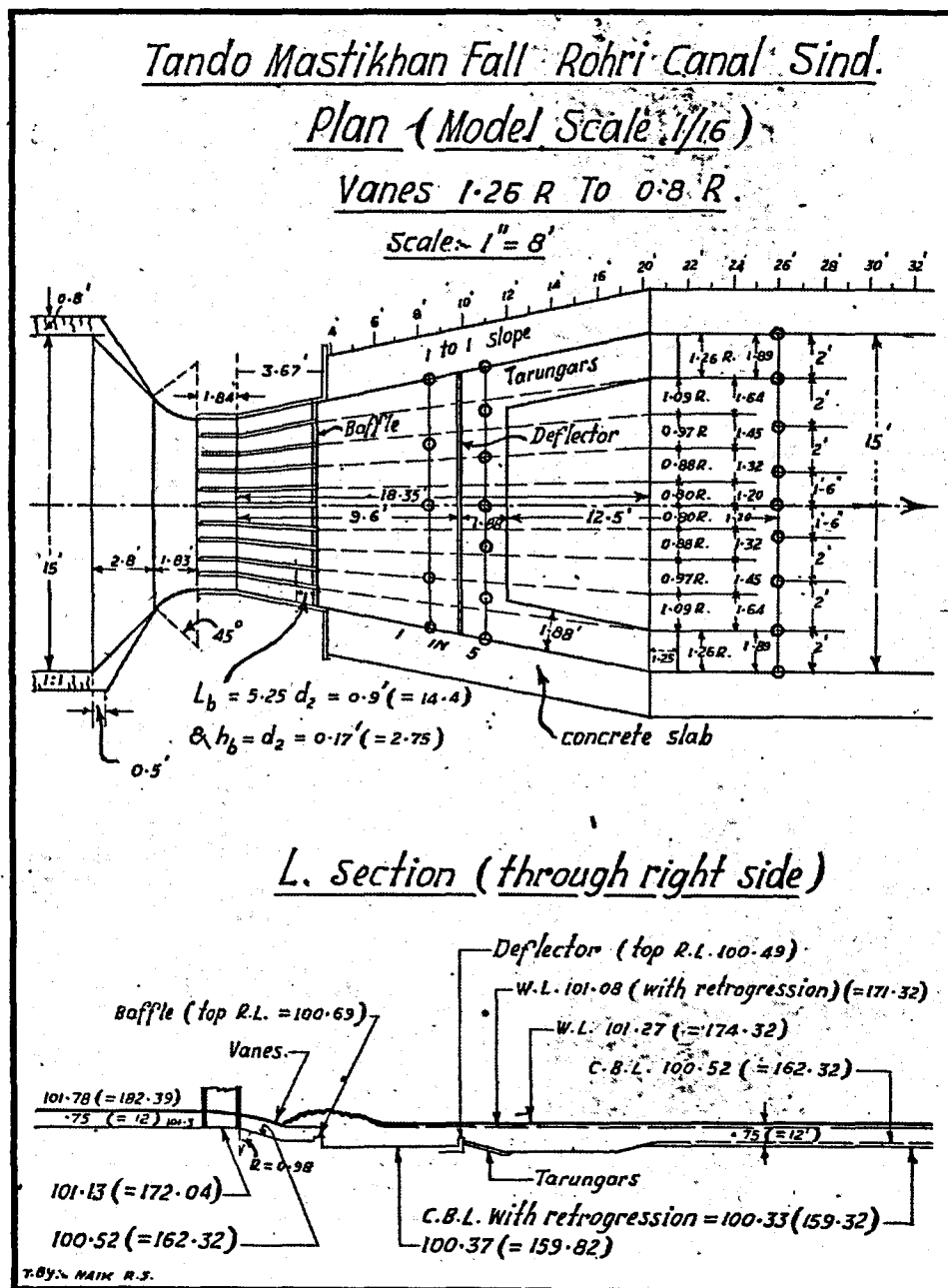

Fig. 113

Example I (a) (ii)

Fig. 113 DETERMINATION OF THE VARIABLE COEFFICIENT OF DISCHARGE OF THE 10,595 CUSECS TANDO MASTIKHAN FALL ON THE ROHRI CANAL, SIND.⁽¹⁾

Fig. 114 These experiments with a geometrically-similar model, in which the relative roughness was correctly maintained, have shown that the coefficient of discharge *decreased* with increase of discharge and hence depth—due to impact losses at pier noses increasing with depth as the proportion of piers submerged—*increased*. The discharge formula of the Tando Mastikhan Fall in Sind was found to be

$$Q = C_1 (B - K_n D) D^{1.5}$$

where

K = coefficient of contraction

= 0.083 in Tando Mastikhan Fall,

n = Number of piers = 9 in Tando Mastikhan Fall,

B = Waterway = 100 ft.,

D = D_1 (Depth of water upstream over sill of flume) + $V^2/50$,

and C_1 = a coefficient.

The accuracy of the results obtained in the model has been borne out by observations in the canal.

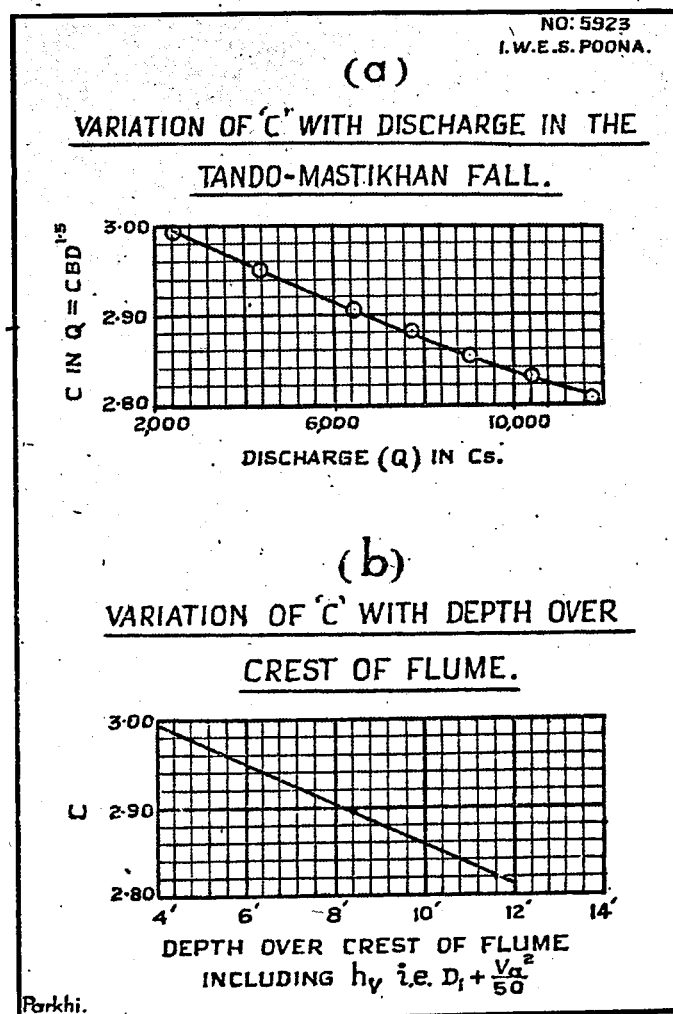

Fig. 114

⁽¹⁾ Appendix III of item 9 of Annual Report (Tech.) 1944, pp. 48, 49, also C.I. & H.R.S.A.R. (T) 1939-40 pp. 59-60 "Effect of piers on coefficients".

*Example I (a) (iii)*COEFFICIENT OF DISCHARGE OF NIRA LEFT BANK CANAL
HEAD REGULATOR.⁽¹⁾

In this case, the problem was to increase the discharge of an existing regulator, consisting of 7 spans of 4 ft., by 50 per cent. Not merely was this achieved by bell-mouthing upstream entrance and constructing an expansion downstream, but the coefficient C (in the formula $Q = VA = AC \sqrt{2gh}$) was increased from .81 to 1.93, making it possible to increase the discharge 2.3 times, with the same head.

Figure 115 shows the original design in full lines and the modified design in dotted lines. The masonry of the sluices in the prototype is of coarsed rubble (second sort). In the model, this was represented by rough-cast cement plaster to obtain approximately the same relative roughness.

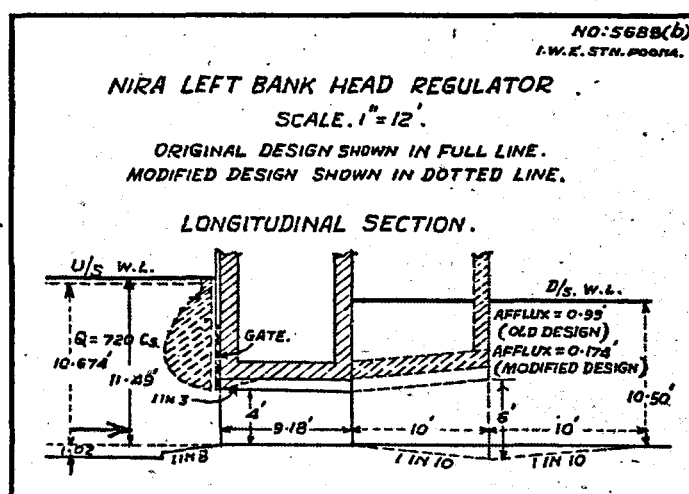

Fig. 115

*Example-I (b) (i)*POSITION OF STANDING WAVE WITH VARIOUS DISCHARGES AND
DIFFERENT DESIGNS OF SILL AT SUKKUR BARRAGE.⁽²⁾

The original design of the Barrage profile consisted of 1 in 30 upstream slope, an 80 ft. length of horizontal sill at R. L. 176 and a downstream glacis slope of 1 in 70. Experiments carried out at Poona showed that the upstream and downstream slopes were much too flat and they were, as a result, altered to 1 in 5 upstream and 1 in 10 downstream and the length of the sill was reduced to one foot and the pavement level lowered to increase the coefficient of discharge and to hold the standing wave just downstream of the Barrage. The undersluice pockets had already been constructed according to the original design; but the main Barrage was constructed according to the recommended design. The model showed that with the original design and anticipated retrogression, the standing wave would, under certain conditions, form *downstream* of the pavement; whereas with the modified design, it would always form *on the glacis*, near the Barrage.

In the undersluice pockets, where the original design had been followed before the alteration was recommended, the cut-off (difference of water-levels upstream and downstream of the barrage) has to be restricted to about 5 ft., because there is an unbalanced standing wave condition with large heads, leading to dangerous bed-scour downstream of the pavement.

(1) Bombay Tech. Paper No. 54 'Note on experiments with a model of the Head Sluices of the Nira Left Bank Canal'.

(2) Bombay Tech. Paper No. 29 'Note on experiments carried out with various designs of piers and sill in connection with the Lloyd Barrage at Sukkur'.

LINES OF FLOW AT OFF-TAKES

Example I(c) (i)

DESIGN OF OFF-TAKE AT THE ENTRANCE TO THE RIGHT POCKET
FROM APPROACH CHANNEL AT SUKKUR⁽¹⁾

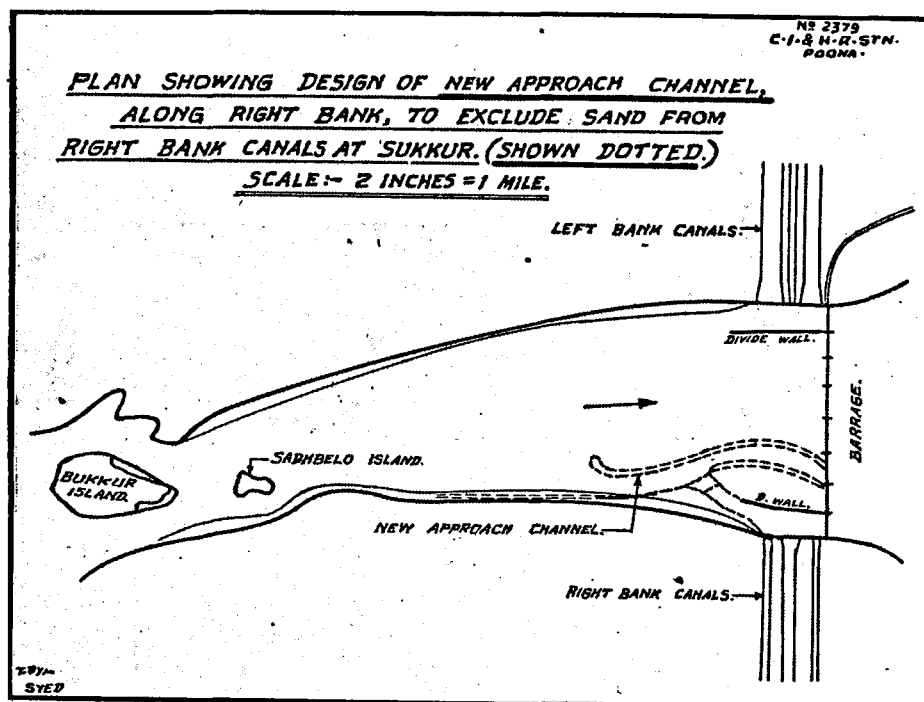

Fig. 116

Fig. 116 Figure 116 is an Index plan of the Indus above the Sukkur Barrage with the new approach channel, which is designed to control the quantity of sand entering the Right Bank Canals. These hitherto drew an excessive load of bed sand. As a result of model experiments carried out 15 years ago⁽²⁾ it was predicted that a sand bank would form along the right bank, and that accretion would occur in the right bank canals.

The advice then given was not acted on; but in the floods of 1936, when the River carried an exceptionally heavy charge of bed sand, heavy accretion occurred in the North-West and Rice Canals. Various alternative methods of reducing the quantity of sand entering the canals were then tested. The design recommended consisted of a curved approach channel 5,000 ft. long—shown in Fig. 116. This investigation presented many difficulties; and six different models (with various scale ratios) were eventually used to determine the effect of different factors. In this particular experiment, a geometrically-similar, part-width, model was used; the same model being later used with increased depths to give a vertical exaggeration of 2, compared with a vertical exaggeration of 7 in the model of the whole river. This model showed that the width at entry should be made 35 per cent less than shown by the vertically-exaggerated river model.

⁽¹⁾Annual Report of C.I. & H.R. Sta, for 1937-38 pp. 26-27

-do- 38-39 pp. 4-10

-do- 39-40 pp. 12-20

-do- 40-41 pp. 12-26

41-42 pp. 16-18

⁽²⁾Bombay P.W.D. Technical Paper Nos. 45, 46 & 52.

Example 1(c) (ii)

LINES OF FLOW AT OFFTAKES.

In Bombay Technical Paper No. 52⁽¹⁾, experiments have been described showing various factors affecting the quantity of sand drawn by off-taking channels. It was found from experiments carried out in models with *rigid* beds and *mobile* beds, that the former are liable to give quite wrong results, a fact which has been overlooked by many investigators. It is also very important to see that the model has the correct degree of vertical exaggeration.

*Example 1(d) (i)*SCOUR DOWNSTREAM OF FLUMED FALLS.⁽²⁾

Scour occurs downstream of falls due to :

(1) excess energy which gives rise to eddies and surging flow ;

and (2) instability of flow, due to a sudden or too sharp expansion, which causes 'heaving' and unbalanced flow, with return flow along one or both banks. This return flow forms a large, slowly-revolving, vortex with vertical axis, which pushes the forward flow away from the bank and thus causes 'jetting'. In this condition of flow, the large vortices rotate with a high peripheral velocity which, in turn, causes bank erosion, especially near the toe, so that the angle of repose of the bank is exceeded and large pieces of banks shear off causing deep embayments, often called 'bellies'. This condition can be prevented by constructing the pavement at such a level relative to the downstream water-level that a standing wave will form at the toe of the glacis of the fall ; and, to ensure that this will occur even should downstream retrogression develop, it is desirable to construct a baffle in such a position, and of such height, that the standing wave is always held at the toe, thus destroying a maximum of energy. A deflector at the downstream end of the pavement should also be constructed to throw the high velocity bed water towards the surface thus producing a bed-roller with horizontal axis, which will prevent, or minimise, downstream scour.

Where a fall has been constructed with too sharp an expansion, it can usually be made to function satisfactorily by building, in addition to a baffle and a deflector, diverging vanes in continuation of the piers, so designed as to fan out the flow.

The Tando Mastikhan Fall was constructed with much too sharply diverging sides, viz. 1 in 5 compared with 1 in 10 required, but when vanes were added to fan out the flow the fall worked very efficiently and still does so, confirming all the conclusions drawn from the model experiments. Fig. 115

Types I & II combined.

SIPHON SPILLWAYS.

Siphon spillways provide a border-line case between Type I and II; in that though they come under Type I as regards coefficients of discharge and pressures, they do not give geometrically-similar priming depths. The prototype also behaves differently from the model when the minimum pressure falls to the equivalent of 7 feet of water above absolute zero pressure, or say 27 feet below atmospheric pressure at sea level⁽³⁾

(1) Bombay P.W.D. Technical Paper No. 52 'Factors affecting exclusion of bed silt taking off from alluvial rivers'.

(2) - do - No. 44 and Annual Report (Tech) for 1944 (pp.29-55).

(3) Annual Report (Tech) 1939-40 pp. 27-29

" " " 40-41 pp. 27-31

" " " 41-42 pp. 26-28

" " " 42-43 pp. 24-29

Prof. Gibson⁽¹⁾ carried out experiments with various sizes of siphon models and has shown that the minimum size of model which gives dynamically-similar results (except priming depth) is such that $d \sqrt{h} > .28$, so as to ensure fully turbulent flow, where d = diam. of siphon and h is the operating head in ft.

Experiments carried out at Khadakvasla in 1928 with a 500 cusecs siphon and its 1/8th scale model showed that though the nature of priming curves and coefficients of discharge were similar in the model and prototype, the priming depth in the full scale siphon was considerably less than in the model, the minimum priming depth in the full scale siphon being 1.15 ft against the equivalent of 1.80 ft. obtained in the 1/8th scale model. Relative pressures were nearly the same at the inner shell, but pressures at the outer shell were slightly greater in the prototype. Thus we only get an approximation to dynamic similarity in pressures.

Prof. Gibson in the above-mentioned Paper showed that with a model in which the head was 3 ft. and a parallel section 12.125" wide by 4", the discharge increased by 3% per cent when the outlet was flared as shown in figure 117, but in experiments carried out at Poona, it was found that though flaring the outlet increased the discharge by 30.6 per cent in a model with head = 2.95 ft., in the full-scale prototype, which was 8 times as large (head = 24.0'), the discharge increased by only 3 per cent and cavitation occurred downstream of the crest, as shown in fig. 118.

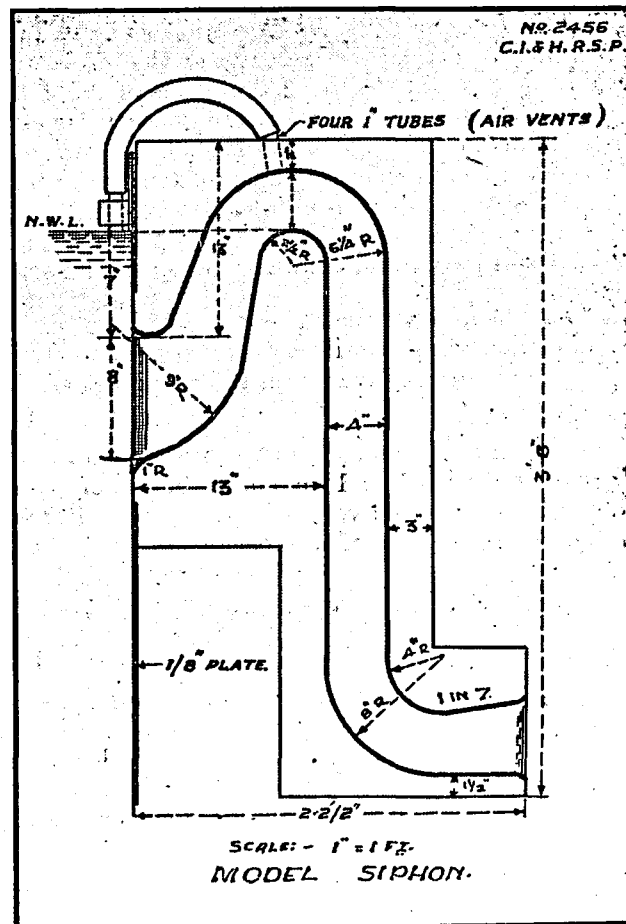

Fig. 117

It was concluded from these experiments that the limiting negative pressures in a well designed siphon is about 27 ft. at sea level and that where a siphon is working near to this limiting pressure, flaring the outlet cannot increase the discharge to an appreciable extent, and is undesirable, because it is likely to induce cavitation and vibration; but where the height of the siphon is small, flaring will increase the discharge to a marked extent.

(1) Inst. of C. E. Paper No. 4810 (1930-31) on 'Experiments with siphon spillways' by Prof. A. H. Gibson.

FIG. 118

SHOWING PRESSURES AT VARIOUS POINTS
IN A FULL SCALE SIPHON
THICK CURVES SHOW PRESSURES WITH A
FLARED EXTENSION ADDED DOWNSTREAM

SCALES [HOR: 1 INCH = 5 FT.
VER: 1 INCH = 4 FT.

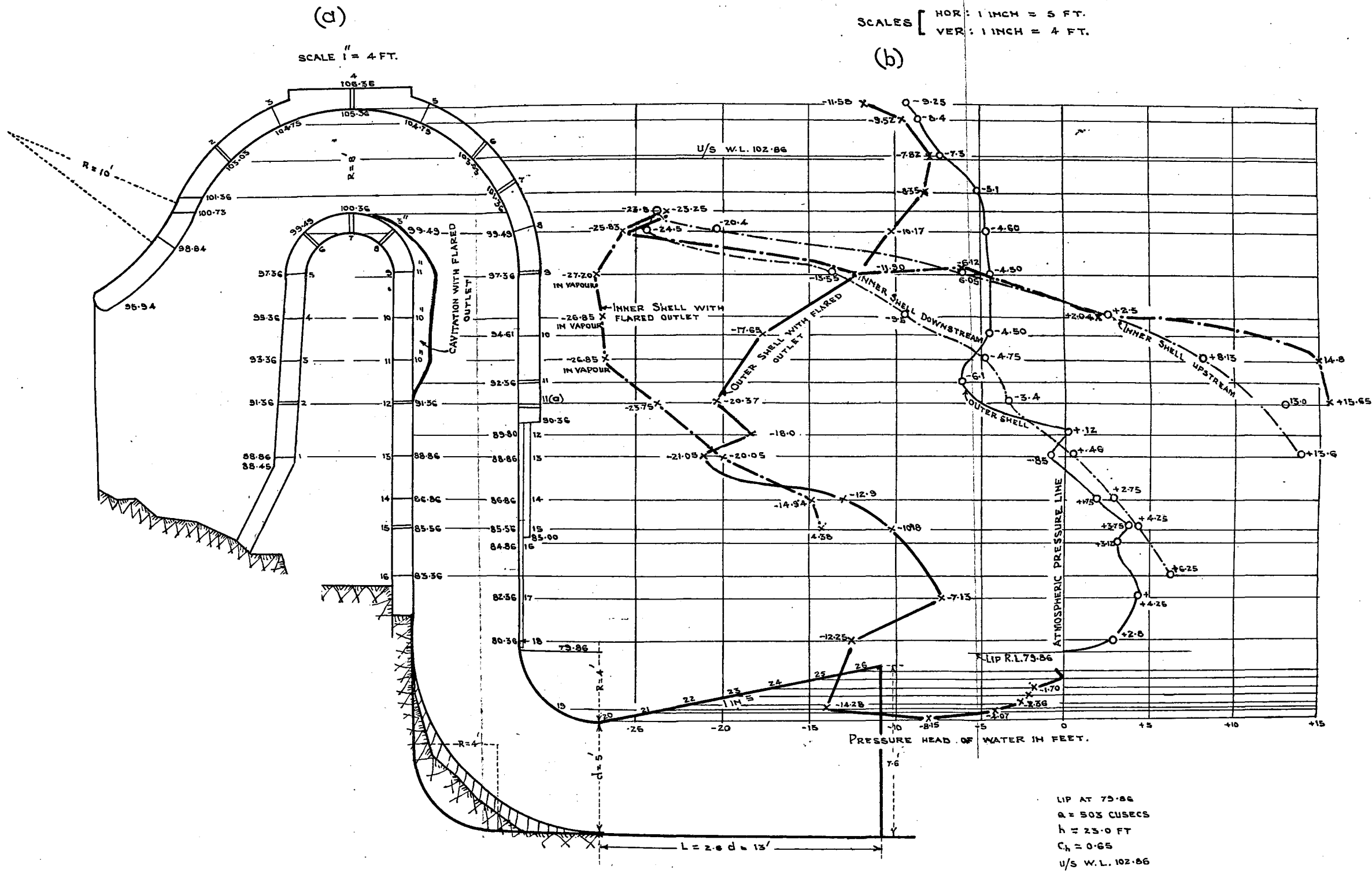

TYPE II. Geometrically-similar models which do not give similar results.

Example II (i).

HIGH COEFFICIENT WEIRS.

Experiments carried out at Poona to determine coefficients of high-coefficient weirs⁽¹⁾ showed that where the curvature of the Weir profile was sharper than the path which filaments of water would follow if discharging freely into air, the coefficient of discharge in the formula $q = c D^{1.5}$ (where q = discharge per foot run and D = upstream depth over weir) increases both with scale and of water over the weir. The former is due to the fact that as Q increases, the natural path of flow under aerated conditions diverges more and more from the curvature of the weir and hence, so long as the water adheres to the weir profile, a reduction of pressure occurs; and as

$$p/w + V^2/2g + Z = \text{constant}$$

for a filament (Bernoulli's theorem), the velocity is correspondingly increased and also the discharge.

No theoretical method of estimating the discharge in the prototype being known, models to different scales were constructed and their results extrapolated to arrive at pressures and discharges to be anticipated in the prototype.

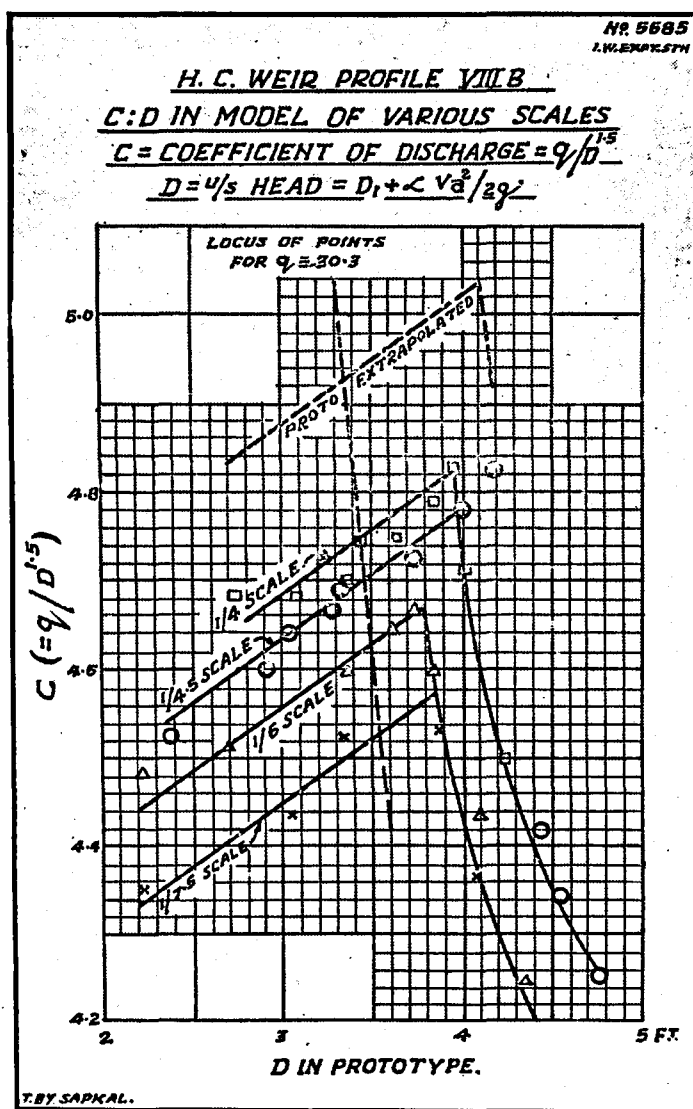

Fig. 119

(1) Annual Report of the C.I. & H.R. Station for 1937-38 pp. 39-44.
 " " " " " " 39-40 pp. 45-50.
 " " " " " " 40-41 pp. 42-50

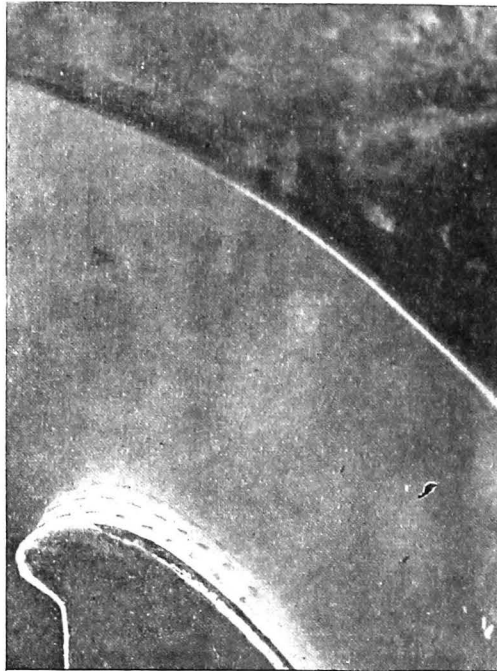

Photo No. 2255. Showing separation of the nappe at side.
(Note the silk threads in the centre and at side).

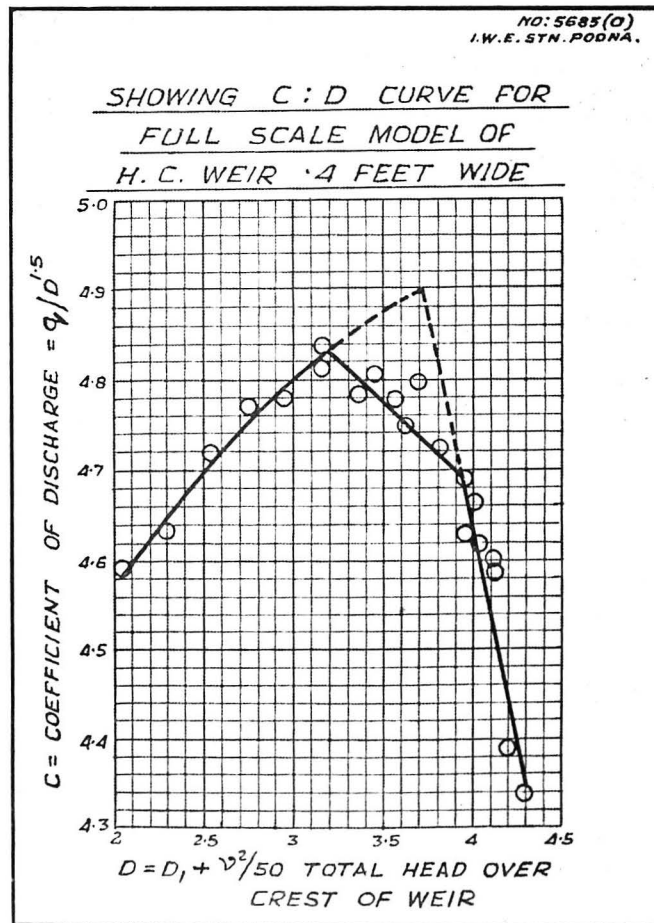

Fig. 120

Figure 119 shows the coefficients obtained in models with scales of 1/4, 1/4.5, 1/5 and 1/7.5 of the prototype. From this it will be seen that the larger the scale the higher the coefficient. When these coefficients were extrapolated, the conclusion arrived at was that the coefficient in the prototype with $D = 3.35$ ft. and $q = 30.3$ cs. per foot would be 4.93, compared with 4.75, 4.7, 4.63 and 4.53 in the various scale models.

In this particular case, as a result of constructing a new 200 cusecs channel we had a check on the accuracy of the conclusions arrived at by extrapolation from small models to full scale; but even this presented difficulties—because, whereas the weir at Bhandardara is 650 ft. long, it was only 4 ft. in the model,⁽¹⁾ so that the effect of the side boundaries, which is negligible in the prototype, was considerable in the full scale model; and so had to be allowed for.

The method adopted after small-scale trials, was to contract the 8 ft. wide channel by a bellmouth into a 4 ft. wide channel containing the model. This had the effect of regularising velocities across the 4 ft. channel. It was necessary, however, to place the model sufficiently far downstream of the bellmouth for the flow approaching the weir to be sensibly parallel. As a result of this, slight boundary layer effect was present. A further difficulty arose due to retardation of the high velocity flow at the sides at the weir. Providing a very small degree of expansion in the side walls reduced the retardation effect at the sides and permitted more axial flow; but caused slight inward flow across the sill, which reduced the negative pressure over the crest, and so reduced the discharge coefficient. This inward bed-flow can be clearly seen in photo no. 2265, which shows threads fixed on the weir indicating distorted lines of flow. Photo 2265

Figure 120 shows the coefficients of discharge plotted against depths D in the formula $q = CD^{1.5}$ Fig. 120

It will be noticed that the coefficient instead of rising to a clear-cut maximum as in figure 119 rises on a curve and, before reaching its natural maximum, falls and meets the rapidly falling line at $C = 4.70$. Dotted lines show the rising and falling curves extrapolated. These meet at $C = 4.9$ with $D = 3.05$ ft. as compared with 4.93 extrapolated from small scale models; but whereas by that method the maximum value of C rose to 5.03 with $D = 4.10$, this was not attained in the part-width, full-scale model, due to side effect; but would be attained in a wide model. Fig. 119

Type III.

MODELS WITH MOBILE BEDS, IN WHICH FLOW PATTERN IS THE DOMINANT FACTOR.

Example III. (i)

Geometrically-similar models.

Flow pattern downstream of rigid structures.

In experiments in which it is desired to reproduce and observe lines of flow, a geometrically-similar model will, if laid with suitable material according to bed levels observed in the prototype, reproduce the prototype flow pattern so long as there is no sand in movement; but should sand be injected, deposition will occur in the scour-hole. A geometrically-similar velocity does not, in fact, create sufficient turbulence to maintain the scour-hole depth; and to create additional turbulence while maintaining geometrically-similar depth, would necessitate increasing the velocity and hence the discharge. This would introduce complicating factors, such as increased impact losses at piers, incorrect distribution of sand across the bed, and distortion of flow pattern, which, in the case of narrow channels, would lead to distortion in plan and exaggeration of "bellies".

(1) Annual Report of C. I. & H. R. Stn, Poona for 1940-41, pp. 42-45.

Example III (ii)

VERTICALLY-EXAGGERATED MODELS.

Scour downstream of rigid structures.

Provided the width is very great compared with the depth, as in the case of large rivers, vertical exaggeration is not objectionable: but where the depth of scour is considerable compared to the width of the channel, so that the side-slopes and "bellies" comprise a considerable part of the wetted perimeter, vertical exaggeration brings in many difficulties; because either the side-slopes must be vertically exaggerated, in which case the angle of repose is much too steep and the flow pattern incorrect; or else the banks must be given flatter slopes, approximating more closely to the angle of repose;—in which case, the model will be widely distorted in plan, the "bellies" being greatly exaggerated.

Thus, the most that can be done is to give a small vertical exaggeration in a big model, holding the sides against scour by the use of erosion-resisting material, and basing one's conclusions regarding the prototype on judgment and experience. We have followed this method with success; but it must be stressed that our recommendations have been mainly based on field experience, and very little on what the models showed, except for comparing the relative value of various alternatives — where the common error could be largely discounted.

*Example III (iii)*SCOUR IN THE GANGES DOWNSTREAM OF THE HARDINGE BRIDGE.⁽¹⁾

In this case, scour depended on 4 factors:

- (i) Curvature of flow upstream,
 - (ii) diving and rotary flow induced at the noses of piers,
 - (iii) 'depth: velocity' relation upstream and downstream,
- and (iv) material of bed downstream.

To reproduce (i), (iii) and (iv), vertical exaggeration was required; while (ii) required geometrical-similarity. Early experiments had been carried out with a full-width model⁽²⁾ with a vertical exaggeration of 7.7, the scale ratios being 1/500 horizontal and 1/65 vertical.

The object of these experiments was to reproduce the severe conditions under which the right guide bank breached on 26th September 1933 during a flood estimated at 1.7 million cusecs. The model was exaggerated in order to reproduce river curvature and similarity of bed scour: When, however, the stone-faced banks at Raita, Sara, Damukdia and the Bridge were vertically-exaggerated to these scales, they were so nearly vertical that the "throw-off" from the banks was quite wrong, the flow tending to hug the banks. Geometrically-similar banks were out of the question, as they would be far too large in plan, so a compromise was made, the banks being constructed to a slope of 1:1 (i.e. V. E. was reduced from 7.7 to 3). The result obtained was thereafter much more satisfactory, in that the cross-sections were more approximately reproduced in shape, though not in maximum depth upstream and downstream of the bridge. The reason for failure to reproduce the maximum depth was that the angle of repose was less than that required to reproduce correct depth in the scour-hole. This made it clear that in cases in which there was deep scour, reasonable similarity could only be obtained by using short-length, part-width, models of such portions, modifying the full-width model so as to reproduce, as nearly as might be, what occurred in the part-width models. Hence the necessity for several models.

(1) Annual Report (Tech) of C. I. & H. R. Station, Poona, 1941-42, pp. 81-82.

(2) Bombay P.W.D. Tech. Paper No. 55 'Investigations carried out by means of models in connection with the protection of Hardinge Bridge, E. B. Railway, (Now Bengal Assam Rly.)

In the present case, the following scale ratios were adopted:

Longitudinal = 1/500
 Latitudinal = 1/400
 and Vertical = 1/266
 and vertical exaggeration = 1.5.

Additional curvature was imposed by means of a curved approach channel and curved vanes as shown in figure 121.

The model was shortened to make the downstream curved expansion of the Right Guide Bank sharper than in the river, so as to reproduce similarity of flow in the form of a large whirl which formed in the river downstream of the Hardinge Bridge near the downstream end of the Right Guide Bank.

Effectively, entry conditions in the model were laterally contracted (a more correct way of visualising vertical-exaggeration) and so gave approximately correct curvature of flow for a short length at the point where it was required; and geometrical similarity also existed in the model for the part of the river under consideration.

In reproducing bridge piers in vertically-exaggerated models, the number of piers should generally be reduced to maintain approximately the same width to depth relation of waterway through each span as in the river; but if the number of piers in the river bridge is even, the number in the model should also be even, and vice versa.

The foregoing examples have been described in some detail to emphasise the importance of the various factors involved in examining scour downstream of rigid structures.

Type IV. Vertically-exaggerated river models.

- (a) rigid
- (b) semi-rigid
- (c) mobile

Type IV (a). Rigid, Vertically-exaggerated, river models.

The usual practice is to fix what experience has shown to be a suitable vertical exaggeration for the conditions and the material considered most suitable for the model, and then to verify slopes for various discharges. If the observed slope is only slightly in error, which will be the case if the model scales and selected roughnesses are suitable, intelligent adjustment in the light of local differences will produce the desired result; but if the design is incorrect, drastic roughening, such as is sometimes adopted at Research Stations, will only produce a sort of *pseudo-correctness*; and it will then be found that though the results may be all right for one discharge, they may be appreciably wrong for other discharges.

For this type of model, a large amount of data should be available, preferably extending over a period of five years or more, because the model, being rigid, cannot adjust itself where it is wrong; so, much patient 'trial and error' work is necessary which, experience at Vicksburg shows, may have to be spread over a period as long as two years. After such verification, it is assumed that approximately correct levels will be obtained for conditions outside the verified range—as for instance in a flood of greater magnitude than previously observed or during peak floods in tributary streams which may reach the main stream at different times from those of previous recorded floods. Rigid models can undoubtedly give most useful information as regards flood levels, lines of flow, and points where violent action will occur under specific conditions; but being rigid they cannot give information regarding changes of the river course due to erosion, nor can they reproduce accretion resulting from heavy charges of debris entering from tributary streams. All such changes must be inferred; and as a consequence, the value of such models is limited to existing or previously recorded conditions, unless the experimenter has the skill to predict future changes.

Example IV (a) (i)

RIGID TIDAL MODELS.

Rigid models have been used to a large extent at the U. S. Waterways Experiment Station at Vicksburg, especially in connection with tidal model studies. In many of these, coal dust and other still lighter materials have been injected to indicate the movement of sediment; and the amount of sediment deposited in various positions, marked out on the bed of the model by white-bordered squares, has been measured by sucking the deposited material through a 'vacuum cleaner' type of machine, the material then being separated by a machine resembling a cream separator.

SCALE RATIOS OF TIDAL MODELS.

The velocity of translation of tidal wave⁽¹⁾ is given very approximately by Rayleigh's relation⁽²⁾

$$V_w = \sqrt{gd} \quad \dots (1)$$

where d is the mean depth of water *including* the height of wave. This is the wave velocity relative to the fluid; the velocity relative to the boundary will be

$$V_w \pm V \quad \dots (2)$$

where V is the mean velocity of flow.

As both V_w and V vary from point to point and with time, the V_w scale ratio must equal the V scale ratio. This raises a difficulty which is frequently ignored—sometimes justifiably, but more generally without justification—that whereas the mean velocity varies as \sqrt{R} (the square root of the hydraulic mean depth), V_w depends mainly on the depth. Now, in a large river, the depth and the hydraulic mean depth differ little from one another; but in a small tidal model there is considerable vertical exaggeration and they differ considerably

Ignoring this for the present, and assuming

$V \propto V_w \propto d^{\frac{1}{2}}$, as a first approximation,

$$V_m/V_p = V_{mw}/V_{pw} = (d_m/d_p)^{\frac{1}{2}} \quad \dots \quad \dots \quad \dots (3)$$

where m and p stand for model and prototype.

d in (3) represents the vertical scale of the model and

$$S \propto d/L \quad \dots \quad \dots \quad \dots \quad \dots (4)$$

where S represents slope and L represents length; so the slope scale is determined by the vertical exaggeration.

For correct reproduction of the wave profile, especially in curved channels, the longitudinal and latitudinal scales must be equal; so L in (4) represents horizontal scale:

Time scale is given by:

$$T \propto L/V \propto L/d^{\frac{1}{2}} \quad \dots \quad \dots \quad \dots (5)$$

and discharge scale by:

$$Q \propto VLd \propto Ld^{3/2} \quad \dots \quad \dots \quad \dots (6)$$

In order to arrange that the water surface slope agrees with (4), it has been the practice to adjust the roughness of the bed and sides of rigid models by trial and error, until the required slope has been obtained. As the slopes must correspond in the model and prototype for a wide range of water-levels, the degree of roughness must vary from point to point, and has to be distributed carefully between different parts of the sides and bed.

(1) Based on Basic Note No. 70 by Mr. A. R. Thomas.

(2) Rouse: Fluid Mechanics, page 279, verified by experiments at Poona Station.

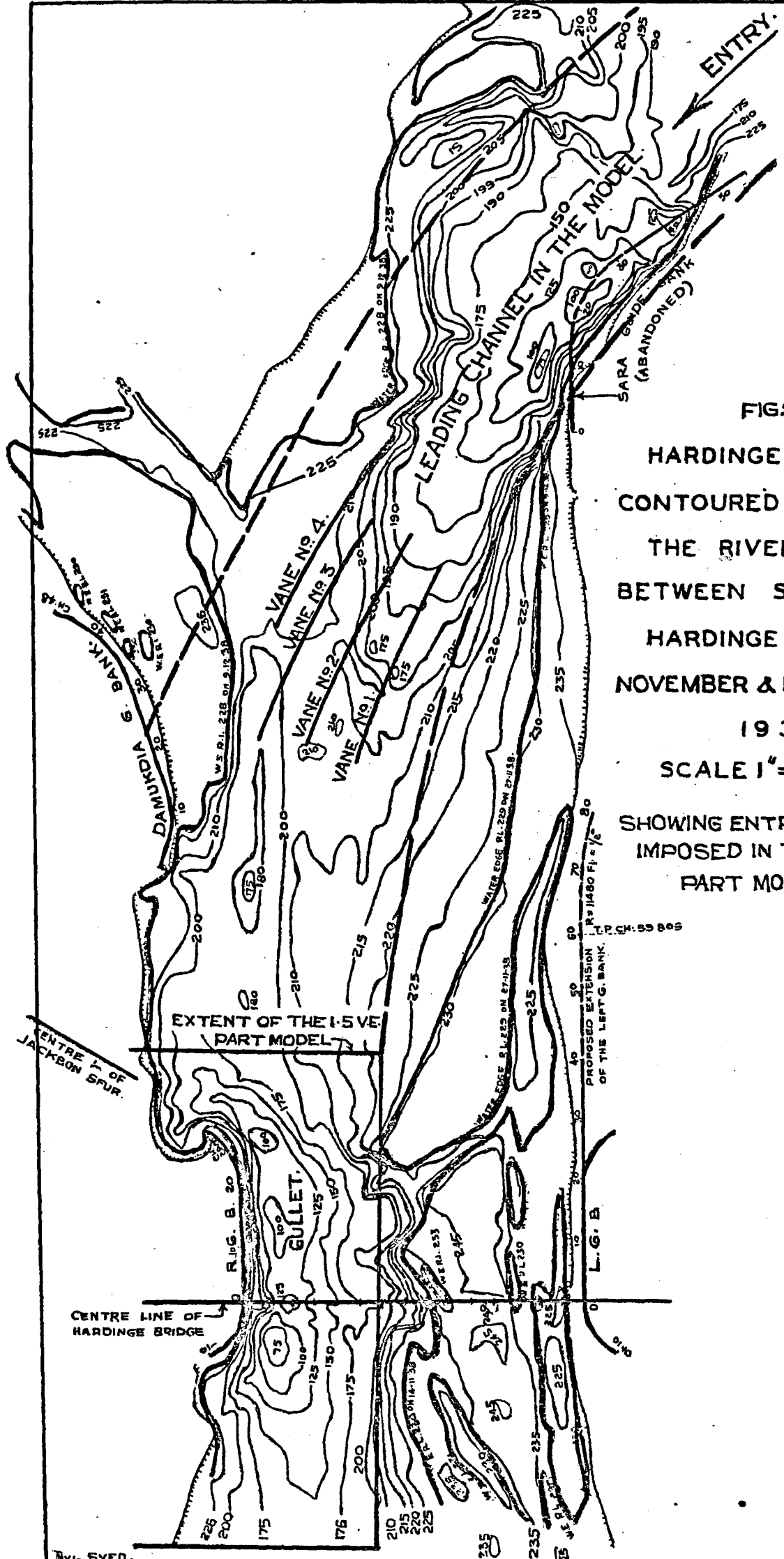

FIG-121
 HARDINGE BRIDGE
 CONTOURED PLAN OF
 THE RIVER BED
 BETWEEN SARA AND
 HARDINGE BRIDGE.
 NOVEMBER & DECEMBER
 1938.
 SCALE 1" = 2,000'
 SHOWING ENTRY CONDITIONS
 IMPOSED IN THE 1.5 V.E.
 PART MODEL.

An indication of the degree of roughness required is given by Manning equation :—

$$V \propto \frac{R^{3/2} S^{1/2}}{N}$$

Combining this with equations (3) and (4).

$$N \propto \frac{R^{3/2}}{L^{1/2}} \dots \dots \dots (7)$$

All the above requirements have to be fulfilled in order to reproduce correct tidal conditions; but in order to achieve this, conditions must be such that a corresponding grade and charge of bed material is transported.

Example IV (a) (ii).

RIGID TIDAL MODEL OF THE HOOGHLY.⁽¹⁾

A *rigid* tidal model of a 20 mile length of the Hooghly above Calcutta was constructed at Poona to scales of 1/300 : 1/60, with the object of determining lines of flow and points where action is severe under various conditions of river and tidal flow. This information was subsequently used in a large scale, *mobile*, short-length model to investigate specific bed-scour and bank-erosion problems, using much larger discharge, and much less vertical exaggeration than in the long model. After much patient trial and error work, the model reproduced tidal flow conditions with a high degree of accuracy.⁽²⁾

Type IV (b).

SEMI-RIGID, VERTICALLY-EXAGGERATED MODELS.

In *semi-rigid* models, the sides, and in some cases large parts of the bed, may be held. This makes it practicable to enforce a bank-slope exaggeration which is far in excess of what would be possible if the banks were erodible; and also to restrict the width, which makes it possible to increase bed action, i.e. the sand charge; but if the problem to be investigated includes future changes of the river course, and the secondary effects due to such changes, the model would help us little.

REYNOLD'S CRITERION OF TURBULENT FLOW IN TIDAL MODELS.⁽³⁾

In order that the motion in a model shall be similar to that in a river, it is necessary that the velocity shall be sufficiently great to ensure 'turbulent flow' and from experiments on models of symmetrical estuaries, Reynolds came to the conclusion that in order to ensure this, the product h^3e should not be less than 0.09, 'h' being the rise of tide in feet at seaward end of the model and 'e' the vertical exaggeration of scales.

The scales of the Hooghly model are : Horizontal scale = 1/300; depth scale = 1/60 and so $e = 5.0$; and the maximum tidal range at the seaward end is 12.5 ft. for a bore tide so the value of h^3e works out to 0.045, which is *considerably less* than 0.09; but the model gave *satisfactory* results. It must be clearly understood, however, that though Reynold's criterion may be suitable for estuaries which are very wide relative to their depth, especially if their sides are held so that reproduction of correct shape ceases to be an important factor—yet, where the depth is considerable relative to the width—as is the case in river channels—adopting correct vertical exaggeration is very important.

The Station has worked out relationships suitable for the materials used by it for discharges found most suitable; but the final scales have to be arrived at

(1) C.I. & H.R.S. A.R.(T). 1940-41, pp. 18-19.

(2) " " " " " "
" " " " " "
1941-42, pp. 23-24.

(3) Extract of Basic Note No. 139 by Mr. Padsalgikar.

by trial and error the model being run until conditions are approximately similar to those in the river; and experience shows that it is much more important to develop known river conditions than try to enforce scales based on assumptions regarding sand load etc., on which formulas have to be based. Indeed, much of our most successful work has been done when we have had little data except an accurate plan. From this, the behaviour, as well as the character, of the river, has been inferred; and we vastly prefer a limited quantity of *reliable* data, rather than a large amount of data of doubtful accuracy.

When we first started model experimentation we wasted much time trying to get results with misleading or fragmentary data, which frequently omitted important information, such as the existence of submerged rock; but latterly we have used the model, *combined with our experience*, to analyse the data, and have frequently found that information supplied has been widely incorrect or omitted important features.

The main difficulty to be overcome in producing similarity of behaviour in models of alluvial rivers is how to reproduce bed-movement correctly—about which no quantitative data are ever available; so, unless a model is laid correctly in the first instance, and the correct charge injected, highly discrepant results are likely to be obtained.

Example IV (b) (i).

HOOGHLY TIDAL MODEL RUN AS SEMI-RIGID MODEL.

After the long, small-scale, model of the Hooghly had been run as a rigid model to observe lines of flow, sand was laid on the bed of the model and it was run as a semi-rigid model—i.e. with rigid banks and mobile bed. The model was then similar in type to several models used in tidal investigations carried out in England, notably the Mersey Model of Osborne Reynolds, the Seine model of Vernon Harcourt⁽¹⁾ and the Severn Model of Gibson⁽²⁾, but the scales and the discharges were very much greater in the Hooghly model.

It was found that when all parts of the model were laid to a uniform vertical exaggeration, movement, though correct in places, was not correct generally, the tendency being for movement to be in excess in the shallow portions and in defect in the deeper parts. Thus the depth was more uniform in the model than in the river.

It was also found that even when the movement of bed-material was suitable with dominant discharge flowing, it was obviously excessive with high discharges and in defect with low discharges, all movement ceasing in the model at a much higher relative discharge than in the river. This is true of all river models.

Example IV (b) (ii)

SHORT, LARGE-SCALE, TIDAL MODEL OF THE HOOGHLY.

In order to reproduce correct bed-scour and accretion in the short model, in which the vertical exaggeration was only 1.4 compared with 5 in the long model, it was necessary to reproduce similarity of lines of flow, based on those observed in the long, small-scale model. The scales being 1/125 : 1/90, it was easy to reproduce and observe the effects of various alternative treatments, a comparison which was quite impossible in the long, small-scale, model in which the side-slopes far exceeded the angle of repose of the material, and the flow-pattern was highly distorted.

In this model, only slight adjustments were required in order to produce similar lines of flow, and bed movement was also found to be satisfactory; but, owing to the relatively large scale of the model, a single tide took 56 minutes, and results would have been delayed unduly had quantitative results of various

(1) Vernon-Harcourt, Proceedings of Royal Society, Vol. XLV, 1888-89.

(2) Gibson "Construction and operation of Severn Tidal Model" H. M. Stationery Office (1922)

treatments not been accelerated by adding silt by hand to raise the bed by an amount equal to three times the depth of the deposition; after which the model was run for another period; after which accretion was again trebled by hand, a procedure which was continued until accretion almost ceased. In this way, it was possible to determine the relative merits of various treatments within a reasonable period of time; after which the most promising treatments were investigated in greater detail.

Example IV (b) (iii)

PORT OF RANGOON TIDAL MODEL.⁽¹⁾

An excellent example of a small tidal model in which conditions were correctly imposed was the Rangoon model⁽¹⁾. In that case the model was bounded by a curved wall which separated the flow to the east; and the right bank of the River was cut away from time to time at a rate assumed by the experimenter, based on judgment. Working on these two assumptions, it was found that while the Port was not threatened by eventual extinction, it was evident that some limitation on the draught of vessels using the Port would be inevitable unless rectification of the approaches was carried out by artificial means—a prediction which, it is understood, has been fulfilled. The point to be emphasised here is that the correct result obtained in this model was due to the skill of the experimenter in making correct assumptions. Had he made incorrect assumptions, he would have got wrong results.

Type IV (c)

VERTICALLY-EXAGGERATED, MOBILE MODELS.

Method of calculating scale ratios in vertically-exaggerated mobile river models.

Introduction.

Experiments carried out at Poona with and without injection have shown that channels become steeper, wider, and shallower as the charge of material in movement increases. A wide, shallow, river is always found in combination with a steep slope relative to the discharge, which indicates a heavy charge of bed material⁽²⁾. If it has split into a number of interlacing channels, this indicates that in addition to a heavy charge, the stream is 'flashy'. If, on the other hand, the channel is deep and narrow with high berms, this indicates a high proportion of silt in suspension, a relatively small bed charge, and a relatively constant discharge. Between these extremes, there is every degree of variation.

It is thus possible for the skilled observer with long practical experience to diagnose from its appearance what type of a river it is, the approximate relation between silt and sand load, and the approximate rate of rise and fall of its floods. If data are available about these matters, so much the better; but the data will always lag far behind what it is possible to diagnose from observing conditions on the spot. Consider, for example, two cases: the Gandak River ($Q_{\max} = 300,000$ cusecs) and the Tapti River ($Q_{\max} = 1,000,000$ cusecs). The Gandak is a wide, shallow, river, having a B/D ratio of 310; whereas the Tapti with three times the discharge is a relatively narrow, deep, river with a B/D ratio of 50.3. If we were to construct 6 cusecs models of each of these rivers, the Gandak would be 13 ft. wide; whereas the Tapti would be only 5.8 ft. wide, i. e. 1/2 the width of the Gandak for the same model discharge, the Longitudinal scale ratios of the two being 1/200 for Gandak and 1/330 for Tapti. In the former case, a heavy charge of sand would have to be injected in the model; while in the latter case, little bed-sand would be injected, but a heavy charge of fine material would probably be desirable, a point which would be shown by the model, provided it was correctly designed and laid.

⁽¹⁾ Instt. of C.E. Paper No. 5100: 'Investigation of outer approach channels to the Port of Rangoon by means of a tidal model' by Oscar Elsdon.

⁽²⁾ Annual Report (Tech) 1941-42, page 10.

(2) *Selection of ratios for vertically-exaggerated models.*

The scale ratios to be selected are :—

- | | | | |
|------|---------------------------|---|---|
| I. | Longitudinal scale ratio. | | |
| II. | Latitudinal | " | " |
| III. | Discharge | " | " |
| IV. | Sand | " | " |
| V. | Depth | " | " |
| VI. | Slope | " | " |
| VII. | Time | " | " |

I. Longitudinal scale ratio.

This should be determined by the discharge considered necessary to reproduce the desired condition. Although we have used discharges up to 30 cusecs in models, we have come to the conclusion that river models of 6 to 10 cusecs are generally most suitable. Smaller models do not, as a rule, produce satisfactory results, while larger models take longer to lay and run, require much more staff, and are much more expensive. Where greater detail is required, we prefer to do part-length or part-width models to a much larger scale in combination with the 6 to 10 cusecs model, rather than to have a very large model of the whole of the river.

II. Latitudinal scale.

It is convenient to construct and operate mobile models with

Longitudinal scale = Latitudinal scale.

$$\text{i. e. } L_p/L_m = W_p/W_m, L \text{ being the length and } W \text{ the width} \quad (1)$$

But $L_p/L_m = \sqrt{Q_p/Q_m}$, vide III below and according to Lacey regime formula

$$W_p = C_p \sqrt{Q_p} \text{ and } W_m = C_m \sqrt{Q_m}$$

$$\text{Equation (1) means } \sqrt{Q_p/Q_m} = C_p/C_m \sqrt{Q_p/Q_m}$$

$$C_p = C_m$$

In other words, as we require equal divergence from regime widths to prevent distortion in plan, we should aim at having longitudinal scale = latitudinal scale.

It is possible to adhere to this provided the material of the banks is scour-resistant; but where the question under investigation is bank erosion, and hence curvature and meandering, model widths generally tend to be too great; and, though this can be neutralised to a certain extent by using a finer bed material and selecting a bank material which is somewhat scour-resistant; yet it is often difficult to maintain the correct width, and time can often be saved by permitting some divergence and allowing for it—which is permissible where the curvature is not great, and meandering is not an important feature.

III. Discharge scale.

Where the *dominant* discharge of a river is not known it can generally be worked out approximately from the meander length; because, despite statements that meander length depends on slope, experience shows that in alluvial tracts

$$M_1 = 42 \sqrt{Q_{\text{dom}}}$$

$$\text{and } M_1 = 30 \sqrt{Q_{\text{max}}} \text{ (roughly).}$$

There are three ways in which the discharge scale may be determined :—

$$(i) Q \propto L^2$$

$$(ii) Q \propto L.d. \sqrt{d}$$

and (iii) by trial and error.

Of these, (iii) is quick and simple. It consists in altering the discharge until approximately correct depths of flow are obtained. Though this is permissible where only short-term results are required; where long-term results are desired—especially where the reproduction of erosion and meanders is important—it is *not* suitable. (ii) is permissible where flow over a weir is approximately axial, and the question to be investigated is water levels and discharge distribution; but where there is curvature—due to embayments or meanders, Q must be kept \propto to L^2 ; and two models are advisable, one to show curvature, and the other to determine discharge relations. In the Lower Sind Barrage Model, satisfactory results were, however, obtained in a single model by making the depth scales for the river and the barrage different:—

Longitudinal scale = 1/250

Q scale = 1/62500

River depth scale = 1/50

Barrage depth scale = 1/40 (from 1/62500 = 1/250 \times $\frac{1}{d^{1.5}}$)

IV. Sand scale ratio

As the limit of diameter within which ripples form is narrow—about 0.2 to 0.4 mm. (weighted mean value of m)—and as the power of f in the formula $d \propto Q/f^3$ is low—approximately 1/3: it is not possible to alter the sand diameter effect to any marked extent without giving rise to other difficulties, but in general a slightly finer sand is desirable in the model.

In the case of boulder rivers and those with material coarser than 0.6 mm., ripples do not form, and the material in the model must be much smaller than in the prototype - see Appendix I.

V. Depth scale.

' d ' is not an independent variable, and so cannot be enforced directly; but it can be modified by altering the discharge or grade of bed material; but the former brings in other errors, and the latter takes time, both for relaying and for a new regime to be set up.

VI. Slope scale ratio.

Slope depends on the discharge, grade and charge of material in movement on the bed.

Although it simplifies work to have V.E. = S.E., our experience is that this is *rarely* attained in fully mobile models, though it can be produced if the banks are held. When the vertical and slope exaggerations do not agree, the model is said to be *tilted*. The depth scale is then different from the slope scale which complicates depth measurements; but other effects due to tilting are less than might be anticipated. The relation between slopes in the prototype and model may be worked out by the Lacey formula,

$$S = .000542 f^{5/3} / Q^{1/6}$$

and the model bed laid *initially* to this slope exaggeration.

The model is then run for some time, being adjusted from time to time till suitable movement is obtained at all sections at dominant discharge. The slope thus obtained gives the slope exaggeration; and a comparison of depths at various cross-sections gives the vertical exaggeration. This trial and error method gives quick results where the designed model scales are approximately correct; but neither this nor any other method will give satisfactory results if the scales originally chosen are wrong. Hence the great importance of adopting correct scales in the first instance.

VII. Time scale ratio.

This factor has got to be determined experimentally. Where silting is the important factor to be reproduced, the time scale will have to be considerably longer than when scour is the important factor to be reproduced. Again, due to bed movement ceasing with relatively high discharges in the model, and scour being in excess above the dominant discharge, low discharges have got to be run for a relatively much longer time than high ones; thus the time scale varies *inversely* as the discharge.

(3) DIFFICULTIES EXPERIENCED IN RIVER MODEL EXPERIMENTATION.

(a) *Effect of vertical exaggeration of embankments and rigid structures.*

(i) *Exaggerated scour-hole.*

Where banks and rigid structures are vertically-exaggerated they occupy a much greater proportion of the model surface than they do in their prototypes; and the deeper the scour, the greater the exaggeration. This causes disproportionately large vortices to form; because these are developed by the velocity of flow which, in turn, is determined by the depth scale, which is vertically-exaggerated. From this it follows that scour-holes are disproportionately large in models; the material scoured from the bed is not carried away but tends to accumulate downstream and when the discharge falls, the scour-holes do not silt; but continue to have a disproportionate effect on flow.

(ii) *Incorrect "Throw off."*

Furthermore, "throw-off" is markedly different from vertically-exaggerated banks or structures; as shown by models of the Ganges upstream of the Hardinge Bridge⁽¹⁾ and Sukkur Approach Channel.⁽²⁾ Careful investigations in connection with the former model, showed that in order to reproduce approximate similarity of throw-off the side slopes of Guide Banks should not be steeper than about 1 to 1; but when such slopes are adopted, the extension of the groyne or other projection laterally is disproportionately great, so that its positioning is very important. If receded too far it has little effect, if projecting too far it has a disproportionately great effect and causes abnormal scour. Each case must be dealt with individually, but generally the projection should be receded till the toe *after scour* is a little in front of the toe in the river. The best position to adopt will vary from model to model, but must be such that approximate similarity is produced at the discharge which matters most; for other discharges, this position will not be correct, and may have to be changed.

Though altering the slope of projections distorts the model in plan and elevation; the reproduction of correct throw-off and curvature is in many cases of prime importance. Under such conditions, such a compromise is essential.

The practice at Poona has been to construct at least two models in such cases: one of the whole river, to a vertically-exaggerated, relatively-small scale, and the other, of a part of the river to a much larger scale, with entry conditions imposed and vertical exaggeration kept as low as practicable. Entry conditions in the part-model are based on lines of flow in the model of the whole river; and flow in the whole-river model is then modified in the light of throw-off and curvature produced in the part-model. If this modification leads to any considerable change in flow conditions in the whole-river model, entry conditions must again be modified in the part-model, and the whole process repeated until approximate similarity of effects is reproduced.

(iii) *Necessity of tilting masonry structures.*

An interesting example of the necessity of distorting a model is exemplified in the Mahanadi-Katjuri model, Cuttack (Orissa)⁽³⁾.

(1) Bombay T.P. 55.

(2) C.I. & H.R. Station, Annual Report (Tech.) for 1941-42.

(3) Indian Waterways Experiment Station, Annual Report (Tech) for 1943 (p.47).

In this model, Mahanadi is the main river and the Katjuri takes off from its right bank at a sharp angle, to flow over Naraj Weir—which extends along the right bank and is roughly parallel to the axis of flow in the Mahanadi. In the prototype, the top of Naraj weir is at the same level all across; but the surface slope of water in the Mahanadi is much less than in the model, because slope exaggeration = vertical exaggeration (approx); so, in the model, Naraj Weir had to be built sloping down from the right bank to the left bank of the Katjuri.

(iv) *Exaggerated vortices.*

Another cause of distortion in the Mahanadi model results from an area of return flow at the entrance to Naraj Gorge, caused by Sidheswar Hill. The length of this vortex tends to be proportional to the vertically-exaggerated depth scale, whereas its width tends to be proportional to the horizontal scale. It follows that unless steps are taken to minimise this effect the vortex is greatly magnified in plan in the model.

(v) *Exaggerated length of standing wave.*

To obtain a correctly positioned standing wave downstream of Naraj Weir, the weir should be geometrically similar; but in that case it would extend far downstream in plan and would cause water to flow away from the weir at a markedly wrong angle.

What had to be done in all these cases to obtain reasonably correct flow conditions was to produce *the best compromise*, making the weir broader (i.e. longer in the line of flow) than correct in plan; but much shorter than geometrically-similar. Obviously, the treatment must differ in different experiments according to the discharge and the exact point under investigation at the time.

(vi) *Necessity of having different scale ratios for rigid and non-rigid portions of models due to excess friction losses in the rigid portions of models.*

Another difficulty was that friction losses over the weir were relatively greater in the model than in the river; so a relatively greater depth was required to pass the same discharge.

In a vertically-exaggerated model of a river, the sill level depends on the intensity of discharge per ft. run; and, as the discharge = $A \times V$, and $V \propto \sqrt{d}$, discharge scale $\propto L \times d \times \sqrt{d}$

But the discharge scale in a river model $\propto L^2$; hence

$$L^2 = L \times d \times \sqrt{d}$$

\therefore depth scale for the rigid structure

$$d = L^{2/3}$$

and unless this holds, we will not get correct water levels in the model.

In practice two cases will arise,

(a) $L^2 = Ld^{3/2}$

and (b) $L^2 > Ld^{3/2}$

Case (a):—Though $L^2 = L \times d^{3/2}$ in the channel portion, we still would not get the correct water level just upstream of the barrage, because the frictional losses due to drag are relatively more in the model than in the river, even though we make the model pavement very smooth. As a result, the coefficient of discharge in the model is *lower* than in the river. This can be overcome in the model for any particular discharge, by lowering the pavement or by increasing the coefficient of discharge by making the length of crest in line of flow less than geometrically-similar and by making the upstream and downstream glacis slopes slightly steeper; but depths in model and prototype will differ somewhat for other discharges.

Fig. 122 Case (b) :—If L^3 is not equal to $Ld^{3/2}$ the water levels obtained will not be correct, so we must adopt a depth scale for the barrage portion, which is different from the scale for the river portion—(depth scale given by $d = L^{2/3}$).

[Note—The water level should be taken as the datum for this new, local, depth scale].

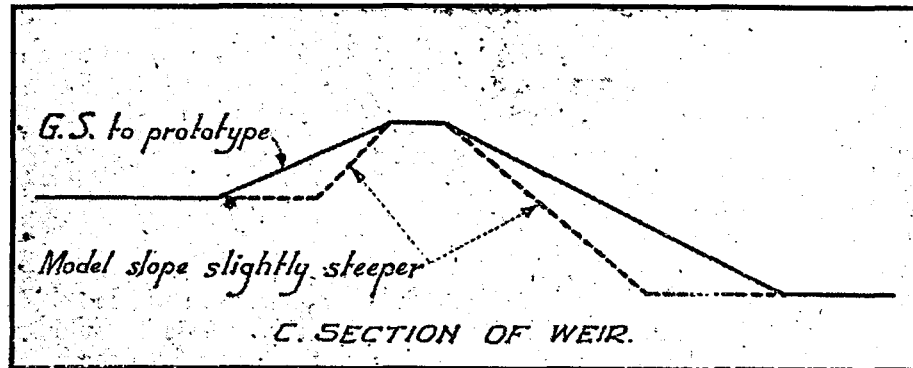

Fig. 122

If, after doing this, we find that the upstream water level is still too high, we must increase the coefficient of discharge by shortening the crest, making the model glacis steeper, or else we must lower the sill level.

Correct conditions can usually be obtained for one discharge by adopting one of these alternatives; but for other discharges some error will remain.

Let us take the concrete example of the Lower Sind Barrage model :—

The length scale for the river = $1/250$

Designed depth scale = $1/50$

∴ Discharge scale = $1/62,500 = L^2$

Discharge scale for

$$\text{the barrage} = LD^{3/2} = \frac{1}{250 \times 50^{3/2}} = \frac{1}{87,500}$$

∴ $L^2 > Ld \sqrt{d}$

When the discharge is 500,000 cusecs with the canals closed,

The downstream level to be maintained = R.L. 59.00

The anticipated upstream level in the river was R.L. 61.00
(2' afflux);

but the upstream water level obtained in the model was \cong R.L. 63.9
(\cong 4.9 ft. afflux)

The upstream water level in the model was thus much too high, partly due to the river afflux being underestimated. For the designed discharge the depth scale for the barrage with correct water level = $L^{2/3} = 40$ —i.e. the pavement level had to be lower than according to the depth scale of the river portion. This does not, of course, affect the depth scale of the mobile part of the model.

(vii) *Longitudinal Distortion.*

Vertical exaggeration is essentially a *latitudinal reduction* and in many cases it is best to visualise it as such. Similarly, slope exaggeration is essentially a *contraction of longitudinal scale*. In spite of this, it is the general practice in model studies, even when the slope exaggeration is increased by tilting the model, to make the longitudinal scale the same as the latitudinal scale in order to prevent distortion in plan.

In extreme cases this slope exaggeration may lead to conditions in the river producing hyper-critical velocities in the model; but, more generally, it merely leads to *distortion*, due to the length in which changes have to take place being foreshortened. As a result, the length in which new lines of flow or eddy-pattern (resulting from changes of section or roughness) have to become established in the model, is often inadequate to establish the change before a further alteration in the angle of flow or roughness occurs in the model.

Two good examples of this are

- (i) flow from the twin gorges at Sukkur⁽¹⁾ and
- (ii) the groynes in the Jumna at Delhi⁽²⁾.

In the former, the gorge is foreshortened $7\frac{1}{2}$ times, affecting both lines of flow and eddy pattern of the water as it leaves the gorge; while in the latter case, the groynes were seven times closer together relative to depth than in the river.

(viii) *Different time scales for scour and accretion*

In a river, by far the greater part of the material in motion is *in suspension*; whereas in models, silt in suspension forms a relatively small part of the total charge. The reproduction of *full natural* silting in the model is therefore well-nigh impossible, because if the time during which the model was run was increased to permit more silt deposition, scour—which occurs relatively much more quickly than silting—would be excessive, which in turn would lead to a disproportionately great accumulation of coarser particles.

This error is accentuated where the model is laid according to 'cold weather' conditions in the river; because, as already explained, scour pits at the noses of groynes are relatively much larger in the model than in the river, and the excess of sand scoured from these pits produces unnatural sand banks in the model which are not removed by subsequent scour, and this excess sand, unless removed, will produce quite wrong results.

Accretion on top of shoals will, on the other hand, be relatively small in the model, with the result that a relatively greater discharge will pass over the shoals. Consequently, reproduction of year to year changes in the river will become more and more incorrect, due to scour and erosion being relatively too quick and silting much too slow. These difficulties were prominent in the 1/500-scale model of the Ganges above the Hardinge Bridge⁽³⁾.

Conclusions.

It will be clear from this note that though some types of problems can be successfully solved with the aid of models, other types, especially problems connected with rivers flowing in alluvium, present *extraordinary* difficulties.

Nevertheless, models are always helpful to enable us

- (i) to visualise the problem,
- (ii) to verify data, to see whether it is correct and adequate or whether important details have been omitted—such as exposed rock, lime kankar, etc.

(1) Annual Report of C.I. & H.R. Station, 1939-40.

(2) Ibid

(3) Annual Report (Tech) C.I. & H.R. Station 1938-39, pp. 22-23.

(iii) to clarify the relative effects of different treatments—making allowance for model limitations—but it must be clearly understood that success depends primarily on a correct diagnosis and evaluation of all the factors causing change. Hence, success depends on a correct analysis of all the data available and on conclusions drawn from that data and if the analysis is wrong, the model will necessarily give wrong results.

Mistakes, normally made, include too great reliance on thought-numbing formulas. They should be used only as a guide for initial laying, thereafter observation of model behaviour and comparison of this with river conditions should be the basis for further modifications.

A common mistake is to relay models for subsequent experiments according to the original scales. This, of course, is wrong. The scale ratios should be modified in the light of results, and the original scales scrapped.

Let us consider the various factors involved :—

- (i) natural slope exaggeration ;
 - (ii) natural vertical exaggeration ;
 - (iii) a very much quicker rate of change in the model (time scale) but the same rate of maturing and consolidation ;
 - (iv) much steeper side-slopes, though the material has practically the same angle of repose ;
 - (v) fluctuating discharges, charges, etc. ;
 - (vi) meanders, spills, cut-offs ;
 - (vii) exaggerated effects in the model due to rigid portions such as rock, lime kankar, clay, barrages, groynes, etc. ;
 - (viii) differences in flood cycles from year to year ;
- and (ix) difference in sand and bed material from point to point.

No formula can be devised to take into consideration all these varying factors. At Poona, we have been doing various scale experiments, for several years with mobile models—to evaluate divergences from natural conditions resulting from various disturbing factors—in order to see how these effects can best be minimised by modifying slope scales, discharge scales, silt charge, and vertical exaggeration.

These investigations have given us a clear understanding of why certain modifications which we have been carrying out have been successful ; but they have not, and cannot entirely, eliminate the inherent divergences, nor resolve the numerous complex factors. Natural mobile models do not give similarity ; but only results which are capable of being translated approximately from river to model and back from the model to equivalent river conditions.

Frequently, it is stated that river results have been verified and have been found to be closely correct ; yet those who make this statement relay their models each year according to the latest survey instead of carrying on from year to year : The reason given for this is that the flood differed from what was assumed ; but the real reason is that only qualitative similarity has been achieved. In any case, our object is to predict what will happen hereafter—not for a year or two, but for several years ahead—and if a correct solution were to depend on our predicting correct river conditions year by year for several years ahead, the model would always be wrong ; because, at best, models, like sausage machines, cannot give you back more than you put into them !

For our purpose, it is necessary to study the data of a river for as many years as available. Flood hydrographs, annual surveys, data about bed material, silt charges, etc.,—but especially river changes,—must all be studied and explained. Only thus can the most probable, and the most extreme variations in river conditions, be predicted and tested in the model.

Our experience of verification is that there is rarely enough river data available to make verification satisfactory except as a rough qualitative check, and even if there were, it would, at best, be a very slow and tedious process; because every appreciable change in one factor affects all the other factors.

Mobile river models are in fact a valuable aid to engineering skill which, however, they can never replace.

APPENDIX I

EQUIVALENT SIZE AND SPECIFIC GRAVITY OF STONES AND BLOCKS IN A MODEL.

Experiments were carried out in connection with the Sarda model.⁽¹⁾ These were more *basic* than specific in character, in that the object was to develop a technique to determine equivalent size and specific gravity of blocks and stones in models. Various grades of sand were tested to ascertain conditions

(a) when movement commenced, and

(b) when general movement developed.

The method followed consisted of laying a flat layer of loose stones and observing the depth of water when

(i) bed movement just commenced; and

(ii) general movement occurred; with different discharges.

The stone was laid in a single layer on a hard smooth bed in one series; and in a 2" layer, with similar stones upstream and downstream, but fixed to the bed in another. In the case of blocks, a single line of isolated blocks was laid across the channel in one series and a closely packed layer in another.

Fig. 123 shows results in two of the series.

Fig. 123

The following conclusions were drawn:—

(1) When (a) V^2/gd in river = V^2/gd in model,

(b) Specific gravity of blocks or stones in prototype and model are equal,

stones above 1/4" grade in a channel less than 1 ft. deep behaved *similarly* under conditions of equal V/\sqrt{gd} with diameter \propto depth; but pebbles less than 1/4" grade tended to depart from this relationship. The same was true of cubical blocks of various sizes ranging from 1/2" to 2" cube. In other words, with equal $Fr (= V^2/gd)$ in model and river, blocks and stones behave similarly when

$$\frac{\text{median diameter of stone}}{\text{depth of flow}}$$

is the same in model and river, within the limits stated.

(2) When

(a) Froude number of prototype is not equal to Froude number of model,

and (b) specific gravity of blocks or stones in river and model are equal,

⁽¹⁾Reproduced from A.R. (T), C.I. & H.R. Stn., 1939-40, pp. 50-51; also see pp. 22-23.

experiments showed that •

$$\frac{\text{median diameter of stone}}{d} \propto (V^2/gd)^{1.3}$$

Fig. 123 *approximately* for commencement of movement. Thus if the ratio of Froude numbers (model: river) is 1.2, the volume of stone in the model should be increased in the ratio, $(1.2)^{1.3 \times 3} = 2.04$ above that given by the depth scale. The index here (1.3) is, however, dependent on the velocity distribution upstream and on the similarity in shape of stones. With similar velocity distribution and shape of stone, the index would be 1.0. This also holds in the case of blocks (see 3 below).

(3) In the case of isolated concrete blocks

$$\frac{\text{Diameter}}{\text{depth of flow}} \propto (\text{Froude No.})^{0.1}$$

(4) When

(a) Froude No. of prototype is not equal to Froude No. of model,

(b) specific gravity of model and prototype blocks are also different,

$$\frac{\text{dia.}}{d} \propto \left(Fr \times \frac{\rho}{\delta - \rho} \right)^{0.1}$$

Fig. 123

where

d = depth of flow

ρ = density of water

δ = density of blocks.

As an example, supposing it is desired to reproduce concrete blocks in a vertically-exaggerated model to a similar scale than the depth scale, then the density of the material to be used is given by

$$\frac{\delta - \rho}{\rho} \propto \frac{V^2 \cdot d^{0.10}}{(\text{dia.})^{1.1}}$$

or

$$\frac{\delta_m - \rho}{\delta_p - \rho} = (V_m/V_p)^2 \times \left(\frac{\text{dia. } p}{\text{dia. } m} \right)^{1.10} (d_m/d_p)^{0.10}$$

where the suffixes m and p refer to model and prototype respectively.

FIG. 123

EXPTS. WITH STONES AND BLOCKS
CONDITIONS FOR INITIAL MOVEMENT OF STONES
IN SINGLE LAYER & ISOLATED CUBICAL BLOCKS.

	CUBICAL BLOCKS		STONES	
	SIZE OF BLOCKS IN FEET.	SP. GR.	MEDIAN DIA. IN FEET.	SP. GR.
x	.043	2.16	.0141	2.9
+	"	2.39	.0229	"
o	"	3.61	.0303	"
□	.083	2.44	.0273	"
△	"	2.28	.0303	"
△	"	2.14	.0369	"

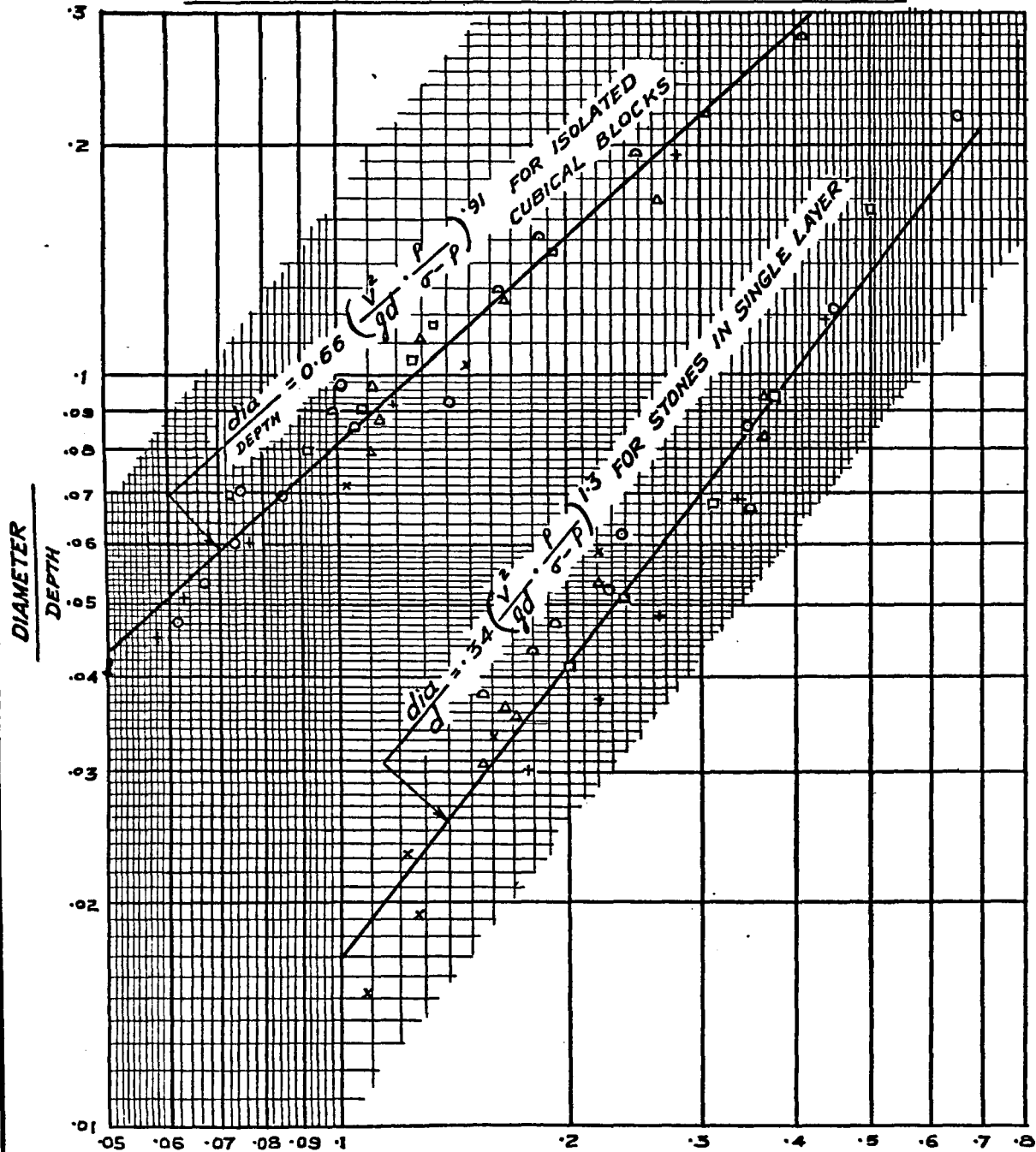

$$\frac{V^2}{gd(\sigma - \rho)}$$

**INDEX OF THE INDIAN WATERWAYS EXPERIMENT STATION,
POONA, ANNUAL REPORT (TECHNICAL)
FOR 1937-38 TO 1945.**

[Note.—Questions dealt with by the Director, but not described in Annual Reports are marked with an asterisk*]

A	Pages of Annual Report (Technical) for the year									
	1937	1938	1939	1940	1941	1942	1943	1944	1945	
	-38	-39	-40	-41	-42	-43				
A										
Abrasion—attrition — degradation of sand.	51	47	40	41	6	...	62	
Accretion in N.W., Rice and Dadu Canals at Sukkur.	16	6,99	...	
Accretion : N. V. relation (N = charge ; V. = terminal velocity)	50	8,33	
Accretion of the Grand Anicut Canal, Cauvery River (Madras).	...	54	
Accretion of the river bed at Sukkur Barrage—causes of— and how to reduce rate of rise —Part II.	59-66	
Advisory enquiries dealt with, without experiments.	81	52	55	62	2	1	(i), (ii), & 1	1	...	
Afflux experiments to determine the effect of bellmouth added upstream and downstream of the top of the openings of the Mula River causeway at Rahuri —District Ahmednagar.	19	
Afforestation—'Chos' Act passed by the Punjab Government for—	3	
Ahmedabad (Bombay) — Khari River at Raipur near—How to prevent outflanking of Barrage on—	(ii)*	
Ahmedabad District—Dissipating energy below the masonry waste weir of the Timba Tank at Harsol, Taluka Prantaj.	84	
Ahmedabad water supply from Sabarmati River — Measures proposed to improve the—	62	

A	Pages of Annual Report (Technical) for the year									
	1937	1938	1939	1940	1941	1942	1943	1944	1945	
Ahmednagar District—Training the Mula above the Rahuri causeway.	14
Ahmednagar District—Training the Sina River with causeway at mile 5 of Nagar Manmad Road.	19
Ajoy River—Failures of piers of bridge under construction over the—in the Santal Parganas, Bihar, during 1942 floods.	3
Alexandra Bridge over the Chenab River near Wazirabad—steps required to prevent damage to the Railway Embankment west of the—	(i)*	3*,5
Alignment of a high coefficient weir for the waste weir of Lake Arthur Hill, Bhandardara (Bombay Presidency).	43
Alignment of inner bank of tail channel at Sukkur (Sind).	13
Alluvial channels—Factors affecting flow in	...	45	...	50	33
Alur on Gadag-Sholapur line of M. & S. M. Railway—deep scour at left abutment of Bridge No. 8 at—	1*
American data of rainfall and run-off	6
American Rivers—curvature of meanders.	10
American Rivers—Meander data and formulae.	9
Amingaon—Brahmaputra Bridge near—design of	(ii)*
Amingaon—Experiments with a model of the Brahmaputra and the proposed Railway bridge at—	44	23
Analysis of Bilot creek and Paharpur canal data (Ex. Indus 35 miles d/s of Kalabagh, N.W.F.P.) in Indus.	32

A	Pages of Annual Report (Technical) for the year								
	1937	1938	1939	1940	1941	1942	1943	1944	1945
	-38	-39	-40	-41	-42	-43			
Analysis of catchment characteristics.	34
Analysis of changes in the course of the River Indus downstream of Kalabagh, N.W.F.P.	8
Analysis of Inundation Canal data in Sind and its comparison with the data of perennial canals.	29, 32
Analysis of—Punjab and Sind data of channels.	2
Analysis of 10 sites on distributaries of the Sarda Main canal (U.P.)—Divergence from Regime in stable channels in alluvium.	30
Analysis—Technical—of available data re: the rise of water levels of the Indus in the past and to be anticipated in future.	15	6,99	...
Apparatus for generating waves in a model.	66
Approach channel at Wazirabad Pumping Station—Effect of straightening, clearing and deepening the, on flow conditions.	5
Approach channel, for the Right Bank Canals at Sukkur, to control sand entering the Canals.	...	9	13	12	16
Approach channel, probable scour along the banks of the	12
Approach channel—scour around the nose of	18	12
Approach channel—various alternatives for constructing, the, in two working seasons.	20
Approach channel at Sukkur—Design of off-take at the entrance to the right pocket from the	96
Apron d/s of tail channel sluices at Sukkur—protection of	19

A	Pages of Annual Report (Technical) for the year								
	1937 -38	1938 -39	1939 -40	1940 -41	1941 -42	1942 -43	1943	1944	1945
Aprons falling—characteristics of—	70
Aprons falling—Effect of dispositions of stone on—	71	37
Aprons falling—Effect of shape and size of stone on—	...	38
Aprons falling — Experiments with.	68	37
Aprons falling — Inclination of slope of—	71	38
Aprons laid on alternate layers of sand and clay—Behaviour of	75
Apron protection, conditions under which, may fail.
Apron protection, failure of, due to slips in sand or to "blow outs."	75
Apron, stone—Protection of island nose by laying an—along its face at Sukkur.	15
Apron testing with scouring discharges in the Right pocket and tail channel at Sukkur.	15
Aquatic weeds in Deccan Irrigation canals.	7
Aquatic weeds — Factors affecting growth of.	7
Aqueduct 4 of Girna Canal (Bombay Presidency)—prevention of scour downstream of the.	23
Assam Access Road—Prevention of scour in Garang River on—	3*	...
Assam, Neamati in—Prevention of erosion at—	3*	...
Attracting groyne — Revetment acts as	2, 104	...
Attracting island—Bukkur island in the Indus acts as an—	97	...

A & B	Pages of Annual Report (Technical) for the year								
	1937	1938	1939	1940	1941	1942	1943	1944	1945
Attracting spurs—the use of—for training a river upstream of a bridge or a Barrage.	46	47	97	...
Attrition of sand—minimum velocity required for	62
Augmentation of Bombay City Water supply	1*	1 & 2
Auranga River, Training the—to protect Bhadeli village, District Surat (Bombay).	...	52
Automatic feed for maintaining a constant water level.	65	...
Automatic gates spillway for the Tansa Dam—Determination of the coefficient of discharge of the	29-36
B									
Baffle below the toe of a fall in a parallel-sided channel—experiments to find the optimum position and height of a	31
Baffle Fall—Hurdling over—	30	...
Baffle platforms below S.W.F.s—Design of—	38	...
Baffles downstream of S.W.F. Falls—stability of—	33
Baffles—Effect of shape of—on stability	33
Baffles to dissipate energy below S.W.F.s—Design of—	39	...
Bagaha—Gandak River at—on the Oudh and Tirhut Railway which has outflanked the bridge—how to divert the—to its original course through the bridge.	(iii)*	10	...
Bakshi Khal.	13	...
Balta Jheel, and Solani Khadir in U.P.—Director's visit to the—	2*	(iii)*

B	Pages of Annual Report (Technical) for the year								
	1937	1938	1939	1940	1941	1942	1943	1944	1945
Balta Jheel, and Solani Khadir schemes in U.P.—Model experiments in connection with—	59	...
Baluchistan—Design for a truncated trapezoidal S.W. Flume for Spin Karez Project (Quetta).	63
Baluchistan — Durrani Outfall channel (Quetta), dissipation of energy in	...	53	...	22
Baluchistan—Experiments with a model of the waste weir channel of the Spin Karez Reservoir for Dissipating energy.	46
Baluchistan—Protection of retaining walls from scour by means of repelling spurs (advice without model experiments.	8
Baluchistan—Spin Karez diversion channel (Quetta).	65
Barrage—Effect of constructing a —across a river, on bed levels and water levels u/s and d/s, with particular reference to the Indus (Sind).	18,	99	...
B.B. and C.I. Railway bridge at Broach—scour caused by left bank groyne.	1*	77,	85
Beas River Training.	2*
Beas River — Control of — by attracting spurs.	(ii)*
Bed load formulas—Schoklitsch's and Meyer Peter's and their comparison with Station formulas.	49,	50	...
Bed materials—attrition of	6
Bed materials—degradation of	6
Bed materials—dilution of	6, 7
Bed materials—effect of decrease of size down canal in various Lacey formulas.	8, 9

B	Pages of Annual Report (Technical) for the year								
	1937	1938	1939	1940	1941	1942	1943	1944	1945
Bed mix and turbulence—relationship between	4
Bed ripples—Formation of	55
Bed ripples and bed waves.	53
Bed sand—Factors affecting the exclusion of	6
Bed sand—Vanes, large radius, at outfall at Sukkur to exclude—	16
Bed silt to be laid in model to simulate silt deposited during the cold weather in river.	39
Beki, Balkadoba and Manas Rivers—How to train and control the—	(ii)*	3,69	...
Bellmouths added u/s and d/s at the top of openings of the Mula River causeway at Rahuri (Dist. Ahmednagar) — Afflux experiments to determine the effect of, on coefficient of discharge.	17
Bell-mouth entrance of flumes and falls—side contractions and humps—	29, 32	...
Bengal—estimated scour round piers of the proposed Damodar Bridge at Burdwan.	24
Bengal — Tidal model of the Hooghly River.	18
Bengal—Training the Ganges at the Hardinge Bridge (E.B. Ry.)	66	22	23
Bhivpuri scheme recommended for the augmentation of Bombay Water Supply.	74	...
Bifurcating channels and their characteristics.	8
Bihar—coefficient of discharge of existing Son Anicut Weir at Dehri.	25
Bihar—Coefficient of discharge of High coefficient Weir for Son Anicut	26

B	Pages of Annual Report (Technical) for the year								
	1937	1938	1939	1940	1941	1942	1943	1944	1945
Bihar—Controlling erosion of the "Bur Gandak" river at Sikan-darpur in Muzaffarpur Division.	83
Bihar—Ejectors for canals taking off the Son at Dehri—Head available for working the—	43
Bihar—Prevention of scour at junction of high level, high coefficient weir and low level, falling shutter portion of the Son Anicut.	21
Bihar—Prevention of scour down-stream of Son Anicut sluices.	21
Bihar—Protection u/s of sluices and along the divide walls of the Son anicut.	21
Bihar — Remodelling the Son anicut at Dehri.	19
Bihar—Siphon spillway for the Jamshedpur water supply stor-age, Tatanagar.	27	27
Bihar—Son anicut at Dehri—Pre-sent method of regulating the—	40
Bihar—Son river at Dehri—sand drawn by the canals and under-sluices u/s of the anicut.	41	58	...
Bilot creek and Paharpur canal— Analysis of data.	32
Blanketing	11
Block and Stone protection— Experiments to determine scale effect for equivalent size and specific gravity of	50
Bombay Presidency — Afflux experiments to determine the effect of bellmouths added to top of openings of the Mula river causeway at Rahuri.	17
Bombay Presidency, Ahmedabad water supply from Sabarmati river — measures proposed to improve the	62

B	Pages of Annual Report (Technical) for the year								
	1937 -38	1938 -39	1939 -40	1940 -41	1941 -42	1942 -43	1943	1944	1945
Brahmaputra bridge near Amin- gaon—design of	(ii)*
Brahmaputra—whether river ghat on—likely to be eroded.	(ii)*
Breach in Right Guide Bank of the Hardinge Bridge on the Ganges—reproduction of	72
Breaches in the Damodar Left Bank Embankment d/s of Burdwan (Bengal).	7
Breaches in the Damodar River— proposals to prevent a recur- rence of damage resulting from breaches in the—	(i)*
Breaches in the marginal bunds of the Indus above Sukkur— Rohri-Quetta Railway— Realignment of the—neces- sitated by the danger of—	(ii)*
Breaches in River Bunds in Sind —Technical enquiry into the causes of and steps required to minimize the danger of recur- rence.	1*	10, 20
Bridge on Beas River near Beas Station on the N. W. Railway on Lahore-Ludhiana section.	2*
Bridge piers—Comparison of scour round the, at Hardinge Bridge and in model.	37
Bridge piers—Discharge causing failure of protection of.	35
Bridge piers—Effect of width of protection round,—on scour.	37
Bridge piers—Effect of high level pitching laid round, on the depth of d/s scour.	31
Bridge piers—Influence of u/s bed level and material of bed on maximum scour at—	32
Bridge piers—Protection of, against scour.	...	39	...	35

C	Pages of Annual Report (Technical) for the year								
	1937	1938	1939	1940	1941	1942	1943	1944	1945
	-38	-39	-40	-41	-42	-43			
Canals—Experiments in connection with seepage losses from	60	50
Canals in Sind—Design of—Part I—New Canals and Part II—Inundation Canals.	21
Canal system type of slope formula.	9
Catchment characteristics.	34
Catchment Area and silting of reservoirs — Relation between the—	32
Catchment, shape of and its effect on the maximum flood run-off.	5	...	38
Catchments in India — run-off from	5
Causes of accretion of river bed at Sukkur Barrage and how to reduce rate of Rise, Part I.	99
Causes of accretion of the river bed at Sukkur Barrage and how to reduce rate of rise—Part II.	59-66	...
Causes leading to erosion of the left bank of the Rupnarain River u/s of the Kolaghat bridge on the B.N. Railway.	14
Causes of floods in Sind.	12
Cauvery river—Madras, accretion of sand in the Grand Anicut Canal	...	54
Cawnpore Electric Supply Corporation — How to secure an adequate supply of water for the river-side power station of the—	3*
Cawnpore Water Supply—Effect of changes in the position of the Ganges on—	1,	15
Cement-sand plaster — Rugosity of, in rigid channels	59
Central island or spur for river training.	47	47	97	...

C	Pages of Annual Report (Technical) for the year								
	1937	1938	1939	1940	1941	1942	1943	1944	1945
Central Provinces—form drag of cylinders in connection with bridge foundations for—	(iii)*	...
Ceylon—advice regarding probable maximum run-off from catchments in—	2*	...
Ceylon—advice regarding waterway of bridges in—	2*	...
Channel experiments — Inlet length.	52	34
Channel flow—Lacey theory of shock—in	3
Channel shape—coherence as it affects—	3
Channels—alluvial—factors affecting flow in	...	45	...	50	33
Channels bifurcating and their characteristics.	8
Channels — Effect of method followed in regulating d/s water levels on shape of.	33
Channels—Factors affecting shapes of	22
Channels — off-taking — effect of meanders of parent channel on	14
Channels—Punjab and Sind data of—Analysis of—	2	...	21
Channels — Wave and surge velocities in	58	3
Charge—Natural regime sand	4
Charge of sand and terminal velocity—Rate of deposition of sand as governed by the—	50	33
Charge : $N.V_s$ relation (N = charge ; V_s = terminal velocity).	50	8, 33
Chashma near Indus—Cause of change of course of, and how to control.	(ii)*

C	Pages of Annual Report (Technical) for the year								
	1937-38	1938-39	1939-40	1940-41	1941-42	1942-43	1943-44	1944-45	1945
Chenab river near Wazirabad— Alexandra Bridge over the— steps required to prevent damage to the Railway Em- bankment west of the	(1)*
Chos Act passed by the Punjab Govt. for afforestation.	3
Cistern — Design of — below flumes.	36, 40
Classification of ripples and waves.	54
Clay and sand—Behaviour of an apron laid on alternate layers of	75
Closing of spills on right bank u/s of Hope Bridge led to heavy erosion of the Rander Road.	87
Coefficient of discharge of drowned weirs.	47
Coefficient of discharge — Effect of drowning, skew flow, scale effect and falling shutters of the Son Anicut, Dehri, on	26
Coefficient of discharge, effect of surface roughness on the	47
Coefficient of discharge of existing Son Anicut weir at Dehri.	25	24
Coefficient of form drag—scale effect on	29
Coefficient of discharge—increa- sing the—by adding bellmouth u/s and expansion d/s of the Head Regulators of Godavari Right and Left Bank Canals (Bombay).	32
Coefficient of discharge of Ganesh Iyer's volute siphon—Factors affecting the—	72-78	...
Coefficient of discharge of High Coefficient weir.	45	42
Coefficient of discharge of High Coefficient weir for the Son Anicut at Dehri.	25

C	Pages of Annual Report (Technical) for the year								
	1937	1938	1939	1940	1941	1942	1943	1944	1945
Coefficient of discharge—of siphon spillway for Jamshedpur water supply storage <i>with</i> and <i>without</i> baby siphon and <i>with</i> and <i>without</i> air inlet.	27	27
Coefficient of discharge of Standing Wave Flume.	92
Coefficient of discharge of Standing wave Flumes — Effect of piers on	59	94
Coefficient of discharge of Nira L.B. Canal Head Regulator.	95
Coefficient of discharge of the automatic gates spillway for the Tansa Dam—Determination of the—	29-36
Coefficient of discharge of undersluices of the Son Anicut at Dehri (Bihar).	24
Coefficient of discharge — with gates above water level (Son Anicut).	25
Coefficient of discharge — with gates partially open and free flow d/s (Son Anicut).	26
Coefficient of form drag (submersible bridges).	52
Coefficient of High coefficient weir for the waste weir of Lake Arthur Hill, Bhandardara (Bombay).	39
Coherence as it affects channel shape.	3
Cold weather silting in the river —bed silt laid in model to simulate the.	38
Collapse of Rohri-Multan Road Bridge over Rohri canal at R D. 52,000 in Sind—Prevention of --	3*	...
Committee — Bombay Water Supply augmentation—	(ii)*

C	Pages of Annual Report (Technical) for the year									
	1937	1938	1939	1940	1941	1942	1943	1944	1945	
Control of sand entering the Vadavar channel of the Lower Coleroon system (Madras Presidency).	82
Control of sand injection and sand and silt in suspension in the Ganges model above the Harding Bridge.	67
Control of scour below falls.	27	28
Control of the Jumna River at Tajewala by means of spurs.	(ii)*
Control of pebbles and sand entering the Sarda main canal by constructing a regulator in the short Banbassa spur.	19
Control of sand entering the Mithrao and Khipro Canals—Ex-Nara River at Makhi, Sind.	6	16	19
Control of sand entering the Right Bank Canals at Sukkur.	26	4	12	13	16
Control of Sur Lake sea-cut with marginal embankments (Orissa), proposed temporary dry masonry sill for—	65
Controlling the sand entering the canals — off Son Anicut at Dehri (Bihar).	20	...	41	58
Crump effect.	5
Crump's original design of S.W.F.	29
Crump's theory of seepage losses from canals.	60
Current meters and velocity rods —Comparison of discharges calculated from velocities observed with	61
Curvature of flow—unfavourable —established in the model of Lower Sind Barrage when constructed at site "C" in the loop.	56

C	Pages of Annual Report (Technical) for the year								
	1937 -38	1938 -39	1939 -40	1940 -41	1941 -42	1942 -43	1943	1944	1945
Cut-off channel—new—factors favourable for opening a— (i) curvature of flow u/s; (ii) relative slope d/s of the bifurcation; and (iii) relative discharges.	69	...
Cut-off in the Malaprabha below Railway Bridge on Gadag-Sholapur line near Alur Station and its effect on condition u/s.	10
Cut-offs in rivers upstream of bridges with guide banks.	47
Cut-offs in the vicinity of Railway Bridges—prediction of—	12
Cut-and ease-waters of bridge piers—suitable shapes for—	9
Curvature of flow—Effect of—on causing maximum scour round a pier.	33
Curvature of flow.	12,16, 18,19, 24,38,	12,13, 15,16, 18,19, 20,23, 32.	4,6,7, 10,11, 13,14, 18,19, 20,21, 46,51, 58.	8,32, 33,35, 37,39, 40,47.	7,8, 10,13, 20,23, 55,58, 69,74, 84,87, 97.	83-85
Curvature of flow due to pitching round piers.	12
Curvature of flow in the approach channel along new right bank at Sukkur—Dredging to improve—	18
Curvature—reproduction of—in a model.	59
Cut-off between Bakshi Khal and Mankur Khal, 1856.	13	...
Curvature of flow in the throat of a standing wave flume.	80-85
Cuttack, Orissa — Katjuri and Mahanadi group of rivers near— Experiments with a model of the—	37

C & D	Pages of Annual Report (Technical) for the year								
	1937	1938	1939	1940	1941	1942	1943	1944	1945
Cuttack (Orissa) — Kendrapara canal taking off Birupa River u/s of Mahanadi Anicut at— How to prevent silting of—	(iii)*
Cuttack (Orissa)—Mahanadi and Katjuri at—Distribution of flood waters between—	37
Cuttack (Orissa) — Naraj weir at — standing wave and drowned condition of the—and their effect on the sand drawn by the Katjuri.	38
D									
Damage in 1944 to the Surat-Rander Road and the City wall of Surat d/s of the Hope Bridge at Surat and recommendations to ameliorate present conditions.	87	...
Damage to lands bordering on the Tapti, Narbada and Sabarmati rivers during 1944 flood season.	84	...
Damodar bridge proposed at Burdwan (Bengal)—estimated scour at piers of.	24
Damodar River Flood Enquiry Committee (Proposals to prevent a recurrence of damage resulting from breaches)—by Government of Bengal and Technical and Joint Committee appointed by the Government of India.	(i), 1,2, 7*	5, 6, 13	...
Damodar left bank embankment d/s of Burdwan (Bengal)—Breaches in the—	5
Damodar River, Bengal—proposals to prevent a recurrence of damage resulting from breaches in the—	3*	...
Danger of water-logging in the Eastern Nara Tract in Khairpur State in Sind.	3*	...

D	Pages of Annual Report (Technical) for the year								
	1937	1938	1939	1940	1941	1942	1943	1944	1945
	-88	-89	-40	-41	-42	-43			
Darakeswar river	13	...
Dates of beginning of depletion from Lake Tansa, Bombay—years 1896 to 1944.	73	...
Dates of break of monsoon at Tansa Lake (Bombay)—years 1896 to 1944.	73	...
Datum area 1,000 ft. d/s of Sukkur Barrage before Right Bank approach channel was constructed and after.	102	...
Deccan canals—Growth of aquatic weeds in the	7
Deccan canals—Varieties of aquatic weeds on	7
Deccan fan catchment flood formula taking shape into account.	37
Deep scour d/s of the N.W. Railway Bridge over the N.W. Canal near Ruk, Sind—experiments carried out to evolve a suitable design of pavement and side expansion to induce accretion.	23	...
Deflecting groyne—Measures taken to control erosion of the left bank of the Rupnarain u/s of the B.N. Rly. Bridge at Kolaghat by means of a—	5-7
Deflector for protecting the bed of the pavement of S.W.F.s and baffle falls—Design of—	40	...
Degradation of sand—see abrasion of sand.	51	47	40	41	6	...	62
Dehri (Bihar)—Son anicut at—present method of regulating the—	40
Dehri (Bihar)—Son river at—sand drawn by the canals and underluices u/s of the anicut—	41
Dehri—Ejectors for canals taking off the Son at—Head available for working the—	43

D	Pages of Annual Report (Technical) for the year								
	1937	1938	1939	1940	1941	1942	1943	1944	1945
Dehri—Groyne with a regulator to reduce sand entry from M.W. Canal at—	23	58	...
Dehri on Son (Bihar)—Remodelling the anicut	19	20	14
Dehri on Son (Bihar)—Protection u/s of the sluices and along the divide walls.	21
Dehri on the Son (Bihar)—Prevention of scour d/s of sluices.	20	20	...
Dehri on Son (Bihar)—Prevention of scour at junction of high level weir and low level falling shutter portion of Son anicut weir.	21
Dehri on Son (Bihar)—sand excluding heads for the M.E. Canal and M.W. Canal on the—	14	40	58	...
Dehri on Son (Bihar)—Coefficient of discharge of weir.	25	58	...
Dehri—Son Anicut at—Controlling the sand entering the canals.	20
Delhi Gate Pumping Station—Training of Jumna River at— with pitched embankment on the right bank.	43-48
Delhi Province—Training of the Jumna near Pallia village.	...	52
Delhi to Okhla weir—Road along the Jumna river from	56
Delhi—Training of the Jumna at Delhi Gate Pumping Station.	65	...	55	...	1*	...	1,* (iii)	8	...
Delhi-Wazirabad Pumping Station 3 miles upstream of the Railway Bridge on the right bank of the Jumna.	56	...	1*
Delhi Water Supply Committee appointed by the Government of India.	1*	5	...

D	Pages of Annual Report (Technical) for the year								
	1937-38	1938-39	1939-40	1940-41	1941-42	1942-43	1943-44	1944-45	1945
Deltaic rivers—Deterioration of, Experiments with a model of the Nuna and Pothi Rivers in the Mahanadi Delta (Orissa).	7
Deltaic rivers—Embankments for controlling—	7
Deltaic rivers—Factors affecting the—	7
Denudation, erosion & floods	3
Denudation—soil—excess sand charge due to—	5
Deposition: N.V. relation (N = charge; V. = terminal velocity).	50	8,33
Depriming device of the Jamshedpur siphon spillway.	26	26
Design of a stilling basin d/s of the overflow section of the main Erinpura Dam in Jodhpur State.	20
Design of approach channel of flumes and falls.	31
Design of canals, in Sind, Part I—New canals and Part II—Inundation canals.	21
Design of channels u/s of S. W. F.s.	31
Design of cistern below flumes.	36, 40
Design of downstream portion of S.W. Flumes, standard design—where very high recovery of head is not essential.	35
Design of downstream portions of S.W. Flumes, standard design—where it is important to lose as little head as possible.	37
Design of guide banks and divide walls downstream of the new undersluices of the Son at Dehri (Bihar).	22

D	Pages of Annual Report (Technical) for the year								
	1937	1938	1939	1940	1941	1942	1943	1944	1945
	-38	-39	-40	-41	-42	-43			
Design of the Lower Sind Barrage—Experiments to test the design for scour and sand exclusion from canals—Sind.	48-59
Design of Lower Sind Barrage at Hajipur.	4, 6, 55	...
Design of new canals in Sind—recommendations for bed width, depth, slope—	27	2*	...
Design of off-take at the entrance to the right pocket from the approach channel at Sukkur.	96
Desilting and dredging of Tanks in Sangli State.	2*	...
Detention reservoirs and their effect on fluctuation in discharge and sand charge.	8
Determination of the coefficient of discharge of the automatic gates spillway for the Tansa Dam.	29-36
Determination of the variable coefficient of the 10,595 cs. Tando Mastikhan Fall on the Rohri Canal, Sind.	94
Device to ensure stilling before water is let into a model.	105	...
Dharamtar, Rewas and Karanja—Landing wharves at—	1*
Dharma Storage Reservoir, Dharwar (Bombay Presidency)—Flumed design of outlet for.	56
Dickens' run-off formula	67
Difficulties experienced in river model experiments due to effects caused by vertical exaggeration.	110-115
Difficulties in combined, rigid, mobile, meandering, river models.	4	2
Difficulties met in experiments with model of the Indus at Sukkur Barrage.	16

D	Pages of Annual Report (Technical) for the year								
	1937	1938	1939	1940	1941	1942	1943	1944	1945
Distributaries and canals—Exclusion of sand from the head of—	6
Divergence experiments.	56	41
Divergence from regime in stable channels in alluvium—analysis of 10 sites on distributaries of the Sarda Main Canal (U.P.).	30
Divergence from regime in stable channels in alluvium—Note on, by the Director.	3
Diversion channel of Spin Karez, Quetta (Baluchistan).	65
Dock—How to reduce waves in a —caused by swell in a harbour	66
Dominant discharge and meander length.	47
Downstream expansions — Rectangular Hyperbolic U.P. design adopted in flumes and falls.	35, 37, 40	...
Drag causing scour of pitching round piers.	12
Drag-form—due to shape of slab or pier obstructing the flow.	29	49, 51
Drag due to skin friction.	29
Drainage channels of the Damodar River.	13	...
Dredging to improve curvature of flow in the approach channel along R.B. at Sukkur.	18
Dr. Bose's slope formula.	2
Dunbar Cotton Mill—Training the Hooghly River at;—with a by-pass channel.	11-18
Dunbar Mill — Longitudinal and cross row of piles at the—to enable accretion and silting to take place.	7	...
Dunbar Mill on the Hooghly—Erosion of bank near the, how to prevent, by a tidal model.	18	23	18	...	7	...

D & E	Pages of Annual Report (Technical) for the year								
	1937	1938	1939	1940	1941	1942	1943	1944	1945
Durrani Outfall Channel (Quetta) —Dissipation of energy below.	53	22
E									
Ease and cut-waters of bridge piers—suitable shapes for.	9
Eastern and Western Jumna Canals—Headworks at Taje- wala.	1*	91	...
Eastern Bengal Railway Bridge at Amingaon on Brahmaputra— Experiments with a model of the	44	23
Eastern Bengal Railway Bridge at Amingaon on Brahmaputra —Experiments with a model of the Ganges at Hardinge Bridge.	66	22	23
Eastern Bengal Railway Bridge at Amingaon on Brahmaputra— Sluices in Railway embank- ments for Abdulpur Nawabganj Railway.	58
Eastern Nara	6
Eastern Nara and Rohri Canals (Sind)—Fluctuations of grade of materials exposed on the beds of—	35
Effect of constructing a barrage across a river on bed levels and water levels u/s and d/s with particular reference to the Indus (Sind).	17	99	...
Effect of closing the Head Regul- ator of the Rohri Canal (Sind) from the top downwards, on the canal regimen:	35
Effect of constructing a trench d/s of a soil dam on the saturation line.	61	...
Effect of high level bridge pave- ment on scour d/s of the Rail- way bridge on the N.W. canal at Ruk, Sind.	23	...

E	Pages of Annual Report (Technical) for the year								
	1937	1938	1939	1940	1941	1942	1943	1944	1945
Effect of shape of catchment on the run-off.	68	...
Effect of staunching due to silting upstream of the Solani dam.	63	...
Effect of storages in Tons and Giri catchments on supplies in the Jumna during flood season and regeneration in the fair season.	94	...
Effect of variation of u/s and d/s water levels of the Solani Khadir dam model on Hydraulic gradients or saturation lines.	61	...
Effect of high level pitching laid round Hardinge Bridge piers on the depth of d/s scour.	31
Effect of method followed in regulating d/s water levels on shape of channels.	33
Effect of residual turbulence on rate of deposition of sand.	33
Effect of shape of baffles on stability.	33
Effect of shortening Barrage on accretion in the Indus d/s of Sukkur Barrage.	3	...
Effect of size distribution of particles, specific gravity, charge of bed sand and discharge, on ripples.	56
Ejectors and Excluders—Reasons why—unsuitable at Sukkur.	17
Ejectors for canals taking off the Son at Dehri (Bihar) Head available for working the—	43
Ekruk Tank (Bombay)—silting of reservoirs with special reference to the—	32
Elutriator—sand and silt—grading sand and silt by washing.	64

E	Pages of Annual Report (Technical) for the year								
	1937	1938	1939	1940	1941	1942	1943	1944	1945
Embankment near Nanpara (U.P.) to divert the whole of the Saraju river into the Gogra, thus preventing spill flowing into the Saraju Tirhi channels.	2*	...
Embankments for controlling deltaic rivers.	7
Emperical run-off formulas	67
Energy dissipation below masonry waste weir of the Timba Tank at Harsol, Taluka Prantaj, Dist. Ahmedabad.	84
Energy dissipation below Spin Karez waste weir channel (Baluchistan).	46
Energy dissipation below Standing Wave Flume Falls.	27	28	29	31	29	...
Engineering Congress (Bombay)—Paper on the "C.I. and H.R. Stn., Khadakwasla" by A. R. Thomas, Dy. Director.	4
Engineering Congress (Punjab)—Written discussion by the Director on paper 245 "Rainfall and run-off".	5
—Do—Paper 275 (1945) "River Training and Control by Pitched ('Attracting') islands".	97	...
Enquiries dealt with, without experiments.	81	52	55	62	13	...	(i), 1	1	...
Entry conditions of models.	4
Entry conditions of model of the Ganges at Hardinge Bridge.	67	22
Equivalent size and specific gravity of stones and blocks in a model.	115- 116
Eradication of water weeds from Canals.	7
Erinpura Irrigation and Hydro-electrical Project siphon spillways in Jodhpur State.	2*	...

E	Pages of Annual Report (Technical) for the year								
	1937	1938	1939	1940	1941	1942	1943	1944	1945
Erosion at Neamati in Assam— Prevention of—	3*	...
Erosion at Ratnagiri—How to improve conditions and prevent further—	(ii)*
Erosion at Vizgapatam foreshore —prevention of—	3*	...
Erosion—control of—due to littoral drift.	(ii)*
Erosion, denudation and floods.	3
Erosion just u/s of the B.N. Rly. Bridge over the Rupnarain River—How to check danger- ous—	(iii)*	13	...
Erosion of agricultural lands along the Tapti, Narbada, and Sabar- mati Rivers—Prevention of—	2,3, 5, 84.	...
Erosion of Kshipra river at Ujjain—Control of—	(ii)*	2*,5	...
Erosion of Spur 2 in the Indus River near Umerkhel—action to be taken regarding.	3*	...
Erosion of the "Bur Gandak" River at Shikandarpur in Muzaffarpur Division (Bihar)— Controlling the	83
Erosion of the right bank of the Indus above Rohri and danger of breach of the main line, N.W. Railway.	(ii)*
Erosion—Prevention of—on Bombay Foreshore and recla- mation of land bearing S. No. 71, part of Juhu and creek-land.	1	...
Estimated depth of scour at bends.	75	...
Estimation of the maximum flood discharge during 1944 by various methods and comparison with the fan catchment formula.	89	...
Excluders and Ejectors—Reasons why--unsuitable at Sukkur.	17

E & F	Pages of Annual Report (Technical) for the year								
	1937-38	1938-39	1939-40	1940-41	1941-42	1942-43	1943-44	1944-45	1945
Exclusion of bed sand from canals and distributaries — factors affecting the	6
Exclusion of bed sand from the Jamrao Canal.	84
Exclusion of bed sand with a model of Faizwah Head Regulator-Ex-Khairpur Feeder West (Sind).	21
Exclusion of sand from canals taking off the Son river in Bihar.	58
Experiments in connection with dissipation of energy downstream of Lower Sind Barrage (2400 ft. upstream of site B near Hajipur).	9-11	...
Experiments to determine a suitable profile of the Lower Sind Barrage to cause minimum afflux with gates fully open.	22-29	...
Experiments with a vertically exaggerated model (1/400, 1/66) of the Mahanadi and its branches at Cuttack (Orissa).	19-22	...
F									
Factors affecting deltaic rivers.	3	7,8
Factors affecting exclusion of bed sand from canals.	6
Factors affecting flow in alluvial Channels.	50	33
Factors affecting growth of aquatic weeds in Deccan Canals.	7
Factors affecting meander of channels.	51
Factors affecting range of Gibb modules.	2	60
Factors affecting silting and scouring of channels"—Note for the Orissa Flood Advisory Committee on "Our present knowledge of the	6

F	Pages of Annual Report (Technical) for the year								
	1937	1938	1939	1940	1941	1942	1943	1944	1945
	-88	-89	-40	-41	-42	-43			
Falls, flumed—scour d/s of	97
Fan catchments—Rainfall and run-off from	5
Farewell speech by Sir Claude Inglis.	6	...
Ferozepore and Suleimanke Head works—Meandering of the River Sutlej between	2
Ferozepore Weir—Retrogression downstream of—	6
Flood Advisory Committee—Orissa	1
Flood discharge of the Brahmaputra at Amingaon—Estimate of the maximum	45	24
Flood of the Ganges and its lessons.	8
Flood protection measures for Nuna-Pothi Rivers in Orissa.	3*	...
Floods—causes of—in Sind.	12
Floods, denudation and erosion.	3
Floods, river—Sunspot intensity cycles as a medium of predicting the probable dates of occurrence of—	86-87
Flow below expansions.	56	41	40
Flow below Standing Wave Flumes—stabilization of—	42
Flow in alluvial channels—Factors affecting	50	33
Flow indicator rod.	56
Flow problems—Use of models for elucidating	3	2
Fluid forces acting on a weir.	48
Fluctuations of grade of materials exposed on the beds of the Eastern Nara and Rohri Canals (Sind).	35

F	Pages of Annual Report (Technical) for the year								
	1937	1938	1939	1940	1941	1942	1943	1944	1945
Flume Meter Baffle Falls—Design of downstream portion of—	35	...
Flumes — pebble-bed — Transportation of pebbles in—	47
Fluming of Outlets — Godavari right and left bank canal Head Regulators (Bombay).	32
Fluming of Outlets — Dharma Storage Reservoir—outlet for (Dharwar, Bombay Presidency).	56
Flumed Falls— Scour downstream of—	97
Form drag— Coefficient of— Scale effect on—	29
Form drag— Due to shape of slab or pier obstructing the flow.	29
Form drag— Impact losses due to, of slabs and piers under axial flow conditions.	28	49
Form drag of cylinders in connection with bridge investigation for Central Provinces.	(iii)*	4*	...
Formula for Venturi Flumes.	...	56
Formula, slope— Dr. Bose's	2
Forty cusecs Standing Wave Flume in the masonry conduit, taking off from the Haleji Reservoir — Karachi Water Supply scheme—	2*	...
Freshet spring and fair weather tide in the Rupnarain River at Kolaghat Railway Bridge on the B.N. Railway in 1944 and in its mobile bed model.	17	...
Fuleli Canal new headworks— scour near the Head of the—	1

G	Pages of Annual Report (Technical) for the year								
	1937	1938	1939	1940	1941	1942	1943	1944	1945
	-88	-89	-40	-41	-42	-43			

G

Gandak River at Bagaha on the Oudh and Tirhut Railway which has outflanked the Bridge—How to divert the—to its original course through the Bridge.	(iii)*	3,	...
								10,	
								13	
Gandak at Bagaha on the Oudh and Tirhut Railway—conditions leading to the outflanking of the Railway Bridge.	10	...
—Do— —Do— Chhitauni groyne acting as an 'attracting' spur in pulling the river round its nose.	10	...
—Do— —Do— afflux u/s of the Railway bridge on the—in 1925.	10	...
—Do— —Do— Prediction of the future movement of.	13	...
—Do— —Do— sand on the bed of the	11	...
—Do— —Do— use of the Mississippi formula for estimating the maximum flood discharge in the—in 1924.	12	...
Ganesh Iyer's volutesiphon—Factors effecting the coefficient of discharge of—	72-	78
Ganges above the Hardinge Bridge (Eastern Bengal Ry.)—Experiments with a model of the	66	92	23
Ganges flood and its lessons.	8
Ganges and three of its tributaries to demonstrate the meandering tendency of rivers carrying sand and silt in alluvial plains—Preliminary experiments with a model of the	37
Ganges—Maximum scour profile between guide banks of the—at the Hardinge Bridge.	4

G & H	Pages of Annual Report (Technical) for the year								
	1937	1938	1939	1940	1941	1942	1943	1944	1945
Groyne repelling—Proposal for protecting the left bank of the Rupnarain River u/s of the Railway Bridge at Kolaghat on the B.N. Railway.	15	...
Groynes and islands—control of flow, through bridges by means of	(iii)*	97	...
Groynes, attracting & repelling.	46	47	104	...
Groynes, Brushwood, effective in eliminating 'bellies' and return flow due to 'jetting', prevented by lowering pavement.	25	...
Groynes on the Sabarmati River at Ahmedabad—Effect of, on its course.	62
Groynes upstream of the Mithrao Approach channel to reverse the curvature of flow and so put more sand into Mithrao.	19
Groynes with a regulator to reduce sand entry in M.W. Canal at Dehri (Bihar).	23
Groynes with a regulator to reduce sand entry in the Sarda Main Canal at Banbassa (U.P.).	19
Guide bank system by Sir Francis Spring.	46
Guntkal-Bezwada section of the M. & S.M. Rly.—Heavy run-off from a small catchment u/s of a bridge on the—which caused the river to overflow the embankment and Railway track causing an accident.	44
H									
Hajipur, Sind, Design of Lower Sind Barrage at	55	...
Haleji Reservoir—Karachi water Supply scheme—Forty cusecs S.W.F. in the masonry conduit taking off from the river.	2*	...

H	Pages of Annual Report (Technical) for the year								
	1937	1938	1939	1940	1941	1942	1943	1944	1945
Harbour—How to reduce waves in a dock caused by swell.	66
Hardinge Bridge — Maximum scour profile between guide banks of the Ganges at the—	4
Hardinge Bridge—Model of the Ganges above the—	66	22	23	...	1*
Hardinge Bridge piers—Comparison of scour round the—with that in model.	38	37
Hardinge Bridge piers—Effect of high level pitching laid round—on the depth of downstream scour.	31
Hardinge Bridge piers 2 and 3—Reproduction in a model, of the scour-hole downstream of—	31
Hardinge Bridge piers—scour caused by—	12
Hardinge Bridge—Relation between maximum scour and discharge at—	13
Hardinge Bridge—Reproduction of breach in Right Guide Bank.	72
Hardinge Bridge — Scour-hole downstream of the—	5
Headworks—Punjab practice of constructing	98	...
Heavy run-off from a small catchment u/s of a bridge on the Guntkal Bezwada section of the M. & S.M. Railway which caused the river to overflow the embankment and railway track causing an accident.	44
High Coefficient Weirs.	99-101
High Coefficient Weir, drowned, Experiments with—	45	49
High Coefficient Weir—Coefficient of discharge of—	42

H & I	Pages of Annual Report (Technical) for the year								
	1937	1938	1939	1940	1941	1942	1943	1944	1945
	-38	-39	-40	-41	-42	-43			
Hooghly semi-rigid tidal model (short).	142
Hope Bridge near Surat—closing of spills on right bank u/s of—led to heavy erosion of the Rander Road.	88	...
Hot Wire observations in experiments for inlet length of open channel.	54
Hot wire observations in model Right Guide Bank of Hardinge Bridge.	74
Hot wire observations in models of submersible bridges (C.P.).	35
Hur Hura khal.	13	...
Hurdling over baffle wall.	30	...
Hydraulic elements and constants—Nomograms for determining the	78-80
Hydraulic gradient or saturation lines—effect of u/s and d/s water levels of the Solani Khadir dam model on—	61	...
Hydrodynamic models as an aid to Engineering skill—Presidential address by the Director before the Engineering Section of the Indian Science Congress.	1
Hydrodynamic Research work done by the Special Irrigation Division (Bombay)—An outline of—	2
I									
Impact losses due to form drag of slabs and piers under axial flow conditions.	28, 31	49, 51
Impact losses on slabs of submersible bridges.	28
Improvement of the Rice Canal due to the Right Bank approach channel at Sukkur.	33

I	Pages of Annual Report (Technical) for the year								
	1937-38	1938-39	1939-40	1940-41	1941-42	1942-43	1943	1944	1945
Improving curvature of flow in the approach channel along inner right bank, Sukkur.	18
Inclination of slope of falling aprons.	71
Indian Railway Conference Association.—Discussion of Paper on "Protection of bridge pier against scour."	1*
Indian Science Congress.—Director's Presidential address to Engineering section on "Hydrodynamic model as an aid to Engineering skill."	1
Indus above Rohri—Erosion on the right bank of the—and danger of breach of the main line N. W. Railway.	(ii)*
Indus above Sukkur (Sind)—Re-alignment of the Rohri-Quetta Railway necessitated by the danger of breaches in the marginal bunds of the—	(ii)*
Indus—Analysis of Bilot creek and Paharpur Canal data (Ex-Indus 35 miles d/s of Kalabagh, N.W.F.P.) in—	32
Indus and the Lloyd Barrage at Sukkur.—Experiments with a model of the, for sand control of the right bank canals.	26	4	12	12	16
Indus, Sukkur—accretion in—	6, 99	...
Indus, Bukkur island, in the—acts as an 'attracting' island—	97	...
Indus at Sukkur (Sind)—New factors which will affect rate of rise of water levels in the—	17
Indus—downstream of Kalabagh—analysis of changes in the course of the—	7
Indus—Jamshoro bund on the left bank of the—near Hyderabad (Sind).	39

I	Pages of Annual Report (Technical) for the year									
	1937	1938	1939	1940	1941	1942	1943	1944	1945	
Indus near Umerkhel—action to be taken regarding erosion of spur 2 in the—	5*	...
Indus—rate of rise of water levels in the—	15	99	...
Indus near Chasma—Cause of change of course of—and how to control—	(ii)*
Indus—Probable effect of constructing the Kalabagh Barrage on the course of the—	10
Indus—Protection of N. W. Railway embankment u/s of the Bukkur gorge.	13
Indus (Sind)—Breaches in the—	20
Indus (Sind)—effect of constructing a barrage across a river on bed levels and water levels u/s and d/s with particular reference to the—	18	99	...
Indus (Sind).—Specific discharge gauges at Bachalshah on the—	101	...
Indus—Technical analysis of available data regarding the rise of the water levels of the—in the past and to be anticipated in future—	15
Indus—Technical enquiry into the causes of breaches in the River Bunds in Sind and steps required to minimize the danger of recurrence.	1,	10	...
Information regarding rainfall, run-off Formulas and rate of silting of reservoirs required in connection with a scheme in Transvaal, South Africa.	2*	...
Inglis' fan catchment discharge formula, introduction of shape factor in—	38	67	...
Inglis' stability factor (f_m) for a canal system.	2
Inlet length channel experiments.	52	34

I & J	Pages of Annual Report (Technical) for the year								
	1937	1938	1939	1940	1941	1942	1943	1944	1945
	-38	-39	-40	-41	-42	-43			
Institution of Engineers (India)— Paper read by S.C. Majumdar, Chief Engineer, Bengal, on "Ganges flood and its lessons" and discussion by C.C. Inglis.	...	8
Inundation Canals in Sind— Analysis of—and its compari- son with the data of perennial canals.	29
Inundation Canals in Sind—De- sign of—	29
Island at Suleimanki.	99	...
Island for the Lower Sind Barrage site C.	98	...
Islands and attracting spurs—use of—for training a river.	46	47	97	...
Islands and groynes—Control of flow through bridges by means of—	(ii)*
Islands for holding a river.	46	47
Islands u/s of the Barrage at Kalabagh.	98	...
J									
Jamrao and Sukkur Barrage Canals—Relationship between surface width and Q of—	25	...
Jamrao and Sukkur Barrage Canals—Relationship between S and Q.	26	...
Jamrao Canal (Sind)—Exclusion of bed sand from the—	84
Jamrao Canals, Sukkur Barrage Canals, L.C.C., L.J.C. (Punjab) —Relationship between area and discharge of.	23	...
Jamrao, L.C.C. and L.J.C. data compared with the U.P. data (10 sites).	31
Jamshedpur Syphon spillway for dissipating energy—alternative designs of baffle platform d/s of the—	20

J	Pages of Annual Report (Technical) for the year								
	1937	1938	1939	1940	1941	1942	1943	1944	1945
	-88	-39	-40	-41	-42	-43			
Jamshedpur Water Supply storage, Tatanagar (Bihar)—siphon Spillway for the—	27	27	26
Jamshedpur siphon design— De-priming device of the—	26
Jamshedpur siphon design— pressures during priming.	27
Jamshedpur siphon spillway experiments—priming and de-priming.	26
Jamshoro Bund on the Left bank of the Indus near Hyderabad (Sind).	39
“Jetting” below canal falls and bridges	25, 30	...
“Jetting” prevented by lowering pavement level at Railway Bridges.	25	...
Jeur Aqueduct on the Nira L.B. Canal (Bombay)— Discharge formula for—	(ii)*
Jodhpur Railway line—Training of Luni River to prevent it damaging the—	36-42
Jodhpur Railway—How to control Luni River where it is crossed by the Samdara-Raniwara Branch Line on—	3*	...
Jodhpur Railway—Steps necessary to protect main Line from Hyderabad to Luni Junction on —from damage by Luni River floods.	3* 5	...
Jodhpur State—Construction of a 500 cusecs standing wave flume in—	2*	...
Jodhpur State—Design of a stilling basin d/s of the overflow section of the main Erinpura Dam in—	2*	...
Jodhpur State—Erinpura Irrigation and Hydro-electrical Project siphon spillways in—	2*	...

J	Pages Annual Report (Technical) for the year								
	1937	1938	1939	1940	1941	1942	1943	1944	1945
Jodhpur State—Runoff from Erin-pura Reservoir.	63	...
Jodhpur Water Supply channel—Modularity of 20 cusecs Standing Wave Flume.	81	6
Jumna at New Delhi—Present and future water requirements and supplies in the—	91	...
Jumna at New Delhi—Training of the, near Delhi Gate Pumping Station.	65	...	55	2* (iii)*	4,	8	...
Jumna canals — Eastern and Western — Headworks at Tajewala.	1*
Jumna near Pallia Village—Training the	52
Jumna River at Delhi Gate Pumping Station—Training of—with pitched embankment on the right bank.	43- 48	...
Jumna river at Tajewala—Control of—by means of spurs.	(ii)*
Jumna river—Relation between floods in the monsoon and regeneration in the hot weather in the—	93	...
Jumna—Road along the, from Delhi to Okhla weir.	56
Jumna—Wazirabad Pumping Station, 3 miles above the Railway Bridge on the right bank of the—	56	5
Junction of High level, High Coefficient Weir and low level, falling shutter weir portion of the Son Anicut at Dehri.	21
Junction of the outer bank of tail channel with Barrage at Sukkur.	15

K	Pages of Annual Report (Technical) for the year									
	1937	1938	1939	1940	1941	1942	1943	1944	1945	
	-38	-29	-40	-41	-42	-43				
K										
Kaira town protection by training the Watrak river in Gujerat (Bombay Presidency).	77	16	
Kalabagh—Analysis of changes in the course of the River Indus downstream of—	8	
Kalabagh Barrage—Effects of constructing the—on supplies to the Paharpur Canal in N.W.F. Province.	2*	
Kalabagh Barrage—Islands u/s of the	98	...	
Kalabagh Barrage — Probable effect of constructing the—on the course of the Indus.	9	
Karachi water supply scheme—40 cusecs standing wave flume in the masonry conduit taking off from the Haleji Reservoir.	2*	...	
Karanja, Rewas and Dharamtar—Landing wharves at—	1*	
Karwar and Kumta—Minor Ports.	1*	
Katjuri and Mahanadi at Cuttack (Orissa)—Distribution of flood waters between—	37	
Katjuri and Mahanadi group of rivers near Cuttack, Orissa—Experiments with a model of the—	57	
Katjuri — Standing wave and drowned conditions of the Naraj weir at Cuttack (Orissa) and their effect on the sand drawn by the—	39	
Kendrapara Canal taking off Birupa river u/s of Mahanadi anicut at Cuttack, Orissa—How to prevent silting of—	(iii)*	
Kennedy and Lacey.	40	

K & L	Pages of Annual Report (Technical) for the year								
	1937	1938	1939	1940	1941	1942	1943	1944	1945
	-38	-39	-40	-41	-42	-43			
Khairpur State (Sind)—Danger of waterlogging in the Eastern Narā tract in—	3*	...
Khari River at Raipur, near Ahmedabad (Bombay) — How to prevent outflanking of Barrage on—	(ii)*	2*	...
Khipro Canal (Sind)—Remodeling the, for sand exclusion.	57	16
Knuckle at Dunbar Cotton Mills—Longitudinal and cross row of piles at the—to enable accretion and silting to take place.	7, 8	...
"Knuckle" formation at several points along the fore-shore of the Hooghly above Calcutta.	23	18
Kosai River.	13	...
Kosi gorge—Land slides in the	3	...
Kosi River — Factors affecting rapid westerly movement of—	13	5	...
Kotri and Sukkur—Silt in suspension at—since 1913—Quality of—	19	...
Kshipra River at Ujjain—Erosion of—control of	(ii)*	2*, 5	...
Kumta and Karwar—Minor Ports.	1*
L									
Lacey and Kennedy.	40
Lacey regime theory.	4
Lacey's formulas.	2
Lacey's formulas—Effect of decrease of size of bed material down canal on various—	8
Lacey's regime formula in connection with model scales.	6
Lacey theory of shock — in channel flow.	3

L	Pages of Annual Report (Technical) for the year									
	1937	1938	1939	1940	1941	1942	1943	1944	1945	
Lake Arthur Hill, Bhandardara (Bombay) — High Coefficient weir for the waste weir of	39	...	27
Lake Arthur Hill, — (Bombay) — Unsuitability of proposal of Siphon Spillway for waste weir of	...	59
Landslides in the Kosi gorge.	3
Landing wharves at Rewas, Karanja and Dharamtar.	1*
Launching an apron.	68
Leakage through Solani embankment.	63
Limitations of model re: reproduction of changes in the river over a long period of Bank erosion in Malaprabha river near Railway Bridge on Gadag-Sholapur line near Alur Station.	11
Limiting pressures in siphon spillways.	26
Lined channels—design of—for minimum slope.	43
Littoral drift—control of erosion due to—	(ii)*
Lloyd Barrage at Sukkur—Experiments with a model of the Indus for sand control of right bank canals.	26	2	12	12	16
Load: $N.V_s$ relation (N = charge; V_s = terminal velocity).	50	8,33
Losses from canals due to seepage—Experiments to determine the	60	50
Lower Coleroon system (Madras Presidency)—Means to prevent sand entering the Vadavar channel of the	82
Low level pitching round Hardinge Bridge piers—Effect of—on scour downstream.	32

M	Pages of Annual Report (Technical) for the year									
	1937	1938	1939	1940	1941	1942	1943	1944	1945	
Madras Presidency — Silting of the Grand Anicut Canal on the Cauvery.	54									
M. & S.M. Railway— Heavy run-off from a small catchment u/s of a bridge of the, on the Guntakal-Bezawada section of the— which caused the river to overflow the embankment and railway tract, causing an accident.							44			
Mahanadi anicut at Cuttack, Orissa-Kendrapara canal taking off Birupa river u/s of — how to prevent silting of—							(iii)*			
Mahanadi and Katjuri at Cuttack (Orissa) — Distribution of flood waters between —							37, 38		19-22	
Mahanadi group of rivers at Cuttack (Orissa) — How to control deterioration of the —							(ii)*			
Major Gorie's Paper on soil denudation.							3			
Malaprabha — Cut off in the — below railway bridge on Gadag-Sholapur line near Alur Station and its effect on conditions upstream.							10			
Malaprabha River at Shivayogmandir, Bijapur District (Bombay) — Design for a high coefficient weir for the pick-up weir across the —			25							
Malaprabha river — Training the — Experiments to compare relative merits of various alternative measures for relieving heavy scour at the railway Bridge abutment.							10			
Malaprabha River — Training the — to protect the left bank and abutment of the M. & S.M. Ry. Bridge No. 8 at Hole-alur on the Hotgi-Gadag line.									7-8	
Malikpur Research Station — Director's visit to the, for advice on Beas spur experiments.							2			

M	Pages of Annual Report (Technical) for the year									
	1937	1938	1939	1940	1941	1942	1943	1944	1945	
	-38	-39	-40	-41	-42	-43				
(j) the Jhelum near Shahpur (N. W. Rly.)	75,82
(k) the Jumna Railway Bridge at Delhi.	"
(l) the Karnaphuli Railway Bridge.	75,78, & 82
(m) the Meghna near Railway Bridge (B. A. Rly.)	75,78 & 82
(n) the Par near Ry. Bridge (B. B. & C. I. Ry.)	"
(o) the Ravi near Ry. Bridge at Dera Baba Nanak (N. W. Ry.)	75,77 & 82
(p) the Sutlej near Empress Ry. Bridge at Adamwahan.	"
(q) the Sutlej near Ry. Bridge at Phillaur.	"
Maximum depth of scour at noses of guide banks, groynes and at sharp bends in —										
(a) Ganges at Sara Guide bank, 3 miles u/s of the Hardinge Bridge.	75,83
(b) Ganges near the nose of the Right Guide Bank of the Hardinge Bridge.	"
(c) Hooghly near Dunbar Cot- ton Mill.	"
(d) Jumna near Delhi Gate Pumping Stn. at spur 5.	"
(e) Narbada River, old Ry. Bridge at Broach, B. B. & C. I. Ry.	75,77 79,83
(f) Right Bank approach channel at Sukkur.	75,77 83
(g) Ravi u/s of Balloki weir —										
(i) at nose of spur 5 on the Right Bank.	76,77 79,80, 83
(ii) at nose of spur 6 on the Right Bank

M.	Pages of Annual Report (Technical) for the year								
	1937 -38	1938 -39	1939 -40	1940 -41	1941 -42	1942 -43	1943	1944	1945
Model limitations—Methods followed in overcoming — and model scale ratios — methods followed in fixing — based on experience gained at the Indian Waterways Experiment Station, Poona.	88-116
Model 1/600 : 1/120 of Indus River u/s of the Bukkur Gorge — experiments with a — in connection with protection of threatened N.W. Railway embankment.	1, 13
Model of the Indus at Sukkur Barrage — Difficulties met in experiments with —	16
Model — Pilot and mobile bed— Experiments with	15	...
Model—reproduction of curvature in a—	59
Model scale ratios — methods followed in fixing—and model limitations — methods followed in overcoming — based on experience gained at the Indian Waterways Experiment Station, Poona.	88-116
Model (1/400, 1/66), vertically-exaggerated—of the Mahanadi and its branches at Cuttack (Orissa). —Experiments with the	19-22
Models—Combined rigid, mobile and meandering, River.	5	3
Models—Geometrically-similar	4	2
Models, geometrically - similar which give geometrically-similar results.	92
Models, geometrically - similar which do not give geometrically-similar results.	99-101
Models, Hydrodynamic, as an aid to Engineering skill; Presidential address by the Director before the Engineering section of Indian Science Congress.	1

M	Pages of Annual Report (Technical) for the year								
	1937	1938	1939	1940	1941	1942	1943	1944	1945
	-38	-39	-40	-41	-42	-43			
(h) Sutlej at u/s of the Ry. Bridge, Ferozepore (N. W. Ry.)—									
(i) at nose of spur 4;								76,77,	...
(ii) at nose of the old Right Guide Bank. }	79,	...
								83	
Maximum depth of scour d/s of bridges in—									
(a) the Ganges d/s of pier 3 of the Hardinge Bridge;	4	2	76,77,	...
								83	
(b) the N. W. Canal d/s of the Ry. Bridge near Ruk (N. W. Ry.);	,	...
(c) the Rice Canal d/s of the Ry. Bridge at R. D. 75,000 (N.W. Ry.);	,	...
(d) the Rohri Canal d/s of the Rohri Multan Road Bridge at R.D. 52,000;	76,77,	...
								81,83	
(e) the Rohri Canal d/s of the Head Regulator at Sukkur;	76,77,	...
								80,83	
(f) scour d/s of the Road Bridges on the Eastern Jumna Canal.	76,77	...
								83	
Maximum depth of scour d/s of Bridges.	75,76,	...
								77,80	
								81,83	
Maximum flood discharge of the Brahmaputra at Amingaon — Estimate of the	45	24
Maximum freshet ebb discharge in the Rupnarain River at Kola-ghat Railway Bridge on the B. N. Ry. in 1944, estimation of	14	...
Meander belts, distance between meanders on axis of stream, width and discharge of River on flood plains and incised Rivers — Relation between	9
Meander data of American rivers.	11
Meander data of Orissa rivers.	9

M	Pages Annual Report (Technical) for the year								
	1937 -38	1938 -39	1939 -40	1940 -41	1941 -42	1942 -43	1943	1944	1945
Meandering of the River Sutlej between Ferozepore and Suleimanke Headworks.	6	(ii)*
Meandering tendency of rivers carrying sand and silt in alluvial plain — Preliminary experiments with a model of the Ganges and three of its tributaries to demonstrate the.	37
Meander length of the Rupnarain River—Increase in the—due to increase in freshet discharge.	14	..
Meanders of channels—Factors affecting—	51
Meander length and dominant discharge.	47, 54
Meander length and meander belt in rivers and small channels—comparison of—	53
Meander length and meandering belt—co-efficient of—in American Rivers and experimental channels.	54
Meander lengths in pebble bed flumes.	50
Meanders—and scale ratios of models.	7
Meanders—Curvature of	10
Meanders—downward movement of—	53
Meanders—Effect of sand charge on	7
Meanders, primary and secondary.	51
Meanders—reproduction of—by model experiments.	54
Measures to prevent bank erosion at the Rupnarain Bridge near Kolaghat on the B. N. Railway in Bengal.	3, 13	...

M & N	Pages Annual Report (Technical) for the year								
	1937	1938	1939	1940	1941	1942	1943	1944	1945
Mula River above the Rahuri Causeway, Dist. Ahmednagar, (Bombay)—Training the	14
Mutha catchment at Khadakwasla, shape of—	35
N									
Nappe — Under surface of — to determine the profile of a high coefficient Weir.	40
Nara—Eastern (Sind).	6
N and N _a with smooth boundaries.	54
Nara—Eastern and Rohri canals (Sind)—Fluctuation of grade of materials exposed on the beds of the—	35
Naraj Weir at Cuttack (Orissa) — Standing wave and drowned condition of the — and their effect on the sand drawn by the Katjuri.	58
Narbada River — Water levels of maximum floods in the—during 1886 and 1944.	85	...
Narbada, Tapti and Sabarmati Rivers — Prevention of erosion of agricultural lands along the—	2,3, 5, 85	...
Natural regime sand charge.	4
Neamati in Assam — Prevention of erosion at—	3*	...
Nikuradse experiments for flow in pipes.	45
Nira L. B. Canal Head Regulator —Coefficient of discharge of the—	95
Nira L. B. canal (Bombay)—Jeur aqueduct on the — Discharge formula for—	(ii)*

N	Pages of Annual Report (Technical) for the year								
	1937	1938	1939	1940	1941	1942	1943	1944	1945
Nira R. B. canal (Bombay Presidency) — Training the Nala passing through Aqueduct 14 of the	81	19
Nomograms for determining commonly required hydraulic elements and constants.	78-80	...
Nomograms—Punjab Irrigation—by Mr. E. S. Lindley.	6	...
Nose of the Right bank approach channel at Sukkur — Scour around the—	18	12
Nose upstream of divide walls of the Son Anicut at Dehri (Bihar) —Prevention of scour at—	19
Number of dry days during which Tansa storage (Bombay) was depleted—years 1896-1944.	73	...
Number of wet days before depletion started in Tansa (Bombay) —years 1896 to 1944.	73	...
Nuna and Pothi Rivers in the Mahanadi delta — Experiments with a model of the—	7
Nuna-Pothi rivers in Orissa — Flood protection measures for—	3	...
N. V_s relation (N = charge; V_s = terminal velocity).	50	8,33
N.W. Canal in Sind—Prevention of scour below a bridge on the—	3	...
N.W. Railway Bridge over the N.W. canal near Ruk, Sind—Deep scour d/s of the—experiments carried out to evolve a suitable design of pavement and side expansion to induce accretion.	23	...
N.W. Railway Embankment—Experiments with a 1/600: 1/120 model of the Indus River u/s of the Bukkur Gorge in connection with protection of threatened—	13

O	Pages of Annual Report (Technical) for the year									
	1937	1938	1939	1940	1941	1942	1943	1944	1945	
	-38	-39	-40	-41	-42	-43				
O										
Offtake — Design of — at the entrance to the right pocket from the approach channel at Sukkur.	96
Off-takes — Sand selection at heads of—	7
Off-taking channels—effect of meanders of parent channel on—	14
Okhla weir—Road along the	56
Open channels—Inlet length of—	52
Open channels—Wave and surge velocity in	58
“Open flow” versus “still pond” regulation at Son Anicut.	22
Orissa, experiments with a vertically-exaggerated model (1/400, 1/66) of the Mahanadi and its branches at Cuttack.	19-22
Orissa, Cuttack — Katjuri and Mahanadi group of rivers near— Experiments with a model of the	37
Orissa, Cuttack—How to control deterioration of the Mahanadi group of rivers in—	(iii)*
Orissa, Cuttack—How to prevent silting of Kendrapara Canal taking off Birupa river, u/s of Mahanadi Anicut at Cuttack (Orissa).	(iii)*
Orissa, Cuttack—Mahanadi and Katjuri at — Distribution of flood waters between—	37	19
Orissa, Cuttack—Naraj weir at— Standing wave and drowned condition of the—and their effect on the sand drawn by the Katjuri.	38	19
Orissa Flood Advisory Committee.	1	...	1*

O & P	Pages of Annual Report (Technical) for the year							
	1937-38	1938-39	1939-40	1940-41	1941-42	1942-43	1943-44	1944-45
Orissa Flood Advisory Committee —Note for, on our “present knowledge re: the factors affecting silting and scouring of channels”.	6
Orissa - Flood protection measures for Nuna Pothi Rivers in—	3*	...
Orissa—Prevention of silt going into the Surada Reservoir at its Padma Intake in—	2*	...
Orissa—Proposed temporary dry masonry sill for control of Sur Lake sea-cut with marginal embankments.	65
Orissa Rivers—Meanders, data of	10
Oudh and Tirhut Railway—Gandak River at Bagaha on the— which has outflanked the bridge—how to divert the—to its original course through the bridge—	(iii)*	10	...
P								
Paharpur Canal and Bilot creek— Analysis of data—	32	...
Paharpur Canal in N.W.F. Province—Effect on supplies to the—by construction of the Kalabagh Barrage.	2	...
Pebbles and Sand entering the Sarda Main Canal—Control of—by constructing a regulator in the short Banbassa spur.	19
Pebble bed flume—Experiments to see what changes occur when the charge of uniform bed material is suddenly increased.	50	...
Pebbles in pebble-bed flumes— Transportation of—	47	...
Permissibility or otherwise of reducing spillway capacity, Berar (Akola Municipality)—	2*	...

P	Pages of Annual Report (Technical) for the year								
	1937	1938	1939	1940	1941	1942	1943	1944	1945
Pick-up weir across the Mala- prabha river at Shiva yogmandir, Bijapur District (Bombay Presi- dency) — Design of High Coefficient Weir for	25
Piers, bridge—Estimated scour at the, of the proposed bridge at Burdwan (Bengal).	24
Piers, bridge — Suitable shape for cut- and ease-waters of —	9
Piers, Drag causing scour of pitching round	12
Piers —Effect of, on Standing Wave flume discharge co-effi- cient.	59
Piers—Bridge, — Failure of the— under construction over the Ajoy River in the Santal Parganas, Bihar, during 1942 floods.	3
Piers, Hardinge Bridge — scour round the	38
Piers —Minimum safe levels of pitching round	32
Piers — Slips downstream of — due to high level pitching.	12
Piers —scour round the	...	39	33	35
Piers —scour round the, of the proposed Eastern Bengal Rail- way Bridge at Amingaon on Brahmaputra.	45	25
Piles —Longitudinal and cross row of — at the knuckle at Dunbar cotton Mills to enable accretion and silting to take place.	7	...
Pilot Model and mobile bed model —Experiments with —	15	...
Pitching — High level — effect of —laid round Hardinge Bridge piers on the depth of d/s scour.	31

P	Pages of Annual Report (Technical) for the year								
	1937	1938	1939	1940	1941	1942	1943	1944	1945
Pitching — Low level — round Hardinge Bridge piers — effect of, on scour d/s	32
Pool — Improvement of —Raji- wada creek and Ratnagiri Bay (Bombay).	1*
Port of Rangoon Tidal Model.	107
Positioning of 'attracting' islands as related to meander length.	97	...
Pothi and Nuna Rivers in the Mahanadi delta — Experiments with a model of the —	7
Prediction of cut-offs in the vicinity of Railway Bridges.	12
Prediction of the future move- ment of the Gandak River at Bagaha.	13	...
Present and future water require- ments and supplies in the Jumna at Delhi.	91	...
Pressures in the Jamshedpur siphon spillway.	27
Prevention of collapse of Rohri Multan Road Bridge over Rohri Canal at R. D. 52,000 in Sind.	3*	...
Prevention of damage to the Surat-Rander Road and the city wall of Surat d/s of the Hope Bridge from floods in the Tapti River in Gujarat.	3,6, 87	...
Prevention of erosion at Neamati in Assam.	3*	...
Prevention of erosion of agricul- tural lands along the Tapti, Narbada and Sabarmati rivers.	3,5, 84	...
Prevention of erosion on Bombay foreshore and reclamation of land bearing S. No. 71 part of Juhu and creek-land.	1*	...
Prevention of foreshore erosion at Vizagapatam.	3*	...

P	Pages of Annual Report (Technical) for the year								
	1937	1938	1939	1940	1941	1942	1943	1944	1945
Prevention of further erosion on the left bank of the Rupnarain river above Kola-ghat Railway Bridge of the B. N. Railway.	13	...
Prevention of scour below a bridge on the N. W. Canal in Sind.	3, 23	...
Prevention of scour in Garang river on Assam access Road.	3*	...
Prevention of scour — Below Durrani Outfall channel at Quetta (Baluchistan).	22
Prevention of scour—at junction of high level weir and low level shutter portion of the Son anicut at Dehri (Bihar).	21
Prevention of scour—At noses of Divide walls u/s and d/s of the Son Anicut undersluices.	21
Prevention of scour — D/s of the Sarda Barrage at Banbassa.	24
Prevention of sea wall erosion at Bombay.	1*	...
Prevention of silt going into the Surada Reservoir at its Padma Intake in Orissa.	2*	...
Priming weir d/s of the Jamshed-pur Siphon spillway.	26
Priming depths of the Jamshed-pur Siphon.	27
Proposal to construct a Barrage on Tank Zam in N. W. F. Province to split up water between several areas.	2*	...
Proposals to prevent a recurrence of damage resulting from breaches in the Damodar river, Bengal.	3*	...
Proposed diversion of 40,000 cs. to relieve flooding at Gorakhpur on O. and T. Railway.	2*	...

P	Pages of Annual Report (Technical) for the year								
	1937	1938	1939	1940	1941	1942	1943	1944	1945
Protection of stones and blocks— Experiments to determine equivalent size and specific gravity of	50
Protection of the Bhadeli village by training the Auranga river (Dist. Surat), Bombay.	...	52
Protection of threatened N. W. Railway embankment—Experiments with a 1/600 : 1/120 model of Indus River u/s of the Bukkur Gorge in connection with—	13
Protecting the toe of a retaining wall from scour, particularly on a curve, in South Quetta, Baluchistan.	1*	...
Protection to the piers of the Elgin Bridge over the Gogra River on O. & T. Railway.	1*	...
Protective measures below the new undersluices of Son at Dehri — Bihar officers' proposals tested in Model.	21	...
Protective measures — Dehri (Bihar) — Optimum design of control blocks and deflectors.	21	...
Publication of the Central Irrigation and Hydrodynamic Research Station, Indian Waterways Experiment Station, Poona, during the year.	3	1	2	10	1	3	...	6	4
Punjab Engineering Congress— Written discussion by Director on "Rainfall and run-off".	5
Punjab Engineering Congress— Written discussion by Director on Paper No. 275 "River-training and control by pitched 'attracting' islands."	97	...
Punjab — Experiments with models of S. W. F. Falls on Montgomery Pakpattan link.	27	28	29	31

R	Pages of Annual Report (Technical) for the year								
	1937	1938	1939	1940	1941	1942	1943	1944	1945
Railway Conference Association, Indian — discussion of the Note on "Protection of bridge piers against scour."	1*
Railway embankments d/s of Son Anicut — effect of, on sand drawn — by M. E. Canal.	21
Railway embankments — sluices for, on Abdulpur Nawabganj Railway (E. B. Railway).	58
Rainfall and run-off in Indian catchments.	5,6	...	34	44, 67	68	...
Rainfall and run-off in American catchments	6	69
Rainfall and run-off from Karamnasa river at Silhat weir, U. P.	68	...
Rajiwada creek and Ratnagiri Bay (Bombay), Improvement of Port.	1*
Rajkot State — Run-off from Lalpuri Tank in —	68	...
Rajkot State — Thorala catchment in — Maximum possible discharge from catchment of —	(ii)
Rander Road — closing of spills on right bank u/s of Hope Bridge near Surat led to heavy erosion of the —	88	...
Rangoon Port Tidal Model.	107
Rapid — Design of a, for waste weir Channel of Spin Karez Reservoir, Quetta, Baluchistan.	50
Rate of sand attrition in channels.	62, 64
Ratnagiri Bay and Rajiwada creek — improvement of Port.	1*
Ratnagiri — Erosion at — how to improve conditions and prevent further —	(ii)*
Recommendations of the Solani dam section based on model experiments	63	...

R	Pages of Annual Report (Technical) for the year								
	1937 -38	1938 -39	1939 -40	1940 -41	1941 -42	1942 -43	1943	1944	1945
Recovery of head, modular limit and range in S.W. Flumes.	37	...
Regeneration in the Jumna river.	93	...
Regime—Definition of—	2
Regulator—Makhi, Sind.	6
Regime —Divergence from— in stable channels in alluvium.	3
Regime formula —Lacey's, in connection with model scales.	6	...	3
Regime—Lacey—theory.	4
Regime, natural, sand charge.	4	5,10
Regime sites—seven—in Sind.	4
Regulation and scouring of tail channel at Sukkur.	14
Regulation of Son Anicut—present method of—on rising flood and falling flood.	20
Regulator, suggested, in right gorge between Sukkur and Bukkur to control sand entering the Canals.	16
Regulator in a groyne to reduce sand entry in M.W. Canal at Dehri (Bihar).	23
Regulator in a groyne to reduce sand entry in the Sarda Main Canal at Banbassa (U.P.).	19
Relation between bulk proportionality and height of hump.	43	...
Relation between floods in the Monsoon and regeneration in the Hot-weather in the Jumna River.	93	...
Relation between maximum scour and discharge at Hardinge Bridge.	13
Relation between mean diameter of bed material and discharge in a canal system.	4

R	Pages Annual Report (Technical) for the year								
	1937	1938	1939	1940	1941	1942	1943	1944	1945
Relation between the mean rainfall at Wada and Bhivandi and Bombay water supply—1895 to 1944.	73	...
Relation between proportionality of discharge in S.W.F.s and height of hump—	43	...
Relation between the size of air pipe, size of the discharge pipe and the drum with leakage from chamber.	67	...
Relation $N.V_s$ (N = charge; V_s = terminal velocity)	8
Relation—slope, of Lacey and Dr. Bose	9
Relationship between area and discharge of L.C.C., L.J.C. (Punjab), Jamrao canals and Sukkur Barage canals (Sind).	23
Relation between mean depth and discharge per foot width of Jamrao and S.B. Canals (Sind).	24
Relationship between S and Q of Jamrao and Sukkur Barrage canals.	26
Relationship between surface width and Q of Jamrao and Sukkur Barrage canals.	25
Relationship between turbulence and bed mix.	4
Remodelling of Son Anicut at Dehri.	14	...	20, 58	...
Remodelling Railway Bridge over the N.W. canal at R.D. 75,000 on the N.W. Railway.	3, 23	...
Remodelling the Rice canal in Head portion.	3, 104	...
Repelling groyne upstream of the Railway Bridge on the Rupnarain River at Kolaghat on B.N. Railway—comparison of results in the model and in the river.	15	...

R	Pages of Annual Report (Technical) for the year								
	1937 -38	1938 -39	1939 -40	1940 -41	1941 -42	1942 -43	1943	1944	1945
Reproduction of scour-hole in a model d/s of Hardinge Bridge piers 2 and 3.	31
Research work—Hydrodynamic, done by the Special Irrigation Division (Bombay), an outline of—	2
Reservoirs—Detention, and their effect on fluctuations in discharge, and sand charge.	8
Reservoirs — Silt accumulation in—	6
Reservoirs — Silting of — with special reference to the Ekruk Tank (Bombay).	32
Residual turbulence—Effect of— on rate of deposition of Sand—	33
Retaining walls from scour— Protection of — by means of repelling spurs (Baluchistan), (advice without model experiments).	S
Retroggression d/s of Ferozepore weir.	6
Return flow below expansions— Conditions under which it develops.	41
Revetment acts as 'attracting' groyne	2, 104	...
Review— Historical— of steps taken by the Sind Government to collect data in connection with Indus and to control it in its passage through Sind.	11
Rewas, Karanja and Dharamtar —Landing wharves at—	1*
Rice Canal — Experiments with model of, in connection with protection of the Railway Bridge at R.D. 74944 —	1, 21
Rice canal in head portion — Remodelling the —	3, 104	...

R	Pages of Annual Report (Technical) for the year								
	1937	1938	1939	1940	1941	1942	1943	1944	1945
Ripples and waves — classification of —	54
Ripples and waves — Factors affecting the shape and dimensions of —	56
Ripples — Effect of size, distribution of particles, specific gravity, charge of bed sand and discharge on.	57
Ripple formation — Mechanism of —	53
Ripples on bed — formation of	55
Ripples to waves — Transition from —	55
River discharge — Calculation of (a) at weirs and (b) by slope method.	7
River models — Scour at spurs in —	38
River model experiments — difficulties experienced in — due to effects caused by vertical exaggeration.	110-113
Rigid structures in wide channels — Scour downstream of —	67-71
Rigid, vertically-exaggerated, models.	103
River floods — Sunspot intensity cycles as a medium of predicting the probable dates of occurrence of	86-87
Rivers on flood plains and incised rivers — curvature of meanders in	10
Rivers on flood plains and incised rivers — Relation between meander belts; distance between meanders on axis of stream, width and discharge of	9
River training and control by pitched islands.	97

R	Pages of Annual Report (Technical) for the year								
	1937	1938	1939	1940	1941	1942	1943	1944	1945
	-38	-39	-40	-41	-42	-43			
Run-off — Heavy — from a small catchment u/s of a bridge of the M. and S.M. Rly., which caused the river to overflow the embankment and railway track, causing an accident.	44
Run-off, maximum flood and catchment area — Relation between—	34	67
Rupnarain Bridge near Kolaghat on the B. N. Railway in Bengal — Measures to prevent bank erosion at	3,	13
Rupnarain River u/s of the Kolaghat bridge on the B. N. Rly. — Causes leading to erosion of the left bank of the—	14	...
Rupnarain River u/s of the Kolaghat bridge on the B. N. Rly.— Fair weather and freshet spring tides in the — in 1944 and in its mobile bed model.	17,	20
Rupnarain River u/s of the Kolaghat bridge on the B. N. Rly.— Maximum freshet ebb discharge in the — in 1944, estimation of	14	...
Rupnarain River u/s of the Kolaghat bridge on the B. N. Ry.— Meander length of the — Increase in the—due to increase in freshet discharge—	14	...
Rupnarain River above Kolaghat Railway Bridge on the B. N. Railway—Prevention of further erosion on the left bank of the—	(iii)*	13	...
Rupnarain River above Kolaghat Railway Bridge on the B. N. Railway—Repelling groyne u/s of the Bridge — Comparison of results in the model and in the river —	18	...
Rupnarain River above Kolaghat Railway Bridge on the B. N. Railway—Tidal range of the —	14	...

R & S	Pages of Annual Report (Technical) for the year								
	1937	1938	1939	1940	1941	1942	1943	1944	1945
Rupnarain u/s of the B. N. Railway Bridge at Kolaghat—measures taken to control erosion of the left bank of the —by means of a deflecting groyne.	5-7
Ryve's Run-off formula	67
S									
Sabarmati, Narbada and Tapti Rivers — Prevention of erosion of agricultural lands along the —	2,3,5,84	...
Sarbarnati River — Measures proposed to improve the water supply at Ahmedabad (Bombay Presidency) —	62
Sabarmati River — Water levels of maximum floods in the — during 1893 and 1944.	86	...
Samasata spur on Sutlej river on the N. W. Railway to prevent dangerous erosion.	3*,5	...
Sand abrasion — Attrition — degradation.	51	47	40	41	6
Sand and clay layers — Effect of launching of an apron laid on	75
Sand and pebbles entering the Sarda main canal — Control of —by constructing a regulator in short Banbassa spur.	19
Sand and silt on the bed of the Rupnarain River at Kolaghat Railway Bridge on the B. N. Rly.	16	...
Sand attrition — rate of — in channels.	62
Sand charge and discharge — affected by detention reservoirs.	8
Sand charge effect on meanders of rivers.	7

S	Pages of Annual Report (Technical) for the year								
	1937	1938	1939	1940	1941	1942	1943	1944	1945
	-88	-39	-40	-41	-42	-43			
Sand charge — Natural regime.	4
Sand — Effect of residual turbulence on rate of deposition of —	33
Sand exclusion and scour from canals—Sind—Experiments to test the design for	48-59	...
Sand exclusion experiments with a model of Faizwah Head Regulator, Ex. West Feeder (Khairpur State, Sind).	51
Sand—Exclusion of bed, from the heads of canals and distributaries.	6
Sand—Factors affecting exclusion of bed, from canals.	6
Sand from the Jamrao Canal — Exclusion of bed.	84
Sand injection; sand and silt in suspension in the Ganges model above the Hardinge Bridge (E. B. Railway)—Control of the	67
Sand — of the Brahmaputra at Amingaon.	44
Sand particles — movement of —	53
Sand — Stable sections without sand injection.	...	45	...	56
Sand charge—Effect of excess— on river movement.	13
Sand charge — Effect of — on dimensions of a channel.	5,1
Sand charge—Effect of reduction of — by sand reducing head Regulator, on dimensions of a channel.	5
Sand charge and terminal velocity — Rate of deposition of sand governed by	50
Sand — Control of bed, entering the Mithrao and Khipro Canals Ex-Nara at Makhi (Sind).	6	...	57	16	19

S	Pages of Annual Report (Technical) for the year								
	1937	1938	1939	1940	1941	1942	1943	1944	1945
	-38	-39	-40	-41	-42	-43			
Sand — Control of — entering off takes.	16
Sand — Entering R. B. Canals at Sukkur — Control of, by means of approach channel.	16
Sand — Entering the Sarda main canal—partial control of	19
Sand — Entering the Sarda main canal — the canals off Son Anicut at Dehri (Bihar)—Controlling the—	20
Sand excluding heads for the M. E. canal and M. W. canal on the Son at Dehri.	16, 18
Sand — Model experiments to verify the efficiency of a proposal made by the Station to exclude bed sand from the Sarda Canal by providing a regulator in the short Banbassa spur.	19
Sand injector.	56
Sand reducing heads for the M.E. and M. W. canals taking off u/s of Son Anicut (Bihar).	23	58	...
Sand selection at heads of off-takes.	7
Sangli State — Desilting and dredging of Tanks in —	2*	...
Santal Parganas, Bihar — Failure of piers of the bridge under construction over the Ajoy River in the—during 1942 floods.	3*
Sarda above the Barrage at Banbassa (U.P.) — Training the	34	10	21
Sarda at Banbassa—Model experiments to verify the efficiency of a proposal made by the Station to exclude bed sand and pebbles from the Sarda Canals by providing a regulator in the short Banbassa spur.	19

S	Pages of Annual Report (Technical) for the year								
	1937	1938	1939	1940	1941	1942	1943	1944	1945
Sarda Main Canal (U.P.) — Analysis of 10 sites on distributaries of the—Divergence from regime in stable channels in alluvium.	30
Saturation line — effect of constructing a trench on the—	61	...
Saturation line or hydraulic gradient—effect of variation of u/s and d/s water levels of the Solani Khadir dam model on—	61	...
Scale effect in high coefficient weirs.	40
Scale effect of various factors affecting model results.	5	2
Scale effect on coefficient of form drag.	29
Scale effect to determine equivalent size and specific gravity of stones and blocks in a model.	50
Scale ratios—Method of calculating — in vertically-exaggerated mobile river models.	107-110	...
Scale ratios of models and meanders.	7
Scale ratios of tidal models.	104-105	...
Schoklitsch's and Meyer Peter's Bed Load formulas and their comparison with Station formulas.	49
Science Congress—Indian, Director's presidential address to Engineering section of — on "Hydrodynamic models as an aid to Engineering skill".	1
Scour along the banks of the Right Bank approach channel at Sukkur.	12
Scour and accretion in models and rivers compared with special reference to islands u/s of the Barrages.	99	...

S	Pages of Annual Report (Technical) for the year								
	1937	1938	1939	1940	1941	1942	1943	1944	1945
	-38	-39	-40	-41	-42	-43			
Scour and sand exclusion from canals—Sind—Experiments to test the design for—	48-59
Scour below a bridge on the N.W. canal in Sind—Prevention of—	3, 23	...
Scour—deep—at left abutment of Bridge No. 8 at Alur on Gadag-Sholapur line of the M. & S. M. Rly.	1*
Scour d/s of rigid structures in wide channels.	67-71
Scour-holes at several points along the banks of the Hooghly.	24
Scour of banks—Prevention of, near Dunbar and Titaghar mills on the Hooghly by a tidal Model.	18	23
Scour around the nose of the right bank approach channel at at Sukkur.	18	12	74	...
Scour at spurs in river models.	38	74	...
Scour between piers with low and and high discharges.	12
Scour caused by Hardinge Bridge piers.	12
Scour caused by left flank groyne of the B. B. & C. I. Rly. Bridge at Broach.	1*
Scour d/s of flumed falls.	97
Scour d/s of the Girna Aqueduct 4 (Bombay Presidency)—Prevention of	23
Scour d/s of the Sarda Barrage at Banbassa (U.P.)—Prevention of—	24
Scour—Effect of high level pitching laid round Hardinge Bridge piers on the depth of downstream—	31

S	Pages of Annual Report (Technical) for the year								
	1937	1938	1939	1940	1941	1942	1943	1944	1945
Scour-hole—Reproduction of—in a model, d/s of Hardinge Bridge piers 2 and 3.	31	74	...
Scour-hole d/s of the Hardinge Bridge.	5	...	74	...
Scour-hole, 47 ft. deep—just d/s of the Head Regulator of the Rohri Canal.	1*	...	74	...
Scour-hole, 35 ft. deep—just d/s of the Road Bridge at R.D. 52,000 of the Rohri Canal, which threatened to undermine the bridge.	1*	...	74	...
Scour-hole, in the canal bed and bellied banks d/s of the Railway Bridge on the Rice Canal at R.D. 74944.	21, 24	...	74	...
Scour-hole d/s of the N.W. Rly. Bridge at Ruk over the N.W. canal—conditions leading to—	23	...
Scour-holes of the present undersluices of the Son at Dehri (Bihar).	20	...
Scour in Garang River on Assam Access Road—Prevention of—	3*	...
Scour profile — maximum — between guide banks of the Ganges at the Hardinge Bridge.	4
Scour—Prevention of, at junction of high level Weir and low level shutter portion of the Son Anicut at Dehri (Bihar).	21
Scour—Prevention of, at nose of divide walls u/s and d/s of the Son Anicut undersluices.	19
Scour—Prevention of, d/s of sluices of the Son Anicut at Dehri.	19	20	...
Scour round bridge piers.	...	39	33	35
Scour round bridge piers—Effect of grade of bed material on	33

S	Pages of Annual Report (Technical) for the year									
	1937	1938	1939	1940	1941	1942	1943	1944	1945	
Scour round bridge piers—Effect of high level pitching laid round bridge piers on the depth of d/s scour.	31
Scour round bridge piers—Effect of oblique flow on	33
Scour round bridge piers—Effect of width of protection on	37
Scour round bridge piers—Influence of the u/s bed level and material on bed on—	32
Scour estimated, at piers of the proposed Damodar bridge at Burdwan (Bengal).	24
Scour round Hardinge Bridge piers.	38
Scour round piers of the proposed bridge at Amingaon on Brahmaputra.	45	25
Scouring of tail channel and regulation, at Sukkur.	14
Scouring the Right bank approach channel at Sukkur—Discharges available for	19
Sea wall erosion at Bombay—Prevention of—	1*
Seepage losses from canals—Experiments in connection with	60	50
Semi-rigid, vertically-exaggerated models	105
Seven regime sites in Sind.	4
Settlement :-N.V. relation (N = charge; V _s = terminal velocity of sand).	50	8, 33
Shape and dimensions of ripples and waves—Factors affecting the—	56
Shape of catchment—effect of—on the run-off.	68

S	Pages of Annual Report (Technical) for the year								
	1937	1938	1939	1940	1941	1942	1943	1944	1945
	-38	-39	-40	-41	-42	-48			
Shape of Channels — Effect of method followed in regulating d/s water levels on —	33
Shape of channels — factors affecting the —	22
Shingle entry in the Western Jumna Canal.	2*
Shock — Lacey theory of — in channel flow.	3
Silt accumulation in reservoirs.	6
Silt and Sand (Sind) — mean diameter of, by sedimentation and sieving, compared with that obtained by Puri Siltometer.	7
Silt deposited during the cold weather in River — bed silt to be laid in models to simulate the	38
Silting and scouring of channels — Factors affecting the, Note for the Orissa flood Advisory Committee on our present knowledge of the	6
Silting of reservoirs and catchment area — relation between the —	32
Silting of reservoirs with special reference to the Ekruk Tank, Bombay.	32
Silting of the Grand Anicut Canal, Cauvery River (Madras Presidency).	...	54
Silt injector.	56
Silt in suspension at Sukkur and Kotri since 1913 — Quality of	19
Silt on bed of Ekruk Tank (Bombay) — Effect of submergence and exposure to air of, on weight.	33
Silt — Prevention of — going into the Surada Reservoir at its Padma Intake in Orissa.	2*

S	Pages of Annual Report (Technical) for the year								
	1937	1938	1939	1940	1941	1942	1943	1944	1945
Sina River with causeway at mile 5 of Nagar-Manmad Road (Bombay Presidency) — Training the	19
Sind — Analysis of Inundation canals in — and its comparison with the data of perennial canals —	29-32	...
Sind—areas flooded as a result of breaches in embankments in— during the 1942 flood season—	11	...
Sind—attrition of sand—minimum velocity required for —	63
Sind—Breaches in the Indus in— How to prevent —	20
Sind—Causes of floods in —	12
Sind — Design of canals in — Part I - New Canals. Part II - Inundation Canals.	21
Sind—Design of lower Sind Barrage at Hajipur.	(ii)	55	...
Sind—Experiments with a model of the Indus and the Lloyd Barrage at Sukkur for controlling the sand entering the Right Bank Canals.	26	4	12	12
Sind Government — Historical review of steps taken by the— to collect data in connection with the Indus and to control it in its passage through Sind.	11
Sind—Head Regulator Ex. West Feeder (Khairpur State) — Experiments for sand control.	21
Sind — Indus at Sukkur — New factors which will affect the rate of rise of water levels in the—	17
Sind — Indus in — Effect of constructing a barrage across a river on bed levels and water levels u/s and d/s with particular reference to the —	18	99	...

S	Pages of Annual Report (Technical) for the year									
	1937	1938	1939	1940	1941	1942	1943	1944	1945	
Sind—Indus in—Technical analysis of the available data regarding the rise of water levels of the — in the past and to be anticipated in future.	15	
Sind — Jamshoro Bund on the left bank of the Indus near Hyderabad.	39	
Sind — Prevention of collapse of Rohri-Multan Road Bridge over Rohri Canal of R.D. 52,000 in—	3*	
Sind and Punjab data of channels — Analysis of	2	
Sind—Rate of rise of water level in the Indus in —	15	
Sind — Realignment of the Rohri — Quetta Railway necessitated by the danger of breaches in the marginal bunds of the Indus above Sukkur.	(i)*	
Sind — Remodelling Railway Bridge over the N. W. canal at R. D. 75,000 on the N. W. Rly.	3,	23	...	
Sind—Remodelling the Rice Canal in head portion.	3	
Sind — Rohri canal — Effect of closing the head regulator of the — from the top downwards on the canal regimen—	35	
Sind — site for the proposed new Barrages in	1*	
Sind—specific discharge gauge at Bachalshah on the Indus in —	101	
Siphons—Volute—originated and designed by Mr. Ganesh Iyer — Experiments to improve the design of —	27	(ii)*	
Siphons — Volute — priming depth and pressures in and coefficient of discharge of —	28	
Siphons at Markonahalli—Volute, priming — Experiments with a model of the —	27	

S	Pages of Annual Report (Technical) for the year								
	1937	1938	1939	1940	1941	1942	1943	1944	1945
Siphon design, Jamshedpur — Depriming device of the—	26
Siphon spillway experiments.	24	97-98
Siphon spillway for the Jamshed- pur Water Supply storage scheme, Tatanagar (Bihar).	27	26
Siphon spillway — alternative design of baffle platform.	20
Siphon spillways.	97-98
Siphon spillway experiments — Jamshedpur — Priming and Depriming.	26
Siphon spillways : Ganesh Iyer's volute siphon — Factors affecting the coefficient of discharge of —	72-78
Siphon spillways in Jodhpur State — Erinpura Irrigation and Hydro-electrical Project.	2*	...
Siphon spillways, Limiting pres- sures in —	25
Siphon spillway over the waste weir of the Lake Arthur Hill at Bhandardara — Unsuitability of proposal for	...	59
Siphon spillways with flared outlet.	24
Slips d/s of piers due to high level pitching.	12
Slips in sand — Conditions under which aprons may fail due to	75
Slope formula—Canal system type of—	9
Slope formula—of channels.	10
Slope formula—Dr. Bose's	2
Slope — Inclination of, in falling aprons.	71
Slope — Relations of Lacey and Dr. Bose formulae.	9

S	Pages of Annual Report (Technical) for the year								
	1937 -38	1938 -39	1939 -40	1940 -41	1941 -42	1942 -43	1943	1944	1945
Sloping groyne above the Old Rly. bridge on the Narbada River at Broach.	85	...
Sluices for Abdulpur-Nawabganj Railway embankments (E. B. Railway).	58
Soil — Transmission constant of, in experiments for seepage losses from canals.	64
Soil denudation — Excess sand charge due to	5
Solani Dam — Recommendations of the — based on Model Experiments.	63	...
Solani Dam—staunching due to silting u/s of the—effect of—	63	...
Solani embankment — Leakage through—	63	...
Solani Khadir and Balta Jheel reservoirs in the U.P.—Model experiments in connection with	59	...
Solani Khadir and Balta Jheel schemes in U.P. — Director's inspection of—	2
Solani Khadir and Balta Jheel (U.P.) — whether material is suitable for constructing a dam in the—	(iii)*
Solani Khadir Dam model—effect of variation of u/s and d/s water levels of the — on hydraulic gradient or saturation line.	61	...
Solani Khadir Dam Project — Special features of—	60	...
Solani soil—Transmission coefficient of the—	63	...
Solids transported—Influence of, upon rivers by Dr. C. M. White.	8
Son Anicut at Dehri (Bihar)—Controlling the sand entering the canals.	20

S	Pages of Annual Report (Technical) for the year								
	1937	1938	1939	1940	1941	1942	1943	1944	1945
	-88	-89	-40	-41	-42	-43			
Son Anicut at Dehri (Bihar)—High coefficient weir over part of—effect of—on sand drawn by canals and formation of islands and channels u/s.	21
Son Anicut at Dehri (Bihar)—Present method of regulation of—on rising flood and falling flood.	20	...	40
Son Anicut at Dehri (Bihar)—Railway embankment d/s of—effect of, on sand drawn by M.E. Canal.	21
Son Anicut (Bihar)—sand reducing heads for the M.E. and M.W. canals u/s of—	23	16 (iii)*	58
Son Anicut—coefficient of discharge of under-slucices of the—	24, 26
Son Anicut—with gates above water level.	25
Son Anicut—with gates partially open and free flow d/s.	26
Son Anicut at Dehri (Bihar)—“Still Pond” versus “Open flow” regulation at—	22
Son at Dehri (Bihar)—Coefficient of discharge of present and proposed H.C. weir.	25
Son at Dehri (Bihar)—Optimum design of control blocks and deflectors.	21	...
Son at Dehri (Bihar)—Protective measures below the new under-slucices.	20, 23	...
Son at Dehri (Bihar)—Remodeling the anicut	19	20	14
Son at Dehri (Bihar)—Scour-hole downstream of the present under-slucices of—	20	...
Son at Dehri—Protective measures below the new under-slucices of—Bihar Officers' proposals tested in Model.	21	...

S	Pages of Annual Report (Technical) for the year									
	1937	1938	1939	1940	1941	1942	1943	1944	1945	
Son River at Dehri (Bihar) — Sand drawn by the canals and undersluices u/s of the anicut.	41
Spin Karez Diversion of channel Quetta (Baluchistan).	65
Spin Karez waste weir channel (Baluchistan) — Experiments with a model of the, for dissipating energy in the—	22
Spin Karez Project—Design for a truncated trapezoidal S.W.F.	63
Special features of the Solani Khadir dam project.	60
Specific discharge gauges at Bachalshah on the Indus, Sind.	101
Specific gravity and equivalent size of stones and blocks in a model.	115-116	...
Spur 6 at Tajewala Headworks acts as an 'attracting' spur.	97
Spurs—attracting and repelling	46	47	97
Spurs—'attracting' at the Delhi Gate Pumping Station.	47
Spurs—'attracting'—in the Beas River.	47	(ii)*
Spurs—Control of the Jumna River at Tajewala—by means of—	(ii)*
Spurs—Experiments with geometrically-similar models of various designs of	60
Spur nose in Sarda model — Design of 'protection blocks round the	22
Spurs—the use of 'attracting'—for training a river, u/s of a masonry work—	46	47	97
Stability of baffle d/s of S.W.F. falls.	33
Stability—Definition of—	2

S	Pages of Annual Report (Technical) for the year								
	1937	1938	1939	1940	1941	1942	1943	1944	1945
Stability—Effect of shape of baffles on—	33
Stability factor (f_m)—Inglis', for a canal system.	2
Stabilization of flow below S.W.F.s.	42
Stabiliser blocks in expansion d/s of Girna canal aqueduct 4 (Bombay)	24
Stabilisers for expanding flow.	58	41	40
Standing Wave Flumes—Coefficient of discharge of	34	92-93
Standing Wave Flume discharge coefficient—Effect of piers on, in Sind falls.	59	94
Standing Wave Flumes—Effect of friction on coefficient of discharge.	47	...
Standing Wave Flumes—Effect of piers on coefficient of discharge of—	48	...
Standing Wave Flumes for the Jodhpur Water Supply channel—Design for	8
Standing Wave Flumes—Parallel flow through the throat of—	21	...
Standing Wave Flumes—Recovery of head, modular limit, and range in—	37	...
Standing Wave Flumes—standard designs of—	45	24	49	...
Standing Wave Flumes—Trapezoidal	34	...
Standing Wave flume without side contraction—calibration of	...	43
Standing Wave Flumes and flume meter Baffle falls—Design of—	29	...
Standing Wave Flumes and falls—Discharge Table of	35	...

S	Pages of Annual Report (Technical) for the year									
	1937	1938	1939	1940	1941	1942	1943	1944	1945	
	-38	-39	-40	-41	-42	-43				
Standing Wave Flumes and Falls. U/s gauge and gauge chambers —Position of—	32
Standing Wave Flumes and Falls —Velocity of approach—effect of—	33
Standing Wave Flume Falls — Stability of baffles d/s of—	33
Standing Wave Flume — curva- ture of flow in the throat of a	80-	85
Standing Wave Flume for the Jodhpur Water Supply channel —Modularity of 20 cs. S.W.F..	6
Staunching due to silting u/s of the Solani Dam—effect of—	63
Statistical analysis of past and future supplies available in the Jumna at the Headworks of the Eastern and Western Jumna canals at Tajewala and at Delhi.	6, 91
S. W. F. Meter Falls for the Montgomery Pakpattan Link (Punjab) — Experiments with models of—	27	28	29	31
“Still pond” versus “open flow” regulation at Son Anicut.	22
Stone apron—Protection of island nose at Sukkur by laying a, along its face.	15
Stone apron—Testing, with scour- ing discharge in the pocket and tail channel at Sukkur.	15
Stone wall built to protect a palace acts as ‘attracting’ groyne and holds the river permanently along the face.	104
Submerged spurs to enable accre- tion and silting to take place in the scour-hole d/s of the knuckle at Dunbar Cotton Mills.	7
Submersible bridges (C.P.) — Experiments with models of—	31	29

S	Pages of Annual Report (Technical) for the year								
	1937	1938	1939	1940	1941	1942	1943	1944	1945
Submersible bridges (C.P.) — Stability of	51
Sukkur Barrage Canals (Sind), L.C.C., L.J.C. (Punjab) and Jamrao canals — Relationship between area and discharge—	23
Sukkur Barrage canals and Jamrao canals — Relationship between surface width and Q.	24
Sukkur Barrage canals—Relation- ship between S and Q of	26
Sukkur Barrage — Causes of accretion of the river bed at— and how to reduce rate of rise— Part II.	59- 66
Sukkur—Canals at—Right and Left bank, difference in the behaviour of—	40	21
Sukkur Right Bank Approach channel to control sand entering the R.B. Canals.	12	16
Suleimanke and Ferozepore Head- works — Meandering of the Sutlej River between—	2, 6
Sunspot intensity cycles as a medium of predicting the probable dates of occurrence of river floods.	86- 87
Surat-Rander Road and the city wall of Surat d/s of the Hope Bridge at Surat—Damage in 1944 to—and recommendations to ameliorate present condi- tions—	87	...
Surface roughness—Effect of, on the coefficient of high coefficient weirs.	45
Surging over baffle wall.	20	...
Sutlej River — Meandering of the—between Ferozepore and Suleimanke Headworks.	2,6	(ii)*

T	Pages of Annual Report (Technical) for the year									
	1937	1938	1939	1940	1941	1942	1943	1944	1945	
	-38	-39	-40	-41	-42	-43				
T										
Tail Channel at Sukkur—Alignment of—	13
Tail Channel: Outer Bank of—Junction of, with Sukkur Barrage.	15
Tail Channel scouring and regulation, at Sukkur.	14
Tail Channel Sluices at Sukkur—Protection of apron d/s of the	19
Tajewala—Control of the Jumna River at—by means of spurs.	(ii)*
Tajewala —Headworks at — of Eastern and Western Jumna canals.	1*
Tando Mastikhan Fall on Rohri Canal (Sind)—Effect of piers on coefficient of discharge of	59
Tansa Dam — Determination of the coefficient of discharge of the automatic gates spillway for the—	29-36	...
Tapti, Narbada and Sabarmati Rivers—Prevention of erosion of agricultural lands along the—	3, 5, 84	...
Tapti River — Water levels of maximum floods in the—during 1872 and 1944.	84
Technical analysis of available data regarding the rise of water levels of the Indus in the past and to be anticipated in future—	15	99
Technical enquiry into the causes of breaches in River Bunds in Sind and steps required to minimize the danger of recurrence.	1	20
Terminal velocity of sand: N.V. relation (N = charge; V. = terminal velocity).	50	8, 33
Theory—Lacey regime.	4

T	Pages of Annual Report (Technical) for the year								
	1937	1938	1939	1940	1941	1942	1943	1944	1945
Training the Khari River so as to prevent outflanking of the pick-up weir and Head Regulator of the Khari-cut canal, and damage to Raipur village in Ahmedabad District.	2*	...
Training the Malaprabha River—Experiments to compare relative merits of various alternative measures for relieving heavy scour at the Railway Bridge abutment.	10, 13
Training the Malaprabha River to protect the left bank and abutment of the M. & S. M. Rly. Bridge No. 8 at Hole-alur on the Hotgi-Gadag line.	7-8
Training the Mula River above the Rahuri Causeway, Dist. Ahmednagar (Bombay).	14
Training the nala passing through Aqueduct 14 of the Nira R. B. Canal (Bombay Presidency).	81	19
Training the river Kshipra near Ujjain in Gwalior State.	2*, 5	...
Training the Sarla above the Barrage at Banbassa (U.P.).	34	10	21
Training the Sutlej by a series of Islands.	47
Training the Watrak river to protect Kaira town, Gujerat (Bombay).	77	16
Training works at Dingra ghat on the Mahananda river in Bengal.	2*	...
Transmission coefficients of the Solani soil.	63	...
Transmission constant of soils in experiments to determine seepage losses from canals.	64
Transported solids — Influence of — upon rivers by Dr. C. M. White.	8

V	Pages of Annual Report (Technical) for the year								
	1937	1938	1939	1940	1941	1942	1943	1944	1945
	-88	-89	-40	-41	-42	-43			
Vanes, Large radius—at Outfall at Sukkur to exclude bed sand.	16
Varieties of water weeds on Deccan canals.	7
Velocity rods and current meters—comparison of discharges calculated from velocities observed with—	61
Velocity—Wave and surge, in open channels.	58	3
Venturi Flumes — approximate formula for	...	56
Vertically exaggerated models.	5	2,3
Vertically-exaggerated models of rivers (tidal and non-tidal).	102
Vertically-exaggerated model (1/400,1/66) of the Mahanadi and its branches at Cuttack (Orissa) — Experiments with the—	19-22
Vertically-exaggerated and semi-rigid models.	105
Vertically-exaggerated and rigid models.	103
Vertical exaggeration—Difficulties experienced in river model experiments due to effects caused by—	110-113
Vertically-exaggerated mobile river models—method of calculating scale ratios in	107-110
Vizagapatam—Prevention of fore-shore erosion at —	3*	...
Volute siphon, Ganesh Iyer's—Factors affecting the coefficient of discharge of—	72-78
V/V ₀ Curves.	42

W	Pages of Annual Report (Technical) for the year								
	1937	1938	1939	1940	1941	1942	1943	1944	1945
	-38	-39	-40	-41	-42	-43			
W									
Waste Weir at Lake Arthur Hill, Bhandardara (Bombay Presidency)—Raising the	39
Waste Weir channel of Spin Karez Reservoir (Baluchistan) — Experiments with a model of the, for dissipation of energy.	46
W type fall in the old Etawah Branch of the Delhi canal—Dissipation of energy below the—	33
Water levels of maximum floods in the Narbada river during 1886 and 1944.	85	...
Water levels of maximum floods in the Sabarmati river during 1893 and 1944.	86	...
Water levels of maximum floods in the Tapti river during 1872 and 1944.	84	...
Water supply at Ahmedabad — measures proposed to improve the—	62
Water supply at Cawnpore.	15
Water supply — Bombay city — augmentation of—	1*	1*	...	70	...
Water supply, Delhi — Jumna River training in connection with—	(iii)*	8, 9	...
Water table — Experiments on seepage losses from canals.	60
Water weeds and their eradication from canals.	7
Watrak River—Training the, to protect Kaira town, Gujerat (Bombay Presidency).	77	16
Wave and surge velocity in open channels.	58	3
Wave crest—Phenomenon at the—	57	...

W, Y & Z	Pages of Annual Report (Technical) for the year									
	1937 -38	1938 -39	1939 -40	1940 -41	1941 -42	1942 -43	1943	1944	1945	
Weir—Fluid forces acting on a—	48	
Weirs, high coefficient	99- 101	
Weirs, high coefficient — Experi- ments with—	39	...	25, 45	42	
Westerly movement of the Kosi— Measures to check the—	15	
Western and Eastern Jumna Canals Headworks at Tajewala.	1*	
Wharves — Landing — at Rewas, Karanja and Dharamtar.	1*	
White, Dr. C. M., Influence of Transported solids upon rivers by	8	
Working range of baffles.	41	...	
Y										
Yield during monsoon from Tansa catchment—years 1896 to 1944.	73	...	
Z										
Zam Tank in N.W.F. Province— Proposal to construct a Barrage on — to split up water between several areas.	2*	...	