

Government of India

CENTRAL WATERPOWER IRRIGATION & NAVIGATION
RESEARCH STATION, POONA.

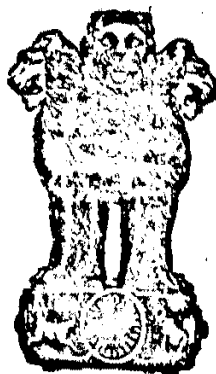

RESEARCH PUBLICATION No. 13

**“THE BEHAVIOUR AND CONTROL
OF RIVERS AND CANALS
(WITH THE AID OF MODELS).”**

Part II

BY

**Sir Claude Cavendish Inglis, C.I.E., B.A., B.A.I., M.I.C.E.,
M. Am.Soc.C.E., M.I.E. (I).**

(In charge of Hydrodynamic Research at Poona from 1920-45; Director of the Indian Waterways Experiment Station from 1936-45; appointed Director, Hydraulics Research Organisation of the Department of Scientific and Industrial Research, London, England, March 1947).

POONA

PRINTED AT THE YERAVDA PRISON

Price: Rs. 16-8-0 or 25 sh. 6 d.
(The price is inclusive of price of Part I.)

IWE. 3-1
2,000 ११५

Government of India

CENTRAL WATERPOWER IRRIGATION & NAVIGATION
RESEARCH STATION, POONA.

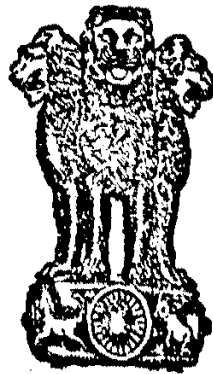

RESEARCH PUBLICATION No. 13

**“THE BEHAVIOUR AND CONTROL
OF RIVERS AND CANALS
(WITH THE AID OF MODELS).”**

Part II

BY

**Sir Claude Cavendish Inglis, C.I.E., B.A., B.A.I., M.I.C.E.,
M. Am.Soc.C.E., M.I.E. (I).**

(In charge of Hydrodynamic Research at Poona from 1920-45; Director of the Indian Waterways Experiment Station from 1936-45; appointed Director, Hydraulics Research Organisation of the Department of Scientific and Industrial Research, London, England, March 1947).

POONA

PRINTED AT THE YERAVDA PRISON PRESS, 1949.

**List of Research Publications of Central Waterpower Irrigation and Navigation
Research Station, (formerly Indian Waterways Experiment Station, Poona)
available for sale with the Manager of Publications, Delhi, and Agents**

Symbol No.	Research Publication No.	Subject.	Price.	Year of Publication.
IHR. 1-39 ...	1	Annual Report of work done during 1937-38 by C. C. Inglis, A. B. Thomas, Rao Sahib D. V. Joglekar and staff at Khadakwasla.	Rs. a. p. 7 8 0	1939
IHR. 1-39 ...	2	Annual Report of work done during 1938-39 by same authors as in 1.	7 8 0	1940
IHR. 2 ...	3	Note on "The theory, design and construction of Gibb Modules which, without moving parts, give a constant discharge within working limits irrespective of variations in upstream and downstream water levels" by C. C. Inglis and Rao Sahib D. V. Joglekar.	3 8 0	1941
IHR. 1-40 ...	4	Annual Report of work done during 1939-40 by C. C. Inglis, A. B. Thomas, Rao Sahib D. V. Joglekar and staff at Khadakwasla	7 8 0	1941
IHR. 1-41 ...	5	Annual Report (Technical) of work done during the year 1940-41 and index for 1937-41 by C. C. Inglis, A. B. Thomas, Rao Sahib D. V. Joglekar and staff at Khadakwasla.	7 8 0	1942
IHR. 1-42 ...	6	Annual Report (Technical) of work done during the year 1941-42 by C. C. Inglis, J. S. Reid, Rao Bahadur D. V. Joglekar and staff at Khadakwasla.	7 8 0	1944
IHR. 1-43 ...	7	Annual Report (Technical) of work done during the year 1942-43 by C. C. Inglis, J. S. Reid, Rao Bahadur D. V. Joglekar and staff at Khadakwasla.	7 8 0	1945
IHR. 1-43 ...	8	Annual Report (Technical) of work done during the year 1943 by C. C. Inglis, Rao Bahadur D. V. Joglekar and staff at Khadakwasla.	7 8 0	1945
IHR. 1-44 ...	9	Annual Report (Technical) of work done during the year 1944 by C. C. Inglis, Rao Bahadur D. V. Joglekar and staff at Khadakwasla.	7 8 0	1945
IWE. 1-45 ...	10	Annual Report (Technical) of work done during the year 1945 by Rao Bahadur D. V. Joglekar and staff at Khadakwasla.	25 0 0	1948
IWE. 1-46 ...	11	Annual Report (Technical) of work done during the year 1946 by K. K. Framji, Rao Bahadur D. V. Joglekar and staff at Khadakwasla.	7 8 0	1947
IWE. 1-47 ...	12	Annual Report (Technical) of work done during the year 1947 by K. K. Framji, Rao Bahadur D. V. Joglekar and staff at Khadakwasla.	25 0 0	1948

THE BEHAVIOUR AND CONTROL OF RIVERS AND CANALS (WITH THE AID OF MODELS)

CONTENTS

	Page.
SYMBOLS AND DEFINITIONS.	... 1
CHAPTER 1.—Introduction	... 85
CHAPTER 2.—Review of factors controlling flow in alluvial channels	... 85
CHAPTER 3.—Historical note on regime flow in channels in alluvium and divergence from regime.	95
CHAPTER 4.—Meandering of rivers.	... 143
CHAPTER 5.—Behaviour of rivers—as exemplified by the Indus in Sind	... 167
CHAPTER 6.—Exclusion of excess bed material from canals and distributaries	... 217
CHAPTER 7.—Factors affecting flow in alluvial channels—as exemplified by the dimensions of canals in Sind.	283
CHAPTER 8.—Maximum depth of scour at heads of guide banks and groynes, pier noses, and downstream of bridges.	327
CHAPTER 9.—The design of falling aprons	... 355
CHAPTER 10.—Control of rivers by guide banks and groynes.	... 379
CHAPTER 11.—Fluming	... 387
CHAPTER 12.—Points worth considering when designing and remodelling canal and river works.	407
CHAPTER 13.—Methods followed in fixing model scale ratios and overcoming model limitations, based on experience gained at the Indian Waterways Experiment Station, Poona.	427
APPENDIX 1.—List of Bombay P. W. D. Technical Papers and Annual Reports of the I. W. E. S., Poona.	453
APPENDIX 2.—Bed ripples and bed dunes	... 459
APPENDIX 3.—Factors affecting exclusion of bed sand from canals taking off from alluvial rivers.	471
APPENDIX 4.—Equivalent size and specific gravity of stones and blocks in a model.	485
INDEX	

FACTORS AFFECTING FLOW

CHAPTER 7

FACTORS AFFECTING FLOW IN ALLUVIAL CHANNELS—
AS EXEMPLIFIED BY THE DIMENSIONS OF
CANALS IN SIND

	Page.
7.00 Introduction	283
7.01 Discussion of flat gradients of Left Bank Canals and steep gradients of Right Bank Canals at Sukkur.	283
7.02 Effect of Approach Channel on Right Bank Canals	289
7.03 Effect of Approach Channel on North Western Canal	289
7.04 Effect of Approach Channel on bed levels in the Rice Canal	289
7.05 Conclusions regarding improvement of flow conditions in the Right Bank Canals.	290
7.06 Variations of grade of materials exposed on the beds of the Eastern Nara and Rohri Canals (Sind).	290
7.07 The design of canals in Sind—Relation between A and Q	301
7.08 Relation between mean depth and discharge per ft. width	301
7.09 Relation between width and discharge	302
7.10 d : Q relation	309
7.11 S : Q relation	309
7.12 In conclusion	310

CHAPTER 7

FACTORS AFFECTING FLOW IN ALLUVIAL CHANNELS—
AS EXEMPLIFIED BY THE DIMENSIONS
OF CANALS IN SIND

7.00 INTRODUCTION

Lacey's formulæ have been mainly based on, and apply most closely to, Punjab channels in incoherent alluvium. In this Chapter the effect of the somewhat different conditions found in Sind are considered and compared with the Lacey formulæ.

7.01. DISCUSSION ON FLAT GRADIENTS OF LEFT BANK CANALS
AND STEEP GRADIENTS OF RIGHT BANK CANALS
AT SUKKUR

The Author has repeatedly emphasized that shape and slope of a canal depend to a marked extent on the quantity of sand in movement.*

If the 1942 data for the Rice Canal—which takes off from the right bank of the Indus at Sukkur—are compared with those for the Rohri Canal, taking off from the left bank, the designed slope of both of which was 1 in 12,000 (= 0.83 per 1,000), it will be noted that though the bed-widths were practically the same, yet the slope in the head reach of the Rohri Canal was 1 in 19,800 (= 0.50 per 1,000) for a Full Supply discharge of 10,800 cusecs whereas the corresponding slope in the Rice Canal was 1 in 7,300 (= 1.37 per 1,000) for F. S. Q. = 10,200 cusecs.

The question to decide is, "Why have the Left Bank Canals scoured their beds and flattened their gradients, while accretion has occurred in the Rice and North Western Canals on the right bank, causing them to increase their slopes?"

In the past, it has been considered that the difference was due to much more sand passing down the Right than the Left Bank Canals; and it was in order to exclude this excess sand that the Approach Channel was designed by the Central Irrigation and Hydrodynamic Research Station, Poonā†. Constructed in 1939-41, this has proved very effective in reducing the accumulations of sand on the beds of the Rice and North Western Canals‡ which shows that excess sand entry was almost certainly the explanation of the previous accretion.

Mr. T. R. Sethna, Executive Engineer, Barrage Division, produced data, however, which was held to cast doubt on "the quantity of sand entering the canals" being the only, or even the major, factor controlling slope. He pointed out that the quantity of sand collected in the turbulence downstream of the Head Regulators in the canals on the two banks had been very much the same—*vide* Fig. 7-1 (a)—and that the grade of sand exposed on the beds of the Left Bank Canals was similar to that on the beds of the Right Bank Canals—Fig. 7-1 (c) and (d).

Fig. 7-1(a)

Fig. 7-1(c)
Fig. 7-1(d)

Though this data seemed to indicate that the material entering the Right and Left Bank Canals was similar, yet all other evidence went to show that this was not the case, and that prior to the construction of the Approach Channel, the charge of bed sand in the Right Bank Canals was very much greater than that in the Left Bank Canals. The explanation seemed to be that the single sample taken from the turbulence at 0.6 depth from the middle of each canal was not a reliable guide; because bed sand normally enters Head Regulators of Canals in a narrow band, through a few spans, or even part of one span; so that unless the narrow band happened to coincide with the centre of each canal, the single sample would not give a representative measurement of the total

* Note on "Divergence from Regime in stable channels in alluvium" by C. C. Ingalls, printed in A. R. (T) for 1941 of C. B. I. and C. I. and H. R. S., A. R. (T) 1941-42, para. 4.

† C. I. and H. R. S., A. R. (T) 1941-42, para. 8.

‡ L. W. E. S., A. R. (T) 1943, para. 8.

quantity of bed material entering each canal; and experience showed that the narrow band rarely passes through the central span. There was also good reason to believe that samples taken from the turbulence at 0.6 depth, did not give a reliable idea of the charge of the coarser grades moving along the bed.

It may also be pointed out that when particles greater than 0.2 mm. are considered—see Fig. 7-1 (b)—the quantity was greater in the Right Bank Canals than in the Left Bank Canals after 1936 when accretion became serious. The grade exposed on the bed of the canals during the “abkalani” was also coarser in the Right Bank Canals than in the Left Bank Canals—as can be seen by comparing Fig. 7-1 (c) and (d)—so the heavy silting which occurred in the Right Bank Canals and heavy scour in the Left Bank Canals were not contrary to the data taken as a whole, though the wide difference in slopes in the Right and Left Bank Canals might seem to exceed what would be expected.

Fig. 7-1 (b)

Fig. 7-1 (c)

Mr. Sethna also showed that the shapes of channel with similar discharges varied widely in Sind. This can also be explained by differences of grade and charge*; because heavy charges of coarse sand create wide, shallow, channels; while channels carrying only a small quantity of coarse bed-sand are normally narrow and deep†. The Author in his discussion on Lala Ishar Das' Paper† on “Hydraulics of Irrigation Channels” said:—

“The shape of a channel in incoherent alluvium depends not merely on the mean diameter as determined from terminal velocities by means of a siltometer; but also on the relative quantities of the fine and coarse particles in movement. If there is a normal distribution of the various grades, regime conditions obtain, and the dimensions closely follow the dimensions of a Lacey channel; but if, as is frequently the case—especially in rivers—the bed silt charge is disproportionately high, the width of the channel is disproportionately great, and the depth small. If, on the other hand, the quantity of fine silt relative to the bed-sand is high, more berming takes place, and the channel is narrower and deeper, and has a flatter slope than a Lacey channel. Channel shape in incoherent alluvium is, in fact, essentially a balance between bed-sand and fine silt in motion.”

We also know that where a channel is excavated in tough material to an unnatural section it tends to persist; and the tougher the material and the lower the velocity—i.e., the finer the berm material, and the smaller the channel—the greater the divergence may be without scour occurring.

Examples of channels of unnatural section which may be quoted as persisting are the head reach of the Rohri Canal, which has remained wide and shallow; while the inundation canals, which, in most cases, were originally designed for smaller discharges than they now carry, have, in many cases, been constructed and maintained as deep, narrow, sections—in order to pass early supplies down them when river levels are still low.

The very flat slopes which have developed in the Rohri and Eastern Nara Canals are not, however, due to their having been constructed to a wider section than is natural for Sind; but to another factor, the importance of which has been generally overlooked—namely that where the bed is very smooth, as it was originally in these two canals, the sand charge is swept along the bed, accompanied by gradual bed-scours—due to the high velocity, and low depth of flow; so that retrogression has occurred at the heads of the canals and downstream of masonry works.

* Note on “Divergence from regime in stable channels in alluvium”, C. B. I. Annual Report (Technical), 1941.

† Paper No. 249, Punjab Engineering Congress, February 1941.

(a)

FIG. 7-1

NR 4734
C.I. AND N.W.C.
(FIG. 16 FROM A.R.T. 1943)

ANNUAL SILT CHARGE (AVERAGE FROM 15TH MAY TO 15TH OCT.)
OBTAINED FROM TURBULENCE AT MIDSTREAM FROM
0.6 DEPTH BELOW HEAD REGULATORS OF CANALS IN
GRAMS PER LITRE (OR IN PARTS PER 1000)

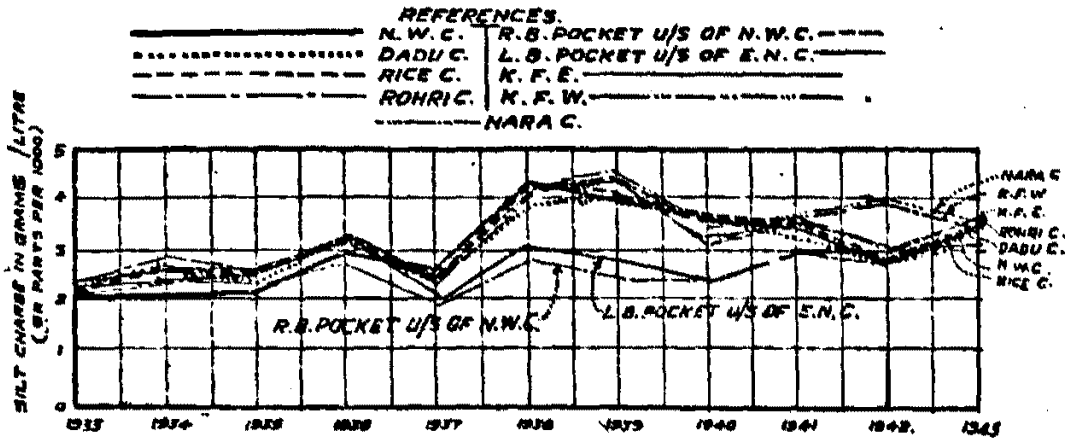

(b)

ANNUAL SILT CHARGE (AVERAGE FROM 15TH MAY TO 15TH OCT.)
(PARTICLES > 2 M.M ONLY) FROM TURBULENCE AT MIDSTREAM
FROM 0.6 DEPTH BELOW HEAD REGULATORS OF CANALS IN
PARTS PER 1000 BY WEIGHT

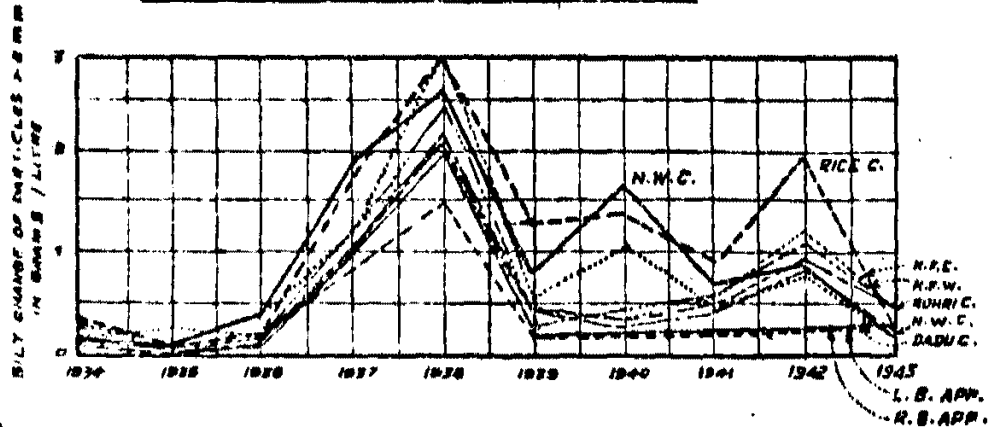

(c)

MEAN DIAMETER OF BED SAND IN ROHRI AND
EASTERN NARA CANALS AT DISCHARGE SITES
1943

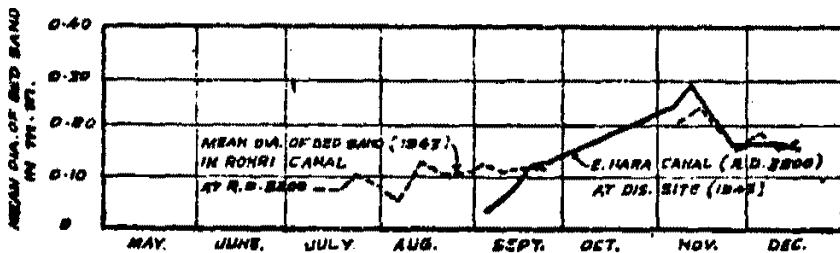

(d)

MEAN DIAMETER OF BED SAND IN N.W.C., RICE
AND DADU CANALS AT DISCHARGE SITES (R.D. 2000)
1941

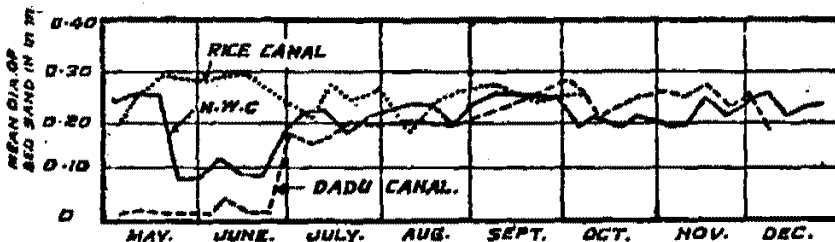

T.S.K.
S.S. BARNAL
2/2/44

287

FIG. 7-2

4971
I.W.E.S. PUNA

L. SECTION OF N. W. CANAL

FOR
20-9-39, 14-9-43 & 1-1-44

SCALE:-
HOR: 1" = 8,000
VER: 1" = 4'

CROSS REGULATOR
WARAH BRANCH
(Q = 1950 Cs.)

RUK REGULATOR

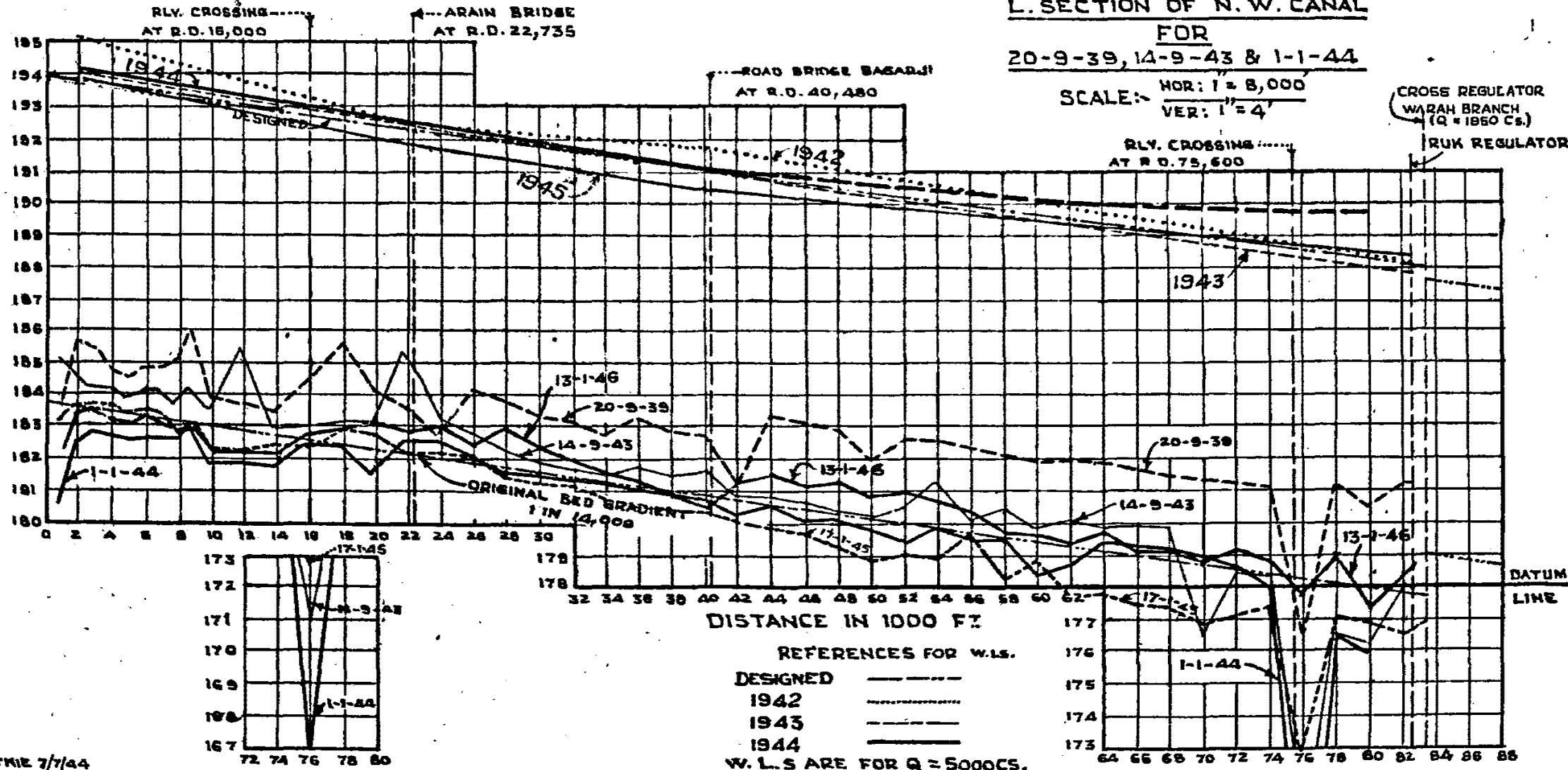

PATHE 7/7/44

REFERENCES FOR W.L.S.

DESIGNED

1942 - · - · - ·

1943 - - - - -

1944 —————

W. L. S ARE FOR Q = 5000CS.

FACTORS AFFECTING FLOW

Experiments which we have carried out at Khadakwasla to verify this point, show that with a smooth bed, several times as much sand charge can be carried with the same slope as where sand is flowing on a sandy floor; and that the same charge can be carried with a much flatter slope. This indicates that it is possible where canal beds can be stabilized, to design canals in such a way that they can be run with very much flatter slopes than we have considered safe in the past, a fact which is clearly demonstrated by the flat slopes of the Rohri and Eastern Nara Canals.

7.02. EFFECT OF APPROACH CHANNEL ON RIGHT BANK CANALS

In judging the merits of the Approach Channel design, it has to be remembered that conditions had reached a sorry pass when the Poona Station was asked to tackle the problem—indeed it looked as though the North Western Canal was going to silt up altogether in a few years; so, what had to be done was not merely to stop this deterioration but also “to bring the canals back” to their original condition. The North Western and Dadu Canals, being perennial, began to improve at once; because the clear water of the fair season washed the sand down the canals, but recovery in the Rice Canal was much slower—because it is closed during the fair season.

7.03. EFFECT OF APPROACH CHANNEL ON NORTH WESTERN CANAL

Fig. 7-2 shows bed levels of the North Western Canal on 20th September 1939 before the Approach Channel was constructed, and on 15th September 1943, 1st January 1944, and 17th January 1945, after completion. Fig. 7-2

The fall in bed levels between 1939 and 1943 was very marked, showing that the Approach Channel was excluding the excess charge of bed material. This improvement continued in 1944 and 1945. In spite of this, however, the water level—with 5,000 cusecs discharge flowing—continued to rise until 1942; but there was a considerable drop in 1943. The surface gradient did not, however, improve until 1944. This improvement was largely due to the sectional area being increased by heading up water $1\frac{1}{2}$ ft. higher than the designed level at Ruk regulator. When the water level was lowered again in 1945 the improvement was maintained, the improvement being at least partly due to a blanket of finer material having accumulated on the bed when water was headed up in 1944. Fig. 7-3, showing specific discharge Gauges, shows the improvement in Gauge readings at the Head of the Canal in 1945 for Gauges in excess of 9 ft.—when Full Supply Discharge was obtained for the first time with less than the designed water level. Fig. 7-3

7.04. EFFECT OF APPROACH CHANNEL ON BED LEVELS IN THE RICE CANAL

Fig. 7-4 shows bed levels in the Rice Canal on 2nd September 1939 before the Approach Channel was constructed; and on 18th September 1941, 13th October 1942, 16th September 1943, after completion. Fig. 7-4

The improvement down to R. D. 42,000 ft. was marked in 1941—the first flood season after the Approach Channel was completed; but bed-sand, scoured from the head, built up the bed further downstream, so that conditions continued to deteriorate down the canal, though the bed scoured at its head.

The breach in the river embankment upstream of Sukkur in July 1942, led to flood water breaching into, and flowing down the Rice Canal, causing abnormal conditions to occur below R. D. 52,000; but by 1943 a marked general improvement had taken place (except at one point at R. D. 46,000) showing that the Approach Channel was excluding excess material satisfactorily. In spite of this, the Full Supply

THE BEHAVIOUR AND CONTROL OF RIVERS AND CANALS

discharge for the same Gauge reading did not increase correspondingly, so the data was further analysed.

Fig. 7-5

Fig. 7-5 shows Gauge discharge curves at the head of the Rice Canal for conditions with rising and falling Gauges from 1939 to 1943, and 1944.

These showed that:—

(i) On a rising Gauge, the discharge for the same Gauge improved at once up to a discharge of 5,000 cusecs; but deterioration continued with larger discharges up to 1942.

(ii) On a falling Gauge, the deterioration for discharges between 3,000 and 8,000 cusecs was very marked; but by the end of 1941 there was a marked improvement compared with 1940 for discharges up to 7,000 cuses; and by 1945, a marked improvement had taken place for discharges up to 9,500 cusecs. Improvement up to Full Supply Discharge may be anticipated within the next few years.

The slow improvement in the specific discharge Gauges for large discharges was partially due to sand washed down the Canal from the "head reach" taking a considerable time to pass down the Canal, and partly due to "residual material exposed on the bed after heavy scour" being coarser than it was before the charge entering the canal was reduced by the Approach Channel.

Fig. 7-6

Fig. 7-6 is a longitudinal section of the Rice Canal down to R. D. 190,000, showing bed-levels up to 1944, and water levels up to 1945.

A marked lowering of bed levels in 1943 and 1944 was partly due to the destruction of the Fall at Naundero at R. D. 190,000 during the floods of 1942, when, as a result of the breach in the river embankment 20 miles upstream of Sukkur, flood water breached into the Canal, and flowed down it. The improvement has, however, been maintained.

7.05. CONCLUSIONS REGARDING IMPROVEMENT OF FLOW CONDITIONS IN THE RIGHT BANK CANALS

When the Approach Channel was constructed, the North Western Canal improved almost at once, most of the improvement taking place during the cold weather seasons. The improvement in the Rice Canal was much slower, owing to there being no cold weather flow; but both Canals have now markedly improved and further improvements may be confidently anticipated as the coarser grades of material are carried down the Canals, to be later blanketed by finer material depositing on them. Improvement could be accelerated and increased by removing residual coarse material from the heads of the two canals.

7.06. VARIATIONS OF GRADE OF MATERIAL EXPOSED ON THE BEDS OF THE EASTERN NARA AND ROHRI CANALS (SIND)

The present practice in connection with regulating flow into the Barrage Canals is to close the regulators from the bottom upwards to make them work as weirs and draw surface water in order to reduce the charge of sand entering the Canals.

The Author was asked in this connection whether—as the Rohri Canal is scouring its bed and flattening its slope in the head reach, due to the charge entering the Canal being less than the Canal is capable of carrying—it would not be advantageous to increase its sand charge by closing the regulator from the top downwards to make it work as an orifice and draw more bed water and hence more sand.

Fig. 7-7

Fig. 7-7 shows the discharge, mean silt charge, and mean diameter of bed sand at discharge sites in the Eastern Nara Canal at R. D. 3,500, and in the Rohri Canal at R. D. 5,200. It will be seen that the material exposed on the beds of both Canals during the "abkalani" (i. e. flood season) was very fine and that it became coarser in the winter season.

FACTORS AFFECTING FLOW

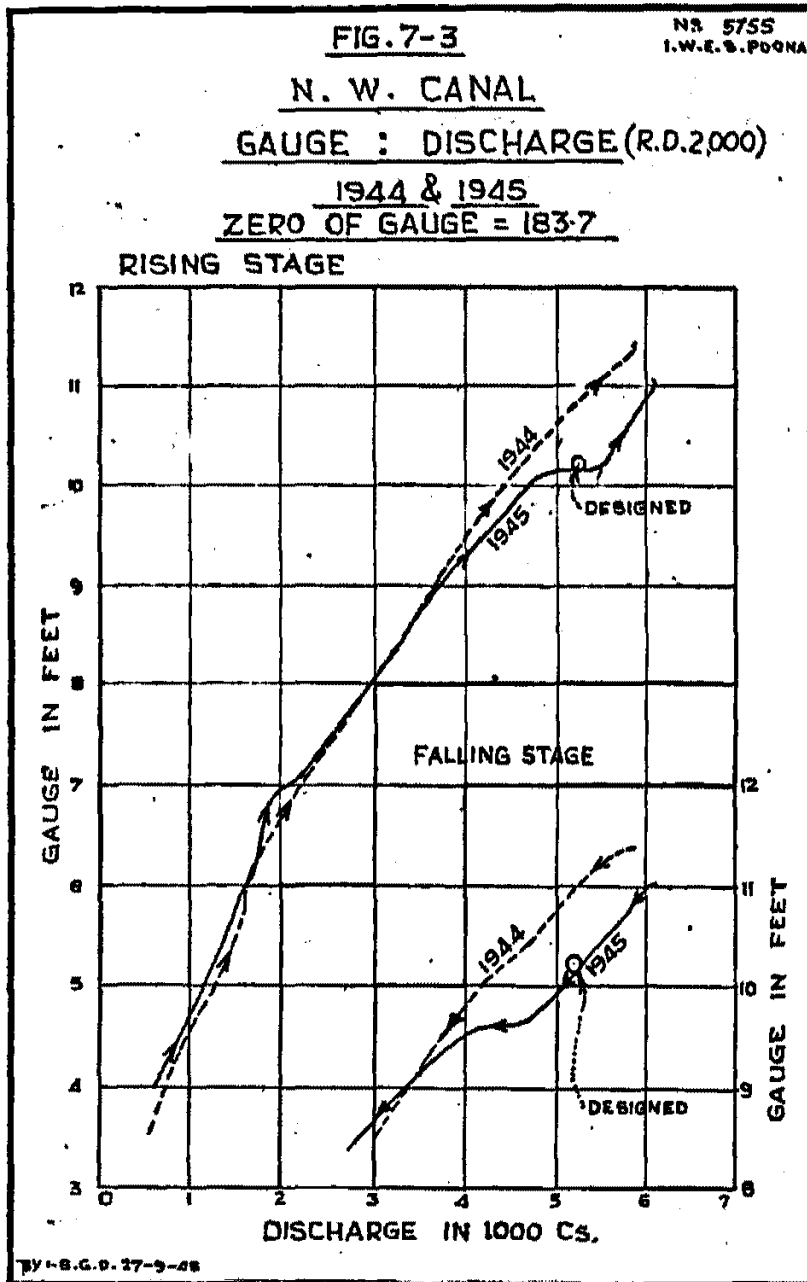
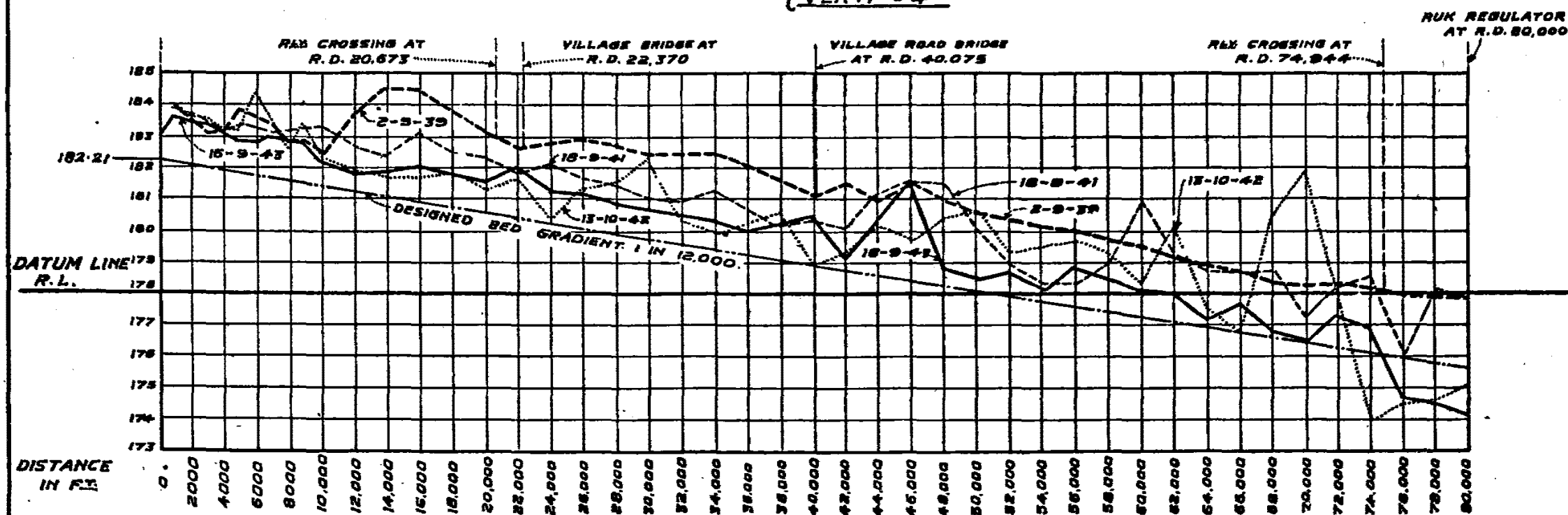

FIG. 7-A
L. SECTION OF RICE CANAL
FOR
2-9-39, 18-9-41, 13-10-42 & 16-9-43

NR 4794
 CENTRAL IRRIGATION & HYDRODYNAMIC
 RESEARCH STATION PUNA.
 (FIG. 35 FROM A.R.T. 1943 OF I.W.E.S.)

SCALE - $\left\{ \begin{array}{l} \text{HOR: } 1'' = 8000' \\ \text{VER: } 1'' = 4' \end{array} \right.$



REFERENCES:-

2-9-39
18-9-41	-----
13-10-42	- . - . - .
16-9-43	—————

T. BY
 S. S. SARKAL
 17/3/44

293

FACTORS AFFECTING FLOW

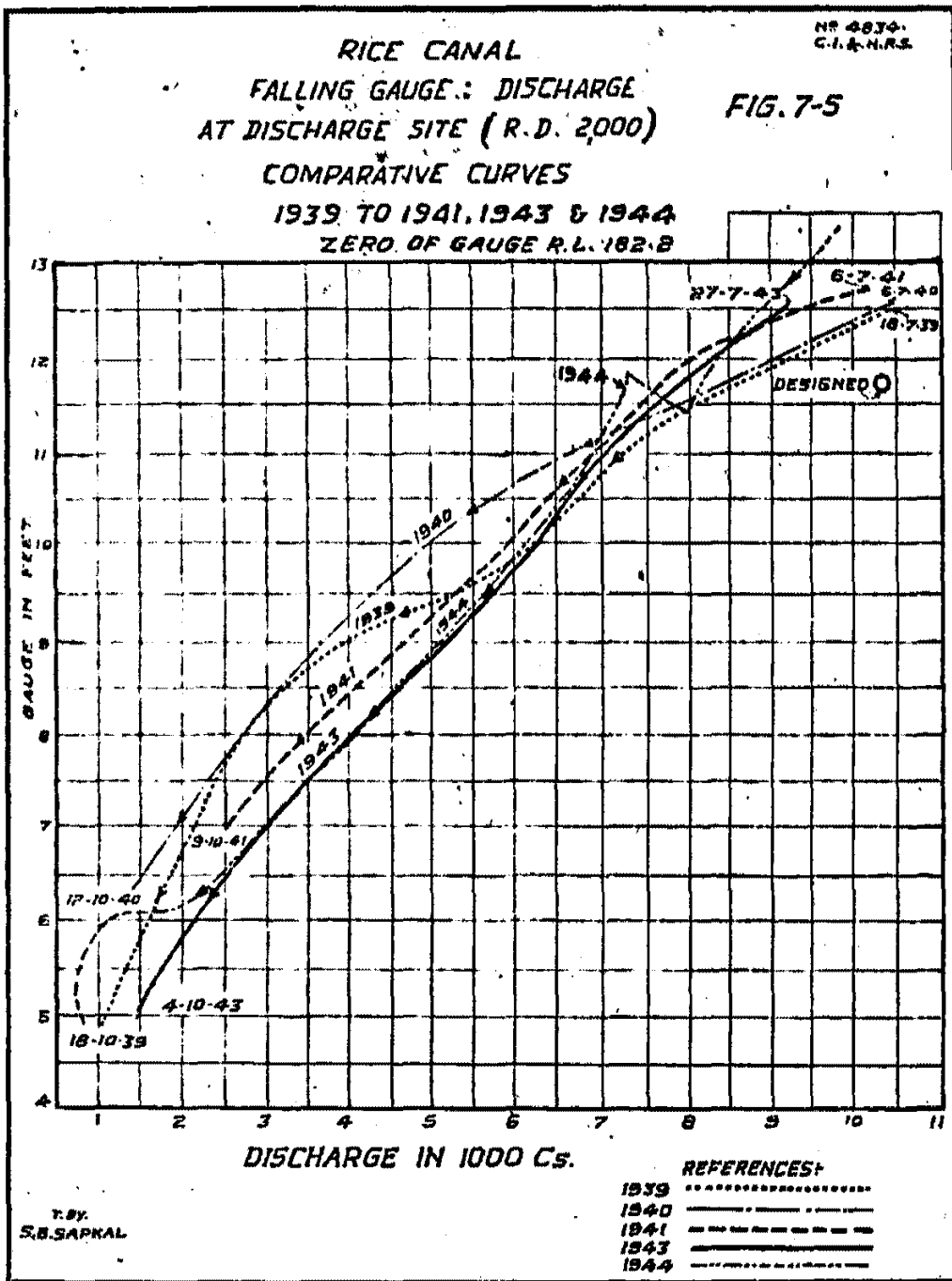

(FIG. 33 FROM A. R. T. 1943 OF I. W. E. STN.)

FIG.7-6

L. SECTION OF RICE CANAL
SHOWING WATER LEVELS FOR Q=10,000 Cs & BED LEVELS
& PROPOSED BED SLOPE FROM HEAD TO R.D. 80000

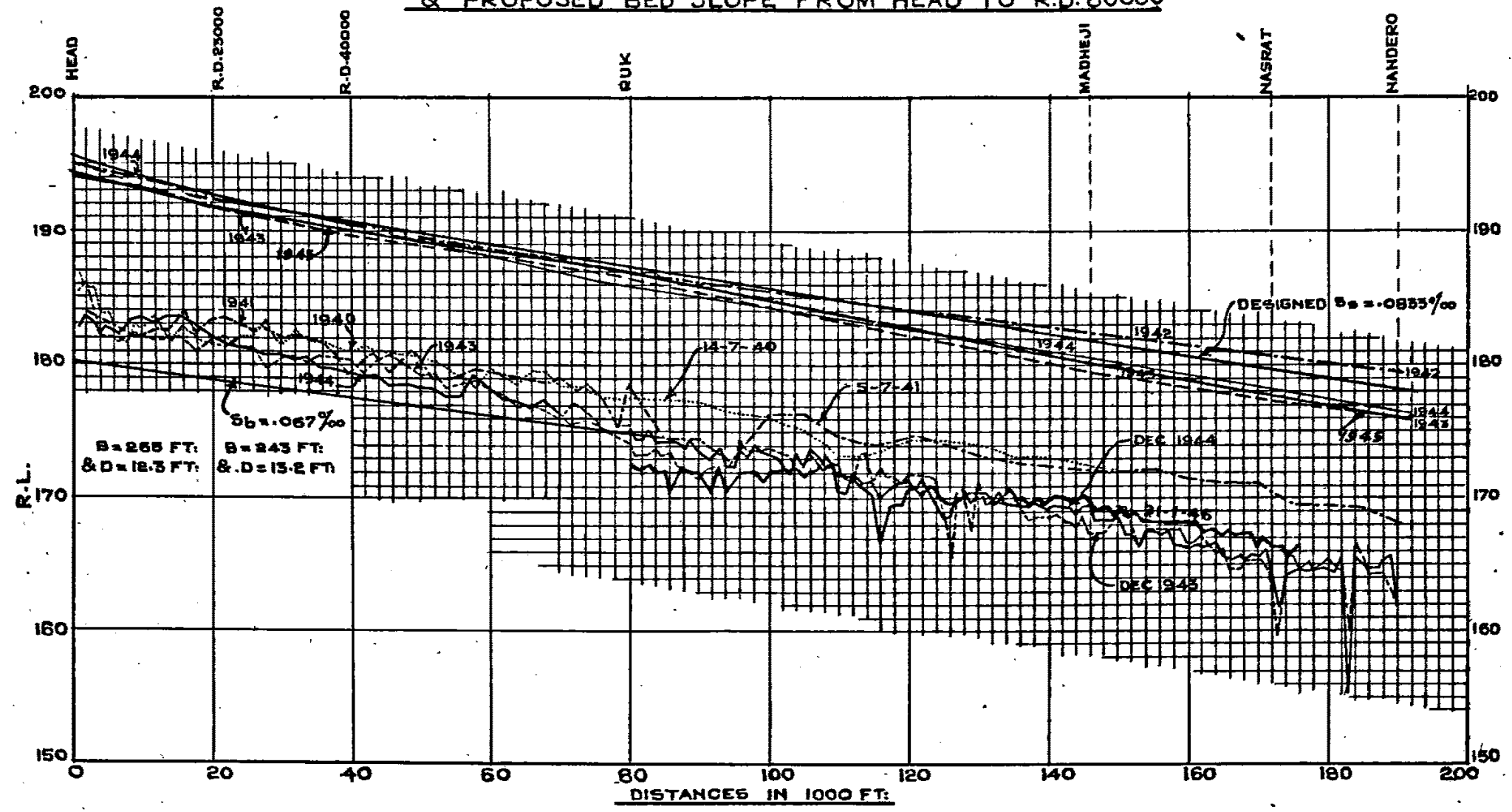

297

FIG: 7-7

EASTERN NARA CANAL (1943)

AT DISCHARGE SITE AT (R.D.3500)

DISCHARGE

MA 4752
CENTRAL IRRIGATION AND
HYDRODYNAMIC RESEARCH STN
POORNA
(FIG. 37 FROM A.R.T.
1943 OF I.W.E.S?)

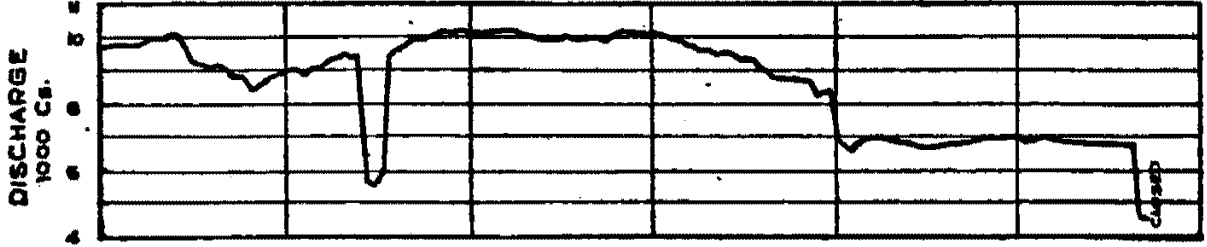

MEAN SILT CHARGE

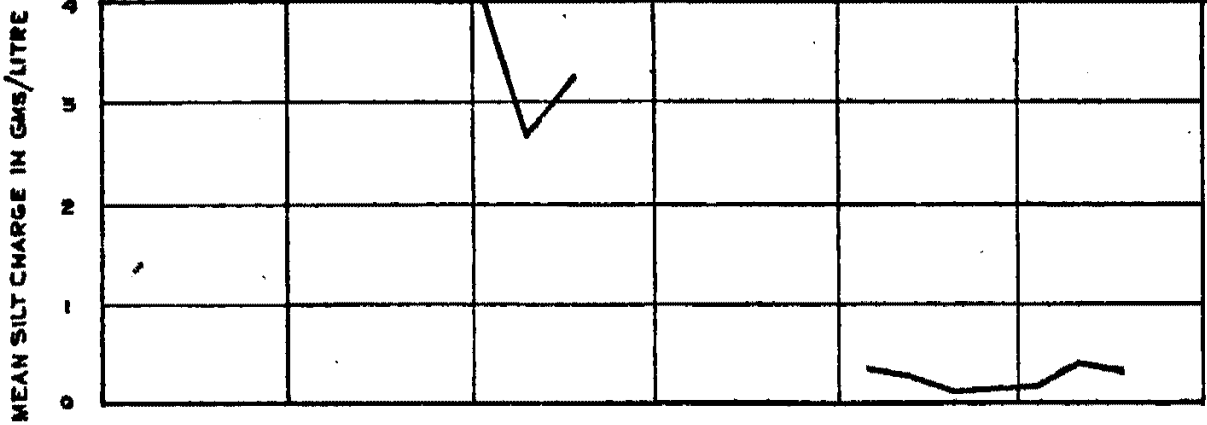

MEAN DIA. OF BED SAND IN m.m.

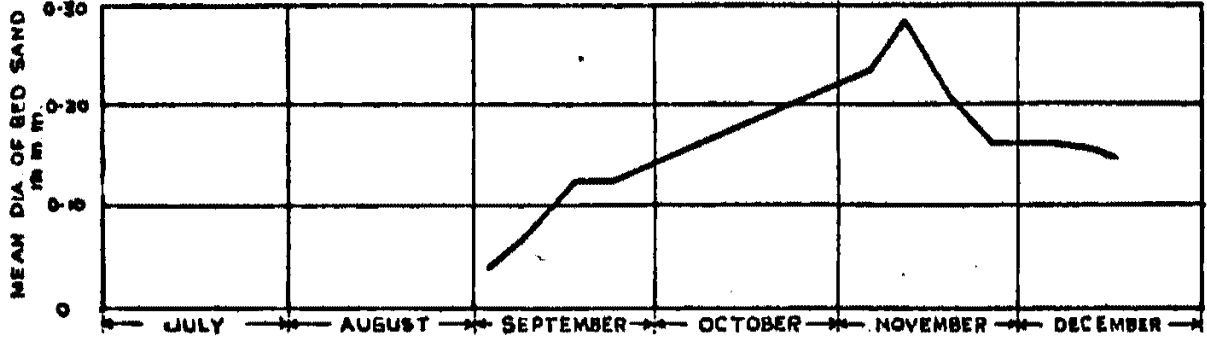

ROHRI CANAL (1943)

AT DISCHARGE SITE (R.D.5200)

DISCHARGE

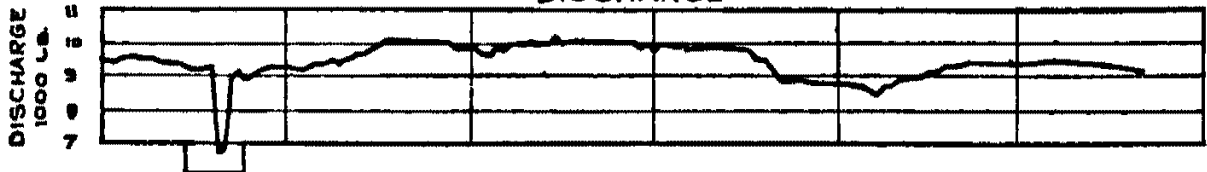

MEAN SILT CHARGE

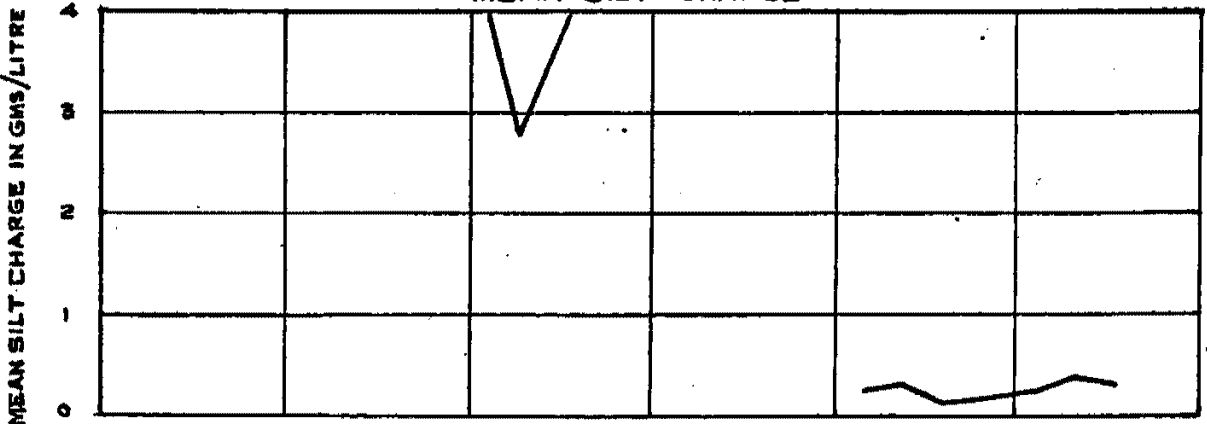

MEAN DIA. OF BED SAND IN mm.

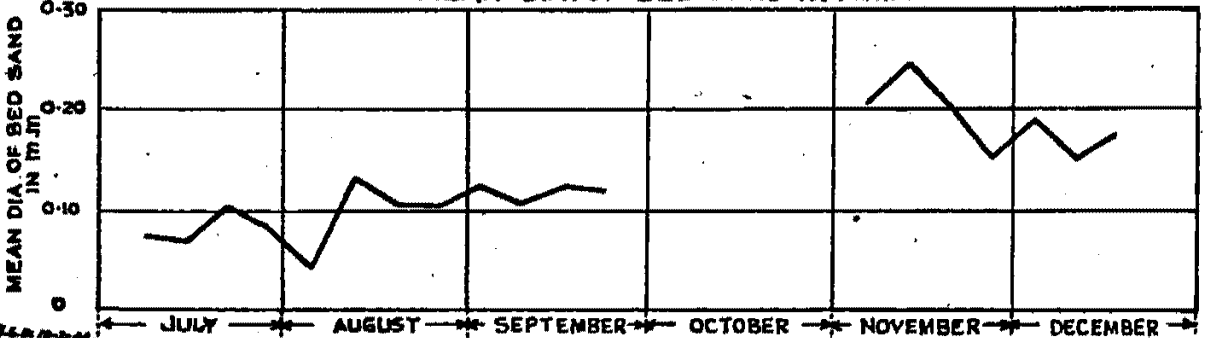

This apparent anomaly was due to clear water picking up fine material from the bed—to carry it away in suspension—leaving the coarser particles behind, while during the flood season, the charge of fine material, being in excess of what the Canal can carry, deposits on its bed; so that the grade exposed on the Canal bed becomes relatively fine. This is also borne out by the longitudinal section of the mean bed level of the Canals, which shows that several feet of silt deposited on the bed of the Canals during the flood season, to be scoured away again in the cold season—see Fig. 7-8.

Fig. 7-8

The data thus showed that if more sand could be put into the Rohri Canal it would not have any permanent good effect, but would, on the contrary, be detrimental; because all the silt and sand which now enters the Canal is scoured downstream; so, admitting extra sand would increase the quantity entering off-taking channels, in many of which it could not be accommodated, as their slopes are already inadequate.

7.07. THE DESIGN OF CANALS IN SIND—RELATION BETWEEN A AND Q

As a preliminary step in connection with the design of canals in Sind, the data available for the Sukkur Barrage Canals and the Jamrao Canal in Sind have been compared with the data available for the Lower Chenab and Lower Jhelum Canals.

The relation which gives the highest correlation is the A:Q relation—see Fig. 7-8—and as $V = Q/A$, the V:Q relation is equally high.

Fig. 7-8

According to Lacey's original formulæ

$$A = PR = 8/3 Q^{1/2} \times 0.472 Q^{1/3} / f^{1/3} = 1.26 Q^{5/6} / f^{1/3} \dots (1)$$

Lower Chenab $A = 1.243 Q^{.886} = 1.26 Q^{5/6}$ approx.

Lower Jhelum $A = 1.170 Q^{.850} = 1.26 Q^{5/6}$ approx.

Sukkur Barrage Canals	$A = 1.650 Q^{.821} = 1.55 Q^{5/6}$	} = 1.5 $Q^{5/6}$... (2)
Jamrao Canal	$A = 1.479 Q^{.830} = 1.45 Q^{5/6}$	

Note.—Sukkur Barrage Canals data = Sind data 1941 for Rohri and Dadu Canals.

Compare these with Lacey's value $A = 1.26 Q^{5/6} / f^{1/3}$

For L. C. C., $f_A = 1.0$; for L. J. C., $f_A = 1.0$

Sukkur Barrage Canals = .54

Jamrao Canal = .6

or say $f_A = 1.0$ for Punjab, and .57 for Central Sind.

The reason why this relation is so constant is because P and R and w and d ($wd = A$) tend to vary inversely.*

7.08. RELATION BETWEEN MEAN DEPTH AND DISCHARGE PER FT. WIDTH

Considering the data available from the Rohri and Dadu Canals† † and the Jamrao Canal, we see that by the rather unsatisfactory log-statistical method, the data gives:

Sukkur Barrage Canals $d = 1.192 q^{.643}$... Fig. 7-9 (i) (b) Fig. 7-9 (i)(b)

The Jamrao data gives $d = 1.150 q^{.653}$... Fig. 7-9 (ii) (b) Fig. 7-9(ii)(b)

Corresponding values for the Punjab:

Lower Chenab Canal $d = .914 q^{.662}$

Lower Jhelum Canal $d = .919 q^{.687}$

* See Dr. Bose's Paper No. 252, Punjab Engineering Congress, 1942: "Design of Channels in alluvium."

† 22 sites on the Rohri and Dadu Canals shown in Statement 8 of the Development and Research Division's Annual Report for 1941. (Site 1 is omitted as its data is highly inconsistent.)

There is a physical reason for differing exponents; but it is convenient for comparison to assume a common exponent of .66 when the values of the coefficients work out to

Lower Chenab Canal	.92 $q^{.66}$
Lower Jhelum Canal	.95 $q^{.66}$
Sukkur Barrage Canals	1.16 $q^{.66}$
Jamrao Canal	1.14 $q^{.66}$

So if we call $d = .935 q^{.66}/f^{\frac{1}{3}} = \text{unity}$ for Punjab, then $d = 1.15 q^{.66}$ gives $f = .54$ for Sind.

7.09. RELATION BETWEEN WIDTH AND DISCHARGE

Before we can work out the $d:Q$ relation we must know the width relation; because $q = Q/w$

In the past, Lacey's formula

$$P = 2.67 \sqrt{Q} \quad \dots \quad (3)$$

has dominated the field. Later he changed this to

$$W = 2.36 \sqrt{Q} \quad \dots \quad (4)$$

where $W = \text{Lacey's 'effective width'} = A/\sqrt{d.D_0}$

and $D_0 = \text{Central depth}$

$$\text{also } w = 8/3 \sqrt{Q} \quad \dots \quad (5)$$

where $w = \text{surface width.}$

The relative merits of the $P:Q$; $W:Q$ and $w:Q$ relations will not be dealt with here; but it must be pointed out that $P:Q$ gives least scatter, because P has an element of both width and depth in it; and as variations in width and depth tend to neutralise each other, P remains relatively constant, even where the width varies considerably from point to point.

Lacey's equivalent width

$$W = A/\sqrt{d.D_0}$$

requires D_0 to be known, and assumes that the greatest depth is central. Where this is so, W may be better than w ; but in general D_0 is not central, and D_{max} varies and is greatest when furthest from mid-bed; so, in general, D_0 varies more widely than d , and so W is not an improvement on $w = A/d$; and both vary much more widely than P ; so, unless very great care is observed in selecting sites and allowing for berm conditions, scatter is greater in $w:Q$ than $P:Q$. This is clearly exemplified in the case of the Jamrao data. It does not follow, however, that $P:Q$ is a more fundamental relation than $w:Q$. Indeed $P:Q$ is definitely wrong for small discharges; and, for design purposes, w has marked advantages; and w and d are easier to visualise than P and R , and W and D_0 , so they have been adopted.

The coefficient $8/3$ in equation (5) does not agree with most of the Sind data, especially in the case of inundation canals, where w is as low as $1.33 Q^{\frac{1}{2}}$, or just half the Lacey width.

In the case of 1941 Sind data* for Rohri and Dadu Canals and the Jamrao Canal data, we get the statistical relations:

Fig. 7-9 (i)(a) $w = 2.52 Q^{.498}$ and $1.803 Q^{.531}$ respectively... Fig. 7-9 (i) (a)
 Fig. 7-9 (ii)(a) ,, 7-9 (ii) (a)

Again, taking the mean exponential value (.516) for comparing coefficients, we get,

$$w = 2.28 Q^{.516} \text{ for Barrage Canals and } w = 1.96 Q^{.516} \text{ for Jamrao Canal.}$$

The former is for canals constructed 10 years ago, and the latter for a canal built forty years ago, which had been gradually silting. A value of 2.12 may be accepted as a standard figure, or

$$w = 2.12 Q^{.516} \quad \dots \quad (6)$$

*From data on pages 62-64 of the Central Board of Irrigation 1939-40 Annual Report (Technical).

FIG. 7-8

A:Q
L.C. CANAL.
 $A = 1.243 Q^{.8363}$ (STATISTICAL)
(FOR STABLE SITES.)

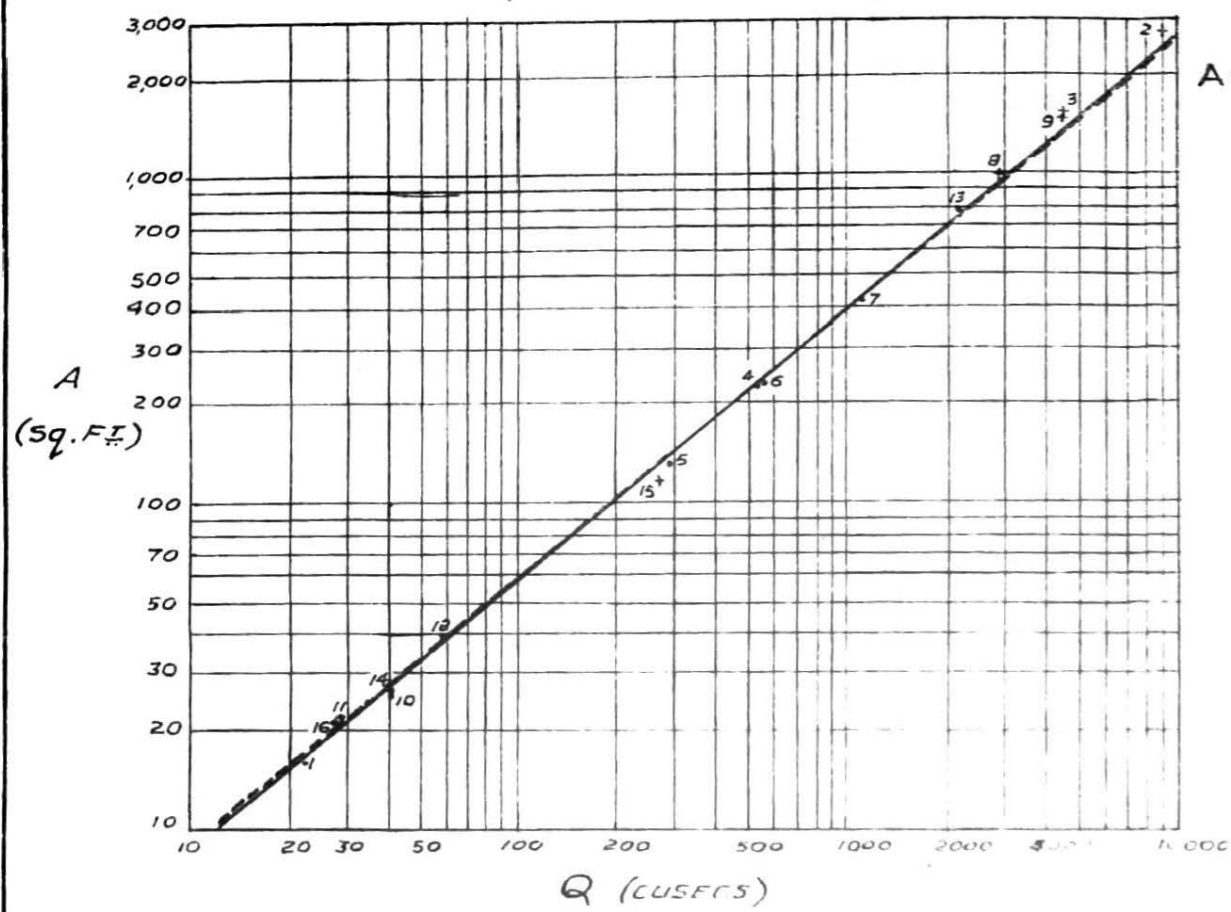

A:Q
JAMRAO DATA.
 $A = 1.479 Q^{.8295}$ (STATISTICAL)
(FOR STABLE SITES)

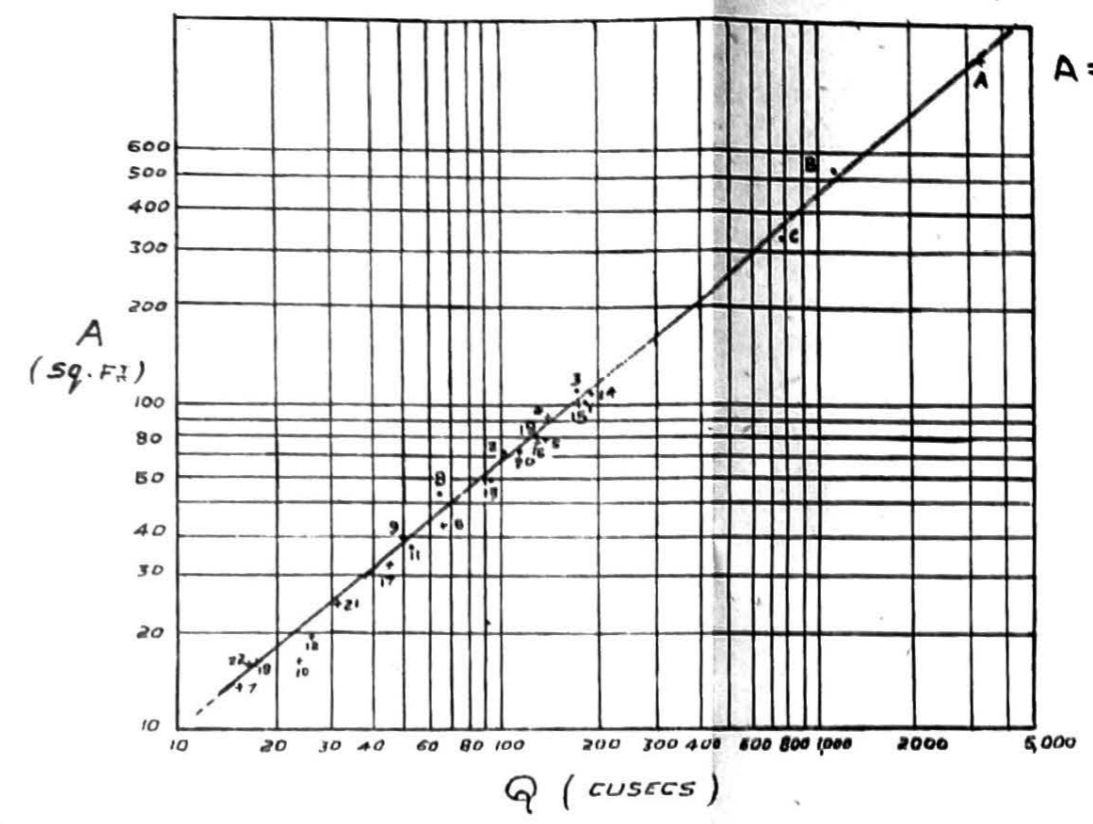

REFERENCES:
STABLE SITES
UNSTABLE SITES

A:Q
L.J. CANAL.
 $A = 1.170 Q^{.8502}$ (STATISTICAL)
(FOR STABLE SITES.)

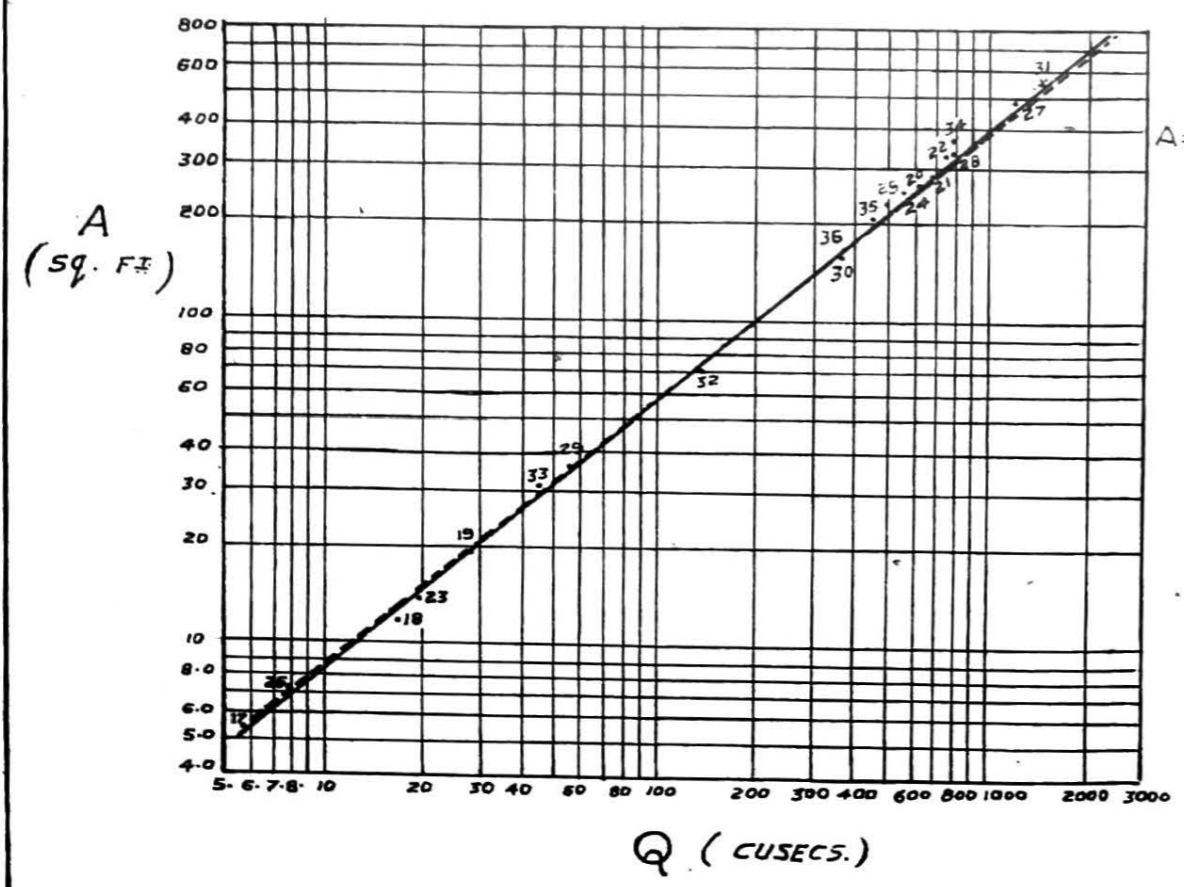

A:Q
S.B. CANAL DATA 1941.
 $A = 1.650 Q^{.8213}$ (STATISTICAL)
(FOR ALL SITES.)

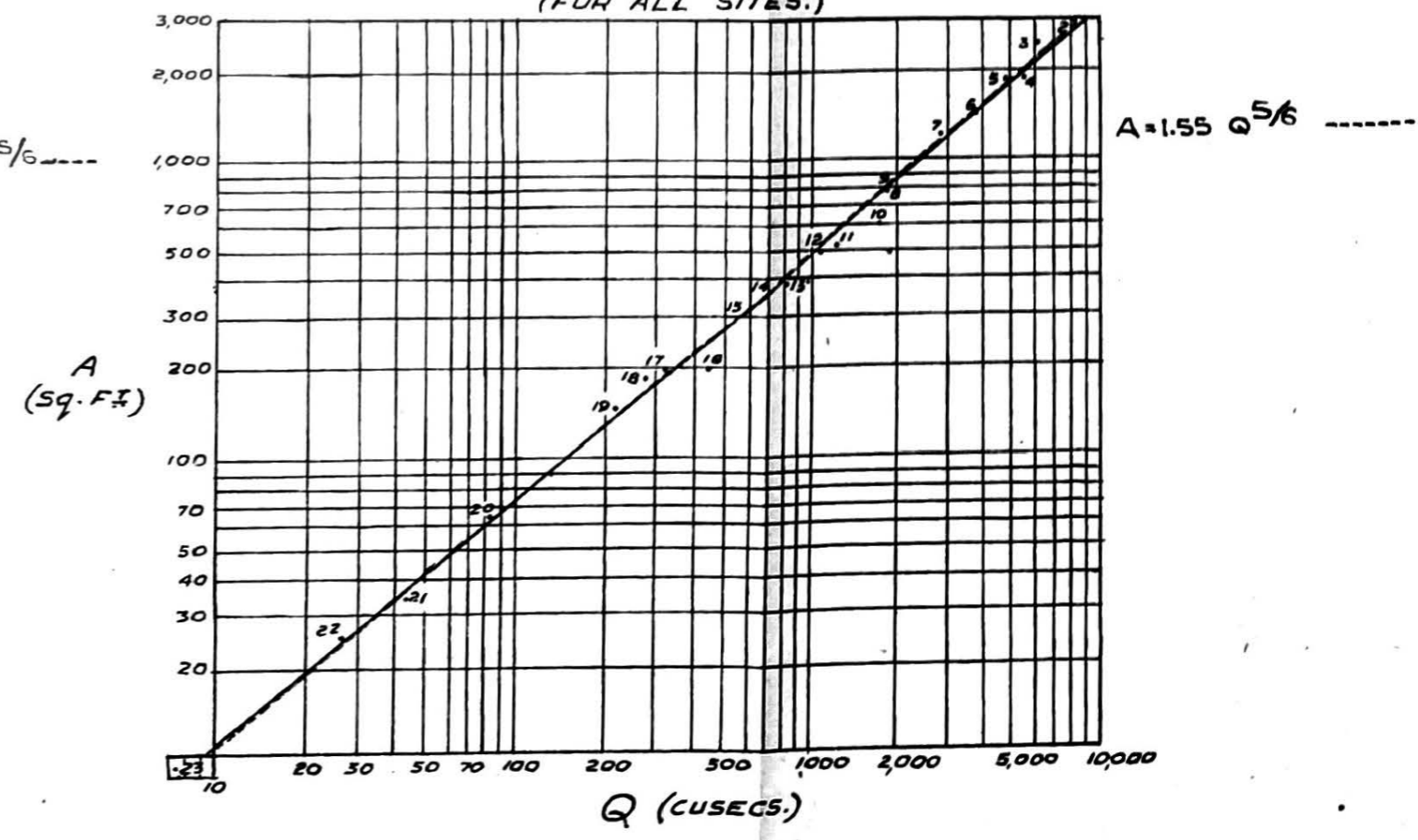

T. BY. SARKAL & PARKHI.
3/4/1944

FIG-7-9(i)

4833

C.I.A.M.O.

(FIG. 20 FROM A.R.T. 1943 OF W.E.S.P.)

SUKKUR BARRAGE CANALS

1941 DATA.

(a) W:Q

$W = 2.570 Q^{.499}$ (Statistical) ———

$W = 2.28 Q^{.516}$ ——— Practically identical curve, so is shown at 2 ends.

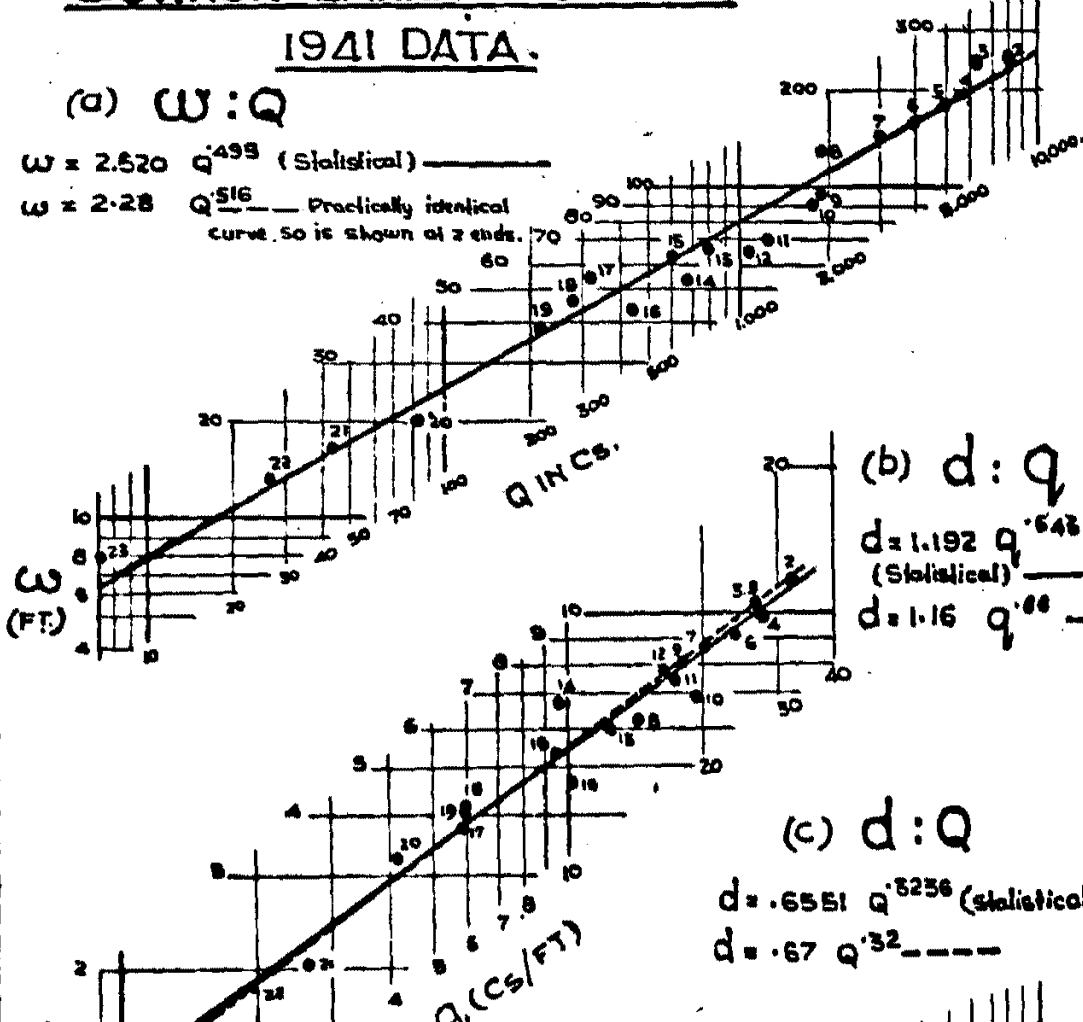

(b) d:Q

$d = 1.192 Q^{.648}$ (Statistical) ———

$d = 1.16 Q^{.66}$ ———

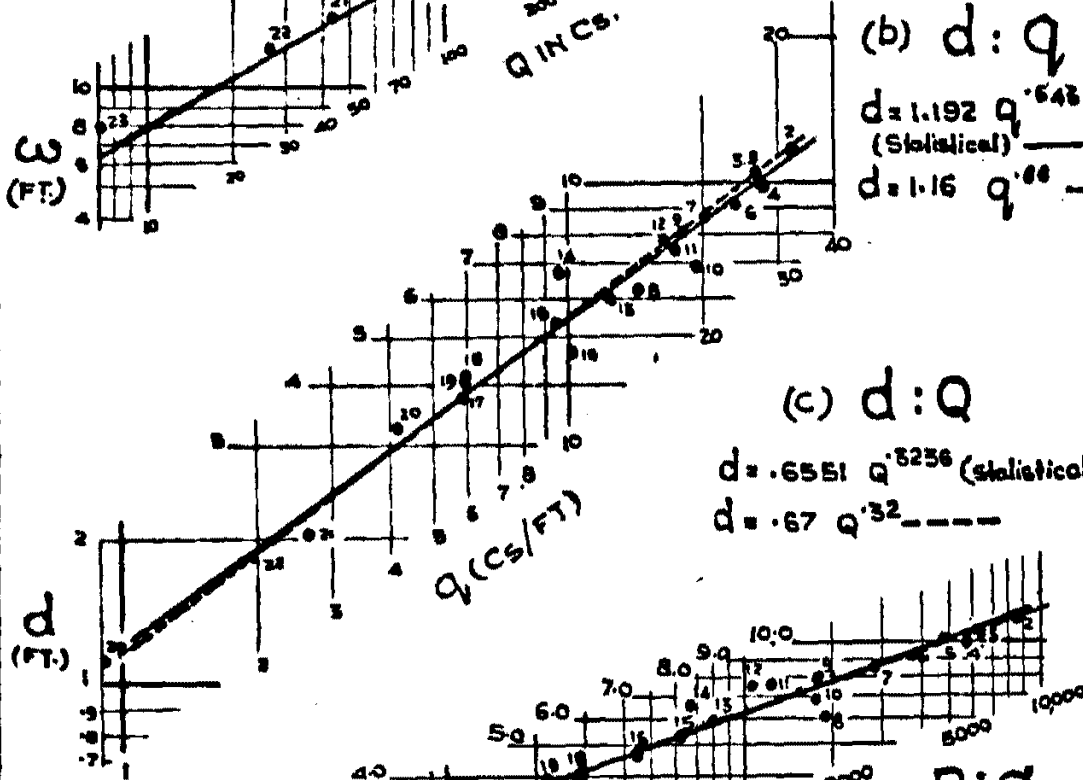

(c) d:Q

$d = .6551 Q^{.8256}$ (Statistical) ———

$d = .67 Q^{.82}$ ———

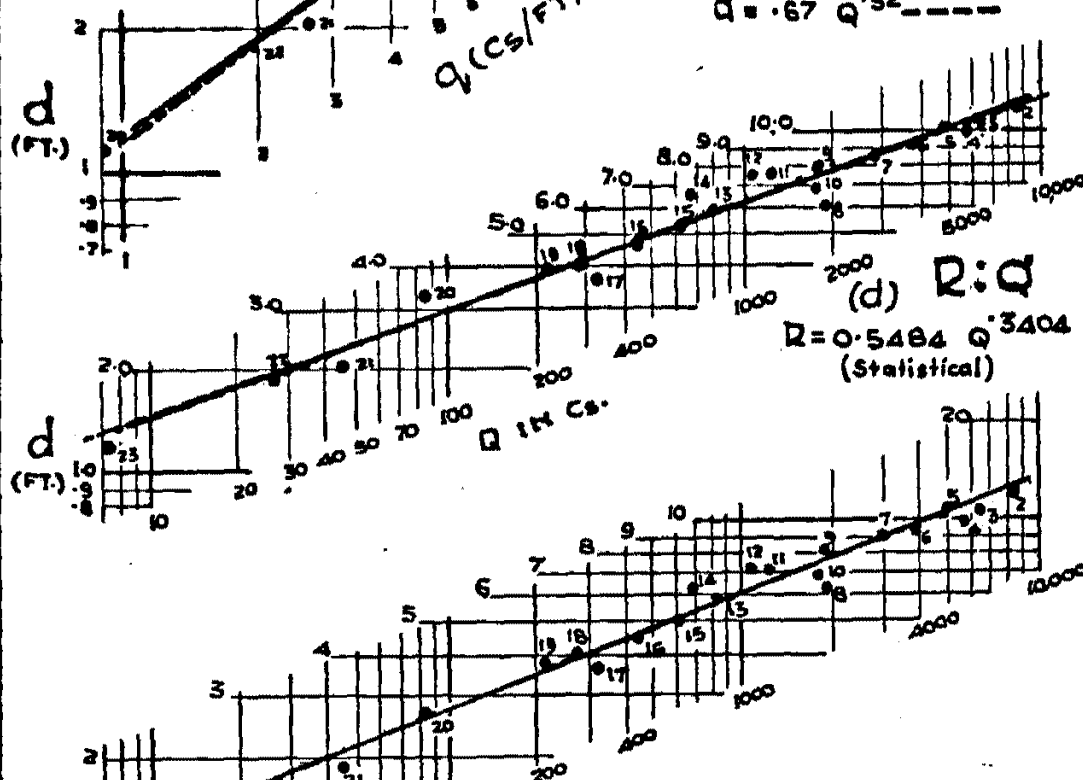

(d) R:Q

$R = 0.5484 Q^{.3404}$ (Statistical) ———

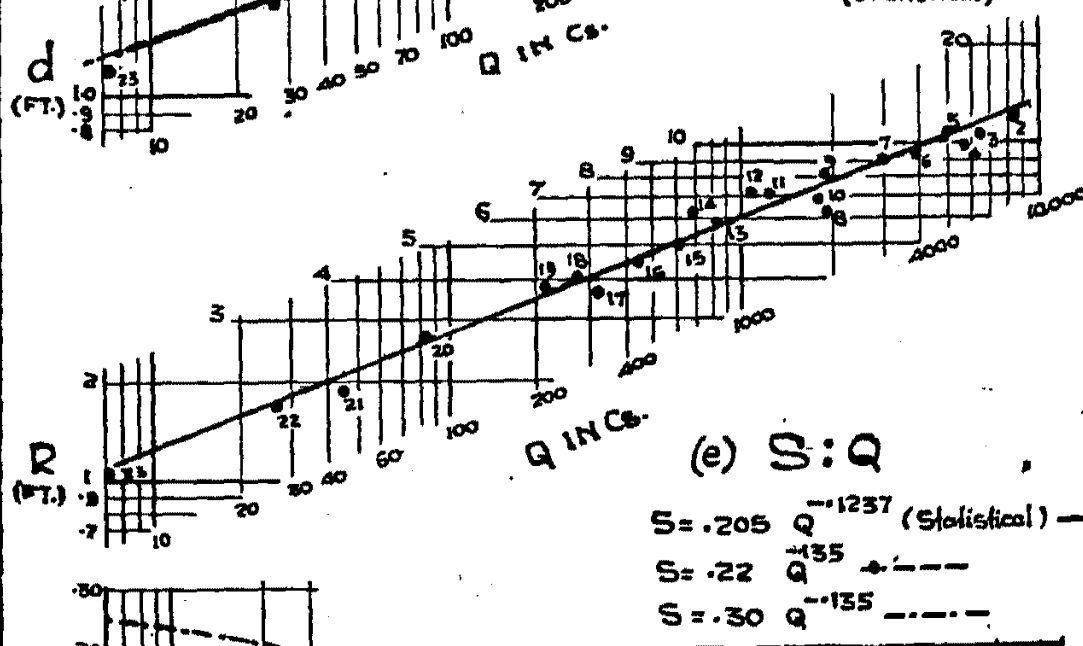

(e) S:Q

$S = .205 Q^{-.1237}$ (Statistical) ———

$S = .22 Q^{-.135}$ ———

$S = .30 Q^{-.135}$ ———

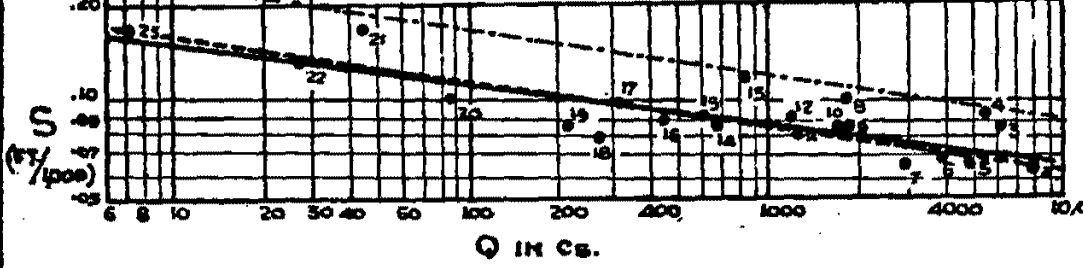

Kalkani

FIG: 7-9 (ii)

JAMRAO DATA

REFERENCES:

- STABLE SITES. •
- UNSTABLE SITES. +

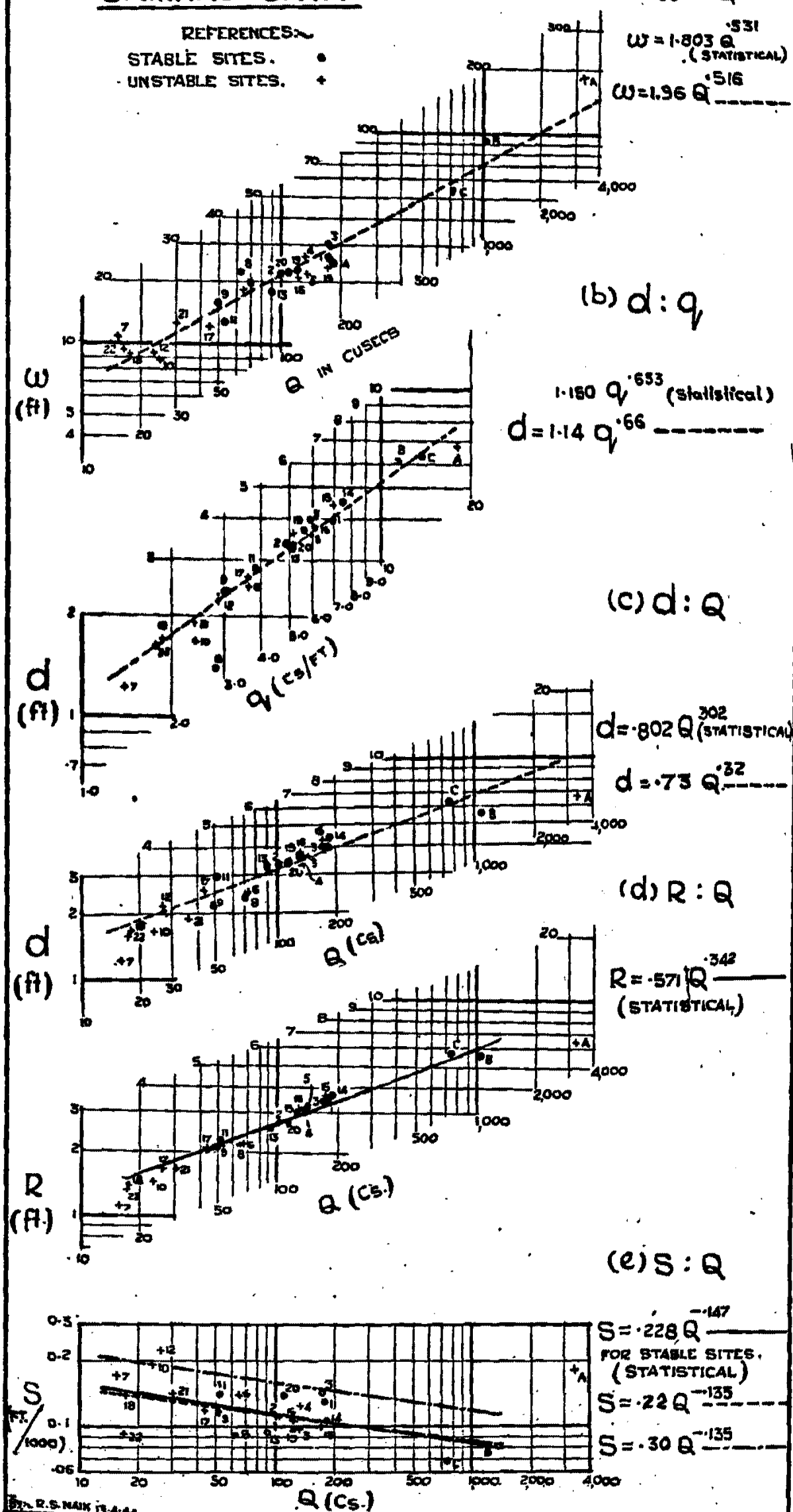

FACTORS AFFECTING FLOW

7.10. d:Q RELATION

$$d = .655 Q^{.324}$$

... Fig. 7-9 (i) (c) Fig. 7-9 (ii) (c)

derived statistically for the Rohri and Dadu Canals; and

$$d = .73 Q^{.32}$$

for the Jamrao. The Jamrao w and d data are not, however, very reliable, due probably to the Jamrao enquiry having been done in terms of P and R, w and d being worked out later, making assumptions.

For purposes of design of new Canals in Sind $d = .7 Q^{.32}$ may be adopted.

This may be compared with Lacey's $R = .427 \left(\frac{Q}{f}\right)^{\frac{1}{3}}$

7.11. S:Q RELATION

Finally we come to the S:Q relation which is the most sensitive and also the most important relation for design purposes; because whereas the w:Q and d:q relations tend to right themselves gradually, any mistake in slope will either lead to heavy silting, and eventually to a reduction of discharge, or else to scour and retrogression of bed levels, which in turn, may lead to deep scour-holes developing below bridges—as has occurred in the Rohri Canal in Sind.

Before considering the slope data we should consider the Lacey relation:

Lacey's formula for the S:Q relation * is

$$S = .000547 f^{\frac{5}{3}} Q^{-\frac{1}{3}}$$

When stated in terms of f_{VB} and f_{BS} it is†

$$S = .000547 f_{VB}^{\frac{1}{3}} \cdot f_{BS}^{\frac{2}{3}} \cdot Q^{-\frac{1}{3}}$$

or calling $\sqrt{f_{VB} \cdot f_{BS}} = f$ = the canal system value

$$S = .000547 f^{\frac{1}{3}} \cdot f_{BS}^{\frac{2}{3}} \cdot Q^{-\frac{1}{3}}$$

To allow for the decrease of particle diameter exposed on the beds of channels down a canal system we may assume decrease in $f_{BS} \propto Q^{\frac{1}{10}}$ so Lacey's formula, altered into a canal system slope formula becomes,

$$S = .000542 f^{\frac{1}{3}} \cdot f^{\frac{2}{3}} \cdot Q^{\left(\frac{1}{10} \times \frac{2}{3}\right) - \frac{1}{3}}$$

$$= .000542 f^{\frac{5}{3}} Q^{-.133} \quad \dots \quad (7)$$

We should, therefore, anticipate that the variation in slope with discharge is less than $Q^{-\frac{1}{3}}$; and this is what is shown by Figs. 7-9 (i)(e) and 7-9 (ii) (e).

Sukkur Barrage Canals (1941) 22 sites: $S = .000205 Q^{-.124}$

Jamrao Data $S = .000228 Q^{-.147}$

and if a mean value of the exponents is taken for the Rohri, Dadu and Jamrao data, this gives the same approximate value, namely

$$S \propto Q^{-.135} \text{ (approx.)}$$

Similarly Dr. Bose's formula

$$S = .000209 m^{.86}/Q^{.21}$$

gives the same exponent as a canal system formula in which the diameter m decreases according to $m \propto Q^{.09}$, which agrees closely with such data as are available.†

* Derived from formulae in "Uniform flow in alluvial Rivers and Canals" Paper 4893, Institution of Civil Engineers, 1934, by Gerald Lacey.

† Note on "Divergence from Regime in Stable Channels" by C. C. Inglis.

THE BEHAVIOUR AND CONTROL OF RIVERS AND CANALS

The values to this common exponent of .135 are:

$$\text{Jamrao Canal} \quad S = .000215 Q^{-.135} \quad \dots \quad (8)$$

$$\text{Sukkur Barrage Canals} \quad S = .000219 Q^{-.135} \quad \dots \quad (9)$$

(Sind 1941 data)

$$\text{or say slope per thousand} = s = .22 Q^{-.135} \quad \dots \quad (10)$$

Though this may be taken as the normal slope, for constructing new canals, there are several cases of slopes about 40 per cent steeper. This is probably due to the normal ripple bed being replaced by bed dunes. This is the case in:

<i>Jamrao Canal</i>	<i>Rohri Canal</i>	<i>Dadu Canal</i>
Dim Minor Head	R. D. 341,000	Head.
Dalor Minor Head	R. D. 460,000	R. D. 477,000

To allow for the possibility of such slopes developing, it should be assumed that the slope may, in certain cases, be as much as $0.3 Q^{-.135}$; so regulators should be provided at suitable intervals to allow for this, and also to maintain the required levels, should retrogression occur; and bridges and regulators should be so designed that they will remain stable even if retrogression occurs; but the canals should be constructed with the smaller, normal, slopes.

In some cases it will be obvious that the slope will be flatter or steeper than the normal; but more generally this will not be known in advance, and hence it is generally best to design for normal conditions, making provision for the development of steeper or flatter slopes.

7.12. IN CONCLUSION

It appears reasonable to anticipate that at the head of a Canal system, where the bed material is coarser, width will be relatively greater than near the tail, owing to increased turbulence, and hence increased capacity to erode the banks; and this appears to be the explanation why in "Canal-system formulae" the exponent in the $w : q$ formula exceeds the .5 of Lacey; and why the exponents of q and Q in the $d : q$ and $d : Q$ formulae are slightly lower than $2/3$ and $1/3$ respectively. The difference is small; but not negligible. Thus, considering the formula

$$w = 2.12 Q^{.116}, \text{ the equivalent } C_w \text{ values in } w = C_w Q^{1/3} \text{ are:}$$

1 cusec	10	100	1,000	10,000
2.12	2.20	2.28	2.37	2.46

Another point which the data brings out is that Sind coefficients in the $w : Q$ formula are lower, while coefficients in the $d : q$ and $d : Q$ formulae are higher than in the Punjab. This is what Lacey would call the "Sind Silt Signature" and the reason for this is the relatively small proportion of coarse material in movement in Sind compared with the suspended silt charge.

Where there is little bed-sand entering a channel, it may be possible, after excavating the bed say 20 per cent deeper than designed, to lay down a blanket of fine silt on the bed by heading up water—as was done in the N. W. Canal by Mr. T. R. Sethna—after which the canal ran with a very small surface slope. In the case of a new canal, it would probably pay to compact the bed where it was desired to run the canal with a small surface slope.

Fig. 7-10 shows curves of area $A=1.5 Q^{.56}$, of $w=2.12 Q^{.516}$ and S per 1,000 = $.22 Q^{-.185}$ as in formulae Nos. (2), (6) and (10). Fig. 7-10

It also shows the formula for bed width = $1.23 Q^{.56}$ (11) and depths of central portions $D_B = 0.90 Q^{.30}$ (12)

—as recommended by us for the design of new channels with $1\frac{1}{2} : 1$ side slope for discharges exceeding 300 cusecs and $1 : 1$ side slope for discharges less than 300 cusecs. These side-slopes are flatter than the final slopes after the berms have silted; but give the best final result.

In many cases, especially in the case of small channels, the designed bed level is near ground level or even above it. In such cases, it is customary in Sind to construct the banks at some distance from the designed channel sides, so that wide berms can form with the aid of juck-work.

Before closing, the Author would like to thank Mr. Sethna for his assistance, persistence, and insistence that there were other factors than "sand exposed on the bed" causing divergence of shape and slope.

APPENDIX 1 TO THE NOTE ON "THE DESIGN OF CANALS IN SIND—PART I—NEW CANALS"

As the relation "area to discharge" gives the highest co-relation, the dimensions of a channel should be worked out from the $A : Q$ relation.

$A : Q$

The mean $A : Q$ relation for the Sukkur Barrage and Jamrao Canals is

$$A = 1.5 Q^{.56} \quad \dots \quad \dots \quad \dots \quad \dots \quad (2)$$

This and other relations are shown in Fig. 7-10. Fig. 7-10

In addition to area, we must assume a shape and either a width or depth dimension.

The commonest shape assumption, based on Kennedy's ideas, was a flat bed and $\frac{1}{2}$ to 1 side slopes, though $1 : 1$ side slopes have also been frequently used.

On this assumption, and using formula (6) of this note to give the surface width dimension,

$$W = 2.12 Q^{.516} \text{ (see Fig. 7-10)} \quad \dots \quad \dots \quad \dots \quad (6)$$

The bed slopes are in accordance with

$$S = .22 / Q^{.185}$$

The relation $D_B : Q$ both for $\frac{1}{2} : 1$ and $1 : 1$ slopes has been worked out from the formula

$$D_B = \frac{w + \sqrt{w^2 - 4n \cdot A}}{2n}$$

derived from

$$B = W = 2n \cdot D_B \text{ and } A = (w - n D_B) D_B$$

B has also been worked out for Sind for a side slope $n=1$. These are shown in faint dash-lines on Fig. 7-10 for comparison with the B and D_B lines for proposed values shown in thicker lines. Fig. 7-10

The formulae for B and D work out to

$$B = 1.23 Q^{.56} \quad \dots \quad \dots \quad \dots \quad \dots \quad (11)$$

$$D_B = .90 Q^{.30} \quad \dots \quad \dots \quad \dots \quad \dots \quad (12)$$

This is a slight modification on dimensions according to Lacey's recent note on "Artificial Channel Shape"; but his concept of a constant B/w ratio is slightly modified in accordance with Sind data for Sukkur Barrage Canals* which indicate that B/w is not constant, but varies as $Q^{.04}$.

* From data on pages 62-64 of the Central Board of Irrigation 1939-40 Annual Report (Technical).

THE BEHAVIOUR AND CONTROL OF RIVERS AND CANALS

An objection to adopting the Lacey concept for construction is that the side slopes would then vary with discharge. This they actually do in nature; but if our values of B and D_B are adopted and side slopes of $1\frac{1}{4} : 1$ used for discharges exceeding 300 cusecs and $1 : 1$ for discharges less than 300 cusecs, the error in cross-sectional area is about +2 per cent down to 50 cusecs and it is only +5 per cent at 30 cusecs and +9.7 per cent for 10 cusecs; and as it is desirable to construct small channels a bit too big in the first instance, this is all to the good. The formula $B = 1.23 Q^{.66}$ is, therefore, recommended as suitable for constructing new canals in Sind, with $1\frac{1}{4} : 1$ side slopes for discharges exceeding 300 cusecs, 1 to 1 for side slopes less than 300 cusecs and D_B values as shown in the thicker line (4b) of Fig. 7-10 for depths in the central portion of channels according to $D_B = .9 Q^{.3}$.

Fig. 7-10

FIG-7-10
 GRAPH SHOWS.

- (1) AREA (A)
- (2) SURFACE WIDTH (w)
- (3a) BED WIDTH (B);
- (b) DEPTH OVER CENTRAL PORTION D_B FOR 1:1 & 1/2:1 SIDE SLOPES.
- (4a) BED WIDTH $B = 1.23 Q^{.56}$
- (4b) $D_B = .90 Q^{.30}$
- (5) SLOPES PER 1,000 (S).

(1 & 5) ARE RECOMMENDED FOR
 CONSTRUCTING NEW CANALS
 IN SIND, WITH 1/4:1 SIDE
 SLOPE FOR $Q > 300$ Cs.
 & 1:1 SIDE SLOPE FOR $Q < 300$ Cs.

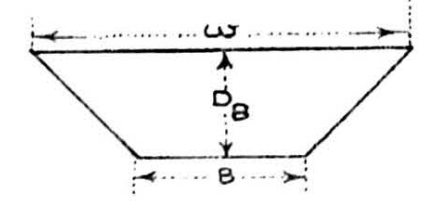
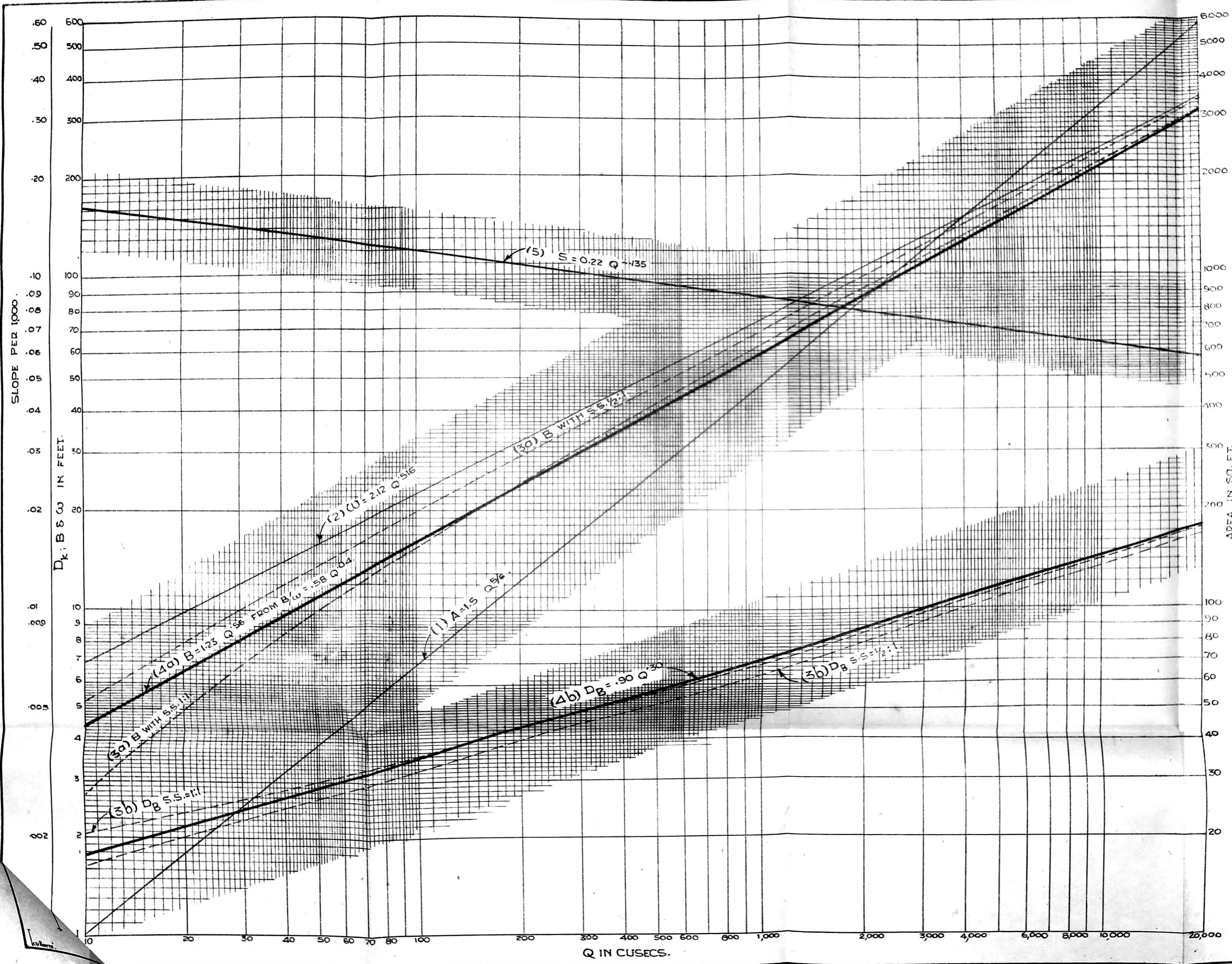

MAXIMUM DEPTH OF SCOUR AT RIGID STRUCTURES

CHAPTER 8

MAXIMUM DEPTH OF SCOUR AT HEADS OF GUIDE BANKS AND
GROYNES, PIER NOSES, AND DOWNSTREAM OF BRIDGES

	Pages.
8-00 Synopsis	327
8-01 Enquiry into scour round bridge piers	328
8-02 Model experiments—scour round piers	328
8-03 Conclusions drawn from field data and pier experiments	328
8-04 Discussion on scour round Hardinge Bridge piers	333
8-05 Scour at guide banks, spurs, and sharp bends	347
8-06 Scour downstream of bridges	348
8-07 Conclusions	348



Photo 1012. Pier experiments showing water profile at pier.

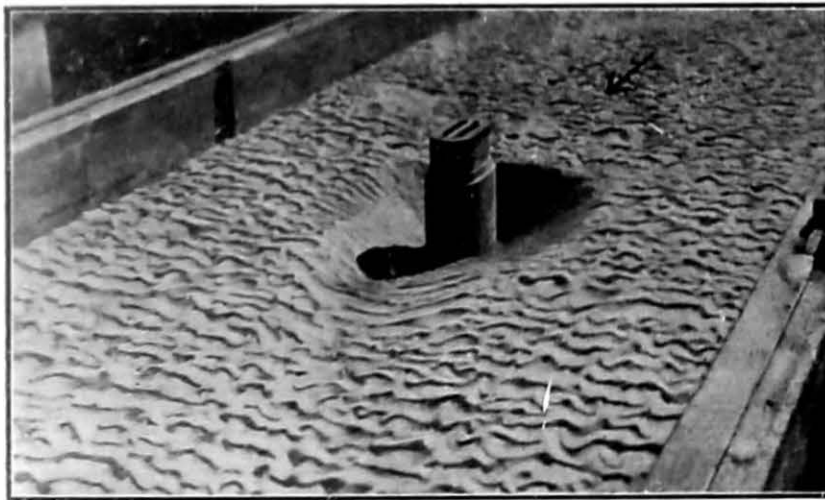

Photo 1410. Cup-shaped scour round pier with no stone protection (looking upstream), 1/40 scale pier.

Photo 1410 from C. I. and H. R. S. A. R. (T.) 1938-39.

TABLE 8-I

SHOWING MAXIMUM DEPTH OF SCOUR IN RIVERS AT BRIDGE PIERS, GUIDE BANKS, GROYNES, SHARP BENDS AND DOWNSTREAM OF BRIDGES

No.	Site.	Q (maximum) (cusecs).	$d_s = \text{max. depth of scour (ft.)}$	Year of observation.	$m = \text{mean grade of bed material (in mm.)}$	$k_s = 1.76 \sqrt{m}$ assumed as an approximation.	$d_s \times \frac{1}{d}$	$D_{Lacey} = \frac{473}{Q^{1/2}} (Q/d)^{1/2}$	d_s/D_{Lacey}	References.
8-I. SCOUR ROUND PIERS OF BRIDGES.										
1 (a)	The Ganges near Hardinge Bridge (Bengal and Assam Railway).	16,75,000	117	1938	0.37	1.07	119.7	54.93	2.18	A. E. (T) 1937-38, p. 66; 1938-39, p. 22 and 1939-40, p. 23; Bombay Tech. Papers 55 and 58.
2	The Brahmaputra at Amingaon ...	22,50,000	104	1938	0.39	1.10	107.4	60.09	1.78	A. E. (T) 1938-39, p. 23.
3	Meghna Railway Bridge (B. & A. Railway) ...	8,00,000	94	1938	0.32	1.0	94	48.91	2.14	Appendix 1 of A. E. (T) 1944 (pp. 78-81)
4	Karnaphuli Railway Bridge (B. & A. Railway).	3,09,000	57	1938	0.32	1.0	57	31.09	1.78	Do. do.
5	The Jumna at Delhi Railway Bridge (E. I. Railway).	43,000	37.5	1941	0.32	1.0	37.5	16.58	2.26	A. E. (T) 1937-38, p. 65.
6	Gandak Railway Bridge at Bagaha (O. & T. Railway).	3,00,000	74	1924	0.38	1.08	75.9	36.87	2.40	A. E. (T) 1944.
7	Par Railway Bridge (E. B. & C. I. Railway) ...	1,68,000	58.5	1941	0.33 (assumed)	1.0	58.5	24.1	2.24	Appendix 1 of A. E. (T) 1944 (pp. 78-81).
8	The Indus in Rohri-Bukkur Gorge ...	4,14,000 (2/3 of 6,20,000 ccs., 1/3 flowing through Bukkur-Sukkur Gorge).	82.7	1938	0.17	.71	73.8	31.48	2.35	See Figs. 36 and 37, A. E. (T) 1937-38.

S 149-46

319

MAXIMUM DEPTH OF SCOUR AT RIGID STRUCTURES

TABLE 8-I—contd.

SHOWING MAXIMUM DEPTH OF SCOUR IN RIVERS AT BRIDGE PIERS, GUIDE BANKS, GROYNES, SHARP BENDS AND DOWNSTREAM OF BRIDGES

No	Site.	Q (maximum) (cusecs).	d_s = max. depth of scour (ft.).	Year of observation.	m = mean grade of material (in mm.)	$t_d = 1.76 \sqrt{m}$ assumed as an approximation.	$d_s \times t_d$	$D_{Lacey} = .475 (Q/t_d)^{1/2}$	d_s/D_{Lacey}	References.
9	Jhelum River Railway Bridge near Jhelum (N. W. Railway).	29,063	25	August 1938	0.34	1.03	25.24	14.40	1.73	
10	Jhelum River Railway Bridge at Shahpur (N. W. Railway).	60,207	48	June 1938	0.32	1.0	48.0	18.54	2.59	
11	Chenab River Alexandra Railway Bridge near Wazirabad (N. W. Railway).	1,03,115	41.7	July 1938	0.37	1.07	42.65	21.68	1.93	
12	Chenab River Alexandra Railway Bridge at Chund (N. W. Railway).	1,09,834	41.4	June 1936	0.30	.96	41.97	22.97	1.80	
13	Chenab River Railway Bridge at Sher Shah (N. W. Railway).	1,58,021	45	August 1933	0.34	1.03	45.44	25.21	1.78	
14	Chenab River Railway Bridge at Chiniot (N. W. Railway).	1,67,357	65.2	July 1932	0.34	1.03	65.85	25.81	2.53	
15	Ravi River Railway Bridge near Dera Baba Nanak (N. W. Railway).	69,747	40.5	August 1942	0.24	.86	38.62	20.47	1.98	
16	Sutlej River Railway Bridge near Phillaur (N. W. Railway).	61,314	39.1	July 1929	0.32	1.0	39.1	18.65	2.09	
17	Sutlej River Empress Railway Bridge at Adamwahan (N. W. Railway).	1,06,747	49.14	August 1933	0.20	.79	45.43	24.28	2.02	
									mean = 2.09 + .27 or - 12.9%	

TABLE 8-II

SHOWING MAXIMUM DEPTH OF SCOUR IN RIVERS AT BRIDGE PIERS, GUIDE BANKS, GROYNES AND SHARP BENDS

No.	Site.	Q max. (Cusecs)	d_s = max. depth of scour.	Year of observation.	m = mean grade of bed material (in mm.)	$f_s = 1.76 \sqrt{m}$ assumed as an approxi- mation.	$d_s f_d$	$D_{Lacey} =$ $473 (Q/f_d)^{1/3}$	d_s/D_{Lacey} .	Reference.
1 (b)	The Ganges at Sara Guide Bank, 8 miles upstream of Hardinge Bridge.	17,00,000	208	1933-35	0.39	1.10	212.6	54.69	3.77	} See Bombay Tech. Paper 55, 58; A. R. (T) for 1937-38; 1938-39 and 1939-40.
1 (c)	The Ganges near the nose of the Right Guide Bank of the Hardinge Bridge.	17,00,000	150	1933	0.37	1.07	153.4	55.2	2.72	
2	Inside the outer bank of the Right Bank Approach Channel at Sukkur.	50,000	66	1940	0.27	.92	64.18	16.93	3.9	A. R. (T) 1940-41, p. 12.
3	Narbada river old Railway Bridge at Bronch (B. B. & C. I. Railway).	10,00,000	106	1939	0.32 (assumed)	1.0	106	47.3	2.24	Appendix I of A. R. (T) 1944. (pp. 78-81).
4	D/s of Knuckle in the Hooghly near Daubar Cotton Mill.	3,00,000	60	...	0.27	.92	58.35	32.56	1.84	A. R. (T) 1941-42, p. 23.
5 (b)	The Jumna near Delhi Gate Pumping Station at Spur 5.	48,000	30	1938	0.32	1.0	30	17.27	1.77	} A. R. (T) 1937-38, p. 65.
5 (c)	Do. Do. ...	31,000	24	1939	0.32	1.0	24	14.86	1.62	
6	The Sutlej upstream of the Railway—									
	(a) at nose of spur 4 ...	2,09,883	65	1944	0.32 (assumed)	1.0	65	27.9	2.33	
	(b) at nose of the old right railway guide bank	2,09,883	68	1944	0.32 (assumed)	1.0	68	27.9	2.44	
7	The Ravi upstream of Balloki Weir—									
	(a) at nose of spur 5 on the right bank ...	50,700	65	1935	0.32	1.0	65	17.4	3.74	} Appendix I of A. R. (T) 1944 (pp. 78-81).
	(b) at nose of spur 5 on the right bank ...	40,000	56.4	1932	0.32	1.0	56.4	16.1	3.5	

S 759-47

321

MAXIMUM DEPTH OF SCOUR AT RIGID STRUCTURES

TABLE 8-III

SHOWING MAXIMUM DEPTH OF SCOUR IN RIVERS DOWNSTREAM OF BRIDGES

No.	Site.	Q max. (cusecs).	d_s = max. depth of scour.	Year of observation.	m = mean grade of bed material (in mm.)	$f_d = 1.76 \sqrt{m}$ assumed as an approxi- mation.	$d_s f_d^{\frac{1}{2}}$	$D_{Lacey} =$ $473 (Q/f_d)^{\frac{1}{2}}$	$d_s / Lacey.$	Reference.
1 (d)	The Ganges downstream of bridge pier No. 3 of the Hardinge Bridge.	16,70,000	216	1938	0.37	1.07	221	54.93	3.04	A. R. (T) 1941-42, p. 31.
2	Rohri Canal downstream of Head Regulator at Sukkur.	10,900	47	0.07	.47	36.55	13.40	3.48	Appendix I of A. R. (T) 1944, (pp. 78-81).
3	Rohri Canal downstream of Rohri Multan Road bridge at R. D. 52,000.	10,900	56	0.056	.42	41.04	14.01	4.0	Do. do.
4	N. W. Canal downstream of the Railway Bridge near Ruk at R. D. 76,000.	5,000	31.5	1942	0.30	.96	31.05	8.2	4.08	A. R. (T) 1944.
5	Rice Canal downstream of the Railway Bridge at R. D. 75,000.	10,050	45	1938	0.32	1.0	45	10.21	4.41	A. R. (T) 1942-43, p. 21.
6	Eastern Jumna Canal downstream of Road Bridge at Malaheri at M 22/5.	2,072	31.5	August 1942	clay	Mean = 3.98 +0.3 or +7.5%
7	Eastern Jumna Canal downstream of Sarkari iron bridge at M 20/1.	2,054	24.5	August 1942	loam
SCOUR IN V. E. MODELS										
1 (a)	The Ganges near right guide bank of the Hardinge Bridge.	8.0	2.3	red silt ($m = 0.5 \text{ mts.}$)	1.25	2.48	.88	2.61	Bombay P. W. D., T. P. 55.
5	The Jumna near Delhi Gate Pumping Station at spur 5.	2.8	1.0	Thick sand ($m = 0.24$)	0.80	.95	.70	1.43	A. R. (T) 1940-41, p. 55 and 1942-43, p. 2.

MAXIMUM DEPTH OF SCOUR AT RIGID STRUCTURES

FIG. 8-1

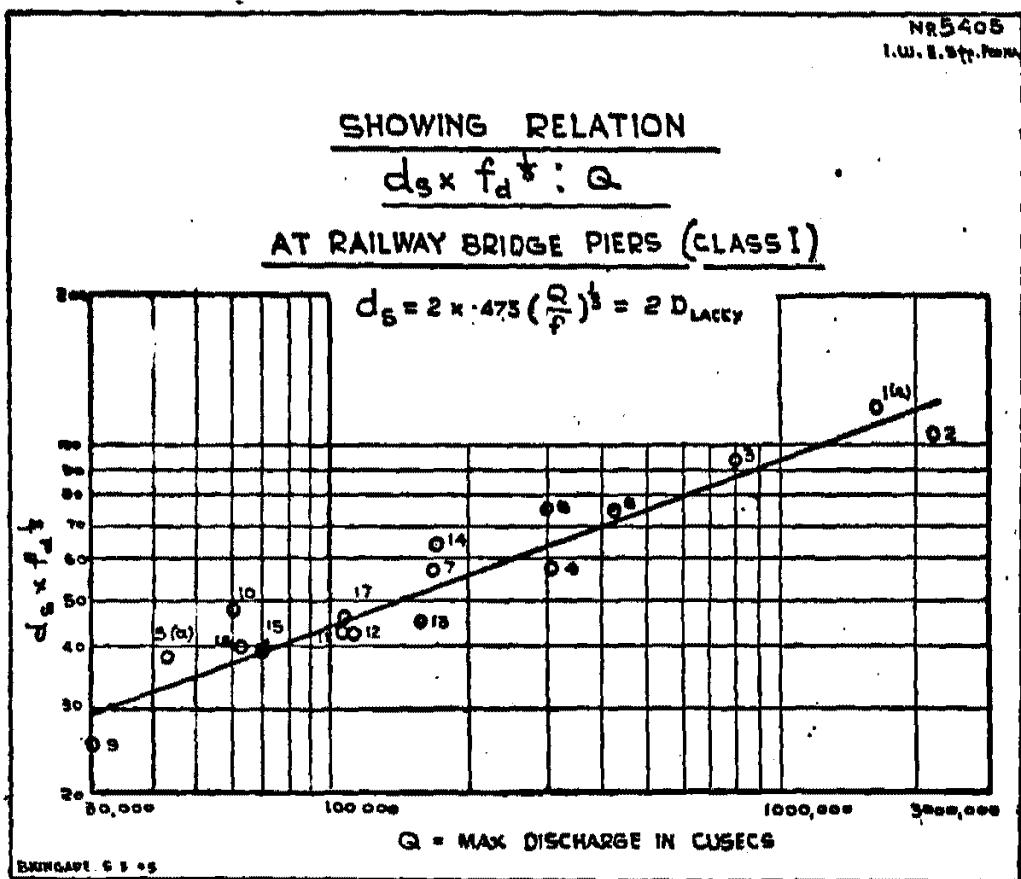

(FIG. 90 FROM A. R. T. 1943 OF I. W. E. STN.)

FIG. 8-2
SHOWING RELATION

$d_s \times f_d^{1/2} : Q$ D/S OF BRIDGES (CLASS III)
 $d_s = 4 \times .473 (Q/p)^{1/2} = 4 \times D_{LACEY}$

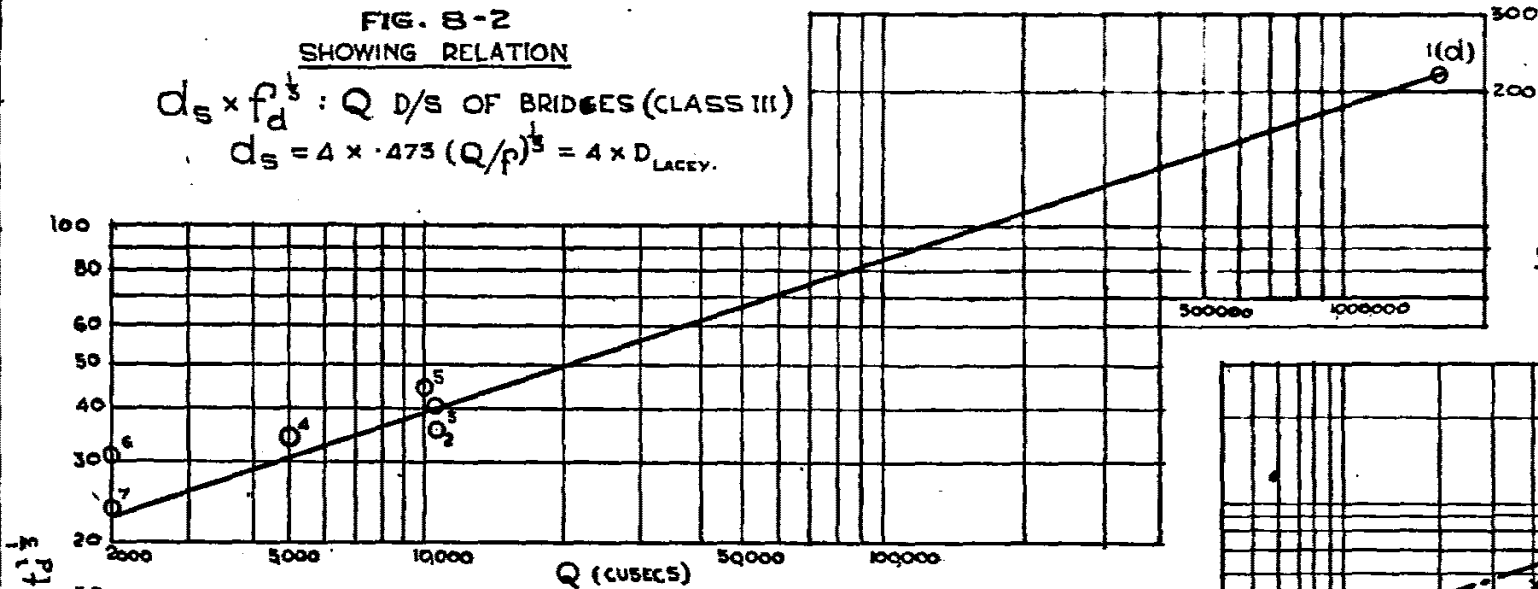

NO 5412
INDIAN WATERWAYS ENGRG SYM
POONA

FIGURE 8-3

(FIG. 91 & 92
FROM A.R.T. 1944
OF I.W.E.SYM)

SHOWING RELATION

$d_s \times f_d^{1/2} : Q$

GUIDE BANKS, SPURS & SHARP BENDS (CLASS II)

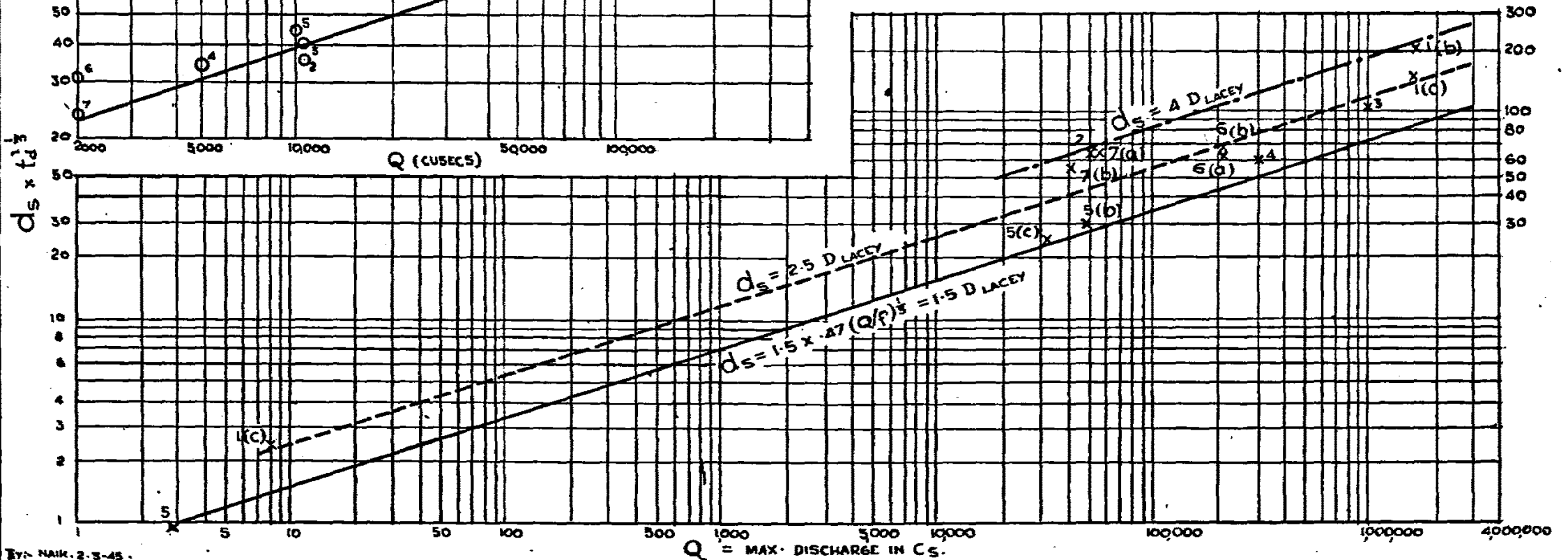

MAXIMUM DEPTH OF SCOUR AT RIGID STRUCTURES

CHAPTER 8

MAXIMUM DEPTH OF SCOUR AT HEADS OF GUIDE BANKS AND GROYNES, PIER NOSES, AND DOWNSTREAM OF BRIDGES

8.00. INTRODUCTION

Deep scour occurs—

- I at noses of piers, due to curved diving flow;
- II at ends of guide banks and groynes, due to flow concentrating and swinging round the extremities, causing large-scale eddies;
- and III downstream of bridges, due to eddies shed from high pavements or stone protection placed round bridge piers.

In all three cases, scour is due to the development of curvature of flow and eddies; so the velocity does not decrease rapidly near the bed, as in natural flow.

Fifteen years ago, Lacey* gave approximate figures for maximum depths of scour at bends, by relating these to his depth formula for regime conditions in a straight channel:

$$D = .47 (Q/f)^{\frac{1}{3}} \quad \dots \quad \dots \quad \dots \quad (1)$$

where D = effective depth,

Q = discharge, and

f = Lacey's silt factor which, for regime conditions, approximates to

$$1.76\sqrt{m},$$

(where m = the weighted mean diameter of the bed material).

In a moderate bend, he considered that the maximum depth might be 1.5 times the regime depth, and in a severe bend, 1.75 times; while in a right-angled bend, he assumed twice the regime depth. In this note, actual maximum depths of scour observed in several places have been collected and related to the corresponding maximum discharges.

At that time, Lacey brought grade of material into the formula to the 1/6th power; but recently he, and others in India, have considered that depth of scour downstream of rigid structures is unaffected by bed material. Work done at Poona seems, however, to indicate that f is a factor and that $f^{\frac{1}{3}}$ is probably of the right order.

The data, classified into three groups, are shown in Tables 8-I, 8-II and 8-III and Figs. 8-1, 8-2 and 8-3.

Table 8-I,
8-II & 8-III.
Fig. 8-1,
8-2 & 8-3.

8-1 Maximum scour at noses of piers due to diving flow, allowing for grade of bed material.

8-2 Maximum scour at guide banks, groynes and sharp bends due to diving flow, allowing for grade of material.

8-3 Maximum scour downstream of piers due to diving flow, allowing for grade of bed material.

These figures show the relation between discharges and depths of scour ($d_s/f_s^{\frac{1}{3}}$) at bridge piers; sharp bends, groynes; and downstream of bridges respectively; where d_s = maximum depth of scour, and $f_s^{\frac{1}{3}}$ (f_s being the bed sand factor) = $1.21 m^{\frac{1}{2}}$; so that m, the normal mean bed-sand value, is 0.32 mm., $f_s = 1.0$; and depth then varies as $Q^{\frac{1}{3}}$; but where the bed material is coarser than $m = .32$, the depth of scour is less than for $m = .32$ and vice versa.

* "Stable Channels in Alluvium." Paper No. 4736, Vol. 229, January 1930.

THE BEHAVIOUR AND CONTROL OF RIVERS AND CANALS

References to various annual reports, in which these cases have been described, are given in the last column of Tables 8-I, 8-II and 8-III.

Tables 8-I,
8-II and 8-III

8.01. ENQUIRY INTO SCOUR ROUND BRIDGE PIERS*

At the request of the Railway Board, experiments were carried out at Poona in 1938 to determine the best means of protecting bridge piers against scour, with particular reference to the piers of the Hardinge Bridge (E. B. Railway) over the river Ganges. The object was to find out what action takes place during periods of high flood when pitching is placed round piers at different levels; the best methods of protection against straight, and oblique flow; and whether it was preferable to delay laying pitching until scour had taken place, when the stones would be dropped from above, many being washed away.

The Hardinge Bridge piers were sunk to a depth of 160 ft. to 180 ft below maximum water level.

8.02. MODEL EXPERIMENTS—SCOUR AROUND PIERS

The piers used in the experiments were geometrically-similar replicas of those of the Hardinge Bridge. A single pier was placed in the centre of a parallel-sided channel, embedded in the sand forming the bed. This was Ganges sand, of mean diameter 0.29 mm., brought from the site of the Bridge.

Fig. 8-4. Fig. 8-4 shows, diagrammatically, the flow around a pier.

Photo Sheet 8-1. Owing to obstruction to flow, water spreads upwards near the surface at the nose—see Photo 1012, sheet 8-1—causing a small surface wave; but except near the surface, water flows downwards and to each side, forming the familiar cup-shaped scour-pit—see Photo 1410, sheet 8-1.

Fig. 8-5. Fig. 8-5 shows the relation between q —discharge per ft. width—and d —depth in flume.

It will be noted that the relation worked out to $d = .93 q^{.71}$ the exponent being .71, and not $\frac{2}{3}$ —as was to be expected.

Fig. 8-6. Fig. 8-6 shows the relation between $\frac{ds}{b}$ and $\frac{q_c^{2/3}}{b}$ where b = width of pier and q_c = discharge per ft. in the centre of the flume—i.e. upstream of the piers—the relation worked out to

$$\frac{ds}{b} = 1.70 \left(\frac{q_c^{2/3}}{b} \right)^{0.78}$$

8.03. CONCLUSIONS DRAWN FROM FIELD DATA AND PIER EXPERIMENTS

Fig. 8-7. (i) If no protection is laid, scour occurs round the piers, with the bed higher between the piers. This condition occurs with low discharges even where pitching has been laid round the piers, and is clearly shown in Fig. 8-7 in spans 3 to 8 during November 1934.

Fig. 8-7 8-8. (ii) It is, however, normal practice to lay stone round the piers of a bridge—either as a flat apron or like an inverted boat—the stone usually being one man stone of 60-129 lbs. weight. When deep scour occurs, it is resisted round the piers, so takes place outside the pitching, which is undermined and launches; so that the maximum scour occurs between adjoining piers—Fig. 8-7 (August 1938 and September 1938)—and upstream and downstream (Fig. 8-8).

(iii) The maximum attack on the loose stone protection occurs at the nose of the pier, and sand and stone scoured from upstream are deposited at the tail.

* C. I. & H. R. S. A. R. (T) 1938-39, pp. 38-41.
1939-40, pp. 33-38.
1940-41, pp. 35-38.
1941-42, pp. 12-13; 31-32; 33-34.

FIG. 8-4

HARDINGE BRIDGE PIER WITHOUT PROTECTION

SHOWING DIAGRAMMATICALLY LINES OF FLOW.

SCALE 1" = 60'

SIDE ELEVATION

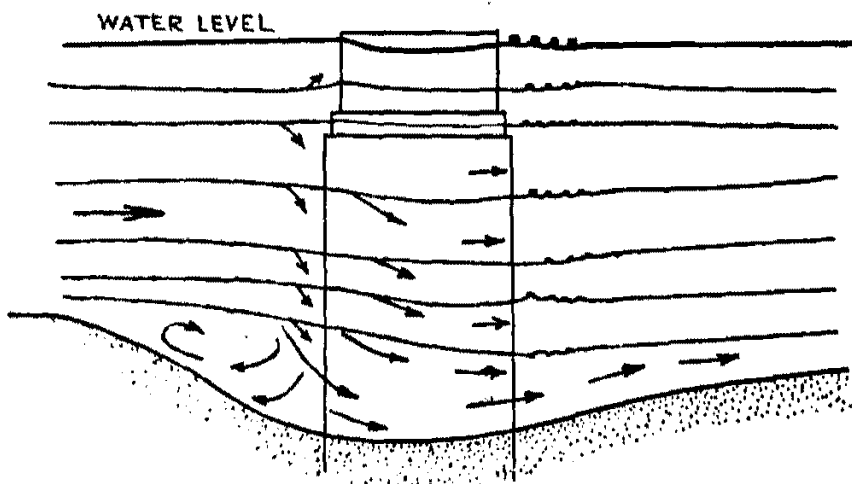

PLAN OF PIER

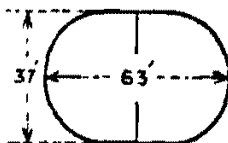

ELEVATION LOOKING D/S

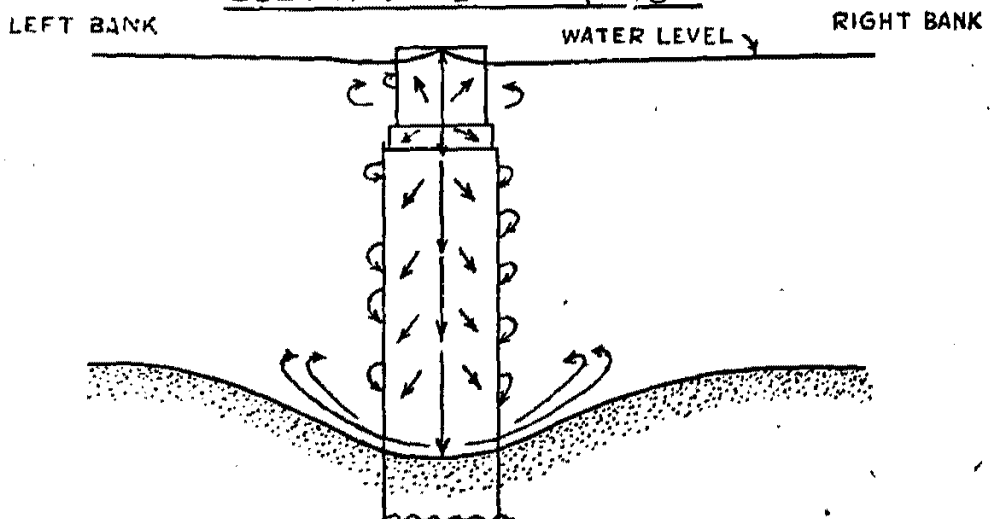

NO 1451A.

CENTRAL IRRIGATION
AND
HYDRODYNAMIC RESEARCH STN
POONA

(FIG. 34 FROM A.R.T. 1939-40
OF C.I. & H.R. STN)

FIGURE. 8-5

MEAN DEPTH OF CHANNEL:

$U/5$ OF PIER : MEAN DISCHARGE PER FT. WIDTH

- | | | |
|-------------------|-------------------|---------------------|
| X 8 FT CHANNEL | } GANGES SAND | |
| □ 11.5 FT CHANNEL | | MEAN DIA. 0.29 M.M. |
| ○ 4 FT CHANNEL | | |
| ● 8 FT CHANNEL. | NALA SAND 13 M.M. | |

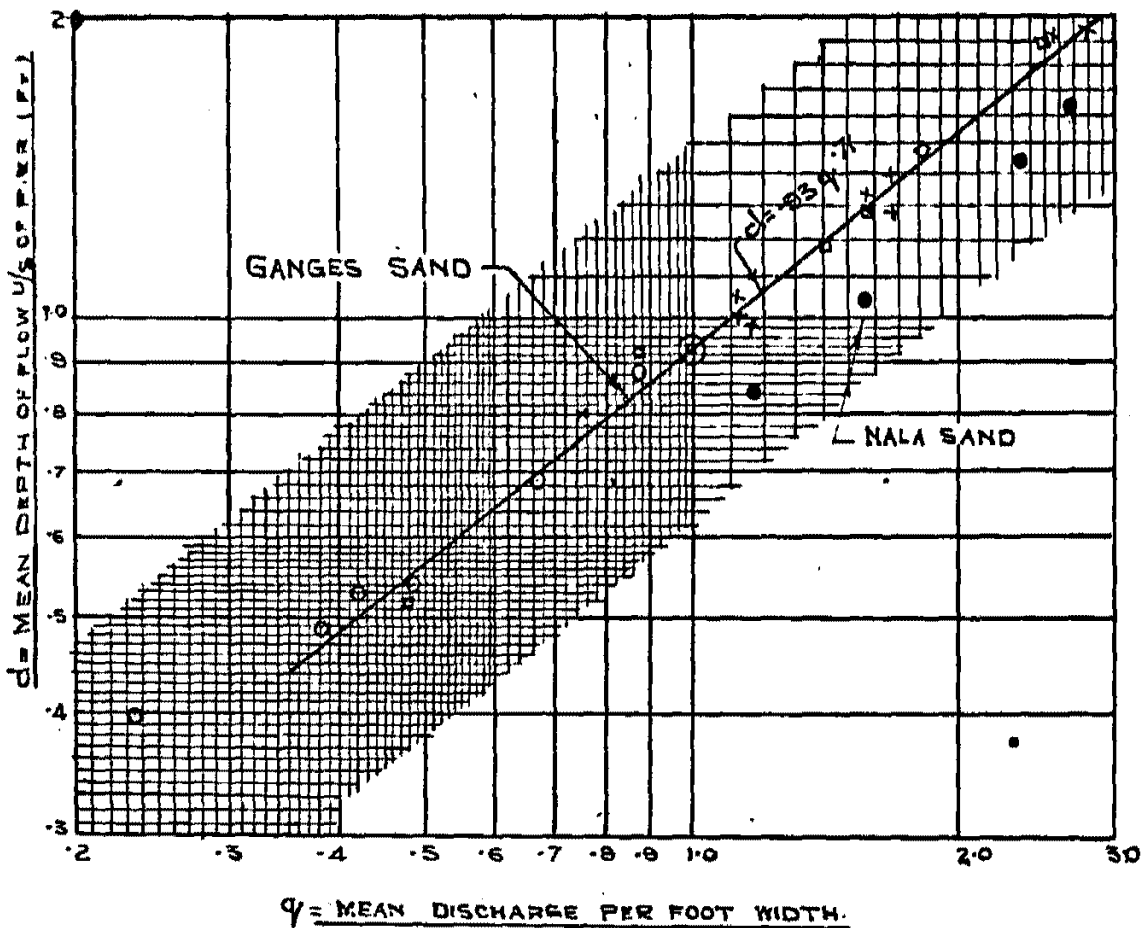

(iv) The stone at the nose remains undisturbed until the attack reaches a critical stage, when the stone suddenly begins to be carried away and a deep scour pit forms, reaching a depth nearly as great as had there been no protective stone (Fig. 8-9).

Fig. 8-9

(v) The greater the depth at which stone is laid, the more stable it is, i.e. the more severe the attack it can withstand without being carried away.

(vi) Because of (ii) above it is necessary to place stone at such a level and to use stone of such size and weight, that it will not be disturbed with the worst attack for which allowance has to be made. Stone laid at higher levels is of little value.

8-4 DISCUSSION ON SCOUR ROUND HARDINGE BRIDGE PIERS

Early in January 1942, the Author wrote a Note* on "Protection of Bridge Piers against scour and minimum safe level at which to lay stone around Piers" based on the above conclusions, which was considered by the Engineering section of the Indian Railway Conference Association on 19th January 1942. In the discussion, it was stated—

(a) "The general principles of 'falling aprons' have so far been adopted in the design of pitching round piers."†

(b) "Normally the centre of a span is scoured more than the portion adjacent to the piers with the result that the bed slopes away from the piers, and so long as these slopes have got an adequate cover of stone, the piers are considered safe."

(c) "The conclusions (relating to the pitching round the Hardinge Bridge piers) arrived at after the model experiments at Poona, do not quite agree with the observations made at the Bridge. Pier No. 3 may be taken as a typical case where the pitching has been maintained at a high level (R. L. 167 to R. L. 179) in spite of the most severe attacks during the floods of 1936 and 1938, when the intensity of discharge along this pier reached as much as 1,437 cusecs/ft."

(d) "It is of course more economical to lay the pitching at a lower level, and it affords a better protection. It is also recognised that the ideal level for laying the pitching is R. L. 150, this level being nearly midway between the H. F. L. and the bottom level of the wells; it also affords sufficient waterway for discharge to pass through the span without undue scour. But it is not always possible to lay the pitching at this desired low level."

The above comments enabled the Author in his reply to bring out points of interest: In reply to (a) and (b) he stated: "Fig. 8-7 shows that when the river discharge is low, maximum scour does not occur between the piers but round the piers, the bed between the piers being silted to a high level. It will also be seen that scour at the centre of spans does not begin until pitching round the piers prevents further scour occurring in their proximity. When that occurs, scour between the piers is inevitable, because the flow concentration is then so great that heavy action is generated, which scours out the sand until a condition is reached when the outside periphery of stones laid round the piers is undermined, and launches; but there is nothing natural about this; it is imposed, due to the pitching round the piers being at an unnaturally high level. Furthermore, under such conditions, the pitching near the piers is in a state of 'strain'. It is, however, possible, where it has been laid at too high level, for it to launch, or even be completely washed away before conditions upstream of the pier have led to failure at the nose; and such stone will not prevent failure at the nose when the discharge reaches the critical value for failure. Indeed, experiments recently carried out show that stones laid round piers at a high level cause deep scour downstream; which may lead to stone being depleted from the tail. This,

Fig. 8-7

* C. I. & H. R. S. A. E. (T) 1938-39, pp. 33-38 and "Protection of Bridge Piers against Scour" by C. C. Inglis—Indian Railway Conference Association—19th January 1942.

† See Chapter 9.

THE BEHAVIOUR AND CONTROL OF RIVERS AND CANALS

in turn, may cause failure by downstream scour before conditions reach the critical value for failure at the nose. This was exemplified in the case of pier 3 of the Hardinge Bridge during the 1938 flood—when the level of pitching round the pier dropped from R. L. 178·9, 172·9 and 170·0 before the 1938 flood, to R. Ls. 152·1, 152·2 and 151·3 at the end of the flood (on the South-West, South and South-East of pier 3). Such downstream slips have been observed at many bridges and barrages, sometimes leading to disastrous results.

Fig. 8-10 In 1938, when the maximum discharge of the Ganges near the Hardinge Bridge was 1,675,000 cusecs, and curvature of flow resulting from "throw-off" at the nose of the Right Guide Bank was marked, the deep scour-hole downstream of piers 2 and 3 was 172 ft. deep, 400 ft. downstream when the slip occurred on 31st July 1938; but increased to 186 ft., 500 ft. downstream on 5th September 1938, when the detailed contour survey was done, and to 216 ft., 800 ft. downstream, on 22nd September 1938; showing that, with a high level of pitching, scour occurred nearer the pier, so was much more dangerous than a deeper hole further away, because the slope towards the scour-hole was steeper.

In the light of this, the first conclusion of the earlier paper, quoted in para. 1, should be modified to:—

(i) Where the stone pitching is laid round a pier at too high a level, failure may occur due to stone launching downstream from the tail; but, normally, failure occurs at the nose.

In reply to para. (c) it was explained that 'scour round pier 3' was not typical of what has occurred at other piers; due, apparently, to proximity to the bank and to curvature of flow. This difference at pier 3 has been borne out in recent model experiments. The explanation seems to be that the discharge figures quoted were based on surface velocities, making the assumption that the mean velocity on all verticals = 85 times the surface velocity. This assumption is not permissible; because, though 85 times the surface may be an approximation for the whole river or where there is axial flow, it is not true for mean velocities on all verticals. Furthermore, scour is due to 'drag', which depends on the 'rate of change of velocity' in the immediate vicinity of the bed; and where, as in this case, curvature of flow is a major factor, 'drag' may have little connection with surface velocity."

Fig. 8-11 Fig. 8-11 helps to explain this point: it shows scour on the centre line of the Bridge between piers 1 to 10 on 15th August 1938, 15th September 1938 and 29th October 1938 compared with a smoothed surface velocity curve plotted from W. L. as datum. On this Figure has also been plotted what may be assumed would have been the bed level profile had there been no piers; and when we compare this with the surface velocity curve, it will be seen that though the surface velocity was a maximum in span 3 and relatively quite low in span 6, yet there was little difference in the scour depth.

An analysis of slips which occurred between 1935 and 1941 showed that stone round piers had been made up yearly to a high level.

	Levels up to which stone laid.	Stable level.
At nose of Pier 2	... R. L. 185	... R. L. 170
" " " " 3	{ R. L. 178 up to 1937 R. L. 166 in 1940	... R. L. 150
" " " " 4	{ R. L. 190 before 1936 R. L. 150 after 1939	... R. L. 140
" " " " 5	... R. L. 165	... R. L. 140
" " " " 6	... R. L. 167	... R. L. 145

(FIG. 35 FROM A.R.T. 1939-40
 OF C.I. & H.R. STN)

FIGURE. 8-6
EXPERIMENTS WITH MODELS OF HARDINGE
BRIDGE PIERS WITHOUT PROTECTION.
RELATIONSHIP BETWEEN d_s = DEPTH OF SCOUR
AT NOSE, b = WIDTH OF PIER AND
 q_c = CENTRAL DISCHARGE PER FT. WIDTH $\frac{1}{5}$ OF PIER

MODEL SCALE.

- | | | |
|---|---|--|
| <p>X.....$\frac{1}{65}$.....</p> <p>□.....$\frac{1}{105}$.....</p> <p>○.....$\frac{1}{210}$.....</p> | } | <p>GANGES SAND MEAN
 DIAMETER 0.29 M.M.</p> |
| <p>●.....$\frac{1}{65}$.....</p> | } | <p>NALAI SAND 1.3 MM</p> |
| <p>■.....$\frac{1}{65}$.....</p> | } | <p>FLOW 45° TO AXIS OF
 PIER. b = PROJECTED
 WIDTH. NALAI SAND 1.3 M.M.</p> |

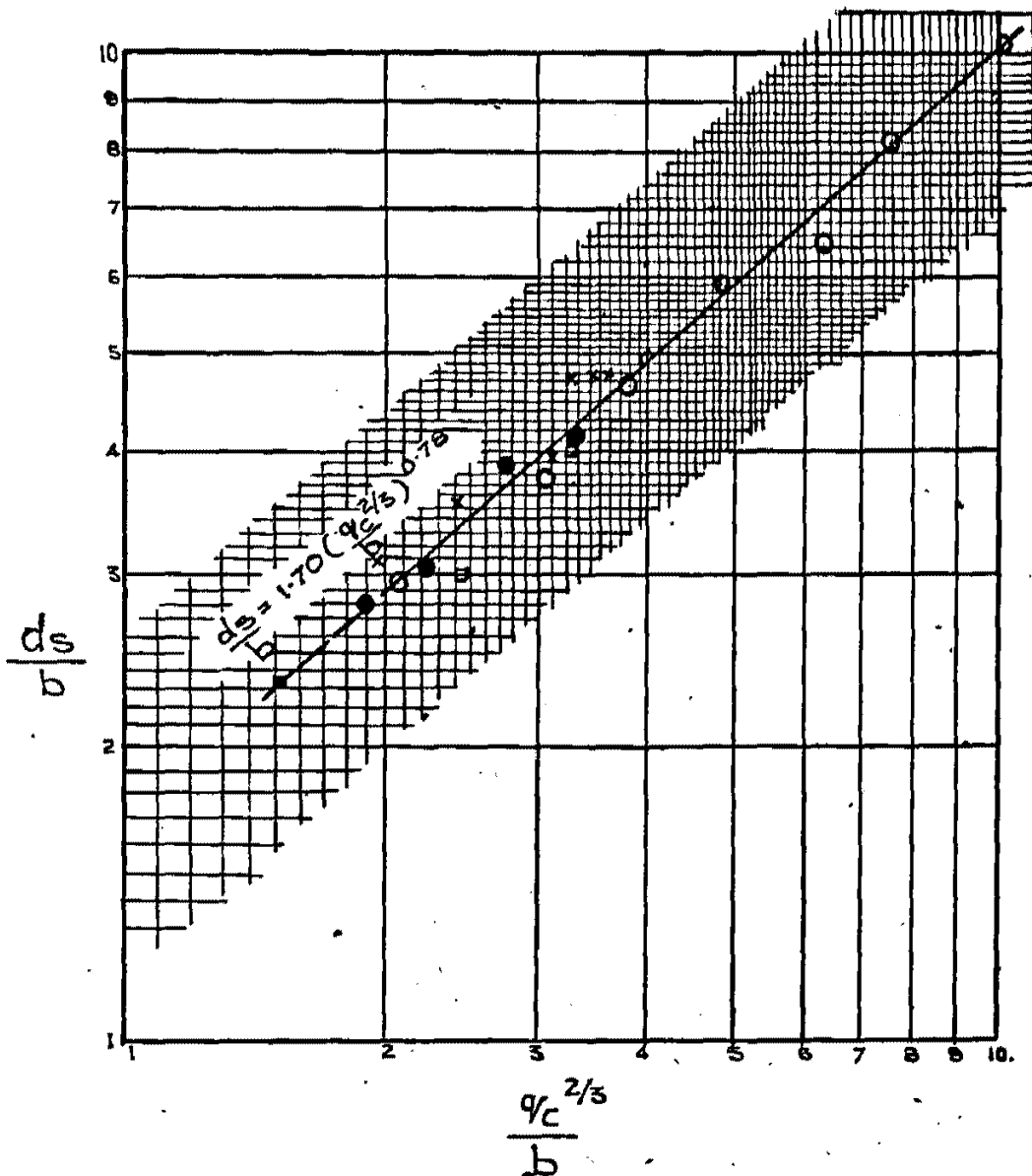

FIG. 8-7

SHOWING SCOUR AT PIERS 1 TO 9 OF HARDINGE BRIDGE

NE 1101 G.I.S.H.R.STN (FIG. 35 FROM A.R.T. 1939-40 OF C.I.&H.R.STN)

SCALE: HOR. 1 INCH = 240 FT VER. 1 INCH = 48 FT

REFERENCES

- NOVEMBER 1934.
- - - - - 24 TH. AUGUST 1938. WATER LEVEL 246.70. Q = 1,520,000 CUSECS.
- 22 ND. SEPTEMBER 1938. WATER LEVEL 244.90. Q = 1,190,000 CUSECS.
- - - - - ESTIMATED CROSS SECTION WITHOUT PIERS FOR 24 TH. AUGUST 1938 FLOOD.
- ESTIMATED CROSS SECTION WITHOUT PIERS FOR 22 ND. SEPTEMBER 1938 FLOOD.
- DECEMBER 1939.

PIERS 10 TO 16 NOT SHOWN.

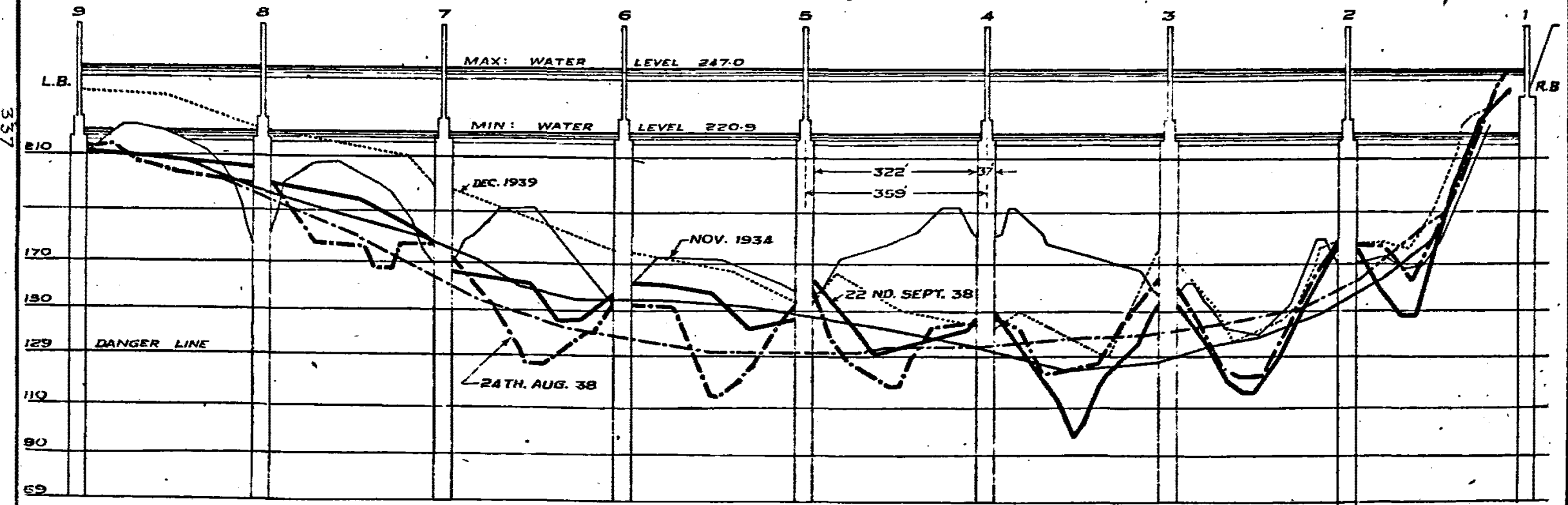

DATUM LINE 50 FT ABOVE.

R.L. 59

EXPTS. WITH 1/65 SCALE MODEL OF
HARDINGE BRIDGE PIER WITH STONE PROTECTION.
SHOWING STONE BEFORE & AFTER EXPT.

STONE : 1/8" - 1/4" = 8" - 15", LAID = 10 FT THICK.

FLOW OBLIQUE. Q = 1.65 C.S. = 865 C.S. PER FT WIDTH.

SCALE 1" = 1' IN MODEL.

= 65 IN. PROTD.

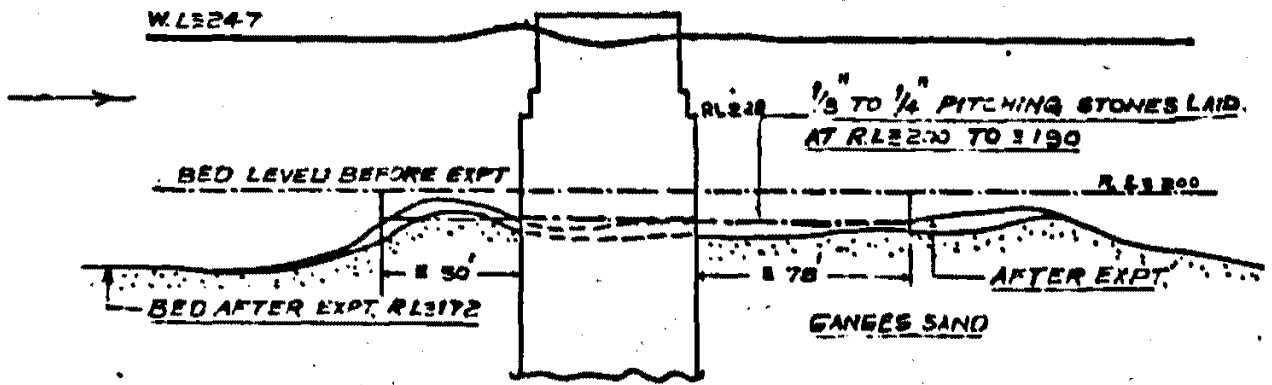

L. SECTION.

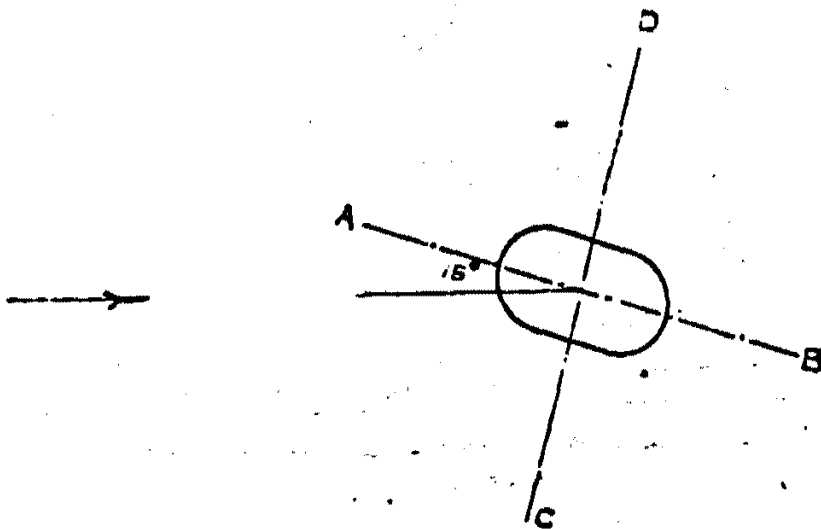

INDEX PLAN SHOWING
OBLIQUE FLOW.

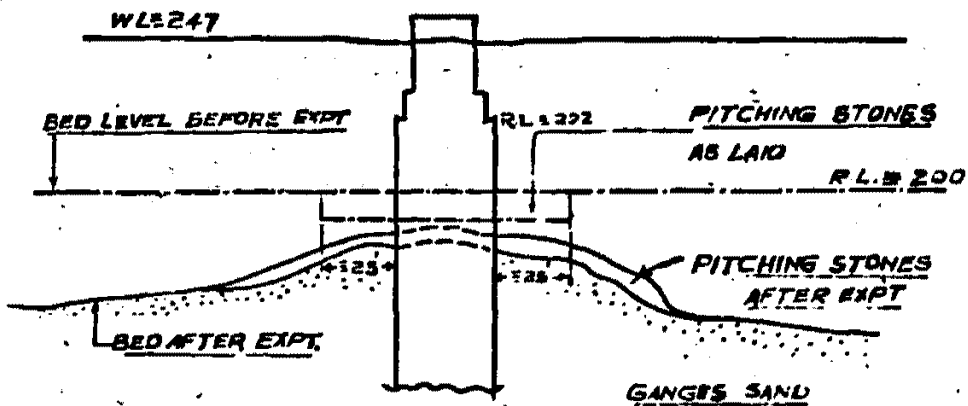

C. SECTION.

FIG. 8-9
EXPT. No. 1.

1/65 SCALE MODEL OF HARDINGE BRIDGE PIER
WITH LOOSE STONE PROTECTION LAID AT \approx R.L. 190
DETAILS OF SCOUR.

AFTER DISCHARGE OF 1.55 CS/FT. \approx 813 CS/FT. (1980,000CS)

SCALE: -1" = 1' \approx 65'

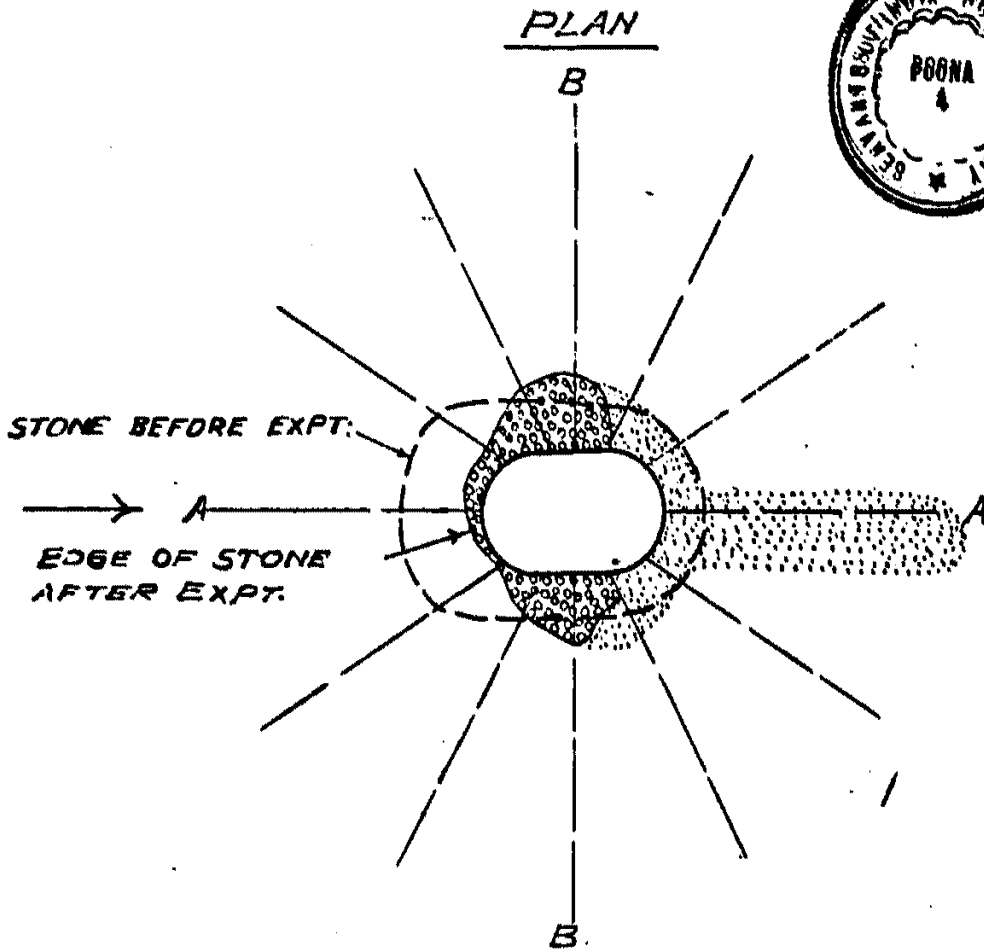
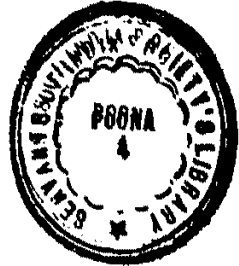

LONGITUDINAL SECTION A.A.

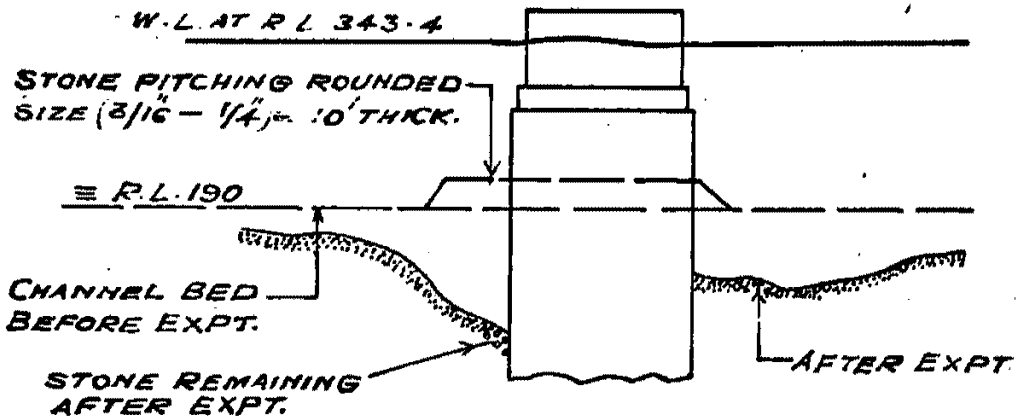

CROSS SECTION B.B

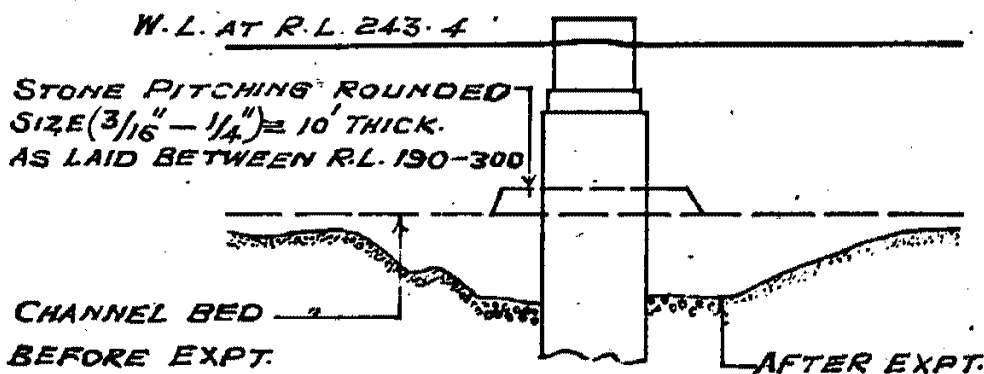

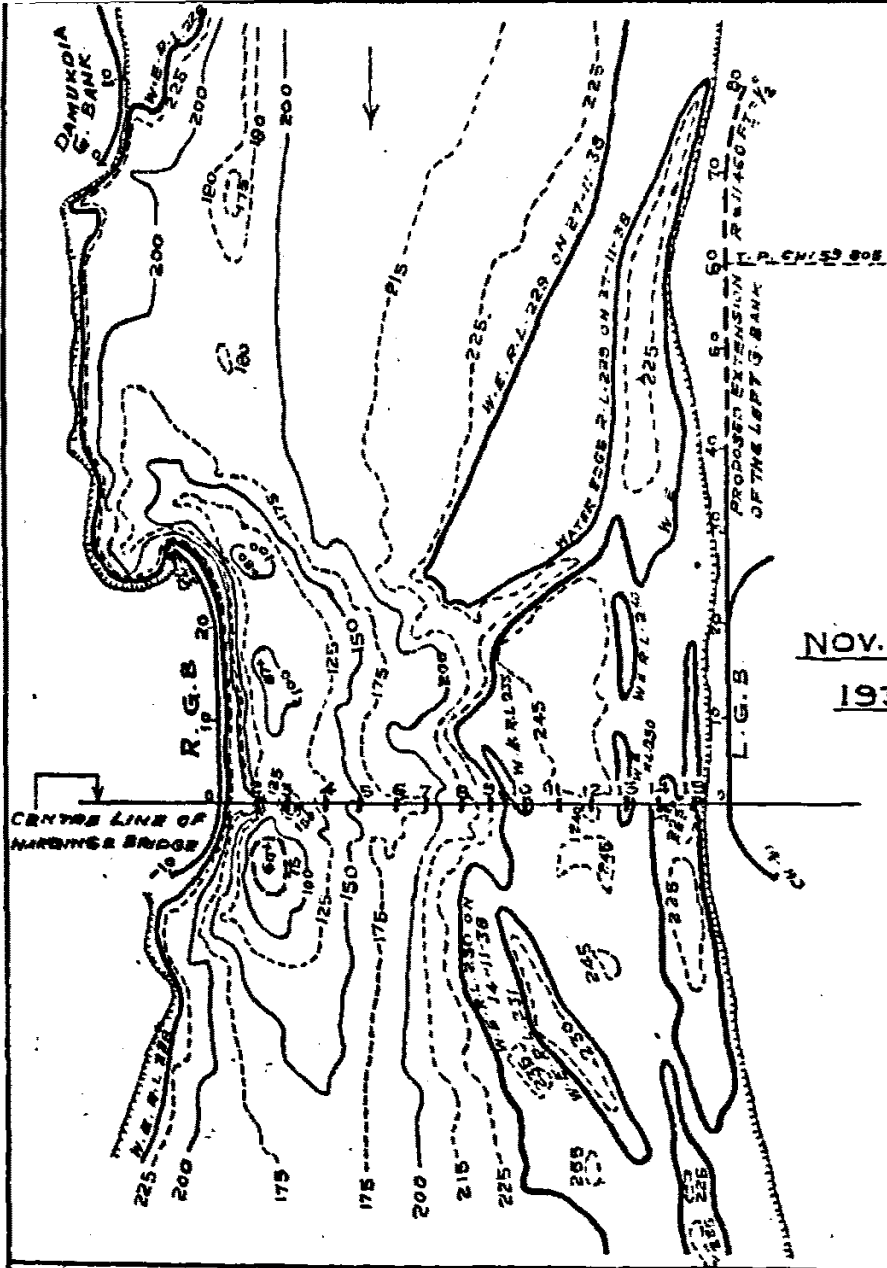

NOV. & DEC.
1938.

FIG. 8 - 10
SHOWING
CONTOURED PLAN OF THE
BED OF THE GANGA
UPSTREAM & DOWNSTREAM
OF HARDINGE BRIDGE.
SCALE 1" = 2,000'
(FIG. 18 FROM A. R. T. 1941-42.)

NOV. & DEC.
1940

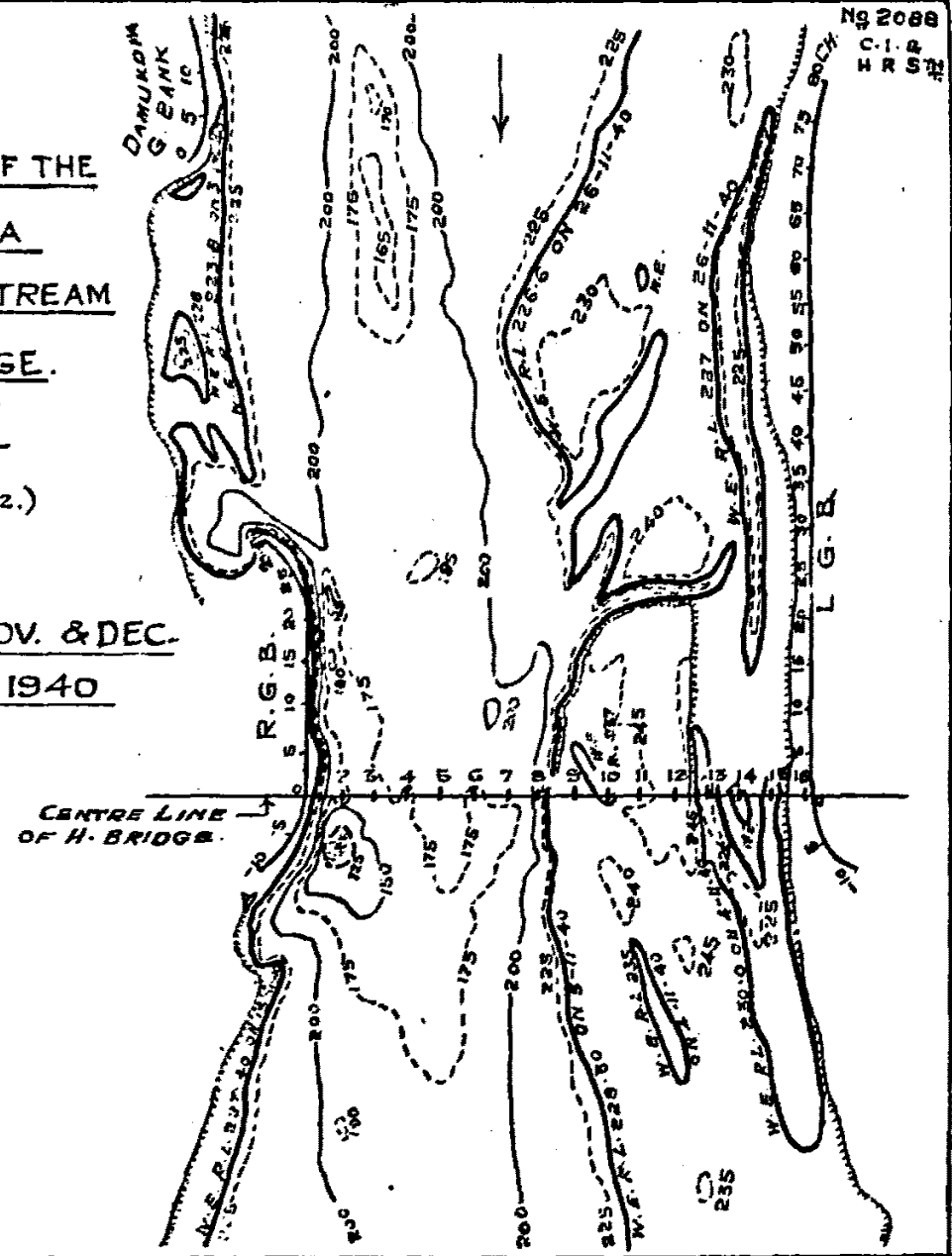

NO 2088
H. C. P.
R. S.
G. P.

(FIG. 17 FROM A.R.T. 1901-42)

FIG. 8-11

SHOWING CROSS SECTION
 ON CENTRE LINE OF
 HARDINGE BRIDGE.

SCALE: HOR. 1" = 400 FT.
 VER. 1" = 40 FT.

SCALE FOR
 VELOCITY IN FT./SEC. } VER. 1" = 2 FEET/SEC.

1938.

DATE	DIS. IN CS.	W.L.
15-8-38	1,674,896 Cs.	246.4
15-9-38	1,800,925 Cs.	246.8
29-10-38	258,204 Cs.	232.7

REFERENCES

DATE	BED R.L.
15-8-1938	_____
15-9-1938	-----
29-10-1938	-----

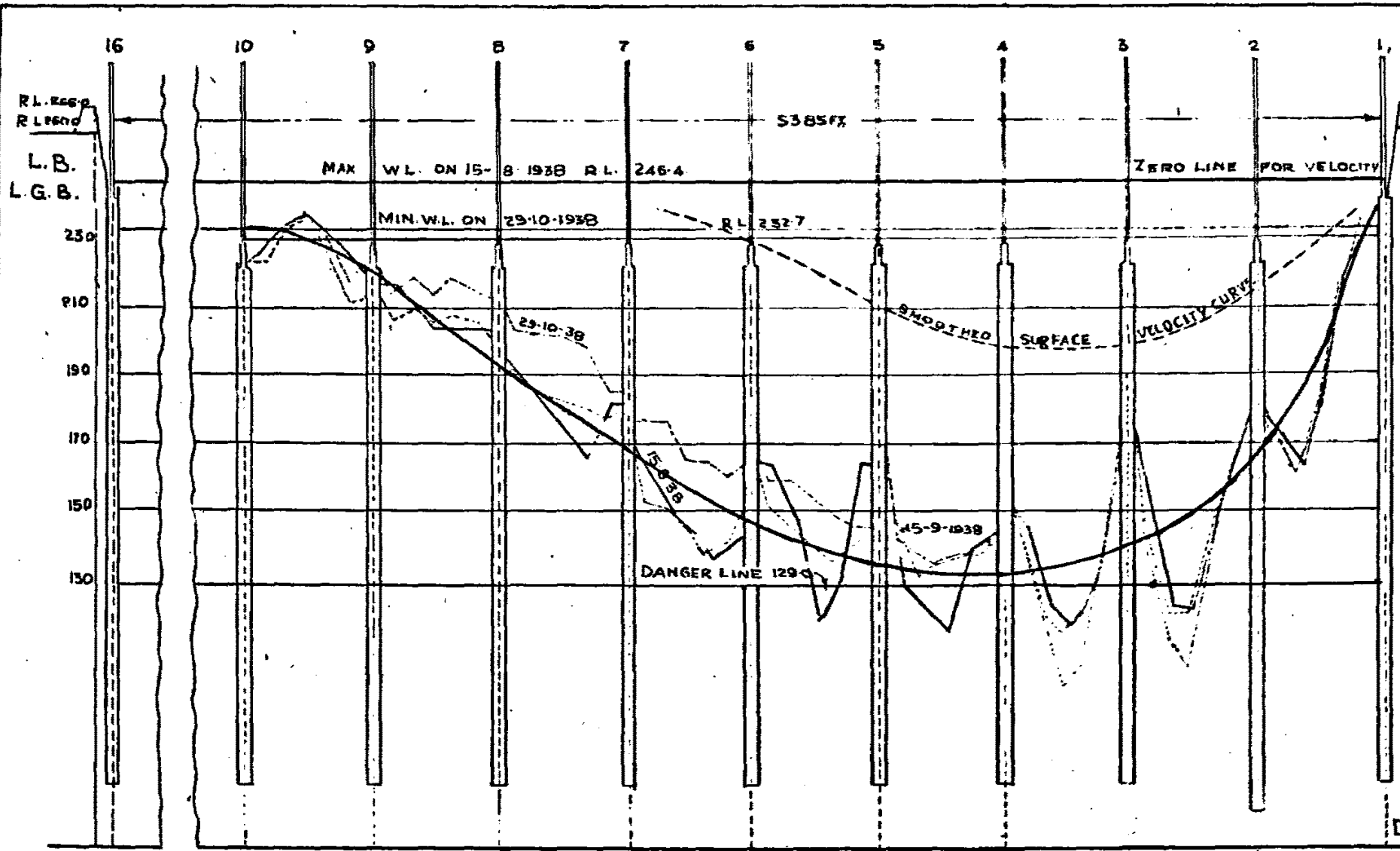

345

As the assumed danger line was R. L. 129 and scour diminishes rapidly as depth increases, experience bore out the model results and showed that making up the pitching above stable depths was unnecessary; while building up the pitching far above the stable depth was a sheer waste of money.

As regards the statement quoted in para. (d): "...it is recognised that the ideal level for laying the pitching is R. L. 150; but it is not always possible to lay the pitching at this desired low level." When attack is severe, or it is feared that it may become severe in the near future, the anxiety to lay stone at a high level can be appreciated; but there is no justification for doing this before there is any danger of deep scour occurring.

The most severe attack at the Hardinge Bridge occurred at about 1/5th to 1/4th the river width from the right bank. It is, however, more correct to say that maximum scour occurred at $0.8 (Q_{\max})^{\frac{1}{2}}$ to $1.2 (Q_{\max})^{\frac{1}{2}}$ from the bank. At some future date, this condition will also occur on the left bank at piers 12 and 13, and scour at piers 3 to 6 and 11 to 14 will be almost as deep; but scour at piers 7 to 10 will be less; because towards mid-stream curvature of flow will be less intense.

Returning now to the data shown in Fig. 8-1. The mean ratio of $d_s/D_L = 2.09 \pm 12.9$ per cent. Fig. 8-1

S. No. 8.—Indus in the Rohri-Bukkur Gorge, 3 miles upstream of Barrage. Here, maximum scour occurred in 1933, when the rocky bed of the Gorge was temporarily cleared of sand. The maximum river discharge was 620,000 cusecs, of which approximately 2/3 (i.e. 414,000 cusecs) passed through this Gorge, while the remaining 1/3 passed through the Sukkur-Bukkur Gorge.

8.05. SCOUR AT GUIDE BANKS, SPURS, AND SHARP BENDS

Fig. 8-2 shows in addition to maximum scour observed in rivers, Fig. 8-2 the corresponding scour obtained in the vertically-exaggerated Ganges model of the Hardinge Bridge at the Station at Khadakwasla. In this, d_s was 2.3 ft. for a total discharge of 8.0 cusecs, and was consistent with the depth observed in the Ganges. In the Jumna model, d_s was 1.0 ft. at spur No. 5 for $Q=2.8$ cusecs, which was relatively slightly less than in the Jumna.

The data taken as a whole shows wide scatter; but this is due to the widely different severity of condition. Thus:—

(i) S. No. 1 (b).—Scour of 206 ft. at Sara Guide Bank ($=3.8 D_L$) was due to sharp curvature accentuated by the remains of the nose of the old Sara Guide Bank, which pointed upstream.

(ii) S. No. 2.—Scour of 66 ft. ($=3.9 D_L$) in the Right Bank Approach Channel at Sukkur, was due to water entering the Approach Channel with a high velocity being very sharply deflected round the nose of the outer bank of the Approach Channel.

(iii) S. No. 1 (c).—Ganges near Right Guide Bank of the Hardinge Bridge:—

$$d_s = 2.7 D_L.$$

(iv) S. No. 3.—Old Railway Bridge on the Narbada at Broach. A pothole, 106 ft. deep, formed upstream of the Bridge, due to water being thrown off from a long, sloping groyne;

$$d_s = 2.24 D_L.$$

(v) S. No. 4.—Scour in the Hooghly downstream of the "Knuckle" at Dunbar Cotton Mill, $d_s = 1.84 D_L$.

The conditions were only moderately severe. The River is tidal at this point.

(vi) S. No. 5 (b) and (c).—The Jumna at Delhi Gate Pumping Station, $d_s = 1.7 D_L$. Conditions only moderately severe.

(vii) S. No. 6 (a).—The Sutlej upstream of Railway Bridge at nose of spur 4 at Ferozepore, $d_s = 2.33 D_L$, and

S. No. 6 (b).—On the same river at nose of old Right Guide Bank, $d_s = 2.44 D_L$.

(viii) S. No. 7 (a).—At nose of spur 5 on Right Bank of the Ravi upstream of Balloki Weir, $d_s = 3.74 D_L$.

(ix) S. No. 7 (b).—At nose of spur 6 on the Right Bank of the Ravi upstream of Balloki Weir, $d_s = 3.5 D_L$.

In both (viii) and (ix), the curvature was very severe.

Thus, scour at the noses of spurs projecting straight upstream is very deep, up to $3.8 D_L$; while Guide Banks, which swing round as arcs of large radius, give much lower values $2.7 D_L$.

Spurs projecting from banks, give widely varying values, ranging from 1.7 to $3.8 D_L$, depending upon the severity of river curvature induced, which, in turn depends upon the length, angle, and position of the spur relative to the attack. Scour at Groyne 5 in the Jumna near Delhi, where flow merely brushes past, was $1.7 D_L$; and scour downstream of the Hooghly knuckle near Dunbar Cotton Mill, where action is not severe, was only $1.84 D_L$.

8.06. SCOUR DOWNSTREAM OF BRIDGES

Where scour occurs downstream of bridges, it usually results from the pavement level being too high, which makes the bed velocity relative to the depth, abnormally high, causing violent eddies to be shed from the downstream ends of the pavements. High level pitching round piers is another cause of violent eddying action near the bed, and hence deep scour.

S. No. 1 (d), scour downstream of pier 3 of the Hardinge Bridge, and S. Nos. 4 and 5, scour downstream of N. W. Railway Bridges over the N. W. Canal and the Rice Canal, and scour in the Rohri Canal downstream of the Head Regulator and downstream of the Bridge at R. D. 52,000 (S. Nos. 2 and 3) all show scour of the order of $4 D_L$. S. Nos. 6 and 7 (scour downstream of road bridges on the Eastern Jumna Canal) also show scour of the order of $4 D_L$. The bed consists of clay and loam; but their equivalent f_d value appears to be 1.0.

8.07. CONCLUSIONS

The data so far available show:—

1. (a) The maximum scour downstream of bridges is of the order of $d_s = 4 D_{Lacey} = 4 \times .473 (Q/f)^{\frac{1}{2}}$.

(b) Scour at straight spurs facing upstream, with steeply sloping heads ($1\frac{1}{2}:1$), is of the order of $d_s = 3.8 D_{Lacey}$; and with long, sloping heads (1 in 20) $= 2.25 D_{Lacey}$.

(c) Scour at noses of large-radius Guide Banks, $d_s = 2.75 D_{Lacey}$.

(d) The maximum scour round bridge piers, $d_s = 2 D_{Lacey}$.

(e) Scour at spurs along river banks, $d_s = 1.7 D_{Lacey}$ to $3.8 D_{Lacey}$ depending on severity of attack, which varies according to conditions, such as length of projection, sharpness of curvature, angle, and position relative to the embayment.

2. The data in Class III (where the range of grade of bed material was from 0.06 to 0.37 mm.) appears to be sufficient to confirm that grade is a factor affecting maximum scour. This is what one would expect—even though flow pattern is the dominant factor.

FALLING APRONS

CHAPTER 9

THE DESIGN OF FALLING APRONS

	Page.
9-00 Introduction	355
9-01 Model experiments	355
9-02 Launching of an "apron" (Series IV)	356
9-03 Effect of disposition of stone (Series VIII)	358
9-04 Inclination of slope (Series IX)	359
9-05 Action with larger stones (Series XIV)	360
9-06 Action with stones of mixed sizes.	360
9-07 Conditions under which a slip or "blow-out" may occur (Series XV)	361
9-08 Apron laid on alternate layers of sand and clay (Series XVI)	361
9-09 Conditions under which apron protection may fail ...	362
9-10 Reproduction of breach in the Right Guide Bank, Hardinge Bridge (Series X.)	362
9-11 Thickness of "one-man stone" resting on the face of the bank after the apron has launched.	368
9-12 Size of stone	370
9-13 Quantity of stone required in a falling apron	370
9-14 Best Method of reinforcing an apron which has already fallen	372
9-15 Summary	372

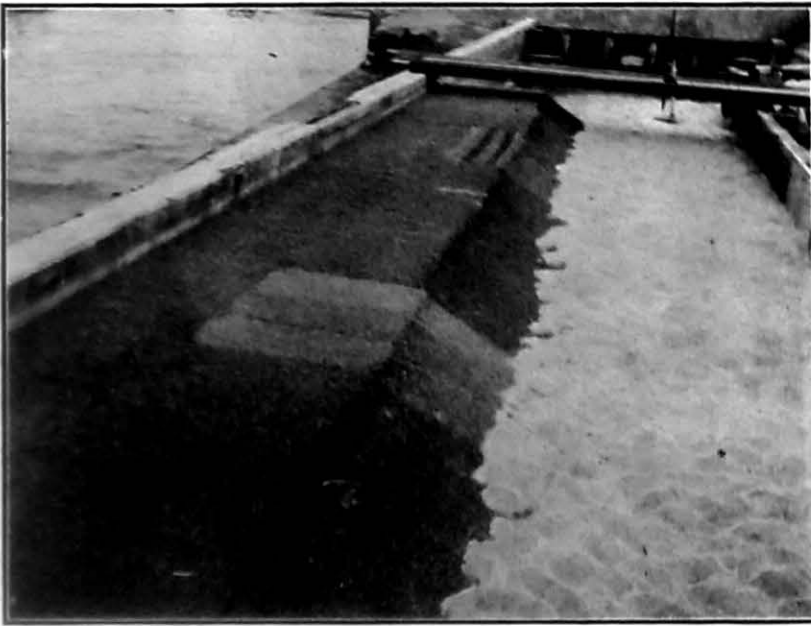

Photo 1167. Showing a falling apron experiment, using bands of differently coloured pebbles to trace how "launching" takes place.

PHOTO FROM C. I. AND H. R. STN. A. R. T. 1937-38.

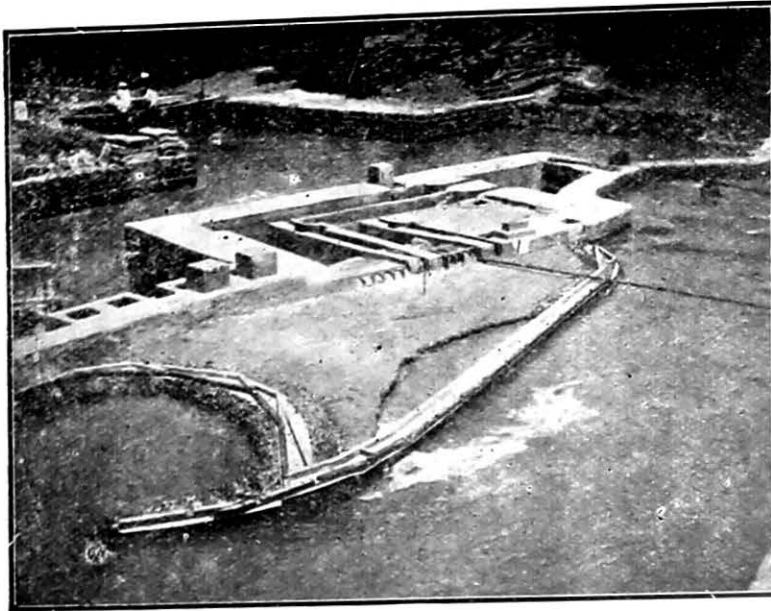

Photo 1187. Showing how and where the slip occurred in the Guide Bank of the Hardinge Bridge.

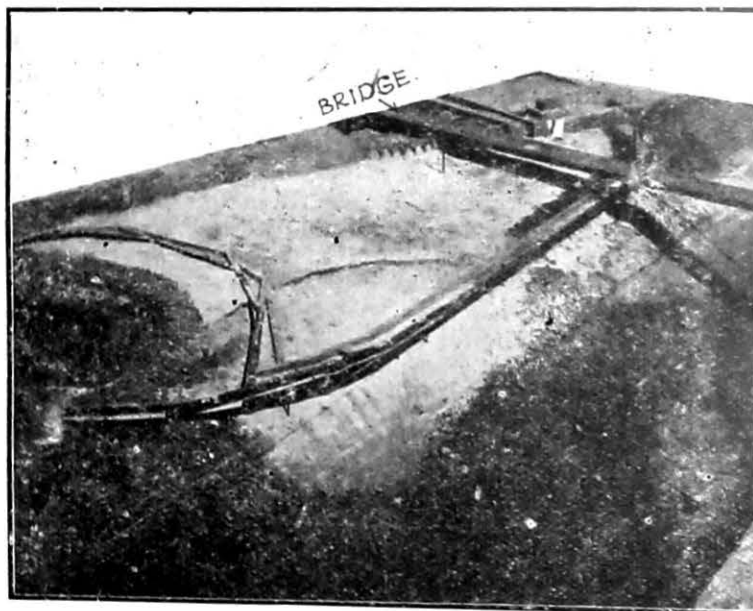

Photo 1192. Experiment with Falling Aprons. Model of Guide Bank at Hardinge Bridge showing formation of breach. (Looking downstream towards Bridge.)

PHOTOS FROM C. I. AND H. R. STN. A. R. T. 1937-38.

THE DIMENSIONS OF GUIDE BANK APRONS.

FIG. 9-1

NO. 3643
(FIG. 118 FROM
A.R.T. 1937-38 OF
C.I. & H.R. STN.)

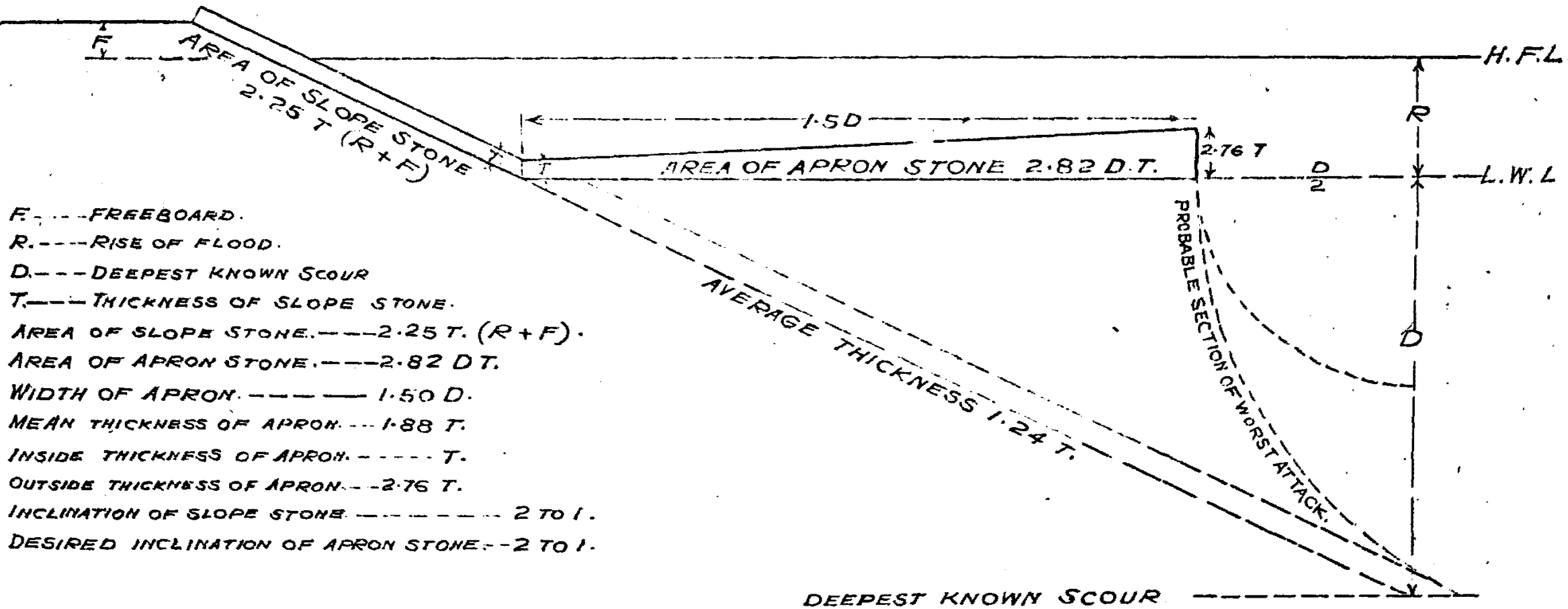

- F. --- FREEBOARD.
- R. --- RISE OF FLOOD.
- D. --- DEEPEST KNOWN SCOUR
- T. --- THICKNESS OF SLOPE STONE.
- AREA OF SLOPE STONE. --- $2.25 T. (R + F).$
- AREA OF APRON STONE. --- $2.82 D.T.$
- WIDTH OF APRON. --- $1.50 D.$
- MEAN THICKNESS OF APRON. --- $1.88 T.$
- INSIDE THICKNESS OF APRON. --- $T.$
- OUTSIDE THICKNESS OF APRON. --- $2.76 T.$
- INCLINATION OF SLOPE STONE. --- 2 TO 1.
- DESIRED INCLINATION OF APRON STONE. --- 2 TO 1.

(REPRODUCED FROM RIVER TRAINING AND CONTROL
ON THE GUIDE BANK SYSTEM.
BY SIR FRANCIS J. E. SPRING, C.I.E.)

353

CHAPTER 9

THE DESIGN OF FALLING APRONS

9.00. INTRODUCTION

A falling apron is a covering of loose stones laid on the berm of a river embankment to protect it from erosion.

The stones, usually "one-man" stone weighing 80-120 lbs., are laid during low water in a horizontal "apron" on the sand or silt berm deposited by the river.

Stone is also laid on the slope of the embankment, but this is intended to remain in position; whereas the "apron" is intended to "launch" or subside when the underlying sand is scoured by the river current—so as to form a continuous protection below water level.

This method of protection appears to have been originated by James R. Bell and was described in his Paper of 1890 on the "Bell bund" system of river control at bridges. Sir Francis Spring produced a modified design, now in general use in Northern India, in his "River Training and Control on the Guide Bank System"*—Chapter IX—from which Fig. 9-1 is an extract.

Fig. 9-1

In the following pages, information derived from model experiments, together with data obtained regarding falling aprons at the Hardinge Bridge and other Bridges in Northern India will be presented.

9.01. MODEL EXPERIMENTS

The model experiments here described were carried out at the Hydrodynamic Research Station at Lake Fife, Poona, in the years 1935-37, at the request of the Railway Board, in connection with the protection of the Guide Banks of the Hardinge Bridge which carries the B. and A. Railway over the Ganges at Paksey.

The terms of reference for experiments were drawn up by the Hardinge Bridge Committee on 19th to 22nd November 1934, as follows:—

(i) That experiments should be carried out on the behaviour of aprons generally, and for the best design of aprons, both in alluvial sand and in strata of clay overlying sand. The aprons in these experiments should be designed in accordance with Spring's formula for scours of 100 feet and 160 feet.

(ii) That experiments should be carried out with regard to the best disposition of stone in an apron, not so much with regard to the thickness as with regard to the relationship between the length of the apron and the depth of the scour.

(iii) That experiments should be carried out for the best method of reinforcement of an apron which has already fallen (as in the case of the Right Guide Bank) and whether such reinforcement should best be placed as a berm at low water level, or whether the reinforcement should be pitched through grids moored over the toe of the fallen apron. At the same time this experiment might be extended to establish whether in the case of an apron which had fallen and over which heavy silting had taken place (as in the case of the Left Guide Bank) reinforcement should be put out in the form of an entirely new apron at low water level, or whether this would be wasteful.

* Technical Paper No. 153, Railway Board, India, 1903 (reprinted in 1935).

THE BEHAVIOUR AND CONTROL OF RIVERS AND CANALS

The experiments were carried out in channels of various widths, ranging from 4 to 20 ft., with discharges up to 24 cusecs. The bank and bed (except in Series I and XIV in which local cohesive red silt was used) were composed of incoherent Ganges sand of mean diameter 0.29 mm., and the protective stone was of grades varying from 1/8 inch to 6 inches, of specific gravity = 2.9.

9.02. LAUNCHING OF AN APRON (SERIES IV)

The following is a description of the launching observed in a model consisting of an apron of 1/8"-4" stones laid horizontally on the berm of a channel formed of Ganges sand. Fig. 9-2 shows the apron as laid.

Fig. 9-2

Fig. 9-2

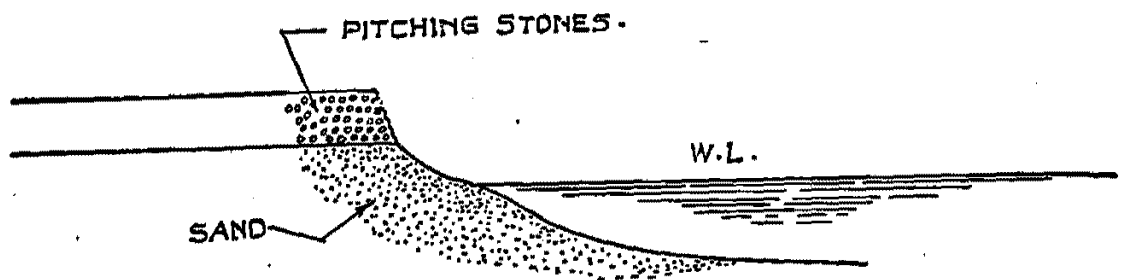

(FIG. 119 FROM A. R. T. 1937-38 OF C. I. AND H. R. STN.)

When the discharge of a river increases, the channel begins to deepen and widen. This was reproduced in the model; and as a result the layer of stones comprising the "apron" was undermined by scour at A—vide Fig. 9-3—causing the undermined stones to settle on the slope; but there were insufficient stones to prevent scour of the sand at A; so further scour took place, causing the horizontal layer of stone to be again undermined.

Fig. 9-3

Fig. 9-3

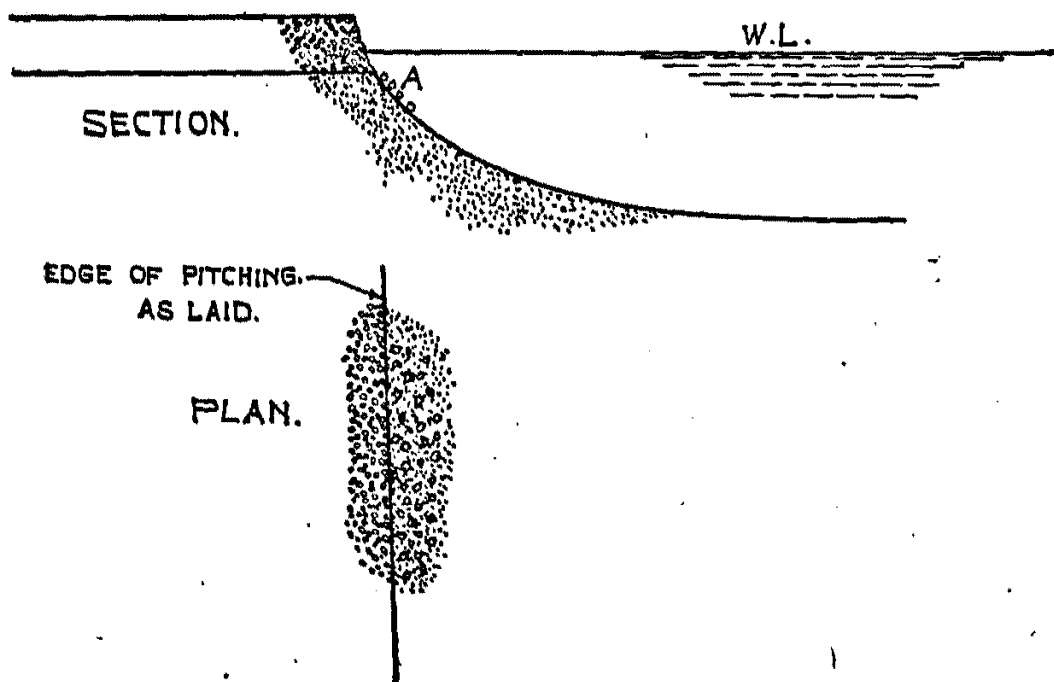

(FIG. 120 FROM A. R. T. 1937-38 OF C. I. AND H. R. STN.)

FALLING APRONS

More stones were thus set in motion, some remaining with the previously fallen stones at A and others rolling down to B—see Fig. 9-4—until a stage was reached when scour temporarily ceased at A, when that part of the bank had become adequately covered with stones; but scour still continued at B.

Fig. 9-4.

Fig. 9-4.

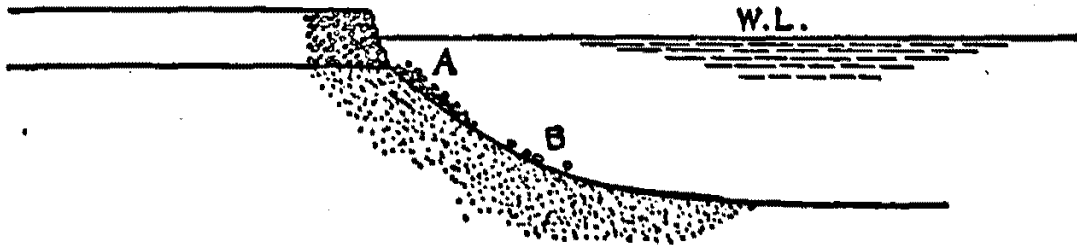

(FIG. 121 FROM A. R. T. 1937-38 OF C. I. AND H. R. STN.)

After a time, scour at B led to the bank at A being undermined, and stones from A rolled or slid down to B—see Fig. 9-5.

Fig. 9-5.

Fig. 9-5.

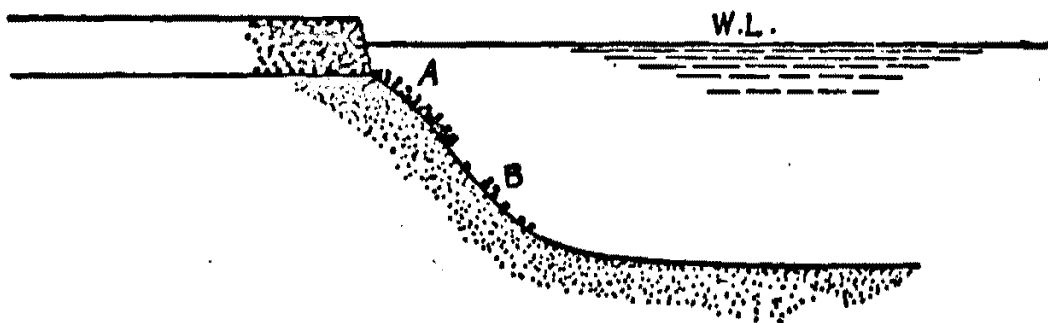

(FIG. 122 FROM A. R. T. 1937-38 OF C. I. AND H. R. STN.)

and a few went beyond to C, as shown in Fig. 9-6.

Fig. 9-6.

Fig. 9-6.

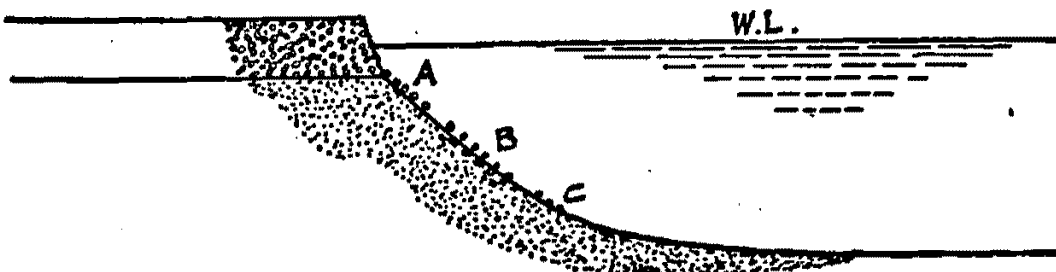

(FIG. 123 FROM A. R. T. 1937-38 OF C. I. AND H. R. STN.)

This caused the sand to be again exposed at A, and further scour occurred, thus undermining the horizontal apron until more stones fell, causing the sand at A to be again covered; so that scour was again checked. Meanwhile, scour was occurring at C, until stones rolled down from B, uncovering sand there, and so allowing scour, which undermined A. Thus the process went on, the stone extending deeper and deeper as bed scour progressed, the pitched slope simultaneously receding towards the bank.

Photo Sheet 9-1. Photo 1167 (Photo Sheet 9-1) shows the apron in process of launching. It will be noticed that settlement of stones was to a uniform slope under steady axial flow conditions.

Some of the stones were coloured in vertical bands and others in horizontal bands to ascertain where they finished up. The results (as may be seen in the photo) showed that the stones subsided straight down the slope, without any appreciable motion along the channel—except for a few stones which were drawn along the toe of the slope in small “gulleys formed in the sandy bed of the channel.”

Thus the “falling apron” slopes at the angle at which rolling or sliding stops, since if the slope were steeper, the stones would begin to roll, while if it were flatter no stones would move. Where the flow is axial the velocity will, in the early stages, be almost the same over the whole slope—which explains why the inclination is approximately constant; but where the bank is being attacked, there is a tendency for surges and curved diving flow to develop and the velocity near the bed is relatively higher than in axial flow; so that where the toe is scouring rapidly, a steep slope develops—with the result that stones move more rapidly near the toe of the slope than near the water surface, so are projected towards mid-stream where the slope is flattening; and the apron finally settles to a curved profile as shown in Fig. 9-7, with its toes resting on the bed in its position of final scour.

Fig. 9-7

Fig. 9-7

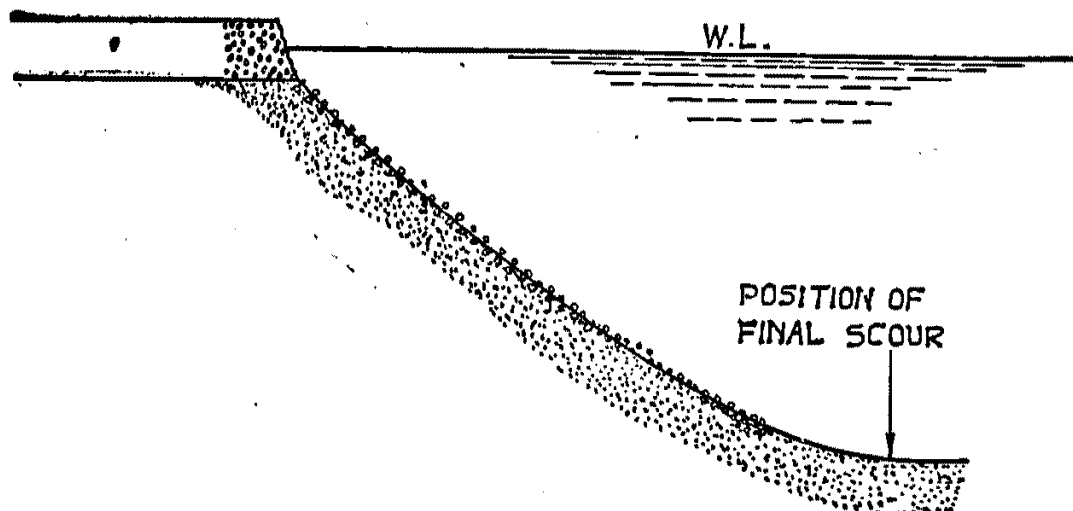

(FIG. 124 FROM A. R. T. 1937-38 OF C. I. AND H. R. STN.)

9.03. EFFECT OF DISPOSITION OF STONE (SERIES VIII)

Prior to these experiments, widely incorrect views had been held regarding the best disposition of stone in an apron; thus Spring, in Chapter IX of his Paper* stated:—

“...the apron should be made broad enough and thick enough not only to cover up the erodible matter exposed by sub-surface erosion; but also to keep the deep part of the erosion so far off, that the automatically pitched sub-surface slope may have an inclination of fully two to one. It stands to reason that the nearer the deep scour is allowed to approach the foot of the guide bank slope before the stone commences to launch, the steeper will be the sub-surface slope, and the more liable it will be to settle further down and require more replenishment from above.”

* “River Training and Control on the Guide Bank System” T. P. 163 Railway Board, India.

FALLING APRONS

These experiments demonstrated, however, that where scour was gradual, the slope assumed by the stone and the quantity of stone required to protect a face of sand were practically the same whether the apron was laid deep and narrow or shallow and wide; but where erosion was taking place rapidly, a shallow wide apron would launch more gradually and so more evenly, and to a slightly flatter slope than a deep narrow apron—as was indicated in Expt. VIII—see Fig. 9-8.

Fig. 9-8

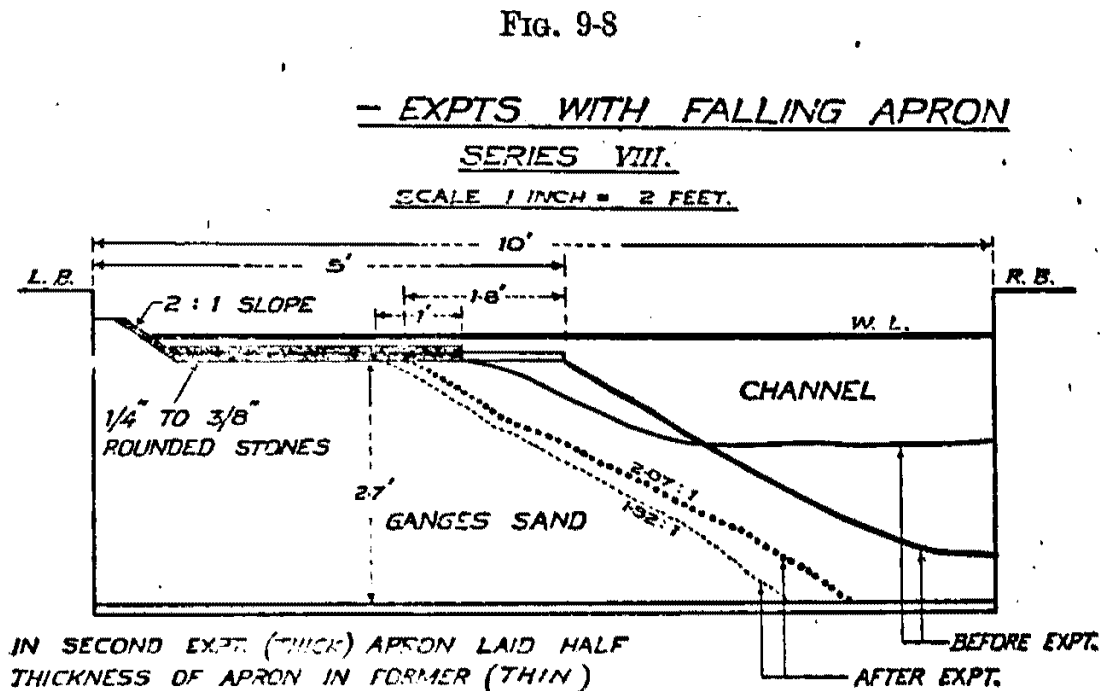

(FIG. 125 FROM A. R. T. 1937-38 OF C. I. AND H. R. STN.)

9.04. INCLINATION OF SLOPE (SERIES IX)

A series was done with a thick layer of stones laid on a "tilting board", which could be set at any angle, to determine the natural angle of repose of the stones in water with various velocities of flow. Stones were dropped on to the stones at the top of the pitched slope, and it was found that at a relatively flat slope most of the stone came to rest, but a few rolled to the bottom; while at a greater slope a few came to rest and the majority rolled to the bottom, an arbitrary criterion for the angle of repose was therefore adopted, viz. the angle at which 50 per cent of the stones came to rest and 50 per cent rolled to the bottom. These stones would form an apron at the toe, which would subsequently launch when further scour took place at the toe.

The angle of repose for stationary stone was also observed, i.e. the angle of slope at which stones lying stationary on the slope would begin to slide down. The following results (Table 9-1) were obtained in still water:—

Table 9-1

TABLE 9-1

	Angle for stationary stones.	Angle for rolling stones.
Rounded stones laid on similar stones.	30° ≅ 1.3 to 1	31° ≅ 1.7 to 1
Angular stones laid on similar stones.	40° ≅ 1.2 to 1	34° ≅ 1.5 to 1
Rounded stones laid on Ganges sand.	31° ≅ 1.7 to 1	25° ≅ 2.1 to 1

Fig. P-9

With flowing water, the angles were flatter. Fig 9-9 shows the curve obtained by plotting the sine of the angle against the velocity $\frac{1}{2}$ " above the stones and, for comparison, points were plotted from data of aprons which had actually launched. These show considerable scatter, but the trend of decrease of slope with increase of velocity is clear.

It was also found, as was to be expected, that flat and angular stones have a steeper angle of repose than rounded stones.

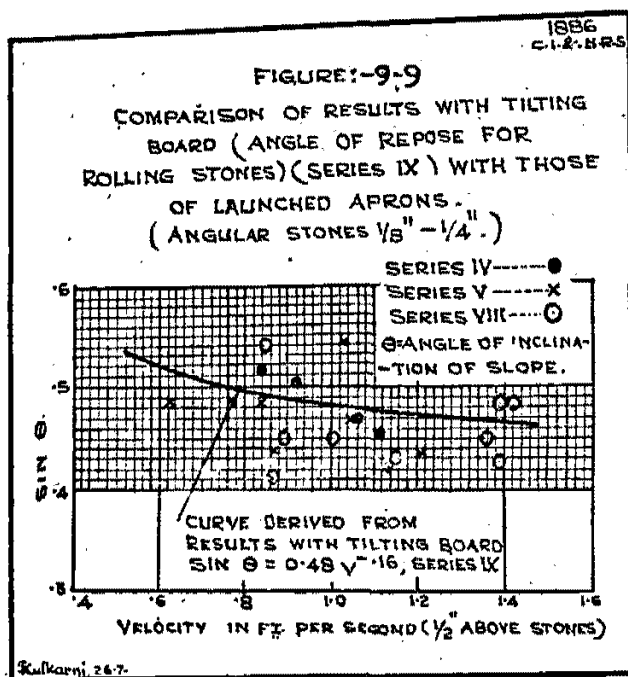

(FIG. 126 FROM A. R. T. 1937-38 OF C. I. AND H. R. STN.)

9.05. ACTION WITH LARGER STONES (SERIES XIV)

All the previous experiments had been done using small stones. To compare the action of larger stones, 3" stones were laid on Ganges sand in a bank at 1.6 to 1 slope and subjected to an increasing current. On the curve at the head of the guide bank, sand was sucked out from between the stones, causing some settlement. This was made good by stones from above, thus giving a greater depth of protection to the sand below. As the discharge increased, the bed scoured and the stones at the toe moved down the slope followed by those above. There was no rolling, and sliding was so slow as to be almost imperceptible.

It was thought that if a few large stones were put at the front of the apron, they would protect the toe from scour; so the bank was laid with $1\frac{1}{2}$ " stones, and 9" stones were gently pushed over the berm, to represent large blocks put in for extra protection. These did not reach the toe, but remained halfway down the slope, and the turbulence generated by these stones displaced some of the $1\frac{1}{2}$ " stones.

9.06. ACTION WITH STONES OF MIXED SIZES

As a further experiment, a model was constructed having a mixture of $1\frac{1}{2}$ ", 3" and 5" stone, laid in a horizontal apron, with the idea that the large stone might form the main protection while the smaller stones would fill the interstices and prevent sand being sucked out, thus protecting the bank. When the discharge was raised the apron launched in the usual way; and sand was sucked out from between the stones as in other experiments. After a time, however, the larger stones sorted themselves out and lay more on the top of the smaller stones; so that the mixture afforded somewhat better protection than stones of one size.

FALLING APRONS

9.07. CONDITIONS UNDER WHICH A SLIP OR "BLOW OUT" MAY OCCUR (SERIES XV)

It had been suggested that slips sometimes occurred due to water trapped behind a bank being some feet higher than in the river; so a model of the Right Guide Bank was constructed with Ganges sand, and a gradually-increasing hydraulic-gradient imposed. There was no failure until the mean hydraulic gradient became 3.6 to 1, when water began to ooze from the bank, causing a slip. This gradient was far steeper than any which could occur in the prototype; but a slip could occur on a rapidly falling river due to bank saturation, as a result of which the hydraulic gradient would be steep at the face of the bank. Slips of this type tend to occur in river banks when the water level is falling rapidly.

It was also thought that slips might be due to heavy superimposed loading on the berm, such as that due to stacking stones. Though loading up to 700 lbs. per square foot was imposed near the edge of the bank, no slip took place; but if the backing became saturated, the extra weight would facilitate a slip.

9.8. APRON LAID ON ALTERNATE LAYERS OF SAND AND CLAY (SERIES XVI)

In order to test the behaviour of an apron laid on a bank consisting of alternate layers of sand and clay—as found at Sara, upstream of the Hardinge Bridge—a 1/40 scale model was constructed (Series XVI) consisting of a bank of alternating horizontal layers of red silt and clay, 3" and 6" thick respectively. The top layer was of silt, on which an apron of 1/4"—3/8" rounded stones was laid.

No scour took place with axial flow, so a concentrated discharge was directed at the bank with the aid of a vane, the mean velocity past the bank being equivalent to 17 ft./sec. in the prototype. The stones slid down as scour occurred, but the clay layers scoured unevenly, the clay scouring into steep cliffs, so that the stone could not come to rest on it, but fell to the bottom (see Fig. 9-10) and it may be said that

Fig. 9-10

Fig. 9-10

EXPERIMENTS WITH FALLING APRON SHOWING APRON LAUNCHED ON ALTERNATING LAYERS OF SILT & CLAY.

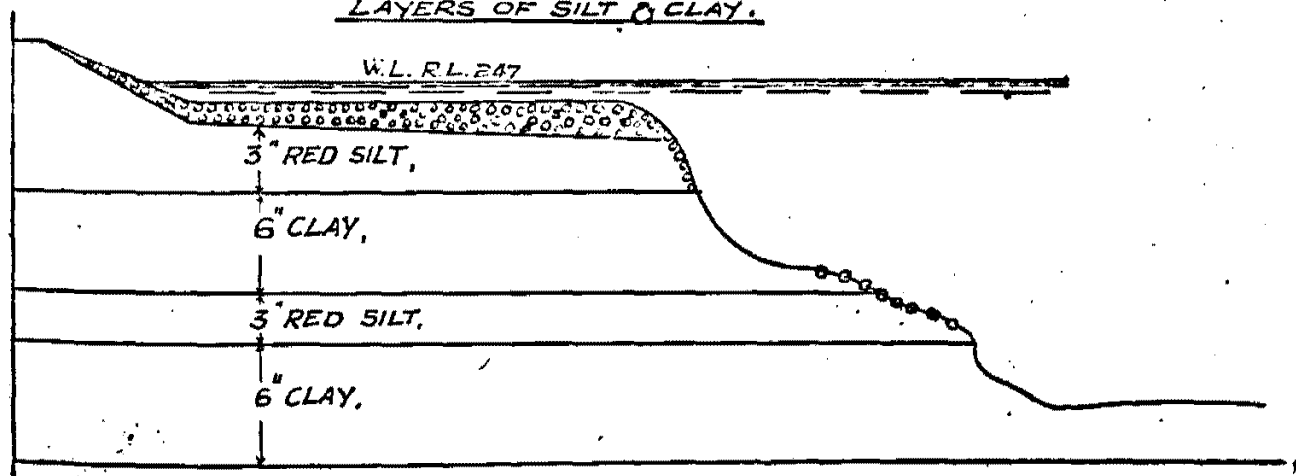

(FIG. 129 FROM A. R. T. 1937-38 OF C. I. AND H. R. STN.)

an apron does not launch satisfactorily unless

- (i) the angle of repose of the underlying material is flatter than that of the stones, and
- (ii) the material scours easily and evenly.

THE BEHAVIOUR AND CONTROL OF RIVERS AND CANALS

9.09. CONDITIONS UNDER WHICH APRON PROTECTION WILL FAIL

Owing to the flexibility of an apron, it can only fail in the following ways, due to:—

(1) launching taking place beyond the capacity of stone reserve.

(2) slips and "blow-outs" in the bank occurring due to a steep subsoil water gradient resulting from a rapidly falling river, or abnormally deep breathing (fluctuating water levels) of several feet.

(3) irregular disposition of stone on the slope due to the presence of layers of coherent material, such as clay, in the banks—as exemplified by the failure of the Sara protection Bank.

(4) a layer of coherent, or resistant, material becoming exposed at the toe, so that all stone reaching the toe is washed downstream until all available stone in the horizontally-laid apron and in the original slope above water level is exhausted, leaving part of the bank-material exposed to the current and wave action—as exemplified by the failure of the Right Guide Bank of the Hardinge Bridge. As regards the above:

(1) should be prevented by adding stone;

(2) can only occur as a secondary effect, or with very large discharges combined with abnormal flow conditions.

(3) and (4), falling aprons should never be used where the angle of repose of the underlying material is steeper than that of the stones to be laid in the apron, or where there are layers of coherent material in the bank or in the bed above the level of maximum scour.

9.10. REPRODUCTION OF BREACH IN THE RIGHT GUIDE BANK, HARDINGE BRIDGE (SERIES X)

The conditions leading to the breach in the Right Guide Bank of the Hardinge Bridge in 1933 were reproduced in a 1/500 scale geometrically-similar model of the Bridge and River,* but model limitations† prevented the breach being reproduced under geometrically-similar conditions of flow.

Fig. 9-11

Fig. 9-11 shows the Bridge and Guide Banks in plan and the place where the breach occurred.

A large geometrically-similar model was then constructed to a scale of 1/200, in which unnatural flow conditions were imposed. This was necessary, because in nature the smaller the discharge, the greater the vertical exaggeration; so that in a geometrically-similar model, velocities have to be exaggerated. At first, 1/16"—1/8" grade stones were used for the apron, this being the approximate equivalent of "one-man" stone to scale; but it was found to be too small to give correct results due to the ratio of size of stone to sand being less in the model than in the river—so 3/8" stone was substituted.

Photo Sheet
9-2.

Photo 1187 (Photo Sheet 9-2) shows the experiment after the slip had occurred.

* Bombay P. W. D., T. P. No. 55 "Report on experiments carried out with models in connection with the protection of the Hardinge Bridge, on the Eastern Bengal Railway," and Annual Report, 1935-36.

† See Chapter 14.

FIG. 9-11 - EXPTS. WITH FALLING APRON.

NR 379.
C.I. & H.R. STN.

SHOWING THE GANGES RIVER
AND GUIDE BANKS AT
HARDINGE BRIDGE

SCALE 1 INCH = 2000 FT.

(FIG. 127 FROM A.R.T.
1937-38 OF C.I. & H.R. STN.)

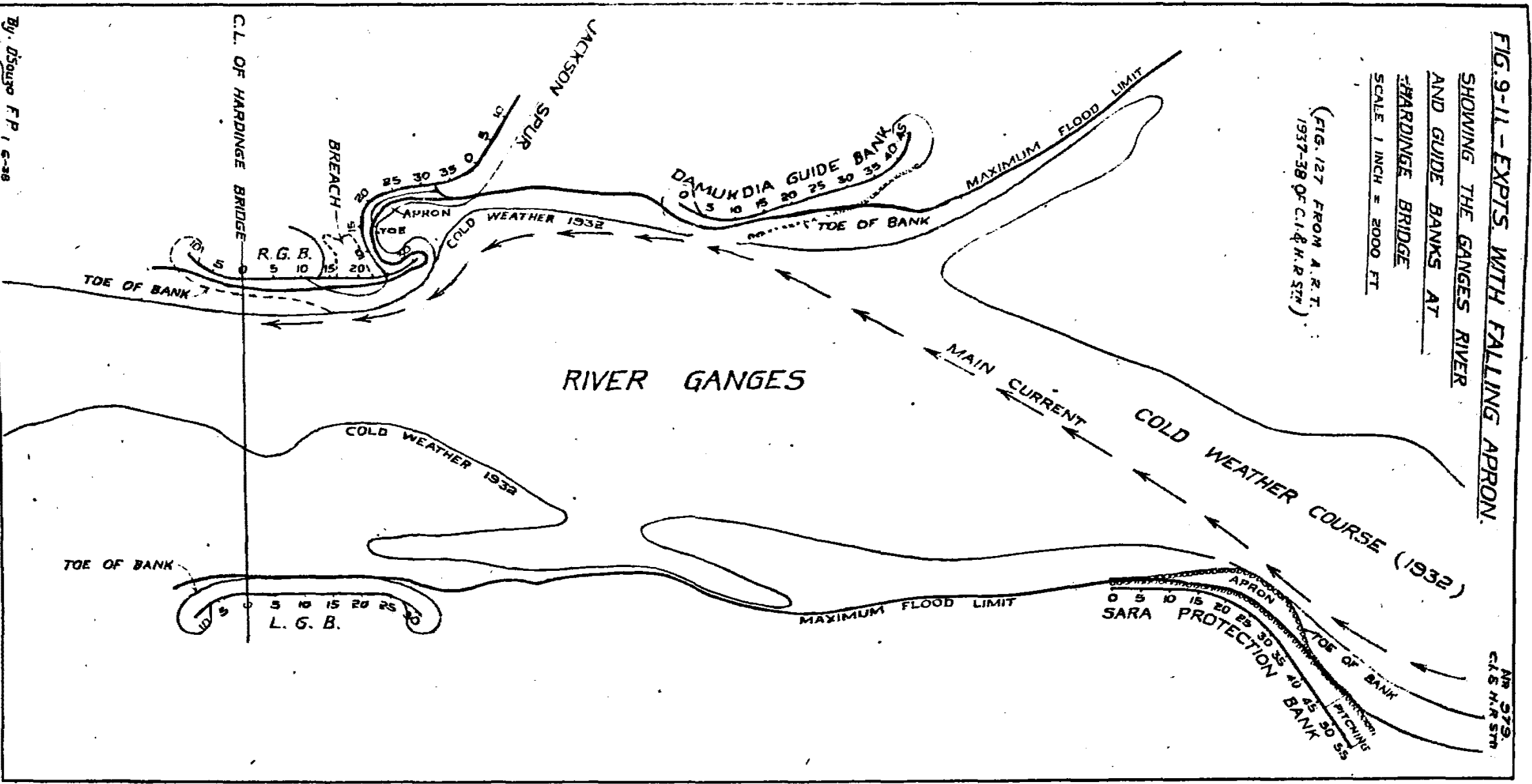

By: D. S. G. P. I. 6-38

FALLING APRONS

The following extracts from the reports of the Hardinge Bridge staff at the time of the breach describe briefly the events as observed by them:—

“Early in September a definite change in the direction of the main current was observed after it had left the Damukdia Guide Bank (Fig. 9-11) and the current impinged on the head of the Right Guide Bank at about chainage 27. Dangerous eddies were observed in front of Ch. 14 to 17.....and on the 26th September at about 4:00 hours this Guide Bank was breached between Ch. 19 and 22, on a rapidly rising river. During the course of the day the breach extended from Ch. 14 to Ch. 25 by erosion from inside the embayment. By 12:30 hours the breach was 1,200 ft. long and the embayment behind was 500 ft. across. The river continued to rise and on 2nd October eroded the narrow neck connecting the head, and allowed a clear flow from the embayment behind the breach, and out again into the river. Reserve stone was rushed up and a retired bund was formed to prevent further extension of the breach, and river later subsided.”

An observer might have thought that the breach, which started at a high level, was due to severe eddy action and strong currents near the surface. The model, however, showed that the surface eddies were practically harmless, while the severe attack was at the toe of the bank, whence stone was carried away and swept downstream. Stone from above then slid down to replace it, only to be in turn carried away, and this process continued until a patch of bank was denuded of stone and the sand exposed just below the water surface. This exposed patch was then eroded very rapidly under the combined action of wavewash and breathing in the river. This filled the breach with water, which was subsequently discharged back into the river with high velocity, sucking out sand. The breach was thus due to stone being carried away from the toe. This, in turn, was due to a clay layer being exposed at the toe.

The breach in the model can be clearly seen in Photo 1192 taken after the top of the bank had been denuded and scoured, but before appreciable flow had occurred from the embayment on the left. The wooden frame shows the original line of the top of the bank. Fig. 9-12 shows the isotachs observed at Ch. 10 and 18 of the guide bank.

CONDITIONS AT THE TOE (SERIES XIII)

In order to observe why the stones were being carried away at the toe, the portion of the bank where the breach occurred was replaced by a glass window through which movement of the bed material and stones could be seen. The glass panel was made flush with the bank at each end and extended from surface to bed. The discharge was then raised to the value at which the breach had occurred, keeping other conditions the same. Cross wires and battens were fixed on the glass to hold one or two rows of stones in place, when desired.

An excellent picture was obtained of what was happening near the bank. At the surface, there was slow return flow; but at the toe there was vigorous forward flow. Slight fluctuating flow was occurring near mid-depth, which was the base of the large slow eddy visible at the surface; and the fact that sand deposited on the glass window at mid-depth showed that the action there was not severe; in fact it was severe only near the toe, where sand and occasional stones were swept past at high velocity.

This was not, however, a steady velocity; but came in surges (about 2 to 5 per second) with a surge of greater velocity at intervals of a few

seconds. The mean flow appeared to be horizontal, not diving; but the direction fluctuated with the surges, perhaps within an angle of $\pm 10^\circ$. The stones on the battens were not carried away by the small surges, but were sometimes rocked and sometimes carried away by the bigger surges; and sand would remain on the glass under a group of stones, being sheltered by them.

In order to obtain a measure of the severity of attack, cement cubes $1\frac{1}{2}$ " up, were lowered on a string to the toe, and the smallest cube which would stay in position was noted. Pitot tube readings were also taken, and recordings made with the hot wire instrument for various conditions of flow.

The size of cube remaining in position was 2" in the case of the flow directed into the embayment, $3\frac{1}{2}$ " when the current was directed at the bank (i.e. worst case), and $2\frac{1}{4}$ — $2\frac{1}{2}$ " in other cases. The velocities recorded gave the same indications. The maximum velocity recorded at the toe was about 3 ft/sec. when the flow was directed at the bank.

The hot wire and oscillograph* for recording turbulence fluctuations, placed 3" away from the toe, showed the most violent fluctuation when the flow was directed at the head of the guide bank, but nearly as much under the conditions which caused the breach; for other conditions they were relatively small.

9.11. THICKNESS OF "ONE-MAN STONE" RESTING ON THE FACE OF THE BANK AFTER THE APRON HAS LAUNCHED

Engineers with experience of rivers can quote cases in which thin coatings consisting of spauls or bricks left on the bed or bank of a river after work has been completed have withstood severe attack; but the safety of a bank, like a chain, depends on its weakest part, and the Author holds that it is an unsound practice to use materials of low specific gravity where stone is available at a reasonable cost; so the formulæ proposed assume the use of one-man stone of normal specific gravity.—but see Appendix 4.

The thickness of "pitching laid by hand on a prepared bank above low-water level" and the thickness of the "face stone required to protect the scoured face of a bank after it has launched" require separate consideration. Where the material is laid by hand above low-water level, spauls or fine material can be laid as a backing and material graded to fill the interstices between stones, so a relatively small thickness of stone is then permissible; but there is little justification for assuming that a mixture of stone laid in an apron will redistribute itself as desired (behind and in the interstices of the stone) after the apron has launched, so the thickness of launched material must be considered in the light of past experience when relatively uniform material was used.

† Sir Francis Spring wrote:—†

"After much consideration, and some hesitation in regard to the standardising of practice, where conditions vary so greatly and so little is really known about them, the Author ventures to put forward the following table; more as a general guide in aid of men's own judgment, than as a rule to be accepted as having been proved to be correct. The table purports to give the thickness, in inches, of the covering of rough heavy loose stone pitching, which ordinarily will suffice, from low water upwards, to prevent natural or artificial banks of sand from being eroded by the current of a river. For pitching dropped through deep water, or which must fall automatically, and which therefore will probably not be very uniform,

* C. I. and H. R. S., A. R. (T) 1933-39 pp. 36, 37.

† T. P. No. 153, Chapter VI, page 33, para. 15.

FALLING APRONS

it will be best to allow perhaps 25 per cent more. The Author is inclined to believe that this table errs, if anything, on the safe side."

Fall per mile of river in inches.	3	12	24
Sand Classification.	Thickness of stone for slopes.		
Very coarse	16"	22"	28"
Medium	38"	34"	40"
Very fine	40"	46"	52"

(Note.—This statement is deliberately abbreviated, as it is not recommended for use.)

What is clear from Spring's wording is that this statement was very tentative, yet it is still being followed.*

Sir Francis Spring made, very tentatively, what appeared to be a most plausible assumption, namely that the thickness of stone required on the slope face depended on the slope of the river and the grade of material behind the stone face. Actually, however, the thickness of launched stone depends mainly on the discharge, and as the river gradient decreases with increase of discharge—other things being equal—slope, which is a dependent variable varying inversely as the discharge, is unsuitable as a factor affecting the thickness of stone required; nor is the grade of sand a suitable factor to select, because, though fine material behind the face stone would be more easily sucked out, the velocity in the river would be correspondingly reduced, thus neutralising the effect of material; so the sand classification would not appreciably affect the thickness of launched stone on the slope—though it would have a marked effect on the minimum size of blocks required to withstand scour.

In the model experiments, a single layer of small pebbles sufficed to protect the underlying sand—so, very large models would be required to give useful data, and even then the formula would have to be extrapolated—always a dangerous proceeding—whereas it was known that several feet thickness of one-man stone was required in the case of embankments in large rivers; and the data afforded a valuable check on the accuracy of the formulæ presented.

Thus bores made in the Damukdia Protection Bank (upstream of the Hardinge Bridge) where stones were exposed above cold weather level, showed thicknesses varying from 5 to 7 ft.

This agrees with the calculated thickness of launched aprons of the Right and Left Guide Banks of the Hardinge Bridge—on the assumption that the stones in the original apron as laid had launched and none been carried away, thus:—

TABLE 9—II

Left Guide Bank.				Right Guide Bank.			
Chainage.	Year of Observation.	Thickness of stone (ft.)	Slope of Stone Bank.	Chainage.	Year of Observation.	Thickness of stone (ft.)	Slope of Stone Bank.
2	1920-21	5.5	2.4:1	29	1931-32	4.8	2.4:1
3.5	1919-20	6.2	2.6:1	24	1931-32	5.7	2.8:1
				9	1932-33	3.9	2.6:1

* T. P. No. 309 "The Section and Armour of a Guide Bank for the Training and Control of the Great Alluvial Rivers" by K. B. Ray, Deputy Chief Engineer, E. B. Railway.

THE BEHAVIOUR AND CONTROL OF RIVERS AND CANALS

The variations in the slope of the stone bank depend upon the direction of flow and the velocity—i. e. on the severity of attack.

At the Kosi Bridge between Kursela and Katoreah, where the discharge was not more than one-third that of the Ganges at the Hardinge Bridge, the head of the Guide Bank was subject to very severe attack, and the original provision of 4 ft. thickness of stone proved inadequate, and large quantities of stone were subsequently added.

At the Sarda Bridge (13 R. K. Railway) where the discharge was much less, the thickness of stone was up to 4 ft.

Taking all the data available into account, the thickness of stone required on the sloping surface to withstand severe action may be taken to be

$$\text{Face thickness} = T = 06 Q^{\frac{1}{3}}$$

Where Q = discharge in cu. ft. per second.

9.12. SIZE OF STONE

Though the question of size of stone was not investigated—because the Station was dealing at the time with problems in which the river bed was of sand, so that 'one-man stone' was almost universally used, it is obvious that the size of protection depends on the degree of turbulence and as turbulence increases with the grade of material, the coarser the material exposed on the river bed, the larger must be the stone protection. For example: stones which would form a suitable protection if the bed material were fine sand would be washed away if the bed and banks were composed of shingle and boulders.

It is for this reason that in boulder rivers, protection generally takes the form of large concrete blocks or large wire crates containing boulders.

This question requires quantitative investigation.

9.13. QUANTITY OF STONE REQUIRED IN A FALLING APRON

The quantity of stone comprised in the stone face after launching depends on the angle of repose of the stone face, depth of scour, and the thickness of stone cover required to protect the slope.

Fig. 9-1. Spring—see Fig. 9-1—assumed a 2 to 1 slope throughout, and hence the slope stone required per cft. above low water level = $2.25 T (R + F)$ where R = rise of flood and F = freeboard.

This may be accepted as a safe slope above low water level.

He assumed an average thickness of $1.25 T$ below low water—or stone per cft. = $2.82 DT$, where D = depth of maximum estimated scour below L. W. L.

Fig. 9-1. This also assumed a slope below low water of 2 to 1, on which the quantities shown by Spring in Fig. 9-1 are based; but flatter slopes have frequently occurred, and Mr K. B. Ray * has stated:—

“The materials of the armour act only as a ‘face wall’ or ‘slope wall’. The Guide Bank slopes should, therefore, be stable by themselves, without any external support. To insure this, the slope should have the same angle as the ‘angle of repose’ of the material of which it is constructed..... The presence of clay in the sand, which is always found in alluvium, of which the bed and banks of an alluvial river is composed, at once makes the angle of repose approximate more towards saturated clay, the wet clay, mixed with the wet sand, apparently acting as a lubricant between the grains of sand, so that the angle of repose of the alluvium is 18° with a slope of about 3 to 1.”

Mr. Ray has then modified the original Spring values to fit a 3 to 1 slope.

* T. P. 809 Railway Board, Government of India, p. 18.

Though slopes of 3 to 1 and even flatter have been observed under exceptional conditions of flow, aprons with slopes of 2 to 1 are much more common, and slopes of $1\frac{1}{2}$ to 1 are found where the material is angular and the attack not very severe. It may be argued that this is due to the material of which the backing is formed being different. Even if this were so, it should be taken into account; but in the light of the model experiments and general experience, the Author believes that shape of stone and severity of attack have much more effect on the slope than material of the bank, and that the slope—other things being equal—tends to flatten with increase of turbulence and hence with increase of discharge; but its effect is small—probably varying as about the $1/9$ th power of the discharge; and shape of stone is more important. The Author considers that the ratio of slope face to depth should be based on experience and judgment, but should not be assumed steeper than 2 to 1, nor flatter than 3 to 1.

As regards depth of scour, Spring wrote:—

“The greatest discoverable depth of scour as measured below low-water level, having somehow been ascertained—and needless to say it ought to be ascertained at the expenditure of any reasonable amount of time, trouble and personal attention—”

but in practice, depth was generally based on

“deepest known scour for a distance of ten miles from the site.” This practice has led to widely incorrect results, which is not surprising, because vorticity at a guide bank far exceeds that normally found in alluvial rivers.

In Chapter 8, all data which could be obtained regarding depth of scour in rivers are listed, and shown in graphs. From this it appears that the maximum depth of scour at curved guide banks is about 2.75 times the Lacey regime depth, or

$$(D + R) = 2.75 \times .473 (Q/f)^{\frac{1}{3}}$$

$$(D + R) = 1.3 (Q/f)^{\frac{1}{3}}$$

$$\text{or } D = 1.3 (Q/f)^{\frac{1}{3}} - R$$

where D = depth below low water, and R = max. rise of flood above L. W. L.

On this basis, the slope face length

$$L = \left\{ 1.3 (Q/f)^{\frac{1}{3}} - R \right\} \sqrt{1 + (S.R.)^2}$$

where (S.R.) = slope face ratio; so with $T = .06 Q^{\frac{1}{3}}$, the total stone per cft. on launched face would be

$$T \times L = 0.06 Q^{\frac{1}{3}} \left\{ 1.3 (Q/f)^{\frac{1}{3}} - R \right\} \sqrt{1 + (S.R.)^2}$$

Assuming 25% of the stone laid in the falling apron fails to settle on the slope, the total quantity of apron stone required per running foot to protect the portion of the bank face below low water level.

$$= 0.08 Q^{\frac{1}{3}} \left\{ 1.3 (Q/f)^{\frac{1}{3}} - R \right\} \sqrt{1 + (S.R.)^2}$$

This question of slope ratio requires further investigation but success will depend to a large extent on experience and sound judgment in its application. Thus conditions will arise—as for instance in estuaries—where the depth of scour will be relatively less.

9.14. BEST METHOD OF REINFORCING AN APRON WHICH HAS ALREADY FALLEN

The Hardinge Bridge Committee desired to know "whether reinforcement should best be placed as a berm at low water level, or whether the reinforcement should be pitched through grids moored over the toe of the fallen apron, and whether in the case of an apron which had fallen, over which heavy silting had taken place, reinforcement should be put out in the form of an entirely new apron at low water level or whether this would be too wasteful".

Fig. 9-13.

The answer depends partly on cost; but if it is possible to dump stone from barges on top of the launched stone before it becomes covered with silt—see Fig. 9-13—this method has some advantages. In practice, however, it will be difficult to distribute stone evenly from barges, and deep silting generally occurs as the discharge decreases; so in most cases stone should be laid as an apron at low water—see Fig. 9-13.

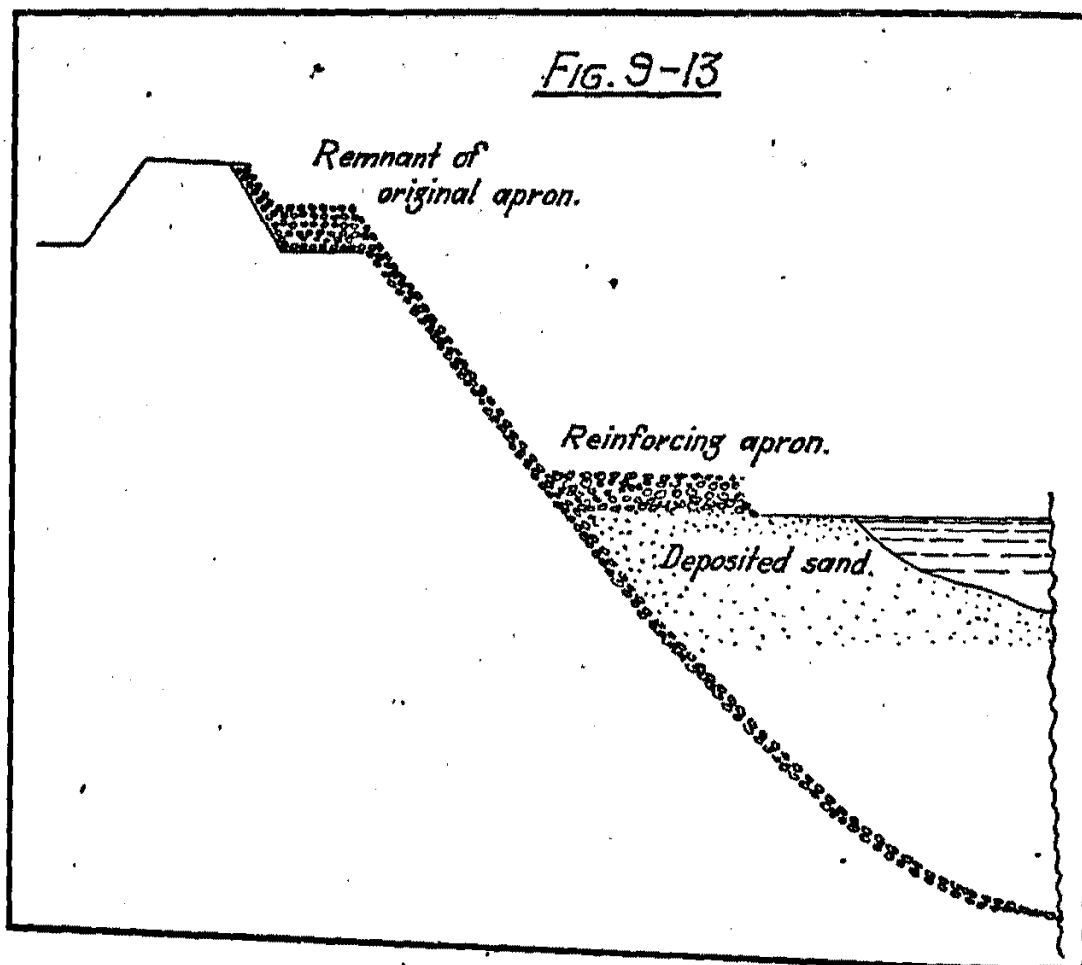

9.15. SUMMARY

(1) A falling apron provides a highly satisfactory form of bank protection where the material of the river bed or sea coast consist of sand or other incoherent material; but it is quite unsuitable where the bed consists of material which does not scour freely—such as clay or rock.

The reason for this is that the launching stone is carried away as quickly as it reaches the toe until the whole of the stone in the apron is exhausted. The bank face then becomes exposed just below water level and is quickly eroded by the current, wave action, and river breathing.

FALLING APRONS

An apron is also unsuitable where conditions are such that it does not launch satisfactorily because,

(i) the angle of repose of the underlying material is steeper than that of the stones, or

(ii) the material does not erode easily and evenly due to the bank consisting of alternate layers of sand and clay.

(2) The outstanding feature of this form of protection is its flexibility in adjusting itself to resist attack. Attack normally starts at the toe—partly because the slope is protected down to the toe, whereas sand is exposed at the toe, and partly because, with a sloping bank, the flow conditions near the bed are almost always most severe; but wherever attack takes place it invariably causes the bank to recede, which automatically reduces the intensity of attack and causes more stone to slide down from above until no more sand is scoured from beneath it.

(3) Provided the material of the bank has a flatter angle of repose than that of the launching stones; the inclination of the stones on the slope depends mainly on the severity of the attack, i. e. on the velocity, turbulence, etc. obtaining; and the severer the conditions, the flatter the slope will be, and it may be as flat as 3 to 1, though 2 to 1 is more normal for discharges up to 300,000 cusecs. Near the top of the bank and where the river discharge is small, the slope may be 1-1/2 to 1.

(4) The thickness of launched stone found on the slope is such that adequate protection is given to the sand beneath. If the scouring action becomes more severe, stone falls and the slope recedes, bringing down more stone from above, thus strengthening the protection, which automatically adjusts itself to the attack. The thickness is scarcely affected by the quantity of material laid in the apron or its disposition; but is determined by the degree of turbulence, which is due to the magnitude of the discharge and the angle of attack.

The thickness of stone after launching.

$$T = .06 Q^{1/3}.$$

(5) The quantity of launched stone required to cover the face of the slope to an adequate depth to protect the material underneath it from being removed by scour is determined by :

(i) the thickness of stone $T = .06 Q^{1/3}$ (where Q = maximum discharge).

and (ii) the extent of the slope face from water level to the toe ; and, the extent of the slope face depends on,

(a) the maximum depth of scour

and (b) the angle assumed by the material on the slope face.

$$\text{The maximum depth of scour} = 1.3 (Q/f)^{1/3}.$$

The ratio of slope free to depth will vary from 2:1 to 3:1 for different conditions.

(6) Normally the supply of stone required to protect the face of a bank launches automatically, and all that is required is to lay sufficient stone in the horizontal apron; but in order to avoid undue slope recession or to provide additional protection it may be advantageous to drop some stone from barges. Where, as is frequently the case, sand deposits on the apron as the river falls, it is better to lay the stone on the sand after the river has fallen to low water level, to act as a reinforcing apron.

THE BEHAVIOUR AND CONTROL OF RIVERS AND CANALS

(7) Slips do not normally take place as a result of a steep hydraulic gradient in the bank nor to the weight of a superimposed load; but local slips occur when a river is falling quickly—due to the bank being saturated above water level.

(8) A graded mixture of stone is more resistant to erosion than stones of a single grade.

(9) Rounded stones assume a flatter slope than flat elongated angular stones.

(10) Falling aprons of one-man stone laid on incoherent sand produce an impregnable bank, but the coarser the material of the bed, larger the stone should be, and experience shows that large blocks are required in boulder channels.

GUIDE BANKS AND GROYNES

CHAPTER 10

CONTROL OF RIVERS BY GUIDE BANKS AND GROYNES

	Page-
10-00. Introduction	... 379
10-01. River control by Denehy T-headed groynes	... 379
10-02. Ball bund system of river control at bridges and barrages...	... 379
10-03. The application of natural curvature of flow, which is associated with - meanders, to river training.	380
10-04. Control of a river by means of a repelling groyne	... 380
10-05. River training upstream of a bridge, or barrage, by means of an attracting groyne.	380

FIG. 10-1
PLAN OF
THE INDUS RIVER.
KAFIRKOT TO BILOT.

SCALE 1" = 2 MILES.



No. 4869.
 CENTRAL IRRIGATION & H. R. ST. N.
 POONA
 (FIG. 7 FROM A. R. T.
 1943 OF I. W. E. ST. N.)

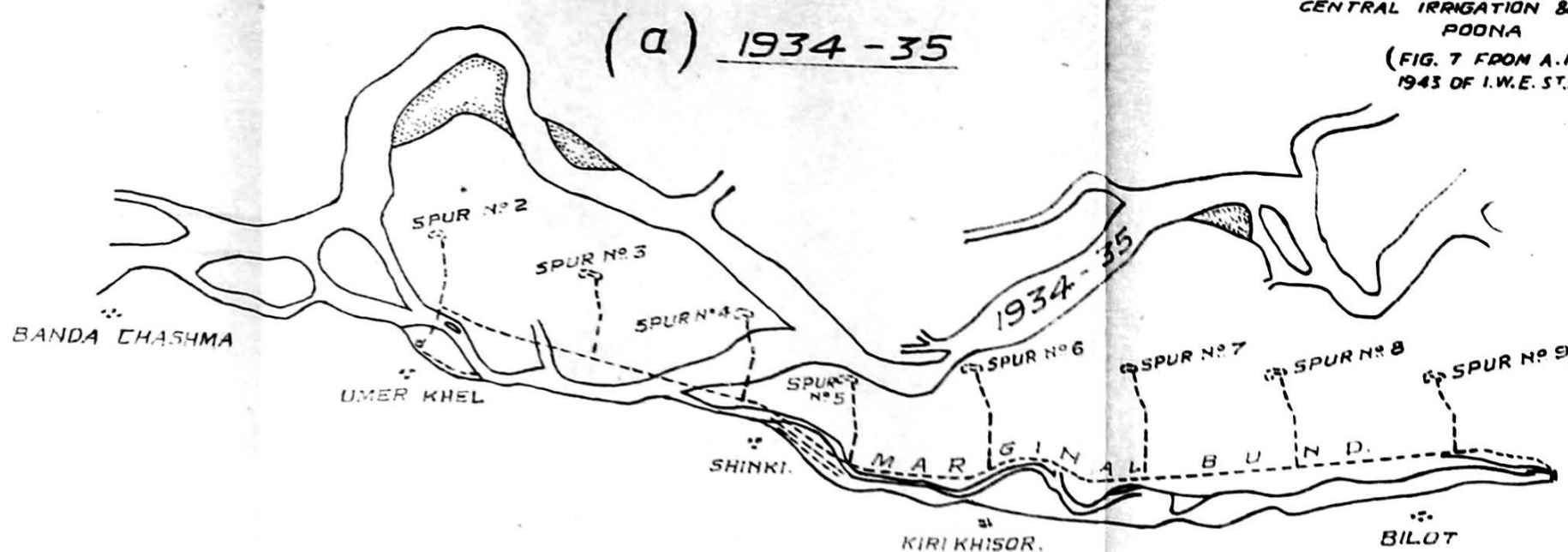

(b) 1936-37 & 1937-38

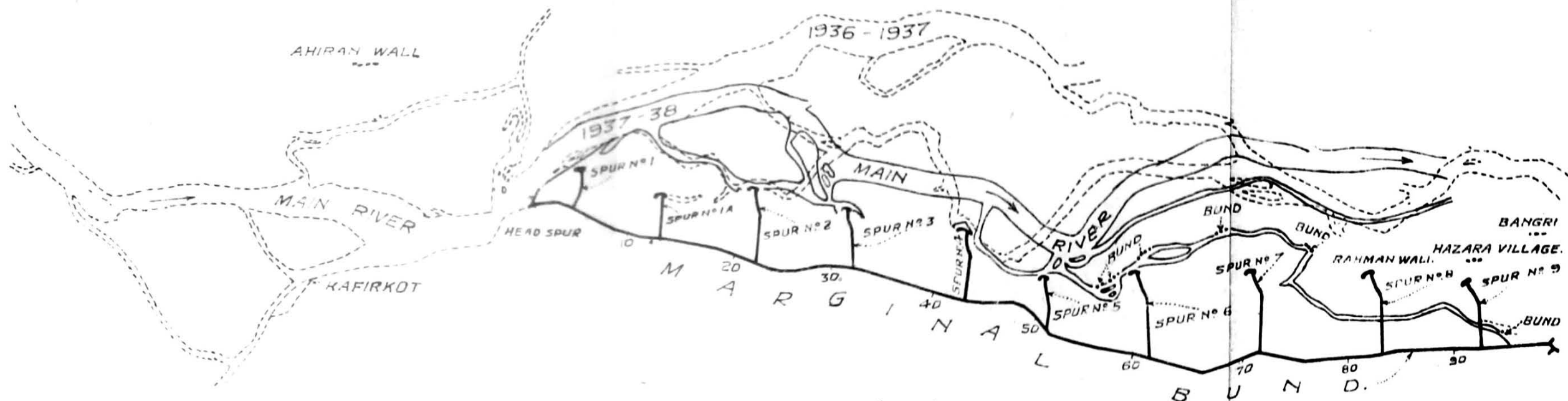

(c) 1942-43

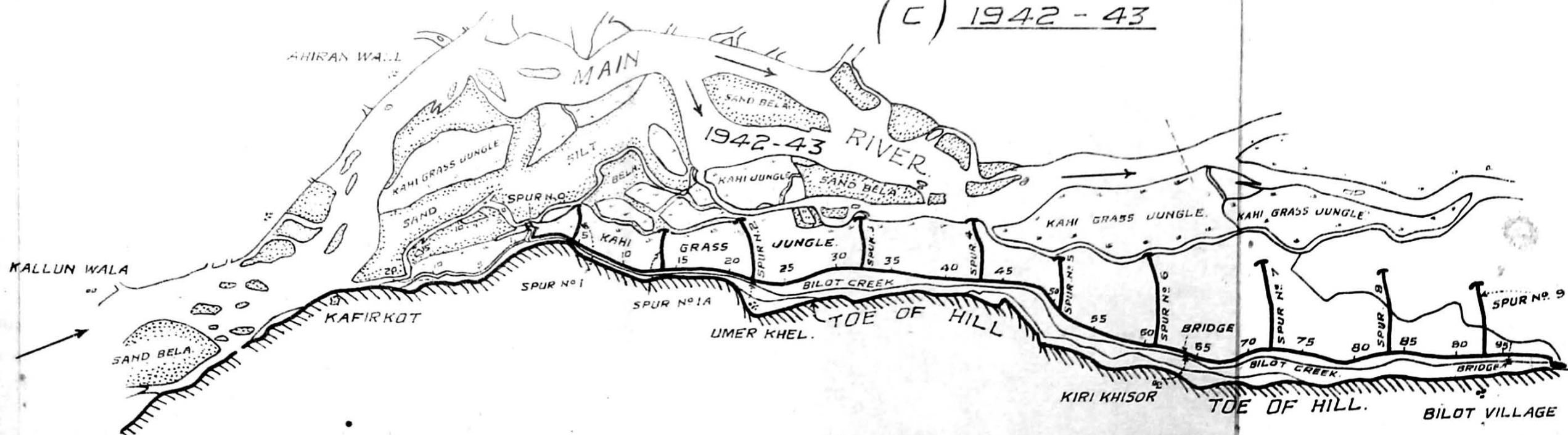

T. BY S. B. SARKAR
 3, 5144

CHAPTER 10

CONTROL OF RIVERS BY GUIDE BANKS AND GROYNES

10.00. INTRODUCTION

The earliest form of river control consisted of retired embankments to prevent spill. At a later stage control was effected by means of groynes, projecting from the banks designed to prevent erosion: and the best-known groyne of this type was the Denehy T-headed groyne.

In the nineties, J. R. Bell introduced the Bell bund system of river control, which was perfected by Sir Francis Spring. The method now recommended—which has been developed during recent years at the Indian Waterways Experiment Station, Poona—utilises the natural meander swing of a river to effect control.

10.01. RIVER CONTROL BY DENEHY T-HEADED GROYNES

A good example of this type of protection is shown in Fig. 10-1. In that case a series of ten T-headed groynes were constructed along the right bank of the Indus some 36 to 50 miles downstream of Kalabagh—to protect the Bilot Creek which feeds the Paharpur Canal.* These groynes may be called “fender groynes”, the object being to direct flow so that it brushes along the faces of the groynes without developing any considerable embayment between them.

The heads of T groynes extend some distance upstream of the shanks of the groynes—so, even if some embayment occurs between successive groynes, the shank of the lower groyne is not breached: But success depends mainly on the correct positioning of the groynes—because if they are too far apart, a deep embayment is likely to occur, and if spaced too close together, they become very costly. Thus, each groyne in this case cost about a lakh of rupees (£ 7,500), at the time they were constructed, and would cost much more now.

Denehy's name has come down to us more because of his skill at positioning groynes than due to the merits of his T-headed groyne, though these are considerable.

Where groynes have been wrongly positioned, they create havoc. This has occurred so often in the past that—to quote F. J. Salberg†—

“a spur or groyne was usually anathema to the ordinary river-training engineer.”

10.02. BELL BUND SYSTEM OF RIVER CONTROL AT BRIDGES AND BARRAGES

This system, introduced by J. R. Bell, was further developed by Sir Francis Spring, who worked out the quantity of stone required to be stacked when the falling apron was constructed.‡ Under this system, the whole flow of a river is passed through a narrow throat, which should be equal to about 2.8 times the square root of the discharge; whereas the swing of an alluvial river is often 10 to 15 times as great. It has been the practice to make the guide banks of about the same length as the throat, and to construct curved heads, with the object of allowing water to swing round them, so as to reduce severity of attack compared with what would occur were the guide banks to project straight upstream.

* I. W. E. S. A. R. (T), 1943, pp. 8-10.

† Discussion on Inst. of C. E. Maritime Paper No. 3 (1946) “Training Works constructed in the Eupnarain River in Bengal” by the Author.

‡ Government of India (Railway Board) T. P. 153. “River training and control on the guide bank system.”

THE BEHAVIOUR AND CONTROL OF RIVERS AND CANALS

The aim of this design is to prevent an embayment forming to such a depth that the approach bank to the bridge could be breached. Though this design has been in favour for some fifty years, it is far from perfect; because stone has to be thrown in from time to time as apron stone gets washed away, and maintenance may be very expensive—as exemplified by the case of the Hardinge Bridge, where nearly a million pounds was spent on repairs in a period of two years. Where the material of the bed is scour-resistant, consisting of hard material such as lime kankar, or even clay, stone is washed away in quantity; and under such conditions, the whole of the stone in an apron may be depleted in a short period of time. (See Chapter 9.)

10.03. THE APPLICATION OF NATURAL CURVATURE OF FLOW, WHICH IS ASSOCIATED WITH MEANDERS, TO RIVER TRAINING

The method of river control which has been developed during recent years at the Indian Waterways Experiment Station, Poona, consists in making use of natural curvature of flow associated with meanders. This necessitates the development of a control point, to limit the swing of the river, either by constructing a repelling groyne or by holding the river permanently where desired, by a suitably positioned attracting-groyne. In either case, the dominant factor is the correct positioning of the training work—the position being determined by meander length for the dominant discharge of the river at that point.

10.04. CONTROL OF A RIVER BY MEANS OF A REPELLING GROUYNE

The Author in a recent Paper* gave an example of the use of a repelling groyne to prevent a bridge being outflanked. This was located 0.4 of a meander length upstream of the Bengal-Nagpur Railway Bridge spanning the Rupnarain River at Kolaghat in Bengal, on the main line between Calcutta and Bombay—see 1.26 and Fig. 1-12, 1-13, 1-14 and 1-15 showing river conditions before the repelling groyne was constructed, and 14 months after the groyne was completed.

Figs. 1-12
1-13 1-14,
1-15.

In this period the river channel moved 2,000 ft. from the left bank where erosion had previously been endangering the railway.

10.05. RIVER TRAINING UPSTREAM OF A BRIDGE, OR BARRAGE, BY MEANS OF AN ATTRACTING GROUYNE

A common problem is the selection of the best position for a new bridge or barrage, and the work necessary to maintain approximately axial flow through such a structure. This presents little difficulty where the natural meander swing is permanently held by local exposures of hard strata on both banks at points a suitable distance apart—as is the case where lime kankar is exposed on the left bank at Benares, and a similar outcrop occurs on the right bank a few miles upstream.

More frequently, the river is held permanently on one bank; but not on the other. There are then two alternatives: either to construct the bridge at the point where the river is held by an outcrop, with a suitably placed attracting groyne about 0.4 of a meander length upstream—as was recommended for the Lower Sind Barrage at Hajipur† (Fig. 10-2); or to construct the bridge, or barrage, about half a meander length downstream of the natural fixed point.

† Fig. 10-2.

* Maritime Paper No. 3 Inst. C. E. "Training works constructed in the Rupnarain River in Bengal after model experiments."

† I. W. E. S. A. R. (T) 1944 pp. 55-57 and 96. "Design of Lower Sind Barrage at Hajipur."

Fig. 10-2

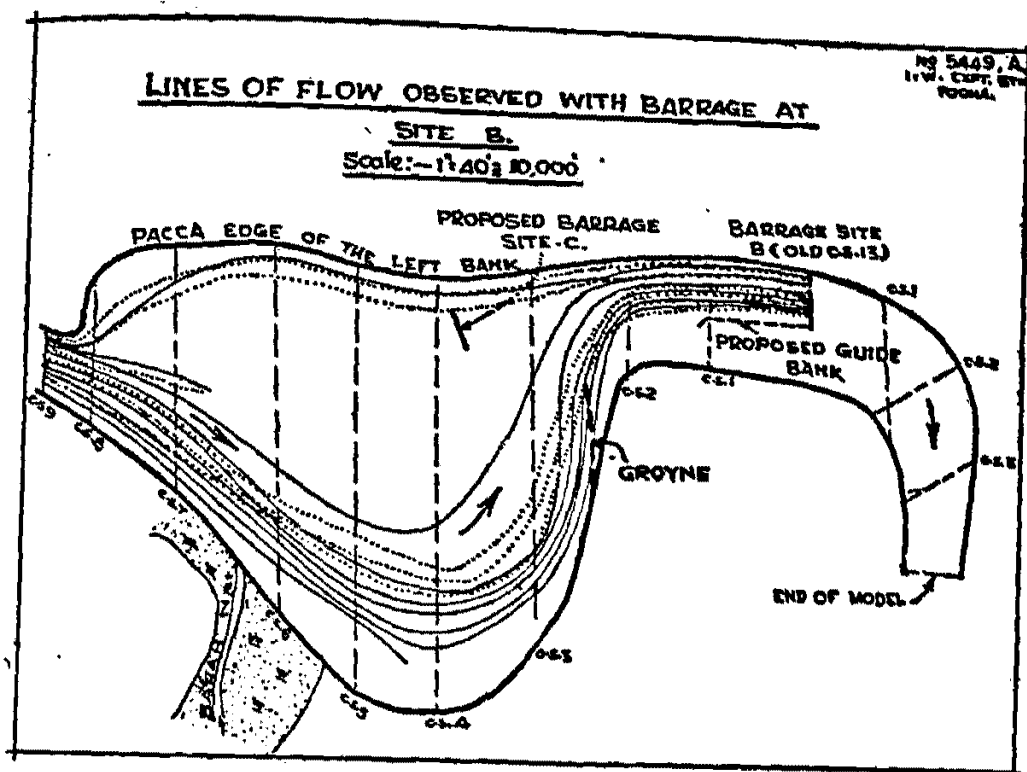

(FIG. 108 FROM A. R. T. 1944 OF I. W. E. STN.)

Where there is no fixed point on either bank—as is frequently the case—the meander tends to progress downstream—the river channel changing from one bank to the other over a period of years. Two fixed points have then to be developed:—

- (a) at the bridge or barrage,
- and (b) at about 0.4 of a meander length upstream.

Sometimes a bridge or barrage has been built where it is unsuitably placed with reference to the natural swing of the river. In that case an attracting island, constructed upstream of the bridge or barrage, may make it possible to centralise flow; but it will generally be better to construct a suitably-placed attracting groyne about 0.4 of meander length upstream.

The above gives a general idea of the method; but successful design necessitates being able to foresee changes which may take place in the river for many years ahead; so no hard and fast rules can be laid down, and success will depend on the experience and skill of the designer.

In every case it is important—almost essential—to make use of models in order to compare the relative merits of various alternatives under various conditions which may arise. Such models must have correct scales—to ensure correct curvature of flow—and they must be very large—to minimise the effects of vertical exaggeration, which is inherent in river models.

FLUMING
CHAPTER 11
FLUMING

	Page.
11.00 Introduction	387
11.01 Fluming to attain modularity	387
11.02 Fluming to reduce cost	387
11.03 Fluming to increase the discharge of a structure	387
11.04 Remodelling the Nira Left Bank Canal Head Regulator to pass 50 per cent more discharge with less loss of head.	388
11.05 A case in which the effect of fluming was overlooked	403



Photo 147. Model of Aqueduct 23, Nira Right Bank Canal, as designed. Full Supply Discharge \approx 474 cusecs. Width 34 feet.



Photo 149. Aqueduct 23 as constructed. Width 14 feet.

PHOTOS FROM BOMBAY T. P. No. 42.

FLUMING
CHAPTER 11
FLUMING

11.00. INTRODUCTION

Fluming, which consists in first contracting and then expanding the section, is based on Bernoulli's theorem,

$$\frac{p}{w} + \frac{V^2}{2g} + z = \text{total head above datum,}$$

where p = pressure, w = weight of a cu. ft. of water and z = height above datum.

Strictly speaking this formula applies only to a filament; but it has become customary to apply it to general axial flow and, provided there is no curvature of flow either in the vertical or horizontal plane, it is understood that $V^2/2g$ is not a true summation of all the point velocities, $\frac{\bar{V}^2}{50}$ being a closer approximation, and losses due to friction are allowed for, it can be usefully applied in this way.

11.01. FLUMING TO ATTAIN MODULARITY

Fluming is resorted to where it is desired to produce hypercritical flow in order to prevent the downstream water level affecting the upstream water level, when flow is said to be modular. The discharge is then dependant only on the upstream water level. This is the principle adopted in "Standing Wave Flumes and Flume Meter Baffle Falls"—see Figs. 11-1, 11-2, 11-3.*

* Fig. 11-1,
11-2,
11-3.

11.02. FLUMING TO REDUCE COST

Fluming has also been adopted in some cases to reduce cost of construction both with hypercritical and hypocritical flow.

In the former case, though a high fluming ratio reduces the initial cost, it produces a correspondingly high discharge per ft. and necessitates much greater expansion downstream—both of which necessitate a longer expansion; so the throat of a flumed fall is not normally made less than two-thirds the normal bed-width of a canal; but where it is considered desirable that the depth of water upstream of a fall should vary proportionately to the natural canal water level for a range of discharges, a fluming ratio of more than 2 is required †

Photos 147 and 149, Sheet 11-1, show models of Aqueduct 23 of the Nira Right Bank Canal. As originally designed it was 34 ft. wide; but was constructed as a flume 14 ft. wide. The additional loss of head through the aqueduct was only 3".

11.03. FLUMING TO INCREASE THE DISCHARGE OF A STRUCTURE

Fluming is most advantageous where the discharge of a masonry structure has to be increased.

When the Nira Left Bank Canal, Poona District, Bombay Presidency, was remodelled to carry 50 per cent more discharge, this had to be arranged with as little increase of head as possible, and without closing the Canal for more than 5 days at a time.

This was successfully achieved in the case of most of the bridges, aqueducts, and culverts, by adding carefully-designed downstream expansions.

*Note on "Standing Wave Flumes and Flume Meter Baffle Falls" I. W. E. S. A. E. (T) 1944. pp. 27-55.

†I. W. E. S. A. E. (T) 1944, pp. 43-46 "Design of proportional Standing Wave Flumes and Height of Jump."

11.04. REMODELLING THE NIRA LEFT BANK CANAL HEAD REGULATOR TO PASS 50 PER CENT MORE DISCHARGE WITH LESS LOSS OF HEAD

The most spectacular example was the remodelling of the Head Regulator of the Nira Left Bank Canal. In this case, the increased discharge had to be passed without dismantling the Regulator, and there was no room to add more spans.

Success was achieved by bell-mouthing upstream and adding an expansion downstream.* See Fig. 11-8.

The model experiments carried out in this connection being of great interest are summarised and described below. The paper dealing with these experiments has long been out of print.

(a) Notation—

Q = total discharge in cusecs.

D_1 = depth of water upstream above sill of the sluice at G_1 —
vide Fig. 11-1.

D_2 = depth of water downstream above sill of the sluice at G_2

A = area of waterway at the upstream end of the sluices
= $4 \times 4 \times 7$ spans,
= 112 sq. ft.

H = difference of water levels upstream and downstream of the sluice under submerged conditions.

$$= D_1 - D_2.$$

h_s = head in ft. of water upstream over soffit of sluice.

x = opening of sluice = 4 ft.

C_H = coefficient of discharge in the formula

$$\begin{aligned} Q &= C_H A \sqrt{2gH} \\ &= C_H \times 112 \times 8\sqrt{H} \\ &= 896 C_H \sqrt{H} \end{aligned}$$

(b) DESCRIPTION OF THE MODEL

The regulator at the head of the Nira Left Bank Canals at Vir consisted of 7 spans, each span 4 ft. wide, with upstream gates 4' x 4'. The sluices were 9 ft. long and had arched tops. The rise of the arch = 9 inches and the gate frames blocked the arch sector. In the Nira Valley Development Project (1922) Rs. 20,000 were provided for increasing the discharge of the Nira Left Bank Canal from 455 cusecs to 720 cusecs—by increasing the number of spans. This work would have been very difficult to carry out, and would have interfered seriously with Canal rotations.

The model consisted of a single span, which was geometrically similar to the prototype. The scale ratio was 1/3.

Full supply discharge desired in the prototype = 720 cusecs for one span = 102.86 cusecs.

$$\begin{aligned} \text{The equivalent discharge in the model} &= \frac{102.86}{3 \times 3 \times \sqrt{3}} \\ &= 6.60 \text{ cusecs.} \end{aligned}$$

Two gauges were fixed in the model, G_1 being 5.3 ft. upstream of the gate and G_2 = 18.7 ft. downstream of the gate—where natural flow was first re-established.

*Bombay P. W. D. T. P. 54 (1935) "Note on Experiments with a Model of the Head Sluices of the Nira Left Bank Canal" by C. C. Inglis and D. V. Joglekar.

STANDARD S.W.F DESIGN

NO 5274

I.W. EXPT. STATION PUNE

FIG :- II-1

(FIG. 37 TO 39 FROM A.R.T. 1944 OF I.W.E.S.)

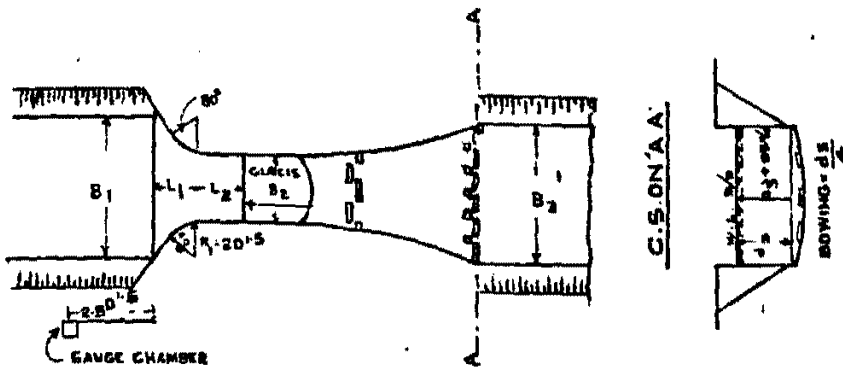

PLAN

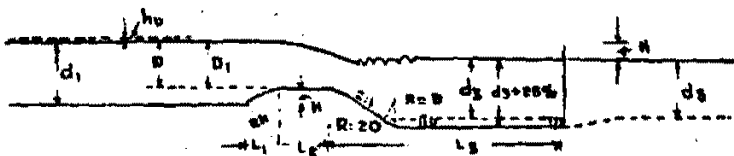

L. SECTION

S.W.F. WITH HIGH MODULAR LIMIT FOR LINED CHANNELS

FIG II-2

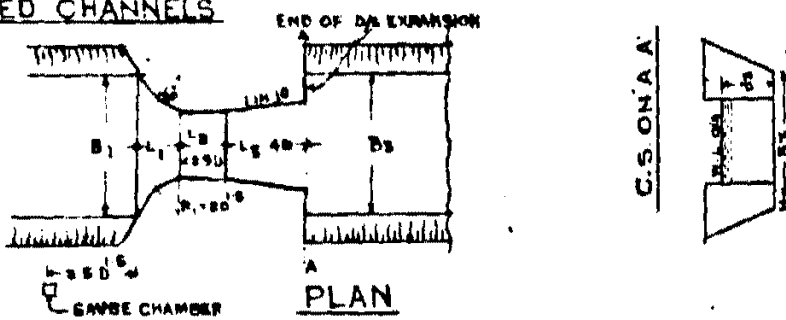

PLAN

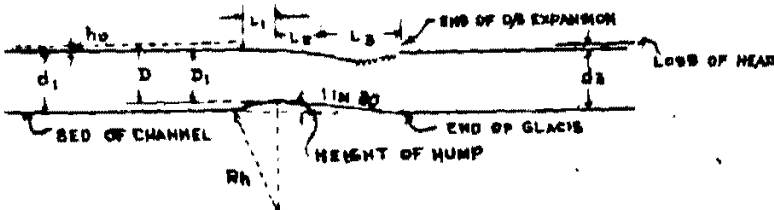

L. SECTION

FIG II-3
FLUME METER BAFFLE FALL

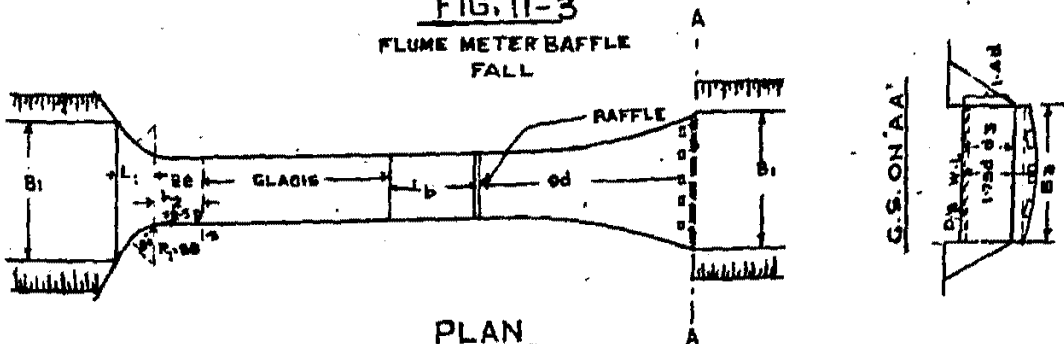

PLAN

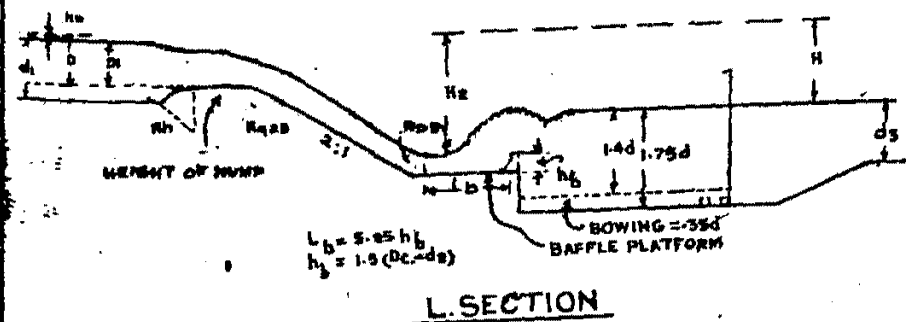

L. SECTION

EXPERIMENTS WITH MODEL OF
N.L.B. HEAD REGULATOR

(FIG. 1 TO 4 FROM
BOMBAY T.P. NO. 54)

Q=720 CFS.

SCALE - 1" = 8 FT.

FIG: II-4

L. SECTION

EXPT: 1 & 2

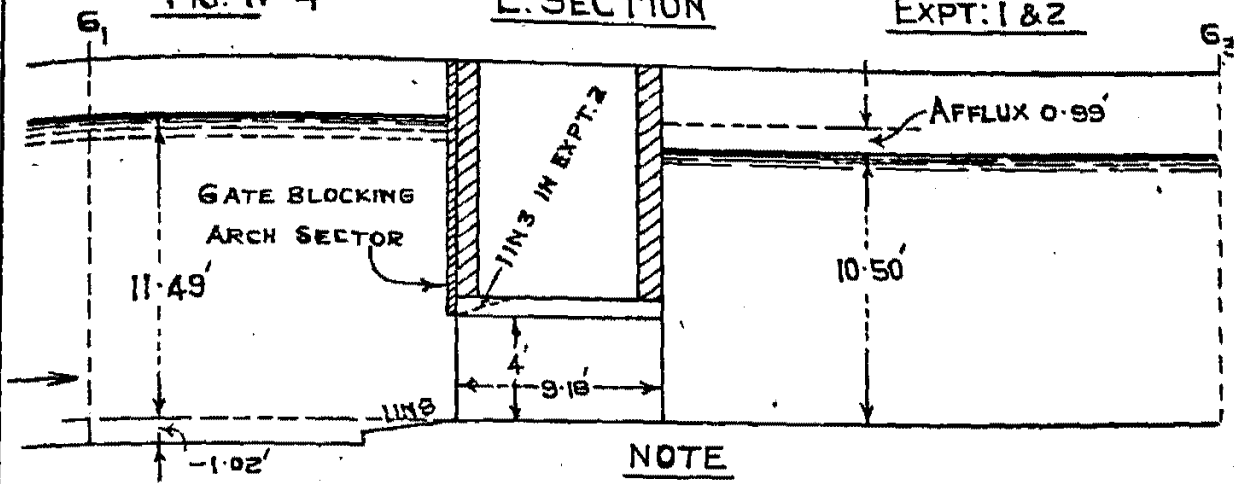

FIG: II-5

L. SECTION.

EXPT: 3

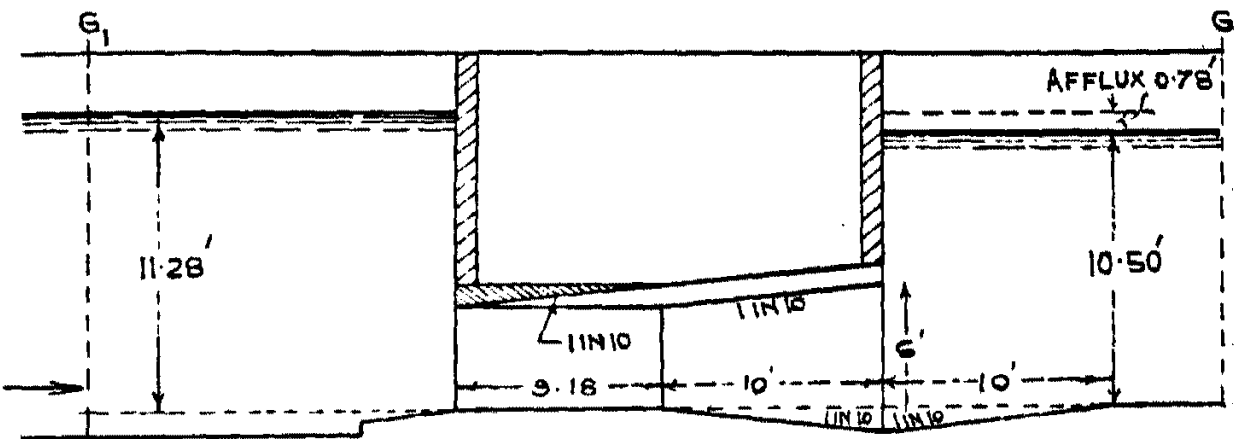

FIG: II-6

L. SECTION

EXPT: 4

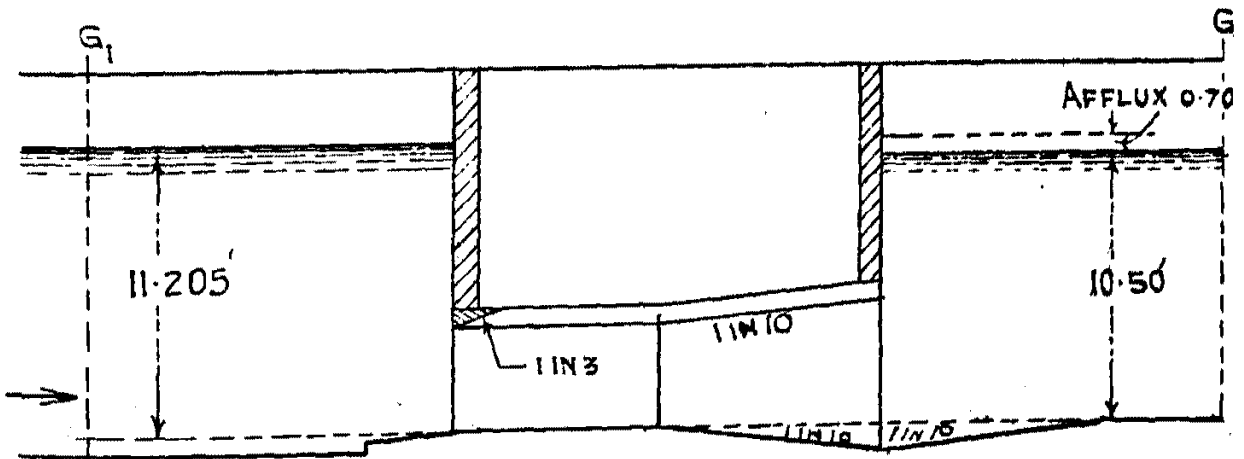
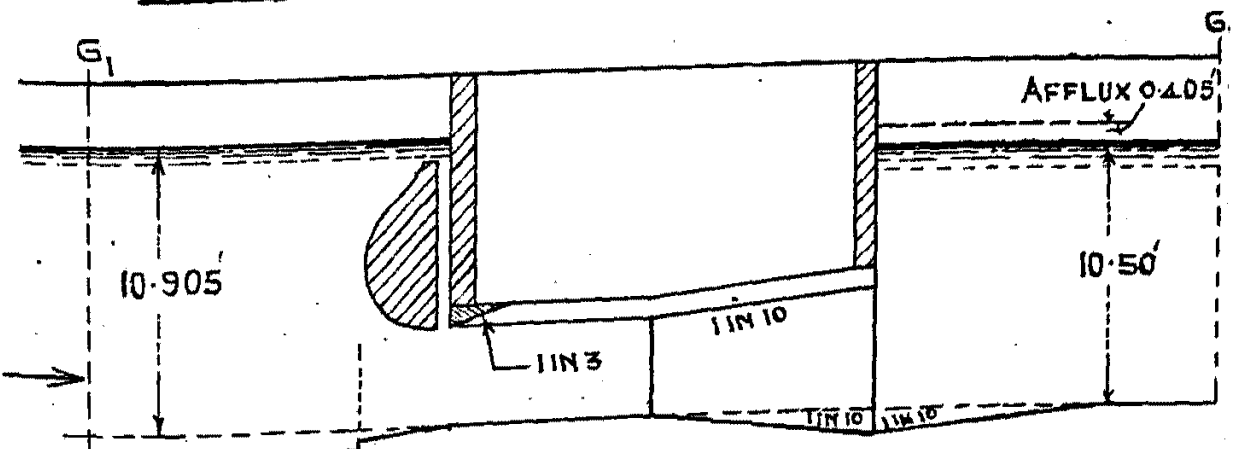

FIG: II-7

L. SECTION

EXPT: 5



EXPERIMENTS WITH MODEL OF N.L.B. HEAD REGULATOR

(FIGS. 5 TO 8 FROM S.T.P. NR 54)

Q = 720 Cs.

FIG. 11-8

L. SECTION

EXPT. 6

SCALE: 1" = 8 FEET.

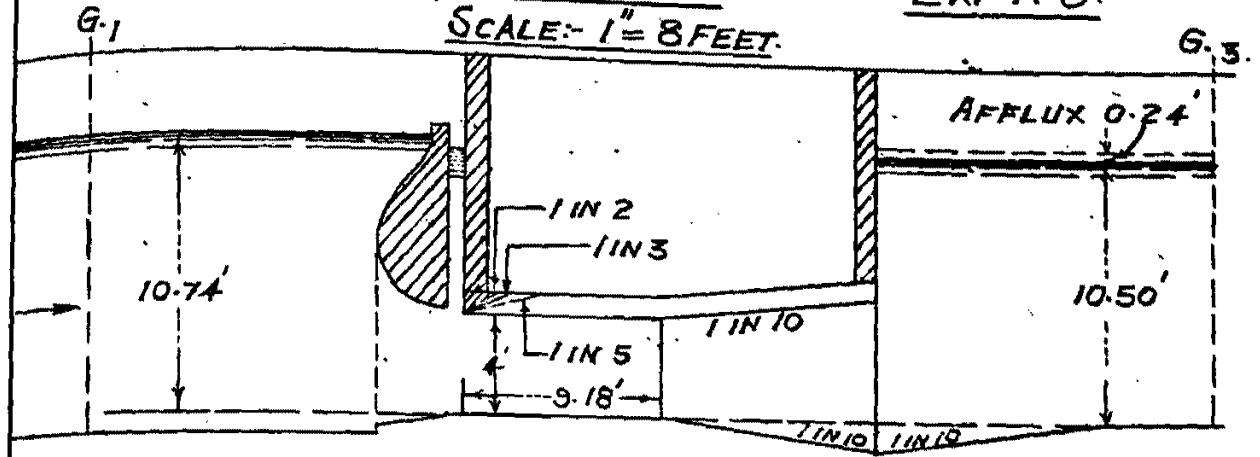

Q = 720 Cs.

FIG. 11-9

L. SECTION

EXPT. 11

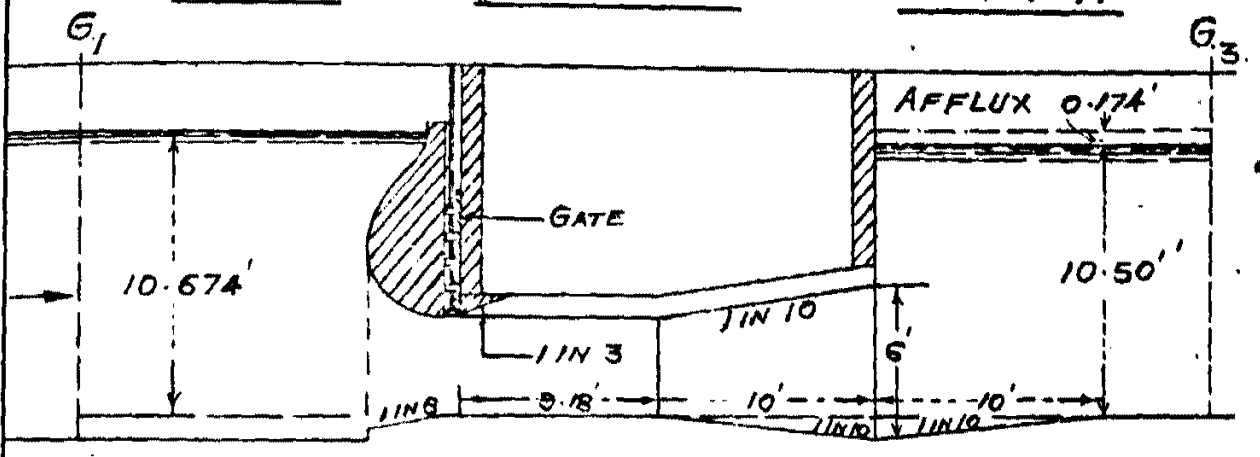

FIG. 11-10

PLAN

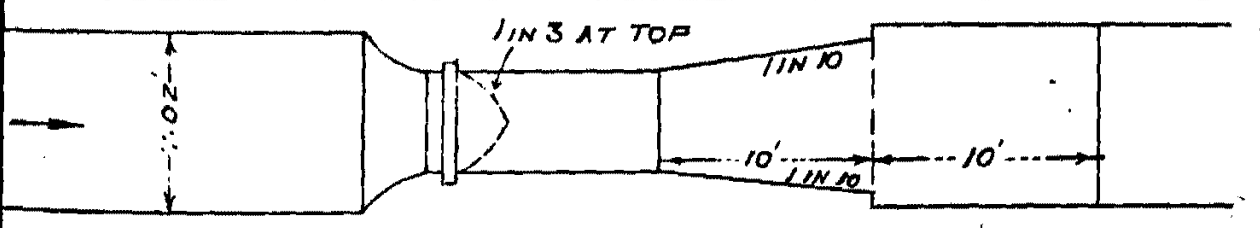
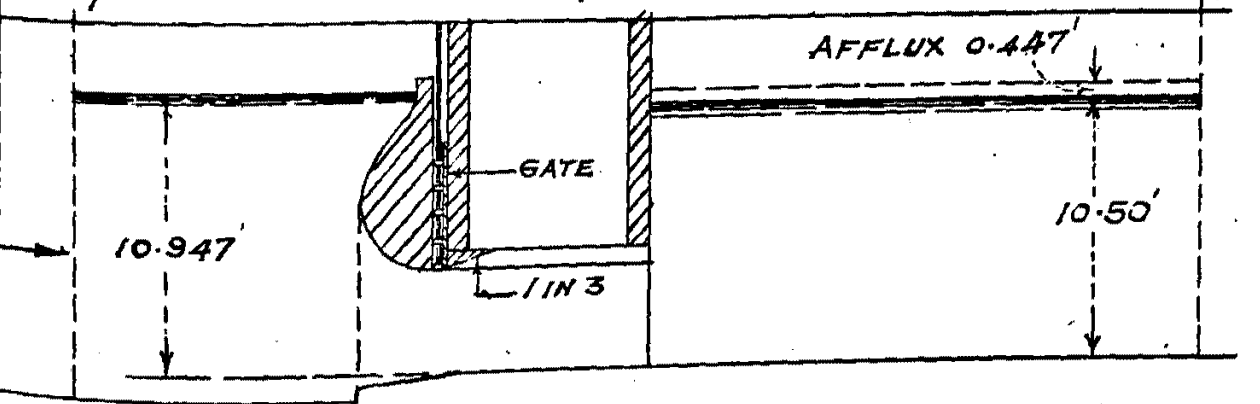

FIG. 11-11

L. SECTION

EXPT. 13



NOTE

	U/S. W.L.	D/S. W.L.	AFFLUX
EXPT. NO 12 WATER SPILLING INTO GAP.	11.181'	10.50'	0.681'
" " 13 CONDITION AS IN FIG. 11-11 (I.E. BOTTOM OF GATE FLUSH WITH BELLMOUTH)	10.947'	10.50'	0.447'

T. BY - MSMBN 21-1-35

TABLE 11-1

Experiment Number	Description.	Discharge (cusecs).	D_1 ft.	D_3 ft.	H ft.	C_H ft.	H in Expts. 2-14 + H in Expt. 1 (b).	C_H in Expts. 2-14 + C_H in Expt. 1 (b).	Remarks'
1	2	3	4	5	6	7	8	9	10
1 (a)	Design before remodelling with gate blocking arch sector Fig. 11-4	635	10.244	9.51	0.774	0.831	In prototype, H was 0.80 ft. and $C_H = 0.817$ with $Q = 655$ cgs. $D_1 = 10.80$ ft. and $D_3 = 9.50$ ft.
1 (b)	Do. do. do.	720	11.490	10.50	0.990	0.808	1.0	1.0	
2	Same as Expt. 1 but arch sector filled with 1 in 3 divergence d/s of gate--shown dotted in Fig 11-4	720	11.383	10.50	0.85	0.852	0.80	1.05	
3	Arch sector filled with 1 in 10 divergence d/s of gate and 1 in 10 divergences d/s of the sluice in sides, bed and top for a length of 10 ft.--Fig. 11-5	720	11.280	10.50	0.780	0.910	0.70	1.13	
4	Arch sector filled with 1 in 3 divergence d/s of gate, otherwise as in Expt 3--Fig. 11-6	720	11.203	10.50	0.705	0.957	0.71	1.18	
5	Bellmouth u/s of gate, arch sector filled with 1 in 3 divergence and 1 in 10 divergences d/s of sluice. Gate was not fixed but a gap equivalent to 6" wide in the prototype was left between the bell-mouth and the sluice to allow the gate to pass through and water was allowed to spill into the gap--Fig. 11-7	720	10.905	10.50	0.405	1.624	0.41	1.56	
6	Same as Expt 5; but water was prevented from spilling into the gap -Fig. 11-8	720	10.740	10.50	0.240	1.640	0.24	2.03	
7	Same as Expt. 5; but with arch sector filled with 1 in 2 divergence d/s of gate--shown dotted in Fig. 11-8; water was spilling into the gap	720	10.914	10.50	0.414	1.249	0.42	1.55	
8	Same as Expt. 5; but with arch sector filled with 1 in 2 divergence d/s of gate--shown dotted in Fig. 11-8; water was prevented from spilling into the gap	720	10.746	10.50	0.246	1.619	0.23	2.00	

395

FLUJING

TABLE 11-I—(contd.)

Experiment Number.	Description.	Discharge (cusecs).	D ₁ ft.	D ₃ ft.	H ft.	C _H ft.	H in Expts. 2-14 + H in Expt. 1 (b)	C _H in Expts. 2-14 + C _H in Expt. 1 (b)	Remarks.
1	2	3	4	5	6	7	8	9	10
9	Same as Expt. 5; but with arch sector filled with 1 in 5 divergence d/s of gate shown dotted in Fig. 11-8; water was spilling into the gap ...	720	10.926	10.50	0.426	1.292	0.43	1.53	
10	Same as Expt. 5; but with arch sector filled with 1 in 5 divergence d/s of gate—shown dotted in Fig. 11-8; water was prevented from spilling into gap ...	720	10.752	10.50	0.252	1.602	0.25	1.98	
11	Bellmouth u/s of gate; arch sector filled with 1 in 3 divergences and 1 in 10 divergences d/s of sluice. Gate was fixed with bottom of gate flush with bellmouth—Fig. 11-9 and 11-10.	720	10.674	10.50	0.174	1.927	0.175	2.38	
12	Bellmouth u/s of gate; arch sector filled with 1 in 3 divergence but without 1 in 10 divergences d/s. A gap 8" wide between bellmouth and sluice and water was spilling into gap—Fig. 11-11 ...	720	11.181	10.50	0.681	0.974	0.69	1.20	
13	Same as Expt. 12; but with gate with bottom flush with bellmouth—Fig. 11-11 ...	720	10.947	10.50	0.447	1.202	0.45	1.49	

FLUMING

(c) EXPERIMENTS AND CONSIDERATION OF RESULTS

The masonry of the sluices in the prototype was of coursed rubble (2nd sort) In the model, this was represented by rough cast cement plaster to obtain approximate relative roughness.

Results of experiments are shown in Table 11-I and Fig. 11-4 to 11-11.

Table 11-I
Figs. 11-4
to 11-11

Experiment No. 1 (a)

Conditions were the same as at present at Vir, the arch sector being blocked by the gate frame.

	<i>At Vir</i>	<i>In model</i>
Q (cusecs)	... 655.0	6.0
D ₃ (ft.)	... 9.50	3.17

The loss of head in the model was 0.258 (equivalent to 0.774 ft. in the prototype), while at Vir, the observed loss of head was 0.8 ft.; the coefficient of discharge in the model was 0.817 against 0.831 in the prototype indicating that the model roughness was a little too great.

The flow downstream of the sluice was of the drowned standing wave type and hence was highly disturbed and there was return flow on the surface from 6.5 ft. downstream of the sluice—*vide* Fig. 11-12 below—equivalent to 19.5 ft. in the prototype.

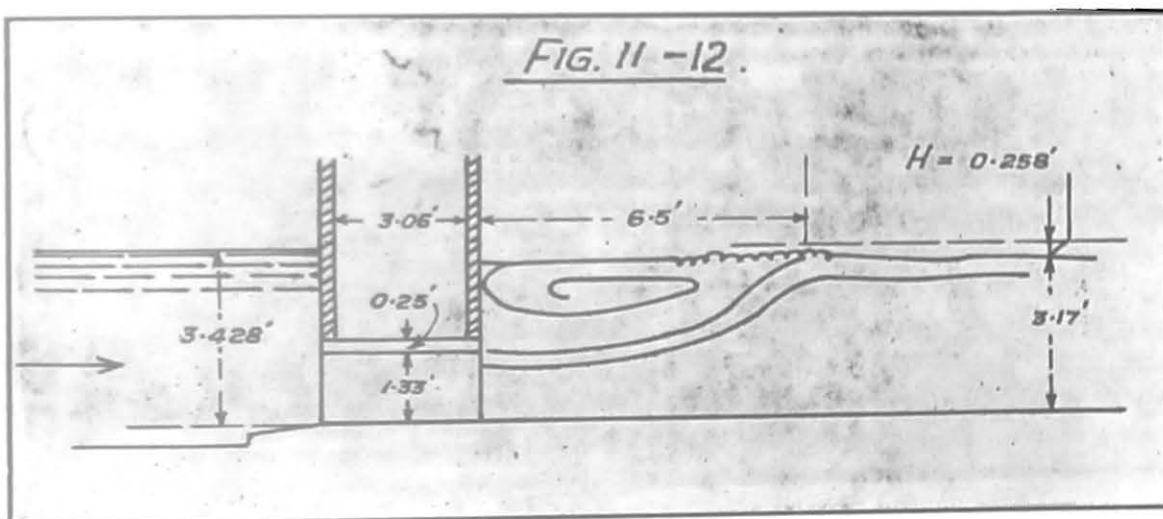

(FIG. 9 FROM BOMBAY T. P. No. 54.)

Experiment No. 1 (b)

With Q=6.6 cusecs (equivalent to 720 cusecs in the prototype— which was the designed Full Supply discharge at the head of the Nira Left Bank Canal) and D₃=3.5 ft. (equivalent to 10.5 ft. at Canal head) the loss of head was 0.33 ft. (=0.99 ft. in the prototype) and C_H=0.808.

Experiment No. 2

In order to reduce the loss of head due to sudden expansion downstream of the gate frame, the arch sector was filled with a 1 to 3 divergence—shown dotted in Fig. 11-4. With Q=6.6 cusecs and D₃=3.5 ft., the loss of head was 0.295 ft. (=0.885 ft. at Vir) and C_H was 0.852. The head lost (H) compared to experiment 1 (b) above—(previous conditions at Vir)—was 89.4 per cent, and the increase in C_H was 5.44 per cent.

Experiment No. 3

With expansion downstream of the gate of 1 in 10 and arched sluice expanding downstream for a length of 3' 4" (≈ 10 ft. at Vir); the bed, sides and arched top all diverging at 1 in 10—as shown in Fig. 11-5 and 11-10.

- (i) The area of waterway at the gate ≈ 16 sq. ft. in the prototype.
- (ii) Do. in the sluice ≈ 18.06 sq. ft.
- (iii) Do. at the end of the 10 ft. length of expansion downstream of the sluice ≈ 42.02 sq. ft.

With $Q \approx 720$ cusecs or discharge of 102.86 cusecs, through each span, the velocities at (i), (ii) and (iii) above worked out to 6.43 ft./second, 5.69 f/s, and 2.45 f/s respectively; i. e. the velocity at the end of the downstream expansion was reduced to 0.38 times the velocity at the gate.

Though there was some return flow downstream of the sluice, the flow was much less disturbed than in experiment 1.

With $Q = 6.6$ cusecs, and $D_s = 3.5$ ft., the loss of head was 0.26 ft. (≈ 0.78 ft. at Vir) and C_H was 0.910. The loss of head (H) as compared to experiment 1 (b) was thus 78.8 per cent and the increase in C_H was 12.7 per cent.

Fig. 11-6. *Experiment No. 4—Fig. 11-6*

Conditions were as in experiment No. 3; but the arch sector was filled with 1 in 3 divergence downstream of the gate.

$H = 0.268$ ft. (≈ 0.705 ft. at Vir) and $C_H = 0.957$.

The loss of head (H) compared with experiment 1 (b) was 71.2 per cent and the increase in C_H was 18.4 per cent.

Fig. 11-7. *Experiment No. 5—Fig. 11-7*

A bellmouth was then constructed upstream. A gap 2 $\frac{3}{4}$ " wide (≈ 8 " in prototype) was left between the upstream face of the existing masonry and the bellmouth, to allow the gate to pass through; but the gate was not fixed. Under these conditions, water was spilling into the gap left for the gate, thus causing interference with the flow.

With $Q = 6.6$ cusecs and $D_s = 3.5$ ft., H was 0.135 ft. (≈ 0.405 ft. at Vir) and $C_H = 1.264$ the loss of head (H) being 41 per cent, and the increase in C_H was 56.4 per cent compared with that in experiment 1 (b).

Fig. 11-8. *Experiment No. 6—Fig. 11-8*

In this experiment, water was prevented from spilling into the gap by raising the wall of the bell-mouth, and as a result H was further reduced to 0.24 ft. and C_H increased to 1.64, i. e. the loss of head (H) was 24.2 per cent of that in experiment 1 (b) and the increase in C_H was 103 per cent.

Experiments Nos. 7 and 8

In experiment No. 7 the arch sector behind the gate frame was filled with 1 in 2 top divergence instead of 1 in 3, other conditions being as in experiment 5, and water was allowed to spill into the gap; H was 0.138 ft. (≈ 0.414 ft.) and $C_H = 1.249$ against $H = 0.135$ ft. and $C_H = 1.264$ in experiment 5. In other words a 1 in 2 top divergence behind the gate frame was not so good as a 1 in 3 divergence.

In experiment No. 8 conditions were the same, but water was prevented from spilling into the gap. H was reduced from 0.138 ft. to 0.082 ft., and C_H increased from 1.249 to 1.619.

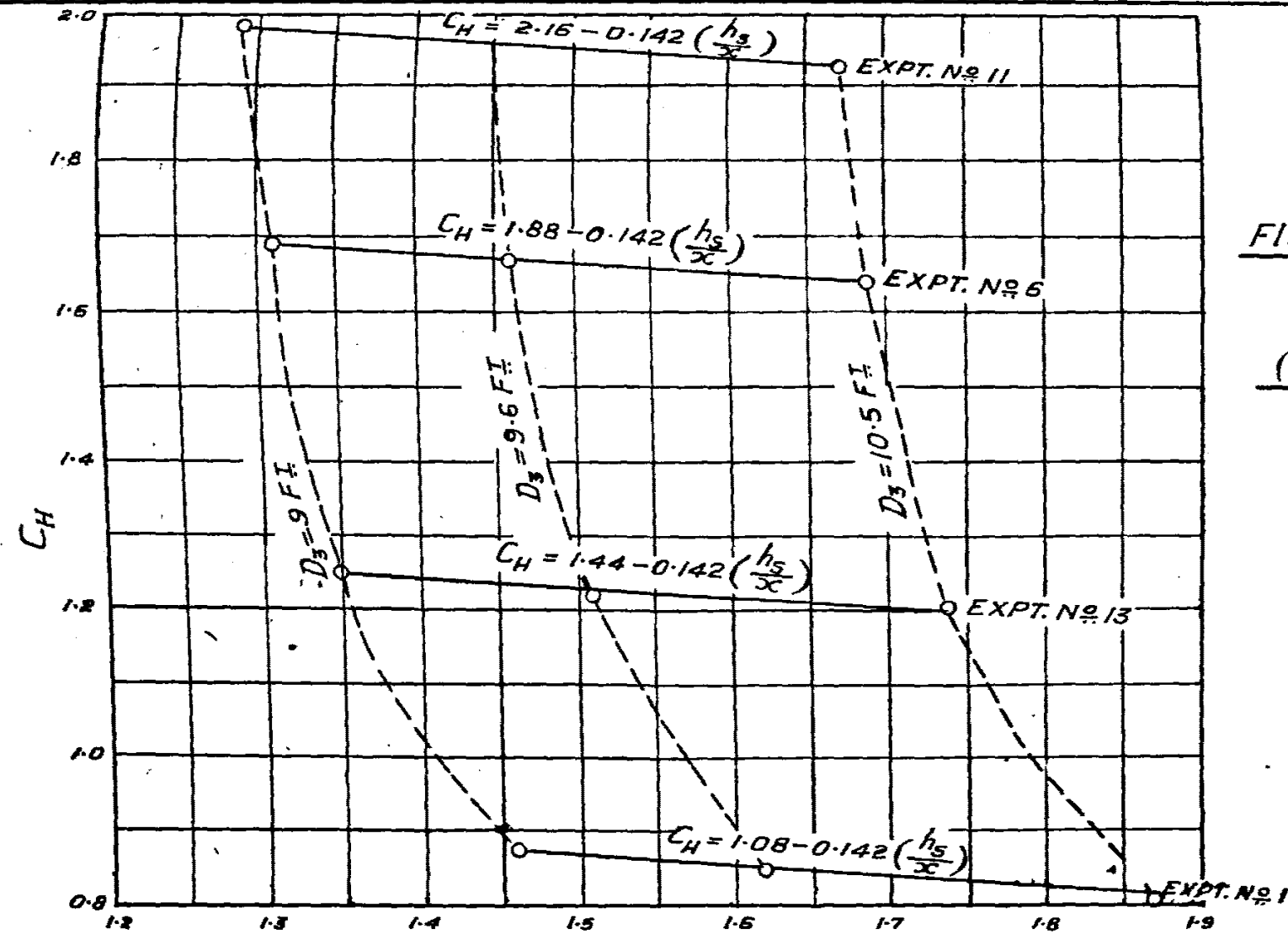

$\frac{h_s}{x}$, WHERE h_s IS HEAD U/S OVER SOFFIT AND
 x = OPENING OF SLUICE = 4 FT

By: Parkhi.

NO. 6140
 C.W. EXPT. STN. P. DOHA.
 (FIG. 10 FROM BOMBAY
 T.P. NO. 54)

FIG. 11-13, SHOWING CORRELATION

BETWEEN C_H & $\frac{h_s}{x}$

(NIRA L.B.C. HEAD REGULATOR MODEL.)

$Q = 720 \text{ CUSECS.}$

Experiments Nos. 9 and 10.

The top divergence in the arch sector downstream of the gate was then altered from 1 in 2 to 1 in 5. When water was spilling into the gap—experiment No. 9— H was 0.142 ft. and $C_H=1.232$; when no water was spilling into the gap in experiment No. 10, H was 0.084 ft. and C_H was 1.602, or 1 in 5 was inferior both to 1 in 3 and 1 in 2 top divergence behind the gate frame. 1 in 3 divergence was approximately the optimum.

Experiment No. 11

With a bellmouth upstream; the arch sector filled with 1 in 3 divergence downstream of the gate frame, and 1 in 10 divergence downstream of the sluice—Fig. 11-9 and 11-10.

Fig. 11-9,
11-10.

In this experiment, the gate was fixed upstream of the sluice, the bottom of the gate being flush with the bellmouth.

H was 0.058 ft. (≈ 0.174 ft. at Vir) and C_H was 1.927—the loss of head (H) being 17.5 per cent of that in experiment 1 (b) and the increase in $C_H=138$ per cent.

Experiments Nos. 12 and 13—Fig. 11-11

Fig. 11-11.

In this series of experiments, the 1 in 10 divergences downstream of the sluice were removed; otherwise the conditions were as in experiments 5 and 11. In experiment 12, the gate was not fixed and water was spilling into the gap; H was 0.227 ft. (≈ 0.781 ft. at Vir) and $C_H=0.974$.

In experiment No. 13, the bottom of the gate being flush with the bell-mouth, H was 0.149 ft. (≈ 0.447 ft. at Vir) and $C_H=1.202$. The loss of head (H) was 45.2 per cent that in experiment 1 (b) and the increase in C_H was 48.8 per cent.

Considering experiments 1 (b), 4, 11 and 13, it will be seen that the saving in head due to the downstream expansion without the upstream bellmouth (*vide* experiment No. 4) $\approx 0.99' - 0.705' \approx 0.285'$; whereas, the saving in head due to a bellmouth upstream without the downstream expansion (*vide* experiment 13) was $\approx 0.99' - 0.447' \approx 0.543'$ or nearly double the effect of the expansion; and when there was a bellmouth upstream and expansion downstream (*vide* experiment No. 11), the saving was $\approx 0.99' - 0.174' \approx 0.816$ ft.

(d) EFFECT OF THE DEPTH OF WATER IN THE CANAL
ON THE COEFFICIENT OF DISCHARGE

Experiments 1, 6, 11 and 13 were carried out with $D_s = 3.5$ ft. (≈ 10.5 ft. at Vir); 3.2 ft. ($\approx 9.6'$) and 3.0 ft. (≈ 9.0 ft.) and the coefficients of discharge were worked out. Fig. 11-13 shows the relationship between C_H and h_s/x . Fig. 11-13.

where h_s = head in ft. of water upstream over soffit of the sluice and x = the opening of the sluice = 4 ft.

It will be seen that as the depth decreased, the coefficient of discharge increased.

In experiments 6, 11 and 13—with a bellmouth upstream—surface vortices formed above the sluice when the downstream depth over the top of the gate was less than 3.3 ft; at this limit a vortex formed at 15" upstream of the bellmouth at long intervals alternately on either side of the Approach Channel through which a few air bubbles were sucked. As the depth downstream decreased, the vortex grew bigger in size—about 2" to 3" in diameter at the surface, and formed at more frequent intervals. The vortex formed when the pressure near the top of the gate entrance fell to less than the depth of superimposed water, due to the combined effect of high velocity and curvature of flow. The effect on the discharge due to air insuction was, however, negligible, and the value of C_H increased slightly as the depth of water decreased.

(E) Summary

- Fig. 11-4. (1) With the old design at the head of the Nira Left Bank Canal at Vir, the loss of head with $Q=720$ cusecs and $D_s=10.5$ ft.—experiment 1 (b), Fig. 11-4—was equivalent to 0.99 feet and $C_H=0.808$.
- (2) Filling in the sharp roof expansion downstream of the gate frame by a 1 in 3 top divergence—which was found to be the best divergence—reduced the head by 10.6 per cent and $C_H=0.852$.
- Fig. 11-6. (3) The addition of an expansion 10 feet long, downstream of the sluice, with 1 in 10 divergences, reduced the head by 28.8 per cent and $C_H=0.957$ —experiment 4, Fig. 11-6.
- Fig. 11-11. (4) A bellmouth (without a 1 in 10 downstream expansion) reduced the head by 54.8 per cent and $C_H=1.202$ —experiment 13, Fig. 11-11.
- Fig. 11-9, 11-10, 11-7. (5) The two combined reduced the head by 82.5 per cent and $C_H=1.927$ —experiment 11, Fig. 11-9 and 11-10.
- (6) In experiment 5 (Fig. 11-7) with water spilling over the bellmouth block into the gate gap, H was 0.405 feet and $C_H=1.264$. In experiment 6 with bellmouth raised above water level and spill stopped, H was reduced to 0.240 feet and $C_H=1.640$. Similarly, in experiments 7, 8, 9 and 10, figures were—

Experiment No.	H (ft.)	C_H
7	0.414	1.249
8	0.246	1.619
9	0.426	1.232
10	0.252	1.602

When the gate was added in experiment 11, its bottom being flush with the bellmouth, H was reduced to 0.174 feet and $C_H=1.927$.

These results showed how important it was to bring the bellmouths above water level—to prevent spill—and to have gates which, when closed, are flush.

A module could probably be evolved, based on this principle, for waterworks regulation; but it would not be reliable for irrigation outlets, because it could be easily tampered with and would be liable to get choked with floating matter.

(7) The coefficient of discharge increased slightly as the water depth in the canal decreased—Fig. 11-13— C_H varying from 0.808 with 10.5 feet to 0.877 with 9.0 feet depth in experiment No. 1 (b) (the existing design); and from 1.927 with 10.5 feet to 1.978 with 9.0 feet depth in experiment No. 11—with a bellmouth upstream and 1 in 10 divergence downstream and gate flush. This was the best result obtained.

(8) It was originally proposed to increase the head regulators to 10 spans at a cost of Rs. 20,000, and the head required, would have been 6". With a bellmouth upstream and 1 in 10 expansions downstream, costing Rs. 5,800, the head required was only 2 inches.

(9) The reduction of loss of head into the Nira Left Bank Canal, at Vir, was important; because the crest of Vir weir was 11.0 feet above the sill of sluices—so with water in Vir basin at 10.7 feet, which is the normal maximum level, the maximum discharge that could be passed was 670 cusecs; but with the bellmouth and expansion added, the full 720 cusecs could be passed with some free-board to spare.

(10) With the same depth upstream and downstream as in experiment 1 (b) and the same design as in experiment 11, $C_H=1.89$ (from the formula $C_H=2.16-0.142(h/X)$) as against $C_H=0.808$; i.e. the discharge would be increased 2.3 times—in other words, the discharge of sluices (of the ordinary type installed at the head of the Nira Left Bank Canal) could be more than doubled by remodelling on quite simple lines.

FLUMING

Alternatively the same discharge could be obtained with 1/6th the head. In practice the results were not quite so good, due to increased losses induced in the canal.

(11) Inferior results were obtained when the velocity through the barrel exceeded \sqrt{gD} —where D=height of barrel of sluice.

11.05. A CASE IN WHICH THE EFFECT OF FLUMING WAS OVERLOOKED

It was desired to pass an increased discharge through an aqueduct, in which there was a central wall which divided the flow into two channels.

With the *intention* of increasing the discharge, without having to increase the water level through the aqueduct, the central wall was removed. When, after the central wall had been removed, the same discharge as before was passed through the aqueduct, the water level in the aqueduct rose several inches and overflowed the side walls.

The explanation is clear if Bernouilli's theorem is borne in mind.

$$\frac{p}{w} + \frac{V^2}{2g} + Z = \text{const.}$$

because, as the kinetic energy head decreased, the pressure head, i. e. the depth—necessarily increased.

REMODELLING AND MAXIMUM RUN-OFF

CHAPTER 12

POINTS WORTH CONSIDERING WHEN DESIGNING AND
REMODELLING CANALS AND RIVER WORKS

	Page
12.00. Introduction	407
12.01. The misuse of groynes	407
12.02. Interference with natural flow round a bend	407
12.03. Objections to inducing an increased charge of sand to enter a canal to reduce scour in its head reaches	408
12.04. Relative merits of canal falls and regulators for absorbing excess energy	408
12.05. "Maximum flood" formulae	409
12.06. Annual run-off from catchments	418

CHAPTER 12

POINTS WORTH CONSIDERING WHEN DESIGNING
AND REMODELLING CANALS AND
RIVER WORKS

12.00. INTRODUCTION

The first point for consideration is whether in any particular case the aim should be to make the design foolproof, and hence rigid; or to have a flexible design, liable to future misuse.

Experience shows that water generally behaves quite differently from what commonsense would lead one to expect; so, even the most intelligent will blunder unless they are restrained by long experience or sound advice. Unfortunately, a considerable proportion of irrigation engineers who have little knowledge of hydrodynamics and still less of the complex factors which determine the behaviour of rivers, consider themselves competent to issue orders on river control problems merely because they have, in the course of years, become senior. The result has nearly always been disastrous; yet the same mistakes are repeated, again and again, just as soon as the last blunder has been forgotten. For this reason, there is much to be said for foolproof designs.

A few examples of oft-repeated mistakes will be stated in the hope that those about to commit them will be deterred.

12.01. THE MISUSE OF GROYNES

The most general mistake is to construct a groyne at the point where attack is taking place, or is anticipated—the idea being that a groyne can be used to deflect flow away from the point of attack. Actually, such a groyne attracts flow towards it, and hence intensifies the attack. This was well-known sixty years ago, and probably long before that; and the experienced have long considered that rigid training works were anathema.* Though this is not quite true, it is a good working rule for the inexperienced.

In general, it is unwise to attempt to resist attack where it is fiercest—unless there is no alternative; but the energy of flow of a river can often be utilised in such a way that the desired result is attained at a relatively small cost. In general, this can best be done by attracting flow away from the point of attack, by an attracting groyne constructed on the opposite bank or by a suitably-positioned repelling groyne.

12.02. INTERFERENCE WITH NATURAL FLOW ROUND A BEND

Fig. 1-5 shows a cross section of a river flowing round a bend, the depth being very much greater at the outside of the bend than near the inside, due to the velocity at the outside being much higher than at the inside. Despite this fact, there is a tendency for engineers to design bridges with piers of uniform depth from bank to bank and to throw stone into the deeper portions in an attempt to maintain a constant depth of scour across the river.†

When this is done, flow becomes seriously distorted, and erosion takes place on the outside of the curve downstream of the bridge, with serious consequences—as at Surat, where the City's walls, which extend up to the river's edge, were undermined.‡

* See Discussion by F. J. Salberg and Reply, Inst. C. E. Maritime Paper No. 3 "Training Works constructed in the Rupnarain River in Bengal" by Sir Claude Inglis, C. I. E.

† I. W. E. S., A. R. (T) 1944 pp. 87-90.

‡ I. W. E. S. A. R. (T) 1944 p. 87-90.

THE BEHAVIOUR AND CONTROL OF RIVERS AND CANALS

A second example is where a barrage is built on a bend—as was the case at Sukkur. The water-level at the outside of the bend is then considerably higher than at the inside, and the discharge through the spans at the outside of the curve is also greater than at the inside of the curve. Normally this is not interfered with, but orders were issued in 1943-44 to maintain a constant discharge through all the spans of the Barrage at Sukkur; and as a result, flow was highly distorted, and afflux increased by more than a foot.

It should be recognised that Nature knows her job best; and though she can be persuaded to do what is desired by tactful treatment, she resents being coerced.

12.03. OBJECTIONS TO INDUCING AN INCREASED CHARGE OF SAND TO ENTER A CANAL TO REDUCE SCOUR IN ITS HEAD REACHES.

Where the bed of a canal is scouring, attempts have sometimes been made to check this by regulating so as to pass a large charge of coarser material into the canal during the flood season. This is unsound, because even though the excess material may temporarily check scour near the canal head, it is subsequently carried down the canal in the fair weather season and will eventually clog those channels which have insufficient slope to carry the increased charge.

The only conditions under which it is justifiable to pass an increased charge into a channel is in order to relieve another channel which has too flat a slope to carry its load.

There seems to be an idea that if trouble should arise in a canal due to excess sand having been passed into it, this can be checked by merely excluding sand when the trouble arises. Actually, however, once the sand has entered a canal it has to be accommodated somewhere in the system. At first this may not cause trouble, or may even improve matters near the head; but after a few years the increased charge will reach a part of the canal where it will cause trouble; and stopping the excess sand at the head when trouble starts will not prevent the excess which has been entering for several years continuing to pass down the canal, and this will continue until the whole excess has been absorbed.

A good example of this is the Mithrao Canal into which a heavy charge of sand began to pass when the Eastern Nara was remodelled to form part of the Barrage system of canals.* Though the excess charge was excluded before the full supply discharge at the head of the canal had been seriously reduced, the sand which had previously entered the canal was carried down to the middle reaches, causing the bed and water-level of the canal to rise considerably so that the banks had to be raised by several feet. Still more serious damage will result when the coarse material passes into distributaries with flat gradients, reducing their discharges, and interfering seriously with irrigation—necessitating continuous removal of sand.

12.04. RELATIVE MERITS OF CANAL FALLS AND REGULATORS FOR ABSORBING EXCESS ENERGY

Where it is possible to predict the slope of a canal, a fall has the merit that the canal will stabilise to a natural regime and the fall can be designed so that downstream scour is eliminated; whereas with a regulator a mistake in regulation may have serious consequences. For example, the Author has known a case in which a 40 ft. scour-hole was developed below a regulator in a few hours as a result of an Assistant Engineer 'trying out' the relative merits of various methods of regulation.

* C. I. & H. R. S. A. R. (T) 1940-1 p. 16.
1941-42 p. 19.

REMODELLING AND MAXIMUM RUN-OFF

Another argument in favour of a fall is that there is much less danger of water being headed up above full supply level than is the case where there is a regulator; because an unauthorised level cannot be explained away in the case of a fall, the water level being automatically determined by the discharge.

Where, however, the slope of a canal cannot be predicted with certainty—as is generally the case—a regulator is preferable, because it gives much more freedom of control. The difficulty of predicting slope was exemplified by canals taking off from the Right and Left Banks of the Sukkur Barrage; it was assumed that the slope would be the same for the same discharge in the Right and Left Bank Canals; and the designed slope in the Rohri and Rice Canals was 1 in 12,000. The slope in the Rohri Canal on the left Bank flattened, however, to 1 in 20,000; whereas the slope in the Rice Canal steepened to 1 in 8,000.

Water levels upstream of a fall can only be satisfactorily raised or lowered by narrowing or widening the throat, or by raising or lowering the crest—the latter necessitating reconstruction on a large scale—so any considerable retrogression downstream will necessitate a large amount of rebuilding. For this reason falls are not satisfactory where the slope cannot be foreseen, unless a regulator is also constructed some miles downstream, which can be used to head up water should this be desirable in order to maintain the downstream water level within the suitable range. Probably the best solution is to dissipate energy on a large scale by a fall, supported by a downstream regulator to 'take up' unpredictable variations.

In the light of the above example, the Author feels that it is generally better to design foolproof structures rather than run the risk of serious damage resulting from bad regulation of sand and water. This assumes, however, that those responsible for the original designs know their job thoroughly. Unless this is the case, the less rigid the designs the better—because mistakes can then be rectified.

12.05. "MAXIMUM FLOOD" FORMULÆ

Empirical run-off formulæ are at present apt to be swept aside; either because they have not applied in a particular case or because they are considered to be unscientific, or out-of-date. It seems desirable, therefore, to explain the uses and limitations of such formulæ.

HISTORICAL

Three empirical "maximum flood" formulæ and Whiting's curve (Bombay) have been widely used in India—Fig. 12-1.

Fig. 12-1

$$\text{Colonel Dickens' formula (Bengal)} \quad Q_{\max} = 825 A^{\frac{3}{4}} \quad \dots (1)$$

$$\text{Ryves' formula (Madras)} \quad Q_{\max} = C A^{\frac{2}{3}} \quad \dots (2)$$

$$\text{Inglis' fan-catchment formula} \quad Q_{\max} = \frac{7000 A}{\sqrt{A+4}} \quad \dots (3)$$

where Q_{\max} = maximum flood discharge,

A = area of catchment in square miles,

C = a coefficient which Ryves put at 450 within 15 miles of the sea; 562.5 from 15 to 100 miles and 675 for limited areas near hills.

THE BEHAVIOUR AND CONTROL OF RIVERS AND CANALS

Note—Dickens' formula was based on only 4 points. He assumed :

- (1) A maximum rainfall on 8 acres of 4" an hour.
- (2) Sir P. Cautley's rule of $\frac{1}{2}$ " an hour for small rivers (50 sq. miles).
- (3) Flood discharge equal to 1/8 inch per hour from the 7,000 sq. miles of the Damodar catchment, and
- (4) A flood discharge observed on the Son equal to 1/10 inch per hour over the whole area of 27,000 sq. miles.

Two points in these formulæ are worth noting :

(i) the exponent has progressively decreased from $\frac{3}{4}$ in the earliest formula to $\frac{1}{2}$ in the latest ;

and (ii) the estimated run-off has progressively increased—except that Ryves figures were lower than Dickens; but Ryves figures were meant to apply to designing the suitable waterway of structures rather than predicting the maximum possible flood and, as a consequence, they were lower.

Subsequently, various engineers have adopted higher coefficients both for Ryves' and Dickens' formulæ—up to 1,600 being used.

TABLE 12-I.

*Indian Data (Bombay Presidency) fan-shaped catchments
(from Bombay P. W. D. Tech. Paper 30)*

S. No.	Name of River and gauging site.	Catchment area in sq. miles.	Maximum discharge in cusecs.
29	Ekruk Tank	159	88,269
30	Mutha at Khadakwasla Dam	196	75,106
31	Kadva at Palkhed	314	54,116
32	Koyna at Helvak	359	113,064
33	Vardha at Banwasi	444	85,029
34	Aner at Ganpur	502	169,168
35	Hathmati at Himatnagar	524	158,112
36	Mula at Chikalthan	581	45,647
37	Mula at Tas	591	62,940
38	Pravara at Ojhar	621	38,694
39	Vaghur at Raipur	700	47,795
40	Nira at Vir	700	10,000
41	Panjhra near Nahalad	802	177,018
42	Mula-Mutha at Jamsetji Bund, Poona	884	166,262
43	Mula at Rahuri	900	74,285
44	Panjhra near Madhi Amalner	1057	184,959
45	Girna near Malegaon, Nasik	1064	169,318
46	Ghatprabha at Dhupdal Weir	1080	184,500
47	Godavari at Nandur-Madhmeshwar	1650	192,181

REMODELLING AND MAXIMUM RUN-OFF

*Indian Data from Note "Statistics of Flood Protective works,
Irrigation & Hydro-electric Schemes",
by Mr. Edgewcombe (No. J152)*

S.No.	River.	Locality.	Catchment area in sq. mile.	Maximum dis- charge in cusecs.
48	Gangan	United Provinces	97	24,225
49	Garai	U. P. (Karman)	113	85,000
50	Ratman	U. P. (Dhanapuri)	120	50,000
51	Kho	U. P. (Headworks)	190	50,060
52	Amlawa Nadi	U. P. (Kalsi Bridge)	960	200,000
53	Poonch	Punjab	1,810	450,000
54	Dasan River at Pahari.	U. P.	3,026	450,000
55	Jumna	U. P. (Faizabad)	4,600	550,000 to 600,000
56	Keu	U. P. (Gangao)	7,199	590,000
57	Damodar	Bengal	7,200	664,000
58	Ganges	U. P. (Raiwala)	8,660	775,000
59	Ganges	U. P. (Raiwala)	9,800	629,214
60	Betwa	U. P. (Pericha)	10,300	700,000
61	Son	Dehri (Bihar)	24,000	214,000
62	Mahanadi	Naraj Weir (Orissa)	50,000	1,543,430
63	Cossye	Mohanpur Anicut (Bengal)	2,260	220,308
64	Brahmani	Orissa (Jenapur)	14,000	643,290
65	Chenab	Marala (Punjab)	11,110	718,000
66	"	Alexandra Bridge	12,465	978,000
67	"	Khanki Bridge	13,202	947,000
68	"	Rivaz Bridge	17,961	650,000
69	"	Sher Shah Bridge	61,614	535,000
70	Indus	Attock Bridge	103,476	818,000
71	"	Kalabagh "	111,900	819,000
72	"	Ghazighat "	138,778	700,000
73	Jhelum	Kohala (Punjab)	9,787	349,000
74	"	Mangala "	13,352	760,000

THE BEHAVIOUR AND CONTROL OF RIVERS AND CANALS

S. No.	River.	Locality.	Catchment area in sq. miles.	Maximum discharge in cusecs.
75	Jhelum ...	Rasul (Punjab)	15,050	875,000
76	Lehri Khámwah River.	Baluchistan	1,344	85,000
77	Kakar Lora ...	"	720	7,984
78	Barshore and Tormorgha.	"	300	11,880
79	Nari Rivers ...	"	10,716	148,600
80	Khaisar River ...	"	432	7,917

Data collected by the Indian Waterways Experiment Station, Poona

81	Silauria nala ...	C. P. & Berar	187	111,300
82	Pariat nala ...	"	42	42,890
83	Lalpuri Tank ...	Rajkot State	32	36,600
84	Nala upstream of M. & S. M. Ry. Bridge No. 445.	Guntkal-Bezawada section of M. & S. M. Ry. at mile 453.	8.35	14,000
85	Karamnasa ...	Silhat weir, U.P.	200	84,777
86	Karamnasa ...	Deodari, U. P.	345	126,000
87	Jawai River ...	Erinpura (Jodhpur State).	304	127,000

Fig. 12-2. When writing "A critical study of run-offs and floods of catchments of the Bombay Presidency", the Author found that nearly all the data for small catchments in Bombay Presidency were for floods measured at masonry works—canal culverts, super-passages, weirs, etc.—and as a consequence, flood absorption and deflection of flow into adjoining Nalas—due to ponding by the canal banks—greatly reduced the discharges. This explains the marked curvature of Whiting's curve, Fig. 12-1. There is, however, also a natural hump in curves bounding maximum run-off data, Fig. 12-3. This is connected with the area that is effectively covered by a maximum storm. Obviously, if the high intensity portion of a storm does not cover the whole catchment, the run-off must be relatively much less than where it does. Thus Fig. 12-3 shows that the discharge per sq. mile decreased relatively slowly for catchment up to 160 sq. miles and then fell away. For this reason a straight line exponential formula like that of Messrs. Khangar and Gulhati† gives widely wrong results for large and small catchments.

Another important factor is "time of concentration" and hence the shape of the catchment. Hence, any general formula must be modified where the catchment is not of the standard shape. Such formulae must not, therefore, be applied blindly, nor should they be condemned blindly.

* Technical Paper No. 30, Bombay P.W.D. 1930, by C. C. Inglis and A. J. Desouza.

† "Rainfall Run-off" by S. D. Khangar and N. D. Gulhati, Punjab Engineering Congress Paper 245 of 1941.

FIG. 12-1
RELATION OF
RUN-OFF : CATCHMENT AREA
ACCORDING TO VARIOUS FORMULAS

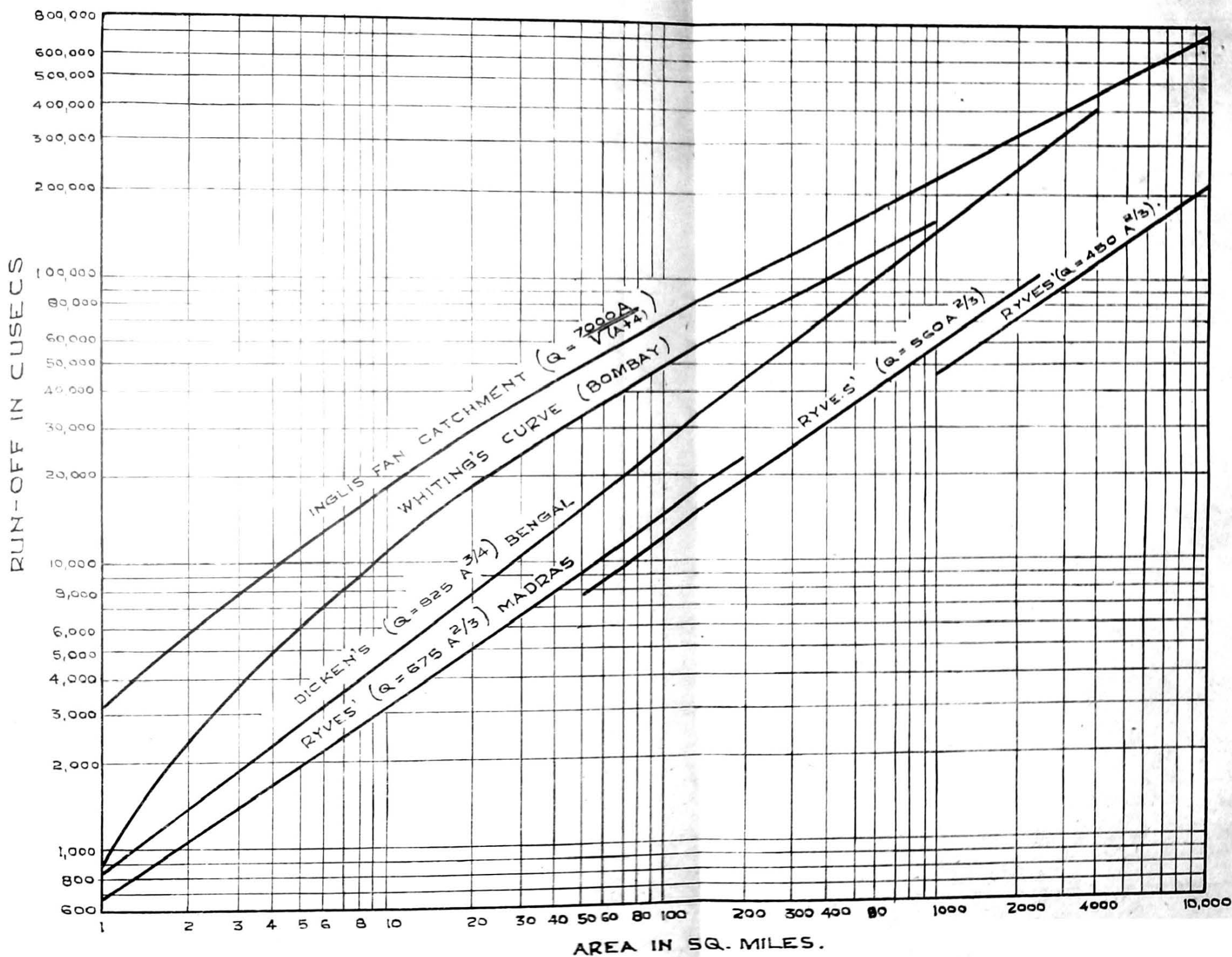

FIG. 12-2

GRAPH SHOWING EXTRAORDINARY FLOODS : CATCHMENT AREA

REFERENCES:-
⊙ (29 TO 47) BOMBAY PRESIDENCY DATA (FAN SHAPED CATCHMENT.)
X (48 TO 87) INDIAN DATA (EXCLUDING BOMBAY PRESIDENCY)

INGLIS FAN
CATCHMENT FORMULA
 $Q = 7000 \frac{A}{\sqrt{A+4}}$

A15

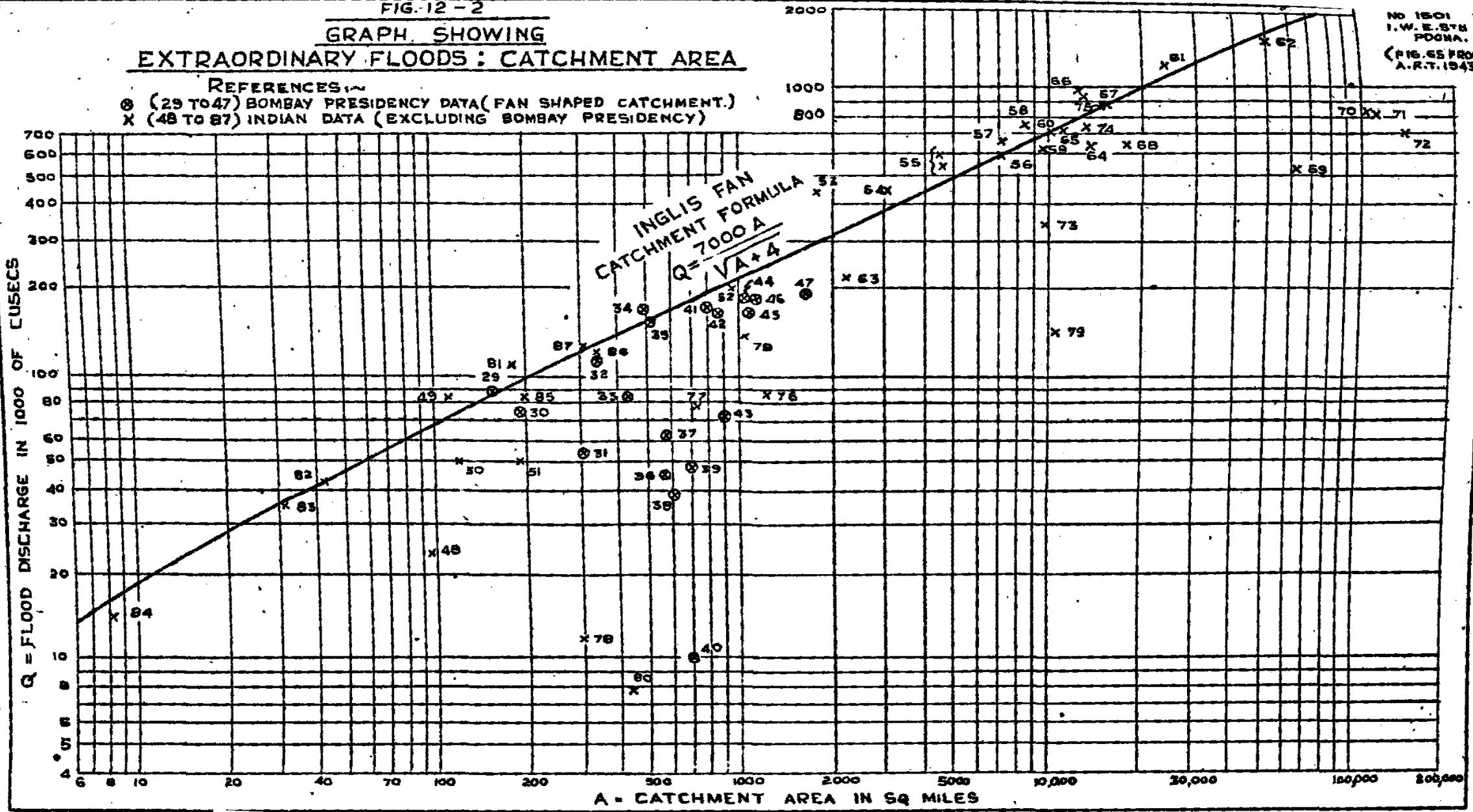

NO 1501
I.W.E.S.T.B.
POONA.
(FIG. 65 FROM
A.R.T. 1943)

This raises a point of very great importance in using empirical run-off formulae: Though the fan-catchment run-off formula gives a very good idea of the maximum run-off from a fan-catchment, it does not give any indication of whether a maximum flood will occur once, or fifty times, in a thousand years.

A general formula does not, in fact, absolve local officers from using their brains, nor should it prevent them referring cases for advice.

Where flood data are available for a period of years, the question can be clarified by plotting "probability" curves for the catchment under consideration. Figures 12-4 and 12-5 show such curves for the Girna and Damodar Rivers respectively.

Fig. 12-4,
12-5.

The slope of the relatively small Girna catchment probability curve is steep, indicating that a much larger flood than recorded in the period of observation may be expected to occur, whereas in the case of the Damodar, two floods have been reported which are much higher than was to be expected from the rest of the record, indicating that no considerably larger flood is likely to occur, unless those storms were entirely different in character. There are some areas in India, like Baluchistan, where rain is so rare and storms so small that the chance of a maximum flood occurring may be said to be nil. There are other areas, like the cyclone areas of Bengal and Orissa, and the Western Ghats, where floods approaching maxima are liable to occur several times in a hundred years.

The only way to decide this question is by judgment, based on past experience and records; but in examining these, one point of importance should be borne in mind: Maximum storms tend to occur more frequently in medium-sized catchments than in very large or very small catchments. The reason for this is that in the case of very small catchments the probability of the heart of the storm passing over the small catchment is remote; while in the case of a very large catchment, the rain storms rarely, if ever, cover the whole of the catchment.

Very large catchments should generally be looked on as consisting of several rivers. Each of these has a small fan-catchment at its upper end, followed by long stretches in which there may be little replenishment from affluents and much reduction of discharge due to flood absorption as the flood flows down the river. In such cases a highly detailed analysis is necessary. The reduction of discharge due to flood absorption in long narrow catchments is very considerable and should be allowed for; but this tends to be neutralised when the storm moves down the catchment with the flood.

In deciding what maximum flood to allow for, judgment must be used as to whether a risk may be taken, or not. If a dam is to be built above a town, no risks can be taken; but if such damage as will occur—say once in a hundred years or more—can be easily rectified, it will often be unnecessary to design for a maximum flood—a "breaching section" may be provided.

To sum up:—No flood which is greatly in excess of the Inglis fan-catchment formula will occur under Indian conditions, but much larger floods have been recorded in an area of abnormal floods in some of the southern United States. If the provision made is much less than according to this formula, there should be clear-cut reasons for the reduction.

The fact that no storm of the magnitude shown by this formula has been recorded in say, 100 years, does not show that such a storm may not occur at rare intervals. Its probability can be roughly estimated by plotting available data on probability paper.

12.06. ANNUAL RUN-OFF FROM CATCHMENTS

Fig. 12-6. Fig. 12-6 shows the relationship of annual run-off to annual rainfall in 'ghat catchments' in Bombay.

Similar formulae, with slight modification of the coefficient and the deduction in inches allowed for evaporation and transpiration, have been found to apply equally well in other parts of India.

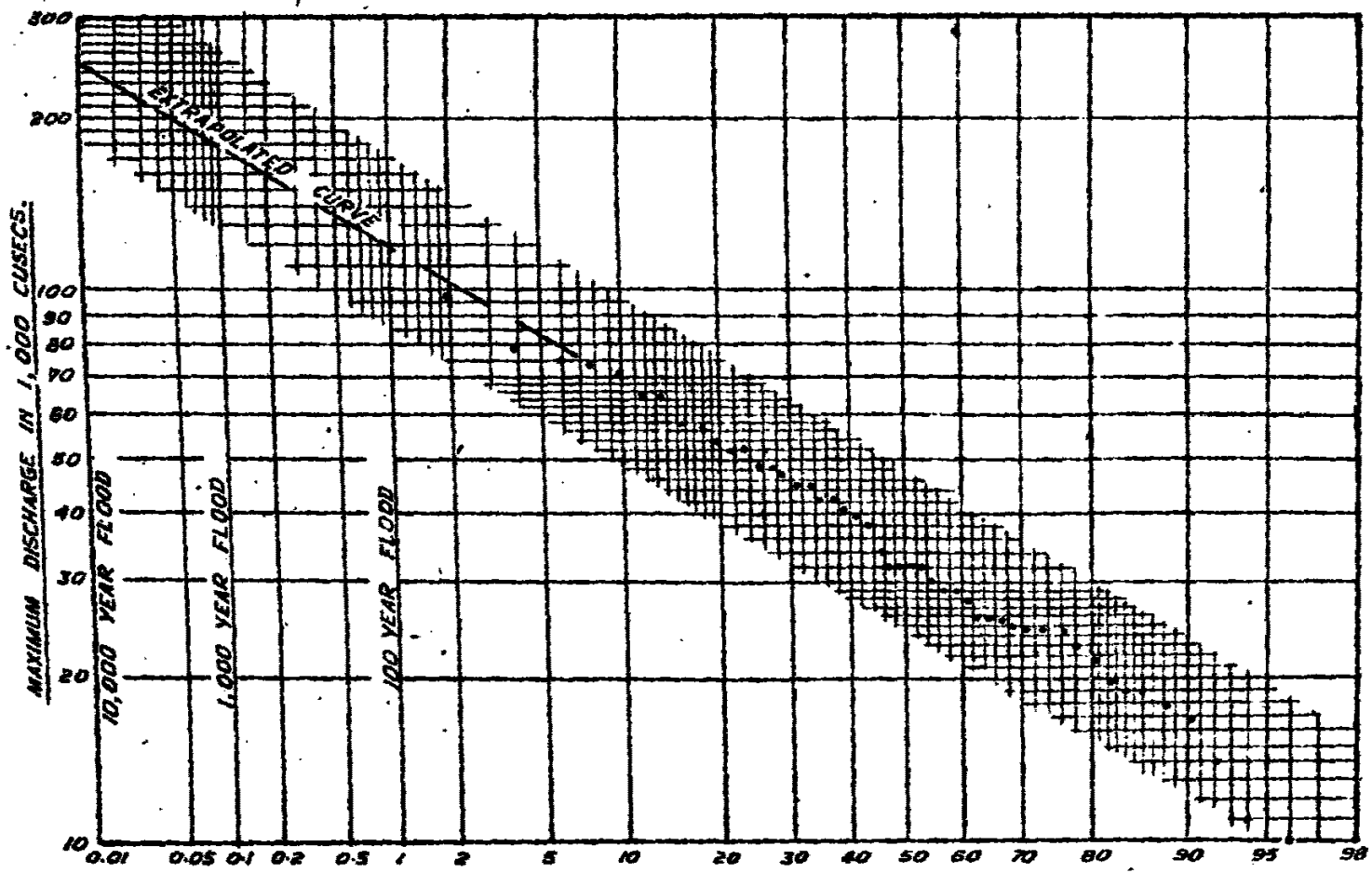

FIG. 12-4
RIVER GIRNA AT
JAMDA WEIR.

PROBABILITY PLOTTING OF MAXIMUM FLOODS.
(BASED ON THE PERIOD 1871 TO 1925.)

By: DAMPH.

617

FIG. 12-5
DAMODAR RIVER
AT
RANIGANJ

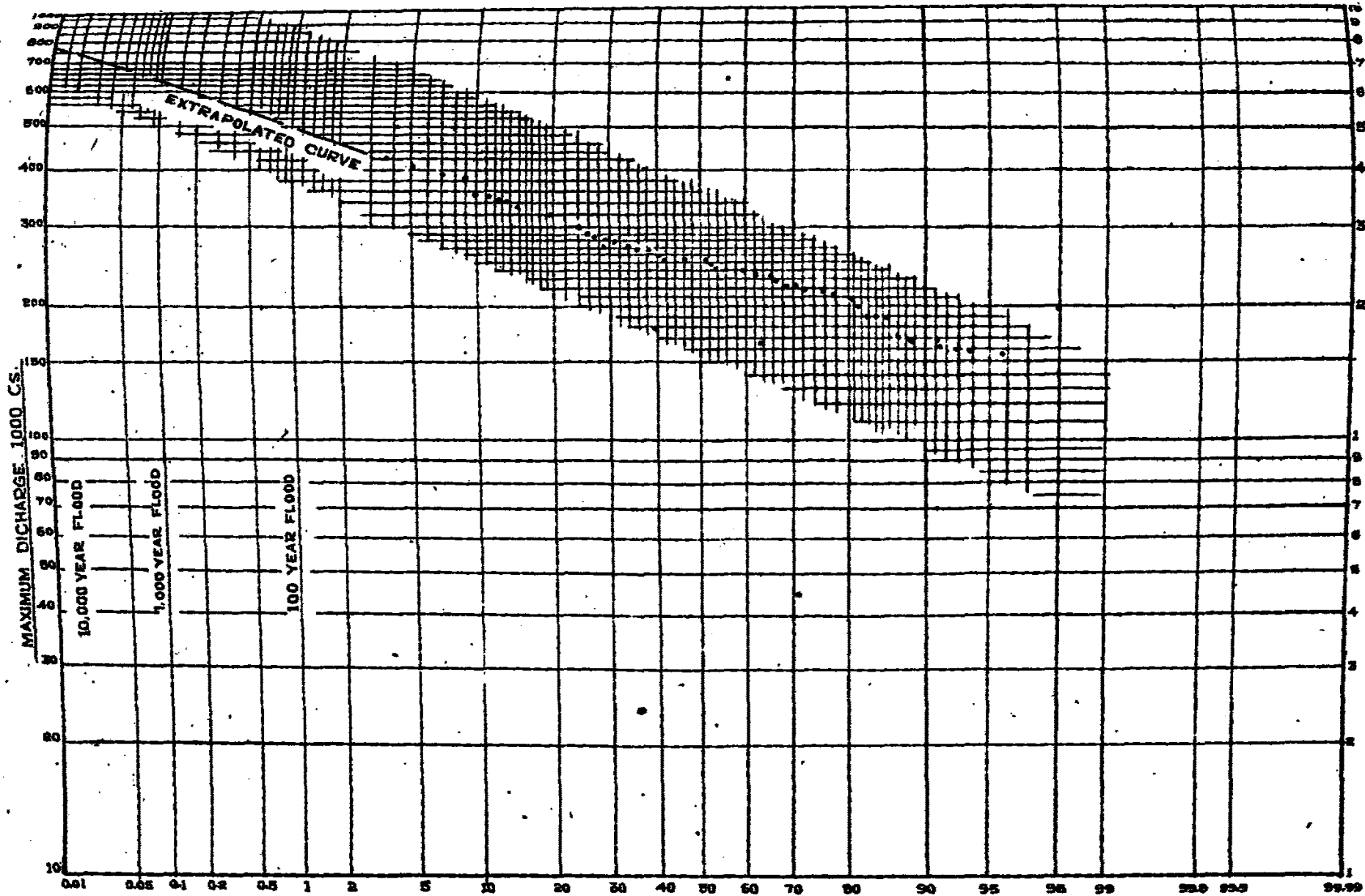

PROBABILITY PLOTTING OF MAXIMUM FLOODS.
BASED ON THE PERIOD 1857 TO 1937

127

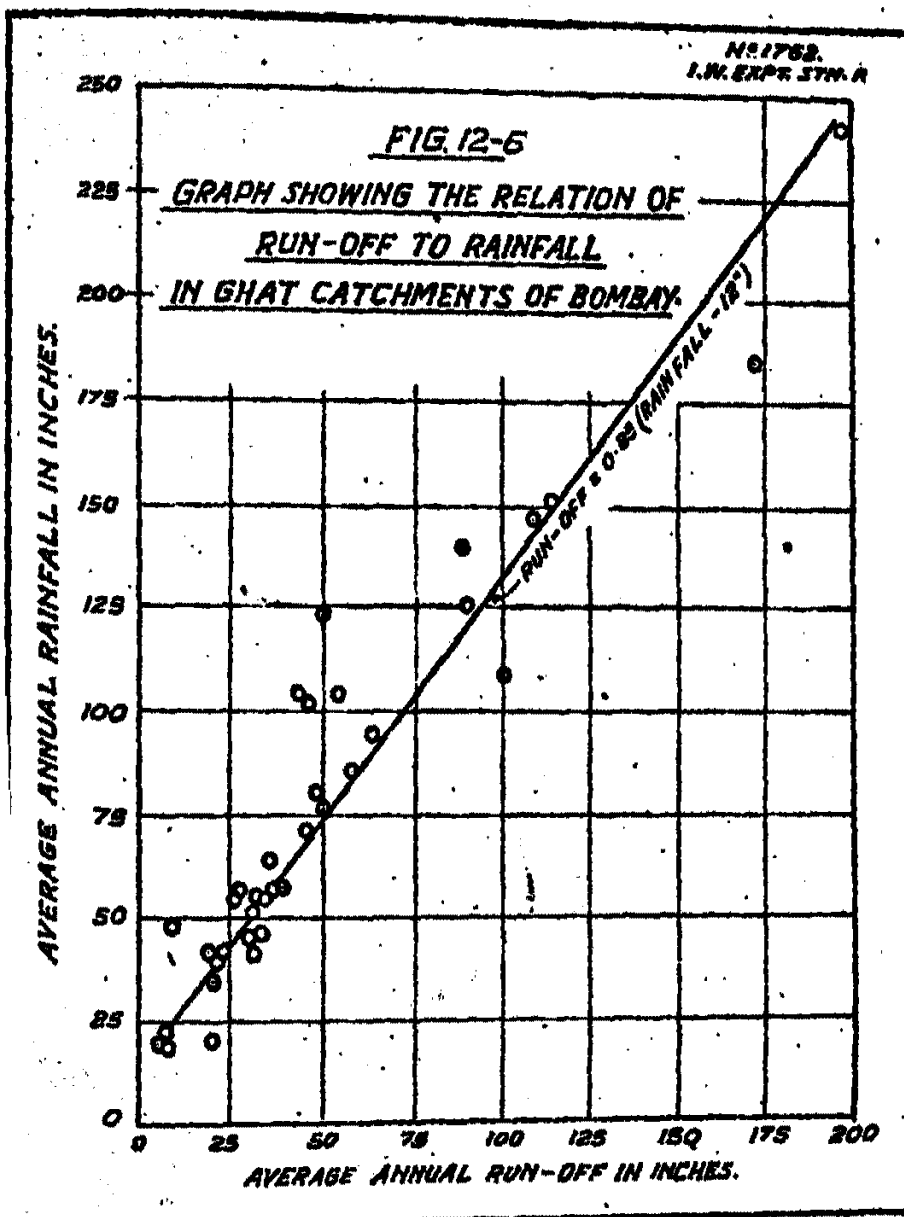

(FIG. 3 FROM A. R. T. 1940-41 OF C. I. AND H. R. STN.)

MODEL SCALE RATIOS AND LIMITATIONS

CONTENTS

CHAPTER 13

METHODS FOLLOWED IN FIXING MODEL SCALE RATIOS AND
OVERCOMING MODEL LIMITATIONS, BASED ON EXPERIENCE
GAINED AT THE INDIAN WATERWAYS EXPERIMENT
STATION, POONA

	PAGE.
13.00. Introduction.	427
13.01. Types of models.	428
Type I—Geometrically-similar models which give geometrically-similar results	428
Type II—Geometrically-similar models which do not give geometrically-similar results... ..	428
Type III—Vertically-exaggerated models (A) tidal and (B) river ...	428
(a) Rigid	428
(b) Semi-rigid	428
(c) Mobile	428
<i>Type I. Geometrically-similar models which give approximately geometrically-similar results.</i>	
13.02. General remarks	428
Rigid (a) Coefficients of discharge of rigid structures ...	428
(b) Standing wave relations. ...	428
Semi-rigid (c) Lines of flow at off-takes ...	428
(d) Scour downstream of falls. ...	428
13.03. Example I (a) (i) Coefficient of discharge of Standing Wave Flumes ...	428
13.04. Example I (a) (ii) Determination of the variable coefficient of discharge of the 10,595 cusecs Tando Mastikhan Fall on the Rohri Canal, Sind ...	430
13.05. Example I (a) (iii) Coefficient of discharge of Nira Left Bank Canal Head Regulator ...	431
13.06. Example I (b) (i) Position of Standing Wave with various discharges, and different designs of sill, at Sukkur Barrage ...	431
13.07. Example I (c) (i) Design of off-take at the entrance to the Right Pocket where it takes off from the Approach Channel at Sukkur..	431
13.08. Example I (c) (ii) Lines of flow at offtakes ...	432
13.09. Example I (d) (i) Scour downstream of flumed falls ...	432
13.10. Types I and II in combination in siphon spillway ...	433
<i>Type II. Geometrically-similar models which do not give similar results</i>	
13.11. Example II (i) High coefficient weirs ...	434
<i>Type III. Vertically-exaggerated models</i>	
13.12. Introduction ...	439
<i>Type III. (A) Tidal models</i>	
13.13. Reynold's criterion for turbulent flow in tidal models ...	439
13.14. Scale ratios of tidal models ...	439
<i>Type III. (A) (a) Vertically-exaggerated rigid tidal models</i>	
13.15. Use of rigid tidal models ...	441
13.16. Example III (A) (a) (i) Rigid tidal model of the Hooghly ...	441

THE BEHAVIOUR AND CONTROL OF RIVERS AND CANALS

	PAGE.
<i>Type III (A) (b) Semi-rigid vertically-exaggerated models</i>	
13.17. The use of semi-rigid tidal models	441
13.18. Example III (A) (b) (i) Hooghly tidal model run as semi-rigid model	442
<i>Type III (A) (c) Mobile tidal models</i>	
13.19. Example III (A) (c) (i) Short, large-scale, mobile tidal model of the Hooghly...	442
13.20. Example III (A) (c) (ii) Port of Rangoon tidal model...	442
<i>Type III (B) River models</i>	
13.21. General remarks	443
<i>Type III (B) (a) Vertically-exaggerated rigid river models.</i>	
13.22. The use of rigid river models	443
<i>Type III (B) (c) Vertically-exaggerated mobile river models</i>	
13.23. The use of mobile river models....	444
13.24. Selection of scale ratios for vertically-exaggerated river models	445
I Length scale ratio	445
II Width " "	445
III Discharge,, "	445
IV Sand " "	445
V Depth " "	445
VI Slope " "	445
VII Time " "	445
13.25. I. Length scale ratio.	445
13.26. II. Width scale ratio	445
13.27. III. Discharge scale ratio	445
13.28. IV. Depth scale ratio	446
13.29. V. Slope scale ratio	446
13.30. VI. Time scale ratio	447
13.31. v II. Sand scale ratio	447
<i>Some of the major difficulties experienced in river model experimentation</i>	
13.32. (i) Exaggerated vortices and scour-holes in vertically-exaggerated models	447
13.33. (ii) Incorrect "throw-off" in a vertically-exaggerated model	447
13.34. (iii) Exaggerated length of standing wave downstream of Naraj Weir in the Mahanadi model	448
13.35. (iv) Necessity of having different vertical scale ratios for rigid and non-rigid portions of models	449
13.36. (v) Longitudinal distortion	450
13.37. (vi) Necessity of tilting Naraj Weir in the Mahanadi model	450
13.38. (vii) Different time-scales for scour and accretion	450
13.39. Conclusions regarding hydrodynamic model experimentation	451

CHAPTER 13

METHODS FOLLOWED IN FIXING MODEL SCALE RATIOS
AND OVERCOMING MODEL LIMITATIONS, BASED ON
EXPERIENCE GAINED AT THE INDIAN WATER-
WAYS EXPERIMENT STATION, POONA

13.00. INTRODUCTION.

To a considerable extent, this Chapter reproduces cases stated in previous Chapters, with, however, this difference—that model scales and model difficulties, rather than the results of the investigations, are stressed.

There are few subjects concerning which so much confusion of thought exists as about the correct role of hydrodynamic models.* Some engineers believe that models can always be relied on to give correct results, others that they are highly untrustworthy. Neither of these views is correct. Some types of models give results which are almost identical with those in the prototype; others give results which require correction for known errors; while in models of alluvial rivers, the banks of which are eroding, only short-term accuracy obtains; so that in complex river problems, correct interpretation depends on wide experience in the field, combined with a natural flair, a scientific background, and much practice with river models.

The aim of this Note is to explain why some experiments give reliable results, while others depend to a marked extent on correct diagnosis—i.e. on making correct assumptions.

The methods followed in designing models and in carrying out experiments are described in detail; and pitfalls to be avoided, and difficulties to be overcome, are explained; with suggestions as to how to mitigate inherent discrepancies. It must, however, be emphasised that no two rivers present the same problem, and success with river model investigations depends essentially on correct diagnosis, combined with the capacity to predict future river conditions in the light of such diagnosis, taking any new factors which have arisen, or are likely to arise, into account.

Generally speaking, Research stations are not consulted about cases until conditions have reached a serious stage. Drastic methods have then to be adopted to avoid a catastrophe; and that too, in a short interval of time. A single mistake would often be fatal, so a heavy responsibility rests on those giving advice. Although it is easy to use formula—the best we know—for working out model scale ratios *as a first approximation*, thereafter the less we think in terms of thought-numbing formula the better.

Experiments should only be started after the model is considered to be reproducing known conditions with a high degree of approximation. This will only be attained after the model has been run for some time, to allow it to adjust itself by sifting the coarse particles from the fine in different parts of the model where scour or accretion are taking place. The model also requires time to correct errors made in laying—resulting from inadequate or incorrect data. Thereafter, when the model is relaid for subsequent experiments, it should be laid for the conditions existing after the model has corrected itself. This, though obvious, is frequently overlooked.

*“Hydrodynamic models as an aid to engineering skill” by C. C. Inglis. Presidential Address, Engineering Section of the 28th Session of the Indian Science Congress, Benares, 1941.

13.01. TYPES OF MODELS

Various types of models are described below, quoting examples of each type:—

Type I.—Geometrically-similar models which give geometrically-similar results.

Type II.—Geometrically-similar models which do not give geometrically-similar results.

Type III.—Vertically-exaggerated models,

(A) tidal, and (B) river.

(a) Rigid.

(b) Semi-rigid.

(c) Mobile.

TYPE I.—GEOMETRICALLY-SIMILAR MODELS WHICH GIVE APPROXIMATELY GEOMETRICALLY-SIMILAR RESULTS

13.02. GENERAL REMARKS

In this type, the models are rigid and the changes in energy relations between velocity and pressure are the chief factors affecting results, requiring a similar Froude number (V/\sqrt{gd}) in model and prototype. This can generally be attained in models used to determine—

(a) Coefficients of discharge of rigid structures; and

(b) Standing wave relations;

and approximately accurate results can also be obtained where changes are not abrupt as regards—

(c) Lines of flow at off-takes; and

(d) Scour downstream of falls.

A few examples of such models will be given; but reference is invited to more detailed information contained in Technical Papers and Annual Reports.

13.03. EXAMPLE I (a) (i) COEFFICIENT OF DISCHARGE OF S. W. FLUMES*

Standing wave flumes give geometrically-similar results provided changes are not abrupt and the models are made relatively smoother than their prototypes: but there is a limit to smoothness— which occurs when the surface is made so smooth that the roughnesses cease to project through the laminar layer. At this stage, flow changes to smooth turbulent flow.

In many cases, however, surface conditions lie between rough and smooth, and the flow is of a type intermediate between smooth and rough turbulent flow. This may occur where the surface is wavy, and tends to exist where the bed is covered with ripples—see Chapter 2. When the flow is fully turbulent, the coefficient of discharge for equal roughness increases with the discharge; so the discharge coefficient tends to vary with the discharge, as exemplified in the case of long-throated flumes and broad-crested weirs:—

TABLE 13-I

Discharge.	C.	Formula
2 cusecs	C = .97	$Q = 3.00 BD^{1.5}$
10 "	C = .98	$Q = 3.03 RD^{1.5}$
50 "	C = .99	$Q = 3.06 BD^{1.5}$
>500 "	C = 1.00	$Q = 3.09 BD^{1.5}$

* See item 9 of I. W. E. S. A. R. (T) 1944, p. 34.

Fig. 13-1

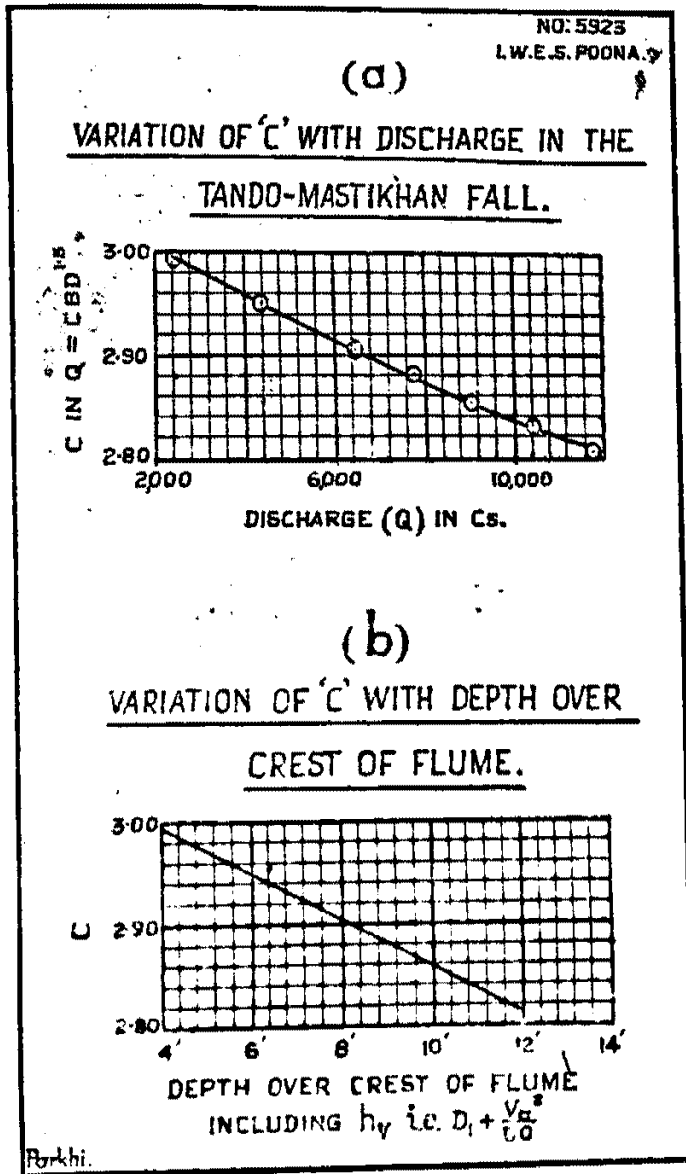

(FIG. 137 FROM A. R. T. 1945 OF I. W. E. STN.)

FIG. 13-2

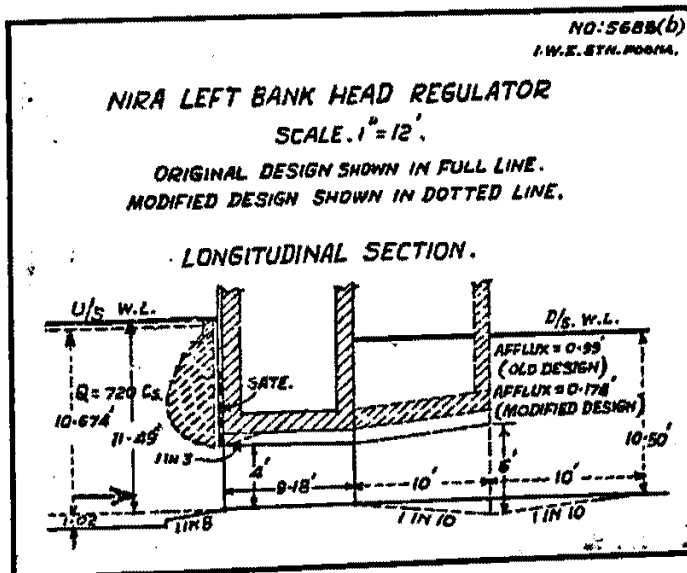

(FIG. 138 FROM A. R. T. 1945 OF I. W. E. STN.)

THE BEHAVIOUR AND CONTROL OF RIVERS AND CANALS

From this it follows that when models are used to determine coefficients of discharge, allowance should be made for the greater loss in the model before applying results to the prototype.

Using Manning's formula to explain this point:

$$V = \frac{1.486}{N} R^{\frac{2}{3}} S^{\frac{1}{2}}$$

and assuming the same roughness in the model as in the prototype,

$$\begin{aligned} h_f \text{ (frictional loss)} &\propto L \cdot V^2/R^{4/3} \\ &\propto \frac{(\text{scale ratio})^2}{(\text{scale ratio})^{4/3}} \\ &\propto (\text{scale ratio})^{\frac{2}{3}} \end{aligned}$$

In other words, the frictional loss is not geometrically-similar. Thus, let h_f in a full-scale flume (with depth above throat = 10') = .153' h_f in 1/10 scale geometrically-similar model will be .153/10^{2/3} = .033 ft. Thus D in full-scale flume (including loss by friction) = 10.153' and D in small model flume (including loss by friction) = 1.033'. To find C, the coefficient of discharge in the model, with D = 1.033', assuming C in prototype = 3.09,

$$\begin{aligned} q \text{ of model} &= \frac{q \text{ of prototype}}{\text{scale ratio}^{1.5}} \\ &= \frac{3.09 \times (10.153)^{1.5}}{(10)^{1.5}} \\ &= 3.16 \text{ cs./ft.} \end{aligned}$$

$$3.16 = C_1 (1.033)^{1.5}$$

or C_1 (of model) = 3.01 (against 3.09 of prototype).

Fig. 1-3

13.04. EXAMPLE I (a) (ii) DETERMINATION OF THE VARIABLE COEFFICIENT OF DISCHARGE OF THE 10,595 CUSECS TANDO MASTIKHAN FALL ON THE ROHRI CANAL, SIND*

Fig 13-1

These experiments, carried out with a geometrically-similar model in which the relative roughness was correctly maintained, have shown that the coefficient of discharge decreased with increase of discharge, and hence depth—due to impact losses at pier noses increasing with depth as the proportion of piers submerged increased. The discharge formula of the Tando Mastikhan Fall in Sind was found to be

$$Q = C_1 (B - KnD) D^{1.5}$$

where

K = coefficient of contraction
= 0.082 in Tando Mastikhan Fall

n = number of piers
= 9 in Tando Mastikhan Fall

B = waterway
= 100 ft.

D = D₁ (Depth of water upstream over sill of flume) + V²/50

C = a coefficient.

The accuracy of the results obtained in the model has been borne out by observations in the canal; but the canal data show much scatter—due to fluctuating conditions.

*Appendix III of Item 9 of A. R. (T) 1944. pp. 48, 49, also C. I. and H. R. S. A. R. (T) 1939-40 pp. 59-60 "Effect of piers on coefficients."

13.05. EXAMPLE I (a) (iii) COEFFICIENT OF DISCHARGE OF NIRA LEFT BANK CANAL HEAD REGULATOR*

In this case, the problem was to increase the discharge of an existing regulator—consisting of 7 spans of 4 ft.—by 50 per cent. Not merely was this achieved by bell-mouthing the upstream entrance and constructing an expansion downstream; but the coefficient (in the formula $Q = VA = AC \sqrt{2gh}$) was increased from .81 to 1.93, making it possible to increase the discharge 2.3 times, with the same head.

Fig. 13-2 shows the original design in full lines and the modified design in dotted lines. The masonry of the sluices in the prototype is of coursed rubble (second sort). In the model, this was represented by rough-cast cement plaster to obtain approximately the same relative roughness.

Fig. 13-2

13.06. EXAMPLE I (b) (i) POSITION OF STANDING WAVE WITH VARIOUS DISCHARGES, AND DIFFERENT DESIGNS OF SILL AT SUKKUR BARRAGE†

The original design of the Barrage profile consisted of 1 in 30 upstream slope, 80 ft. length of horizontal sill at R. L. 176 and a downstream glacis slope of 1 in 70. Experiments carried out at Poona showed that the upstream and downstream slopes were much too flat and they were, as a result of model experiments, altered to 1 in 5 upstream and 1 in 10 downstream, the length of the sill being reduced to one foot and the downstream pavement level lowered to increase the coefficient of discharge and to hold the standing wave just downstream of the Barrage. The undersluice pockets had already been constructed according to the original design; but the main Barrage was constructed according to the recommended design. The model showed that with the original design and the anticipated retrogression, the standing wave would, under certain conditions, have formed downstream of the pavement, causing it to collapse; whereas with the modified design, it would always form on the glacis, near the Barrage.

In the undersluice pockets, where the original design had been followed before the alteration was recommended, the cut-off (difference of water-levels upstream and downstream of the Barrage) had to be restricted to about 5 ft., because of the danger of bed-scour downstream of the pavement—resulting from unbalanced standing-wave conditions which would arise with larger heads.

13.07. EXAMPLE I (c) (i) DESIGN OF OFF-TAKE AT THE ENTRANCE TO THE RIGHT POCKET WHERE IT TAKES OFF FROM THE APPROACH CHANNEL AT SUKKUR‡

Fig. 13-3 is an index plan of the Indus above the Sukkur Barrage showing the new Approach Channel, which is designed to control the quantity of sand entering the Right Bank Canals. These canals had previously drawn an excessive load of bed sand, but as a result of model experiments carried out in 1930§, it was predicted that accretion would occur in the Right Bank Canals.

Fig. 13-3

In 1938, when the River carried an exceptionally heavy charge of bed sand, heavy accretion occurred in the North-Western and Rice Canals. The design recommended to exclude excess sand consisted of a curved

*Bombay Technical Paper No. 54 "Note on experiments with a model of the Head Sluices of the Nira Left Bank Canal." (Reproduced in Chapter 11, para. 11.04).

†Bombay Technical Paper No. 29 "Note on experiments carried out with various designs of piers and sill in connection with the Lloyd Barrage at Sukkur."

‡C. I. and H. R. S. A. B. (T) 1937-38, pp. 26-27.

" " 1938-39, pp. 4-10.

" " 1939-40, pp. 12-20.

" " 1940-41, pp. 12-26.

" " 1941-42, pp. 16-18.

§Bombay P. W. D. Technical Papers Nos. 45, 46 and 52.

Fig. 13-3 Approach Channel 5,000 ft. long—shown in Fig. 13-3. This investigation presented many difficulties; and six different models (with various scale ratios) were eventually used to determine the effect of different factors. In this particular experiment, a geometrically-similar, part-width, model was used; the same model being later used with increased depths to give a vertical exaggeration of 2, compared with a vertical exaggeration of 7 in the model of the whole river. This model showed that the width at entry should be made 35 per cent less than shown by the vertically-exaggerated river model, demonstrating the fact that similar conditions of flow cannot be reproduced in a single model, part of which is rigid and part of which is mobile.

FIG. 13-3

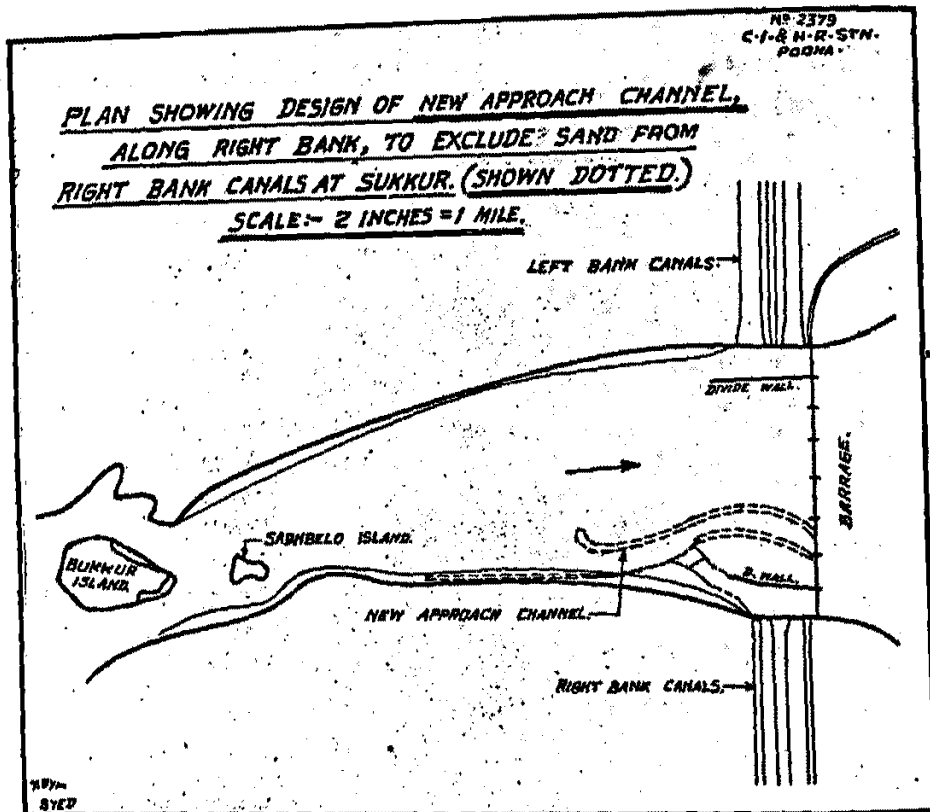

(FIG. 139 FROM A. R. T. 1945 OF I. W. E. STN.)

13.08. EXAMPLE I (c) (ii) LINES OF FLOW AT OFF-TAKES

In Bombay Technical Paper No. 52*, experiments have been described showing various factors affecting the quantity of sand drawn by off-taking channels. It was found from experiments carried out in model with (a) rigid beds, and (b) mobile beds, that the former are liable to give quite wrong results, a fact which has been overlooked by many investigators. It is also very important to see that the model has the correct degree of vertical exaggeration—a point which has been shown scant respect outside India.

† 13.09. EXAMPLE I (d) (i) SCOUR DOWNSTREAM OF FLUMED FALLS†

Scour occurs downstream of falls due to:

- (1) excess energy which gives rise to eddies and surging flow; and
- (2) instability of flow, due to a sudden, or too sharp, expansion.

These cause 'heaving' and unbalanced flow, with return flow along one, or both, banks. This return flow forms a large slowly-revolving vortex, with a vertical axis. These vortices push the forward flow away from one or other bank, or from both banks, thus causing 'jetting'. In this condition of flow, forced vortex conditions hold, so that the peripheral velocity is relatively high, leading to heavy bank erosion, especially near the toe; so that the angle of repose of the bank is

* Bombay P. W. D. Technical Paper No. 52 "Factors affecting exclusion of bed silt taking off from alluvial rivers"

† Bombay P. W. D. Technical Paper No. 44.

I. W. E. S. A. R. (T) 1944, pp. 29-55.

MODEL SCALE RATIOS AND LIMITATIONS

exceeded and large pieces of bank shear off, causing deep embayments—called 'bellies' in Sind. This condition can be prevented by constructing the pavement at such a level relative to the downstream water-level to ensure that this will occur even should retrogression develop downstream, it is desirable to construct a baffle in such a position, and of such height, that the standing wave is always held at the toe*, thus destroying a maximum amount of energy. A deflector at the downstream end of the pavement should also be constructed to throw the high velocity bed-water towards the surface, thus producing a bed-roller with horizontal axis, which will prevent or minimise, downstream scour.

Where a fall has been constructed with too sharp an expansion, it can usually be made to function satisfactorily by building, in addition to a baffle and a deflector, diverging vanes in continuation of the piers; these being so designed as to fan out the flow.

The Tando Mastikhan Fall was constructed with much too sharply diverging sides, viz. 1 in 5 compared with 1 in 10 required; but when vanes were added to fan out the flow, the fall worked very efficiently, and still does so; confirming all the conclusions drawn from the model experiments.

Fig. 1-3

13.10. TYPES I AND II IN COMBINATION IN SIPHON SPILLWAY

Siphon spillways provide a border line case between Type I and II; in that though they come under Type I as regards coefficients of discharge, they do not give geometrically-similar 'priming depths'. The prototype also behaves differently from the model when the minimum pressure falls to the equivalent of 7 feet of water above absolute zero pressure, or say 27 feet below atmospheric pressure at sea level.†

Professor Gibson‡ carried out experiments with various sizes of siphon models and showed that the minimum size of model which gives dynamically-similar results (except priming depth) is such that $d\sqrt{h} > .28$, where d = diam. of siphon and h is the operating head in ft.

Experiments carried out at Khadakwasla in 1928 with a 500 cusecs siphon, and its 1/8th scale model, showed that though the nature of 'priming curves' and 'coefficients of discharge' were similar in the model and prototype, the priming depth in the full-scale siphon was considerably less than in the model, the minimum priming depth in the full-scale siphon being only 1.15 ft. against the equivalent of 1.80 ft. obtained in the 1/8th scale model. Relative pressures were nearly the same at the inner shell, but pressures at the outer shell were slightly greater in the prototype. Thus we do not get exact dynamic similarity in pressures; but only an approximation.

Professor Gibson in the above-mentioned Paper showed that with a model in which the head was 3 ft., and a parallel section 12.125" wide by 4", the discharge increased by 39 per cent when the outlet was flared, as shown in Fig. 13-4.

Fig. 13-4

* I. W. E. S. A. R. (T) 1944, pp. 29-55.

† C. I. and H. R. S. A. R. (T) 1939-40, pp. 27-9.

" " 1940-41, pp. 27-31.

" " 1941-42, pp. 26-28.

" " 1942-43, pp. 24-29.

‡ Inst. of C. E. Paper No. 4910 (1930-31) on "Experiments with Siphon Spillways" by Professor A. H. Gibson.

FIG. 13-4

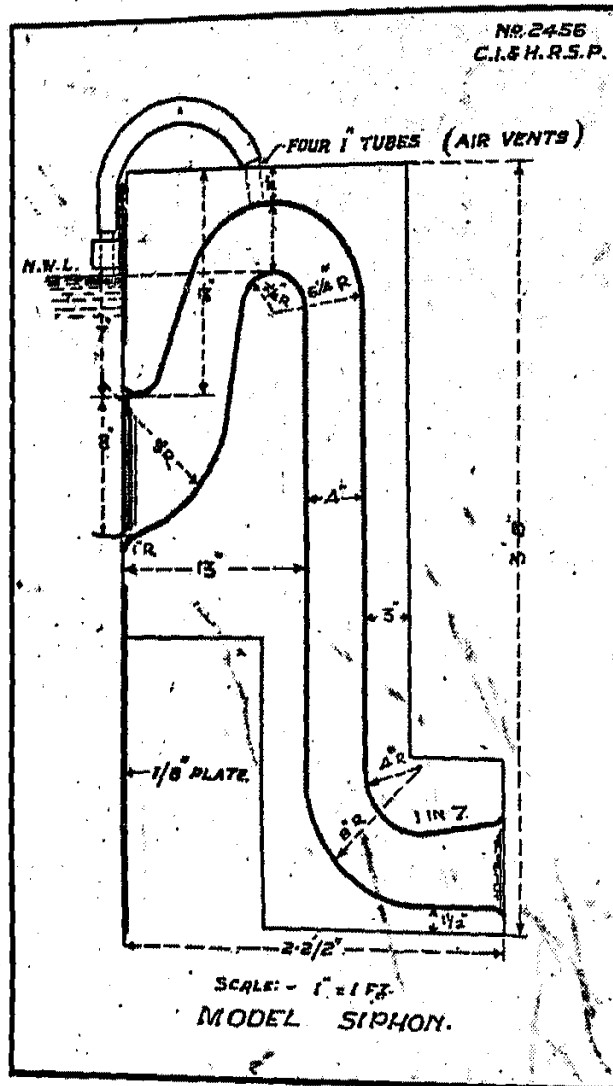

(FIG. 140 FROM A. R. T. 1945 OF I. W. E. STN.)

In experiments carried out at Poona, it was found that though flaring the outlet increased the discharge by 30.6 per cent in a model with head = 2.95 ft.; in the full-scale prototype, which was 8 times as large (head = 24.0') the discharge increased by only 3 per cent, and cavitation occurred downstream of the crest, as shown in Fig. 13-5.

It was concluded from these experiments that the limiting negative pressures in a well-designed siphon is about 27 ft. at sea level; and, where a siphon is working near to this limiting pressure, flaring the outlet cannot increase the discharge to any appreciable extent, and is undesirable—because it is likely to induce cavitation and vibration, but where the height of the siphon is small, flaring will increase the discharge to a marked extent.

TYPE II: GEOMETRICALLY-SIMILAR MODELS WHICH DO NOT GIVE SIMILAR RESULTS

13.11. EXAMPLE II (i) HIGH-COEFFICIENT WEIRS

Experiments carried out at Poona to determine coefficients of high-coefficient weirs* showed that where the curvature of the weir profile was sharper than the path which filaments of water would follow if

* C. I. and H. R. S. A. R. (T) 1937-38, pp. 39-44.
 " " 1938-40, pp. 45-50.
 " " 1940-41, pp. 42-50.

FIG. 13-5

(FIG. 118 FROM A.R.T.
1945 OF I.W.E.S.P.)

SHOWING PRESSURES AT VARIOUS POINTS
IN A FULL SCALE SIPHON
THICK CURVES SHOW PRESSURES WITH A
FLARED EXTENSION ADDED DOWNSTREAM

SCALES [HOR : 1 INCH = 5 FT.
VER : 1 INCH = 4 FT.

(a)

SCALE 1" = 4 FT.

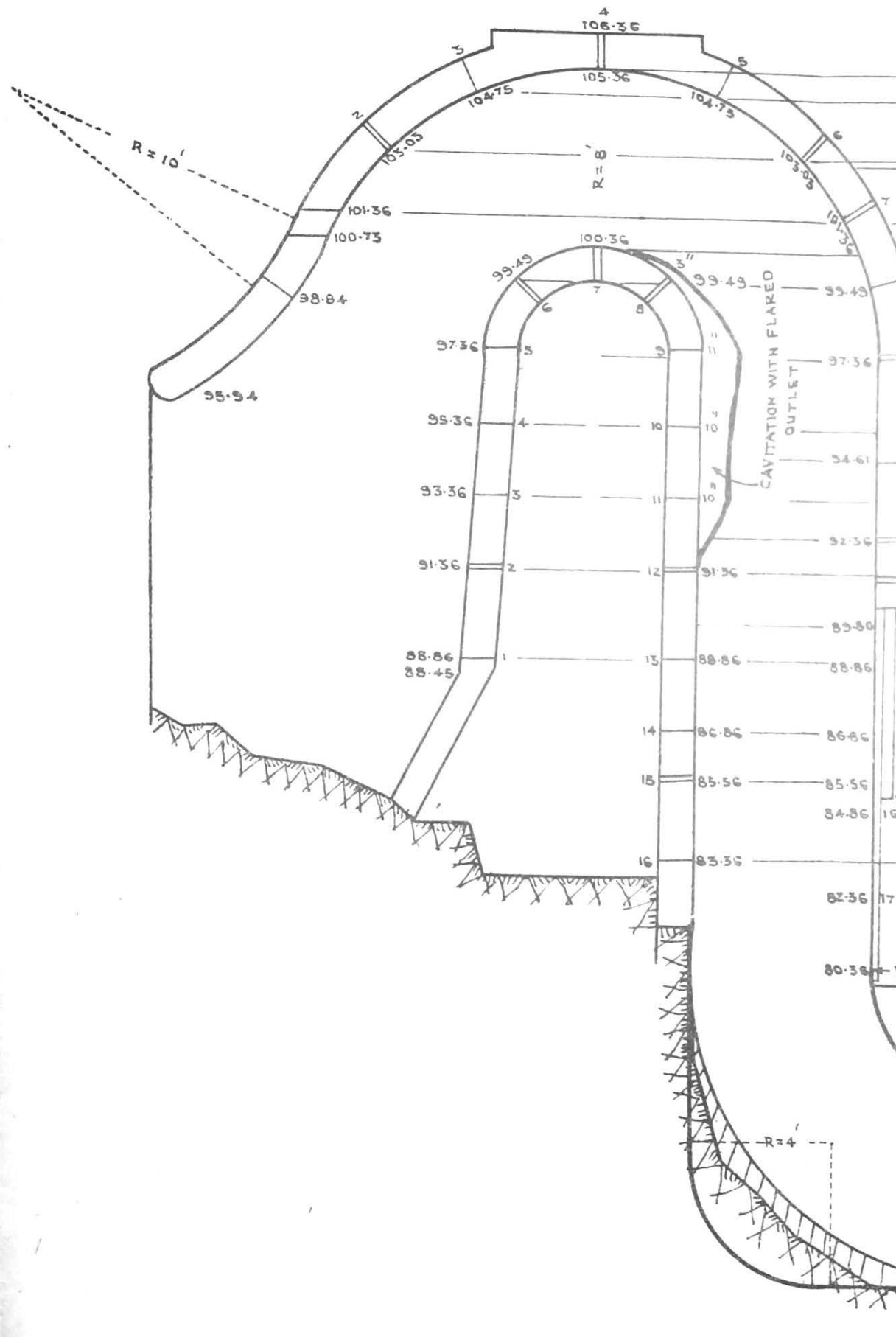

(b)

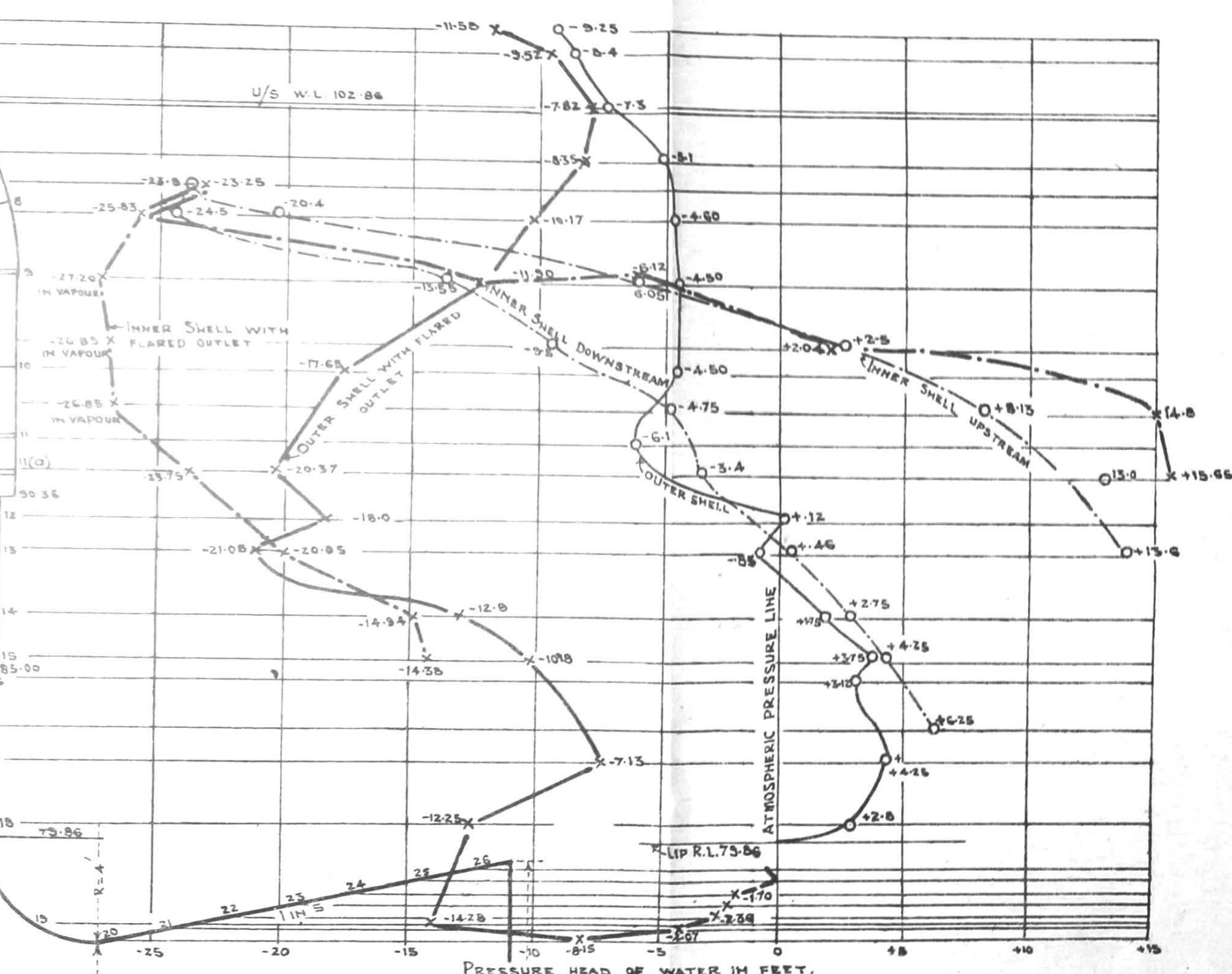

LIP AT 75.86
Q = 503 CUSECS
h = 23.0 FT
C_d = 0.65
u/s W.L. 102.86

MODEL SCALE RATIOS AND LIMITATIONS

discharging freely into air, the coefficient of discharge in the formula

$$q = c D^{1.5}$$

(where q = discharge per foot run and D = upstream depth over weir) increases with scale and also with depth of water over the weir so long as there is free flow downstream. The former is due to the fact that as Q increases, the natural path of flow under aerated conditions diverges more and more from the curvature of the weir, and hence, so long as the water adheres to the weir profile, a reduction of pressure occurs; and as

$$p/w + V^2/2g + z = \text{constant}$$

for a filament (Bernoulli's theorem), the velocity is correspondingly increased and also the discharge.

No theoretical method of estimating the discharge in the prototype being known, models to different scales were constructed, and their results extrapolated, to arrive at pressures and discharges to be anticipated in the prototype.

FIG. 13-6

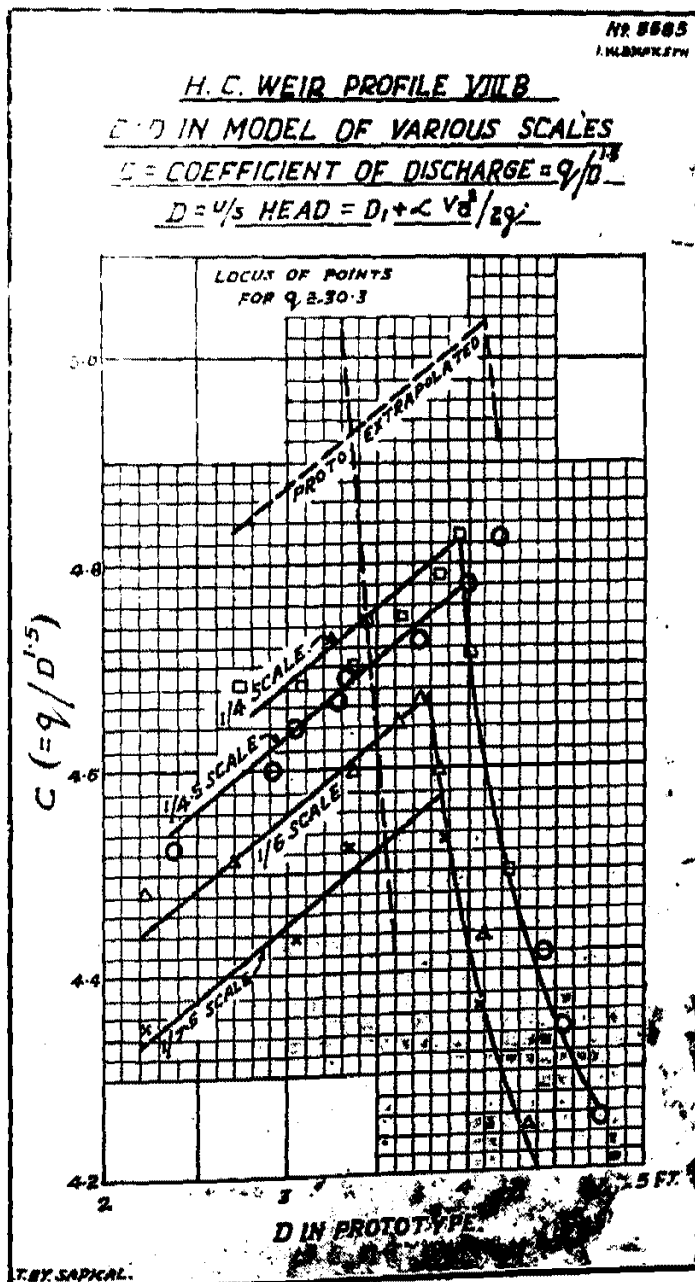

(FIG. 142 FROM A. R. T. 1945 OF I. W. E. STN.)

Fig. 13-6 Fig. 13-6 shows the coefficients obtained in models with scales of $1/4$, $1/4.5$, $1/6$ and $1/7.5$ of the prototype. From this it will be seen that the larger the scale, the higher the coefficient. When these coefficients were extrapolated, the conclusion arrived at was that the coefficient in the prototype with $D = 3.35$ ft. and $q = 30.3$ cs. per foot would be 4.93, compared with 4.75, 4.7, 4.63, and 4.53 in the various scale models.

In this particular case, as a result of constructing a new 200 cusecs channel, we appeared to have an opportunity to check the accuracy of the conclusions arrived at by extrapolation from small models to full scale; but even this presented difficulties—because, whereas the weir at Bhandardara is 650 ft. long, it was only 4 ft. in the model*, so the effect of the side boundaries, which is negligible in the prototype, was considerable in the full-scale model. Allowance had to be made for this.

The method adopted, after small-scale trials, was to contract the 8-ft.-wide channel by bellmouthing it into a 4 ft. wide throat containing the model. This had the effect of regularising velocities across the 4 ft. channel. It was necessary, however, to place the model sufficiently far downstream of the bellmouth for the flow approaching the weir to be sensibly parallel. As a result of this, slight boundary layer effect developed, which caused retardation of high velocity flow at the sides.

Though a small amount of expansion in the sides downstream of the weir was provided—to reduce the retardation effect at the sides and to produce more axial flow; yet this caused slight inward flow across the sill, which reduced the negative pressure over the crest, and so reduced the discharge coefficient.

Fig. 13-7 Fig. 13-7 shows the coefficients of discharge plotted against depths D in the full-scale model, in the formula $q = c D^{1.5}$.

FIG. 13-7

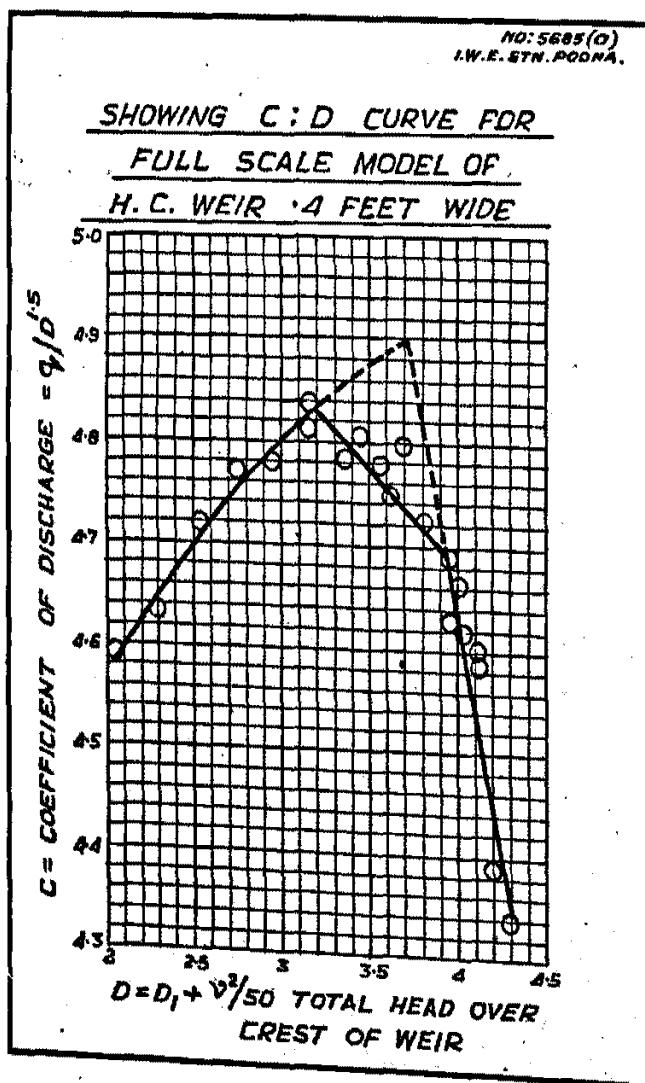

(FIG. 143 FROM A. R. T. 1945 OF I. W. E. STN.)

*C. I. and H. R. S. A. R. (T) 1940-41, pp. 42-45.

MODEL SCALE RATIOS AND LIMITATIONS

It will be noticed that the coefficient instead of rising to a clear-cut maximum as in Fig. 13-6, rises on a curve and, before reaching its natural maximum, falls towards the rapidly falling line at $C=4.70$. Dotted lines show the rising and falling curves extrapolated. These meet at $C=4.9$ with $D=3.35$ ft., as compared with 4.93 extrapolated from small-scale models; but, whereas by that method the maximum value of C rose to 5.08 with $D=4.10$, this was not attained in the part-width, full-scale, model—due to side effect; but would be attained in the wide weir of the prototype.

Fig. 13-6.

Type III. Vertically-exaggerated models

13.12. INTRODUCTION

Owing to the earliest models—those of Osborne Reynolds and Vernon-Harcourt—being tidal models of estuaries,* and to tidal flow being dominated by tidal wave conditions and hence the Froude number— V/\sqrt{gd} —it came to be believed that provided conditions were such as to produce turbulent flow and the Froude number relation was the same in the model as in the prototype, any degree of vertical exaggeration was permissible.

As will be seen later, this does not hold even for tidal flow except in cases where curvature of flow and reproduction of bed movement are unimportant; and in the case of river flow “vertical exaggeration”—or more correctly “width and length contraction”, and “slope exaggeration”, are uniquely determined. This question has been dealt with in Chapter 3, where it is shown that according to Lacey’s formulae equivalent shape and slope can be arrived at as follows:—

$$P = 2.66Q^{1/3}$$

$$R = 0.4725 (Q/f)^{1/3}$$

Shape for equivalent bed movement gives

$$P/R = 56.5 Q^{1/6} f^{1/3}$$

and $S = 0.00547 \times f_{VR}^{1/3} \cdot f_{RE}^{2/3} / Q^{1/6} = 0.00547 \times f_m^{1/3} \cdot f_{118}^{2/3} / Q^{1/6}$ gives equivalent slope for equivalent bed-movement.

III (A). Tidal models

13.13. REYNOLD’S CRITERION OF TURBULENT FLOW IN TIDAL MODELS

In order that the motion in a model shall be similar to that in the prototype, it is necessary that the velocity shall be sufficiently great to ensure “turbulent flow” and from experiments on models of symmetrical estuaries, Reynolds came to the conclusion that in order to ensure this, the product h^3e should not be less than 0.09, ‘h’ being the rise of tide in feet at the seaward end of the model and ‘e’ the vertical exaggeration of scale.†

13.14. SCALE RATIOS OF TIDAL MODELS

Where the height of wave relative to the depth is small, the velocity of translation of a tidal wave‡ is given very approximately by Rayleigh’s relation§

$$V_w = \sqrt{gd} \quad \dots \quad \dots \quad \dots \quad \dots \quad (1)$$

where d is the mean depth of water including the height of wave. This is the wave velocity relative to the fluid; the velocity relative to the boundary will be

$$V_w + V \quad \dots \quad \dots \quad \dots \quad \dots \quad (2)$$

where V is the mean velocity of flow.

* Based on Basic Note No. 70 by Mr. A. R. Thomas.
 † Professor A. H. Gibson’s Vernon Harcourt Lecture 1935-36 on “Tidal and River Models” Supplement to Journal No. 8, 1935-36 of Inst. C. E. page 706.
 ‡ Based on Basic Note No. 70 by Mr. A. R. Thomas (not published). See also Chapter 1, para. 1-18.
 § Rouse: “Fluid Mechanics”, p. 379, verified by experiments at Poona Station.

THE BEHAVIOUR AND CONTROL OF RIVERS AND CANALS

As both V_w and V vary from point to point and with time, the V_w scale ratio must equal the V scale ratio. This raises a difficulty which is frequently ignored—sometimes justifiably, but more generally without justification—that whereas the mean velocity varies approximately as \sqrt{R} (the square root of the hydraulic mean depth), V_w depends mainly on the depth. Now, in a large river, the depth and the hydraulic mean depth differ little from one another; but in a small tidal model there is considerable vertical exaggeration, so they differ considerably.

Ignoring this, for the present, and assuming

$$V \propto V_w \propto d^{1/2}, \text{ as a first approximation,} \quad (3)$$

$$V_m / V_p = V_{wm} / V_{pw} = (d_m / d_p)^{1/2} \dots \dots \dots$$

where m and p stand for model and prototype.

d in (3) represents the vertical scale of the model and

$$S \propto d/L \dots \dots \dots (4)$$

where S represents slope and L represents length; so the slope scale is determined by the vertical exaggeration.

For correct reproduction of the wave profile, especially in curved channels, the longitudinal and latitudinal scales must be equal; so L in (4) represents horizontal scale:

Time scale is given by:

$$T \propto L/V \propto L/d^{1/2} \dots \dots \dots (5)$$

and discharge scale by:

$$Q \propto V.L.d \propto L.d^{3/2} \dots \dots \dots (6)$$

In order to arrange that the water surface slope agrees with (4) it has been the practice to adjust the roughness of the bed and sides of rigid models by trial and error, until the required slope has been obtained. As the slopes must correspond in the model and prototype for a wide range of water-levels, the degree of roughness must vary from point to point, and has to be distributed carefully between different parts of the sides.

An indication of the degree of roughness required is given by Manning's equation:—

$$V \propto \frac{R^{2/3} S^{1/2}}{N}$$

Combining this with equations (3) and (4)

$$N \propto R^{2/3} / L^{1/3} \text{ (Manning)} \dots \dots \dots (7)$$

$$N \propto R^{3/4} / L^{1/4} \text{ (Lacey)} \dots \dots \dots (7a)$$

The tendency has been to consider Manning's formula as more suitable for rigid models and the Lacey formula as applicable to mobile models; but the range within which approximately equivalent roughness is attained is narrow, and though a certain amount of latitude is permissible in the case of rigid models, this is not so in the case of mobile models—in which the corresponding grade and charge of bed materials should be transported—and it is not justifiable to assume that because the bed pattern in the model approximates roughly in the bed pattern in the estuary, after running a number of tides, that therefore the model has been reproducing bed-movement correctly. All it shows is that the material has tended to accumulate where it is least affected by tidal flow—a very different thing.

MODEL SCALE RATIOS AND LIMITATIONS

Type III (A) (a) Vertically-exaggerated rigid tidal models

13.15. USE OF RIGID TIDAL MODELS

Rigid models have been used to a large extent at the U. S. Waterways Experiment Station at Vicksburg, especially in connection with materials—such as Gilsonite—have been injected to indicate the movement of sediment; and the amount of sediment deposited in various positions, marked out on the bed of the model by white-bordered squares, has been measured by sucking the deposited material through a 'vacuum cleaner' type of machine, the material then being 'separated' by a machine resembling a 'cream separator'.

13.16. EXAMPLE III (A) (a) (i) RIGID TIDAL MODEL OF THE HOOGLY*

A rigid tidal model of a 20 mile length of the Hooghly above Calcutta, was constructed at Poona, to scales of 1/300: 1/60, with the object of determining lines of flow and points where action is severe under various conditions of river and tidal flow. This information was subsequently used in a large-scale, mobile, short-length, model to investigate bed-scour and bank-erosion problems, using a much larger discharge, and much less vertical exaggeration than in the long model. After much patient 'trial and error' work, the model reproduced tidal flow conditions with a high degree of accuracy.†

Type III (A) (b) Semi-rigid, vertically-exaggerated, models

13.17. THE USE OF SEMI-RIGID TIDAL MODELS

In semi-rigid models, the sides, and in some cases large parts of the bed, may be held. This makes it practicable to enforce a bank-slope exaggeration which is far in excess of what would be possible if the banks were erodible; and also to restrict the width, which makes it possible to increase bed action, i.e. the sand charge; but if the problem to be investigated is curvature of flow or includes future changes of the river course and the secondary effects due to such changes, a model with rigid banks would help us little; and if—as would be necessary to get useful results—the banks were cut away from time to time to simulate erosion, success would depend mainly on the experience and skill of whoever directed the experiments.

The scales of the Hooghly model were: Horizontal scale=1/300; depth scale=1/60 and $e=5.0$, and the maximum tidal range at the seaward end is 12.5 ft. for a bore tide, so the value of h^3e works out to 0.045, which is considerably less than 0.09; but the model gave satisfactory results. It must be clearly understood, however, that though Reynold's criterion may be suitable for estuaries which are very wide relative to their depth, especially if their sides are held—so that reproduction of correct shape ceases to be an important factor—yet, where the depth is considerable relative to the width—as is the case in river channels—adopting correct vertical exaggeration is very important.

* C. I. and H. R. S. A. B. (T) 1940-41, pp. 18-19.

† C. I. and H. R. S. A. B. (T) 1940-41, pp. 18-19.

C. I. and H. R. S. A. B. (T) 1941-42, pp. 23-24.

13.18. EXAMPLE III-(A)(b)(i) HOOGHLY TIDAL MODEL,
RUN AS SEMI-RIGID MODEL

After the long, small-scale, model of the Hooghly had been run as a rigid model to observe lines of flow, sand was laid on the bed of the model and it was run (at a somewhat higher level) as a semi-rigid model—i.e., with rigid banks and mobile bed. The model was then similar in type to several models used in tidal investigations carried out in England, notably the Mersey model of Osborne Reynolds, the Seine model of Vernon-Harcourt* and the Severn model of Gibson†; but the scales and the discharges were very much larger in the Hooghly model.

It was found that when all parts of the model were laid to a uniform vertical exaggeration, movement, though correct in places, was not correct generally, the tendency being for movement to be in excess in the shallow portions and in defect in the deeper parts. Thus, the depth was more uniform in the model than in the river.

It was also found that even when the movement of bed-material was suitable with dominant discharge flowing, it was excessive with high discharges and in defect with low discharges, all movement ceasing in the model at a much higher relative discharge than in the river. This is true of all river models.

Type III-(A)(c) Mobile tidal models

13.19. EXAMPLE III-(A)(c)(i) SHORT, LARGE-SCALE, MOBILE
TIDAL MODEL OF THE HOOGHLY

In order to reproduce correct bed-scour and accretion in the short model—in which the vertical exaggeration was only 1·4 compared with 5 in the long model—it was necessary to reproduce similarity of lines of flow, based on those observed in the long, small-scale model. The scales being 1/125 : 1/90, it was easy to reproduce, and observe, the effects of various alternative treatments, a comparison which was quite impossible in the long, small scale, model, in which the side slopes were far steeper than the angle of repose of the material, and the flow-pattern was highly distorted.

In this model, only slight adjustments were required in order to produce similar lines of flow, and bed movement was also found to be satisfactory; but, owing to the relatively large scale of the model, a single tide took 56 minutes, and results would have been delayed unduly had quantitative results of various treatments not been accelerated by adding sand by hand to raise the bed by an amount equal to three times the depth of the deposition—after which the model was run for another period, and accretion again trebled by hand; a procedure which was continued until accretion almost ceased. In this way, it was possible to determine the relative merits of various treatments within a reasonable period of time—after which the most promising treatments were investigated in greater detail.

13.20. EXAMPLE III-(A)(c)(ii) PORT OF RANGOON TIDAL MODEL‡

An excellent example of a small tidal model in which conditions were correctly imposed, was the Rangoon model.‡ In that case the model was bounded by a curved wall which separated the flow it was considered affected the problem, from flow to the east; and the right

* Vernon-Harcourt, Proceedings of the Royal Society, Vol. XLV, 1888-89.

† Gibson, "Construction and operation of Severn Tidal Model" H. M. Stationery Office (1933).

‡ Inst. of C. E. Paper No. 5100: "Investigation of outer Approach Channels to the Port of Rangoon by means of a tidal model" by Oscar Elsdon.

bank of the River was cut away from time to time at a rate assumed by the experimenter, based on judgment. Working on these two assumptions, it was found that while the Port was not threatened by eventual extinction, it was evident that some limitation on the draught of vessels using the Port would be inevitable unless rectification of the approaches was carried out by artificial means—a prediction which, it is understood, has been fulfilled. The point to be emphasised, however, is that the result obtained in this model was mainly due to the experimenter making two assumptions; and had his assumptions been wrong, he must have got wrong results.

Type III-(B) River models

13.21. GENERAL REMARKS

The essential difference between tidal and river models is that in the former, tidal flow—determined by V/\sqrt{gR} —is the major factor developing bed-movement; whereas in river models, bed-movement is determined by the slope, or more correctly, slope is determined by the charge—which cannot be measured directly in a river, so has to be inferred from the river conditions, i.e. it has to be diagnosed.

In practice, the chief difference is that river models give clearly divergent results unless the charge—which determines both the slope and shape—corresponds with that in the prototype, whereas tidal models with equivalent values of V/\sqrt{gR} appear to give approximately similar results over a range of slope and vertical exaggeration; but, as explained at the end of para. 13.14, this difference is more apparent than real; because even in tidal models, corresponding bed movement only occurs in channels of limited width if the grade, the charge, the width, and length scales and the slope exaggeration correspond with those in the tidal channel.

Type III-(B)(a) Vertically-exaggerated rigid river models

13.22. THE USE OF RIGID RIVER MODELS

The usual practice at Poona has been to fix what the Lacey formulæ, modified by experience, have shown to be suitable slope and vertical exaggerations for the conditions, and then to verify slopes for various discharges. If the observed slopes are only slightly in error—which will be the case if the model scales and roughnesses have been carefully selected—intelligent adjustment in the light of local differences will produce satisfactory results; but if the designed slope is incorrect, drastic roughening—such as is frequently adopted at Research Stations—will at best produce only a sort of pseudo-correctness, and it will then be found that though the results may be suitable for one discharge, they will be considerably in error for other discharges.

For this type of model, a large amount of data should be available, preferably extending over a period of more than five years; because the model, being rigid, cannot adjust itself where it is wrong. Much patient “trial and error” work is, therefore, necessary. This, as experience at Vicksburg shows, may have to be spread over a period of as long as two years. After such verification, it is assumed that approximately correct levels will be obtained for conditions outside the verified range—as for instance in a flood of greater magnitude than previously observed or during peak floods in tributary streams—which may reach the main stream at different times from those of previous recorded floods.

THE BEHAVIOUR AND CONTROL OF RIVERS AND CANALS

Rigid models can undoubtedly give useful information as regards flood levels, lines of flow, points where violent action will occur under specific conditions, etc; but being rigid, they cannot give information regarding changes of the river course due to erosion, nor can they reproduce accretion resulting from heavy charges of debris entering from tributary streams. Such changes must be inferred; and, as a consequence, the value of such models is limited.

Type III-(B)(c) Vertically-exaggerated mobile river models

13.23. THE USE OF MOBILE RIVER MODELS

Experiments carried out at Poona with injection have shown that channels become steeper, wider, and shallower as the charge of material in movement increases; and experience in the field confirms that a wide, shallow, river is always found in combination with a heavy charge and steep slope relative to the discharge.* If a river splits into a number of interlacing channels, this indicates that the stream is "flashy"; with periods during which the charge is very heavy. If, on the other hand, the channel is deep and narrow, with high berms; this indicates a high proportion of silt in suspension, a relatively small bed-charge, and a relatively constant discharge. Between these extremes, there is every degree of variation.

It is thus possible for the skilled observer to diagnose in the light of his practical experience what type of a river it is, the approximate relation between silt and sand load, and the approximate rate of rise and fall of its floods. If data are available about these matters, so much the better, but data are generally inadequate and are often misleading, and it is generally necessary to diagnose conditions from observation on the spot. Let us consider two cases: the Gandak River ($Q_{\max} = 300,000$ cusecs) and the Tapti River ($Q_{\max} = 1,000,000$ cusecs).

The Gandak is a wide, shallow, river, having a B/D ratio of 310; whereas the Tapti, with three times the discharge, is a relatively narrow, deep, river with a B/D ratio of 50. If we were to construct a 6 cusecs model of each of these rivers, the Gandak would be 13 ft. wide; whereas the Tapti would be only 5.8 ft. wide, i.e. less than half the width of the Gandak for the same model discharge, the longitudinal scale ratios of the two being 1/200 for the Gandak and 1/330 for the Tapti. In the former case, a heavy charge of sand would have to be injected in the model; while in the latter case, little bed-sand would be injected, but a heavy charge of fine material would be desirable.

The Station have worked out relationships suitable for the materials used by them for discharges found most suitable; but the final scales have to be arrived at by trial and error, the model being run until conditions are approximately similar to those in the river. In this connection, experience shows that it is much more important to develop known river conditions than try to enforce scales based on assumptions regarding sand-load, etc. on which formulæ have been based. Indeed, much of our most successful work has been done when we have had little data except an accurate plan. From this, after inspection, it has been possible to infer the behaviour and characteristics of a river, and it is vastly preferable to have a limited quantity of reliable data, than a large amount of data of doubtful accuracy.

When model experimentation was first started at Poona 26 years ago, much time was wasted in trying to reproduce river results from misleading or fragmentary data, from which important information, such as the existence of submerged rock, was omitted; but as our experience increased, it was found possible to spot discrepancies and set them right.

* G. I. and H. R. S. A. E. (T) 1941-42, page 10, paras. 35-38.

MODEL SCALE RATIOS AND LIMITATIONS

The main difficulty to be overcome in producing similarity of behaviour in models of alluvial rivers is how to reproduce bed-movement correctly. About this, quantitative data are never available; yet, unless a model is laid to suitable scales in the first instance, and the correct charge injected, highly discrepant results are likely to be obtained.

13.24. SELECTION OF SCALE RATIOS FOR VERTICALLY-EXAGGERATED RIVER MODELS

From what has gone before in Chapters 1, 2, 4, 5, 7 and 13.21, it is clear that corresponding results can only be approximated to in a river model if all scale ratios are appropriately selected.

The scale ratios to be selected are :—

I	Length	scale	ratio.
II	Width	„	„
III	Discharge	„	„
IV	Sand	„	„
V	Depth	„	„
VI	Slope	„	„
VII	Time	„	„

13.25. I. LENGTH SCALE RATIO

It has often been stated that model scale ratios are determined by the floor space available. That may perhaps be allowed to pass for simple geometrically-similar rigid models; but in loose-boundary models, the length scale should be determined by the discharge required to give satisfactory results—to which it is related—

$$\frac{L_m}{L_p} \propto \sqrt{\frac{Q_m}{Q_p}}$$

Although discharges up to 30 cusecs have been used in river models at Poona, models of 6 to 10 cusecs are generally the most suitable for river investigations. Smaller models do not, as a rule, produce satisfactory results, while larger models take longer to lay and run, require more staff, and are much more expensive. Where, as is often the case, great detail is required regarding a limited length of the river, it is better to construct a second, part-length, part-width, model to a large scale, than to have a very large model of the whole length of the river under investigation.

13.26. II. WIDTH SCALE RATIO

Though loose-boundary models—the sides of which are not held—tend to become wider than according to the length scale, it is the almost universal practice to lay the model on the assumption that

width scale = length scale.

Were this not done, the model would be distorted in plan; and *though a certain amount of distortion in plan is natural*, the distortion varies from point to point, and is not calculable, nor even closely predictable—so it is best to allow the model to adjust itself gradually, and naturally.

13.27. III. DISCHARGE SCALE RATIO

The dominant discharge of a river in India is rarely known. Where the whole river is contained in a single channel, the dominant discharge can be worked out approximately from bank-full stage in a straight reach; but where such conditions do not exist it can generally be determined approximately from the meander length—for, despite misleading half-truths—such as that “meander length depends on slope”—experience shows that the model meander-length in alluvial channels approximates to $36\sqrt{Q_{dom}}$.

THE BEHAVIOUR AND CONTROL OF RIVERS AND CANALS

The discharge scale is generally held to be determined by

$$Q \propto L.d.\sqrt{a} \quad \dots \quad \dots \quad \dots \quad (1)$$

but where movement of bed material and curvature of flow are important factors,

$$Q \propto L^2 \quad \dots \quad \dots \quad \dots \quad (2)$$

must be satisfied.

Having constructed the model according to these scales, some Stations then alter the discharge until the designed depth of flow is obtained. This saves time and is sometimes permissible where short-term results will suffice; but it is not suitable where long-term results are desired—especially where the reproduction of erosion and meanders is important.

13.28. IV. DEPTH SCALE RATIO

Depth is a dependent variable, so cannot be directly enforced; but it can be modified by altering the discharge, the slope, the charge, and the grade of bed material. Altering the charge brings in other errors, and altering the grade or the slope takes time—both for relaying and for a new regime to be set up. To obtain satisfactory results the slope has generally to be slightly altered.

13.29. V. SLOPE SCALE RATIO

Slope depends on the discharge and the grade and charge of material in movement on the bed. Although it simplifies work to assume that

$$\text{slope exaggeration} = \text{vertical exaggeration,}$$

experience shows that this is rarely maintained in fully mobile models, though it can be produced if the banks are held.

When the vertical and slope exaggeration do not agree, the model is said to be 'tilted'. The depth scale is then different from the slope scale. This complicates depth measurements; but other short-term effects due to tilting are less than might be anticipated.

The relation between slopes in the prototype and model may be worked out by the Lacey formula

$$S = 0.00547 f^{\frac{3}{2}} / Q^{\frac{1}{2}}$$

where f is a bed sand factor covering charge and grade.

The model is then run for some time with the estimated dominant discharge, the model slope—and where necessary the grade and charge—being adjusted until suitable bed-movement is obtained at all sections at *dominant discharge*.

The slope thus obtained gives the optimum slope exaggeration; but the greater the divergence from dominant discharge, the greater the slope error.

A comparison of depths at various cross-sections gives the mean depth scale natural for conditions in the model.

This trial and error method gives satisfactory results where the scales to which the model was laid were approximately correct; but neither this, nor any other method, can give satisfactory results if the scales originally chosen were wrong. Hence, the great importance of adopting suitable scales in the first instance; which, in turn, depends mainly on a correct diagnosis of movement of bed material in the river, combined with experience of model behaviour under variable flow conditions which can only be mastered by years of study of rivers and their models.

MODEL SCALE RATIOS AND LIMITATIONS

13.30. VI. TIME SCALE RATIO

Where silting is the important factor to be reproduced, the time scale will have to be much longer than where scour is the important factor; and, due to bed movement not starting in the model until a much higher relative discharge than that which causes bed movement in the river, and to scour being in excess for discharges in excess of the dominant discharge, low discharges have got to be stepped up and run for a relatively much longer time in the model, and high discharges run for a much shorter relative time—i.e. the time scale varies inversely as the discharge.

13.31. VII. SAND SCALE RATIO

As the range of diameter of particles within which normal ripples form is narrow—from about 15 mm. to 50 mm.—and as the exponent 'n' in the Lacey formula

$$d \propto (q/m^{1/2})^n$$

is low— $\frac{1}{2}$ —it is not possible to change flow conditions to any marked extent by altering the sand diameter, without giving rise to other complications.

Where quartz sand is used, the material on the bed should generally be slightly finer than that in the prototype.

In the case of boulder rivers and those where the material is coarser than 6 mm.—so that ripples do not form—the material used in the model must be much smaller than in the river—see Appendix 4.

SOME OF THE MAJOR DIFFICULTIES EXPERIENCED IN RIVER MODEL EXPERIMENTATION

13.32. (i) EXAGGERATED VORTICES AND SCOUR-HOLES IN VERTICALLY-EXAGGERATED MODELS

The length of a vortex tends to be proportional to the vertically-exaggerated depth scale; whereas its width tends to be proportional to the width scale.

The total effect is that the vortex is much longer and somewhat wider than according to the width scale; but is not so long as according to the depth scale. It is relatively much larger in plan in the model than in the river.

Similarly, scour-holes caused by vortices are relatively much larger in the model than in the river, and as the material scoured from the scour-hole in the model is not carried down-stream to the same extent as in the river, it accumulates; and, as a result, the scour-hole does not get filled with material to the same extent as in the river when the discharge falls; so the scour-hole has a disproportionately great effect on flow. A good example of the abnormal effect of a vortex was afforded by the area of 'return flow' downstream of Naraj Gorge—caused by the projection of Sideswar Hill—which had a markedly distorting effect on flow over Naraj Weir. Photo Sheet
1-22

13.33. (ii) INCORRECT 'THROW-OFF' IN A VERTICALLY-EXAGGERATED MODEL

'Throw-off' from vertically-exaggerated model structures is markedly different from the corresponding 'throw-off' in the prototype—as shown by the model of the Ganges upstream of the Hardinge Bridge* and by the model of the Sukkur Approach Channel.† This difference is partly *
†

* Bombay P. W. D. T. P. 55.

† C. I. & H. B. S. A. R. (T) 1941-42.

because the height of the structure is vertically-exaggerated relative to the bed-width; but chiefly because the lines of flow are highly distorted by the relatively very steep side slopes. Investigations in connection with the model of the Ganges near the Hardinge Bridge showed that in order to reproduce approximate similarity of 'throw-off', the side-slopes of Guide Banks should be about 1 to 1—or about one-third as steep as according to scale; but where such a slope is adopted, the lateral extension of the groyne or other projection is disproportionately great. Thus, the positioning of groynes in models is very important: If they are receded too far, they have little effect; whereas if they extend too far, they cause abnormal scour. Each case must be dealt with individually; but generally speaking, the projection should be receded till the toe (*after scour*) is only a little in front of the toe in the river. The best position to adopt will vary from model to model; and with different discharges in the same model; but it should be such that approximate similarity is produced at the discharge which matters most. For other discharges, this position will not be correct, and may have to be changed.

Though altering the slopes of a projection distorts the model both in plan and elevation, the reproduction of correct 'throw-off' is so important that distortion is essential; but its effect must not be overlooked.

The practice at Poona has been to construct at least two models in such cases: One model comprising the whole river to a vertically-exaggerated, relatively-small, scale; and the other, of a part of the river to a much larger scale, with entry conditions imposed and vertical exaggeration kept as low as practicable. Entry conditions in the part-model are based on lines of flow observed in the model of the whole river; and flow in the whole-river model is then modified in the light of throw-off and curvature produced in the part-model. If this modification leads to any considerable change in flow conditions in the whole-river model, entry conditions must again be modified in the part-model, and the whole process repeated until approximate similarity of effect is reproduced.

13.34. (iii) EXAGGERATED LENGTH OF STANDING WAVE DOWN-STREAM OF NARAJ WEIR IN THE MAHANADI MODEL

An interesting example of the necessity of distorting a model was exemplified in the Mahanadi-Katjuri model (Cuttack-Orissa).*

Photo Sheet
1-22
Fig. 1-10

In that model, the Mahanadi is the main river, and the Katjuri takes off from its Right Bank at a sharp angle, to flow over Naraj Weir. This Weir extends along the Right Bank of the Mahanadi and is roughly parallel to its axis of flow.

To produce a correctly-positioned standing wave on the glacis downstream of Naraj Weir, the model weir should have been geometrically-similar; but in that case it would have extended far downstream in plan, and water would have flowed away from the Weir at a markedly wrong angle.

In such cases the best compromise has to be adopted—making the Weir somewhat broader (i.e. longer in the line of flow) than correct in plan; but much shorter than if it were geometrically-similar.

The best treatment differed in this model in different experiments—according to the particular discharge being run, and the exact point under investigation at the time.

* I. W. E. S. A. R. (T) 1943, p. 47.

MODEL SCALE RATIOS AND LIMITATIONS

13.35. (iv) NECESSITY OF HAVING DIFFERENT VERTICAL SCALE RATIOS FOR RIGID AND NON-RIGID PORTIONS OF MODELS

In a vertically-exaggerated model of a river, the sill level depends on the intensity of discharge per ft. run; and, the discharge = $A \times V$, and $V \propto \sqrt{d}$ (approximately); so discharge scale is approximately proportional to $L.d.\sqrt{d}$, whereas in the river portion of a model the discharge scale $\propto L^2$; hence, for equality,

$$L^2 = L \times d \times \sqrt{d}$$

$$d = L^{\frac{2}{3}}$$

In practice, two cases arise:—

(a) $L^2 = L.d^{\frac{3}{2}}$ (approximately)

(b) $L^2 > L.d^{\frac{3}{2}}$

Case (a):— $L^2 = L.d^{\frac{3}{2}}$ holds approximately in a straight mobile channel.

FIG. 13-8

Fig. 13-

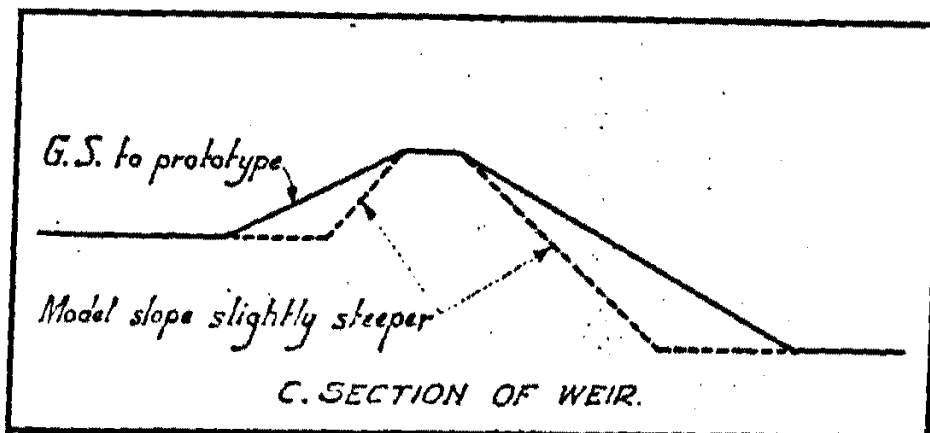

(FIG. 145 FROM A. R. T. 1945 OF I. W. E. STN.)

Case (b):—where part of a model is mobile and part rigid,

$$L^2 > L.d^{\frac{3}{2}}$$

because the vertical scales differ in the rigid and mobile portions, and if made the same would give incorrect results. This difference can be reduced to a small extent by making the rigid portion smoother than in the prototype (see para. 13.03) and by increasing the steepness of the glacis slope—which increases the coefficient of discharge; but the distortion has different effects with different discharges and different drowning ratio—thus an increased glacis slope leads to an increase of coefficient with free flow; but a reduction of coefficient with drowned flow. It follows, therefore, that distortion of the rigid portion does not neutralise the scale effect. This can be overcome for a particular discharge by adopting different depth scales for the river portion and the Barrage portion—i.e. by lowering the sill of the Barrage to pass the designed discharge; but this alters the drowning ratio, and downstream flow conditions and the divergence increases with other discharges, and flow over the weir would continue after it had ceased in the prototype..

(Note.—The water level must be taken as the datum for the local depth scale of the rigid portion.)

THE BEHAVIOUR AND CONTROL OF RIVERS AND CANALS

In the Lower Sind Barrage model—in which flow is almost axial—satisfactory results were, however, obtained in a single model by making the depth scales for the river and the Barrage different:—

$$\text{Longitudinal scale} = 1/(250)^2$$

$$\text{Q scale} = 1/62,500$$

$$\text{River depth scale} = 1/50$$

$$\text{Barrage depth scale} = 1/40 \text{ (from } 1/62,500 = 1/250 \times d^{1.5}\text{)}$$

13.36. (v) LONGITUDINAL DISTORTION

Vertical exaggeration is essentially a width reduction and in many cases it is best to visualise it as such. Similarly, slope exaggeration may be looked on as a foreshortening, or relative reduction of longitudinal scale; but depth remains the same whether viewed in its relation to width or length; hence depth should be looked on as basic, and length and width as related to depth; so that width and length reduction are more precise terms than the usual expression—vertical exaggeration.

In a very small model, a high slope exaggeration may lead to hyper-critical velocities; but more generally it merely leads to distortion—due to the length in which changes have to take place being foreshortened. As a result, the length in which new lines of flow and eddy-patterns (resulting from changes of section, or roughness) have to become established in the model, is often inadequate to establish the change before a further alteration in the angle of flow, or roughness, occurs in the model.

Two good examples of this are—

- * (i) flow from the twin gorges at Sukkur,* and
- † (ii) the groynes in the Jumna at Delhi.†

In the former case, the gorge was foreshortened $7\frac{1}{2}$ times in the model, affecting both lines of flow and eddy pattern of the water as it issued from the gorge; while in the latter case, the groynes were seven times closer together relative to depth than in the river.

13.37. (vi) NECESSITY OF TILTING NARAJ WEIR IN THE MAHANADI MODEL

Photo Sheet
1-22
Figs. 1-10

The top of Naraj Weir, over which water flows from the Mahanadi into the Katjuri, is horizontal from bank to bank. If the discharge per foot run at all points of the Weir were relatively the same in the model as in the prototype, the Weir would be horizontal in the model also; but as explained in 13.35, the vertical scale of the Weir portion has to be different from the vertical scale of the river portion in order to give corresponding discharges, so the sill of the Weir had to be lowered. This lowering was not uniform from the right bank to the left bank, because the greater the depth of water over the sill, the more the Weir has to be lowered to pass the correct discharge. In other words, the weir had to be tilted as well as lowered, and the level should have varied with the discharge.

This question was still further complicated due to the lines of flow and eddy pattern of the water as it issued from Naraj Gorge being different in the model from those in the river—as explained in 13.36.

13.38. (vii) DIFFERENT TIME SCALES FOR SCOUR AND ACCRETION

In a river, by far the greater part of the material in motion is in suspension; whereas in most models, silt in suspension forms a

* C. I. and H. R. S. A. R. (T) 1939-40.

† Ibid.

MODEL SCALE RATIOS AND LIMITATIONS

relatively small part of the total weighted charge; and experience shows that the reproduction of full natural silting in a model is impracticable. If the time during which a model is run is increased to permit more silt deposition, scour—which occurs relatively much more quickly than silting—is excessive; which, in turn, leads to a disproportionately great accumulation of coarser particles.

This error is accentuated where the model is laid according to 'cold weather' conditions in the river; because, as already explained, scour pits at the noses of groynes are relatively much larger in the model than in the river, and the excess of sand scoured from these pits produces unnatural sand-banks in the model, which are not removed by subsequent scour. This excess sand, unless removed, will produce quite wrong results.

Accretion on top of shoals is, on the other hand, relatively small in the model, with the result that a relatively greater discharge passes over the shoals. Consequently, reproduction of year to year changes in a river becomes more and more incorrect as the period of flow increases. These difficulties were prominent in the 1/500 scale model of the Gauges above the Hardinge Bridge.*

13.39. CONCLUSIONS REGARDING HYDRODYNAMIC MODEL EXPERIMENTATION

Though some types of problem can be solved with a high degree of accuracy with the aid of models; other types, especially problems connected with rivers flowing in alluvium, present extraordinary difficulties; so, if anyone has hoped to learn enough from this Chapter to enable him to carry out river model experiments successfully, he will be disappointed.

Models are, however, always helpful, in that they make it easier—

(i) to visualise the problem;

(ii) to verify data, to see whether it is correct and adequate, or whether important details—such as rock exposed in the bed, outcrops of lime kankar, etc.—have been omitted;

(iii) to evaluate the relative effects of different treatments—making allowance for model limitations;

but it must be clearly understood that success depends primarily on a correct diagnosis, and evaluation of all the factors causing change.

In general, the tendency is to place too great reliance on thought-numbing formulæ. They should be used only as a guide for initial laying. Thereafter, observation and comparison of model behaviour with river conditions should be the basis for further modifications.

A common mistake is to relay models for subsequent experiments according to the original scales. This is wrong. The scale ratios should be modified in the light of results, and the original scales discarded.

Factors involved in reproducing river conditions in a model include:—

(i) natural slope exaggeration;

(ii) natural width reduction;

(iii) a very much quicker time scale in the model than in the river, but the same rate of maturing and consolidation;

(iv) much steeper side-slopes in the model—though the material has practically the same angle of repose as in the river;

(v) fluctuating discharges and charges, the latter not being capable of measurement in the river; but having to be injected in the model;

* C. I. and H. R. S. A. R. (T) 1938-39, pp. 22-23.

THE BEHAVIOUR AND CONTROL OF RIVERS AND CANALS

(vi) exaggerated effects in the model due to rigid portions such as rock, lime kankar, clay, barrages, groynes, etc. These cause elongated vortices, and distorted lines of flow and 'bellies';

(vii) meanders, spills, cut-offs are affected by the relative coherence and angle of repose of the material in the river and model—the relation varying with variations in discharge;

(viii) differences in flood cycles from year to year—which have to be assumed and imposed in the model to predict future changes;

(ix) difference in vertical scale and length scale effects in rigid and non-rigid portions of a model.

No formula can be devised to take all these varying factors into consideration; all that can be done is to carry out experiments with mobile models to evaluate divergences from natural conditions resulting from various disturbing factors, in order to see how far these effects can be minimised.

Such investigations have been in progress at Poona for a great many years. These have given a clear indication of why certain modifications which we have been carrying out have been successful; but they have not, and cannot, eliminate the inherent divergences, nor can they fully resolve the numerous complex factors.

Frequently it is stated that river results have been reproduced in a model; yet those who make this statement relay their models each year according to the latest survey, instead of allowing the model to carry on from year to year. The reason given for this is that the flood differed from what was assumed; but the real reason is that only rough qualitative similarity has been achieved, and errors are cumulative. Our object is to predict what will happen hereafter—not for a year or two—but for several years ahead—and if a correct solution of such a problem depended on the model having to predict correct river conditions year by year for several years ahead, the model would give a wrong answer—not merely because models, like sausage machines, cannot give back more than is put into them; but still more because the effect of many factors differs, and the time-scales for accretion and scour are widely different.

For our purpose, it is necessary to study the data of alluvial rivers for as many years as available. This data should include flood hydrographs, annual surveys, data about bed material, and silt charge, etc.—but the most important investigation is with regard to river changes which have taken place in the past and are in progress. These must be studied in the field. Only thus can the most probable, and the most extreme, variations in river conditions be predicted.

Though alluvial river models have many clear-cut limitations; yet they give essential information to those who can interpret them. They should not be expected to show what will happen over a long period of years; their chief value being as an aid to engineering skill which they can never replace.

APPENDIX 1

List of Bombay Public Works Department Technical Papers and Annual Reports of the Indian Waterways Experiment Station, Poona

Bombay
T. P. No.

13. *Soil and Sub-Soil Surveys* in the Deccan Canal areas, by C. C. Inglis and V. K. Gokhale.
14. A Short Note on the *Improvement of Damaged Lands in the Canal Irrigated Tracts* of the Bombay Deccan, by C. C. Inglis.
15. Notes on *Standing Wave Flumes and Flume Meter Falls*, by C. C. Inglis.
16. Note on *Irrigation on the Block System* in the Deccan Canal Tracts by C. C. Inglis.
17. Note on the *Effluent Farm* near Poona (1918-19 to 1925-26) by C. C. Inglis.
19. Note on the *Design of Distributaries and their Outlets* in the Bombay Deccan, by C. C. Inglis.
20. Note, dated November 1927 on Model experiments to ascertain the effect of *Partial Lining of the Malegaon Cut* in miles 38 and 39 of the Nira Left Bank Canal by C. C. Inglis and D. V. Joglekar.
21. Note on the *Outturn and Profit from Sugarcane Crops* grown in the Deccan Canal Tracts, by C. C. Inglis and V. K. Gokhale.
22. Note on Experiments carried out at the Hydraulic Testing Station at Distributary No. 5, Mutha Right Bank Canal, near Poona, with a *Limley Type Standing Wave Flume* by C. C. Inglis with assistance of D. V. Joglekar.
23. A note on *Standing Wave Pipe Outlets*, by C. C. Inglis.
24. Report on *Land Drainage Experiments* at Baramati, by C. C. Inglis, with V. K. Gokhale and staff of Baramati Development Sub-Division.
25. *Moduling operations* on Distributary No. 8, Nira Left Bank Canal and application of the Results to other Distributaries, by C. C. Inglis, with D. V. Joglekar.
26. Report on Tests made on a Model of the Group of *Regulators at Olerolal* at mile 169 approximately of the Rohri Main Canal, Sind, by C. G. Hawes and C. C. Inglis.
27. Report on Experiments on *Model Culverts* made with *Hume Pipes*, by C. G. Hawes and H. S. Kahai, with appendix containing a Note on the use of Hume Pipes for irrigation purposes, based on Notes by C. C. Inglis.
28. Note on *Research work done by the Special Irrigation Division since its formation in June 1916*, by C. C. Inglis.
29. Note on Experiments carried out with various *designs of piers and sills* in connection with the Lloyd Barrage at Sukkur, by C. C. Inglis and C. G. Hawes, with J. S. Reid, D. V. Joglekar and H. V. Katakhar.
30. A note on a Critical Study of *Run-off and Floods of Catchments of the Bombay Presidency* with a short Note on losses from lakes by evaporation, by C. C. Inglis with A. J. DeSouza.
31. Report on Experiments carried out at the Karachi Model Testing Station on a Model of a *Flumed Regulator* by C. G. Hawes, and H. S. Kahai, with a note by C. C. Inglis.
42. Notes on (1) *Flumed Aqueducts*,
(2) *Remodelling an existing Canal or Distributary, to pass an increased discharge*,
(3) *Afflux caused by heading up water at regulators of a canal and the extent of backwater and*
(4) *Distribution of velocities in channels*, by C. C. Inglis.

THE BEHAVIOUR AND CONTROL OF RIVERS AND CANALS

44. *The Dissipation of Energy below Falls*, by C. C. Inglis and D. V. Joglekar.
45. Note of May 1931 on *Silt Exclusion from Canals "Still Pond" versus "Open Flow"* part I, by C. C. Inglis.
46. Note on *Silt Exclusion from Canals*, Part II—First report on experiments with the full width model of *the Sukkur Barrage* at Khadakwasla with Appendices on the design of dynamically—similar models in accordance with Lacey's formulas, by C. C. Inglis and D. V. Joglekar.
49. *Development of Irrigation in the Deccan Canal Areas*, by C. C. Inglis and V. K. Gokhale.
51. Note on experiments carried out with a *Short-crested weir model*, by C. C. Inglis and D. V. Joglekar.
52. Factors affecting *exclusion of bed silt from Canals* taking off from alluvial rivers, by C. C. Inglis and D. V. Joglekar.
54. Note on experiments with a model of the *Head sluices of the Nira Left Bank Canal*, by C. C. Inglis and D. V. Joglekar.
55. Report on experiments carried out with Models in connection with the protection of the *Hardinge Bridge*, on the Eastern Bengal Railway, by C. C. Inglis and D. V. Joglekar.
56. *Land Drainage in the Deccan Canal Area* by W. A. Evershed.
57. Note on *disposal of Poona Sewage Effluent*, by C. C. Inglis and D. V. Joglekar.
58. Report of *work done at Lake Fife Hydrodynamic Research Station* during the year 1936-37, by C. C. Inglis and D. V. Joglekar.
59. *Silt Control at Heads of Canals and Distributaries*, by C. C. Inglis and D. V. Joglekar.

Research
Publication
Number.

1. Annual Report of work done during 1937-38 by C. C. Inglis, A. R. Thomas, D. V. Joglekar and staff at Khadakwasla.
2. Annual Report of work done during 1938-39 by same authors as in 1.
3. Note on the theory, design and construction of Gibb Modules which, without moving parts, give a constant discharge within working limits irrespective of variations in upstream and downstream water levels by C. C. Inglis and D. V. Joglekar.
4. Annual Report of work done during 1939-40 by C. C. Inglis, A. R. Thomas, D. V. Joglekar and staff at Khadakwasla.
5. Annual Report (Technical) of work done during the year 1940-41 and index for 1937-41 by C. C. Inglis, A. R. Thomas, D. V. Joglekar and staff at Khadakwasla.
6. Annual Report (Technical) of work done during the year 1941-42 by C. C. Inglis, J. S. Reid, D. V. Joglekar and staff at Khadakwasla, with index for 1937-42.
7. Annual Report (Technical) of work done during the year 1942-43 by C. C. Inglis, J. S. Reid, D. V. Joglekar and staff at Khadakwasla, with index for 1938-42.
8. Annual Report (Technical) of work done during the year 1943 by C. C. Inglis, D. V. Joglekar and staff at Khadakwasla, with index for 1939-43.
9. Annual Report (Technical) of work done during the year 1944 by C. C. Inglis, D. V. Joglekar and staff at Khadakwasla, with index for 1940-44.
10. Annual Report (Technical) of work done during the year 1945 by D. V. Joglekar and staff at Khadakwasla, with index for 1937-45.

BED RIPPLES AND BED DUNES

APPENDIX 2

BED RIPPLES AND BED DUNES

	Page.
A2.00. Introduction 459
A2.01. Movement of sand particles 459
A2.02. Mechanism of ripple formation 460
A2.03. Classification of ripples and dunes 461
A2.04. Transition from ripples to dunes 462
A2.05. Factors affecting the shape and dimensions of ripples and dunes 465
A2.06. Effect of size distribution of particles on the ripples 466
A2.07. Effect of charge of bed sand 466
A2.08. Effect of discharge 466
A2.09. Phenomenon at the dune crest 466
A2.10. Scour of the upstream slope of the dune crests 467
A2.11. Summary of the Note 467



Photo 2289. Photo looking upstream in sand channel experiments, showing typical ripple formation in white V sand (unscreened), 0.24 mm., with $Q = 1.5$ cusecs without sand injection.

PHOTO FROM I. W. E. STN. A. R. T. 1943.

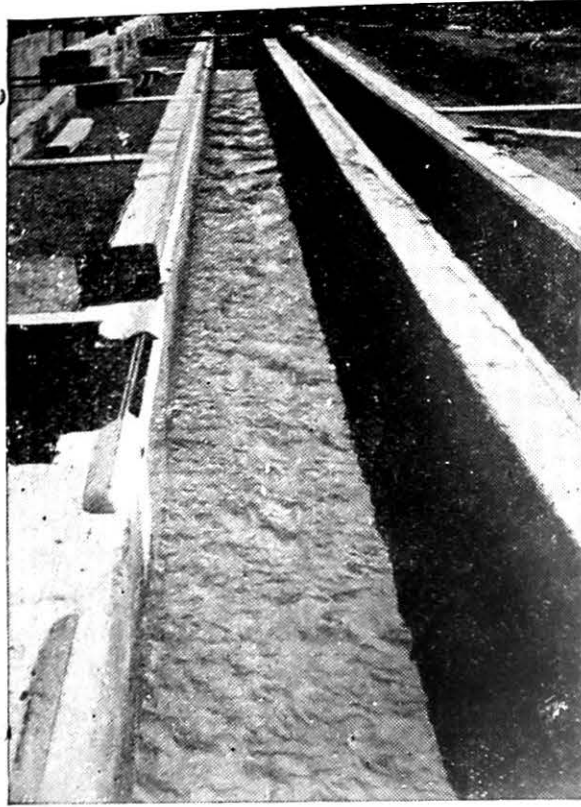

Photo 3067 Looking upstream showing appearance of bed dunes at the upstream end and intermediate condition between large ripples and small dunes at the lower end in experiment with $Q = 6.75$ cusecs and $X = 0.2$ per thousand by dry weight of V sand (0.35 mm.) in L. B. flume.

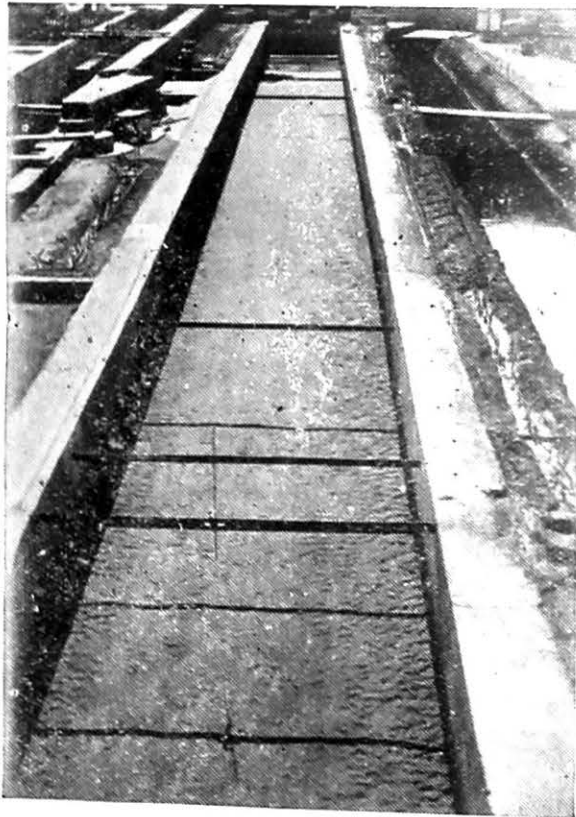

Photo 2510. Looking upstream showing the bed condition with Theur sand ($m = 0.23$ mm.) after ripples had been washed away, except near the sides, by increasing the velocity from 1.08'/sec. to 2.08'/sec., by reducing depth with same q ($= 1.08$ cs./ft.) to about half.

PHOTOS FROM I. W. E. STN. A. R. T. 1943.

APPENDIX 2

BED RIPPLES AND BED DUNES

A2.00. INTRODUCTION

The formation of ripples on the bed of an alluvial channel has been studied in detail at Poona. In 1940, experiments were carried out under the supervision of Mr. A. R. Thomas,—Deputy Director—in a 2.5 ft. wide channel, in which a predetermined discharge was run, the water level being lowered until bed movement commenced. The water level then being gradually lowered 0.05 ft. and maintained constant until bed movement had practically ceased. The mean height of bed ripples (top of crest to bottom of trough) and length (crest to crest) were found from the average of several ripples.

The experiments showed that

(i) ripple height varied with different materials;

(ii) when the water level was lowered rapidly, keeping the charge constant, vigorous scour occurred and the ripples which formed were higher, the final depth of water greater, and the velocity lower than where water was lowered gradually—that is to say, increased charge led to an increase of ripple height, an increase of depth, and a reduction of velocity;

(iii) though ripples formed when flow was initiated in a channel with a bed of Khadakwasla sand, they gradually disappeared, due to the material ($m=0.20$ mm.) being partially cohesive;

(iv) bed ripples did not form on a bed of coarse sand;

and

(v) the energy slope increased with coarseness of material as well as with relative roughness (h_r/d).

Further experiments were carried out in 1943 by Mr. S. C. Desai to ascertain the factors affecting the formation of bed ripples and sand dunes on the beds of alluvial channels.

Bed-ripples are small undulations which appear in a distinct pattern on the bed of a channel—see Photo 2289. Photo Sheet
A2-1.

Ripples appear and develop wherever bed movement occurs, even though it is very small; and their shape and dimensions depend on the discharge of water, the sand charge, grade of material, its size-distribution, and specific gravity.

A2.01. MOVEMENT OF SAND PARTICLES

When the water level in a flume flowing with constant discharge with incoherent white V sand on the bed ($m=0.21$ mm.) was gradually lowered, it was found that a stage was reached when very light particles of the mixture exposed on the bed began to be thrown into suspension (see Fig. A2-1), while heavier particles did not move. On Fig. A2-1;

FIG. A2-1

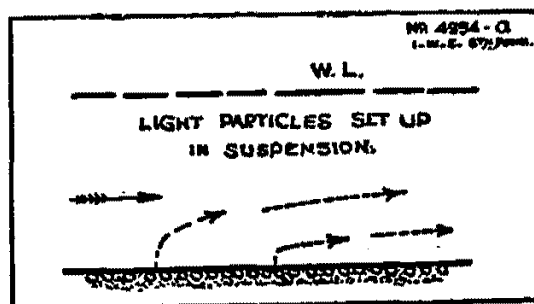

(FIG. 49 FROM A. R. T., 1943 OF I. W. E. STN.)

THE BEHAVIOUR AND CONTROL OF RIVERS AND CANALS

further increasing the velocity, by lowering the water level, it was observed that large particles in the mixture began to move on the bed; and on lowering the water level still further, the medium and fine particles moved. The reason for large particles moving before the medium and fine particles is due to the larger particles protruding a small distance above the general bed level, so that they are acted on by relatively high velocities at some distance above the bed, whereas the finer particles which fill the interstices between the larger particles, are acted on by relatively low velocities.*

A2.02. MECHANISM OF RIPPLE FORMATION

FIG. A2-2

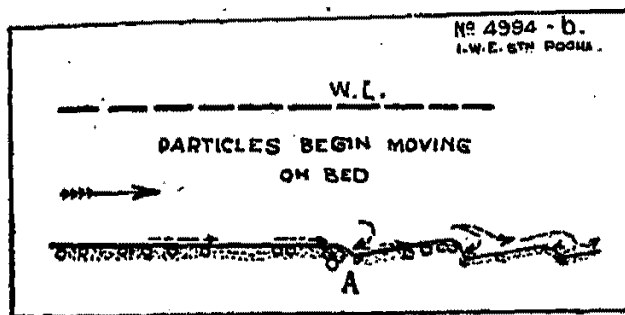

(FIG. 50 FROM A. R. T. 1943 OF I. W. E. STN.)

As the sand grains in a given mixture vary in size and shape; and in turbulent flow, any random collection of particles will occur on the bed—as at point A (Fig. A2-2)—this will cause a small eddy to form downstream; and, due to the formation of this eddy, material will be scoured from the trough and the scoured material will deposit at a point further downstream to form another ripple crest which, in turn, will lead to the formation of another eddy; and the process thus becomes continuous downstream until a series of ripple crests and troughs is formed.

FIG. A2-3

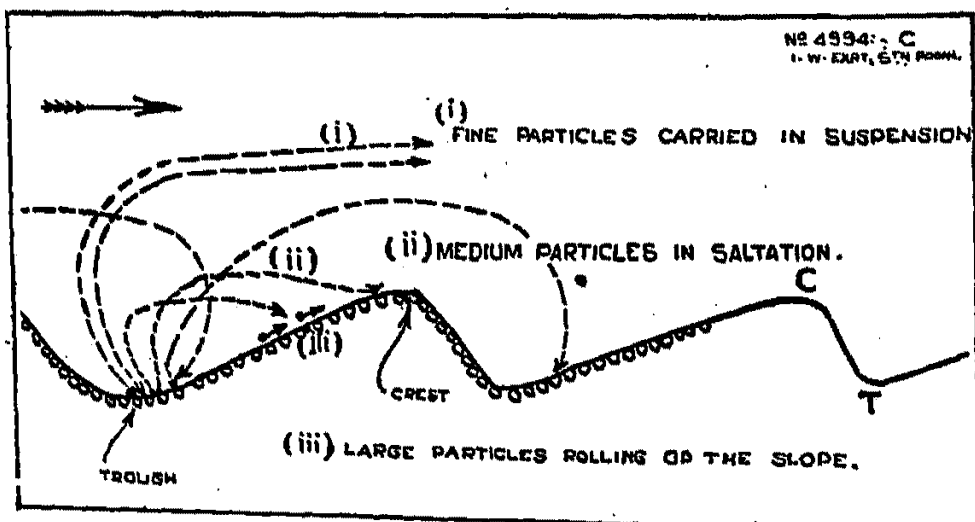

(FIG. 51 FROM A. R. T. 1943 OF I. W. E. STN.)

Due to eddies formed in the trough of sand ripples, particles of sand are shot up in all directions from the trough, very fine particles being shot up higher than less fine particles, to be carried away in suspension—see Fig. A2-3.

*Paper No. 17, U. S. Waterways Experiment Station, Vicksburg, Mississippi, 1935.

BED RIPPLES AND BED DUNES

Some of the medium particles are also shot up from the trough; but these are not carried in suspension, but mostly fall on the upstream slope of the ripple, though some of them fall on the upstream slope of the next ripple. The particles which impinge against the larger particles lying on the upstream slope, set some of them in motion, though this action is feeble.

FIG. A2-4

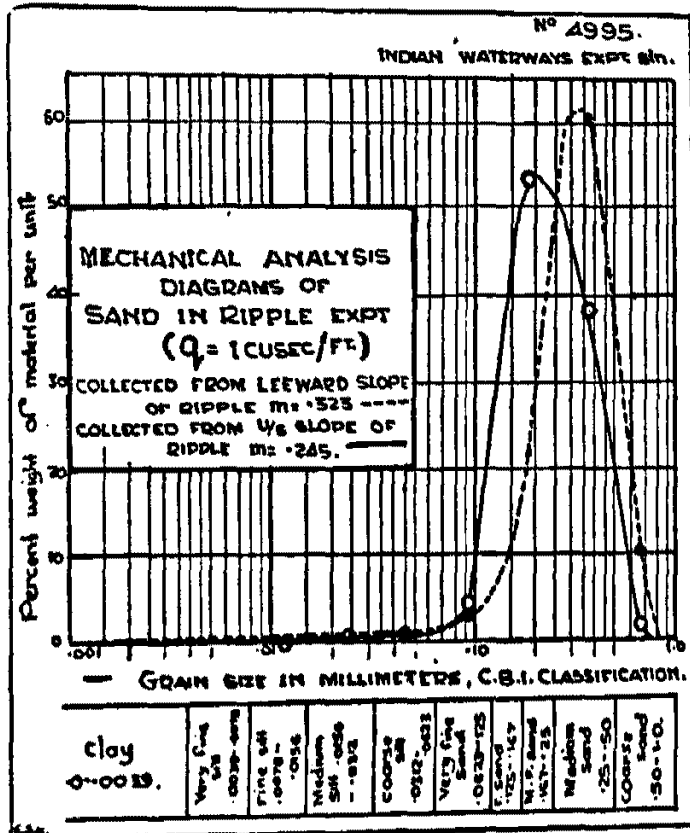

(FIG. 52 FROM A. R. T. 1943 OF I. W. E. STN.)

The rest of the particles are rolled up the ripple surface towards the crest and then slide down the lee face, to form a leeward slope with an angle of repose which is steeper than the normal angle of repose. This is due to the upward current of the bed roller in the trough; and large particles are found on the leeward slope, whereas a mixture of fine and coarse particles is found on the upstream slopes of the ripples. This is shown by Fig. A2-4 which depicts the mechanical analysis of white V Fig. A2-4. sand, collected from the upstream and downstream slopes of a sand ripple.

A2-03 CLASSIFICATION OF RIPPLES AND DUNES

There are four distinct stages of bed roughness. Ripples; a condition intermediate between ripples and dunes; and sheet movement. Kramer* based his ripple classification on the ratio of height of a ripple to the depth of water which formed it and classified as excessive ripples if h_r were greater than 8 per cent of the depth of flow, medium ripples if h_r were 3 to 5 per cent of depth of flow, and weak ripples if h_r were less than 3 per cent of depth of flow. At the Waterways Station at Poona we have found, however, that all incoherent sands with mean diameters up to 0.43 mm. form ripples greatly in excess of 8 per cent, especially where depths of water are low; and that the ratio of h_r/d decreases with increase of discharge per foot run. Hence such a classification is unsuitable for defining types of ripples.

* Hans Kramer: "Sand mixtures and sand movement in Fluvial Models", Paper No. 1909, American Society of Civil Engineers, 1934.

Photo Sheet
A2-2. 
Fig. A2-5.

Ripples and dunes can be better classified from their pattern on the bed of a channel; see photo 3067—Photo Sheet A2-2—and Fig. A2-5. Ripples form irregularly, whereas the crest of a dune stretches across a considerable width of the bed. In the case of a ripple there are no secondary ripples on the upstream slope, whereas small secondary ripples appear at times on the upstream slopes of dunes.

A2.04. TRANSITION FROM RIPPLES TO DUNES

With increase in bed movement, conditions gradually change from a smooth bed to ripples from ripples to, small, medium, and large ripples; and from large ripples to small, medium and large dunes, and eventually to sheet movement. It was also found that after the bed of the channel has attained equilibrium, if the velocity were suddenly greatly increased (say doubled), the crest of the ripples was washed away, and an almost smooth bed resulted—as shown in Photo 2510—Photo Sheet A2-2.

Photo Sheet
A2-2.

FIG. A2-6

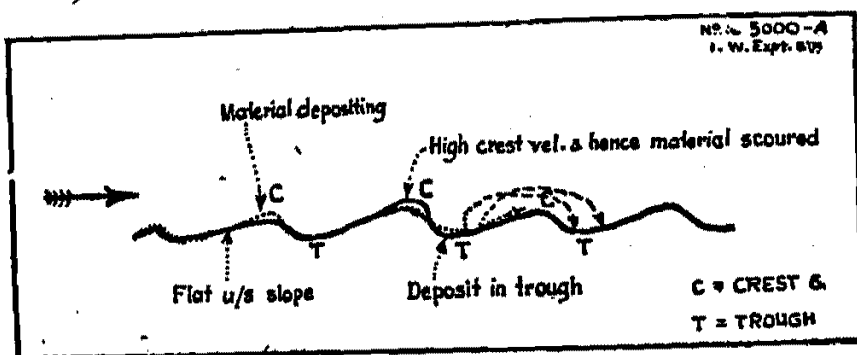

(FIG. 54 FROM A. R. T. 1943 OF I. W. E. STN.)

Fig. A2-6.

The upstream slope of a ripple results from a balance of forces—if it is too flat, material will deposit at the crest and the slope will become steeper. If it becomes too steep, the crest will be scoured, some of the scoured material depositing in the trough, (see Fig. A2-6) and some on the next upstream slope, till the upstream slope is reduced to the normal slope.

For a given length of ripple, the height is a maximum when the upstream and downstream slopes are steepest. Bagnold* has pointed out that

“the length of the characteristic path of particles increases with increase in velocity.”

Fig. A2-7 (a)
and (b).

He was writing about air-transported sand, but the same holds for water-transported sand; and as a result the length of the ripple also increases with velocity, while the upstream slope flattens and deposition takes place at the crest; so that the height increases. This is limited by the velocity at the crest; and increase in height relative to the increase in length decreases as the velocity at the crest increases, until l/h exceeds that for normal ripples, and dunes develop. Due to this flattening of the upstream slope of the sand dune, convergence of bed flow is reduced and is less than in the case of normal ripples and is insufficient to smooth out all the turbulence at the toe of the slope where flow emerges from the trough. This reduction of convergence leads to instability of flow and the formation of small ripples on the upstream slopes of the bed—see Fig. A2-7 (a) and (b)—each ripple having a roller with horizontal axis formed in its lee, as could be seen through a glass window in the side of the flume.

Fig. A2-7 (b)

Due to different grades of material in the mixture, the characteristic hops of grades differ considerably, and some of the particles (especially the larger ones) thrown up from the trough saltate only a short distance, to fall on the upstream slope of the next ripple. Thereafter, they move by bed-creep, mingling with the secondary small ripples which have formed on the slope—see Fig. A2-7 (b).

* “The Physics of Blown Sand and Desert Dunes” by Brigadier R. A. Bagnold, F. R. S.

FIG. A 2-5

BED RIPPLES & BED WAVES.

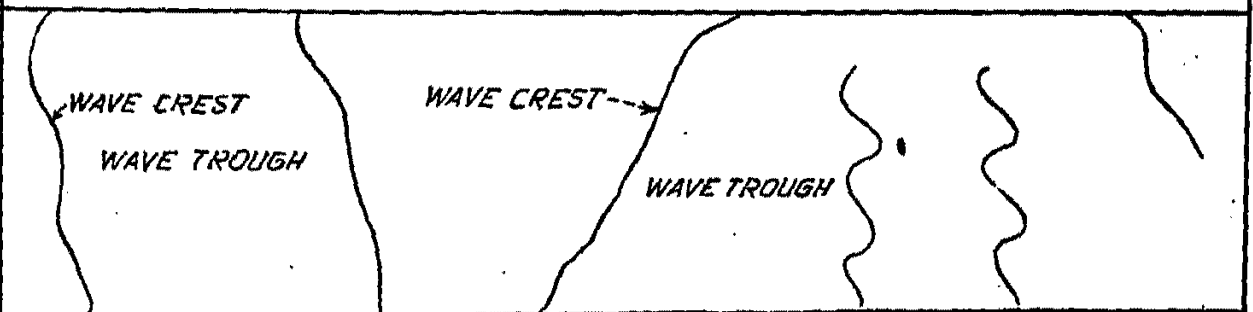
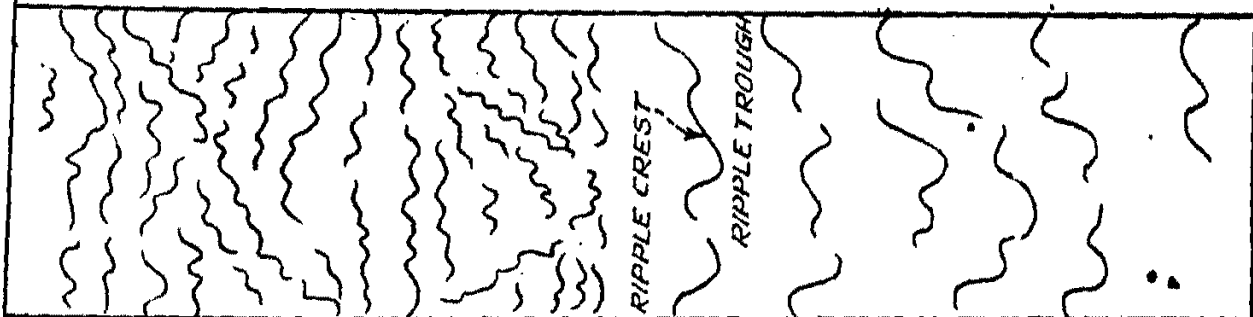
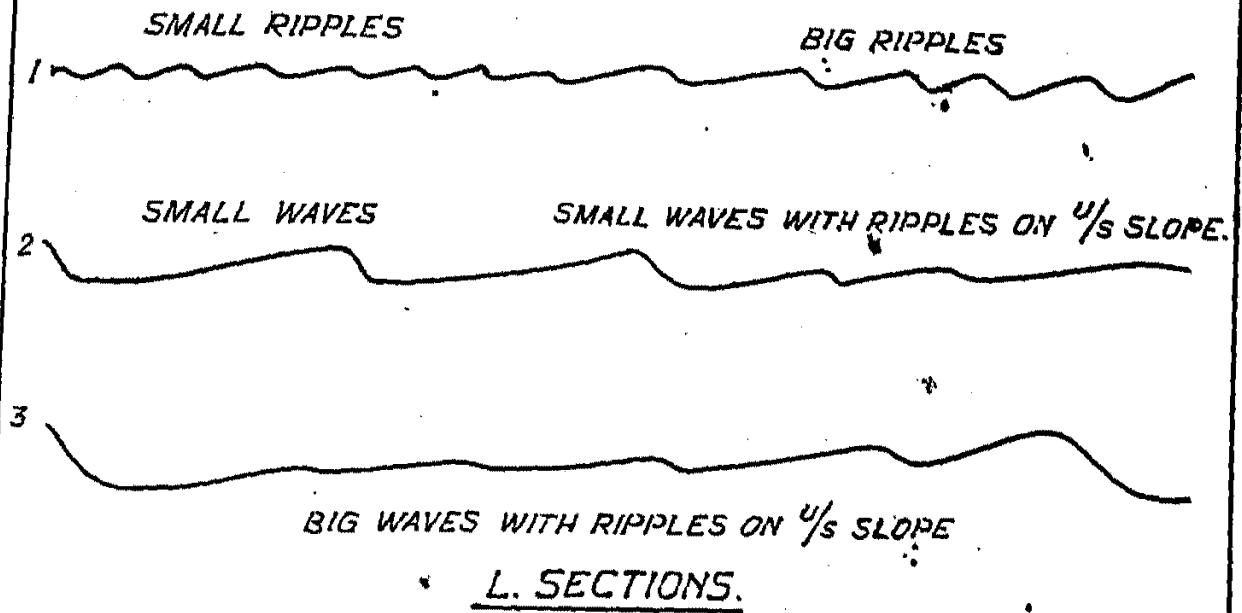

SMALL WAVES SMALL WAVES WITH RIPPLES ON u/s SLOPE

LARGE WAVES WITH RIPPLES ON u/s SLOPE



PLAN

PARKHI.

BED RIPPLES AND BED DUNES

Fig. A2-7 (a) and (b)

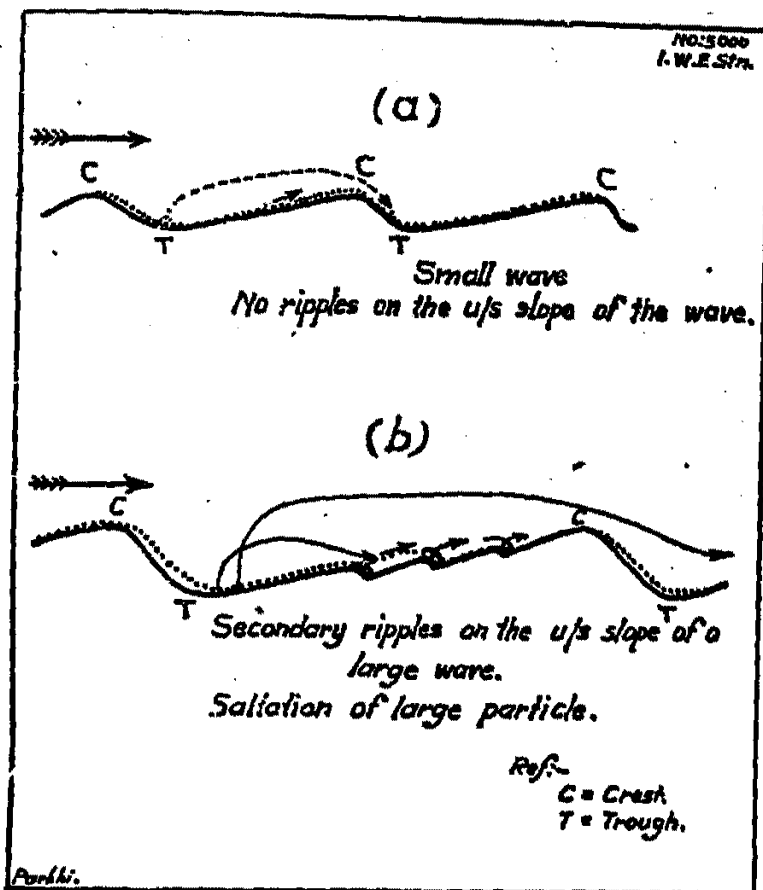

(FIG. 55 FROM A. R. T. 1943 OF I. W. E. STN.)

A2.05 FACTORS AFFECTING THE SHAPE AND DIMENSIONS OF RIPPLES

Experiments have been carried out in open channels at the Station with incoherent V sand of 0.21 mm., 0.24 mm., and 0.43 mm.; Nala sand of 0.65 mm., Nala gravel 1.4 mm., and 4.94 mm.; in open channels; and with materials of 4.22 mm., 8.7 mm., and 19.4 mm., in flume experiments. These showed that ripples do not form where the bed material consists of gravel but that sands up to about 0.5 mm. mean diameter produce ripples.

* Rubey concluded that particles having a mean diameter of less than 0.10 mm. follow Stoke's law, i.e. the formula for viscous resistance ($V_s \propto m^2$) while those with $m > 0.5$ mm. follow the formula for movement by impact of water ($V_s \propto m^{1/2}$). For intermediate grades the movement of particles is controlled both by viscous resistance and impact of the fluid.

A table based on Zahm's extension of Stoke's equation† indicates a much shorter transition range than assumed by Rubey and an intermediate range between $m = 0.2$ and $m = 0.5$ in which $V_s \propto m$ (approximately), with short transition regions each end.

• Experiments with Nala sand (0.65 mm.) showed that ripples do not form in Nala sand > 0.65 mm., and such small ripples as formed at higher stages of flow were due to an admixture of particles finer than 0.50 mm. Hence, the presence or absence of ripples is closely linked with the way in which the particles move, which in turn depends upon the grade of material.

* "Settling velocities of gravel, sand and silt particles" by William W. Rubey pp. 825-839 Vol. XXV, American Journal of Science, April 1933.

† Punjab Irrigation Research Institute Report for year ending April 1937, p. 46 and Table 16.

THE BEHAVIOUR AND CONTROL OF RIVERS AND CANALS

A2.06. EFFECT OF SIZE DISTRIBUTION OF PARTICLES ON THE RIPPLES

The height of ripples in unscreened white V sand— $m=0.24$ mm.—containing 5 per cent of coarse material above 0.6 mm. was only about half that of ripples in screened V sand of 0.21 mm. This difference was largely due to the coarse particles of unscreened sand accumulating in the troughs.

A2.07. EFFECT OF CHARGE OF BED SAND

Sand load experiments were carried out in the 2.25' and 4.5' vertical-sided flumes with white V sand— $m=0.35$ mm. The discharge and charge were the same in the two channels, being 4 cusecs and 0.2 per cent by dry weight respectively. Equilibrium was reached with large dunes in the 2.25' flume and with small dunes in the 4.5' flume. In experiment 3 of that series, the charge was reduced to 1/4th, i.e. $X=0.05$ per cent by dry weight, and it was observed that with reduction in charge the bed condition in both the flumes gradually changed, the large dunes being replaced by small dunes in the 2.25' flume, and the small dunes by ripples in the 4.5' flume.

These experiments showed that ripples or dunes increase with increase in charge when discharge is kept constant.

A2.08. EFFECT OF DISCHARGE

In sand bed experiments carried out in the 4.5' flume with white V sand (0.36 mm.), it was found that with the same charge (0.2 per 1,000 by dry weight) but with various discharges (3.6 cusecs, 5.0 cusecs and 6.75 cusecs) small dunes formed on the bed; and the height of dunes increased with increase in discharge, but ratios of height of ripples to depth of flow were nearly similar.

A2.09. PHENOMENON AT THE DUNE CREST (Observed through the glass side of the flume)

As in the case of ripples, large particles move by bed-creep on the upstream slope of dunes, while some of the medium particles move by saltation, the fine particles being in suspension.

Fig. A2-8

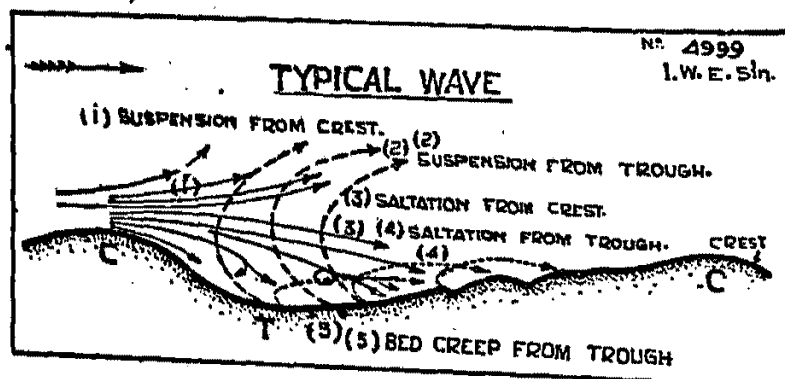

(FIG. 56 FROM A. R. T. 1943 OF I. W. E. STN.)

Fig. A2-8.

Movement of material on the wave crest is shown in Fig. A2-8. Due to the sharp curvature of flow at the wave crest, some of the fine particles were swept up by the turbulent flow and were carried away in suspension. The course of medium particles curved downwards and struck the upstream slope of the next dune, setting particles in motion—suspension, saltation or bed-creep. This action of a descending cloud of grains was very considerable. It was also observed that due to small irregular eddies in the troughs, the movement of particles from the troughs was intermittent.

BED RIPPLES AND BED DUNES

Fig. A2-9

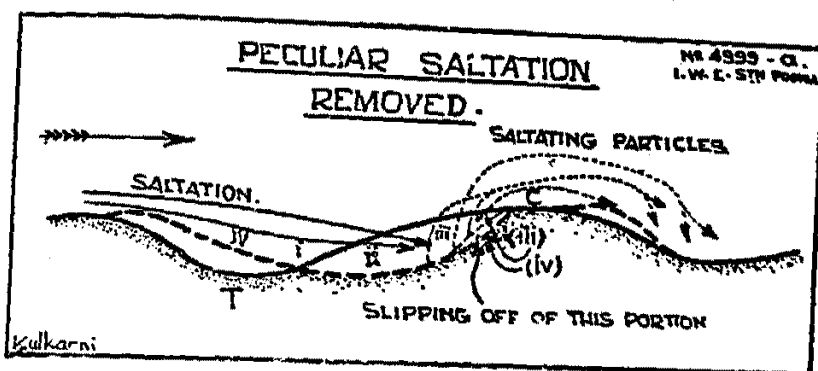

(FIG. 57 FROM A. R. T. 1943 OF I. W. E. STN.)

A2.10. SCOUR OF THE UPSTREAM SLOPE OF DUNE CRESTS

At times it was observed that heavy saltation developed from a dune crest, the particles striking the upstream face of the next dune. Heavy scour then occurred and almost all particles moved by saltation. [see Fig. A2-9, (i), (ii) and (iii)]. This action was so severe that the upstream slope of the dune crest became very steep, which led to the upper portion—from (iii) to (iv)—slipping off. During this motion it was observed that the rate of travel of the dune crest was less than the rate of movement occurring at the upstream end of the dune, due to scour, and hence the length of the dune decreased, until, in some cases, the whole of the dune was destroyed. The mean length of the path of the saltating particles from the scoured portion was nearly equal to the length of a small dune. When the length of a dune became about 10 per cent greater than normal, small secondary ripples developed on the upstream slope of the dune. These results were for equilibrium conditions with a discharge of 2.22 cusecs per ft. run and $X=0.2$ per cent. Under these conditions, the slope was found to be 0.63 per cent, $d=1.33'$, $V=1.67'$ /sec. and $V/d=2.08$.

A2.11. SUMMARY OF THE NOTE

1. Bed ripples and dunes are undulations which appear as a distinct pattern on the bed.
2. The origin of ripple formation lies in the uneven movement of material caused by the flow of water.
3. Random collections of particles occur on the bed. These create eddies, and material deposits at a point one ripple length downstream, where the same process takes place, and ripples appear on the bed further and further downstream as a series.
4. Ripples develop wherever bed movement occurs, even though it is very small; and their shape and dimensions depend on the discharge of water, the sand charge, grade of material, its size-distribution, and specific gravity.
5. With increase in bed movement the ripples change to small, medium, and large ripples; and large ripples change to small, medium, and large dunes; until eventually, with still further increase in bed movement, sheet movement occurs.
6. With increase in bed velocity the characteristic path of saltating particles increases and the ripple length increases, with a corresponding small increase in height.
7. The upstream slope of a ripple which has formed on a dune is dependent on the balance of forces between the rate of bed movement and the crest velocity. The downstream slope is determined by the angle of repose as controlled by the upward current of flow in the roller eddy (with horizontal axis) which forms in the trough.

APPENDIX 3

Sheet A3-1



Photo 479. Escape at the nose of the Divide Wall—facing towards the canals—looking upstream.



Photo 489. Escape at the nose of the Divide Wall—facing away from the canals—looking upstream.

$$Q_R = 4.06 \text{ cs.}; Q_{cs} = 2.5 \text{ cs.}; Q_{(\text{escape})} = 1.56 \text{ cs.}$$

PHOTOS FROM BOMBAY T. P. No. 52.

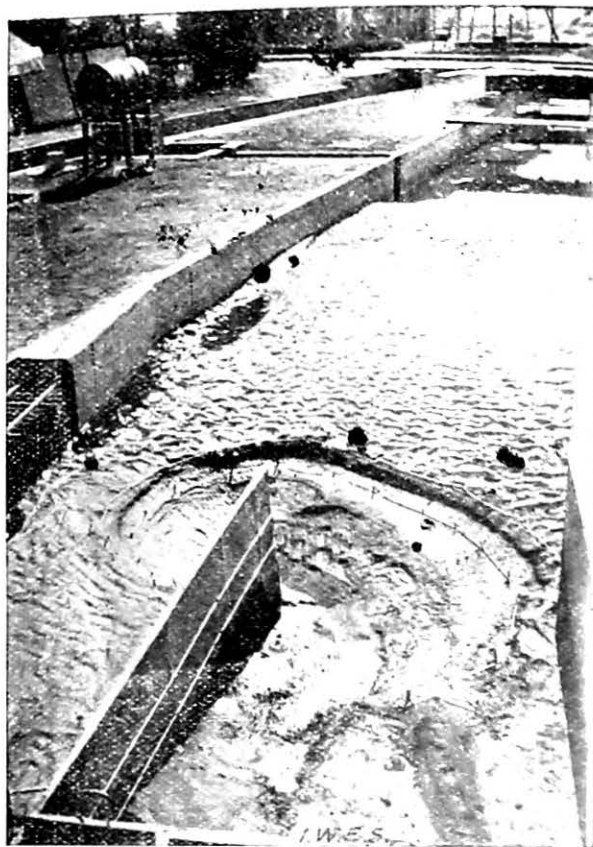

Photo 530. Scour at a vertical-nosed Divide Wall ending opposite the upstream end of Eastern Nara Canal after 15 hours flow.

$$Q_R = 8.32 \text{ cs.}; Q_B = 5.82 \text{ cs.}; Q_{cs} = 2.5 \text{ cusecs};$$

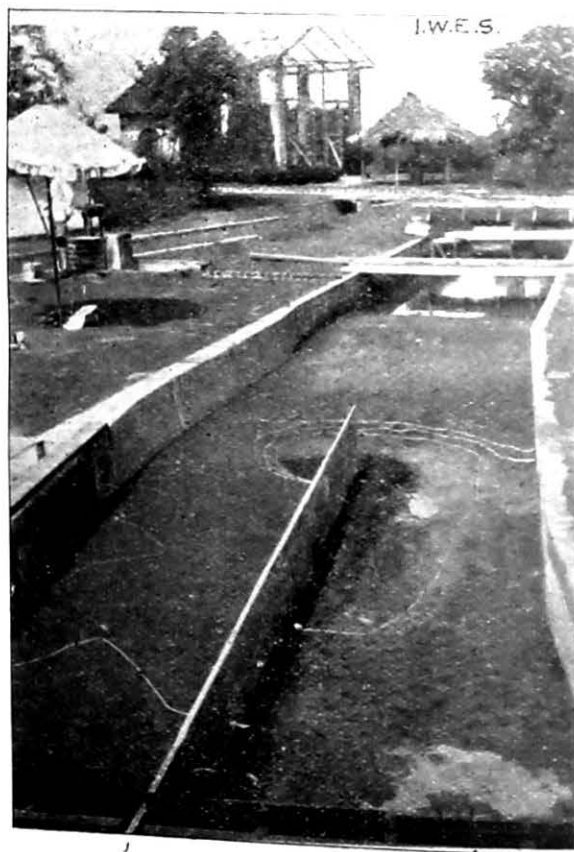

Photo 605. Long Divide Wall with pitching laid round nose after scour, showing the residual pitching in the form of an inverted boat.

PHOTOS FROM BOMBAY T. P. No. 52.

FACTORS AFFECTING EXCLUSION OF BED SAND.

APPENDIX 3

FACTORS AFFECTING EXCLUSION OF BED SAND FROM CANALS TAKING OFF FROM ALLUVIAL RIVERS

SUMMARISED FROM BOMBAY P. W. D. T. P. 51.

Model experiments carried out at Poona* in connection with the design of Sukkur Barrage showed that the proportion of bed water to surface water drawn from a 9 ft. wide, lined flume into a 3 ft. wide off-take with its bed at the same level, the discharge being one-third that in the parent channel — so that V^2/d was the same — was 1.28 with 3 cusecs in the parent channel, whereas with 6 cusecs, the ratio increased to 2.13 showing that doubling the velocity in the parent channel increased the ratio of bed water to surface water drawn, by 66 per cent.

When a sill = $d/3$ was added, the ratio fell to 1.69 or by 11 per cent; and adding piers reduced the ratio to 1.80 or by a further 5 per cent.

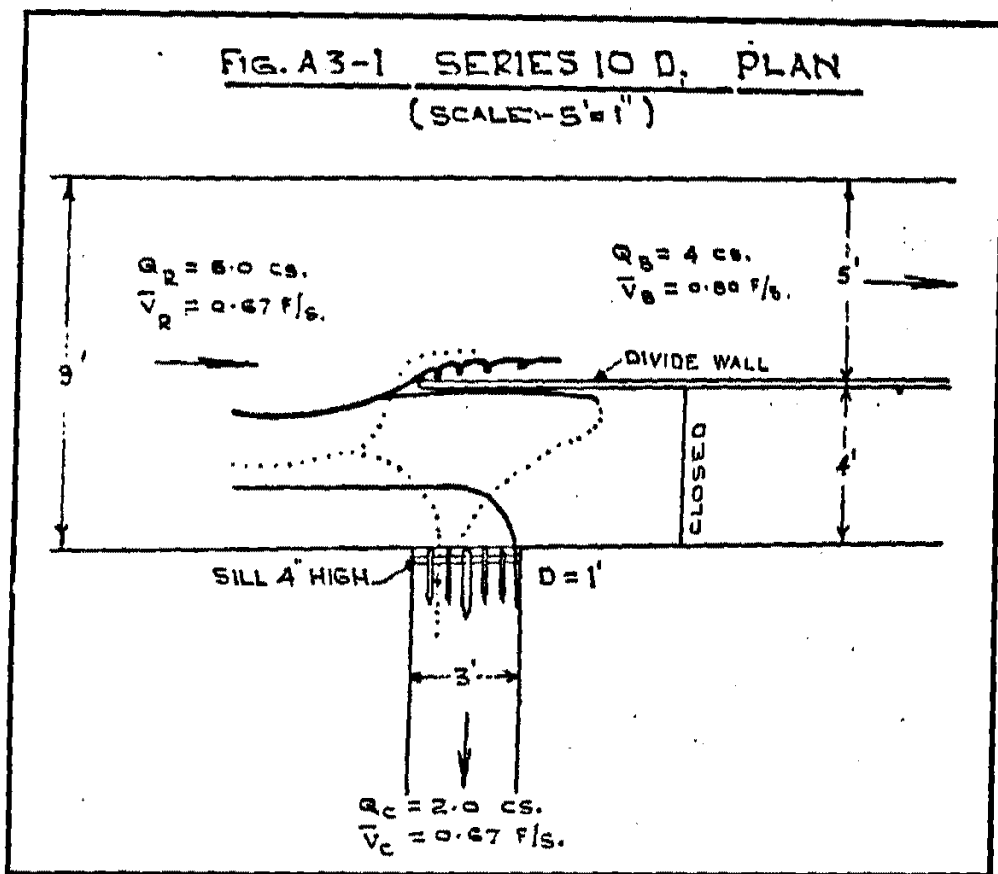

(FIG. 9 FROM BOMBAY T. P. No. 52)

When a divide wall was added (Fig. A3-1), making a pocket = $4/9$ ths the width of the parent channel, with "still pond" running imposed, the ratio was reduced from 1.80 to 0.62; but when the discharge outside the divide wall was reduced from 4 to 3.42 cs. and the undersluices were opened to pass 0.52 cusec, the pocket ratio was approximately unity.

* Bombay P. W. D. T. P. No. 52 "Factors affecting Exclusion of Bed Silt from Canals taking off from Alluvial Rivers."

THE BEHAVIOUR AND CONTROL OF RIVERS AND CANALS

TABLE A3-I

			Series 9 without a divide wall.	Series 10-D with a divide wall and under-slucices closed.
Q_B (cusecs)	6.0	6.0
Q_B (cusecs)	4.0	4.0
Q'_C (cusecs)	2.0	2.0
\bar{V}_B (f/s)	0.67	0.67
\bar{V}_B (f/s)	0.67	0.80
\bar{V}_C (f/s)	0.67	0.67
Surface divide (ft.)	2.5	3.25
Bed divide (ft.)	4.5	2.0
Ratio of $\frac{\text{bed water}}{\text{surface water}}$ drawn into Canal			1.80	0.62

Though these experiments were done with a rigid bed they give a clear-cut qualitative result indicating the relatively small effect of a raised sill on excluding bed sand and the greater effect of 'still pond' running. The benefit of 'still pond' running decreases rapidly as the pocket silts; so that even this is not a solution.

The optimum length of divide wall was investigated at Poona in connection with sand exclusion at Sukkur, and the conclusions arrived at were that

(i) A divide wall should not normally extend beyond the upstream end of the upper canal.

(ii) A shorter divide wall is almost equally effective for excluding bed-sand, and makes it possible to scour the bed of the pocket more quickly and effectively, and gives better control.

Other conclusions arrived at were that

(iii) In general, it may be said that the higher the velocity through the under-slucices the greater the proportion of bed-sand drawn by the Canals. The reason for this is twofold — due to the higher velocity of flow at the entrance to the pocket, a higher proportion of bed-sand is drawn into the pocket; and due to the higher velocity of water through the pocket, more top-water flows through the under-slucices, and hence a large proportion of bed-water enters the Canals.

(iv) Where there are several canals, the bed water tends to flow into the upper and larger canals.

(v) Where there is a pavement, sand exclusion will not merely be quantitatively different from that which occurs where there is no pavement and a free scouring bed, but the result may even be reversed.

It follows from this, that under some circumstances a paved floor is desirable while in others the reverse is true.

(vi) Where there is a curvature of flow, the top, high velocity water tends to flow outwards, and the relatively slow-moving bed-water is deflected towards the convex bank. In other words, curvature of flow tends to deflect bed sand from the concave bank.

FIG. A 3-2 (LINED BED) WITHOUT SAND ON BED.
SHOWING LINES OF FLOW

$Q_R = 4.06 \text{ CS. } Q_U = \text{NIL.}$

$Q_B = 1.55 \text{ CS. } Q_{CS} = 2.5 \text{ CUSECS.}$

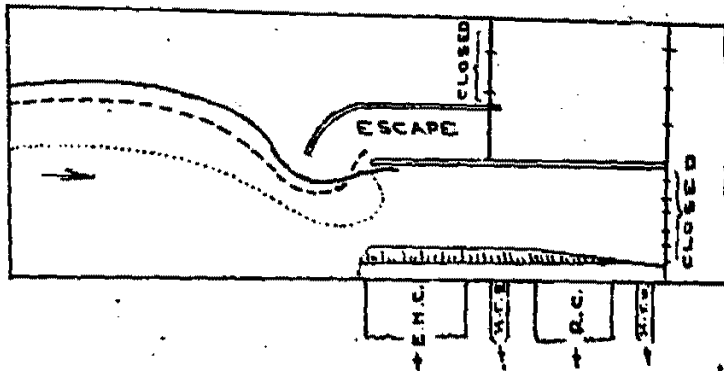

FIG. A3-3 WITH SAND ON BED SHOWING LINES OF FLOW

$Q_R = 4.06 \text{ CS. } Q_U = \text{NIL}$

$Q_B = 1.56 \text{ CS. } Q_{CS} = 2.5 \text{ CUSECS}$

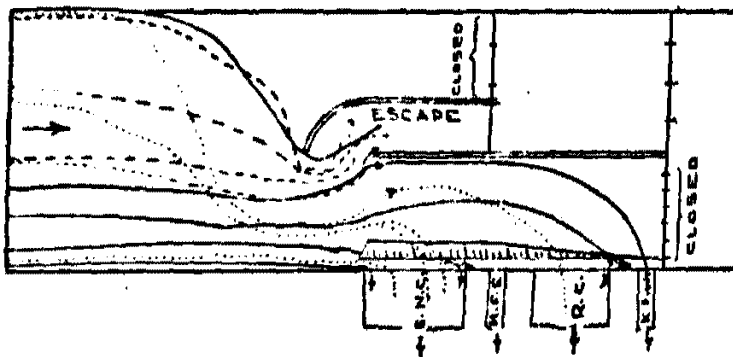
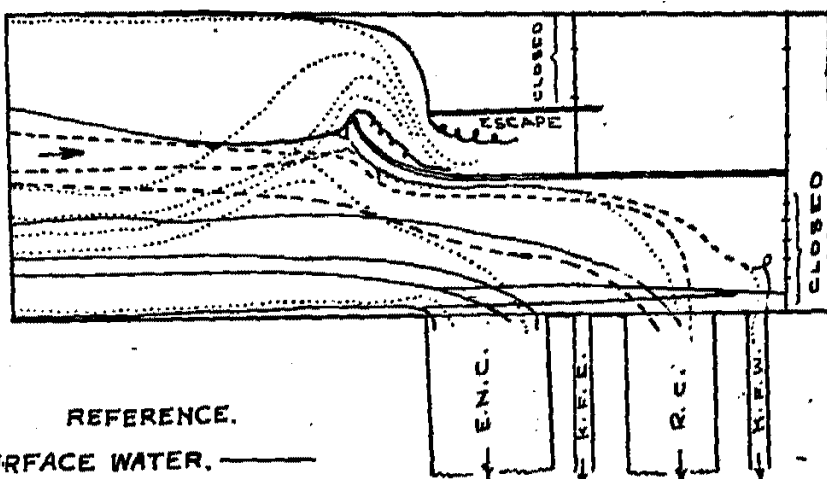

FIG. A3-4 (SERIES 36) WITH SAND ON BED
SHOWING LINES OF FLOW

$Q_R = 4.0 \text{ CS. } Q_U = 0$

$Q_B = 1.56 \text{ CS. } Q_{CS} = 2.5 \text{ CUSECS.}$



REFERENCE.
 SURFACE WATER. ———
 MID-DEPTH - - -
 BED - · - · -

FACTORS AFFECTING EXCLUSION OF BED SAND

As an offtake from a straight channel causes curvature of flow towards the offtake, the offtake draws bed-water. If this curvature is reversed by constructing a pocket in front of the canals and running it "still pond" the curvature is reversed and bed-sand excluded. When the "velocity : depth" ratio in the River falls below that in the pocket the canals will then draw more than their share of bed-sand; but this would also occur without a divide wall, and does not matter, because at such times the movement of bed-sand is negligible.

(vii) In order to "draw" sand away from a canal, water must be "drawn towards" mid-stream of the parent channel, to obtain the correct "surface outwards" rotation.

(vi) and (vii) are illustrated in Figs. A3-2, A3-3, and A3-4 (showing lines of flow and Table A3-II). Figs. A3-2, A3-3, A3-4.

TABLE A3-II

Table A3-II.

Divides Total width=9 ft.	Series 35- Lined bed.		Sanded Bed.		Series 36- Sanded bed.	
	Canal.	Escape.	Canal.	Escape.	Canal.	Escape.
Surface water divide (ft.).	6.5	2.5	3.2	5.8	6.25	2.75
Mid-depth divide (ft.).	6.0	3.0	3.8	5.2	4.5	4.5
Bed-water divide (ft.).	4.5	4.5	9.0	0.0	2.5	6.5
Bed water.	0.69	1.80	2.81	0.0	0.40	2.36
Surface water.						

Photo 479 (sheet A3-1) and Figs. A3-5 (Series 35X), Photo 489 (Sheet A3-1) and Fig. A3-6 (Series 36) showing bed contours, explain why the reversed escape of Series 36 was so much more successful than the Series 35X lay out. Photo Sheet A3-1. Figs. A3-5 A3-6.

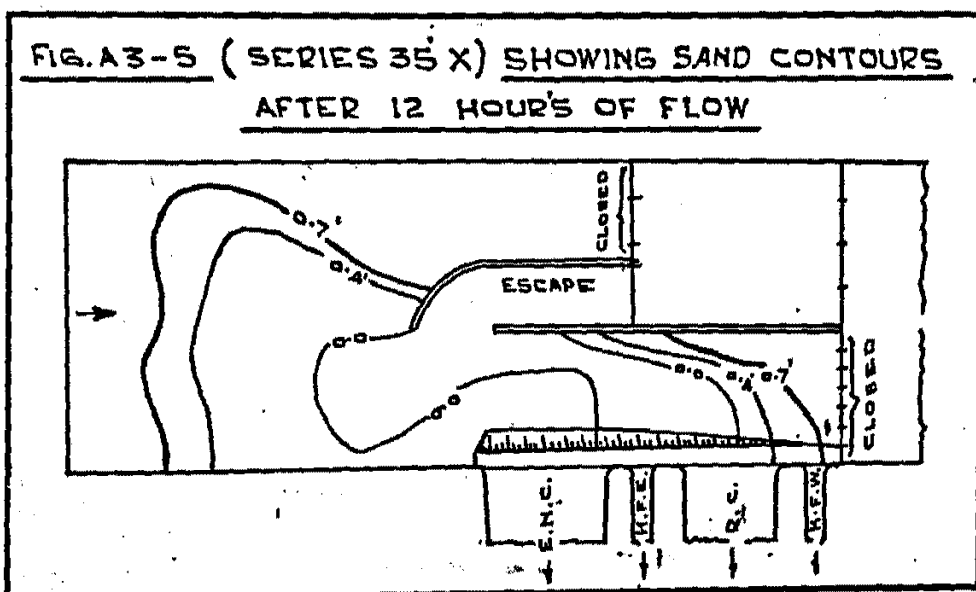

(FIG. 21 FROM BOMBAY T. P. No. 52)

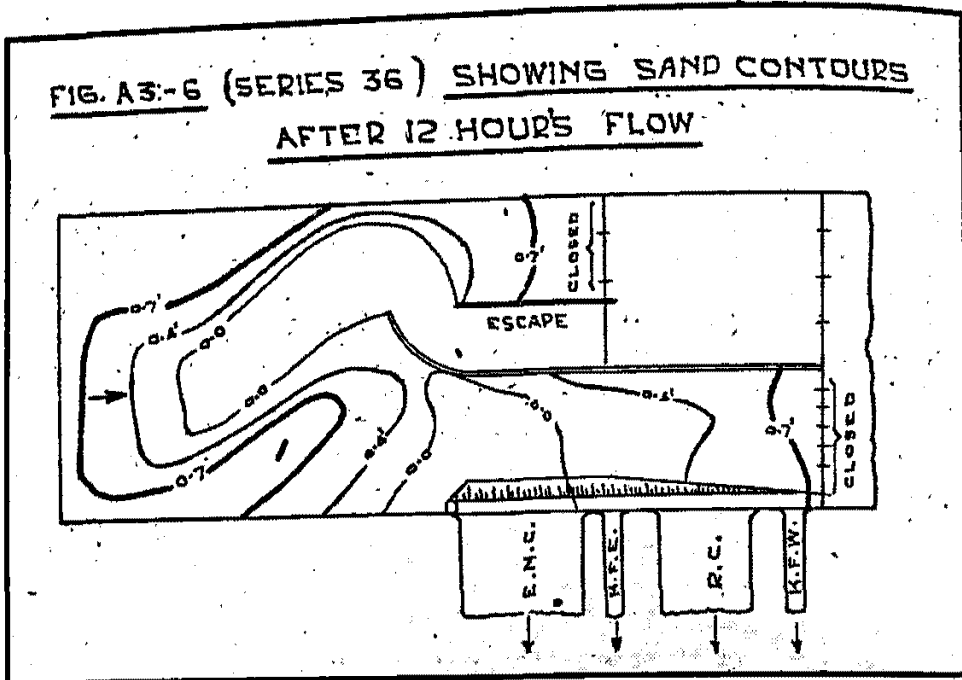

(FIG. 23 FROM BOMBAY T. P. No. 52)

(viii) As sand exclusion is governed by curvature of flow, which in its turn is governed by the ratio of critical velocity ratios inside and outside the divide wall, it follows that diverging divide walls are—within limits—better for sand exclusion than those constructed parallel to the face of the canal regulators.

(ix) The rate of movement of rolling bed sand around the nose of a divide wall is not uniform; but takes place in a series of hops, whirls, checks and darts, and when a seed was laid on the bed, it progressed like a live thing—such as a fish or water insect (Fig. A3-7 and Table A3-III).

Fig. A3-7,
Table A3-III.

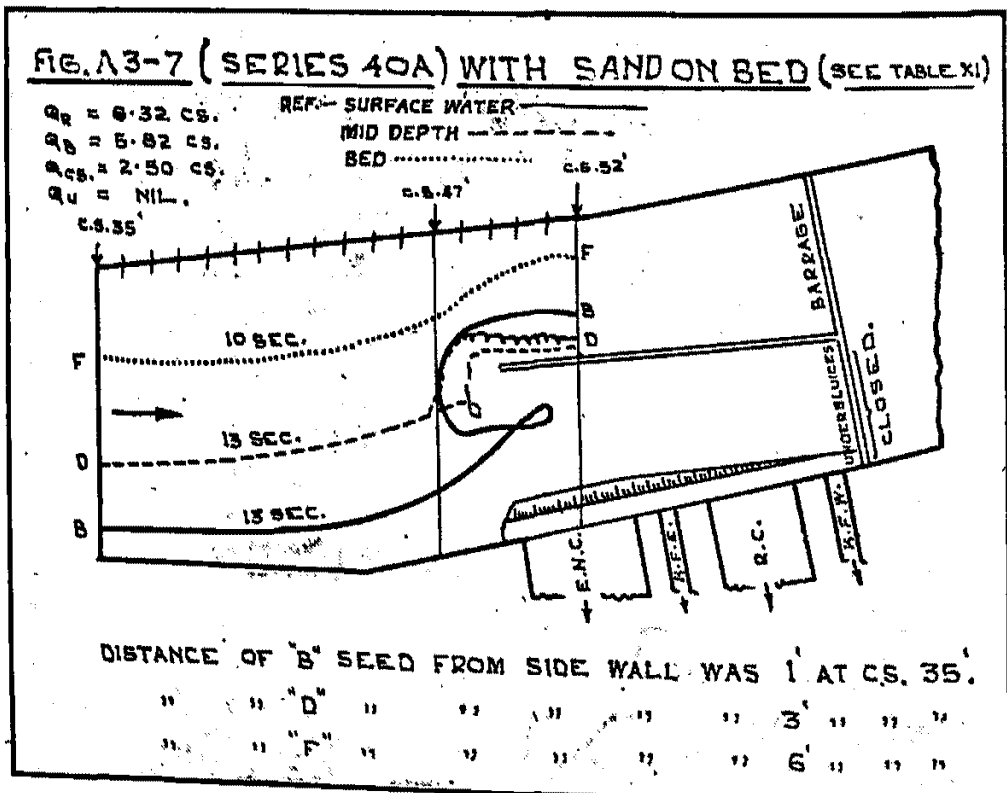

(FIG. 26 FROM BOMBAY T. P. No. 52)

FACTORS AFFECTING EXCLUSION OF BED SAND

TABLE A3-III

Seeds.	Time in seconds from C. S. 35' to C. S. 47'.	Approx. Velocity from C. S. 35' to C. S. 47' (f/s).	Time in Seconds from C. S. 47' to C. S. 52'.	Approximate velocity from C. S. 47' to C. S. 52' (f/s).
B	13	0.90	15	0.33 f/s and flowed towards Barrage.
D	13	0.90	9	0.56 f/s and flowed towards Barrage.
			7	0.70 f/s and flowed towards Barrage.
F	10	1.2	5	1.0 f/s and flowed towards Barrage.

(x) Large radius (R=20') concave vanes built upstream of the pocket were more effective in excluding bed sand than vanes of smaller radius (Photo 530, Sheet A3-2)

Photo Sheet A3-2.

(xi) Vanes with tops sloping longitudinally upwards or downwards caused disturbed flow downstream, and bed sand was thrown into suspension.

The best results were obtained with a horizontal vane of height = 1/3rd the depth of water with a gap between vane and divide wall (Fig. A3-8 and A3-9).

Fig. A3-8 and A3-9.

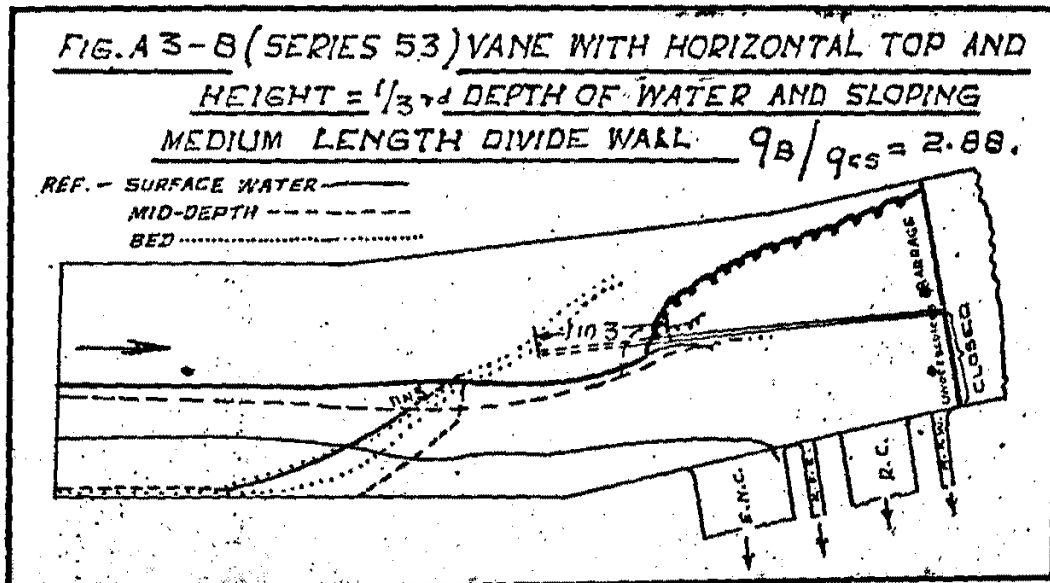

(FIG. 31 FROM BOMBAY T. P. No. 52)

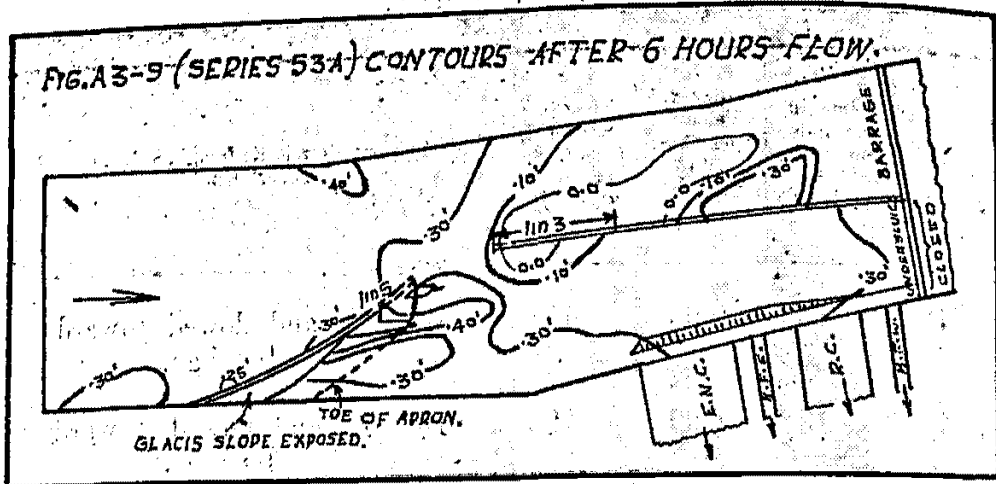

(FIG. 32 FROM BOMBAY T. P. No. 52)

When the vane was made continuous with the divide wall (i. e. with no channel between the divide wall nose and the vane), curved flow persisted right down to the entrance to the pocket. This threw sand into suspension.

(xii) With a divide wall but no vane, ^{when} $\frac{Q_B}{Q_{CS}} = 2.88$ and 1.56 respectively and all the bed water that entered the pocket was drawn by the first canal, i. e. the Eastern Nara (Fig. A3-10).

Fig. A3-10.

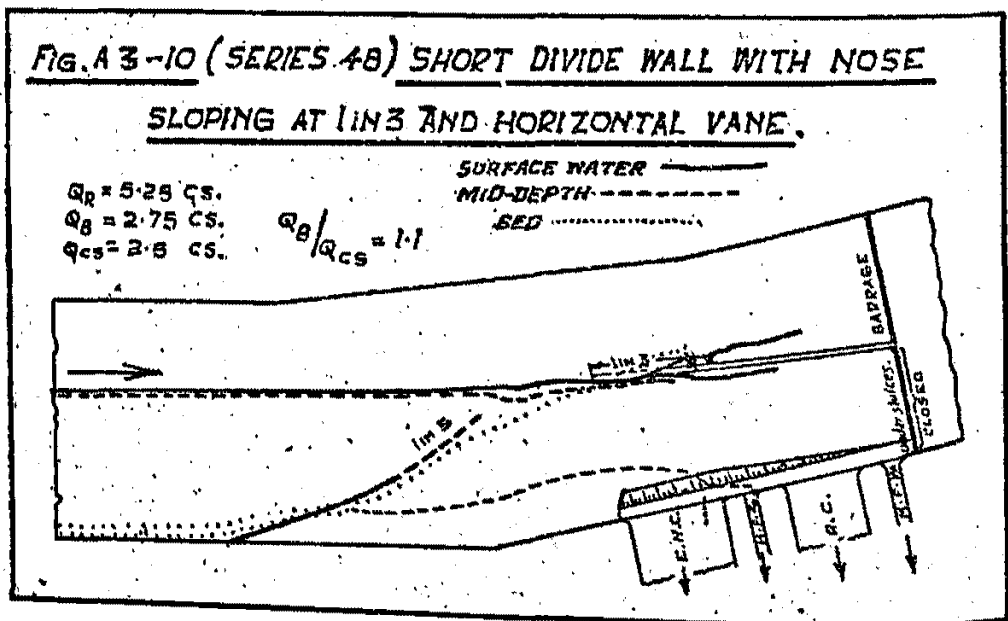

(FIG. 38 FROM BOMBAY T. P. No. 52)

(xiii) When the divide wall was unprotected by pitching, the greatest depth of scour occurred at the nose. (Figs. A3-11 and A3-12).

Figs. A3-11, A3-12.

FIG. A3-II SERIES 40A-MEDIUM LENGTH
DIVIDE WALL WITH A VERTICAL NOSE

$$\left. \begin{aligned} Q_B &= 5.82 \text{ CS, } Q_{CS} = 1.38 \text{ CS.} \\ Q_{CS} &= 2.5 \text{ CS, } Q_{CS} = 0.48 \text{ CS.} \end{aligned} \right\} \frac{Q_B}{Q_{CS}} = 2.88. \text{ PERIOD OF FLOW} = 15 \text{ HOURS.}$$

PLAN

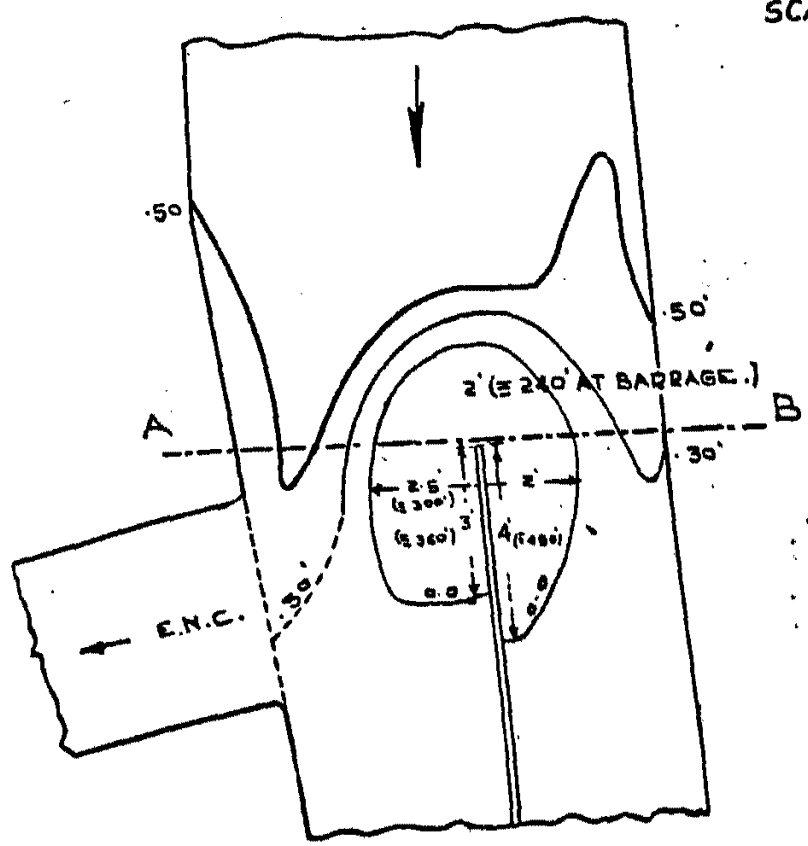

SCALE FOR PLAN
4' = 1"

FIG. A3-12 CROSS SECTION ON AB.

SCALE:- { HOR. 4' = 1"
VER. 1' = 1"

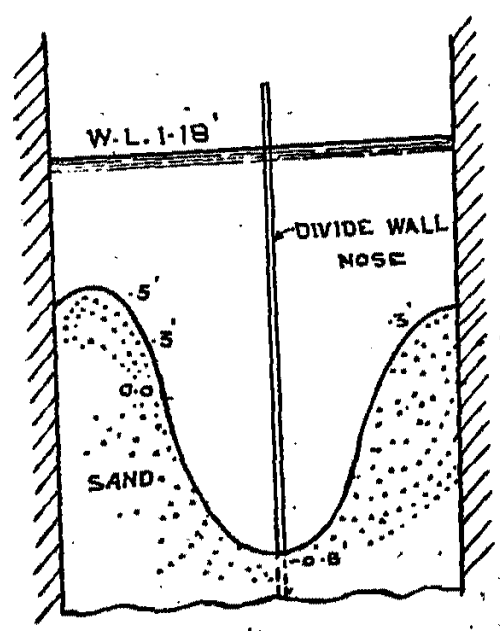

FIG. A 3-13 SERIES SBA-LONG DIVIDE WALL (FIG. 47 & 48 FROM BOMBAY T.R. 1952)

$Q_B = 5.82 \text{ cs.}$ $Q_{B'} = 1.39 \text{ cs.}$ } $q_s = 2.88$. PERIOD OF
 $Q_{CS} = 2.5 \text{ cs.}$ $q_{CS} = 0.49 \text{ cs.}$ } q_{CS} . FLOW = 15 HOURS.

PLAN

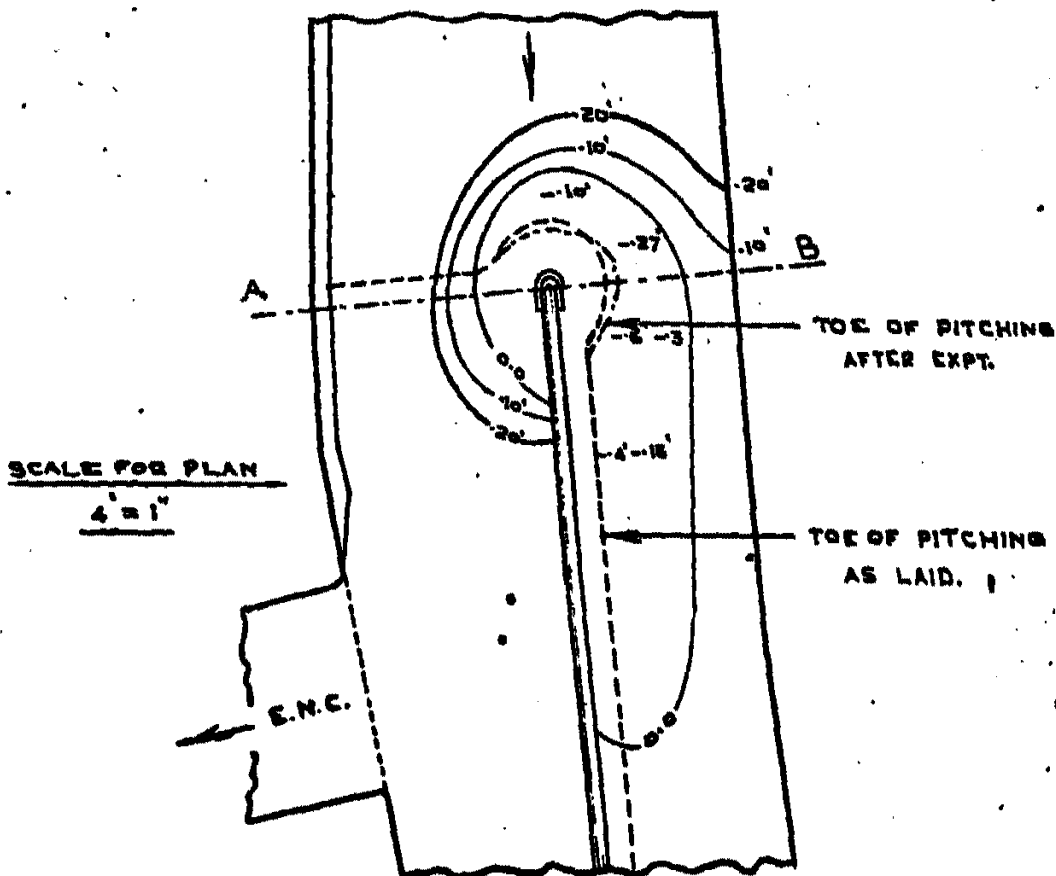
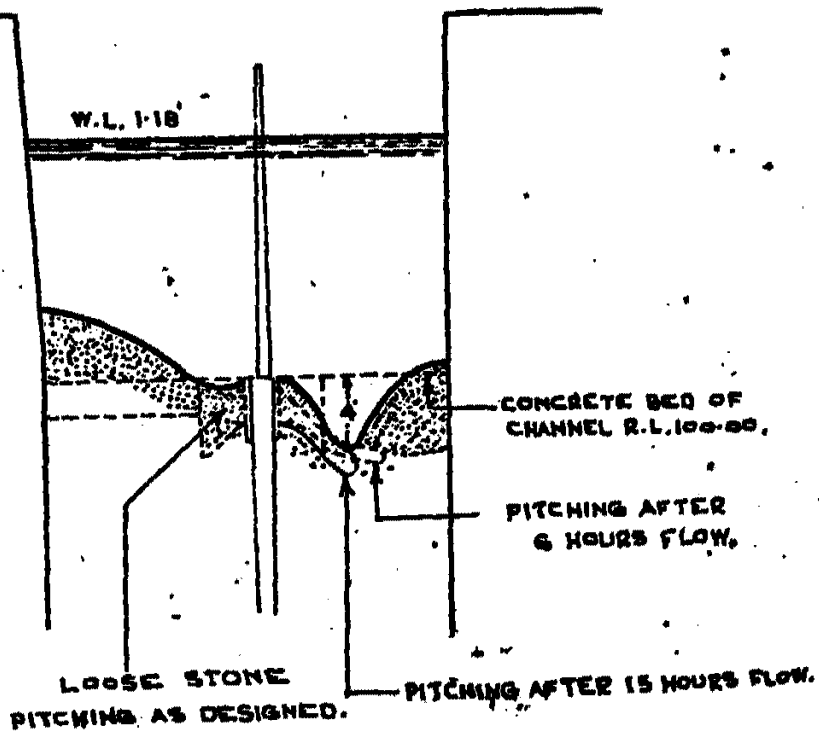

FIG. A 3-14 CROSS SECTION ON AB.

SCALE:-- { HOR. 4" = 1"
VER. 1" = 1"



FACTORS AFFECTING EXCLUSION OF BED SAND

Scour was considerably less when the nose of the divide wall was constructed sloping at 1 vertical: 3 horizontal (=1:18 at Sukkur); but a flat slope was not considered to be desirable at Sukkur as it would have endangered boats; also sand exclusion was much less effective.

(xiv) When loose stone pitching was laid round the nose, it was gradually scoured away and redeposited, sloping outwards from the divide wall (Photo 605, Sheet A3-2, Figs. A3-13 and A3-14).

Photo Sheet
A3-2.
Figs. A3-13,
A3-14.

(xv) The further the scour was removed from the nose by pitching, the less its intensity. Hence it is desirable to provide very strong bed protection at the nose of a divide wall.

(xvi) A divide wall should not extend beyond the upstream end of the upper canal, and a shorter divide wall is almost equally effective for sand exclusion and enables the pocket to be scoured out more quickly and effectively and gives better control. Taking everything into account, it appears that in general a divide wall extending for 2/3rds the distance of the canal or canals from the Barrage gives the best results.

(xvii) This Paper deals primarily with channels taking off from a straight channel. The general principles are applicable to all cases; but it is unwise to assume that details of design are universally applicable. Actually they are not, because in curved channels the curvature of the channel is generally the dominant factor. Hence it is advisable to carry out model experiments in every case and to take all probable changes of conditions into account.

APPENDIX 4

EQUIVALENT SIZE AND SPECIFIC GRAVITY OF STONES AND BLOCKS IN A MODEL

Experiments were carried out in connection with the Sarda model.* These were more basic than specific in character, in that the object was to develop a technique to determine equivalent size and specific gravity of blocks and stones in models. Various grades of sand were tested to ascertain conditions.

The method followed consisted of laying a flat layer of loose stones, and observing the depth of water with different discharges when—

- (i) bed movement just commenced; and
- (ii) general movement occurred.

In one series, the stone was laid in a single layer on a hard smooth bed. In another, a 2" layer of loose stones was laid in the observation length, with similar stones upstream and downstream (but fixed to the bed). In the case of blocks, a single line of isolated blocks was laid across the channel in one series, and a closely-packed layer in another.

Fig. A4-1 shows results in two of the series.

Fig. A4-1

The following conclusions were drawn:—

- (1) When (a) V^2/gd in river = V^2/gd in model, and
- (b) specific gravity of blocks or stones in prototype and model are equal,

stones above $\frac{1}{4}$ " grade in a channel less than 1 ft. deep behaved similarly under conditions of equal V/\sqrt{gd} with diameter \propto depth; but pebbles less than $\frac{1}{4}$ " grade tended to depart from this relationship. The same was true of cubical blocks of various sizes ranging from $\frac{1}{4}$ " to 2" cube. In other words, with equal Fr ($= V^2/gd$) in model and river, blocks and stones behave similarly when

$$\frac{\text{median diameter of stone}}{\text{depth of flow}}$$

is the same in model and river, within the limits stated.

- (2) When (a) the Froude number of the prototype is not equal to the Froude number of model, and
- (b) the specific gravity of blocks or stones in river and model are equal.

Experiments showed that

$$\frac{\text{median diameter of stone}}{d} \propto \left(\frac{V^2}{gd}\right)^{1.3}$$

approximately for commencement of movement. Thus if the ratio of Froude numbers (model : river) is 1.2, the grade of stone in the model should be increased in the ratio

$$(1.2)^{1.3 \times 3} = 2.04$$

above that given by the depth scale. The index here (1.3) is, however, dependent on the velocity distribution upstream and on the similarity in shape of stones. With similar velocity distribution and shape of stone, the index would be 1.0. This also holds in the case of blocks [see (3) below].

- (3) In the case of isolated concrete blocks

$$\frac{\text{Diameter}}{\text{depth of flow}} \propto (\text{Froude No.})^{0.1}$$

* Reproduced from C. I. and H. B. S. A. R. (I) 1939-40, pp. 50-51. Also see pp. 22-23.

THE BEHAVIOUR AND CONTROL OF RIVERS AND CANALS

- (4) When (a) Froude No. of prototype is not equal to Froude No. of model,
 (b) specific gravity of model and prototype blocks are also different.

$$\frac{\text{dia.}}{d} \propto \left(\text{Fr} \times \frac{\rho}{\sigma - \rho} \right)^{0.1}$$

Where d = depth of flow
 ρ = density of water
 σ = density of blocks.

As an example, supposing it is desired to reproduce concrete blocks in a vertically-exaggerated model to a smaller scale than the depth scale, then the density of material to be used is given by

$$\frac{\sigma - \rho}{\rho} \propto \frac{V^2 \cdot d^{0.10}}{(\text{dia.})^{1.1}}$$

or

$$\frac{\sigma_m - \rho}{\sigma_p - \rho} = (V_m/V_p)^2 \times \left(\frac{\text{dia}_p}{\text{dia}_m} \right)^{1.1} (d_m/d_p)^{0.10}$$

where the suffixes m and p refer to model and prototype respectively.

EXPTS. WITH STONES AND BLOCKS

CONDITIONS FOR INITIAL MOVEMENT OF STONES
 IN SINGLE LAYER & ISOLATED CUBICAL BLOCKS

	CUBICAL BLOCKS		STONES	
	SIZE OF BLOCKS IN FEET.	SP. GR.	MEDIAN DIA. IN FEET.	SP. GR.
x	.043	2.15	.0141	2.9
+	"	2.39	.0229	"
o	"	3.61	.0303	"
□	.093	2.44	.0273	"
△	"	2.28	.0303	"
△	"	2.14	.0359	"

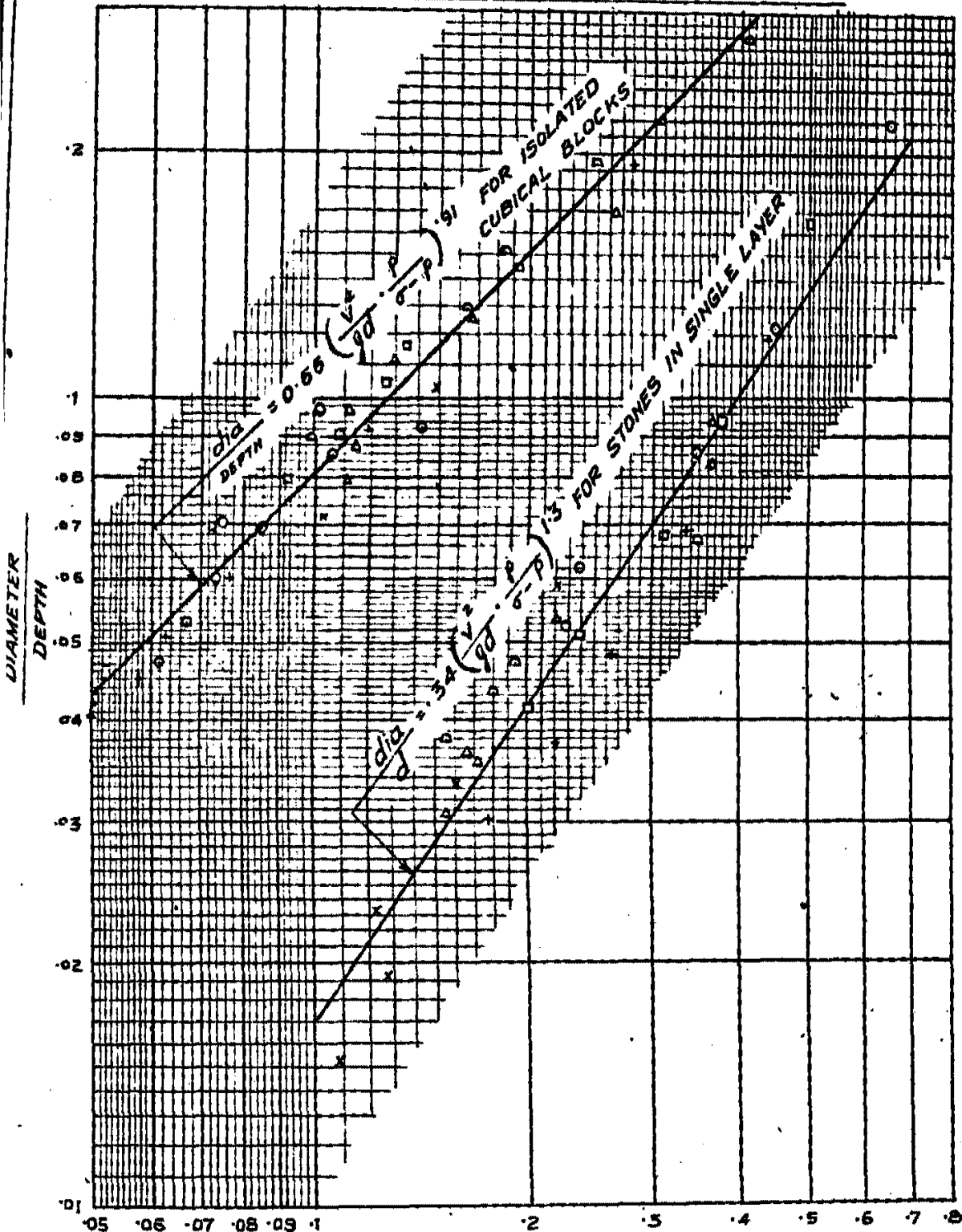

$$\frac{V^2}{gd(\sigma - \rho)}$$

INDEX

A	Para. number.	Figure number.	Photo Sheet number	Page number of Para.
Accretion—Definition of—	(i)
" —Rice and North Western Canals	1-11, 6-09	46, 241
" —River Indus at Sukkur	Chapter 7	283
" —River Indus at Sukkur	1-28	75
" —Time scales different for scour and—	Chapter 5	167
Adjustments in rivers	19-39 (vii)	450
Adjustments in rivers	2-09, 4-07	88, 159
Afflux—Definition of—	(xvi)	5
Ajmer-Merwara. Unprecedented flood in	12-05	409
Alluvial channels. Factors affecting flow in	Chapter 7	283
Alluvium, flow in. Lacey Papers of 1929 and 1933	3-08	96
Alternate layers of sand and clay, Apron laid on	9-08	361
Amlawa Nadi (U. P. Kalsi Bridge)—Maximum flood discharge in the—	12-05	409
Anathema. Groynes are usually—to river training engineer.	10-01	379
" Training works long considered	12-01	407
Aner at Jaipur (U. P.)—Maximum flood discharge in the—	12-05	409
Annual Reports (Technical)	Appendix 1	452
Annual run-off from catchments	12-08	418
Approach Channel. Effect of—on N. W. Canal	7-03, 7-05	289, 290
" " Effect of—on Bice Canal	7-04, 7-05	289, 290
" " Effect of—on water levels	5-14, 6-08	189, 224
" " Mithrao Canal	6-09	241
" " Effect of—Sukkur	6-14, 6-20, 6-17, 6-18, 6-4, 6-5	245, 252
" " Night Bank—Sukkur	7-02	289
" " Outer bank of—	1-12, 6-07	...	6-1	51, 281
" " Outer bank of—	1-14, 6-1	...
Apron. Alternate layers of sand and clay laid in—	9-08	361
" Blow out in falling—	9-07	361
" Conditions under which a falling apron may fail	9-09	362
" Grade of stone required in—	9-12	370
" Launching of—	9-02	356
" Mixture of stone in—	Chapter 9	355
" Quantity of stone required in falling—	9-11	369
" Slope. Inclination of launched—	9-13	370
" Slip in falling—	9-04	359
" Reinforcing a fallen—	9-07	361
" Stones of mixed sizes in—	9-14	372
" Failure of Hardinge Bridge—	9-05, 9-06	360, 360
" Failure of Hardinge Bridge—	9-10	362
Aprons. Falling—	Chapter 9	355
Areas. Change in Datum—downstream of Barrage	5-13	5-12	...	184
" Change in sectional—for 300,000 cusecs	5-13	5-12	...	184
Attack reduced by attracting groynes	12-01	407

INDEX

A and B.	Para. number.	Figure number.	Photo Sheet number.	Page number of Para.
Attraction of Lime Kankar	10.05	380
Attracting groynes	10.05	10-2	...	380
" " Attack reduced by—	12.01	407
B				
B-bed width	(X)	2
Baffle. An obstruction to dissipate energy	1-1	...
Begaba. Model of Gandak River and Bridge at—	1.29	...	1-21	54
Baitarni River. Maximum flood of—	12.05	409
Baluchistan. Floods in—	12.05	409
Barrage. Effect of Upper Sind—on d/s water levels	5.19	308
Barrage. Lower Sind—	10.05	380
Barrage. Effect of—on charge entering canals	6.04	220
" Effect of heading up water at Sukkur—	5.06	172
" Lower Sind—recommendations	1.29	75
" Sukkur—Modifications recommended	1.07	45
Barsore and Termorgha (Baluchistan)—Maximum flood discharge in the—	12.05	409
Beale's flood formula	...	12-8
Bed materials. Exclusion and ejection of—	Chapter 6	217
" movement. The main difficulty in mobile models	Appendix 8	471
" ripples and bed dunes. Movement of—	18.29	444
" ripples and bed dunes. Movement of—	Appendix 2	459
Bed-load distribution between off-takes	6.22	266
Bell bund	10.00, 10.02	379, 379
Benares. Ganges held along left bank by outcrop of lime Kankar at—	10.05	380
Bend. Interference with natural flow round a—	12.02	407
Bends. Maximum depth of scour at guide banks, groynes (or spurs) and sharp—	Table 8—II 8.05	321 347
Berm material	2.01	85
Bernoulli's theorem	11.00	387
Betwa (U. P. Paricha)—Maximum flood discharge in the—	12.05	409
Bilot Creek (Indus). Groynes to protect—	10.01	319
Blanketing. Definition of—	(iv)	5
"	2.18	91
Blasius formula for smooth stage boundary layer	3.22	130
Blench T—Paper on "Turbulent flow theory from the viewpoint of an irrigation engineer from India", written for U. S. Bureau of Reclamation Library, Denver, Colorado, also in La Houille, Blanche "Théorie de l'Ecoulement Turbulent".	3.22	130
Blench T—and King C—Paper on "effect" of dynamic shape on Lacey relations", Annual Report (Tech.), C. B. I. (India), 1941.	3.22	130
Blench T—Institution of Civil Engineers, Paper on "A Universal flow formula", Journal April, 1939.	3.22	130
Blocks. Equivalent size of—in models	Appendix 4	465
Blow-out in falling apron	9.07	361
Bombay. List of Technical Papers	Appendix 1	453
" Presidency. Rainfall to run-off relation in Ghat catchments.	12.06	418

INDEX

B and C	Para. number.	Figure number.	Photo Sheet number.	Page No. of para.
Bose, Dr. N. K.—Ph. D., P. E. C. Paper 192 "Silt movement and design of channels."	3-03	93
Bose. Flow formulae of 1936	3-03	93
Boundary layer. Separation of—	1-17	...	1-17	52
Brahmani (Orissa). Maximum flood discharge in the	12-05	409
Brahmaputra River. Model of—Bridge at Amingaon	1-22, 1-23	...	1-21	54, 54
Breaches. Prevention of—in river embankments in Sind...	1-27	75
Bridge piers. Maximum depths of scour round—	8-01 to 8-04	8-1 to 8-9	8-1	328 to 333
Buckley on Beisida equation for constant silt charge	3-23	132
Bukkur Gauge	Table 8-1	...	1-11	319
" Max. and min. flood levels	5-08	5-9	...	177
" Accretion in Gorge between Bukkur and Mohri	...	5-11
Bund, Bell	10-00, 10-02	379, 379
Bund Manual, Sind	5-22 (xvi)	206
C				
Canal. Eastern Nars—Variations in grade of bed material in—	7-06	290
" Jamrao—	8-16, 8-16	111, 119
" North Western—Effect of Approach Channel on	7-03, 7-05	289, 290
" Bico—Effect of Approach Channel on	7-04, 7-05	289, 290
" Rohri—Variations in grade of bed material in	7-06	290
Canals at Sukkur. Flat gradients of Left Bank	7-01	288
" at Sukkur. Steep gradients of Right Bank	7-01	288
Catchment formula. Inglis fan—	12-05	12-1, 2 and 8	...	409
Catchments. Annual run-off from—	12-05	418
" Cautley's flood run-off value for small—	12-05	409
" Inglis on run-off and floods of	12-05	409
Cautley's flood run-off value for small catchments	12-05	409
C. B. I. Paper No. 20 of 1939, Lacey's—	8-09	102
Channel at Sukkur. Effect of Approach—	7-02	289
" Definition of—	(xxxv)	4
" Sand—experiments	1-16	...	1-16	62
Channels. Factors affecting flow in alluvial—	Chapter 7.	288
" And shoals in tidal models	19-14	439
" E. W. Lane's Paper of 1935 on Stable—	3-06	100
Characteristics of rivers. Factor determining—	2-11, 2-12	90, 90
Charge. Definition of—	(xxv)	2
" Significance of weighted mean (\bar{X} , V_s)	8-13	98
" To enter an off-take. Unsound to induce an excess.	12-08	403
Charge, terminal velocity and grade—their effect on area, velocity, slope, shape and width of a channel.	3-24	136
Charge (X) and terminal velocity (V_s) and their effect on Lacey formulae as modified by Sir Claude Inglis.	3-24	136
Chenab (Alexandra Bridge, Punjab)—Maximum flood discharge in the	12-05	409

INDEX

C and D	Para. number.	Figure number.	Photo Sheet number.	Page No. of para.
Chenab (Khenki Bridge, Punjab) ...	12-05	409
" (Marala, Punjab) ...	12-05	409
" (Rivaz Bridge, Punjab) ...	12-05	409
" (Shar Shah Bridge, Punjab) ...	12-05	409
" Lower ...	8-16, 8-16	111, 119
Coefficient of discharge of remodelled Head Regulator of Nira L. B. Canal. High—	13-05	431
Coefficient of discharge of Standing Wave Flumes	13-03	428
Coefficients. Lacey's early formulae with latest—	8-04	99
Commonsense not a guide to river behaviour	12-00	407
Concave submerged vane at Sukkur	1-11, 6-06	...	1-11	46; 220
Conclusions regarding hydrodynamic model experimentation.	13-39	451
Conditions under which a falling apron may fail	9-09	362
Confusion due to lack of precision in terminology	Symbols & Defs.
Continuity of progression of materials	8-10	88
Contraction. Width—Definition of	(lix)	5*
" Length— " "	(lx)	5
Control of rivers by repelling groyne	10-04	330
Cossye (Mohanpur Anicut, Bengal), Maximum flood discharge in the—	12-06	409
Crossing, Cross-over. Definition of	(xliv)	4
Curvature of flow (In many Chapters but see especially)	6-00, 6-05 6-20	6-2 (a) to (d)	...	217, 220 238
Curvature of flow. Application of—to river training	10-03	330
" " flow associated with meanders—	10-03	330
" " flow. Effect of—on sand exclusion	Appendix B	...	A3-1, A3-2	471
Out-off. Definition of—	(xlv)	4
" Demonstration model of—	1-14	51
" Ratio. Definition of	(xlv)	5
Outlook, Orissa. Model of Mahanadi and Katjuri at—	1-24	...	1-22	64
D				
d=average depth=A/W	(ix)	2
D= a length characterising the effective depth of an alluvial channel—unless otherwise stated.	(v)	2
Damodar (Bengal). Maximum flood discharge in the	12-06	409
Damodar flood	12-05	12-5	...	409
Daman River at Pahari (U. P.). Maximum flood discharge in the—	12-05	409
Datum area at Sukkur. Changes in—	5-13	5-12	...	184
Definitions. Symbols and—	Symbols & Defs	...	1-3, 1-6	1
Deflector	1-06 and 1-09.	...	1-9	40 & 46
Delta. Seaward extension of—	5-05	171
Demonstration models.	1-13	...	1-15	51
Denshy T-headed groynes	10-00	10-1	...	379
	10-01	379
Deposition of silt	5-03	169

INDEX

D and E	Para. number.	Figure number.	Photo Sheet number.	Page number of Para.
Depths. Maximum—downstream of bridge piers ...	Table 8—III 8-06	8-10	...	322 346
" " —of scour at guide banks, groynes (and spurs) and sharp bends	8-05 Table 8—II	347 391
" " —of scour round bridge piers ...	8-01 8-04 Table 8—1	8-1 to 8-9	8-I	328, 333 319
Depth scale ratio ...	13-28	448
Deterioration due to heading up at a Barrage ...	5-06, 5-1	5-7	...	172, 201
Dicken's max. flood formulae ...	12-05	12-1	...	409
Difficulty. The main—in mobile models is bed movement...	13-23	444
Different scale ratios of rigid and non-rigid portions of vertically-exaggerated models. Necessity of—	13-36 (iv)	449
Discharge. Fluming to increase—	11-09 11-04	11-4 to 11-13	...	387, 388
" relation in canal system. Inglis on grade to—	8-15	111
" scale ratio ...	13-27	445
Discrepancies inherent in models ...	13-00	427
Distortion. Longitudinal—	13-36 (v)	450
" of flow ...	12-02	407
Distribution of bed-load between off-takes ...	8-25	286
Divergence from Lacey regime $= (\frac{t}{v_n} \frac{t}{R_s})^{\frac{1}{2}}$...	8-05	90
Divergence from regime. Inglis on—	8-14	107
" Introduction of measure of normality and—by Inglis	8-06	99
Divide wall excluder ...	6-12, 6-19	6-15, 6-16	1-10, 6-3	242, 267
Dominant discharge. Definition of—	(xxxi)	8
" " Effect of reduction of—	2-08, 5-18	88, 201
" discharge. Meander length determined by—	10-09	380
Downstream of bridge piers. Max. depth of scour—	8-06 Table 8—II	8-10	...	348 321
Draw down. Definition of—	(xlix)	8
Dunes. Movement of bed ripples and—	Appendix 2	459
" Sand—	Appendix 2	459
E				
Eastern Nara Canal feeds Jamrao, Mithrao, Khipro and Hiral Canals.	6-14	...	6-1 to 6-5	245
" " Canal takes off from Left Bank upstream of Sukkur Barrage.	6-14	...	6-1 to 6	245
Eastern Nara Canal. Variations of grade of bed material in—	7-06	290
Ejectors. Sand—	6-22, 6-26 6-29	204, 268 275
" Tunnel Type Sand—	6-02	319
Ekruk Tank (Bombay)—Maximum flood discharge in the—	12-05	409
Eladen. The late F. V.—initiated tunnel-type excluders	6-02, 6-23	219, 267
Elutriator. Sand—	2-3	...
Equilibrium. Definition of—	(xxix)	8
Equivalent size of stones and blocks in a model ...	Appendix 4	486
Erosion. Definition of—	iii)	5
Erosion and its prevention ...	10-04	390
Eustatic rise of sea level ...	5-03	169

INDEX

E and F	Para. number.	Figure number.	Photo Sheet number.	Page number of Para.
Exaggerated. Vertically—(A) tidal and (B) river models ...	13.12	489
Exaggerated length of standing waves in a vertically-exaggerated model.	13.34 (iii)	443
Excess charge entering Mithrao Canal. Effect of temporary—	12.03	408
" " Unsound to induce an—to enter an off-take...	12.03	408
" " energy. Merits and demerits of Canal Falls and	12.04	408
" " Regulators for absorbing—	13.03	428
" " friction loss in rigid models
Excluders and ejectors. Relative merits of—	6.27, 6.30	275, 275
Excluders. Divide Wall—	6.19	6-15, 6-16	1-10, 6-8	257
" V. F. Haigh on—	6.25	267
" Open-type	6.03 to 6.13, 6.15	219 to 242, 245,
	6.16	216
" Band—	Chapter 6	217
	Appendix 3	471
" Tunnel-type, abutment—at Tajewala	6.24	267
" Tunnel type—	6.03 6.28 to 6.25, 6.27	219, 267 to 267 275
Exclusion. Additional—difficulties when Canals take off from both banks.	6.28	6-4, 6-22 6-23	...	275
Exclusion of bed sand at Head of Dim Minor, Jamrao Canal, Sind.	1.15	...	1-16	61
" Effect of curvature of flow on sand—	Appendix 3	...	A3-1 A3-2	471
" of bed sand from Canals, factors affecting—	Appendix 3 Chapter 6	A3-1 to A3-14	A3-J. A3-2	471 217.
Experience. Importance of field—in mobile investigations.	1.31	76
F				
$f_{va} : f_{ms} : f_m : Q$ relation in a canal system	3.16	119
Facilities available at Poona Research Station	1.02	36
Factors affecting exclusion of bed sand	Appendix 3	...	A3-1, A3-2	471
" affecting flow in alluvial channels	Chapter 7	253
Failure of Hardinge Bridge aprons	9.10	...	9-2	362
Fall. Remodelling of Tando Mastikhan	1.06	40
Falling aprons	Chapter 9	355
" apron. Conditions under which a—may fail	9.09	362
Falls and Regulators for absorbing excess energy. Merits and demerits of—	12.04	408
" Design of Flume meter—	1.06	40
" Scour downstream of flumed—	13.09	431
Fan catchment formula. Inglis'—	12.05	12-1, 2 and 3	...	409
Field inspection. Importance of—	1.31	76
Fish-like movement of sand particles	(ix)	476
Floored siphon outlet. Increased discharge due to—	13.10	433
Flat gradients of Left Bank Canals at Sukkur	7.01	283
Flexible design? Foolproof or—	12.00	407
Flood formula, Beale's—	...	12-3
" " Dicken's—	12.05	12-1	...	409
" " Gutmann's—	...	12-3
" " Inglis' fan catchment—	12.05	12-1, 2 and 3	...	409
" " Khangar and Gulbati's—	...	12-3

INDEX

F and G	Para. number.	Figure number.	Photo Sheet number.	Page number of Para.
Flood formula Ryve's—	12-05	12-1	...	409
" " Whiting's—	...	12-1
" levels. Progressive rise of—in alluvial rivers	...	5-07
" of Baitarni River. Maximum—	12-05	439
" Unprecedented—in Khari River in Ajmera-Marwara—	12-05	409
" run-off value for small catchments, Cautley's	12-05	409
Floods, Damodar—	12-05	12-5	...	409
" Girna—	12-05	12-4	...	409
" Son—	12-05	409
" in Baluchistan	12-05	409
" of catchments. Inglis on Run-off and—	12-05	409
Flow. Distortion of—	12-02	407
" Bose's—formulae of 1936	8-03	98
" Factors affecting—in alluvial channels	Chapter 7	283
" Historical Note on regime—	Chapter 8	95
" Lacey Papers of 1919 and 1933 on—in alluvium	8-03	98
" round a bend. Interference with natural—	12-02	407
Fluctuating discharges. Effects of—	Chapter 11	887
Flooding.	Chapter 11	887
" to attain modularity	11-01	11-1	...	887
" increase discharge	11-03, 11-04	11-4 to 11-18	...	887 819
" reduce cost	11-02	...	11-1	887
" of masonry works	1-04	40
Flume. Standing Wave—	1-04	40
Foolproof or flexible designs?	12-00	407
Formulae of 1919. Lindley's—	8-01	95
" " 1936. Bose's—	8-03	98
" with latest co efficiencies Lacey's—	8-04	99
$F = \text{Froude number} = \frac{V^2}{gD}$ in terms of depth	(xix)	2
$F_r = \text{Froude number} = \frac{V^2}{gW}$ in terms of width	(xix)	2
Francis Spring. Sir—	Chapter 9	855
Friction loss in rigid models	9-11	803
" Excess—	13-35	410
Friedkin's Vicksburg meander experiments	4-05	151
Froude number	13-12	439
G				
$g = \text{gravity}$	(xviii)	2
Gandak River	13-23	444
" " at Bagaha. Model of—	1-23	...	1-21, 1-12	54
Gangan (U. P.) Maximum flood discharge in the—	12-05	409
Ganges. Hardinge Bridge over—				
" Experiments and recommendations	1-19, 10-02	53, 370
" Hardinge Bridge. Models of—	1-19	...	1-18	58

INDEX

H, I and J	Para. number	Figure number.	Photo sheet number	Page number of para.
H				
Halgh F. F.—on excluders and ejectors	6-25 6-27	267 275
Harcourt Vernon	13-12	439
Hardinge Bridge Aprons, Failure of—	9-10	9-2	...	362
" " Experiments and recommendations	1-19	59
" " over Ganges	10-2	379
Hathmati at Himatnagar (Bombay). Maximum flood discharge in the—	12-05	409
Hawas C. G.	1-32, 2-01	77, 85
Heading-up. Definition of—	(ivi)	5
Hlokin S. B. Construction of Approach Channel at Sukkur	6-09	241
High coefficient of discharge of remodelled Head Regulator of Mira L. B. Canal	12-05	431
High coefficient weirs	1-17 13-11	...	1-17	52 434
" level sill for excluding sand	6-11, 13-07	242 431
" sill off-take from Sukkur Approach Channel to exclude bed sand from Right Bank Canals	6-07, 13-07	...	6-1	231 431
Historical note on regime flow	Chapter III	95
Hooghly Tidal Model	1-25	...	1-23	68
Hydrodynamic model experimentation. Conclusions regarding—	13-30	451
I				
Inclination of launched apron slope	9-04	359
Incorrect throw-off in vertically-exaggerated models	13-39	447
Indus. Groynes to protect Bilot Creek	10-01	379
Indus (Attock, N. W. F. P.) Maximum flood discharge in the—	12-05	409
" (Ghazighat, N. W. F. P.) Maximum flood discharge in the—	12-05	409
" (Kalabagh, N. W. F. P.) Maximum flood discharge in the—	12-05	409
Inglis' discussion on Dr. Bose's P. E. C. Paper	8-05	99
" fan catchment formula	12-05	12-1, 2 and 3	...	409
Inglis on $f_{rs} : f_{ms} : f_{M} : Q$ relations in a canal system	8-16	119
" Introduction of measure of normality and divergence from regime	8-05	99
" Grade: discharge relation in a canal system...	8-15	111
" $m \propto Q^{1/3}$ relation in a canal system	8-15	111
" run-off and floods of catchments	12-05	409
" Paper on "Divergence from Regime".	8-14	107
" "meanders and their bearing on river training", Maritime and Waterways Paper No. 7, Instt. of C. E.	8-24	135
Inherent discrepancies in models	13-00	427
Instability of flow. Scour due to—	13-09	432
Interference with natural flow round a bend	12-02	427
Irrigation Development and Research Circle. Work done by	1-03	35
Isostatic depression	5-03	169
J				
Jamrao Canal	8-15, 8-16	111, 119

INDEX

J, K and L	Para number.	Figure number	Photo sheet number	Page number of Para.
Jawal River at Ecinpura (Jedhpur State). Maximum flood discharge in the—	12-05	409
Jetting downstream of Sukkur Barrage			1-9	...
Jhelum Lower—Canal	3-15, 8-16	111, 119
Jhelum (Kahala, Punjab) Maximum flood discharge in the—	12-05	409
" (Mangala, Punjab). Maximum flood discharge in the—	12-05	409
" (Basal, Punjab). Maximum flood discharge in the—	12-05	409
Jumna (U. P., Faisalabad) Maximum flood discharge in the—	12-05	409
K				
Kadwa at Palkhed (Bombay). Maximum flood discharge in the—	12-05	409
Kaira. Erosion of bank by Watrak River at—			1-20	
Kakar Lora (Baluchistan) Maximum flood discharge in the—	12-05	409
Kalabagh tunnel-type excluder		6-21(b)	...	
Kankar. Attraction of lime—	10-05	380
Karmanasa (Silhat Weir, U. P.) Maximum flood discharge in the—	12-05	409
" (Deodari, U. P.)	12-05	409
Katjuri River at Cuttack. Model of—	1-22
Kennedy's formula 1895	8-80	95
Kou (U. P., Gangan). Maximum flood discharge in the—	12-05	409
Khadakwasji Dam, Lake Fife (site of C. I. & H. R. S. later I. W. B. S.).				Frontispiece.
Khalsar River (Baluchistan). Maximum flood discharge in the—	12-05	409
Khangar and Gulhati's flood formula		12-8	...	
Rhanki tunnel-type excluder, designed and constructed by the late H. W. Nicholson.	6-23	6-20	...	267
Khari River in Ajmere-Merwara. Unprecedented flood in—	12-05	409
Rhipro Canal (See Mithrao Canal)	6-20	268
Khe (U. P. Headworks). Maximum flood discharge in the—	12-05	409
King O and Blench T—Paper on "Effect of dynamic shape on Lacey relations" Annual Report (Tech.), C. B. I. (India), 1941.	3-22	130
King O. Paper on "Practical design formulae for stable irrigation channels" Annual Report (Tech.), C. B. I. (India), 1943.	3-22	130
King's Vanes for excluding sand	6-18	6-13, 6-14	6-3	246
Kosi Bridge. Thickness of stone at—	9-11	368
Koyana at Helwak (Bombay). Maximum flood discharge in the—	12-05	409
L				
Lacey, Gerald—	1-32, 2-02, 2-03, 2-04, 2-05, 2-06	77, 86, 87, 96, 327.
Lacey's C. B. I. Paper No. 20 of 1939	3-09	102
" discussion on Lane's Paper	3-07	100
" " " White's "	3-12	107
" early formulae with latest coefficients	3-04	99

INDEX

L and M	Para number.	Figure number.	Photo sheet number.	Page number of Para.
Lacey's Papers of 1929 and 1935 on flow in alluvium ...	9.09	96
" "shock theory" ...	9.10	109
Lacey G.—Paper on "A general theory of flow in alluvium" journal Institution of Civil Engineers, November 1946, Paper No. 5518.	9.23	152
Lalpur Tank (Rajkot State). Maximum flood discharge in the—	12.05	469
Lane, M. W.—Paper of 1925 on "Stable Channels" ...	9.06	100
Lane's reply to discussion ...	9.08	101
" Paper. Lacey's discussion on— ...	9.07	100
Launched apron slope. Inclination of— ...	9.04	359
" stone. Thickness of—on slope ...	9.11	368
Launching of an apron ...	9.09	358
Layers of sand and clay. Apron laid on alternate— ...	9.08	361
Lehri—Khamwan River (Baluchistan). Maximum flood discharge in the—	12.05	409
Length. Exaggerated—				
" of standing wave in vertically-exaggerated model	18.34 (iii)	448
" Scale ratios of— ...	18.25	445
Lindley's formulae of 1919 ...	9.01	95
Lime Runkar. Attraction of— ...	10.05	380
Limitation of models ...	1.81, 18.89	74 451
Lines of flow at offtakes ...	18.08	6-2	...	432
List of Annual Reports (Technical) ...	Appendix 1	453
" " Bombay P. W. D. Technical Papers ...	Appendix 1	458
Longitudinal distortion ...	18.86 (v)	450
Lower Chenab Canal ...	8.15, 8.16	111, 119
" Jhelum Canal ...	8.15, 8.16	111, 119
" Sind Barrage ...	10.05	380
M				
m = weighted mean diameter in mm. ...	(xxvi)	2
$m_{10} \propto Q$ in a canal system (Eng'g) ...	8.15	111
Mahanadi River Model ...	1.24	...	1-22	64
Mahanadi (Naraj Weir, Orissa). Maximum flood discharge in the—	12.05	409
Makhi Regulator. See Eastern Nara and Mithrao	1-15	...
Malaprabha. Model of Bridge over—at Hol-Alur (M. & S. M. Railway)	1-15	...
Malhotra. Dr.—on "shock theory" ...	8.14	107
Maximum depth of scour round bridges ...	8.01, 8.04, Table 8-1	8-1 to 8-9	8-1	228, 238, 319
Maximum flood formulae ...	12.05	409
" " of Baitarni River ...	12.05	409
Meander experiments ...	4.03	149
" length determined by dominant-discharge ...	10.03	380
Meandering of Rivers ...	See Chapter 4	143

INDEX

M and N	Para. number.	Figure number.	Photo sheet number.	Page number of para.
Meanders Adjustments to meet varying river conditions...	4.07	153
" Comparison of—in river models	4.04	150
" Conditions giving rise to—	4.05	152
" Curvature of flow associated with—	10.09	980
" Definitions of—	(xxvii) to (xi)	4 to 4
" Factors affecting—	4.01	143
" Field data	4.02	144
" Vicksburg experiments	4.05	151
"Meanders and their bearing on river training" by Inglis, Maritime and Waterways Paper No. 7, Inst. of C. E.	3.24	136
Misuse of groynes	12.01	407
Mithrao Approach Channel	6.14, 6.20	6-12 6-18	6-2 to 6-5	245, 258
" Canal. Effects of temporary excess charge in—	12.03	408
" " Exclusion of bed sand from—	6.14 to 6.20	6-12 6-18	6-2 to 6-5	245 to 258
Mixed sizes of stones in aprons	9.05, 9.06, 9.11	360, 360, 36
Mobile river models. Vertically-exaggerated—	13.23	444
Models. Conclusions regarding—	13.39	451
" Discrepancies inherent in river—	13.00, 13.39.	427, 451
" Equivalent sizes of stones and blocks in—	Appendix 4	485
" Exaggerated length of standing wave in vertically-exaggerated—	13.34 (iii)	448
" Excess friction loss in rigid—	13.45	449
" Incorrect throw off in vertically-exaggerated—	13.33	447
" Necessity of different scale ratios of rigid and non-rigid portions in vertically-exaggerated—	13.35 (iv)	449
" Rigid tidal—	13.15, 13.16	441
" River—	13.21	443
" Semi-rigid tidal—	13.17 to 13.20	441 to 443
" Vertically-exaggerated rigid river—	13.21	443
" Vertically-exaggerated mobile river—	13.23	444
" Vertically-exaggerated (A) tidal and (B) river—	13.13	439
Modularity. Fluming to attain—	11.01	11-1	...	337
Movement of bed ripples and bed dunes	Appendix 2	459
" Bed—The main difficulty in mobile models	13.23	444
Mula-Mutha at Jamsetji Bund, Poona (Bombay), Maximum flood discharge in the—	13.05	409
Mula at Chikhalthan (Bombay). Maximum flood discharge in the—	13.05	409
Mula at Rahuri (Bombay). Maximum flood discharge in the—	13.05	409
Mula at Tas (Bombay). Maximum flood discharge in the—	13.05	409
Mutha at Khadakwala Dam (Bombay). Maximum flood discharge in the—	13.05	409
N				
Nala upstream of M. & S. M. Railway Bridge, 445 (Guntakal-Beavada Section-mile 453). Maximum flood discharge in the—	12.05	409

INDEX

N, O and P.	Para. Number.	Figure Number.	Photo Sheet No.	Page No. of Para.
N=Coefficient of rugosity with subscript if necessary K=Kutter. M=Manning	(xxii)	2
Na=Lacey's coefficient of rugosity $Na = \frac{1.346}{V} R^{\frac{1}{2}} B^{\frac{1}{2}}$...	(xxiii)	2
Nara, Eastern—Canal	6-14	245
" " " Variations in grade of bed material in—	7-06	290
Naraj Weir. "Tilting" of—	13-37 (vi)	450
Nari Rivers (Baluchistan)—Maximum flood discharge in the—	12-06	409
Natural flow round a bend. Interference with—	12-02	407
Nature's way of excluding sand	6-03	219
Necessity of different scale ratios of rigid and non-rigid portions of vertically-exaggerated models.	13-35 (iv)	449
Nicholson, H. W.	1-32, 5-13, 6-23, 6-30	77, 201 267, 275
Nile at Beleida. Phillips equation for the—	3-23	132
Nira at Vir (Bombay). Maximum flood discharge in the—	12-05	409
Nira Left Bank Canal. Head Regulator. Effect of remodelling of—	11-04	388
Nira Left Bank Canal. High coefficient of discharge of remodelled Head Regulator of—	13-05	431
Normality and divergence in flow by Inglis	3-05	99
North Western Canal. Effect of Approach Channel on—	7-03, 7-05	289, 290
North Western Canal. Effect of depth of sand on bed of—	6-09	6-8	...	261
North Western Canal at Sukkur	1-12	51
O				
Object of Report on the Behaviour and Control of Canals and Rivers.	1-01	85
Oderolai Regulator	1-10	...
Off-take. High sill—from Approach Channel at Sukkur to exclude sand.	13-07 6-07	481, 281
Off-take. Lines of flow at an—	13-08	6-2	...	482
One-man stone. Thickness of launched apron of—	9-11	366
One-man stone	9-11	366
Open-flow. See Still-pond.	6-19	6-16	6-3	257
Osborne Reynolds	13-12 13-13	489 489
Outer bank of Approach Channel	1-14	...
Outfall. Gauge at—cross-section	...	6-6 (c)
P				
P=wetted perimeter	(vi)	2
Paharpur Canal	10-01	379
Panjhra near Nahalad (Bombay). Maximum flood discharge in the—	12-05	409
Panjhra near Madhi Amalner (Bombay). Maximum flood discharge in the—	12-05	409
Fariat Nala (C.P. & Berar). Maximum flood discharge in the—	12-05	409
Pavement. Modification of—at Sukkur Barrage	1-07	45
Phillips equation—for the Nile at Beleida	3-23	132

INDEX

P, Q and R.	Para. number.	Figure number.	Photo sheet number.	Page No. of Para.
Piers. Maximum depth of scour round bridge—	8-01, 8-04 Table 8-I	8-1 to 8-9	8-1	328, 333 319
" Maximum depth of scour downstream of bridge—	8-06 Table 8-III	8-10	...	348 322
" Models of Sukkur Barrage—	1-08	...	1-8	45
Ponding. Definition of—	(xlviii)	5
" Effect of—on water levels upstream	5-06	172
Poonoh (Punjab) Maximum flood discharge in the—	12-05	409
Pravara at Ojhar (Bombay) Maximum flood discharge in the—	12-05	409
Precision in terminology. Confusion due to lack of—	Symbols & Defs.
Q				
Q=Discharge in cusecs	(i)
q=Discharge per ft. width	(ia)	2
Quantity of stone required in falling aprons	9-19	370
R				
R=Hydraulic mean depth = A/P	(vii)	2
R_n =Reynolds number = $(VD)/\nu$	(xiv)	2
Rainfall. Relations in Ghat catchments Bombay Presidency between—and run-off.	12-06	418
RGS: S*	8-13	107
Ratios. Scale—in vertically-exaggerated models	13-24 to 13-21	145 to 144
Ratman (U. P., Dhanapuri). Maximum flood discharge in the—	12-05	409
Rayleigh	18-14	489
Rayleigh's wave relation $V_w = \sqrt{gd}$	18-14	489
Reach. Definition of—	(xxxvi)	4
Recession of valleys	5-05	171
Reduction. Effect of—of charge	5-18	201
" " " " discharge	5-18	201
" " " " grade	5-18	201
" Cause of—in silt charge at Su ur and Kotri.	5-21	208
Regime and Stability	Symbols and Defs.
" flow. Historical note on—	Chapter 3.	95
" Inglis on divergence from—	3-14	107
" Lacey's definition	2-02	86
" Lacey—formulae	2-03	87
Regulator. Effect of remodelling Nira Left Bank Canal Head—	11-04	388
Regulators for absorbing excess energy. Merits and demerits of—	12-04	408
Reinforcing a fallen apron	9-14	372
Remodelling. Effect of—Nira Left Bank Canal Head Regulator.	11-04	388
Remodelling. Effect of—pavement of Sukkur Barrage	1-07	45

INDEX

B and S.	Para. number.	Figure number.	Photo sheet number.	Page No. of Para.
Repelling groynes above B. N. Railway Bridge over Rupnarain.	10-04	390
" " Control of river by—	10-04	390
Reports. List of Annual Technical—	Appendix 1.	459
Retgression. Definition of—	(xiv)	5
" of water levels at Sukkur	5-09	178
" Sympathetic—	5-18	201
Reynolds. Osborne—	19-19	499
" " "	19-18	499
" " Criterion of turbulent flow	19-19	499
" " "	19-19	499
Rice Canal, Sind. Accretion in—overcome	7-04	289
" " Depth of sand on bed of—	6-09	6-8	...	241
" " Effect of Approach Channel on—	7-04, 7-05	289, 290
Rigid river models. Vertically-exaggerated—	19-21	443
Rigid tidal models. Vertically-exaggerated—	19-16	441
	19-16	441
Ripple movement	9-10	9-2	9-1	89
Ripple turbulence	9-04	87
Ripples. Movement of bed—and bed dunes	Appendix 9	459
Rise of water levels due to Sukkur Barrage	5-09, 5-10,	5-10	...	179, 189
River. Application of curvature of flow to—training	10-08	390
River. Experiments with—models	18-89	451
River models. See Chapter 18	18-91	449
River training engineers. Groynes are usually anathema to—	10-01	379
River Training—"Meanders and their bearing", by Inglis, Maritime and Waterways Paper No. 7, Inst. of C. E.	8-24	126
River. Vertically-exaggerated rigid—models	18-22	449
Rivers. Professor C. M. White's Paper of 1939 "The Influence of Transported Solids on—"	8-11	102
Rohri Canal. Variations of grade of bed material in—	7-06	290
Run-off and floods of catchments. Inglis on—	12-05	409
" from catchments. Relation of Annual—to rainfall in Ghat catchment, Bombay Presidency.	12-06	418
Rupnarain. B. N. Railway over—	10-04	390
" model	1-26	...	1-24	78
" Repelling groyne above—	10-04	390
Ryve's maximum flood formula	12-05	12-1	...	409
S				
S=slope=energy gradient	(xii)	2
S°=slope per 1,000 ft.	(xiii)	2
S° V: Ra S°	3-13	107
Salberg F. J. Discussion by—on Rupnarain model	10-01	379, 407
	12-01	52
Sand channel experiments	1-16	...	1-16	52
Sand excluding sill	6-07, 6-16	6-5, 6-7 (a)	1-16	281, 246
Sand exclusion. Effect of curvature of flow on—	Appendix 9	...	A9-1, A9-2	471

INDEX

S	Para. number.	Figure number.	Photo sheet number.	Page No. of Para.
Sand. Factors affecting exclusion of bed—	Appendix 9	...	A9-1, A9-2	471
Sand from Right Bank Canals. High sill offtake from Approach Channel at Sukkur to exclude bed—	6-07, 18-07	...	6-1	281, 431
Sand=material >0.10 mm. and <0.60 mm.	2-01.	85
Sand movement	2-10 (d)	2-11	...	90
Sand Scale ratio of—in models	18-31	447
Sanding=deposition of sand	(ii)	5
Sarda Bridge. Thickness of stone at—	9-11	368
Sarda River. Model of groynes in—at Bambassa, to protect Right Aflux Bund.	1-20	...	1-19	54
	1-17	52
Scale effect
" ratio. Depth—	18-28	448
" " Discharge—	18-27	445
" " In vertically-exaggerated models	18-24 to 18-31	445 to 447
" " Length—	18-25	445
" " Sand—	18-31	447
" " Slope—	18-29	448
" " Time—	18-30	447
" " Width—	18-26	445
Scale ratios of rigid and non-rigid portions of vertically-exaggerated models. Necessity of different—	18-95 (iv)	449
Scour—	Chapter 9	355
" and accretion. Time scales different for—	18-88 (vi)	450
" definition of—	(iv)	5
" downstream of flumed falls	18-09	432
" due to instability of flow	18-09	432
" Maximum depth of—downstream of bridge piers	8-06	8-10	...	318
	Table 6—III	322
" Maximum depth of—round bridges	8-01, 8-04	8-1 to 8-9	8-1	328, 333
" Maximum depth of—at guide banks, groynes (or spurs) and sharp bends.	Table 8—I 8-05	319 347
	Table 8—II	331
Semi-rigid tidal models	18-17, 18-18, 18-19, 18-20	441, 442 443, 443
" " vertically-exaggerated models	18-12	439
Sheet movement	2-06	88
Shock theory. -Lacey's—	8-10	102
" " Dr. Malhotra on Lacey's—	9-14	107
Shoals and channels in tidal models	18-14	439
Short spur at Bambassa to protect Right Aflux Bund	1-19	...
Silauria Nala (O. P. & Berar). Maximum flood discharge in the—	18-05	409
Sill. High—off-take from Approach Channel at Sukkur to exclude excess bed sand from Right Bank Canals.	6-07, 18-07	281, 431
Silt, siltting.	Symbols & Defs.
" charge. Progressive reduction of—at Sukkur	5-16, 5-21	5-15, 5-16	...	189, 308
" and sand exclusion	6-10	6-5, 6-7(a) 6-10	1-16	242
Siltting. Definition of—	(k)	5

INDEX

S	Para. number.	Figure number.	Photo sheet number.	Page No. of Para.
Silting in Right Bank Canals, Sukkur ...	1-05	40
Similar. Geometrically-similar models which give partly— and partly dissimilar results, siphon spillways.	13-10	433
Similar results. Models giving geometrically—	13-02 to 13-04	428 to 430.
Sind Barrage. Lower—	10-05	390
Siphon. Increased discharge due to adding flared outlet—	13-10	433
Siphon spillways	Frontis- piece.	...
" " Geometrically-similar models give partly similar and partly dissimilar results.	13-10	433
Size of stones and blocks. Equivalent—to be used in models.	Appendix 4	485
Slips in falling aprons	9-07	361
Slope exaggeration. Definition of—	(iv)	5
" scale ratio	13-29	446
Son at Dehri. Exclusion of sand from—	6-28	375
" Maximum flood in—River	12-05	409
Son (Bihar, Dehri). Maximum flood discharge in the—	12-05	409
Special Irrigation Division. Work done by—	1-08	86
Specific discharge gauge reading. Definition of—	(xxii)	8
" discharge gauge reading downstream of Sukkur Barrage.	5-09	5-10	...	178
" discharge gauge reading. Short period variations in—	5-15	5-13, 5-14	...	180
Spring. Sir Francis—	Chapter 9 10-00, 10-09	355 370
" " " —"River Training and Control on the Guide Bank System" G. of I. Ry. Board T. P. 158 (1903).	10-00	379
Spurs and sharp bends. Maximum depth of scour at guide banks, groynes (or —)	8-05 Table 8—II	347 321
Stability. Definition of—	(xxx)	8
" Regime and—	Symbols & Data.
Stable channels. E. W. Lane's Paper of 1935 on—	8-05	100
Standing wave. Enforcement of—	1-09	...	1-3, 1-4 1-5 to 1-9	46
" " flume at Sukkur Barrage	13-06	431
" " flumes	1-2 to 1-6	...
" " " Coefficient of discharge of—	13-08	423
" " in vertically-exaggerated model. Exag- gerated length of—	13-34 (iii)	443
Steep gradients of Right Bank Canals at Sukkur	7-01	233, 257
Still pond—see open flow	6-19	6-16	6-3	...
Stone. One man—	9-11	363
" Mixture of—of various sizes in apron	9-11	363
" Thickness of launched—on slope	9-11	363
" Thickness of—at Kosi Bridge	9-11	363
" Thickness of—at Sarda Bridge	9-11	363
Stones. Equivalent size of—in models	Appendix 4	435
" of mixed sizes in aprons	9-05, 9-06	360, 360
" Quantity of—required in falling aprons	9-13	370

INDEX

S and T.	Para. number.	Figure number.	Photo Sheet number.	Page number of Para.
Submerged vane. Exclusion by means of a—	1-11, 6-06 6-17.	...	I-11	46, 220 246
Sukkur Barrage. Causes of accretion at—	1-11	46
" " Approach Channel to—	1-12	51
" " Modification of downstream pavement of— to exclude excess sand.	1-07	45
" " Position of standing wave at—	13-06	481
" " Rice and N. W. Canal (Right Bank) at—	1-05	40
" " Rise of water levels at—due to accretion ...	6-09, 5-10	5-10	...	178, 182
" " Rohri and E. Nara Canals (Left Bank) ...	7-01	288
" " Specific discharge gauge readings down- stream of—	5-09	5-10	...	178
Symbols and Definitions	Symbols and Definitions.
Sympathetic retrogression	5-18	201
T				
T-headed groynes, Denshy—	10-00 10-01	379 379
Tajewala tunnel-type excluder	6-24	267
Tando Mastikhan Fall, Remodelling of—	1-06	40
" " Fall, Variable coefficient of discharge of—	18-04	430
Tapti River	18-28	444
Technical, List of Annual Reports—	Appendix I	453
" List of Bombay—Papers	"	453
Temporary. Effect of—infow of sand on regime	6-21	266
" Excess charge entering Mithrao Canal. Effect of—	12-08	408
Terminal velocity, charge, and grade—their effect on Area, velocity, slope, shape and width of a channel.	3-24	136
Terminal velocity (V_g) and charge (X) and their effect on Lacey formulae as modified by Sir Claude Inglis.	3-24	136
Terminology. Confusion due to lack of precision in—	Symbols and Defa.
Theorem, Bernouilli's—	11-00	387
Thickness of launched stone on slope	9-11	368
" " Stone—Kosi Bridge	9-11	368
" " " —Sarda "	9-11	368
Throw-off in vertically-exaggerated models, Incorrect—	18-38	447
Tidal models. Hooghly—	1-25	68
" " Rigid—	18-15, 18-16	441 441
" " Rupnarain—	1-26	79
" " Scale ratios of—	18-14	439
" " Semi-rigid—	13-17 to 13-20	441 to 442
" " Shoals and channels in—	13-14	439
Tilt. Definition of—	(lviii)	5
Tilting of Naraj Weir	13-34	448
Time scale ratio	13-30	447
" scales different for scour and accretion	13-38	450
Turbidity. Definition of—	(xli)	4
Training works considered anathema	12-01	407

INDEX

T, U, V and W.	Para. number.	Figure number.	Photo Sheet number.	Page number of Para.
Transported Solids on Rivers." Professor C. M. White's Paper of 1939 on "The Influence of—	3-11	109
Trimmu tunnel-type excluder ...	6-23 to 6-25	6-21 (a)	...	267 to 267
Tunnel-type ejectors ...	6-25 to 6-29	6-21 (a)	...	268 to 275
" " excluders (Elsden-Nicholson) Khanki, Kalabagh, Trimmu, Tajewala.	6-09, 6-23 to 6-25	219, 267 to 267
Turbulent flow. Reynold's criterion of—	18-12 to 18-13	439 to 439
U				
Unprecedented flood in Khari River in Ajmer-Marwara ...	12-05	409
Unsound to induce an excess charge to enter an off-take ...	12-03	403
V				
Vaghur at Raipur (C. P. and Berar). Maximum flood discharge in the—	12-05	409
V=mean velocity ...	(iii)	2
V_g =terminal velocity. Definition of—	(xxvii)	3
$V_w = \sqrt{gDS}$ (effect of shape and slope of channels on wave velocity.)	1-17	...
Valley. Recession of—	3-05	...	1-17	171
Vane. Effect of Left Bank attracting—near Rohri ...	1-11	46
" Submerged concave—for excluding sand ...	1-11, 6-16 to 6-17	1-11	...	46, 246 to 246
Vanes. King's—	6-18	6-13, 6-14	6-3	240
" Effect of adding splayed—at Tando Mastikhan Fall,	1-06	40
Vardha at Banwas (C. P. & Berar). Maximum flood discharge in the—	12-05	409
Variable coefficient of discharge at Tando Mastikhan Fall...	18-04	430
Variations in grade of bed material in the Eastern Nara Canal.	7-06	90
Variations in grade of bed material in the Rohri Canal ...	7-06	90
Velocity. Effect of shape of channel on wave—	1-17	...
Velocity terminal, charge and grade—their effect on Area velocity, slope, shape, and width of a channel.	3-24	136
Velocity terminal (V_g) and charge (X) and their effect on Lacey formulae as modified by Sir Claude Inglis.	3-24	136
Vernon-Harcourt ...	18-12	439
Vertical exaggeration. Definition of—	(vi)	5
Vertically-exaggerated (A) tidal and (B) river models ...	18-12	439
" -exaggerated mobile river models ...	18-23	444
" -exaggerated rigid river models ...	18-21	443
" -exaggerated. Scale ratios in—models ...	18-24 to 18-31	445 to 447
Vicksburg meander experiments ...	4-05	151
W				
W=a length characterising the effective width of an alluvial channel except where otherwise stated.	(iv)	2
W=surface width, or weight of a cu. ft. of water ...	(viii)	2
Watrak River (Kaira). Model of—	1-21	...	1-20	54
Wave relation $V_w = \sqrt{gd}$ —Rayleigh's	13-14	439
White, C. M.'s discussion on Sir Claude Inglis' paper on "Meanders and their bearing on river training", Maritime and Waterways Paper No. 7, Inst. of C. E.	3-24	136
White, Professor C. M. Paper by—(1939) on "The Influence of transported solids on rivers."	3-11	102