

ELECTRICITY AS · A · WIZARD

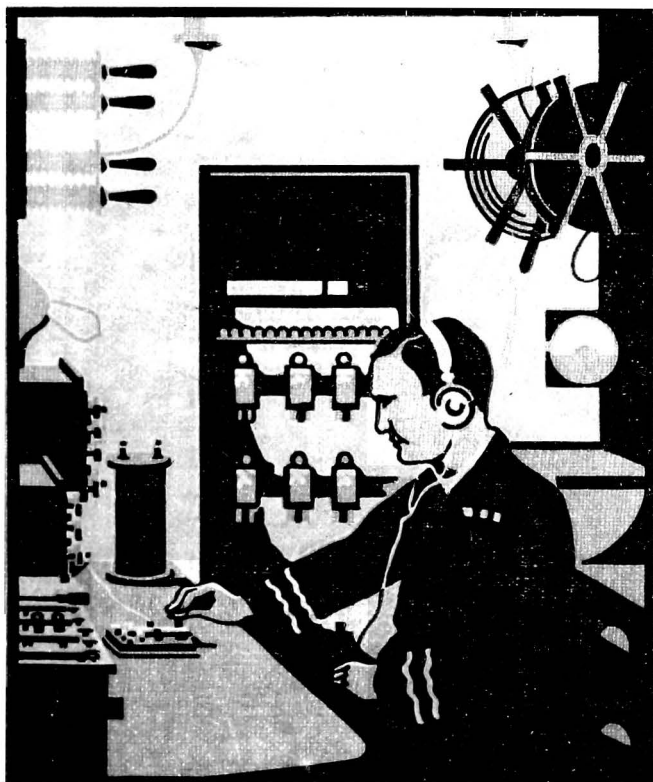

CHARLES · R · GIBSON

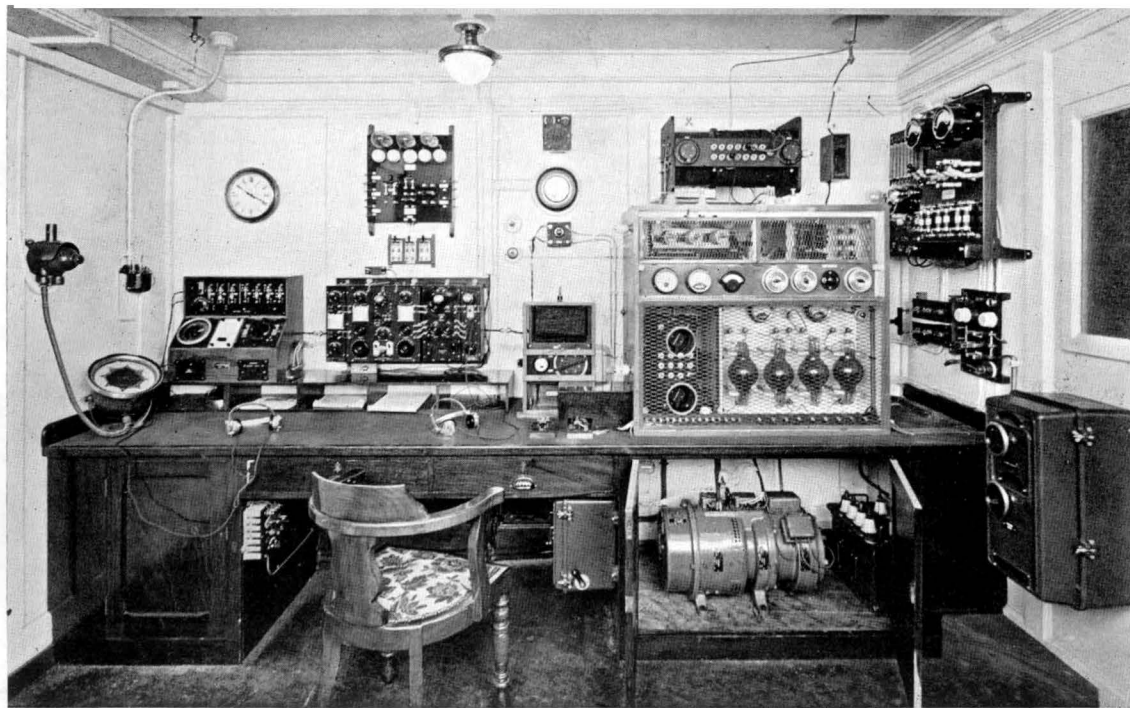

By permission of Messrs. Marconi's Wireless Telegraph Co., Ltd.

WIRELESS ON A LINER

The apparatus from left to right is: Direction Finder, Receiver, Quenched Spark Transmitter, Transmitter for a wave range of 600-850 metres and 2000-2750 metres. This apparatus is in accordance with the Washington Conference Resolution.

ELECTRICITY AS A WIZARD

Explaining how it works and
what we know of it

BY

CHARLES R. GIBSON, LL.D., F.R.S.E.

Author of "How we Harness Electricity" "Wireless"
"Telephones and Gramophones" &c.

BLACKIE & SON LIMITED

LONDON AND GLASGOW

BLACKIE & SON LIMITED

50 Old Bailey, London

17 Stanhope Street, Glasgow

BLACKIE & SON (INDIA) LIMITED

Warwick House, Fort Street, Bombay

BLACKIE & SON (CANADA) LIMITED

1118 Bay Street, Toronto.

PREFACE

It is improbable that this preface will be read by the young people for whom the book has been written, but it explains the occasion of writing the book, and also tells what the book is about.

It is the author's forty-third book, and was written in connexion with the Christmas Lectures which he delivered to young people in Glasgow, at the request and under the auspices of the Royal Philosophical Society of Glasgow.

The Society desired to follow the lead, in a humble way, of the world-famous Christmas Lectures which have been delivered in the Royal Institution of London since the days of Faraday, and the author has followed the practice of some of the distinguished lecturers in writing the subject in book form, and then speaking from notes taken from the book. Of course, it was impossible to give all the details of the book in the lectures, but both cover the same ground.

The title—*Electricity as a Wizard*—was suggested to the author by his brother-in-law, Rev. W. J. Finlay Maguire, of Belfast, and it was

intended to indicate that the lectures were not ordinary school lectures.

Thinking it would be helpful to realize what the children think about electricity, the author asked the headmasters of four large schools to set an essay on the subject of electricity, and to give no time for preparation. The results showed the author where the difficulties lie; the essays are dealt with in two of the following chapters.

The lecturer dealt with electricity as a worker of wonders, and the idea of the wizard permeated the whole subject. As will be seen from the book, the lectures covered a very wide field, and dealt with Discovery, Invention, and Theory. It was explained that every existing thing was composed of electricity, and the inner meaning of things was explained in simple language; among the many marvels it was suggested that the most "wizardous" thing was making an iron plate speak in the telephone receiver.

The whole subject is kept well within the easy grasp of all boys and girls of school age.

Contents

CHAP.	Page
I. A WORKER OF WONDERS - - - - -	1
II. HOW THE WIZARD WAS DISCOVERED - - - - -	9
III. A GREAT DISCOVERY - - - - -	26
IV. AN INVISIBLE MESSENGER - - - - -	37
V. MESSAGES ACROSS THE SEA - - - - -	48
VI. SPEAKING THROUGH SPACE - - - - -	61
VII. THE VALVE IN WIRELESS - - - - -	74
VIII. MAKING A PIECE OF IRON SPEAK - - - - -	87
IX. MAKING THE WHEELS GO ROUND - - - - -	101
X. ALADDIN - - - - -	112
XI. THE WIZARD IN WARFARE - - - - -	120
XII. FLOODING A ROOM WITH LIGHT - - - - -	125
XIII. TELEGRAPHING PHOTOGRAPHS - - - - -	134
XIV. OTHER WONDERS OF THE WIZARD - - - - -	139
XV. WHAT BOYS AND GIRLS THINK ABOUT ELECTRICITY	144
XVI. MORE IDEAS AND THE ORTHODOX - - - - -	156
XVII. HOW OUR IDEAS CAME ABOUT - - - - -	163
XVIII. WAVES IN THE ÆTHER - - - - -	176
XIX. MORE ABOUT WAVES - - - - -	190
XX. THE CONCLUSION OF THE WHOLE MATTER - - - - -	204
APPENDIX—	
LIST OF EXPERIMENTS SHOWN IN LECTURES - - - - -	207
INDEX - - - - -	202

List of Plates

	Facing Page
WIRELESS ON A LINER - - - - <i>Frontispiece</i>	
PRODUCING HYDROGEN AND OXYGEN COMMERCIALY - -	17
AN IGRANIC LIFTING MAGNET - - - - -	32
CREED RECEIVER; CREED PRINTER - - - - -	48
BRIDGEWATER BEAM RECEIVING WIRELESS STATION - -	81
INTERIOR OF THE AUTOMATIC TELEPHONE EXCHANGE AT YORK	96
FARADAY'S ELECTROMAGNET - - - - -	101
DIRECT-CURRENT GENERATOR RATED AT 550 KW. - -	108

ELECTRICITY AS A WIZARD

CHAPTER I

A Worker of Wonders

Dictionaries give several meanings for the word *wizard*; one of these is *a worker of wonders*, and it is in this sense that the word is used in the title. We are going to consider, first of all, how the Wizard works, and then see what is known about him. It is a pity it has to be a one-sided talk, as no doubt there will be many questions you might wish to ask; but I shall endeavour to imagine and answer such questions.

Suppose we take a look at the wonderful things this Wizard can do. We have become so accustomed to his working that we cease to wonder. *Too much familiarity breeds contempt*. But suppose someone who had never heard of the wonders should visit us: what would he think? I want to

introduce you to an old gentleman who was born almost 200 years ago. You know that he is not alive to-day, but I wish you to imagine that he pays us a visit.

One reason why I wish to introduce you to this particular gentleman is that he wrote a very interesting book in the year 1767, which was entitled *The History and the Present State of Electricity*.

His name is the Rev. Dr. Joseph Priestley; he was born in 1733, and in introducing him to you I must tell you something about him. When he was a young clergyman he had a very small stipend, so he opened a school, which was attended by thirty boys and six girls. In order to add to the popularity of the school he bought some scientific apparatus, and he allowed the boys and girls to entertain their parents and friends with experiments. His school became popular, and he himself set out on a scientific career. Electricity did not work any of its great wonders at that time.

Picture Priestley going to a scientific meeting of the Lunar Society. There was no electric light, nor was there gaslight; indeed the roads were so dark that these meetings were always held on the Monday nearest the full moon—hence its name, *The Lunar Society*. The meetings were held then in order to give the members the benefit of the moonlight on their way home.

Priestley was accustomed to a room lighted by candles which gave a very dim light; imagine his surprise when, on entering a dark room with you and, merely touching a knob on the wall, you flood the whole room with a bright light. It would appear as magic to him. He is surprised again when, by touching another knob, you get the warmth of a fire. He was accustomed to seeing people strike fire in a most laborious manner with a flint and steel, and setting some dry tinder alight with the sparks. It seems to him like a fairy tale that you can obtain light and heat by merely touching a switch.

Before coming to you he has just heard that a relative of his old friend James Watt, of steam-engine fame, is living in Scotland. He remarks on this, and you ask him if he would like to speak to him. Yes, but he is in a distant town. That will make no difference; you can speak to people even in distant countries.

Ridiculous! Impossible!

The conversation proceeds. "You remember meeting Benjamin Franklin nearly 150 years ago? Well, you may speak to some of his descendants in America." "Yes, if I go to them." "No need to go out of this room—we have here an instrument called a *telephone*, which you, being a good Greek scholar, can see means *speaking to a distance*. You speak into the instrument here, and a

little flat iron disc in an instrument in America will imitate your voice so well that a friend may recognize it." "Wonderful! I can scarcely believe it to be true."

Then you touch a button in the wall, a maid appears, and you ask her to bring your portable wireless set. You place this box on a table, and the room is filled with beautiful music. The old gentleman quotes a verse from Shakespeare's *Tempest*:

"Be not afeard; the isle is full of noises,
Sounds and sweet airs, that give delight and hurt not.
Sometimes a thousand twangling instruments
Will hum about mine ears, and sometimes voices."

And after listening for a little he quotes further the words of Caliban: "This will prove a brave kingdom to me, where I shall have music for nothing."

You turn a switch in the box and you hear a voice. That is a Frenchman speaking in Paris. Another turn of the switch and you hear a German speaking in Berlin; and the Rev. Joseph Priestley says: "Marvellous! Had I not heard it myself I should have said it was impossible, and to think that this is all due to the Electricity about which I wrote in 1767."

When you go out into the streets he is utterly surprised to see a large car coming along without

the aid of any horses, and no one is pushing it. It seems to go by itself. How is it done? By the Wizard Electricity.

We see a man rushing towards a red-painted box in the street; he breaks a glass in order to get at a push which he presses, and almost before you can explain that a house is on fire, a fire engine dashes up. It is all done so quickly that Priestley wonders who could have told the firemen where to come. Again it is the Wizard. You explain that in many large buildings Electricity is keeping watch lest fire should occur, and that as soon as there is an outbreak of fire—the Wizard sends a signal on his own account to the Fire Brigade by means of an automatic fire alarm.

We buy a newspaper and read of a terrible disaster that has just occurred in Japan. How can we know? Because the Wizard has brought us the news by the electric telegraph, we know what is happening all over the world.

We visit a hospital, and we follow a mother who is hurrying in with her little girl. She tells the doctor that the child has swallowed a halfpenny. An operator places a small screen in front of the girl, and a glass globe behind her, and after setting an instrument to work we see right through the little girl, and there we see the halfpenny sticking in her throat. The doctor puts a small umbrella-like thing down her throat and it opens under the

coin and he fishes it up; he warns the mother not to let the little one play with halfpennies in future.

Just then a man comes in with a broken arm, and on the screen the doctor can see exactly what has happened to the bones, for there he sees the living skeleton. Again it is the Wizard Electricity who enables us to see these living bones in the body.

We take another look at the newspaper and read: "American liner rescues a sinking ship. All passengers saved." We explain to Dr. Priestley that a ship is not left, nowadays, to sink unheeded; that when a ship is in trouble it sends out a wireless call of distress stating its exact latitude and longitude, and immediately all the steamers for miles and miles around go to the rescue. This could not be done without the Wizard Electricity.

Next morning we take Dr. Priestley to some works where he sees kettles, made of common metal, being turned into silver ones. He exclaims "Aladdin!" We explain that what the Wizard does is to give the common metal kettle a complete coat of solid silver, which will wear a lifetime.

We can tell Priestley of other wonderful things Electricity can do. It can even take down a telephone message during the absence of the owner and repeat it to him on his return; we call the instrument a *Telegraphone*. A business man can tell this instrument what he wants to say in reply

to a letter which he has received, and it will repeat this to the typist, and if she does not take it all in at first, it will repeat the difficult part a second or even a third time.

Of all the most "wizardous" things that Electricity can do, the one which appeals to me most is the fact that it can make a flat piece of iron speak. This so surprised Lord Kelvin when he heard it for the first time that he felt he had to assure his friends that there was no deception. We have the same marvel in the gramophone, in which a flat plate usually made of mica can talk to us. The gramophone, as you know, does not require electricity. It was invented about the same time as the telephone, and some people could not believe it possible that the little plate could speak, and they attributed the speech to some hidden ventriloquist, who was pretending that the machine talked.

Is it not wonderful that the little plate in the telephone receiver, and also in the gramophone, can do that for which we require to use our lungs, vocal chords, mouth, teeth, tongue, lips, and nose, and it can do it so well that you recognize the imitation as the voice of a friend who is distant many miles from you, and whose voice does not leave the distant room in which he speaks.

Another wonderful thing that Electricity can do is to enable a blind person to read ordinary

print. Impossible! No, it is done, as we shall see later. The blind person hears certain chords of music in his ears; and as each letter of the alphabet produces a different set of chords, which he quickly recognizes, by putting the letters together he reads the words by the sounds in the telephone. The instrument is called the *Optophone*.

Yet another wizard-like thing is done by Electricity. It telegraphs photographs over great distances, even without connecting wires. But surely enough has been said to prove that Electricity is indeed a Wizard.

CHAPTER II

How the Wizard was Discovered

A great many boys and girls think that Electricity was discovered in the sky, and that it was first discovered by Benjamin Franklin sending up a kite, and bringing down some electricity from the clouds. But how do I know what boys and girls think? If it is because one or two of my young friends have told me so, it would be a little like the three tailors of Tooley Street who petitioned Parliament regarding some grievance, and who commenced their petition with "We, the people of England". But that is not my position, for hundreds of boys and girls were good enough to write essays at my request—and I am very much indebted to them for helping me to learn what they think of Electricity.

As I read shoals of essays with care and with much interest, I have some authority for saying that many boys and girls think that Electricity was first discovered by Benjamin Franklin and his kite. That interesting experiment took place in

1752, but electricity had received its name from one of Queen Elizabeth's physicians 150 years before that time, and electric machines had been in existence for nearly one hundred years.

Electricity was discovered 2000 years before the kite experiment was made. We do not know exactly when or where or by whom, but it was known at least 600 years before the time of Christ, although it had not been christened then.

What happened was that some wise man of the East rubbed a piece of amber, whereupon he observed that small pieces of straw or other light objects jumped towards the amber and clung to it. This was very mysterious, but the ancients did not say, "Behold a wizard!" They said, "The amber possesses a soul, and the rubbing gives it heat and life." You say "Ridiculous!"; I quite agree.

The ancients discovered that a piece of jet would act in the same way, and they thought that this attractive power belonged to amber and jet alone. If they had only tried a piece of glass, or sulphur, or resin, they would have found it was really a property common to matter. Why did they not try these things? Because they did not believe in experiments. Later people preferred to believe the sayings of a great Greek philosopher, whose name—Aristotle—is known to many of you. If Aristotle had said anything it must be true.

You remember how Galileo got into trouble by questioning one of Aristotle's sayings. Aristotle had said that a heavy weight fell in less time than a lighter weight, and everyone believed this to be true. But Galileo, who was nicknamed "The Wrangler" (because he dared to question the truth of some of Aristotle's sayings), suggested an experiment with two unequal weights.

Galileo was then a youthful professor in the University of Pisa, and when he proposed dropping the two unequal weights from the top of the leaning tower of Pisa, there was much excitement among the professors and students of the University; but they all believed Galileo's experiment would be useless, for Aristotle was bound to be correct. When they saw the two unequal weights reach the pavement at the same moment—a dead heat—they turned away, still believing in Aristotle. It is said of them: "Yet the Aristotelians who with their own eyes saw the unequal weights strike the ground at the same instant, ascribed the effect to some unknown cause, and preferred the decision of their master to Nature herself." I think you know that a sovereign (or a penny) and a feather (two things of very unequal weight) will fall together if placed in a vessel with no air in it; Galileo used very much heavier weights.

My object in reminding you of Galileo is to explain why amber and jet remained, for 2000

years, the only known possessors of this attraction—now called electrical attraction; such other substances as glass and sulphur were experimented upon by Dr. William Gilbert, of the Court of Queen Elizabeth, in or about the year 1600.

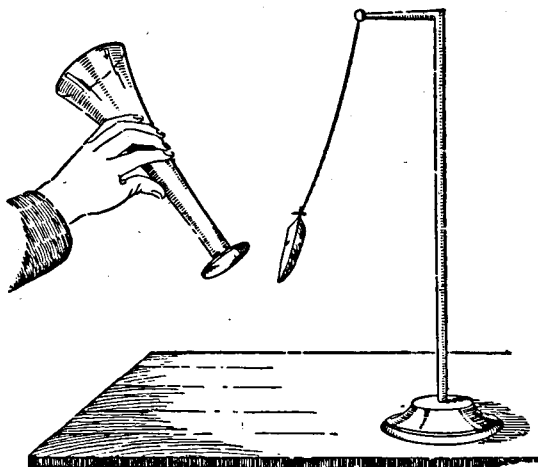

Fig. 1.—Glass Vase attracting a Feather

If we rub a glass rod with a piece of silk we see that it attracts any light object towards itself. Here (fig. 1) is a glass vase attracting a feather towards it.

You may use a glass vase and a feather, or a paper butterfly, or any similar light objects. A fountain pen rubbed on your coat sleeve will attract little pieces of paper. We shall see what

really happens when we deal with electrical attraction.

People got tired of rubbing pieces of glass, sulphur, &c., in their hands, and so one man mounted a large ball of sulphur on a wooden axle as in fig. 2.

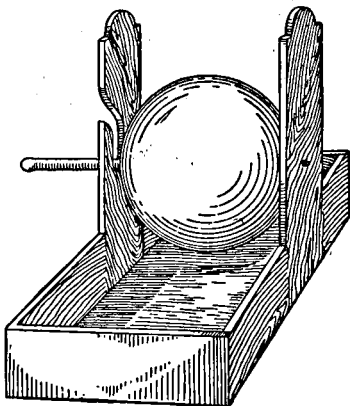

Fig. 2.—Simple Electrical Machine

The inventor of this machine was Otto Von Guericke, whose name you may know in connexion with the air-pump. He was a German scientist, about whose life we know very little, though we know that he visited England.

When using this machine he employed his hands as the rubber, and by means of this machine he discovered the electric spark.

Later, a ball of glass was used in place of the

sulphur one, and the hand was still the rubber. Some of you know a more modern electrical machine, such as in fig. 3.

You may know that it has a brass piece with points like a comb and that this collects the elec-

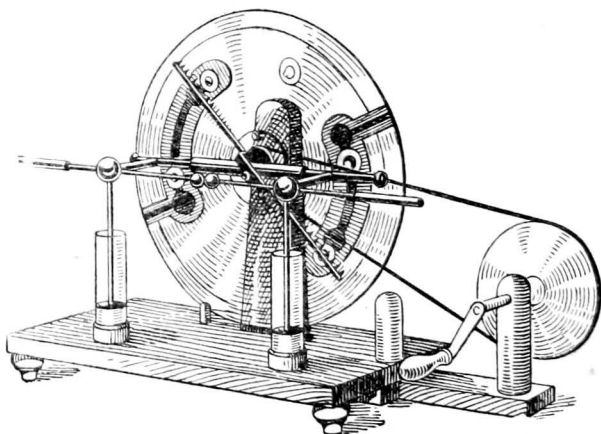

Fig. 3.—Electrical Machine

This glass plate machine produces a charge of electricity.

tricity from the plates. This brass piece is called the prime conductor. It came about in this way.

A seventeenth-century scientist found that when a man stood on a cake of resin and held in his hand an iron tube, it collected electricity from the rubbed glass globe. As it was tiresome holding the iron tube, he suspended it by silk threads. This professor, whose name was Bose, found that

he could explode gunpowder by a spark from his simple machine.

It was a Scottish monk who first used a cushion of woollen materials to do the rubbing in place of the hand. His machine also had an iron tube as prime conductor, but the points were not added till a later machine was constructed. Later large glass plates were used in place of the ball and cylinders of glass; the plates rubbed against a cushion, and some of them produced sparks capable of jumping across a distance of 22 inches. In the modern machines there is no rubbing; the charge is induced by revolving the plates at a high speed in opposite directions, and very close together, but these *influence machines* were not invented till well on in the nineteenth century.

A Dutch professor, living in the middle of the eighteenth century, and working with one of these frictional machines, wondered if he could not store up some of the electricity in water contained in a glass vessel from which the electricity could not escape. He took a medicine bottle and filled it partly with water, and then he led the electricity from his machine to the water by means of a small brass chain with an iron nail dipping into the water. Holding the bottle with one hand, the other happened to touch the nail, whereupon he received a violent shock. He repeated the experiment, but the shocks so alarmed him that he

wrote to a friend that he would not take another shock even if he were offered the crown of France. This discovery gave rise to the Leyden jar, so called because the experiments were made at Leyden, in Holland.

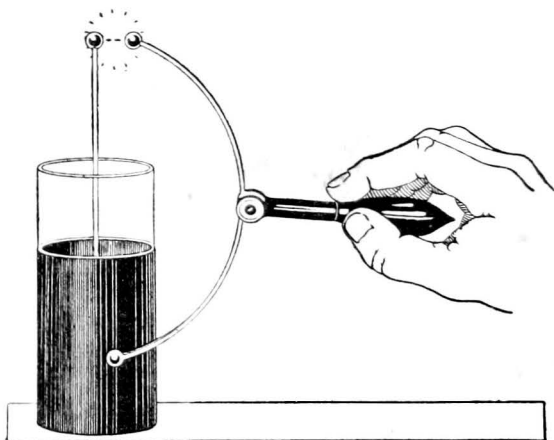
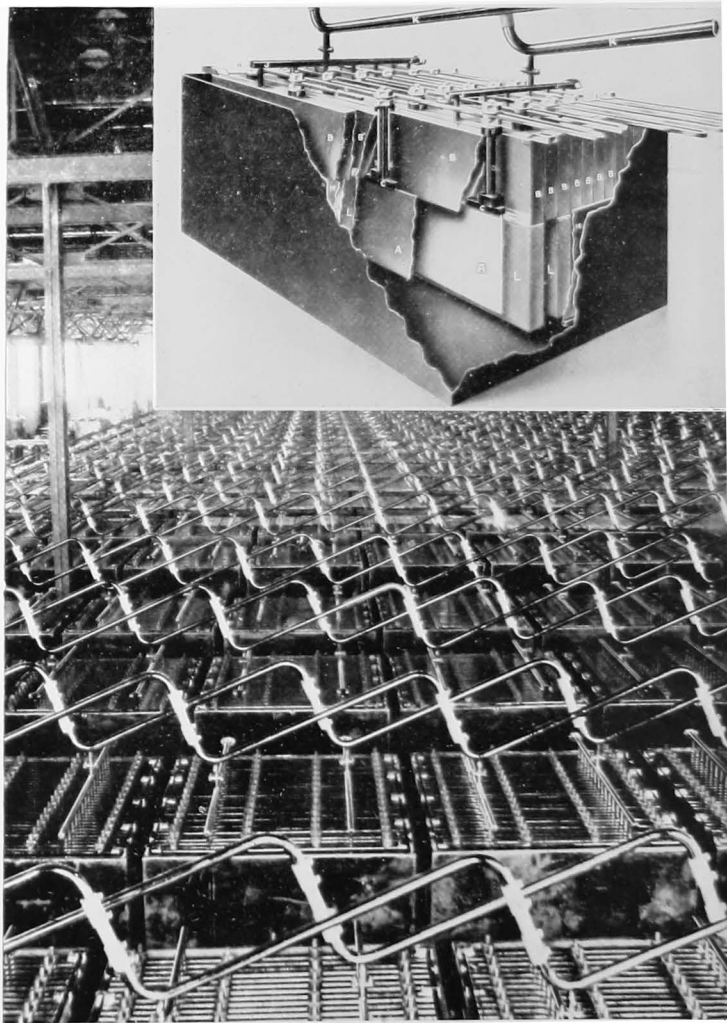

Fig. 4.—Leyden Jar

This jar charged with electricity produces a bright spark when discharged.

In the Leyden jar (fig. 4) there is a coating of tin foil inside instead of water, and another similar coating on the outside in place of the experimenter's hand. We can store electricity, charging the Leyden jar by the machine, and when the electricity is allowed to discharge, as in the diagram, a bright electric spark occurs. A much more violent spark



By permission of Messrs. The International Electrolytic Plant Co., Ltd.

PRODUCING HYDROGEN AND OXYGEN COMMERCIALY

Part of an installation of 800 cells. The inset shows a section of a single cell. AA a electrodes suspended from gas-collecting bells BB and separated by asbestos diaphragms LL. Offtake pipes JJ, one for each gas, collect the gas from alternate bells and convey it to pipes KK.

See page 22.

may be obtained by a battery of Leyden jars, as in fig. 5. Very many years ago a friend of mine used to amuse people by giving such a shock to a row of them, hand in hand, but I strongly advised him against it, as the shock from a battery of Leyden jars is very alarming.

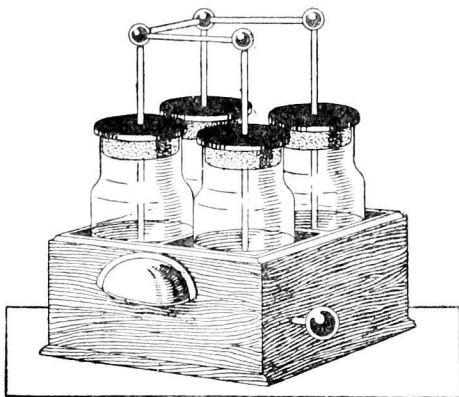

Fig. 5.—Battery of Leyden Jars

When discharged, these show a very bright spark accompanied by a noise.

Benjamin Franklin made many experiments with the Leyden jars, but we must hurry on to consider his well-known experiment with his kite, which led to the invention of lightning conductors.

Boys, and girls too, are interested in kites. Franklin's kite was made of silk, so that it would not be damaged by rain, and it had a wire con-

ductor in the form of a piece of sharp-pointed wire fixed on the top, so that it might collect electricity from the thunder clouds.

He flew the kite with string, just as you do, but he fastened an iron key to the end of the string, which he did not hold in his hand as he did not wish the electricity to escape through him to the earth. He fastened a piece of silk ribbon to the key, and thus insulated it; placed it on an island, as it were.

When the string became wetted by the rain, it was able to conduct the electricity from the kite to the key, but the insulating ribbon had to be kept dry as it was not to conduct, so the experimenter stood under cover of an open shed. Franklin was able to draw sparks from his key, and to make other experiments such as he had made with Leyden jars. Then he got the bright idea of robbing the thunder clouds of their charge of electricity (and thus prevent the electricity jumping to the earth) by conducting it down a wire attached to high buildings, which ran some risk of being struck by lightning. Others made experiments with kites, and one experimenter used a tin tube in place of the key. He placed three straws on the ground and held the electrified tin tube over them, whereupon the straws stood up erect and began a sort of puppet dance. While watching the straws a terrific explosion occurred

and produced a hole in the ground immediately below the tube.

Our friend Rev. Joseph Priestley describes this occasion in his book on the history of Electricity, and he tells us that, after the explosion, one of the pieces of straw ran up the kite string to a height of one hundred yards, being alternately attracted and repelled by the string, while a flash of light was seen every time it was attracted. On another occasion a Russian professor lost his life through a sudden discharge of electricity which came down a wire from the clouds.

Many interesting experiments were made by early electric machines, and these were continued by many people as sources of amusement. I remember seeing many of them when I was your age; but we must pass on to the discovery of the electric current, which came about in this way.

An Italian professor—Luigi Galvani—had the legs of a dissected frog lying on a table in his laboratory. When I was a boy I was told that he had been preparing frog soup for his invalid wife, but I think that is a fairy tale. He was a professor of anatomy, and was accustomed to examine the legs of frogs and to experiment with them. He tells us about the incident himself, and he never mentions the soup or the invalid wife. One of his assistants noticed the legs of a dead frog twitch when he touched a nerve with a metal instrument,

and he thought it happened when an electrical machine made a spark in its neighbourhood. But when Galvani tried some experiments with the frog's legs, it occurred to him to see if lightning would act upon them as the spark was supposed to have done, so he placed the legs upon a brass hook and, taking this out to his garden, he placed it upon an iron railing, whereupon the frog's legs twitched without the aid of lightning or an electric spark. He jumped to the conclusion that there was electricity stored in the muscles of the frog, and that when the metals touched each other the electricity was discharged and gave the frog's legs a shock which made them twitch. He wrote a paper on this Animal Electricity, but another professor in Italy—Alessandra Volta—disputed the existence of animal electricity, and said that the electricity resided in the pieces of metal and that the frog's legs acted merely as an indicator of the electric discharge. It may have seemed to some too trivial a matter to have a serious dispute about, but we know how much has depended upon the dispute, for it led to the discovery of the electric current. Volta wished to prove his theory, so he made a pile of metal discs and he placed between these a piece of cloth moistened with water in which there was a little acid. Very possibly he was imitating the moist flesh of the frog. In any case he placed a piece of these moistened cloths

between each pair of metal discs, one of which was copper and the other zinc (fig. 6).

This is known as Volta's pile, and from it he obtained a flow of electricity; he fixed a wire to the uppermost copper and another wire to the lowest zinc, and on joining these wires he got a supply of electricity. Possibly he found the moistened cloths troublesome as they would soon dry; in any case he put each couple of metals in a separate vessel filled with acidulated water (fig. 6a), and in doing so he invented the electric battery.

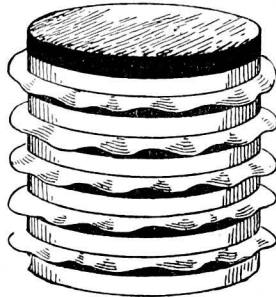

Fig. 6.—Volta's Pile

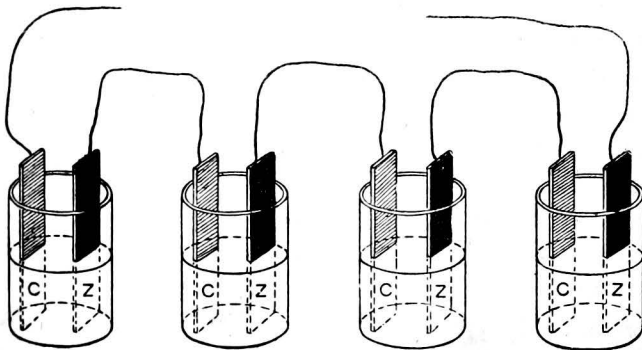

Fig. 6a.—Electric Battery

c, Carbon in acidulated water. z, Zinc.

You see how the copper in one cell is connected to the zinc in the next cell, leaving a copper and a zinc free at the outer cells. The copper was found to be positively, and the zinc negatively, electrified.

News of this discovery came to Great Britain, and two men named Nicholson and Carlisle made a Voltaic pile from the description received. While working with this the ends of the wires happened to rest in some of the acidulated water which they were using in the pile. It was evident that the electric current had a chemical effect, and that it was producing gas, and so they tried the experiment on a larger scale. They passed the electric current through the water, and they found gas being given off at the end of one wire, while the end of the other wire became tarnished. This was a sign of chemical action, and to prevent the tarnishing they fixed a piece of platinum to the end of that wire. Why? Because it would not tarnish. When they had done this they found gas escaping from both wires. They collected the gases in test tubes, as you do in school, and when they tested the contents of the tubes, they found one to contain hydrogen gas and the other oxygen gas. They knew that water is composed of oxygen and hydrogen atoms, and so it was evident that the electric current was breaking up the water into the substances of which it was composed.

This experiment was made more than a hundred years ago. We will repeat it with a little variation. Instead of collecting the gases in tubes, we will let this apparatus blow soapy bubbles filled with the gases mixed together—and I think some of

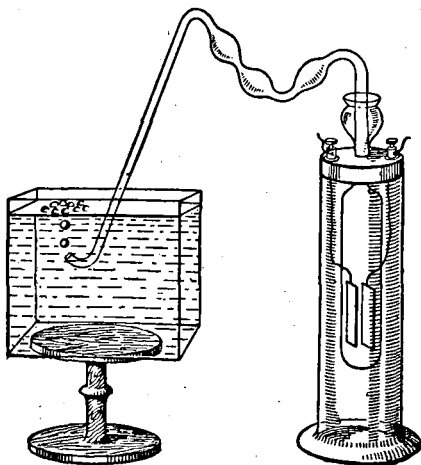

Fig. 7.—Blowing Gas Bubbles

Water is decomposed into oxygen and hydrogen gases and blows soap bubbles. For completion of experiment see fig. 8.

you know that a mixture of hydrogen and oxygen is an explosive mixture—and so we can explode the bubbles.

First of all a gentle bang, then we will make more bubbles and make a respectable noise.

The apparatus is shown in figs. 7 and 8. You will notice that before exploding the gases we take

care to remove the gas-producing apparatus, in case we have a bigger explosion than intended; we do not wish to blow up the apparatus.

Sir Humphry Davy sent an electric current through a piece of potash, which is a compound of an element called *potassium*, while the other partners in the compound substance are hydrogen

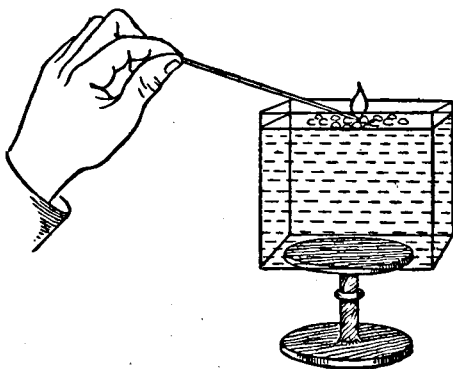

Fig. 8.—Exploding Gas Bubbles

The gas bells, having been formed as shown in fig. 7, are then exploded.

and oxygen. He found that when the potassium atoms were separated from the others they joined hands and made a metal. This was the first time the metal potassium had been seen, and Davy was so excited that he bounded about the laboratory like an excited schoolboy.

Some of you know that potassium is an exceedingly strange metal; it behaves in a ridiculous manner. We use water to put out fire, but it

actually sets this metal on fire. You see that when I throw a small piece of it into water, the metal bursts into flame.

When I was a boy I played a trick on a policeman who was standing in a quiet street one dark night when there were pools of water in the street. After passing him to a respectful distance, I took from my pocket a bottle containing some small bits of potassium and I threw them into a pool of water. There was a series of small explosions, and then fire. I heard the policeman hurrying along to see the cause of this, but I did not wait to help him to solve the mystery.

CHAPTER III

A Great Discovery

The discovery with which we have been dealing was made by Carlisle and Nicholson when using the first Volta pile in this country; it is a great discovery, because it gave rise to all the great electrochemical industries of to-day, such as the works at Kinlochleven, Ben Nevis, the Falls of Clyde, and many chemical works throughout the world. But the discovery I am going to tell you about now was a far greater discovery, because it gave rise to all electrical engineering, and, apart from chemistry, to nearly all the practical applications of electricity.

So that you may understand without any trouble on your part, I will introduce you first of all to magnetism.

Thirty years ago I was telling an audience of deaf and dumb people about the discovery of magnetism, and I said that a man discovered a natural magnet in the earth. I looked to see how the interpreter was getting along and I saw him pretend he was holding the piece of lodestone, and he put his other hand to his head, and then

he suddenly pointed at the lodestone, and these gestures told the audience what I was saying.

We do not know who it was that first discovered lodestone, but the ancients knew all about it long before the time of Christ. They found this natural magnet which is really a piece of iron ore. The ancients not only discovered that the lodestone had an attractive power, but that it could impart its power to pieces of iron which were stroked by it, and without any loss to itself.

The ancients discovered also that when pieces of iron were magnetized they were different at either end. They called one end a north-seeking pole and the other a south-seeking pole—because when suspended freely they always came to rest with one end pointing towards the north pole of the earth, and the other end pointing south. They discovered that, while a magnet would attract iron equally well by either pole, the two north poles would have nothing to do with one another; they repelled each other. Two south poles were just as unfriendly to one another, but a north and a south pole always attracted one another. Professor Oersted, whom I will introduce to you in a few minutes, was not the first to wonder if magnetism was not connected in some way with electricity. He was making his inquiry in the year 1820, while almost a hundred years before this, long before the electric current was discovered,

some people had observed a connexion between the frictional electricity of these days and magnetism—as on the occasion I am going to relate.

I shall tell it to you just as it was told in the *Philosophical Magazine* of 1735.

“ A tradesman of Wakefield, having put a large number of knives and forks in a large box, and having placed the box in a corner of a room, there happened a sudden storm of thunder and lightning by which the corner of the room was damaged, the box split, and a good many knives and forks melted. The owner emptying the box upon the counter where some nails lay, the persons who took up the knives observed that the knives took up the nails.”

It was evident that the lightning had magnetized the knives.

Some years later Benjamin Franklin succeeded in magnetizing a sewing needle by means of the discharge of an electrical machine. Although all this happened long before Oersted's time, his discovery of the connexion between magnetism and the electric current was indeed a great one, because it showed us how we could get magnetism and electricity to work together.

But I have not introduced Professor Oersted to you. He was a professor of Natural Philosophy, or in other words Physics, and he lived and worked in Copenhagen, which you all know is the capital

of Denmark. You may be interested to know that he did much to popularize science by writing a book entitled *The Soul of Nature*.

I want you to visit him in his lecture-room. While he is speaking to his students it occurs to him to place a magnetic needle near a wire carrying an electric current, to see if there is any connexion between magnetism and electricity. There might

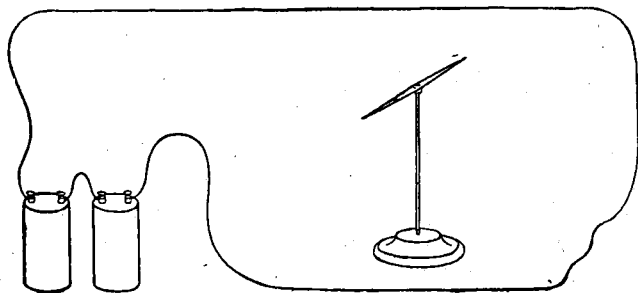

Fig. 9.—Oersted's Experiment

possibly be a magnetic effect connected with the current, and if so the magnet might be attracted and repelled.

He placed the needle at right angles to the wire carrying the current, and nothing happened; which was very disappointing, but after the lecture we see him trying the needle in another position, lying in the same plane or direction as the wire, and now something does happen, as you will see when we repeat the experiment (see fig. 9).

The little magnet turns round and tends to place itself at right angles to the wire. You can see in the diagram that it no longer lies in the same plane as the wire.

You can understand how nothing happened on the first occasion, during the lecture, for Oersted had already placed the needle in the position to which it would move.

To an onlooker, it might have seemed all very trivial, but to us it is a great discovery because we know the great things to which it has led, such as the telegraph, the telephone, electric bells, dynamos, electric motors, and a crowd of other things; indeed almost all the practical applications of electricity.

Another discovery was that steel needles became magnetic when they were placed in a coil of wire carrying an electric current. It was quite evident that the coil had a magnetic effect. Indeed it was found later that a coil of wire carrying an electric current behaved exactly like a magnet.

If a coil were made into a long shape like a cylinder, it behaved like a weak magnetic needle, and if two coils were arranged as in fig. 10, each coil was found to have a north and south pole just like the needle, so that magnetic attraction can be shown between a north and a south pole, or magnetic repulsion between two similar poles.

These long coils of wire are called *solenoids*. If

we have a solenoid or a coil, and attach a piece of sheet zinc to one end of the wire and a piece of sheet copper to the other end, as shown in the figure (fig. 11); we get the action of a compass needle when we float it in a basin of acidulated water.

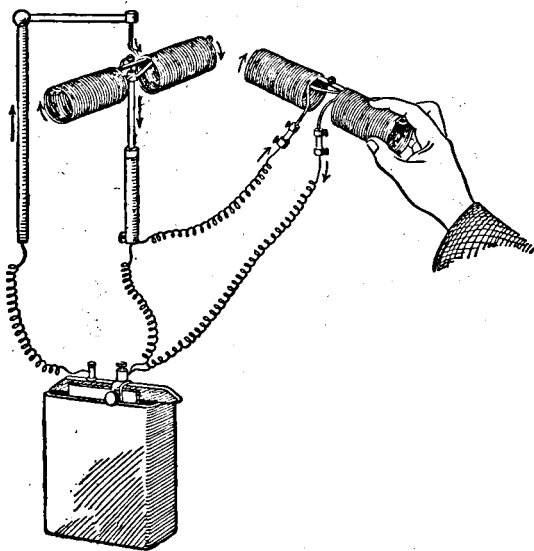

Fig. 10.—Coils behaving like Magnets

When a current of electricity is passed through the coils, they behave like magnets.

You can see that the copper and zinc will form an electric battery while in the acidulated water, and the electric current which will pass through the solenoid will cause it to behave exactly like a magnetic needle.

In fig. 11*a* the zinc and copper plates are enclosed in a small cell, so that when the coil is floated in a basin of water, it carries its battery with it.

We have seen that pieces of steel (sewing needles)

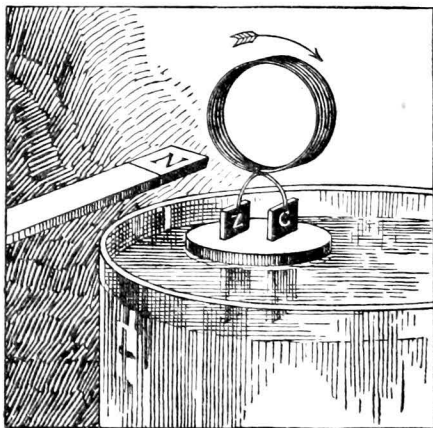

Fig. 11.—Floating Coil

This coil is mounted on a cork, and the pieces of zinc and copper which it carries are in acidulated water so that a current of electricity is produced, and the coil then behaves like a magnet.

when placed in a coil of wire carrying an electric current will become magnetized. This was discovered by two professors working independently. One of these professors was Sir Humphry Davy, to whom I have introduced you already, and he made the discovery while working in London in the Royal Institution, where many discoveries were



By permission of Messrs. The Igranic Electric Co., Ltd.

AN IGRANIC LIFTING MAGNET

In use on a travelling crane for lifting and transporting iron and steel scrap.

made. The other professor was François Arago, generally spoken of as Arago. He was a French astronomer and physicist. He fascinated all Paris with his lectures on astronomy.

Following up this discovery of Davy and Arago, which they made in 1820, a Londoner, William Sturgeon, invented an electromagnet, such as is shown in fig. 12.

In this form it is a rod of soft iron bent into a horse-shoe, and with an

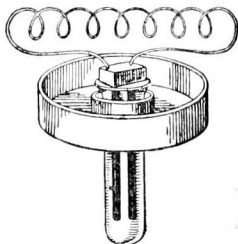

Fig. 11a.—Coil which acts as a Compass

When this apparatus is floated on water, it will act as a compass needle. The coil carries its own battery with it.

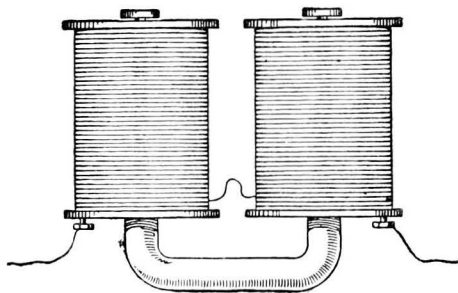

Fig. 12.—An Electromagnet

insulated wire wound on two bobbins around its ends.

A simpler way of making an electromagnet is to

wind an insulated wire around a kitchen poker, as in fig. 13.

Of course the poker will only hold the key so long as the electric current is passing through the coil. If we disconnect the battery, the key will fall.

It is a very convenient thing to have a magnet which will attract and let go at will, and many of you know that large electromagnets are used in

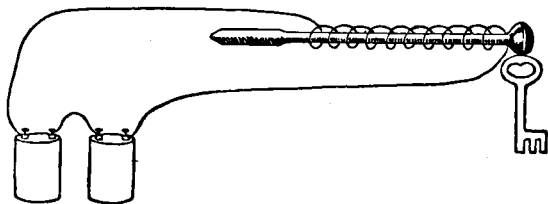

Fig. 13.—A Poker as a Magnet

connexion with cranes in iron-works. You can understand the awkwardness of lifting pig iron by a crane, but the electromagnet has merely to be placed in position and the current switched on, whereupon the iron can be lifted quite securely. Large pieces of iron weighing several tons are handled in this way. Another use of powerful electromagnets is to attract little pieces of metal out of the eye of an injured workman.

An interesting experiment may be made with a large solenoid, in the form of a giant bobbin

with a nice clean hole down its centre, the hole being large enough to admit a heavy rod of soft iron and leave some space between the rod and the sides of the hole.

We fix the coil upon a stand in such a way that the rod may be passed up or down through the solenoid. Of course if we place the rod in the solenoid and let go, the rod will fall down by gravity; but if we place it in the coil and then switch on the current it is held up against gravity, and if we push it downwards it jumps up again and dances up and down, floating in the air under the magnetic attraction of the coil. If, while it is supported by the coil, we bring a box of nails near the lower end of the rod, the nails will jump out of the box and cling to the magnetized rod.

As soon as we stop the current by disconnecting it from the mains, to which it was attached through a suitable resistance, down comes the heavy iron rod with a good thump on the lecture table.

On one occasion when lecturing to boys, very many years ago, I was anxious to impress them with the strong pull of an electromagnet. I first of all showed them a small magnet lifting a fourteen-pound weight, then I put a boy in a small chair and tied a piece of rope to the chair and to the keeper of the magnet, and I supported the boy and chair by means of the magnet.

Then to amuse them I fixed the electromagnet

to a long piece of rope and to another piece I fixed the armature or keeper of the magnet. Having switched on the current to the magnet, the keeper was held on so firmly that it was quite impossible to pull it off. Then I asked a number of them to take one of the ropes while another party of boys took the other rope, and they had a regular tug-of-war and yet the keeper clung to the magnet.

I have a photograph of a piece of iron magnetized by an electric current and holding on to the side of a ship so firmly that it is able to carry a group of men standing upon it.

You know how an electric tramway car can be pulled up very quickly by an electromagnet attracting the rail and holding on very firmly; the car can be pulled up so suddenly that you are shot along the seat, or if you happen to be standing you may be thrown down, because of the momentum the tramway car has given you.

We shall see that electromagnets play a very important part in the workaday world, but first of all we wish to see how the Wizard enables us to send messages with lightning speed all round the world.

CHAPTER IV

An Invisible Messenger

Thinking of Oersted's discovery, and the fact that you can control the movements of a magnetic needle by an electric current, might suggest to you the possibility of signalling to someone at a distance by sending an electric current along a wire to a distant coil, and there controlling the movements of a little magnet.

This idea did occur to quite a lot of people, only they thought at first it would be necessary to have as many needles as there are letters in the alphabet.

But before we consider the needle telegraph, we might take a look at an earlier telegraph, one which was invented long before the electric current was discovered. Several inventors tried to use the discharge of electrical machines as a means of producing signals at a distance.

One of these attempts is described in the *Scots Magazine* of 1st February, 1753. The letter describing the experiment was signed C. M., and

it was discovered about a hundred years later that the name was Charles Morrison, and that he practised as a surgeon in Renfrew, which is near to Glasgow. This is what he did.

He connected two cottages by twenty-six sepa-

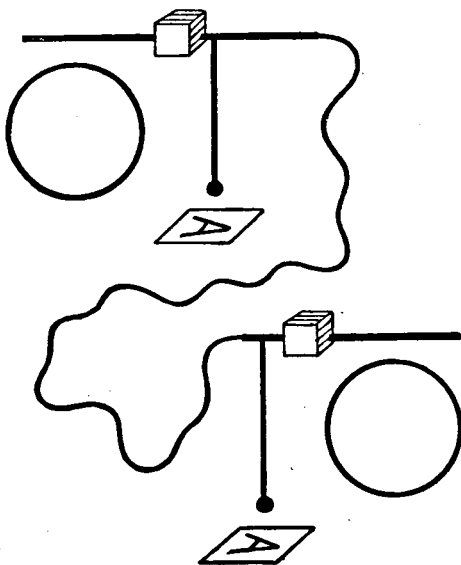

Fig. 14.—An Early Telegraph

rate wires, one for each letter in the alphabet, and he placed an electric machine in each cottage. The ends of the wires could be made to touch the glass cylinders of the machines, and in this way an electric charge was transmitted from one cottage to the other. When this charge of elec-

tricity arrived at the distant cottage it electrified a small metal ball which attracted a piece of paper lying below the ball as in fig. 14. You see the letter "A" upon the paper; there were twenty-six balls and as many papers, so that there was one paper for each letter of the alphabet.

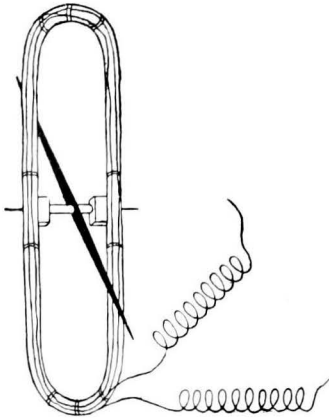

Fig. 15.—Needle Telegraph Coil

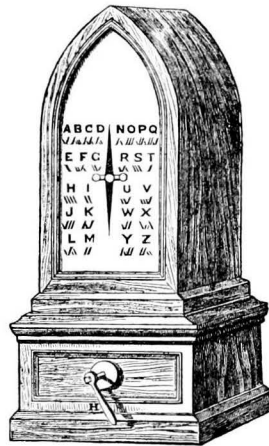

Fig. 15a.—Needle Telegraph Instrument

It was said of Morrison that he "could speak with lightning", but his invention was not a success because, as he said himself, he found it difficult "to prevent the electric fire mixing with the atmosphere". Later on we see the needle telegraph with a single needle, and placed in a coil, as in fig. 15 and 15a. In this arrangement

the needle moves to the left hand or right hand at will.

The needle telegraph (fig. 15*a*) was able to use the well-known Morse Code, although that was invented for a different kind of telegraph. Here is the Morse code arranged for the needle telegraph

	A \ /	J \ ///	S \ \ \ \	
	B. / \ \ \	K / \ /	T /	
Written thus \	C / \ / \	L \ / \ \	U \ \ /	Written thus /
	D / \ \	M //	V \ \ \ /	
	E \	N. / \	W \ //	
	F \ \ / \	O ///	X / \ \ /	
	G // \	P \ // \	Y / \ //	
	H \ \ \ \	Q // . /	Z // \ \	
	I \ \	R \ / \		

Fig. 16.—Signals for Needle Telegraph

The figures at the side illustrate the Single Needle Telegraph Instrument.

(fig. 16). You see that the needle has never to move more than four times to signal any letter, also that the single movement to the left is used for the letter "E", and the single movement to the right is for the letter "T". Why? Because these two letters are used oftener than any others.

In the instrument the little magnet and its coil

are placed on the back of a board upon the face of which a little indicator moves on the same axle as the magnet. When the needle telegraph was invented it did not make much headway; it was only tried on railways for sending messages about on-coming trains. But one day a murderer, fleeing from justice, boarded a train leaving Slough for Paddington station in London. It occurred to one of those who were chasing him that, although it was impossible to overtake him, it would be possible to let the people at Paddington station know that he was on that train. They spelt out this information on the needle telegraph, and as they had not arranged any signal for the letter "Q" they said he was dressed as a *Kwaker*, which was a euphonic way of spelling Quaker. The man stepped out of the train at Paddington, thinking himself safe, but he was followed to a coffee house where he was arrested. This incident showed the public the use of electric telegraphy—I do not mean as a means of catching murderers only, but as a means of speedy communication over a distance. The electric telegraph soon became popular.

It is interesting to note that the Government of that day refused an offer of the electric telegraph, stating that they were quite satisfied with the semaphore system, which, however, could only be used as far as one could see, the signals being

made by two large wooden arms just as a boy scout does with flags.

The needle telegraph was invented in 1837, which you may remember is the year in which Queen Victoria ascended the throne. About the same time another kind of telegraph was invented by one whose name you know very well—Samuel B. Morse (U.S.A.).

In his instrument he used an electromagnet. Morse was a professor of Art, but he had attended lectures on electricity, and on one occasion, when he was crossing the Atlantic in a sailing ship, he had discussed the possibility of telegraphing by electricity.

A fellow passenger happened to have an electromagnet with him, and showed it as a novelty. Morse confided his ideas to this passenger, and they arranged to make some experiments in America, but the passenger took no further part in the matter, except to claim an interest after Morse's success, but he failed to prove that he took any real part in the invention.

I think that you all know that in a Morse sounder telegraph there is an electromagnet (fig. 17). You see how the magnet will attract the little lever and cause it to knock against the stops. When it strikes the lower stop it makes a noise not unlike "click", and when it strikes the upper stop it makes a sound like "clack", and its whole lan-

guage consists of these two sounds, but with these the Morse code may be signalled as long and short "click-clacks".

For instance, to signal the letter "S" the mag-

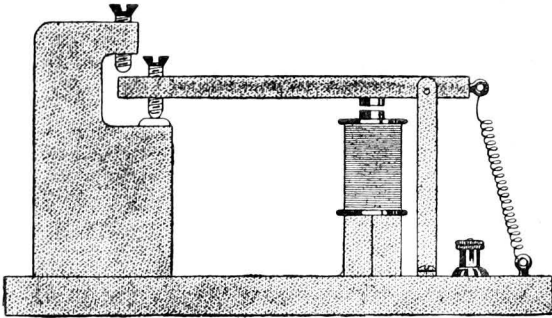

Fig. 17.—Model of a Morse Sounder

net after producing a "click" follows it quickly with a "clack", and repeats this three times in all, whereas to signal the letter "O" it makes three long "click-clacks", so that the S.O.S. signal (fig. 18) is



Fig. 18

The Morse sounder put the needle telegraph at a great disadvantage, because the sounder left the operator free to write down the message as soon as it reached his ears, whereas the needle telegraph had to be watched to see what signals it was

making, and therefore the writing of the message was intermittent.

Morse's invention had another advantage; an instrument could write down the signals. This may not seem to you any great advantage, but it enabled messages to be sent much quicker than could be read by ear. But an operator cannot work the sending key as quickly as the writing

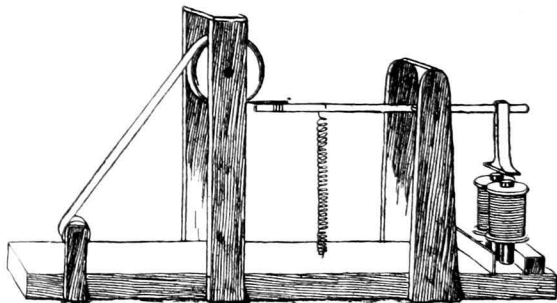

Fig. 19.—Model of a Morse Writer

instrument could take down the message, so another instrument was invented by which the closing and opening of the battery circuit was done automatically.

When I was a boy I made a rough model of a Morse writer (fig. 19). You see the electromagnet, which pulls one end of the horizontal lever so that the other end brings a charcoal pencil against a paper ribbon wound on a drum. You see the spiral spring which pulls the lever free again. The

By means of another invention the Wizard can produce a type-written message at the distant station. There were as many as 150 inventors at work on such instruments during the nineteenth century, but the first really successful machine was made by a young Australian early in the twentieth century. In his invention there were three operations—one to prepare a perforated ribbon to control the electric current, which went out to the distant station where another machine prepared a duplicate of the perforated ribbon. This ribbon, having been prepared by telegraph, was run through a third machine: an automatic type-writing machine which printed the message. You can guess from its nickname that it was not a success; it was called a cross between a sewing machine and a barrel-organ, and no doubt this was suggested by the fact that the operator had to turn a handle to drive the machine. Other nicknames were "Murray's Coffee Mill", "The Australian Sausage Machine", "The Baby", and from the last of these it was evident that the machine wanted a lot of nursing. But the inventor defeated all these nicknames, and in an improved form it was a great success.

Another wonderful thing the Wizard can do is to send a number of messages over the same line at one time without any confusion. This does seem ridiculous. First of all he was able to send

two messages in opposite directions, and you may picture the receiving instrument being shielded from the outgoing electric current.

But this is not the best thing he can do, for eight operators may be working on one single wire, four operating at each end, and yet the Wizard does not confuse the messages. This is called *quadruplex telegraphy*. It is even possible for the Wizard to send a larger number of messages. By automatically giving each operator the use of the line for a fraction of a second at a time, it comes round to his turn again in time to carry on the signals. As many as a dozen different messages may be sent simultaneously.

In yet another arrangement you move a pen just as you do when writing, and at the distant end two electromagnets control a pen on the end of a pendulum, and you may write a message on a piece of paper hundreds of miles away. But the telephone is still better than these, and proves too great a rival for such inventions.

CHAPTER V

Messages across the Sea

When Benjamin Franklin was alive, 200 years ago, he had to cross the Atlantic each time by sailing ship as there were no steamers, and you know what a slow method of transport a sailing ship is.

He was sometimes delayed greatly by the absence of wind. All news had to travel across the seas by sailing ship also, so that the news was many weeks old when it reached America; nowadays we know what is happening each day in America, thanks to the Wizard!

It was an easy thing to connect two places on land by a telegraph line, but to lay a submarine cable across the Atlantic seemed almost an absurd idea. It was certainly a very difficult task, and it was a case of try, try, try again.

First of all they had to make a cable that would stretch from land to land across the Atlantic. The cable had to measure 2500 miles, and a cable is composed of many wires. Indeed, if all the wires

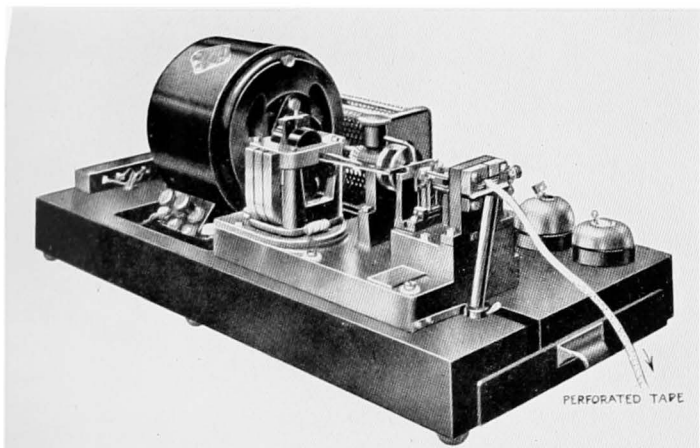

CREED RECEIVER

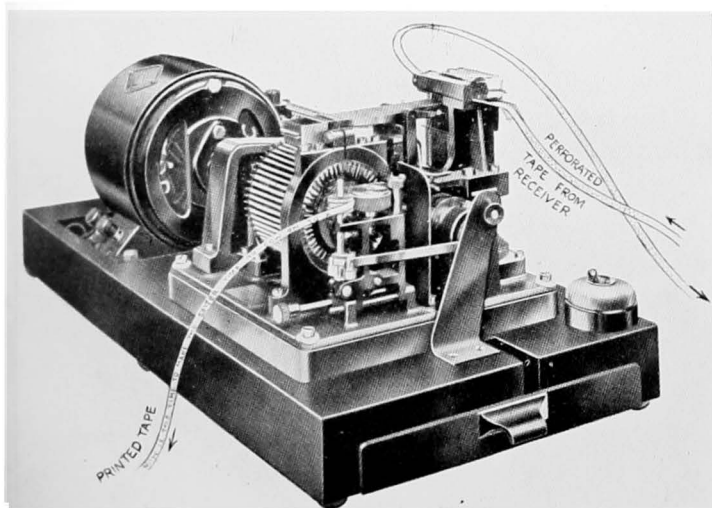

By permission of Messrs. Creed & Co., Ltd.

CREED PRINTER

The incoming message to the receiver (upper photograph) causes the mechanism to punch a paper tape with perforations. This punched paper tape is fed through the printer which prepares from it another paper tape on which the message is printed in roman letters.

forming the first Atlantic cable were joined into one long length the wire would stretch not only round and round the earth, but from the earth to the moon, a distance of almost 240,000 miles. It required a large ship to carry the cable, and for this purpose the American and the British Governments each gave the use of one of their warships. The American warship was to carry one half of the cable and to commence laying it from the Irish coast, while the British warship was to commence the other half from the American coast. After leaving one end of its half of the cable on the Irish shore, the American warship set off at a leisurely pace towards America, but it had only gone a few miles when the cable broke, so that they lost the end in the sea. They had to go back to land and trace the cable out from the shore to the broken end. When they found the loose end they spliced it to the main part of the great cable, and went on as carefully as possible with the laying of it. They managed to lay nearly 400 miles of it—the distance from London to Edinburgh—when it broke again, and this time they were in much deeper water; the broken end sank to a depth of 2000 fathoms. This was a great disappointment, as they had no means of finding it and getting it up from such a depth. It was with heavy hearts they returned home to tell of their failure.

To some this failure would not be surprising,

as on three occasions the engineers had tried to lay a cable from England to Ireland, and each time they had lost the cable; it was only on a fourth attempt, and with a heavier cable, that they had succeeded. But an Atlantic cable was of so much importance that they determined to make another attempt, and for this trial they made new laying machinery. This time they tried a different plan; two steamers carrying the cable would go to the middle of the Atlantic, and one would work its way to the English coast and the other to the American coast. After splicing the ends of the two halves in mid-ocean, the two warships steamed away from one another towards the appointed shores; but they had only got a few miles on the long voyage when the cable broke, and there was nothing for it but to make another start. They kept up telegraphic communication, and, so long as they had the connecting cable, they had to send the messages through the whole length of the cable.

Things were going better the second time, but when forty miles were laid there was another break. The steamers returned again to mid-ocean and made another splice, and this time they managed to get one hundred miles of cable laid before it broke.

They had arranged before starting that if the cable broke after they had laid a hundred miles

they would abandon it, and both ships would make for the Irish coast. As it was not really more than a hundred miles when the cable broke, the British warship returned to mid-ocean, but after waiting for several days it became evident that the American ship had made for the shore.

The company who were trying to lay the cable were advised to give it up, and sell the remainder of the cable, but they determined to make another attempt, and they succeeded on the next occasion. It was a great achievement, and the people in both Britain and America were quite excited about it. It would be a great advantage to business men to be able to communicate at once with their friends across the sea. It would be of great interest to hear news of what was happening across the Atlantic. It so happened that instructions had been sent by mail ordering two British regiments to return from Canada and help to quell the Indian Mutiny, but after the letter was dispatched, the mutiny came to an end. The regiments would have sailed for Britain before another letter could have reached them, but the new cable enabled the War Office to tell the regiments that they were not required, and to pay no attention to the letter which had been sent, and in this way many thousands of pounds of expenses were saved.

All seemed well for the cable company till they found the messages beginning to weaken and

finally die away altogether, and no more messages could be sent; the dead cable lay at the bottom of the ocean. This was in 1858. Years passed, and it was not until 1865 that they determined to lay a new cable, and one better suited for carrying the electric current. Indeed they felt sure the trouble had been that the electric current had pierced the insulator of the cable which they had laid successfully.

It so happened that a very large steamer—the *Great Eastern*—had been built for trading purposes, and had been found to be much too large to be a success at this time. It seemed quite suitable for holding the big Atlantic cable, and so it was taken over by the company. Even with all the experience the engineers had gained the cable broke before they had got very far on their voyage, and the giant ship had to return to the shore, but in the end they succeeded, not only in laying the new cable but in finding the other cable.

I think every boy and girl knows that Lord Kelvin took a great part in connexion with the first Atlantic cable. He was known then as Professor William Thomson, and I would like to take you on a visit to the cable-laying ship to see the part he played. We are making this visit in imagination, by reading a letter written by one of the staff after a voyage. The letter refers to Thom-

son's instrument for detecting the signals and which was known as a marine galvanometer, but was nick-named by the sailors "Jack-in-the box". The letter reads:

"This little 'Jack-in-the-box', as we often call it, does the work of every instrument on the table in its own peculiar way, and a deal more accurately. . . . It is rather an exciting occupation to watch the tell-tale signals as we pay out. Few but the sailors ever sleep soundly. Professor Thomson frequently does not put off his clothes at night.

"To-night we had an alarming crisis. We had signalled the *Niagara*, 'Forty miles submerged', and she was just beginning her acknowledgment, when suddenly, at 10 p.m., communication ceased. According to orders those on duty sent at once for Dr. Thomson. He came in a fearful state of excitement. The very thought of disaster seemed to overpower him. His hand shook so much that he could scarcely adjust his eyeglass. His face was deadly pale. After consulting his marine galvanometer, he said the conducting wire was broken but still insulated from the water. . . . The scene in and about the electrical room was such as I shall never forget. The two clerks on duty watching, with the common anxiety depicted on their faces, for a propitious signal; Dr. Thomson in a perfect fever of nervous excitement, shaking like an aspen leaf, yet in mind clear and collected,

testing and waiting, with half-despairing look for result; Mr. Bright (the brilliant young Engineer-in-Chief) standing like a boy caught in a fault, his lips and cheek smeared with tar, looking to the professor for advice; . . . the Captain viewing with anxious look the bad symptoms of the testing as pointed out by Dr. Thomson. Behind, in the darker part of the room, stood various officers of the ship. Round the door crowded the sailors of the watch, peering over each other's shoulders at the mysteries, and shouting 'Gangway' when anyone of importance wished to enter. The eyes of all were directed to the instruments, watching for the slightest quiver indicative of life. Such a scene was never witnessed save by the bedside of the dying. Dr. Thomson and the others left the room convinced they were once more doomed to disappointment. The clerks continued sending regular currents. . . . Suddenly one sang out, 'Halloa, the spot has gone up forty degrees.' The clerk at the instrument bolted right out of the room, scarcely knowing where he went for joy; ran to the poop and cried out, 'Mr. Thomson! the cable's all right; we got a signal from the *Niagara*'. In less than no time he was down, tested, found the old dismal result, and left immediately. He had not disappeared in the crowd when a signal came which undoubtedly originated in the *Niagara*. Our joy was so deep and earnest

that it did not suffer us to speak for some seconds. But when the first stun of pleasure had passed, each one began trying to express his feelings in some way more or less energetic. Dr. Thomson laughed right loud and heartily. Never was more anxiety compressed in such a space."

Perhaps you do not see the difficulty of getting signals made at the end of a long Atlantic cable. The ordinary telegraph instruments were of no use, as the electric current getting through the cable was not strong enough to work them.

Lord Kelvin made a very sensitive instrument in which a little mirror was attached to a very light magnet, and was moved by the electric current passing through a coil in its neighbourhood. A beam of light was reflected by the small moving mirror and it formed a spot of light on a white screen. When the mirror moved with the magnet, the spot of light also moved, and as it could be moved to the right or left at will, the Morse signals could be made. Then Lord Kelvin made an instrument that would write down the signals, and I remember his brother telling me of it when I was about your age. Instead of the mirror he used a very light pen which was made of a fine glass tube, through which ink would flow. The glass tube had such a small bore that it was difficult to get the ink to flow, but Lord Kelvin found that by electrifying the ink he got it to

flow nicely. One end of this little pen could move with the magnet from left to right, while the other end dipped into a little well of ink. This pen left tell-tale marks of its movements upon the paper. If no current arrived it would make a straight line down the middle of the paper ribbon, but as the little magnet was turned from side to side the pen made marks such as shown in fig. 21. In the diagram you see the first three letters of

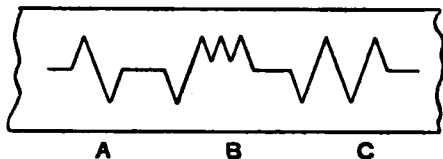

Fig. 21.—Siphon Recorder, A, B, C

the alphabet, and these signals are the same as those given for the needle telegraph on page 40.

If we were having a conversation about the instrument, which, by the way, is called a *Siphon Recorder*, I have no doubt you would ask some questions. One of these might be regarding the flow of ink from the well to the paper. The name of the instrument suggests that there is a siphon at work. I think every boy and girl will know what a siphon is, though they may not be clear as to how it works.

If we had water in two vessels arranged as in fig. 22, we can get the water to flow from the

higher vessel to the lower one. No, we cannot get it to flow up the hill.

On one occasion a coach told a student of a siphon, whereupon the student said, "Yes, but will it work?"

I have seen a boatman bale his boat of water with the aid of a siphon consisting of a long rubber tube. He sucked the water into the tube, and then, putting one end in the bottom of the boat and

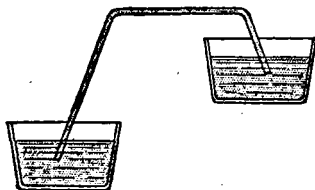

Fig. 22.—Siphon

the other on the shore, the water ran out of his boat without all the trouble of baling it.

Well, the little glass pen is a siphon, but how did Lord Kelvin know to electrify the ink to get it to flow evenly?

I have no doubt he knew of a discovery made in 1780, that water issuing from a nozzle in drops would flow in a stream when electrified. Later it was found that if a vibratory or shaking motion were given to the siphon the ink would flow evenly.

If a submarine cable breaks, or shows a leakage, as is often the case, the Wizard helps the electricians to find out where the fault is.

It was in connexion with the working of the Atlantic cable that Lord Kelvin invented some of his wonderful instruments, and it was he who enabled the Wizard to send messages across the seas.

You may be amused by the following rhyme, which was written by the distinguished scientist Clerk Maxwell of Cambridge, who was a great friend of Lord Kelvin. Clerk Maxwell sent the rhyme, in a letter, to a friend.

“ I was writing great screeds of letters to Professor Thomson about those rings (Saturn), and lo! he was a-laying of the telegraph which was to go to America, and bringing his obtrusive science to bear upon the engineers, so that they broke the cable with not following (it appears) his advice. However, I know nothing. List to the new words to a common song, which I conceived on the railway to Glasgow. As I have only a bizzing, loose, interruption-to-talking-and-deathblow-to-general-conversation memory of the orthodox version, I don't know if the metre is correct, but it is some such rambling metre anyhow, and contains some insignificant though apparently treasonable remarks in a perfect thicket of vain repetitions. To avoid these let (U) = “ Under the sea ”, so that 2 (U), by parity of reasoning, represents two repetitions of that sentiment. This being granted, we shall have as follows:

THE SONG OF THE ATLANTIC TELEGRAPH
COMPANY ¹

“ 2 (U)

Mark how the telegraph motions to me,

2 (U)

Signals are coming along,

With a wag, wag, wag,

The telegraph needle is vibrating free,

And every vibration is telling to me,

How they drag, drag, drag,

The telegraph cable along.

“ 2 (U)

No little signals are coming to me,

2 (U)

Something has surely gone wrong,

And it 's broke, broke, broke;

What is the cause of it does not transpire,

But something has broken the telegraph wire

With a stroke, stroke, stroke,

Or else they 've been pulling too strong.

“ 2 (U)

Fishes are whispering. ‘What can it be,’

2 (U)

So many hundred miles long?

For it 's strange, strange, strange,

How they could spin out such durable stuff,

Lying all wiry, elastic, and tough,

Without change, change, change,

In the salt water so strong.

¹ It will be understood that where “2 (U)” appears in a line, one is to read, “Under the sea, under the sea.”—C. R. G.

ELECTRICITY AS A WIZARD

“ 2 (U)

There let us leave it for fishes to see;

2 (U)

They 'll see lots of cables ere long,

For we 'll twine, twine, twine,

And spin a new cable, and try it again,

And settle our bargains of cotton and grain,

With a line, line, line—

A line that will never go wrong.

CHAPTER VI

Speaking through Space

It does seem quite ridiculous to think of one man speaking to another when they are separated by the wide Atlantic ocean.

This speaking through space was indeed a surprise to our old friend Dr. Priestley on his imaginary visit to us. Again, it would seem impossible to get into communication with a ship far out at sea, even if we knew exactly where the ship is; and yet you may go into any post office and send a message to your friend who is on a voyage across the seas.

The late Professor Ayrton, who is well known to electrical engineers, made a prophecy about wireless telegraphy long before it was invented. He said, "The day will come, when we are all forgotten, when copper wires, guttapercha covers, and iron bands are only to be found in museums, that a person who wishes to speak to a friend but does not know where he is, will call with an electrical voice which will be heard only by him who

has a similarly tuned electric ear. He will cry 'Where are you?' and the answer will sound in his ear, 'I am in the depth of a mine, on the summit of the Andes, or on the broad ocean.' Or perhaps no voice will reply, and he will know that his friend is dead."

On one occasion I was being shown over the Marconi works at Chelmsford, and as we came into one room the operators were just leaving their instruments, when the man in charge asked if I would like to speak to some men who were touring the country in a motor-car making experiments in transmission and reception. I said I should be very much interested, whereupon they set the transmitter in operation again; but after calling for some time in vain, he said he was sorry he could not get in touch with them, to which I said this was rather a serious matter, and reminded him of Professor Ayrton's prophecy that if you could get no reply you would know that the friend was dead.

Before wireless telephony there came wireless telegraphy, and you may think I am joking when I say that wireless telegraphy was suggested three hundred years ago, but our old friend Galileo had the suggestion made to him by a stranger who called upon him.

This man offered to sell to Galileo two magnetic needles which would enable him to send signals

through space. All that was necessary was to turn one needle into a certain position, whereupon the other needle which had been placed at a distance would turn into the same position, and you can see how easy it would be to make the needles point to the letters of the alphabet if placed in a circle like the direction markings on a compass card. I don't know what the proposed method was, further than that the needles were sympathetic, the one following the movements of the other. Someone says "Fiddlesticks!", and I expect Galileo said something similar. At any rate he said he would not purchase the needles until he saw them at work, and he suggested that the man should send signals across the room; but the charlatan said the distance was not great enough, whereupon Galileo suggested that the man should leave one of the needles with him, and that he should take the other to some distant country, and if he succeeded in sending a message to Galileo he would purchase the magic needles. Needless to say the would-be swindler was not agreeable to this proposal.

The first time I heard the suggestion of sending signals through space was in 1890, during a lecture delivered by Sir Oliver Lodge to an audience of ladies and gentlemen in Lord Kelvin's lecture theatre in the University of Glasgow. Lodge had been showing the following experiment, when

either he or Lord Kelvin suggested that signals might be sent through space; I cannot remember which of them made the proposal, but I remember the proposal very clearly though about forty years have passed since then. For the experiment which was shown, the first Lord Blythswood lent some very large Leyden jars, and two of them were

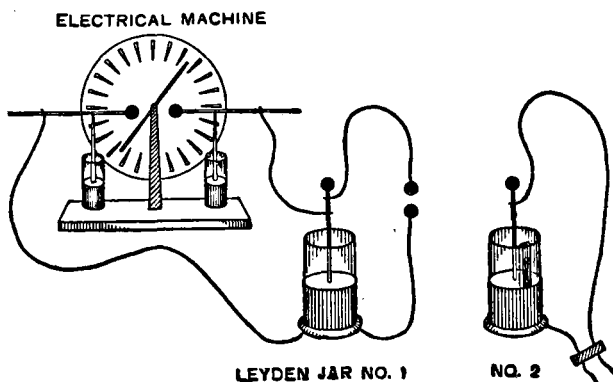

Fig. 23.—Lodge's Experiment

arranged as in fig. 23. You see that one jar (No. 1) can receive an electric charge from the electric machine, but the other jar (No. 2) has no machine in its circuit. In this jar a strip of tin foil very nearly joins the inner coating of tinfoil to the outer coating, but there is a small air-gap left, across which the electricity will jump when the jar becomes charged.

It is found that when the electric machine is

set in action sparks will occur between the balls attached to jar No. 1, but strange to say sparks appear also at No. 2 jar in the air-gap to which I have referred. This is indeed strange, for the two circuits do not seem to be connected in any way. But they are connected by the invisible æther of space, and the signals at No. 1 jar set up waves in the æther, and these waves set particles of electricity vibrating in jar No. 2, and some of them jump the air-space. The circuit with No. 1 jar acts like a transmitting aerial, and the circuit with No. 2 jar acts as a receiving aerial. The connexion may be illustrated by an analogy, water taking the place of the æther.

Picture a boy standing in a pool of water and having in his hand a short pole with a round wooden float on the end of it. The purpose of this is to enable him to make waves on the surface of the water, and this he does by moving the float up and down in the water.

At some distance from him there is a cork floating on the water, and when the boy moves his float he produces waves which cause the cork to rise and fall in sympathy with the movements of the float. If the boy moves the float at a slow rate, he produces what we call *long* waves—which means waves with a long distance from crest to crest. These waves rise and fall at a slow rate and so does the sympathetic cork. If the boy

moves the float rapidly, we say he is moving it at a higher frequency; the waves are more frequent, and we call them *short* waves—a shorter distance from crest to crest—and again the cork responds to the rhythm.

In the wireless apparatus, in the sparks there are particles of electricity moving to and fro at a certain rate and producing long waves in the surrounding æther of space, while in the receiving aerial particles of electricity respond to these waves, and move to and fro in sympathy with the particles of electricity in the transmitting aerial, and in this way the wireless telegraph instruments work. But how did we ever find out about these invisible waves?

Clerk Maxwell, whom I have introduced to you already, predicted the existence of such waves by means of his mathematics, and they were detected for the first time by a young German professor—Heinrich Hertz. He succeeded in detecting these waves in 1888, which you will notice was two years before the lecture of which I have been telling you.

How did Hertz succeed in detecting the invisible waves? Perhaps you picture some very sensitive electrical instrument which is capable of responding to the waves. If so, you are entirely wrong, for the means which Hertz used was a simple length of wire with a spark gap in it (fig. 24).

The waves falling upon the circuit of wire caused particles of electricity in the wire to surge to and fro, and some of the electrons managed to jump the air-space and in doing so they produced sparks. The transmitting apparatus is shown in fig. 25.

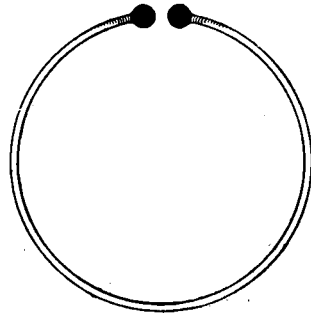

Fig. 24.—Hertz Detector

In the diagram there is a battery connected to an induction coil, through a key with which the electric current may be switched on and off to produce

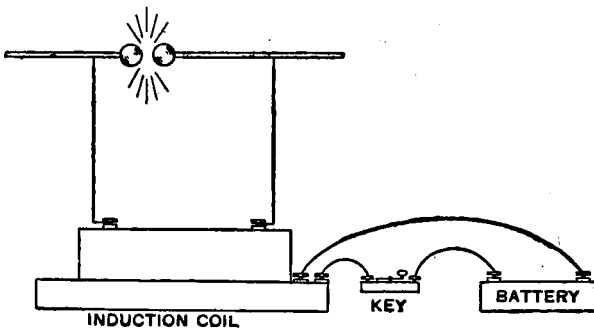

Fig. 25.—Hertz Transmitter

signals. The current from the coil produces sparks as shown, and in these sparks particles of electricity are surging to and fro, thus producing the waves.

Hertz found that when he placed his detector at a certain distance from the sparking apparatus, he got sparks in his detector, but when he placed it a little nearer or a little farther away he got no sparks. Why? Because he was sending the waves against a large lead screen on the wall, and other waves were reflected back, and the original waves met the reflected waves which interfered with one another, and produced calm places, when a trough overlapped a crest.

I can show you sound waves interfering; these are waves in the ocean of air, which is quite different from the ocean of æther. You will not be able to see the air waves because the air is invisible, but you will be able to hear them.

Here I have two bars of steel cut to certain lengths, and, although they look very much alike, there is a slight difference. One of the bars vibrates 500 times per second, and the other 504 times per second. These rates are so close together that you can scarcely notice any difference in the sounds.

I vibrate them by stroking them with a piece of cane held in a suitable handle. This method was introduced by an old gentleman I knew—Joseph Goold, of Nottingham.

When I sound each bar separately you hear clear uninterrupted notes, but when I sound the two together, the waves interfere with one another, and you notice little silences in the sound which

are caused by the air waves interfering with one another; you hear what we call *beats*.

This experiment gives a picture of the way in which Hertz detected the æther waves, when they interfered and produced no signals.

Although a Hertz detector was able to detect the waves, it was not a convenient method of re-

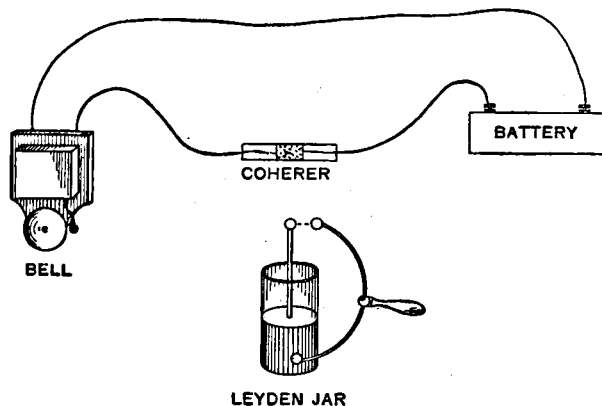

Fig. 26.—Principle of Wireless

ceiving signals, but a better receiver was made, which was based upon a discovery made many years earlier.

It had been observed that when electric waves fell upon metallic filings, their electric resistance is altered. In fig. 26; you see a *coherer*, which is a glass tube containing some metallic filings, and these form part of the circuit in which a battery

is trying to pass a current to a bell. In the ordinary state of affairs the current cannot pass through the filings, as they cause too much resistance, but when the æther waves fall upon them they let the current pass and the bell rings.

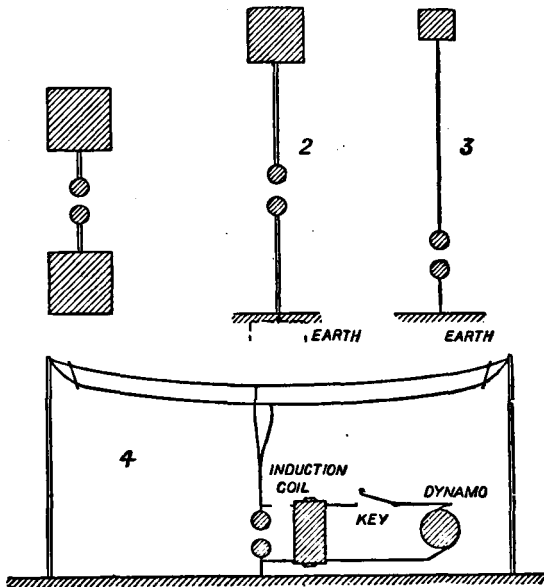

Fig. 27.—Four Stages in the Evolution of the Aerial

These drawings show how the aerial has grown from a simple beginning.

In the diagram the sparks are being produced by the discharge of a Leyden jar, as it fits into the diagram more easily. Any electric spark will produce waves.

Marconi started his experiments with a Hertz

transmitter (fig. 25) and a coherer (fig. 26). He had been attending the lectures of Professor Rhigi in Italy; this was in 1895. It so happened that Professor Rhigi read a lecture delivered by Sir Oliver Lodge at the Royal Institution, and in this lecture Lodge described a coherer. Professor Rhigi set about making coherers, and he showed them to his students, among whom was Guglielmo

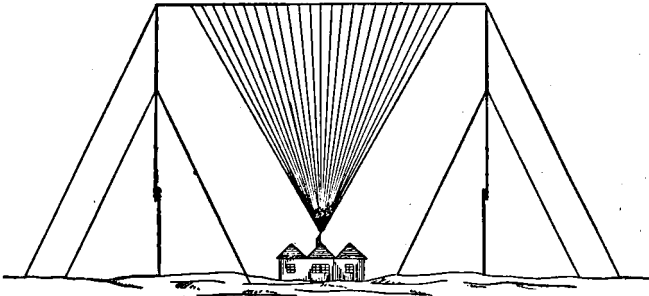

Fig. 28.—An Atlantic Aerial

Marconi. Marconi set about making similar experiments, sending signals across a room, then across his father's garden in Bologna (Italy). Marconi was twenty-one years of age at this time. He made the great discovery that if he added aerials to the circuit he could increase the distance over which the signals could be sent. In fig. 27 we see the evolution of the aerial from simple pieces of metal fastened to the sparking arrangement. This was a great invention made by Mar-

coni. He came to London, and took out a patent for wireless telegraphy, and he made many experiments, commencing in 1896. He sent signals across the Bristol Channel.

In 1897 Marconi returned to Italy and gave a demonstration there under the auspices of the Italian Government. He sent signals across a distance of two miles, on land, and then he put one set of apparatus on board a steamer and succeeded in sending messages ten miles, and so the distance gradually became greater, until in 1899

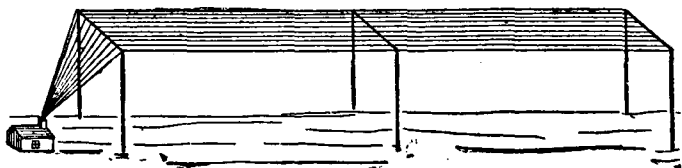

Fig. 29.—Horizontal Aerial

it was found possible to send messages across the English Channel. By 1901 Marconi had succeeded in sending signals (the letter "S") across the Atlantic ocean from Great Britain to America. For this experiment he used a very large aerial as shown in fig. 28, and later he used a horizontal aerial (fig. 29) which gave direction to the æther waves. Instead of sending æther waves in every direction this aerial sends them in one particular direction, and this saves a lot of energy.

Of course when a ship is calling in distress it sends its signals in all directions. \

Many different kinds of wireless receivers were invented in Great Britain, Italy, France, Germany, &c., but all these have been eclipsed by the invention of the *thermionic valve*, about which we will read in the following chapter.

CHAPTER VII

The Valve in Wireless

Every boy and girl knows of the valve in wireless receivers. You will see a drawing of the first valve in fig. 30. This valve was invented by Professor J. A. Fleming of University College, London, and you will be interested to know how it came to be invented.

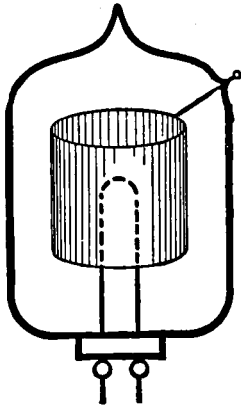

Fig. 30.—The First Valve

The telephone receiver had come to be used for reading the Morse signals in wireless telegraphy, and this did not suit Professor Fleming, as he is unfortunately very deaf.

Because of his deafness he wondered if he could not amplify (make greater) the electric current in wireless so that it would be able to make something move to give a visible signal. He succeeded in inventing the valve, but instead of getting rid

of the telephone, he made wireless telephony possible.

But what made Professor Fleming think of the valve? It was suggested to him by a discovery he made when studying a lamp which Edison had made years before (1883). In fig. 31 you see a drawing of Edison's lamp, and you see that it has a metal plate within it, and that this is attached to a circle marked "G", which represents a galvanometer for detecting an electric current. When Edison connected the other end of the galvanometer to the filament of the lamp, it was found that when the filament was kept incandescent an electric current flowed from the filament to the metal plate.

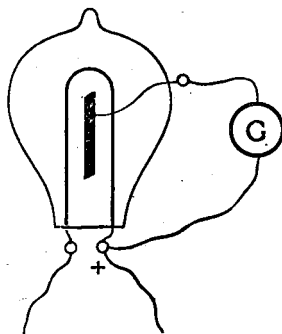

Fig. 31.—Edison Effect

I wondered how Edison came to put a metal plate inside a lamp, and I wrote to him about this, and he told me that he was trying to prevent the blackening of the glass globes due to particles of the carbon filament breaking away.

When working with one of these lamps, which produces what we call the "Edison Effect", Fleming found that if he passed an electric current through the lamp the current could only pass

through in the one direction. Here was a means of turning an alternating or to-and-fro current into a direct or continuous current; we say that Fleming's valve *rectifies* the current.

This valve was most useful to the Wizard Electricity, and he has enabled us to carry on telephone

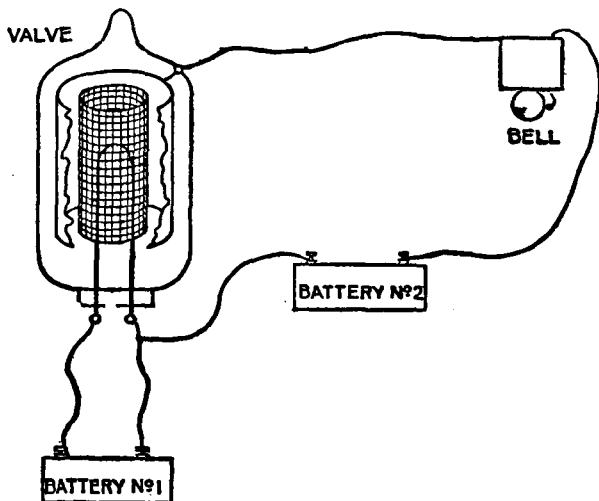

Fig. 32.—Valve with Grid

conversation through space; we can receive music and speech without any connecting wires.

Meantime we want to look at fig. 32, in which we see a valve with a grid made of wire gauze. It will be observed that this grid is placed between the filament and the plate. The grid valve was invented by Lee de Forest, an American.

This valve opens and shuts the door upon the current from the higher-tension battery in your wireless set; the opening and closing is controlled by the waves arriving at the aerial.

The low-tension battery merely heats the filament of the lamp forming the valve, and a weaker electric current is made to open and close the valve upon a stronger battery current. We can thus

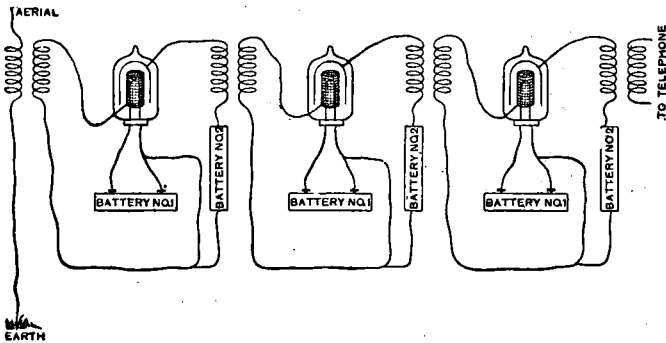

Fig. 33.—Cascade of Valves

amplify the current. We can control a battery current, making it ring a bell at will, and if you look at fig. 33 you will see how a number of valves (called a cascade) is controlled by the æther waves arriving at the aerial, and how the current is amplified so that it may operate a telephone.

In the drawing I have put a separate battery for each valve because that seemed to be the easiest way of showing the working of the valves,

but in your wireless set you know that the one low-tension battery (No. 1) heats the filaments of all the valves, and the one higher-tension battery (No. 2) supplies all the valves with the current which is to be controlled.

The full title of the valve is a *thermionic valve*. I believe some of you will be able to guess the derivation of the word *thermionic*. You may recognize that it is a distant relation of the word thermometer, and even if you do not know the Greek word *thermos*, you could tell that the thermometer has something to do with heat. The *therm* of thermionic valve signifies something to do with heat, and the boys and girls who have studied chemistry may have heard of the *ion*, which means a wandering atom charged with electricity. You know that heat is applied by sending an electric current from the low-tension battery through the filament.

Looking at fig. 33 again, you will observe that the aerial is not connected directly to the grid, and that there is a coil formed in each circuit, the coils being placed opposite each other. In fig. 10 we saw that coils of wire carrying electric current behave exactly like magnets. We may vary that experiment by arranging the coils on stilts as in fig. 34. It will be seen that the electric current passes through both coils, and you have seen already in fig. 10 that when the current is arranged

to pass through the two coils in opposite directions they will repel one another. Therefore when these coils are treated in the same manner they will repel each other and will fall down. The coils if made of very light wire may be suspended, when both attraction and repulsion may be shown.

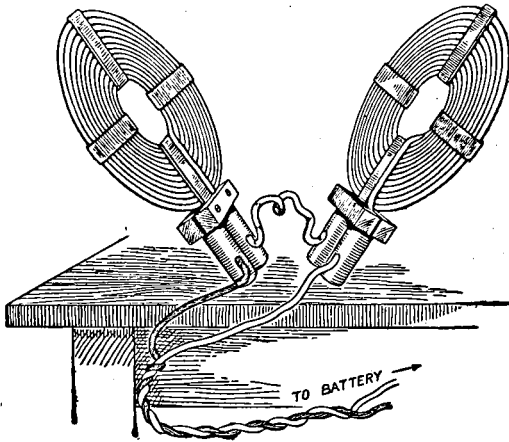

Fig. 34.—Falling Coils

These coils behave like magnets and may be made to repel one another, and fall down.

Why I am showing you this experiment (fig. 33) now, is to impress upon you that there is an electromagnetic field surrounding a coil in which an electric current is flowing. Why call it a field? For the same reason as we speak of a potato or a turnip field. This field contains electromagnetic force.

Now I wish you to come with me again to the Royal Institution, where we find that Sir Humphry Davy has been succeeded by Michael Faraday, and Faraday is busy experimenting with some coils of wire. (The date is 1831.) He has placed two coils within a short distance of each other. In fig. 35 you see the two coils, there being no connexion between them excepting the air, which does not count, as the electromagnetic fields exist in the

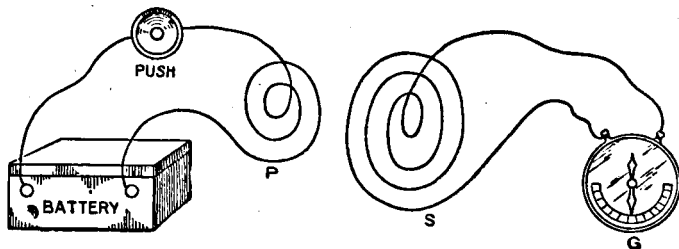
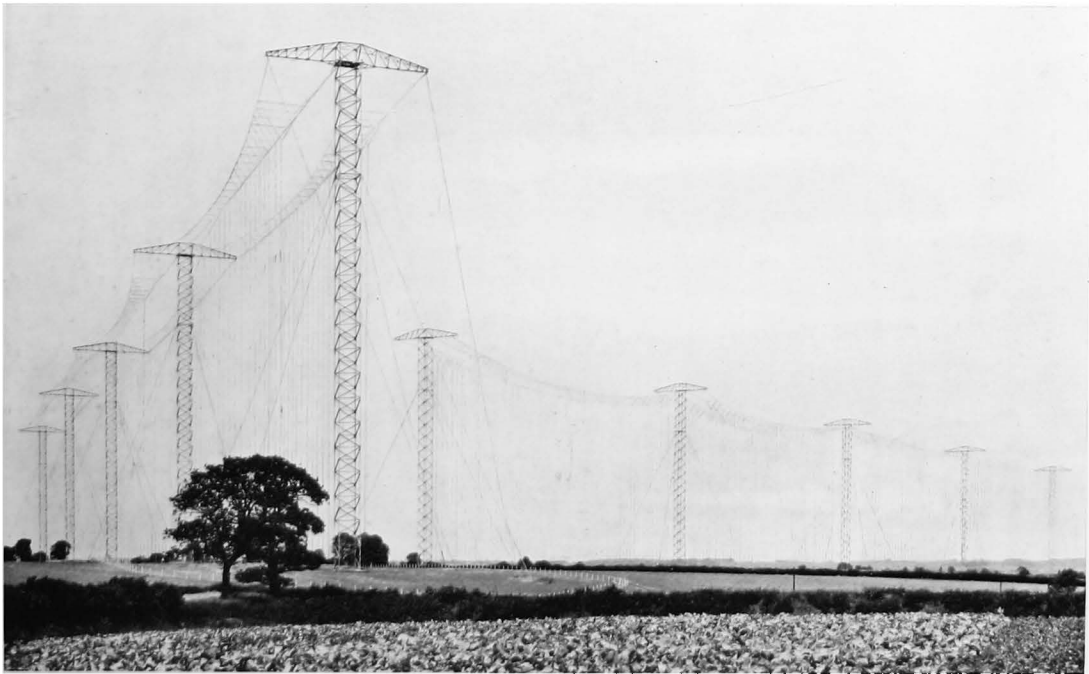

Fig. 35.—The Principle of Induction

P, Primary coil. S, Secondary coil. G, Galvanometer.

æther. You see there is a battery and a bell-push in circuit No. 1. We can start and stop the electric current at will. In circuit No. 2 there is no source of current, but, what seems rather useless, a galvanometer for detecting the presence of any current.

Faraday had two coils arranged something like this, and he discovered that when he started the current in one circuit there appeared a momentary electric current in the neighbouring circuit (No. 2).



By permission of Messrs. Marconi's Wireless Telegraph Co., Ltd.

BRIDGEWATER BEAM RECEIVING WIRELESS STATION

Five masts for receiving from Canada on left. Five masts for receiving from South Africa on right.

Nothing happened so long as the current was flowing steadily, but on stopping the current there was another induced current in No. 2 coil, and so Faraday succeeded in inducing a current to appear in a neighbouring coil.

You can see now how we use coils in the wireless circuit (fig. 33), and you can understand that although the aerial circuit is not in contact with the grid circuit (of the valve) there is this connexion of induced current through the æther.

Suppose we had two long wires lying parallel to one another, we could show the same induction as with the coils.

On one occasion the owner of a telephone in Gray's Inn Road, in London, complained of Morse signals interfering with his speech, and on investigation it was found that a telegraph cable ran near his telephone wire and parallel to it, and it was quite evident that the make and break signals of the Morse alphabet were inducing similar signals in the telephone wire.

This and similar incidents suggested to Sir William Preece, Engineer-in-chief to the Post Office, the idea of sending messages between parallel wires, and when the telegraph cable to the Isle of Wight broke down he tried the experiment on a large scale there. This was in 1882. There happened to be a telegraph line running across the Isle of Wight; the line measured about

twenty miles. This made one circuit by placing both ends in the earth, and using good copper plates to make good earth connexions. Another parallel telegraph line on the shore was arranged in the same manner to make the second circuit.

When signals were sent in the one aerial by making and breaking the circuit, similar signals were induced in the distant telegraph line, and in this way messages were sent between the mainland and the island. And so we had wireless telegraphy in 1882, which was fourteen years before the arrival of Marconi, but it is interesting to note that we had real wireless telephony still earlier, and within two years of the invention of the telephone, which was invented in 1876. In 1878 the inventor of the telephone spoke without any connecting wires. He used a beam of light reflected by a small mirror which formed the vibration plate of the transmitter, and the light fell on a selenium cell which controlled the telephone. This was using æther waves just as we do to-day in wireless, but the waves of light used in the early wireless telephony were a very great deal shorter than any waves we use to-day.

The only difference between light and present-day wireless waves is that the light is composed of very much shorter waves. The light waves are measured in ten-thousandth parts of an inch. Hertz used waves measuring about a foot between

the crests, but many wireless waves are miles apart, and you know that those used in broadcasting are about a quarter of a mile from crest to crest.

On one occasion, during the time of the Great War, I went to Cambridge to deliver a lecture on wireless telegraphy to some of the soldiers billeted there. I very naturally wanted to show them wireless instruments at work, but we were not allowed to use wireless at that time.

I called at one of our large technical colleges and saw a friend who was the professor of electrical engineering there, and I asked him if he could lend me a small wireless set. He said he dared not do so, as the Postmaster-General had ordered that no such instruments were to be used. I went through his room to the laboratory where I saw one of his lecturers, who happened to have a small wireless set in his possession. I asked for the loan of this, making it a condition that I would not use it without the permission of the Postmaster-General. On my way through the professor's room again, I told him what I was doing and he said that he would write to me in my internment. I wrote to the Postmaster-General, telling him, first of all, that I was lecturing at a school in Cambridge on a certain Saturday, and asked permission to use a small wireless set during the lecture. I did not expect to get this permission,

but I wanted to allow the Postmaster-General to say No! in the hope he might say Yes! to my other request that I might use it for the troops on Sunday, and I got my answer just as I expected.

The General who was in the chair at the lecture said to me afterwards that they were all very curious to know how I had got round the Postmaster-General, for they were not allowed to use wireless instruments for teaching purposes. However, I merely said that it was a little piece of human nature that succeeded.

On the Saturday I was out boating on the river with some school boys, when we met a soldier rowing a boat all over the place, and we had to get to one side to get clear of him, and as he passed he shouted, "I want the river to myself". On Sunday evening I told the soldiers that we felt very much the same way as that soldier; in the early days of wireless we wanted the æther to ourselves.

A friend of mine went to one of our colleges to give one of the early lectures on wireless telegraphy, and he wanted, of course, to show them the apparatus at work, and so he took it with him.

When putting up the apparatus before the lecture, he found his wireless receiver replying to signals, before he had fitted up his transmitter. He knew that no one else had a wireless apparatus in the neighbourhood, so he went to investigate,

and found that a lecturer in another part of the building was using a large induction coil for X-ray work, and the sparks of this coil were sending out waves in the æther, which were operating his wireless receiver. This was before the days of tuning.

I showed the soldiers the principle of tuning by using some tuning forks, two of which are seen in

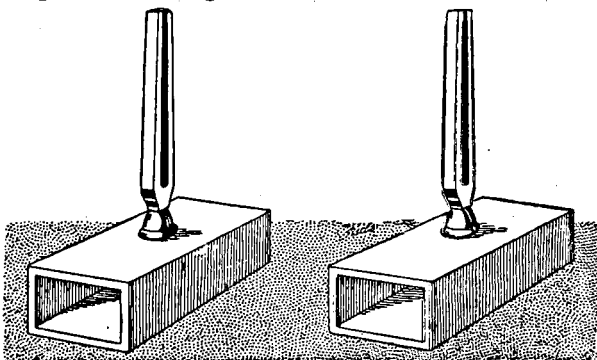

Fig. 36.—Tuning Forks

fig. 36. These two forks vibrate at the same rate (400 times per second); we say they are of the same pitch, because they produce the same musical note. I placed one of these in a group of forks of different pitches, and the other in a similar group. I then caused one of the forks to vibrate, and the air waves produced thereby fell upon the distant group of forks and caused the similar fork to sing out its note; when I stopped

the first fork vibrating, the other fork was heard to be sounding the same note. You will observe that only the fork that was in tune with the transmitting fork received the impulse. I pointed out that the wireless receivers were similarly tuned to respond to a definite transmitter, and I even repeated the experiment using a 500-per-second fork in the one group, whereupon the 500-per-second fork in the second group was the only one to respond. But although I thought I had made the meaning of tuning clear to all, I was disappointed to find in several newspaper reports that what I was supposed to have explained was that the instruments were tuned according to the distance to which the messages had to be sent. In the present days of broadcasting no one is likely to make that mistake, and indeed boys and girls know about the particular wave-lengths to which each station is tuned.

CHAPTER VIII

Making a Piece of Iron Speak

The fact that a little disc or plate of some material could be made to speak was known at least 250 years ago, for Robert Hooke described what we call a string telephone such as shown in fig. 37.

You may have heard of Robert Hooke, who lived at the same time as Sir Isaac Newton, and was also a friend of Robert Boyle, who gave us Boyle's law in Physics.

Hooke wrote: "I can assure the reader, that I have, by the help of a distended wire, propagated the sound to a very considerable distance in an instant, . . . incomparably quicker than through the air." The string telephone, or as it is sometimes called the lovers' telephone, may be worked with two empty cocoa tins and a length of string, and with this arrangement we get the metal discs forming the bottoms of the tins to reproduce words at a distance from the speaker.

But how was iron made to speak electrically as in a telephone?

The first instrument to which the name was attached was invented by Philip Reis in 1861, but he was not trying to make it speak, he was only intending to convey music to a distance. However, it is said to have spoken words, by accident.



Fig. 37.—String Telephone

Reis had observed that an iron rod made sounds when an electric current passed round it, and was interrupted; there was no sound so long as the current flowed steadily. He produced the interruptions by means of a musical instrument to control the transmitter, while the distant receiver (fig. 38) reproduced the sounds.

This was the first electric telephone, but it could not really speak, as speech cannot be made

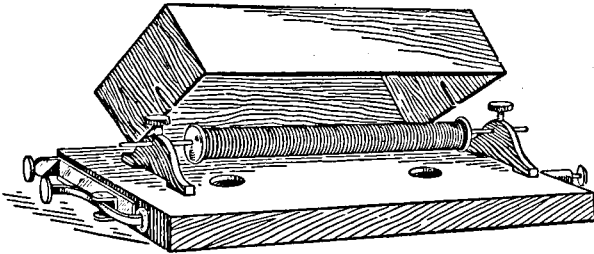

Fig. 38.—First Telephone Receiver

The iron rod made a noise when vibrated by the electric current, and by this means music was reproduced at a distance.

by interrupted currents. The inventor of the first speaking telephone was Alexander Graham Bell,

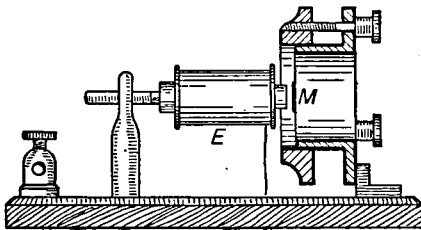

Fig. 39.—Receiver of First Speaking Telephone

M represents the diaphragm, which is vibrated by the electromagnet E.

who was interested in sound through the teaching of deaf mutes.

Bell was working with a musical telegraph when he invented the speaking telephone. Fig. 39 shows

the arrangement of his first speaker, and figs. 40 and 41 show the transmitter. Fig. 40 is what we call an elevation and fig. 41 is what is called a diagram in plan.

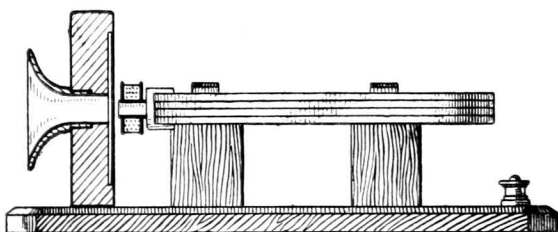

Fig. 40.—Elevation

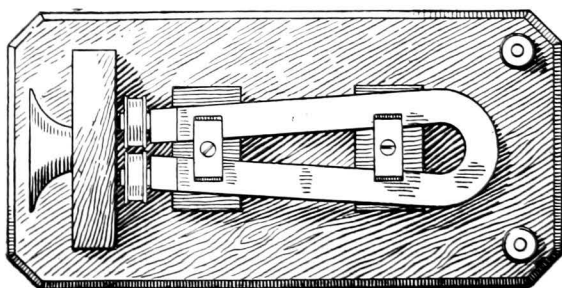

Fig. 41.—Plan

Bell's Telephone Transmitter

The two drawings show different views of the transmitter invented by Graham Bell.

In the receiver (fig. 39) you can see the little electromagnet with the metal disc, or plate, or diaphragm, placed close to one end. The attraction of the magnet, under control of the electric current, caused the diaphragm to vibrate in

exactly the same manner as the diaphragm in the transmitter (figs. 40 and 41). The transmitter diaphragm vibrated under the control of the human voice, and the electric current was produced by the movements of these iron diaphragms in the magnetic field, thus inducing a current to flow on the outgoing line to the receiver, where the current energized the electromagnet, which operated the diaphragm and caused it to vibrate in sympathy with the diaphragm in the transmitter. In this way sound waves were produced, and these were so like the original sound waves produced by the voice of the speaker that the voice might even be recognized.

You will observe that the transmitter (fig. 41) has an electromagnet and diaphragm just as in the receiver, indeed the only difference is the addition of a mouthpiece in the transmitter. The old Bell telephone still exists in our telephone receivers, and if you use one of these as a transmitter you will find that you can carry on a conversation over a short distance, but it is more convenient to have a separate receiver. At first they had no separate receivers, and people using the telephone were instructed not to speak with their ears, nor listen with their mouths.

The following incident will amuse you. I had a telephone receiver in the drawing-room of my house, which was connected by a length of wire

to a wireless instrument in the study, where there was also a telephone receiver.

One evening my wife suggested to our son that he should put papers over some chrysanthemums in the garden to protect them in case of frost. The boy said we might wait till we heard the farmers' weather report, and when this was due I took up the telephone receiver or "headphones", and I heard what I believed to be the official weather report, and was surprised that it ended with the remark that as there would be no frost there was no need to put papers over the chrysanthemums. I remarked to my wife that I did not know that this plan with papers was common knowledge, and just then my son entered the room, and made it known that he had slipped out of the drawing-room quietly and had been speaking into the telephone receiver in the study.

Some days later a professor friend was sitting in the drawing-room and happened to pick up the telephone receiver before the broadcasting was due. I said that I did not think it had begun yet, but it would soon come on, and I winked to my son, who quietly left the room. Giving him time to be ready in the study, I suggested to the learned professor to try the telephone now, whereupon he said, "I am surprised they predict thunder and lightning," and he was quite taken in by the imitation.

You know that a battery current is used in the transmitter nowadays, and in fig. 42 you see the arrangement. The transmitter has a small box filled with carbon powder; the small particles offer considerable resistance to the passage of the electric current which has to go through them. This resistance is lessened by the pressure of the diaphragm when it is vibrating under the control of the voice. In this way we have the electric current

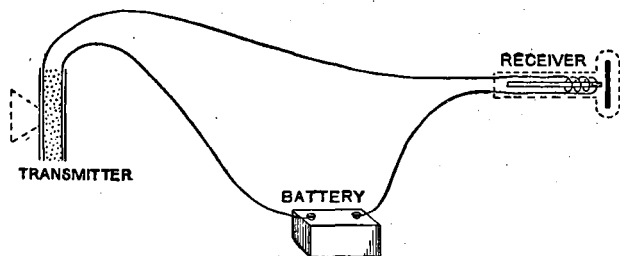

Fig. 42.—Principle of Telephony

varying according to the voice, and you see how the line carrying this current is connected to the telephone receiver, in which an electromagnet controls the iron diaphragm which speaks.

Graham Bell wanted to show his new speaking telephone at an exhibition in America, where he was living at the time of his invention. He was a Scotsman who went to live in America, originally to Canada, on account of his health.

He put the instrument on exhibition, but he was not one of the inventors who was to be allowed

to have a demonstration. You can imagine his disappointment, for it would not be properly understood without a demonstration; but the committee evidently did not see the importance of this.

Graham Bell was walking through the exhibition, feeling rather cut up about it, when he happened to meet the Emperor of Brazil, whom he had previously met in connexion with the work among deaf mutes. The Emperor spoke to him, and Bell told him of the great disappointment he had just got, whereupon the Emperor said he would see matters put right. He proved as good as his word, for Bell received permission to demonstrate his telephone, and he suggested that the Emperor should be the first at the exhibition to try it. Someone went to the distant transmitter, and when the Emperor heard the voice in the receiver, he exclaimed, "My God, it speaks!"

Lord Kelvin, who was accustomed to many marvels in science, was present, and also tried the new telephone. It was so surprising that he felt, when writing home about it, he had to assure his friends that there was no deception. He said there was no doubt, as he recognized Watson's voice. Watson was Graham Bell's assistant.

I have already told you that I always think of the speaking diaphragm as one of the greatest existing marvels.

When an Indian saw a man speaking into a telephone, he asked him what he was doing, and when told he was speaking to a man, the Indian said, "Heap little man," thinking he must be in the telephone instrument. At first telephones were fitted up to connect one place with another, and then the idea occurred of having all the lines connected to one building in which any two lines might be connected together, and so the telephone exchange was founded.

I think you know that the connexions are made by a number of young ladies sitting at boards fitted with small sockets into which they place connecting plugs attached to the ends of the lines.

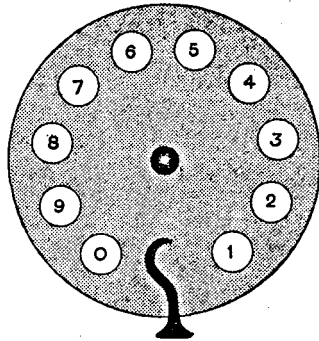

Fig. 43.—Automatic Telephone Indicator

We can even dispense with the young ladies and make the connexions automatically. By putting a finger in one of these holes in a dial (fig. 43) on the telephone, we can, by turning a disc, send out electric impulses which move a selector which controls a contact maker which is shown in fig. 44. The selector is operated by electromagnets which are energized by the impulses sent by the dial already referred to.

It is quite uncanny to stand in an automatic telephone exchange and watch these selectors moving and making one connexion after another. Of course, if any of the selectors go out of order they cannot put themselves right, so there is an engineer at hand, and the Wizard Electricity calls his attention to a selector which has failed to operate. First of all a red lamp lights up, and if

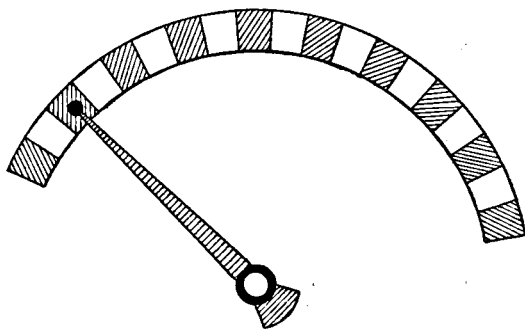
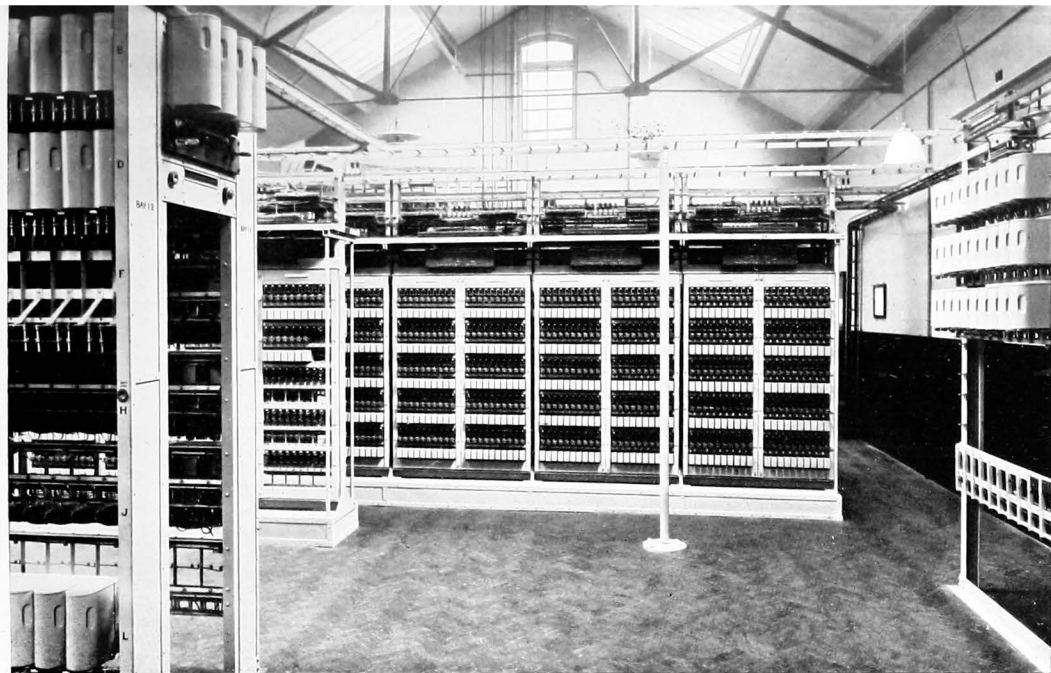

Fig. 44.—Automatic Telephone Selector.

the engineer does not attend to it very quickly an electric bell rings.

Most boys, and girls too, have had a look at the inside of an electric bell, and know how the electro-magnet pulls the hammer so that it strikes the gong. I think you know that when the hammer goes forward it leaves the pillar against which it was resting, and breaks the path through which the current passes, as it goes by way of the hammer itself. The current being broken, the electro-



By permission of Messrs. The Automatic Telephone Manufacturing Co., Ltd.

INTERIOR OF THE AUTOMATIC TELEPHONE EXCHANGE AT YORK

Automatic exchanges were first used in America, but there are now several of them in Great Britain.

magnet lets go the hammer, which falls against the pillar, receives current and is again attracted, but only to break the circuit once more, and so on it goes trembling between the magnet and the pillar.

When speaking of Electricity as a worker of wonders, I mentioned the telegraphone and the optophone, and you may be interested to see how the Wizard works these.

In the telegraphone the in-coming current does not operate a telephone receiver on the arrival of the message, but makes spots of magnetism on an iron wire which is passed close to the electromagnet. Then when this wire is, later on, passed near the electromagnet of a telephone receiver the spots of magnetism in these induce an electric current in the electromagnet, and this sets the diaphragm vibrating just as it would have done had it received the original telephone current. In this way the instrument takes down a message and repeats it, making a convenient substitute for a shorthand writer.

The optophone has been very briefly described in the opening chapters of this book, when speaking of the wonder-worker, but more details may be of interest. The different parts of the instrument are shown in fig. 45 and the rotating disc is shown in fig. 46. The light (reflected from the letters) passes through the holes in this disc, and

is thus interrupted, and the interruptions are heard in the form of musical chords.

If you examine fig. 47 you will see that the letters cover a scale, Soh, Doh, Ray, Me, Soh,

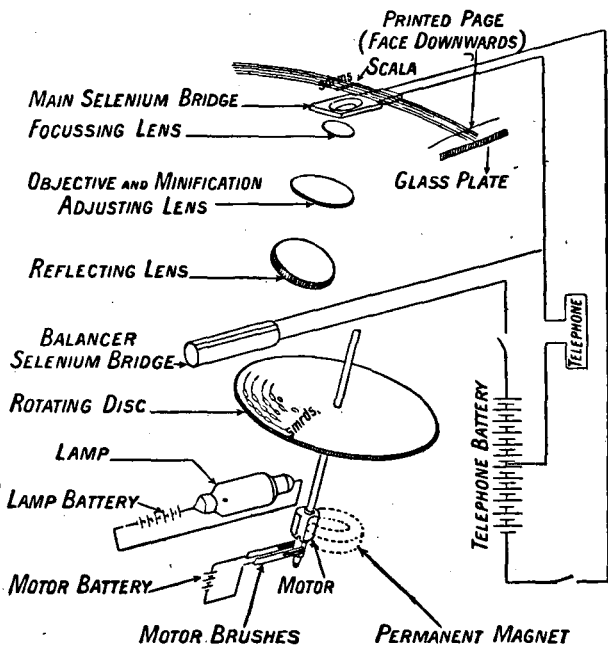

Fig. 45.—Diagrammatic Arrangement of Optophone

and that the light reflected by the letters gives a chord according to the position on the scale.

But someone may say that black letters do not reflect light, they absorb it; and so they do, but the electrical action is reversed, so that it is just

the same as though they reflected the light themselves. For the capital "T" the telephone produces notes from Doh to Soh and continues to sound Soh; this indicates the stroke of the "T" and the line across the top, and so on with other letters. In this way the optophone converts visible

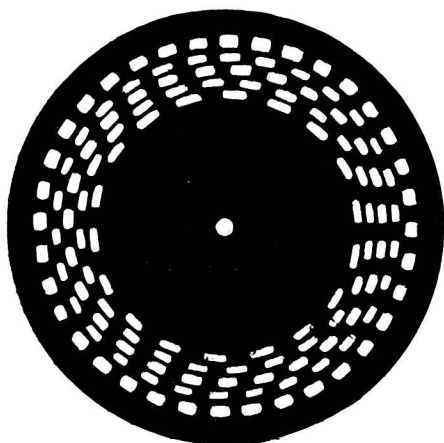

Fig. 46.—Rotating Disc in Optophone

signals into audible ones and this suits the blind man, woman, or child.

The conversion from light waves to the electric current is obtained by the light operating on a selenium cell. When no light falls upon it the electrical resistance prevents any current passing, but when light falls upon it, that resistance is lessened and the current passes to the telephone,

and by means of the rotating disc a chord is sounded. You will count five rows of holes, and each row forms a different note because the number of holes in the rows is different.



Fig. 47.—Musical Signals in Optophone

You will remember that in all the telephone instruments it is a little flat plate of iron which does the talking, and that it is the Wizard Electricity who operates the instrument.

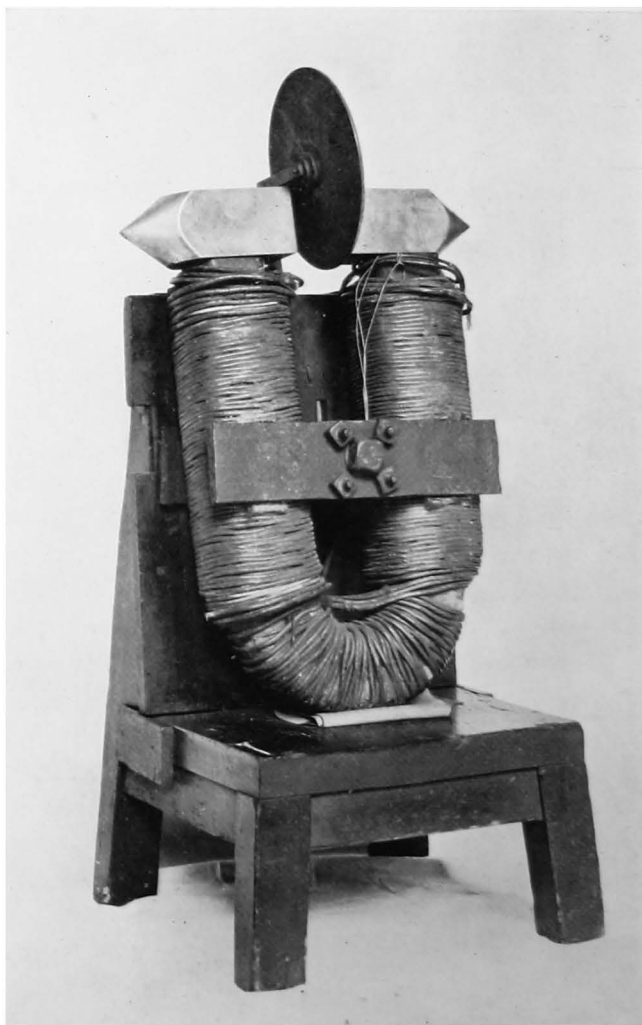

Photo. W. E. Gray.

By permission of the Editor of *The Illustrated London News*.

FARADAY'S ELECTROMAGNET

With this he made some of his greatest discoveries, such as the production of electric currents by the rotation of a copper disc between the poles of a magnet. The magnet is preserved at the Royal Institution of Great Britain.

See page 102.

CHAPTER IX

Making the Wheels go Round

When you were in the nursery you read in *Helen's Babies* that Toddy wanted to see the wheels go round, and I am going to suppose you are now curious to know how the Wizard Electricity makes the wheels go round in the case of tramway cars and machines in general.

When a Chinaman saw one of our tramway cars going along without horses and without any obvious thing drawing it, he said, "No pushee, no pullee—Go like mad."

We wish to see how this driving power of electricity came to be, and to do so I wish you to pay yet another visit to the Royal Institution, where we find Faraday experimenting with a coil of wire and a magnet. He is using no battery, but has the coil attached to a galvanometer so that he can detect the presence of any current which may appear in the coil. Faraday discovers that when he moves either the coil or the magnet, the two being near each other, an electric current appears

in the coil and moves the magnetic needle in the galvanometer. Nothing happens while the two things, the coil and the magnet, remain at rest, but each time the coil moves in the field of the magnet—or, as Faraday would say, each time the coil cuts the magnetic lines of force—an electric current is generated in the coil.

Suppose we repeat this experiment on a larger scale and we revolve a coil of wire at a rapid rate between the poles of a powerful electromagnet, we will succeed in generating a considerable electric current. Such a machine is called a *dynamo*, meaning a machine of force, the word being derived from the Greek word *dynamis*, meaning *force*.

But Faraday did not live to see a practical dynamo, although he lived thirty-six years after he made this discovery in 1831, from which statement you can tell that Faraday died in 1867. The self-exciting dynamo, as you know it, was not invented until 1870.

Faraday made a very simple dynamo by rotating a disc of copper between the poles of a permanent magnet, but success came by using a coil of wire, and all that was necessary was that the coil cut the lines of magnetic force.

Faraday received a letter from a stranger suggesting a machine in which six horse-shoe magnets were attached to a disc, which rotated in front of

six coils of wire wound on bobbins. By rotating the disc the currents of the magnets induced electric current in the stationary coils.

The inventor of this dynamo was Pixii, and the date 1832. It was soon improved upon by others, whose machines moved either the magnet or the coil, and in all the early machines permanent steel magnets were used. These machines are still used for giving people shocks; I mean machines made on the same principle.

Then someone made such a machine for energizing the electromagnet in a larger machine in which a coil was revolved, and in this way a more powerful electric current was produced.

The next step was to dispense with the permanent magnet and use an electromagnet, without requiring a separate machine to energize the electromagnet. It is easy to see that while the machine is generating current we may steal some of that current for the purpose of energizing the electromagnet, but how are we to get the current started without a permanent steel magnet? The fact is, that a little magnetism always remains in the electromagnet, and the weak field produced by it is sufficient to generate a weak current in the rotating coil, which in turn feeds the electromagnet with the current produced, thus making the electromagnet more powerful, and this improved magnetic field then produces a greater electric

current, and so on it goes until we have a very considerable electric current.

You know that the rotating coil is called the *armature*, and that the electromagnet is called the *field magnet*. You know also that we require a steam-engine, a gas-engine, a steam-turbine, or a water-turbine to drive the armature round. We require considerable power to drive the armature while the machine is generating current, but if we break the circuit so that no current is generated, we find that the armature may be rotated with great ease. How is this? While the machine is generating current the armature will, of course, behave like a magnet, and there will be a great attraction between it and the field magnet; the engine is required to overcome this attraction.

A young friend of mine, home from abroad, told me of an amusing incident which happened where he had been in charge of some dynamos for the lighting of the town and pumping up water for the water supply.

He proposed a new engine for the pumps, and one of the governing committee said it was absurd to make such a proposal. Why not make the engine which was driving the dynamo do this pumping as well, for, he said, scarcely any power is necessary to turn the armature of the dynamo as it spins round quite easily, and there was plenty of spare power there for the pumps. It

was evident that his experience of the dynamo was while the circuit was open, and he was not aware of the great attraction between the coil and the field magnet while the machine was running with the circuit closed.

Only a small part of the electric current which is generated goes to feed the electromagnet; the

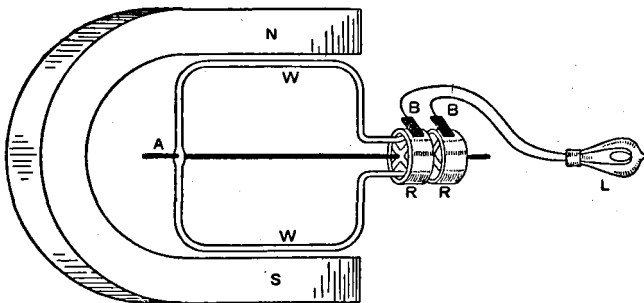

Fig. 48.—Dynamo producing Alternating Current

N and s, North and south poles of magnet. w, w, Coil of wire.
 A, Spindle on which coil revolves. R, R, Rings. B, B, Carbon brushes.
 L, Electric glow lamp.

main part of the current is led out to the mains. In fig. 48 you see the principle of a dynamo supplying an alternating or to-and-fro current. In the real dynamo you know that there is an electromagnet, and that instead of a simple coil there are many turns of wire wound on an iron core, so that it may be rotated. It is not difficult to see how the current is led out of the rotating coil. Each end of the coil is attached to a ring, and on

each ring there rests a contact piece called a *brush*. The current passes out to the mains by one of these brushes and back by the other. As the rotating coil passes first one pole of the magnet and then the other, the electric current is generated as a to-and-fro or alternating current, and with the arrangement as shown in fig. 48 the current

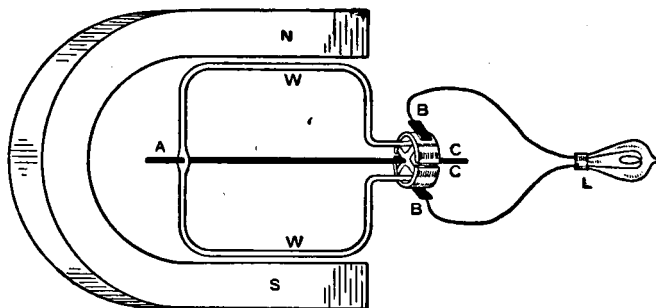

Fig. 49.—Dynamo producing Direct or Continuous Current

N and s, North and south poles of magnet. w, w, Coil of wire.
 A, Spindle on which coil revolves. c, c, Commutator (split ring).
 B, B, Carbon brushes. L, Electric glow lamp.

in the mains will be alternating also. How can we make it flow as a direct or continuous current in the mains?

In fig. 49 you see a different arrangement for leading out the current; each wire is fastened to a segment or what you might describe as a half ring. The brushes are so arranged that when the coil rotates, carrying these segments with it, the brushes, which are stationary, come in contact

first with one segment and then the other. Picture the current swinging to and fro in the rotating coil, so that it feeds current in and out alternately from the brushes. Think of the brushes alone, and picture current first flowing into the main, and then by the time it is feeding inwards, the second segment has come in contact with it, so that the current, having entered the mains by the first segment, leaves it by the second segment. This goes on repeating itself, always feeding in at one end of the coil and out at the other end, thus giving a direct current in the mains. The arrangement of brushes and segments as in fig. 49 is called a *commutator*, from the Latin words, *com* and *muto*, I change.

But all this talk has been about the dynamo, which generates an electric current, whereas what we set out to see was how the wheels of a motor go round. The reason for dealing with the dynamos is that the electric motor is just the same as a dynamo, only in the one case you drive the armature round and produce an electric current, and in the motor you supply the machine with current and then the wheels go round.

For lecture purposes, thirty years ago, I used to have a dynamo fitted with a large wheel for turning the armature, and as I turned this a little electric lamp gave quite a bright light. I pointed out that when I supplied mechanical energy to

the machine it sent out an electric current to the mains. I then took the lamp away and replaced it by a battery, and by sending an electric current into the machine the large wheel which I had been driving by hand began to rotate. The machine was now turning electrical energy into mechanical energy; it will be clear to you that the electric motor is just the converse of the dynamo. What happens nowadays is that we use a dynamo to supply the current for driving the electric motor.

In the early days, and before the self-exciting dynamo had been invented, an inventor gave a demonstration of a simple motor, to which he fixed a large fly-wheel, and when the motor was once going an electric battery was able to keep the wheel turning. Someone, who was thinking of investing money in the new invention, asked Faraday to go and see the machine at work. Faraday looked at it and at the battery which was keeping it in motion, then picking up a brush lying nearby, he pressed it against the fly-wheel till the motor stopped; then he turned and went off without expressing any opinion in words.

If a motor is fixed below a tramway car it may make the wheels go round. The electric current is generated in the power station, and the electric current acts merely as a go-between, a connecting link between the dynamo and the motor.

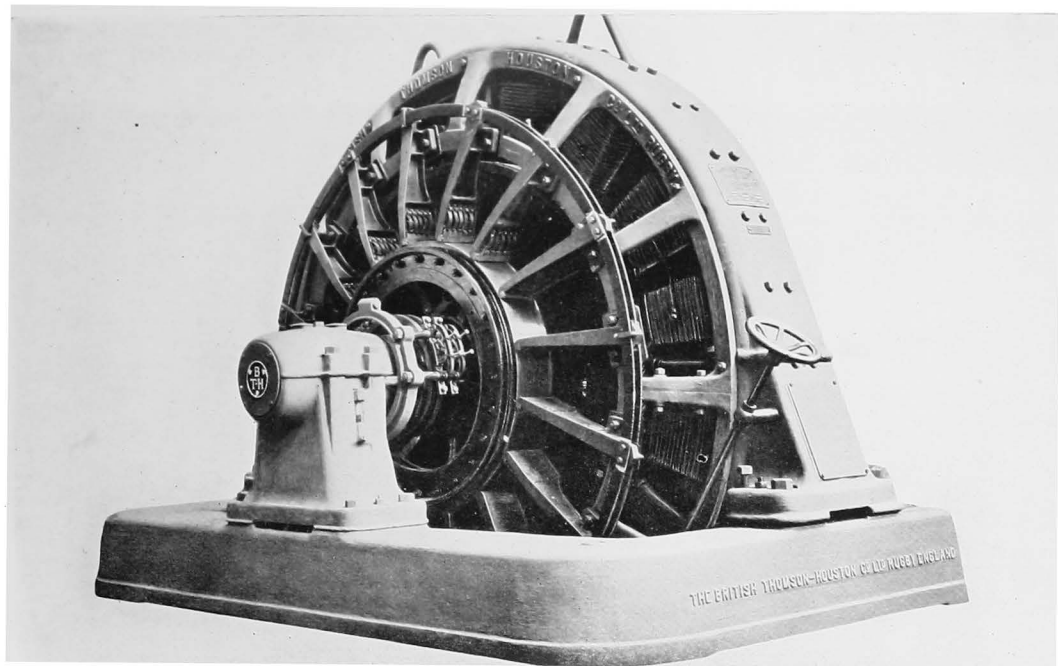

By permission of Messrs. The British Thomson-Houston Co., Ltd.

DIRECT-CURRENT GENERATOR RATED AT 550 KW.

It has 16 poles and is used for lighting on the 3-wire system.

I think you all know the function of the trolley-pole, although one boy had a very strange idea, and how he got it I cannot think; he believed the function of the pole was to keep the car from falling. I heard of a conversation between two workmen who were riding on the outer deck of a tramway car. One asked the other what made the car go, and the other, pointing at the trolley-pole, said, "That fishing rod pushes it along." You know that the trolley-pole conducts the electric current from the overhead wire to the motor beneath the car.

The current does not come directly from the power station by the overhead wire. This overhead wire is in sections or *islands* and each of these is fed from an underground cable, and these cables come from sub-stations, which receive the current from the power station at a much higher voltage than is used for the cars; the sub-station steps down the voltage or pressure by means of *transformers*.

The rails on which the car runs form the return part of the circuit, and, so that they may conduct the electric current well, they are *bonded* or connected together by a short piece of wire joining each rail to its neighbour.

The Wizard Electricity does not only drive the car but he pulls it up suddenly in case of emergency. What he does is to energize a magnet

placed near the rail, and when energized, the magnet is attracted to the iron rail, and holds on, causing considerable friction, and at the same time forcing the ordinary brakes on to the wheels. And it acts still further. The motor is converted into a dynamo so that current may be generated for the emergency brake, so that it is quite independent of the current which is brought on board by the trolley-pole, which might happen to be dislodged from the overhead wire just when the emergency brake is required. So by moving a handle the motor-man switches the connexions so that the motor receives no current, but the force or *momentum* of the moving car drives the motor as a dynamo and the current generated goes to the brake.

You will remember it requires considerable power to drive a dynamo when generating electricity, and some of the momentum of the car is quickly used up in driving the dynamo, and this acts as a third braking power.

You know also that the tramway cars are well lighted by electric lamps, and that they have electric bells. These bells are what we call single-stroke bells, they do not tremble; the wiring is such that the electromagnet holds on to the hammer so long as you keep the circuit closed, and then leaves it when your finger is released from the push. In this way the conductor can signal one stroke to tell the motor man to stop.

Two strokes tell him to go ahead, and a number of strokes indicates to him that the car is full—so not to stop.

A great deal of machinery in factories is driven by electric motors. Sometimes one motor drives a lot of machines by means of a shaft with pulleys on it. But very often a machine has an individual motor to itself, and this may be coupled direct to the machine.

Electricity gives us a very convenient method of conveying power to tools held in the hands of the workman, who may be on scaffolding, or inside a boiler, or somewhere that a belt with power could not reach.

CHAPTER X

Aladdin

All boys and girls have been introduced to Aladdin in the *Arabian Nights Tales*, which, although not really "as old as the hills", go back about one thousand years and probably further. You know the wonderful things Aladdin could do with the aid of his lamp, and the Wizard Electricity is not unlike Aladdin in that he can turn articles made of common metal into silver ones. Of course he does not really change the material, but he gives the common metal such a good coating of silver that it appears to be solid silver throughout.

You have all seen *silver-plated* or *electro-plated* goods, and you are aware that the most parts of your cycles are nickel-plated. How is it done? First of all we must see that the articles which are to be plated are free of all dirt, so they are boiled in caustic potash to remove any grease; they are then placed in dilute nitric acid to dissolve all rust from the surface, and then scoured with

fine sand. Before putting them in the plating bath, they are put into a bath of nitrate of mercury, which leaves a thin film of mercury on them. I have mentioned these details because I have heard of boys trying to electro-plate articles and not getting good results; they had not prepared the articles in these ways. The bath in which the electro-plating is to take place is made of some non-conducting material such as earthenware. The bath contains a solution of 100 parts of water, 10 parts of cyanide of potassium, 1 part of cyanide of silver. It is evident that all the silver required for forming the coating is not in the solution. No. We require to attach a plate of silver to the positive electrode. We have now given the Wizard the materials to work with, it only remains to hand him the articles to be plated; he sets about things in the following manner.

In fig. 50 the artist has imagined part of the side of the trough cut away so that you might see how the articles are arranged, and glass would be quite a suitable material to use, as it is a non-conducting material.

How did we find out that the Wizard could do this?

In 1803, which was three years after the discovery of the electric current, it was observed that when a current was passed through silver

wires in solutions of copper salts, the copper attached itself to the silver wire connected to the negative pole of the battery, and two years later a silver medal was placed in a solution containing gold, and on passing a current through the solution the gold plated the silver medal. There was no good in using such an expensive metal as silver, seeing it was to be completely hidden, and so it

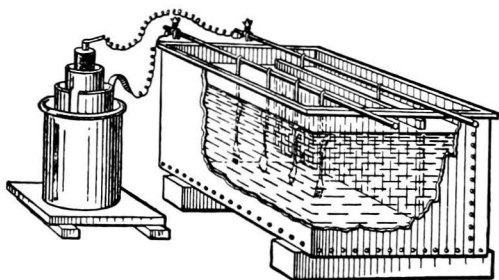

Fig. 50.—Electro-plating. Articles of common metal are attached to one electrode and a piece of solid silver to the other electrode. The electric current deposits silver on the articles.

came about that common metals were used. Electro-plating did not become an art until 1839, and the first patents in this country were taken out by Elkington, who still occupy a most important position in this business.

At first the electric current was obtained from primary batteries. I think that you know that by *primary* battery we mean a battery which generates the current, and we call accumulators, which do not generate the current on their own account,

secondary batteries. As the art of electro-plating was to be carried out on a large scale it was necessary to employ a dynamo to generate the current.

An ordinary dynamo would not be suitable, because it is arranged to deliver the current at a considerable pressure or voltage, whereas scarcely any pressure is necessary to pass the current through the solution; a pressure of 4 or 5 volts is sufficient. Too high a pressure would spoil the coating by making it uneven, and so special dynamos of low voltage had to be made.

Electro-plating may be used for copying medals and ornaments. First of all an impression or mould of the medal is taken by hand, and a plaster of Paris cast made from the mould. But the plaster is a non-conductor of electricity, so we have to make its surface conducting, and this we do by giving it a coat of some conducting material, which may be done by brushing it over with plumbago (blacklead).

You know to attach the plaster medal to the negative pole of the battery so that it may receive a coating of the silver or gold, according to your wish, but if you use gold you must have a solution containing gold. It is from the solution the current takes the gold for the coating, and then the solid gold keeps supplying the solution with further gold, the passage of the electric current acting chemically upon the gold electrode.

Another use of electro-plating is to obtain a piece of pure copper, or other metal. In the case of copper we use a solution of copper sulphate (bluestone), and we take a piece of copper which is impure and fix it to the positive electrode. Then we must have something on which we may deposit the coating, and so we fasten a thin strip of copper to the negative pole. The electric current then deposits pure copper on to this thin plate and gradually there is formed a piece of solid copper, while the impurities fall to the bottom of the electro-plating bath. Of course, pure gold may be obtained by the same means.

So much for electro-plating.

Another use of the electric current is in the electric furnace, in which an enormous temperature can be reached. It came about in this way.

Two brothers, E. and A. Cowles, went to South Africa to develop a zinc mine; their father had invested a lot of money in the mine. They found that the ore from which the zinc was obtained was rich also in silver, but the furnaces were not capable of separating the silver from the ore. They tried furnaces elsewhere, and found the separation could not be done even by the most powerful furnace they could find, but they were unwilling to abandon the matter.

It so happened that one of the brothers was an

electrician and the other a chemist, and so they put their heads together to find a way out of the difficulty. The electrician suggested the electric arc as a source of higher temperature, and they lost no time in testing the matter. They filled a fireclay pipe with the troublesome ore, and mixed with it some charcoal powder. They placed some electric-light carbons at each end of the pipe, and these of course formed the electrodes. The arrangement was completed by closing up the ends of the pipe, and by attaching the carbon electrodes to a dynamo. When they switched on the current the pipe got so hot that the fireclay partly melted, but the ore was reduced.

They found that what had caused the pipe to melt was that the charcoal powder (a bad conductor) had been converted into graphite (a good conductor). The brother who was a chemist suggested that they soak the charcoal powder in lime water, and then try it. The coating of lime thus obtained acted as a non-conductor, and so they succeeded in making the furnace a success.

They also tried to get aluminium separated from the compounds which contained it, and which required enormous quantities of coal to separate the metal. Now there are great works for such processes. What cost at one time fifty pounds now costs less than two shillings, and this great reduction in price is due to the Wizard Electricity.

Fig. 51 shows a simple electric furnace as used in a laboratory.

The heating power of the electric current is used also in welding metals, but there are now other means as rivals, such as the oxyhydrogen and the acetylene flames.

You may have seen men using electric welding in connexion with the bonding of tramway rails.

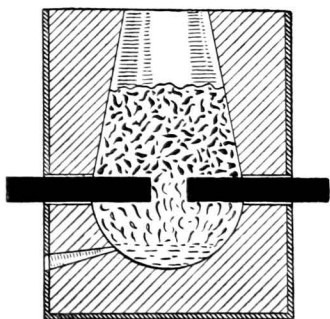

Fig. 51.—A Simple Electric Furnace

An electric arc formed between the electrodes produces the intense heat of the furnace.

They have a convenient source of electricity at hand in the overhead wire, to which they attach one wire, and the other terminal is the rail.

An attempt was made to produce artificial diamonds—or rather to produce real diamonds by artificial means. It had been found that a meteorite arriving on this planet from space

had in it some very small diamonds, which had evidently been formed by cooling from an enormous temperature and with pressure, for you know that a meteorite becomes incandescent when it reaches our atmosphere; the friction caused by the air is enormous.

The experimenters put some iron in a crucible

(a meteorite is made chiefly of iron); and then they had to add the material of which diamonds are formed, and this you all know to be carbon. The Wizard Electricity then raised the temperature of the former to something like that of the incandescent meteorite, and it only remained to cool it suddenly to bring about the great pressure necessary. How is the cooling to be done? You might suggest to plunge the crucible into cold water, but that would produce a coating of gas on the outside of the crucible which would not cool quickly enough. You may be surprised at the plan which they adopted. They plunged the white-hot crucible into molten lead, which you know is itself very hot. This looks a little like the funny man who put his feet in hot water to keep them cool, but if you consider the temperature of the molten lead and the temperature of the furnace you will see that it was quite a good scheme. The drop of temperature was from 5000 degrees to 606 degrees (Fahrenheit), a drop of over 4000 degrees.

But what about the diamonds? Diamonds were formed, but they were so small that they could only be seen with the aid of a microscope; you could not imagine a lady wearing these stones.

CHAPTER XI

The Wizard in Warfare

The Wizard Electricity has been pressed into man's service in warfare. One of his duties is to telegraph messages, which is a much better plan than trying to pass a message along from man to man. There is a story told of such a message turning out a farce. The message as it set out was: "We are going to advance, send reinforcements," but when it reached the other end of the line it came out: "We are going to a dance, send three and fourpence." So the story says.

An actual case did occur, but fortunately it was during manœuvres and not in actual warfare. An inquiry was made as to a submarine at the Needles, and the message was mistaken for an inquiry about a case of needles. It is because of the possibility of such mistakes that a rule was made that all army orders should be delivered in writing, but much useful information is obtained by means of telegraph and telephone.

So far back as the battle of Tel-el-Kebir (1882)

the telephone receiver was used in telegraphy for reading the Morse signals. You will remember this battle as the scene of a great victory by the British forces, under Sir Garnet Wolseley, over the Egyptian forces of Arabi Pasha.

You know that electricity plays a part in exploding mines placed at the bottom of the sea, or in the earth. Another duty assigned to electricity is to fire a whole broadside of guns on board a warship, and this can be done by the officer-in-charge.

Wireless is very useful in warfare, not only for transmitting messages, but also for directing aeroplanes, which have on board a direction-finder. The general principle of this is to turn a coil into the position in which it receives the maximum or minimum signals (fig. 52). The operator has a head telephone in which he hears the signals produced by a land station.

Another part played by the Wizard is in giving guiding directions to ships entering a harbour during wartime. Such entrances are blocked and protected in various ways so that the enemy may not be able to enter. In a submarine cable a current of electricity is kept flowing when required. The ship has two receivers on board, one on the port and the other on the starboard side, and signals sent through the submarine cable induce similar signals in the receivers, and these would

be heard equally well so long as the ship kept over the cable. With any deviation from this the signals would become weaker, and so the ship could make sure when it was right over the guiding cable; it mattered not whether there was fog

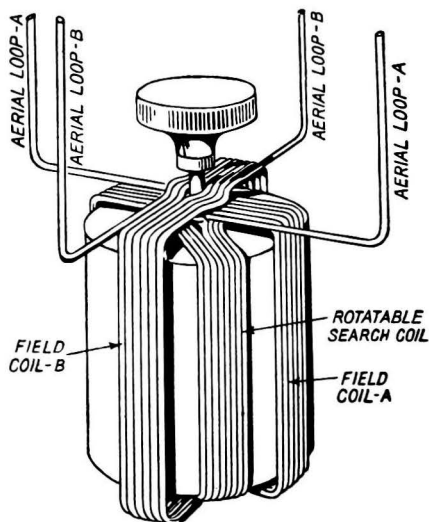

Fig. 52.—Wireless Direction Finder

This shows the search coil in the interior of a direction finder.

or mist, and she might be guided when she had all lights out.

Another duty which is assigned to electricity is to drive our submarines when they are under the sea, at which time they cannot use an engine. We are not concerned with what enables the sub-

marine to sink to any desired level, but as I have an interesting experiment which shows this, you might like to see it.

In an ordinary medicine bottle of large size you see a glass doll (fig. 53). The bottle is filled with water and the doll has only enough water in its legs to make it stand upright. Now, if I press the glass sides of the bottle I force some more water into the doll, through a hole in its tail. That additional water makes the doll sink in the water, and if I press hard enough and long enough I succeed in sending "obo" to the bottom. But I may make him take up a position nearer the surface, as in the diagram (fig. 53). When I release the pressure the air which has been compressed in the doll is released also, and the additional water comes out; in the same fashion a submarine sinks and rises. The electrical part played on

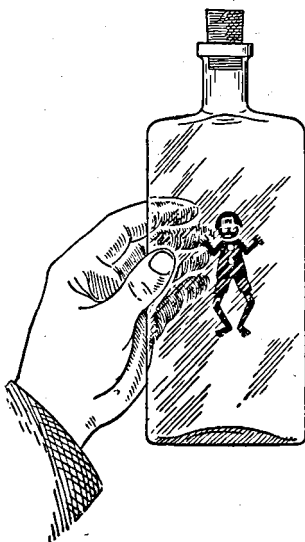

Fig. 53.—Glass Doll in Bottle

This doll rises and falls according to the pressure of the fingers on the bottle, and illustrates the method used in submerging a submarine.

board a submarine is not confined to the motors (accumulators are the sources of power). The submarine is not only lighted by electricity, but its gyro-compass is driven by an electric motor, and in addition to this electricity helps in detecting the presence of other ships in the neighbourhood. The sound, from the other ships, travelling through the water operates a telephone called a *hydrophone*, and the listener hears the beats of the distant propellers. We earnestly trust that there will be no occasion to call the Wizard Electricity to warfare again.

CHAPTER XII

Flooding a Room with Light

This is one of the marvels: that a room may be flooded with light by merely moving a switch on the wall.

Standing on my study desk is a *crusie*—it is made of brass and has four little arms with holes in them to admit soft wicks to oil in a central well. It is not filled with oil to-day, it is merely an ornament now, but it reminds us of the method of lighting a room in the olden days, and it gave a very poor light. Another old method was by candles, and in the days of our great-great-grandfathers they were very inferior to those we have to-day. Candlesticks used to be accompanied by a pair of snuffers, for the wick had to be “snuffed” off as soon as it was burnt. Why do we not require snuffers with our candles? Because the wick of a modern candle does not stand in the gas of the candle as it used to do, but bends over into a position in which the wick can find oxygen to unite with it and cause combustion; it is to ensure this that the wick is plaited.

There is a great deal of interest in a candle, but

all we want to do at present is to impress our minds with the great advance, in lighting a room, which has been made since the days of our great-grandfathers.

Coal-gas lighting was a great advance on the old crusic and the more modern oil-lamps, but electric light as you know is ever so much more convenient, besides being cleaner.

Think of the difference between striking the old flint and steel to light some tinder with which to light the candles, and on the other hand the mere touch of a switch flooding the room with a brilliant light.

An old clergyman lived near me many years ago; he had been the Parish Minister of the district for over fifty years—I remember that he told me of some experiences he had had when he was a young man and when he was dependent for lighting upon the tinder box. His maid would sometimes work with the flint and steel for half an hour without success, and in the end be forced to cross the fields to a neighbouring house to get a light.

I remember hearing of one incident which may interest you. In the long ago he was sitting in his study when a note was received by him saying that a gentleman, who had arrived from London by stage coach, had brought with him a box of matches which would light by merely rubbing them upon

a box, and that a demonstration of these would be given at a certain hour in the centre of the village. My old friend went down to see this marvel, and was utterly surprised to see the head of the match get a light by merely rubbing it on the side of the box. It was so great an advance on the tinder box that the crowd around gave a cheer. Although this old gentleman, who told me of the incident, died about thirty years ago, he had lived to see the great marvel of electric lighting.

It will be of interest to see how we found out that electricity could produce light, and how the Wizard has been coaxed into giving us light whenever we wish it. It was Sir Humphry Davy who made the discovery in 1802.

At the Royal Institution, in which he was a professor, as you know, there was a huge battery of 2000 cells. Davy was experimenting with the powerful electric current produced by this giant battery, and on touching the ends of its wires together they melted, whereupon the current jumped the empty space and produced a wondrously bright flame. This flame was formed in an arch or *arc*, being carried upwards by the heated air, and so the light was called an arc light. But the ends of the wires kept melting away, so Davy attached pieces of carbon to them, and he found that when he touched them together to complete the circuit and give the current a start,

it was able to jump an empty space between the ends of the carbons when separated to a short distance. Indeed, it was no longer an empty space, but was filled with vaporized carbon.

If we place two carbon pencils in a vacuum as in fig. 54, we can get a beautiful arc with twenty

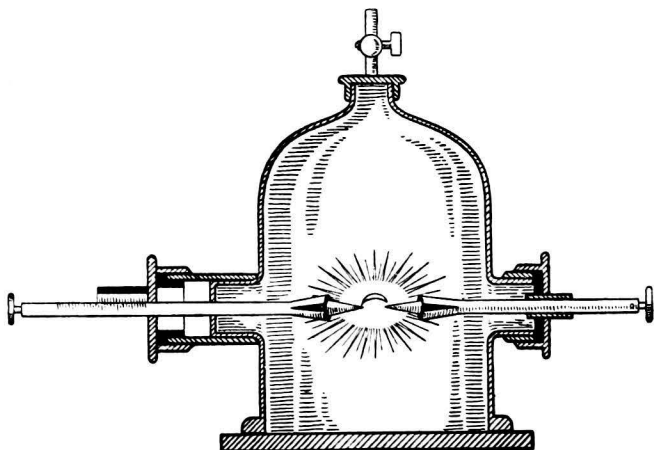

Fig. 54.—An Electric Arc

This shows an electric arc being formed in a glass receiver from which the air has been exhausted.

cells. You may think it was a very simple affair to make a practical arc lamp, but the problem took up the attention of many inventors. It did not mean merely fixing two carbon pencils in position in a lamp; the points "burnt away" so that too great a space would be left, and therefore the distance must be self-adjusted.

There was no practical use of making arc lamps so long as they had to be dependent upon batteries, but the invention of the dynamo opened up a wide field for them.

At the first public trials the distance between the carbons was adjusted as required by hand, but it would never do to have this always done by hand.

In an automatic lamp one of the carbons could be fixed so long as the other could be moved. In an earlier part of the lecture I showed you a bar of iron floating in the air, and forming the core of a large solenoid. You will remember that when I forced the bar downwards or upwards it

always came back to a certain level. Such an arrangement on a smaller scale was used in the making of an arc. A cord and pulley pulled the lower carbon (fig. 55) upwards till it touched the fixed carbon, then the current passed and energized

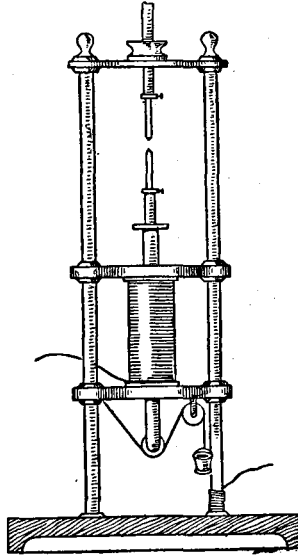

Fig. 55.—A Simple Arc Lamp

This shows the electromagnet for pulling the lower carbon away to strike the arc.

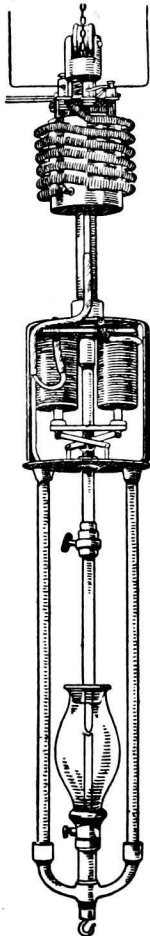

Fig. 56.—An Arc Lamp

This shows the different parts of an electric arc lamp.

the electro-magnet which pulled the iron core downwards and separated the carbons, and this struck the arc.

But the carbons would soon burn away and leave too great a space, and some mechanism had to be devised to feed forward the movable carbon. A clockwork was added; at first there were two clockworks, one to push the carbon upwards and the other to draw it downwards, and these were controlled by the action of the solenoid, but we can pass on to a modern lamp (fig. 56). The coil at the top is a resistance coil, then you come down to an electromagnet which controls the movable carbon, and below the movable carbon is the fixed carbon.

But you will be more interested in the incandescent glow lamp, such as you have in your own home if it is electrically lighted.

Davy found that a small pencil of carbon could be made incandescent by passing an electric current through it.

Some thirty years ago I used for lecture purposes a chain made of

alternate links of platinum and silver, and I see from catalogues that these are still offered for sale. When an electric current from a battery is passed through such a chain, the platinum links become red hot, while the silver links remain cool; the silver being a better conductor of electricity than the platinum.

Edison was the inventor of the incandescent glow lamp, and he had a great deal of trouble in getting a suitable filament. He tried carbonized cotton threads, he tried carbonized paper, and he tested thousands of different fibres, and ultimately found a durable filament made of strips of bamboo. But before he hit upon this, he had sent men to many parts of the world to find a suitable fibre.

The date of his patent for the bamboo filament is 1880. Later on the filaments were made by squirting a solution of cellulose through a nozzle so that it formed a fine thread which was then carbonized; but all carbon filaments are now ancient history, having been displaced by the metallic filament lamps at present in use. Edison's first lamp had a metallic filament, made of a fine wire of platinum, and he took out a patent for this in 1878, but it was not a success. Success came when some of the rarer metals were tried in recent times. One of these rare metals used was osmium, which had been discovered as far back as 1803, but which was not well known; these early lamps were exceedingly fragile.

A strong filament was then made of tantalum, and this was followed by a tungsten filament; it is such a good conductor that only a very fine wire will offer sufficient resistance to the current to produce a white heat. Then followed the Osram lamp, employing an alloy for the filament. All these were a great boon, as they saved more than half the current.

Edison took out a great host of patents in connexion with electric-light systems. I thought it would be of interest to others as well as myself to know which of all his inventions he considered the greatest, and which had given him the most pleasure in inventing. The reply came back that he considered electric lighting his greatest invention, and the one which had given him most pleasure in working out was the phonograph.

In all, Edison has taken out over one thousand patents; he made up his mind when he was a young man that he would devote his life to inventing, and although over eighty years of age he is still busy in his laboratories. There is another kind of electric lighting used for signs, and it is in the form of a long tube which is bent into the shapes of letters. There is no filament, but there is a discharge through a partial vacuum. The tubes are first of all filled with neon gas and then the bulk of the gas is withdrawn, but sufficient molecules are left to conduct the discharge, and

it is the bombardment of these particles by electrons which produces the coloured glow in the tubes.

The picture signs which you see in large cities, and which are used to advertise many things, are usually made up of coloured glow lamps, and a little motor switches off and on the lights in any desired order. Our old friend Dr. Joseph Priestley would indeed have been surprised to see the present state of electric lighting, had he been able to return to Time and Space.

CHAPTER XIII

Telegraphing Photographs

No boy or girl will be simple enough to think of actual photographs being sent by telegraph, but there is a story of an old woman who believed she could send a pair of new boots to her son John by the newly invented electric telegraph.

She took the boots to a quiet country road along which the telegraph line ran, and tying the laces together, she threw the boots astride the line, and went off home.

It was not long before a tramp, seeing the new boots, thought they would be better than his old ones, so he made an exchange, leaving his old ones on the telegraph line. When the old lady came out again to see if the boots had gone, and found an old pair on the line, she thought her son John had sent her back his old boots.

But every boy and girl knows that it is only an electric current that passes along the telegraph line. How then does the current transmit a photograph?

Let us pay a visit to the transmitting station.

Here we see a transparent negative covering a glass drum or cylinder. A lamp (fig. 57) produces a pencil of light with the aid of a lens. The lamp is a particular kind, and it is called a Nernst lamp. "C" represents the glass cylinder around which the transparent photo-

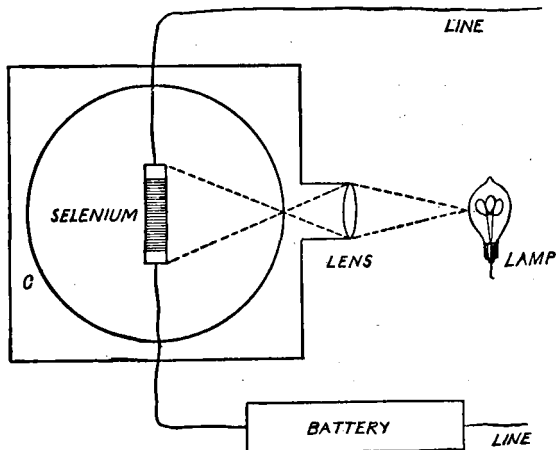

Fig. 57.—Telegraphing Photographs

graph was placed. Inside the cylinder is shown a selenium cell, and the cylinder is enclosed in a dark box. A battery supplies the electric current, which meets with great resistance in passing through the cell if no light is falling on the cell. This resistance decreases when light falls upon it, and does so in accordance with the amount of light falling upon the cell.

A dark part of the photograph will stop the light from passing through to the cell, which will therefore cut off the electric current. A clear part of the photograph will let all the light through, and a shaded part will only let a portion of the light through; so you see that the selenium cell

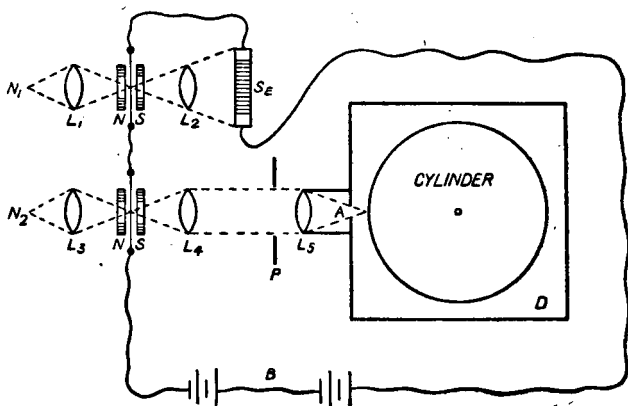

Fig. 58.—Telegraphing Photographs

The diagram shows the means by which the photograph is reproduced at the receiving end, and is described in the text.

will receive a variety of light and shade and darkness, and will respond to all these variations and will vary the outgoing electric current accordingly.

The varying current on arrival at the distant receiving station finds its way to a lamp (N₂), fig. 58. The upper lamp (N₁) and the apparatus connected with it is simply a compensating

arrangement which hastens the movements of the main parts of the apparatus, so we need pay it no further attention.

The light from the Nernst lamp (N_2) has to pass through a galvanometer arrangement shown in fig. 59, in which a small shutter, when at rest, blocks the way of the light, but the ingoing current controlled by the distant photograph causes the little shutter to turn round and let the light pass to a cylinder around which a sensitized photographic paper is placed. The little shutter (fig. 59) will then turn farther and farther, and more light is allowed to pass, and the photographic paper will be affected accordingly. The little shutter

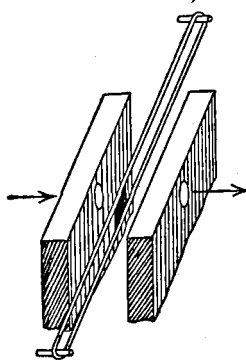

Fig. 59

galvanometer is shown also in fig. 58 at NS, between lenses L_3 and L_4 . It only remains to drive the two cylinders at the same speed; we say the movement of the cylinders must be synchronized. How is this accomplished?

Each cylinder is driven by an electric motor, and these are regulated to a certain number of revolutions per minute, but the receiving cylinder is arranged to go a very little faster than the

transmitting cylinder. Why? So that we may get it to mark time if it is getting ahead of the other one. It is pulled up at the end of each revolution, so that it never gets ahead, for at the receiver it is only released when the transmitting cylinder has made a complete revolution.

This instrument was invented by Professor Korn of Berlin, who gave me a description of it so that I was able to write one of the earliest accounts of it in English. He also sent me photographs which had been telegraphed over a distance of 700 miles; some of our newspapers now telegraph photographs for illustrations.

CHAPTER XIV

Other Wonders of the Wizard

Electricity can carry the time throughout a large building, saving the necessity of having innumerable pieces of clockwork all trying to do the same thing and each requiring winding and regulating; electricity can even drive all the clocks throughout a city. All that the Wizard wants for this purpose is a simple clock dial with hands and an electromagnet to move simple gear wheels; there is no clockwork, not even in the master clock which controls these dials.

In the master clock there is a heavy pendulum, which when put in motion will continue to swing for a considerable time, but would, of course, be brought to rest by gravity in the end. The Wizard, by means of an electromagnet, pulls down a lever and gives the swinging pendulum a very gentle push, which is sufficient to keep it swinging continuously. This master clock, by the revolution of a wheel, switches on the current to the dials at the end of each half-minute. This

electric impulse arriving at the dial energizes the electromagnet and moves the hands forward one half-minute on the dial. The clock may be driven very conveniently from the mains, but may, of course, be worked by batteries if desired.

The old needle telegraph is still alive in railway signal cabins in a simple dial on which it can give three signals by taking up three different positions (fig. 60); it is known as the block system. You see that the needle when at rest points to "line blocked", and if the Wizard should fail to operate the needle, it would not let a train pass, for while in that position the signalman must not pull a signal down.

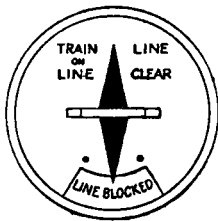

Fig. 60.—Railway "Block Indicator".

Moving the needle to the left signals "train on line", and the needle remains in that position until the train has passed out of that section, whereupon the needle signals "line clear" by pointing to the right. So that there can be no misunderstanding, the instrument is controlled by the signalman in the next cabin.

You know that many railway accidents are due to the engine-driver either failing to notice a danger signal or misunderstanding the signal; the Wizard Electricity is willing to step into the cabin

and give the driver a visible signal and also an audible one by blowing the whistle of the engine. This is how he does it.

A dial is placed beside the starting lever, right in front of the driver and his fireman. It shows a white signal when the line is clear, and then when the line is not clear it shows the word "danger" painted on a red background, and in case this signal might not be observed at once, the Wizard blows the whistle as soon as the "danger" signal appears, and leaves the whistle blowing continuously until the driver pulls a lever to stop it, and thereby sets it again for the Wizard's further operation.

The Wizard leaves no room for doubt about the "clear" signal also, for as soon as the white signal appears in the dial, a gong is sounded and continues to sound until a push is pressed.

The Wizard takes the precaution that the driver cannot run past a danger signal, for he applies the brakes without the aid of the driver or fireman, as soon as the danger signal is given from the cabin. But how can the signalman send the signals to the moving train?

At places where it is desired to give signals, a bar of iron is fixed to a wooden base and placed in the centre of the track; it is called a *ramp* rail. This ramp rail is connected by wires to the signal cabin, and there is a contact on the locomotive

which picks up an electric current from the ramp, provided the rail is connected to the battery. Things are so arranged that when the current is sent by the pulling of the "all right" lever the white signal in the cab of the locomotive is operated, and when the danger lever is pulled in the signal cab, no current is sent and the danger signal is given in the cab.

The ramp is about sixty feet in length; it gives good contact as it is slightly arched, while its two ends are at the level of the rails. The ramp is a fixture and has no moving parts whatever.

A metal shoe or sliding piece is fixed below the locomotive and this makes contact with the ramp. When sliding along the ramp this shoe is raised by the arch about one and a half inches, and is held downwards by a spiral spring. When in its normal position the shoe closes an electric circuit on the locomotive, and a local battery keeps an electromagnet energized. This magnet holds up a lever which keeps the steam whistle closed, but when the shoe is raised by the arch, this electric current on the locomotive is broken, so that the magnet lets go the lever and the whistle blows, and the danger signal appears on the dial. But it looks as though this would happen each time the train passed a ramp rail, and so it would unless the signalman sent his "clear" signal, which sends an electric current to the dial by way of the shoe.

This electric current energizes an electromagnet in the cab, and this magnet completes another circuit and holds up the lever to prevent the whistle being blown, and also prevents the danger signal being given and the brakes being applied. These are only operated when the signalman sends no current to the ramp and allows the arch to operate the apparatus. When the line is clear, the electric current being present in the ramp, it reaches the white signal and lets the driver know that he may go full steam ahead, the gong being sounded at the same time. You will see the safety in this arrangement, for if the apparatus should fail in any way, the ramp's arch will pull up the train, as there will be no electricity to prevent it operating.

You can see the great advantage in such a system during foggy or dirty weather, and it makes sure that the driver cannot fail to observe a signal, the Wizard keeping him right, and taking the full responsibility.

CHAPTER XV

What Boys and Girls think about Electricity

When preparing the Christmas Lectures which led to the writing of this book, I wanted to find out what boys and girls thought about electricity, and as already said, if I had depended upon questioning a few young friends I would have placed myself in the same position as *The Three Tailors of Tooley Street*, so I asked the headmasters of several schools if they would help me. They very kindly agreed to set an essay on electricity, for the best of which I offered some of my books as prizes.

On a previous occasion, after delivering a lecture at one of the English public schools, I asked the boys if they would write me an essay on the subject on which I had just lectured. It was a voluntary essay to be done in their own time—not a school essay as on the present occasion, and I got a large number of very helpful essays.

I told the boys they could make the essay any length they chose; there were no rules, and I

amused them by telling them of the little girl who was asked to write an essay of 250 words on the Motor Car, whereupon she wrote as follows:

“ My uncle bought a new car and went for a run in the country, but going up a steep hill the engine busted. . . . I think that is about 50 words, and the other 200 are what my uncle said as he walked back to town, but I am sorry they are not fit for publication.”

Some boys make mistakes in spelling, like the little boy who spelt circus in a letter to his mother, *sirkus*, and said it did not matter as his mother would understand.

An essay which I received from one of the boys of that boarding-school was crammed full of misspellings, but these were not taken into account in reckoning the value of the essay as it was only the scientific value I was counting, but I wrote to the boy that he would find some consolation if he went into a certain museum in the town and looked at some of Robert Louis Stevenson's letters, which were exhibited there. “ I am going to write another *vollum*, and I hope it will carry more *wieght*,” and so on. He was an atrociously bad speller.

On one occasion I was telling this to a distinguished professor, and he said to me he was relieved to know that he himself was in good company, for he was such a bad speller that after

writing possession as *posession*, he corrected it by stroking out the last "s" and putting a "t" in its place.

Of course, I got some *howlers* among the essays with which I am now dealing, but I was not looking for howlers; what interested me was wherein lay the difficulties of the boys and girls. The first thing that surprised me was the number of young people who thought that electricity was got from the air, and "gathered in by a dynamo", but that was really better than the idea of electricity being *created*, or again *manufactured* by machines. A great many of the essay writers spoke of electricity being *made*, but I believe they were thinking of the electric current and not of electricity itself. The number of particles of electricity is just the same to-day as it was when "In the beginning God created the heavens and the earth". You know that the electric current is merely these negative particles in motion, and so we can make an electric current in the sense of setting the electrons in motion.

Those who say that electricity comes from the sky or that it is formed in the heavens are evidently under the impression that we get it from the air, and were not, as I supposed at first, merely referring to Benjamin Franklin's kite experiment.

Indeed many of the writers of the essays go on to say such things as these:

“It is formed in the heavens, or at least it comes from the air.” “Electricity is currents of some kind in the air, which, when gathered together make a very valuable form of power.” “Electricity comes from the sky and machines get to work and gather in the electricity.” “It is caused by the clouds when they meet and produce a ray which gives light and heat and other substances.” “I think electricity is formed by constant friction of the clouds.” “Electricity is a certain form of air.”

I could go on quoting many more such sentences, but I think I have quoted sufficient to show that this idea of “electricity being gathered from the atmosphere” is quite a common idea among boys and girls. Another surprise I got was the large number of young people who think that electricity is got by the friction of running water. When I came across the first references to electricity being made by running water, I thought the idea was merely that the water was used to turn a waterwheel or turbine and thus drive a dynamo, which generated the electric current. I soon found that while some boys and girls did mean that, others thought that the water made the electricity directly. Here are a few quotations, the first of which might not mean what I say:

“It is usually caused by some fast flowing river or by some waterfall.” It may be that this boy

is thinking of turbines; it is remarkable the number of young folks who think that water power is the chief source for driving dynamos. The real facts are these. Only a very small number of the stations in the country use water power, and the saving in cost is not so great as boys and girls think. But here are quotations which leave us no doubt about the idea of the water itself making the electricity.

“Electricity is a power which is created by water power moving at a great pace through a tunnel.” “Electricity is composed of waterfalls. It is put from the falls into a big box where it lets out its powers.” “The force of running water generates electricity, by a machine through which the water rushes with great force and so makes electricity.” “My idea of electricity is some mysterious force which can be extracted in some manner from waterfalls.” “Electricity is a wonderful thing which is got out of running water.” “The water striking the instrument creates great friction (being electricity) and it is conveyed away by wires.”

The idea of friction is firmly embedded in the minds of many boys and girls, and is probably due to their knowledge of rubbed amber and the glass frictional machines.

“A waterfall rushes down and turns a wheel which rubs against another wheel. This makes electricity.”

I think one boy had the old tinder box with its flint and steel in his mind when he wrote:

“Electricity is made by two pieces of flint striking together.”

I think, however, that his idea is partly due to a confusion between electricity and sparks, for there are many references to electricity being made of sparks.

“Electricity is a sort of powerful spark or a lot of sparks taken from the air by a dynamo.”

This boy goes on to explain how the electricity, when thus extracted, is captured and put in cylinders at the power station, and then led out by wires from the cylinders.

One boy makes no doubt about the part played by water, for he says, “If there was no water there would be no electric light.”

Another boy gives the reason why he is satisfied that electricity comes from the air, and this is because he knows of a golfer who, when swinging an iron club to get a ball out of the rough, gathered so much electricity in the club that he received so severe a shock that he was killed.

I think I have said already that it is remarkable how many young people think of electricity as an invention.

“The most popular of all inventions.” “Quite a recent invention.” “The greatest invention of the day,” and so on, and so on.

Others make it quite clear that electricity was discovered ready made, but they go astray as to the date of the discovery. I was surprised how many attributed the discovery to Benjamin Franklin and his kite; this places the discovery about the middle of the eighteenth century and not the seventeenth century as most of the writers say. You know, however, that electricity was discovered before the time of Christ.

One boy says it was discovered "by some genius about 50 years ago", and another makes it more recent by saying "about 20 years ago".

While some boys correctly connect electricity with the æther of space, they cannot get away from the idea of friction.

"When the current is made by friction it is caught in what are called cells or batteries."

We speak of storing electricity in accumulators, but it is really chemical energy which we store in these. In a Leyden jar there is a real storing of electricity. In the minds of some boys batteries play too important a part, as is evidenced by the following quotation:

"When electricity is installed in a house, all the power seems to come from a battery, that is so charged with electric power that it is able to distribute into many rooms." "A power house has one large battery or a lot of little batteries. I think more probably the latter."

When I read the following, "Electricity is made by friction and the power so made is carried by wires and stored in batteries," it reminded me of an incident which happened thirty years ago. A subway or underground railway had just been opened in my native city; it was a haulage cable, but the cars were lighted by electricity. On my first journey I was looking through a window to see how the electricity was collected from rails placed alongside the tunnel, and I saw that it was a sort of sliding skate and not a trolley wheel. Just then the passenger sitting next to me said that it was a wonderful arrangement; and when I asked him how it was, he said, "You see the electricity is got by the friction of that rubbing on the rail, and it costs nothing." I remarked with apparent innocence that it would be awkward when we stopped at the station, as the light would go out. "Oh no, it seems to gather enough electricity to keep it going while at the station."

You can hardly dare explain matters to those who know so much. I have listened to the most weird description of how a telephone works, while standing with a stranger who was also waiting for a trunk call in a hotel. Of course, I pretended to take it all in, which was doubtless very wrong.

Some boys have queer ideas as to the production of lightning: "Lightning is probably caused by the earth going so near to another planet that

an electric contact is made, in almost the same manner as one is made in an ordinary sparking coil."

But the earth does not go careering about in space. We pass the other planets at regular intervals and keep at a respectful distance, as each planet has its own racecourse.

Another idea is that clouds made of hydrogen and others made of nitrogen collide and produce lightning. I don't know how this idea originated unless the writer thought that a mixture of hydrogen and nitrogen is explosive, which it is not.

I have not quoted a number of howlers lest the writers might read them in this book and take possible offence, but they ought really to join in the fun.

Many years ago a little fellow was showing me a general knowledge paper which he had to answer at one of the large boarding-schools. He told me his answers, some of which were very funny, but he had the good sense to join in the laugh himself.

One question was: Complete the following proverb, "A little knowledge . . .", to which he said, "A little knowledge goes a long way."

I told him he might have found fault with the question, as the proverb says, "A little *learning* is a dangerous thing."

Well, here is one howler from the essays.

“When the electricity is made it is put into a pan affair to be cleaned; it is then sent out to the houses.”

I believe the writer was thinking of coal gas, which has to be cleaned before being delivered to the houses.

So far I have been dealing with the essays from one school, and I have been dealing with the difficulties. Some boys—not many—know all about electrons and protons, and electric charges, and what the electric current is; but there is in some cases an idea of two currents where there is only one—the negative current—due to the march of the electrons.

Even with the current it seems difficult to get away from the idea that friction plays an important part. For instance:—

“The light in an electric bulb is just the spark caused by two currents meeting.”

And again:

“The positive and negative currents meet, and this causes friction which makes the wire hot.”

The statement made in one essay, that electricity burns, reminded me of an incident which took place more than thirty years ago. I was speaking with a very charming old lady, who had been in bed for twenty-one years, the result of an accident, and she had never seen electric light. She asked me if the electricity burned in the lamps like gas or oil.

When I suggested sending a young man in to put up an electric bell for her, she would rather not in case he was killed when working with the electricity, and she was a little anxious about the possibility of it setting fire to the bed-clothes.

One boy's description of a dynamo is too good to pass over:

"The generator consists of a long wire bound tightly together. This ball turns very quickly and hits the inside of the generator, thus forming electricity."

Another boy excels greatly in his descriptions, and I close the present chapter with a quotation from his essay, which deserves some praise for its ingenuity.

"Combing my hair the other morning a train of thought was started in my head by the loud crackles which resulted when I approached the comb to my hair, after having combed it vigorously for a few minutes. This phenomenon I knew to be due to the collection of that mysterious thing 'a charge of electricity' on the comb and of an opposite charge on my hair. But how and why had these charges got there? Cogitating on this matter for some time and making use of the scrappy notes I have read from time to time concerning electrons, protons, and all the other mysterious things ending in—oms, and ons, and ins—I came to the conclusion that the comb and

my hair started life with an equal amount of negative and positive charge (called I believe, electrons and protons). Things went on all right until Nemesis, in the guise of Vanity, prompted me to comb my hair. In doing this I ruthlessly split up the happy homes of many innocent protons and electrons, causing all the electrons to be stranded on the comb, and all the protons on my hair.

“ Now it appears that these electrons are not as fond of one another as they might be but are frightfully infatuated with certain protons and consequently when the comb returns to anything like a reasonable distance from my hair the electrons on the comb and the protons (I hope I have hit the correct name! or is ‘ proton ’ another name for ‘ Vitamin B ’?) leap gleefully towards one another and embrace with such force that in the dark you can see a spark.

“ This sort of electricity is not, I know, the same as the sort which makes the trams go and heats the electric toaster. That is a much higher caste and is studied at school under the high-sounding name ‘ Current Electricity ’. To be able to say that you have ‘ done current electricity ’ is to be admitted into the higher social circles of the scientific world—at school.”

CHAPTER XVI

More Ideas and the Orthodox

No doubt every boy and girl will understand that *orthodox*, appearing in this chapter's heading, means *according to the accepted belief*. On reading a second batch of essays from another district, I was surprised to find the same belief in water taking the same important part in the production of the electric current, one essayist going the length of saying that electricity is formed from water, and another that "water must have a lot to do with it".

Again the air comes in as being the great storehouse of electricity, while some think that the electric current comes out of the æther and after doing its work returns to this illimitable medium. They are nearer the truth, for we do believe that electricity is composed of the æther, but it is not manufactured, as we require it; it is composed of permanent particles, as has been described already. The electricity which produces the current is within the wire and belongs to the atoms forming

the wire, but the energy is carried by the æther surrounding the electrons.

It is interesting to learn the thoughts of some boys and girls regarding the nature of electricity. Here are a few:

“Electricity as I think of it, is a thing which moves in small balls, through whatever it is in, and all the balls are joined together by some thread-like substance at exactly equal distances apart.”

You are aware of the orthodox belief, which is of electrons (not matter) being handed on from atom to atom along the line. Another says that electricity is not so simple as it looks, it seems to be alive.

Again:

“To me, electricity seems a vast nothingness, yet it is a useful nothingness.”

And:—

“Electricity is a kind of abstract thing, but as it can be collected in a battery, it shows that it is not totally abstract.” “Electricity is a kind of atom in the air.”

Some boys and girls think electricity is one of the elements, and they picture it combining with other elements in a radiator and so on:

“Electricity is the name given to an element discovered in the earth’s surface.”

And another says:

“Electricity is one of many elements, and combines with other elements to form visible light.” “Electricity is a condensing of vital matter.”

Referring to the passage of the electric current, one girl says:

“It seems to cling to the wire, by surface tension,” but you know what really happens.

Again quite a number speak of electricity as an invention, and one boy adds he does not see how it was invented, as lightning is not an invention.

The same idea turns up in this batch as in the former batch—this was that electric light is produced by two currents colliding, whereas you know that the heat is produced by the activity of the electrons setting the atoms into a state of vibration.

I have remarked in an earlier chapter that one boy thinks that the trolley-pole of a tramway car is to prevent the car falling, and I said I could not see how he got this idea, but in reading his essay again I see that he says: “The electricity attracts the iron trolley, and so prevents the car falling.” He says prevents “from falling”, but the *from* is unnecessary.

I see that several writers attribute the discovery of the electric current to Voltaire, and that reminds me of another occasion when a mother was overheard telling her boy that the steam loco-

tive was invented by Robert Louis Stevenson, whereas she should have said George Stephenson.

One boy attributes the electric light to one electron rubbing against another, whereas the orthodox belief is that the electrons can never get near one another; they repel one another, and in the atom act like planets going round a sun.

Others think that in the dynamo the friction of the brushes on the commutator produces the electric current, but in that case why bother about a revolving coil of wire and a field magnet?

Quite a number of young people picture the electric current as being sent through the iron core of an electromagnet, but as you know the current is confined to an insulated wire which need not touch the iron core, as when I showed the iron bar floating in the air.

Many of the essayists excuse themselves for not knowing what electricity is. One says that even Sir Oliver Lodge when lecturing on electricity admitted that he knew nothing about it, which is a little like the Irishman who said he did not understand the electric telegraph, but he thought he could explain it.

One girl is very amusing—I mean intentionally so:

“Youth is the period of self-confidence and conceit; we young people think we are very wise and that we know a great deal. For instance, after

the science period at school, I go home and tell my mother wonderful things about her cooking materials, and I feel very superior. Now, suppose I were to visit the British Museum and I went up to examine an Egyptian Mummy who to my surprise, would ask me to explain all the wonders of our world, I would tell him perhaps, that these dazzling lights were caused by electricity. He would ask, 'But what is electricity, and how does it work?' and I would go home a sadder and a wiser girl."

The essayist goes on to tell of a second visit which she would pay to her "mummified friend", and how in the meantime she would read all the books on electricity she could find, "but", she adds, "I doubt if I should be any the wiser."

The last sentence is rather hard on the authors, but I am hoping my books were not included, though one essayist said very nice things about my books, and a friend spoilt a fine compliment by declaring that the boy knew for whom the essay was intended; and this reminded me of the young man who was being examined in First Aid work. When the examining doctor described a very serious case, and asked him what he would do, the youth said, "The case is so serious that it would require the very best medical attention, and I should certainly send for you, doctor."

I have been surprised how many essayists have

taken notice of the Robot, or electrical man, and the great future predicted for him.

One boy says:

“ Electric robots will take the place of the hard-working man. Traffic policemen will be relics of the past. Such things as buttoning waistcoats and putting on shoes, even a valet will be too lazy to do. Human navvies and miners will be things of the days gone by. The man of that time will live for sport and pleasure.”

Another says:

“ Possibly in the future, in the time of robots, even people will be run by electricity.”

One boy is milder in his beliefs; his hope is that some day electricity will be able to wash our faces. I presume he finds this act a hardship.

Another boy is “ surprised that we should go on quarrelling about some small point in economics, when the invention of the mechanical man threatens to revolutionize the whole of society”.

I have not heard such rosy prophecies arising from scientific centres.

The orthodox belief of the occasions when one may receive an electric shock is not accepted by some boys and girls.

Here is one sentence:

“ If one should touch the telephone wires without wearing rubber gloves one would be electrocuted.”

I think the confusion is between the trolley wire and the telephone wire, but there is no mistaking the meaning of the boy who thinks that you can get a shock direct from a small battery. He says:

“What better protection from footpads could there be than a portable battery in your pocket and a current of electricity running around your overcoat. Of course, your clothes would require to be of a non-conducting material, or it would be a case of the biter bit, with a vengeance.”

I find that a number of young people think that a certain dose of electricity will kill you, but that a greater dose will not kill you, and I can see how the misunderstanding has arisen.

The dose that does not kill is really a very small current (small amperage) at a very high pressure (or voltage).

If you could send a large current at ever so high a voltage it would certainly kill you despite its high voltage. We can step up a battery current of say two volts to thousands of volts by means of an induction coil, but there is extremely little current.

CHAPTER XVII

How our Ideas came About

We have seen how the Wizard Electricity was discovered through the rubbing of a piece of amber, and how that led to the invention of electric machines, and how for a long time—from 1600 to 1800—electricity remained in this untamed condition. Even in these far-off days people began to wonder about the nature of electricity.

You remember that one of Queen Elizabeth's physicians—Dr. William Gilbert—was the first to find that glass, sulphur, and other substances could behave in the same manner as amber. He formed ideas about what electricity was, and being a physician he thought of the *humours* or fluids which they pictured in the human body, and he said electricity is a fluid. He suggested that when objects were rubbed, this fluid created an atmosphere around the object, and that this accounted for these effects due to what we now call electric and magnetic fields, which surround the object. This atmosphere was supposed to condense and re-enter the object when the field disappeared. This idea was believed for one

hundred years, until one, Stephen Gray, discovered that the supposed atmosphere could be conducted from one object to another, which showed that it did not belong to, or rather was not part of, the object. Indeed it became evident that the electric fluid was quite independent of the object itself.

Then in 1733 Du Fay suggested that there were two different kinds of electricity. His reason for suggesting this was that when any light objects were electrified by a glass rod they repelled each other, although the same objects, if electrified by a resin rod, would attract an object electrified by a resin rod. It was suggested that the glass electricity was different from the resin electricity, and so they called them *vitreous* and *resinous* electricities. They said that like electricities repelled one another, and that unlike electricities attracted one another.

About twenty years later (1750) our old friend Benjamin Franklin threw this idea of two electricities overboard (*and we know now that he was wrong*)—saying that there was only one electricity. He explained the difference in electrification by saying that some objects had a surplus of the fluid, while others had a deficiency of it. He said that the fluid was elastic, and by that he meant that its particles repelled one another, and we know that this is true.

Our eccentric friend, Henry Cavendish, who was a very great scientist, supported Franklin's ideas. It was Cavendish who suggested the idea of things being at different electric potentials, and it was about this time the name of positive was given to vitreous electricity, and negative to the resinous electricity. Lord Kelvin thought it a pity that the older names were not retained, as there was no reason for calling one of the electricities positive any more than the other. However, the present-day ideas have been adapted to these newer names.

I must tell you of a philosopher, named Robert Symmer, who was in the habit of wearing two pairs of silk stockings and who, in 1759 made some experiments with his stockings. He wore a black pair of stockings on the top of a white pair, and he noticed that on taking them off there was a crackling sound which he attributed to electricity, just as the essayist combing his hair did.

Symmer found that the two black stockings repelled one another, and that the white pair behaved in the same way, but that a black and a white one attracted one another. This was really nothing new, but it seemed to him to support the two-fluid theory of Du Fay. Symmer made other experiments which seemed to satisfy the philosophers, and the two-fluid theory was gene-

rally accepted, and we know to-day that there are two electricities.

It is interesting to note that Franklin, who had suggested the one-fluid theory, sent some apparatus to Symmer to help him to test his two-fluid theory.

Later on people began to think it all nonsense about there being any fluid at all; they said electricity is not really a thing; it is merely a condition of things (like heat); there is no electricity, is what they really said, but things get into a certain condition, and we merely think some existing thing is present. One very distinguished scientist even said in 1892 that the word *electricity* would disappear, and only such words as *electric* and *electrification* would remain. Now all this does not go so very far back, for when I was at school I was taught that electricity was not a thing *per se* (by itself) but merely a "mode of motion".

This wrong idea existed until the electron was discovered by Sir J. J. Thomson in 1897. This discovery came about in the following manner. When working with vacuum tubes, Sir Wm. Crookes, in 1879, suggested that the glow in the tube was really radiant matter. That was a new suggestion; we already knew of three conditions of matter, *solid*, *liquid*, and *gaseous*, and the new suggestion was that there was a fourth condition, in which matter became radiant.

There is a good deal of truth in this suggestion, for we know now that the glow is due to electrons and these are part of the stuff of which matter is composed. The scientists could not accept this idea of radiant matter, it seemed too fantastic. Their idea was that the discharge passing through the tubes was composed of rays, and they were called *cathode rays*, because they originated at the cathode or negative electrode of the tube. Lenard (a Dutch professor) made an interesting experiment; it was as follows.

This professor made a vacuum tube with an aluminium window on the end, where the rays struck the wall of the tube, and he found that the cathode rays were able to escape through the solid aluminium window. Surely this should prove that the cathode rays were really rays and not particles of anything. Although it seemed to prove that, an English professor (Schuster) proved by mathematics that the *cathode rays* were particles, and although some people may think that figures can prove anything you like, we know now that this professor was right. People continued to be interested in and to examine the cathode rays, and then in 1897 Sir J. J. Thomson made his great discovery of the electron. You will be interested to know how this discovery came about. He made a special tube through which he sent a beam of electricity by means of a battery

and an induction coil, which, as you know, steps up the pressure greatly, so that the electrons can overcome the partial vacuum; there is always some air or gas left in, no matter how well we try to pump it out. Here is the arrangement of the apparatus (fig. 61). You see that a battery is connected to the induction coil, which sends the

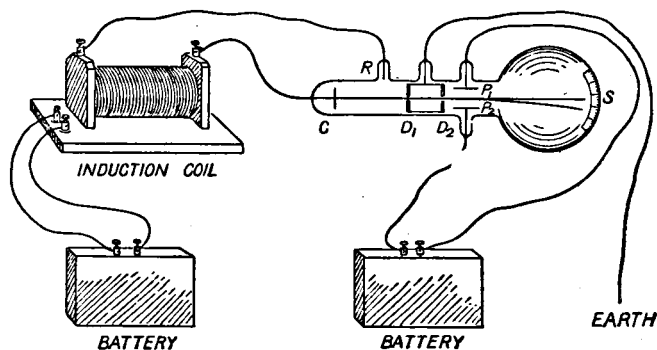

Fig. 61.—Discovery of the Electron

The negative particle of electricity, which has been christened the electron, was discovered by Sir J. J. Thomson, and was measured by the apparatus depicted in the diagram.

discharge through the special tube. Another battery supplies an electric field between the plates P_1 and P_2 . The electrons set out from the cathode C , and become a narrow beam in passing through a hole in D_1 and D_2 . This stream of electrons then passes between the electrified plates, and also between the poles of a large electromagnet which is not shown in the diagram. The

screens D₁ and D₂ are earthed so that they will not become charged. I think you can tell what will happen when the negative electrons pass between the positively and negatively electrified plates. The electrons will be repelled by the negative plate and will be attracted by the positive plate, so that the beam will be bent out of its normal path, and, as it is striking a phosphorescent screen (S) on the end of the tube, the amount of displacement may be observed.

Then what will happen when the electromagnet is energized?

Let us make an experiment on an ordinary vacuum tube and we find that when we bring a magnet near it the beam is deflected. The same thing will, of course, happen in the special tube, in which it is arranged that the electric plates send the beam in one direction while the electromagnet pulls it back in the opposite direction, so that if the forces are equalized the beam will be in a straight line. By finding these forces Thomson was able to calculate the charge carried by the electron; he could also calculate the velocity.

When dealing with wireless and the first detector of electric waves, I introduced Professor Hertz to you. He was a very brilliant professor in Germany, but unfortunately he died when he was only thirty years of age. Hertz had tried to deflect the cathode rays before the electron was discovered, and he

failed to do so, not because he was unaware of the existence of the electron, but because he did not use a high enough vacuum. It was because Thomson had a better vacuum that he met with success.

It was found that a flame or other incandescent substance gave off electrons, and it was found that no matter from what source they were taken they were all identical; it became evident that they are part of the constitution of matter, and that atoms must contain electrons. An atom could not be made of electrons alone, for you know how they repel one another, so they could not congregate together to form an atom unless there were an equal force in positive electricity which would attract them, and thus balance the repulsion. The difficulty was to think of the form in which the positive electricity might exist, and the first suggestion or *guess*, if you like, was that it existed as a *sphere* of positive electricity within which the electrons revolved like a miniature solar system, only there was no central part like a sun, its place being taken by the enclosing sphere. But all the electrons were not locked up in the sphere, there were some satellite electrons as shown in fig. 62.

This is known as the *Kelvin atom*, because it was Lord Kelvin who suggested it.

The outer ring of electrons, the satellite ones, were supposed to be responsible for all chemical properties of the atom, and also for the production

of light. Suppose we take the chemical properties first. All boys and girls know something about molecules, atoms, and electrons, but I remember when the word electron was not well known. I used it in the title of a book entitled *The Autobiography of an Electron*, and many people asked, "What is an electron?" An American publisher asked if he might publish it under some other

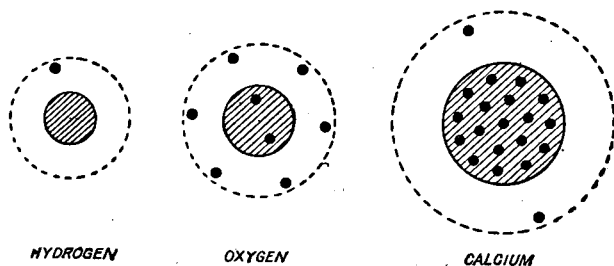

Fig. 62.—A Picture of Atoms

This was the first picture with electrons, which are represented by black dots; the positive electricity is represented by the shaded spheres.

title, and it was translated into German, the title being changed by the translator to the equivalent of *What is Electricity?* An English edition under that title did much better than it had done under the title with the word electron in it. That was about twenty years ago, but to-day nearly everyone has heard of electrons, and knows that they are particles of negative electricity.

At first it seemed a very strange idea that electricity is of an atomic nature.

But we set out to consider the chemical properties of the atom and to see the part played by those satellite electrons.

It so happens that some of these outer rings of electrons are not very secure. Some atoms can part with an electron, while others are willing to accept another electron, and so when brought near to each other the one transfers an electron to another, and I think you can guess what this will result in. The atom receiving an electron will become negatively charged, because it has had a particle of negative electricity added to it, and nothing added to its positive charge. Then again the atom which has lost an electron will be short of a particle of negative electricity, and the fixed quantity of positive electricity will predominate, so that this atom will be positively charged. The two atoms being unlike in their electrification will attract one another and join hands, as it were. We say they have a *chemical affinity*, and that they are linked together in *chemical union*, but having got behind the scenes you can see that it is really electrical attraction which holds the atoms together to form molecules.

Then what about the production of light, which you, no doubt, know is composed of waves in the æther of space. Waves are produced by a vibrating or to-and-fro motion, but as we shall be considering æther waves in the succeeding chapter I shall

only say at present that the Kelvin atom was supposed to make the waves by the electrons in its outer ring vibrating to and fro, while they continued to revolve around the positive sphere.

The meaning of a charge of electricity is almost self-evident, and is no doubt clear to you already. A negatively electrified object will possess a surplus of electrons, and in a positively electrified object there will be a shortage of electrons (that is less than normal), so that the positive parts of the atoms predominate.

For instance, when you rub a glass rod with a silk handkerchief, you rub electrons off the glass and these escape by way of your body to the earth, leaving the glass short of electrons, and so we say that the glass is positively charged. The silk would be negatively charged had it been able to retain the electrons which came from the glass, and it would do so if the silk were insulated. In the case of a rubbed rod of vulcanite, electrons pass from the cat's fur, with which it is rubbed, to the vulcanite, so that the rod becomes negatively electrified, and the fur would be positively electrified but for the easy passage of electrons from the earth by way of your body to the fur.

The picture of the atom has now changed to one having a nucleus or core of positive electricity in the centre and rings of electrons revolving round it (fig. 63).

This is a more complete solar system than the Kelvin atom, as it has a central sun. But this positive nucleus is very much smaller than can be represented in the diagram. The particles of positive electricity which it contains are called *protons*, and are nearly two thousand times smaller than the electron, which again is a mere speck compared to the atom.

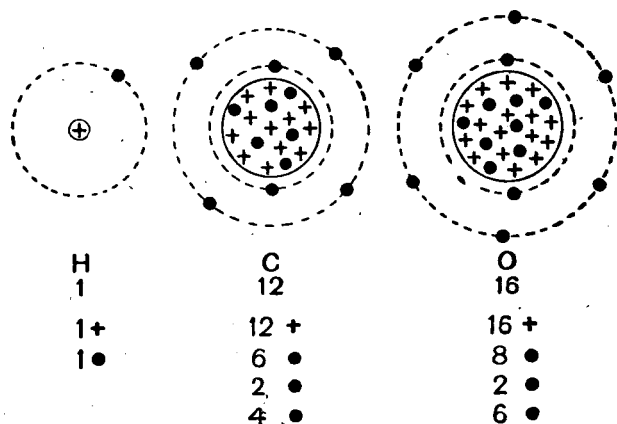

Fig. 63.—Another Picture of Atoms

This shows another picture of atoms, in which the black dots represent electrons and the cross signs represent positive particles of electricity (protons).

If you examine fig. 63, you will see that each atom has just as many protons as it has electrons, so that, in its normal state, the atom is not electrified, for its positive and negative electricities balance one another. It is only when a neighbouring atom is robbed for the time being of one of its electrons that it becomes positively electrified.

There are other pictures of an atom such as in figs. 64 and 65, but we are not going to worry

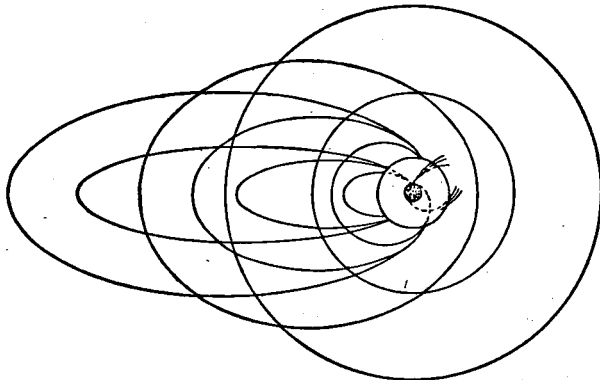

Fig. 64.—The Electrons' Orbits

This shows the paths of electrons revolving around the positive centre.

about these elliptical and cubicle atoms, but rather pass on to consider in the next chapter how the

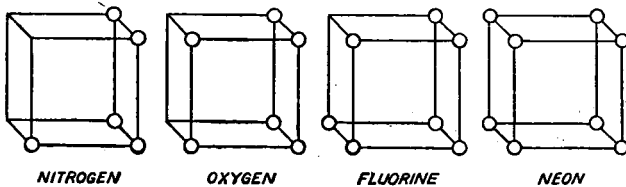

Fig. 65.—Another Picture of Atoms

In this diagram the electrons are represented by small circles, and are pictured as forming cubes. We cannot say which is the true picture.

nuclear atom is supposed to produce waves in the æther.

CHAPTER XVIII

Waves in the Æther

You know of several kinds of waves, such as waves in water, waves in a cornfield, or you can make waves run along a length of rope, and then you know of the invisible waves in the ocean of air, and the more invisible waves in the æther of space.

You know that when waves pass over the surface of water nothing really travels but the motion, the water merely rises and falls; and a cork does not really travel along unless the wind is blowing it. This lack of travel is perhaps more apparent in the case of the cornfield, but it holds good in the air also when sound waves travel along, and in the æther when light waves travel.

The rate of travel is very different in the different oceans. You can see the waves in the sea making ready to lift you as you swim along, and you know that the air waves travel very much quicker, and I have no doubt you could tell me that sound travels 1100 feet per second in air, quicker through

water, and still quicker through a solid, but in every case it is a snail's pace compared to the waves in the ocean of æther, in which they travel at the rate of 186,000 miles per second. How do we know?

Old Galileo thought he could time light in its flight, and this is the plan which he adopted; and please do not laugh at his idea for the principle was right, it was only his method was too clumsy. He arranged with a friend that they should each climb a mountain as far separate from one another as possible so long as they could see a light made by a lantern on the mountain. The idea was that Galileo would send light from a lantern to his friend, who would then send light back, by uncovering a lantern as soon as he saw the light which Galileo would suddenly allow to escape from his lantern, and then Galileo would see the time required for the light to travel across the distance separating the mountains and back again, but you can guess the movement of the light was far quicker than Galileo could observe. I have said that the idea was correct but that the method was too clumsy, and you will see that light can really be timed in its flight from one point to another.

Instead of using lanterns there is a lamp and a rotating toothed wheel, so arranged that each tooth of the wheel acts as a stop to a hole through

which the light of the lamp is passing out to a distance, where it strikes a mirror and is reflected back to the hole through which it passed out between the revolving teeth. On its return it enters an eye-piece in which it may be seen. Now you can easily see what will happen when the wheel is revolved. If light takes no time to travel it will always be able to get back again through the same tooth space as it left, but if we can arrange the speed of the wheel so that a tooth is blocking the way on the return of the light it will be cut off and no light will be seen in the eye-piece. We find that is what really happens. We may spin the wheel so that a tooth arrives in front of the hole just as the light returns, and then we may increase the speed of the wheel so that the next tooth space is in a position to let the light through.

Now it is apparent that light has taken just as long to go from the lamp to the mirror and back again, as it took the wheel to travel round from one tooth space to the next, and it is not difficult to calculate how long the wheel took to travel that distance, and therefore we know the time taken to travel the to-and-fro distance between the mirror and the lamp, and so we can tell the velocity of light, which comes out at 186,000 miles per second, which, if you work it out you will find is equal to eleven million miles per minute.

You see the similarity between Galileo's clumsy

experiment and the one I have just described. Galileo's lantern is changed to a lamp with a toothed wheel which covers and uncovers the light, while the friend's lantern is replaced by a mirror, so you will agree that Galileo's idea was all right, the fault being that light moved at too great a velocity to be measured by his clumsy apparatus.

The velocity of light had been discovered long before it was measured by the toothed-wheel apparatus. It had been known for 250 years, for a Danish astronomer (Roemer) discovered it in 1676, while examining the moons of Jupiter. I think you know that Jupiter is very rich in moons, although they were not all known in Roemer's day. What he observed was that one of the moons appeared to be later in appearing from behind the planet at one time of the year than was the case at another time, six months later. It so happened that our going round the sun brought us nearer to Jupiter at one time than at another, and it was when we were farthest from the planet Jupiter that the moon was about quarter of an hour later. The only reasonable explanation was that it took the light a quarter of an hour to cross the earth's racecourse around the sun (fig. 66). From this fact you can calculate the velocity of light on your own account. You know that the earth is about 93,000,000 miles from the sun, and if you

multiply that radius by 2 you have the length of the diameter—which comes out 186,000,000 miles. That gives you the distance that light travelled in quarter of an hour. If you calculate the number of seconds in quarter of an hour, you will find it is just about 1000, so we need not trouble with pencil and paper to find out the velocity per second, for we can divide 186,000,000 miles by

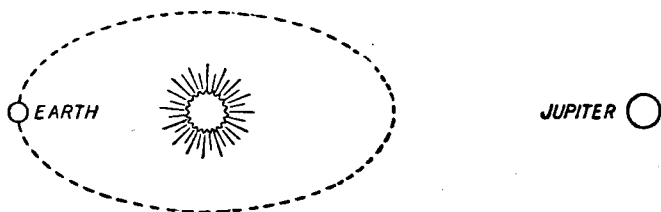

Fig. 66.—Measuring the Velocity of Light

Light from one of Jupiter's moons was found to take about a quarter of an hour to travel across the earth's orbit or racecourse, and this means a velocity of 186,000 miles per second.

1000 by striking off the last three nothings, and the answer is 186,000 miles per second, which is the same as was found in the toothed-wheel experiment.

All æther waves travel at the same velocity, no matter whether they are what we call visible light, radiant heat, or wireless waves. Fig. 67 shows the æther waves classified.

The wireless wave division includes all æther waves that will affect a detector, and not merely the waves used in broadcasting. These are shown

in fig. 68, in which the waves are set out in a scale, and in which you see the different sources

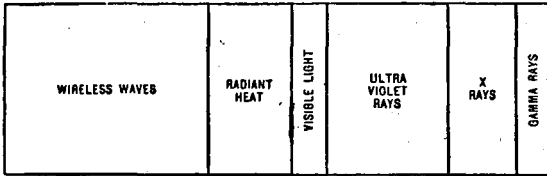

Fig. 67.—Variety of Æther Waves

The long waves commence at the left hand and the shortest waves are at the right hand.

of the waves and the various detectors. I promised to tell you how the nuclear atom is supposed to originate æther waves, and we might picture

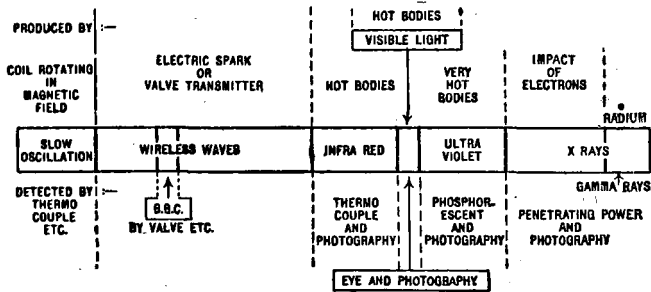

Fig. 68.—Scale of Æther Waves

This diagram explains the means of production and detection of the waves.

again the boy making waves in water. He stands in the centre of a pond and has in his hand a float on the end of a pole, and by moving this

up and down on the surface of the water, he can produce a great variety of water waves.

We have already seen that when he moves the float at a slow rate he produces what we describe as waves of low frequency, meaning that they are not very frequent; we also call them *long* waves, because there is a long distance between the crest of one and that of its neighbour. You could tell what he must do to produce waves of higher frequency; he must move the float or plunger more frequently. You know that wireless waves are of a very low frequency compared with those of visible light. When you are told that wireless waves may be measured in millions of vibrations per second, I think you would say that they are of very high frequency, and so they are if you compare them with waves in the air, which are reckoned in hundreds per second, but the wireless waves are of a low frequency for æther waves; the waves of visible light have to be reckoned in hundreds of billions per second.

Many years ago I was desirous of finding an analogy which would impress people with the enormous difference between a million and a billion. I remember the occasion distinctly; it was a very wet day and we were staying at the coast. I was employing the time by writing a lecture, when these thoughts about millions and billions occurred in connexion with this difference

between waves of visible light and wireless waves. I remember sending to a grocer's shop for some dried peas, and I tried to write a graphic description of the length of a row of one million peas, and another row of a billion peas. I made a short row of peas, measured the length, and counted the peas. It was an easy problem in arithmetic to tell how long a row of a million peas would measure. I found it would be about four and a half miles. I then calculated the length of a row of a billion peas, taking the English plan of reckoning a billion as a million million. I found that the row of a billion peas would go round and round the Earth one hundred and eighty times. Needless to say I did not lay out a million peas and then measure the length, although I heard that stated on one occasion.

While this analogy of the two rows of peas was helpful, it is impossible to visualize the size of the Earth, so I tried weighing the peas, but this was not even so good. Then I tried another plan. I pictured a tank holding a million peas, and in imagination placed a little clockwork trap-door in the bottom of the tank, the trap-door being so arranged that it opened once every second and let a pea fall out. It was a case of simple arithmetic to calculate how long it would take to empty the tank of a million peas. You may try the calculation for yourself. I made this suggestion in a

lecture at a girls' boarding-school, and I was told that the following morning there was no speaking to the girls as they were all busy calculating the pea problem. Well, you will find that it would take about $11\frac{1}{2}$ days to empty the tank of a million peas. Then I pictured a larger tank capable of holding a billion peas, and fitted with the same clockwork arrangement—one pea per second. I was surprised at the result brought out by arithmetic, and had to check it before accepting it. It would take 30,000 years to empty the tank of a billion peas.

It would be possible to make an actual experiment with a tank of a million peas; but had a similar experiment with a billion peas been begun in the days of Abraham, of Isaac, and of Jacob, the tank would be almost full still, as not one-sixth part of its contents would have escaped from the tank during these five thousand years. You see that the difference between a million and a billion is as $11\frac{1}{2}$ days are to 30,000 years, and that is the difference between the frequency of wireless waves and the frequency of visible light.

When the boy in the pond produces waves of higher frequency the waves naturally follow more closely at one another's heels; we call them *short* waves, and so also we call visible light short waves; they range from about one forty-thousandth to one seventy-thousandth part of an

inch, and their frequencies are from 400 to 750 billions per second, whereas you know that the waves used in broadcasting measure about a quarter of a mile from crest to crest, and some wireless waves are many miles apart.

Thinking of the cornfield with a wave motion sweeping over it in gusts of wind, you will be able to realize that nothing really travels from the Transmitting Wireless Station to the Receiving Station; it is only a wave motion in the æther.

I remember an old lady, on one occasion in the early days of wireless telegraphy and before wireless telephony had been accomplished, saying to me that what puzzled her was how the words could fly through the air. I explained that even while I was speaking to her there were no words passing but merely a wave motion in the ocean of air, and that these invisible waves set her hearing apparatus in action, and that in similar fashion in wireless there were only waves in the æther passing—no words—but the telephone receiver made the air waves which give us the sensations which we call words.

One young lady asked me why it was that when listening in wireless you do not hear the birds singing in the trees through which the waves are passing; her house stood in a large park with many woods around it. I told her that there was a very good reason for the absence of the birds'

singing, and that was because the bird was not singing into a microphone but merely making waves in the air, and that these, of course, did not disturb the surrounding æther in any way; it required the Wizard Electricity to assist with an æther disturbance.

Let us examine the scale of waves (fig. 68). The lowest pitch is at the left hand, as in a piano, and at this end you find "slow oscillations", which is another way of saying waves of low frequency. You see that they are produced by a coil rotating in a magnetic field, and that these very long waves may be detected by a thermo-couple, which means by their heating effect, and the "etc." in the diagram includes electrical effects and magnetic effects. These waves are too low in frequency to operate a wireless detector, but they merge into the boundary line of such waves.

Looking again at the diagram you see that the wireless waves occupy more space than any of the other kinds of waves, and that these can be produced by the electric spark or by a transmitting valve. You will observe what a small range of waves is used for broadcasting (marked B.B.C.). These waves may—as you very well know—be detected by the valve, or by a coherer, or any of the detectors used before the invention of the valve, some of which were electromagnetic, thermoelectric, and electrolytic.

Going up the scale to higher frequencies we find a section marked *infra-red*, which you can guess is another name for radiant heat, as it is produced by hot bodies and is detected by a thermocouple, which by the way is an electric thermometer and may be called a pyrometer. You will notice that these infra-red waves may be detected also by photography, as they affect some chemicals just as daylight does. Then we come to a very important section, which is so small in the diagram that I could not get its name into the space in the scale which is occupied by it. We call it *visible light*, but being æther waves it is of course really invisible. What we mean by visible, in this case, is that it stimulates our vision; it is by the aid of this light that we see.

Taking the whole scale of about 60 octaves, visible light occupies only one single octave, fairly near the centre of the scale; there are really more waves longer than visible light than there are shorter ones. After finishing our general survey of the scale we shall go into more details of interest.

Farther up the scale we come to *ultra-violet light*, light beyond the violet end of the visible spectrum, and you know that ultra-violet light does not stimulate our vision, though it affects a photographic plate. You will observe that it is detected also by the shining of a phosphorescent screen.

Then we finish with quite a large section of X-rays, which are connected with the sudden stopping or starting of electrons, as we shall see. You know that they illumine a chemical screen, and that they affect a photographic plate and also that they have great powers of penetration. These properties they show, whether they are produced by an X-ray tube or by radium.

The X-rays produced by the explosions of the radium atom are much shorter waves than those which we produce with our X-ray apparatus, but you will hear all about them in the succeeding chapter.

I remember being present at a scientific meeting when an old gentleman rose and objected to the lecturer speaking of æther waves as if they were real things; to him they had no existence. I think the one thing that has done more than any other to help the general public to realize that there are such things as æther waves, is the advent of broadcasting stations whose different wavelengths are well known.

I was sitting at lunch one day with a very intelligent man, when he so surprised me with the following question that I thought at first he was joking. "Why do you scientists sometimes call the air the æther, and at other times give it its proper name, the air?" I found that he really believed the air and the æther to be one and the

same thing, and on asking him a few questions, I found that he pictured the air as filling all space, and not merely forming a blanket around this planet Earth. He thought it was the air which was the medium of wireless communication, and it had often puzzled him why we should use the name of æther at all.

I remember in the early days of wireless telegraphy there was great confusion between the air and the æther on the part of writers in magazines and in the daily press.

They did not doubt the existence of the two oceans, but it was often said that the æther carried sound waves and the air carried wireless messages. That was at the beginning of wireless, but nowadays nearly everyone is conversant with the fact that wireless is dependent upon waves in the mysterious æther of space.

CHAPTER XIX

More about Waves

Thinking of wireless telegraphy you may wonder how sparks produce waves in the æther. The electric spark is due to electrons being shot across an air gap in a circuit, and then being thrown back again and forward again, and these to-and-fro movements are described as *oscillations*. In oscillating, the electrons disturb the surrounding æther, and produce waves long or short according to the rate of oscillation.

The waves are not dependent solely upon the electrons actually taking part in the spark, for the aerial is attached to the sparking circuit and electrons surge to and fro in the aerial in sympathy with those in the spark gap.

We picture the æther waves spreading all around the aerial just as water waves produced by dropping a stone into a still pond. This is what we really want when we are sending out S.O.S. signals at sea; but we often wish to send the message to some particular point, and that gave rise to

directional aerials such as the one shown in fig. 29, on page 69, which was first used for trans-Atlantic work, and more recently it has been found possible to send a beam of wireless waves in any particular direction.

When a valve is acting as a transmitter, whether accidentally oscillating in a receiving set, or oscillating for the purpose of making waves to send messages, the waves are again due to the electricity surging to and fro in the aerial which is connected to the valve circuit, being attached to the grid.

For the purpose of wireless telephony the transmitter sends out what is called a carrier wave, fig. 69. The second line of the diagram shows the modulation or changes superimposed on this wave by the action of the telephone transmitter under the control of the voice.

The third line of the diagram shows the modulated wave *rectified*, which means changed from a to-and-fro current (due to the surging electrons) to a direct or continuous current, in which the electrons are made to drift in one direction only.

This change is made by the valve in the receiver, which as you know only lets an electric current pass through it in one direction. It is this rectified current which operates the telephone receiver, which is not affected by the very high frequency of the carrier wave.

Some boys may wish to see how a valve acts as a transmitter, so fig. 70 has been inserted and I leave them to puzzle it out for themselves, only I might explain that the valve acts like the escapement wheel of a clock and that the high-

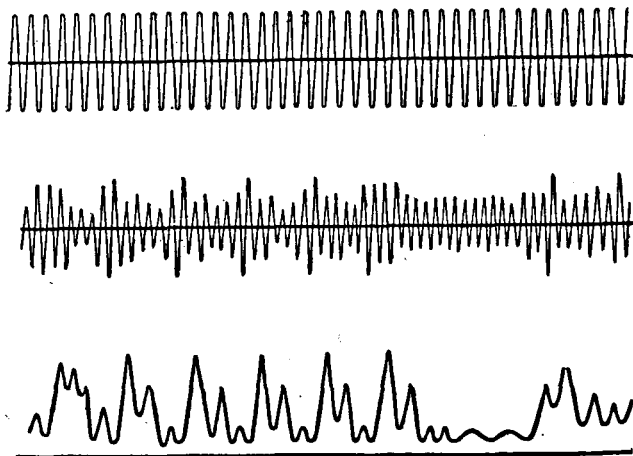

Fig. 69.—Carrier Wave in Wireless

The uppermost line shows the carrier wave itself. The central line shows the same wave modified by the voice. The lowest line shows the same rectified by the valve.

voltage battery is like the clock spring, and that the current from the battery is held up and set free alternately, owing to the surging to and fro of the electrons.

So much for the production of wireless waves.

We wish to see about the shorter waves—which

are still considered long waves—the infra-red light. We call it invisible light, but we are not really referring to the fact that the æther waves are invisible, we mean that those rays do not stimulate vision.

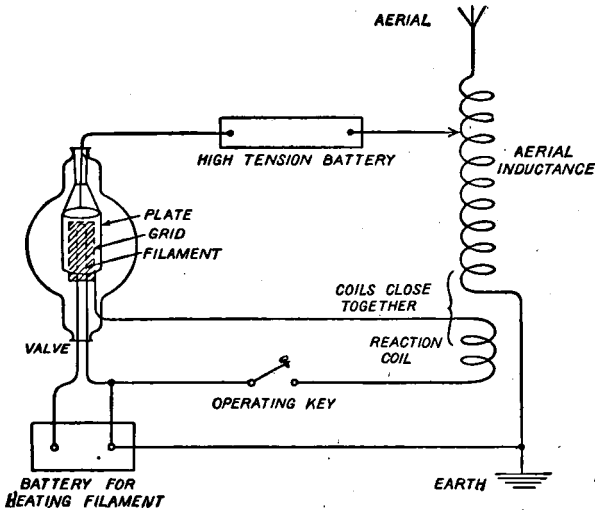

Fig. 70.—Valve as a Transmitter

As explained in the text, the valve is used both as a receiver and a transmitter.

You know that a great deal of infra-red rays come from the sun, and from a fire; they are the heating rays. You know that the sun is sending out such powerful rays that we can feel their heating effect across a distance of 93 million miles. How can they travel so far? There is nothing to stop them till they reach the planet,

to which they give its heat, or in other words affect the electrons in the planet, and cause them to set particles of matter vibrating. It has been said already that they affect some chemicals on a photographic plate; I have seen photographs produced by this invisible light.

As you know some Latin I need not stop to point out that infra-red light means "light below red", that is below the red of the spectrum, and consequently longer waves than those stimulating the sensation of red.

You know that if we photograph a spectrum of daylight we find it extending a long way beyond the visible spectrum at both ends, as both the infra-red and the ultra-violet rays have a chemical effect.

We pass on to have a talk about the visible spectrum, and the first think of interest is that daylight produces all the known varieties of colours.

I hope that no one will run away with the idea that *white* light, as we call it, is composed of coloured rays mixed together, and that the whole of these acting together make white light. I have found some grown-up people imagining this fantastic idea to be true. Think of the actual thing! Outside of ourselves there are these invisible æther waves; they fall upon our eyes and in some mysterious way they produce those

sensations within us which we know as Red, Yellow, Green, and Blue, and all the variety of colour which you have seen or ever can see. You will realize that colours are merely sensations, and do not belong to the so-called coloured objects.

You may say, nonsense! but I think I can convince you—if you will come into a dark room in which I have a lantern. As you enter, the light is shining upon a large board, and I ask you what it is; the answer is an easy one—it is a black board.

But you change your mind when I make an alteration in the light of the lantern, by pulling out a glass screen which I had put in it. Now you see it is a bright red board. Which is it? The board has not changed; it is the æther waves of light which have been changed, and the colour is entirely due to the effect of these waves on your eyes.

Some years ago, two school girls were visitors in my house and they were puzzled about colour, through their teacher having told them that if they could see their dresses when hanging in the wardrobe they would find they were not coloured. It reminded me of the Irishman who said he had nothing left in his wardrobe but the armhole of an old waistcoat.

I asked the girls into my study, where I showed them some red cloth by the light of a sodium flame (salt and methylated spirits) and they saw the red

cloth apparently turn into a black cloth. Why? Because there were no red-producing rays in the sodium light. That is the method I adopted to play the trick on you with the red board. I put a piece of greenish-blue glass in the lantern and this prevented any red rays getting out, so that the board did not get a chance of reflecting red light as there was none present. When I withdrew this screen from the lantern the red-producing rays in the white light were reflected and the rest of the æther waves were absorbed by the board. An object only appears to be the colour produced within us, by the rays it reflects.

All colours are merely sensations, as already pointed out, and you know from their position in the spectrum that the red-producing waves are the longest of the visible light, and the blue ones are the shortest. Then come the waves still longer or shorter which fail to produce any sensation within us, excepting that the long ones are felt in heat.

But how does an object manage to reflect light? Its electrons are set into vibration by the incoming æther waves.

We might take the tuning fork by way of analogy, and if we arrange the forks as shown in fig. 71, including a second and similar group at some distance, it may help us to realize what takes place when light is reflected. First of all

let us have the experiment itself. I cause the 400 per second fork to vibrate, and I may use

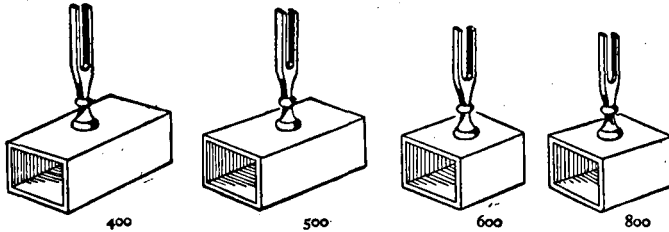

Fig. 71.—Group of Tuning Forks

the same method of vibration as I used for the steel bars as shown in fig. 72. When I make the 400 tuning fork send out its note, and when after

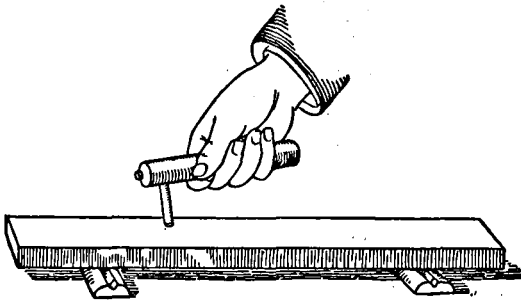

Fig. 72.—Vibrating a Bar of Steel

a little I stop it, I hear the same note being sung by one of the forks in the other group, we can soon discover, if we do not know at once, which fork is responding to the 400 fork. Of course it is the other 400 fork.

If I sound the 500 one, the fork capable of vibrating at that rate responds in the other group. We picture the air waves from the 500 fork in group No. 1 falling upon all the forks in group No. 2, but the only one which is capable of falling into step with the waves is the 500 fork, and so it

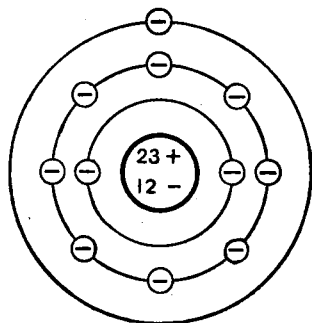

Fig. 73.—Atom of Sodium

The small circles represent electrons, and the figures in the centre represent the number of protons and electrons in the core.

alone is set in motion, because the other forks absorb the energy of the waves. So much for the experiment. What about light or æther waves?

We picture electrons in the source of light sending out æther waves in the manner above described, and these waves (say 400 billion per second) fall on a sheet

of what we call white paper; remember that it reflects white light, which our "black-red" board could not do.

But we wish to know what happens to the 400 billion per second waves when they fall on the white paper. Only those electrons that can vibrate at 400 billion times per second respond.

When we were using the early picture of the atom (fig. 62, p. 171), in which there were electrons revolving around a positive sphere, we pictured

these electrons being set into vibration, in which condition they set up æther waves. Now we picture an atom as shown in fig. 73, which represents an atom of sodium. You see that it has different sets of rings. There are four rings in which electrons may revolve around an atom, and these are called K, L, M, and N rings (fig. 74).

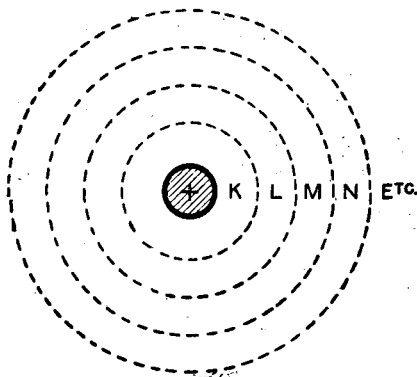

Fig. 74.—The Racecourses of Electrons

This drawing shows the rings in which electrons travel. They are named K, L, M and N rings, and beyond these are rings to which the electrons may jump.

An electron may be forced by an incoming æther wave to jump from one ring to another, and in making these jumps it produces waves in the surrounding æther. There are possible rings or levels outside the N ring to which electrons may jump when æther waves fall upon them. When we make a body incandescent, or bring

about chemical action, the electrons jump inwards to a ring nearer the centre.

Some of you boys and girls may have heard of the quantum theory, but it is not likely you have met it in its full war-paint, which is in higher mathematics. You may be curious to know what it is about. It deals with the jumps of the electrons, and pictures the radiation energy as being in portions or *quanta*. There are large quanta (blue light) and the largest of all is the X-ray quanta. It is a very funny idea that energy is a definite "thing" existing in particles. Of course it is not a thing in the sense of being material, but it goes to help in the construction of the atom, for the little solar system of an atom only exists because of the energy of the moving electrons, which occupy the space by flying all over the place in the orbits of the atom. And so we see the modern idea of the reflection and absorption of light.

I think you know that a so-called green object absorbs all the æther waves excepting those which produce the green sensation, but a white paper is capable of reflecting all the variety of "visible" waves. Having mentioned the *quantum theory*, I have no doubt it has caused some boys and girls to think of another difficult thing known as the theory of *relativity*, and if we were having a two-sided talk one of the questions asked would

possibly be, "What about this theory of relativity?" Again it goes deeply into higher mathematics, and cannot be properly understood without mathematics, but I might try to tell you what it is all about.

If a man could take a ride on the back of a meteorite as it flies through space, he would have a very different view of the things from that which we have when at rest on the surface of this planet Earth.

Perhaps some boy thinks the man on the meteorite would be burned alive, but only if the meteorite entered the atmosphere surrounding the earth. Of course the idea of riding on a meteorite is quite ridiculous, but I merely want to impress upon you the fact that our view of things depends whether we are at rest or our motion is relative to a position of rest.

The theory of relativity deals with the measurement of Time and Space relative to the observer, and this varies for each observer.

I promised to tell you something more about the other æther waves, all of which are transverse waves or to-and-fro waves moving across (*trans*) the direction of their flight. We say their motion is at right angles to the line of propagation. Air waves are different; they are longitudinal or move to and fro in the same line as the direction of their propagation; just like a crowd of people

trying to pass through a narrow entrance, they surge to and fro in the direction in which they are moving.

I need not say more about the infra-red waves, excepting that when a piece of iron is being made red hot it sends out these long waves first, and as the temperature rises the visible rays appear from the red end of the spectrum and the short waves are added until it becomes white hot. Of course

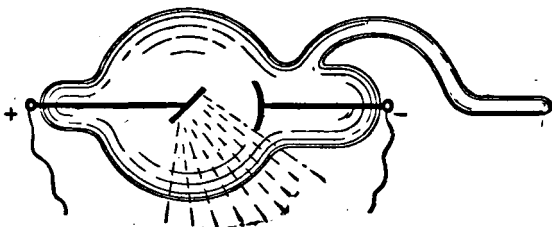

Fig. 75.—X-Ray Tube

it does not appear green or blue at any time because the red waves are always acting at the same time. I need not say much more about the ultra-violet light excepting that a man may have his portrait taken by these invisible rays alone. Does it not seem strange to sit in a dark room and have your portrait taken?

I must close with a short reference to X-rays. I think you know how they are produced. If not, you can easily understand by looking at fig. 75.

The artist has had to suppose the X-rays to be

visible in order to show you that they originate at that centre target which is placed in the path of the electrons which are shot off from the *cathode* or negative electrode, and which is indicated by the minus sign in the diagram. It is the sudden stopping of the electrons which produces the X-rays, and if you wish to know more about it you may picture electrons within the nucleus of the atoms of metal being disturbed and sending out the X-rays. Before closing I might remind you that the so-called gamma rays from radium are really X-rays of shorter wavelength than those we can produce with an X-ray tube.

CHAPTER XX

The Conclusion of the Whole Matter

Every boy and girl will surely admit that electricity is indeed a Wizard, and further that the very existence of our bodies and all material things is dependent upon electricity—that we could not live but for the work of the Wizard, who brings us light and heat from the sun, who holds us on to the surface of this planet Earth as it flies through space at a thousand miles per minute, for Gravitation, whatever it is, is certainly the work of the Wizard. I need not sum up all the manifold things which electricity does for us in the workaday world, they are evident around us.

When you sit down to listen to your wireless telephone, think of the words from Shakespeare's *Henry IV*:

“ And these musicians that shall play to you
Hang in the air a thousand leagues from hence
And straight they shall be here. Sit and attend.”

You could almost think that Shakespeare had seen visions of the future, and pictured giant aerial wires hanging in the air.

The Wizard has accomplished much, but he has not exhausted his powers. There is no doubt that he will go on adding to his works of wonder, and if we could only return to the world in the distant future, as we have imagined Priestley returning to our time, we should no doubt be just as surprised at the wonders that will have been added in future years.

Before taking farewell of you there is just one suggestion I should like to make, and that is that every boy and every girl should take up some definite hobby, and devote some of their spare time to a branch of science—which word means *knowledge reduced to a system*. You have a wide field to choose from, and I place the sciences here in alphabetical order: Anatomy, Anthropology, Archæology, Astronomy, Biology (which includes both Botany and Zoology), Geography, Geology, History, Meteorology, Philosophy, Physiology, Psychology, Sociology, and Theology.

If you do not know the meaning of any of these sciences you must look them up in your dictionary, and if you still desire a wider field I might add Cosmology, Embryology, Epistemology, Histology, Hexicology, Morphology, Ornithology, Palæontology, and Philology.

I have left those ending with "ic" to the last, and these are: Ethics, Logic, Mathematics, Mechanics, Metaphysics, Politics, and Physics.

Then if you are not satisfied yet, or have difficulty in making up your mind, I might mention some branch or subdivisions: Acoustics, Algebra, Arithmetic, Chemistry, Crystallography, Dermatology, Dynamics, Electricity, Ethnology, Etiology, Etymology, Geometry, Hydraulics, Ichnology, Ichthyology, Metallurgy, Mineralogy, Magnetism, Optics, Pneumatics, Statics, and there are still more, but perhaps you feel quite sufficiently wandered amidst such a galaxy of subjects.

We do not get a chance of remaining on this planet long enough to acquire a knowledge of all these subjects, but if you choose one as a hobby, you will soon find it overlapping and leading you into other branches.

Out of all this great array I think the following the most suitable for boys and girls to take up: Astronomy, Archæology (dealing with antiquity), Botany, Zoology, Geography, Geology, History, and Physics, which deals with matter, and includes both Chemistry and Electricity. There is plenty to keep you going, and you know what Cowper said:

“ An idler is a watch that wants both hands,
As useless if it goes as if it stands.”

LIST OF EXPERIMENTS SHOWN IN LECTURES

1. Glass rod and butterfly.
2. Glass cylinder machine.
3. Wimshurst machine.
4. Leyden jar.
5. Battery of Leyden jars.
6. Model of Volta's pile.
7. Cell of battery.
8. Exploding gas bubbles.
9. Potassium on water.
10. Lodestone.
11. Oersted's experiment.
12. Bar magnet and magnetic needle.
13. Horse-shoe electromagnet and weight.
14. Large solenoid and iron rod.
15. Coil and vertical needle.
16. Needle telegraph.
17. Morse sounder.
18. Mirror galvanometer.
19. Hertz detector.

20. Wireless valve.
21. Coils on stilts.
22. Two coils showing induction.
23. Coherer.
24. Four tuning forks.
25. Large model of telephone receiver.
26. Obo in bottle.
27. Electric arc.
28. Selenium cell.
29. Spectrum on screen.
30. Spectrum (luminosity produced by ultra-violet light).
31. Ultra-violet light discharging electroscope.
32. Ultra-violet light and screen.
33. Colour blind—red board.
34. Colour blind—red coat.
35. Colour blind—cloths.
36. Colour blind—yarns.
37. Two groups of forks.
38. Four steel bars.
39. Vacuum tubes.
40. X-rays and bag.
41. X-rays and umbrella.
42. X-rays and box of tools.
43. X-rays and hand.

The author was indebted to his friend Professor James Muir, of the Royal Technical College, Glasgow, for providing the experiments.

INDEX

- A B C, Morse, 40.
A B C, needle-telegraph, 40.
A B C, siphon recorder, 56.
Acidulated water, 20, 22.
Aerial, 70, 71, 72.
Affinity, chemical, 172.
Air and ether, 188, 189.
Air and electricity, 147, 149.
Aladdin, 6, 112.
Alternating current, 105.
Aluminium window in tube, 167.
Amber, 10, 163.
Amber's soul, 10.
America, 3, 48.
American warship, 49.
Amusing incident with dynamo, 104.
Amusing wireless incidents, 62, 91, 185.
Analogy of billions, 183.
Animal electricity, 20.
Arabian Nights' Tales, 112.
Arabi Pasha, 121.
Arago, 33.
Arc, electric, 127, 128.
Arc lamp, 128, 129, 130.
Aristotelians, 11.
Aristotle, 10, 11.
Artificial diamonds, 118, 119.
Atlantic, 48, 51, 72.
Atlantic cable, 48.
Atmosphere around charged body, 164.
Atom, hydrogen, 22.
Atom, oxygen, 22.
Atomic nature of electricity, 168.
Atoms, cubical, 175.
Atoms, elliptical, 175.
Attractive power, 12.
Audience of mutes, 26.
"Australian sausage machine", 46.
Autobiography of an electron, 171.
Automatic railway signalling, 141.
Automatic telephone exchange, 95, 96.
Automatic transmitter, 45.
Ayrton's prophecy, 61, 62.
"Baby", 46.
Bad spelling, 145.
Battery, electric, 21.
Battery of Leyden jars, 17.
Battery, primary, 114.
Battery, secondary, 115.
Beam of light carrying speech, 82.
Beats, 69.
Before Christ, 150.
Bell, electric, 96, 110.
Bell, Graham, 93, 94.
Ben Nevis, 26.
Black board, 195, 196.
Blanket of air, 189.
Block system on railway, 140.
Blythswood, Lord, 63.
Boatman and siphon, 57.
Bonding of rails, 109.
Boy combing hair, 154.
Boy making water waves, 65, 181.
Boys boating at Cambridge, 84.
Boy's idea of battery, 150, 162.
Boy's idea of dynamo, 154.
Boy's idea of electricity, 147, 148, 157, 158.
Brake, electric, 36, 110.
Brazilian Emperor, 94.
Breaking-up water, 22, 23.
Britain and America, 48, 72.
Broadcasting, 186.
Broken cable, 49.
Brush of dynamo, 107.
Bubbles exploded, 23, 24.
Cable, Atlantic, 48.
Cable (1865), 52.
Caliban, 4.

- Cambridge boating, 84.
 Cambridge lecture, 83, 84.
 Canada, 93.
 Candles snuffed, 125.
 Car, tramway, 5, 36, 101, 109, 158.
 Carlisle and Nicholson, 22, 26.
 Carrier wave in wireless, 192.
 Cathode rays, 168.
 Cell, electric, 22.
 Cell, selenium, 82, 98, 135.
 Chain of platinum and silver, 130, 131.
 Charge of electricity, 173.
 Charged, negatively, 173.
 Charged, positively, 173.
 Chelmsford incident, 62.
 Chemical action, 22.
 Chemical affinity, 172.
 Chemical union, 172.
 Chemical works, 26.
 Chinaman and car, 101.
 Clergyman and matches, 126.
 Clerk Maxwell, 58, 66.
 Clerk Maxwell's song, 59, 60.
 Clock, electric, 139.
 C.M., 37.
 Coal-gas, 126.
 Coherer, 69.
 Colour sensation, 195, 196.
 Combing hair, 154.
 Commutator, 106.
 Compass needle, 27, 33.
 Connexion between electricity and magnetism, 28, 29.
 Continuous electric current, 106.
 Copenhagen, 28.
 Copying medals, 115.
 Cowles brothers, 116.
 Cranes, 34.
 Crookes, Sir Wm., 166.
 Crusie, 125.
 Cubical atom, 175.
 Current, alternating, 105.
 Current, continuous, 106.
 Current, direct, 106.
 Current, discovery of, 20, 21.
 Cylinder electric machine, 14.

 Davy, Sir Humphry, 24, 32, 33, 127, 130.
 Deaf and dumb audience, 26.
 Decomposition of water, 22, 23.
 Deflection, magnetic, 169.
 Diamonds, making, 118, 119.
 Direct current, 106.
 Discharge magnetizes needle, 28, 30.
 Discovery by Oersted, 27, 28, 29.
 Discovery of electron, 166, 168.

 Discovery of potassium, 24.
 Discovery of the Wizard, 9.
 Dutch professor, 16.
 Dynamo, 102, 105, 106, 146.

 Early telegraph, 37, 38.
 Early wireless lecture incident, 84.
 Edison, 75, 132.
 "Edison effect", 75.
 Edison's greatest invention, 132.
 Edison's patents, 132.
 Electric arc, 127, 128.
 Electric attraction, 12.
 Electric battery, 21.
 Electric brake, 110.
 Electric charge, 173.
 Electric clocks, 139.
 Electric current, 20, 101, 102.
 Electric furnace, 117, 118.
 Electric light, 3, 125.
 Electric machines, 14, 28, 38.
 Electric motor, 107, 108.
 Electric shock, 15, 17.
 Electric sparks, 13, 15, 16, 65, 66, 149, 190.
 Electric tools, 111.
 Electricity and air, 147, 149.
 Electricity and magnetism, 28, 29.
 Electricity and sparks, 149.
 Electricity and water, 147, 148, 149.
 Electricity as a messenger, 5, 37.
 Electricity, boy's idea of, 147, 148, 157, 158.
 Electricity, discovery of, 9.
 Electricity, resinous, 164.
 Electricity, vitreous, 164.
 Electrified hair, 154.
 Electrified stockings, 165.
 Electro-magnet, 36.
 Electro-magnet, a tug-of-war, 36.
 Electro-magnet and weight, 36.
 Electro-magnet induction, 80.
 Electro-magnet, inventor of, 33.
 Electron, discovery of, 168.
 Electron jumps, 190.
 Electron rings, 172, 174, 198, 199.
 Electrons, 166, 168, 172, 174, 198, 199.
 Electrons escape from flame, 170.
 Emperor of Brazil, 94.
 Essays, 144, 156.
 Exchange, telephone, 95.
 Explosion of bubbles, 23, 24.

 Faraday, Michael, 101, 102, 108.
 Fay, Du, 164, 165.
 Filaments of lamps, 78, 131, 132.

INDEX

c

- Filings and electric waves, 69.
 Fire-alarm, 5.
 First speaking telephone, 89, 94.
 Flame and electrons, 170.
 Fleming, Prof. J. A., 74.
 Flint and steel, 126.
 Forks, tuning, 85, 197.
 Franklin, Benjamin, 3, 9, 17, 28,
 48, 146, 150, 164, 166.
 Frog's legs, 19.
 Furnace, electric, 117, 118.
- Galileo, 11, 62, 63, 177.
 Galvani, Prof., 19.
 Galvanometer, marine, 53, 55.
 Galvanometer, mirror, 55.
 Gilbert, Dr. Wm., 12, 163.
 Girl and mummy, 160.
 Glass cylinder machine, 14.
 Glass electrified, 10, 164.
 Glass plate machine, 14.
 Goold, Joseph, 68.
 Government and telegraph, 41.
 Gramophone, 7.
 Gravity defied, 35.
 Gray's Inn Road incident, 81.
 Gray, Stephen, 164.
Great Eastern, 52.
 Guericke, Otto von, 13.
- Helen's Babies*, 101.
 Hertz detector, 66, 67, 68.
 Hertz, Prof., 66, 169.
 Hertz transmitter, 67.
History of Electricity, Priestley's, 2.
 Hobby, 205.
 Hospital, 5.
 Howlers, 146, 152, 153.
 Humours, 163.
 Hydrogen atom, 22.
 Hydrogen gas, 22.
- Incandescent electric lamp, 131.
 Indian and telephone, 95.
 Indian Mutiny, 51.
 Individual motors, 111.
 Induction, electro-magnet, 80.
 Influence machine, 16.
 Infra-red rays, 188, 194, 202.
 Ink electrified, 57.
 Insulated ribbon of kite, 18.
 Interference of electric waves, 68.
 Interference of sound waves, 68.
 Invisible messenger, 37.
 Iron floating in air, 35.
 Iron made to speak, 7, 87.
 Ironworks, 34.
- Islands of overhead tramway wires,
 109.
 Isle of Wight, 81.
- Jar, Leyden, 16, 64.
 Jet, 10.
 Jupiter's moons, 179.
- Kelvin atom, 170.
 Kelvin, Lord, 7, 52, 57, 58, 63, 94,
 165.
- Kinlochleven, 26.
 Kitchen poker, 34.
 Kite, 9, 17, 18, 146, 150.
 Knives magnetized by lightning, 28.
 Korn, Prof., 138.
 "Kwaker", 41.
- Lenard, Prof., 167.
 Letter concerning Atlantic cable, 53.
 Leyden jar, 16, 64.
 Light, electric, 3, 125.
 Light, invisible, 193, 194.
 Light, visible, 181, 182.
 Lightning, 17, 18, 27, 151, 152.
 Lightning and knives, 28.
 Lightning conductors, 18.
 Light waves, 181.
 Lodestone, 26, 27.
 Lodge, Sir Oliver, 63.
 Long waves, 65, 182.
 Lunar Society, 2.
- Magnet, natural, 26, 27.
 Magnetic deflection, 169.
 Magnetic solenoid, 31.
 Making an iron plate speak, 87.
 Making the wheels go round, 101.
 Marconi, 70, 71, 72.
 Marconi's greatest invention, 71.
 Marine galvanometer, 53, 55.
 Measuring the velocity of light, 179.
 Metallic filings and waves, 69.
 Mode of motion, 166.
 Morrison, Charles, 38.
 Morse code, 40.
 Morse, Samuel B., 42.
 Morse sounder, 42, 43.
 Morse writer, 43.
 Motor, electric, 107, 108.
 Mummy, 160.
 Murderer and telegraph, 41.
 "Murray's Coffee Mill", 46.
- Nails and lightning, 28.
 Natural magnet, 26, 27.
 Needle, compass, 27, 33.
 Needle magnetized by current, 33.

- Needle magnetized by discharge, 28, 30.
 Needle telegraph, 39, 40, 42.
 Needles, confusion about, 120.
 Negative electricity, 165.
 Neon lamp, 132.
 Nernst lamp, 135.
Niagara warship, 53.
 Nicholson and Carlisle, 22, 26.
 Nickel-plated, 112, 114.
 North and south, 27.
- Oersted's great discovery, 27, 28, 29.
 Old lady and electricity, 154.
 Old woman and telegraphing boots, 134.
 One-fluid theory, 164.
 Optophone, 8, 97, 98, 99, 100.
 Orthodox, 156.
 Oscillations, 190.
 Osram lamp, 132.
 Oxygen atom, 22.
 Oxygen gas, 22.
- Paddington Station, 41.
 Pea analogy, 183.
 Pen telegraph, 47.
Philosophical Magazine (1735), 27.
 Phosphorescent screen, 5, 6.
 Photographs telegraphed, 8, 134, 135, 136, 137.
 Physician to Queen Elizabeth, 10, 163.
 Pig-iron, 34.
 Pile, Volta's, 20, 26.
 Pixii's dynamo, 103.
 Platinum, 22, 131.
 Platinum and silver chain, 130, 131.
 Poker magnetized, 34.
 Policeman and potassium, 25.
 Positive electricity, 165, 172.
 Positive sphere atom, 171.
 Potassium, discovery of, 24.
 Preece, Sir Wm., 82.
 Priestley, Rev. Dr. Joseph, 2, 19, 133.
 Priestley's *History of Electricity*, 2.
 Primary batteries, 114.
 Prime conductor, 14.
 Production of waves, 65, 171.
 Protons, 154, 174, 198.
- Quadruplex telegraphy, 47.
 Quaker murderer, 41.
 Quanta, 200.
 Quantum theory, 200.
 Queen Elizabeth's physician, 10, 163.
- Radiant matter, 166.
 Radium, 203.
 Railway block system, 140.
 Ramp rail, 141.
 Rays, cathode, 168.
 Receivers (wireless), 73.
 Rectified current, 76, 191, 192.
 Red board, 195, 196.
 Reis, Philip, 88.
 Relativity, theory of, 201.
 Renfrew, 38.
 Rescue of ship, 43, 190.
 Resin, 10.
 Resinous electricity, 164.
 Ridiculous behaviour of a metal, 24.
 Rings of electrons, 172, 174, 198, 199.
 Robots, 161.
 Roemer, 179.
 Royal Institution, 32, 101, 127.
 Russian professor killed, 19.
- Scale of waves, 181, 186.
 Schoolgirls and colours, 195.
 Schuster, Prof., 167.
 Sciences, variety of, 205.
Scots Magazine (1753), 37.
 Secondary batteries, 115.
 Selenium, 82, 98, 135.
 Self-exciting dynamo, 102.
 Semaphore system, 41.
 Sensation, colour, 195, 196.
 Sewing-needle magnetized, 28, 30.
 Shakespeare, 4, 204.
 Shock, electric, 15, 17.
 Short waves, 66.
 Silk and glass, 12.
 Silver-plating, 112, 114.
 Single-needle telegraph, 39, 40, 42.
 Single-stroke bell, 110.
 Siphon and boatman, 57.
 Siphon recorder, 56.
 Slough, 41.
 Sodium flame, 195.
 Solenoid, 30, 31, 35.
 Song of Electric Telegraph Co., 59, 60.
 S.O.S., 43, 190.
 Soul of amber, 10.
 "Soul of Nature", 29.
 Spark, electric, 13, 15, 16, 65, 66.
 Speaking along a beam of light, 82.
 Speaking telephone, the first, 89, 94.
 Speaking through space, 61, 76.
 Stockings electrified, 165.
 Surgeon, Wm., 33.
 Submarines, 122, 123.
 Substation, 109.

INDEX

e

- Sulphur, 10, 12.
 Sulphur machine, 13.
 Swallowed halfpenny, 5.
 Symmer, Robert, 165.
- Tank of peas, 183.
 Tantalum filament, 132.
 Telegraph, 5, 37, 39, 40, 42.
 Telegraphing photographs, 8, 134, 135, 136, 137.
 Telegraphing with pen, 47.
 Telegraphone, 6, 97.
 Tel-el-Kebir, 120.
 Telephone and beam of light, 82.
 Telephone and Morse signals, 74, 121.
 Telephone, description of, 3, 82, 89, 93.
 Telephone exchange, 95.
 Telephony, wireless, 61, 76, 82.
 Thermionic valve, 73, 78.
 Thermo-electric couple, 187.
 Thomson, Prof. Wm. (Lord Kelvin), 7, 52, 53, 57, 58, 63, 94.
 Thomson, Sir J. J., 166.
 Three Tailors of Tooley Street, 9.
 Thunder clouds, 18.
 Tinder-box, 126.
 Toddy in *Helen's Babies*, 101.
 Tools, electric, 111.
 Tradesman of Wakefield, 28.
 Tramp and boots, 134.
 Tramway car, 5, 36, 101, 109, 158.
 Transformers, 109.
 Transmitter, automatic, 45.
 Trembler-bell, 96, 110.
 Trolley pole, 158.
 Tug-of-war with magnet, 36.
 Tungsten filament, 132.
 Tuning, analogy with forks, 85, 197.
 Tuning-forks, 85, 197.
 Tuning in wireless, 85.
 Two-fluid theory of electricity, 164, 165.
 Two thousand years ago, 10.
 Typewriting telegraph, 46.
- Ultra-violet light, 187.
 Union, chemical, 172.
- Vacuum tube, 166.
 Valve as transmitter, 193.
 Valve, wireless, 74, 76.
 Velocity of light, 177, 178, 179.
 Velocity of waves, 176.
 Ventriloquist, 7.
 Vibrating bars, 197.
 Visible light, 181, 182.
 Vitreous electricity, 164.
 Volta's pile, 20, 21, 26.
 Volts, 20.
- Wakefield tradesman, 28.
 Warfare, 120.
 War Office, 51.
 Water and electricity, 147, 148, 149.
 Water, decomposition of, 22.
 Water waves, 65, 176, 181.
 Watt, James, 3.
 Wave, carrier, 191, 192.
 Wave interference, 68.
 Waves in æther, 176, 181, 186.
 Waves, long, 65, 182.
 Waves, rate of travel, 176.
 Waves rectified, 192.
 Waves, short, 66.
 White light, 194.
 Wight, Isle of, 81.
 Wireless receivers, 73.
 Wireless telegraphy, 6, 69.
 Wireless telephony, 4, 191, 192.
 Wireless waves, 180.
 Wizard, meaning of, 1.
 "Wizardous", most, 7.
 Wolseley, Sir Garnet, 121.
- X-ray quanta, 200.
 X-ray tube, 202.
 X-ray waves, 188.
 X-rays and broken arm, 6.
 X-rays and child, 5.
 X-rays from radium, 188, 203.
- Young lady and birds in wireless, 185.
- Zinc, 21, 22.
 Zinc mines, 116.