



ANTIBIOTICS



5053

ANTIBIOTICS

ANTIBIOTICS

ROBERTSON PRATT, PH.D.

*Associate Professor of Pharmacognosy and Plant Physiology,
University of California College of Pharmacy;
Consultant on Antibiotic Research*

AND

JEAN DUFRENOY, D. SCI. (PARIS)

*Research Associate in Antibiotics,
University of California College of Pharmacy*

66 Illustrations



Philadelphia

London

Montreal

J. B. LIPPINCOTT COMPANY

COPYRIGHT, 1949
BY J. B. LIPPINCOTT COMPANY

**THIS BOOK IS FULLY PROTECTED BY COPYRIGHT AND,
WITH THE EXCEPTION OF BRIEF EXTRACTS FOR
REVIEW, NO PART OF IT MAY BE REPRODUCED WITH-
OUT WRITTEN PERMISSION FROM THE PUBLISHERS**

PRINTED IN THE UNITED STATES OF AMERICA



Preface

The purpose of this book is to present in a succinct, integrated plan the facts and principles of fundamental and permanent value relating to antibiotics. Much of this information is now widely scattered in thousands of publications embracing the vast scientific literature of the subject. Some of it is derived from the authors' own researches in this field published over a period of years.

The object has been, first, to give an understanding of the fact that, in developing chemical therapy by means of antibiotics, man has merely adapted to his own ends the capacity that certain microorganisms possess to wage a war of extermination against other microorganisms, and, second, to present a general survey of the principles involved in the industrial, commercial, pharmaceutical, and medical aspects of the field of antibiotics.

The advent, about 1942, of the modern era of antibiotic chemotherapy for the treatment of systemic infections unquestionably marks one of the greatest advances in man's continuing battle against infectious diseases.

In terms of human suffering that has been alleviated, the discovery of practical means of applying microbial antagonisms for curative purposes easily ranks with the great contribution of the nineteenth century, i. e., the introduction of anesthesia in surgery one hundred years earlier.

In terms of volume, the industrial production of antibiotics outranks all other medicinals. It has been estimated that in 1948 penicillin and streptomycin alone accounted for more than one half of manufacturers' income from the sale of synthetic drugs. This figure is especially impressive when it is realized that penicillin first became available commercially in 1943 and that streptomycin was not available com-

mercially until two or three years later. Within the last year three additional antibiotics, bacitracin, aureomycin, and chloromycetin have become available. More will undoubtedly follow.

Penicillin proved to be of immense value in World War II, not only in humanitarian terms, but also in military terms, because its use returned to active service many men who otherwise would have succumbed to infection or would have been permanently disabled. In the same way, on a larger scale, many other antibiotics are proving of immense economic as well as humanitarian value in the post-war era, by reducing periods of hospitalization or of quarantine, and by rehabilitating many chronic cases. Thus, proper use of antibiotics lightens the financial burden of public health and welfare agencies.

For this reason, countries not self-sufficient with respect to production of antibiotics, find it economically advantageous to spend their limited supplies of dollars for importation of these agents in preference to a number of other "essential" commodities. Drug exports from the United States for 1948 totaled 191 million dollars: approximately 40 per cent of this sum was spent for antibiotics (mostly penicillin and streptomycin).

Antibiotics have been used largely for treatment of human patients, but with increasing production, the cost of penicillin has dropped so markedly that its wide application in veterinary medicine has become practicable, resulting in large savings for cattle, dairy, poultry, and other livestock industries. With time, similar developments may be expected for other antibiotics.

There is a genuine need for a treatment of the broad principles of antibiotics and antibiotic chemotherapy sufficiently comprehensive to satisfy those whose business is concerned with the health sciences but not so technical as to discourage the interested individual whose major activities lie in other fields.

The authors modestly hope that the present volume will help to satisfy this need by filling the gap between the necessarily brief popular accounts on the one hand and the technical accounts intended for specialists on the other hand.

Since the aim of this book has been to achieve an integration of pertinent facts and principles in a coherent picture, no attempt has been made to cite exhaustively all of the extensive literature pertaining to the several aspects of the subject, but all important critical review papers are listed, as are the principal scientific articles of historical interest.

ROBERTSON PRATT
JEAN DUFRENOY

It is with deep appreciation that we acknowledge the services of Louise Noack Gray, who designed the cover of this book, and the ceaseless secretarial and proofreading labors of my wife, Jean, and my mother.

R. P.

University of California
College of Pharmacy
San Francisco, California



Contents

CHAPTER	PAGE
1. THE CONCEPT OF ANTIBIOSIS	1
2. BIOLOGIC SIGNIFICANCE OF FIELDS OF DIFFUSION	9
Mutual Relations among Organisms	9
Discovery of Antibiotics from Soil Organisms	10
Significance of Fields of Diffusion	12
Modification of the Sigmoid Curve by Growth Accelerators or Inhibitors	18
The Concept of Threshold and Optimal Concentrations ...	19
3. INDUSTRIAL PRODUCTION AND CONTROL OF ANTIBIOTICS ...	27
The Concept of Chemotherapy	27
Requisites for an Ideal Antibiotic	29
Industrial Point of View	29
Clinical (Medical) Point of View	30
Industrial Production of Antibiotics	31
Preparation of Inoculum or "Seed"	32
Biosynthesis	35
Extraction and Purification	40
Testing	42
Government Control of Antibiotics	53
4. THE CONCEPT OF ANTIBIOTIC SPECTRA	55
5. PENICILLIN	61
Penicillin as a Chemical Compound	62
The Family of Penicillins	62
Biosynthesis	64
Extraction and Purification	75
Stability	77
Penicillin as a Chemotherapeutic Agent	82
Factors Influencing Antibacterial Action	86
Chemotherapeutic Use	97

x Contents

CHAPTER	PAGE
6. STREPTOMYCIN	119
Streptomycin as a Chemical Compound	120
Different Forms of Streptomycin	121
Biosynthesis	124
Extraction and Purification	126
Expressing the Potency of Streptomycin (Unitage) ..	126
Stability	129
Streptomycin and Dihydrostreptomycin as Chemotherapeutic Agents	131
Factors Influencing Antibacterial Action	131
Chemotherapeutic Use	139
7. CHLOROMYCETIN AND AUREOMYCIN	151
Chloromycetin	151
Microbiology	152
Chloromycetin as a Chemical Compound	152
Chloromycetin as a Chemotherapeutic Agent	153
Physiologic Effects of Chloromycetin on the Patient ...	155
Aureomycin	156
Microbiology	156
Aureomycin as a Chemical Compound	160
Aureomycin as a Chemotherapeutic Agent	161
8. POLYMYXIN	167
Microbiology of Polymyxins	168
Polymyxins as Chemical Compounds	169
Polymyxins as Chemotherapeutic Agents	170
9. TYROTHRICIN	173
Microbiology of Tyrothricin	173
Tyrothricin as a Chemical Compound	175
Tyrothricin as a Chemotherapeutic Agent	177
10. OTHER ANTIBIOTICS	179
Criteria for Identification of Antibiotics	181
Antibiotics from the Bacillus Subtilis Group	189
Antibiotics from the Enterobacteriaceae	194
Antibiotics from Pseudomonas Aeruginosa	195
Antibiotics from Actinomycetes	195

Contents xi

CHAPTER	PAGE
10. OTHER ANTIBIOTICS (<i>Continued</i>)	
Antibiotics from Fungi	200
Antimicrobial Agents from Higher Plants	201
11. MECHANISMS OF ANTIBIOTIC ACTION	205
Distinguishing Characteristics of Antibiotics	206
Penicillin	208
Morphologic Observations	210
Cytochemical Observations	211
Comparative Effects of Penicillin Under Aerobic and Semi-anaerobic Conditions	221
Streptomycin	224
Morphologic Observations	225
Cytochemical Observations	227
Tyrothricin (Gramicidin and Tyrocidin)	229
Development of Resistant Strains	230
12. RETROSPECTS AND PROSPECTS	235
INDEX	243

Among the lower beings, even more than among the higher animals and plant species, life destroys life. —L. PASTEUR AND J. JOUBERT (1877)

CHAPTER

1

The Concept of Antibiosis

The component members of any society, whether it be an aggregation of human beings or of other living organisms, are continuously influenced by their environment. Furthermore, the neighboring beings or organisms or cells constitute an important part of that environment. Several organisms or cells, whether of the same or of different kinds, cannot long exist in a limited space without affecting and (or) being affected by their neighbors. This fact is fundamental in all studies of growth and development, whether one is concerned with an individual organism or with the growth, development, and decline of mixed populations of plants or of animals. The same principle applies even in the waxing and waning of human civilizations.* This book treats of various ways in which some of these relationships among micro-organisms can be applied for practical clinical control or cure of pathogenic disorders of man and his domestic animals and plants and, so far as is possible with present knowledge, of the mechanisms by which the end result is accomplished. This is the subject matter of the comparatively new field of antibiotics.

The term "antibiotic," according to its derivation, has a very broad meaning and might be used to indicate any agent or condition detrimental to life. The word "antibiosis" appears to have been coined in 1889 by Vuillemin who wrote, "The lion that springs on its prey and

* For a more comprehensive treatment of this idea, developing some of the points of similarity between microbial societies and societies of higher animals, including man himself, see Pratt (1949).

2 The Concept of Antibiosis

the serpent that poisons the wound before devouring its victim are not considered to be parasites. There is nothing unequivocal about it—one creature destroys the life of another in order to sustain its own, the first being entirely active, and the second entirely passive; one is in unrestricted opposition to the other. The relation is so simple that it has never been named, but instead of being examined in isolation it can be viewed as a factor in more complex phenomena. For simplicity we shall refer to it as *antibiosis*; the active participant will be the *antibiot*.” As currently used in pharmaceutical and medical practice, however, the term antibiotic has a very definite and limited connotation. It is used to designate a metabolic product of one micro-organism that is detrimental or inimical to the life activities of other micro-organisms, usually even when present in extremely low concentrations. According to this commonly employed definition, antibacterial substances derived from higher plants or from animals (other than protozoa) are excluded from the subject matter of antibiotics.*

In some cases the antibiotic principle has been extracted from the producing micro-organism or from the liquid in which it has grown and has been purified and identified chemically, but in many cases only crude or more-or-less purified extracts have been obtained. The best-known antibiotics are penicillin and streptomycin. Structural formulas have been proved for both compounds.

Antibiotics have been known, if not in the pure form, at least by their effects for centuries; but have only recently assumed the dominating position in clinical medicine and in the pharmaceutical industry that they now occupy. Although the Chinese were aware at least 2,500 years ago of the ameliorating properties of molded curd of soy bean when applied to carbuncles, boils and like infections and used this treatment as standard procedure in such conditions, the potential significance and value of micro-organisms as curative agents or as sources of

* The major portion of this book is concerned with the antimicrobial properties of substances produced by micro-organisms. However, we shall devote a small section (part of Chap. 10) to a discussion of similarly acting agents derived from higher plants and animals.

useful drugs for the treatment of systemic infections seems to have been neglected until the latter part of the nineteenth century. This is not surprising, however, when one realizes that the subject of bacteriology, as a scientific study, was born only about the middle of the nineteenth century as the result of the work of Pasteur and his students. As a matter of fact, Pasteur and Joubert (1877) appear to have been the first to recognize the clinical potentialities of micro-organisms as therapeutic agents as well as causal agents in disease. They observed that anthrax bacilli (*Bacillus anthracis*) grow rapidly when introduced into sterile urine at an appropriate pH, but that they fail to grow and soon die if one of the "common bacteria" of the air is inoculated into the urine at the same time. They wrote "It is remarkable that the same phenomenon is seen in the body, . . . leading to the astonishing results that anthrax can be introduced in profusion into an animal, which yet does not develop the disease; it is only necessary to add some 'common bacteria' at the same time to the liquid containing the anthrax bacteria. *These facts perhaps justify the highest hopes for therapeutics.*" (The italics are ours.)

A few years later Tyndall (1881) in his "Essays on the Floating Matter of the Air" described the clearing of solutions made turbid by the growth of bacteria when species of *Penicillium* subsequently grew on the surface of the liquid, and in 1885 Cornil and Babes conceived the role of definite chemical inhibitors in these phenomena of antagonism in the microbial world. These chemical entities that are produced by one micro-organism and that, depending upon their concentration in the medium, inhibit, kill or lyse other micro-organisms, are now called antibiotics.

The therapeutic use of antibiotic agents represents merely a practical, controlled and directed application of phenomena that occur naturally and continuously in soil, sewage, water and other natural habitats of micro-organisms. During the late years of the nineteenth century and the first decade of the twentieth century, several antibiotics were tested clinically. The first crude attempts made in the 1880's involved "replacement therapy," i.e., inoculation of a

4 The Concept of Antibiosis

patient infected with a pathogenic organism with a nonpathogenic bacterium that previously had been demonstrated to be antagonistic to the pathogen *in vitro*. This technic was used with some success in the treatment of tuberculosis, diphtheria, anthrax, cholera, plague and other diseases. The next refinement, introduced in the 1890's, was administration of crude, or more-or-less purified, extracts of one organism to check the growth of, or even to eradicate, invading pathogens. Extracts of fungi as well as of bacteria were used successfully in this way. About 1900 pyocyanase, an extract from the blue-pus organism, *Pseudomonas pyocyanea* (*Ps. aeruginosa*), was prepared commercially in Germany and was used extensively. The historical phases of the early experiments in this phase of therapy have been discussed in a competent and interesting way by Florey (1945) and by Weintraub (1943).

The trend in the pharmaceutical and medical professions has ever been away from the preparation and administration of crude extracts and toward the goal of administering definite amounts of identified compounds. The phase of chemotherapy concerned with antibiotics is no exception. The most recent research and development in this field, resulting in the preparation of crystalline antibiotics on an industrial scale and intelligent therapeutic use of these agents according to a definite dosage schedule, has involved the co-operation and effort of many biologists, chemists, physicists, and engineers in this country and abroad, but was stimulated by, and may be said to have stemmed largely from, Fleming's observation in 1929 of the action of *Penicillium sp.* on *Staphylococcus aureus* and from the classical studies of the British school made during the following years on the metabolic products of molds, especially of the Penicillia.

In the early years of World War II the sulfonamide drugs were the only really effective chemotherapeutic agents available for treatment of bacterial infections, and these drugs had several undesirable characteristics. In many patients they produce serious untoward reactions. A number of strains of bacteria are naturally resistant to their action, and in other cases highly resistant strains of bacteria

often develop from susceptible species that have been exposed to the sulfonamide drugs, so that a considerable percentage of bacterial infections is not amenable to sulfonamide therapy. Furthermore, even in the case of susceptible pathogens, the usefulness of the sulfonamides is limited by the fact that their antibacterial activity is lessened when large numbers of bacteria are present or even when dead bacteria, pus, blood serum, or other products likely to be found in infected wounds are present. Therefore, there was an intense desire to find new antibacterial agents that might not have these undesirable properties. The available evidence suggested that penicillin might be at least a partial answer, and accordingly the governments of the United States and of Great Britain agreed to pool their research resources of man power, facilities, etc., to sponsor an intensive co-ordinated program of co-operative research on this antibiotic. The decision proved to be a wise one and in a period of a few years penicillin developed from a laboratory curiosity to a major item in medicine and in the pharmaceutical industry, and helped to save the lives of untold thousands of battle casualties and civilians.

Shortly before initiation of the intensive research program on penicillin the work of Dubos (1939) on antibacterial products found in filtrates from cultures of *Bacillus brevis* had reawakened interest in antibiotics as potential chemotherapeutic agents. Dubos isolated tyrothricin which was shown to be extremely active against a number of pathogens previously not amenable to chemotherapy, but unfortunately this natural product was too toxic for parenteral administration, a fact that seriously limited its usefulness. This served to stimulate a search for other less toxic antibiotics.

Subsequently, Waksman and his students (1944) discovered a new source of antibiotics in the actinomycetes, a mold-like class of organisms considered to be intermediate between bacteria and fungi in evolutionary development. The importance of Waksman's observations and his diligence in initiating the development of streptomycin on a scientific plane and on a commercial scale cannot be over-emphasized, since research on this antibiotic and its commercial

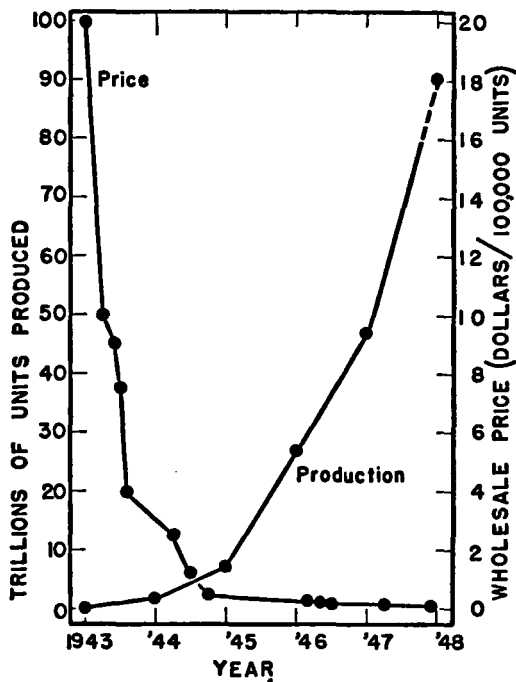

FIG. 1. Production of penicillin in the United States from 1943 through 1948 and the wholesale price of penicillin per 100,000 units during the same period. The production figure for 1948 is estimated from the actual production of the first nine months, hence the dashed line for the last three months. One unit crystalline penicillin = 0.6 microgram (6×10^{-7} gram). The first penicillin, marketed at \$20/100,000 units, was an impure amorphous product with approximately 250 to 350 units of activity per mg. The current product is a highly purified crystalline preparation assaying 1500 to 1600 units or more per mg. and costs about \$0.09 per 100,000 units (January 1949). The theoretical potency of the sodium salt of crystalline benzyl penicillin is 1667 units per mg.

development did not receive the kind of government support that did so much to further production of penicillins in the United States and Great Britain.

The antibiotics already occupy an eminent rank in the pharmaceutical industry and, in terms of volume of business, may soon occupy a dominant position. It has been estimated that penicillin and streptomycin together accounted for more than one half of manufacturers' income realized in 1948 from the sale of synthetic drugs, an especially impressive figure when it is realized that penicillin first became available commercially in 1943 and that the first commercial lots of streptomycin were not offered for sale until two or three years later. The tremendously rapid growth of the antibiotics industry is indicated by the data in Figure 1 which show the annual production of penicillin from 1943 through 1948.

Other antibiotics which are available for distribution through regular retail outlets are aureomycin (Duomycin), bacitracin, chloromycetin (Chloramphenicol), and tyrothricin. Several others are undergoing clinical trial. Polymyxin and subtilin appear to be the most promising of the latter group. More than one hundred antibiotics have been discovered and many of these have been fully or partially characterized chemically. Only a small percentage of the antibiotics that are discovered prove to be clinically useful, however. The reasons for this will become apparent as our story unfolds in the following pages.

REFERENCES

- Cornil, C. V., and Babes, V., 1885, Concurrence vitale des bactéries; atténuation de leurs propriétés dans des milieux nutritifs modifiés par d'autre bactéries; tentative de thérapeutique bactériologique, *J. Connaiss. Méd. Prat. et Pharmacol.*, 7:321-323.
- Dubos, R., 1939, Bactericidal effect of an extract of a soil bacillus on Gram positive cocci, *Proc. Soc. Exper. Biol. Med.*, 40:311-312.
- Fleming, A., 1929, On the antibacterial action of cultures of a penicillium with special reference to their use in the isolation of *B. influenzae*, *Brit. J. Exp. Path.*, 10:226-236.

8 The Concept of Antibiosis

- Florey, H. W., 1945, The use of micro-organisms for therapeutic purposes, *Brit. Med. J.*, 2:635-642.
- Pasteur, L., and Joubert, J., 1877, Charbon et septicémie, *Compt. Rend. Acad. Sci., Paris*, 85:101-115.
- Pratt, R., 1949, Armageddon of the microbes: a consideration of certain relationships in a microbiological society, *Texas Reports Biol. & Med.*, 7:12-21.
- Tyndall, J., 1881, *Essays on the floating matter of the air in relation to putrefaction and infection*, New York, Appleton.
- Vuillemin, P., 1889, Antibiose et symbiose, *Compt. Rend. Assoc. franc. Av. Sci.*, 2:525-543.
- Waksman, S. A., Bugie, E., and Schatz, A., 1944, Isolation of antibiotic substances from soil micro-organisms, with special reference to streptothricin and streptomycin, *Proc. Staff Meet. Mayo Clinic*, 19:537-548.
- Weintraub, R. L., 1943, Chemotherapeutic agents from microbes, *Smithsonian Inst. Washington Annual Report*, pp. 545-568.

Life is a principle of growth, not of standing still,
a continuous becoming, which does not permit
of static conditions.

—JAWAHARLAL NEHRU (1946)

CHAPTER

2

Biologic Significance of Fields of Diffusion

MUTUAL RELATIONS AMONG ORGANISMS

It was pointed out in Chapter 1 that several organisms cannot long exist in the same environment without in some way affecting or being affected by their neighbors. Both organisms may benefit mutually from the association, each supplying a need of the other. This is the case with the algae and fungi which together form lichens. Such a relation is called symbiotic (sym = together + bios = life). The condition of living together in this fashion is called symbiosis. In other instances one organism may live at the expense of the other, as, for example, do the various mildew and rust fungi that are pathogenic on plants and the different fungi that parasitize man and other animals. Such a condition is known as parasitism (derived from Greek and meaning literally, to eat beside or at the table of another). The aggressor in such a relationship is called a parasite and the other member is called the host.

In still other cases one of the associates may inhibit or prevent altogether the growth of another without deriving any known particular direct benefit from the arrangement although it may benefit indirectly by the fact that some of its competitors for *lebensraum* and for available nutrients are eliminated from the scene. Such a relationship is known as antagonism. The active aggressor is called an antago-

nist and is comparable to the "active antibioter" in Vuillemin's definition of antibiosis. It is principally with the antagonistic relationships of micro-organisms that this book is concerned.

DISCOVERY OF ANTIBIOTICS FROM SOIL ORGANISMS

In bygone times considerable interest was evidenced in the soil as a potential reservoir of various kinds of pathogenic organisms. It was argued that since animal and human excreta containing various pathogens ultimately often find their way into the soil and since bodies of individuals who die from various diseases are buried in the earth, the soil and possibly neighboring streams and water supplies might become infected. However, following the entrance of bacteriology as a real science in the nineteenth century, soils were searched intensively for organisms known to be pathogenic for man and other animals, and it was soon found that such organisms generally do not long survive in normal soil.

When this was discovered, it was thought, at first, that perhaps the soil serves as a filter or that many pathogenic organisms fail to survive because of their peculiar physical and chemical requirements (temperature, humidity, nutrition, etc.). However, it was soon found that the chances of survival are much greater in sterilized soil than in natural soil and that some organisms which do not survive in natural soil actually grow well in sterilized soil. This gave weight to the idea that micro-organisms in normal unsterilized soil tend to prevent the growth of introduced foreign pathogens. With the exception of the micro-organisms causing anthrax (*Bacillus anthracis*), tetanus (*Clostridium tetani*), gas gangrene (various species of *Clostridium*), undulant fever (*Brucella abortus*), and typhoid fever (*Eberthella typhosa*), most micro-organisms pathogenic for man fail to survive more than a few days in soil, either because of failure to obtain proper nutrition, or because of inability to compete with other micro-organisms, or as the result of actual antibiosis.

The hypothesis that destruction of pathogens in the soil obtains through the production of antibiotic substances by other micro-

organisms which are antagonistic to the pathogens and that development of the nonpathogens might be stimulated by presence of appropriate pathogens prompted Dubos to institute his technic of bacterial enrichment of the soil by artificial addition of cultures of the micro-organisms against which an antibiotic was desired. This resulted in the isolation in 1939 of gramicidin, an antibiotic produced by the common soil inhabitant, *Bacillus brevis*. Gramicidin is lytic for many Gram-positive organisms. Despite the enormous amount of work done over the previous 65 to 70 years, no antibiotic substance from a mold or bacterium had found an undisputed and permanent place in medicine before that time, but it became apparent in 1939, as the result of Dubos's work, that the soil, rather than being a major reservoir of pathogens, might actually be a source of valuable chemotherapeutic agents.

From the historical point of view organisms isolated from the soil played an important role in the renewed development of interest in antibiotics. Pioneers in the field were Weindling (1934) and Dubos (1931, 1939). The most significant success was achieved by Waksman and his co-workers. An indication of the amount of energy, labor, and time involved in studies of this sort is given by Waksman's recent statement (1948) that "About 10,000 cultures of organisms were studied" in his laboratory alone, and that "Of these, about 1000 were found to have antibacterial properties. . . . When these were grown in liquid culture media, only about 100 were able to produce in the medium substances which had the capacity of inhibiting the growth of various bacteria and other organisms. Of these, ten substances have actually been isolated and described. Of these ten, one proved to be streptomycin." In general, therefore, although many micro-organisms may be involved in phenomena of antibiosis only a few produce an antibiotic of potential interest to the pharmacist and the clinician. Of the numerous antibiotics so far isolated only two, penicillin and streptomycin, have actually become industrially important chemotherapeutic agents. Two more recent additions to man's armamentarium of antibiotics that bid fair to become impor-

tant industrially as well as clinically are aureomycin and chloromycetin. A few more appear worthy of clinical trial; among these are polymyxin which is active against Gram-negative bacteria, subtilin which appears to be active against the tuberculosis organism (*Mycobacterium tuberculosis*), and some of the agents derived from micro-organisms which have been reported to affect the growth of tumor cells.

SIGNIFICANCE OF FIELDS OF DIFFUSION

Beneficial and inimical relationships among the members of a society depend in large measure on fields of diffusion. A field of diffusion may be defined as a sphere of influence in which one or more forces exert an effect and in which there exist concentration gradients of the effective forces. The diffusible factors may belong to the physicochemical world, as is the case with micro-organisms and some higher plants, and as such they may be amenable to precise measurement by physical or chemical means, or they may be intangible but none-the-less real, like the economic, psychical, and spiritual forces that are often difficult to evaluate with precision and that seriously complicate attempts to make quantitative studies of the "mechanism of action" in societies of human beings or of some other species of animals. The student may consider comparison of a human society with a society of micro-organisms novel and perhaps even absurd. Of course there are many differences between the two, but there are also a number of similarities.* For example, the similarity of growth curves for a typical micro-organism and for three phases of human endeavor suggests the existence of some fundamental relationship to time in these widely divergent activities (Figs. 2 and 3). It will be noted that each of these sigmoid (S-shaped) curves may be considered roughly as composed of three phases. The first is a period of adjustment, the so-called lag phase, during which at first there is no or very little perceptible increase, with a slow increase

* For further discussion of this point, see Pratt (1949). *Loc. cit.* in Chapter 1, and the recent work on "Social Physics" by Stewart (1948).

later. The second period is characterized by initiation and maintenance of a rapid, constant geometric rate of increase, the so-called logarithmic or log phase. The third period during which the rate of increase slows down, and eventually tends asymptotically to reach an upper limit, is known as the stationary phase.

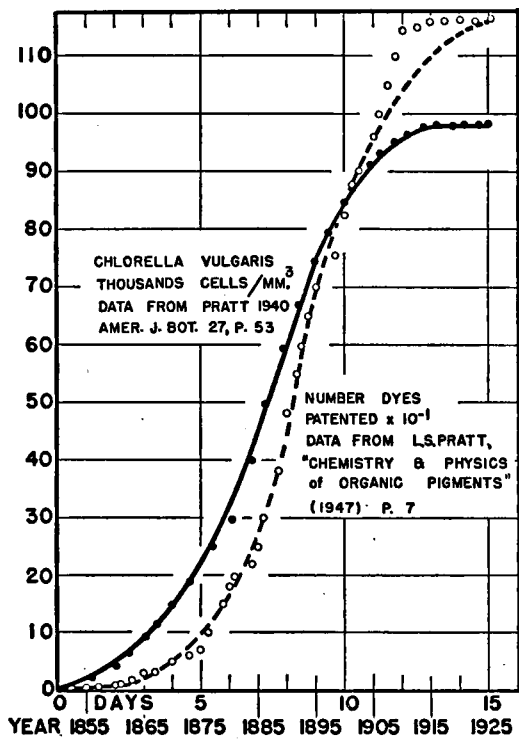

FIG. 2. Growth curves for *Chlorella vulgaris*, a unicellular green alga, and for the synthetic dye industry with respect to time. Data for *Chlorella* (solid circles) represent thousands of cells/cu. mm. of culture solution. Those for dye industry (open circles) represent number of synthetic dyes patented. For actual number of dyes multiply numbers shown by 10. Time scale is in days for *Chlorella*, and is indicated by years for dye industry.

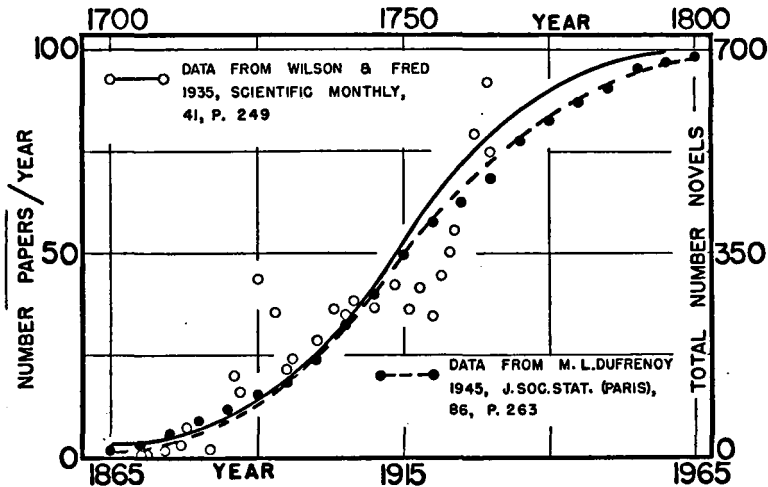

FIG. 3. Growth of a scientific literature and of a fictional literature with respect to time. Open circles show number research papers dealing with nitrogen fixation by bacteria published each year from 1865 to 1930 and extrapolated to 1960 (ordinate and abscissa scales at left and bottom, respectively). Deviation from the theoretical sigmoid curve between 1915 and 1920 may be attributed to disruption of normal agricultural research during the first World War. Solid circles represent total number of novels dealing with an oriental theme published in France in the eighteenth century (ordinate and abscissa scales at right and top, respectively).

The shape of the sigmoid curve, as it flattens out near the upper limit, suggests a tendency of the environment where growth was initiated to oppose unlimited growth. This was at first visualized as the result of crowding, tending to cause "saturation," in the limited space available; it was thought that crowding might not only induce "space antagonism," a condition in which the organisms would be physically limited in the space available to them, but might also deplete the available source of nutrients below a certain critical threshold. Moreover, an excessive number of individuals might bring about other undesirable physicochemical changes in the culture medium.

A similar crowding or saturation effect may well operate in determining the growth of a literature or of any human activity. Fads

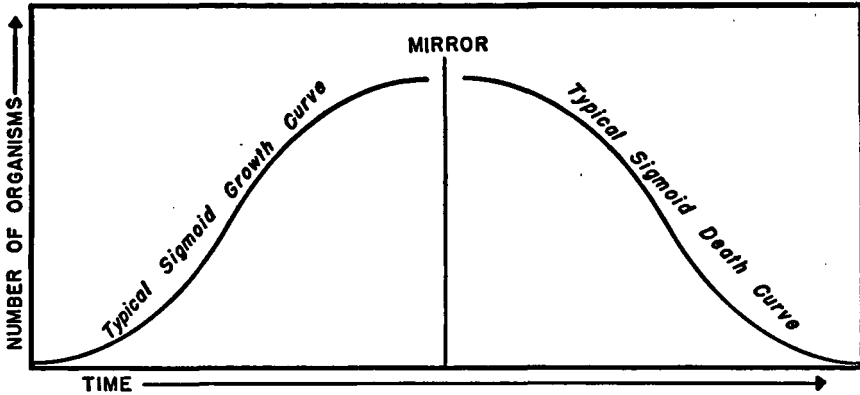

FIG. 4. Idealized curves for cultures of micro-organisms showing the general relationship of population to time under normal conditions. Both the growth curve and the death curve are sigmoid, and one may be considered the mirror image of the other.

and fancies develop just as populations of organisms do. In time, people become “saturated” with the new idea, interest lags, and the “growth curve” tapers off. A similar but reverse relationship to time is characteristic of death curves for a population. Such curves may be considered as mirror images of growth curves. (See Fig. 4.)

With the advent of the “antibiosis” concept, the notion of chemical inhibitors that diffuse away from the producing organism tended to supersede the notion of physical crowding. The typical growth curve can be modified at will, irrespective of the crowding effect, merely by exposing the organisms, in the presence of abundant nutrients, to the diffusible metabolic products of individuals of the same species (staling or auto-antibiotic effect) or to the products of other species. An outstanding example of auto-antibiosis is evidenced by the unicellular green alga, *Chlorella vulgaris*, which has been studied extensively by Pratt (1940-1948). Figure 5 shows the depressing effect on the growth of *Chlorella* of filtrates from cultures of the same species of organism. All cultures were rich in nutrients and all were inoculated at the same time with equal numbers of young cells, but increasing the amount of filtrate in the culture medium reduced both the rate

and final amount of growth (as measured by increase in population).

Phenomena of antagonism are not restricted to micro-organisms. One of the most striking examples of inhibition of one kind of organism by another under conditions where physical crowding is not a factor is seen in the case of certain species of *Encelia* (flowering

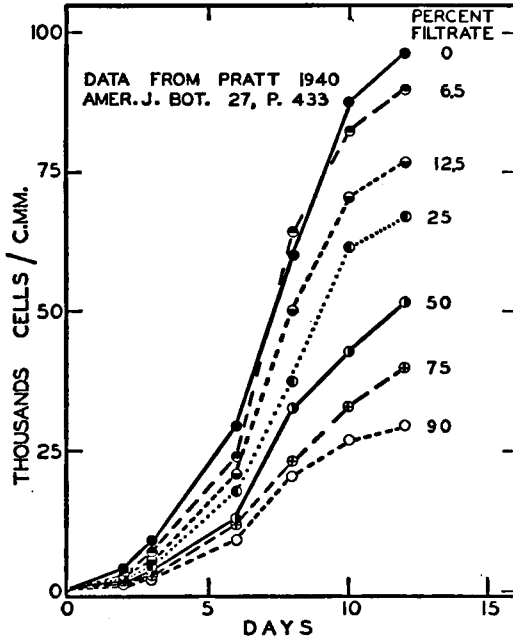

FIG. 5. Growth of *Chlorella vulgaris* in nutrient solutions prepared with different amounts of cell-free filtrate obtained from old cultures. Such filtrates contain an antibiotic substance called chlorellin. The solutions were inoculated with young cells; initial population = 100 cells per cu. mm.

plants of the daisy or Compositae family) that grow in the sparsely vegetated Colorado and Mohave deserts of Southern California. It has been observed for some time that other plants normally do not grow within a definite radius of an *encelia* plant, each *encelia* being

in the center of an otherwise barren area. Recently it has been demonstrated that these plants produce a compound (3-acetyl-6-methoxybenzaldehyde) that inhibits the growth of other plants. Another example of antagonism among higher plants is seen in the case of the walnut (*Juglans hindsii*) which produces juglone, a quinonic compound that inhibits the growth of other plants, and that tends to prevent growth of other species of plants near the walnut.

In a general discussion of this subject, Pratt (*loc. cit.*, 1949) has pointed out that "Perhaps the relationships among different components of a homogeneous or heterogeneous population are most readily reduced to quantitative physicochemical terms when the subjects under observation are micro-organisms, and when the active diffusible factor of one of the associated members can be extracted from the organism and isolated as a pure chemical compound. This can be done in the comparatively new field of research in antibiotics. The relations between bacteria and penicillin (which is produced by several species of molds) have been studied most extensively, and will be drawn upon freely to illustrate the concepts that are presented. Similar relationships, *mutatis mutandis*, exist between other organisms and other antibiotics.

"In a heterogeneous society of micro-organisms (mixed culture) all of the individuals of a given species may be considered collectively as one member or component of the population and as such they may be considered roughly analogous to what in human society is recognized as a 'pressure group.' Given sufficient time, in a limited environment such as exists in laboratory cultures or in small pools or lakes, generally a given group or even a single species of micro-organism will dominate or be dominated. It will supplant or be supplanted by other species or groups. The well-known succession of species is in part a manifestation of the continuous battle for *lebensraum*, for survival, and for supremacy. This phenomenon of conflict or of antagonism among different kinds of micro-organisms was employed empirically thirty or more centuries ago by the Chinese. . . . The more recent development of a system of chemotherapy employing antibiotics is

essentially a refinement and extension of the crude technic of the ancient Chinese. Penicillin, streptomycin, aureomycin, polymyxin, and chloromycetin are only the more prominent of many natural antibiotic compounds that have been isolated from different molds and bacteria and that have been employed therapeutically to combat infectious germs. The usefulness of these technics in which man adapts to his own ends the 'war-making potential' of certain microscopic organisms is established beyond doubt. It is unnecessary for both organismal protagonists in the conflict to be present. When the active, diffusible principle of one of the opponents is extracted and concentrated and then is transferred to a new environment, it constitutes a new center for a field of diffusion which is similar in biological properties to the field that existed initially around the living organism. Harnessing of the natural antagonisms of the lower organisms to make them serve man's purpose need no longer be limited to therapeutic treatment of superficial local infections that can be reached by topical application of the moldy curd of soy bean or by poultices of moldy bread such as the ancient Greeks employed. Instead, a field of diffusion of the active material can be established in muscle, the blood, or almost any tissue of the body, thus making possible successful treatment of a number of deep-seated or systemic infections."

MODIFICATION OF THE SIGMOID CURVE BY GROWTH ACCELERATORS OR INHIBITORS

The sigmoid curve represents not only the trend of growth from the lag phase to the stationary phase, but it also represents the trend of the vital biochemical activities of the population, for example, rate of absorption of O_2 or emission of CO_2 .

The sigmoid curve, which represents the normal growth or one of its biochemical manifestations, may be modified by removing from or introducing into the culture agents that are capable of affecting the duration of the lag phase, or of the log phase, or are capable of shifting the upper limit of the curve upwards or downwards. This is illustrated in Figures 5 and 6 which show data obtained with *Chlo-*

rella vulgaris. Addition of the auto-inhibiting substance (chlorellin), produced by *Chlorella*, to fresh cultures appreciably increases the duration of the lag phase and lowers the upper limit of population attained (Fig. 5), while removal of chlorellin prolongs the log phase and permits attainment of a denser population (Fig. 6).

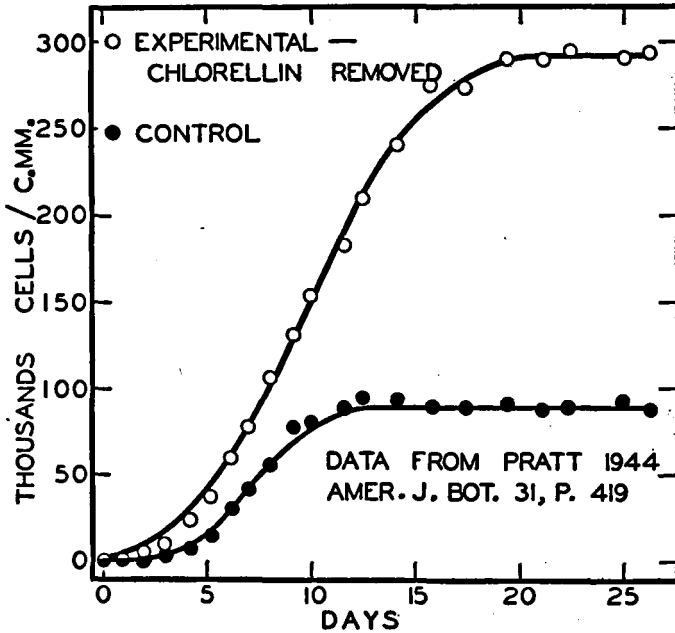

FIG. 6. Effect of continuous removal of chlorellin from the culture on the growth of *Chlorella vulgaris*. Solid circles represent growth of control cultures in which chlorellin accumulated normally. Open circles represent growth when chlorellin was removed continuously by dialysis. Initial population in both cultures = 100 cells per cu. mm.

THE CONCEPT OF THRESHOLD AND OPTIMAL CONCENTRATIONS

Threshold Concentration. The response of many biological systems to a change in their chemical or physical environment appears to operate on an “all-or-none” principle. That is to say, variations in

their environment upwards or downwards from the norm produce no readily perceptible change in the behavior of the organism until a certain critical or threshold concentration has been reached. This can be neatly demonstrated on penicillin assay plates.

In the standard biological assay of penicillin, Petri dishes containing nutrient agar are "seeded" with a thin layer of the bacteria (usually *Staphylococcus aureus*). Then small metal or glass cylinders (approximately 8 mm. diameter) are placed on the seeded agar surface, care being taken to secure a "leak-proof" seal between the edge of the cylinder and the agar. Then the solution to be tested is placed in the cylinder and the assay plates are placed in an incubator (37° C.) for an appropriate period of time. After suitable incubation there is evident around each cylinder or reservoir of penicillin solution a circular clear area (zone of inhibition) in which multiplication of the bacteria has been blocked by the antibiotic. The diameter of the inhibition zone is, within limits, a function of the concentration of penicillin in the solution under test. This matter will be discussed more fully later (Chap. 3). Outside the clear area no inhibition occurs and consequently, the agar surface is more or less opaque due to the proliferation of the test organisms.

There is more to the story than this, however. When the plates are examined carefully, it is found that the boundary of the inhibition zones is composed of a narrow ring where growth has been most intense so that in this ring of enhanced growth the bacterial population is much more dense than in the remainder of the uninhibited portions of the assay plate. Thus, the zone of inhibition is sharply defined by the contrast between an area where growth is blocked and one in which it is exaggerated. This is shown diagrammatically in Figure 7.

It is obvious that under such experimental conditions the test organisms are exposed to uniform conditions of aeration, nutrients, etc., and that there is but one variable, namely the concentration of penicillin (or other antibiotic). As the penicillin diffuses outward from the cylinder a gradient of concentrations is established. The concentration diminishes with increasing distance away from the cylinder.

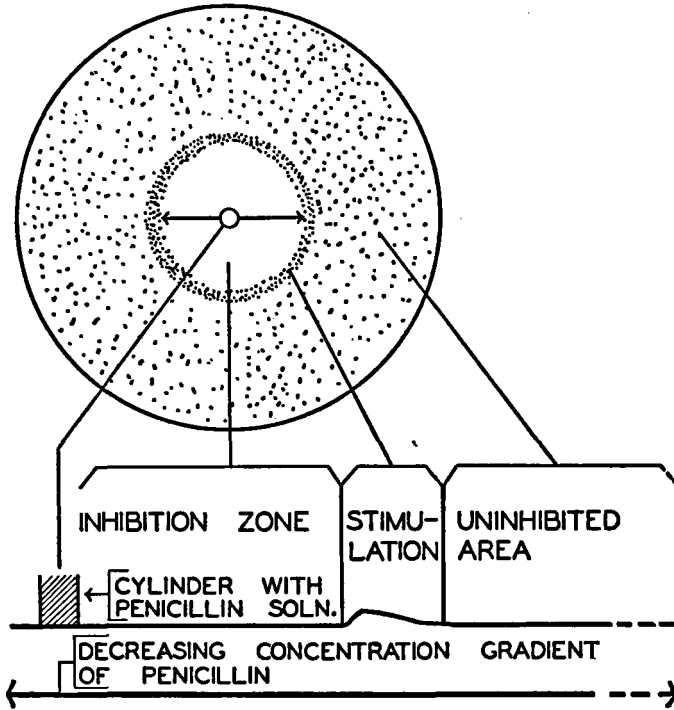

FIG. 7. Diagrammatic representation of a penicillin assay plate: surface view above; sectional view below. The cylinder containing a solution of penicillin is the center of a field of diffusion in which the concentration decreases with increasing distance from the cylinder. The ring of enhanced growth (stimulation) just beyond the site where the threshold concentration obtains is densely stippled, the unaffected area of normal growth is sparsely stippled. The surface of the agar in the region of stimulation is slightly elevated because the cells form a thicker growth in this area.

The results obtained by this method of testing show that down to a certain concentration the diffusing antibiotic interferes with the normal cycle of growth of the bacterial population. The ultimate expression of this interference becomes manifest as an "inhibition zone." At some infinitesimally lower concentration there is not only a normal amount of growth, but actually a stimulation of bacterial growth.

This abrupt change occurs at the threshold concentration. At higher concentrations apparently growth is inhibited. At lower concentrations normal growth occurs just as if no penicillin were present. It has been estimated that the threshold concentration of penicillin for *Staphylococcus aureus* on assay plates is between 6×10^{-4} and 6×10^{-3} micrograms per ml. (Pratt and Dufrenoy, 1948). This concept of a threshold concentration required to elicit a response in an organism to a change in its chemical or physical environment is common in physiology throughout the realm of nature. It is not limited to the response of bacteria to penicillin or other antibiotics. As a matter of fact, the phenomenon of a pain-threshold is the basis for testing the efficacy of analgesics. A rat or other appropriate animal is exposed to some stimulus capable of producing pain, and the intensity of stimulus required to produce a response is noted. Then the compound to be tested is administered and after sufficient time for absorption is allowed, the test is repeated. If the preparation is analgesic, a greater stimulus is required to evoke a response in the animal. The amount the threshold is elevated is considered a measure of the effectiveness of the product.

Likewise the phenomenon of low concentrations of a noxious substance increasing the activity of organisms is not peculiar to bacteria under the influence of antibiotics. It is the rule, rather than the exception, in nature. For example, alcohol and many other drugs in low concentration cause exhilaration and stimulation while higher concentrations cause severe depression of physiologic activity.

Not only does the threshold concentration define the discontinuity between "no growth" and "growth," but it also defines the demarcation between "no growth" under the effect of bacteriostatic concentrations and "enhanced growth" under the effect of an appropriate subbacteriostatic concentration. When this phenomenon was first noted for penicillin it was defined as the "biphasic effect of penicillin." As pointed out above, however, this effect is no special privilege or characteristic of penicillin. On the contrary it is a common

property of all agents capable of suppressing metabolic activity at low concentrations.

Optimal Concentration. It has been observed in laboratory experiments with penicillin *in vitro* that, under some conditions, inhibition or killing of bacteria by bacteriostatic or bactericidal concentrations is not always a direct function of concentration. Thus, several investigators from 1946 on have noted that bacteria may be killed more rapidly at a given, relatively low, cidal concentration than at a somewhat higher concentration. This work has been reviewed by Pratt and Dufrenoy (1948, 1949). The explanation for this apparently paradoxical situation will be discussed later in connection with the mechanism of penicillin action on bacteria (Chap. 11). It will suffice at this point merely to call attention to the fact that the doctrine "if a little penicillin is good, more will be better" is not always true. The concentration causing most rapid killing is called the optimum concentration. At lower and higher concentrations, still within the bactericidal range, the rate of killing may be markedly slower. This is illustrated in Figure 8.

This phenomenon is not peculiar to penicillin. It applies to a great many agents capable of affecting metabolic activity at low concentrations. As early as 1906 Richet considered this phenomenon as a "general law." This matter will be discussed below under the heading of "Dosage-response Curves" (Chap. 5).

In fact, intensive study of dosage-response curves, *i.e.*, the response evoked by different concentrations of compounds, played an important role in development of current standard methods of assaying biologically, not only penicillin, but a number of other antimicrobial agents of nonbiologic as well as of biologic origin. Of fundamental importance in the development of current methods was the introduction by Robert Koch [Fortschritte der Medizin, 1883 (Beilage 13) 1:103-106] of gelatin to "solidify" culture media for bacteria and the subsequent introduction of agar to replace gelatin by one of his assistants (*cf.* J. Bact. 35:21-22, 1938). Thus there became available a suitable surface on which to establish a field of diffusion and to

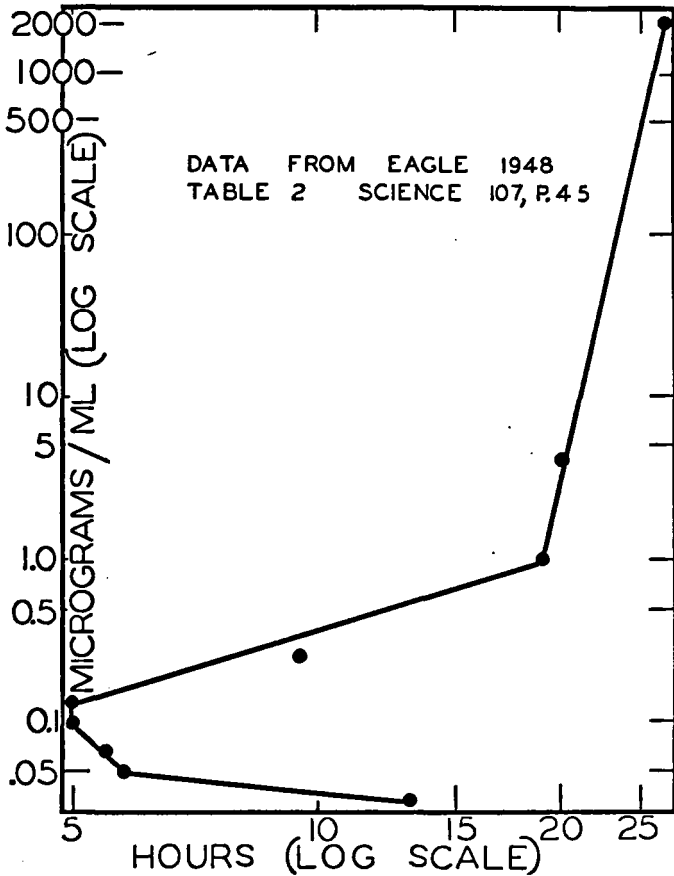

FIG. 8. Time required to kill 99.9 per cent of cells in cultures of *Staphylococcus aureus* exposed to different concentrations of penicillin. (Note that concentrations are expressed in micrograms per ml. To convert to Oxford units per ml. divide by 0.6.)

demonstrate that one micro-organism, producing a diffusible product, can exert an antagonistic (or beneficial) action on another through a measurable distance.

REFERENCES

- Dubos, R., 1939, Bactericidal effect of an extract of a soil bacillus on Gram-positive cocci, *Proc. Soc. Exper. Biol. Med.*, 40:311-312.
- Dubos, R., 1939, Studies on a bactericidal agent extracted from a soil bacillus, *J. Exper. Med.*, 70:1-17.
- Dubos, R., and Avery, O. T., 1931, Decomposition of the capsular polysaccharide of pneumococcus type III by a bacterial enzyme, *J. Exper. Med.*, 54:51-71.
- Pratt, R., and Dufrenoy, J., 1948, Cytochemical interpretation of the mechanism of penicillin action, *Bact. Revs.*, 12:79-103.
- Pratt, R., and Dufrenoy, J., 1949, Recent research on penicillin action, *Texas Reports Biol. & Med.*, 7:180-219.
- Pratt, R., 1948, Studies on *Chlorella vulgaris* XI. Relation between surface tension and accumulation of chlorellin, *Am. J. Bot.*, 35: 634-637.
- Richet, C., 1906, De l'action des doses minuscules de substances sur la fermentation lactique. Périodes d'accélération et de ralentissement, *Arch. intern. physiol.*, 4:18-50.
- Stewart, J. Q., 1948, Concerning "Social Physics," *Sci. Am.*, 179: 14-17.
- Waksman, S. A., 1948, Antibiotics, *Biol. Revs. Cambridge Phil. Soc.*, 23:452-487.
- Weindling, R., 1934, Studies on a lethal principle effective in the parasitic action of *Trichoderma lignorum* on *Rhizoctonia solani* and other soil fungi, *Phytopath.*, 24:1153-1179.

Science is the soul of the prosperity of nations and the living source of all progress. . . . What really leads us forward are a few scientific discoveries and their application.

—L. PASTEUR (1822-1895)

CHAPTER

3

Industrial Production and Control of Antibiotics

Observation and recording of natural and social phenomena comprise only one phase of scientific work. These occupations are important, but are of value only inasmuch as they provide foundations on which to construct coherent theories that lead to discovery of "laws" that operate in the natural and social sciences and that may be applied ultimately to further human progress and to alleviate suffering.

THE CONCEPT OF CHEMOTHERAPY

It has long been the dream of mankind to find specific chemotherapeutic agents for the cure of various ailments to which the race is subject. This idea was expressed clearly and picturesquely by Paul Ehrlich who stated that the goal of chemotherapy is to treat diseases "by magic bullets which strike only those objects (i.e., the invading pathogens) for whose destruction they have been produced." A concept of fundamental importance is implied in this statement, namely, specificity of action against the pathogen, and a correlative lack of toxic action on the host. This ideal had already been partially attained at the close of the nineteenth century in the treatment of some protozoan infections (quinine for malaria, emetine for amoebic dysentery, and organic arsenicals for syphilis), but systemic infections due

to bacteria remained outside the range of chemotherapy until 1935-1936 when Domagk suggested therapeutic use of the sulfonamide drug, Prontosil, for various bacterial infections and Fournau et al. showed that the sulfonamides embody a molecular configuration possessing the specific property of blocking some vital metabolic processes in certain pathogenic bacteria without fatally interfering with the life processes of the patient. However, although the discovery of the antibacterial properties of the sulfonamides was a long step forward in man's war against pathogenic bacteria, these drugs were not ideal. It has been pointed out (Chap. 1), that in some patients the sulfonamide drugs produce serious untoward reactions, that a number of strains of bacteria are naturally resistant to the action of sulfonamides, that other strains initially susceptible to the drug may rapidly develop resistance, and that the antibacterial action of the "sulfas" is markedly reduced when large numbers of bacteria are present, or in the presence of pus, serum, dead bacteria, etc. Thus the search continued.

Ehrlich's dream seems finally to have come nearer materialization with the chemotherapeutic application of penicillins which, at optimal concentrations, hit a specific target, namely, an enzymatic system of the pathogen, thereby starting a chain of reactions detrimental to the invader without affecting the host tissues menaced by the invasion. The discovery of the penicillins which are so effective against Gram-positive pathogens while exhibiting virtually no toxicity for the host (except in the cases of the relatively small percentage of allergic individuals) did much to renew interest in micro-organisms as potential sources of chemotherapeutic agents. Despite intensive searching for new antibiotics, however, the penicillins, of which there are many, still come closest to the ideal "magic bullet." Although many other antibiotics have been isolated, few of them known thus far seem to possess the specificity of action combined with the same degree of lack of toxicity that is characteristic of the penicillins.* Indeed, it seems possible that the lack of toxicity of penicillins for the host may

* See chloromycetin, Chapter 7.

be a consequence of the specificity of their antibacterial action (see Chap. 11).

It should be pointed out that the concept of chemotherapy (literally treatment of disease by chemical agents) differs fundamentally from the concept of prophylaxis (derived from the Greek and meaning literally to guard against). The former aims at suppressing the causal organism of a disease by agents that act specifically on the pathogen without involving the host. The latter aims at enabling the host to successfully fight acute infections by building up a reserve of the antibodies necessary to battle against invading pathogens before an acute infection is incurred.

REQUISITES FOR AN IDEAL ANTIBIOTIC

There are a number of qualities that a potential antibiotic must possess in order to be considered generally useful. These may be considered under two categories, (1) the industrial point of view and (2) the clinical point of view.

1. Industrial point of view

- a. The antibiotic should be obtainable on an industrial scale from biosynthesis in an inexpensive culture medium or, alternatively, from chemical synthesis (see Chap. 7).
- b. A relatively short fermentation period (preferably not more than two or three days) should suffice for reasonably good production.
- c. The antibiotic should be obtainable from submerged cultures in large tanks. Its production should not require individual handling of many separate cultures growing on the surface of liquid or solid culture media.
- d. At the end of the incubation (fermentation) period, the antibiotic should be present in the culture liquor, not "locked" in the cells of the organism producing it.
- e. The antibiotic should be soluble in water.
- f. The antibiotic should be recoverable from the culture liquor by solvent-extraction or by adsorption and elution technics.

- g. The antibiotic should be stable against destruction by heat, acid, alkali, light, enzymes, etc.

2. Clinical (medical) point of view

- a. The compound should be soluble in water and in physiologic saline.
- b. The compound should have a broad antibiotic spectrum, i.e., it should be antagonistic to a large number of pathogenic species, preferably of different physiologic groups (see Chap. 4 for further discussion of this point).
- c. The compound should be nontoxic for the host.
- d. It should be active against micro-organisms at pH values near neutrality.
- e. It should be nonproteinaceous.
- f. The antibiotic activity of the compound should not be reduced in the presence of pus, serum, large numbers of bacteria, or other conditions commonly encountered in infectious diseases.
- g. Organisms initially sensitive to the antibiotic should not readily develop resistance to its action.

Of course in the final analysis, the clinical considerations are as important to a manufacturer as the industrial considerations, since they bear directly on the economic future of the product. There is little incentive for a manufacturer to invest large sums of money for equipment and personnel to produce an item that will not find general acceptance or wide use.

Probably comparatively few, if any, antibiotics will be found to possess all the attributes deemed desirable. Still an antibiotic may be a very valuable chemotherapeutic agent, viz., streptomycin, if it meets only a few of the prerequisites listed above. Of the antibiotics known at the present time, the penicillins (and perhaps chloromycetin) most nearly satisfy the prerequisites for an "ideal" antibiotic. The usefulness of both of these antibiotics is limited, however. The principal value of chloromycetin is due to its therapeutic effectiveness in

rickettsial infections (Chap. 7). The penicillins are usually active against Gram-positive bacteria but are not considered effective against most infections due to Gram-negative bacteria, to protozoa, to viruses, or to rickettsias, with the notable exception of gonorrhoea, caused by Gram-negative gonococci, and of psittacosis or parrot fever, which is caused by a virus.

Clinically, therefore, the choice of an antibiotic is made according to the kind of micro-organism responsible for the infection to be treated. Thus, if the infection is due to Gram-positive bacteria, a penicillin is generally first choice; if infection is due to a Gram-negative organism, a form of streptomycin or perhaps polymyxin is selected; aureomycin or chloromycetin is prescribed for treatment of rickettsial infections. This is not meant to imply that there is no cross-activity among antibiotics, nor is it meant to imply that a given antibiotic is equally effective against all species of micro-organisms of a given class. For example, some Gram-positive bacteria are inhibited by streptomycin and a number of bacterial species are inhibited by chloromycetin and aureomycin (Chap. 7); within a given group of micro-organisms different species, or even different strains of a single susceptible species, may evidence considerable difference in sensitivity to the antagonistic action of a given antibiotic. This subject is treated in subsequent chapters under the heading of Antibiotic Spectrum and in the discussion of individual antibiotic agents.

INDUSTRIAL PRODUCTION OF ANTIBIOTICS

The problems involved in the production of all antibiotics are essentially similar. Of course there are specific problems attending the production of each different antibiotic, but in the main, the kinds of problems are the same; the differences are principally ones of degree. No attempt will be made here to discuss the technical details encountered in preparing each antibiotic for its ultimate use in medicine. Instead a broad outline of the general steps applicable to the production of all antibiotics will be presented, and the steps will be

illustrated, where necessary, by specific procedures employed in the manufacture of penicillin for medicinal use.

The preparation of antibiotics can be separated into five stages. For convenience, these can be labeled (1) preparation of inoculum or "seed," (2) biosynthesis, (3) extraction, (4) purification, and (5) testing.

Preparation of Inoculum or "Seed." Antibiotics are produced during the course of the growth and development of certain micro-organisms in or on an appropriate nutrient medium. To obtain the maximum yield of a desired antibiotic in a reasonable length of time, it is important first, that a pure culture, i.e., one containing cells of only the producing organism, be used to inoculate or "seed" the fermentation medium, second, that the medium be sterile, and third that an adequate amount of inoculum or "seed" be introduced into the medium.

Selection of an appropriate strain of micro-organism is of prime importance. This is abundantly evident from consideration of the history of penicillin production. The first strain of *Penicillium notatum* that was used commercially produced a maximum yield of about 100 units* penicillin/ml. under conditions of commercial production. Furthermore, it produced industrial yields only when grown on the surface of culture media, a factor which seriously limited output and contributed to high production costs. Subsequently, strains of *Penicillium chrysogenum* were isolated which were capable of producing similar yields in submerged cultures, i.e., in large tanks containing thousands of gallons of fermentation liquor which was continuously agitated by propellers and finely dispersed sterile air under high pressure. One such strain was designated 1951. Almost immediately attempts were made to isolate strains capable of greater penicillin production and to artificially induce development of higher yielding mutants. Various technics were used, but the most notable advances were made by exposing cultures of the parent strain to X-ray and

* One unit of pure benzyl penicillin equals 0.6 microgram. For further discussion see page 44.

to ultraviolet radiations, and then starting new colonies from individual spores isolated from the irradiated cultures. More than 10,000 mutant strains isolated from single spore cultures of this kind were examined. Some produced no penicillin, some produced as well as but no better than the parent strain, but a few gave superior yields. One strain (designated 1951·B25) was isolated which was capable of producing about 250 units of penicillin/ml. in the same culture medium. X-irradiation of this strain yielded many mutants, one of which (X-1612) was capable of producing 500 or more units/ml. under industrial conditions. Treatment of strain X-1612 with ultraviolet radiations yielded another string of mutants, among which one, designated as Q-176, was found to yield 900 to 1000 units/ml. in the same relatively simple and inexpensive culture medium. This is the strain which is currently used by most manufacturers for production of penicillin. Further increases in yield have subsequently been made by modifying the composition of the fermentation liquor in which the mold is produced (see Chap. 5).

The sequence of these events and their effect on the total output of penicillin is shown in Figure 9. It should be pointed out, however, that improved strains were not alone responsible for the tremendous increase in production that is recorded. Substitution, in 1944, of "submerged culture" technics for the original "surface culture" methods made possible much more efficient operating methods. This change became possible, however, only with the introduction of the new strains of mold which are amenable to submerged culture. From statistical data available from a penicillin plant,* it may be estimated that conversion from "surface" to "submerged" fermentation increased the amount of penicillin produced 20-fold in terms of space required for biosynthesis, and 72-fold in terms of man hours. Total industrial output was further increased by more and larger fermentation tanks being placed in operation at various plants throughout the United States.

* Data kindly made available by the Cutter Laboratories, Berkeley, California.

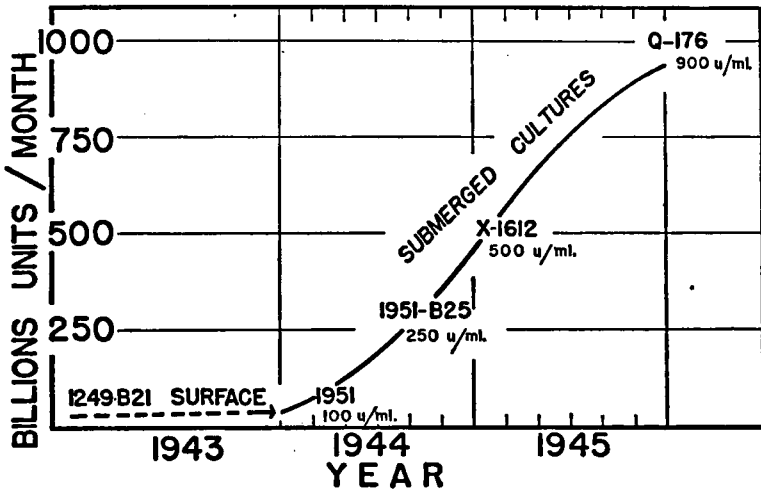

FIG. 9. Total monthly production of penicillin in the United States from 1943 to 1945 and the approximate times at which several different mutant strains derived from *Penicillium chrysogenum* 1951 were introduced in industrial production. Submerged culture technics were first used for biosynthesis of penicillin in 1944. (See text for further explanation.)

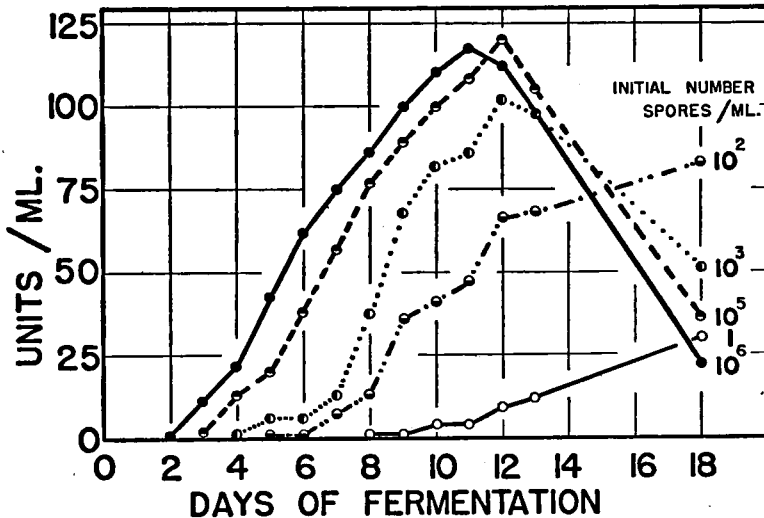

FIG. 10. Influence of initial number of spores of *Penicillium notatum* in a rich culture medium on the production of penicillin. (Data from surface culture experiments.)

With the increase in volume of fermentation medium to be inoculated, the production of sufficient material for inoculation itself became an industrial problem. The problem of inoculation is two-fold. As shown in Figure 10, the rate of synthesis in a given volume of medium is, within limits, a function of the amount of the inoculum.

However, high yields can be obtained only as long as the "seed" material maintains its high-yielding capacity. Successive transfer of mycelium and spores from one production tank to another often results in reduction of yield. This "run-down" of strains has been troublesome in industrial production of penicillin, and even more so in production of streptomycin. This creates the problem of maintaining stock cultures and protecting them against deterioration. Although "cross-inoculation" from a tank of fermented medium to one containing medium to be fermented may be used successfully for a limited number of transfers, most producers consider it advantageous to resort periodically to a freshly prepared inoculum.

Many fungi and bacteria may be stored in a quiescent state for several years if kept dry at a low temperature. Cultures may be lyophilized, i.e., dried rapidly by evaporating the water at a low temperature under vacuum in a tube or other suitable vessel, which is then hermetically sealed.

"Seeding" material retaining the properties of the original culture can be prepared as needed by transferring some of the contents of the tube to a suitable nutrient medium. In industrial practice, inoculum or "seed" for several thousand gallons of liquor is obtained stepwise: a culture of *Penicillium* started from a few lyophilized spores on an appropriate nutrient agar substratum produces abundant mycelial growth and several million spores in four to five days when incubated at approximately 25° C. The spores are washed off in sterile water or nutrient solution and the resulting spore-suspension provides an inoculum for several gallons of culture medium. After proper incubation for a few hours under forced aeration this culture is used to "seed" large fermentation tanks.

Biosynthesis. The elaboration of organic compounds from less

complex compounds by living organisms is termed biosynthesis. This may involve the mere linking together of two or more preformed moieties of the more complex molecule or some relatively simple molecular rearrangement; but in many instances organisms biosynthesize complex organic molecules from relatively simple inorganic materials. The process of photosynthesis, on which all our industries, arts, and sciences depend directly or indirectly, is an outstanding example of biosynthesis in which the chlorophyll-bearing parts of the plants, utilizing radiant energy of appropriate wave lengths, succeed in compounding carbon dioxide and water into saccharides. Likewise, proteins, fats, and vitamins, as well as alkaloids, glycosides, and other important classes of drugs are biosynthesized from less complex materials by living organisms.

Although synthesis of penicillin in the laboratory has been reported, the method is not commercially feasible at the present time. Currently, the fundamental step in industrial production of most antibiotics is a biosynthesis performed by an appropriate strain of micro-organism cultured in a suitable nutrient medium, generally in tanks or fermenters ranging in size from several hundred to 20,000 gallons capacity (see Fig. 11 and Plate 1).

The organisms are carefully selected and the composition, pH, temperature, and aeration of the medium are carefully regulated, since these are all factors of the utmost importance in determining the ultimate yield of the crude antibiotic that will be obtained from the culture. Some of these, such as control of temperature and aeration, present difficult engineering problems, and the current great production of antibiotics is an attainment achieved by co-ordinated research and close collaboration of microbiologists, chemists, physicists, and engineers.

The submerged fermentation technic makes it possible to provide, throughout the fermentation cycle, the optimal conditions for rapid production of the desired antibiotic. Following initial compounding and sterilization, the fermentation medium can, at any time, be adjusted to the desired pH or rH, and can be continuously aerated and

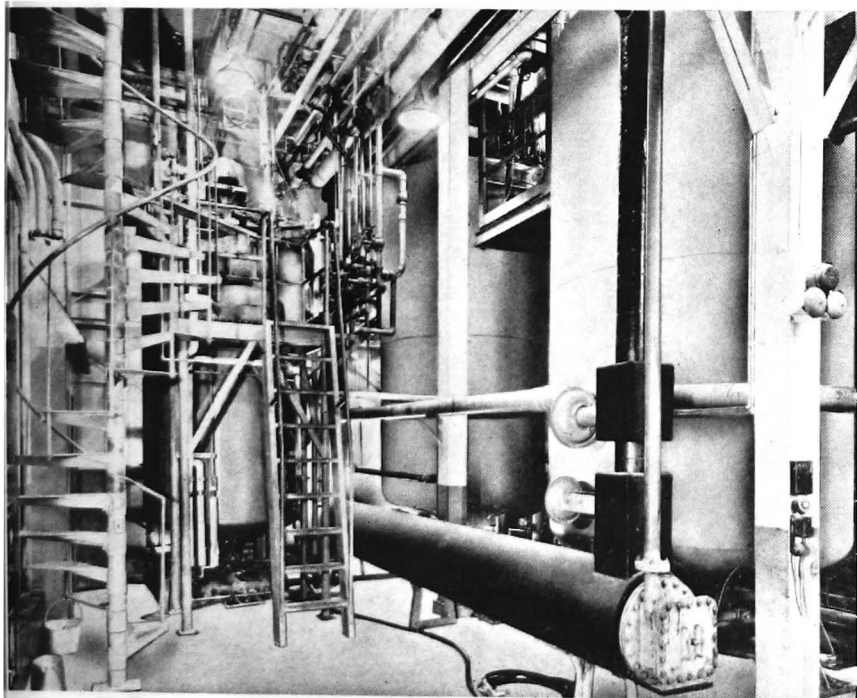
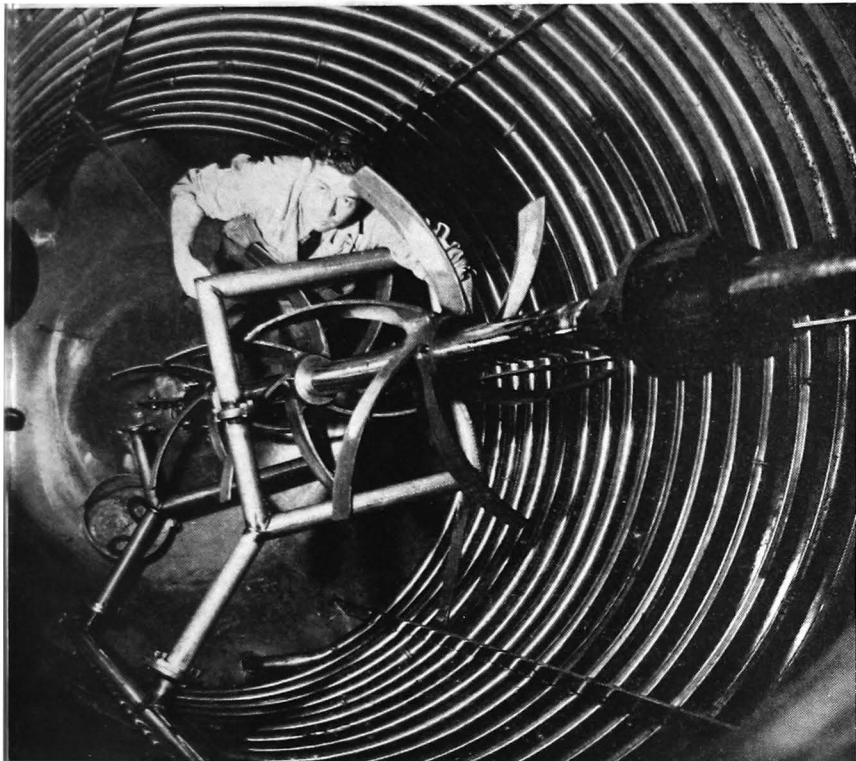

PLATE 1. Industrial fermenters of type used for biosynthesis of antibiotics. (*Top*) Interior view of one of the 5,000 gallon fermenters shown at bottom. (Cutter Laboratories)

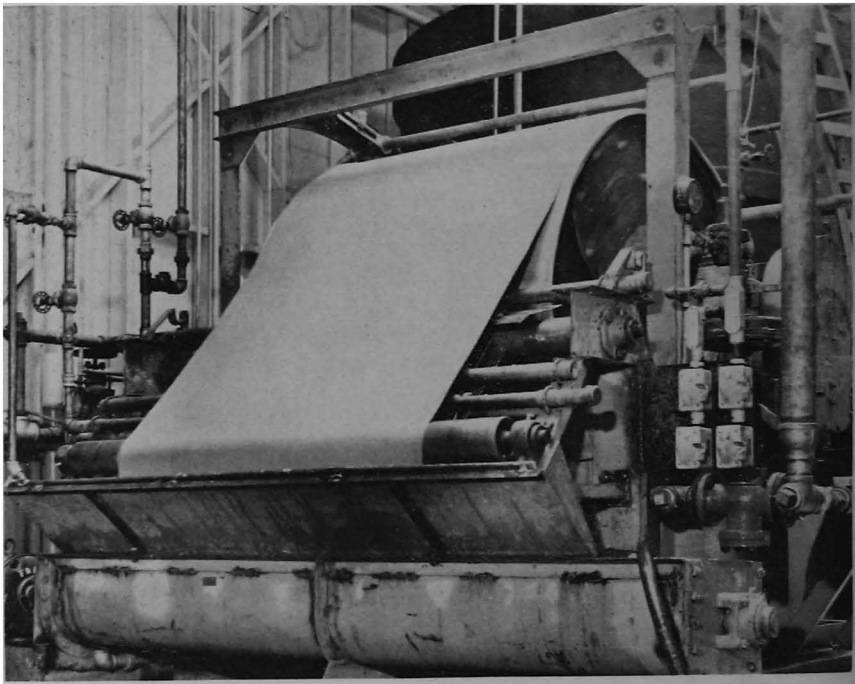
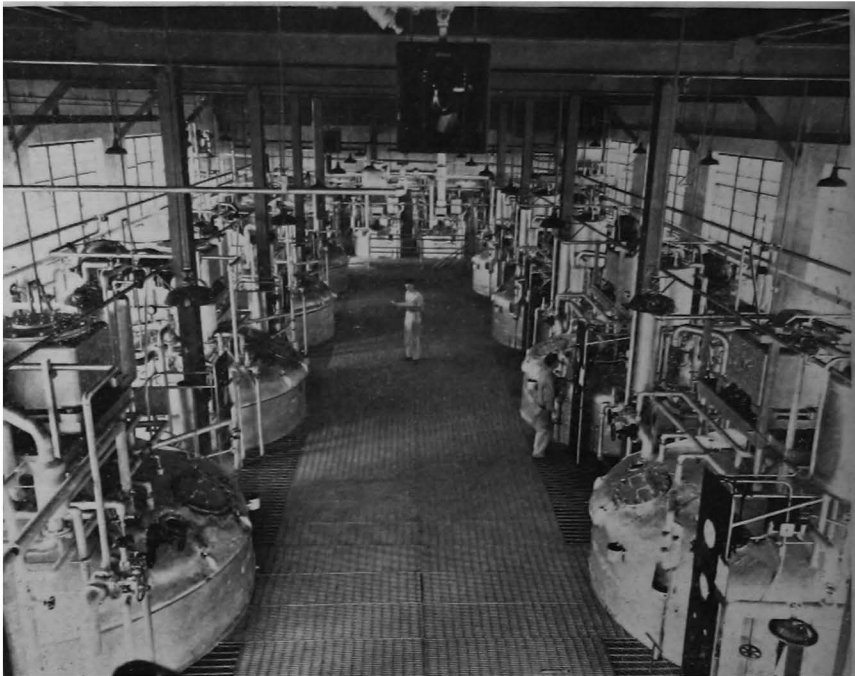

PLATE 1 (Continued). (Top) General view of battery of fermenters used for industrial production of antibiotics. (Merck Institute for Therapeutic Research.) (Bottom) Removal of penicillin from crude fermented liquor by rotary drug filter. (Cutter Laboratories)

stirred. Moreover, various chemical groupings that the organism can incorporate into the desired antibiotic molecule can be added to the medium periodically or continuously throughout the fermentation cycle, thereby increasing the yield. All these processes are carried

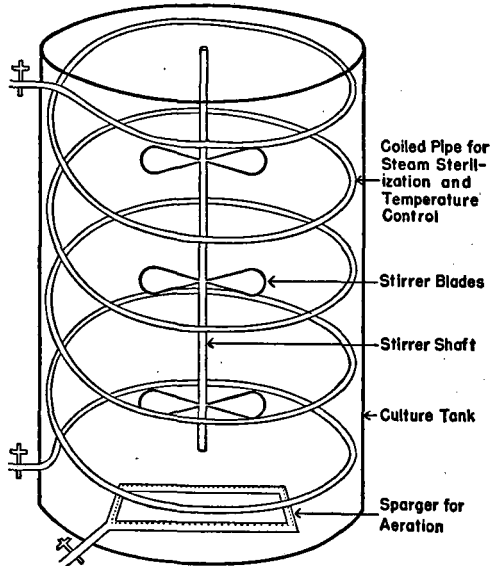

FIG. 11. Simplified diagrammatic representation of essential features of culture tank for production of penicillin and other antibiotics by submerged culture technic. Sterile air is introduced under pressure in a highly dispersed state through the sparger. The mold and other solids in the culture medium are kept suspended by the stirrer. Sterilization is effected by running steam through the coiled pipe. Since the tank is hermetically sealed, the temperature and pressure may be raised so that the fermenter becomes, in effect, a huge autoclave. After sterilization, the medium can be cooled rapidly by circulation of cold water through the pipes. The temperature of the medium can be regulated during incubation by circulation of hot or cold water in the pipe, as required. (See Plate 1 for photograph of tank.)

out under adequate protection from contamination by other micro-organisms.

The micro-organisms that are used currently for industrial production of antibiotics lack the ability to sustain themselves and to grow in a purely inorganic medium, that is to say, they are heterotrophic. This is in contrast to the autotrophic chlorophyll-bearing plants (and a few isolated species of sulfur bacteria and iron bacteria) which are able to obtain all the energy required for their metabolism from oxidation of inorganic substrates and are capable of biosynthesizing organic molecules from inorganic materials. Some heterotrophic organisms can satisfactorily produce the proteins, amino acids, fats, vitamins, etc., required for their growth if a suitable organic source of carbon (such as sugar, glycerol, starch, etc.) is provided, but other organisms are more fastidious and require also an external organic source of nitrogen (as from proteins or amino acids) and in extreme cases they fail to grow unless vitamins and other complex growth factors are provided in the medium.

With regard to nitrogen metabolism, some species of micro-organisms can utilize $-\text{NO}_3$, $-\text{NO}_2$, $-\text{NH}_3$, or $-\text{NH}_2$ as sources of nitrogen; others can utilize nitrogen only from $-\text{NH}_3$ or $-\text{NH}_2$; and some can use only $-\text{NH}_2$ incorporated in the proper stereochemical configuration, as in specific amino acids.

With regard to sulfur metabolism, some species of micro-organisms are able to utilize sulfur in various stages of oxidation, as in $-\text{SO}_4$ or $-\text{SO}_3$; others require reduced forms of sulfur. In the latter case they may metabolize S only from sulfides or they may require sulfhydryl sulfur ($-\text{SH}$) properly embodied in amino acids or in growth factors.

To biosynthesize an antibiotic at a rate compatible with industrial production, most micro-organisms require a richer and more complex medium than is required merely for their growth. For example, suitable strains of *Penicillium* species biosynthesize penicillin in a medium consisting only of minimal concentrations of appropriate inorganic sources of hydrogen, oxygen, phosphorus, sulfur, potassium,

magnesium, and nitrogen with traces of iron, copper, and zinc, plus a sugar or other suitable organic carbon compound. But in commercial practice, production is accelerated and increased by providing the organism with more than the minimal requirements and by addition to the medium of a compound that provides in its molecular structure a configuration that can be embodied as such into the penicillin molecule. Such a compound affords an example of a precursor, of which numerous examples are known, not only for the biosynthesis of penicillin and other antibiotics, but also for elaboration of other organic products. Not all compounds capable of accelerating growth or output of antibiotics by micro-organisms can be used in industrial practice because some of them contribute constituents which are difficult to remove from the finished product and may be responsible for untoward effects in the patient to whom the antibiotic is administered.

Selection of precursors depends on the antibiotic to be produced and on the strain of mold or bacterium that is being used. This problem is discussed in later chapters in connection with specific antibiotics. In a given species, the more efficient strains for production of a given antibiotic are those which consume less material and energy in growth and shunt more material and energy into the chain of reactions involved in biosynthesis of the desired compound.

Micro-organisms used currently for the production of antibiotics are aerobes, i.e., they must have access to atmospheric oxygen in order to carry on the normal respiratory activities from which is derived the energy required for their growth and for the biochemical reactions involved in maintenance of all their metabolic activities. Therefore, when these organisms are grown under submerged conditions, atmospheric oxygen must be provided by forced aeration throughout the liquid. In practice, sterile air is forced into the fermenters under pressure. Maintenance of a higher pressure within the fermenters than outside tends to prevent air-borne micro-organisms from entering and contaminating the cultures. This technic is not new nor peculiar to the production of antibiotics, having been employed at least 40 years ago in various industrial fermentations. The

importance of aeration in production of antibiotics by submerged fermentation is indicated in Figure 12 which shows the relation of the maximum yield of penicillin to rate of aeration in a typical experiment.

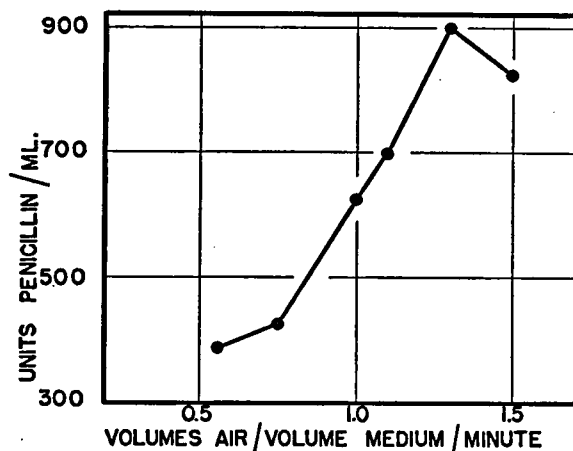

Fig. 12. Influence of rate of aeration on yield of penicillin by *Penicillium chrysogenum* Q-176 in 500-gallon fermenters. Yields of penicillin are shown on the ordinates. Abscissas indicate rate of aeration in volumes of air per volume of culture liquor per minute, in other words, gallons of air forced through the liquor each minute for each gallon of liquid.

For most rapid biosynthesis of penicillin more than one volume of sterile, humidified air under pressure must be forced into the tank every minute for each volume of medium. Intense bubbling of finely dispersed air and rapid mechanical agitation by stirrers prevent the mycelium from forming a continuous felt or mat at the surface, as is the normal habit of the molds. Instead, the mycelia form innumerable separate spherical colonies.

Extraction and Purification. The first step in recovery of antibiotics from the fermented culture liquor is elimination of the microorganisms by use of appropriate filters or centrifuges. A rotary drum

filter which is commonly used for effecting separation of mycelia from fermented liquor is diagrammed in Figure 13, in the legend for which the principles of its operation are given. A photograph of the apparatus is reproduced in Plate 1.

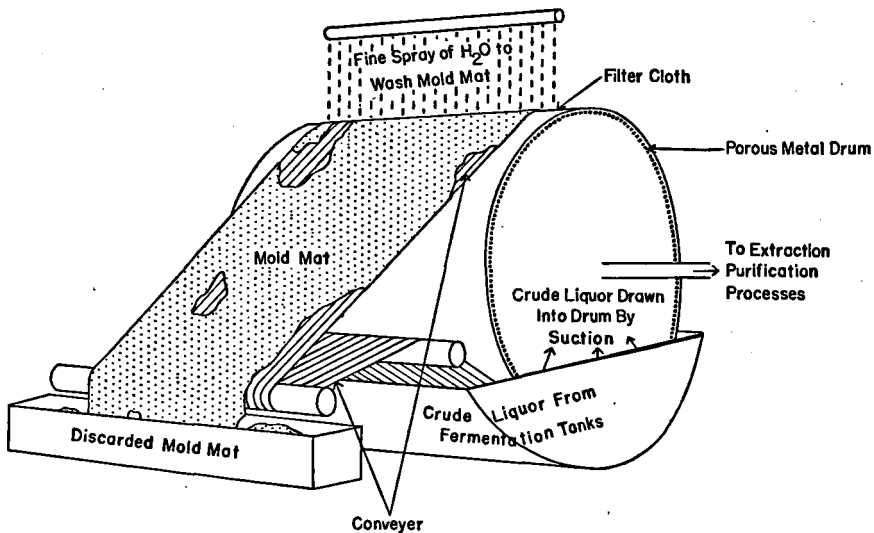

FIG. 13. Rotary drum filter for removal of the mycelium and other solid matter from fermented culture medium prior to extraction of penicillin. This device is, in effect, a huge Buchner filter. The crude liquor is piped into a trough into which a large, porous, metal drum covered with fine cloth dips. As suction is applied to the drum, the liquid enters it and the solid matter is deposited on the cloth. The drum rotates in a counter-clockwise direction and the solid matter is carried off on a conveyer that consists of a number of strands of twine or fine wire wrapped around the cloth cover and threaded over rollers as indicated. (See Plate 1 for a photograph of this device.)

Recovery of the antibiotic from the filtrate is accomplished by one or more physicochemical methods that depend upon adsorption and elution or ion exchange technics or on partition coefficients of acid and basic forms of the antibiotic between water and organic solvents at different pH values. Electrodialysis has also been used as a means of separating antibiotics from impurities, especially pyrogenic materials. The details of the procedures used are determined according

to the antibiotic being processed, and often industrial processing of a single antibiotic brings into play all of these phenomena. In some cases, the antibiotic is crystallized repeatedly from different solvents until a product of the desired purity is obtained. The crystalline or amorphous final product must be obtained aseptically from a solution made sterile by passage through a bacteriologic filter, or it must be sterilized by some appropriate method. Finally, the sterile product must be freed aseptically of water or other solvents. This is commonly accomplished by lyophilization, particularly for those antibiotics that are readily destroyed by heat.

Testing. Before entering commerce for medicinal use, antibiotics must pass tests for potency, sterility, safety (toxicity), clarity, absence of pyrogens, and moisture content. Special pharmaceutical preparations may be required to pass additional tests such as stability, pH, particle size, and duration for which a therapeutic concentration of the antibiotic exists in the blood following a single dose. Chemical, physical and biologic methods are employed in carrying out these tests.

POTENCY TESTING. The goal in pharmacy and medicine, with respect to administration of drugs, is always to administer a definite weight or volume of a chemically defined compound. However, no antibiotic thus far used therapeutically was chemically pure when first introduced into medical practice. Therefore, the dosage has been designated in units of activity against some test organism rather than on a weight basis. In some instances, as in the case of penicillin, doses are still prescribed in terms of "units" even though the chemically pure compound is available.

Expressing the potency of a product in units of activity implies measuring the potency in terms of an effect on some living system, in other words, by means of a biologic assay. The principle on which bio-assays are conducted is that equivalent doses of a given drug will exert approximately equal effects in similar populations of the same species of living organisms. Although higher plants and animals are used as test organisms for assaying several drugs, there has been a growing tendency in recent years to resort, wherever possible, to

microbiologic assays, i.e., bio-assays in which micro-organisms are used as the test objects. In such assays it is important that the test be performed on populations as homogeneous as possible with respect to the response that is used as a criterion of activity. To insure such homogeneity, care must be exercised to use only pure cultures of a properly defined strain of organism and to conduct the tests only on cultures of similar physiologic activity. To accomplish this it is imperative that the organisms be cultured under rigidly controlled conditions of temperature, pH, humidity, and composition of nutrient substrate, and that they be used only when at a definitely specified phase of their growth cycle.

Since an antibiotic is used clinically as a chemotherapeutic agent, its potency is best expressed in terms of the response of a given microbial test organism to a given dosage of the antibiotic. Microbiologic assays of antibiotics, such as penicillin, are simplified by use of technics in which an "all-or-none" effect can be observed, that is to say, by observing the minimum concentration of the antibiotic required to prevent growth. This minimum must be reached but need not be exceeded to cause inhibition. It may, therefore, be defined as a threshold concentration. The threshold concentration defines the dosage level at which there is an abrupt change from no inhibitory effect to full inhibitory effect (Chap. 2). It is apparent, therefore, that it is important clinically to ensure exposure of the disease-causing organism to the threshold concentration for an adequate period of time, and that, this being achieved, no additional benefit can be anticipated from maintaining higher concentrations. As a matter of fact, some antibiotics may be less effective at extremely high dosage levels than at the threshold dosage necessary and sufficient to cause inhibition (see Chap. 2 and later sections of the present chapter). For a given organism, the threshold concentration is different for each antibiotic, and for a given antibiotic is different for different species or strains.

The threshold concentration can be determined experimentally by serial dilution or by cylinder- or cup-plate technics.

In the standard serial dilution methods several tubes, each containing initially the same number of bacterial cells and the same volume of broth, but differing in the amount of antibiotic dissolved therein, are incubated long enough for all uninhibited cultures to evidence growth, which becomes manifest by development of turbidity in the broth due to the increased number of cells suspended therein. The incubation period may vary from a few hours to several days or even weeks, depending on the test organism that is used. In any case the threshold concentration is defined as the lowest concentration of antibiotic that prevents development of cloudiness in the broth. The threshold may be defined also in terms of inhibition of any detectable cellular activity associated with the growth of the test organism, such as hemolyzing activity of streptococci, coagulating activity of lactobacilli, or proteolytic activity of lactococci.

Historically, one unit of penicillin was defined as the minimum amount of the antibiotic which would just inhibit the growth of a prescribed strain of *Staphylococcus aureus* in 50 ml. of nutrient broth under specified conditions. Thus, a preparation, one ml. or one mg. of which would prevent growth of the test organism when dissolved in as much as, but no more than, 50 ml. of the standard broth, was considered to have a potency of one unit per ml. or per mg., as the case might be. Correspondingly, if a like amount of the preparation caused inhibition when diluted to as much as but not more than 500 ml., it had a potency of 10 units per ml. or per mg.

The serial dilution technic at best yields an approximate value, since it merely locates the threshold as lying between two terms of a discontinuous series. Thus, if each tube contains 50 ml. of broth and each dilution in the series is twice the preceding one (i.e., the series of concentrations is x , $x/2$, $x/4$, $x/8$, $x/16$. . . etc.) and growth occurs in the tube $x/32$ but not in tube $x/16$, one can merely say that the concentration in the unknown is at least 16 units/ml. and is less than 32 units/ml. Finer definition can be obtained by decreasing the intervals between dilutions, but obviously this is costly in time and labor.

It is possible, however, at least in the case of antibiotics capable of diffusing in an aqueous gel (see Chap. 2), to use the threshold concentration to define a continuous dosage-response curve, as shown in the following discussion of Figure 14.

In the series of tubes, containing solutions with concentrations x , $x/2 \dots x/128$ of the antibiotic, growth occurs in tubes containing concentrations of $x/128$, $x/64$, and $x/32$ but not in tubes with con-

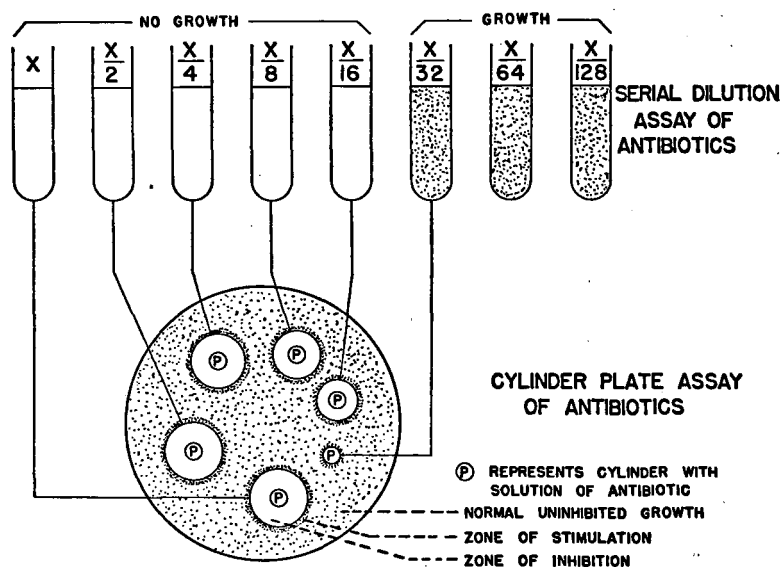

Fig. 14. Diagram to show relationship between results obtained by serial dilution assays of antibiotics and results obtained by the cylinder-plate technic. (See text for further explanation.)

centrations $x/16$ to x . If the undiluted solution (concentration x) or any dilution of it up to and including $x/16$ is placed in a cylinder and permitted to diffuse through an agar surface which is seeded with the test organism, growth will be evident, after a period of incubation, all over the plate except within the areas where the threshold concentration has been equalled or exceeded. Assuming for the present discussion that the threshold concentration is the same on such assay

plates as in broth cultures, there would be no inhibition zone around a cylinder containing solution $x/32$ or higher dilutions, but zones of inhibition would be apparent around cylinders from which solutions containing $x/16$ or lower dilutions were diffusing, and the diameter of the zone of inhibition would be increasingly larger as the solution was less dilute, within certain limits. Within these limits there is a

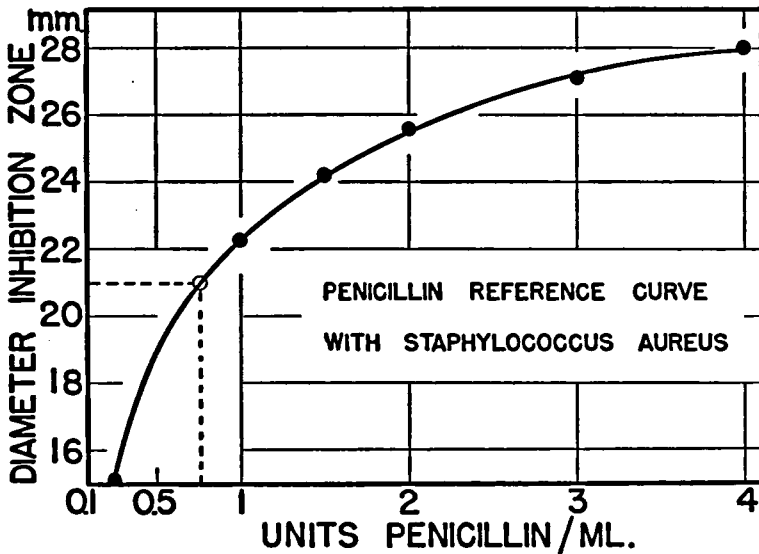

FIG. 15. (Solid circles and curve). Reference dosage-response curve for penicillin assays performed by the standard 16-hour cylinder-plate technic employing *Staphylococcus aureus* as the test organism. The open circle and dashed lines indicate method of ascertaining concentration of an "unknown" solution of penicillin by interpolation. (See text for explanation.)

simple relationship between the diameter of the zone of inhibition and the concentration. Thus, a dosage-response curve or "reference standard curve" can be constructed. Such a standard curve for penicillin is shown in Figure 15.

Although variations in intangible factors that are difficult or impossible to control may cause minor variations from day to day in the

response to a given dosage, the responses to other dosages are affected accordingly: thus the dosage-response curve may be displaced upward or downward on the ordinate scale, but its shape is not distorted. Therefore, to perform an assay by the cylinder-plate technic, it is necessary to determine the position of the curve by measuring the zone produced by a solution of known concentration. Then the concentration of an "unknown" solution may be determined by noting the diameter of the inhibition zone it produces and interpolating on the standard reference curve. The standard dosage-response curve is seldom linear when plotted arithmetically. The standard reference curve for the conventional cylinder plate assay of penicillin (Fig. 15), for example, tends to become asymptotic with respect to response elicited at dosage levels above 3 or 4 units/ml. In dealing with such antibiotics, it is necessary to dilute concentrated solutions before assaying them. Of course, the dilution must be taken into account in calculating the actual potency of the original undiluted solution. If the sample has been diluted N times, the value read by interpolation must be multiplied by N . For example, if a solution known to contain one unit of penicillin/ml. produced a zone of 22.3 mm. in diameter and the solution to be assayed produced a zone 21 mm. in diameter in the same assay, reading from the curve (Fig. 15), one would ascertain that the sample of "unknown" placed in the cylinder contained 0.75 units/ml. If this sample were a 1/100 dilution of the original preparation, the concentration of that original would be determined as 75 units/ml. If the sample were a 1/10 or a 1/1000 dilution, the concentration of the original would be 7.5 or 750 units/ml., respectively.

It is not necessary to use cylinders on assay plates. Any suitable reservoir may be substituted, provided it permits diffusion of the solute and prevents spreading of the solution over the surface of the plate. For example, a drop of the solution to be tested can be deposited on a disk of filter paper (of standard size and quality) placed on the surface of the test agar. The "paper disk" method demands precise measurement of the volume of solution, since the diameter of

the inhibition zone is a function of the total amount of active substance placed on the disk. The volume of test solution is less critical when the "cylinder" technic is used: then, under the usual conditions of the test, the diameter of the zone is a function of concentration, and is practically independent of volume.

Alternatively, "wells" made in the agar by removing plugs of agar with a cork borer, have been used as reservoirs of antibiotic solutions in performing plate assays.

It has been pointed out that using proper technics, an "all-or-none" effect of antibiotics on bacteria can be demonstrated, since below a certain threshold concentration growth is possible, while at or above the threshold growth is inhibited. However, for any antibiotic tested against any appropriate organism, there is a definite period of incubation which best brings to evidence the "all-or-none" effect. A culture of test organisms exposed to a given concentration of an antibiotic may appear clear and devoid of growth at a given time, and later become cloudy due to proliferation of the organisms during a "post-lytic" wave of growth (Figs. 16 and 17).

A population of micro-organisms is never perfectly homogeneous with respect to the minimal concentration of antibiotic required to kill each individual member: only those cells which are in the most active metabolic state, i.e., cells which are in the logarithmic phase of growth, are likely to be killed by the minimal concentration. When the cells are killed, some of their constituents are released into the culture medium from which they may be absorbed by less active neighboring individuals for which they then serve as growth factors. These hitherto less active individuals are then stimulated to a state of more active metabolism and growth in which they become more susceptible to the action of the antibiotic and may be killed by a minimal concentration.

Therefore, in a culture containing the minimal amount of antibiotic necessary to provide the threshold concentration, there are successive waves of growth. At first the more sensitive organisms are inhibited, and as the products released by their lysis stimulate the neighboring

cells these cells enter a phase of active growth and in time become subject to the bacteriostatic and bacteriolytic effects of the antibiotic, resulting again in a decrease in turbidity of the culture. Absorption of the lysis products of these cells may serve to stimulate growth of even more sluggish cells so that these in turn become amenable to the action of the antibiotic. The process may be repeated several times, until ultimately the solution is sterilized. This succession of events can be demonstrated by continuous photometric recording of the changes in ability of the cultures to transmit light. By properly standardizing the duration of the incubation period and the range of concentrations of the antibiotic in a series of different cultures, it is possible to plot a curve relating "per cent of light transmitted" to the dosage of antibiotic, and to use this master curve in estimating the concentration of the antibiotic in solutions of unknown strength. It should be kept in mind, however, that values determined in this way by the photometric determination of turbidity have little meaning unless the duration of the incubation period is specified and is rigidly controlled from one test to the next (Figs. 16 and 17).

Biologic assays are subject to irregularities due to inherent variations in the populations of the test organism. These irregularities can be reduced to a minimum by rigidly exercising proper physical and biologic control of the organisms and of the conditions under which the tests are carried out. None-the-less, it would be desirable to have available reproducible and reliable methods which would not necessitate use of living organisms and the variations that are inevitably entailed.

Physical and chemical assay methods have been proposed for a few antibiotics. The most reliable are those for penicillin and streptomycin. These are discussed in the sections pertaining specifically to those antibiotics. Further work is required to establish unequivocally the general usefulness of the physical and chemical methods that have been proposed for other antibiotics.

STERILITY TESTING. Any product intended for parenteral administration must be sterile. The student may wonder how an antibiotic

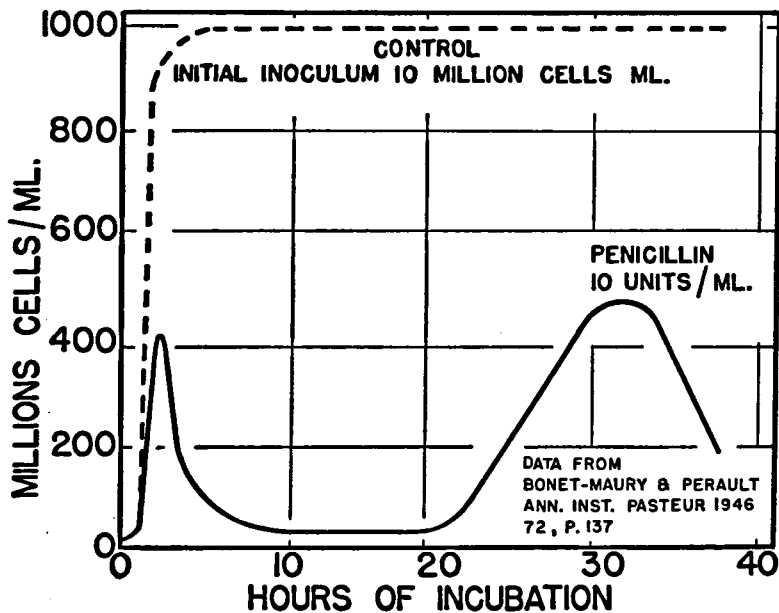
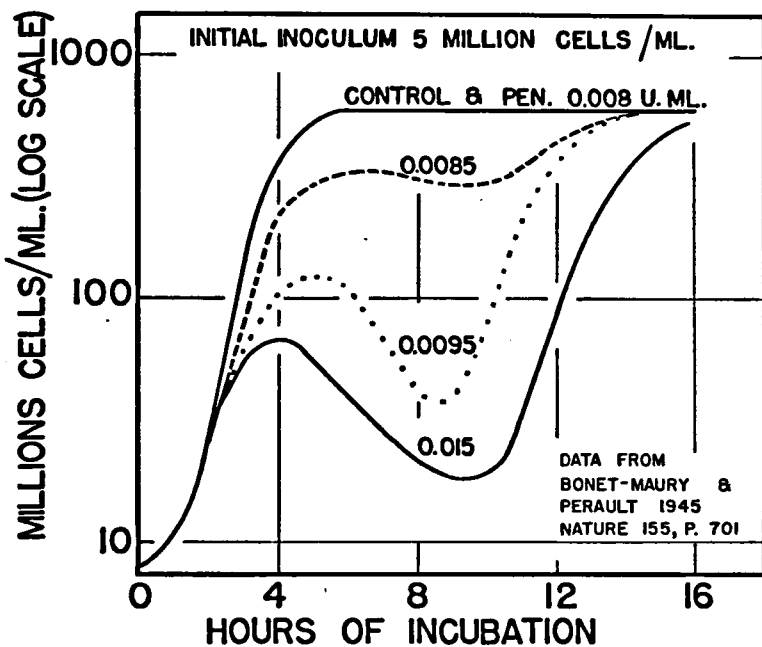

which itself is supposed to kill germs could be unsterile (contaminated with living organisms) and why it is necessary to test it for sterility. It should never be forgotten, however, that efficient therapeutic agents as the antibiotics are, there are definite limits to their activity. These limits are described in terms of their biologic spectra (Chap. 4). In fact, a concentration of a given antibiotic which is sufficient to kill certain susceptible species of micro-organisms may be totally ineffective against another species or may even enhance its growth. Therefore, it is quite possible for an antibiotic to be unsterile.

In order to test for sterility it is necessary to inactivate the antibiotic by some appropriate means, and then to introduce it into a sterile culture medium of proper composition. If growth fails to occur after suitable incubation, the antibiotic is considered sterile. In such tests, it is, of course, necessary to ascertain that the antibiotic has actually been inactivated. This is accomplished by means of a control broth solution containing the inactivated antibiotic but inoculated with an appropriate test organism. If growth occurs in this culture, it is assumed that the antibiotic preparation was adequately inactivated. In practice a sterile solution of hydroxylamine hydrochloride is used to inactivate penicillin or streptomycin.

TOXICITY TESTING. A product may be sterile but none-the-less quite toxic. Many antibiotics that are highly effective antibacterial agents cannot be administered internally because of their toxicity. For example, the use of tyrothricin, which is extremely active against many bacteria, is limited to topical application because of its hemolyzing action on red blood corpuscles. Likewise, actinomycin, an antibiotic obtained from certain species of actinomycetes is so toxic that it cannot be used clinically, although it is many times more active than penicillin and streptomycin against a number of species of pathogenic bacteria. Any new antibiotic, just as any other new drug, must

FIGS. 16 and 17. Secondary waves of growth in bacterial cultures exposed to different concentrations of penicillin. Note in figure (*top*) evidence of a threshold effect; 0.008 units penicillin/ml. caused no depression of growth but a pronounced effect was produced by 0.0085 units/ml. Note from figure (*bottom*) importance of time of incubation in performing turbidimetric assays.

be proved safe for use before it can be introduced clinically. Safety, or lack of toxicity, is tested by administering the drug to a number of animals of some appropriate species and determining the amount (in terms of mg./Kg.) required to kill a certain percentage of the test animals.

Not only must a new antibiotic be proved nontoxic, or relatively so, before it can be introduced into practice, but each new batch of a given antibiotic must also pass a safety test before it can be certified for release by the manufacturer to the pharmacist. Mice are used routinely for conducting toxicity tests on commercial lots of penicillin, streptomycin, and other antibiotics for which standards have been prescribed. In the official test five mice weighing between 18 and 25 Gms. each are injected with a sterile solution containing a specified concentration of the antibiotic. If no animal dies within 48 hours the product is considered nontoxic. If one or more animals die within the specified time the test must be repeated using mice weighing 20 Gm. \pm 0.5 Gm.; if all animals survive the second test, the product is declared nontoxic.

Incomplete removal of organic constituents from the culture medium or of solvents used during the purification processes are the principal sources of toxic impurities in penicillin, streptomycin, and similar antibiotics that are normally considered safe to use.

PYROGEN TESTING. Pyrogens are substances that have the property of causing fever in animals. The derivation is from roots meaning to give rise to (gen) and heat (pyro). Even though sterile and nontoxic, a compound may give rise to a more or less transient rise in temperature (fever) if contaminated with pyrogenic substances.

The exact nature of pyrogens is somewhat obscure, but they are generally considered to be organic products arising from the breakdown of organic compounds as the result of bacterial activity, such as may occur even in distilled water, and perhaps of the bacterial cells themselves.

Rabbits are generally used for pyrogen testing. Three specimens whose normal body temperature is between 38.8° and 39.9° C. are

selected. The sterile sample to be tested is diluted with sterile pyrogen-free water and warmed to approximately 37° C. Then the specified dosage of the antibiotic is injected intravenously in the ear. Temperatures are read from a rectal thermometer (or some suitable recording device) hourly for four hours. If no animal shows a rise in temperature of more than 0.6° C. during this period the product is considered nonpyrogenic. If only one animal shows such a rise, or if the sum of the temperature increase in the three animals exceeds 1.4° C. the test must be repeated with five animals. The product is considered nonpyrogenic if not more than one of these animals shows a temperature rise of 0.6° C. or more.

MISCELLANEOUS TESTS. In addition to the foregoing tests, different antibiotics must also meet certain other specified requirements for particle size, moisture content, pH, clarity, etc., before they can be certified for use. These requirements, which vary for different antibiotics and for different pharmaceutical forms of a given antibiotic, are discussed in subsequent sections devoted to specific antibiotics.

GOVERNMENT CONTROL OF ANTIBIOTICS

Detailed specifications for different antibiotics and prescribed methods for conducting tests are published by the Food and Drug Administration, a division of the Federal Security Agency.

Rigid control is exercised over all antibiotics. Each manufacturer conducts the required tests on each lot of his own product and also sends samples of each batch to the F. D. A. laboratories where similar tests are performed. If the product passes all tests in both laboratories, the F. D. A. certifies the product for release to the pharmacist. Then, and not until then, can the manufacturer legally distribute the product.

REFERENCES

- Domagk, G., 1935, Ein Beitrag zur Chemotherapie der bakteriellen Infektionen, *Deut. Med. Wochschr.*, 61:250-253.

54 Industrial Production and Control of Antibiotics

- Fourneau, E., et al., 1936, Chemothérapie des infections streptococciques par les dérivés du *p*-aminophénylsulfamide, *Compt. Rend. Soc. Biol.*, 122:258-259.
- Lee, S. B., 1949, Fermentation, *Ind. Eng. Chem.*, 41:1868-1879.
- Tréfouël, J., Nitti, F., and Bovet, D., 1935, Activité du *p*-aminophénylsulfamide sur les infections streptococciques expérimentales de la souris et du lapin, *Compt. Rend. Soc. Biol.*, 120:756-758.

Science is built up of facts, as a house is built up of stones; but an accumulation of facts is no more a science than a heap of stones is a house.

—H. POINCARÉ (1902)

CHAPTER

4

The Concept of Antibiotic Spectra

Drugs may be classified on the basis of their biologic activity or on the basis of their chemical structures. Ideally, one might hope to classify chemotherapeutic agents in terms of their chemical properties and the stereochemical configurations, upon which their biologic activities depend.

The antibiotics which currently appear to be of greatest promise for clinical application can be segregated roughly as (1) organic acids, (2) organic bases, and (3) polypeptides. Acids, such as penicillin, and bases, such as streptomycin, form salts easily. As a matter of fact, the acidic or basic properties of such antibiotics are employed in effecting extraction of the compounds from the crude culture liquor and in effecting their ultimate purification. In the case of the polypeptide antibiotics, the compound may possess the ability to form salts readily (aureomycin, polymyxin, etc.) or may lack such ability (tyrothricin). The ability to form salts easily is a reflection of the fundamental structure of the molecule; those polypeptides which possess such ability may be assumed to contain free amino or carboxyl groups or other radicals capable of salt formation, and those lacking such ability may be assumed not to possess such free groups.

The chemistry of penicillin, of streptomycin, of chloromycetin and of tyrothricin has been studied intensively and is known reasonably

well. The chemistry of other antibiotics, however, is less well known, and, in some cases, is quite obscure. Therefore, it is difficult, if not impossible, at the present time to classify adequately in such a system all the antibiotics now recognized, or even all of those which have reached the stage of clinical testing. Indeed, some of them have never been isolated in a chemically pure form.

For this reason, in this book, each of the antibiotics now known to be, or surmised to be, potentially useful as a chemotherapeutic agent is discussed in terms of its principal clinical applications, i.e., to borrow a term from physics, the antibiotics discussed in this work are classified on the basis of the dominant lines of their respective antibiotic spectra.

The antibiotic or biologic spectrum defines the range of antibacterial activity. Thus, a compound like actinomycin, which is active in low concentrations against a large number of bacterial species (including Gram-negative, Gram-positive, and acid-fast forms) is said to have a broad antibiotic spectrum, whereas a compound like penicillin, which is effective principally against only certain species of Gram-positive organisms, or one like polymyxin, which is effective against only certain species of Gram-negative organisms, is said to have a relatively narrow antibiotic spectrum. The high degree of selectivity of action possessed by many antibiotics is one of the most distinctive features of this class of chemotherapeutic agents and serves to sharply distinguish them physiologically from the common disinfectants such as phenol, mercurials, arsenicals, and salts of other heavy metals. Although, ideally, one might wish for an antibiotic that would display a broad or all-inclusive antimicrobial spectrum at low concentrations, the chances of finding such an antibiotic that will be generally useful in the clinic seem slim. In order to be effective against such a broad range of organisms, a compound would probably need to interfere with some biochemical process at a level common to all living cells; thus it might be expected to evidence toxicity to the host as well as to the pathogen. Actinomycin is such an antibiotic. (See Table 11.) Thus, it appears that narrowing or restriction of the anti-

biotic spectrum is the price one must pay in order to obtain an agent that is capable of inhibiting pathogenic organisms without causing serious injury or death to the host.

It has been suggested that "Bacteria show in their biochemical evolution a tendency towards states of minimum metabolism through an increasing saving of chemical reactions," thus becoming more dependent upon external sources for many essential nutrients and for more or less complex compounds necessary to keep their biochemical machinery working properly. Thus, by successive stages organisms develop which lose the ability to provide certain essential materials for themselves, and ultimately they become so highly specialized, biochemically speaking, that they become dependent on strictly defined pathways of metabolic activity. Such organisms tend eventually to become so dependent on external sources of complex materials that they can survive, in nature, only in or on other living creatures, and so become parasitic. These pathogenic organisms often are very difficult to control. Many of these, however, are amenable to chemical control by agents, such as the antibiotics, which in extremely low concentrations are capable of blocking a step that is essential in, and often peculiar to, the chain of metabolic reactions on which survival of the organism depends.

An antibiotic has a narrow spectrum if it blocks a metabolic pathway on which one or a few strains of micro-organisms are so dependent that they cannot by-pass it, whereas most micro-organisms may use alternative pathways. If the antibiotic blocks some reaction which cannot be by-passed and which is common to a large number of organisms, it has a broad spectrum.

Micro-organisms differ markedly in the array of enzymatic systems they can muster in their service. Some organisms are relatively limited in the ways in which they can utilize diverse substrates to obtain the energy they require for growth and other metabolic activities. Such organisms are generally relatively sensitive to one or more antibiotics. Other microbes, however, can readily adapt themselves to altered chemical environments by shunting reactions in-

volved in energy transformations from one metabolic pathway to another so that if one road is blocked they may by-pass the usual route and utilize another. Such micro-organisms are often relatively insensitive to the action of antibiotics, or if initially sensitive, may develop resistance; the degree of resistance that develops being related to the biochemical versatility of the organism. These ideas are shown in highly schematized and simplified form in Figure 18.

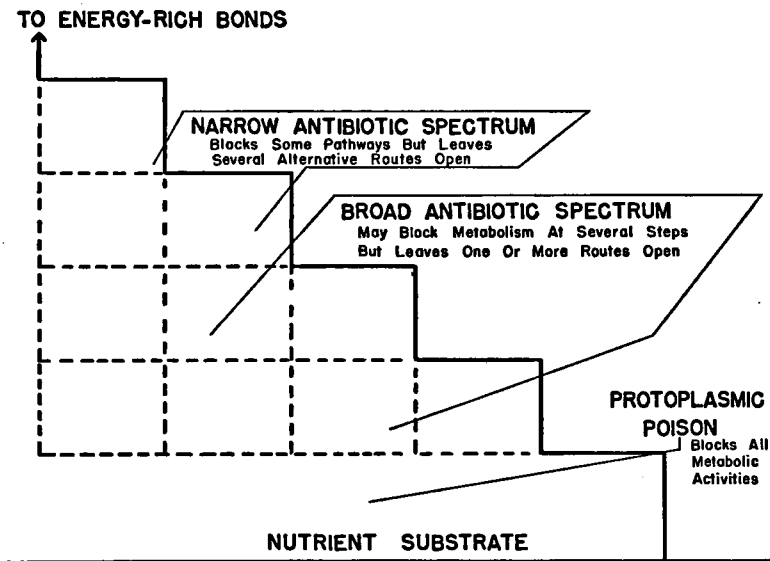

FIG. 18. Diagrammatic representation of the activity of different antibiotics with narrow and with broad spectra, respectively. See text for further explanation.

If we visualize, in a schematic way, the metabolic activity of micro-organisms as being effected stepwise through the transfer of hydrogen and phosphate from suitable donors to the ultimate acceptors, we may represent the "normal" metabolic stairway by the solid line in Figure 18. The inhibitory efficacy of an antibiotic would depend on the blocking of one or more steps which the test organism could not by-pass through some of the dashed lines.

A general protoplasmic poison may be a "surface active" agent which by virtue of its detergent properties is able to impair the structural integrity of the cell or some of its parts. It may be a reagent that is able to react with one or more of the readily accessible "active groups" (e.g., $-\text{SH}$, $-\text{NH}_2$, etc.) of enzymes or other essential constituents of the cell; or it may simply cause coagulation or denaturation of protoplasmic material. Higher selectivity of antimicrobial action depends, in large measure, on restriction of the ability to react with "active" groups in the cytochemical structure, which in extreme cases may involve restriction of reactivity to a certain chemical group having a prescribed stereochemical relationship to other vicinal groups.

To borrow and paraphrase the concept of the "receptor" or "lock and key" theory of toxin-antitoxin action from immunology, one might visualize an antibiotic with a broad biologic spectrum as analogous to a master key capable of fitting into and acting on a large number of locks (cytochemical systems), while an antibiotic with a narrower spectrum would be analogous to a key which would fit into and react with only a limited number of locks (cytochemical systems) with a very definite structure. It is obvious that in some cases a given "key" will fit only a specific "lock" with the appropriate architecture.

*The blue and white and several kinds of hairy
mouldy spots . . . will not be unworthy of our more
serious speculation and examination.*

—R. HOOKE (1665)

CHAPTER

5

Penicillin:

An Antibiotic Useful Principally Against Gram-positive Pathogens

It is asked in the Bible, "Is there anything whereof it may be said, See, this is new?" (Ecclesiastes I:10). In the several fields of science, certainly there are numerous instances in which facts or natural phenomena or natural laws have been "discovered" several times, recalling the cliché, "There is nothing new except what is forgotten" (attributed to Mme. Bertin, 1744-1813). It appears that the "discovery" of penicillin in 1929 (Fleming) may, in a sense, be a case in point. Certainly, the curative properties of certain molds had been employed empirically thousands of years before by the Chinese (see Chap. 1). Coming to more recent times, we find that the folklore of certain tribes of American Indians includes the belief that wood in the last stages of disintegration by various molds has curative properties for open sores and infected wounds (Brunel, 1944). Other more scientific applications of antibiotics have been alluded to in Chapter 1.

The real contribution made by Fleming (1929) was his recognition of the fact that an appropriate strain of *Penicillium*, grown on a simple medium can produce a specific substance, which he designated penicillin, that this substance can be extracted from the medium, and that it is endowed with selective antibacterial activity.

PENICILLIN AS A CHEMICAL COMPOUND

The Family of Penicillins. The penicillins comprise a family of antibiotics that are biosynthesized by several species of molds, notably *Penicillia* belonging to the *notatum-chrysogenum* group. More than a dozen penicillins are recognized to occur naturally, and from some of these (principally penicillin X) many derivatives have been prepared. Furthermore, different species or strains of *Penicillium* possess the ability to incorporate preformed carboxylic moieties, through an acetamide linkage, into the penicillin molecule. More than three dozen "unnatural" penicillins have been biosynthesized by adding various precursors, supplying diverse types of acyl groups, to the fermentation medium. However, only five or six penicillins are commonly encountered. All possess the same fundamental structure.

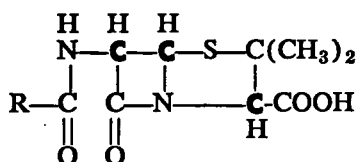

The penicillins are characterized stereochemically by the three asymmetric* carbon atoms (bold face type in the above formula) which are responsible for the optical rotation of penicillin solutions. Various treatments which result in loss of antibacterial activity also cause a decrease in optical activity of the molecule. The several penicillins differ markedly in their pK values, their distribution between polar and nonpolar solvents, and their biologic activity in vitro and in vivo according to the character of the R group. (Fig. 19 and Table 1.)

Laboratory experiments with animals and clinical trials and evaluations have shown that the relative effectiveness of the different penicillins in vivo depends upon the rate of excretion, degree of protein binding in the blood, the pathogen involved, and several other factors. In practice, benzyl penicillin (penicillin G) has been found to be the most generally useful.

* A carbon atom with four different atoms or groups attached to it is designated as asymmetric.

TABLE 1. CHARACTERISTICS OF FIVE COMMON PENICILLINS

R GROUP		Common Name	Mol. Wt. of Na Salt	pK	IN VITRO ACTIVITY (units/Mg. against)		Optical Rotation
Carboxyl Residue	Acetamide Linkage				<i>S. aureus</i>	<i>B. subtilis</i>	
Phenylacetic	Benzyl	G	356.2	2.5	1,667	1,667	$[\alpha]_D^{23} + 280^\circ$
<i>p</i> -Hydroxy-phenylacetic	<i>p</i> -Hydroxy-benzyl	X	372.2	2.5	900	1,500	$[\alpha]_D^{25} + 260^\circ$
3-Hexenoic (hydrosorbic)	Δ^2 Pentenyl	F	334.2	2.7	1,500	970	$[\alpha]_D^{25} + 305^\circ$
Caproic	<i>n</i> -Amyl	Dihydro F	335.2	2.7	1,670	660	$[\alpha]_D^{23} + 319^\circ$
Octanoic (caprylic)	<i>n</i> -Heptyl	K	364.3	5.0	2,300	700	$[\alpha]_D^{25} + 275^\circ$

In this book, following established custom, the term penicillin will be used to designate a salt of benzyl penicillin unless otherwise specified. The calcium, the potassium, the sodium and the procaine salts of penicillin are official in the United States Pharmacopoeia, Fourteenth Revision.

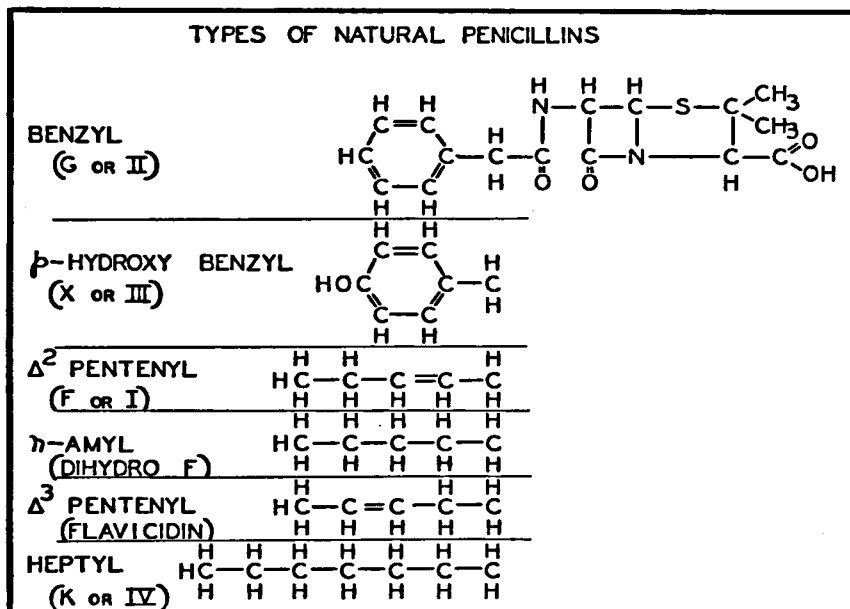

FIG. 19. Types of natural penicillins showing differences in structure of the R groups entering into the acetamide linkage. (Pratt and Dufrenoy: La Papeterie, Paris, p. 387.)

Biosynthesis. It is well known that carbon, hydrogen, nitrogen, oxygen, phosphorus, and sulfur are essential constituent atoms of the cytoplasmic and nuclear components of cells. Of these, C, H, N, O, and S are integral constituents of the penicillin molecule, but P is lacking. Of course in addition to the above named elements which are used in relatively large quantities, living organisms require also lesser amounts of potassium, calcium, magnesium, iron, copper, zinc,

boron, manganese, and in some cases, of other elements, such as molybdenum, aluminum, chromium, etc.

In commercial practice, penicillin is produced by appropriate strains of *Penicillium notatum* or of *Penicillium chrysogenum* growing on or in a culture medium consisting of a dilute suspension of corn steep liquor* supplemented with inorganic salts, lactose (as a source of carbon), and various organic substances which embody in their molecular structure moieties of the specific penicillin that is desired. Such compounds, embodying in their molecules preformed fractions of the desired molecule, or structures that are readily converted into the desired configurations are called precursors (Chap. 3). The ability to use precursors is not limited to species of *Penicillium*, but is common to many micro-organisms.

The necessity for proper control of aeration, pH, temperature, etc., during biosynthesis of penicillin has been indicated previously (Chap. 3). No less important is the composition of the fermentation medium. Different species and strains of *Penicillium* capable of producing penicillin differ in their nutritional requirements. Both the total concentration of all nutrients and the relative concentration of any one nutrient with respect to the other compounds present are important. For best results it is necessary to balance properly the concentrations of PO_4^{\equiv} , Mg^{++} , $\text{SO}_4^=$, and NO_3^- in the solutions and to use a solution with the proper total salt concentration. For a given initial level of PO_4^{\equiv} , as the initial concentration of Mg^{++} and $\text{SO}_4^=$ is raised, it is necessary to lower the concentration of NO_3^- . This is shown in Figure 20.

Figure 21 shows the relation between penicillin titer produced in surface cultures by a variant strain of *Penicillium notatum* derived from strain 1249·B21 and the total concentration of supplemental salts added to a medium consisting of lactose (0.111 M.), $\text{ZnSO}_4 \cdot 7\text{H}_2\text{O}$ (0.00015 M.), phenylacetic acid (0.00183 M.), and corn steep liquor solids (40 Gm./L.).

* Corn steep liquor, a by-product of the corn milling industry, consists of a concentrate of the water-soluble materials of corn. The composition varies from one batch to another (Liggett and Koffler, 1948).

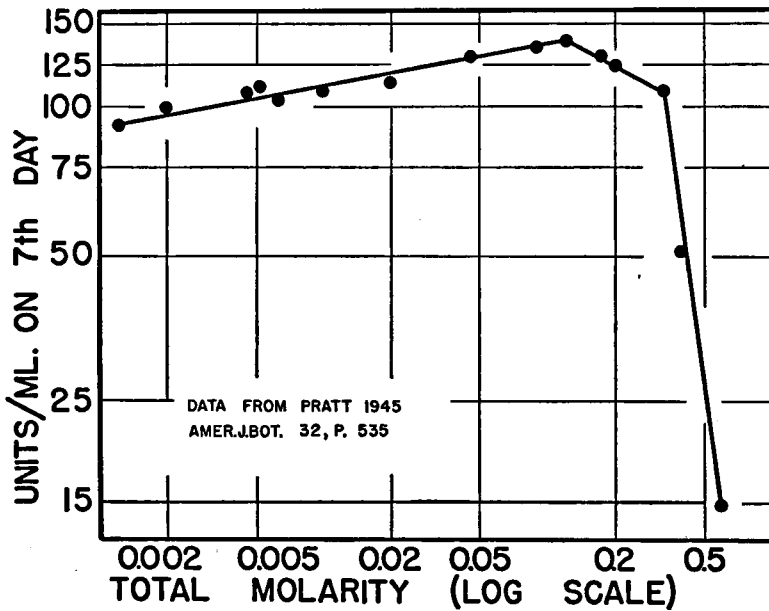

FIG. 21. Relation between penicillin titer in culture solution after seven days of fermentation by *Penicillium notatum* 1249·B21 and total concentration of KH_2PO_4 , $\text{MgSO}_4 \cdot 7\text{H}_2\text{O}$, and NaNO_3 . Molar proportions of the three salts were KH_2PO_4 , 0.475; $\text{MgSO}_4 \cdot 7\text{H}_2\text{O}$, 0.05; and NaNO_3 , 0.475.

The use of fermentation media containing corn steep liquor is advantageous for commercial production of penicillin, and valuable information on the biosynthesis of penicillin has been acquired with such media. However, ideally, research designed to ascertain the course and mechanism of biosynthesis of penicillin (or of any other natural product) should be conducted with chemically defined mixtures, i.e., with substrates in which the kind and amount of each substance are known. Such culture media are called synthetic.

Several synthetic media from which different species and strains of *Penicillium* can biosynthesize penicillin have been formulated. One of the simplest, in which yields of penicillin from several strains of the mold are comparable in magnitude to those obtained in corn

steep liquor media, has the following composition. Quantities are given in grams per liter: Starch, 5; lactose, 25; crude glucose, 5; glacial acetic acid, 6; Na_2HPO_4 , 1.6; K_3PO_4 , 2; NH_4NO_3 , 4; $(\text{NH}_4)_2\text{SO}_4$, 1; KNO_3 , 1; $\text{MgSO}_4 \cdot 7\text{H}_2\text{O}$, 0.25; $\text{FeSO}_4 \cdot 7\text{H}_2\text{O}$, 0.2; $\text{ZnSO}_4 \cdot 7\text{H}_2\text{O}$, 0.04; $\text{CuSO}_4 \cdot 5\text{H}_2\text{O}$, 0.005; Cr (from $\text{K}_2\text{Cr}_2\text{O}_7$), 3 micrograms.

The biochemical differences in ability of various strains of fungus to utilize different substrates for biosynthesis of penicillin can be easily demonstrated in such a medium. Additions of numerous adjuvants, singly and combined (except phenylacetic or phenacetic acids or esters of same), produced little, if any, increase in yield of penicillin from *Penicillium chrysogenum* X-1612. However, under similar conditions, *P. chrysogenum* 1984-A produced less than one-fifth as much penicillin when cultured in the basal medium without adjuvants (see Fig. 22), but when appropriate precursors were added this strain of mold gave yields approximately as high as those obtained from X-1612. In such a synthetic medium, adjuvants enhanced considerably the production of penicillin by strain 1984-A, as the following were concomitantly made available:

1. Cysteine (or cystine in the presence of a suitable reducing agent)
2. The —C—C—N chain with the proper linkage at each end

$$\begin{array}{c} \parallel \quad | \\ \text{O} \quad \text{H} \end{array}$$
3. The phenyl ring, or preferably 2 and 3 combined as phenacetates, α -phenylacetamide, or β -phenylethylamine.

Cysteine and cystine are too costly for use in industrial production of penicillin. However, sulfite waste liquor (SWL) which is a waste product from paper mills is an inexpensive source of forms of sulfur and other precursors that are suitable for large scale production (Dufrenoy and Pratt, 1948b).

The potential importance of cysteine and of other amino acids as precursors for biosynthesis of penicillin is shown schematically in Figure 23 which, when read from bottom to top, indicates theoreti-

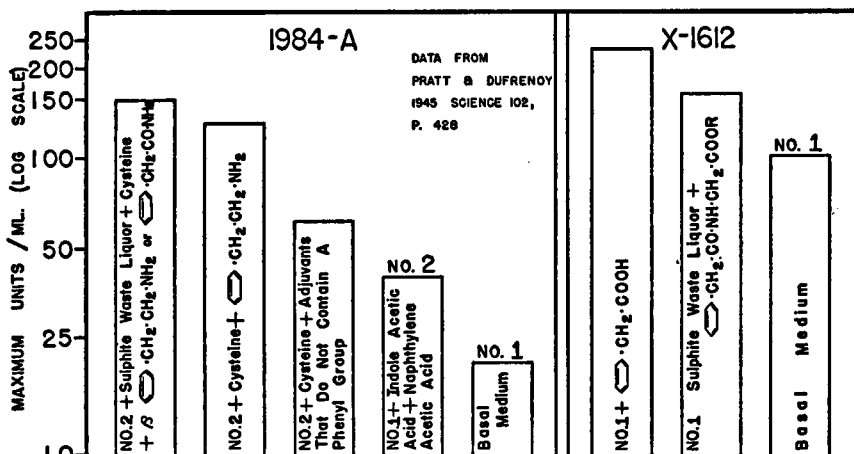

FIG. 22. Maximum yields of penicillin with two different strains of *Penicillium chrysogenum* in synthetic medium with and without adjuvants. (Data from Pratt and Dufrenoy, Science, 102:428.)

cally possible pathways of biosynthesis of penicillin, and when read from top to bottom, shows a theoretically possible course of degradation of the penicillin molecule. It has not been proved that these are the normal pathways of biosynthesis and of degradation of penicillin, but the figure serves to show how consideration of the stereochemical configuration of a desired biologic product may suggest potentially useful precursors for the biosynthesis of that product.

Writing the molecular structure of the penicillins as shown in Figure 24 makes it apparent that the common part of the molecule (to which the various residues, R, can attach) can be considered as made of two residues, each comprising three carbon atoms, of which one is an actual or potential carboxylic carbon, while the next one (alpha) bears the N from a potential amino group.

These two alpha carbon atoms are mirror images of each other: the one bearing the N atom entering into acetamide linkage with the R residue of the aromatic or aliphatic acid is of the *l* type; the other, bearing the N responsible for the fusion of the thiazolidine and beta

lactam rings, is of the *d* type. Hydrolysis, opening the thiazolidine and beta lactam rings, restores the carboxylic group of the *l* residue; and restores both the amino group on the alpha carbon and the —SH group on the beta carbon of the *d* residue, yielding dimethyl cysteine,

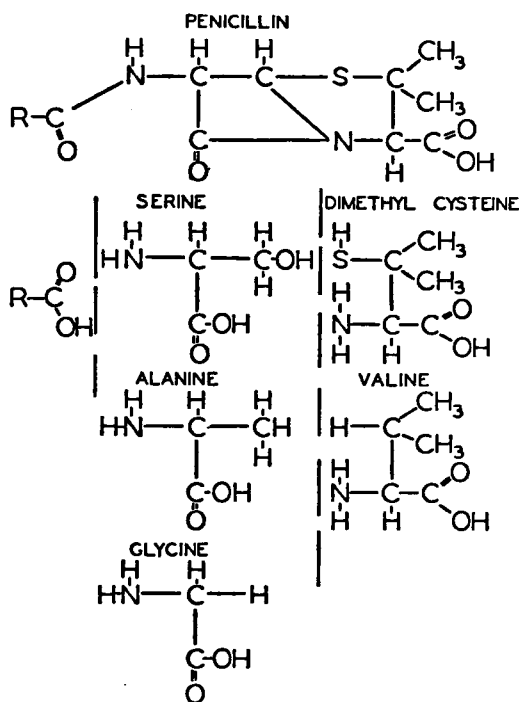
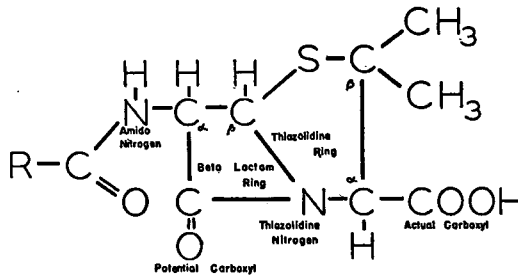

FIG. 23. Schematic representation to show possible relationships between penicillin and several common amino acids. Read from top to bottom, the diagram indicates possible pathways of degradation of penicillin; read from bottom to top, it indicates a theoretical pathway of biosynthesis of penicillin. (Pratt and Dufrenoy: La Papeterie, Paris, p. 389.)

which is also called *d* penicillamine. Biosynthesis of the part of the molecule common to all penicillins may be visualized (in idealized form) as arising from fusion of *d* dimethyl cysteine with an *l* amino acid residue through loss of two molecules of water (Fig. 25). Practi-



PENICILLIN

FIG. 24. Structure of penicillin molecule. Note that thiazolidine and β -lactam portions of the molecule may be considered as composed of two residues of three carbons each, one carbon of each residue being an actual or potential carboxyl group; the adjacent (α) carbon of each residue bears a nitrogen atom from a potential amino group and the β carbons of the two residues share a sulfur atom.

SCHMATIC REPRESENTATION TO SHOW FORMATION OF THIAZOLIDINE AND BETA LACTAM RINGS FROM DIMETHYL CYSTEINE AND AN AMINO ACID RESIDUE

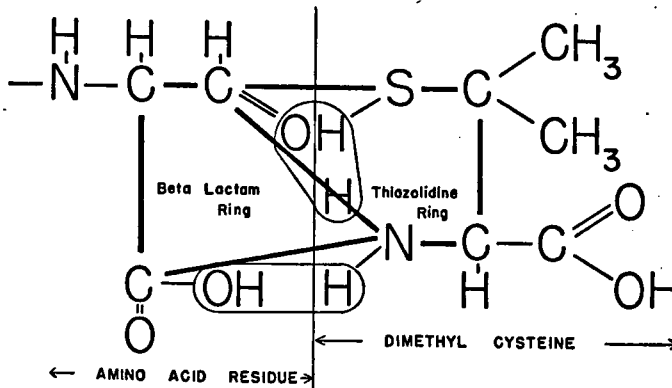

FIG. 25. Diagram to show a possible means of biosynthesizing the β -lactam and thiazolidine rings of penicillin by fusion of dimethyl cysteine and an amino acid residue through loss of two molecules of water.

cal application of these observations has been recognized in patents covering the use in fermentation media of compounds isomeric with the *l* configuration of the penicillin molecule; for example, N-phenyl acetyl derivatives of valine, of norvaline, of isoleucine, or of β , β diethylalanine.

Idealized as the above schemes are, they may, never the less, afford a partial explanation for the value of corn steep liquor in the biosynthesis of penicillin. It is reported that at least one-fourth of the nitrogen present in corn steep liquor is in the form of alanine, which on substitution of an OH for one H on the beta carbon may yield serine, an *l* alpha amino acid apt to promote closure of the thiazolidine ring. Furthermore, corn steep liquor is a rich source of organic sulfur, especially in the form of cysteine, methionine, and several other amino acids. It also contains valine which may be of value as a source of a dimethyl beta carbon configuration and in addition provides aluminum, copper, manganese, iron, zinc, and other elements required in trace amounts for growth of the mold.

The ability to introduce an amino group on the alpha carbon of different fatty acids is widespread among micro-organisms, and is prominent among the *Penicillia*. Therefore, various fatty acids may be considered as potential precursors for biosynthesis of the part of the molecule common to all penicillins. Acetic acid, for instance, is a valuable constituent of synthetic media; propionic acid cannot be used, as such, because of its toxicity, even at low concentrations, but some of its derivatives are useful.

In general, the strains of *Penicillium* which most actively biosynthesize penicillins have a high capacity to use oxygen for the oxidation of reduced constituents in the fermentation medium. Other things being equal, a given strain usually yields best when nitrogen and sulfur are made available jointly in the form of the proper sulfhydryl-bearing ($-\text{SH}$) amino acid; and next best when nitrogen is available from simpler amino acids or from acetamides: when nitrogen is available from mineral sources only, it may be necessary to

provide nitrate concomitantly with ammoniacal N to prevent an undue rise of pH as the NH_2 is metabolized.

There may be some question as to whether or not the carbon skeletons corresponding to different moieties of the penicillin molecule, and theoretically provided by suitable adjuvants or precursors, are incorporated, as such, into the molecule or are merely utilized in some biochemical reaction essential for the growth of the mold which then proceeds to biosynthesize penicillin from simpler constituents of the medium. Although under certain conditions some of the adjuvants may actually be metabolized for essential reactions, there is abundant evidence that many compounds may be incorporated directly into the penicillin molecule in a stoichiometric relation. This is most readily demonstrated by experimental modification of the proportions of the various penicillins biosynthesized by a given strain of mold in the presence of varying proportions of molecular structures able to contribute to the acetamide side chain (R residue).

Different strains of *Penicillia* vary in their propensity for biosynthesizing different types of penicillin. For example, *P. notatum* 1249·B21 normally produces predominantly benzyl and Δ^2 pentenyl penicillins (*G* or II, and *F* or I, respectively): *P. chrysogenum* Q-176 normally produces predominantly heptyl (*K* or IV) penicillin and relatively little of the clinically more desirable benzyl form: and some strains tend to produce *para*-hydroxy-benzyl (*X* or III) penicillin. The natural propensity of these strains for producing one form or another of penicillin may be accentuated or suppressed by proper use of appropriate adjuvants.

In general, excess of fatty acids tends to favor biosynthesis of penicillins with an aliphatic R residue, such as heptyl or *n*-amyl penicillins, but use of aromatic acids, such as phenyl acetic acid, favors formation of benzyl penicillin. Similarly, a number of different radicals, both aromatic and aliphatic, may be substituted in the R position. The fact that varieties of penicillin not normally produced by a given strain of mold may be formed by that strain when it is provided with precursors embodying the particular molecular group-

ing that is desired seems to afford reasonable evidence that segments of the precursor molecules are incorporated directly into the molecule of penicillin. In commercial practice large quantities of phenylacetic acid and of phenylacetamide are included in the fermentation medium to "steer" the biosynthesis toward production of benzyl penicillin.

In view of the above discussion, some of the longer-chain unsaturated fatty acids take on added interest as potential adjuvants to increase the biosynthesis of penicillin, inasmuch as they may break down oxidatively to form C_6 aliphatic residues, which in turn might yield appropriate C_3 residues capable of entering into the thiazolidine and beta lactam structures of penicillin.

This view has been confirmed experimentally (Dufrenoy and Pratt, 1948a). Within limits, the yield of penicillin by *P. chrysogenum* X-1612 is increased proportionately as linoleic acid is added to the culture medium. When different amounts of linoleic acid are added to the medium in the form of various vegetable oils, the linoleic content of which is well known, the results, which are shown in Figure 26, parallel those obtained when equivalent amounts of pure linoleic acid are added. This suggests the possible use of vegetable by-products to stimulate biosynthesis of penicillin.

Addition of straight-chain fatty acids to the fermentation medium not only increases the total penicillin titer of the liquor, but also reduces the time required for the maximum titer to be reached. These aliphatic acids, however, favor the biosynthesis of the less desirable penicillins embodying aliphatic side chains unless suitable amounts of phenylacetic acid or phenylacetamide or other similar compounds are concomitantly made available to the fungus. Maintenance of a proper balance between suitable aliphatic acids and appropriate aromatic compounds in the medium provides a means of obtaining maximum yields of the preferred benzyl penicillin in the minimum time.

The law of mass action determines the proportions of aromatic and aliphatic type penicillins produced by a given strain of mold in a medium of a given composition. Within limits, the molds can tolerate

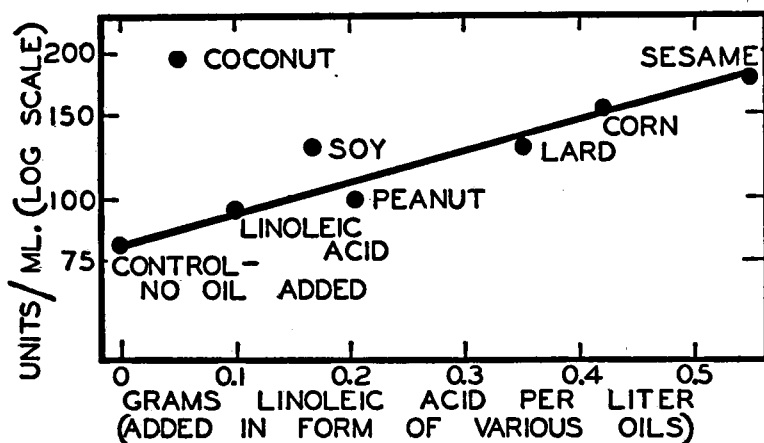

FIG. 26. Influence of linoleic acid, added in the form of various vegetable oils, on the yield of penicillin from *Penicillium chrysogenum* X1612 in a synthetic medium. (See text for further explanation.)

higher concentrations of phenylacetic acid as larger amounts of aliphatic residues are available. Thus, the industrial production of penicillin, directed toward providing benzyl penicillin, calls for simultaneous use of aromatic and aliphatic acetyl derivatives.

The importance of acetyl derivatives in problems concerned with penicillin is not restricted to aromatic vs. aliphatic as they pertain to biosynthesis of the different types of the antibiotic. Phenylacetic acid from the fermentation liquor, if not completely removed from the final purified product, may act as an "enhancement factor," apparently increasing the antibacterial activity of the product. Likewise, indole acetic acid, which is metabolized by the mold, can, when and if carried to the finished product, be responsible for a number of different effects observed with amorphous, partially purified penicillins, but not with highly purified crystalline penicillins.

Extraction and Purification. Penicillin is an acid and, as such, has the capacity to form salts with cations. The salts are soluble in water and are relatively insoluble in organic solvents: the reverse is true of the acid form. These facts underlie the current methods of extracting penicillin from the crude fermented liquor.

The pH of the harvested crude liquor is usually between 7.0 and 8.0, and the crude penicillin is, therefore, present as salts (penicillates). Acidification to pH 2.0-2.5 converts the penicillate to the acid which can be separated from water-soluble impurities by extraction with an appropriate immiscible organic solvent, such as amyl acetate, various phthalates, etc. At low pH values the partition coefficient favors solution of penicillin in the organic solvent. Adjustment of the pH to the alkaline range converts the penicillin to a salt which is soluble in water. Thus, by successive steps, in which the pH is properly manipulated and a series of different organic solvents are employed, first one group of impurities and then another can be removed, until ultimately a pure sodium, potassium, or other penicillate that can be crystallized is obtained. Since the structural integrity of the penicillin molecule is readily impaired, especially at extremes of pH, all of the reactions are carried out at low temperatures in order to retard the destructive processes.

In present industrial practice, exchanges of penicillin (acid) and penicillates (salts) between organic solvent and aqueous phases are effected continuously in counter-current extraction columns where a continuous stream of crude penicillin liquor flows in one direction against a counter-flowing stream of an appropriate solvent of different density. The process is highly mechanized, control of pH, rate of flow, temperature, etc., being operated automatically or semi-automatically. Samples of the aqueous phases are removed periodically at different stages of the process and are assayed to check the efficiency of the recovery.

The purified product is crystallized, dried, and then subjected to the several tests mentioned previously (Chap. 3). It is important that the crystallization be properly controlled to produce uniform crystals; the limits of size permitted by the Food and Drug Administration depend on the pharmaceutical form in which the product is to be administered.

Other methods of separating penicillins from impurities in the crude fermentation liquor and of separating the several types of peni-

cillin from each other are also available. Adsorption and elution technics have been used successfully for processing relatively small batches of crude liquor. A slurry may be made by mixing an appropriate adsorbent with the crude liquor. The slurry is filtered and many impurities are discharged in the filtrate. Then by use of suitable solvents, the penicillin is released (eluted) from the adsorbent, and the purification process may be continued via the solvent-extraction technic employing proper manipulation of pH, etc. The adsorption and elution technic is too cumbersome to be practical for processing the large volumes of crude liquor that are involved in present industrial production of penicillin. Furthermore, sizable losses often are sustained in the adsorption technic if the penicillin is not completely eluted.

Losses may also occur in solvent-extraction procedures, due to the fact that the various types of penicillin differ in their solubility in different solvents. Indeed, the existence of *para*-hydroxy-benzyl penicillin was first discovered because of failure of the then current methods of extraction to satisfactorily recover all the penicillin known to be present in the crude liquor. It was found that one fraction, then called penicillin X and later identified chemically as *para*-hydroxy-benzyl penicillin, was insoluble in chloroform, a solvent commonly used in the recovery process at that time.

Different types of penicillin in a mixture can be detected, identified, and assayed quantitatively by physical, chemical, and biologic methods. The various penicillins differ in their pK values (see Table 1), and, therefore, can be separated from each other by means of differential solubilities in various solvents and by chromatographic methods. Each isolated penicillin can then be identified and assayed by means of its physical and chemical properties. For example, benzyl penicillin can be identified and assayed by diazotization of its phenyl group, and, if crystalline, by means of its infrared absorption spectrum. Each penicillin has a characteristic absorption spectrum and a characteristic optical rotation.

Stability. The instability of the relatively impure penicillins that

were first available presented a real problem for manufacturers and for pharmacists. The stability of different lots of penicillin varied markedly with the qualitative and quantitative differences in the foreign matter present and with the moisture content. To retard deterioration, all penicillin products were stored at refrigerator temperatures (2-4° C.). Even under these conditions, the products often deteriorated relatively rapidly so that they were stamped with an expiration date allowing only three months from the time of manufacture.

As refinements were introduced into the extraction and purification and drying procedures, however, the stability of the product improved. Today the stability of dry sodium or potassium salts of benzyl penicillin is sufficiently great so that it no longer presents a practical problem for either the manufacturer or the pharmacist.

The fundamental course of deterioration of penicillin is hydrolysis, and water is the worst enemy of penicillin. Following reaction with two molecules of water, one molecule of penicillin is hydrolyzed, giving rise to dimethyl cysteine (penicillamine), an acylated amino-acetaldehyde, and carbon dioxide. The ultimate products of hydrolysis differ according to the pH at which the process is carried out. Acid hydrolysis yields penillic acids which result from molecular rearrangement as shown below:

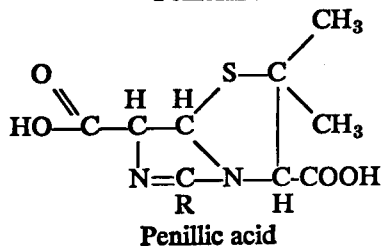
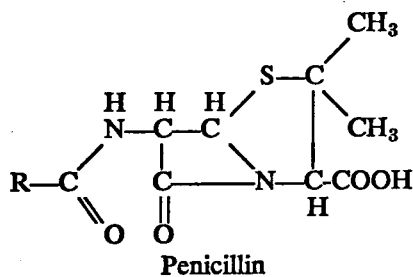

Inactivation under alkaline conditions or in the presence of penicillinase or of metal catalysts, such as copper or zinc,* yields penicilloates, in which the β -lactam linkage is ruptured while the thiazolidine ring is unaffected. Penicilloic acid has the following structure:

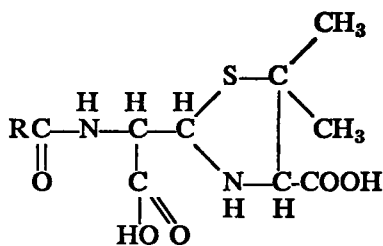

Penicilloic acid

The crystalline sodium and potassium salts of benzyl penicillin currently available are of sufficient purity so that they are stable indefinitely in the dry state without refrigeration. However, penicillin and especially some of the extraneous impurities that accompany it are hygroscopic so that once a vial is opened its contents are subject to rapid deterioration, the rate increasing with increased temperature. Furthermore, solutions of penicillin deteriorate rapidly. This problem was always important but has become more so since the advent of crystalline salts, since, paradoxical as it may seem, solutions prepared from crystalline salts of penicillin G lose their antibacterial activity more rapidly than do solutions prepared from less highly purified, amorphous products. Crude penicillins contain a number of different impurities, some of which tend to favor deterioration while others hinder deterioration of the antibiotic molecule. Thus, since the inactivators tend to be eliminated during the early steps of purification, one is confronted with the anomalous situation that a crude preparation which is unstable in solution may, after proper processing, give rise to a product that yields stable solutions, while further purification yields the pure crystalline salts which are unstable in solution.

* Inactivation of penicillin by Zn is of particular interest to pharmacists, since zinc compounds are used in vulcanizing natural, and especially synthetic, rubber. This may explain the inactivating effect of rubber tubing and stoppers on aqueous solutions of penicillin.

An interesting and practical observation in this connection is the fact that low concentrations of phosphates tend to stabilize purified penicillins, independently of their buffering action (Pratt, 1947; Smith, 1946). The optimum concentration of phosphate with respect to molarity is about 0.005 M. The optimum concentration range with respect to unitage of penicillin is relatively wide, being in the order of 0.0525-0.184 millimoles phosphate per 100,000 units of penicillin. The useful life of sterile solutions of sodium penicillin may be increased three to five-fold, depending on the temperature, when phosphate is present in a concentration of 5 millimoles per liter and 0.0525 millimoles per 100,000 units. The useful life of a solution may be taken as the time required for loss of 15 per cent of the initial antibacterial potency: the regulations of the Food and Drug Administration permit a 15 per cent leeway in the potency of penicillin preparations. Accurate measurements of changes in pH of the solutions throughout the course of the experiments showed that the results could not be attributed to the buffering effect of the phosphates. The following solution was recommended: NaCl, 0.14 M. (8.18 Gm./L.); $\text{NaH}_2\text{PO}_4 \cdot \text{H}_2\text{O}$, 0.003 M. (0.41 Gm./L.); and Na_2HPO_4 , 0.002 M. (0.28 Gm. anhydrous salt/L.). This solution, having a calculated freezing point depression of 0.56°C ., is isotonic with blood serum. The results obtained in typical experiments with a sodium salt of benzyl penicillin are shown graphically in Figure 27.

The mechanism responsible for the protective action of phosphates in low concentrations is not clear. It apparently is greater for partially purified penicillin (purity about 1,000-1,200 units per mg.) than for crystalline penicillin.

These comments on the protective action of low concentrations of phosphates are not meant to minimize the importance of hydrogen ion concentration in stability of penicillin, since it is well established that the pH of the solution is quite important in this respect. Sodium and potassium benzyl penicillates exist as salts in the pH range 5.0 to 8.0. Maximum stability of aqueous solutions of these salts obtains in the pH range 6.0 to 6.8. In solutions more acid than pH 5.0 or

more alkaline than pH 8.0 biologic activity of the compounds disappears rapidly.

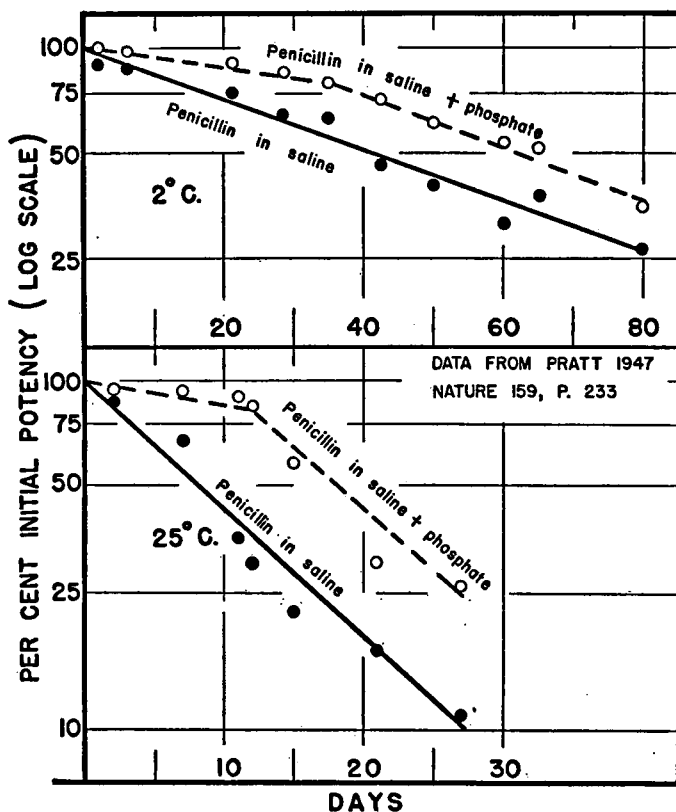

FIG. 27. Per cent initial antibacterial potency remaining in sterile solutions of sodium penicillin in physiologic saline U.S.P. (solid curves) and in saline containing 5 millimoles phosphate per liter (dashed curves) after different periods of storage at 2° C. (upper pair of curves) and at room temperature, i.e., about 25° C. (lower pair of curves). In this set of experiments initial concentration of penicillin = 9,525 units per ml.; initial concentration of phosphate with respect to penicillin = 0.0525 millimoles per 10⁵ units; pH = 6.7; purity of penicillin = 1,156 units/mg.

PENICILLIN AS A CHEMOTHERAPEUTIC AGENT

The highly selective action of penicillin is simultaneously its greatest virtue and the single factor that imposes limitations on its use. The virtual lack of toxicity of penicillin for the tissues of the host (except in a relatively small percentage of the population which is allergic to it) makes this antibiotic the drug of choice for all infections caused by organisms that are inhibited by concentrations of 0.1 unit or less per ml. But at the same time, this selectivity of action which is limited principally to the Gram-positive cocci renders the drug useless against many important pathogens. In general, diseases caused by Gram-negative bacteria, acid fast bacteria, viruses, rickettsias, and protozoa are not considered amenable to chemotherapeutic treatment by penicillin because the organisms are not inhibited by doses that it is practicable to attain and maintain clinically. Notable exceptions are gonorrhea, caused by Gram-negative gonococci, for which penicillin is the agent of choice; and psittacosis, caused by a virus. There is some evidence that penicillin is effective in the treatment of syphilis which is caused by a protozoan, but more research is necessary to unequivocally evaluate penicillin in the chemotherapeutic treatment of this disease. In Table 2 are listed representative pathogenic organisms which are generally considered susceptible to the action of penicillin in practicable clinical doses and organisms causing diseases which are not generally amenable to penicillin therapy. The table is by no means complete. It is intended to indicate representative species of penicillin-sensitive and of penicillin-resistant organisms. The last column lists some of the antibiotics which have been shown to be effective, at least in vitro, against some of the penicillin-resistant pathogens. The toxicity of some of these antibiotics (gliotoxin, notatin) limits their use. These are marked by an asterisk. Some typical infections amenable to penicillin therapy and average dosage schedules are given in Table 3.

Not all strains of a species of micro-organism susceptible to the action of a given antibiotic are equally sensitive, and, indeed, dif-

TABLE 2. SENSITIVITY OF MICRO-ORGANISMS TO PENICILLIN

SUSCEPTIBLE TO PENICILLIN	RESISTANT TO PENICILLIN BUT SUSCEPTIBLE TO OTHER ANTIBIOTICS AS LISTED
<i>Actinomyces bovis</i>	<i>Blastomyces</i> , various species (fungi) Gliotoxin ?
<i>Bacillus anthracis</i>	<i>Brucella abortus</i> Chloromycetin
<i>Bacillus subtilis</i>	<i>Eberthella typhosa</i> Streptomycin
<i>Clostridium botulinum</i>	<i>Escherichia coli</i> Streptomycin, polymyxin, chloromycetin
<i>Clostridium perfringens</i>	<i>Hemophilus influenzae</i> Bacitracin
<i>Clostridium septicum</i>	<i>Hemophilus pertussis</i> Bacitracin, chloromycetin
<i>Corynebacterium diphtheriae</i>	<i>Klebsiella pneumoniae</i> Polymyxin, chloromycetin
<i>Diplococcus pneumoniae</i>	<i>Monilia</i> , various species (fungi) Gliotoxin*
<i>Erysipelothrix rhusiopathiae</i>	<i>Mycobacterium tuberculosis</i> Streptomycin, subtilin, chloromycetin
<i>Neisseria gonorrhoea</i>	<i>Pasturella multocida</i> Polymyxin
<i>Neisseria intracellularis</i>	<i>Proteus vulgaris</i> Streptomycin, chloromycetin
<i>Staphylococcus aureus</i>	<i>Pseudomonas aeruginosa</i> (<i>Ps. pyocyanea</i>) Streptomycin
<i>Staphylococcus albus</i>	<i>Rickettsia</i> , various species Aureomycin, chloromycetin
<i>Streptococcus salivarius</i>	<i>Salmonella enteritidis</i> Polymyxin, gliotoxin,* notatin,* streptomycin, chloromycetin
<i>Streptococcus pyogenes</i>	<i>Salmonella paratyphi</i> Gliotoxin,* streptomycin, chloromycetin Streptomycin
	<i>Serratia marcescens</i> (<i>Bacillus prodigiosus</i>) Polymyxin, chloromycetin
	<i>Shigella paradysenteriae</i> Polymyxin, aureomycin
	<i>Shigella dysenteriae</i> Aureomycin
	<i>Streptococcus faecalis</i> Chloromycetin ?
	<i>Vibrio cholerae</i>

* Too toxic for parenteral use.

ferences in sensitivity to a given antibiotic are often evidenced by different cells of a pure culture derived from a single cell. For example, studies on 100 cultures of *Neisseria gonorrhoea* to determine the minimum inhibiting concentration of penicillin revealed an 8-fold

TABLE 3.
SOME INFECTIOUS DISEASES AMENABLE TO PENICILLIN THERAPY*

INFECTION	AVERAGE DAILY DOSE AND DURATION OF PENICILLIN THERAPY RECOMMENDED†
Actinomycosis	100,000 units; 2 weeks to 3 months
Bacterial endocarditis due to	
Nonhemolytic Streptococci	} More than 300,000 units; 1 to 3 months
β-hemolytic Streptococci	
Pneumococci	
Staphylococci	More resistant than other forms
Clostridial infections	
Gas gangrene	40,000-60,000 units; 5 days to 2 weeks
Miscellaneous	40,000-150,000 units; 1 to 3 weeks
Gonococcal infections	100,000-300,000 units; 1 to 3 days
Meningococcal infections (except endocarditis)	100,000-450,000 units; 10 days or more
Pneumococcal infections (except endocarditis)	100,000 units or less; 1 week or less
Staphylococcal infections (except endocarditis)	200,000 units or more; 1 to 2 or more weeks
Streptococcal infections	
β-hemolytic	100,000 units; 7 to 10 days
Nonhemolytic	60,000-100,000 units; 7 to 10 days

* This list includes the major groups of infections in which administration of adequate doses of penicillin may be expected to effect cures or improvement; it is not intended as a complete listing of all diseases in which penicillin may be useful. For such information the reader should consult the clinical literature.

† These "average" doses and frequency of administration are based on blood levels attainable by intramuscular injection of water-soluble benzyl penicillin. When other forms of penicillin are employed the dosage schedule may be varied in accordance with the ability of the preparation to produce equivalent blood levels for equivalent periods. In any event, therapy should be continued at least 24 to 48 hours after subsidence of temperature to normal.

range in resistance. Some cultures were inhibited by as little as 0.0025 microgram penicillin/ml., but the most resistant forms were checked only by a concentration as high as 0.02 microgram/ml. (see Fig. 28).

Similar experiments by other investigators on different organisms have yielded similar results. A 15-fold range in resistance has been reported among strains of *Streptococcus pyogenes* and more than a

25-fold range in different cultures from a species of *Pneumococcus*. In all these cases, however, the resistance of even the most recalcitrant forms studied is sufficiently low so that infections caused by them are amenable to penicillin therapy, i.e., the organisms are

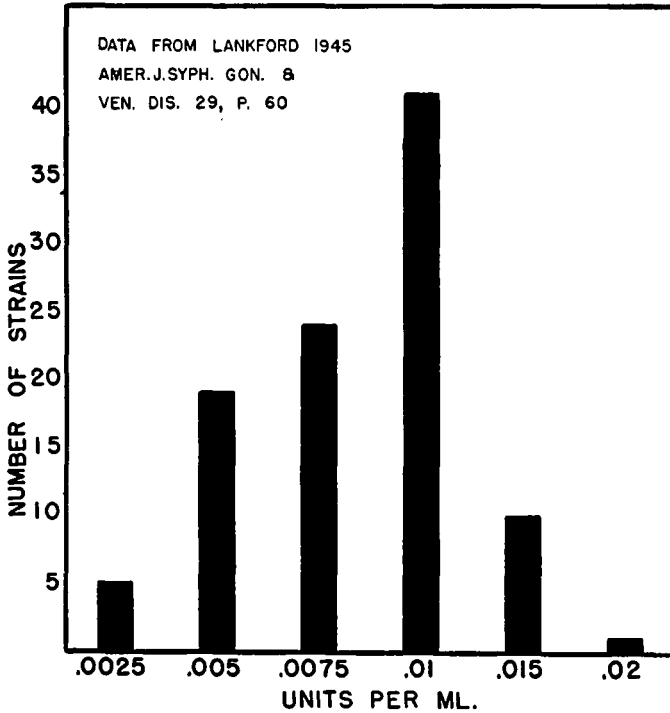

Fig. 28. Distribution of penicillin-sensitivity among 100 cultures of *Neisseria gonorrhoea*. The minimum concentration required to prevent growth of the organisms in vitro was determined. The number of cultures falling in each class represented along the base is indicated by the height of the vertical bars.

inhibited or killed by concentrations of the antibiotic that can be maintained reasonably well in the blood serum of man and of other animals. An organism which is inhibited by penicillin concentrations of the order of 0.06 unit/ml. (0.03-0.04 microgram/ml.) or less

is generally considered penicillin-sensitive. With the development of dosage forms and of various other pharmaceutical modifications of penicillin that make it possible to maintain higher serum concentrations of the antibiotic it is possible to bring within the range of penicillin therapy infections caused by some micro-organisms that are inhibited only by higher concentrations.

FACTORS INFLUENCING ANTIBACTERIAL ACTION

Factors that influence antibacterial action are of the greatest importance in laboratory studies and in routine procedures as well as in the clinical treatment of infections. There are a number of factors which are capable of determining, or at least modifying, the antimicrobial action of antibiotics. The same general factors apply to consideration of the activity of any antibiotic, although the relative importance of a given factor may vary from one antibiotic to the next. These factors are set forth in some detail at this point, since most individuals still think first of penicillin when antibiotics are mentioned. It is important that all of the following conditions be taken into consideration in selecting an antibiotic for specific clinical application.

Sensitivity of the Pathogen. The questions of antibiotic spectra in general and of differences in sensitivity and resistance of different strains within a given susceptible species have been discussed briefly above (Chap. 4). Ideally, to decide which antibiotic, if any, to use, the pathogens should be isolated, in pure culture, from the patient, and, if identified as Gram-positive, should be tested *in vitro* against penicillin: if penicillin is ineffective in clinically obtainable concentrations, other antibiotics should be tried. Of course, many infections characterized by well defined clinical symptoms can be identified as being due to penicillin-sensitive organisms without resorting to preliminary microbiologic tests. Inappropriate or unwarranted use of penicillin, or of any other antibiotic, may not only be useless, but may be harmful, as reported in cases of tuberculosis (see Chap. 6). In cases of mixed infections in which the primary aggressor is Gram-negative, use of penicillin, by eliminating the Gram-positive organ-

isms, may favor proliferation of the Gram-negatives. Such cases of mixed infections due to Gram-positive and Gram-negative organisms call for mixed therapy, i.e., penicillin and streptomycin, penicillin-sulfonamide, streptomycin-sulfonamide, etc. It is important in such cases to avoid concomitant use of antibiotics that may antagonize each other (Chap. 7).

Number of Organisms Initially Present. For all practical purposes, this factor is of little importance in penicillin therapy. This is in sharp contrast to the situation in sulfonamide therapy where the dose of drug required to bring an infection under control is a direct function of the density of bacterial population and where, consequently, the danger of untoward toxic reactions to the drug is increased in more severe infections in which the patient is likely to be in a more debilitated state. The relation between number of organisms and dose of penicillin required for their inhibition will be discussed more fully in connection with the mechanism of antibiotic action (see Chap. 11).

pH of the Medium. The hydrogen ion concentration of the medium exerts a profound effect on the action of penicillin. The effect of pH may be dual: first, a direct effect on penicillin per se; second, an indirect effect caused by the influence of hydrogen ion concentration on the growth and activity of the pathogen. Penicillin in solution is destroyed rapidly and loses its antibiotic activity as the pH of the solution deviates from the range of approximately 6.0-6.8.*

* This may seem paradoxical when it is recalled that during the last stages of the fermentation cycle when the highest titers of penicillin in the crude liquor obtain, the pH of the medium is about 8.0, and that during extraction and purification the pH of the menstruum is reduced to approximately 2.2. However, it should be recalled also that duration of the periods when the penicillin is in such acidic solutions during purification is reduced to a minimum and that during such periods destruction is retarded by use of near-freezing temperatures.

At the relatively high pH values that obtain in the culture medium at the time of harvesting penicillin, it may be surmised that some of the penicillin undergoes hydrolysis continuously, but the hydrolytic products are likely to be rebiosynthesized by the mold into more penicillin. Furthermore, there appear to be present in crude penicillin factors that tend to protect the molecule against chemical destruction (see page 79).

Penicillin exerts greatest effect against organisms which are growing and metabolizing most rapidly (see Chap. 3). Consequently, it may be expected to be most effective, other conditions being favorable, at hydrogen ion concentrations most favorable for growth of the particular pathogen to be controlled. This factor is of most significance *in vitro*. Most pathogenic organisms amenable to penicillin therapy infect body fluids and tissues that are buffered at a pH which may not be changed markedly without incurring serious physiologic complications for the patient. Fortunately, the normal pH of blood serum and other body fluids and tissues subject to invasion by organisms amenable to penicillin therapy is within a range in which penicillin is stable and effective.

Presence of Inhibitors or Interfering Substances. The outstanding virtue of penicillin, in contrast with many other antibiotics and with other chemotherapeutic agents, such as the sulfonamides, is that the antibacterial activity of penicillin is not impaired in the presence of normally occurring concentrations of constituents of blood or serum and is not impaired by the presence of pus or dead bacteria. As early as 1940, however, Abraham and Chain isolated a substance from *Escherichia coli* which completely inhibited the antibacterial activity of penicillin. This enzyme-like substance, which was designated *penicillinase*, was obtained subsequently from other species of bacteria and from fungi and actinomycetes. Some penicillin-resistant strains of *Staphylococcus aureus* produce penicillinase. However, the matter of susceptibility vs. resistance to penicillin in bacteria is not simply a question of whether or not the organism produces penicillinase. Many initially resistant organisms do not produce penicillinase; nor is the acquisition of resistance by strains of organisms derived from initially sensitive species (by continued subculturing in increasing concentrations of penicillin) necessarily accompanied by production of penicillinase. In a few instances the presence of penicillinase has been reported in penicillin-sensitive species. Therefore, it is clear that in most cases the explanation for the sensitivity or resistance of different species of micro-organisms must be sought in

terms of the cytochemical and biochemical differences that characterize the different species and strains (Chap. 11).

Penicillinase, produced commercially from cultures of *Bacillus cereus*, and the similarly acting clarase, produced from cultures of *Aspergillus orizae*, have been used as penicillin-inactivators in performing sterility tests on penicillin samples during manufacture (see Chap. 3). They have been used also in clinical testing of blood samples from patients who have recently had a course of penicillin therapy. Addition of sufficient penicillinase or clarase to inactivate any residual penicillin in the blood sample tends to preclude the possibility of obtaining false negative results. Commercial samples of penicillinase and clarase have shown considerable variation from one batch to the next, and, therefore, definitely identified chemicals, such as hydroxylamine, are preferred for sterility tests.

Presence of Enhancing Factors, Activators, or Synergists. Any agent that is capable of increasing the effectiveness of an antibiotic is potentially a valuable adjunct to the clinicians' armamentarium if that agent is not toxic per se in the concentrations required to produce the enhancing effect. Reports of the enhancement of the antibiotic activity of penicillin have been in the literature since 1944 when it was independently observed by different investigators that partially purified penicillin exerted a selective action in vitro against rat and mouse sarcoma cells in tissue cultures, whereas pure penicillin possessed no such activity. In 1945 it was shown that partially purified penicillin reduced the motility of the syphilis-causing protozoan, *Treponema pallidum*, and that crystalline penicillin did not do so. Subsequently, there was reported the occurrence in some commercial lots of amorphous (partially purified) penicillin of an unidentified factor which, though devoid of protective activity itself, enhanced the protective action of penicillin against *Eberthella typhosa* in mice as much as 100 per cent in some cases, i.e., 2000 units of amorphous penicillin containing the enhancing factor or of crystalline penicillin with the factor added were as effective as 4000 units of crystalline penicillin alone. Later it was observed that some batches of impure penicillin

were three to five times more effective than crystalline penicillin G in protecting mice against *Streptococcus hemolyticus* and *Diplococcus pneumoniae*. The precise nature of these natural enhancing factors is not clear but they may be related in some way to incomplete removal of phenylacetic acid or other precursors added to the fermentation medium during biosynthesis. This view has been questioned but not disproved. Similar enhancing effects have been observed following addition of penicillin K and of inactivated penicillinase to crystalline penicillin. In this connection, it should be noted that crude penicillin, i.e., the filtrate remaining after removal of the mold, has been reported to possess factors which tend to detoxify bacterial toxins, thereby reducing their noxiousness to the host (Ramon and Richou, 1948). This property is not possessed by purified penicillins.

However, as was pointed out in Chapter 1, the trend in the pharmaceutical industry and in medicine has ever been away from the use of unidentified or crude preparations and toward the goal of administering definite amounts of identified compounds. Thus, if the use of adjuvants to enhance or to potentiate the action of penicillin should some day be deemed clinically practicable, it would seem desirable to offer the profession chemically defined compounds. Cobalt chloride and vitamin K₅ (2-methyl-4-amino-1-naphthol hydrochloride) in concentrations ranging from 0.1 to 10 mg./L. exert such an effect and may find clinical application as enhancing adjuvants in penicillin therapy. For example, appropriate concentrations of cobalt chloride, nonbactericidal or nonbacteriostatic per se, increase the protective action of crystalline penicillin G in mice infected with *Eberthella typhosa* at least two-fold.

Recently, a polycyclic acid with the empirical formula C₂₈H₄₃O₆N has been isolated from amorphous penicillin previously inactivated by boiling in methanol. This compound, named borrelidin because it possesses marked antibiotic activity in vitro against spirochaetes of the genus *Borrelia*, is totally devoid of demonstrable activity in vitro or in vivo against *Eberthella typhosa*, *Escherichia coli*, and the organisms generally considered susceptible to the action of penicillin.

However, when borrelidin, in appropriate amounts, is administered to experimental animals along with crystalline penicillin, it enhances several fold the effectiveness of crystalline penicillin against *Staphylococcus aureus* and renders the penicillin therapeutically effective in infections due to *Eberthella typhosa* or to *Escherichia coli*, Gram-negative organisms generally considered outside the range of effective penicillin chemotherapy. Maximum enhancement is obtained when borrelidin is added to crystalline penicillin in approximately the same proportions that the compound occurs in partially purified, amorphous penicillin. If borrelidin is added in excess of the natural proportion, not only does no enhancement of penicillin action occur, but the action of the penicillin is inhibited and the animals die from the experimental infection. It has been found that borrelidin is highly active in vitro against *Sarcina lutea*. This observation is a considerable step forward that should facilitate study of the compound, since it affords a means for quantitative studies without recourse to time-consuming and expensive animal studies.

Borrelidin is insoluble in water but its sodium salt is soluble. The compound has been isolated from corn steep liquor, and it has been estimated that the amount found in amorphous penicillin can be accounted for in the amount initially present in the steep liquor used in the fermentation medium.*

Several other substances have been reported to act synergistically with penicillin. Among these products are bacitracin, streptomycin, bismuth, and certain dyes.

Two or more agents are said to be synergists when the effect elicited by their joint use is greater than would be anticipated from the sum of their independent actions when used separately. The phenomenon of synergism (derived from Greek roots meaning work

* Borrelidin has been isolated also from a corn steep liquor medium fermented by an unidentified species of *Streptomyces*, and in this case the amount of borrelidin extracted from the fermented liquor far exceeds the amount that can be accounted for in the unfermented liquor. It appears, therefore, that some species of *Streptomyces* may biosynthesize this compound when provided with a suitable substratum.

and together) is not limited to the field of antibiotics, but is common in pharmacology.

The possible *modus operandi* of the synergistic action of these substances and of penicillin will be discussed in connection with the mechanisms of antibiotic action (Chap. 11). It will suffice to suggest here that in general the synergistic effect may be brought about in different ways. In some instances (cobalt, bismuth, and possibly the natural enhancing factor in different lots of amorphous penicillin) the agents may act as growth-promoting factors for the micro-organisms, thereby stimulating them to a state of intense metabolism in which they are more sensitive to penicillin. In other cases (streptomycin) the synergizing agent may be surmised to inhibit those organisms in the bacterial population which are least sensitive to penicillin and might, therefore, persist in the presence of penicillin alone.

The type of penicillin that is used may markedly influence the speed with which a penicillin-sensitive infection is brought under control and, in some cases, may even determine the success or failure of a course of penicillin therapy.

The several types of natural penicillins shown in Figure 19 differ in their *in vivo* and *in vitro* antibacterial activity as well as in the chemical structure of the side chains entering into the acetamide linkage and in their chemical and physical properties. The type of penicillin that is biosynthesized in the fermentation liquor depends primarily on the species and strain of mold that is used and the composition of the medium and, to a lesser extent, on the cultural conditions, i.e., aeration, pH, etc. The natural propensity of different strains of *Penicillium* sp. for biosynthesizing different types of penicillins and the alteration of these natural proclivities by use of appropriate precursors has been referred to above. The types of penicillins that are recovered from fermentation liquors containing mixtures of different penicillins depend on the methods of extraction and purification that are employed and on the solvents and reagents that are used. For example, the existence of penicillin III, or X, was first suspected when it was discovered during commercial processing in some plants that

unaccountable losses of antibiotic activity were sustained when chloroform was introduced as an extracting agent in one step of the purification procedure. This suggested the existence of a chloroform-insoluble penicillin; subsequent research confirmed the correctness of this supposition.

The several penicillins differ markedly in the threshold concentration required for chemotherapeutic effectiveness *in vivo* or for inhibition of a given pathogen *in vitro*. Typical examples, selected from published data are shown in Table 4. In this table the activity of benzyl penicillin is arbitrarily rated as unity and the activities of the other penicillins are rated proportionately. Thus, a figure greater than 1.0 indicates greater activity than penicillin G and a figure less than 1.0 indicates weaker activity than penicillin G.

The first lots of commercial penicillin produced from *Penicillium notatum* in surface cultures were impure mixtures, only 15-20 per cent of which was penicillin (mostly penicillins F and G, sometimes with varying proportions of X). As production and recovery methods

TABLE 4. RELATIVE ACTIVITY OF FOUR NATURAL PENICILLINS AGAINST DIFFERENT PATHOGENS *IN VIVO* AND *IN VITRO*

ORGANISMS	TYPE OF PENICILLIN			
	I or F	II or G	III or X	IV or K
<i>in vivo</i>				
Bacillus anthracis	0.8	1.0	1.1	0.4
Diplococcus pneumoniae (type I) .	0.8	1.0	1.6	0.2
Neisseria gonorrhoeae	0.6	1.0	1.6	0.3
Staphylococcus aureus	0.9	1.0	1.3	0.4
Streptococcus pyogenes	0.5	1.0	2.6	0.1
Treponema pallida (in mice)	0.4	1.0	?	0.1
<i>in vitro</i>				
Bacillus anthracis	0.5	1.0	1.6	0.3
Diplococcus pneumoniae (type I) .	0.6	1.0	1.4	1.8
Neisseria gonorrhoeae	3.3	1.0	7.3	1.5
Staphylococcus aureus	0.9	1.0	1.5 - 2.0	1.4
Streptococcus pyogenes	0.8	1.0	1.5	1.2
Treponema pallida	0.5	1.0	0.5	0.8

were improved, more highly purified products became available, and late in 1945 the average purity of commercial penicillin was about 70-75 per cent or higher, i.e., it contained not more than 25-30 per cent of extraneous matter. Soon after that time crystalline penicillin became available.

As the "purity" of commercially available penicillins, in terms of "units per milligram," was increased it was observed independently by numerous investigators in different laboratories and hospitals that many common infections formerly amenable to penicillin therapy did not respond favorably to the more highly purified penicillin: it was found necessary to use appreciably larger doses of the more highly purified forms to bring some infections under control. Two explanations to account for these observations were promptly suggested, i.e., (1) that the therapeutic properties of the earlier, amorphous, less highly purified compounds were not due entirely to penicillin but were due in part to the presence of some other antibacterial agent or agents which were removed from the more highly purified penicillin preparations and (2) that many Gram-positive pathogens were developing resistance to penicillin or that the Gram-positive strains susceptible to penicillin were gradually being eliminated so that only the penicillin-resistant strains were being transmitted from patient to patient. The latter assumption seemed plausible enough, since similar experiences had been encountered in the field of sulfonamide therapy.

Actually, however, the major part of the trouble was found to be neither of these, but a third factor which was not related primarily to the *purity* of the penicillin but rather to the *type* of penicillin. It will be recalled that *P. chrysogenum* X-1612 was introduced early in 1945 and that later that year strain Q-176 was first introduced for the industrial production of penicillin (Fig. 9). Soon thereafter virtually all producers were using these strains because of the higher yields of penicillin they produced. However, it so happens that both of these strains of *Penicillium chrysogenum*, and especially Q-176, tend to produce predominantly the heptyl-penicillin (penicillin K) which, as is evident from Table 4, is much less efficient therapeutically than

any of the other natural types against a number of common pathogens, although it is somewhat more active than penicillins G or F in vitro against *Staphylococcus aureus* which is the organism used routinely for testing potency. Since some lots of commercial penicillin contained as much as 65 per cent heptyl penicillin, and since the potency stated on the label was determined by in vitro tests against *Staphylococcus aureus*, it is clear that the labelled unit contents of a vial was not always a true indication of the therapeutically active penicillin contents. The motives of the manufacturers should not be impugned in this connection. From a practical standpoint, the vials were misbranded, i.e., the labels actually gave a false impression of the therapeutically active contents, but this was a situation which came about quite innocently, since no one at the time was aware of the clinical inferiority of heptyl penicillin. For that matter, it had not yet been clearly established that the molds were producing a different type of penicillin. As soon as the situation was recognized, steps were taken to correct it; first, by devising differential assays that make it possible to discriminate one type of penicillin from another and to determine the proportions of different penicillins in a mixture by in vitro tests, second, by prescribing minimum requirements as to the content of benzyl penicillin, and, finally, by adding aromatic precursors to the fermentation medium.

The present regulation, specified by the Food and Drug Administration, is that material labelled crystalline penicillin G must contain a minimum of 85 per cent benzyl penicillin, on a weight basis. Average commercial penicillins sold today usually contain not more than 2 to 5 per cent heptyl penicillin, due to the fact that all manufacturers use phenyl acetic acid or some similar phenyl compound as a precursor in the fermentation liquor to "steer" the biosynthesis by the mold away from heptyl penicillin and toward benzyl penicillin.

Although undoubtedly the progressive increase in the concentration of penicillin K was a major factor responsible for the gradual apparent decrease in the efficacy of penicillin as a chemotherapeutic agent, the partial elimination of enhancing factors from crystalline

penicillin cannot be totally ignored. It seems clear from current evidence, however, that, at most, such factors were of relatively minor importance in the change that was noted.

The concept that gradual decline in apparent efficiency of penicillin was due to development of resistant strains appears invalid. It is true that highly resistant strains of organisms may develop in vitro from initially sensitive species or strains, but there is little, if any, conclusive evidence to indicate that this phenomenon occurs in vivo during penicillin therapy of infections due to a single organism. In cases of mixed infections where some of the invaders are sensitive to penicillin while others are resistant, uncritical observation might lead one to the conclusion that resistant strains had developed during penicillin therapy, but this, of course, would not be true.

It is well established that for treatment of some infections *p*-hydroxy benzyl penicillin (X) is distinctly superior to the other common types. However, the current methods of industrial production of penicillin are not conducive to biosynthesis of this type and, consequently, it is not commercially available at the present time. In the first place, the strain of mold most commonly employed in submerged fermentation does not produce appreciable amounts of penicillin X, which is produced most abundantly in surface cultures of *Penicillium notatum*.^{*} Strains of *Penicillium chrysogenum* that produce a relatively high proportion (about 40 per cent) of penicillin X are known, but the total yield of penicillin by these molds is considerably less than the yield given by Q-176. Furthermore, different extraction and purification procedures are required for penicillin X. Therefore, in view of the economics of the situation, there is little incentive for producers to engage in large scale production of this type of penicillin at the present time. This might be changed if the antibiotic spectrum of penicillin X should be shown to be markedly different qualitatively as well as quantitatively from that of penicillin G.

^{*} It appears that penicillin X is produced most easily in surface cultures employing *Penicillium notatum*. A device which incorporates in surface cultures the advantages of submerged fermentation technic has been described (Stice, E., and Pratt, R., 1946, *Science*, 103:535-537).

CHEMOTHERAPEUTIC USE

It will be advantageous to discuss the physiologic and certain pharmaceutical aspects of penicillin therapy together because the two are so interdependent that it is impossible to completely divorce one from the other. For effective therapy of systemic infections, the concentration of penicillin in the blood serum must be maintained at or above a certain minimum level which corresponds to the threshold concentration discussed above, if not continuously, at least during periods recurring frequently enough to suppress successive waves of bacterial growth such as are pictured in Figures 16 and 17.

Penicillin diffuses from the blood into all tissues of the body, except the bone marrow, the intact central nervous system, and the cerebrospinal fluid.* Therefore, systemic treatment through maintenance of an adequate blood level (concentration) of penicillin is effective for treatment of localized infections also. In such cases it is necessary to secure a concentration of penicillin in the blood sufficiently high to permit attainment of the threshold concentration at the site of infection. Even in cases where the focus of local infection is readily accessible to topical medication it is advisable to fortify the local treatment by building up the blood level of penicillin through systemic administration.

The threshold concentration that is required for treatment of a specific infection depends primarily on the sensitivity of the pathogen to penicillin or the antibiotic that may have been selected for use. Most infections amenable to penicillin therapy can be successfully treated by maintaining a blood level of 0.03 to 0.05 units (0.02 to 0.03 microgram) of penicillin per ml. of serum as long as fever persists and for at least 18 to 24 hours thereafter. Some authors, however, suggest maintaining a level as high as 0.16 unit (0.1 microgram) per ml. of serum. This or even higher levels can be achieved; but special technics, to be discussed below, are necessary to insure their maintenance for therapeutically effective periods of time.

* In patients with meningitis or in other conditions in which the meninges are acutely inflamed or injured penicillin may diffuse into the spinal fluid following ordinary intravenous or intramuscular administration.

Infections in which penicillin is indicated are notably those caused by the organisms listed in Table 2 (column 1). A number of other infections caused by Gram-positive organisms are also amenable to penicillin therapy.

Absorption, Blood Levels, and Excretion. Normally, penicillin is rapidly excreted from the blood stream into the urine. Therefore, the rate of excretion depends on the rate at which penicillin reaches the blood. This, in turn, depends on the mode of administration and the amount administered. The factors which influence the serum concentration may be outlined as follows:

- I. Method of administration and size and form of dose (intravenous, intramuscular, subcutaneous, oral, inhalation).
- II. Rate of excretion which depends on
 - A. Rate of absorption which, in turn, depends on
 1. Rate of release from vehicle in which administered
 2. Rate of diffusion from one body tissue or fluid to another
 3. Rate of destruction or inactivation in body which, in turn, is influenced by
 - a. Presence of mixed infections involving penicillinase-producing organisms
 - b. Kind of penicillin used
 4. Presence of enhancing factors which may be
 - a. Naturally occurring or
 - b. Intentionally added.

AQUEOUS SOLUTIONS. Intravenous Injection. The appearance and subsequent increase of penicillin in urine concomitantly with disappearance of the antibiotic from the blood following a single intravenous injection is shown in Figure 29 which shows also that penicillin persists for several hours in urine when kidney function is normal. Figure 30 shows the effect of renal failure on blood levels and excretion of penicillin. As a matter of fact, during the years when penicillin was very scarce, it was recovered routinely from the urine of treated patients.

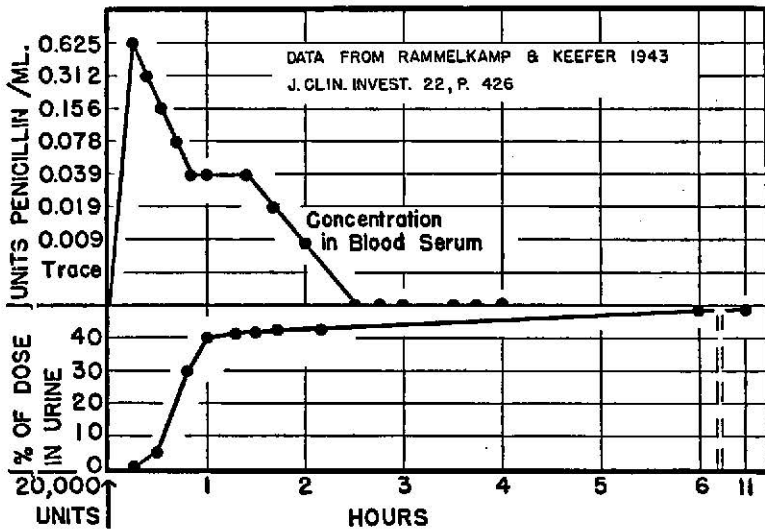

FIG. 29. Concentration of penicillin in serum and in urine at different times following a single intravenous injection of 20,000 units in aqueous solution.

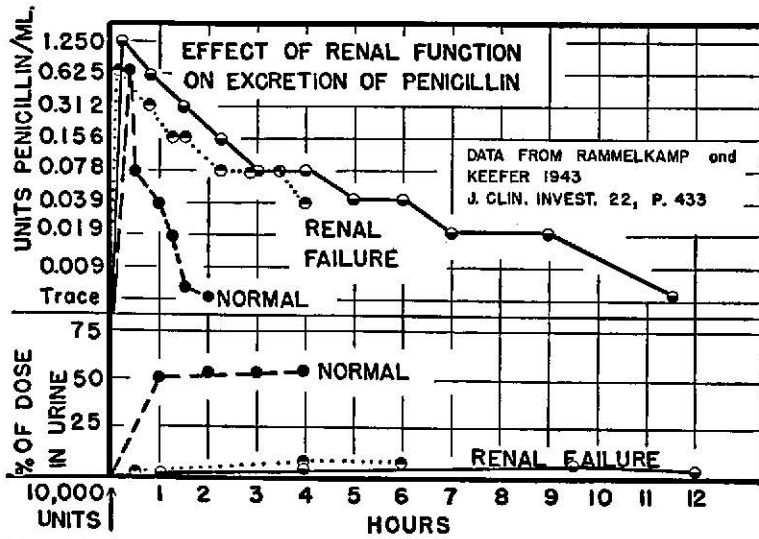

FIG. 30. Effect of impaired renal function on excretion of penicillin in urine and on concentration in serum.

Following intravenous injection, penicillin is rapidly distributed throughout the blood serum and consequently the maximum concentration attained is proportional to the amount injected. Figure 31 shows that the period during which therapeutic blood levels of penicillin (about 0.075 unit/ml.) are maintained is somewhat prolonged, but not markedly, as the dose is increased over a relatively wide range.

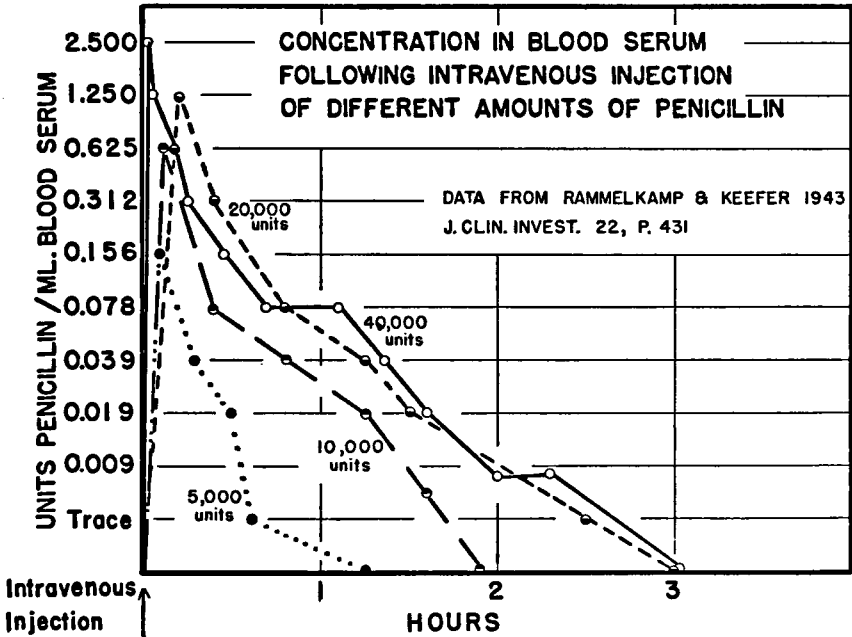

FIG. 31. Concentration of penicillin in serum at different times following intravenous injection of different amounts of the antibiotic in one ml. of an aqueous solution.

When penicillin is administered intravenously, it is necessary to give a priming dose sufficient to bring the blood level into the therapeutic range, and then to continuously inject the antibiotic at a rate at least equal to that at which it is being dissipated. The continuous intravenous drip technic requires immobilization of the patient and more or less continuous supervision by a physician or nurse and, therefore, now is resorted to only in exceptional or critical cases, since simpler

methods, described below, are adequate to insure satisfactory treatment for most infections.

Intramuscular Injection. Following intramuscular injection of penicillin in saline or other aqueous medium, maximum concentration in the serum is reached in from 15 to 30 minutes. The concentration remains at approximately this level for a short period and then decreases rapidly (see Fig. 32).

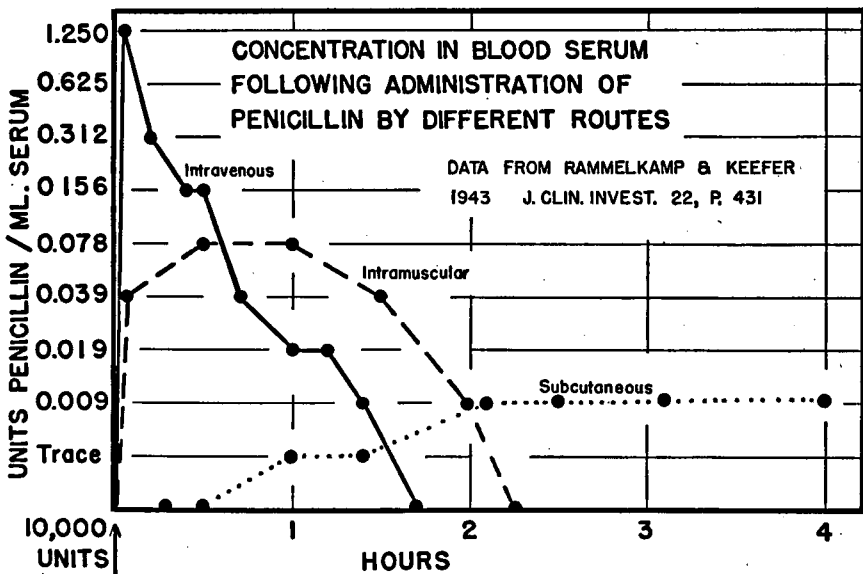

FIG. 32. Concentration of penicillin in serum at different times following administration of 10,000 units in one ml. of aqueous solution by different routes.

Figure 32 shows that, once the penicillin concentration in the serum begins to decline, the “die-away” curves are approximately parallel, regardless of whether the intravenous or intramuscular routes of administration are used. Since the curves represent concentration on a logarithmic scale and time on an arithmetic scale, and the curves are essentially linear, it is obvious that the rate of decrease is approximately exponential, i.e., a definite percentage of the penicillin that

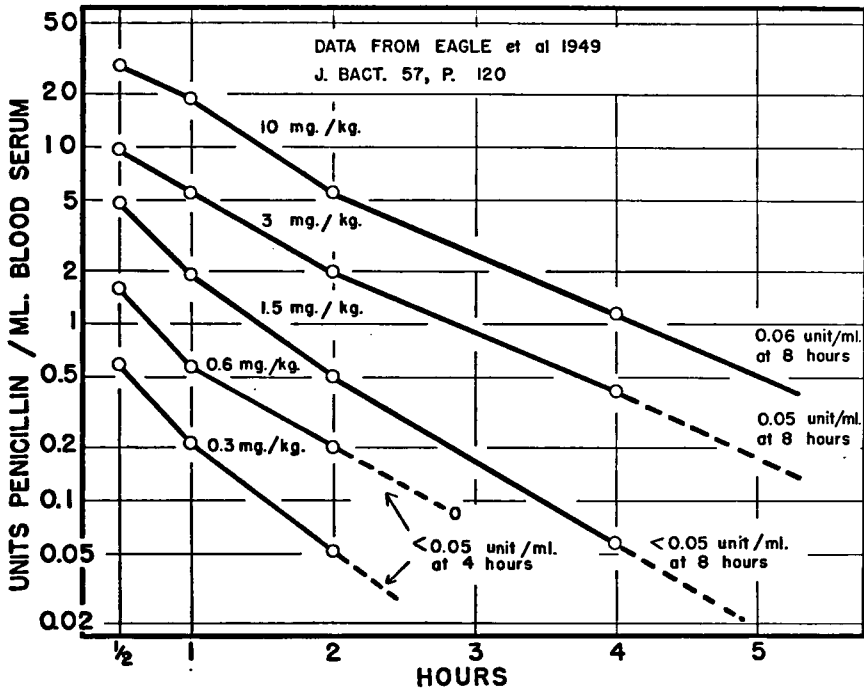

FIG. 33. Die-away curves of penicillin concentration in blood serum of man following intramuscular injection of different amounts of penicillin G in aqueous solutions. The amount injected is shown above each curve.

is present in the serum is dissipated in each unit of time. Eagle and co-workers have observed that in man the rate of decrease of penicillin concentration in serum over the first two hours varies from approximately 65 per cent to 80 per cent per hour, smaller doses being dissipated more rapidly than larger ones (see Fig. 33).

Since penicillin, administered in an aqueous solution, disappears from the blood so rapidly, it is necessary, in order to maintain therapeutically effective concentrations in the blood, to administer one very large dose or else to administer smaller doses frequently. Administration of excessively large doses is undesirable because the excess penicillin beyond the threshold concentration needed to check the pathogen is wasted and, in fact, may even increase the time required to

bring the infection under control (see Fig. 8). Frequent administration of smaller doses, i.e., 10,000 units every three to four hours, is more efficient therapeutically. For example, Eagle (1947) has shown that "the total curative dose of penicillin in experimental syphilis (in rabbits) on a single injection was greater than 300,000 units per Kg.; on 8 injections at 4-hour intervals, 80,000 units per Kg.; and on 50 injections at 4-hour intervals, a total of only 360 units per Kg. Similarly in pneumococcal infections of white mice, the single curative dose of penicillin G was 113 mg. per Kg.; on 4 injections at 1-hour intervals, 6.8 mg. per Kg.; and on 10 injections at 1-hour intervals, 1.18 mg. per Kg."

However, the administration of numerous injections at short intervals:

1. Does not maintain uniform or nearly uniform concentration in the serum but gives a series of "peaks and valleys"
2. Is wasteful of penicillin
3. Requires frequent attention from nurse or physician
4. Disturbs patient's rest
5. Is uncomfortable for patient.

Figure 34 is a diagrammatic representation of serum levels obtained by a series of intramuscular injections of penicillin in aqueous solution. Two features are apparent: first, most of the time the penicillin concentration is in great excess over that required, second, the periods of excess are followed by periods of deficiency. These periods of deficiency may be dangerous if they are long enough, or recur frequently enough, to permit postlytic waves of growth among the pathogens (see Figs. 16 and 17). But if the doses are large enough and are properly scheduled, discontinuous penicillin therapy may be therapeutically satisfactory for most infectious diseases. Return to normal temperature affords a useful criterion of clinical control in pneumonia and similar infections. The comparative data from pneumonia patients treated with discontinuous and continuous regimens of penicillin therapy plotted in Figure 35 show similar

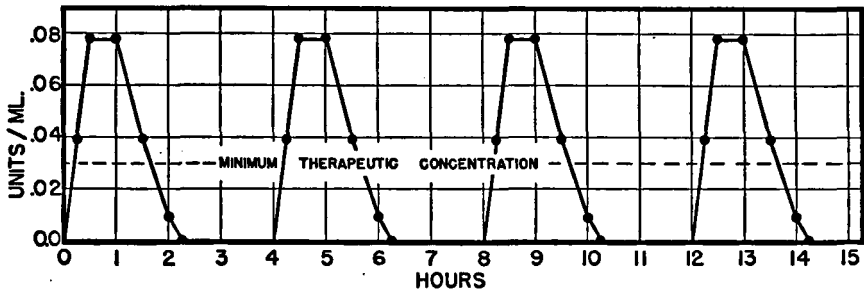

FIG. 34. Concentrations of penicillin obtained in blood serum by a series of intramuscular injections of sodium penicillin in aqueous solution.

results. The patients on a "continuous" schedule received one dose of 300,000 units procaine penicillin in oil daily; those on the "discontinuous" schedule received a dose of 300,000 units sodium penicillin G in saline at 12-hour intervals for 36 hours and then one dose every 24 hours. The blood levels at different times in patients on these two dosage schedules conformed closely to the data for "sodium penicillin in water" and "procaine penicillin" shown in Figure 37.

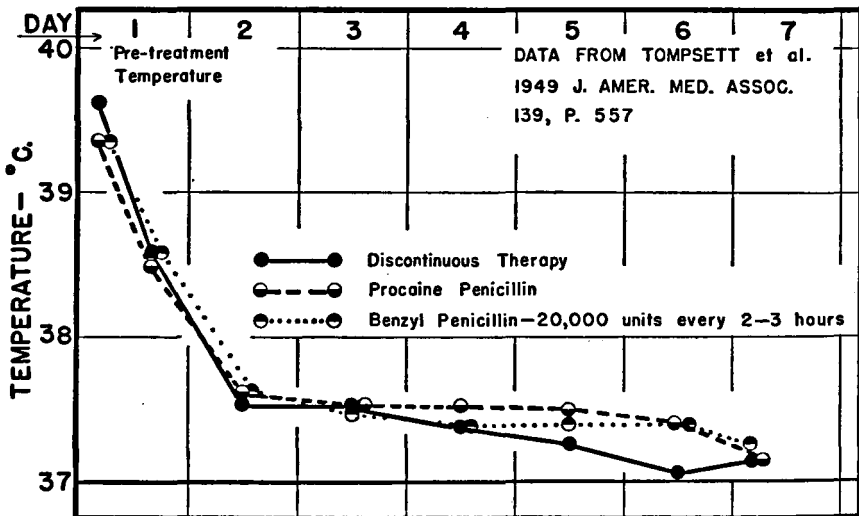

FIG. 35. Course of temperature in different patients with pneumococcal infections treated with different regimens of penicillin therapy.

Following intramuscular injection of equivalent doses, in terms of units, penicillin K produces lower plasma levels than either penicillins G or X. Data from a typical experiment are shown in Table 5.

TABLE 5.
CONCENTRATION OF PENICILLIN IN BLOOD OF HUMAN SUBJECTS AT DIFFERENT TIMES AFTER INTRAMUSCULAR ADMINISTRATION OF 25,000 UNITS OF PENICILLINS G, K, OR X.

PENICILLIN	UNITS/ML. AT DIFFERENT TIMES						
	0.5 Hr.	0.75 Hr.	1.0 Hr.	1.5 Hr.	2 Hr.	3 Hr.	4 Hr.
G	...	0.36	0.2	0.06	0.04	0.00	0.00
K	0.04	0.00	0.00	0.00	0.00	0.00	0.00
X	0.70	...	1.1	...	0.20	0.09	0.03

The above data afford an explanation for the clinical observation that penicillin K is less effective than penicillin G for treatment of a number of infections. Following administration of a large dose, penicillin K is excreted more rapidly than G; however, this does not fully account for the pronounced difference in blood levels at different times after administration of the two types of penicillin. Even in renal-ligated animals, penicillin K disappears from the blood considerably more rapidly than G. This suggests differential inactivation *in vivo* by some constituent of blood. In fact, *in vitro* the order of inactivation of the various penicillins by serum is $K > G > F > X$. However, one should be cautious about attempting to translate results of *in vitro* experiments of this type in terms of what happens in living tissues and animals.

Studies have been made of the rate of inactivation of penicillins G and K by isolated liver and kidney tissues under aerobic and anaerobic conditions and also of the rate of oxygen uptake by the two kinds of tissue in the presence of each type of penicillin. The oxygen uptake of tissue slices suspended in buffer was the same regardless of the type of penicillin that was present (15 units per Gm. of tissue),

but there were pronounced differences in the inactivation of the two penicillins. In two hours under aerobic conditions, penicillin K was inactivated by slices of liver tissue nearly four times as rapidly as penicillin G, and about 2.5 times as rapidly by kidney tissue. These observations appear to be at variance with those obtained with emulsions of different tissues, from which it appeared that, in general, G is destroyed more rapidly than K by liver and that both forms are destroyed at essentially the same rate by kidney emulsions. However, it is difficult to make direct comparisons of these two series of experiments because of the widely divergent conditions under which they were performed.

It may be concluded that experiments which most nearly simulate conditions that exist in the intact animal suggest that penicillins K and G are both bound or destroyed to some extent by blood serum and are inactivated by living kidney and liver tissues but that penicillin K is bound or inactivated much more rapidly than penicillin G. This undoubtedly accounts, in large measure if not entirely, for the decided clinical inferiority of the heptyl penicillin (K).

Experiments have shown that considerably higher blood levels are attained and that a therapeutically effective blood level is maintained approximately twice as long following intramuscular administration of 20,000 units of penicillin X than following administration of the same number of units of penicillin G. This undoubtedly accounts, in part, for the clinical superiority of *para*-hydroxy benzyl penicillin (X). However, specific differences in the antibiotic spectra of the two forms of penicillin cannot be entirely discounted, since penicillin X is known to be more active than G against some pathogens in vitro.

Subcutaneous Injection. Following subcutaneous administration of aqueous solutions of penicillin the concentration in the blood rises slowly to a relatively low level which is maintained for several hours as shown in Figure 32.

Oral Administration. Early reports indicated penicillin to be ineffective for treatment of systemic infections when administered orally, and the ineffectiveness was attributed to destruction of the

penicillin by the acidity of the gastric juice. Subsequently, it was found that therapeutically adequate blood levels can be attained and maintained if (1) sufficiently large doses are given, and (2) a suitable buffering agent (antacid) is administered along with the antibiotic. However, to insure the same satisfactory blood levels, it is necessary that at least five times as much penicillin be administered orally as intramuscularly. Insufficiency of the oral method of administration may be attributed primarily to incomplete absorption in the upper intestinal tract and subsequent destruction in the lower regions. Enteric coated preparations of penicillin are unsatisfactory, probably because of the variability in the time and site of disintegration in the intestinal tract. Penicillin escaping destruction in the stomach may be readily destroyed by penicillinase-producing Gram-negative bacterial flora of the intestinal tract. Penicillin blood levels following oral administration may be prolonged by concomitant administration of sodium sulfanilate or of sodium benzoate, which inactivate penicillinase, or of bromosaligenin, which inhibits *Escherichia coli*.

The incidence of allergic reactions to penicillin is considerably greater following oral administration than when parenteral routes are employed. Today the oral route is seldom used for securing a systemic effect except for treatment of gonorrhea. In such cases protection against infection depends on ingestion promptly after exposure.

Inhalation of appropriate amounts of penicillin in the form of an aerosol mist is an effective means of administration for the treatment of some infections, particularly those involving the lungs or bronchial tubes. Inhalation of an aerosol containing particles of penicillin 5 microns or less in diameter provides a relatively high concentration locally on the surface of the respiratory tract and concomitantly provides for a systemic effect as well, since some of the penicillin passes into the blood stream. The concentrations of penicillin that may be obtained in the blood and the rate of penicillin excretion in the urine following this form of administration are comparable to those observed following intravenous or intramuscular injection (see Fig. 36). Administration by inhalation may be rather wasteful, however. In a

typical experiment in which approximately 260,000 units of nebulized penicillin were delivered in one half hour approximately 60,000 units were accounted for in urinary excretion. If one assumes that 50 to 75 per cent of the penicillin that reaches the blood may be recovered in the urine, it would seem that about 80,000 to 120,000 units of the penicillin inhaled passed into the blood stream. Thus,

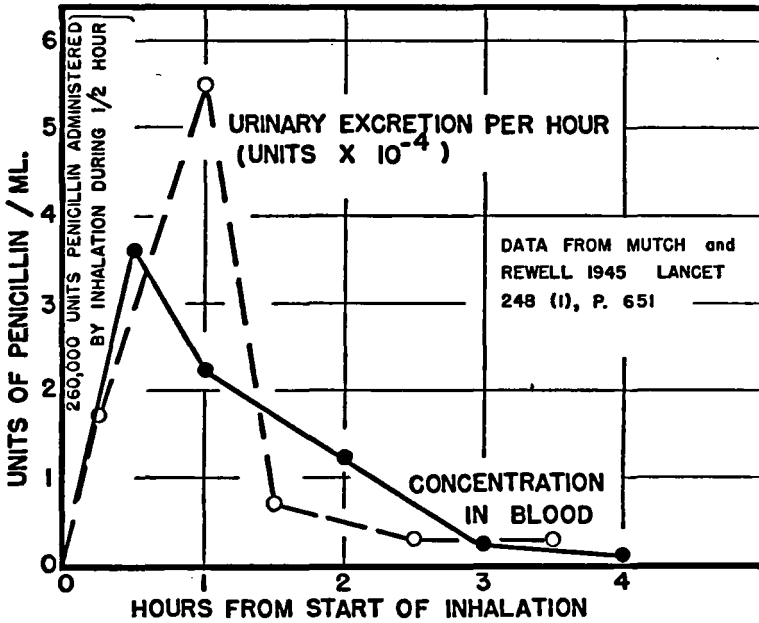

FIG. 36. Concentration of penicillin in the blood serum and cumulative urinary excretion of penicillin following administration of 260,000 units of sodium penicillin by inhalation.

this method of administration might be considered about 30 to 45 per cent efficient as a means of delivering penicillin to the blood stream.

The use of aerosol mists to administer penicillin is wasteful of the antibiotic and, therefore, is relatively expensive. Moreover, the penicillin so administered is rapidly absorbed into the blood stream and dissipated therefrom. Finally, inhalation of the mist is somewhat

tiring for the patient, since it must be continued for from 20 to 30 minutes. The use of aerosol dusts has been recommended to obviate these difficulties. Penicillin is ground to a fine dust and placed in an appropriate "smoke chamber." It has been reported that when properly used 95 per cent of the penicillin placed in the chamber may be delivered to the patient in the form of "smoke" in from two to four minutes. Furthermore, when a dry preparation is used the rate of absorption from the lungs is retarded so that the antibiotic is released to the blood stream more slowly, thereby providing therapeutic blood levels for from four to five hours or longer, depending on the dose administered.

SUSPENSIONS AND INSOLUBLE SALTS. Just as substitution of an aerosol dust of penicillin for an aerosol mist retards absorption and prolongs the period during which therapeutic blood levels are maintained, so substitution of suspensions of penicillin for solutions serves to prolong the therapeutic action of penicillin injected intramuscularly or subcutaneously. Since the intramuscular route is the most generally useful, attempts were made at a relatively early date to inject penicillin into the muscle in such a way that it might form a local depot or reservoir from which it would be released slowly into the blood. This has been achieved (1) by suspending penicillin in mixtures of oil and wax of such a composition that they remain liquid at ordinary room temperatures, and, therefore, are suitable for injection; and (2) by preparing relatively insoluble salts of penicillin that, when injected, dissolve and are released to the blood stream only slowly.

Suspensions in Oil and Wax. Among the substances proposed as agents to prolong the duration of therapeutic concentrations of penicillin in the blood, some may be added to the aqueous solutions to act physically, as by increasing viscosity (gelatin, plasma, pectin, etc.); others, such as vasoconstrictors, renal blocking agents, etc., are added to act physiologically. All of these agents provide some retardation of absorption, as does the simple physical expedient of chilling the site of application for several minutes before and after in-

jection, but none of them as much as doubles the time for which a given dose of penicillin will provide an effective therapeutic blood level.

Alternatively, water, as a vehicle, may be replaced by organic solvents (such as polymers of vinyl pyrrolidone) which are only slightly miscible with plasma, or by oils in which penicillin may be suspended.

The best agent available for delaying absorption of benzyl penicillin appears to be an appropriate mixture of vegetable oil and beeswax. As originally proposed by Romansky and Rittman (1944), the formula consisted of calcium or sodium penicillin G suspended in a menstruum of peanut oil or sesame oil in which approximately 4.8 per cent (w/v) of white beeswax was dispersed. Blood levels in excess of 0.03 units per ml. can be maintained for at least 12 hours following injection of 300,000 units suspended in one ml. of this preparation (see Fig. 37).

In order to maintain assayable levels in the blood serum at least 2,500 units (1,500 micrograms) of penicillin must be absorbed every hour. In order to provide for this rate of absorption 300,000 units of penicillin in oil and wax must be injected every 12 hours. To reduce the injection schedule to one each 24 hours, 600,000 units must be given.

Oil and wax preparations made according to the original formula possess a number of disadvantages. The product is quite viscous and needs to be heated to render it fluid before injection. At the site of injection it forms a pellet, which may give rise to local irritation and, in some few instances, to a sterile abscess. By using proper sterilization technics and by agitating the product during cooling it is possible to obtain a preparation which remains fluid enough to be injected without preheating. Since crystalline penicillin is used in the manufacture of commercial oil and wax preparations, refrigeration is unnecessary. Indeed, refrigeration must be avoided, since it causes "setting" or solidification of the wax.

Insoluble Salts of Penicillin. The disadvantages of the oil and wax suspensions of penicillin and the fact that even with such preparations

therapeutic blood levels are not maintained for more than 12 to 24 hours has stimulated searches for other ways of attaining the desired goal. The most satisfactory method available for delaying absorption appears to be injection of suspensions of sparingly soluble salts of penicillin in a suitable vehicle. To date, the most satisfactory salt available for this purpose is the procaine salt which was first described in 1948 (Sullivan, et al.).

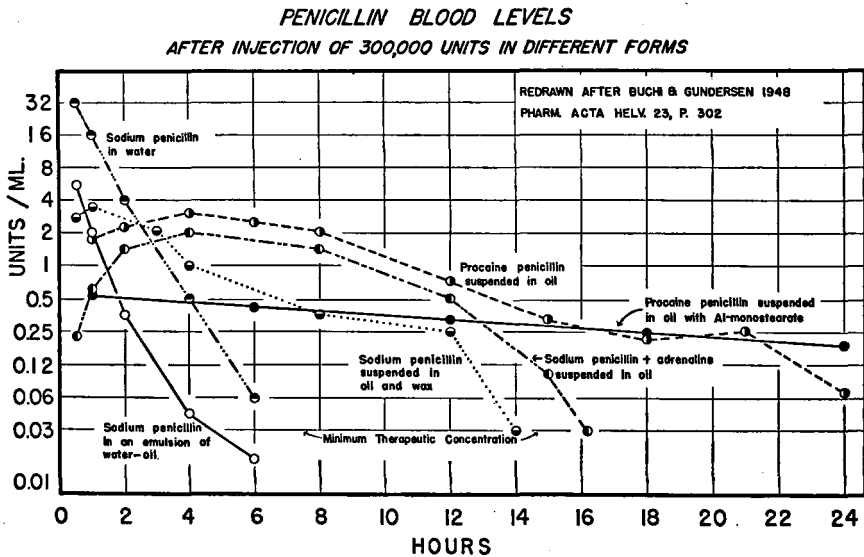

FIG. 37. Comparison of penicillin blood levels at different times after injection of 300,000 units of penicillin in different forms.

A single injection of 300,000 units of procaine penicillin, properly prepared and suspended in a mixture consisting of appropriate vegetable oils and aluminum stearate, maintains serum levels above 0.03 unit per ml. for four days. Factors that influence the rate of release of penicillin from the repository are viscosity, size of particles, and the amount of muscular movement in which the patient engages. The viscosity of the preparation depends, in turn, on the amount and kind of oil that is used, the amount and kind of stearate, i.e., mono-

di-, or tri-, that is used, and the technics of sterilization and subsequent handling.

Procaine penicillin is valuable not only for treatment of generalized systemic infections, but is also most helpful in dental surgery.

Prolonging the Duration of Therapeutic Blood Levels by Physiologic Means. The methods for prolonging maintenance of therapeutic blood levels discussed in the preceding sections are essentially pharmaceutical, i.e., they depend on altering the physicochemical properties of the medicament, largely by selection of appropriate vehicles, in such a way that the antibiotic will not be dissipated rapidly but will be released into the blood stream at a relatively slow rate. The problem may be approached also from the physiologic point of view.

USE OF VASOCONSTRICTORS. Concentrations of epinephrine sufficient to insure prolonged local vasoconstriction at the site of administration without inducing appreciable systemic effects have been used to prolong absorption of penicillin. A preparation containing 300,000 units of benzyl penicillin and 0.3 mg. of epinephrine in 1 ml. of vegetable oil provides for approximately a two-fold increase in the period for which effective penicillin concentrations are maintained in the serum (Fig. 38). Alternatively, the *l*-ephedrine salt of benzyl penicillin has been used with reported success. This product embodies both antibacterial and vasoconstrictor effects.

This product is fluid at room temperature and can be injected easily, a distinct advantage over the older types of oil and wax and procaine penicillin preparations. However, procaine penicillin preparations that can be injected with equal facility and that are more efficient in prolonging serum levels of penicillin are now available, and seem preferable to the vasoconstrictor type of medication.

MODIFYING RATE OF EXCRETION. It will be recalled that normally penicillin is excreted in the urine; that impaired renal function delays excretion and prolongs the period during which therapeutic blood levels are maintained (Fig. 30); and that the rate of decrease of penicillin concentration in the blood is exponential, i.e., during each

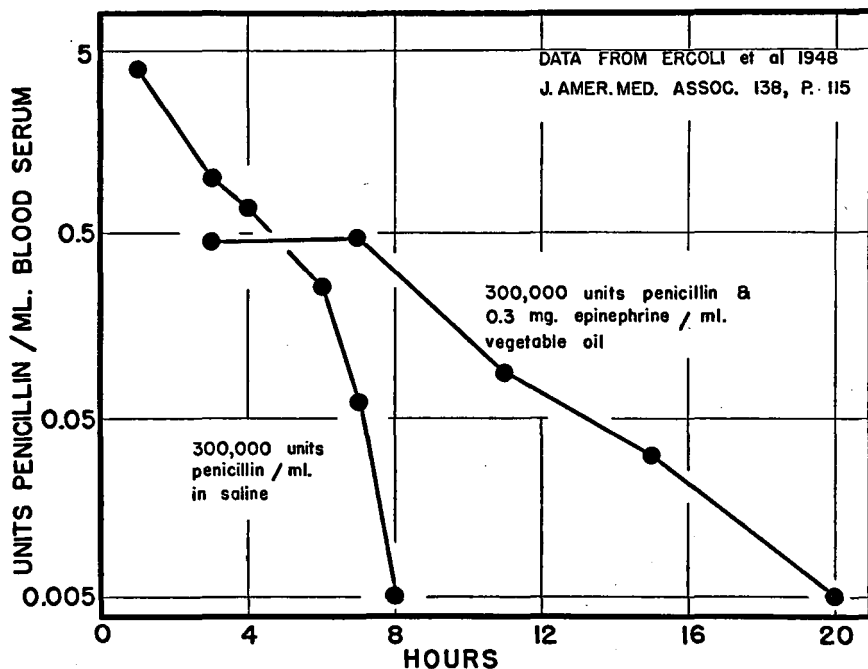

FIG. 38. Concentrations of penicillin in blood serum at different times after intramuscular injection of 300,000 units of sodium penicillin in saline and 300,000 units with a vasoconstrictor in an appropriate oil.

interval of time a constant percentage of the penicillin present at the beginning of that interval is excreted (Fig. 33). The same phenomenon holds for excretion of certain other compounds. Therefore, introducing into the blood, concomitantly with penicillin, a chemical which is excreted via the same mechanism may have the same result, in terms of prolonging the duration of a given blood level, as would increasing the dosage of penicillin.

Para-amino-hippurate has been used to delay excretion of penicillin on the assumption that both chemicals would compete for the same renal excretion mechanism and that, therefore, they would be excreted more slowly than if either were present alone. This technic has been found effective in increasing the duration of therapeutic

penicillin blood levels. Maintenance of *p*-amino-hippuric acid concentrations in the blood at a minimum concentration of 10 mg. per 100 ml. has been reported to increase the duration of effective penicillin concentrations 3- to 6-fold. In order to maintain a concentration of 10 mg. per 100 ml., *p*-amino-hippuric acid must be administered at a rate of about 80 mg. per Kg. per hour. No untoward effects have been noted following such a dosage schedule maintained for several days.

Alternatively, benzoic acid has been recommended to prolong the duration of therapeutically effective serum levels of penicillin. Benzoic acid is assumed to be detoxified in the normal liver by conjugation with glycine to form hippuric acid. Some success in prolonging duration of effective penicillin blood levels has been achieved by oral administration of benzoic acid in a sweet gelatin dessert or in acacia. This technic is effective, however, only on a restricted diet in which the intake of liquid is drastically curtailed. Under these conditions, i.e., restricted water intake, any diet which favors an increase in hippuric acid synthesis may prolong the duration of penicillin action.

Another compound, caronamide, has been used clinically to prolong penicillin action (Fig. 39). Caronamide is 4'-carboxy-phenylmethane sulfonamide, and has the following structure:

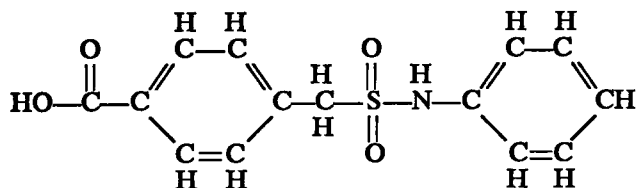

Caronamide

A concentration of approximately 20 to 30 mg. of caronamide per 100 ml. of serum is required to inhibit normal renal tubular excretion of penicillin and to achieve a two-fold to four-fold increase in the penicillin concentration two to four hours after administration of a dose of the antibiotic. An oral dose of 2 to 4 Gm. of caronamide

every four hours is required to maintain a suitable concentration in the serum. Mild toxic effects (gastro-enteric disturbances, nausea, etc.) have been observed when caronamide concentrations sufficient to prolong effective penicillin levels have been achieved.

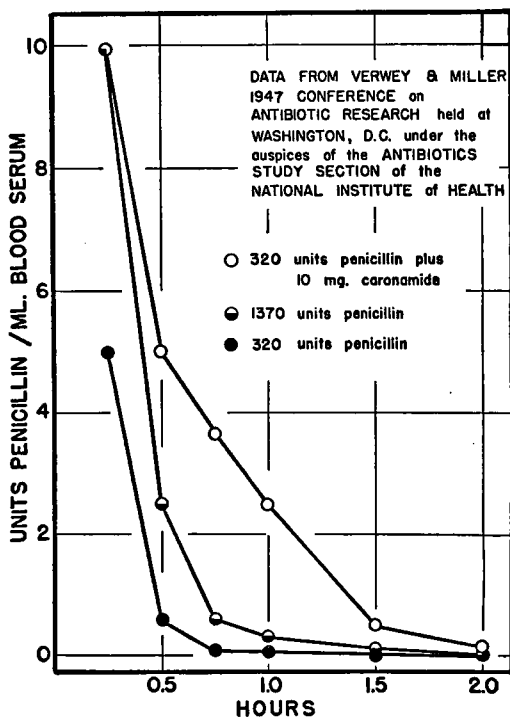

FIG. 39. Concentrations of penicillin in blood serum at different times after intramuscular injection of penicillin with and without concomitant oral administration of caronamide.

Additional careful pharmacological evaluation of caronamide is necessary before this drug can be recommended unequivocally for general use.

In view of the fact that the more recently developed preparations of procaine penicillin in suitable vehicles are capable of giving satisfactory serum levels for four days or longer, it seems unlikely that

the physiologic approach to the problem of prolonging the duration of effective concentrations will become very popular. One of the great virtues of penicillin is its lack of toxicity. It seems totally illogical, therefore, to use toxic agents to prolong its stay in the blood when effective nontoxic preparations are available.

Physiologic Effects of Penicillin on the Patient. For all practical purposes pure penicillin may be considered devoid of toxicity for the average patient, especially when administered parenterally. The most common undesirable outward manifestation of reaction to penicillin is development of transient pruritis or urticaria which occur in approximately 10 per cent of the patients, and are more pronounced following topical or oral administration. In the latter instance nausea may occur also. Local irritation of mucosal membranes in the mouth has also been described as resulting from oral administration of penicillin. Another common symptom following use of oral penicillin is the so-called "penicillin tongue," a condition in which the tongue becomes covered with a fur-like covering consisting of innumerable closely packed filamentous strands that are brownish, greenish, or yellowish in color. These unexplained symptoms generally do not develop until oral penicillin, or especially lozenges, have been used over a period of 48 hours or more. They generally subside three to four days after therapy is stopped and gradually disappear.

Other reactions of much less frequent occurrence, limited mostly to patients with a previous history of allergy, are asthmatic attacks, anaphylaxis, and serum sickness.

It is quite clear that pure penicillin is nontoxic for the average patient and that untoward reactions are most common in individuals who exhibit allergy toward other agents also or in those who have had a previous history of some fungus infection.

The literature contains conflicting statements on the effect of penicillin on the clotting time of blood; some clinicians have reported decreased clotting time, others have reported increased clotting time, and still others have been unable to detect significant differences. The preponderance of evidence seems to favor the view that normal thera-

peutic doses of penicillin exert very little, if any, effect on the clotting time of blood, although local application of excessively large doses may delay clotting in the area involved. Thus, it is clear that the one-time common practice of placing dry penicillin in a tooth socket following extraction should be discouraged. If penicillin is indicated in dental surgery, the operational area should be irrigated with a solution of penicillin. In most cases, the local treatment should be supplemented by systemic penicillin therapy.

When a regimen of penicillin therapy, designed to maintain continuously a therapeutic concentration in the blood, is instituted early in the course of certain streptococcic infections, normal formation of antistreptolysin is impeded or may be prevented altogether. This is attributed to the fact that patients subjected to penicillin therapy from the start of an infection, no longer being exposed to the metabolic products of the pathogens, may fail to produce antibodies. Interference with immunologic reactions may be minimized by using the discontinuous therapy outlined above. This phenomenon is not peculiar to penicillin therapy nor to streptococcic infections, but probably applies to any effective chemotherapeutic agent. (See similar phenomenon reported for aureomycin, Chap. 7.)

REFERENCES

- Abraham, E. P., Chain, E., 1940, An enzyme from bacteria able to destroy penicillin, *Nature*, 146:837.
- Brunel, J., 1944, Qui a découvert la pénicilline? *Rev. Can. Biol.*, 3: 333-343.
- Dufrenoy, J., and Pratt, R., 1948a, Significance of fatty acids in biosynthesis of penicillin, *Amer. Chem. Soc.*, Abstracts of papers presented at 114th meeting, pp. 15A-16A.
- Dufrenoy, J., and Pratt, R., 1948b, Utilisation des eaux-résiduaire de papeteries pour la biosynthèse des pénicillines, *La Papeterie*, 70: 386-391.
- Eagle, H., 1947, The kinetics of the bactericidal action of penicillin and the therapeutic significance of the blood penicillin level. Paper

- presented at Conference on Antibiotic Research, held at Washington, D. C., under the auspices of the Antibiotics Study Section of the National Institute of Health.
- Fleming, A., 1929, On the antibacterial action of cultures of a Penicillium with special reference to their use in the isolation of *B. influenzae*, Brit. Jour. Exp. Path., 10:226-235.
- Liggett, R. W., and Koffler, H., 1948, Corn steep liquor in microbiology, Bact. Revs., 12:297-311.
- Pratt, R., 1947, Influence of phosphate on stability of partially purified penicillins, J. Am. Ph. Assoc. (Sci. Ed.), 36:69-72. (See also Nature, 159:233).
- Pratt, R., Dufrenoy, J., and Strait, L. A., 1948, The enhancement of penicillin effectiveness in vivo by traces of cobalt, J. Bact., 55:75-79.
- Ramon, G., and Richou, R., 1948, Les propriétés antidotiques des filtrats de culture de *B. subtilis* et de *Penicillium notatum*, Scientia, 83:64-67.
- Romansky, M. J., and Rittman, G. E., 1944, A method of prolonging the action of penicillin, Science, 100:196-198.
- Shortridge, R. W., and Carr, C., 1949, Hexammincobalt (III) benzylpenicillinate, Amer. Chem. Soc., Abstracts of papers presented at 116th meeting, p. 17M.
- Smith, E. L., 1946, Some aspects of penicillin stability, Quart. J. Pharm. Pharmacol., 19:309-321.
- Sullivan, N. P., et al., 1948, A new penicillin for prolonged blood levels, Science, 107:169-170.

... I heard the Mother of all,

As she called to her earth....

Absorb them well . . . I charge you lose not my
sons, lose not an atom,

Which holding in trust for me faithfully back again
give me many a year hence, . . .

—WALT WHITMAN (1819-1892)

CHAPTER

6

Streptomycin:

An Antibiotic Useful Principally Against Gram-negative Pathogens and the Tuberculosis Organisms

In general, penicillin is ineffective against infections due to Gram-negative organisms and to the Gram-positive, acid-fast Mycobacteria. Therefore, much effort has been directed toward the goal of discovering an antibiotic agent as effective for clinical treatment of infections due to these kinds of organisms as penicillin is for those due to most Gram-positive bacteria.

Many chemotherapeutic agents, including antibiotics, with varying degrees of activity in vitro against Gram-negative pathogens and against the tuberculosis-causing Mycobacteria have been isolated, but the work has been attended by many disappointments, since often the compounds have proved to be ineffective in vivo or, if effective, to be so toxic that they cannot be used safely for parenteral or enteral administration. Thus, clinical application of many of these agents has been very limited, if not impossible. In the search for antagonistic micro-organisms, especially those active against Gram-negative bacteria, the class of organisms known as actinomycetes, commonly inhabiting soils, has offered extensive possibilities. The actinomycetes comprise a class of organisms that are characterized by rods approximately 3 to 4 microns in length by 0.6 micron in width; but these

may elongate somewhat and form filamentous, branched, mycelial-like growths, occasionally with club-like swellings as much as 10 microns in diameter. The actinomycetes appear to bear some resemblance to the Mycobacteria and they are considered by many authorities to be intermediate in evolutionary development between bacteria and fungi.

The first antibiotic of practical clinical importance to be isolated from an actinomycete was streptomycin, which was discovered in 1944 by the group of investigators working under the leadership of Dr. Selman Waksman. This agent was found to be active in vivo against Gram-negative pathogens and against *Mycobacterium tuberculosis*, and to be of sufficiently low toxicity so that its clinical use was considered warranted. Although Waksman and his group were the first to isolate this compound and to study its properties systematically, the lytic action of certain actinomycetes toward various micro-organisms was described as early as 1890 (see Brunel, *loc. cit.*, Chap. 5).

STREPTOMYCIN AS A CHEMICAL COMPOUND

Streptomycin is the name of a specific antibiotic agent, but the word is also used loosely to designate several chemically related antibiotics that are biosynthesized by different species of actinomycetes, belonging principally to the genus *Streptomyces* or related genera.

Streptomycin is a base and, therefore, forms salts with anions. This is in contrast with penicillin which, being an acid, forms salts with cations. The streptomycin molecule embodies a substituted cyclohexane ring to which is attached, by glycosidic linkage, a complex sugar residue involving an NH group. The molecule may be considered as consisting of two parts, streptidine and streptobiosamine. Streptidine is 1,3-diguanidino-2,4,5,6 tetrahydroxy cyclohexane. Streptobiosamine consists of two moieties, i.e., the peculiar sugar, streptose, and another sugar, 2-(methyl amino) glucose which is generally known as N-methyl glucosamine. The structures of the several moieties and of streptomycin are shown in Figure 40. The

solid letters and bonds indicate the structure of streptomycin. The dotted letters and bonds represent atoms and bonds that are part of the structures of the molecules of the individual moieties but that are eliminated when these condense to form streptomycin. The figure shows that streptomycin may be considered as resulting from condensation of streptidine, streptose, and 2-(methyl amino) glucose, with elimination of two molecules of water.

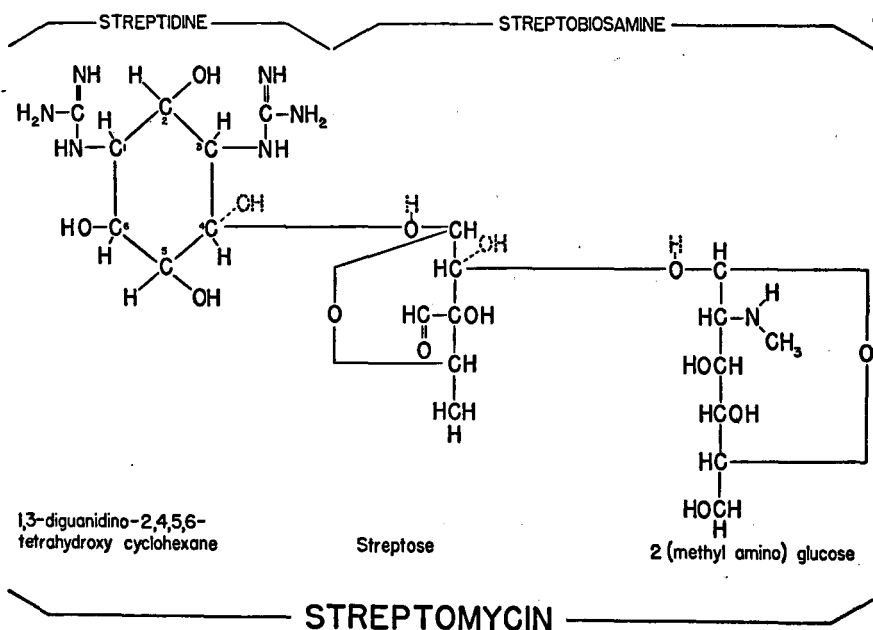

FIG. 40. Structure of streptomycin. Dotted letters and lines indicate atoms and bonds that are present in individual moieties of streptomycin but that are eliminated when these moieties condense to form the antibiotic molecule. (See text for further explanation.)

Different Forms of Streptomycin. Almost from the first clinical use of streptomycin, it has been recognized that neither the free base nor its salts are ideal chemotherapeutic agents. (Principally the hydrochloride and the sulfate have been used.) Toxic manifestations, varying in intensity and including pain at the site of injection, nausea,

dizziness, histamine-like shock (resembling anaphylactic shock), labored breathing, lowered blood pressure, transient or permanent impairment of hearing (including total deafness), and fatty infiltration of the liver, were encountered in some patients. Although it was recognized that pure streptomycin (or its salts) might very well possess some toxicity, the fact that there was considerable qualitative and quantitative variation in toxicity of commercial streptomycin from one batch to the next led many authorities to believe that some of the untoward effects that were observed were caused by incomplete removal of impurities during the extraction procedures. For example, the histamine-like reaction was attributed to histamine or similar products present in corn steep liquor and carried over into the final product.

The first practical result of attempts to develop a form of streptomycin that could be obtained in a higher degree of purity was production of a streptomycin calcium chloride complex. The empirical formula of this product is $C_{21}H_{39}O_{12}N_7 \cdot 3HCl \cdot \frac{1}{2}CaCl_2$. The streptomycin calcium chloride complex that is available commercially is said to contain virtually no impurities. Development of this form of streptomycin, which was a decided step forward in the effort to reduce untoward reactions in cases where streptomycin therapy was indicated, resulted in marked reduction in incidence of acute reactions involving nausea, dizziness, and symptoms of histamine-like shock following administration. However, even this improved form of streptomycin frequently induces symptoms of chronic toxicity (dizziness, deafness, fatty infiltration of liver) when used over a long period of time, as in treatment of tuberculosis, leprosy, etc., and sometimes induces acute toxic symptoms.

The reduced form of streptomycin, known as dihydrostreptomycin, appears to be the most desirable form of medication for cases in which streptomycin is indicated. Dihydrostreptomycin, which like streptomycin is administered largely in the form of the sulfate, differs structurally from streptomycin only in that the carbonyl group of the streptose moiety is reduced to an alcohol. The streptidine and

2-(methyl amino) glucose portions of the molecule are unchanged (see Figs. 40 and 41).

Dihydrostreptomycin and the streptomycin calcium chloride complex are man-made modifications of streptomycin. However, natural variants of streptomycin have been reported. These have been designated streptomycin B, streptomycin II, and "residual form" of streptomycin.

STRUCTURE OF STREPTOSE MOIETY OF
STREPTOMYCIN AND OF DIHYDROSTREPTOMYCIN

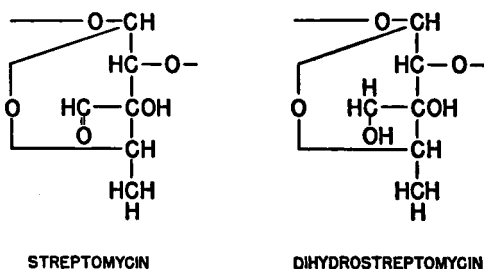

FIG. 41. Reduction of carbonyl group of streptose moiety of streptomycin yields dihydrostreptomycin. (See also Figure 40.)

Streptomycin B was separated from crude concentrates of streptomycin by means of chromatography and fractional crystallization. It contains streptose and an hexosamine, probably D-mannose. Streptomycin B is approximately one-fourth to one-eighth as effective as streptomycin on a weight basis. Its toxicity is about the same as that of streptomycin. Streptomycin B may be reduced to dihydrostreptomycin B by catalytic hydrogenation without loss of antibacterial activity.

An antibiotic, designated streptomycin II, has been recovered from culture filtrates of an actinomycete isolated from soil taken from Bikini and, therefore, designated *Streptomyces bikinienses*. Streptomycin and streptomycin II were discriminated on the basis that they are produced by two different species of *Streptomyces*. However, in

view of the similarity of chemical and biologic properties of the two compounds, there appears to be no tenable reason for considering them to be different.

A "residual form" of streptomycin which remains in crude filtrates after removal of crystalline salts of streptomycin has about the same biologic activity as streptomycin *in vivo* and about the same order of antibiotic activity *in vitro* against most organisms. The "residual form" was distinguished from streptomycin by the fact that it was about five times more active than streptomycin against *Eberthella typhii* when tested *in vitro*.

None of these natural variants of streptomycin is clinically important at the present time.

Biosynthesis. The principles involved in industrial production of streptomycin are similar to those employed in biosynthesis of penicillin (Chaps. 3 and 5), i.e., submerged fermentations are carried out in fermenters of from 5,000 to 20,000 gallons capacity, and similar problems are encountered in preparation of "seed," or inoculum, in providing aeration and proper nutrients, and in maintaining sterility, proper pH, etc.

Industrial producers of streptomycin must continuously select active strains from cultures of the parent strain of *Streptomyces griseus* because there is considerable variability in the capacity of different subcultures to produce the antibiotic. This problem appears to be more acute in the case of strains of *Streptomyces griseus* used for production of streptomycin than in the case of cultures of *Penicillium* used for industrial biosynthesis of penicillin. Even good antibiotic-producing cultures of *Streptomyces griseus* frequently tend to produce mutants that are poor or worthless as sources of streptomycin. One of the most common difficulties is emergence of nonsporulating strains. Such strains almost invariably yield little, if any, streptomycin.

Another difficulty that plagues the streptomycin industry is the occasional appearance of a phage which attacks species of *Streptomyces*, causing lysis of the cells. Phage is a class name for virus-like infections of bacteria and fungi, and many varieties of phage are

known. Literally, the word means to eat or devour. When a phage contaminant finds its way into a streptomycin plant, the only course for the manufacturer to follow is to shut down operations until the entire facilities have been cleaned and sterilized and new phage-free cultures of the producing mold have been established.

Recent research indicates that several species or strains of the genus *Streptomyces*, and perhaps some species outside this genus, are capable of producing streptomycin when provided with an appropriate culture medium. The micro-organism that is used for industrial production, however, is a strain of *Streptomyces griseus*. In order to produce streptomycin the mold requires, in addition to inorganic salts, a source of carbon and of nitrogen as well as certain precursors which have not yet been completely identified.* These precursors are present in meat extract, in corn steep liquor, in soy bean flour, and in yeast autolysate, which suggests that they may be nitrogenous. The cells of several species of micro-organisms, including some actinomycetes, have also been found to be sources of suitable precursors. The work of Dulaney (1948) suggests that the stimulatory effect of meat extract, corn steep liquor, etc., on biosynthesis of streptomycin is not due to a single amino acid. However, it may be due to a specific combination of amino acids as well as to other unidentified compounds.

Despite the effectiveness of corn steep liquor in stimulating biosynthesis of streptomycin, it seems desirable to avoid use of this ingredient in the fermentation liquor, since it has been suggested that the histamine-like reaction that some lots of streptomycin induce in patients (page 148) may be attributable, in part at least, to impurities present in corn steep liquor and not completely removed during the extraction and purification steps. Addition of proline, as the only amino acid, to a synthetic medium promotes the active synthesis of streptomycin. Any other amino acid by itself fails to act as a precursor (Dulaney, 1948). This suggests that proline embodies a struc-

* Biosynthesis of streptomycin, on a laboratory scale, in simple synthetic media containing only glucose, an ammonium salt, and inorganic salts has been reported (Dulaney, E. L., 1948, *J. Bact.*, 56:305-313). These solutions are not used industrially, however.

ture similar to that of a precursor of streptomycin; and, in that respect, it may be noted that the linkage of two molecules of proline would yield a cyclohexane derivative from which could be derived the cyclohexane derivative linked to streptobiosamine in the streptomycin molecule.

Extraction and Purification. Streptomycin is soluble in water but is relatively insoluble in organic solvents such as ether, chloroform, acetone, etc. When the fermentation liquor has attained maximum antibiotic titer (usually from 48 to 72 hours under current industrial conditions), the organism is separated from the broth by filtration (see Chap. 3) or by centrifugalization. The antibiotic may be isolated from the cell-free filtrate by adsorption on activated charcoal which then is separated from the liquid and is washed with alcohol to remove impurities. Subsequent washing with an acid-alcohol mixture brings the streptomycin into solution from which the adsorbent is removed by filtration or centrifugalization. Neutralization of the solution causes precipitation of additional impurities; following removal of the precipitate, the solution may be concentrated by addition of ten volumes of ether which takes up the alcohol and leaves crude streptomycin as a yellowish, brownish, or reddish aqueous concentrate. A solid preparation may be obtained by precipitation of this concentrate upon addition of acetone or upon vacuum desiccation. Most of the early work on the properties of streptomycin was done on impure products of this kind. Further purification and subsequent crystallization involve additional steps. Alternatively, countercurrent extraction methods similar in principle to, but differing in detail from, those used for purification of penicillin may be employed. The calcium chloride complex and dihydrostreptomycin are prepared from partially purified streptomycin by additional chemical steps.

Expressing the Potency of Streptomycin (Unitage). The principles involved in the biologic assay of streptomycin are similar to those employed in assaying penicillin and other diffusible antibiotics.

Standardized strains of *Escherichia coli* and of *Bacillus subtilis* are commonly used as test organisms.

Originally, one unit of streptomycin was defined as that amount per ml. which would just inhibit the growth of a suspension of standard age and density of population of a specified strain of *Escherichia coli* in a specified nutrient medium. Historically, this was designated an "S" unit. This was convenient for microbiologic work, but was inconvenient for pharmacologic and clinical experiments where larger quantities of the antibiotic were required. Consequently, an "L" unit, representing the quantity of material just inhibiting growth of the standard suspension of test organism in one liter of standard medium was proposed. One "L" unit was equivalent to 1,000 "S" units.

When crystalline streptomycin became available, a new standard of unitage based on the activity of a definite weight of the pure streptomycin base was established. According to this scheme, which is used today, one microgram (1×10^{-6} gram) equals one unit. Thus, one gram is equivalent to 1,000,000 units.

This does not mean that one gram of the commercially available streptomycin or dihydrostreptomycin (or salts of these) is equivalent to 1,000,000 units. The unit value (1 microgram = 1 unit) applies to the pure, crystalline streptomycin base. But the commonly available material is in the form of a salt* and, furthermore, contains varying amounts of different impurities. Therefore, more than one gram of these products is required to provide the action equivalent to one gram of the pure base.

It is important that the basis for determining unitage of different antibiotics be understood, especially if attempts are made to compare the activities of several antibiotics. In general, antibiotic substances assayed under similar conditions (as on assay plates) might be expected to yield a family of more or less similar dosage-response curves, but the actual dosage required to elicit a given response

* Streptomycin and dihydrostreptomycin are generally administered as the trihydrochlorides or occasionally as the trihydrosulfates, the anions being attached to the two NH_2 groups of the streptidine moiety and to the NH group of the 2-(methyl amino) glucose moiety.

against a given organism varies widely from one antibiotic to the next. Since penicillin was the first antibiotic to become available in large quantities and is perhaps the best known antibiotic, there has often been a tendency to compare the activities of different antibiotic agents that can be tested against a penicillin-sensitive organism in terms of "penicillin units." This is, in most instances, an unwarranted and illogical procedure.

The physiologic activity of a chemically defined compound is best expressed in terms of the molar concentrations required to elicit a given, measurable response in a test organism. As long as the molecular weight is unknown, the dosage cannot be expressed in terms of moles per ml., but it can be expressed, provisionally, in terms of arbitrarily defined units per ml., provided a dosage-response curve has been established. It should be stressed that a different dosage-response curve represents the activity of each antibiotic against each species or strain of test organism under each set of prescribed conditions and that comparisons of the activity of different antibiotics in terms of arbitrarily defined units may be misleading unless the experimental conditions of the comparative tests are clearly and precisely defined and unless the dosage-response curves for the different antibiotics, tested against the same organism, can be represented by equations of similar form.

Attempts have been made on different occasions to compare the relative effectiveness of penicillin and streptomycin in terms of units required to inhibit one or more different kinds of test organisms. Such comparisons are illogical and meaningless, since, historically, the unitage of penicillin is based on the quantity of the antibiotic required to inhibit growth of the Gram-positive *Staphylococcus aureus* in 50 ml. of broth (see Chap. 3) whereas the unitage of streptomycin is based on the quantity necessary to inhibit the Gram-negative *Escherichia coli* in 1 ml. of broth. In terms of dry weight

1 unit benzyl penicillin = 0.0006 mg. sodium salt

1 unit streptomycin = 0.0010 mg. pure base.

Expressed in another way

1 Gm. sodium benzyl penicillinate = 1,666,666 units

1 Gm. streptomycin base = 1,000,000 units.

If comparisons are to be made, they should be on a molar basis and against the same strain of organism. This can be done for streptomycin and for penicillin, the chemistry of which is well known, but is impossible in the case of most antibiotics at the present time because even empirical formulas are unknown for all but a small number of them. On a molar basis

1 unit sodium benzyl penicillinate = 1.71×10^{-9} M.

1 unit streptomycin base = 1.81×10^{-9} M.

1 mole sodium benzyl penicillinate = 583.3×10^6 units

1 mole streptomycin base = 551×10^6 units.

Stability. In contrast to penicillin, streptomycin is remarkably stable, not only in the partially purified dried form but also in solution under ordinary conditions of storage. Although purified crystalline penicillin is stable at ordinary room temperatures for long periods of time, it will be recalled that partially purified amorphous penicillin is relatively unstable and should be stored under refrigeration (Chap. 5). Partially purified streptomycin, on the other hand, retains its antibiotic activity for considerable periods of time even at room temperatures, if kept dry.

Both the pure streptomycin base and the commercially available salts are hygroscopic and should be protected from moisture during storage. The rate of deterioration of different streptomycin preparations varies with the kind and amount of impurities that are present and is always accelerated by the presence of moisture. For example, at 50° C. dry salts of streptomycin may lose 2.5 to 5 per cent of their antibiotic activity in ten weeks, but when in solution at pH 6.6 they may lose as much as one third of their activity in two weeks. Although refrigeration is not considered necessary for streptomycin, it is desirable, especially for solutions. At ordinary room temperatures solutions of streptomycin salts are relatively stable within the pH range 3 to 7. As the temperature is raised above 25-28° C., however, or as the pH is lowered below 3 or is raised above 8, the

rate of deterioration of solutions increases rapidly. At room temperature, reasonably pure dry salts of streptomycin (containing less than 1 per cent moisture and equivalent in activity to 500 or more units of streptomycin base per mg.) are stable at least 18 months, and probably for considerably longer periods of time.

Streptomycin in solution is subject to irreversible destruction by acid and by alkali. On acid hydrolysis, the molecule is cleaved into two basic fractions, streptidine and streptobiosamine (see Fig. 40), and, upon further acid hydrolysis, the latter compound ultimately yields N-methyl-glucosamine. Alkaline hydrolysis of streptidine yields streptamine, 1,3-diamino,2,4,5,6-tetrahydrocyclohexane. These several moieties and derivatives lack antibiotic activity.

Micro-organisms are not generally considered to inactivate streptomycin. However, from certain species of organisms, initially sensitive to this antibiotic, strains may arise that are actually dependent on streptomycin for their continued growth (see below). This strongly suggests the possibility that these strains may produce an enzyme that is capable of rupturing the glycosidic linkage.

A number of chemical agents have been reported to impair or to completely inhibit the antibiotic activity of streptomycin. The deleterious effect of acids and alkalies has been mentioned. In addition, cysteine, in relatively large quantities, has been shown to interfere with the *in vitro* activity of streptomycin. It is not clear at present, however, whether this is due to actual inactivation of the antibiotic molecule by cysteine or whether the effect is an indirect one exerted through the test organism. It is possible that in the presence of sufficiently large amounts of cysteine the threshold concentration required for inhibition of various bacteria by different antibiotics may be considerably elevated. This matter is discussed more fully in connection with the mechanisms of antibiotic action (Chap. 11).

Hydroxylamine hydrochloride quickly destroys streptomycin and is used as an inactivating agent in performing sterility tests. The antibiotic activity of streptomycin has been reported to be diminished also by the following reducing agents: NaH_2PO_2 , NaHSO_3 , SnCl_2 , and

$\text{NaH}_2\text{S}_2\text{O}_4$. The cyanate ion inactivates streptomycin as do the following oxidizing agents: KMnO_4 , HNO_3 , KIO_4 , H_2O_2 , and HClO_3 .

STREPTOMYCIN AND DIHYDROSTREPTOMYCIN AS CHEMOTHERAPEUTIC AGENTS

Perhaps the greatest virtue of streptomycin and dihydrostreptomycin as chemotherapeutic agents is their effectiveness in the clinical management of tuberculosis. Many drugs have been tested as "cures" for the "white plague." Although some of them have appeared promising in vitro and a few have exerted some favorable action in vivo none of them has proved to be as significantly effective in clinical trials as streptomycin and dihydrostreptomycin. These two antibiotics alone may not cure tuberculosis, but they exert a strong suppressive action on the course of the disease and are valuable adjuncts to the standard treatments, including rest, collapse of the lung, and surgery. Streptomycin and dihydrostreptomycin are effective not only in pulmonary tuberculosis but in other tubercular involvements as well. It is unfortunate that they are not endowed with the freedom from toxicity that distinguishes penicillin.

In addition to their antitubercular properties, streptomycin and dihydrostreptomycin are effective clinically in the treatment of infections due to various Gram-negative pathogens. They are active also to some extent against a number of Gram-positive bacteria, but normally are not prescribed for infections due to such organisms, since, in general, such infections respond more favorably to penicillin therapy. In cases in which the two types of antibiotics are equally effective for controlling infections, penicillin is always the drug of choice, since it is virtually nontoxic to the patient, whereas acute, and especially chronic, toxic manifestations are of fairly common occurrence when streptomycin or dihydrostreptomycin is used.

FACTORS INFLUENCING ANTIBACTERIAL ACTION

Factors that influence the antibacterial action of streptomycin and dihydrostreptomycin are of considerable importance in the

TABLE 6. SOME COMMON INFECTIOUS AGENTS THAT ARE OFTEN SUSCEPTIBLE TO STREPTOMYCIN OR DIHYDROSTREPTOMYCIN*

Aerobacter aerogenes
 Alcaligenes faecalis
 Bacillus tularensis
 Brucella abortus
 Brucella melitensis
 Brucella suis
 Eberthella typhosa
 Klebsiella pneumoniae
 Mycobacterium tuberculosis var. hominis
 Mycobacterium, various species
 Pasteurella pestis
 Proteus vulgaris
 Pseudomonas aeruginosa
 Salmonella enteritidis
 Salmonella paratyphi
 Salmonella schottmülleri
 Salmonella, various species
 Shigella paradysenteriae

* The bacteria listed are the most common causes of infections that may be treated more or less "routinely" with streptomycin. Not all strains of these species are initially susceptible, and resistant strains may develop from sensitive ones during the course of therapy. The success of the treatment depends on the sensitivity of the pathogen and, often, on the site of infection and duration of infection before the beginning of streptomycin therapy. For discussion of average doses for chronic and acute infections see text.

routine conducting of assays and laboratory studies and, in some cases, are important also in clinical applications of these antibiotics and may determine, in some measure, the success or failure of the treatment. In the discussion that follows, unless specifically indicated to the contrary, the term streptomycin will be used to include both streptomycin and dihydrostreptomycin, since both compounds appear to possess essentially the same antibiotic activity. The differences between the two drugs are primarily chemical and pharmacologic.

Sensitivity of the pathogen is, of course, the single factor of greatest importance. A number of Gram-negative and Gram-positive species of bacteria (including the acid-fast *Mycobacterium tubercu-*

losis) are sensitive to the action of the streptomycins, but there is wide variation in the sensitivity. One series of observations on the sensitivity of different strains of the organism causing pulmonary tuberculosis in man revealed a thirty-fold difference in sensitivity of the pathogens to streptomycin. Some strains (about 11 per cent) were inhibited in vitro by as little as 0.1 microgram streptomycin per ml. and 99.9 per cent of the 140 strains tested were inhibited by 1 microgram or less per ml. But one strain was inhibited only by 2 micrograms per ml. and a concentration of 3 micrograms per ml. was required to inhibit the most resistant strain in this series. The results are shown graphically in Figure 42.

It should be stressed that these data are for cultures of organisms isolated from patients who had received no previous treatment for the infection; following a course of therapy with the streptomycins a much greater percentage of resistant forms may occur (see below).

Among the Gram-negative species, members of the colon and Friedlander groups in the usual laboratory media are, for the most part, inhibited in vitro by concentrations of 6 to 8 units or less per ml. A number of species are inhibited by less than one unit per ml. *Bacillus proteus*, *Aerobacter aerogenes*, *Salmonella typhosa*, and *Pseudomonas aeruginosa* include a number of strains that are inhibited only by concentrations of 10 or more units per ml. In the Gram-positive group, staphylococci are generally inhibited in vitro by concentrations of 2 to 3 units or less per ml., but usually somewhat higher concentrations are required to inhibit streptococci. For example, *Staphylococcus aureus* (strain 209P) is reported to be inhibited by 0.828 microgram streptomycin and by 1.39 microgram dihydrostreptomycin per ml., but the concentrations of the two antibiotics required to inhibit *Streptococcus pyogenes* (strain C-203) are 11.7 micrograms per ml. and 15.9 micrograms per ml., respectively.

In general, the relative sensitivity of micro-organisms to the streptomycins is similar in vitro and in vivo. In other words, the presence of serum or whole blood does not markedly alter the effectiveness of these antibiotics in most instances. Notable exceptions are the non-

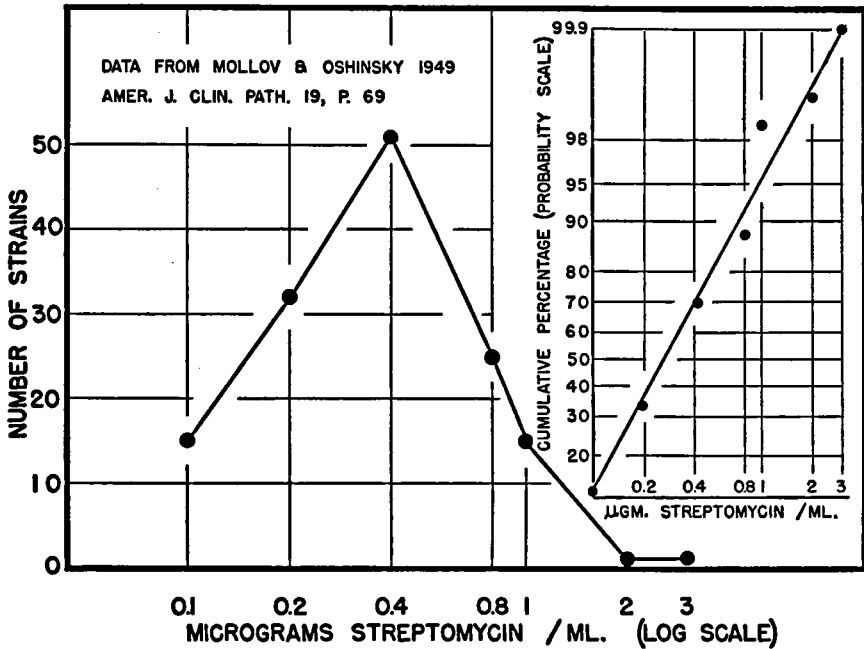

FIG. 42. Sensitivity of 140 different cultures of organisms isolated from tubercular patients. (Left) Frequency of cultures inhibited by different concentrations of streptomycin. Note that the distribution is "log-normal." This is further emphasized by the curve at the right where the cumulative percentages plotted on a probability scale are rectilinearly related to the inhibiting dosages, plotted on a log scale.

hemolytic streptococci and the hemolytic staphylococci which require four to eight times as much streptomycin for inhibition in the presence of blood or serum as in their absence.

Development of induced resistance and of streptomycin-dependence in organisms exposed to the streptomycins seriously complicates studies of these antibiotics in the laboratory and impairs their usefulness in the clinic. These problems are discussed in a later section.

The number of organisms initially present in a culture is an important factor that must always be regulated properly when assaying antibiotics. This factor is particularly important in assays per-

formed by technics involving serial dilutions in broth but is less significant in agar-plate assays.

Not only the number of organisms present in the broth is important in such assays; the density of population may be equally important in determining the threshold required for inhibition. It appears that more streptomycin per ml. may be required to check the growth of all the organisms in a dense suspension than in a more sparsely populated culture in which the same total number of bacteria is dispersed in a larger volume of broth. Addition of bacteria, killed by heat (56-57° C.) or by chloroform, to cultures with a given density of population increases seven- to eight-fold the concentration of streptomycin required for inhibition. This effect is not specific but can be demonstrated among different species of bacteria, including *Staphylococcus aureus*, *Escherichia coli*, and *Pseudomonas aeruginosa*; killed cells of each species are antagonistic to the action of streptomycin against the same or different species. This phenomenon deserves further study. It may not be peculiar to the streptomycins, but may be merely a manifestation of the same fundamental phenomenon described as postlytic waves of growth in connection with penicillin and aureomycin (Chaps. 3, 5, and 7).

Clinically, there is little reliable evidence to indicate that the variations in bacterial cell count that normally occur in infections play an important part in determining the success or failure of streptomycin chemotherapy. The location of the infectious organisms and their phase of development are of much greater significance. Sometimes the bacteria are deeply embedded in tissues or are surrounded by mucus or tissue debris so that the antibiotic reaches them only with difficulty, if at all. Micro-organisms are always more sensitive to the action of antibiotics of this type when in an actively metabolizing and growing state than when they are older and less active physiologically. Therefore, the duration of infection is often influential in determining the effectiveness of treatment with the streptomycins or, for that matter, with any antibiotic except the surface active types (see Chap. 11). In chronic infections of relatively long

duration, often the pathogens are not as active as in more recent infections, and they are, therefore, more difficult to eradicate by chemotherapeutic means. Moreover, there is greater probability that the pathogens will be more deeply embedded in the host tissues when the infection has persisted for some time than when it is of recent origin. When the pathogens are well ensconced in the tissues of the host, it is usually necessary to employ larger doses of the antibiotic and to continue administration for a longer period of time than is necessary in infections of shorter duration. This affords greater opportunity for development of strains resistant to the therapeutic agent. This seems to be of little consequence in penicillin therapy (Chap. 5) but is a problem of major importance in the clinical management of patients receiving streptomycin or dihydrostreptomycin (see below).

The pH of the medium is important in laboratory studies and assays of the streptomycins. Some typical data are recorded in Table 7.

TABLE 7. MINIMAL CONCENTRATIONS OF STREPTOMYCIN HYDROCHLORIDE REQUIRED TO INHIBIT THE GROWTH OF DIFFERENT PATHOGENS IN BROTH ADJUSTED TO DIFFERENT pH VALUES*
(Concentrations are in micrograms per ml.)

pH	ORGANISM			
	<i>Aerobacter aerogenes</i>	<i>Escherichia coli</i>	<i>Pseudomonas aeruginosa</i>	<i>Proteus vulgaris</i>
7.9	3.12	25	100	50
7.2	12.50	100	250	250
6.3	100	250	2000	1000
5.8	250	500	4000	2000

* Data are from Murray, R. M., and Finland, M., 1948, Effect of pH on streptomycin activity, *Am. J. Clin. Path.*, 18:247-252.

Hydrogen ion concentration is of less importance in clinical practice, however, since the clinician has to work within the biologic range of hydrogen ion concentrations. Streptomycin is most effective

in media which are neutral or somewhat alkaline in reaction.* The activity decreases as the hydrogen ion concentration increases. Therefore, streptomycin is of relatively little value for treatment of certain types of empyema in which the accumulated fluid is generally acid.

Presence of salts, inhibitors, and interfering substances may often play an important role in determining the effectiveness of streptomycin.

The literature contains conflicting reports concerning the effect of cations and anions on streptomycin activity. This "salt effect" may not be particularly important in vivo, but must be taken into consideration in performing streptomycin assays. The presence of various salts in the medium in or on which the test organisms are grown or in the solution to be assayed (in the case of plate assays) has been contradictorily reported to have an enhancing action and a depressing action on the effect of streptomycin. The biologic factor cannot be ignored in any consideration of this problem; probably the species of organism used for the test is as important as the qualitative and quantitative ionic composition of the medium.

It has been reported that acetate accumulates in sensitive microorganisms exposed to streptomycin, suggesting that perhaps the antibiotic interferes with acetate metabolism. It may be significant in this connection that among the anions, acetate and pyruvate scarcely interfere with bacteriostasis by streptomycin hydrochloride, whereas nitrate, chloride, lactate, phosphate, tartrate, citrate, and sulfate seem to interfere with the ability of streptomycin to prevent growth of *Klebsiella pneumoniae*.

Among the cations, the bivalent magnesium, calcium, and barium ions seem to cause greatest interference with the antibacterial activity of streptomycin. The effect of cations and anions has been reported to be additive, greatest interference being caused by magnesium sulfate and calcium chloride.

* It has been reported that the streptomycins are most active at pH 9.0, where they exist mostly as the free bases. However, tests performed at pH levels so far outside the normal biologic range are difficult to evaluate, since media with such alkaline reactions are in themselves deleterious to many bacteria.

Probably, the effect of the salts is not a direct effect on streptomycin per se, but rather is an effect exerted on the organisms. In view of the current lack of definitive knowledge of "salt effects" on bacteria and the contradictory reports concerning the relation between various salts and streptomycin activity, a detailed discussion of influence of salts on the effectiveness of streptomycin seems unwarranted in the present volume.

Various organic acids are capable of modifying the activity of streptomycin. As is true of the "salt effect," the direction and magnitude of the effect depend on the specific acid, its concentration, and the species of test organism. Among the organic acids pyruvic and fumaric acids (neutralized to pH 7.0 to avoid the unfavorable effect of acid pH values) nullify the antagonistic effect of streptomycin on the growth of *Escherichia coli* and *Proteus vulgaris* and, to a lesser extent, diminish the effect of the antibiotic on *Aerobacter aerogenes* and *Staphylococcus aureus*. Fumaric acid has hardly any effect and pyruvic acid no effect in suppressing inhibition of *Mycobacterium tuberculosis* by streptomycin. This suggests interesting and fertile problems to be investigated in determining the specific enzyme systems that are blocked by streptomycin in various organisms, since it may be presumed that ability of certain organic acids to suppress streptomycin-inhibition of different bacteria is a function of the ability to enable the organism to by-pass specific systems that are blocked by streptomycin (see discussion of antibiotic spectra, Chap. 4 and Fig. 18).

At different times it has been suggested that the antibiotic action of streptomycin is due to its precipitating or in some other way rendering desoxyribonucleic acid unavailable for participation in essential metabolic reactions in the sensitive bacterial cell. This hypothesis was founded on the fact that streptomycin, being a base, might link with desoxyribonucleic acid to form a complex salt. Indeed, attempts have been made to interpret the depressing action of salts on streptomycin activity (the "salt effect" referred to above) in terms of interference with the precipitation of desoxyribonucleates by

streptomycin. This view hardly seems tenable, however, since the order of effectiveness of different salts in interfering with formation of streptomycin-desoxyribonucleate complexes is different from their order of activity in inhibiting bacteriostasis by streptomycin.

Urea, lipositol, and other organic compounds that are commonly present in body fluids or tissues and that are of the utmost biologic significance have been shown repeatedly to markedly inhibit the action of streptomycin *in vitro*.

Presence of activators and synergists appears to be of less importance in assays of streptomycin than in tests of penicillin. For example, the action of streptomycin is enhanced but little in the presence of traces of cobalt, which markedly sensitize bacteria to penicillin (Chaps. 5 and 11).

Surface active agents may also enhance the action of streptomycin, at least *in vitro*.

In specific instances, synergism between streptomycin on the one hand and a variety of other agents on the other hand has been reported, both *in vitro* and *in vivo*. Among these agents are penicillin, calciferol, and various sulfa-drugs. It is not clear that the instances reported are cases of true synergism, i.e., that the effect of concomitant use is greater than could be expected from additive effects. Rather, it seems likely that the combinations are more effective than streptomycin alone, because the second agent inhibits organisms resistant to the streptomycin.

CHEMOTHERAPEUTIC USE

Streptomycin and dihydrostreptomycin, like penicillin, are readily absorbed into the blood stream and distributed to the various body fluids and tissues following intramuscular or deep subcutaneous administration. Discovery of these antibiotics was, therefore, greeted with enthusiasm, since they offered the hope of a cure for a number of serious systemic infections previously outside the range of effective chemotherapy.

Infections in Which Streptomycin Is Indicated. In general, streptomycin is indicated for treatment of systemic infections caused by sensitive Gram-negative and acid-fast, Gram-positive bacteria. Perhaps its greatest value is in the management of various forms of tuberculosis. Its usefulness in other infections should not be minimized, however. Streptomycin and dihydrostreptomycin exert striking therapeutic effects in various diseases for which no really effective treatment was known previously. Among these are urinary infections, especially those due to *Escherichia coli*, *Proteus vulgaris*, *Aerobacter aerogenes*, and *Pseudomonas aeruginosa*; various forms of brucellosis, such as tularemia, caused by *Brucella tularensis* (*Bacterium tularense*), and undulant fever, caused by *Brucella melitensis*; pulmonary infections by species of *Klebsiella* and *Hemophilus*; and various enteral infections, especially those due to *Salmonella* sp. and *Shigella dysenteriae*.

With the advent of the streptomycins, man possessed for the first time an effective weapon against bubonic and pneumonic plague, caused by *Pasteurella pestis*. Pneumonic plague is highly contagious, spreading from one individual to another by droplet infection without the agency of rats or fleas, and before streptomycin was available it was usually fatal. Streptomycin has also had extensive trials in the clinical treatment of chronic ailments, such as tuberculosis and leprosy, which are caused by species of acid-fast *Mycobacterium*.

The diseases mentioned above may be classified as due to either acute or chronic infections. Representative of the former are plague and tularemia. Among the chronic diseases are tuberculosis and undulant fever. The urinary infections may be either acute or chronic. Treatment of chronic infections with streptomycin often is attended by serious bacteriologic and pharmacologic sequelae.

The clinical problems raised by chemotherapeutic use of streptomycin in cases of tuberculosis or other chronic infections that may require administration of the drug over a period of several months are two fold: first, there is the tendency of prolonged streptomycin therapy to induce development of resistant strains; second, there is

the problem of chronic toxicity. Introduction of dihydrostreptomycin has reduced the latter problem somewhat, but it is still very serious.

These difficulties may be diminished to some extent by properly regulating the dosage and duration of streptomycin therapy. The dosage varies considerably according to the diagnosis and the clinical condition of the patient. The trend is toward smaller doses than were used formerly. In the early days of streptomycin therapy, doses of 1 to 3 grams daily were administered for from two to six months in treating cases of tuberculosis. It is now recognized, however, that in many cases a favorable therapeutic effect can be obtained and that there is less likelihood of untoward reactions occurring if relatively small doses are given for relatively brief periods. Many cases respond favorably to a dose of 0.5 gram (somewhat less than 500,000 units) daily for six weeks: alternatively, two-gram doses may be given at intervals of two to five days for three to four months.

Streptomycin should not be considered a cure for all cases of tuberculosis, but it is often a very useful adjunct when used with other already established methods including rest and surgery. Indeed, in some cases where the patient is in too poor a condition for surgery to be risked, use of streptomycin may bring about sufficient improvement so that surgery becomes practicable.

Streptomycin may be used to advantage in combination with other agents. For example, in guinea pigs experimentally inoculated with the tuberculosis organism and subsequently treated with streptomycin or with streptomycin and potassium iodide, the combined therapy is so much more effective than either drug alone that clinical trial on human patients seems warranted. Administration of streptomycin with promin (sodium *pp'*-diamino-diphenyl-sulfone-*NN'* didextrose sulfonate) and *para*-aminosalicylic acid has been reported to reduce the hazard of developing resistant strains of the pathogen. A typical treatment calls for daily intramuscular injection of streptomycin (1 Gm.) and promin (4 Gm.) supplemented by oral administration of *p*-aminosalicylic acid, dosage of the latter varying according to the tolerance of the patient. Alternatively, promizole (4,2'-diamino-

diphenyl-5'thiazole sulfone) and sulfetrone [bis (α -phenyl-n-propyl-amino)-di-phenylsulfone tetrasodium sulfonate] have been used concomitantly with streptomycin toward the same end. Of these several adjuvants, singly or together, *para*-amino-salicylic acid (PAS) currently seems to offer the greatest promise of clinical usefulness. The dosage varies according to the tolerance of the patient; but usually daily doses of 10 to 14 grams may be given for an indefinite time without development of untoward reactions.

Growth of tubercle bacilli is known to depend on metabolization of *para*-amino-benzoic acid, and it is recognized that PAS exerts a specific inhibiting action on this process in these organisms. Therefore, PAS by itself is partly inhibitory for the tuberculosis organism. Thus, when PAS and streptomycin are used conjointly, the organisms are attacked simultaneously through two different metabolic pathways and consequently tend to succumb sooner than if either agent were used alone. The reduction in the necessary period of chemotherapy is undoubtedly an important factor in lowering incidence of acquired resistance to streptomycin in organisms in patients treated with PAS plus streptomycin (see below).

Development of Resistance Among Pathogens. Micro-organisms may be divided into two classes on the basis of their reaction to streptomycin. There are recognized (1) the sensitive forms that are unable to grow in media containing concentrations of streptomycin of the order of those that are commonly obtained in the blood (less than 10 micrograms per ml.) during clinical streptomycin therapy, and (2) the resistant forms that are able to grow in culture media even in the presence of 10 or more micrograms of streptomycin per ml. In the latter class are two groups of organisms, i.e., streptomycin-tolerant and streptomycin-dependent species. The latter fail to grow in nutrient media unless streptomycin is added. They represent mutants that normally would not survive in nature because of a deficiency in their biochemical constitution. Among the streptomycin-tolerant species may be recognized two groups. Some species can grow in nutrient media either with or without streptomycin.

These might be designated as streptomycin-indifferent. Other strains are able to grow either in nutrient media or in aqueous solutions of streptomycin sulfate and, therefore, must be able to metabolize streptomycin as well as other metabolites. These relationships are shown diagrammatically in Figure 43.

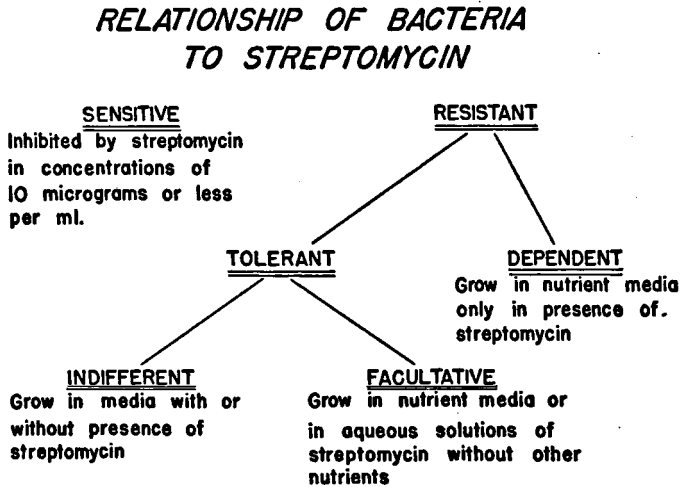

FIG. 43. Diagram to show reactions of different species of bacteria to streptomycin. (See text for further explanation.)

Development of resistant strains from initially sensitive pathogens during streptomycin therapy is a problem of major concern for the clinician. The development of resistance during chemotherapy of chronic diseases is important, however, because once the resistant forms appear, the patients' own defense mechanisms can no longer depend on assistance from streptomycin, and often relapses occur.

Streptomycin-resistant strains of bacteria may develop with astonishing rapidity from cultures of organisms exposed to the antibiotic. Two kinds of *in vitro* experiments have been reported. In one, which parallels standard serial dilution technics, test organisms are transferred at regular intervals from the tube with the highest concentration of streptomycin that permits some to survive to another series.

of tubes containing a higher range of concentrations. Each day organisms are removed from the highest concentration that permits survival of some, and these are inoculated into broth containing still higher concentrations. By this technic, in only 14 transfers, strains of *Escherichia coli* have been developed that are able to grow in broth containing 226,000 times as much streptomycin as was required to inhibit all growth in the initial culture. Although this kind of experiment is interesting and demonstrates the potential magnitude of the problem of resistance, experiments in which the organisms are cultured continuously in a given relatively low concentration of streptomycin seem to have more significance, since they more nearly simulate clinical conditions.

In one such series of experiments, daily transfers of *Pseudomonas aeruginosa* were made in nutrient broth and in broth containing 0.001, 0.01, or 0.1 microgram streptomycin per ml. Initially, the organisms were inhibited by streptomycin at a concentration of 0.78 microgram per ml. After ten such daily transfers, cultures carried in broth alone still showed the same sensitivity to streptomycin as initially, but some of those carried in broth containing 0.001 or 0.01 microgram per ml. were inhibited only by 25 or more micrograms of streptomycin per ml.; 250 micrograms of streptomycin per ml. were required to inhibit the most resistant cells that had been cultured in broth containing 0.1 microgram of the antibiotic per ml.

Thus, it is apparent that strains with a high degree of streptomycin-resistance can develop rapidly when continuously exposed to sublethal concentrations of streptomycin. There is abundant evidence that this can and does occur in vivo as well as in vitro. In a typical case of pulmonary tuberculosis, in which bacterial samples were taken periodically, before chemotherapeutic treatment with streptomycin the ratio of "resistant" organisms (tolerating 10 micrograms of streptomycin per ml.) to the total number of organisms isolated was 1:88,750; after two weeks of treatment the ratio was 1:13,174; after four weeks, 1:588; and after five weeks 1:367. Figure 44 shows the trend of incidence of resistant strains of tubercle bacilli in relation to

level and duration of streptomycin dosage in a number of different cases. It is not known how long resistance persists in vivo. Cases have been reported in which resistant strains of tubercle bacilli were isolated from patients with arrested pulmonary tuberculosis three years after streptomycin therapy was discontinued.

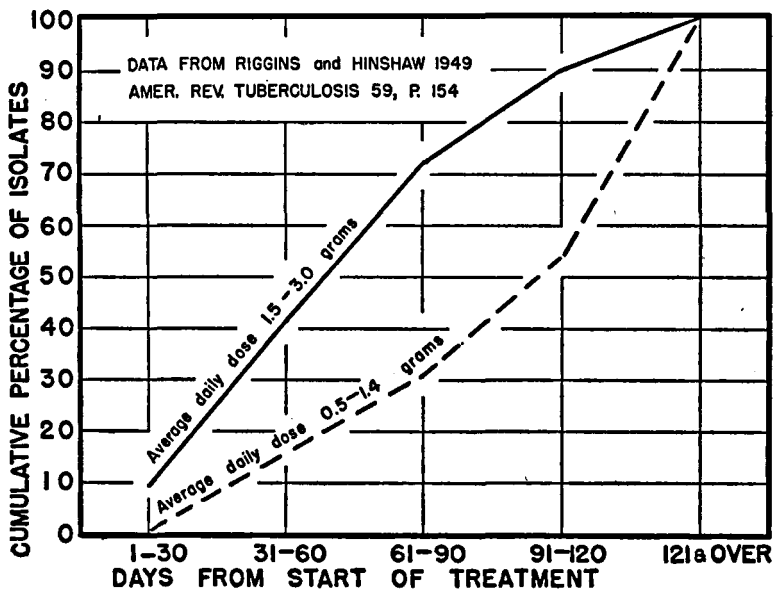

FIG. 44. Incidence of strains of tubercle bacilli resistant to 10 or more micrograms of streptomycin per ml. isolated from patients receiving two different dosage levels of streptomycin for different periods of time.

The results shown in Figure 44 are of the utmost significance. When streptomycin first became available, it was believed that high dosages should be used until complete eradication of the invading pathogens was accomplished. It now appears, however, that a course of therapy with minimal therapeutically effective doses for one to two months, repeated if necessary after a lapse of a few weeks, is more desirable than treatment with larger doses. If the lower doses are continued more than four months the same incidence of resistant

forms is noted as when larger doses are used (Fig. 44) although the symptoms of toxicity in the host may be less marked. It is the consensus at present that streptomycin therapy of chronic ailments like tuberculosis should be limited to relatively low doses for periods of six weeks or less.

Absorption, Blood Levels and Excretion. The patterns of absorption, blood levels attained, and excretion are essentially the same for streptomycin and dihydrostreptomycin following intramuscular or deep subcutaneous injection, which are the only practicable routes of administration except for intrathecal injection which is sometimes used also in cases of tuberculous meningitis. Histologic sections of the brain of patients dying of this disease generally show the tubercle bacilli embedded in an exudate of fibrin. Lysis of the fibrinous exudate and consequent exposure of the pathogen to streptomycin may be facilitated by intrathecal injection of streptomycin-streptokinase mixtures. Streptokinase is a natural biosynthetic product of certain strains of hemolytic *Streptococcus* and appears to activate formation of fibrinolysin.

It has been estimated that blood levels of 5 to 7 gamma per ml. are adequate for treatment of tularemia, various forms of meningitis, urinary infections, and other acute infections not accompanied by bacteremia; concentrations of 10 to 15 gamma per ml. may be required for successful treatment of bacteremia. The level of 10 gamma per ml. has been chosen as a value that affords a reasonable discrimination between sensitive and resistant strains of *Mycobacterium tuberculosis*. In human patients this level may be maintained for 6 to 8 hours following a single intramuscular injection of streptomycin or dihydrostreptomycin. Maximum levels of 40 to 50 micrograms per ml. obtain about one hour after administration, and significant amounts (1-2 gamma) are present after 24 hours, at which time an average of 50 to 80 per cent or more of the administered dose can generally be recovered from the urine of patients with normal renal function. Unduly high concentrations of streptomycin may prevail in the blood of patients with renal dysfunction and may cause serious pharmacologic

consequences (see below). In such patients the dose should be adjusted accordingly.

Like the penicillins, the streptomycins permeate various tissues and body fluids and pass through the placental membrane. Dihydrostreptomycin has been reported in the cerebrospinal fluid following intramuscular injection in patients being treated for tuberculous meningitis and neurosyphilis.

Maintenance of a given blood level of streptomycin throughout the duration of an infection may be essential for curing acute infections, but adequate control of chronic infections due to slow-growing microorganisms may be achieved without maintenance of a bacteriostatic blood level. Indeed, continuance of a high concentration for prolonged periods of time may have dire pharmacologic and bacteriologic consequences. Administration of 1 gram in a single dose every day or of 2 grams in a single dose every two to four days has been reported to afford satisfactory control of pulmonary tuberculosis.

Physiologic Effects of Streptomycins. Early in the clinical history of streptomycin it was learned that this antibiotic is not endowed with the lack of toxicity that characterizes its illustrious predecessor, penicillin, in the field of antibiotic chemotherapy. At first only symptoms of acute toxicity were apparent, but as the drug was used over longer periods of time symptoms of chronic toxicity were reported. More recently, it has been recognized that the drug may also be hazardous to the personnel who handle it during the several stages of extracting, processing and packaging. These matters are discussed briefly in the following paragraphs.

EFFECTS OF THE STREPTOMYCINS ON THE PATIENT may be considered under two headings, i.e., acute and chronic. As Goldstein (1949) has pointed out in his comprehensive review, "Toxicity, broadly speaking, is of two kinds: one bears a definite relation to dosage; the other falls into the category of sensitivity phenomena, whose incidence and severity do not strictly depend upon the amount of drug administered. Either type may appear after brief or prolonged

exposure to a drug." Unfortunately, the use of streptomycin is very frequently attended by toxic reactions, the kind and intensity of which vary considerably from one patient to the next. It should be stressed that, in contrast to penicillin, streptomycin itself is pharmacologically active, regardless of impurities that may be present.

The introduction of dihydrostreptomycin into clinical practice has helped to reduce the incidence of untoward effects and their intensity. The indications are that dihydrostreptomycin is about one third to one half as toxic as streptomycin.

Acute symptoms of streptomycin toxicity include local irritation at the site of injection; more or less generalized urticaria or rash of varying intensities; nausea; and, in some instances, reactions resembling anaphylactic shock in which there is a sudden and pronounced drop in blood pressure, accompanied by labored breathing and asthmatic symptoms. These acute reactions, notably nausea and vomiting, can be alleviated by use of drugs with an antihistamine action. Shock reactions may be induced by streptomycin itself irrespective of impurities. One type of shock, which may be alleviated by use of cocaine or procaine, and in some instances even by glucose, has been ascribed to the guanidine groups; another type of shock has been ascribed to the formation of an insoluble complex of streptomycin with cephalin.

Chronic symptoms of streptomycin toxicity are variable in detail. In a few cases, fatty infiltration of the liver, damage to the kidney, and blood dyscrasia have been reported. However, the major chronic effects of streptomycin involve principally the eighth cranial nerve, which regulates vestibular and auditory functions. Transient or permanent, partial or complete impairment of hearing may follow prolonged use of streptomycin. Similarly, vestibular dysfunction may be transient or permanent, depending on the dosage and duration of streptomycin therapy. These reactions seldom occur during or after treatment of acute infections but are common in tuberculous patients or others to whom the drug may be administered over relatively long periods of time. This indicates that the total dose adminis-

tered is the principal factor that determines incidence and severity of these reactions.

The doses originally recommended for tuberculosis were of the order of 3 to 6 grams daily in divided doses for four to six months or longer. It is now recognized that even a dose of 2 grams of streptomycin daily for four months produces irreversible and complete depression of vestibular functions in about 85 per cent of the patients. Lowering the daily dose to 0.5 or 1 gram results in a sharp decline in incidence of chronic toxicity and is not accompanied by any significant loss of therapeutic effectiveness.

Basing judgment on early experience with penicillin, it was thought formerly that effective therapy with streptomycin required maintenance of a certain minimum threshold concentration in the blood, and that to maintain this concentration the daily dose of the drug should be administered in divided doses. However, it is now known that the frequency of administration can vary widely; when the total daily dose is 1 gram or thereabouts, comparable therapeutic results are obtained whether streptomycin is administered in one injection or is divided into smaller doses given at intervals varying from 4 to 12 hours. Toxic manifestations are reduced when the entire daily dose is given in one injection. An even better regimen appears to be 2 grams given at intervals of two to four days over a period of four to six weeks.

It is important to recall that smaller doses of streptomycin should be used in treating patients with renal impairment, since in these cases excretion of the drug is slowed down and consequently higher blood levels obtain for a longer period of time.

Pharmacologically, dihydrostreptomycin is less dangerous than streptomycin. Therefore, one might be tempted to use larger doses of dihydrostreptomycin. It should be emphasized, however, that bacteriologically the two drugs are essentially similar. Resistant forms of bacterial pathogens develop rapidly regardless of whether streptomycin or dihydrostreptomycin is administered. Therefore, in order to avoid this complication as far as possible, it seems desirable, when

using larger doses, to reduce the duration of therapy as much as is consistent with obtaining the desired therapeutic result.

PERSONNEL HANDLING STREPTOMYCIN often develop skin reactions of a histamine-like type. It is well recognized that workers engaged in the extraction, purification, and packaging of streptomycin, as well as nurses, physicians, and others who have occasion to handle the drug may develop urticaria and other manifestations of irritation and toxicity. These symptoms can be alleviated to some extent by use of drugs with an antihistamine action.

REFERENCES

- Dulaney, E. L., 1948, Observations on *Streptomyces griseus*. II. Nitrogen sources for growth and streptomycin production, *J. Bact.*, 56:305-313.
- Goldstein, A., 1949, Antibacterial chemotherapy, *New England J. Med.*, 240:98-107; 137-147; 180-188.
- Schatz, A., Bugie, E., and Waksman, S., 1944, Streptomycin, a substance exhibiting antibiotic activity against Gram-positive and Gram-negative bacteria, *Proc. Soc. Exper. Biol. & Med.*, 55: 66-69.
- Waksman, S., 1948, The literature of streptomycin, New Brunswick, Rutgers University Press.
- Waksman, S. A., 1949, Streptomycin, Its Nature and Practical Application, Baltimore, Williams & Wilkins.

*Man, learning Nature's ways aright,
Obeying, can control.*

—W. C. D. DAMPIER (1929)*

CHAPTER

7

*The earth would have been wearing out long ago
were it not for compost, wherein there accrue,
daily, waste products from the living and where-
from there spring rejuvenating principles.*

—J. CAZOTTE (1776)

Chloromycetin and Aureomycin: *Antibiotics Useful Against Rickettsial and Viral Infections*

Penicillin and streptomycin, especially in the newer forms which became available in 1948, are of immense value in combatting certain pathogenic bacteria. Although, as early as 1946, penicillin was found effective in the treatment of psittacosis, formerly believed to be caused by a virus but now tentatively ascribed to some pathogen akin to the rickettsias (Weiss, 1949), the whole group of the typhus and other fevers due to species of *Rickettsia* remained outside the range of effective chemotherapy until 1948.

In 1948 two antibiotics that are highly effective in curing rickettsial infections became available industrially. These are chloromycetin and aureomycin.

CHLOROMYCETIN

Announcement in 1947 (Ehrlich et al.) of a new antibiotic, chloromycetin, marked a notable addition to the already large list of anti-biotically active agents biosynthesized by actinomycetes of the genus *Streptomyces*. Chloromycetin, so named because it was soon recognized to embody nonionic chlorine in its molecule, is remarkable on

* A History of Science and Its Relations with Philosophy and Religion, Cambridge Univ. Press, 1949.

several counts: (1) it is highly effective therapeutically in typhus and other rickettsial infections; (2) it can be administered orally and appears to be practically devoid of acute and chronic toxicity; (3) within one year of its discovery, chloromycetin became commercially available from organic synthesis as well as from biosynthesis.

Microbiology. Chloromycetin is biosynthesized by *Streptomyces venezuelae*, a new species of actinomycete, so named because originally it was isolated from a sample of soil collected in Venezuela. Subsequently, chloromycetin was found in culture filtrates from liquor fermented by a similar, if not identical, strain of *Streptomyces* isolated from a compost pile in Illinois.

Streptomyces venezuelae grows well and produces industrial yields of chloromycetin on a medium containing maltose, amino acids, "distillers' solubles," and sodium chloride. Yields of 85 to 100 or more micrograms chloromycetin per ml. are obtained in submerged fermentations on an industrial scale. The organism is subject to attack and destruction by actinophages, but this is of less importance here than in the case of streptomycin biosynthesis (Chap. 6), since chloromycetin can be produced on an industrial scale by organic synthesis.

Chloromycetin may be assayed microbiologically by turbidimetric measurements of standard broth cultures seeded with *Shigella paradysenteriae*. The potency of the crude liquor or partially purified chloromycetin is expressed in terms of the concentration of the crystalline compound (0.2 microgram per ml.) required to cause 50 per cent inhibition. Other Gram-negative pathogens often associated with enteral disorders are also susceptible to the action of chloromycetin, *Escherichia coli*, *Salmonella schottmülleri*, and *Proteus* sp. being markedly inhibited by as little as 0.33 microgram per ml. Alternatively, the activity can be tested in terms of the concentration of the antibiotic required to prevent development of rickettsial organisms inoculated into eggs.

Chloromycetin as a Chemical Compound. Chloromycetin is a neutral crystalline compound which embodies nitrogen and non-ionic chlorine and has the empirical formula $C_{11}H_{12}Cl_2N_2O_5$; it

melts at 149.7-150.7° C. Four isomers have been synthesized in the laboratory but only one of these possesses the biologic, chemical, and physical properties of the biosynthesized compound. This isomer is marketed under the name, Chloramphenicol. The antibiotic activity probably is correlated with the following stereochemical structure embodying two asymmetric carbon atoms (bold face).

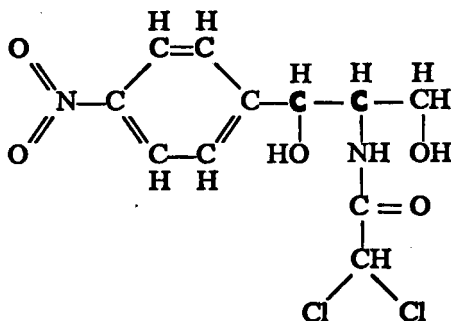

Chloromycetin or Chloramphenicol
(D-threo-1-paranitrophenyl-2-dichloroacetamide-1,3-propanediol)

Chloromycetin is soluble in water to the extent of about 2.5 mg. per ml. at 25° C., and is freely soluble in the lower alcohols, propylene glycol, and acetone .

The antibiotic is thermostable both in the dry condition and in solution; boiling in distilled water for five hours does not impair its biologic activity. At room temperature, it is stable in aqueous solutions over the pH range from about 2 to 9 for at least 25 hours.

Chloromycetin as a chemotherapeutic agent gives promise of relieving the human race of typhus (Smadel, 1949), the dreaded scourge that has been the aftermath of war in all parts of the world through the centuries.* This applies to both the louse-borne typhus, caused by *Rickettsia prowazekii*, and scrub typhus, due to *Rickettsia nipponica* (*R. tsutsugamushi*) which is transmitted by chigger mites (*Trombicula akamushi* and *T. deliensis*). The efficacy of chloro-

* More than 2000 years ago the Egyptians were using the freshly expressed sap of *Urginea maritima* (common squill) for chemotherapeutic treatment of a tick-borne (exanthematic) typhus but this remedy apparently was forgotten (Roques, 1944).

mycetin as a chemotherapeutic agent for typhus was dramatically demonstrated within a few months of its discovery when epidemics were controlled by its use in Bolivia, Mexico and Malaya. When an epidemic of scrub typhus broke out in Malaya in 1948, one pound of chloromycetin (the total supply in the world at that time) was flown

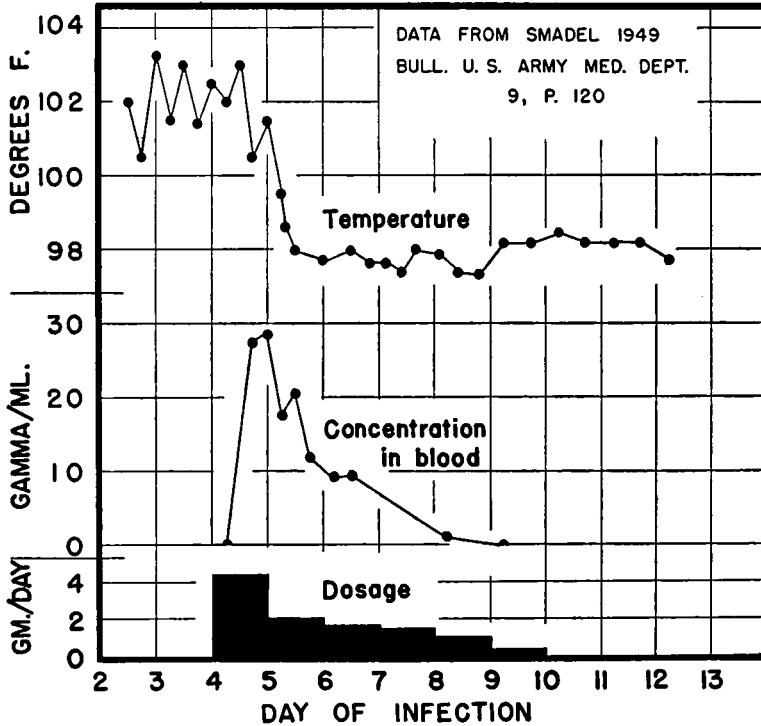

FIG. 45. Chart of typical typhus patient treated with chloromycetin from the fourth day of infection.

to the afflicted area, and within two to three days of the first administration of the drug the temperature of all treated patients was restored to normal. This is the usual occurrence, not only in typhus cases, but in all cases of acute infections amenable to chloromycetin therapy (Fig. 45).

Among other diseases of rickettsial origin that respond to treatment with chloromycetin are Rocky Mountain spotted fever (due to *Rickettsia rickettsi* transmitted by the dog tick) and Q-fever, a disease which was first described from Queensland, Australia,* but has since been observed in various parts of the Old and New Worlds, chiefly among people who are in contact with goats or sheep.

Chloromycetin is both prophylactic and chemotherapeutic. Administration of the drug before inoculation with various rickettsias has been shown to prevent development of infection in animals (mice), and 100 per cent cures have been obtained when chloromycetin therapy was started as long as five days after the onset of rickettsial infections.

The following list is abridged from the long list of diseases for treatment of which chloromycetin is indicated: (1) relapsing fever, caused by the spirochete *Borrelia recurrentis*; (2) psittacosis; (3) all rickettsial infections; (4) undulant fever, caused by various species of *Brucella*; and (5) a number of enteral and genito-urinary infections due to various Gram-negative organisms. For treatment of the latter infections, chloromycetin may, because of its lack of toxicity, be preferred to streptomycin.

Chloromycetin can be detected in the blood within 30 minutes after ingestion of a single dose of 1 gram; the concentration reaches a maximum in about two hours, then falls off progressively to undetectable levels after eight hours. Consequently, sustaining doses of 0.25 to 0.5 grams are given at intervals ranging from two to six hours. Chloromycetin is eliminated in the urine where it appears within 30 minutes following an initial oral dose of 1 gram.

Physiologic Effects of Chloromycetin on the Patient. Chloromycetin appears to fulfill almost ideally the two fundamental requirements of a chemotherapeutic agent, i.e., it shall be deadly to the disease-causing microbes but at the same time shall be harmless to

* Although the disease was first described from Queensland, the "Q" has no geographic connotation, but instead stands for "question" alluding to the elusiveness of etiology of the fever.

the tissues of the host. Prolonged dosing of human volunteers with 1 gram chloromycetin daily caused no detectable ill effects either during the treatment or later.

Experimental animals fail to show ill effects following relatively large oral or intramuscular doses of chloromycetin. For example, in white mice the LD₅₀ is reached only when 245 mg. per Kg. are given orally in a single dose. This is equivalent to a dose of approximately 17 grams for a man weighing 150 pounds: the average human dose is about 1 to 2 grams daily. Thus, with this drug, as with penicillin, there appear to be no clinical problems of acute or chronic toxicity, barring possible incidences of allergy.

AUREOMYCIN

Microbiology. Aureomycin is a yellow, crystallizable antibiotic biosynthesized by the actinomycete, *Streptomyces aureofaciens*, which was discovered by Dr. B. M. Duggar (1948) during the course of a screening program, in which he investigated hundreds of different species and strains of soil-inhabiting micro-organisms—principally actinomycetes. Several mutant strains of this *Streptomyces* have been induced by artificial means (irradiation) and one of these, designated A-377, has been selected as giving superior yields of the antibiotic in either surface or submerged cultures.

Aureomycin has a wide antibacterial spectrum which includes a number of Gram-positive and Gram-negative organisms and which embraces, in addition, several of the rickettsias. It is the activity against these latter infectious agents that gives aureomycin the greatest clinical significance. In vitro, aureomycin is, in general, less effective than penicillin against the Gram-positive cocci. The only notable exception that may be of clinical importance appears to be in the case of *Streptococcus faecalis*, one of the species commonly encountered in bacterial endocarditis. Chandler and Bliss (1948) observed six strains of *Streptococcus faecalis* which were more sensitive to aureomycin than to penicillin. Several strains of each of several species of *Staphylococcus*, *Pneumococcus*, and hemolytic

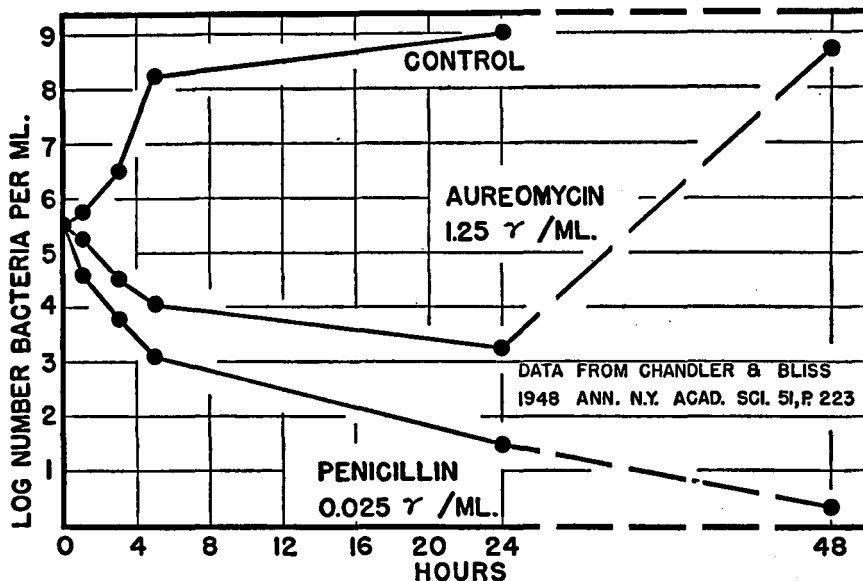

FIG. 46. Effect of aureomycin and penicillin on multiplication of the C203 strain of β hemolytic *Streptococcus*.

Streptococcus were tested and all were inhibited by less than one microgram of aureomycin per ml.

The comparative effects of penicillin and aureomycin on a strain of *Streptococcus* are shown in Figure 46.

It has been hypothesized, on the basis of data such as those plotted in Figure 46, that aureomycin is bacteriostatic and not bactericidal. Note that whereas penicillin brought about a continuous decrease in bacterial count and eventual sterilization of the medium, aureomycin brought about a reduction in bacterial count during the first 24 hours but after that time the cell count rose and eventually equalled that of the control culture. However, care should be exercised in drawing general conclusions from this kind of experiment. The eventual outgrowth of the organisms might be due to deterioration of the antibiotic during incubation, to survival of resistant organisms, or to a postlytic wave of growth induced among less susceptible cells by

products released from the more sensitive cells which are affected first by the antibiotic. It will be recalled that such postlytic waves of growth have been reported in similar experiments with penicillin at or near the threshold concentration (Chap. 3, Figs. 16 and 17).

General conclusions can hardly be drawn from experiments performed at only one concentration. The experimental results plotted in Figure 47 bear on this point. Note that concentrations of 0.125 and 0.5 microgram aureomycin per ml. inhibited growth of a strain of *Streptococcus pyogenes* for several hours and that the duration of inhibition increased with increasing dosage. The periods of inhibition were followed by periods of renewed growth. Even at a concentration of 2.0 micrograms per ml., which eventually effected sterilization of the culture, postlytic waves of growth occurred.

There is no evidence of correlation between the response of different organisms to aureomycin and their response to penicillin, streptomycin, or diverse other antibiotics.

In common with other antibiotics which are not primarily surface-active, aureomycin is most effective against actively multiplying organisms, and exerts relatively little effect against fully grown or metabolically relatively inactive cultures. In serial dilution studies, the density of population is an important factor, more aureomycin being required for inhibition of dense cultures than for more sparsely populated ones. This factor is of less importance in agar-plate tests.

The pH of the medium is important in performing assays of aureomycin. This antibiotic is most active in the acid range; the optimum for laboratory studies probably is about pH 6.0. For some organisms 64 times as much aureomycin may be required to cause total inhibition at pH 8.0 as at pH 6.0.

Serum, whole blood, and a variety of compounds normally present in biologic fluids and culture media diminish the antibiotic activity of aureomycin in in vitro tests; this factor must always be reckoned with in performing assays to determine aureomycin blood levels. However, satisfactory cylinder plate and serial dilution assays, employing a strain of *Bacillus subtilis*, have been developed and are described in

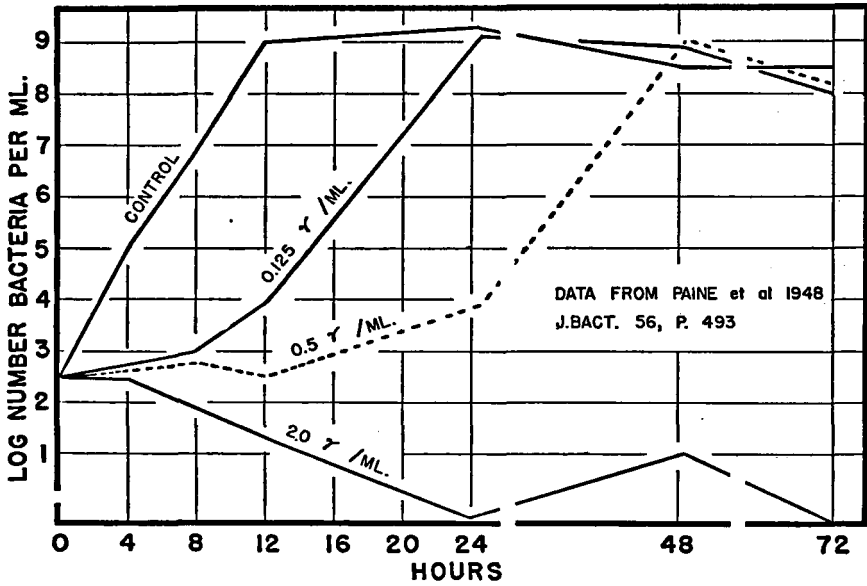

Fig. 47. Effect of different concentrations of aureomycin on growth and survival of *Streptococcus pyogenes*, strain 98.

the Annals of the New York Academy of Sciences, 51, 1948. The fact that aureomycin appears to be much more effective in vivo against some bacterial pathogens than would be anticipated from its in vitro performance has led some authors to suggest that its mechanism of action on micro-organisms may be different in the two cases.

No organisms are known at present to inactivate aureomycin and in only a few instances has evidence of resistance appeared following continued or repeated exposure of "sensitive" bacteria. It has been noted that after 14 transfers *Salmonella typhosa* may increase four-fold in resistance. This is in contrast to a 226,000-fold increase in resistance of the same species in the same number of transfers in media containing streptomycin. In another series of studies, when different strains of *Staphylococcus* cultures were prepared with uniform inocula, it was observed that whereas 31 mutant colonies with 3- to

10-fold increase in tolerance developed in media containing penicillin and from 8 to 63 mutant colonies with 10- to 1000-fold increase developed from cultures exposed to streptomycin, only 17 mutant colonies with a 2- to 5-fold increase in resistance developed in the aureomycin series. Increase in resistance to one antibiotic did not alter the sensitivity of the pathogen to the other antibiotics. Subsequent tests showed that the aureomycin-tolerance of artificially induced resistant strains was undiminished after 30 transfers on aureomycin-free media.

No organisms are known to be aureomycin-dependent but a resistant mutant strain of *Staphylococcus aureus*, the growth of which is markedly stimulated by aureomycin, has been reported.

Aureomycin as a Chemical Compound. Aureomycin, known also as aureomycin A-377 and as Duomycin, is a yellow, crystalline, weakly basic compound that contains C, H, N, Cl, and O. The molecular weight is 508, and the melting point is 168-169° C. (uncorrected). It is soluble in water (at 25° C.) only to the extent of 0.5 per cent, but is freely soluble in dioxane, carbitol, and various Cellosolves. It is slightly soluble in the lower alcohols, acetone, ethyl acetate, and benzene, and is insoluble in ether and petroleum ether. Aureomycin is amphoteric since it enters into salt formation as either a cation or an anion, depending on the pH of the medium. Both the hydrochloride and the sodium salt are prepared easily. Aureomycin borate has been prepared also and has been used in ocular infections (see below). The hydrochloride, sold as a crystalline or an amorphous yellow powder, is soluble only to the extent of 1 per cent in normal saline, but is soluble in distilled water and in 5 per cent solutions of glucose in distilled water. Four per cent solutions are achieved readily in these latter solvents; the pH of such solutions is about 2.5 to 2.9. Precipitation occurs when the solution is neutralized. Analysis of the hydrochloride has been reported as follows:

C	51.84
H	5.24
N	5.46
Cl	13.27 (of which 6.69 is ionic)
O	24.19

The sodium salt is soluble to the extent of at least 4 per cent in carbonate buffer at pH 8.5. Precipitation occurs if the solution is neutralized.

Aureomycin and its salts appear to be stable for many months at room temperature when dry, i.e., moisture content less than 1 per cent. Solutions of aureomycin (in high concentrations) in distilled water are stable at 37° C. and at refrigerator temperatures. At low concentrations, however, or when dissolved in broth, plasma, blood agar, or a variety of other components of standard culture media, the potency decreases rapidly at 37° C., slowly at 4° C. Solutions of aureomycin hydrochloride in distilled water (20 micrograms per ml.), having a pH of about 2.5, are reasonably stable at room temperature; but they are unstable at 37° C., 15 per cent of their activity being lost in 5 hours and 50 per cent in 24 hours. In neutral or alkaline solutions aureomycin deteriorates rapidly, even at room temperature; deterioration is said to be more rapid at pH 7.0 than at higher pH values. At 4° C. solutions ranging from pH 7.0 through pH 10 are stable for at least 18 hours.

Aureomycin as a Chemotherapeutic Agent. As stated above, aureomycin is effective both *in vitro* and *in vivo* against a variety of pathogenic bacteria but its greatest potential value as a chemotherapeutic agent probably lies in its rickettsicidal activity, although it now seems that it may be superseded by chloromycetin. Rocky Mountain spotted fever and epidemic typhus respond remarkably well to either antibiotic.

Guinea pigs infected with highly virulent rickettsiae are protected by aureomycin, the degree of protection afforded depending on the time interval between inoculation of the experimental infection and

start of antibiotic therapy. When the course of aureomycin therapy (single daily doses of 1 to 3 mg., injected subcutaneously or intermittent treatment every two or three days) is started within 48 hours after inoculation of the animals with lethal doses of the rickettsiae, complete or partial suppression of fever is generally obtained in either spotted fever or epidemic typhus. With few exceptions all treated animals recover, whereas there is high fatality among untreated animals.

Guinea pigs having recovered from Rocky Mountain spotted fever are resistant to reinfection, regardless of whether complete or partial suppression of the fever was achieved during the course of chemotherapeutic treatment. A correlation exists between the dosage of aureomycin and the titer of complement-fixing antibodies in treated animals. Animals receiving a total dose of 10 mg./Kg. in mg. doses every two or three days develop higher complement-fixing antibody titers in their sera than animals receiving 20 mg./Kg. in doses of 2 mg. each.

Intermittent treatment with aureomycin may be more desirable than continuous therapy because it may permit regrowth of surviving organisms which then, being in a more active metabolic state, are more sensitive to the action of the antibiotic. However, it is important in such intermittent therapy with aureomycin, as with penicillin (Chap. 5), that the intervals between doses be of short enough duration so that the regrowth of the organisms does not nullify the beneficial effect of the preceding doses. When treatment of human subjects suffering from Rocky Mountain spotted fever is initiated from the second to eighth day of disease, recession of symptoms and effective clinical cure may be expected in from 1.5 to 3 days after the start of therapy. Human patients with epidemic typhus (Brill's disease) treated with aureomycin starting on the second to sixth day of infection have become asymptomatic within two days. Similarly remarkable results have been achieved when aureomycin has been used in treating Q-fever patients.

Aureomycin has been used successfully in treating many human

patients afflicted with acute brucellosis; typhoid fever; infection by hemolytic *Staphylococcus aureus*; primary atypical pneumonia; chronic urinary tract infections due to penicillin- streptomycin- and sulfonamide-resistant *Bacterium coli-aerogenes*, *Bacterium paracolon*, or *Streptococcus faecalis*; and a smaller number of cases suffering from bacteremia (*Escherichia coli*), gonorrhoeal urethritis, acute pneumococcal pneumonia, acute meningococemia, lymphogranuloma venereum, psittacosis, and *Salmonella* infections. In approximately 98 per cent of the cases clinical cures have been effected rapidly.

Direct application of aureomycin borate alone, or supplemented by systemic administration of the hydrochloride, has been effective in treating staphylococcal, streptococcal, gonococcal, meningococcal, pneumococcal, and influenzal conjunctivitis, and other ocular infections due to various viruses, as well as to diplobacilli, Friedlander's bacillus, and various coliform bacteria. Remission of symptoms generally occurs in from 1.5 to 3 days after administration of the first dose of the antibiotic. No complications have been reported following use of aureomycin in any of these cases and convalescence has been routine.

Aureomycin may be administered orally, subcutaneously, or intramuscularly. The total dose and the dosage schedule depend upon the infection under treatment and duration of the infection before starting therapy. A common current recommendation for average oral dosage is as follows:

50-100 mg./Kg./day for rickettsial infections

300-500 mg./Kg./day for typhoid and *Salmonella* infections

25-50 mg./Kg./day for pneumococcal infections

given in divided doses every four hours during the first twenty-four hours and then every six hours. Oral doses of aureomycin are well tolerated: mice tolerate 1,500 mg./Kg. and rats 3,000 mg./Kg. Parenterally, the drug is not seriously toxic but may cause irritation.

Intravenously, the LD₅₀ for mice is 134 mg./Kg. when the drug is administered as the hydrochloride (pH about 2.5). The LD₅₀ for rats is about the same order of magnitude. Dogs and cats easily

tolerate intravenous doses of 50 mg./Kg., either at pH 2.5 or 8.5 (sodium salt), but subcutaneous, intramuscular, or intraperitoneal administration of solutions at pH 2.5, 7.0, or 8.5 are somewhat irritating, transiently. No evidence of irritation is present after 24 hours. Irritation is avoided to a large extent if 0.5 per cent solutions of aureomycin in normal physiologic saline are used.

Severe chronic toxicity has not been observed in mice, rats, dogs, or cats following administration of aureomycin for as long as 15 weeks, and pathologic symptoms have not been observed when the animals have been autopsied. In a few cases, transient albuminuria has been reported. Aureomycin is mildly diuretic, being about 40 per cent as active as caffeine and about 10 per cent as active as theobromine in this respect.

No untoward reactions, save occasional transient irritation at the site of injection, have been observed in human patients receiving aureomycin parenterally. Oral doses sometimes cause nausea.

Aureomycin is excreted in the urine. It first appears in the urine about one hour after an oral dose, and normally excretion continues for from six to twelve hours or longer. Significant concentrations of aureomycin can be found in the cerebrospinal fluid within six hours following intravenous injection.

Aureomycin has been suggested to be of value in veterinary medicine. It strongly inhibits growth of members of the Chlamydozoaceae which cause sinusitis in turkeys.

A curious antagonistic action in vitro of aureomycin and penicillin and of aureomycin and streptomycin has been reported and merits comment. Data for aureomycin and penicillin are plotted in Figure 48. In cultures of *Staphylococcus aureus*, F.D.A. strain 209, concentrations of aureomycin from 0.01 to 0.015 microgram per ml. appear to interfere with the antibacterial action of low concentrations of penicillin. Thus, more growth obtains in cultures partially inhibited by penicillin when aureomycin is present than when it is absent. Apparently, low concentrations of penicillin exert even more pronounced antagonizing effects on aureomycin, especially in certain

ranges of concentration, notably when the concentration of aureomycin is between 0.02 and 0.04 microgram per ml. However, at a critical balance of concentrations (aureomycin about 0.01 microgram per ml. and penicillin 0.0036 microgram per ml.) the two antibiotics appear to act synergistically. Somewhat similar effects have been observed in experiments in which bacteria were exposed simultaneously to different concentrations of aureomycin and streptomycin.

It is not known at present whether similar effects obtain *in vivo*, but the problem warrants study, since there is a growing tendency to use mixed antibiotic therapy in the treatment of mixed infections.

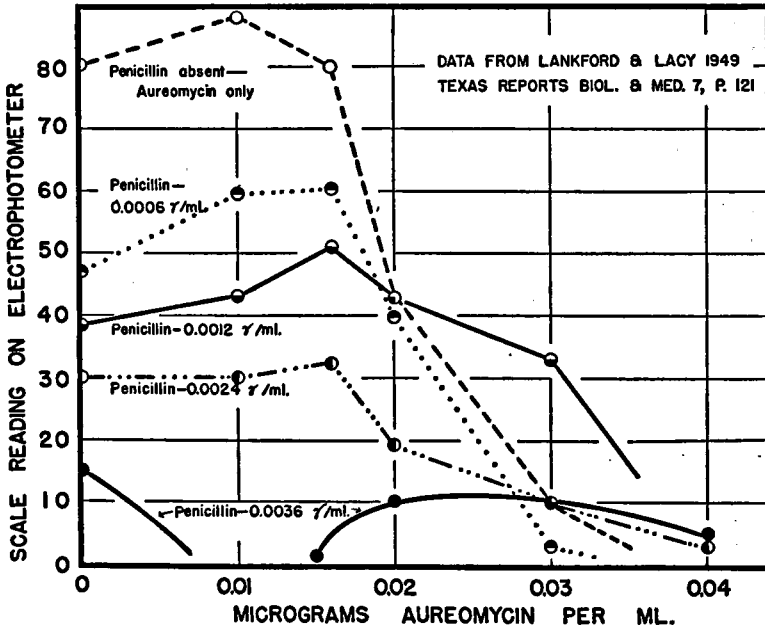

FIG. 48. Survival and growth of *Staphylococcus aureus* after 18 hours in broth containing different concentrations of aureomycin and of penicillin. Ordinates, which are in terms of electrophotometer readings, indicate absorption of light by the cultures. A high reading indicates high absorption—in other words, a densely populated culture. A scale reading of 80 in this experiment corresponded to a population of approximately 10^9 to 1.25×10^9 cells per ml. (See text for further explanation.)

The full meaning of these observations is not known at present, but apart from their potential clinical importance (whether the effects are synergistic, additive or antagonistic) they may help to elucidate the mechanisms of antibiotic action.

REFERENCES

- Chandler, C. A., and Bliss, E. A., 1948, In vitro studies with aureomycin, *Ann. New York Acad. Sci.*, 51:221-227.
- Duggar, B. M., 1948, Aureomycin: a product of the continuing search for new antibiotics, *Ann. New York Acad. Sci.*, 51:177-181.
- Ehrlich, J., Bartz, Q. R., Smith, R. M., Joslyn, D. A., and Burkholder, P. R., 1947, Chloromycetin, a new antibiotic from a soil actinomycete, *Science*, 106:417.
- Roques, H., 1944, Sur un traitement curatif du typhus exanthématique par la scille fraîche (*Urginea maritima*), *Bull. Soc. Hist. Nat. Afrique du Nord.*, 35:17-18.
- Smadel, J. E., 1949, Chloromycetin in the treatment of typhus fevers, *Bull. U. S. Army Med. Dept.*, 9:117-123.
- Weiss, E., 1949, The extracellular development of agents of the psittacosis-lymphogranuloma group, *J. Inf. Dis.*, 84:125-149.

A successful pursuit of science makes a man the benefactor of all mankind and of every age.

—J. PRIESTLY (1733-1804)

CHAPTER

8

Polymyxin:

An Antibiotic Active Specifically Against Gram-negative Organisms

After several years of research, Stansly et al. (1947) announced the discovery of an antibiotic that is effective specifically against Gram-negative micro-organisms. They designated the antibiotic polymyxin in allusion to its biologic source, *Bacillus polymyxa*, an aerobic, spore-forming soil-inhabitant that was already in industrial use for the production of 2,3-butanediol from starch by fermentation. *Bacillus polymyxa* is also known as *Aerobacillus polymyxa*. During the same year, Benedict and Langlykke (1947) independently reported that sterile culture filtrates of *Bacillus polymyxa* inhibit the in vitro growth of a species of *Brucella*.

Soon after discovery of polymyxin in the United States, another closely related antibiotic specifically active against Gram-negative pathogens was found in England in culture filtrates from an aerobic soil inhabitant designated *Bacillus aerosporus*. This antibiotic, which was called aerosporin, is now designated polymyxin A: the original polymyxin is designated polymyxin D.

Reinvestigation of the taxonomy of the American *Bacillus polymyxa* and of the British *Bacillus aerosporus* has shown that the two species are identical; these two isolates, and other strains of *B. polymyxa* more recently isolated, produce antibiotics belonging to the family of polymyxins. We shall use the term polymyxin collectively to

include all the polymyxins, except where specifically indicated to the contrary. The several polymyxins differ in pharmacologic properties, but all are characterized by a narrow antibiotic spectrum that is limited to certain Gram-negative organisms. As originally isolated, polymyxin and aerosporin contained a nephrotoxic factor which could not be removed by chemical purification. Recently, however, strains of *Bacillus polymyxa* have been isolated which produce antibiotics with similar biologic spectra but less damaging to the kidneys: these new polymyxins are designated as polymyxin B and polymyxin E. Polymyxins B and E can be administered intramuscularly in doses of 2.5 mg./Kg./day without causing renal damage; renal injury occurs when the dose is raised to 4 to 5 mg./Kg./day.

MICROBIOLOGY OF POLYMYXINS

Polymyxins may be produced industrially by different strains of *Bacillus polymyxa* in submerged culture in an inexpensive medium containing mineral salts and a suitable organic source of carbon. The yield is improved by addition of yeast extract, or of various industrial by-products, including corn steep liquor, soy bean oil meal, etc. Under favorable conditions (20°-30° C., pH about 6 to 7, proper agitation, aeration, etc.), the fermented liquor can be harvested in from two to three days.

Even the crude filtrate is highly active in vitro against a number of Gram-negative pathogens: the highest inhibitory dilutions for typical Gram-negative and Gram-positive pathogens are given in Table 8.

TABLE 8. HIGHEST INHIBITORY DILUTIONS FOR
TYPICAL PATHOGENS

GRAM-NEGATIVE	DIL.	GRAM-POSITIVE	DIL.
<i>Escherichia coli</i>	1,024	<i>Streptococcus</i> , Group A	8
<i>Eberthella typhosa</i>	2,048	<i>Streptococcus</i> , Group B	4
<i>Shigella dysenteriae</i>	512	<i>Streptococcus</i> , Group D	no inhibition
<i>Salmonella schottmülleri</i>	128	<i>Diplococcus pneumoniae</i>	32
<i>Pseudomonas aeruginosa</i>	128	<i>Staphylococcus aureus</i>	no inhibition
<i>Klebsiella pneumoniae</i>	512	<i>Clostridium welchii</i>	16
		<i>Erysipelothrix rhusiopathiae</i>	8

The outstanding feature of the tabulated data is the marked contrast between the sensitivity of Gram-negative and Gram-positive species. The slight activity of the crude filtrates against some Gram-positive species has been ascribed to the presence of a second antibiotic;* purified polymyxin hydrochloride appears to be totally devoid of activity against these bacteria. Approximately 90 per cent of the strains of Gram-negative bacteria that have been tested in vitro are inhibited by polymyxin hydrochloride in concentrations ranging from 0.5 to 16 micrograms per ml. Most Gram-positive organisms are unaffected by concentrations as high as 64 micrograms per ml. The high selectivity of polymyxins makes them useful in the laboratory for eliminating Gram-negatives from mixed cultures without harming Gram-positives. The activity of polymyxins is not affected by the presence of blood, pus, or serum or by changes in pH within the range 5 to 8.

When polymyxin is assayed by an agar-plate technic using *Escherichia coli* as the test organism, the calibration curve (diameter of inhibition zone/log concentration) is linear over the range 1 to 256 units per ml. An arbitrary value of 2000 units per mg. has been assigned to the purified hydrochloride of polymyxin. Thus, 1 unit = 0.5 microgram.

POLYMYXINS AS CHEMICAL COMPOUNDS

Polymyxins may be recovered from the crude fermented liquor by adsorption and elution technics or by formation of an helianthate, and subsequent conversion to an hydrochloride.

Polymyxins are basic polypeptides that are readily soluble in water. The hydrochlorides are soluble in water and in methanol, but solubility decreases with ascent in the alcohol series. They are insoluble in ether, acetone, chlorinated solvents and hydrocarbons. The relative solubilities of the constituents of the several polymyxins in water

* It has been suggested that small amounts of tyrothricin are present in the crude filtrates. This could account for the hemolyzing action of such filtrates as well as for their activity against Gram-positive organisms (see Chap. 9).

and in different organic solvents have been used to separate the fractions by chromatography.

All the polymyxins contain threonine, α , γ -diaminobutyric acid, and a saturated, optically active fatty acid ($C_9H_{18}O_2$). The original polymyxin, now called polymyxin D, also contains leucine and serine; the original aerosporin, now called polymyxin A, contains leucine but no serine.

Polymyxin is thermostable in aqueous solutions and in dilute acidic alcoholic solutions at or near neutrality; but its antibiotic activity is rapidly lost, even at room temperature, in strong acids or alkalis. However, its activity is not affected by prolonged incubation with pepsin, trypsin, pancreatin, and other common enzymes, nor by various sulfhydryl-bearing compounds.

POLYMYXINS AS CHEMOTHERAPEUTIC AGENTS

Polymyxins are effective in protecting mice experimentally inoculated with a lethal dose of *Klebsiella pneumoniae* or of *Pasteurella multocida* (related to the plague organism). A single dose of 0.5 mg. per Kg. affords 80 to 100 per cent protection against both infections whether given immediately or four hours after inoculation. The drug is equally effective whether administered subcutaneously or intravenously. In one series of experiments the oral dose for protection was found to be about 64 times the parenteral dose, a fact which, if substantiated, would seem to limit the systemic use of polymyxin to parenteral administration.

Human infections caused by *Pseudomonas aeruginosa*, by *Klebsiella pneumoniae*, by *Hemophilus pertussis*, and by *Brucella abortus* have been cured by use of polymyxins, but perhaps the greatest promise of polymyxin lies in its potential value in treating infections due to *Hemophilus pertussis* (whooping cough).

An additional merit of polymyxin is that initially sensitive bacteria do not appear to develop resistance to this antibiotic as they do to streptomycin.

The antibiotic action of polymyxin is impaired by soap, lipositol, and other agents that antagonize cationic detergents. It is noteworthy, however, that cationic detergents generally are effective against Gram-positive organisms while polymyxins are active only against Gram-negative organisms. Polymyxins, in contrast with the antibiotics discussed previously, are more effective against older cultures than against young ones.

The most serious obstacle to wider clinical use of polymyxins is their toxicity, which may be due to the presence of *d*-serine. Substances which afford protection against the toxicity of *d*-serine also protect animals against the nephrotoxicity of polymyxins. Glutathione and *dl*-methionine are most effective, especially if followed by *S*-methyl cysteine. Partial protection is afforded by *dl*-alanine, glycine, or *dl*-threonine, and by glycolic, butyric, or pyruvic acids.

REFERENCES

- Ainsworth, G. C., et al., 1947, Aerosporin, an antibiotic produced by *Bacillus aerosporus* Greer, *Nature*, 160:263.
- Benedict, R. G., and Langlykke, A. F., 1947, Antibiotic activity of *Bacillus polymyxa*, *J. Bact.*, 54:24-25.
- Long, P. H., 1949, Antibiotics derived from *Bacillus polymyxa*, *Ann. N. Y. Acad. Sci.*, 51:855-1000.
- Stansly, P. G., Shepherd, R. G., and White, H. G., 1947, Polymyxin: a new chemotherapeutic agent, *Bull. Johns Hopkins Hosp.*, 81: 43-54.

Or speak to the earth and it will teach thee. . . .

—JOB XII:8

CHAPTER

9

Tyrothricin:

A Surface Active Antibiotic

Antibiotics can be divided into two groups. The members of one group do not significantly modify the surface tension of the water in which they are dissolved, at least in the range of concentrations used therapeutically. The members of the second group, of which tyrothricin is representative, are surface active agents. Surface active agents, by virtue of their disruptive effect on the cellular complex, cause lysis of bacterial cells and consequent liberation of the amino acid, lysine. The mechanism of action of the two groups of antibiotics will be compared in Chapter 11.

MICROBIOLOGY OF TYROTHRIN

In 1939, René Dubos isolated from soil, which he had repeatedly contaminated with suspensions of pathogenic bacteria, a Gram-positive, spore-forming aerobe which he identified as *Bacillus brevis*. Culture filtrates of this organism are capable of inhibiting the growth of Gram-positive pathogens similar to those used previously to contaminate the soil. The antibiotic that was isolated through this "soil enrichment" technic he called tyrothricin because *Bacillus brevis* belongs to the group of organisms to which Duclaux, in 1898, applied the name *Tyrothrix*.

After *B. brevis* has been grown for three to four days at 37° C. in

well aerated 1 per cent tryptone broth, there can be recovered from the crude filtrate a mixture of basic polypeptides. This mixture (tyrothricin) contains 20 to 25 per cent gramicidin (so named because of its lethal action on Gram-positive cocci) and approximately 60 per cent tyrocidin. The comparative antibacterial activities of tyrothricin and its constituents against representative organisms *in vitro* are shown below, in terms of minimal inhibiting concentrations.

TABLE 9. COMPARISON OF ANTIBACTERIAL STRENGTH OF TYROTHRICIN AND ITS CONSTITUENTS (Minimal Inhibiting Concentrations)

ORGANISM	TYROTHRICIN (micrograms/ml.)	GRAMICIDIN (micrograms/ml.)	TYROCIDIN (micrograms/ml.)
<i>Diplococcus pneumoniae</i>			
Type I	2.5	1.0	100
Type III	1.0	0.5	20
Type XIX	not determined	2.5	40
<i>Hemolytic streptococcus</i>	10.0	5.0	80

The bactericidal activity of tyrothricin has been correlated with its ability to cause lysis. Lysis is evidenced morphologically by disruption of the structure of the bacteria; it is evidenced biochemically by the release of amino acids, notably lysine, from the cell into the external medium. Liberation of lysine is proportional to the concentration of tyrothricin or tyrocidin (or of other surface active agents) up to the concentration causing complete lysis. About one hundred million molecules of tyrocidin may be required to kill and lyse one *Streptococcus* cell. Figure 49 shows the rate of liberation of lysine from *Streptococcus faecalis* following addition of different amounts of tyrocidin to the culture broth.

Tyrothricin causes lysis of susceptible bacteria irrespective of their age or metabolic condition. This is in contrast to penicillin which exerts its antibacterial action most vigorously against actively metabolizing organisms.

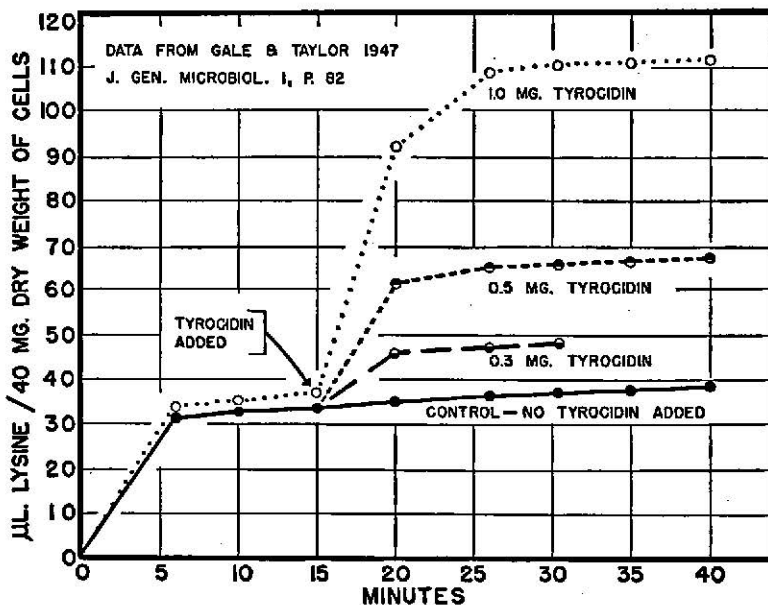

FIG. 49. Effect of adding tyrocidin to cultures of *Streptococcus faecalis* on the liberation of lysine. The same amount of lysine was liberated whether the cells were boiled (not shown in graph) or whether 1 mg. tyrocidin was added. This indicates that addition of sufficient tyrocidin causes complete liberation of lysine.

TYROTHRIN AS A CHEMICAL COMPOUND

Tyrothricin is a mixture of basic polypeptides. The steps involved in recovering tyrothricin from the crude fermented liquor and in fractionating the antibiotic into its components, gramicidin and tyrocidin, have been schematized by Hotchkiss (1944) as shown on following page.

Gramicidin* is a polypeptide which contains *l*-tryptophane, *d*-leucine, *d*-valine, *l*-valine, *l*-alanine, glycine, and an aminoethanol. A

* Gramicidin S, isolated in 1944 by Gause and Brazhnikova (Nature, 154:703), differs from the gramicidin of Dubos and Hotchkiss. It is very closely related to tyrocidin chemically and biologically. Both tyrocidin and gramicidin S are cyclopolypeptides in which the only free —NH_2 group is the *delta* amino group of the ornithine residue. The five amino acids entering into the structure of gramicidin S are *l*-valine, *l*-ornithine, *l*-leucine, *d*-phenylalanine, and *l*-proline.

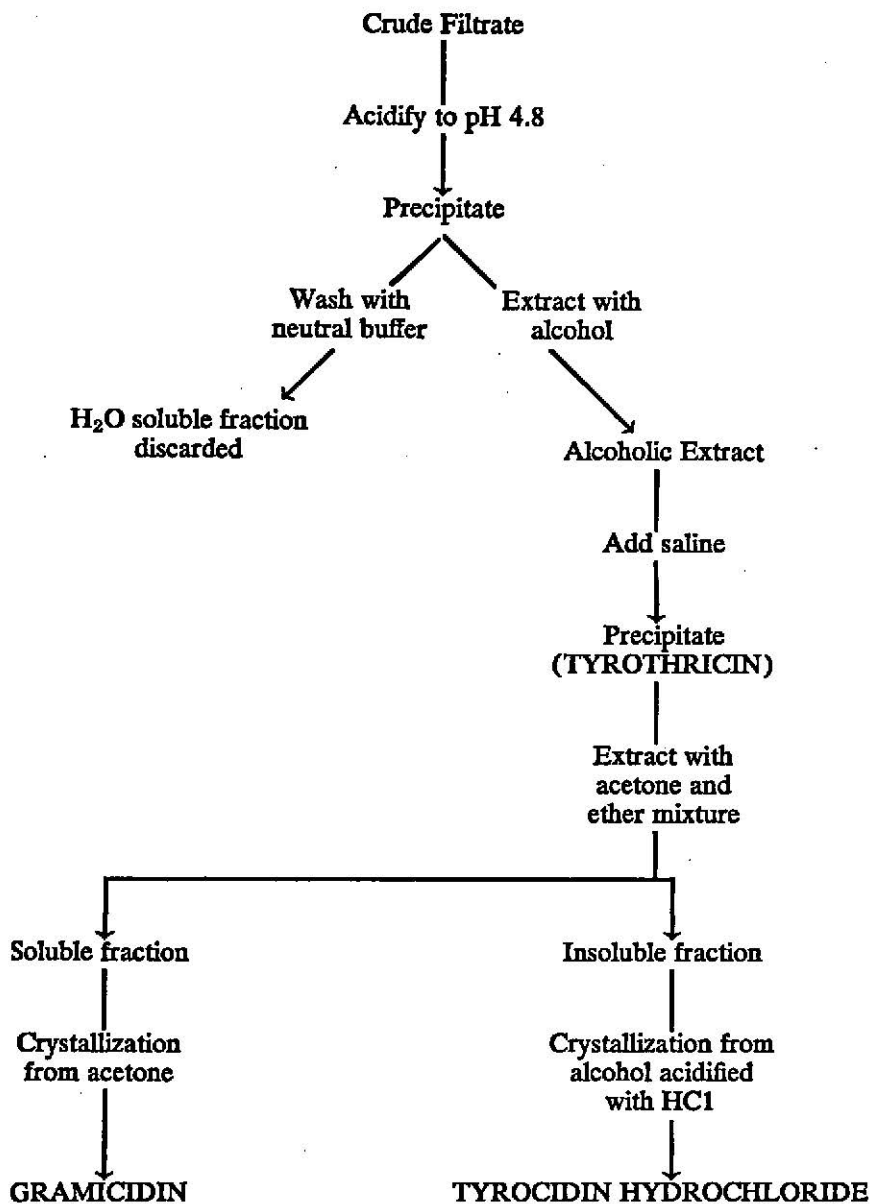

(Hotchkiss, R.D.: *Advances in Enzymology*, 4:153-199.)

noteworthy feature of the molecule is the presence of valine in both the *d* and the *l* forms.

Tyrocidin* is a cyclopolypeptide in which there are only two free chemical groups, namely, the *delta* amino group of ornithine and the hydroxyl group of tyrosine.

Both gramicidin and tyrocidin are slightly soluble in water and depress surface tension. They form fairly stable colloidal emulsions in distilled water; tyrocidin, which behaves like a cationic wetting agent, seems to increase the stability of emulsions of gramicidin.

Tyrothricin is relatively insoluble in water. However, it is soluble in alcohol, and suspensions suitable for experimental or clinical use can be prepared by adding appropriate quantities of stock solutions of tyrothricin in alcohol to physiologic saline or to distilled water. Alternatively, clear aqueous solutions of tyrothricin, which normally forms only colloidal suspensions in water, can be prepared when formaldehyde is used as a solubilizing agent; concomitantly, the toxicity of tyrothricin is reduced by formaldehyde.

TYROTHRIN AS A CHEMOTHERAPEUTIC AGENT

Gramicidin and tyrocidin, and hence tyrothricin, are fairly active against most Gram-positive pathogenic cocci.

Although effective *in vitro* against many Gram-positive pathogens, tyrothricin, because of its hemolytic action (due mostly to tyrocidin), is not suitable for systemic chemotherapy. The slight hemolytic action of gramicidin can be reduced without loss of antibacterial activity by preparation of methylol or formaldehyde derivatives. However, one of the globulin fractions of plasma inhibits the bacteriolytic activity of gramicidin and of tyrocidin. Therefore, the clinical application of these antibiotics is limited to topical use. Even local

* See footnote, p. 175

application involves some risk and should not be resorted to without medical advice. For example, indiscriminate nasal application may result in irreversible injury to the olfactory nerve.

Despite its several limitations, tyrothricin may be indicated in some specific infections as, for example, in bovine mastitis, and, in general, in localized sites of infection which are more readily accessible to direct irrigation than to systemic chemotherapy; for example, various types of carbuncles, infected wounds, and ulcers, notably those accompanying leprosy, often respond favorably to tyrothricin. Likewise, tyrothricin may be used to advantage in controlling certain superficial fungus infections in man and domestic animals.

In vitro experiments suggest that local chemotherapy involving gramicidin plus penicillin merits clinical trial. At least twice as much gramicidin or penicillin is required to suppress growth of various staphylococci and streptococci when each antibiotic is used alone as when the two are used conjointly.

In summary, tyrothricin possesses certain advantages for topical use, namely, stability in presence of pus, compatibility with salts and ionic detergents, relatively wide antibiotic spectrum among Gram-positive organisms, and lack of sensitizing properties.

REFERENCES

- Dubos, R., 1939, Bactericidal effect of an extract of a soil bacillus on Gram-positive cocci, *Proc. Soc. Exper. Biol. & Med.*, 40:311-312; *J. Exper. Med.*, 70:1-10, 11-17.
- Hotchkiss, R. D., 1944, Gramicidin, tyrocidin, and tyrothricin, *Advances in Enzymology*, 4:153-199.

For many are called, but few are chosen.

—ST. MATTHEW, XXII:14

CHAPTER

10

Other Antibiotics

Rediscovery in 1929 of the antibiotic properties of some of the *Penicillia* and subsequent successful clinical use of even crude preparations of penicillin, followed in 1939 by isolation of another clinically useful antibiotic (tyrothricin) in a purified crystalline form, stimulated an intensive search for chemotherapeutic agents among all manner of micro-organisms. During the following years many antibiotics with varying degrees of activity *in vitro* were reported from actinomycetes, bacteria, fungi, unicellular algae, lichens, and protozoa. Figure 50 shows that more than one hundred "new" antibiotics were described between 1929 and 1949.

In the early years of this antibiotic era many research workers, when they isolated an organism that displayed antagonistic, lytic, or lethal activity against another micro-organism, could not resist the temptation to describe a "new" antibiotic: generally it was named by adding the suffix *in* to some portion of the generic or specific name of the organism by which it was biosynthesized. Thus, there is much synonymy among the terms used to describe the antibiotically active metabolites from different groups of organisms. The dual naming of agents from the *Bacillus polymyxa* group has been mentioned (Chap. 8). Among the antibiotics from the *Penicillia* one finds in the literature patulin, derived from *Penicillium patulum*; expansin, derived from *Penicillium expansum*; and claviformin, derived from *Penicillium claviforme*: all of these are now known to be identical with

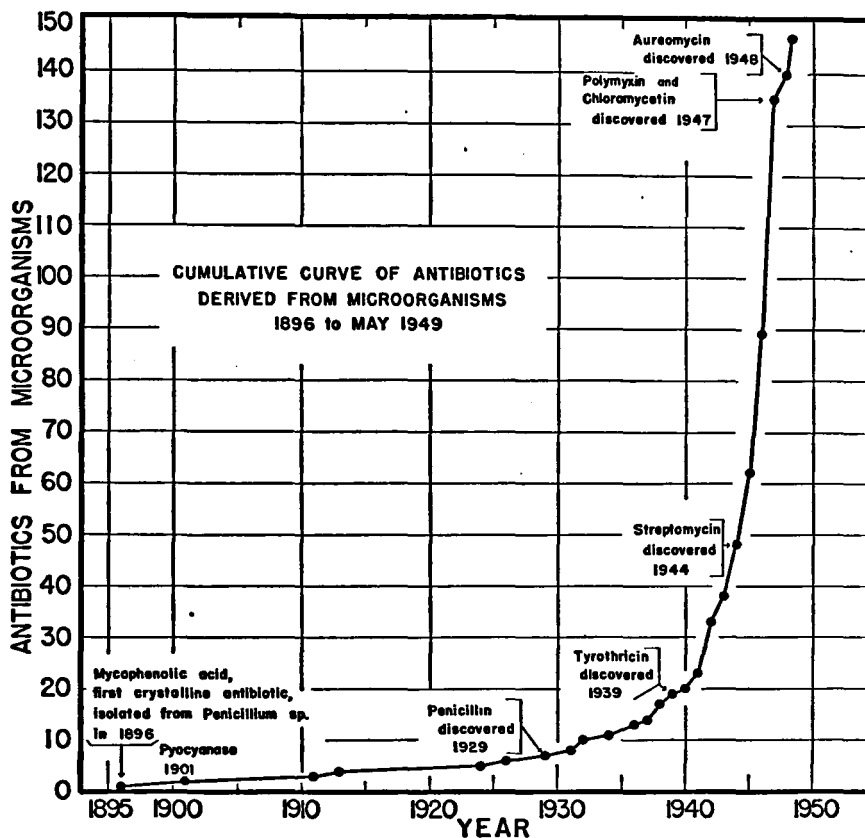

FIG. 50. Cumulative curve showing total number of antibiotics, bio-synthesized by micro-organisms, reported in the literature between 1896 and 1949.

clavacin which is obtained from cultures of *Aspergillus clavatus*. Among the multiple-named metabolic products of the *Aspergilli* are gigantic acid, derived from *Aspergillus giganteus*, and parasiticin, derived from *Aspergillus parasiticus*; both are identical with flavacin (also designated as flavatin or flavicidin), which is biosynthesized by *Aspergillus flavus* and corresponds to Δ^3 pentenyl penicillin. Numerous other examples can be cited, but the above illustrations are sufficient to indicate the confusion that can arise from indiscriminately

coining a new name every time a micro-organism with antibiotic properties is isolated. Some of this synonymy has arisen from the fact that a given antibiotic substance may be biosynthesized by micro-organisms belonging to different species, or sometimes even to different genera; some has arisen from the fact that different workers in different parts of the world have independently and almost simultaneously discovered and named the same antibiotic. Duplications have been avoided in constructing Figure 50; only antibiotics authenticated as being different from the others have been included.

Having studied in the preceding chapters the antibiotics currently of greatest chemotherapeutic significance, we will in this chapter discuss many antibiotics which have been assigned various names by authors working in different countries; and we will attempt to simplify the array of names by indicating probable synonymy. In order to accomplish the latter objective, it is necessary to establish definite criteria for discriminating among different antibiotics.

CRITERIA FOR IDENTIFICATION OF ANTIBIOTICS

Antibiotics are chemical compounds that possess biologic activity. Therefore, two systems of classification and identification are possible: one, the physicochemical system, would distinguish antibiotics from each other on the basis of chemical and physical properties; the other, the biologic system, would discriminate among the different antibiotics on the basis of their qualitative and quantitative biologic activity, in other words, in terms of their antimicrobial spectra and their pharmacologic properties.

Ideally, chemical compounds should be identified by means of their physical and chemical constants, such as molecular weight, melting point, solubility, optical activity, absorption spectra, crystal structure, stereochemical configuration, reactivity with or inactivation by various chemical agents, stability under different conditions of pH, temperature, etc. Practically, for many antibiotics, one is forced to rely on the biologic activities in order to distinguish them from each other.

To prove that a "new" antibiotic has not been described previously

it is necessary to test it chemically and physically (if it is sufficiently pure to warrant such procedures) or, alternatively, to compare carefully, both qualitatively and quantitatively, its antibiotic spectrum with that of all the previously identified antibiotics. Preferably, both physicochemical and biologic tests should be made because occasionally chemically and physically similar isomers differ in biologic activity (see chloromycetin, Chap. 7). Conversely, different antibiotics that differ chemically occasionally have very similar antibiotic spectra, e.g., penicillin and bacitracin.

Since the physicochemical properties and even the antimicrobial activity of many antibiotics are imperfectly known, in Tables 10 to 13 and in the following pages the different antibiotics have been grouped according to the class of organism by which each is biosynthesized. Only certain strains of the species listed under Biologic Source are capable of biosynthesizing the different antibiotics and often even these strains require special nutrients for biosynthesis. The column indicating activity of the antibiotics illustrates the broad class or classes to which sensitive organisms belong; it is not meant to imply that all species of these classes are susceptible to the action of the antibiotic. Of the antibiotics tabulated, only those agents which have already been applied clinically or give promise of some clinical or other value are discussed in the present volume.

TABLE 10. ANTIBIOTICS BIOSYNTHESED BY BACTERIA

ANTIBIOTIC	BIOLOGIC SOURCE	ACTIVE PRINCIPALLY AGAINST THE FOLLOWING CLASSES OR SPECIES OF MICRO-ORGANISM	DATE DIS- COVERED
Aerosporin (same as polymyxin A)			1947
Amylolytic factor (see subtilysin)			1949
Antibiotic X G	Bacillus subtilis X G	Fungi	1949
Bacillin	Bacillus subtilis	Gram +; Gram —	1946
Bacitracin	Bacillus subtilis	Gram +	1945
Chlororaphin	Pseudomonas chlororaphis	Gram +	1943

TABLE 10. ANTIBIOTICS BIOSYNTHESIZED BY BACTERIA
(Continued)

ANTIBIOTIC	BIOLOGIC SOURCE	ACTIVE PRINCIPALLY AGAINST THE FOLLOWING CLASSES OR SPECIES OF MICRO-ORGANISM	DATE DISCOVERED
Circulin	Bacillus circulans	Gram —	1948
Colicine	Escherichia coli	Enterobacteriaceae	1946
Colistatin	Aerobic spore former	Gram +; Gram —	1946
Diplococcin	Streptococcus sp.	Lactic cocci	1944
Endosubtilysin	Bacillus subtilis	Staphylococci	1946
Eumycin	Bacillus subtilis	Pathogenic fungi; Mycobacterium tuberculosis; Corynebacterium diphtheriae	1946
Gramicidin	Bacillus brevis	Gram +	1941
Gramicidin S	Bacillus brevis	Gram +; Gram —	1944
Iodinin	Chromobacterium iodinum	Gram +; Gram —	1938
Licheniformin	Bacillus licheniformis (Bacillus subtilis?)	Gram + including acid fast	1946
Mycosubtilin	Bacillus subtilis	Fungi	1941
Nicin	Streptococcus lactis	Streptococcus agalactiae; Staphylococci	1944
Oxphenazine	Pseudomonas aeruginosa	Gram +	1941
Phthiocol	Mycobacterium tuberculosis	Gram +; Gram —	1946
Polymyxin A	Bacillus polymyxa	Gram —	1947
Polymyxin B	Bacillus polymyxa	Gram —	1948
Polymyxin C	Bacillus polymyxa	Gram —	1948
Polymyxin D	Bacillus polymyxa	Gram —	1947
Polymyxin E	Bacillus polymyxa	Gram —	1948
Prodigiosin	Chromobacterium prodigiosum	Gram +	1946
Pyo compounds			1945
I	Pseudomonas aeruginosa	Gram +	
II	Pseudomonas aeruginosa	Gram +	
III	Pseudomonas aeruginosa	Gram +	
IV	Pseudomonas aeruginosa	Gram +	
1b	Pseudomonas aeruginosa	Gram +	
1c	Pseudomonas aeruginosa	Gram +	
Pyocyanase	Pseudomonas aeruginosa	Gram +	1901
Pyocyanin	Pseudomonas aeruginosa	Gram +	1924
Pyolipic acid	Pseudomonas aeruginosa	Mycobacterium tuberculosis	1946
Simplexin	Bacillus simplex	Gram +; Gram —; fungi	1942
Subtenolin	Bacillus subtilis	Gram +; Gram —	1948
Subtilin	Bacillus subtilis	Acid fast; fungi	1944
Subtiline	Bacillus subtilis	Detoxifies certain bacterial toxins	1946
Subtilysin } Subtilyne }	Bacillus subtilis	Gram +; Gram —	1945

TABLE 10. ANTIBIOTICS BIOSYNTHESIZED BY BACTERIA
(Continued)

ANTIBIOTIC	BIOLOGIC SOURCE	ACTIVE PRINCIPALLY AGAINST THE FOLLOWING CLASSES OR SPECIES OF MICRO-ORGANISM	DATE DIS- COVERED
Tyrocidin	<i>Bacillus brevis</i>	Gram +	1941
Trypanotoxin	<i>Bacillus subtilis</i>	Trypanosomes	1911
Tyrothricin	<i>Bacillus brevis</i>	Gram +	1939
Violaicin	<i>Chromobacterium violaceum</i>	Gram +	1926
Factor from	<i>Bacillus abyssus</i>	Gram +	1947
Factor from	<i>Bacillus borborokoites</i>	Gram +	1947
Factor from	<i>Bacillus larvae</i>	Gram +; some acid fast	1945
Factor from	<i>Bacillus submarinus</i>	Gram +	1947
Factor from	<i>Bacillus thalassokoites</i>	Gram +	1947
Factor from	<i>Corynebacterium diphtheriae gravis</i>	Gram +; Gram —	1947
Factor from	<i>Micrococcus infimu</i>	<i>Sarcina lutea</i>	1947
Factor from	<i>Micrococcus maripunicus</i>	Gram +; some acid fast	1947
Factor from	<i>Micrococcus sedimenteus</i>	<i>Sarcina lutea</i>	1947
Factor from	<i>Staphylococcus aureus</i> (unidentified virulent strain)	Gram +; Gram —	1946
Factor from	<i>Staphylococcus aureus</i> 'H'	<i>Corynebacterium</i> species	1947
Factor from	<i>Staphylococcus mitis</i>	<i>Corynebacterium diphtheriae</i>	1946
Factor from	<i>Staphylococcus pyogenes</i>	Gram —	1947
Factor from	Unidentified bacillus brevis-like organism	Gram +	1946

TABLE 11. ANTIBIOTICS BIOSYNTHESIZED BY ACTINOMYCETES

ANTIBIOTIC	BIOLOGIC SOURCE	ACTIVE PRINCIPALLY AGAINST THE FOLLOWING CLASSES OR SPECIES OF MICRO-ORGANISM	DATE DIS- COVERED
Actidione	<i>Streptomyces griseus</i>	Fungi	1946
Actinomycetes lysozyme	<i>Streptomyces</i> sp.;	Micrococci	1947
Actinomycetin	<i>Actinomycetes violaceus</i>		
	<i>Streptomyces albus</i> ;	Gram +	1947
	<i>Actinomycetes violaceus</i>		
Actinomycin	<i>Streptomyces</i> sp.	Gram +; Gram —	1940
Actinorubin	<i>Actinomycetes</i> sp.	Gram +; Gram —	1947

TABLE 11. ANTIBIOTICS BIOSYNTHESIZED BY ACTINOMYCETES
(Continued)

ANTIBIOTIC	BIOLOGIC SOURCE	ACTIVE PRINCIPALLY AGAINST THE FOLLOWING CLASSES OR SPECIES OF MICRO-ORGANISM	DATE DISCOVERED
Antismegmatis factor	Actinomyces sp.	Some acid fast	1946
Aureomycin	Streptomyces aureofaciens	Gram +; Gram —; rickettsias	1948
Borrelidin	Unidentified sp. of Actinomycete; corn steep liquor (?)	Borrelia; enhances activity of penicillin in vivo but not in vitro	1949
Chloromycetin	Streptomyces venezuelae	Gram +; Gram —; rickettsias	1947
Dihydro-streptomycin	Formed by catalytic hydrogenation of streptomycin	Gram —; acid fast	1946
"F" factor	Streptomyces sp.	Gram —	1947
Grisein	Streptomyces griseus	Gram +	1947
Lavendulin	Actinomyces lavendulae	Gram +; Gram —	1947
Litmocidin	Proactinomyces cyaneus	Gram + including acid fast	1946
Micromonosporin	Micromonospora sp.	Gram +	1946
Musarin	Unidentified Actinomycete	Fusaria	1948
Mycetin	Actinomyces violaceus	Gram +	1944
Mycomycin	Actinomyces sp.; Nocardia acidophilus	Gram +; Gram —; fungi	1947
Neomycin	Streptomyces fradiae	Streptomycin-resistant Gram — and acid fast	1949
Nocardin	Nocardia coeliaca	Mycobacterium tuberculosis	1947
Streptin	Streptomyces sp.	Gram +; Gram —; acid fast	1946
Streptocin	Streptomyces griseus	Trichomonas vaginalis	1949
Streptomycin	Streptomyces griseus	Gram —; acid fast	1944
Streptomycin B	Streptomyces griseus	Gram —; acid fast	1947
Streptomycin II (probably same as streptomycin)	Streptomyces bikiniensis	Gram —; acid fast	1947
Streptothricin	Streptomyces lavendulae	Gram +; Gram —; fungi	1942
Sulfactin	Streptomyces sp.	Gram +	1947
Xanthomycin	Streptomyces sp.	Gram +; Gram —	1948

TABLE 12. ANTIBIOTICS BIOSYNTHESIZED BY FUNGI

ANTIBIOTIC	BIOLOGIC SOURCE	ACTIVE PRINCIPALLY AGAINST THE FOLLOWING CLASSES OR SPECIES OF MICRO-ORGANISM	DATE DIS- COVERED
Aspergillic acid	<i>Aspergillus flavus</i>	Gram +; Gram —; Myco- bacterium tuberculosis	1940
"Aspergillin"	Term indiscriminately applied to various antibiotics, later identified as flavicidin, gliotoxin, etc., isolated from various species of <i>Aspergillus</i> and other genera of fungi. Since the name was used by Linossier in 1891 to designate the black pigment from the spores of <i>Aspergillus niger</i> , it should not be applied to antibiotics.		
Avenacein	<i>Fusarium avenaceum</i>	<i>Mycobacterium phlei</i>	1947
Biformic acid	<i>Polyporus biformis</i>	Gram +; Gram —	1947
Biformin	<i>Polyporus biformis</i>	Gram +; Gram — in vitro;	1947
		fungi	
Candidulin	<i>Aspergillus</i> sp.	<i>Mycobacterium</i> sp.	1949
Chaetomin	<i>Chaetomium chochlioides</i>	Gram + in vitro	1944
Citrinin	<i>Aspergillus niveus</i>	Gram +	1931
Clavacin	<i>Penicillium patulum</i> ; <i>P. claviforme</i> ; <i>P. expansum</i> ; <i>Aspergillus clavatus</i>	Gram +; Gram —; fungi; neutralizes tetanus toxin in vivo	1942
Clavatin (see clavacin)			1942
Claviformin (see clavacin)			1942
Clitocybin	<i>Clitocybe gigantea</i> var. <i>candida</i>	Gram +; Gram —; Myco- bacterium tuberculosis	1947
Corylophilin (see notatin)			1944
"Curling factor" (probably same as griseofulvin)	<i>Penicillium janczewskii</i>	Causes stunting of germ tubes of certain fungus spores	1939
<i>E. coli</i> factor (see notatin)			1943
Enniatin A (see Lateritin-I)	<i>Fusarium orthoceras</i> var. <i>enniatinum</i>		1947
Enniatin B	<i>Fusarium orthoceras</i> var. <i>enniatinum</i>	<i>Mycobacterium</i> , var. sp.	1947
Erdin	<i>Aspergillus terreus</i>	Inert antibacterially	1937
Expansin (see clavacin)			1946
Flavicidin (see Δ^3 pentenyl penicillin)	<i>Aspergillus flavus</i>		1943

TABLE 12. ANTIBIOTICS BIOSYNTHESIZED BY FUNGI
(Continued)

ANTIBIOTIC	BIOLOGIC SOURCE	ACTIVE PRINCIPALLY AGAINST THE FOLLOWING CLASSES OR SPECIES OF MICRO-ORGANISM	DATE DIS- COVERED
Flavacin (Flavatin) (see Δ^3 pentenyl penicillin)	<i>Aspergillus flavus</i>		1943
Fructigenin	<i>Fusarium fructigenum</i>	Gram +; Gram —; <i>Mycobacterium phlei</i>	1947
Fumigacin	<i>Aspergillus fumigatus</i>	Gram +; tubercle bacilli	1942
Fumigatin	<i>Aspergillus fumigatus</i>	Gram + (limited activity)	1938
Geodin	<i>Aspergillus terreus</i>	Gram +; Gram —	1947
Gigantic acid (same as <i>n</i> -amyl [dihydro F] penicillin)	<i>Aspergillus giganteus</i>		1942
Gladiolic acid	<i>Penicillium gladioli</i>	Fungi; weak against Gram +	1943
Gliotoxin	<i>Aspergillus fumigatus</i> ; <i>Gliocladium fimbria- tum</i> ; <i>Trichoderma lignorum</i> ; and other genera of fungi	Gram +; fungi; actinomycetes	1936
Glutinosin	<i>Metarrhizium glutinosum</i>	Fungi	1946
Griseofulvin	<i>Penicillium</i> , var. sp.	Fungi	1939
Helvolic acid (see fumigacin)			1945
Hirsutic acid A	<i>Stereum hirsutum</i>	Gram + (weak)	1947
Hirsutic acid C	<i>Stereum hirsutum</i>	Inactive, but Na salt readily converted to hirsutic acid N	1947
Hirsutic acid N	<i>Stereum hirsutum</i>	Gram +; Gram —	1947
Javanicin	<i>Fusarium javanicum</i>	Gram +, including acid fast	1946
Kojic acid	<i>Aspergillus flavus</i> ; <i>Aspergillus oryzae</i>	Gram + (weak); Gram —	1934
Lateritin-I	<i>Fusarium lateritium</i>	Gram +, including acid fast	1947
Lateritin-II	<i>Fusarium</i> sp. F.-75	Gram +, including acid fast	1947
Lycomarasin	<i>Fusarium lycopersici</i>	<i>Lactobacillus casei</i>	1947
Mycocidin	<i>Aspergillus</i> species	<i>Mycobacterium tuberculosis</i>	1946
Mycocin C	<i>Penicillium claviforme</i>	Gram +; Gram —	1947
Mycophenolic acid	<i>Penicillium brevi- compactum</i>	Fungi	1896
Notatin	<i>Penicillium notatum</i>	Gram +; Gram —	1942
Parasiticin (same as Δ^3 pentenyl penicillin)	<i>Aspergillus parasiticus</i>		1947

TABLE 12. ANTIBIOTICS BIOSYNTHESIZED BY FUNGI
(Continued)

ANTIBIOTIC	BIOLOGIC SOURCE	ACTIVE PRINCIPALLY AGAINST THE FOLLOWING CLASSES OR SPECIES OF MICRO-ORGANISM	DATE DIS- COVERED
Patulin (see clavacin)			1942
Penatin (see notatin)			1943
Penicidin	<i>Penicillium terrestre</i>	<i>Eberthella typhosa</i>	1942
Penicillic acid	<i>Penicillium</i> sp.	Gram +; Gram —	1913
Penicillin (for clinically and industrially impor- tant penicillins see Chapter V)			1929
Penicillin A (see notatin)			
Penicillin B (see notatin)			
Penicillin- crustocin (prob- ably penicillin F)			1945
Pleurotin	<i>Pleuroteus griseus</i>	Gram +; Gram —	1947
Polyporin	<i>Polystictus sanguineus</i>	Gram +; Gram —	1946
Puberulic acid	<i>Penicillium puberulum</i>	Gram + (weak)	1932
Puberulonic acid	<i>Penicillium</i> <i>aurantu-virens</i>	Gram +; Gram —	1932
Sambucinin	<i>Fusarium sambucinum</i>	<i>Mycobacterium phlei</i>	1947
Spinulosin	<i>Penicillium spinulosum</i> ; <i>Aspergillus fumigatus</i>	Gram +	1938
Phycomyces factor	<i>Phytophthora</i> sp.; <i>Pythium</i> sp.	Trypanosomes (in vitro, weak)	1946
Tardin	<i>Penicillium tardum</i>	Gram +; Gram —	1947
Trichothecin	<i>Trichothecium roseum</i>	Fungi	1949
Ustin	<i>Aspergillus ustus</i>	Gram +, including acid fast	1945
Viridin	<i>Trichoderma viride</i>	Fungi	1944
Factor from	<i>Aspergillus flavus</i> , Strain No. 70	Fungi	1946
Factor from	<i>Aspergillus fumigatus</i>	Carcinoma and lympho- granuloma cells	1947
Factor from	<i>Aspergillus terreus</i>	Gram +	1947
Factors other than ustin from	<i>Aspergillus ustus</i>		
A. U. N. #1 }		Same as ustin	1945-1947
A. U. N. #3 }			
Factor from	<i>Fusarium scirpi</i>	<i>Mycobacterium tuberculosis</i>	1946

TABLE 13. ANTIBIOTICS BIOSYNTHEZIZED BY MISCELLANEOUS MICRO-ORGANISMS

ANTIBIOTIC	BIOLOGIC SOURCE	ACTIVE PRINCIPALLY AGAINST THE FOLLOWING CLASSES OR SPECIES OF MICRO-ORGANISM	DATE DISCOVERED
Algae Chlorellin	<i>Chlorella vulgaris</i> ; <i>C. pyrenoidosa</i>	Gram +; Gram —	1944
Lichens (probably by fungus component) <i>l</i> -Usnic acid and <i>d</i> -Usnic acid	<i>Cetraria islandica</i> and other lichens	Gram + including acid fast	1936
Paramecia Paramecin	<i>Paramecium aurelia</i>	Various species of <i>Paramecium</i>	1938

ANTIBIOTICS FROM THE *BACILLUS SUBTILIS* GROUP

Members of the *subtilis* group of bacilli have long been known to be antagonistic to a wide variety of microbial species, and are fruitful sources of antibiotics, such as:

Bacillin	Subtenolin
Bacitracin	Subtilin
Endosubtilysin	Subtiline
Eumycin	Subtilysin (subtilyne)
Mycosubtilin	Trypanotoxin

Of these only bacitracin and subtilin have received adequate clinical attention for evaluation and only bacitracin has become commercially available.

Bacitracin, which is perhaps the most prominent of the *subtilis*-type antibiotics, was discovered in 1945 during the course of a routine survey of the microflora from contaminated wounds. The name bacitracin was coined to recognize both the genus (*Bacillus*) and the patient (Tracy) from whom the active strain was isolated.

Bacitracin is produced industrially by the Tracy I strain of *Bacillus subtilis* in well-aerated media containing in addition to the usual

mineral salts and sugars suitable sources of nitrogen. Good yields are obtained from media containing a soy bean digest, tryptone, or beef infusion.

Bacitracin differs from subtilin in that it is not precipitated from the original crude liquor by manipulation of pH; it is first extracted by *n*-butanol and then is further concentrated by distillation *in vacuo* in the presence of water. Alternatively, the active principle can be precipitated from crude bacitracin without loss of potency, by proper use of salicylic acid.

A unit of bacitracin has been defined tentatively as "the amount which when diluted 1 to 1024 in two-fold serial dilutions in 2 ml. of beef infusion broth," completely inhibits growth of a stock strain of *A* hemolytic streptococcus in cultures of standard age and population density. Subsequently, plate assays using appropriate strains of *Corynebacterium* or of *Staphylococcus aureus* as test organisms have been developed.

Bacitracin is soluble in methanol, ethanol, isopropanol, *n*-butanol, and cyclohexanol, but is insoluble in most other organic solvents. Phenylalanine, leucine, isoleucine, glutamic acid, aspartic acid, lysine, histidine, cysteine, and ammonia have been identified among the constituents of bacitracin, suggesting that it is a polypeptide.

With respect to stability, bacitracin parallels penicillin closely. Dry samples (moisture less than 1 per cent) have been stored at 37° C. for 15 months with no loss of potency; at 56° C. or higher temperatures potency is lost rapidly. Aqueous solutions, adjusted to pH 5.0 to 7.0 lose about 10 per cent of their activity in two to three months when stored at 4° C., but deteriorate rapidly at 25° C.

In antibiotic spectrum also, bacitracin closely resembles penicillin qualitatively in that it inhibits aerobic and anaerobic Gram-positive bacteria but fails to inhibit most Gram-negative species in doses that are clinically practicable. Staphylococci are generally inhibited by bacitracin in concentrations of 5 units or less per ml.; streptococci and clostridia are generally more sensitive, the former being inhibited by 0.008 units or less per ml. and the latter by 0.002 to 0.05 units

per ml. However, bacitracin is not inactivated by Gram-negative organisms as penicillin may be and, therefore, can be used therapeutically for the control of Gram-positive pathogens in certain mixed infections in which penicillin would be inactivated. The activity of bacitracin is not impaired in the presence of whole blood, serum, or pus, nor by the presence of large numbers of bacteria.

It has been reported that among susceptible species of bacteria, fewer strains are initially resistant to bacitracin than to penicillin. The data in the following table seem to support this view (Table 14).

TABLE 14. SUSCEPTIBILITY AND RESISTANCE OF DIFFERENT STRAINS OF BACTERIA TO BACITRACIN AND TO PENICILLIN

ORGANISM	NUMBER OF STRAINS*			
	Bacitracin S Penicillin S	Bacitracin S Penicillin R	Bacitracin R Penicillin S	Bacitracin R Penicillin R
Hemolytic streptococci	4	2	0	0
Nonhemolytic streptococci	2	11	0	2
Staphylococci	57	15	6	4
Anaerobic cocci	10	2	0	0
Gram-negative rods	0	0	0	8

(Data from Meloney and Johnson, 1947, J.A.M.A., 133:675-680.)

* The designations S and R in the column heads indicate susceptible and resistant, respectively. The strains tested were isolated from infected wounds.

Clinical results have established the effectiveness of bacitracin, applied locally, for management of surgical infections, furuncles, carbuncles, abscesses, ocular infections, acne, and numerous pyogenic skin infections due to Gram-positive bacteria and its ineffectiveness against fungi and Gram-negative bacteria (except gonococci).

There is no question of the antimicrobial efficacy of bacitracin when injected parenterally; however, irritation and necrosis at the site of injection as well as nodules in the lungs, liver, spleen, kidney, and heart of experimental animals have been reported. Occasional symptoms of histamine-like reactions which occur following parenteral use

of bacitracin differ from the symptoms of typical histamine shock in that they are not alleviated by antihistamine agents such as Benadryl and Pyribenzamine.

Following parenteral administration, bacitracin is excreted in the urine, the rate of excretion approximating the rate of glomerular filtration; occasional transient albuminuria has been reported. The antibiotic, like penicillin, does not pass the blood-brain barrier and is not found in the cerebrospinal fluid except in cases characterized by inflamed or damaged meninges.

Following enteral administration, bacitracin is absorbed poorly, if at all, and is excreted in the feces.

Subtilin is a polypeptide with antagonistic activity *in vivo* toward a number of Gram-positive species, including the tuberculosis organism. On the basis of *in vitro* tests, it may be assumed to have potential value also against the Gram-negative *Neisseria gonorrhoea* and *Neisseria catarrhalis*, and against certain species of fungi.

Appropriate strains of *Bacillus subtilis* provided with a suitable nutrient medium produce subtilin in either surface or well aerated submerged cultures but tend to retain the antibiotic within the cells.

The unit of subtilin has been defined as the amount present in 1 ml. of the highest dilution capable of killing *Staphylococcus aureus* in ten minutes at 37° C. by the F.D.A. phenol coefficient method.

Subtilin is soluble in water in the pH range 2.0 to 6.0; solubility decreases above pH 6.0 but may be enhanced by proper treatment with methanol or ethylene glycol. It is soluble in methanol or in ethanol (up to 80 per cent), but not in dry ethanol or other common organic solvents. Subtilin is relatively stable in acidic solutions, but is unstable in strong alkali. It is inactivated by pepsin and trypsin and is destroyed by light, especially when in solution.

Subtilin is a surface tension depressant; this probably accounts for its reported ability to rupture the cell membranes of *Endamoeba histolytica*. The antibiotic action of subtilin is markedly enhanced by concomitant use of wetting agents such as "Tergitol" and "Tween 80," but is reduced by sodium lauryl sulfate.

Although subtilin has a relatively wide antibiotic spectrum, its

greatest potential value appears to be its activity against the tuberculosis organism. This aspect of subtilin activity which was announced in 1946-1947 may be considered a rediscovery, rather than something new. As early as 1907 and 1912, Nicollé and Rappin, respectively, independently observed that certain cultures of *Bacillus subtilis* or their cell-free filtrates exert a strong action against the tuberculosis organism in vitro.

Other important disease producing organisms that are susceptible to the antibacterial action of subtilin in vivo are the following:

Bacillus anthracis

Bacillus megatherium

Corynebacterium diphtheriae

Diplococcus pneumoniae (both parent and sulfa-resistant strains)

Mycobacterium tuberculosis

Neisseria gonorrhoea

Staphylococcus aureus, various strains

Streptococcus faecalis, various strains

Streptococcus lactis, various strains

Streptococcus pyogenes, various strains

In vitro, subtilin inhibits the activities of *Treponema pallidum* also, and it may possess some activity in vivo (experimental rabbit syphilis). However, it does not appear to be a promising chemotherapeutic agent for syphilis.

Upon continuous exposure, initially sensitive strains of bacteria may rapidly develop resistance to subtilin. Artificially induced resistant strains may lose resistance if transferred daily in normal media lacking subtilin for a sufficient period, but they do not revert to their initial sensitivity. Table 15 shows that a high degree of resistance is retained for a long time, or is even increased.

Subtilin appears to be characterized by low acute toxicity, but may produce symptoms of chronic toxicity. Autopsies performed on mice receiving from 0.5 to 1.0 mg. subtilin daily by the intramuscular or subcutaneous routes reveal large accumulation of blood in the lungs and other pathologic symptoms. In view of the fact that subtilin may be considered to be toxic and that organisms readily develop re-

TABLE 15. DEVELOPMENT AND RETENTION OF
SUBTILIN RESISTANCE BY STRAINS OF BACTERIA FROM
INITIALLY SENSITIVE STRAINS

ORGANISM	THRESHOLD CONCENTRATION OF STANDARD SUBTILIN SOLUTION PERMITTING GROWTH				
	At Start of Experiment	After <i>n</i> Daily Transfers to Broth Containing Sublethal Concentrations of Subtilin		After <i>m</i> Further Daily Transfers to Subtilin-free Media	
		<i>n</i>		<i>m</i>	
Staphylococcus aureus	1:400,000	2	1:200,000	91	1:50,000
		3	1: 33,333	86	1:25,000
		4	1: 10,000	86	1:20,000
		5	1: 2,000	82	1:12,500
		6	1: 1,000	77	1: 2,500
Mycobacterium phlei	1:500,000	9	1: 2,000	72	1:33,333
Escherichia communior	1:5,000	3	1: 1,000

(Data from Salle and Jann, 1948, J. Bact., 55:463-469.)

sistance to it, it seems unlikely that this antibiotic will replace dihydrostreptomycin as an antitubercular drug.

Although it seems unlikely that subtilin will become an antibiotic of major clinical importance, it may, none the less, become important in agriculture as a seed disinfectant, since a number of "seed-rot" fungi are susceptible to its action.

ANTIBIOTICS FROM THE ENTEROBACTERIACEAE

The ability of certain species of Enterobacteria, especially strains of *Escherichia coli*, to produce antibiotics has been recognized since 1925 when Gratia reported antagonism between two strains of *Escherichia coli*. Subsequent studies of nearly nine hundred strains of various species of the Enterobacteriaceae have revealed that members of this group produce at least 17 different antibiotics (designated colicines) which may be distinguished from each other on the basis of antibiotic spectra and physicochemical properties. Although some of these are active against virulent pathogens such as various species

of *Shigella* and *Micrococcus*, none has reached the stage of extensive trial in vivo or become clinically important.

ANTIBIOTICS FROM PSEUDOMONAS AERUGINOSA

Pseudomonas aeruginosa (*Ps. pyocyanea*) deserves special mention because it is the source of pyocyanase, the first antibiotic to be prepared on an industrial scale. Pyocyanase was produced in Germany early in the twentieth century and enjoyed considerable popularity for several years. This antibiotic is interesting historically also because as early as 1906 the principle of differential toxicity, which governs the choice of antibiotics today, was enunciated in discussing its activity. Pyocyanase, which is capable of lysing cells of *Bacillus anthracis*, *Corynebacterium diphtheriae*, Staphylococci, and *Pasturella pestis*, was considered to be more harmful to susceptible bacteria than to the cells of animals.

However, considerable lot-to-lot variation, caused principally by lack of proper biologic and chemical controls during biosynthesis and extraction and inadequate methods of standardization, soon caused the antibiotic to fall into disrepute, since inconsistent clinical results often attended its use.

It is now recognized that at least nine different antibiotics, all with essentially the same biologic activity, i.e., principally against Gram-positive bacteria, but differing in chemical and physical properties are produced by strains of *Pseudomonas aeruginosa*. Several of these have interesting applications in research, but none is able to compete with penicillin in clinical usefulness.

ANTIBIOTICS FROM ACTINOMYCETES

Among the most common micro-organisms found in soils are actinomycetes. These comprise an interesting group of organisms that many authorities consider stands between the true bacteria and the true fungi in the evolutionary scale. The members of this group are characterized by cellular dimensions of the order of magnitude found among bacteria (usually less than one micron in diameter) but in some species the cells form mycelium-like filaments reminiscent of

the molds. The order Actinomycetales includes three families, i.e., Mycobacteriaceae, Actinomycetaceae, and Streptomycetaceae. It is with the last two families, which for convenience we shall designate actinomycetes, that the following discussion is concerned.

Some actinomycetes cause infections (actinomycosis) in man and animals and a few species may parasitize plants; most of them are harmless, however, and a few species are of considerable value as sources of antibiotics. The outstanding genus in this respect is *Streptomyces*, different species of which biosynthesize streptomycin (Chap. 6), chloromycetin, and aureomycin (Chap. 7). More than twenty other antibiotics, less illustrious than these, have also been isolated from various species of the two genera, *Streptomyces* and *Actinomyces*.

Many of these antibiotics are extremely active against a wide variety of pathogens; it is unfortunate, therefore, that so many of them are characterized by high acute and/or chronic toxicity for animals when injected or ingested. Some of these antibiotics may find practical clinical application for topical use, however. Of greatest potential interest in this respect are actidione and streptothricin, both of which are antagonistic to certain yeasts and fungi, and streptocin, which is active against the stubborn pathogenic flagellated protozoan, *Trichomonas vaginalis*.

Actidione can be crystallized from media fermented by streptomycin-producing strains of *Streptomyces griseus*. It has the following structure:

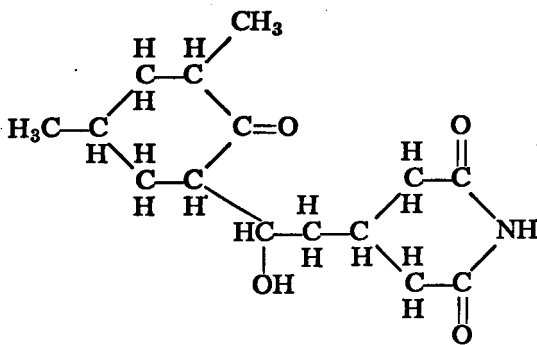

Actidione

Yields of actidione and of streptomycin may vary independently of each other, however, depending on the composition of the medium.

Actidione differs biologically from streptomycin in that it possesses no marked antibacterial activity but is highly active against a large number of yeasts and molds. For example, crystalline actidione in a concentration of 0.2 micrograms per ml. completely inhibits growth of the pathogen *Cryptococcus neoformans* in broth. More than a dozen other fungus pathogens of man either were not inhibited at all or were inhibited only by concentrations of actidione ranging from 12.5 to more than 1000 micrograms per ml. There is marked species variation in the acute toxicity of actidione for animals as shown in Table 16.

TABLE 16. LD₅₀ OF ACTIDIONE FOR DIFFERENT ANIMAL SPECIES

ANIMAL	ROUTE OF ADMINISTRATION		
	Subcutaneous	Intravenous	Intraperitoneal
Rat	2.7 mg./Kg.	2.5 mg./Kg.	...
Mouse	150.0 mg./Kg.	...
Rabbit	17.0 mg./Kg.	...
Guinea Pig	60.0 mg./Kg.
Cat	4.0 mg./Kg.

In the field of plant pathology, actidione in concentrations of 1 to 6 parts per million has been reported to control mildew infections on bean plants. Another antibiotic, antimycin, from an unidentified *Streptomyces*, has been reported as a protectant fungicide in phytopathology.

Streptothricin (C₁₃H₂₅N₅O₇) is biosynthesized by *Streptomyces lavendulae*. It is antagonistic to Gram-positive and Gram-negative bacteria and to several species of yeasts and fungi, including some pathogens, but because of the availability of less toxic antibiotic agents it seems to hold little clinical promise for chemotherapy of bacterial infections.

Streptothricin and streptomycin are compared in terms of acute and delayed toxicity in Figures 51 and 52.

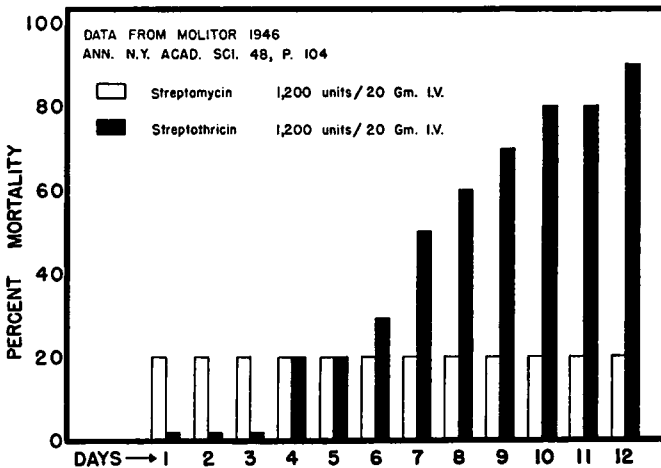
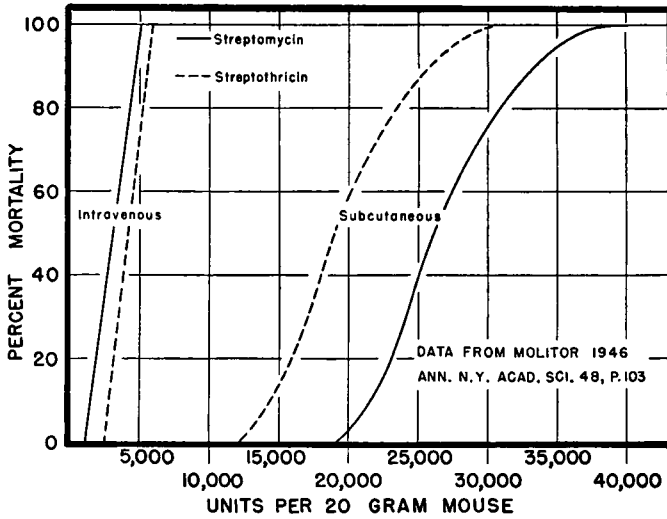

FIGS. 51 and 52. Comparison of acute and delayed toxicity of streptothricin and streptomycin following a single dose in mice: acute (*above*); delayed (*below*). (Redrawn from Molitor, 1946, Ann. New York Acad. Sci., 48:103-104.)

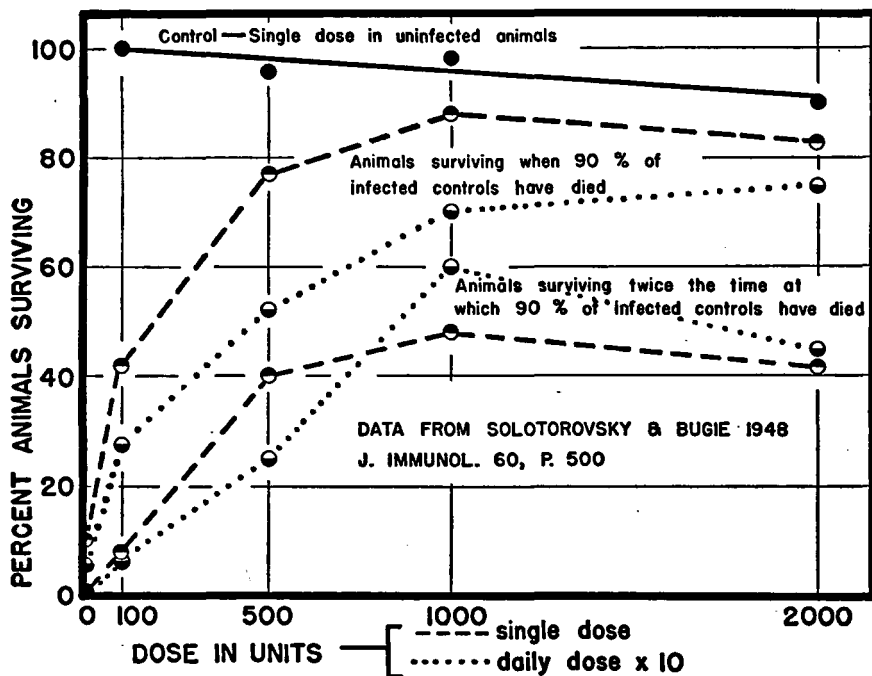

FIG. 53. Per cent of mice infected with *Cryptococcus neoformans* and treated with streptothricin surviving when 90 per cent of inoculated but untreated animals had died.

Although streptothricin has generally been considered too toxic for systemic use in man, perhaps, in the light of its demonstrated efficacy against certain systemic fungus and yeast infections in mice, it should be reinvestigated as a potential antibiotic for treatment of similar infections in higher animals. Figure 53 shows the therapeutic value of streptothricin for systemic infections by *Cryptococcus neoformans* in mice.

Neomycin deserves special mention because of its high degree of activity against bacteria, including *Mycobacterium tuberculosis*, which have developed resistance to streptomycin and because organisms initially sensitive to neomycin do not readily become resistant to it. It has been used successfully for treatment of animals experi-

mentally infected with streptomycin-resistant cultures of *Staphylococcus aureus* and *Salmonella schottmülleri*.

Neomycin is biosynthesized by a strain of *Streptomyces fradiae*. Like streptomycin, neomycin is a basic compound and is most active in alkaline media; it is thermostable and is soluble in water.

Miscellaneous antibiotics from actinomycetes have been reported to possess varying degrees of activity against a number of phytopathogenic fungi. This suggests the possible chemotherapeutic or prophylactic use of antibiotics for infectious diseases of plants, a field which deserves more attention than it has yet received.

Musarin, an antibiotic produced by an unidentified actinomycete, is highly antagonistic to various wilt-producing fungi and to species of *Fusarium* that frequently ravage banana plantations in the West Indies.

Other antibiotics from this group are highly active in vitro against *Venturia inaequalis* which causes the "apple scab" disease, and a number of other agriculturally important fungi and bacteria pathogenic for plants.

Filtrates from cultures of various species of *Actinomyces* and *Streptomyces* have been reported to contain substances endowed with antidotical properties and enzymes which cause lysis of cell debris and mucus, in addition to antimicrobial substances.

ANTIBIOTICS FROM FUNGI

Penicillin is outstanding in chemotherapeutic value among the many antibiotics that are biosynthesized by various species of fungi, ranging from the yeasts through the higher basidiomycetes. However, among the other fungus metabolites which have been isolated from molds, several warrant mention because of their antifungal or differential cytotoxic properties.

Clavacin (patulin), gladiolic acid, gliotoxin, glutinosin, griseofulvin ("curling factor"), trichothecin, and viridin are generally active against most fungi other than the ones specifically producing them, and they may have an application in agricultural practice for the control of fungus phytopathogens. Gliotoxin has also been tested

clinically with some success for treating dermatophytic infections in man. Gliotoxin has also been shown to be highly active against tumor cells *in vitro*.

Clavacin (patulin) merits further mention because of its demonstrated ability, at low concentrations, *in vitro* to inhibit the growth of cancerous tissues while mildly stimulating growth of normal tissues. It may, therefore, deserve more study as an agent for promoting the healing of wounds and for blocking proliferation of cancerous cells.

ANTIMICROBIAL AGENTS FROM HIGHER PLANTS

As commonly used in pharmaceutical and medical circles, the term antibiotic is applied to products that are derived from micro-organisms and that are antagonistic in low concentrations to the same or different species of pathogenic microbes. None the less, extracts from certain species of higher plants have been used for centuries for the treatment of infected wounds. The search for antibiotics from higher plants has been disappointing: from some of these extracts chemically defined compounds endowed with antimicrobial properties have been isolated. However, few if any of the compounds that have been extracted from the thousands of species investigated can compete with the typical antibiotics as antibacterial agents, since, in general, they are effective only at or above threshold concentrations that are expressed in terms of milligrams instead of micrograms per ml. Moreover, with the exception of the alkaloids, quinine and emetine, they are not generally characterized by the highly selective antimicrobial activity that distinguishes most of the antibiotics derived from micro-organisms and they are, therefore, too toxic for systemic use in the doses required to inhibit pathogenic micro-organisms. The greatest potential value of these products probably resides in their antifungal activity. Some of them have been used topically for clinical control of dermatomycoses; others may become useful as agents to promote the healing of wounds, largely by suppressing contaminating microflora.

The principal "antibiotics" biosynthesized by phanerogams are

sulfur compounds, glycosides, alkaloids, unsaturated lactones, fatty acids, and quinones and their derivatives.

1. Representative of the sulfur compounds are *n*-propylthiol from onion (*Allium cepa*), *l*(-)-*S*-allyl-cysteine sulfoxide (*alliin*), the precursor of allicin in the bulbs of garlic (*Allium sativum*), *raphanin* from the seed of radish (*Raphanus sativus*), and the *mustard oils*, embodying thioglycosides, obtained from the seeds of various crucifers. These thioglycosides are either aliphatic, such as allyl thiocyanate, allyl sulfocyanate, and allylsenevol, or aromatic, such as the β -phenetyl isothiocyanates; both types exhibit inhibiting action against various species of dermatophytic fungi and phytopathogens.

2. *Tomatin*, a glycosidal alkaloid that can be extracted from the leaves of certain varieties of tomato (*Lycopersicum* sp.), inhibits the growth of certain bacteria, such as *Phytomonas solanacearum*, and fungi, such as species of *Fusarium*, that are important plant pathogens. It is also active against the human pathogen *Candida albicans*. The crude extracts, designated tomatine (lycopersicin) may fail to show any activity if they contain rutin.

3. Typical of the unsaturated lactones are *anemonin* (1,2-dihydroxy-1,2-cyclobutane-diacrylic acid dilactone) from various Ranunculaceae, principally of the genus *Anemone*, and the antibacterial principle from *Arctium minus*.

4. *Juglone* (5-hydroxy-1,4-naphthoquinone) from the black walnut and other species of *Juglans*, and *plumbagin* (5-hydroxy-2-methyl-1,4-naphthoquinone) from species of *Plumbago* and of *Drosera* are the most interesting of the quinones of higher plants, from the antibiotic point of view. Plumbagin is outstanding among the products from higher plants because of its relatively high degree of activity against some of the pathogenic yeasts such as *Coccidioides immitis* and *Histoplasma capsulatum* which are highly resistant to most chemotherapeutic agents.

5. A number of fatty acids of both plant and animal origin have long been known to possess antibacterial and antifungal properties. *Lauric acid* derived from the California bay laurel, *Umbellularia cali-*

forfica, and other sources is a typical example. In this connection, it is interesting to speculate on the role of natural oils in the skin of man as agents instrumental in warding off skin infections. For example, the relatively high degree of resistance to ringworm infections in man after the age of puberty is commonly attributed to the presence of pelargonic acid, $\text{CH}_3(\text{CH}_2)_7\cdot\text{CO}_2\text{H}$, in the scalp. Before puberty this fatty acid is lacking or at least is present only in minimal concentrations.

SUGGESTED READING

- Antibiotic substances, their biological and chemical properties, ed. 2, 1948. Published by Antibiotics Study Section of the National Institute of Health, Washington, D. C.
- Bailey, J. H., and Cavallito, C. J., 1948, *Antibiotics*, *Ann. Rev. Microbiol.*, 2:143-182.
- Benedict, R. G., and Langlykke, A. F., 1947, *Antibiotics*, *Ann. Rev. Microbiol.*, 1:193-236.
- Brian, P. W., 1949, Studies on the biological activity of griseofulvin, *Ann. Bot.*, 13:59-77.
- Editorial, 1949, Antibiotic agents, *J. Amer. Vet. Med. Assoc.*, 114:194-196.
- Fredericq, P., 1948, Actions antibiotiques réciproques chez les *Enterobacteriaceae*. Thesis from Univ. of Liège, Belgium.
- Kavanagh, F., 1947, Antibacterial substances from fungi and green plants, *Advances in Enzymol.*, 7:461-511.
- Luteran, Ph. J., 1947, Remarques sur les antibiotiques, principalement d'origine fungique, *Ann. Parasit.*, 22:110-124.
- Waksman, S. A., 1947, Microbial antagonisms and antibiotic substances, ed. 2, New York, Commonwealth Fund.
- Waksman, S. A., 1948, *Antibiotics*, *Biol. Revs.*, 23:452-487.

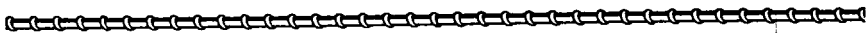

*We will now discuss in a little more detail the
Struggle for Existence.*

—CHARLES R. DARWIN (1809-1892)

CHAPTER

11

Mechanisms of Antibiotic Action

Remarkable cures of infectious diseases have been effected by use of antibiotics even though their mode of action was not understood. However, an understanding of the mechanisms of action of each antibiotic on susceptible organisms cannot fail to lead to more efficient and economical treatment, and may also bring within the range of chemotherapy diseases for which no effective measures have yet been devised.

The object of this book and especially of this chapter is to integrate into a rational picture the fragmentary information about the action of antibiotics now scattered in the scientific literature.

To develop a rational picture of antibiotic action, it is necessary to study the effect of an antibiotic not only on an individual cell or organism, but on the population or society of organisms as a whole, including survivors as well as those individuals which succumb. Moreover, it is not enough to observe how bacteria that have been killed by an antibiotic differ from their surviving relatives; the organisms should be studied while they are dying, i.e., from the onset to the aftermath of exposure. The words of Goethe, although written in another sense, are quite appropriate to studies of the mechanism of antibiotic action. He wrote: "Nature and works of art are not understood when completed. They must be studied during their creation if they are to be appreciated."

DISTINGUISHING CHARACTERISTICS OF ANTIBIOTICS

Antibiotics differ from antiseptics and other synthetic antimicrobial drugs in the following ways:

Origin. An antibiotic has been defined as a substance that is biosynthesized by a living organism, and that is capable of inhibiting growth or otherwise interfering with the metabolic activities of the same or of other species of micro-organisms. Historically, the term antibiotic has generally been limited to products that are biosynthesized by micro-organisms: but a number of compounds that possess antimicrobial activity have been isolated from higher plants and some animals, and the term antibiotic probably should be expanded to include these agents also, if they meet the other requirements of a typical antibiotic.

Effective Concentration. A typical antibiotic is capable of suppressing the activity of one or more species of micro-organisms at low concentrations, usually 10 micrograms or less per ml. (0.001 per cent or less). Only those antibiotics that are characterized by a high therapeutic index are suitable for systemic use. The therapeutic index appears to be correlated with specific stereochemical configurations, notably with regard to reactivity of the antibiotic with thiol compounds. For example, penicillin, which is inhibitory to susceptible micro-organisms at concentrations far below those which can cause damage to the host tissues and, therefore, has a high therapeutic index, is easily inactivated by β (-dimethylamino)-ethanethiol but not by the analogue where one more carbon intervenes between the sulfhydryl and amino groups. Conversely, antibiotics that are less exacting can be inactivated by various thiol compounds and usually have both a broader antibiotic spectrum and greater cytotoxicity. Gramicidin, tyrocidin, and other antibiotics which are thiol-insensitive are generally too toxic for parenteral use and are limited to topical application.

Mode of Action. For the clinician, an antibiotic is a chemical compound which, under the conditions outlined above, blocks some

biochemical pathway essential in the metabolism of the pathogen without affecting adversely the tissues and functions of the host.

The third requisite imposes severe limitations on the compounds ranking clinically as antibiotics, since the ways and means by which life operates are fundamentally alike in all living systems, whether they be unicellular micro-organisms or the cells of man and other animals or of plants.

It would be surprising if all antibiotics were to exert their action on susceptible bacteria in the same way. The very fact that antibiotics differ markedly in their antibiotic spectra suggests that their mechanisms of action are different; the results of recent research confirm the correctness of this view. Numerous papers purporting to deal with the mechanisms of antibiotic action have been published since 1942, but comparatively few of these have really come to grips with the fundamental problems involved. Selected readings on this subject are listed at the end of this chapter.

Antibiotics may be classified primarily as biochemically active and as surface active. Penicillin, streptomycin, and other antibiotics which are primarily biochemical antagonists intervene in one or more metabolic reactions of the cell by disturbing the normal chain of events through which C, H, O, N, P, S, and other metabolites are absorbed from the environment and incorporated into "energy rich" linkages from which the cell ultimately derives the energy necessary to sustain its life. Surface active agents, like tyrothricin, cause disruption of the structural integrity of the cell. These groups are not mutually exclusive; surface active antibiotics may exert a secondary effect by modifying the stereochemical structure of proteins, lipoids, and other essential protoplasmic constituents so that they are no longer able to participate normally in the reactions on which survival, growth, and multiplication depend. It will be convenient to discuss the different antibiotics separately. Independently of the action exerted by the antibiotic itself, the surface tension of the medium in which the micro-organisms are growing may be altered as the antibiotic causes

certain substances to be released by the cell. This has been discussed by Pratt (1948, *Amer. J. Bot.*, 35:634-637).

As specific examples of the above general statements, we will discuss first the mechanisms by which penicillin and streptomycin inhibit bacteria and then contrast these with the action of tyrothricin.

PENICILLIN

The effects of antibiotics on bacteria may be discussed in terms of morphologic and of biochemical changes; these may be studied by using a modification of the cylinder-plate assay technic. Since there must be a diffusion gradient outward from the central cylinder containing the antibiotic, one can study the effects of graded concentrations of the antibiotic on the same culture. Cultures of different ages may be studied readily by seeding the plates with bacteria and then incubating them for different lengths of time before applying the antibiotic in the cylinder. Since the test organisms are most reactive to penicillin when metabolizing most actively, i.e., in the logarithmic phase of growth, it is often desirable for cytochemical studies to use a primary incubation period, without antibiotic, of sufficient duration to permit the bacteria to reach this phase of development. Then the antibiotic may be placed in the cylinders and the plates may be reincubated.

It is reasonable to expect sub-bacteriostatic concentrations to exist beyond the zones of inhibition. Two observations are important in this connection: (1) appropriate sub-bacteriostatic concentrations of penicillin are known to enhance metabolic activity, growth, and multiplication of sensitive organisms; (2) a narrow band of enhanced growth immediately surrounding the zones of inhibition is generally evident on test plates (Figs. 7 and 60). These bands of increased growth coincide with areas of relatively intense reducing power. These areas represent regions in which test organisms, having been subjected to sub-bacteriostatic concentrations of the antibiotic without subsequent exposure to bacteriostatic, bactericidal, or bacteriolytic concentrations, have been stimulated to a state of intense metabolism.

The concentration of antibiotic in these regions represents the threshold concentration below which no readily apparent effects are exerted (normal background outside ring of enhanced growth) and above which the cells are inhibited, killed, or lysed (inhibition zone). It has been estimated that on typical penicillin assay plates the threshold concentration is between 0.001 and 0.01 unit per ml. (6×10^{-10} to

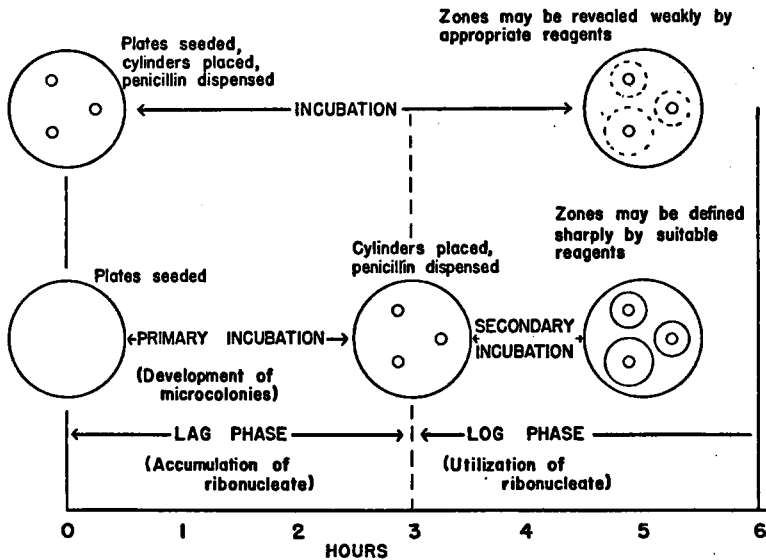

FIG. 54. Diagrammatic comparison of standard cylinder-plate technic for assaying antibiotics and modified cylinder-plate technic employing primary incubation without antibiotics followed by secondary incubation with antibiotic. (See text for further explanation.)

6×10^{-9} grams) for *Staphylococcus aureus*. According to published data, when a culture of *Staphylococcus aureus* is immersed in a solution of penicillin, the antibiotic diffuses into the cell until an equilibrium is established between the concentrations of intracellular and extracellular solutions. If the cells are then washed in several changes of penicillin-free water or broth, much of the internal penicillin is leached from the intracellular environment. However, there is always a certain amount, 750 molecules per cell to be precise, which is not

released. This amount seems to be firmly bound and is assumed to be specifically absorbed. Similar experiments with a yeast, *Saccharomyces cerevisiae*, which is insensitive to the action of penicillin, evidence no such absorption.

Morphologic Observations. Bacteria under the influence of bactericidal concentrations of penicillin undergo distortion and swelling, and ultimate lysis. Microscopical examination shows that the cells not only increase in size but tend to become concatenated. In rod forms such as *Escherichia coli* and *Bacillus subtilis* this becomes manifest by development of elongated mycelial-like structures, and in cocci by formation of chains of cells. Thus, cells of *Staphylococcus aureus* under the influence of penicillin tend to form streptococcus-like chains, concomitantly losing their Gram-positiveness and the ability to absorb vital stains. This is followed by swelling and abnormal enlargement of the cells. This tendency toward concatenation is also shown in streptococci which under the influence of penicillin tend to form longer chains than normal.* At sub-bactericidal concentrations, penicillin stimulates metabolism and may act as a "growth factor" in promoting increase of cell size, although at the same time it disharmonizes the processes of cellular enlargement and cellular division.

The modification of the geometric arrangement of the individuals in the colony may be correlated with a change in the distribution of electrostatic charge at the cell surface. In fact, some workers have gone so far as to attribute the action of penicillin primarily to this effect. The modification of distribution of electrostatic charges on seeded plates exposed to penicillin can be revealed by flooding the plates with suspensions of electropositive or of electronegative particles and then studying the sites of flocculation (Plate 2). The patterns so revealed can be correlated with the patterns revealed by pH and rH indicators and by reagents for specific cellular constituents and enzyme systems. The over-all effect can be interpreted in terms of inhibition of mononucleotide catabolism and of a shift of sulf-

* It should be pointed out that this response is not specific to penicillin, since it may be induced also by certain other agents.

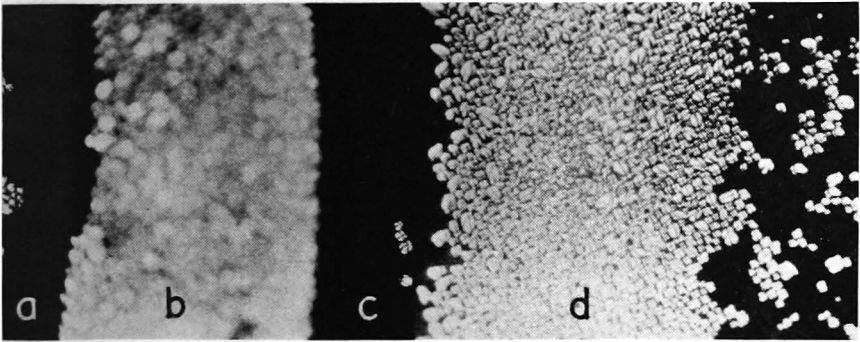

PLATE 2. Reproduction of a photograph of a segment of an inhibition zone on a penicillin assay plate that was flooded for a few minutes with a suspension of starch in phosphate buffer (pH 6.8) and from which the excess suspension was later decanted. It shows (a) a few scattered starch grains at the site of the buffered penicillin solution inside the "penicylinder"; (b) starch grains sedimented in the trough where the "penicylinder" had rested (out of focus because in a different plane from the surface of the agar); (c) a narrow ring devoid of starch around the trough; and (d) the circumjacent wide band of starch grains covering most of the width of the inhibition zone and extending up to the ring of enhanced growth where a few scattered grains appear on the right. (Dufrenoy and Pratt, 1948, *Nature*, 161:849.)

hydriyl (—SH) to disulfide (S—S), of aldehydic COH to carboxylic COOH or ketonic CO , and/or of enolic COH to ketonic CO (see discussion of cytochemical observations).

Cytochemical Observations. A penicillin assay plate with its zone of inhibited and of normal uninhibited growth of test organisms may be regarded as a field of distribution of different chemicals; the pattern of that distribution may be regarded as representative of the distribution of the several constituents and metabolic products and by-products of cells that are growing normally and of cells that are under the influence of penicillin. Therefore, addition of suitable reagents and careful observations of the reactions that occur in different parts of the test plates can be used to gather information concerning the mechanism of the action of penicillin on the test organisms.

Using many different reagents that give color reactions with specific reactive chemical groups, tests have been made for —SH , aldehyde, dienol, lipids, phospholipids, various nucleic acid fractions, various amino acids, and among enzyme systems, dehydrogenase, indophenol oxidase, and phosphatase. All of the reagents, when properly used, intensify the boundaries between areas of inhibition and noninhibition whether the zones are clearly discernible (as in the standard over-night assay) or are only faintly visible (as after only two to three hours of incubation and diffusion of penicillin). All convergent tests agree in locating the boundary between the two areas at the same distance from a cylinder from which a given concentration of penicillin has been permitted to diffuse for a given length of time. This is of some practical interest, since it opens up several new methods of conducting rapid assays of antibiotics without the use of expensive or elaborate equipment (Pratt and Dufrenoy, 1947, *Nature*, 159:576).

The theoretical implications are of greater interest, however, since they all provide convergent lines of evidence that a threshold effect obtains on penicillin assay plates and that the effect depends, in part at least, upon an oxidation-reduction threshold. The sharp boundaries at the margins of the inhibition zones may be an expression of the

irreversible shift of —SH to S—S , since reagents stated to be specific for —SH groups in living cells and tissues fail to reveal such groups in the zones of inhibition but indicate their presence outside the zones. Other reagents for detecting the activity of dehydrogenase systems indicate that, in comparison with areas of normal growth, the areas of inhibited growth are deficient in dehydrogenase activity. This is pertinent, since it is known that many dehydrogenase systems depend for their activity in hydrogen transfer on the presence of sulfhydryl groups. Use of the "thydi" reagent indicates a higher oxidase activity in areas of inhibition than in areas of normal growth.

Microscopical study of changes occurring within cells under the influence of penicillin shows that the first effect is failure of the dividing organism to apportion vacuolar material to the daughter cells. This is followed by failure of the vacuoles to retain material normally encompassed therein. These changes are manifest in cells under the influence of penicillin, first by loss of ability to accumulate vital dyes in the vacuolar solution, and second by dispersion of the vacuolar solution, originally centrally located, toward the periphery of the swelling cell (Fig. 55).

Accumulation of vital dyes against a concentration gradient in normally functioning aerobic organisms is a physiologic process entailing expenditure of energy that is derived from respiration. As respiration becomes unbalanced, the vacuolar solution not only becomes unable to absorb materials from the external environment, but even becomes unable to retain the solutes it already contains (Fig. 58). This condition occurs concomitantly with loss of positive Gram-staining reactions and with the disorganization of the cellular nucleoproteins and the liberation of lipids and fatty acids. Use of appropriate reagents shows that lipids are displaced from cells under the influence of penicillin and are hydrolyzed to fatty acids. This may account for the downward shift of pH that can be demonstrated on penicillin assay plates.

These experiments suggest that cells under the influence of inhibiting concentrations of penicillin may actually starve to death by

virtue of their inability to absorb essential nutrients from the surrounding environment and to retain those they already possess. Under the influence of inhibiting concentrations of penicillin, the Gram-positiveness of the cells fades out as the vacuolar material loses its other characteristic properties. These observations are in agreement with the work of Gale and Taylor who concluded that cells of *S.*

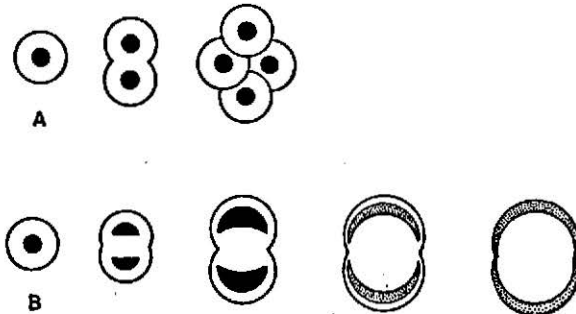

FIG. 55. Diagrammatic representation of *Staphylococcus aureus* stained vitally with neutral red. A. Phases of cell division in normal *Staphylococcus aureus*. Vacuolar material which selectively stains red is shown as solid black. B. Phases of unsuccessful attempt toward a first division of *Staphylococcus aureus* under the influence of a bacteriostatic concentration of penicillin. Successive diagrams from left to right show that the cell swells; material staining with neutral red diffuses from the vacuole to the periphery; the cell fails to divide and eventually swells into an empty shell, which exhibits diffuse bipolar staining (stippled area). (Redrawn from Pratt and Dufrenoy, 1947, *J. Bact.*, 54:129.)

aureus under the influence of bacteriostatic concentrations of penicillin may be considered as starving for glutamine, and with the recognized fact that "starving bacteria gradually lose their Gram-positivity, passing through a stage where they present a stippled appearance with Gram-positive granules throughout."

A completely satisfactory physiologic interpretation of the mechanism of action of penicillin on susceptible organisms, however, cannot

be based solely on these simple observations involving evidence for the loss of the Gram-positive reaction. Any attempt to correlate sensitiveness to penicillin with staining reaction must meet the objection that the Neisserias are very sensitive to penicillin, though they are not generally classified as Gram-positive.

This raises the interesting problem of studying comparatively Gram-positive and Gram-negative organisms. Application of the same technics to *Staphylococcus aureus* and *Bacillus subtilis* as representatives of the Gram-positives and to *Escherichia coli*, *Eberthella typhosa*, and *Proteus vulgaris* among the Gram-negatives shows that the same pattern develops on all penicillin plates treated with a given reagent, irrespective of the test organism that is used, provided the proper concentrations of penicillin are used and provided the proper balance of the biologic and physical factors involved in the cylinder plate method of assay is achieved by properly controlling the primary and secondary incubation periods. The evidence indicates that penicillin affects aerobic Gram-positive and Gram-negative organisms by blocking the catabolism of mononucleotides. The threshold concentration at which its effects become manifest is, however, many times greater on plates seeded with Gram-negative organisms than on those seeded with Gram-positive organisms.

The proper use of trace amounts of cobalt lowers the effective threshold in vitro on test plates and in serial dilution and also in vivo so that it may be possible eventually to extend the clinical use of penicillin to the treatment of infections due to Gram-negative pathogens. This will be referred to later.

It is well known that the growth of *Staphylococcus aureus* is dependent on an external source of —SH groups, such as presumably may be converted to cysteine, and on an external source of glutamic acid. These facts, together with the results of tests with various reagents, suggest that glutathione (γ -glutamyl-cysteinyl-glycine), resulting from the linkage of glutamic acid to glycine via cysteine, may be involved in the mechanism of bacteriostasis of Gram-positive organisms by penicillins, since the various penicillins may be written

as stereochemical analogues of glutathione with glycine replaced by dimethyl serine, and the glutamyl fraction replaced by an R residue (Fig. 56).

Organisms that depend for their survival on absorption of glutamic acid from the substrate are penicillin sensitive. Staining reactions on assay plates seem to point directly to the involvement of glutathione. It will suffice to cite one experiment. When assay plates are flooded with a 1 per cent solution of 2,6-dichlorophenolindophenol in a satu-

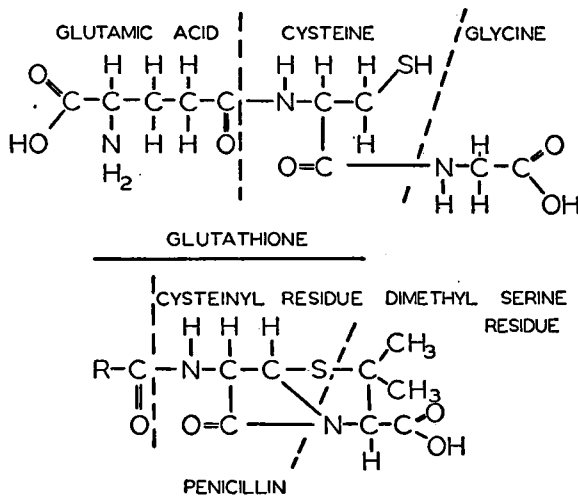

FIG. 56. Structure of glutathione and of penicillin. (Pratt and Dufrenoy: J. Bact. 55:727.)

rated aqueous solution of NaHCO₃, the inhibition zones promptly stain intensely blue and are sharply delineated from the faintly bluish uninhibited background by a narrow colorless rim that locates the ring of enhanced growth that circumscribes each zone. Similar patterns obtain on plates pretreated for five minutes with acetone under conditions which block —SH groups from cysteine but not those from glutathione. However, if the plates are pretreated with a M/1000 solution of *p*-chloromercurybenzoate which blocks —SH groups from glutathione also, the 2,6-dichlorophenolindophenol is no longer reduced to the colorless form in the ring of enhanced growth, which

now stains deep blue. A similar result *mutatis mutandis* is obtained with other reagents for detecting —SH groups or for detecting dehydrogenase activity.

The reducing activity in the regions of enhanced growth may be strikingly revealed also by flooding the plates with a 0.5 per cent aqueous solution of 2,3,5-triphenyltetrazolium chloride, whereupon the regions become intensely red, while the zones of inhibition remain uncolored. The tetrazolium salt is colorless and soluble but in the reduced state is converted to an insoluble red formazan. However, if the plates are pretreated with *p*-chloromercurybenzoate no red color develops when they are subsequently flooded with the tetrazolium chloride.

Such simple experiments do not themselves afford unequivocal proof of the participation of glutathione in the mechanism of penicillin action. However, chromatography of hydrolytic products from bacteria has confirmed the prevalence of —SH-bearing amino acids among bacterial constituents, and has focussed anew attention on the significance of —SH groups in bacterial metabolism. The above results from penicillin assay plates indicate that some of the —SH groups involved are less reactive than those of cysteine, and in view of the work showing the role of glutamine, it seems reasonable to deduce the involvement of glutathione.

These observations suggest that the over-all effect of penicillin may be traceable ultimately to dehydrogenation of reduced glutathione to oxidized glutathione resulting largely from the increased rate of metabolism that is induced by appropriately low concentrations of penicillin. The most efficient bacteriostatic or bactericidal concentration of penicillin may be visualized as one which promotes dehydrogenation faster than rehydrogenation can restore —SH groups, thus shifting the aerobic respiratory system out of balance and depriving the micro-organisms of the respiratory energy required to provide for absorption of essential metabolites from the substrate.

If these assumptions are correct, it follows that penicillin will be most effective at a concentration such that it accelerates the transfer

of hydrogen from —SH groups without impeding the activity of hydrogen acceptors. Therefore, for each set of experiments in vitro and in vivo there would be expected a threshold value, below which the antibiotic speeds up metabolic processes without irreversibly shifting them out of balance, and above which it increases dehydrogenation beyond the rate compatible with maintenance of the proper redox systems and thereby causes irreparable damage to the cells. According to this hypothesis, penicillin at an appropriate subthreshold concentration would be expected to act as a "growth factor," and it is noteworthy that such an effect in vitro has been reported repeatedly. Concentrations greatly in excess of the threshold would be expected to impair the effectiveness of hydrogen acceptors and so to partially protect hydrogen donors against rapid, irreversible dehydrogenation. Therefore, it would be predicted that the most efficient and rapid bacteriostatic effects would follow use of the minimal concentration capable of inducing irreversible injury to the cells. The validity of this view is supported not only by the results of our own researches and experimental evidence in the literature (Chap. 2) but also by the wealth of clinical evidence showing excellent therapeutic results with the minimal doses that were administered in the early 1940's when penicillin was very scarce. (See Anderson and Keefer, 1948, *The therapeutic value of penicillin, a study of 10,000 cases*, Ann Arbor, Mich.)

Another feature of penicillin action that merits attention is the occurrence of postlytic waves of growth (Chap. 3). In broth cultures exposed to low concentrations of penicillin, following the first increase and subsequent decrease in number of viable cells there is often a second wave of growth during which the number of viable cells again increases. Then a period of decrease occurs. This phenomenon may be repeated several times (Figs. 16 and 17). These results indicate that when cells are suspended in broth containing very low concentrations of penicillin the most sensitive organisms which are affected first, as they undergo lysis, release into the me-

dium substances which promote a second wave of growth among the more resistant cells, thus inducing the latter into a more active metabolic state in which they are more susceptible to the action of penicillin. Therefore, the course of events in a culture exposed to penicillin might be visualized as similar to a "chain reaction." Since lysis of senescent cells normally occurs in cultures of micro-organisms, penicillin, in proper concentration, may be considered as hastening the process of aging.

The prominent role played by ribonuclease, actively secreted by aging bacteria, in promoting the lysis of the extranuclear content of senescent bacteria is well known. Similar patterns can be revealed on seeded assay plates irrespective of whether the central cylinder contains ribonuclease or penicillin; this seems to support the view that penicillin accelerates the aging of bacterial cells. The normal sequence of events in the degradation of nucleic acid complexes in living cells has been visualized as proceeding in three major steps involving depolymerization of the nucleic acid macromolecules to tetranucleotide units which are hydrolyzed to mononucleotides which, in turn, are dephosphorylated with consequent release of bases, a sugar, and phosphoric acid. This concept is schematized in Figure 57. There is still much controversy over the state of polymerization of ribonucleic acid units which are assumed to be composed of tetranucleotides, an undetermined number of which may be linked together to form the macromolecules. Ribonuclease may be considered as the enzyme which depolymerizes the macromolecules into tetranucleotides and hydrolyzes these into mononucleotides. The mononucleotides are made up of phosphate, ribose, and organic bases.

Cytochemical studies on various bacteria show that penicillin does not interfere with the activity of ribonuclease, indicating noninterference of penicillin with depolymerization of the nucleic acid macromolecule (step I in Fig. 57). Penicillin does interfere, however, with the dephosphorylation of mononucleotides (step III in Fig. 57). This is indicated by abundant accumulation of mononucleotides where

cells are inhibited by penicillin. When assay plates seeded with *Staphylococcus aureus* are exposed in the usual way to penicillin diffusing outward from a cylinder, the zones of inhibition may be revealed as areas in which dehydrogenase and phosphatase activity are blocked, in which ribonucleic acid macromolecules (basophilic materials) are lacking or minimal, and in which free phosphate is lacking or minimal. Thus, accumulation of mononucleotides coincides with disappearance of ribonucleic macromolecules without

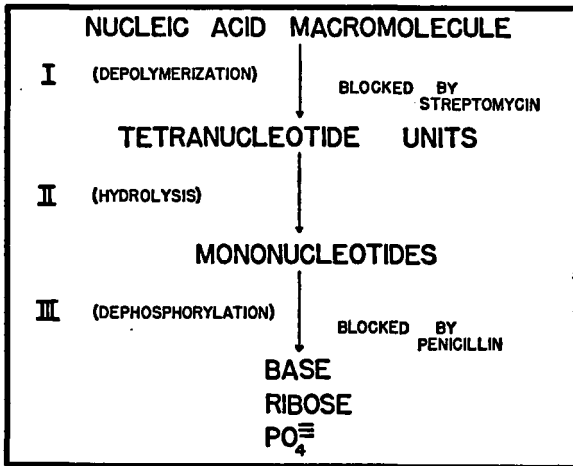

FIG. 57. Schematic representation of the major steps involved in degradation of nucleic acid complexes. (From Pratt and Dufrenoy, 1949, after Tipson, 1948, J. Am. Pharm. Assoc. [Sci. Ed.], 37:45-53.)

release of free phosphate. These are the effects that would be expected to result from blocking of the dephosphorylation step in Figure 57.

The results of tests for various chemical groups and enzyme systems on penicillin assay plates are summarized in Figure 58.

As related above, the site of the threshold concentration of penicillin causing inhibition of mononucleotidase (as detected notably by

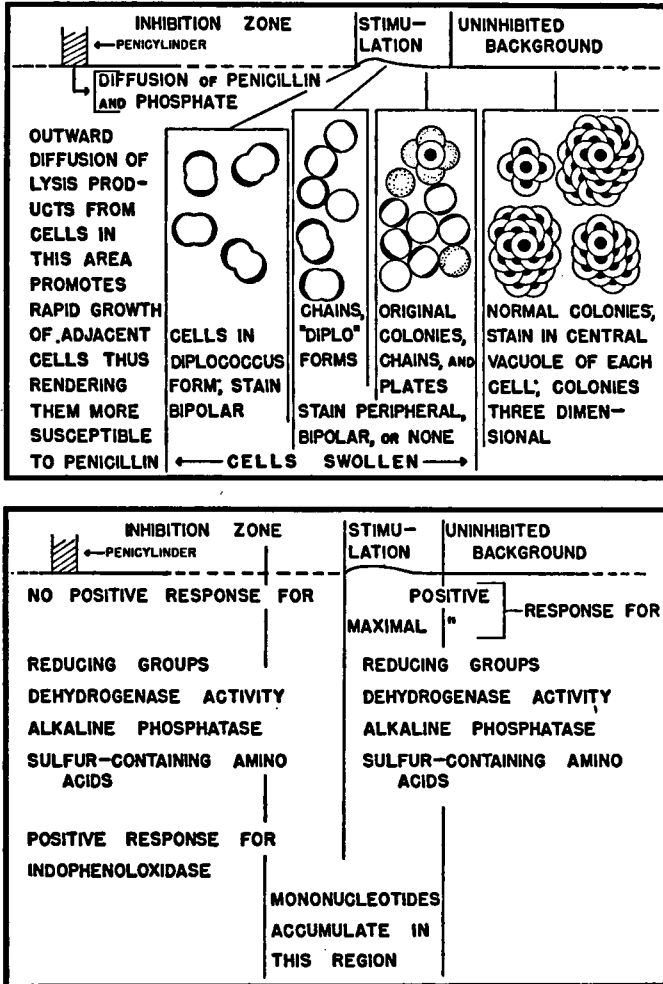

FIG. 58. Diagrammatic summary of response to staining tests for specific chemical groups and enzyme systems in different areas of a seeded agar plate exposed to penicillin diffusing from a central reservoir and of the accompanying morphologic and staining characteristics on such a plate seeded with *Staphylococcus aureus*. The hump in the region of stimulation is caused by active proliferation of colonies that tend to crowd the surface of the agar. (From Pratt and Dufrenoy, 1949, Texas Reports Biol. & Med., 7:188.)

phenolphthalein phosphate*) coincides with the threshold concentration of penicillin causing inhibition of dehydrogenases (as tested by triphenyltetrazolium chloride*) or causing disappearance of the positive response for —SH groups (as exhibited by formation of prussian blue following treatment with ferricyanide, then with a ferric salt*).

The close relationship between inhibition of mononucleotidase and disappearance of positive response for —SH groups might be expected, since the micro-organisms depend on liberation of the free base from the mononucleotide for the maintenance of the redox potential at a level low enough for glutathione to be reversibly oxidized and reduced. When the catabolism of the mononucleotides is blocked by penicillin, the base can no longer be liberated to function in poisoning the internal redox potential.

Penicillin, therefore, can be visualized as exerting its bacteriostatic action by blocking the system whereby the redox potential is normally maintained low enough for the —SH groups to be protected from irreversible dehydrogenation.

Since —SH groups act as donors for the H to be ultimately "accepted" by atmospheric oxygen, the dehydrogenation will proceed more rapidly as there is more O₂ available, and therefore penicillin acts most effectively on aerobic organisms when they are freely exposed to oxygenation.

COMPARATIVE EFFECTS OF PENICILLIN UNDER AEROBIC AND SEMI-ANAEROBIC CONDITIONS. It may be assumed that on penicillin assay plates there is a uniform oxygen tension and that there is a gradient of penicillin concentration which decreases from the cylinders outward. Conversely, it may be assumed that in broth cultures there is a uniform penicillin concentration in the medium but that there is a gradient of oxygen tension which decreases from the surface

* The reagents mentioned are merely illustrative of many that have been used. In general, conclusions should not be based on a single reaction. Actually, many tests, all yielding convergent lines of evidence, have been made. For technical details and more thorough treatment, the reader should see a series of articles under the general title "Cytochemical Mechanisms of Penicillin Action" published in the *Journal of Bacteriology* during, 1947, 1948, and 1949.

downward. An interesting comparison and demonstration of a critical oxidation-reduction potential threshold may be made by applying appropriate redox indicators to cultures on standard assay plates and in serial dilutions.

When assay plates seeded with *Staphylococcus aureus* and incubated for 16 hours as in the standard cylinder-plate assay are flooded with appropriate redox indicators each zone of inhibition is promptly outlined by a ring that is the site of enhanced activity of the cells and that indicates the position on the scale of redox potentials of a threshold above which the cells are unable to grow (inside of zone) and below which they grow normally (uninhibited background). Likewise, if equal volumes of broth containing different amounts of penicillin are inoculated with equal numbers of organisms of the same age and are incubated until bacteriostasis is evident in the tube with the highest concentration of penicillin, addition of a suitable redox indicator reveals that an oxidation-reduction threshold has been established in each tube and that the distance of this threshold from the surface increases as the concentration of penicillin increases. In fact, the thickness of the "oxidized" layer is a linear function of the log of the concentration of penicillin in the broth. The more active the dehydrogenases in a given tube, the closer to the surface will a given redox indicator be reduced to the leuco-base. The concentration of antibiotic in the broth can, therefore, be expressed in terms of the depth of the layer of the unreduced dye in the upper layer of the suspension.

A comparison of results obtained from *S. aureus* 16 hour assay plates and serial dilution assays treated with a mixture of dimethyl-paraphenylenediamine hydrochloride and thymol is diagrammed in Figure 59. Similar results may be obtained using Janus green or Indigosol green IB. The upper row represents the inhibition zones surrounding cylinders containing geometrically increasing concentrations of penicillin on standard 16 hour assay plates. Correspondingly, the lower row represents the thickness of the layer of "oxidized" dye in the several tubes. The numerals indicate the concentration of peni-

cillin, in units per ml., in the different cylinders or tubes, which have been spaced as on a logarithmic scale in the diagram. The approximately linear relation between response (diameter of zone or thickness of "oxidized" layer) and log concentration of penicillin is indicated by the lines drawn along the edges of the inhibition zones on plates, and through the lower edges of the layers of "oxidized" dye in the tube experiments.

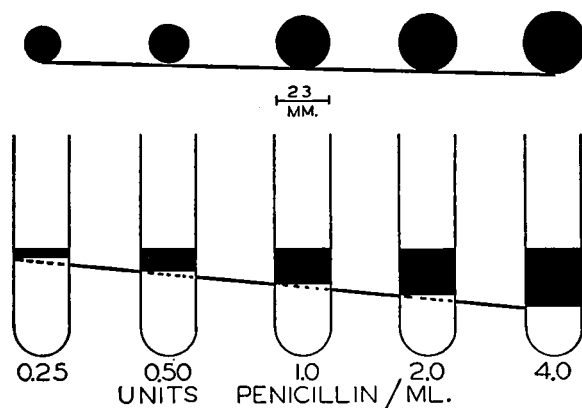

FIG. 59. Diagrammatic representation of inhibition zones on penicillin assay plates and of "oxidized" layers in serial dilution assays in broth, following addition of suitable dye. See text for explanation. (From Pratt and Dufrenoy, 1948, *Bact. Revs.*, 12:92.)

Any agent which serves in oxygen transfer accelerates dehydrogenation in the cells and favors loss of reducing capacity of the cells. Such an agent may tend to increase the action of a given concentration of penicillin, and may, therefore, have important clinical implications in making amenable to penicillin therapy diseases caused by infectious agents which otherwise are inhibited only by concentrations of penicillin outside the range of practicable clinical doses. For example, 2,000 units of penicillin administered with a small amount of $\text{CoCl}_2 \cdot 6\text{H}_2\text{O}$ confer greater protection on mice inoculated with *Eberthella typhosa* (resistant to penicillin) than do 4,000 units of penicillin alone, as shown in Table 17.

TABLE 17. EFFECT OF TRACE AMOUNTS OF COBALT ON THE EFFECTIVENESS OF BENZYL PENICILLIN IN PROTECTING MICE INOCULATED WITH *EBERTHELLA TYPHOSA*

DRUG ADMINISTERED	PERCENTAGE MORTALITY
Control (no drug)	92
Penicillin (2,000 units)	80
Penicillin (3,000 units)	77
Penicillin (4,000 units)	45
Penicillin (2,000 units) plus CoCl ₂ ·6H ₂ O (0.256 mg.)*	39
CoCl ₂ ·6H ₂ O (0.256 mg.)*	96
Cobalt control: CoCl ₂ ·6H ₂ O (0.256 mg.)* only (no inoculation with <i>E. typhosa</i>)	00

(From data of Pratt, Dufrenoy, and Strait, 1948, *J. Bact.*, 55:75-77.)

* Corresponding to 0.066 mg. cobalt.

It is apparent from the table that cobalt chloride alone, in the concentration used, had no protective action. Experiments in vitro confirmed the fact that the doses of cobalt that enhance penicillin action are far below those that injure the test organism. It can be said of cobalt in this connection, as was said of penicillin (Chap. 2), that the dictum if a little is good, more will be better, is false. There can be defined for each test organism and level of penicillin dosage a concentration of cobalt chloride (in the range of 0.1 to 1 part per million) that promotes maximal enhancement of penicillin action; either lower or higher concentrations are less effective.

STREPTOMYCIN

Susceptible bacteria exposed to threshold or higher concentrations of streptomycin exhibit a number of changes which when observed superficially may seem similar to those induced by appropriate concentrations of penicillin. Careful study, however, shows that aberrations caused by streptomycin and penicillin are fundamentally different, even though the end result may be the same, i.e., inhibition, death,

and ultimate lysis. This recalls the now famous words of Lapique, "A cell may die of many causes but there is only one way in which it may die."

Even a cursory survey of the antibiotic spectra of penicillin and of streptomycin reveals certain notable differences between the two antibiotics. In the first place, the activity of penicillin (in the range of concentrations that it is feasible to attain and maintain in the blood of patients) is limited for the most part to Gram-positive bacteria that are not acid fast, while streptomycin is effective against both Gram-negative and Gram-positive (including acid fast) bacteria, although it is not generally used clinically for treating infections due to Gram-positive pathogens which are not acid fast. In the second place, the organisms that are susceptible to penicillin (in clinically practicable doses) are in the main species that are comparatively rapid growers, whereas a number of relatively slow growing species and strains such as those of *Mycobacterium* and *Pasteurella* can be controlled clinically by streptomycin. These differences in range of activity suggest fundamental differences in mechanisms of action of the two antibiotics, i.e., in the enzyme systems and/or energy-yielding reactions with which penicillin and streptomycin interfere.

Morphologic Observations. Streptomycin, at low inhibiting concentrations, markedly affects the morphology of bacterial cells. For example, cells of *Escherichia coli* suspended for a few hours in broth containing 25 to 50 micrograms of streptomycin per ml. fail to divide but they continue to grow. Typically, under these conditions the individual cells form long, filamentous, mycelial-like strands that are characterized by numerous swellings which may be terminal or scattered in various positions along the length of the filament. Cells of *Escherichia coli* exposed to sufficiently high concentrations of penicillin have a similar appearance but there is one important difference which is a reflection of fundamentally different cytochemical conditions in the two cases. When penicillin assay plates seeded with *Escherichia coli* are treated with an appropriate carbolic solution of trypan blue in alcohol and acetic acid and then are thoroughly lixi-

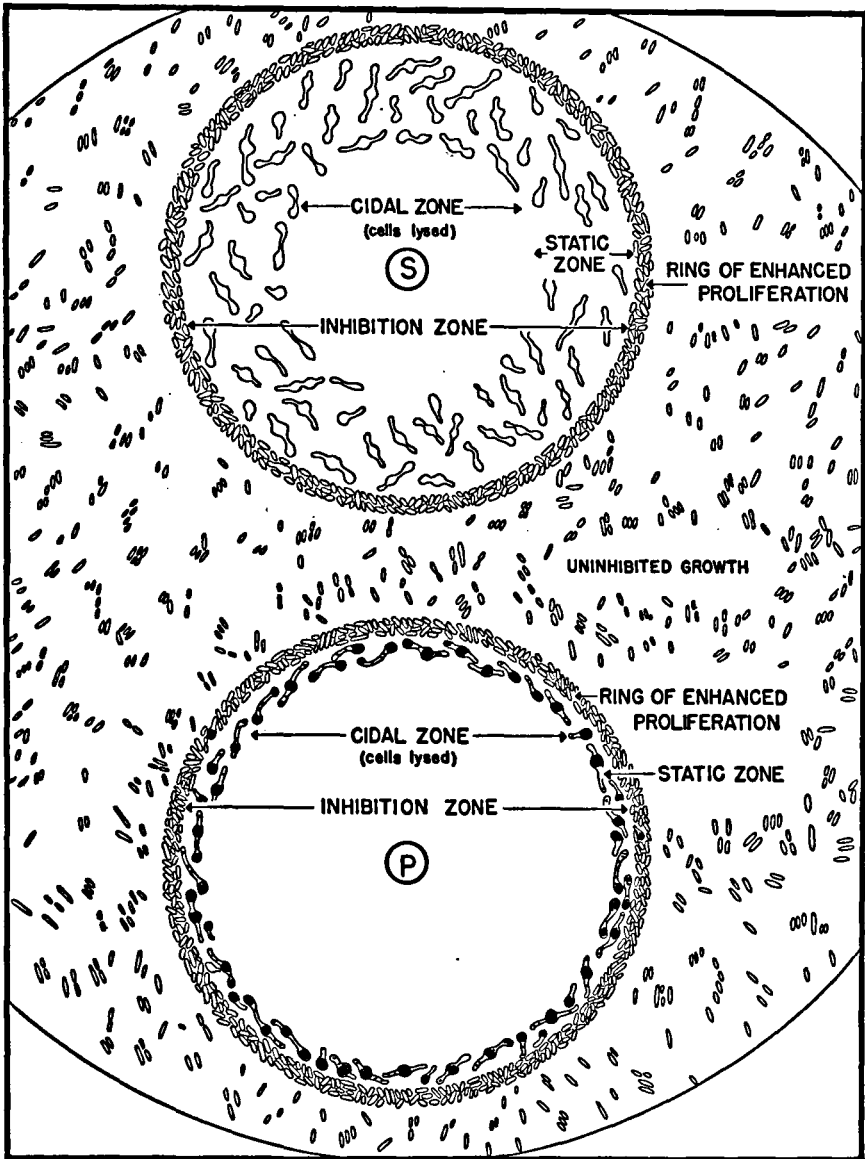

FIG. 60. Diagrammatic representation of changes in distribution, morphology, and reaction to trypan blue induced in *Escherichia coli* upon exposure to streptomycin (S) and to penicillin (P) diffusing from cylinders on an agar plate. Note difference in retention of dye (black in diagram) and in relative width of static zones. (See text for explanation.)

vated with an alcoholic solution of Orange G, the blue dye is retained by the cells in the outermost regions of the zones of inhibition. Microscopic examination shows that the dye appears in granules throughout the cells and is particularly abundant in the swollen portions which usually are entirely blue. Following similar treatment of streptomycin assay plates the dye is not retained by any portion of the cells. This difference which is diagrammed in Figure 60 indicates a fundamental cytochemical difference in the cells after exposure to penicillin and to streptomycin and has been interpreted to mean that the two antibiotics intervene at different points to block the chain of reactions involved in nucleotide catabolism.

In either case, the onset of events is observed in bacteriostatic regions which comprise the outermost regions of the zones of inhibition; these are regions in which there has been attained the threshold concentration required for blocking an essential reaction but in which exposure to the inhibiting concentration has not been of sufficient duration to cause death. In general, the bacteriostatic region occupies a larger portion of the inhibition zone and is, therefore, more conspicuous around cylinders from which streptomycin is diffusing than around cylinders containing penicillin. Often on unstained plates this tends to obscure somewhat the true margin of the zone of inhibition around cylinders containing streptomycin. A further reason for the relative lack of a sharp definition of zones produced by streptomycin may be the rapid development of streptomycin-resistant mutants.

Cytochemical Observations. Under the conditions of the experiments described above, trypan blue may be used as a test for the presence of mononucleotides. Thus, it may be inferred from the results of the staining tests that mononucleotides accumulate in cells exposed to bacteriostatic concentrations of penicillin but that they do not accumulate in cells exposed to bacteriostatic concentrations of streptomycin.

Tests with phenolphthalein phosphate show that alkaline phos-

phatase activity is blocked in cells exposed to streptomycin. Therefore, the failure in this case to detect mononucleotides cannot be attributed to their having been catabolized to their constituent sugar, base, and phosphate. This view is confirmed by the negative tests for free phosphates in such cells. Moreover, one of the first cytochemical changes concomitant with elongation following loss of ability to divide is marked accumulation of basophilic materials (ribonucleic acid macromolecules in Fig. 57). These convergent lines of evidence all point to the conclusion that streptomycin intervenes in ribonucleic acid metabolism by blocking a reaction preceding the formation of mononucleotides. The evidence derived from cytochemical studies has been fully substantiated by the results of quantitative biochemical analyses.

Although streptomycin and penicillin interfere with nucleotide catabolism at different levels, the end result is to prevent the cell from using essential reserves. This interference permits the redox potential to rise to a level that is incompatible with proper functioning of dehydrogenases and other enzyme systems involving the transfer of hydrogen.

In summary, comparing and contrasting penicillin and streptomycin, it should be recalled that, as used clinically, penicillin is a salt of an acid, whereas streptomycin is a salt of a base which can dissociate and form salts with ribonucleic acid. Evidence in the literature suggests that the bacteriostatic effect of streptomycin follows the formation of a ribonucleic acid-streptomycin complex or salt which is not amenable to enzymatic degradation. However, the streptomycin may be displaced from such a complex by NaCl or other salts. This may account for the "salt effect" which reduces the action of streptomycin (Chap. 6). Likewise, high molecular weight substances, such as agar, tend to reduce the action of streptomycin *in vitro* by competing with the ribonucleic acid in the test organisms for adsorption of streptomycin. These and other pertinent differences between penicillin and streptomycin may be tabulated comparatively as shown in Table 18.

TABLE 18. COMPARISON OF PENICILLIN AND STREPTOMYCIN

POINT OF COMPARISON	PENICILLIN	STREPTOMYCIN
Chemical nature	Acid	Base
Effect of nutrition and temperature on minimal bacteriostatic (threshold) concentration	Lowest under optimal conditions for growth	Lowest under conditions suboptimal for growth
Effect of number of bacteria present	Nil	Activity somewhat lower in presence of large number of bacteria
Minimal exposure required for bacteriostasis	About ½ hour (time for one division of test organism)	About 1 to 4 hours
Effect of agar, sugar, or salts	Nil	Depression
Effect of phthalyl sulfathiazole	Depression	?
Effect of low concentrations of cobalt	Enhancement	No significant effect
Effect of low concentrations of vitamin K ₅	Enhancement	No significant effect
Effect on nucleotide catabolism	Mononucleotidase inhibited	Polynucleotidase inhibited
Resistant strains develop in vivo from initially sensitive strains	Slowly, if at all, and then in only small percentage of cases	Rapidly and in large percentage of cases
Virulence of resistant mutants	Generally diminished	Generally undiminished
Rate of proliferation of resistant mutants	Diminished	Diminished
Toxicity to patient	Of negligible clinical importance	Appreciable, but less for dihydrostreptomycin than for streptomycin
Hazard to personnel handling drug	Negligible, restricted to small percentage of individuals handling crude product during processing	Occasional allergic responses of nurses, doctors, and others handling purified product

TYROTHRICIN (GRAMICIDIN AND TYROCIDIN)

In contrast with penicillin and streptomycin (the initial action of which, on bacterial cells, is effected biochemically) tyrothricin, by virtue of its content of tyrocidin, probably exerts its primary action through physical means, i.e., disruption of the structural integrity of the cell. As a consequence, dehydrogenases (notably pyruvic

acid and alanine dehydrogenases) cease to function, while ATP and PO_4^{\equiv} are released from the cells to the medium. In further contrast to penicillin and to streptomycin, tyrocidin is as effective against resting bacteria as against those which are vigorously metabolizing and proliferating. The gramicidin component of tyrothricin has itself a biochemical action in that it inhibits the transphosphorylation process required for the formation of ATP. The fact that gramicidin and penicillin block different enzyme systems in the cell may explain the synergism that occurs when the two antibiotics are used concomitantly (Chap. 9).

DEVELOPMENT OF RESISTANT STRAINS

Experimental evidence demonstrates that upon exposure to sublethal concentrations of an antibiotic an initially susceptible strain of micro-organism may give rise to less susceptible strains. Furthermore, acquisition of increased resistance to one antibiotic does not necessarily entail acquisition of resistance to other antibiotics. In other words, development of resistance to different antibiotics proceeds independently.

From a culture of bacteria exposed to a concentration (C_1) of penicillin or streptomycin inhibiting 99.9 per cent of the organisms in the population, there may be recovered organisms able to survive in the presence of a concentration (C_2) which is greater than C_1 and would have caused 100 per cent killing of the original population. If C_2 is great enough to inhibit 99.9 per cent of the survivors of the C_1 culture, there can be recovered from cultures exposed to C_2 some survivors capable of withstanding an even higher concentration (C_3). This stepwise increase in resistance can be repeated several times, yielding in ten transfers or less strains that exhibit several thousand times the resistance of the initial population. Resistance to very high concentrations may develop rapidly, since the stepwise increase at successive transfers is a logarithmic function of the concentration.

It is a common assumption that resistant strains arise through mutations. To interpret the experimental evidence it has been postu-

lated that several equally potent regulatory factors ("genes") are involved in development of resistance to penicillin while the factors involved in development of resistance to streptomycin are of unequal activity and that for this reason resistance to penicillin develops in a regular stepwise pattern as first one factor and then another is blocked or impaired, but that development of resistance to streptomycin follows no such regular pattern.

The data may, however, be interpreted in other ways that involve less speculation and are more readily amenable to experimental confirmation. On the basis of a normal distribution curve, one would expect to find variations in the reactions of different cells of a culture to antibiotics or any other unfavorable environmental factor. It would be surprising if all the individuals comprising a population were equally sensitive. Consequently, at first consideration, little theoretical interest would seem to attach to the occurrence in a penicillin-sensitive culture of the small number of resistant cells which probably are always present in the population but which normally are overwhelmed by the vastly larger number of the normal members of the population and, therefore, have an opportunity to develop abundantly and to become prominent only under conditions that tend to suppress their more numerous relatives. Experimental confirmation of this view has been provided by the expedient of adding penicillin to a culture in sufficient concentration to inhibit all the actively growing individuals, thereby revealing the presence of "biochemically deficient mutants" which could not successfully compete with the more rapid growers, but once these competitors had been removed, were given a chance to manifest themselves. In some cases the less sensitive forms have been shown to be characterized by lower rates of respiration and metabolism than the typical cells of the culture and this is generally accepted as an adequate explanation for their lower sensitiveness, since it is well known that in species that are amenable to treatment with penicillin there is a direct correlation between effectiveness of the antibiotic and the rate of metabolism. Although one may thus explain adequately the partial indifference of these cells to the action of peni-

cillin, no explanation is afforded thereby for their lower metabolic activity. Acquisition of resistance to either penicillin or streptomycin is accompanied by a reduced rate of growth. Illustrative data from experiments with streptomycin are shown in Figure 61.

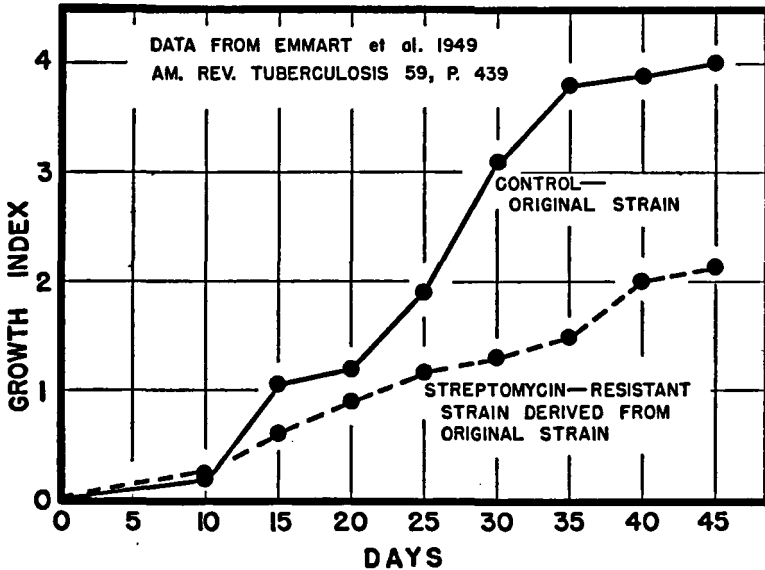

FIG. 61. Growth of two strains of *Mycobacterium tuberculosis* in streptomycin-free broth.

Reduction of growth rate induced by penicillin is accompanied by reduction of virulence. Although no such general correlation obtains in the case of induced streptomycin resistance, reduction of the rate of growth of the invader may give the infected subject a better chance to combat the pathogen through its natural defence mechanisms.

The fact that some of the individuals in a population become capable of growing and reproducing when their more numerous neighbors are eliminated by use of antibiotics suggests that normally the minority, composed of less sensitive cells, may be under some inhibiting influence exerted by the majority, composed of sensitive individuals.

It might be profitable to study antibiotic-sensitive species of bacteria with a view to determining whether in the absence of the antibiotic the more numerous "typical" cells produce and liberate into the medium a substance that is antagonistic to other individuals in the population. Similar studies on the unicellular green alga, *Chlorella vulgaris*, and on *Chilomonas*, *Paramecium*, and other species of protozoa have revealed the presence of powerfully active growth-regulating substances in cultures of these organisms, and it seems likely that a similar situation may exist in pure cultures of bacteria.

SUGGESTED READING

- Bailey, J. H., and Cavalito, C. J., 1948, The reversal of antibiotic action, *J. Bact.*, 55:175-182.
- Demerec, M., 1948, Origin of bacterial resistance to antibiotics, *J. Bact.*, 56:63-74.
- Gale, E. F., 1948, The nitrogen metabolism of Gram-positive bacteria, *Bull. Johns Hopkins Hosp.*, 83:119-175.
- Gale, E. F., Taylor, E. S., and others, 1947, The assimilation of amino acids by bacteria, *J. Gen. Microbiol.*, 1:314-325, 327-334.
- Krampitz, L. O., and Werkman, C. H., 1947, On the mode of action of penicillin, *Arch. Biochem.*, 12:57-67.
- Linz, R., 1948, Contribution à l'étude du mécanisme de l'action de la streptomycine, *Rev. Belge path. méd. exp.*, 19 supplément, 3:1-78.
- Macheboeuf, M., 1948, Recherches biochimiques sur le mode d'action des antibiotiques: pénicilline, streptomycine, tyrothricine, *Bull. chim. Soc. biol.*, 30:161-184.
- Pratt, R., and Dufrenoy, J., 1948, Cytochemical interpretation of the mechanism of penicillin action, *Bact. Revs.*, 12:79-103.
- Pratt, R., and Dufrenoy, J., 1949, Recent research on penicillin action, *Texas Reports Biol. & Med.*, 7:180-219.

If one is sufficiently lavish with time, everything possible happens.

—HERODOTUS (B.C. 484?-425?)

CHAPTER

12

Retrospects and Prospects

Throughout this volume we have surveyed the aspects of interaction among micro-organisms that have been applied in developing a system of antibiotic chemotherapy.

The phenomenon of antibiosis may also be considered as one aspect of the general problem of interactions between living beings. Under the impact of an antibiotic, or of any diffusible factor, whether it be chemical, physical or spiritual, neighboring individuals may be affected. Among micro-organisms, this effect is generally evidenced first by modified growth rate. The modification may be evidenced by accelerated growth, in which case the diffusible agent acts as a growth factor, or it may be manifest by inability of the individual or of the population to successfully complete its growth cycle, in which case the factor acts as an antibiotic and usually causes premature death. Intermediate, between these extremes, are those cases in which the induced modification permits indefinite survival at a reduced tempo of metabolism; such is the case among micro-organisms which acquire resistance to penicillin, streptomycin, etc.

Man has made empirical use of natural antagonism among micro-organisms for the control of infectious microbes for at least 30 centuries; but it was only after the birth of bacteriology as a science, in the latter quarter of the nineteenth century, that rational application of microbial antagonisms according to definite principles became possible. Even then, for several decades the concept of antibiotic

chemotherapy was largely speculative and a dream for the future, although numerous attempts with varying degrees of success were made to employ products of microbial metabolism clinically between 1880 and 1915. It is a curious reversal of events that the concept of antibiotic chemotherapy, which fell into disrepute about the time of one world war (1914-1918), was brought into prominence again and received the greatest impetus for industrial and clinical development by another world war (1939-1945). War-time research and development, which demonstrated the practicability of industrial production and clinical use of penicillin, telescoped into a period of only three or four years in the early 1940's a development that might have required at least a quarter of a century in time of peace.

There are several reasons for this reversal: three are probably fundamental. First, methods of extraction and purification were not so well developed then as they are today, nor was the need for rigid standardization so well recognized. Consequently, there was often considerable qualitative variation in the composition of a given product from one lot to the next and, correspondingly, marked qualitative and quantitative difference in the reaction of the patient and in the therapeutic effectiveness of the drug. Second, the science of microbiology was relatively young, and the importance of strain variations and of starting the fermentations with organisms from pure "stock" cultures, stored under conditions designed to prevent or retard development of undesirable mutants, was not fully appreciated. This ignorance or disregard of the importance of strain variations no doubt was a major factor contributing to variability in the final product and, in the absence of adequate measures for testing and standardizing, often resulted in production and distribution of therapeutically inferior and sometimes quite toxic preparations. Furthermore, in 1910, salvarsan, or "606," was introduced successfully for the treatment of syphilis and this fact tended to divert attention from microbes as sources of chemotherapeutic agents and direct it toward synthetic organic chemical compounds. In the following years, several therapeutically active synthetics were developed, but their usefulness was

limited to treatment of infections caused by protozoa. Despite more or less continuous searching for chemotherapeutic agents clinically effective against pathogenic bacteria, 25 years elapsed before partial success was achieved when introduction of prontosil in 1935 opened the way for sulfonamide therapy of a limited number of diseases caused by bacteria. Valuable as the sulfonamides are, they are far from ideal chemotherapeutic agents (Chap. 1): therefore Fleming's observation on penicillin in 1929 and Dubos's isolation of purified crystalline antibiotics (gramicidin and tyrocidin) a few years later re-awakened interest in micro-organisms as potential sources of chemotherapeutic drugs. Research and development were further stimulated soon after by the exigencies of war and the realization that possession of an effective agent for curing infections of bacterial origin would not only be an eventual boon to mankind and would help to raise the standard of public health and to alleviate suffering, but would be of immediate value, since it would reduce loss of active personnel and, therefore, would be in its own way a valuable weapon. Hence, the wartime research program on penicillin and the search for other antibiotics, carried on at top priority levels and under the utmost secrecy, were born.

Experience gained in work with penicillin, and later with streptomycin, was soon applied to the study of a wide variety of micro-organisms and more than 75 antibiotics were recognized and named between 1945 and 1949.

In the history of antibiotics, the year 1946 will be remembered as the year in which "pure" crystalline penicillin became available on an industrial scale. Great as that achievement was in making available dry penicillin salts which no longer required refrigeration, it was soon realized that the amorphous yellow penicillin embodied a number of potentialities that the "pure" crystalline product lacked. Clinically speaking, some amorphous penicillins are now recognized as superior chemotherapeutically to crystalline penicillins. Chemically speaking, it is recognized that crude or amorphous penicillins contain metabolites such as indolacetic acid, phenylacetic acid, various di-

carboxylic fatty acids, and other compounds which may enhance the activity of penicillin against various pathogens or exert other favorable influences. One such group of impurities has been called "antidotic" because of their detoxifying action on bacterial toxins, especially after appropriate treatment. Therefore, the trend in penicillin research through 1948-1949 was back to the study of the crude liquors fermented by *Penicillium* in search of the active "impurities" that are removed and currently are discarded during purification and crystallization of penicillin. Similar lines of investigation on other antibiotics might be profitable.

Certainly at no time in the long history of medicine and pharmacy before the modern era of antibiotic chemotherapy have such important developments come in more rapid succession. Within a span of less than ten years it has become possible to effect dramatic cures in a large percentage of patients suffering from diseases previously dreaded. Even such a chronic scourge as tuberculosis can often be treated successfully with antibiotics.

What does the future hold in the realm of antibiotic research and chemotherapy? It is easy to recount what has occurred; to prognosticate the future is more difficult. Perhaps in this connection one would be wise to follow the advice of James Russell Lowell,

". . . never say nothin' without you're compelled tu,
An' then don't say nothin' thet you can be held tu."

However, one may with propriety indicate problems for future study and suggest possible developments.

To date the emphasis in research intended to reveal new antibiotics has been principally on screening large numbers of different kinds of organisms for antagonistic properties. This line of investigation should be continued, but undoubtedly, as the chemical structures of more antibiotics become known, the chemical approach to the problem of securing new antibiotics will be emphasized. Knowledge of the structure of naturally biosynthesized compounds with antibiotic activity will provide leads for the chemist to follow and will suggest chemical groupings that should be investigated.

In biosynthesis, the emphasis has been mostly on working with pure cultures, as it no doubt should be in the early stages of research. During 1948-1949, however, studies of mixed cultures have yielded interesting and promising results. Nature affords many examples of two different micro-organisms living together for indefinite times, each of the conjoints keeping the other under control through the production of chemical growth regulators; the most familiar example is that of the lichens, which have recently contributed some typical antibiotics, such as usnic acid which occurs in 17 species of the genus *Cladonia* and which inhibits *Bacillus subtilis*. In imitation of this natural example, it has been possible to reproduce in Petri dishes, various types of chemical interaction between two or more different organisms. Where two different micro-organisms can be made to live together, each one chemically controlling the other, there must occur biosynthesis of growth regulating factors or antibiotics. Some of these may be of potential chemotherapeutic value. In 1948 and 1949 chemotherapeutic agents were obtained from mixed cultures of *Penicillium notatum* with *Aspergillus flavus* and an attenuated pathogenic strain of *Mycobacterium tuberculosis* and from mixed cultures of *Penicillium* sp., *Bacillus subtilis*, and an actinomycete. The crude filtrates from such mixed cultures often contain, in addition to the antibiotics characteristic of the several biologic components of the mixture, antibiotically active ingredients not previously recognized. This line of investigation holds much promise for the future.

Clinically, major emphasis was first devoted to the study of antibiotic therapy of bacterial infections. This was, in large measure, dictated by circumstances, since the antimicrobial activity of the first antibiotics to become readily available for study was chiefly against bacteria. Later, discovery of chloromycetin and aureomycin brought rickettsial and viral pathogens within the range of antibiotic chemotherapy.

To date, relatively few fungus pathogens have been controlled clinically by antibiotics. Much current research is directed toward isolating clinically useful antibiotics for treatment of fungus diseases

and it seems reasonable to expect success. Already several biosynthetic compounds capable of inhibiting the growth of pathogenic fungi *in vitro* and that show clinical promise are known.

Antibiotic chemotherapy is well established for susceptible infections in man and his domestic animals; but the problem of applying similar technics for the control of plant diseases has received little attention, beyond the mere recording of the fact that crown gall, due to *Phytoplasma tumefaciens* (*Bacterium tumefaciens*), and tobacco mosaic, due to a virus, can be controlled by certain products of fungus metabolism.

Several antibiotics have been shown to have greater toxicity for cancer cells than for normal cells, and although antibiotic therapy of cancer is not a clinical reality at present, some of the experimental results warrant further research. This is especially true in view of the demonstration that at least some types of cancer may be caused by an infectious virus and that certain fungus metabolites are capable of inhibiting the phytopathogenic virus causing tobacco mosaic.

The business of producing antibiotics on a large scale is too new an industry for the matter of useful by-products to have received more than passing attention. However, it is already apparent that the antibiotics industry may make useful contributions in this direction. The penicillin mold mat, when removed from fermentation liquors and dried, has been used experimentally as feed for chickens, hogs, and other domestic animals. It is also a rich source of ergosterol. Of great interest to the pharmacist and physician and to the patient, since it is he who ultimately foots the bill for medication, is the discovery that vitamin B₁₂ may be obtained in industrial yields from cultures of *Streptomyces griseus* used for biosynthesis of streptomycin. Formerly, this vitamin, which embodies the cobalt-containing complex that is effective in the treatment of pernicious anemia, was obtainable only from liver extracts and was quite costly. Production of the vitamin as a by-product of the streptomycin industry might serve to effect a decline in cost of both the basic product, streptomycin, and the by-product. Other developments undoubtedly will follow.

The "growth curve" showing the number of recognized antibiotics (Fig. 50) is still rising abruptly and probably will continue to do so for many years to come. As another measure of growth, one might consider the number of antibiotics given official status in the United States Pharmacopoeia and the National Formulary. Of 211 new items admitted to the U.S.P. XIV, 18 are antibiotics or preparations thereof and seven are compounds, such as polyethylene glycols (Carbowax), polysorbates (Tweens), propylene glycol, etc., that are used as vehicles for antibiotics. Thus, more than 10 per cent of the newly admitted items pertain directly to antibiotics. This is the largest percentage gain for any single class of medicament and attests the increasingly dominant position of antibiotics with respect to other drugs.

Even if one does not consider the significance of recoveries from infections likely to be fatal in the pre-antibiotic days, it may be concluded that the money invested in the development of antibiotics has already paid high dividends: not only has the industrial development of antibiotics been financially beneficial to the pharmaceutical industry and the pharmaceutical profession in the United States but to the civilized world as a whole. Antibiotics made available to European countries have gone far toward compensating the war's devastating effects on public health. For example, it has been estimated that, thanks principally to antibiotics, the mortality in France in 1947 was reduced 30 per cent from the level of the last pre-war year (1938). As the economic condition changes so that foreign nations have more dollars available for importing American goods and as they become able to produce more antibiotics themselves, the public health picture with respect to infectious diseases should become increasingly brighter.

What does the future hold in the way of antibiotic chemotherapy? Pasteur and Joubert, in commenting on their observations in 1877, stated what is still, after more than 70 years, the best answer to this question when they wrote, "These facts (microbial antagonisms) perhaps justify the highest hopes for therapeutics."

Index

(Only those authors are listed whose work is of historical significance or whose papers are cited in the References or in the Suggested Readings at the ends of chapters. Authors' names appear in capitals; names of organisms, in italics.)

- ABRAHAM, E. P., 88, 117
Absorption, of antibiotics. *See under specific antibiotic*
Acetates, effect of on streptomycin assay, 137
Acetic acid, in penicillin biosynthesis, 68
 derivatives of, as enhancing factors, 75, 90
 in penicillin biosynthesis, 90
3-Acetyl-6-methoxybenzaldehyde, antibiotic principle of *Encelia*, 17
Acids. *See specific compounds or types*, i. e., glutamic, penicilloic, pyruvic, etc., or aliphatic, amino, etc.
Actidione, 184, 196-197
Actinomyces. *See also Streptomyces*
 antibiotics from, 5, 184-185, 195-200, 239
 toxicity of, 196
 WAKSMAN'S researches on, 5, 11, 120
Actinomyces bovis, 83
 griseus. *See Streptomyces griseus lavendulae*, 185
 lysozyme, 184
 violaceus, 184, 185
Actinomycetes. *See also Actinomyces and Streptomyces*, 88, 119-120
Actinomycetin, 184
Actinomycin, 51, 55, 184
Actinomycosis, penicillin in, 83, 84
Actinophage, 124-125, 152
Actinorubin, 184
Activators, 89. *See also under specific antibiotic*
Adjuvants, in biosynthesis, 62
 to enhance antibiotic activity, 90, 92, 141, 165
Aeration, in biosynthesis, 32, 39-40, 65
Aerobacillus polymyxa, 167
Aerobacter aerogenes, 132, 136, 140
Aerosols, of penicillin, 107, 109-110
Aerosporin. *See Polymyxins*
Agar, in assay of antibiotics, 20, 23, 228-229
AINSWORTH, G. C., 171
Alanine, in penicillin biosynthesis, 70, 72
Alcaligenes faecalis, 132
Algae, as source of antibiotics, 16, 19, 189
Aliphatic acids, in biosynthesis, 69, 74-75
Alkaline phosphatase, 211, 219-221
Allicin, 202
Alliin, 202
Allium cepa, 202
 sativum, 202
All-or-none response, 19, 43, 48
Aluminum, in penicillin biosynthesis, 65, 72
 monostearate, in penicillin suspensions, 111
Amino acids, in antibiotics, 70, 170, 175, 177
 in biosynthesis, 70-72, 125, 152
Amino groups, importance in antibiotic action, 59

- Amylolytic factor, 182
Anemonin, 202
Antagonism, among antibiotics, 164, 235
 due to chemical inhibitors, 3, 17
 among *Encelia* plants, 16-17
 among higher plants, 16-17
 among micro-organisms, 2-4, 15-17
 by walnut trees, 17
Anthrax, 3, 4, 10
Antibiosis, concept of, 1-8, 15
 definition of, 1-2
Antibiotic XG, 182
Antibiotics. *See also specific antibiotic*
 biologic (antibiotic) spectrum of, 31, 55-59
 biosynthesis of, 35-39
 criteria for identification of, 181-182, 206-208
 danger from indiscriminate use of, 86
 definition of, 2, 206
 derived from actinomycetes, 184-185
 algae, 189
 bacteria, 182-184
 fungi, 186-188
 higher plants, 201-203
 lichens, 189
 paramecia, 189
 factors influencing action of, 86-96
 history of, 2-7, 61, 128
 industrial production of, 27-54, 87
 biologic problems in, 32-40, 42-43
 by-products of, 240
 engineering problems in, 36
 magnitude of, 6-7
 requisites for ideal, 29-30
 selection for therapy, 31, 86
 from soil micro-organisms, 11, 119, 152, 156, 167, 173
 unitage, 127-129. *See also specific antibiotic*
Antidotic effects of antibiotics, 200, 238
Anti-smegmatis factor, 185
Antistreptolysin, 117
Arctium minus, 202
Aspergillic acid, 186
Aspergillin, 186
Aspergillus clavatus, 180, 186
 flavus, 180, 186, 187, 188, 239
 fumigatus, 187, 188
 giganteus, 180, 187
 niger, 186
 niveus, 186
 oryzae, 89, 187
 parasiticus, 180, 187
 terreus, 186
 ustus, 188
Assays. *See also* Testing, biologic, 20, 42-50, 208-209, 211, 214, 222-223
 chemical, 49
 physical, 49
ATP, formation of inhibited by gramicidin, 230
Aureomycin, 55, 117, 151, 156-166, 185, 239
 antagonists of, 164-165
 antibiotic spectrum of, 83, 156-161, 163
 assay of, 158
 chemistry of, 160-161
 chemotherapeutic use of, 161-166
 dosage, 162-163
 excretion, 164
 interaction with other antibiotics, 164-166
 resistant organisms, 159-160
 salts of, 160, 163
 toxicity of, 163-164
Autoantibiosis, 19
Avenacein, 186
AVERY, O T., 25

BABES, V., 3
Bacillin, 182, 189
Bacillosporin. *See* Polymyxins
Bacillus abyseus, 184
 aerosporus, 167
 anthracis, 3, 10, 83, 93, 195
 borborokoites, 184
 brevis, 5, 11, 173, 182, 184

- Bacillus* (Continued)
cereus, 89
circulans, 182
larvae, 184
licheniformis, 183
polymyxa, 167, 179, 183
prodigiosus, 83
submarinus, 184
subtilis, 83, 127, 158, 182-184, 210, 214
 antibiotics from, 182-184, 189-194, 239
thalassokoites, 184
tularensis, 132, 140
Bacitracin, 83, 91, 182, 189-192
 antibiotic spectrum of, 190-191
 toxicity of, 191-192
 unit, defined, 190
Bacteremia, 146, 163
Bacterium tumefaciens, 240
BAILEY, J. H., 203, 233
Barium, effect of on streptomycin assay, 137
BENEDICT, R. G., 167, 171, 203
Benzoic acid, to retard excretion of penicillin, 113-114
 p-amino—, growth factor for *Mycobacterium*, 142
 metabolic antagonist for streptomycin, 142
Benzyl penicillin. *See* Penicillin
Bio-assay. *For general methods, see* Assays; *for various test organisms, see under specific antibiotic*
Biformic acid, 186
Biformin, 186
Biologic spectrum, definition of, 2. *See also* Antibiotics
Biosynthesis, 32-40, 239. *See also specific antibiotic*
 by autotrophic organisms, 38
 by-products of, 240
 by heterotrophic organisms, 38
 definition, 35-36
 precursors in, 62, 65, 68, 72, 125
Bismuth, 91-92
Blastomyces, sp., 83
Blood, effect on antibiotic action, 133, 161, 177
 clotting, effect of penicillin on, 116-117
 levels of antibiotics. *See specific antibiotic*
Borrelia recurrentis, 155
Borrelidin, 90-91, 185
BOVET, D., 54
BRIAN, P. W., 203
Brill's disease (epidemic typhus), 162
Bromosaligenin, with oral penicillin, 107
Brucella abortus, 10, 83, 132, 170
 melitensis, 132, 140
 suis, 132
 tularensis, 140
Brucellosis, 140, 163
BRUNEL, J., 61, 117
BUGIE, E., 150
BURKHOLDER, P. R., 166
Calciferol, enhances action of streptomycin, 139
Calcium, chloride complex of streptomycin, 122, 126
 effect of on streptomycin assay, 137
 penicillinate, 68
Calibration curves, 46, 47
Cancer (sarcoma) cells, effect of antibiotics on, 89, 201, 240
Candida albicans, 202
Candidulin, 186
Carbon, activated as adsorbent in purification of antibiotics, 77, 126
 atoms, alpha in fatty acids, important in penicillin biosynthesis, 70-72
 asymmetric in antibiotics, 62, 153
Caronamide, to delay penicillin excretion, 114-115
 toxicity of, 115
Cations, effect of on streptomycin assay, 137
CAVALLITO, C. J., 203, 233
Cephalin, complex of with streptomycin, 148

- Certification of antibiotics, 53
Cetraria islandica, 189
CHAIN, E., 88, 117
Chaetomin, 186
Chaetomium chochlioides, 186
Charcoal. *See* Carbon, activated
Chemotherapy, definition of, 27, 29
vs. prophylaxis, 29
Chlamydozoaceae, 164
Chlorella pyrenoidosa, 189
vulgaris, 13, 15, 18-19, 189, 233
Chlorellin, 16, 19, 189
Chloramphenicol. *See* Chloromycetin
Chlorides, effect of, on streptomycin
assay, 137
Chloromycetin, 31, 83, 151-156, 185,
239
antibiotic spectrum of, 152, 155
assay of, 152
chemistry of, 152-153
chemotherapeutic use of, 153-156
dosage of, 155-156
toxicity of, 152, 155-156
unitage of, 152
Chlororaphin, 182
Cholera, 4
Chromium, in penicillin biosynthesis, 68
Chromobacterium iodinum, 182
prodigiosum, 183
violaceum, 184
Circulin, 183
Citrates, effect of on streptomycin as-
say, 137
Citrinin, 186
Clarase, 89. *See also* Penicillinase
Clavacin, 179, 186, 200
Clavatin, 186
Claviformin, 179, 186
Clitocybe gigantea, 186
Clitocybin, 186
Clostridium botulinum, 83
perfringens, 83
septicum, 83
tetani, 10
Welschii, 168
Cobalt, enhances effect of penicillin,
90, 92, 214, 223-224, 229
present in vitamin B₁₂, 240
Coccidioides immitis, 202
Colicine, 183, 194
Colistatin, 183
Concentration, optimal, 19, 23, 224
threshold, 19, 22, 43-45, 97, 209,
214, 217
Copper, inactivates penicillin, 79
in penicillin biosynthesis, 64, 68, 72
Corn steep liquor, as source of bor-
relidin, 91
composition of, 65, 72
in biosynthesis of antibiotics, 65, 72,
122, 125, 168
CORNIL, C. V., 3
Corylophilin, 186
Corynebacterium diphtheriae, 83, 182,
184, 195
Crown gall, effect of penicillin on, 240
Cryptococcus neoformans, 197, 199
Cup-plate assay. *See* Cylinder-plate
assay
Curling factor, 186, 200
Curves, calibration, 46, 47
cumulated for antibiotics, 180
death, 15
"die-away" for penicillin in serum,
101-102, 104, 108
dosage-response, 23, 45-47, 128,
223
growth, 12-15
artificial modification of, 18-19
reference, in assays, 46, 47
sigmoid, significance of, 14
standard, 46, 47
Cyanates, effect of on streptomycin,
131
Cyclohexane, in streptomycin, 120,
126
1,3-diguanidino-2,4,5,6-tetrahy-
droxy—, 120
Cyclopeptides. *See* Gramicidin S,
Polymyxin, Tyrocidin
Cylinder-plate assay, 20-22, 43-48, 214
compared with serial dilution assay,
45-46, 222-223
modified cylinder-plate assay, 208
209, 222

- Cysteine, derivatives in penicillin, 68-70
interaction with antibiotics, 130
- Dehydrogenases, effect of antibiotics on, 211-212, 216, 219-223, 230
- DEMEREK, M., 233
- Dermatomycoses, antibiotic therapy of, 199, 201
sensitize patients to penicillin, 116
- Desoxyribonucleic acid, complex with streptomycin, 138-139
- Diffusion, of antibiotics, 15, 18, 20-21
field of, defined, 12
significance of fields of, 9-24
- Dihydrostreptomycin, 122-150, 185.
See also Streptomycin
chemistry of, 122-123
preparation of, 126, 127
toxicity of, 122, 131, 141, 147-150
- Dihydrostreptomycin B, 123
- Diphtheria, 4
- Diplococcin, 183
- Diplococcus pneumoniae*, 83, 90, 93, 168, 174
- DOMAGK, G., 28, 53
- Dosage. *See under specific antibiotic*
- DUBOS, R., 5, 11, 25, 173, 175, 178
- DUFRENOY, J., 25, 117, 233
- DUGGAR, B. M., 156, 166
- DULANEY, E. L., 125, 150
- Duomycin. *See* Aureomycin
- EAGLE, H., 24, 102, 103, 117
- Eberthella typhosa*, 10, 83, 89, 90, 91, 124, 132, 168, 188, 214, 223
- EHRlich, J., 166
- EHRlich, P., 27, 28
- Electrodialysis, in purification of antibiotics, 41
- Electrostatic field, on assay plates, 210
- Emetine, 27, 201
- Empyema, 137
- Encelia*, 16
- Endamoeba histolytica*, 192
- Endocarditis, bacterial, penicillin in, 84
- Endosubtilysin, 183, 189
- Enhancement factors, 89-92. *See also under specific antibiotic*
- Enniatin A, B, 186
- Ephedrine, to delay absorption of penicillin, 112
- Epinephrine, to delay absorption of penicillin, 112
- Erdin, 186
- Ergosterol, from *Penicillium*, 240
- Erysipelothrix rhusiopathiae*, 83, 168
- Escherichia coli*, 83, 90, 107, 127, 128, 135, 136, 140, 144, 152, 168, 182, 210, 214
antibiotics from, 194
cytochemical response to antibiotics, 225-228
factor, 186
morphologic response to antibiotics, 225-227
penicillinase from, 88
- Eumycin, 183, 189
- Excretion of antibiotics. *See under specific antibiotic*
- Expansin, 179, 186
- Extraction, of antibiotics, 32, 40-42
- "F" factor, 185
- Fatty acids, in penicillin biosynthesis, 72-75
- F. D. A. *See* Food and Drug Administration
- Fermentation, 34-40. *See also* Biosynthesis
aerobic, 39
submerged, 32-40
"submerged-surface," 96
surface, 32, 34
- Fibrin, 146
- Flavacin, 187
- Flavatin, 180, 187
- Flavicipin, 180, 186
- FLEMING, A., 4, 7, 61, 118
- FLOREY, H. W., 4, 8
- Food and Drug Administration, certification of antibiotics, 53
official tests, 53
regulations, 76, 80, 95

- Formaldehyde, tyrocidin complex, 177
FORNEAU, E., 28, 54
FREDERICQ, P., 203
Fructigenin, 187
Fumaric acid, effect of on Streptomycin assay, 138
Fumigacin, 187
Fumigatin, 187
Fusarium avenaceum, 186
 fructigenum, 187
 javanicum, 187
 lateritium, 187
 lycopercici, 187
 orthoceras var. *enniatium*, 186
 sambucinum, 188
 scirpi, 188

GALE, E. F., 213, 233
Garlic, 202
Gas gangrene, 10, 84
Gelatin, in assays, 23
 for delaying absorption of antibiotics, 109
Geodin, 187
Gigantic acid, 180, 187
Gladiolic acid, 187, 200
Gliocladium fimbriatum, 187
Gliotoxin, 83, 186, 187, 200
Globulin, effect on gramicidin and tyrocidin, 177
Glucosamine, N-methyl, 120, 121, 123
Glucose, 2-(methyl amino), 120-121, 123
Glutamic acid, role of, in penicillin action, 213-216
Glutamine, role of, in penicillin action, 213-216
Glutathione, in penicillin action, 214-216
 stereochemical relation to penicillin, 215
Glutinosin, 187, 200
Glycine, in penicillin biosynthesis, 70, 72
 in penicillin therapy, 114
GOLDSTEIN, A., 150
Gonococci. *See* *Neisseria*
Gonococcic infections, penicillin in, 82
Gonorrhoea, 82, 107
Gramicidin, 11, 174-178, 183, 206, 229-230, 237
Gramicidin S, 175, 183
Gram-negative micro-organisms, 31, 56, 119-120, 182-189. *For reaction to different antibiotics see also specific antibiotic*
Gram-positive micro-organisms, 31, 56, 119-120, 182-189. *For reaction to different antibiotics see also specific antibiotic*
Gram-positive reaction, loss of under influence of penicillin, 210, 213
Grisein, 185
Griseofulvin, 187, 200
Growth, enhancement of by antibiotics, 20-22, 51, 208, 210, 217
 of test organisms, 48
 post-lytic waves of, 48, 103, 135, 158, 217-218
Guanido groups, in streptomycin, 121
 shock due to, 148

Helvolic acid, 187
Hemophilus influenzae, 83, 140
 pertussis, 83, 170
Hippuric acid, in penicillin therapy, 114
Hirsutic acid A, C, N, 187
Histoplasma capsulatum, 202
HOTCHKISS, R. D., 175, 178
Hydroxylamine hydrochloride, 51, 89, 130
Hypothrombinemia. *See* Blood, clotting

3-Indole acetic acid, 75, 237
Indophenol oxidase, effect of penicillin on, 211

- Infection, effect of duration of, on success of antibiotic therapy, 136
- Inhibition, zone of, 20-22, 227. *See also* Assays, Testing
- Iodinin, 182
- Janus Green, in penicillin assay, 222
- Javanicin, 187
- JOUBERT, J., 1, 3, 8, 241
- Juglans hindisii*, 17
- Juglone, 17, 202
- KAVANAGH, F., 203
- Klebsiella pneumoniae*, 83, 132, 168, 170
- KOCH, R., 23
- KOFFLER, H., 65
- Kojic acid, 187
- KRAMPIZ, L. O., 233
- Lactate, effect of, on streptomycin assay, 137
- Lactobacilli, as test organisms for assays, 44
- Lactobacillus casei*, 187
- Lactococci, as test organisms for assays, 44
- Lactose, in penicillin biosynthesis, 65, 66
- LANGLYKKE, A. F., 167, 171, 203
- Lateritin-I, -II, 187
- Lauric acid, 202
- Lavendulin, 185
- Leprosy, 140, 178
- Licheniformin, 183
- Lichens, usnic acid from, 189
- LIGGETT, R. W., 65
- Linoleic acid, in penicillin biosynthesis, 74, 75
- LINZ, R., 233
- Lipositol, inhibits streptomycin, 139
inhibits polymyxins, 171
- Litmocidin, 185
- LUTERAAN, Ph. J., 203
- Lycomarasmin, 187
- Lycopersicin, 202
- Lymphogranuloma venereum, 163
- Lyophilization of antibiotics, 42
of stock cultures, 35
- Lysine, liberation of during bacteriolysis, 173-175
- MACHEBOEUF, M., 233
- Magnesium, effect of, on streptomycin assay, 137
- Malaria, 27
- Mass action, law of, in biosynthesis of penicillin, 74
- Mastitis, 178
- Mechanisms of antibiotic action
penicillin, 208-224
streptomycin, 224-229
tyrothricin, 229-230
- Meningitis, 84, 97, 146
- Metabolism, effect of rate of, on response to antibiotics, 48-49, 92, 135, 158, 174, 218, 229-231
- Metarrhizium glutinosum*, 187
- 2-Methyl-4-amino-1-naphthol hydrochloride (vitamin K₈), 90
- Micrococcus infimu*, 184
maripuniceus, 184
sedimenteus, 184
- Micromonosporin, 185
- Monilia* sp., 83
- Mononucleotidase, 219-221
- Mononucleotides, 214, 218-221
- Musarin, 185
- Mustard oil, 202
- Mutations, affecting biosynthesis of antibiotics, 32-34, 124, 156, 236
affecting response of pathogens to antibiotics, 230-231
- Mycetin, 185
- Mycobacterium phlei*, 186
tuberculosis, 12, 83, 120, 132, 182, 183, 185, 186, 188, 199, 239
discrimination between streptomycin sensitive and resistant strains, 146
PAS retards development of resistance, 142
- Mycocidin, 187

- Mycoin C, 187
Mycomycin, 185
Mycophenolic acid, 180, 187
Mycosubtilin, 183, 189
- Neisseria catarrhalis*, 192
 gonorrhoea, 82, 83, 85, 93, 192
 intracellularis, 83
Neomycin, 185, 199-200
Nicin, 183
NITTI, F., 54
Nocardia acidophilus, 185
 coeliaca, 185
Nocardin, 185
Norvaline, in biosynthesis of penicillin,
 72
Notatin, 187
Nucleotides, in mechanism of antibi-
 otic action, 214, 218-221,
 227-229
- Oils, as vehicle for antibiotics, 110
 in penicillin biosynthesis, 73-75
Oxidation-reduction, threshold for, 222
 as means of assaying penicillin, 223
Oxphenazine, 183
- PAB. *See* Benzoic acid, *p*-amino
"Paper-disk" method of assay, 47-48
Paramecin, 189
Paramecium aurelia, 189
Parasitacin, 180
Parasitism, 9, 187
 origin of, 57
PAS. *See* Salicylic acid, *p*-amino
PASTEUR, L., 1, 3, 8, 27, 241
Pasteurella pestis, 132, 140, 195
 multocida, 83, 170
Patulin, 179, 188, 200
Pectin, for delaying absorption of anti-
 biotics, 109
Pelargonic acid, 203
Penatin, 188
Penicidin, 188
Penicillamine, 70, 78
Penicillic acid, 188
Penicillin, 31, 55, 61-118, 188, 207-
 224, 226, 229
- Penicillin (*Continued*)
 A, 188
 absorption, factors influencing, 98
 retardation of, 107-112
 action of, prolonging, 109-116
 by pharmaceutical means, 109-
 112
 by physiological means, 112-116
 administration, continuous vs. dis-
 continuous, 103-104, 117
 routes of, 98-112
 amorphous, enhancing factors in, 92
 vs. crystalline, 75, 79-80, 89-90,
 94-96
 n-amyl, 63-64, 73
 antagonists of, 88, 206
 antibiotic spectrum of, 62, 82-86,
 93, 95, 98, 225
 assay of, 42-49, 223
 B, 188
 benzyl, 63-64, 73-74, 78, 90, 93,
 102, 104-106, 112, 128, 129
 p-hydroxy—, 62-64, 73-77, 92,
 93, 96, 104, 106
 biosynthesis of, 62, 64-75, 95
 pathways of, 70
 precursors for, 62, 68-69, 72-75, 95
 yield from different strains of
 Penicillium, 32-34, 65-69,
 73, 94, 96
 blood levels of, following different
 methods of administration,
 97-116
 chemistry of, 62-64, 69-74, 78-79,
 87, 120
 chemotherapeutic use of, 28, 97-117
 comparison of different types, 63-64,
 93
 crystalline vs. amorphous, 75, 79-
 80, 89-90, 94-96
 cytochemical effects of on bacteria,
 211-224
 dihydro F. *See* Penicillin, *n*-amyl
 dosage of, 84-85, 103
 enhancing factors, 75, 87, 89-92, 95
 excretion of, 62, 98-109, 112
 methods of delaying, 112-116
 extraction of, 75-77, 87

Penicillin (Continued)

- F. *See* Penicillin, Δ^2 pentenyl
 G. *See* Penicillin, benzyl
 heptyl, 63-64, 73, 90, 94-95, 104-106
 infections in which indicated, 98
 K. *See* Penicillin, heptyl
 mechanism of action, 208-224
 contrasted with streptomycin, 225-229
 Δ^2 pentenyl (F), 63-64, 73, 93, 95, 105
 Δ^3 pentenyl (flavicipin), 63-64, 73
 pharmaceutical forms
 aerosols, 107-109
 aqueous solutions, 98-106
 insoluble salts, 109-112
 suspensions, 109-112
 purification of, 75-77
 resistant organisms, 82-86, 88
 lower metabolism of, 88, 92
 salts of, 64, 75-76, 78, 104, 111-112
 stability of, 76-81, 87, 105-106, 206
 synergists, 89, 223
 toxicity of, 28, 52, 82, 107, 110, 116-117, 229
 unit, defined, 44, 128
 X. *See* Penicillin, *para*-hydroxy benzyl
- Penicillinase, 79, 88-89, 107
 Penicillin-crustocin, 188
Penicillium, biosynthetic aptitude of
 different species, 68, 73, 94
 antibiotics from, 62, 186-188
 aurantu-virens, 188
 brevi-compactum, 187
 claviforme, 179, 187
 chrysogenum, 32, 62, 65, 75, 94, 96
 expansum, 179
 gladioli, 187
 janczewskii, 186
 notatum, 32, 62, 65, 93, 96, 187, 239
 patulum, 179
 puberulum, 188
 spinulosum, 188
 tardum, 188
 terrestre, 188
- Penicilloic acid, 78
 Penillic acid, 78
 Pertussis, polymixin therapy of, 170
 Phage. *See* Actinophage
 Phenaceturic acid, 68
 Phenolphthalein phosphate, reagent
 for phosphatase, 221, 227
 Phenylacetic acid, 65, 68, 73-75, 90, 95, 237
 Phosphatases, effect of penicillin on, 211, 219-221
 Phosphates, as stabilizers for penicillin, 80-81
 effect of on streptomycin assay, 137
 Phthiocol, 183
 Phycomyces factor, 188
 Phytopathology, use of antibiotics in, 194, 197, 200, 202, 240
Phytomonas solanacearum, 202
 tumefaciens, 240
Phytophthora sp., 188
 Plague, bubonic and pneumonic, 4, 140
Pleuroteus griseus, 188
 Pleurotin, 188
 Plumbagin, 202
 Pneumonia, penicillin in, 84, 104
 Polymyxins, 31, 55, 83, 167-171, 183
 amino acid content of, 170
 antibiotic spectrum, 168-169
 assay of, 169
 chemistry of, 169-170
 dosage, 170
 toxicity of, 168
 unit, defined, 169
 Polyporin, 188
Polyporus bififormis, 186
Polystictus sanguinensis, 188
 Population, microbial compared with human, 1, 12, 17
 Potassium iodide, used conjointly with streptomycin, 141
 in penicillin biosynthesis, 64, 66-68
 penicillinate, 64
 Potency, molar comparison of penicillin and streptomycin, 129
 PRATT, R., 1, 8, 12, 25, 118, 233

- Precursors, 39
 as enhancing factors, 90
 in penicillin biosynthesis, 62, 65, 68, 72-75, 95
 in streptomycin biosynthesis, 125
Proactinomyces cyaneus, 185
Procaine penicillin, 64, 111-112
Prodigiosin, 183
Proline, in streptomycin biosynthesis, 125-126
Promin, in streptomycin chemotherapy, 141
Promizole, in streptomycin chemotherapy, 141
Protosil, 28, 237
Prophylaxis vs. chemotherapy, 29
Proteus vulgaris, 83, 132, 136, 140, 214
Pseudomonas aeruginosa (*Ps. pyocyanea*), 4, 83, 132, 135, 136, 140, 144, 168, 170, 183
 antibiotics from, 195
 chlororaphis, 182
Psittacosis, 82, 151, 155, 163
Puberulic acid, 188
Puberulonic acid, 188
Pyo compounds, 183
Pyocyanase, 4, 183, 195
Pyocyanin, 183
Pyolipic acid, 183
Pyrogens, separation by electrodiagnosis, 41
 test for, 52
Pyruvates, effect of on streptomycin assay, 137
Pyruvic acid, interaction with streptomycin, 137
Pythium sp., 188

Q-fever, 155, 162
Quinine, 27, 201

RAMON, G., 90, 118
Raphanin, 202
Raphanus sativus, 202
Redox indicators, in assays of antibiotics, 221-223
Relapsing fever, 155

Renal blocking agents, for delaying excretion of antibiotics, 112-116
Replacement therapy, 3-4
Resistance of pathogens, development of, 142-146, 230-233
 induced by streptomycin, 142-146
 effect of PAS on, 141-142
 induced by sulfonamides, 4, 28
 relation to alternative metabolic pathways, 58-59
RICHET, C., 23, 25
RICHOU, R., 90, 118
Rickettsia, 82, 83, 151, 156, 185
 nipponica, 153
 prowazekii, 153
 rickettsi, 155
 tsutsugamushi, 153
Ringworm, 203
RITTMAN, G. E., 110
Rocky Mountain fever, 155, 161
ROMANSKY, M. J., 110
ROQUES, H., 153, 166
Rubber, inactivation of penicillin by, 79
"Run-down" of antibiotic-producing organisms, 35, 124
Rutin, masks activity of tomatine (lycopersicin), 202

Saccharomyces cerevisiae, 210
Salicylic acid, *p*-amino, in streptomycin therapy, 141
Salmonella enteritidis, 83, 132
 paratyphi, 83, 132
 schotmülleri, 132, 152, 168, 200
"Salt effect," in assay of streptomycin, 137-138, 228
Salvarsan, 236
Sambucinin, 188
Sarcina lutea, 91, 184
Sarcoma, inhibition of by amorphous penicillin, 89, 201, 240
SCHATZ, A., 150
Serial dilution assay, 43-45, 48-49
 compared with cylinder-plate assay, 45-46
Serine, nephrotoxic factor in polymyxin, 168

- Serine (*Continued*)
 glutathione as antagonist of, 215
 in penicillin biosynthesis, 70, 72
Serratia marcescens, 83
Shigella dysenteriae, 83, 140, 168
 paradysenteriae, 83, 132, 152
Sigmoid curve, significance of, 14
 artificial modification of, 18
Simplexin, 183
Sinusitis, aureomycin in treatment of, 164
SMITH, E. L., 80, 118
"Social" physics, 12, 25
Sodium benzoate with oral penicillin, 107
 nitrate in penicillin biosynthesis, 65-68
 penicillinate, 64, 111
 phosphate in stabilizing penicillin, 80-81
 sulfanilate with oral penicillin, 107
Soil, organisms in, 10-11, 119, 152, 156, 167, 173
Soy bean, in biosynthesis of antibiotics, 125, 168, 190
 molded curd of, as source of antibiotics, 2
Spectrum. *See* Antibiotics, biologic spectrum
Spinulosin, 188
STANLY, P. G., 167, 171
Staphylococcus albus, 83
 aureus, as test organism, 44, 46, 128, 190, 192, 209, 214
 sensitivity to antibiotics, 83, 91, 93, 94, 133, 135, 163, 200
 mitis, 184
Stereum hirsutum, 187
Sterility, need for in production of antibiotics, 37-38, 42
Sterility tests, 49, 89
STEWART, J. Q., 12, 25
Streptamine, 130
Streptidine, 120-121, 130
Streptin, 185
Streptobiosamine, 120-121, 126, 130
Streptocin, 185, 196
Streptococcus agalactiae, 183
 faecalis, 83, 156, 175
 hemolyticus, 90
 lactis, 183
 pyogenes, 83, 93, 133, 158
 salivarius, 83
Streptokinase, 146
Streptolysin, 117
Streptomyces, antibiotics from, 120, 151. *See also Actinomyces*
 albus, 184
 aureofaciens, 156, 185
 bikiniensis, 123, 185
 fradiae, 185, 200
 griseus, 124, 184, 185, 196, 240
 lavendulae, 185, 197
 venezuelae, 152, 185
Streptomycin, 5, 11, 31, 55, 83, 86, 92, 119-150, 185, 207
 absorption of, 139, 146-177
 anaphylactic reactions to, 122, 125, 148
 antagonists of, 130-131, 135, 137
 antibiotic spectrum of, 120, 131-138, 140, 225
 factors influencing, 131, 139
 assay of, 126-127, 137
 B, 123, 185
 biosynthesis of, 124-126
 blood levels, 146-147
 calcium chloride complex, 122, 126
 chemistry of, 120-123
 chemotherapeutic use of, 139-150
 cytochemical effects of, 226-229
 dependent organisms, 130, 134
 dihydrostreptomycin, 122, 127, 131-150, 185
 discovery of, 120
 dosage, 141, 143-145, 147-150
 excretion, 146-147, 149
 extraction of, 126
 inactivators, 130-131
 indifferent organisms, 143
 infections in which indicated, 140-142
 joint use, with penicillin, 87, 91
 with sulfonamides, 87

- Streptomycin** (*Continued*)
 mechanism of action, 138-139, 224-229
 contrasted with penicillin, 226, 229
 precursors for, 125
 residual form, 123-124
 resistant strains, 133-134, 136, 139, 140, 142-146, 227, 229-233
 "salt" effect, 137-138, 228
 salts, 121, 127
 sensitive organisms, 132, 142
 stability of, 129-131
 synergists, 91
 tolerant organisms, 142
 toxicity of, 120-122, 125, 131, 140-141, 147-150, 198, 229
 antidotes for, 148
 unit, defined, 127-129
 II, 123, 185
- Streptose**, 120-121
- Streptothricin**, 185, 197-199
 antibiotic activity, 185, 197
 toxicity, 198
- Subtenolin**, 183, 189
- Subtilin**, 12, 83, 183, 189, 192-194
 antibiotic spectrum, 192-193
 as a seed disinfectant, 194
 resistant strains, 193
 stability of, 192
 toxicity of, 193
 unit defined, 192
- Subtiline**, 183, 189
- Subtilyne**, 183, 189
- Subtilysin**, 183, 189
- SH**. *See* Sulphydryl
- Sulfactin**, 185
- Sulfates**, effect of on streptomycin assay, 137
- Sulfatrene**, in streptomycin chemotherapy, 142
- Sulphydryl groups**, detection on assay plates, 211, 216
 in antibiotic molecule, 68-71
 importance in antibiotic action, 59, 210-212, 214-217
 in penicillin biosynthesis, 72
- Sulfite waste liquor**, in penicillin biosynthesis, 68
- Sulfonamides**, 5, 28, 94, 139
 effect of number of organisms on action of, 87
- SULLIVAN, N. F.**, 111, 118
- Symbiosis**, 9
- Synergism**. *See under specific antibiotic*
- Synergists**, 89, 91-92, 139, 165. *See also under specific antibiotic*
- Syphilis**, 27, 82, 89, 147
- Tardin**, 188
- Tartrates**, effect of on streptomycin assay, 137
- TAYLOR, E. S.**, 233
- Testing**, 32, 42
 potency, 42-48
 pyrogen, 52, 53
 sterility, 49-51, 89
 toxicity, 51-52
- Tetanus**, 10
- Thiols**, inactivation of antibiotics by, 206
- Tomatin**, 202
- Tomatine**, 202
- Toxicity**. *See specific antibiotic; also Testing*
- TREFOUËL, J.**, 54
- Treponema pallidum*, 89, 93, 193
- Trichoderma lignorum*, 187
viride, 188
- Trichomonas vaginalis*, 185, 196
- Trichothecin**, 188, 200
- Trichothecium roseum*, 188
- 2,3,5-Triphenyltetrazolium chloride**, as test reagent, 216, 221
- Trombicula akamushi*, 153
deliensis, 153
- Trypan blue**, as test for mononucleotides, 225-227
- Trypanotoxin**, 184, 189
- Tuberculosis**, 4, 86, 119, 131, 140, 144, 238
- Tularemia**, 140, 146
- Turbidimetric assays**, 44, 49
- TYNDALL, J.**, 3, 8

- Typhoid fever, 10, 163
Typhus, 151, 153
Tyrocidin, 174-178, 184, 206, 237
 mechanism of action, 229-230
Tyrothricin, 51, 55, 169, 173-178, 184, 207
 antibiotic spectrum of, 173, 177
 biosynthesis of, 173-174
 chemistry of, 175-177
 mechanism of action, 229-230
 toxicity, 5, 51, 177-178
Tyrothrix sp., 173
- Ultra violet radiation, use of to produce mutants, 33, 156
Umbellularia californica, 202
Undulant fever, 10, 140, 155
Unit, principles for basis for comparison of antibiotics, 126-129
 defined, for bacitracin, 190
 penicillin, 44
 polymyxin, 169
 streptomycin, 127
 subtilin, 192
Urea, inhibits streptomycin, 139
Urginea maritima, use of in typhus, 153
Urethritis, 163
Usnic acid, 189, 239
Ustin, 188
- Valine, precursor in penicillin biosynthesis, 70, 72
Vasoconstrictors, use of to prolong penicillin action, 109, 112
Vehicles. *See under specific antibiotic*
Venturia inaequalis, 200
Vibrio cholerae, 83
Vinyl pyrrolidine, as vehicle for antibiotics, 110
Violacein, 184
Viridin, 188, 200
Vitamin B₁₂, 240
 K₆, 90, 229
VUILLEMIN, P., 1
- WAKSMAN, S. A., 5, 8, 11, 120, 150, 203
WEINDLING, R., 11, 25
WEINTRAUB, R. L., 4, 8
WEISS, E., 151, 156
WERKMAN, C. H., 233
Whooping cough, 170
- X-ray, use of to produce mutants, 33
Xanthomycin, 185
- Yeast, autolysate of in streptomycin biosynthesis, 125
- Zinc, in corn steep liquor, 72
 inactivates penicillin, 79
 in penicillin biosynthesis, 64, 68, 72
Zone of inhibition, 20-22, 226, 227