

E.M.B. 35.



The Relative Values of Cod Liver Oils from Various Sources

BY

Professor J. C. DRUMMOND, D.Sc.
(University College, London)

AND

Professor T. P. HILDITCH, D.Sc.
(University of Liverpool)



DECEMBER, 1930

Crown Copyright Reserved.

LONDON :

PUBLISHED BY HIS MAJESTY'S STATIONERY OFFICE

To be purchased directly from H.M. STATIONERY OFFICE at the following addresses

Adastral House, Kingsway, London, W.C.2 ; 120, George Street, Edinburgh ;

York Street, Manchester ; 1, St. Andrew's Crescent, Cardiff ;

15 Donegall Square West, Belfast ;

or through any Bookseller.

1930

Price 1s. od. Net.

PREFACE

THE Imperial Economic Committee, in their Report on Fish, recommended that the Empire Marketing Board should promote research on :—

- (1) the nature of the variations in the vitamin content of cod liver oils produced from fish from various sources and a study of the underlying causes of such variations ;
- (2) the methods of manufacture and refinement of medicinal cod liver oil with a view to retain to the full the vitamin properties of British Empire oil, whilst securing high marketable qualities.

The Report which follows deals with the conclusions arrived at on these points by Professor J. C. Drummond, of University College, London, and Professor T. P. Hilditch, of Liverpool University, who conducted, on behalf of the Empire Marketing Board, a comprehensive study of the composition of cod liver oil, its manufacture and its medicinal value.

The research work carried out has demonstrated beyond doubt the unrivalled medicinal value of the cod liver oils produced in Scotland and Newfoundland. This result, together with the improvement in technical quality which is being effected in Newfoundland, should go far to establish the position of the oils from Empire sources.

I think we have reason to appreciate this very interesting and valuable Report and to be grateful to its authors.

T. DRUMMOND SHIELS,
Chairman of the Research Grants Committee.

August, 1930.

CONTENTS.

	Page.
CHAPTER 1.—General Introduction	7
Theories regarding the Medicinal Value of Cod Liver Oil ..	7
CHAPTER 2.—General Scheme of Experimental Observations undertaken in collecting material for this Report	15
Summary of Material collected and examined	17
CHAPTER 3.—Method of Assay of Vitamin Potency of Cod Liver Oil ..	21
Vitamin A	21
Vitamin D.	38
CHAPTER 4.—General Character of Cod Liver Oils from various Localities ..	42
The Composition of the Fatty Acids present in Cod and other Fish Liver Oils	51
The Constituents of the Non-saponifiable Fraction of Cod Liver Oil	62
Relation between Colour of Cod Liver Oil and Vitamin Potency	63
CHAPTER 5.—Biological Factors influencing the Vitamin Content of Cod Liver Oil	65
Origin of Vitamins A and D	65
Physiological Condition of the Fish	70
CHAPTER 6.—Technical Production of Cod Liver Oil	76
Relation between Time of Storage of Livers and Quality of Oil	80
Influence of Conditions of Steaming on Character of Oil produced	86
Refining of Medicinal Oil	91
Storage and Bottling of Medicinal Oil	97
CHAPTER 7.—Cod Liver Oil Manufacture in Newfoundland	108
Government Inspection	108
Production	113
CHAPTER 8.—Cod Liver Oil for Human Use	114
Suggested Specification	115
Colour, Taste and Smell	115
Alleged Toxicity of Cod Liver Oil	116
CHAPTER 9.—Cod Liver Oil for Animal Feeding	118
CHAPTER 10.—General Conclusions	123

CHAPTER 1.

GENERAL INTRODUCTION:

THEORIES REGARDING THE MEDICINAL VALUE OF COD LIVER OIL.

IT is known that the liver oils of cod and related species have been employed for centuries as trusted household remedies by the fisher folk scattered along the coasts of Norway, Greenland and Scotland. There are also records of the export of considerable quantities of the oil from Norway to the Hanseatic ports during the 15th and 16th centuries, although it is probable that this product, known as Bergenthran, was used for technical rather than medicinal purposes. Indeed, it would appear that the general recognition of its great therapeutic value is comparatively recent. According to Dr. Thomas Percival (*Medical Essays*, Vol. II, 1789, p. 354), the first record of the use of the oil on any extensive scale relates to the clinical trials made by Dr. Samuel Kay, who was a physician on the staff of the Manchester Infirmary, from 1752 to 1784. According to the information contained in a letter dated 1782 from Dr. Darbey to Dr. Thomas Percival, who from 1779-1804 was also a physician at the Manchester Infirmary, Dr. Kay and his colleagues employed the oil somewhat extensively for the treatment of bone affections and rheumatism. Darbey states: "So general has been the use of the oil with us, that we dispense 50 or 60 gallons annually; and the good effects of it are so well known amongst the poorer sort, that it is particularly requested by them for almost every lameness. Except bark, opium and mercury, I believe no one medicine in the *materia medica* is likely to be of greater service" "and I could wish for a more general use of it in order to prove that the above account of its good effects is no exaggeration."

It is of considerable interest that the oil which was used at the Manchester Infirmary with such good results was obtained, according to Percival, from Newfoundland. Considerable quantities of "trayne oyle" were landed at West of England ports by boats engaged in the important trade with Newfoundland that flourished during the 17th, 18th and first half of the 19th centuries. Most of this oil was, of course, used for treatment of leather.

The success which attended the use of the oil at Manchester greatly impressed a German physician, Dr. Schenck, who carried out a series of clinical trials on his return to Germany. The publication in 1822 of his experiences led to a much wider appreciation of the medicinal value of the oil, and, as is clear from the books of Bennett¹ and de Jongh,² and a series of writings in "Hufeland's Journal", the product was in fairly general use in Western Europe by 1840. Although at first employed in a somewhat haphazard manner for the treatment of almost every form of disorder, the medical profession soon recognised that its real virtue lay in its power to rebuild the constitution in conditions of malnutrition, particularly rickets.

A survey of the literature of this period shows that speculation was rife concerning the reason for the beneficial effects of cod liver oil, and in this connection considerable attention was paid to the differences between this and other oils which were revealed by chemical examination.

Nearly a century ago Hupfer de l'Orme (1836) detected the presence of a trace of iodine in cod liver oil, and advanced the suggestion that this component was responsible for the therapeutic action. His theory survived, passing through phases of varying popularity, until Williams^{3,4} showed that the medicinal effect of refined oils did not run parallel to the amount of iodine present. As an alternative hypothesis he advanced the view that the beneficial action of cod liver oil in conditions of malnourishment is due to the readiness with which the highly unsaturated fatty acids it contains can be assimilated.

The opening of the 20th century was marked by a remarkable development of scientific research on problems of human and animal nutrition. After over half a century of close attention to the study of the quantitative aspect of the food requirements of the organism, investigators turned their attention to the qualitative point of view.

Within a few years this new line of attack led to the discovery of the vitamins, a discovery that has exerted as profound an influence

¹ "Treatise on the oleum Jecoris Aselli or cod liver oil as a Therapeutic Agent in certain forms of gout, rheumatism and scrofula." John Hughes Bennett, M.D. London, 1841.

² "The three kinds of cod liver oil comparatively considered with reference to their chemical and therapeutic properties." L. J. de Jongh, M.D. Translated from the German by E. Carey, M.D. London, 1849.

³ *Brit. Med. J.*, 1912, **11**, 700.

⁴ *Pharm. J.*, 1913, **89**, 806.

on theories of nutrition as the classic investigations of Lavoisier on respiration. It was not long before the physiological action of cod liver oil was attributed to the presence of a vitamin⁵, but proof that this action was due to something other than the oil (glyceride) itself was not provided until it was shown in 1919 that, provided care is taken to prevent oxidation, the active principle can be concentrated in the small fraction (0.6–1 per cent.) which is not saponified by treatment with caustic alkalis.⁶ As this highly active material, usually referred to as the unsaponifiable fraction, was found to contain no iodine when prepared from a high grade medicinal oil, and as all the fatty acids had been removed during saponification, it was clear that the older theories must be abandoned.

When it was first suspected that the beneficial effect of cod liver oil was due to the presence of an organic substance of the vitamin type, it was mainly the question of the growth and development of the young that was being considered.

A few years afterwards the researches of Mellanby attracted attention to the part played by this or a similar dietary factor in the prevention or cure of the bone disease known as rickets.⁷ For a short time the evidence seemed to indicate that only one substance was concerned, but, later, it was conclusively proven that there are at least two physiologically important vitamins in cod liver oil. For convenience these agents have been labelled vitamin A and vitamin D, until such time as it can be decided whether they are individual substances or complexes, and until more precise information regarding their chemical nature has been obtained.

Vitamins A and D.

For detailed information regarding these substances the reader is referred to one of the current monographs,^{8,9} but for convenience a short review of certain salient features may be given. Vitamin A is an organic substance or, possibly, group of substances of unknown constitution, believed to be formed in green plant tissues under the influence of light. It is apparently not synthesised in the tissues of

⁵ Osborne & Mendel, *J. Biol. Chem.*, 1914, **17**, 401.

⁶ Drummond, *Biochem. J.*, 1919, **13**, 81.

⁷ Medical Research Council Report, No. 61, 1921.

⁸ "The Vitamins". Sherman & Smith. American Chemical Society Monograph, 1922.

⁹ Medical Research Council Report No. 38.

the higher animals, so that normal growth and development is inhibited if an adequate supply is not provided by the food. Not only is there a failure of the young organism to grow when the supply of vitamin A is restricted, but both young and old show a decline of health which may end fatally. Perhaps the most characteristic disturbance of health associated with this form of dietary deficiency is an undermining of the resistant powers of the tissues against infection. This fact has so strongly impressed Mellanby that he has designated vitamin A the "anti-infective" vitamin.¹⁰ The curious condition known as night-blindness has also been associated with the consumption of foods deficient in vitamin A,^{11,12} and in this connection it is interesting to note that an Egyptian papyrus of about 1500 B.C. contains a reference to the use of liver preparations as a cure for this disorder.¹³ Another eye disease, known as xerophthalmia or keratomalacia, occurring in young children and animals has been found to be due to an inadequate supply of vitamin A.^{14,15} The investigation into the chemical nature and properties of vitamin A will be described in some detail in Chapter V, but it may be said at this point that considerable progress has been made. Unfortunately the same cannot be said regarding the efforts to solve the problem of the role of the vitamin in the internal economy of the organism. The symptoms of disordered metabolism that are associated with an inadequate supply of vitamin A in the diet can be readily recognised, but we are at present wholly ignorant of the manner in which the vitamin assists to maintain the normal functioning of some, or possibly all, of the body tissues.

The history of biochemical research contains few chapters more romantic than that which describes the evolution of our modern views regarding the relation of vitamin D to the development of bone in young animals. The recognition that the disorder of bone growth, known as rickets, can be prevented or cured either by ensuring an adequate supply of this vitamin in the food or by exposure of the skin of the child to certain forms of light, not only led to a reconciliation between two conflicting theories regarding the origin of the

¹⁰ *Brit. Med. J.*, 1923, ii, 691, 1929, i, 984.

¹¹ Fridericia. *Amer. J. Physiol.*, 1925, 73, 63, 79.

¹² Akroyd. *Irish J. Med. Sci.*, 1928, 161.

¹³ Van Lersum. *Nederl. Tijdschrift voor Geneeskunde*, 1924, 4.

¹⁴ Bloch. *J. Hygiene*, 1921, 17, 283.

¹⁵ Widmark. *Lancet*, 1924, 1206.

disease, but paved the way for the truly remarkable discovery that a known chemical substance, ergosterol, can be converted into the vitamin by the action of the same light waves.^{16, 17}

It is not yet known what is the actual chemical relationship between vitamin D and its parent substance ergosterol, but research is active and the results are awaited with optimism.

It would seem that plant foods are not particularly rich in vitamin D, unless they have been exposed to sunlight, or other sources of ultra-violet radiations, a comparatively short time before they are consumed. Nevertheless, the animal must derive its supplies of this essential unit from plant sources, unless its skin is freely exposed to sunlight. A number of animal foods are antirachitic, but as a class the fish liver oils are by comparison with other foodstuffs so potent in this respect as to stand by themselves.

The part played by vitamin D in assisting the deposition of lime in developing bone is not yet wholly understood. The evidence from experiments seems to indicate that it exerts an influence in regulating the reaction of the contents of the intestine, so that the calcium and phosphoric acid absorbed in the upper part of the canal are normally utilised and are not lost by re-excretion further down the gut.

Vitamin Value of Cod Liver Oil.

Even in the earlier literature references can be traced to variations in the medicinal value of cod liver oil. Until the last quarter of last century practically all the oil coming on to the market for medicinal use was produced by the old "rotting" process. Such oil was deep golden brown in colour, possessed a highly objectionable flavour and a strong fishy smell. It was frequently adulterated with sperm, whale or herring oils. Even when the cleaner oils prepared by the steaming processes gradually displaced the more crude "rotted" oils, indications were obtained that variations in medicinal value occurred.

Nothing definite was established, however, until the biological tests carried out by Drummond and Zilva in 1920-22 revealed that such

¹⁶ For a review of the development of this work see a paper by Drummond (*J. Soc. Chem. Ind.*, 1930, Jan. 3rd).

¹⁷ The subject is very fully treated in a recent volume by A. F. Hess. "Rickets, Osteomalacia and Tetany," London. 1930.

variations not only occur, but that their range is not inconsiderable.^{18,19,20} Efforts were made to trace the origin of these variations, and a lengthy investigation was made of the influence on the vitamin value of the liver oil of a number of factors such as the food supply and physiological condition of the fish, and methods of preparing and refining.

As a result of a close examination of cod liver oil preparation in Norway in 1921, it was concluded that the "steaming" methods produce an oil of as high, if not actually higher vitamin potency, than the older "rotting" process. The modern methods of refining were found to be without appreciable influence on the vitamin value of the oil, with the one exception that bleaching, rarely practised to-day, tended, as would be expected, to cause loss.

The information obtained during this study did not reveal whether the variations in vitamin content were a reflection of differences in the diet or in the physiological state of the fish at the various seasons.

The greater part of the Norwegian medicinal oil was at that time derived from the "Skrei" fishing, which takes place early in the year when the cod come inshore to spawn on the coastal banks in the Romsdal and Lofoten areas. The vitamin value of this oil was found to be a good deal lower than that of the oil prepared later in the year when the fish are caught along the Finmarken coast. It was at first thought that prior to spawning there might be a considerable transference of vitamin from the liver to the rapidly growing reproductive tissues, and that this might be responsible for the reduced value of the oils made during this period. In support of this possibility was the fact that the eggs and sperm were found to be very rich in vitamins. A more detailed study of the potency of oils extracted from the livers of fish in different stages of the reproductive cycle²¹ indicated, however, that neither the sexual condition nor the age of the fish appeared to be responsible for the less potent oils obtained at certain times. This conclusion directed attention to the question of the food supply of the fish at various seasons of the

¹⁸ *J. Soc. Chem. Ind.*, 1922, **41**, 280.

¹⁹ *Lancet*, 1921, ii, 753.

²⁰ *J. Soc. Chem. Ind.*, 1923, **42**, 185, 205.

²¹ *Biochem. J.*, 1924, **18**, 178.

year, since in the original investigations²² it had been shown that the ultimate origin of the vitamin A can be traced to the microscopic green plant life of the sea (phyto-plankton).

This aspect of the problem was of particular importance when considering the vitamin content of the cod liver oils produced within the Empire.

Zilva and Drummond²⁰ were the first to draw attention to the high vitamin value of oil prepared in Newfoundland: an observation that has been repeatedly confirmed.^{23,24,25} The majority of these oils coming on the market are of a decided yellow tint as, are also, many of those from Scotland and Iceland, and in spite of the high medicinal value this feature has tended to make them unpopular with the pharmacists and manufacturers.

When the "steaming" process for the extraction of liver oils was introduced about 1850 it brought about a revolution in the cod liver oil industry. The dirty, unpalatable, brown "rotted" oils gave place almost at once to clean and almost colourless products. The aim of the manufacturers became to prepare water-white and tasteless oils, and it was soon the accepted view that any appreciable colour in a cod liver oil was a certain sign of careless manufacture.

It is largely for this reason that the Norwegian industry has flourished so successfully. The oils that separate from the freshly steamed livers in the main fishing areas of Romsdal and Lofoten are usually of a very pale colour and for this reason have been desired by the pharmaceutical trade.

On the other hand there were grounds for believing that a natural yellow pigmentation of the oil might be a highly satisfactory, rather than an undesirable, feature. It has been shown that the vitamin A value of butter is, roughly speaking, proportional to the amount of natural yellow pigment present.^{26,27} Apparently a parallel transference of vitamin A and yellow fat-soluble pigment from the food to the milk fat occurs.

²² *Ibid.*, 1922, **16**, 518.

²⁰ *J. Soc. Chem. Ind.*, 1923, **42**, 185, 205.

²³ Lesné and Simon. *Comp. rend. Acad. Sci.*, 1926, **182**, 1424.

²⁴ Bills. *J. Biol. Chem.*, 1927, **72**, 751.

²⁵ Deas. *Can. Med. Assoc. J.*, 1924, **14**, 959.

²⁶ Drummond and others. *Biochem. J.*, 1920, **14**, 668.

²⁷ *J. Agric. Sci.*, 1924, **14**, 531.

It seemed to be a matter of considerable importance to ascertain whether there may be an association between a yellow colour and vitamin activity in cod liver oils, particularly in the light of the recent controversy regarding the relative merits of oils from various areas.²⁸ This enquiry naturally opened up the question of the origin of the colour, and called for a re-examination of the problem of the primary source of the vitamins themselves.

At the same time it was impossible to study colour in liver oil, without paying due attention to methods of manufacture and refining. In this manner the original plans for the investigation broadened until it was decided to make a somewhat exhaustive study of the composition of cod liver oil, the methods of preparation of the medicinal oil and the factors that influence its nutritive value.

²⁸ Drummond. *Lancet*, 1925, ii, 679; Poulssen, *ibid.*, 1926, i, 320; Zilva, *ibid.*, 1926, i, 463; Drummond, *ibid.*, 1928, i, 1353.

CHAPTER 2.

THE GENERAL SCHEME OF EXPERIMENTAL OBSERVATIONS UNDERTAKEN IN COLLECTING MATERIAL FOR THIS REPORT.

It will be appreciated that the greatest difficulty of an investigation of this nature is precise definition and control of the conditions affecting each or all of the actual observations. Thus, it will be evident that it is exceedingly difficult, by examination of cod livers collected at different periods, to be certain on the one hand that the fish caught, for example, in autumn are from the same group or have followed similar changes in feeding, etc., as those which may have been taken from the same or another locality some months earlier; and, on the other hand, variations from one cod to another are probably frequent both in the physical condition, the size of the liver and the proportion of oil present therein, and possibly also in the vitamin potency of the extracted oil.

It is therefore necessary, in work of this kind, to aim at obtaining average conditions as far as possible throughout any given range of observations, whilst it is also essential to define as exactly as possible the range of variation which may be expected in any given factor.

The experimental material which has been utilised in the course of this work may be divided mainly into two classes, namely: (1) observations on as wide a variety of cod liver oils of known origin as could be collected with reference to their chemical and biochemical characteristics, and (2) several series of experiments on the actual extraction of oil from cod livers, which represent, for the most part, observations on fish of known origin, state of development, feeding and general condition. The work in the second category forms the basis of the information which has been gathered concerning factors which influence the processes of extraction and refining of the medicinal oil.

For the purpose of this report the experimental material has been classified in the following manner:—

(1) A summary has been made of all the data which have been collected in the present investigation with regard to fresh cod liver oils and the liver oils of certain other fish; figures are given for the relative vitamin potency (measured colorimetrically by the antimony trichloride test), the colour of the oils themselves, their free acidity, iodine values and saponification values.

Also, detailed chemical analyses of the composition of the fatty acids present in typical cod liver oils and some other fish liver oils have been made in order to open up the question as to whether any general relationship subsists between the composition of the fatty matter and the amount of vitamins A and D which the oil normally carries. With complex fatty acid mixtures such as those of the fish oils, an analysis of this kind occupies several weeks, and it has only been possible to carry out a few typical examples.

(2) The biological factors influencing the vitamin content of cod liver oils have been studied from the points of view of the food taken by the fish, of the condition of the fish (including age, sex, stage of maturity, and the influence of the spawning period), and of the general seasonal factors operating in connection with the cod.

In the course of this work, a sufficient number of feeding tests was carried out to afford reasonable certainty that the blue colorimetric test for vitamin A by means of antimony trichloride was, in each case studied, definitely parallel with the biological test. It is, therefore, believed that the colorimetric test, which has been employed alone for a large number of the numerous samples obtained during this work, can be regarded as a fair criterion of their relative vitamin A potency. The conclusions to be drawn from the fresh information which we have gathered on factors influencing the vitamin content of the oils are developed in detail in Chapter V, but it may be stated at this point that, whilst our results serve further to indicate the very complex and involved nature of these relationships, they have also given prominence to several features which have not, so far as we know, been pointed out previously, and which have a distinct bearing upon the best procedure to be employed in collection and rendering of the cod livers.

(3) This is devoted to an examination of the technical processes which are used in the manufacture of medicinal cod liver oil from the following standpoints:—

(a) the collection and storage of the cod livers, with especial reference to the time which elapses between the death of the fish and the working up of the liver in relation to the quality of the oil obtained ;

(b) the conditions obtaining in the steaming of the livers, notably the duration of the boiling process and the pressure of the steam employed ;

(c) an examination of refining processes which may be applied to the crude oil, including centrifuging, chilling and pressing, bleaching by agitation with adsorbent materials or by agitation with air ;

(d) the conditions under which medicinal cod liver oil is best stored and bottled, with particular reference to proposals for exclusion of air from the containers, and to the influence of light on the vitamin content and other properties of the bottled oil.

Here, again, the reasons for our final recommendations will be gathered from a perusal of the detailed account of our investigations in Chapter VI, but it may be emphasised that best quality oil can only be produced if the livers are steamed immediately after removal from the fish ; that steam at a pressure of 60-100 lbs. per sq. inch is on the whole more likely to give satisfactory results than that at a lower pressure ; that somewhat prolonged steaming tends to give a better product than very short steaming ; that subsequent refining processes should be reduced to a minimum and should, if possible, be restricted to removal of moisture, debris and " stearin " by means of chilling and centrifuging or pressing ; and, finally, that medicinal oils should be stored in vessels impermeable to light and containing as little free air space as possible.

(4) A visit was paid by one of us in July and August, 1929, to the Newfoundland fisheries, and an account is given of observations made in that locality.

SUMMARY OF MATERIAL COLLECTED AND SUBMITTED TO EXAMINATION IN THE COURSE OF THIS INVESTIGATION.

In order to render subsequent reference to the various samples studied somewhat more easy, a more or less chronological statement of the materials collected at various stages of this work will be given before proceeding to the detailed account of our experimental results under the above headings.

The samples examined fall into two main divisions, namely, those submitted to us as being genuine specimens of Newfoundland, Norwegian, or Iceland cod liver oil, and those which were collected (and for the most part prepared) by ourselves from fish caught in the Moray Firth and the North Sea.

The samples obtained from outside Britain fall into the following classes :—

(a) Newfoundland cod liver oils from the summer, autumn and winter catches of the 1928 and 1929 seasons ;

(b) Norwegian and Iceland cod liver oils from the spring catches of the 1928 and 1929 seasons.

The material collected by ourselves was obtained from three different sources as follows :—

Moray Firth Cod Fishing, March, 1928.—A short cod fishing season obtains in the Moray Firth for about 8–10 weeks in the early part of each year, commencing late in January and terminating towards the end of March. The fish, which are netted by steam drifters or motor drifters based mainly on Buckie, come into the Firth about the earlier date mentioned for spawning, and thus an excellent opportunity is given for observations on the state of the fish livers just before, during, and subsequent to the spawning period.

When the Empire Marketing Board decided to undertake this investigation, the Moray Firth season of 1928 was almost at an end ; but we were in time to visit Buckie and to obtain a series of samples of oil as manufactured there from livers which for the most part were derived from spent or almost spent fish. In our work at Buckie, both in 1928 and in the corresponding season of 1929, we received invaluable assistance from Mr. J. Spencer and Mr. Tawse of Messrs. Isaac Spencer & Co. (Aberdeen) Ltd., who placed the resources of their factories at Aberdeen and Buckie entirely at our disposal.

At the end of March, 1928, we saw several batches of livers rendered in the Buckie factory, and tests were carried out for us on 5-cwt. charges of livers which were respectively one, two, and three days old (samples F, G, H, Buckie, 1928). In addition, we obtained samples of crude cod liver oil (A), centrifuged crude cod liver oil (B) and non-freezing medicinal cod liver oil (C) taken from bulk in Messrs. Isaac Spencer & Co.'s Aberdeen factory.

These oils were utilised for a large number of storage and other tests made during 1928 in our laboratories.

Moray Firth Cod Fishing, February–March, 1929.—Advantage was taken of the 1929 season to carry out a more detailed investigation in Messrs. Isaac Spencer's Buckie factory than had been possible in the preceding year. On this occasion a number of samples were

collected as before from the large-scale renderings carried out during the normal production at the factory, but in addition, a considerable number of experimental boilings were made in a small tinned steel vessel which had been constructed for use on the F.R.S. "Explorer" (see below). Details of this vessel, which dealt conveniently with about 14 lbs. of livers, are given subsequently (Chapter VI). The work included the following points:—

Series A and B.—Small scale boilings of livers (1) when quite fresh, (2) after one, two, three, etc., days' storage until too soft to work up.

Series C, D, E, E¹, F, and N.—Small scale boilings of fresh livers for varying periods of time with steam at varying pressure from 10–100 lbs. per square inch.

Series G and H.—Samples taken from large-scale production after boiling for varying periods of time.

Series I and J.—Small scale boilings of livers from selected male or female fish taken throughout the season from the pre-spawning period until the fish were fully spent, with concurrent observations on the food contents of the stomachs.

Work carried out on F.R.S. "Explorer" July–September, 1928.—By the kindness of the Scottish Fishery Board and of Dr. Alexander Bowman, their Scientific Superintendent at Aberdeen, arrangements were made for us to accompany the Scottish Fishery Board's research steamer "Explorer" on two voyages off the eastern and western coasts of Scotland in the late summer of 1928. During this period, fish livers of various kinds were steamed in the small boiler mentioned above, immediately after the fish had been trawled. During the two trips no large amount of cod was encountered, but fair amounts of saithe, dogfish and ling liver oils were prepared with smaller quantities of hake, skate and haddock liver oils.

The characteristics and vitamin contents of all the oils collected were determined and the results were correlated with the data obtained by the Fishery Board's Marine Laboratory at Aberdeen on the food found in the respective fish.

Samples of meganyctiphanes, nephrops, and copepods, which formed an important part of the food of many of the fish, were also collected, dried and extracted with ether, in order to examine the resulting oil for vitamins.

Some experiments were also carried out on the effect of storing fish livers in brine prior to steaming, but it was found that this effected no improvement in the keeping qualities of the livers; this is in consonance with the general results of our work, which go to confirm the fact that putrefactive decomposition of the oil sets in from within the livers and is therefore not preventable by external treatment.

The following is a summary of the oils collected on the "Explorer" :—

TABLE I.

<i>Fish.</i>	<i>Date.</i>	<i>Locality.</i>	<i>Depth.</i>
Cod ..	July 12, 1928 ..	Farne Deep ..	—
Cod ..	July 19, 1928 ..	Cullen Deep, Moray Firth	—
Cod 1 ..	August 16, 1928..	58° 29' N., 7° 35' W. ..	130 metres.
Cod 2 ..	August 17, 1928..	58° 03' N., 6° 13' W. ..	137 ..
		58° 03' N., 6° 12' W. ..	137 ..
Cod 3 ..	August 29, 1928..	55° 24' N., 4° 59' W. ..	73 ..
Cod 4 ..	September 1, 1928 ..	58° 40' N., 5° 04½' W. ..	152-137 ..
Saith ..	July 11, 1928 ..	Firth of Forth ..	—
Saith 1 ..	August 17, 1928..	58° 03' N., 6° 13' W. ..	137 ..
		58° 03' N., 6° 12' W. ..	137 ..
Saith 2 ..	August 22, 1928..	56° 54' N., 7° 10' W. ..	148 ..
Saith 3 ..	August 29, 1928..	55° 24' N., 4° 59' W. ..	73 ..
Dogfish ..	July 23, 1928 ..	North Sound, Orkneys ..	—
Dogfish ..	July 24, 1928 ..	58° 37' N., 1° 06' W. ..	—
Dogfish ..	August 16, 1928..	58° 29' N., 7° 35' W. ..	130 ..
Ling 1 ..	August 17, 1928..	58° 03' N., 6° 13' W. ..	137 ..
		58° 03' N., 6° 12' W. ..	137 ..
Hake 1 ..	August 9, 1928 ..	Off Wick ..	—
Hake 2 ..	August 13, 1928..	58° 42' N., 6° 15' W. ..	112 ..
Hake 3 ..	August 17, 1928..	58° 03' N., 6° 13' W. ..	137 ..
		58° 03' N., 6° 12' W. ..	137 ..
Hake 4 ..	August 22, 1928..	56° 54' N., 7° 10' W. ..	148 ..
Hake 5 ..	August 23, 1928..	56° 2' N., 7° 3' W. ..	78 ..
Hake 6 ..	September 12, 1928 ..	55° 34' N., 5° 24½' W. ..	88 ..
Skate ..	August 13, 1928..	58° 17' N., 6° 11' W. ..	15-18 ..
Haddock 1	August 8, 1928 ..	Aberdeen Bay ..	—
Haddock 2	August 9, 1928 ..	Clyth Ness ..	—

CHAPTER 3.

METHODS OF ASSAY OF VITAMIN POTENCY OF COD LIVER OIL.

1. *Vitamin A.*

When this investigation was planned, the question of the most suitable method to be used for the estimation of the vitamin A content of cod liver oil assumed great importance. Obviously, the most satisfactory method is the biological test, in which the vitamin A value is assessed from a study of the response in growth shown by groups of comparable animals (usually rats) whose development has been retarded by a diet deficient in A, and to which different doses of the foodstuff to be tested are given. Unfortunately, the variations in response shown by individual animals in such a test as this are so large that the method cannot be regarded as more than roughly quantitative, unless considerable numbers of rats are employed in each group. Appreciating this fact, it was apparent that to compare the vitamin A value of several hundred samples of cod liver oil by a reliable biological method would present almost insuperable practical difficulties. The alternative was to rely on other methods, such as the colorimetric assay based on a colour reaction originally described by Rosenheim and Drummond.¹ In view of some question regarding the specificity of this test, it was considered advisable, however, to make a careful comparative examination of the two methods in order to decide whether the rapid and comparatively accurate colorimetric estimation could be trusted to give results in agreement with those yielded by an adequate biological test.

(a) *Biological Assay.*

The character of the animal test required careful consideration. By a regrettably premature decision there was included in the Tenth Edition of the United States "Pharmacopœia," published in 1926, a method for the biological assay of vitamin A, which appears to have been based on the procedure described by Sherman and Munsell.² Almost as soon as it appeared this method was shown to be untrustworthy, in that it provided no certainty that the animals would receive an adequate supply of vitamin D during a critical phase of

¹ *Biochem. J.*, 1925, **19**, 753.

² *J. Amer. Chem. Soc.*, 1925, **47**, 1639.

the test. It has, however, been used somewhat extensively, particularly in the United States, where it remains the official test.

This method laid down that the vitamin A potency of cod liver oil shall be expressed in units per gram of oil; the unit to be the minimum daily amount of cod liver oil required to cure induced symptoms of vitamin A starvation in young albino rats, and to cause a gain in weight of from 10 to 20 gm. within a period of thirty-five days under the conditions of growth and diet specified in the assay.

Essentially the same method was proposed for the assay of cod liver oils in a memorandum drawn up in July, 1925, by Prof. Poulsson of Oslo, and presented to the Permanent Standards Committee of the League of Nations Health Organisation, but it was unanimously rejected as unreliable by the British authorities serving on the Accessory Food Factors (Vitamins) Joint Committee of the Medical Research Council and the Lister Institute for Preventive Medicine.³ This committee recommended the following general lines for the biological estimation of A in cod liver oils:—

- (1) Young rats of weight 40–50 g., 20–30 days old, to be used.
- (2) The number of control animals to be equal to that in each group receiving oil.
- (3) The animals to be fed on an artificial diet devoid of fat-soluble vitamin until growth ceases, and excess of antirachitic vitamin (in form of irradiation, irradiated foodstuffs, or irradiated cholesterol) to be supplied during the whole or latter part of this pre-observation period.
- (4) The material to be tested to be added to the diet when growth has ceased and the weight of the animal has become constant or is beginning to decline.
- (5) The animals to be observed during a further period of four weeks, during which time the antirachitic vitamin should be supplied.
- (6) Comparison to be instituted between the doses of the various oils required to restore the same rate of growth.
- (7) Not less than three animals to be used for each dose of oil. The oil to be administered separately to each animal. The diluent to be some inert solvent, whose inactivity should be controlled by the behaviour of control animals.

³ *Lancet*, 1928, i, 148.

A method complying with these requirements was employed in the comparative tests undertaken in the course of this investigation. It is fully described in a scientific paper,⁴ in which are also set out the results of the biological tests of a series of cod liver oils of different vitamin potency.

TABLE II.

Results of Biological Test of Vitamin A Potency of Oil F.

Dose (Mg.).	No. of Rats.	Reference No. •	Period on Test (Weeks).	Change in Weight (g.).	Change in Weight per Week (g.).	Average for Group (g.).
10	7	210	6.0	+48	+8.0	+8.5
		213	6.0	+45	+7.5	
		214	6.0	+44	+7.3	
		L40/180	5.0	+58	+11.6	
		L39/174	5.0	+35	+7.0	
		L39/175	5.0	+49	+9.8	
7	8	L31/132	5.5	+15	+2.7	+5.5
		L37/167	5.5	+16	+2.9	
		209	7.0	+34	+4.9	
		212	5.5	+40	+7.3	
		L39/172	5.5	+15	+2.7	
		L39/173	5.0	+20	+4.0	
		215	5.0	+60	+12.0	
		L38/168	5.0	+32	+7.4	
5	9	218	4.5	+27	+6.0	+4.3
		L34/135	5.0	+23	+4.6	
		L35/152	6.0	+14	+2.3	
		L20/78	5.5	+25	+4.5	
		L21/83	6.0	+21	+3.5	
		208	5.5	+17	+3.1	
		L34/144	5.0	+20	+4.0	
		207	5.5	+32	+5.8	
		L29/123	6.0	+31	+5.2	
2	6	L20/75	6.0	+19	+3.2	+2.3
		L21/91	5.0	+14	+2.8	
		231	5.0	+9	+1.8	
		232	5.0	+28	+5.6	
		L20/74	3.0	-10	-3.3	
		L21/82	5.5	+19	+3.5	

⁴ Drummond and Morton, *Biochem. J.*, 1929, **23**, 785.

This series of tests revealed in a most striking manner the disturbing nature of the individual variations of response that may be encountered in these animal tests. They were, in this case, of such an order of magnitude as to make it a matter of great difficulty to distinguish with certainty between two oils showing less than 100 per cent. difference in vitamin A content. This may be illustrated by the details of the tests of two of the oils, one of which (F) (Table II, p. 23) was believed to be about twice as rich in vitamin A as the other (K) (Table III, below).

TABLE III.
Results of Biological Tests of Vitamin A Potency of Oil K.

Dose (Mg.).	No. of Rats.	Reference No.	Period on Test (Weeks).	Change in Weight (g.).	Change in Weight per Week (g.).	Average for Group (g.).
10	6	L41/187	5.0	+39	+7.8	+5.8
		L42/193	6.0	+39	+6.5	
		L47/211	5.0	+50	+10.0	
		L48/216	5.0	+24	+4.8	
		L47/213	5.5	+33	+6.0	
		L42/198	5.0	0	0	
7	6	L43/196	5.0	+12	+2.4	+3.2
		L46/204	7.0	+46	+6.6	
		L48/215	6.0	+28	+4.6	
		L49/224	6.0	+29	+4.8	
		L76/284	6.0	-4	-0.7	
		L76/299	5.0	+7	+1.4	
5	6	L41/186	5.0	+42	+8.4	+2.5
		L42/192	4.0	-4	-1.0	
		L50/227	5.0	+15	+3.0	
		L50/228	5.5	+5	+1.0	
		L55/237	5.0	-6	-1.2	
		L72/278	5.0	+23	+4.6	
2	6	L55/238	5.0	-8	-1.6	-0.6
		L55/239	5.0	-6	-1.2	
		L72/277	5.0	+22	+4.4	
		L63/268	4.0	-13	-3.2	
		L72/279	5.0	-4	-0.8	
		L67/282	5.5	-5	-1.0	

Expressing Results of Biological Assay of Vitamin A.

The very important question of the most suitable method of expressing the vitamin potency of cod liver oils, or other materials, is one that needs careful consideration. The method proposed in the United States "Pharmacopœia" compares the activities of oils by reference to the minimum doses that will promote a recovery of growth at a rate of about 3 gms. weekly for five weeks. If this dose is found to be 10 mgm., the oil is stated to contain 100 units of vitamin A, whilst an oil active to this extent in a dose of 12 mgm. would be evaluated at 80 units. Much as a method of evaluation in units is to be desired, it is obvious, from what has been said regarding the variations encountered in the biological assay, that the system proposed in the United States "Pharmacopœia" is unsatisfactory, particularly when oils of relatively high or low potency are being examined. Thus, for example, the values of 20-30 units given to salmon body oils by Schmidt-Nielsen⁵ are, in our opinion, without significance, beyond indicating that very little vitamin A is present. An oil given the value of 50 units would not necessarily be twice as rich in vitamin A as one to which the value 25 had been ascribed, unless the biological tests had been carried out with very large groups of animals, and unless an adequate series of doses had been examined.

On the other hand, the evaluation of vitamin-rich oils presents difficulties. Schmidt-Nielsen gave a value of 600 units to a sample of salmon liver oil, whereas our tests gave results from which we could have deduced values of the order of 3,000. When, however, Schmidt-Nielsen extended his animal tests to the examination of much smaller doses he found it necessary to raise his previous evaluation of 600 units to 10,000.

In the published research by Ahmad and Drummond⁶ this question has been examined in detail, and the conclusion is expressed that, unless the biological assay of a cod liver oil is carried through with large groups of animals and a wide range of doses, the results cannot fairly be expressed in such units as those proposed by the United States "Pharmacopœia". The use of the word "unit" suggests a reasonable degree of accuracy, whereas in our opinion the values usually obtained in this manner are little more than rough approximations.

⁵ *Kon. Norsk. Videnskab.* 1928, No. 15, 29, 63; 1929, No. 13.

⁶ *Biochem. J.*, 1930, 24, 27.

(b) *Colorimetric Assay.*

In the preliminary comparative survey the colorimetric tests were carried out by two methods. One was essentially the Carr and Price (1926) modification of the Rosenheim and Drummond test⁷. It is, however, necessary to lay down with precision the conditions for carrying out the test, as the intensity of the colour is dependent on a number of factors, of which the more important are the dilution of the oil, the concentration of the antimony trichloride reagent, the time elapsing between mixing and measuring the colour and the temperature.

The influence of these factors has been studied in some detail by Wokes and Willimott⁸, who made the following suggestions regarding the application of the reaction to the quantitative estimation of vitamin A :—

(a) *Reagent.*—A saturated solution of pure antimony trichloride (recrystallised from chloroform), concentration 26 or 27 per cent., weight in volume, in anhydrous chloroform. The reagent should be protected from light and moisture, and decanted before use. Two c.c. to be placed in a clean dry cell $\frac{1}{2}$ in. deep (thickness).

(b) *Solution of Oil.*—To be prepared freshly with anhydrous chloroform. Strength to be adjusted so as to keep the amount to be added between 0.1 and 0.3 c.c. This to be run into the cell already in position in the tintometer, and containing the reagent. To be mixed immediately by stirring with a clean glass rod, and the time of mixing noted.

(c) *Tintometer readings.*—To be measured in Lovibond units (blue), 30 seconds after mixing. Conditions to be adjusted so that reading of blue units is below 18.

(d) *Temperature.*—To be kept at about 16°C. Divergence of more than one degree from this to be noted, and a correction applied.

One of the drawbacks to the colorimetric method is that the relation between the intensity of colour developed and the

⁷ *Biochem. J.*, 1926, 20, 497.

⁸ *Biochem. J.*, 1927, 21, 419 ; *Analyst*, 1927, 52, 515.

concentration of oil is not linear, but is represented by a line which to a greater or lesser degree falls away at the higher concentrations (Fig. 1). As this does not occur when concentrates of vitamin A, free from fatty acids, are examined in solutions of various strengths, (Fig. 2) it seems probable that in the former case secondary reactions are responsible for the failure to develop the full intensity of blue colour.* The matter assumes some practical importance when the comparison of a wide range of oils is being made. In our experience

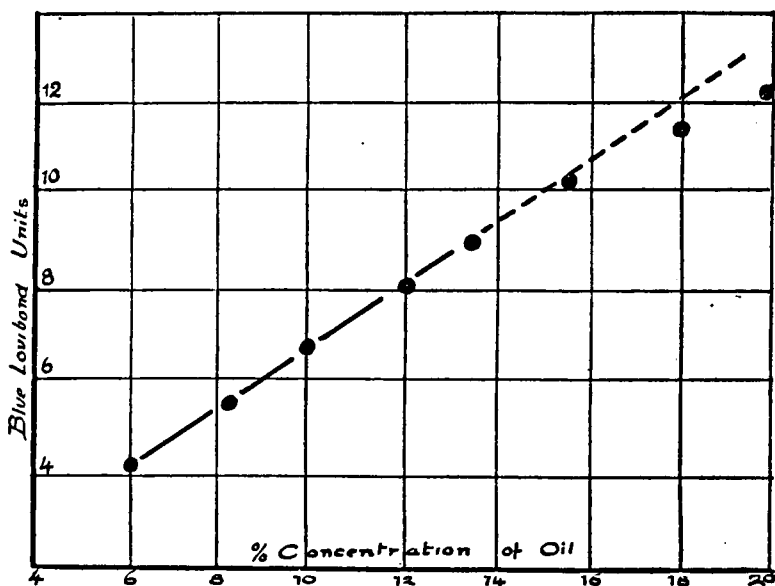

FIG. 1.

Chart showing relation between the blue colour produced with antimony trichloride and the concentration of the chloroform solution of cod liver oil. The relation is approximately linear at concentration below 16% but the readings fall away at higher concentrations.

* This view is confirmed by the results of the recent investigation by Norris and Church (*J. Biol. Chem.*, 1930, **85**, 477). Deviation from the straight line relation between concentration of oil and blue colour in the case of cod liver oils is shown to depend on the interference of oleic and other unsaturated acids. Quantitative comparisons of oils should, therefore, be carried out at concentrations for which the linear relationship holds. In all our tests this was done.

measurements of the blue colour are most accurately made by the majority of observers over the range between 5 and 15 blue units. Certain oils, when examined by the technique described above, using 0.2 c.c. of a 20 per cent chloroform solution, give blue values of about 5-10. Other oils examined in this concentration may give readings as high as 30 ; a depth of colour which is not conveniently

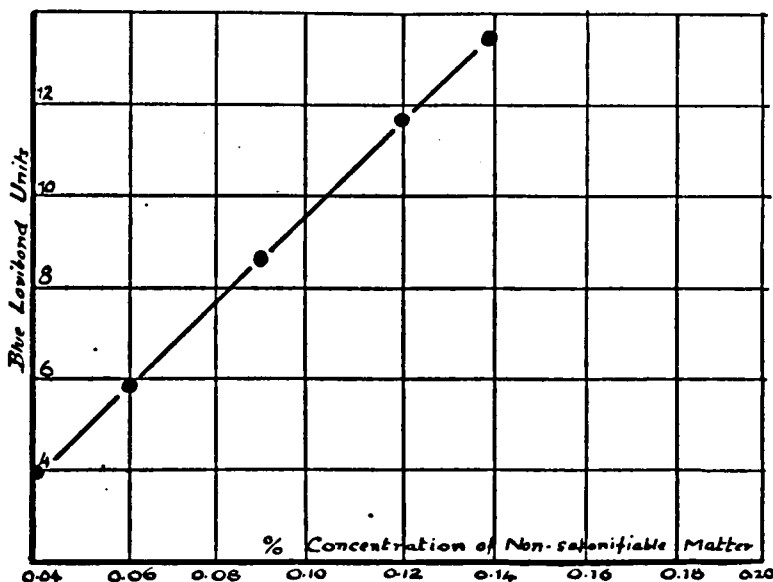

FIG. 2.

Chart showing that the relation between the blue colour produced with antimony trichloride by the non-saponifiable fraction of cod liver oil and the concentration of that fraction is linear. The non-saponifiable matter examined in this test was derived from the oil on which the estimations in Fig. 1 were obtained. This oil contained 0.7. % of non-saponifiable matter, so that a concentration of 0.04 of this fraction corresponds approximately to a 6% solution of the original oil.

measured by the Lovibond instrument. If a more dilute solution of such an oil be made, say 5 per cent, the blue colour reading will not be found to be 7.5, but will more probably be in the vicinity of 9 or 10. As yet we have devised no satisfactory means of overcoming

this difficulty of the colorimetric method. On the other hand we have found that the *best comparison of a range of cod liver oils can be made by comparing the colours produced by mixing 2 c.c. of the antimony chloride reagent with 0.2 c.c. of a 10 per cent. solution of the oil in chloroform: the colour intensity being measured in a 1 cm. cell 30 seconds after mixing. Throughout this report the vitamin A values of the oils are expressed in the Lovibond blue units determined in this manner.*

There are errors in this method, of which the most important arise from variations in the ability of individuals to match blue colours quickly, and from a failure to match the colour at the moment of its maximum intensity. The dimensions of these errors are made clear from the results of a comparative examination of two samples of cod liver oil that was arranged by Norman Evers. These results are published in full⁹, but we are indebted to Mr. Evers for permission to reprint certain extracts. The oils were independently examined in six different laboratories by the following technique:—

Technique A.

A quantity of oil is pipetted into a 10 c.c. stoppered cylinder, the number of c.c. taken being obtained by dividing the expected number of "blue units" into 10. Dry chloroform is then added to 10 c.c. 0.2 c.c. of the solution is accurately pipetted into a dry test-tube and 2 c.c. of the antimony trichloride reagent are added from a pipette. A stop-watch is started at the end of the addition of the reagent. The mixture is quickly mixed and poured into a 1 cm., glass cell and the colour is measured at the end of 30 seconds in the tintometer. A confirmatory test is carried out in the same way and a third, if the first two do not agree. The reading should lie between 4 and 6 blue units. If this is not so, the test should be repeated using a larger or smaller quantity of oil. The number of blue tintometer units thus obtained is multiplied by 2 and divided by the number of c.c. of oil taken = no. of "blue units".

Table IV shows the results obtained on the two oils in one laboratory, and illustrates the range of variation due, largely, to individual differences in matching blue colours.

⁹ *Quart. J. Pharm.*, 1929, 2, 566.

TABLE IV.
Cod Liver Oil A.

Date of Test.	Concentration of Oil.	Reading		"Blue Units."	Observer.
		B.	Y.		
	Per cent.				
25.10.29	5	3.6	1.6	14.8	N.E.
25.10.29	5	3.8	1.6	15.2	J.H.B.
25.10.29	5	4.2	2.4	16.8	W.S.
25.10.29	5	3.4	1.8	13.6	J.M.D.
4.11.29	5	3.8	1.6	15.2	J.H.B.
7.11.29 } Dull day ..	5	3.9	1.6	15.6	J.H.B.
7.11.29 } ..	5	3.9	2.0	15.6	N.E.
19.11.29 } Dull day ..	5	4.3	2.8	17.2	W.S.
19.11.29 } ..	5	4.3	2.7	17.2	N.E.
19.11.29 } ..	5	4.3	2.8	17.2	J.H.B.
20.11.29	5	4.0	2.6	16.0	W.S.
20.11.29	5	4.1	2.6	16.4	J.H.B.
20.11.29	5	3.95	2.4	15.8	N.E.
<i>Average of all values</i>				15.9	"blue units."

Cod Liver Oil B.

25.10.29	20	5.6	0.6	5.6	N.E.
25.10.29	20	5.7	0.6	5.7	J.M.D.
25.10.29	20	5.7	0.7	5.7	C.J.E.
25.10.29	20	6.2	1.0	6.2	W.S.
25.10.29	20	6.5	1.0	6.5	J.H.B.
4.11.29	20	6.3	1.0	6.3	J.H.B.
7.11.29 } Dull day ..	20	7.0	1.4	7.0	J.H.B.
7.11.29 } ..	20	6.1	0.9	6.1	N.E.
19.11.29 } Dull day ..	20	6.3	1.0	6.3	N.E.
19.11.29 } ..	20	6.2	1.1	6.2	W.S.
19.11.29 } ..	20	7.4	1.4	7.4	J.H.B.
20.11.29 } Bright day ..	20	5.95	0.95	5.95	W.S.
20.11.29 } ..	20	5.95	0.8	5.95	N.E.
20.11.29 } ..	20	5.95	1.0	5.95	J.H.B.
<i>Average of all values</i>				6.2	"blue units."

Table V compares the values obtained in the six laboratories, using the method described on p. 28. The values refer to a 20 per cent. solution of the oil.

TABLE V.

Laboratory.	Oil A.	Oil B.
Evers	15.9	6.2
Drummond	15.0	5.6
Glaxo Research	16.8	4.8
Pharmaceutical Society	15.0	5.3
British Drug Houses	13.2	4.6
Laboratory No. 5	—	5.2

The method actually adopted in the laboratories at University College throughout this two years' investigation of cod liver oil is as follows :—

Technique B.

About 1 gm. of the oil is accurately weighed out* and dissolved in 10 c.c. of redistilled chloroform. Into a 1-cm. cell there is placed 0.2 c.c. of this solution and to it is quickly added from a burette 2 c.c. of a 30 per cent. solution of antimony trichloride in chloroform. The cell is shaken during the mixing and exactly thirty seconds after the addition of the antimony chloride was begun the blue colour is matched in a Rosenheim-Schuster tintometer. At least four separate estimations on 0.2 c.c. are made, and then, depending on the chromogenic power of the oil, a series of colour estimations is made on greater or lesser concentrations of the oil solution (e.g. 5 per cent. or 15 per cent.). At these concentrations the relation between the amount of oil and the blue colour developed is in our experience nearly always linear, and from the plotted results the value for a 10 per cent. solution can be obtained.

The results on a typical oil are given in Fig. 3. In the later stages of the research the technique was slightly modified, mainly in the direction of regulating the conditions of the test.

* We recommend weighing out the sample of oil as being more accurate than the simpler method of measuring by volume with a pipette. In the latter case errors may readily arise from imperfect washing out of the pipette or from oil draining from the outside.

Technique C.

About 1 gm. of the oil is accurately weighed out in a 10 c.c. volumetric flask and dissolved in 10 c.c. of redistilled chloroform. The temperature of the solution must be between 15 and 17° C., as must also be that of the antimony trichloride reagent. Into a glass cell of 1 c.m. internal thickness there is pipetted 0.2 c.c. of the oil solution and to it there is quickly added from a burette exactly 2 c.c. of a 30 per cent. solution of antimony trichloride solution in chloroform.

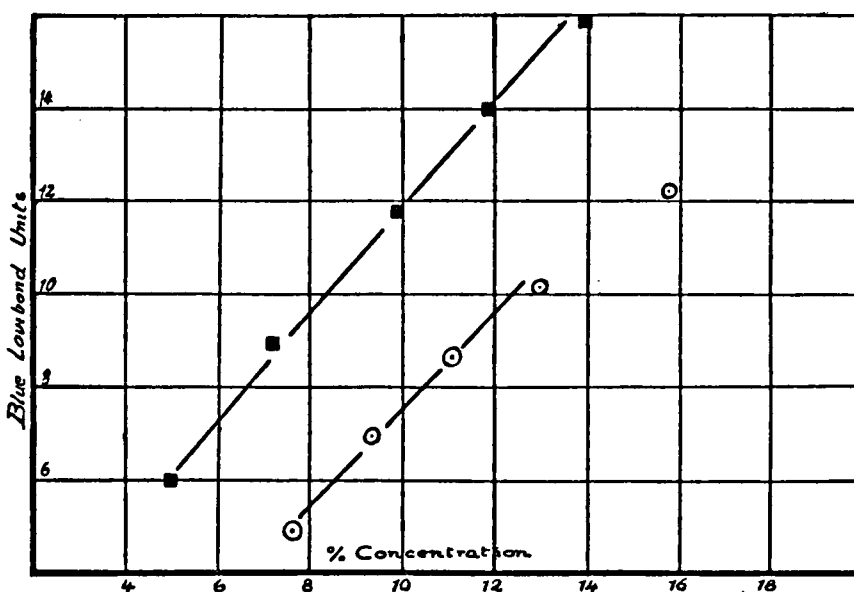

FIG. 3.

Curves given by two typical cod liver oils when estimations on Vitamin A by the colour reaction with antimony trichloride by Techniques B or C are carried out. The relationship between colour and concentration is linear at 10% concentration. At higher concentrations this does not hold.

The cell is gently shaken during the addition of the reagent and exactly 30 seconds after the addition was begun the blue colour is matched in a colorimeter of the Rosenheim-Schuster pattern. Only the measurement of the blue colour need be noted, and it is most conveniently expressed in terms of the standard Lovibond tinted

glasses. It is best to employ a source of diffuse daylight from a north window transmitted through the special Lovibond paper. Daylight lamps are unreliable. Three separate estimations should be made.

If the colour produced in this test by a sample of oil is more than 10 blue Lovibond "units", a set of estimations must be made on two lower concentrations, say 5 and 7 per cent., on the other hand, if the response is not so good, higher concentrations should be tested. The results are plotted and the value for a 10 per cent. solution read from the chart, if the relation is linear. If it is not, as is occasionally the case with oils of low grade, it is advisable to separate the non-saponifiable matter with precautions against oxidation and carry out the test on appropriate dilutions of that material. The interfering substances are removed by saponification and sharp results may then be obtained.

Saponification and Separation of Non-saponifiable Fraction for Colorimetric Estimation of Vitamin A.

Fifty or a hundred grams of the cod liver oil are accurately weighed out and saponified by boiling for four hours with an excess of freshly prepared alcoholic solution of potassium hydroxide. During the treatment a slow current of nitrogen is passed over the surface of the boiling fluid. The saponified material is diluted with a convenient quantity of distilled water and extracted repeatedly with ether; the free space in the separating funnels being swept out each time with a current of nitrogen before shaking. The ether extracts are well washed with water, dried over anhydrous sodium sulphate and the solvent removed at low temperature in a current of nitrogen. The residue is resaponified with an excess of freshly prepared sodium ethylate in alcoholic solution at boiling point for two hours. The final extraction and recovery of the non-saponifiable fraction are also carried through as far as possible in an inert atmosphere of nitrogen. The product, after weighing, should be examined without delay, as the chromogenic substance undergoes destruction much more readily in this form than when present in the parent oil. If it is not possible to examine the material immediately, it must be stored in a sealed glass vessel kept in the dark at 0° C. Before sealing the air must be evacuated or replaced by pure nitrogen.

The values, referred to a 20 per cent. solution, for the two oils obtained by the technique A and B respectively were:—

				<i>Oil A.</i>	<i>Oil B.</i>
Technique A	14·8	5·6
Technique B	14·3	6·0

This difference is not very serious and a review of the whole series of figures suggests that individual differences of ability to match blue colours are the chief cause of the variations.

In order to throw further light on this source of error a series of control experiments was made on the oils that had been assayed by the biological method, in which the intensity of the blue colour as measured by the Lovibond instrument and also by means of a Hilger-Nutting spectrophotometer, attached to a constant deviation wave-length spectroscop. This latter procedure is probably the most accurate method available for the absolute measurement of the intensity of absorption at the head of the band responsible largely for the blue colour.

The blue colour to be measured suffers from the disadvantage of being transient, and special precautions had to be taken to ensure the recording of the maximum intensity of absorption. The type of cell used is specially well adapted for spectroscopic work with transient colours. It is made in one piece of fused quartz with flat fused-on end plates. Two such cells are placed empty in the cell holders and the zero adjustment of the photometer checked. The comparison cell, without being removed from the cell holder, is then filled with the solution of antimony trichloride. Using a specially calibrated pipette with a fine jet, 0·3 c.c. of a solution of the cod liver oil, at an appropriate dilution in chloroform, is run into the other cell. The observer then adjusts the drum of the wave-length spectrometer to $608\mu\mu$, the head of the sharp absorption band, in preparation for making rapid measurements. A second worker than allows 3 c.c. of the 30 per cent. solution of antimony trichloride to run into the absorption cell, tapping it to secure a homogeneous mixture. The observer matches the intensity of the blue colour every 15 seconds, the readings being recorded by a colleague.

The photometer readings are in terms of $\log I_0/I$: I_0 being the intensity of the light incident on the absorption cell and I that of the emergent light. When $\log I_0/I$ is plotted against time the absorption at $608\mu\mu$ reaches a maximum after about one minute. If the maxima in these curves are compared for different samples

(equating the concentrations and cell thicknesses), the relative values express the relative intensities of the blue colours for the different samples. This procedure, with practice, gives trustworthy results.

The relative values obtained by the two modifications of the colorimetric test are given in Table VI; the value for the poorest oil L being taken as unity.

TABLE VI.

Oil.	Relative Intensities of Blue Colours measured by Lovibond Tintometer.	Relative Intensities of Blue Colours measured by Spectrophotometer.
C	2.5	2.65
F	3.3	3.30
G	3.0	3.14
J	1.7	1.70
K	1.8	1.77
L	1.0	1.0

The agreement between the two forms of the colorimetric method is good, and for the great majority of estimations made in the course of this investigation the simpler Lovibond method was employed.

Results of Comparison of Assay of Vitamin Potency of Cod Liver Oils by the Biological and Colorimetric Methods.

The comparison of the relative vitamin A potency of ten cod liver oils fully assayed by the biological and colorimetric methods is given in Table VII.

TABLE VII.

Relative Vitamin A values of Cod Liver Oils.

Oil.	Biological Method.	Colorimetric Method.
C	2	2.5
F	5	3.3
G	2	3.0
J	2	1.7
K	1.5	1.8
L	1	1.0
C ₁ (L)	1	1.2
C ₂ (D)	1-2	1.7
L ₁ (L)	0.5-0.3	0.3
L ₂ (D)	0.5 (probably less).	0.7

Apart from these comparative tests a large number of other parallel estimations by the two methods have been made during the course of this work. A few of these are presented in Table VIII.

TABLE VIII.

Material Tested.	Biological Test ("Recovery" Test).		Colorimetric Test expressed in Blue Units.*
	Dose mg.	Result.	
1. Caplin oil (oil extracted from whole body).	10	No growth ..	No colour.
	20	No growth ..	
2. Squid (body oil)	20	Very slight growth.	Very slight transient blue.
	40	Growth about 5 g. weekly.	Not measurable.
3. Oil extracted from <i>Nephrops norvegicus</i> .	30	No growth ..	No colour.
	60	No growth ..	—
4. Oil extracted from <i>Megan-yctiphanes norvegicus</i> .	30	No growth ..	Very slight suggestion of blue.
5. Oil extracted from <i>Calanus finmarchicus</i> .	30	No growth ..	No colour.
	60	No growth ..	—
6. Unsaponifiable fraction from sample of plankton oil (5).	30	No growth ..	No colour.
		No growth ..	—
7. Oil extracted from a mixed plankton sample consisting largely of copepods.	30	No growth ..	No colour.
	10	No growth ..	—
8. Oil extracted from sheep liver.	0.1	Growth about 3-5 g. weekly.	180
	0.3	Growth about 8 g. weekly.	—
9. Unsaponifiable fraction from sample of sheep-liver oil (8).	0.0005	Growth 2-3 g. weekly.	1,630
	0.01	Growth 5-7 g. weekly.	—
	0.03	Growth 10 g. weekly.	—

Note.—Tests 1-9 reported fully Drummond and Morton, *Biochem. J.*, 1929, 23, 785

* The numbers in this column refer to 10 per cent. dilutions (*see* p. 29).

TABLE VIII—continued.

Material Tested.	Biological Test ("Recovery" Test).		Colorimetric Test expressed in Blue Units.*
	Dose mg.	Result.	
10. Salmon body oil	10	No growth ..	No colour.
	100	No growth ..	—
11. Salmon liver oil	0.3	} Growth about 3-4 g. weekly.	59
	0.5		
	1.0		
12. Herring body oil	10	No growth ..	No colour.
	100	No growth ..	—
13. Herring liver oil	2	Growth about 7 g. weekly.	11
14. Basking shark liver oil ..	1	No growth ..	No colour.
	10	No growth ..	—
	100	No growth ..	—

Note.—Tests 10-14 reported fully Ahmad and Drummond, *ibid.*, 1930, 24, 27.

* The numbers in this column refer to 10 per cent. dilutions (see p. 29).

The view that the blue colour is a measure of the A activity of fish liver oils has recently received substantial support from the researches that have been reported on the formation of vitamin A from certain plant pigments. Euler¹⁰ and his co-workers have advanced evidence that carotene, a widely distributed plant pigment of the lipochrome class, can serve as a source of vitamin A for animals.

It was soon apparent that there could be no question of the identity of carotene and vitamin A, and the recent work of Moore¹¹ has made it clear that carotene is converted in the animal body into the vitamin, probably in the liver. The substance produced from carotene gives the characteristic blue colour with antimony trichloride (max. 600-610 $\mu\mu$).

From these results it was concluded that there was no objection to employing the colorimetric method as a rapid and trustworthy means of comparing the vitamin A content of the large number of samples of cod liver oil which it was necessary to examine during the course of a lengthy investigation.

¹⁰ *Biochem. Zeits.*, 1928, 203, 370; *Svensk. Kem. Tidsk.*, 1929, 40, 256; *Helv. Chim. Acta*, 1929, 12, 278.

¹¹ *J. Soc. Chem. Ind.*, 1930, 49, 238.

Relation of Colorimetric Assay to United States Pharmacopœia "units".

It has been suggested by Jones¹², that the blue units given by 0.2 c.c. of a 20 per cent. solution of oil in the antimony trichloride test multiplied by 85 gives an approximation to the number of United States Pharmacopœia biological units. There appear to be grave objections to the use of such a factor.

Accordingly, the colorimetric determinations were made throughout by the technique described on p. 31, and the values set out throughout the main part of this report are the *Lovibond blue units which match the colour produced 30 seconds after mixing 0.2 c.c. of a 10 per cent. solution of the sample of cod liver oil in pure chloroform with 2 c.c. of a 30 per cent. solution antimony trichloride in the same solvent.*

2. Vitamin D.

There is, as yet, no alternative to a biological method for assaying cod liver oils with reference to vitamin D, and the examination of a large number of oils by such a method is, therefore, a somewhat formidable task.

Of the many biological methods of assay that have been described the most satisfactory appear to be those in which the curative effect of the oil on experimentally induced rickets is compared with that of a preparation of known anti-rachitic potency.

Some such comparison is essential to guard against variations which may occur in the behaviour of different lots of animals and against disturbances from other factors. It would appear from the very careful studies being carried out in this country under the auspices of the Medical Research Council and the Pharmaceutical Society that it is possible with a considerable degree of accuracy to express the anti-rachitic potency of foodstuffs in the form of "units" based on the activity of a standard preparation of irradiated ergosterol.*

At the time the investigation described in this report was begun this method of assay was not available, and it is not possible,

¹² *Quart. J. Pharm.*, 1928, 401.

* I am greatly indebted to Dr. Katharine Coward for permitting me to see the results of an exhaustive study made on this question in the Laboratories of the Pharmaceutical Society, and for much help and guidance in the difficult matter of deciding on a method for evaluating oils for vitamin D.—J. C. D.

therefore, to give all the values for the anti-rachitic potencies of the oils in the units that were subsequently adopted. It would appear advisable to describe first the method that was adopted for nearly all the assays made during the investigation, and which is based on that elaborated by Dr. Coward.¹³

(a) *Method of Biological Assay.*

Litters of young black and white rats bred from laboratory stock of known nutritional history were selected, and at the age of 28 days were given the rachitogenic diet, originally described by Steenbock and Black¹⁴.

Yellow maize 76 per cent.
Gluten flour 20 per cent.
Calcium carbonate 3 per cent.
Sodium chloride 1 per cent.

Two litters of animals (10–12) were used for the assay of each sample of oil. After having received this ration for 10 days the young animals were X-rayed to determine the extent to which rickets had developed. If, on examination of the films, it was apparent that a severe, or moderately severe rachitic condition was established, different doses of the oil were given to some of the rats whilst others were selected as controls. The "negative controls" received no supplement, whilst the "positive controls" were given a daily dose of 0·0001 mg. of irradiated ergosterol. After 10 to 14 days more the animals were again examined by X-rays, and the change in the bones noted. In most cases following the X-ray examination the rats were killed by chloroform and the bones examined by the "line test" of McCollum¹⁵. The agreement between the results of the two methods of detecting deposition of lime salts was very satisfactory.

(b) *Expressing Results of Vitamin D Assay.*

The Pharmaceutical Society of Great Britain has provisionally adopted as a unit of vitamin D assay the amount of anti-rachitogenic activity in 0·0001 mg. of a particular preparation of irradiated ergosterol supplied by the Medical Research Council. Dr. Katharine Coward of the Research Laboratories of the Pharmaceutical Society

¹³ *Quart. J. Pharm.*, 1928, 1, 27.

¹⁴ *J. Biol. Chem.*, 1925, 64, 263.

¹⁵ *J. Biol. Chem.*, 1922, 51, 41 ; 1928, 78, 495.

has informed us that reference to this standard preparation has proved satisfactory over a period of two or three years.*

This procedure is more satisfactory in many respects than that described by Poulsson, or that set out by the Council of Pharmacy and Chemistry of the United States. The main defect of Poulsson's method of assay (^{15a}) is that it estimates the amount of cod liver oil necessary to heal completely rats which have been shown by X-ray examination to have a certain degree of rickets, without reference to a preparation of constant potency. From a survey of Poulsson's work, it appears that his unit is about one-half to one-quarter that adopted by the Pharmaceutical Society.

* In a recent announcement (*The Lancet*, 30th August, 1930, p. 503) the Medical Research Council has given notice that a standard preparation is now available for use in carrying out assays of vitamin D. This article contains the following statement :

"Any unit or standard based directly on the response of the experimental young rats to administration of antirachitic material is unsatisfactory, owing to the disproportionate variation in the response to equal doses of apparently similar animals, when tested at different seasons of the year or bred in different laboratories. The vitamin D unit should rather be referred to a stated quantity of some standard antirachitic material, with which comparison can be made by any reliable biological method."

A very exhaustive series of tests was carried out under the direction of the Medical Research Council as a result of which it appears that specimens of irradiated ergosterol, prepared in a suitable manner, retain their activity unchanged for two years if maintained at or below 0° C. If they are kept at room temperature, loss of activity may occur.

The announcement contains the following important recommendations :

(a) That the standard solution of irradiated ergosterol prepared and maintained by the National Institute for Medical Research be recommended for adoption as a standard for the comparative estimation of vitamin D.

(b) That the unit of vitamin D be defined as the antirachitic potency of a quantity of this preparation corresponding to 0.0001 mg. of the ergosterol used in its production.

(c) That either the X-ray method, the "Line test," or chemical analysis of the bones of the experimental animals, be recommended for use in the estimation of vitamin D.

(d) That supplies of the standard material be made available for general distribution from the National Institute for Medical Research, Hampstead. As the supply is limited it is hoped that users will themselves prepare standard solutions of irradiated ergosterol for use in individual tests, retaining the National Institutes' material for reference. It is important that all such standard materials be kept at temperatures not exceeding 0° C.

^{15a} *Biochem. J.*, 1928, 22, 135.

The method proposed by the American Council of Pharmacy and Chemistry is on another basis and is equally open to criticism¹⁶. How misleading the use of such widely differing "units" may be, can be illustrated by some figures, for permission to reproduce which we are indebted to Dr. K. H. Coward. By means of the method of assay used by the Pharmaceutical Society a series of cod liver oils were assessed as follows:—

2	samples	under	50	units	per	gram.
5	"	"	60	"	"	"
11	"	"	100	"	"	"
9	"	containing more than 100 units per gram.				

By Poulsson's method two oils were found to contain respectively 250 and 300 of *his* units, whilst expressed in the American units most cod liver oils appear to have values of the order of 13. Unfortunately, until International agreement on the question of this assay has been reached, there is likely to be much confusion arising from the use of these different "units".

Throughout the investigation reported in this paper we have employed the "unit" of the Pharmaceutical Society of Great Britain, except in the case of a few oils that were examined before the method described above was adopted.

In these cases the values are expressed in the form of the least daily dose of oil in milligrams that produced a satisfactory cure of rickets in rats in 10 days. In these experiments the "positive control" animals received a daily dose of irradiated ergosterol, but as this was not 0.0001 mg. but a larger amount (usually 0.0005 mg.) it is not possible to express the curative value of the oil in the units that were adopted later. An approximation based on a re-examination of the X-ray plates in the light of our later experience with the more reliable method is given in brackets.

¹⁶ *J. Amer. Med. Assoc.*, 1929, 93, 693.

CHAPTER 4.

GENERAL CHARACTERISTICS OF COD AND SIMILAR LIVER OILS FROM VARIOUS LOCALITIES, WITH DETAILED ANALYSES OF THE COMPONENT FATTY ACIDS OF SOME TYPICAL OILS.

The large range of samples of liver oils studied in the course of this investigation has presented an opportunity for recording their chief characteristics; the tables below give summaries of the colour, free acidity, mean saponification value, iodine value, and vitamin content of fresh liver oils from various localities in Newfoundland, Scotland, Iceland and Norway, the oils in all cases being the whole oil from the liver (i.e. they have not been chilled and separated from the semi-solid "stearin", as for medicinal oils).

In addition to these general data, certain typical oils have been submitted to detailed analysis with a view to ascertaining the general composition of their combined fatty acids. This procedure involves a long and tedious separation of the fatty acids, and each analysis occupies several weeks in the case of fish oils, which possess a particularly complex mixture of fatty acids. The information to be gathered from such detailed analyses, when a sufficient range of the latter have been undertaken, may be expected to throw additional light on the relationship, if any, between the constitution of the fatty oil and its potency as a vehicle for vitamins or similar active principles. The immediate conclusions to be drawn from work of this nature are perhaps not so relevant to the primary objects of the present investigation, although it should be pointed out that this method is the only means by which the individual fatty acid components of the liver oils of cod and other fish can be definitely ascertained and compared.

1. *General Characteristics of Cod and similar Liver Oils from various localities.*

The crude oils were examined as soon as possible after collection or receipt with respect to the following characteristics:—

Colour.—This was assessed by measuring the intensity of the colour of the oil in a 1-in. cell in a Rosenheim-Schuster colorimeter expressed in yellow (Y) and red (R) Lovibond units.

Free acidity was determined in the customary manner by titration of the oil in hot neutral alcohol with N/10 alcoholic potassium hydroxide, using phenolphthalein as indicator; the results are given in terms of the percentage of free fatty acid (calculated as oleic acid).

Saponification values were determined by the usual standard methods and refer to the whole oil (i.e., without allowance for unsaponifiable matter).

Iodine values were determined for the most part by the Wijs method, but in some cases the Rosenmund-Kuhnhehn bromine-pyridine-sulphuric acid process was employed.

Vitamin A content is recorded as described in the previous chapter (p. 31) in terms of the blue colour developed by 0.2 c.c. of a 10 per cent. solution of the oil in chloroform with 2 c.c. of a 30 per cent. chloroform solution of antimony trichloride, except in the case of the oils set out in Table IX. In this table are given the results of the biological tests of a number of oils of different origin for both vitamin A and vitamin D.

TABLE IX.

General Characteristics of whole Newfoundland Cod Liver Oils.

Our Ref. No.	Description.	Season.	Colour.		Per cent. F.F.A.	Sap. Value.	Iod. Value.	Vitamin A. B.U.
			Y.	R.				
	<i>Cod feeding on caplin.</i>							
T1	1928	4.0	0.2	0.36	—	169.0	12.5
T2	Bonavista	1928	3.7	0.2	0.84	186	169.0	10.0
T3	Grate's Cove	1928	4.6	0.4	0.44	186	165.0	10.5
T4	Paradise	1928	3.9	0.3	0.35	186	163.0	9.0
T5	Fogo	1928	4.4	0.6	0.32	186	159.0	10.0
T6	Point aux Gaul	1928	3.9	0.4	0.26	185	168.0	8.0
	<i>Cod feeding on squid.</i>							
U1	Paradise	1928	3.2	0.1	0.13	186	174.0	9.2
U2	Bay de Verd	1928	3.2	0.1	0.46	186	163.0	9.0
U3	Pass Island	1928	3.7	0.3	0.22	185	164.0	8.7
U4	Joe Batt's Arm	1928	3.0	0.1	0.44	189	164.0	9.2
U5	Groan's Island	1928	3.0	0.2	0.47	189	160.0	9.0
U6	Bonavista	1928	3.0	0.1	0.23	188	164.0	7.8
U7	Fogo	1928	4.0	0.2	0.47	188	160.4	8.3

TABLE IX—continued.
General Characteristics of whole Newfoundland Cod Liver Oils.

Our Ref. No.	Description.	Season.	Colour.		Per cent. F.F.A.	Sap. Value.	Iod. Value.	Vitamin A. B.U.
			Y.	R.				
R1	1928	3.8	0.3	0.25	184	169.0	12.7
	King's Cove	1928	3.3	0.3	—	—	159.7	—
	West Coast	1928	2.7	—	0.19	—	167.9	—
	Jan., 1929	5.4	0.2	0.12	—	—	23.0
V1	(Medicinal)	1927	4.0	0.5	0.23	189	176.1	9.0
	(Frozen)	Sept. 1928 } Jan. 1929 }	4.5	0.0	0.45	—	—	8.9
V2	Bay Bulls	Oct., 1928	5.1	0.0	0.83	—	—	8.8
<i>Cod feeding on caplin.</i>								
X1	1929	3.8	—	0.34	186	171	8.0
X2	1929	3.5	0.1	0.22	—	—	12.0
X3	1929	3.7	0.1	0.25	—	—	10.0
X4	1929	4.0	0.1	0.31	—	—	11.6
X5	1929	3.8	0.1	0.34	184	176	13.8
X6	1929	7.2	0.8	0.50	—	—	13.0
X8	1929	6.0	0.6	0.38	—	—	12.0
X9	1929	3.1	0.5	0.25	—	—	8.0
X10	1929	3.4	0.5	0.34	—	—	9.0
X11	1929	6.8	0.7	0.70	—	—	14.0
X12	1929	4.0	0.6	0.60	184	170	10.6
X14	1929	3.5	0.9	0.34	—	—	9.0
X15	1929	3.4	0.8	0.24	—	—	8.2
X16	1929	4.0	0.5	0.29	188	169	12.0
X17	1929	6.0	0.3	0.41	—	—	13.0
X18	1929	5.1	0.7	0.38	—	—	9.6
X19	1929	3.5	0.7	0.24	—	—	7.3
X20	1929	4.5	0.5	0.53	182	173	12.4
X21	1929	5.4	0.7	0.50	—	—	12.4
X22	1929	4.1	0.6	0.47	—	—	11.0
X23	1929	3.4	0.1	0.69	—	—	12.0
X24	1929	3.5	0.1	0.44	—	—	13.1
X25	1929	3.6	0.1	0.66	186	172	11.0
X26	1929	4.3	0.1	0.66	—	—	13.0
X27	1929	5.3	0.2	0.47	—	—	13.1
X28	1929	4.2	0.2	0.81	—	—	12.0
X29	1929	3.9	0.3	0.60	188	168	9.0
X30	1929	—	—	0.34	—	—	—
X31	1929	—	—	0.09	—	—	—
<i>Winter oils.</i>								
Y1	Dec.- Jan. 1929 }	2.7	—	0.31	186	174	10.5
Y2	3.0	0.1	0.29	—	—	11.4
Y3	3.3	0.3	0.49	—	—	11.4
Y4	3.0	0.2	0.40	188	168	10.8
Y5	3.5	0.6	0.50	—	—	11.9
Y6	2.8	—	0.11	—	—	10.6
Y7	4.1	0.5	0.33	186	169	14.5

TABLE X.
General Characteristics of whole Scottish Cod Liver Oils.

Description.	Season.	Colour.		Per cent. F.F.A.	Sap. Value.	Iod. Value.	Vitamin A. B.U.
		Y.	R.				
Moray Firth, livers 1 day old	March, 1928	3.3	0.1	0.45	184	177.1	11.0
Farne Deep	July 12, 1928	—	—	0.05	182	142.0	5.6
Cullen Deep, Moray Firth ..	July 19, 1928	—	—	0.14	—	—	4.8
58° 29' N., 7° 35' W., 130 metres	Aug. 16, 1928	28.1	0.4	0.19	181	172.4	3.6
58° 03' N., 6° 13' W., 137 metres	Aug. 17, 1928	4.7	0.5	0.04	182	164.4	8.5
58° 03' N., 6° 12' W., 137 metres	Aug. 29, 1928	Over 29	7.4	0.32	183	145.2	—
55° 24' N., 4° 59' W., 73 metres	Sept. 1, 1928	5.0	1.0	0.14	184	144.7	2.8
58° 40' N., 5° 04½' W., 152-137 metres.							
Moray Firth, fresh livers, pre-spawning, mixed.	Feb., 1929	—	—	0.07	—	173.6	5.5
Do. do.	Feb., 1929	2.0	—	0.04	—	185.4	4.4
Do. do.	Feb., 1929	2.1	—	0.16	—	168.4	4.7
Do. do.	Feb., 1929	2.3	—	0.11	—	179.3	5.5
Moray Firth, fresh livers, running and spent, mixed.	March, 1929	2.3	—	0.29	—	179.4	6.2
Do. do.	March, 1929	2.5	—	0.10	—	178.0	7.7
Moray Firth, fresh male livers, pre-spawning.	Feb. 27, 1929	2.0	—	0.12	—	174.4	4.6
Do. do.	Mar. 4, 1929	2.2	—	0.14	—	174.9	5.2
Moray Firth, fresh male livers, spent.	Mar. 26, 1929	2.6	—	0.35	—	179.7	5.8
Moray Firth, fresh female livers, pre-spawning.	Feb. 27, 1929	2.4	—	0.11	—	179.8	3.6
Do. do.	Mar. 4, 1929	2.6	—	0.13	—	172.8	4.1
Moray Firth, fresh female livers, spent.	Mar. 21, 1929	3.5	—	0.38	—	177.4	10.1
Do. do.	Mar. 25, 1929	4.3	0.1	0.35	—	175.2	10.3
Off Scarborough*—Male livers	June, 1929	3.0	—	0.15	186	171.2	5.7
		2.8	—	0.16	184	173.0	4.8
Female livers	June, 1929	2.6	—	0.21	188	169.0	3.1
		2.3	—	0.11	187	166.3	3.2
Mixed ..	June, 1929	2.1	—	0.31	184	167.0	4.1
		2.2	—	0.17	184	167.9	2.5

* These oils are included in this Table because of the relation between the fish caught in the early spring in the Moray Firth and those caught later in the year off the Yorkshire Coast.

TABLE XI.
General Characteristics of whole Iceland Cod Liver Oils.

Description.	Colour.		Per cent. F.F.A.	Sap. Value.	Iod. Value.	Vitamin A. B.U.
	Y.	R.				
Season, 1929	7.3	0.9	0.18	182	151	11.0
Season, April, 1929 (spawned fish)	8.5	1.0	0.15	—	—	11.5
Season, early May, 1929	10.5	1.0	0.80	184	162	19.6

TABLE XII.
General Characteristics of whole Norwegian Cod Liver Oils.

Description.	Season.	Colour.		Per cent. F.F.A.	Sap. Value.	Iod. Value.	Vitamin A. B.U.
		Y.	R.				
Lofoten	1928	2.9	0.2	0.36	187	156	6.9
Lofoten	1928	2.3	0.0	0.14	—	—	6.7
Lofoten (previous oil, refined, medicinal).	1928	2.5	0.1	0.20	188	159	6.7
Lofoten (refined)	1928	2.2	0.1	0.38	182	153	7.2
(Producer No. 1), refined	1927	2.6	0.6	0.34	186	158	3.7
(Producer No. 2), refined	1927	3.0	0.6	0.45	188	159	5.3
(Producer No. 2), refined	1927	3.6	0.8	0.52	—	154	6.2
(Producer No. 3) (bad), refined..	1927	2.5	0.4	0.49	—	159	4.0
(Producer No. 1) (very good), re-fined.	1928	2.3	0.2	0.28	175	160	8.4
(Producer No. 2) (good), refined	1928	2.6	0.2	0.38	180	160	6.6
Lofoten (refined)	1927	2.4	0.2	0.33	181	160	4.5
Lofoten (refined)	1928	2.6	0.3	0.35	—	—	5.4
Lofoten	1927	2.6	0.4	0.36	178	160	4.7
Lofoten	1928	2.4	0.3	0.42	179	158	5.5
Aalesund	1927	2.9	0.5	0.36	—	—	3.4
Lofoten, crude	1929	1.7	0.0	0.27	185	162	3.6
Lofoten (same oil refined)	1929	1.7	0.0	0.26	—	—	3.8

TABLE XIII.

General Characteristics of other Fish Liver Oils examined.

Fish.	Description.	Date.	Colour.		Per cent. F.F.A.	Sap. Value.	Cod. Value.	Vitamin A. B.U.
			Y.	R.				
Saith ..	Firth of Forth ..	July 11, 1928.	—	—	0.06	—	141.6	11.7
.. ..	58° 03' N., 6° 13' W., 137 metres.	Aug. 17, 1928.	3.1	0.0	0.11	185	157.1	7.2
.. ..	58° 03' N., 6° 12' W., 137 metres.							
.. ..	56° 54' N., 7° 10' W., 148 metres.	Aug. 22, 1928.	4.9	0.5	0.07	184	167.5	7.8
.. ..	55° 24' N., 4° 59' W., 73 metres.	Aug. 29, 1928.	4.8	0.6	0.05	185	167.1	9.5
Dogfish	North Sound, Orkneys	July 23, 1928.	6.2	1.4	0.07	—	—	6.4
..	58° 37' N., 1° 06' W.,	July 24, 1928.	4.0	0.6	0.06- 0.19	—	116.8- 120.7	7.0-7.7
..	58° 29' N., 7° 35' W., 130 metres.	Aug. 16, 1928.	9.3	0.8	—	—	121.8	6.5
..	58° 40' N., 5° 04½' W., 152-137 metres.	Sept. 1, 1928.	Over 29	3.7	0.14	163	128.6	—
Ling ..	58° 03' N., 6° 13' W., 137 metres.	Aug. 17, 1928.	8.7	0.8	0.22	187	150.3	29.3
Hake ..	Off Wick	Aug. 9, 1928.	24.1	2.2	0.26	—	—	—
.. ..	58° 03' N., 6° 13' W., 137 metres.	Aug. 17, 1928.	12.3	0.8	0.14	185	150.6	21.7
.. ..	58° 03' N., 6° 12' W., 137 metres.							
.. ..	56° 54' N., 7° 10' W., 148 metres.	Aug. 22, 1928.	6.3	0.9	0.10	18.3	158.5	3.4
.. ..	56° 2' N., 7° 03' W., 78 metres.	Aug. 23, 1928.	6.4	0.8	0.18	185	158.6	?
.. ..	55° 34' N., 5° 24½' W., 88 metres.	Sept. 12, 1928.	16.0	2.3	0.12	186	149.2	?
Skate ..	58° 17' N., 6° 11' W., 15-18 metres.	—	Over 29	8.6	0.38	168	210.2	3.1
Haddock	Aberdeen Bay ..	Aug. 8, 1928.	25.0	4.5	0.29	184	172.7	Nil.

TABLE XIV.
Range of Characteristics of the preceding Oils.

Fish.	Locality.	Season.	Description.	Colour.		Per cent. F.F.A.	Sap. Value.	Iod. Value.	Vitamin A. B.U.
				Y.	R.				
Cod ..	Newfoundland	Summer, 1923.	Feeding on caplin.	3.7-4.6	0.2-0.6	0.26-0.84	185-186	159-169	8.0-12.5
			Feeding on squid	3.0-4.0	0.1-0.3	0.13-0.47	185-189	160-174	7.8-9.2
" ..	" ..	Summer, 1929.	Feeding on caplin.	3.1-7.2	0.0-0.9	0.09-0.70	182-188	169-176	7.3-14.0
			Winter, 1929.	2.7-3.5	0.0-0.6	0.11-0.50	186-188	168-174	10.5-14.5
" ..	" ..	1928-1929	Various samples	2.7-5.4	0.0-0.3	0.12-0.83	184	159.7-169.0	8.8-23.0
			Observed during July-August, 1929. visit.	2.8-7.2	0.0-0.9	0.09-1.22	7-14 (mean 11)
" ..	Scottish ..	Summer, 1923.	Samples <i>ex</i> " Explorer."	4.7-29	0.4-7.4	0.04-0.32	181-184	142.0-172.4	2.8-8.5
			Pre-spawning ..	2.0-2.6	0.0	0.04-0.16	..	168.4-185.4	3.6-5.5
" ..	Moray Firth ..	March, 1928, 1929.	Running and Spent	2.3-3.3	0.0-0.1	0.10-0.45	..	173.2-182.3	3.4-11.0
			Spent males* ..	2.6	0.0	0.35	..	179.7	5.8
" ..	" ..	" ..	Spent females..	3.5-4.3	0.0-0.1	0.35-0.38	..	175.2-177.4	10.1-10.3
			Off Scarborough	June, 1929.	Males ..	2.8-3.0	..	0.15-0.16	184-186
" ..	" ..	" ..	Females ..	2.3-2.6	..	0.11-0.21	187-188	166.3-169.0	3.1-3.2
			Mixed ..	2.1-2.2	..	0.17-0.31	184	167-167.9	2.5-4.1
" ..	Iceland ..	1929.	7.3-10.5	0.9-1.0	0.15-0.80	11.0-19.6
			Norway ..	1927.	2.4-3.6	0.2-0.8	0.33-0.52
" ..	" ..	1928	2.2-2.9	0.0-0.3	0.14-0.42	5.4-8.4
			1.7	0.0	0.27	3.6
Saith ..	Off N.W. Scotland and Firth of Forth.	July-August, 1928.	(4 specimens) ..	3.1-4.9	0.0-0.6	0.05-0.11	184-185	141.6-167.5	7.2-11.7
			Dogfish	Off N.W. Scotland and North Sea.	(4 specimens) ..	4.0-29	0.6-3.7	0.06-0.19	163
Ling ..	Hebrides	(1 specimen)* ..	8.7	0.8	0.22	187	150.3	29.3
Hake ..	Hebrides	(5 specimens) ..	6.3-24.1	0.8-2.3	0.10-0.26	183-186	149.2-158.6	3.4-21.7
			Skate ..	Hebrides ..	(1 specimen)* ..	over 29	8.6	0.38	168
Haddock	Aberdeen Bay *	25.0	4.5	0.29	184	172.7	Nil.

Table XIV includes the maximum and minimum values observed in all cases which have come under our personal observation during this investigation; the ranges for Moray Firth cod liver oils, 1929, include, in addition to the instances given in Table X, the other samples prepared in the course of our study of technological factors (conditions of steaming, etc.), which are described in detail in Chapter 6.

It is of interest to note that A. D. Holmes and W. Z. Clough¹ have observed that, in 122 samples of American Atlantic coast (New York to Labrador) crude medicinal cod liver oils, the range of characteristics was free fatty acid 0 : 27-1.65 per cent.; saponification value, 181-191; iodine value, 151-183; and unsaponifiable matter, 1.0-1.4 per cent. Similarly, examining 20 samples of industrial cod oil (trade quality), A. D. Holmes, W. Z. Clough and R. J. Owen report as follows: free fatty acid, 7.2-20.1 per cent.; saponification value, 184-195; iodine value, 146-169; and unsaponifiable matter, 1.2-2.8 per cent.²

The free acidities and the colours of the oils are undoubtedly partly due to characteristics of the various types of cod (e.g., the colour and free acidity of the Newfoundland oils tend to be slightly greater than those of Norwegian oils) and partly to the conditions of extraction of the oil.

No great significance can be attached to the variations in iodine value, which may range from about 160 to 185 for oils of good medicinal value.

The figures for the estimations of vitamin A by the colorimetric method show that although there are wide variations in the oils from different areas, it is evident that, on the whole, the Norwegian oils are the lowest, followed in increasing order by the Scottish, Icelandic and Newfoundland oils.

In Table XV are set out the results of the biological tests of a number of oils of each class for vitamin A and vitamin D. Although these tests were carried out with considerable care, the variations in the response of the animals given the various doses of the oils was so large that it was often a matter of the greatest difficulty to draw conclusions regarding their relative potencies. Thus, for example, oil X₁₀, a Newfoundland sample, gave approximately the same rate of growth (3-5 g. weekly over a period of five or six weeks) with doses

¹ *Oil and Fat Industries*, 1927, 4, 403.

² *Ibid.*, 1929, 6, (10), 15.

of 1 or 2 milligrams, whilst oil G gave a similar response with both 5 and 7 milligrams. Either dosage might be taken as having produced the rate of growth required by the U.S.P. method of assay, so that X₁₀ could be considered either as a 500 or as a 1,000 unit oil, whilst G could be given the value of either 140 or 200 units.

TABLE XV.
Comparison of Vitamin A and Vitamin D Values of Oils of different origins.

Origin.	No.	Description.	Vitamin A Tests.			Vitamin D Tests.	
			Colour Test B.U.	Dose giving growth at rate of 3-5 g. week (mg.).	U.S.P. units A.	Dose curing Rickets in 10 days (mg.).	Pharm. Soc. units D.
Newfoundland	T ₁	Summer, 1928 (Caplin feed)	10.0	2	500	5	200
"	U ₁	" " (Squid feed)	7.8	1.5	660	5	200
"	V ₁	" " "	8.7	2-3	500-330	3	330
"	V ₂	Winter, 1929	23.0	0.5	2000	2	500
"	X ₁	Summer, 1929 (Caplin feed)	12.0	1	1000	5	200
"	X ₁₀	" " "	9.0	1-2	1000-500	7	140
"	X ₁₁	" " "	10.6	2	500	7	140
"	X ₁₂	" " "	13.0	1	1,000	3	330
"	X ₁₇	" " "	11.0	2	500	5	200
Scottish and North Sea.	C ₁	Moray Firth, April, 1928	10.0	5	200	10	(100)*
"	F ₁	" " "	11.0	2	500	10	(100)*
"	G ₁	" " "	11.6	5-7	200-140	12	80
"	I ₁	" " Feb., 1929	4.6	10	100	12	80
"	I ₂	" " "	5.3	7	140	10	100
"	J ₁	" " Mar., 1929	3.6	10	100	12	80
"	J ₂	" " April, 1929	4.1	7	140	10	100
"	J ₃	" " "	6.1	7	140	5	200
"	I ₃	Scarborough, June, 1929	5.7	10	100	10	100
"	J ₄	" " "	3.2	10	100	12	80
Iceland	W ₁	Mar., 1929	11.0	1	1,000	5	200
"	W ₂	May, 1929.. ..	19.6	0.5	2,000	2	500
Norwegian	K ₁	Lofoten, Feb., 1928 ..	7.2	7	140	5	(200)*
"	L ₁	" Feb., 1927	3.7	10	100	5	(200)*
"	M ₁	" Feb., 1928	8.4	7	140	10	100
"	O ₁	" 1928	5.4	7	140	10	100
"	P ₁	" 1928	5.5	7	140	10	100
"	Q	Aalesund, 1927	3.5	10	100	5	200
"	"	Lofoten, Feb., 1929 ..	3.6	7-10	140-100	7	140
"	"	Mar., 1929	3.8	10	100	10	100
"	"	Mar., 1929	4.0	10	100	5	200

* N.B.—These values are approximate (see p. 38) as they were arrived at before a satisfactory method of comparison with the irradiated ergosterol was devised.

The actual figures for units of A are, therefore, of little significance beyond giving a clear indication that the vitamin A potency of the Newfoundland and Iceland oils examined was high compared with that of oils of Norwegian origin. The Scottish oils occupy an intermediate position. On the whole, there is good agreement between the results of the colorimetric test and those derived from feeding experiments. A few cases of disagreement are to be noted, as, for example, the oils X₂₅, G and W, all of which gave about 11 blue units, but there is little doubt that these are due to the inaccuracies of the biological test.

The vitamin D tests also reveal the relatively high value of the Newfoundland and Icelandic oils. Generally speaking, there is a parallel between the vitamin A and vitamin D potencies of the oils, although a few exceptions are to be noted. Thus, the Norwegian oils L and Q are of low vitamin A value but relatively good as sources of D.

2. *The Composition of the Fatty Acids present in combination in Cod and other Fish Liver Oils.*

The mixtures of fatty acids combined as triglycerides in marine animal oils are some of the most complex found in natural fats: some twelve or more different fatty acids are generally present, and the unique feature of these oils is their content of highly unsaturated acids containing twenty and twenty-two carbon atoms in the molecule and four, five or six ethylenic linkings.

The determination of the percentage proportions of each fatty acid present in fatty oils—a procedure which has only been developed in comparatively recent years even in the case of comparatively simple fats—is of considerable scientific value in that it permits of gradual correlation of the composition of fats with their biological origin and with other factors. The usual technical analytical characteristics such as saponification and iodine values afford data which, whilst most useful in checking the standard of a given fatty oil or group of fatty oils, are the resultants of the whole mixture of fatty acids present and do not discriminate at all between the latter.

Consequently, special methods have to be employed in the determination of the approximate composition of a complex mixture of fatty acids; the process is lengthy and, in the case of the fish oil acids, requires from three to four weeks for each analysis in the hands of an experienced worker.

It is not intended here to enter at any length into the experimental details of such analyses, in which the majority of those who use this Report will probably not be greatly interested. Those who desire a fuller exposition of this somewhat academic side of the investigation, will find a complete account of the analyses in question published separately in the *Biochemical Journal*³. It is proposed only to quote in this Report the final results of the investigations, which, we believe, present for the first time a detailed account of the approximate composition of the fatty acids of cod, saith, hake, ling, dogfish and skate liver oils. Briefly, the procedure adopted was to prepare the mixed fatty acids from the oils by saponification, and to divide these into two groups, (a) those the lead salts of which were insoluble in 95 per cent. alcohol, and (b) those the lead salts of which were soluble in this medium. Group (a) consisted of most of the saturated fatty acids present, with some oleic and most of the monoethylenic acids $C_{20}H_{38}O_2$ and $C_{22}H_{42}O_2$, whilst group (b) contained some myristic and traces of palmitic acid, with all the highly unsaturated acids of the C_{20} and C_{22} series, and all the monoethylenic (oleic) acids except those referred to in group (a). Each group of acids was converted into methyl esters, which were then quantitatively distilled from a Willstätter fractionating bulb heated by means of an oil-bath, the operation being carried out under as high a vacuum (about 1 mm.) as possible. By means of systematic fractionation and refractionation, and observation of the saponification and iodine values of the fractions collected, it was possible to determine the approximate composition of the latter, and thence ultimately to deduce that of the original mixture of fatty acids.

Earlier work on this subject was mainly qualitative in nature: in 1906 Bull⁴ established the presence in cod liver oil of palmitoleic ($\Delta^9:10$ -hexadecenoic acid⁵) acid, $C_{16}H_{30}O_2$, and of gadoleic acid, $C_{20}H_{38}O_2$, whilst the first references to the occurrence of highly unsaturated ("clupanodonic") acids of the C_{20} and C_{22} series in this oil appear to have been made by Tsujimoto⁶ and by Marcusson and Botger⁷. Other references to specific fatty acids present in the liver oils now being considered include the following:—

³ Guha, Hilditch and Lovern. *Biochem. J.*, 1930, 24, 266.

⁴ Bull. *Ber.*, 1906, 39, 3570.

⁵ Armstrong, E. F. and Hilditch. *J. Soc. Chem. Ind.*, 1925, 44, 182T.

⁶ Tsujimoto. *Chem. Revue*, 1913, 20, 70.

⁷ Marcusson and Botger. *Ibid*, 1914, 21, 180.

Cod liver oil:—palmitoleic acid (Schmidt-Nielsen⁸), "clupanodonic" and "jecoric" acids (Fahrion⁹); highly-unsaturated acids (Toyama and Tsuchiya¹⁰); qualitative data for the oil of *Gadus macrocephalus* (Toyama¹¹); some mixed glycerides present in cod liver oil (Suzuki and Masuda¹²); relation of composition to vitamin content (Holmes¹³); percentage of highly unsaturated acids (from ether-insoluble polybromides) given as 10–15 per cent by various workers.

Saith Liver Oil:—percentage of highly unsaturated acids (from ether-insoluble polybromides) about 17 per cent. (Lewkowitsch-Warburton¹⁴).

Ling Liver Oil:—Percentage of highly unsaturated acids (from ether-insoluble polybromides) about 14 per cent. (Lewkowitsch-Warburton¹⁴).

Dogfish Liver Oil:—unsaponifiable matter present has been found to vary between the limits of 4 and 33 per cent., both squalene and cholesterol frequently being present; the iodine value of the mixed fatty acids is usually lower than in the preceding cases (cf. Chapman¹⁵, Lexow¹⁶, Holmes and Piggett¹⁷, etc.).

Reference should also be made to the work of Tsujimoto¹⁸ and of Toyama¹⁹, who have found that the lithium (or, under certain conditions, the sodium or ammonium) salts of the highly unsaturated fish oil acids are soluble in 90 per cent. acetone, whilst the corresponding salts of the remaining fatty acids present are insoluble in this medium; this gives an alternative measure of the proportion of highly unsaturated C₂₀ and C₂₂ acids present in a fish oil, and, by combining this process with the lead salt separation previously referred to, it is possible to obtain an estimate of the respective amounts of fully-saturated, monoethylenic and polyethylenic fatty acids present.

⁸ Schmidt-Nielsen. *Chem. Umschau*, 1922, 29, 54.

⁹ Fahrion. *Ibid.*, 1917, 24, 4.

¹⁰ Toyama and Tsuchiya. *Ibid.*, 1925, 32, 204.

¹¹ Toyama. *J. Soc. Chem. Ind. Japan*, 1926, 29, 172.

¹² Suzuki and Masuda. *Proc. Imp. Acad. Tokyo*, 1927, 3, 531; 1928, 4, 165.

¹³ Holmes. *Ind. Eng. Chem.*, 1924, 16, 1181.

¹⁴ Lewkowitsch-Warburton. "Oils, Fats and Waxes," 6th Edition, 1922, Vol. I, p. 459.

¹⁵ Chapman. *Analyst*, 1918, 43, 156.

¹⁶ Lexow. *Chem. Umschau*, 1922, 29, 59.

¹⁷ Holmes and Piggett. *Ind. Eng. Chem.*, 1925, 17, 310.

¹⁸ *J. Soc. Chem. Ind. Japan*, 1920, 23, 1007; 1923, 26, 891.

¹⁹ *Chem. Umschau*, 1925, 32, 204.

Our present method, on the other hand, gives, in the case of the fish oils, the approximate amount of each homologous acid, saturated and unsaturated, but does not differentiate between acids of varying degrees of unsaturation; it is possible, however, to indicate in most cases the average unsaturation of the acids concerned (including both mono- and poly-ethylenic members). This is conveniently given in terms of the average number of gram-atoms of hydrogen lacking as compared with the corresponding saturated acid; thus ($-2.0H$) indicates the presence of acids containing only one ethylenic linking, whilst ($-4.0H$) might imply the presence of only a diethenoid acid, of an equimolecular mixture of mono- and tri-ethenoid acids, or, equally, of a mixture of acids containing one, two, three or more ethylenic linkings, the mean unsaturation of which happened to coincide with this figure. The methods at present available do not, unfortunately, permit of the determination of the individual unsaturated acids present in any but the simplest cases (e.g., where it is known that only two acids, such as oleic and linoleic, are present). Qualitative information can, however, be added in several cases which supplements the quantitative data by general statements as to the predominance or otherwise of particular components.

The various oils which have now been analysed in detail had the general analytical characteristics shown in Table XVI:—

TABLE XVI.
General Analytical Characteristics of the Liver Oils.

Fish Liver Oil.	Fish taken.	Sap. Value.	Iodine Value.	Free Acidity (as oleic acid). per cent.	Un-saponifiable per cent.	Colour of Oil.*		Vitamin A (Colorimetric). Blue Units.
						Yel-low.	Red.	
Cod (Newfoundland) ..	July, 1928 ..	186	163.0	0.46	0.87	3.2	0.1	9.0
" (Scottish) ..	March, 1928	184	177.1	0.45	0.91	3.3	0.1	11.0
" (Norwegian) ..	1929 (Lofoten)	185	161.8	0.27	0.63	1.7	0.0	3.6
Coalfish (Saith) I ..	Aug. 30, 1928	185	167.1	0.05	0.80	4.8	0.6	9.5
" " II ..	Aug. 22, 1928	184	167.5	0.07	0.60	4.9	0.5	7.8
Hake I ..	Aug. 17, 1928	185	150.6	0.14	0.91	12.3	0.8	21.7
" II ..	Aug. 22, 1928	184	158.5	0.14	1.65	6.4	0.9	3.4
" III ..	Sept. 12, 1928	186	149.2	0.12	1.21	16.0	2.3	ca. 8
Ling ..	Aug. 17, 1928	187	150.3	0.22	1.16	8.7	0.8	29.3
Skate ..	Aug. 13, 1928	168	210.2	0.38	0.31	ca. 30	8.6	3.1
Dogfish..	Aug. 16, 1928	163	121.8	0.14	10.5	9.3	0.8	6.5

* Determined in a 1-in. cell by the Rosenheim-Schuster Colorimeter.

The final results obtained for the component fatty acids of these various oils are collected in Table XVII :—

TABLE XVII.

Composition of Fatty Acids combined in Liver Oils of cod, saith, hake, ling, skate and dogfish.

Liver Oil. Fish taken.	Newfound- land, July, 1928.	Cod. Scottish, March, 1928.	Norwegian. 1929 (Lofoten).	Saith.		I. Aug. 17, 1928.	Hake.		Ling. Aug. 17, 1928.	Skate. Aug. 13, 1928.	Dogfish. Aug. 16 1928.
				I. Aug. 30, 1928.	II. Aug. 22, 1928.		II. Aug. 22, 1928.	III. Sept. 12, 1928.			
<i>Saturated Acids—</i>											
Myristic acid ..	6.0	3.5	5.0	6.5	6.0	7.0	4.5	5.5	5.0	4.0	6.0
Palmitic	8.5	10.0	6.5	13.0	12.0	13.0	12.0	11.0	13.0	14.0	10.5
Stearic	0.5	—	Trace	0.5	Trace	—	0.5	0.5	1.0	—	3.0
<i>Unsaturated Acids—</i>											
C ₁₄ group ..	Trace	0.5(-2H)	0.5(-2H)	—	Trace	Trace	—	—	Trace	Trace	—
C ₁₆	20(-2H)	15.5(-2H)	16.0(-2H)	14.5(-2H)	9.5(-2H)	17(-2H)	12(-2H)	8(-2H)	13.0(-2H)	10.5(-2H)	9.0(-2H)
C ₁₈	25(-3H)	25.0(-3H)	31.0(-3H)	31.0(-3H)	29.5(-3H)	18(-3H)	27(-3H)	34(-3H)	32.5(-3H)	20.5(-3H)	24.5(-
C ₂₀	26(-6H)	31.5(-6H)	30.5(-5H)	24.5(?)	26.5(-5H)	31(-5H)	30(-4H)	25(?)	24.0(-6H)	32.5(-7H)	29.0(-3H)
C ₂₂	10(-7H)	14(-7H)	10.5(?)	10(?)	16.5(-7H)	14(?)	14(-6H)	16(?)	11.5(-7H)	18.5(-9.5H)	12.0(-4H)
C ₂₄	—	—	—	—	—	—	—	—	—	—	6(-2H)

It may be said at once that no apparent correlation between the vitamin potencies of the oils studied and the composition of their fatty acids is revealed as a result of these figures; in the cases examined, the highest vitamin potency was observed in liver oils from the family *Gadidae*, but this may be a more or less fortuitous observation.

So far as the component fatty acids go, the *Gadidae* liver oils (cod, saith, hake and ling) and the skate liver oil are all closely and even quantitatively similar in most respects; the dogfish liver oil stands somewhat apart, but for reasons given below the fatty components of the skate, dogfish and other *Elasmobranch* oils are particularly interesting in that their nature appears to vary with the amount of accompanying non-fatty matter, especially in regard to the squalene content of the latter.

The highly unsaturated compounds present appeared to fall into two classes, namely, those which were altered or polymerised to a greater or less extent during the distillation of their esters, and those which were unaffected in this way. The respective unsaturated esters from the cod, saith and hake liver oils were all more or less susceptible to polymerisation of this kind, and the suggested figures (where given) for the mean unsaturation of the C_{20} and C_{22} groups are probably lower than the real values. On the contrary, the corresponding esters from ling, skate and dogfish oils were entirely stable during distillation, and in the two former cases, it may be permissible to think that there is some evidence in this fact for suggesting that the unsaturated acids concerned may not always have the same chemical constitution in different oils.

The fatty acid compositions of the individual oils may be commented upon as follows:—

(i) *Cod Liver Oil Acids*.—The saturated acids were present in somewhat lower proportions than in the other *Gadidae* liver oils, but, like these, consisted chiefly of palmitic with subsidiary amounts of myristic acid. Myristoleic acid was only present in minute amounts, whilst palmitoleic formed from 15–20 per cent. of the whole; the C_{18} unsaturated acids consisted of approximately equal proportions of oleic and linoleic acids, oleic showing a tendency to predominate. Of the acids of the C_{20} and C_{22} groups, gadoleic (the monoethylenic C_{20}) acid was present in

some quantity, but the amount of cetoleic (the corresponding C_{22}) acid was apparently small; the highly unsaturated acids of each group probably formed 10–15 per cent. of the total fatty acids of the oil, and were susceptible to polymerisation by heat. There was no very marked difference in the composition of the fatty acids of the Newfoundland, Scottish, and Norwegian oils. The Newfoundland sample was from the 1928 season (feeding on squid), the Scottish sample from the Moray Firth (1928) season (fish spawning), and the Norwegian oil was from the 1929 Lofoten catch; all the oils analysed were "crude", i.e., rendered from fresh livers but not chilled and separated into "medicinal" quality.

(ii) *Saith Liver Oil Acids*.—The saturated acids were almost identical in each of the two samples examined—about 6 per cent. myristic and 12–13 per cent. palmitic acid, the latter figure being higher than in the cod liver oils but practically the same as in hake, ling, and skate liver oil fatty acids. The unsaturated acids of saith liver oil closely resembled those of the cod liver oils in their quantitative composition and in the susceptibility of the highly unsaturated portion of this group to polymerisation; whilst those of saith liver oil II, whilst also generally similar to the cod liver oil acids, contained somewhat less palmitoleic acid and correspondingly more of the unsaturated acids of the C_{22} series, and, curiously, little or no tendency to polymerisation was observed during distillation of the highly unsaturated esters of the C_{20} and C_{22} series.

Apart from these minor differences, however, all the cod and saith liver fatty acids show a strong general similarity, a feature which is the more striking when it is remembered that the five oils in question were from fish taken at varying periods in localities so widely separated as the seas off Newfoundland, the Lofoten Islands, and the north and west of Scotland.

(iii) *Hake Liver Oil Acids*.—Here, again, the proportions of the fatty acids are generally on similar lines to those of the cod and saith oils, especially in the case of hake oils II and III; in all three cases the highly unsaturated acids were particularly prone to polymerisation.

(iv) *Ling Liver Oil Acids*.—The sample studied in this case was from the liver of a single fish. The figures are again very like those of the cod and saith oil acids. Little polymerisation of the highly unsaturated group occurred during the analysis and the figures given for the mean unsaturation of each group are probably close to the truth in this case; some monoethylenic C_{30} acid was present, but apparently only very small quantities of monoethylenic C_{22} acid.

(v) *Skate and Dogfish Liver Oil Acids*.—These fish belong to the *Elasmobranch* group and it is convenient to discuss them in conjunction with existing data for other fish oils of the same nature. It may be noted here, however, that the skate fatty acids, although otherwise similar to the preceding *Gadidae* fatty acids in general proportions, possessed unusually high mean unsaturation in the C_{20} and C_{22} groups, the esters of which, moreover, were distilled without any sign of polymerisation.

The dogfish liver oil, which contained about 11 per cent. of non-fatty matter, was somewhat different in fatty acid composition to the rest; highly unsaturated acids were present in only small quantities, if at all, and a small proportion of the monoethylenic selacholeic acid, $C_{24}H_{46}O_2$, was observed to be present.

It is profitable to consider the foregoing analyses in conjunction with the few results of a similar nature which have been previously published for other marine animal oils. All the data at present available (including the present analyses) are classified in Table XVIII according to the biological origin of the oils: the data for the whale oils (*Balaena* sp.), menhaden oil and Japanese sardine oil are taken from a communication by Armstrong and Allan²⁰, those for the liver oils of *Scymnorhinus* and allied genera were given by Hilditch and Houlbrooke²¹, those for the head and blubber oils of the sperm whale by Hilditch and Lovern²², and for sperm liver oil by Tsujimoto and Kimura²³.

²⁰ *J. Soc. Chem. Ind.*, 1924, 43, 216T.

²¹ *Analyst*, 1928, 53, 246.

²² *J. Soc. Chem. Ind.*, 1928, 47, 105T.

²³ *Chem. Umschau*, 1928, 35, 317.

TABLE XVIII.
Percentage composition of fatty acids of marine animal oils.

Oil.	Species.	Saturated Acids.			Unsaturated Acids.					
		C ₁₄ .	C ₁₆ .	C ₁₈ .	C ₁₄ .	C ₁₆ .	C ₁₈ .	C ₂₀ .	C ₂₂ .	C ₂₄ .
(Sub-division <i>Teleostomi</i> , Order <i>Teleostei</i> .)										
Family <i>Gadidae</i> .										
Cod liver (New-foundland).	<i>Gadus morrhua</i>	6.0	8.5	0.5	Trace	20.0	29.0	26.0	10.0	—
Cod liver (Scottish)	" "	3.5	10.0	—	0.5	15.5	25.0	31.5	14.0	—
Cod liver (Norwegian).	" "	5.0	6.5	Trace	0.5	16.0	31.0	30.5	10.5	—
Coalfish (saith) liver I.	<i>G. virens</i>	6.5	13.0	0.5	—	14.5	31.0	24.5	10.0	—
Coalfish (saith) Liver II.	" "	6.0	12.0	Trace	Trace	9.5	29.5	26.5	16.5	—
Hake liver I	<i>Merluccius merluccius</i> .	7.0	13.0	—	Trace	17.0	18.0	31.0	14.0	—
" " II	" "	4.5	12.0	0.5	—	12.0	27.0	30.0	14.0	—
" " III	" "	5.5	11.0	0.5	—	8.0	34.0	25.0	16.0	—
Ling liver	<i>Molva molva</i> ..	5.0	13.0	1.0	Trace	13.0	32.5	24.0	11.5	—
Family <i>Clupeidae</i> .										
Japanese sardine (whole fish).	<i>Clupanodon melanostica</i> .	6.0	10.0	2.0	—	13.0	24.0	26.0	19.0	—
Menhaden (whole fish).	<i>Alosa menhaden</i>	6.0	16.0	1.5	—	15.5	30.0	19.0	12.0	—
(Sub-division <i>Elasmobranchii</i> , Order <i>Selachii</i> .)										
Family <i>Squalidae</i> .										
Dogfish liver	<i>Squalus acanthias</i> .	6.0	10.5	3.0	—	9.0	24.5	29.0	12.0	*6.0
Mixed liver oils from	<i>Centrophorus, Lepidorhinus, etc., sp.</i>	1.0	13.0	2.5	Trace	3.5	35.5	*16.5	*16.0	*12.0
Family <i>Dalatiidae</i> .										
Liver oil of	<i>Scymnorhinus lichia</i> .	1.0	14.5	3.5	0.5	4.0	29.0	*10.5	*26.0	*10.0
Family <i>Rajidae</i> .										
Skate liver	<i>Raja maculata</i>	4.0	14.0	—	Trace	10.5	20.5	†32.5	†18.5	—
(Division <i>Mammalia</i> , Order <i>Cetacea</i> .)										
Family <i>Balaenidae</i> .										
Whale oil (blubber)—Arctic	<i>Balaena mysticetus</i> .	4.0	10.5	3.5	—	18.0	33.0	20.0	11.0	—
Newfoundland	" "	7.5	10.0	3.0	1.5	18.0	44.0	—	16.0	—
South Sea	<i>Balaena australias</i> .	8.0	12.0	2.0	1.5	15.0	43.0	8.0	10.5	—
Family <i>Physeteridae</i> .										
Sperm whale—Head†	<i>Physeter macrocephalus</i>	14.0	8.0	2.0	14.0	15.0	*17.0	*6.5	—	—
Blubber	" "	5.0	6.5	—	4.0	26.5	*37.0	*19.0	—	—
Liver	" "	(24.6 per cent. saturated.)			(42 per cent. monoethylenic and 23.4 per cent. polyethylenic.)					

* Practically only monoethylenic acids present.

† Particularly high average unsaturation.

‡ The head acids also contained 3.5 per cent. capric, 16 per cent. lauric, and 4 per cent. lauroleic acids; the blubber acids, 1-2 per cent. of lauric acid.

The figures in Table XVIII are perhaps chiefly valuable at the moment in suggesting the desirability of adding as rapidly as possible to the meagre number of quantitative data of the kind which have so far been collected. Investigations of this kind are necessarily lengthy and tedious, but the results so far obtained indicate the possibility that they may lead to useful correlations as well as differentiations between the build of the fats occurring in different classes of marine animals or, for example, present in different parts of the same animal.

Inspection of Table XVIII will show that, leaving apart minor differences in the percentages of the fatty acids concerned, the liver oils of the *Gadidae* and the flesh oils of the two members of the herring family stand out from the rest in the approximate constancy of their general composition, the range of which is as follows:—

	Per cent.	Mean unsaturation.
Myristic acid	3.5-7	
Palmitic "	6.5-13	
Stearic "	nil-1	
Myristoleic acid	trace-0.5	(-2.0 H)
Palmitoleic "	13-20	(-2.0 to - 3.0 H)
Oleic and linoleic acids	18-32.5	(-2.8 to - 4.0 H)
Unsaturated C ₂₀ acids	19-31.5	(-4.9 to - 7.3 H)
" C ₂₂ "	10.19	(-5.4 to -10.0 H)

The blubber fats of the ordinary whales approach most closely in composition to the foregoing, but on the whole appear to contain greater amounts of oleic and linoleic acids, with corresponding reduction in the total proportions of polyethylenic C₂₀ and C₂₂ acids, the total percentage of saturated acids being little different in either group. The interesting, but only partially quantitative, study by Tsujimoto and Kimura²² (*loc. cit.*) of the fatty acids of the liver of the sperm whale suggests that here also the composition is much the same as in the body-fats of the *Balaenidae* and *Clupeidae* and the liver-fats of the *Gadidae*, and these authors also state that the fat as obtained contains only 16 per cent. of unsaponifiable matter, of which 8 per cent. is cholesterol, higher fatty alcohols being probably absent; sperm head and blubber oils, on the contrary, contain 33-40 per cent. of combined higher fatty alcohols, whilst the fatty acids also present are entirely different in character from those of any other marine animal (Hilditch and Lovern²³, *loc. cit.*).

²² *Chem. Umschau*, 1928, 35, 317.

²³ *J. Soc. Chem. Ind.*, 1928, 47, 105T.

Whilst differences of the latter kind point clearly to synthesis of particular varieties of fatty compounds by specific classes of animals, the general similarity in composition, previously referred to, of the fatty acids of the livers, and in some cases the body oils of many marine animal fats of diverse biological orders hints that fish and marine mammalia derive a considerable proportion of their fats by direct assimilation. The polyethylenic acids of the C_{20} and C_{22} series, which at one time were known only as characteristic of fishes and marine mammals, have been detected by Tsujimoto²⁴ in algae of different kinds in every instance tested, although it is true that the proportion present is much lower than in the fish liver oils which are the primary subject of this paper; furthermore, it is stated by Grün and Halden²⁵ that the fat of birds which feed on fish also contains these highly-unsaturated acids, which are not present in the fat of birds whose diet is confined to insects, grain, etc., from non-marine sources. The determination of the origin (evidently marine in nature) of these unique highly unsaturated fatty acids is thus a problem of great interest which remains to be solved.

Finally, the detailed composition of the fatty acids of the *Elasmobranchii* deserves further attention, in view of the interesting results so far obtained.

It has already been pointed out that, in this group, the acids of skate liver oil alone resemble those of the more frequently-occurring type (but possess distinctly greater average unsaturation and amount of polyethylenic C_{20} and C_{22} acids, whilst the monoethylenic acids of these series are only present in minimal quantities); this skate liver oil, however, contains, for an *Elasmobranch* oil, a very low proportion of unsaponifiable matter—lower, indeed, than any of the *Gadidae* oils.

At the other extreme are the fats of *Centrophorus*, *Lepidorhinus* and *Scymnorhinus* species, which were the complement of large proportions of unsaponifiable matter composed mainly of the hydrocarbon squalene; the fatty acids from these sources contained no highly unsaturated C_{20} and C_{22} derivatives, but were mainly ethylenic in character and notable amounts of the monoethylenic (selacholeic) acid, $C_{24}H_{46}O_2$ (Tsujimoto²⁶), were also present.

²⁴ *Chem. Umschau*, 1925, 32, 125.

²⁵ *Analyse der Fette und Wachse* (J. Springer, Berlin), 1929, Vol. II, 520.

²⁶ *J. Soc. Chem. Ind. Japan*, 1927, 30, 868.

The dogfish liver oil reported upon in this paper was intermediate in character between these varieties of *Elasmobranch* oil; it contained 10.5 per cent. of unsaponifiable matter, which consisted partly of liquid hydrocarbons (squalene) and partly of solid crystalline compounds (cholesterol?). The fatty acids present were also intermediate in composition between those of the two extreme types, for selacholeic acid was present in small quantity, whilst the mean unsaturation of the C_{20} and C_{22} acids (about — 4.0 H) was higher than monoethylenic but less marked than in the cod and other fish liver oils which were first discussed.

So far as the present data go, therefore, there is a definite and close relation in the *Elasmobranch* group between the character of the fat present and the amount and nature of the unsaponifiable matter. We are not inclined at this juncture to do more than point out that our recent results strengthen the conclusion of Hilditch and Houlbrooke²¹ (*loc. cit.*) that there is some connection between the absence of the polyethylenic C_{20} and C_{22} acids so characteristic of most animal oils and the presence of large proportions of squalene. We believe that at present no suggestion can be usefully offered to explain the genesis, much less a hypothetical transmutation into one another, of either the polyethylenic acids, of squalene, or of cholesterol or other sterols which are frequent components of the non-fatty matter. Bearing in mind what is already known of the fundamental differences in chemical structure of these compounds (the normal aliphatic carbon chain present in the polyethenoid C_{20} and C_{22} acids; the aliphatic branched chain system of squalene, $C_{30}H_{50}$, built up from isoprene units; and the complex condensed ring-systems present in cholesterol, $C_{27}H_{46}O$), it is very difficult to imagine that they are mutually interconvertible by ordinary biochemical processes. It is perhaps more opportune, for the moment, to speculate whether different metabolic processes characteristic of specific organisms may not lead, according to circumstances, to the accumulation of differing kinds of organic compounds and the disappearance of other forms which are further utilisable by the organism concerned.

The Constituents of the Non-saponifiable Fraction of Cod Liver Oil.—The following estimations of the non-saponifiable matter in cod liver oils of known origin were made. In all cases the material isolated after the initial saponification with alcoholic potash was resaponified with freshly prepared sodium ethylate.

²¹ *Analyst*, 1928, 53, 246.

TABLE XIX.

Oil.				Origin.			Per Cent. Non-Saponifiable.
	Newfoundland	Summer, 1927	0·67
T ₂	"	" 1928	0·69
U ₆	"	" 1928	0·69
X ₁₅	"	" 1929	0·76
X ₁₇	"	" 1929	0·79
C	Scotland	Feb., 1928	0·65
I ₂	"	" 1929	0·70
I ₆	Scarborough	June, 1929	0·71
	North Sea	Summer, 1928	0·80
K	Norwegian	Lofoten, Feb., 1928	0·66
M	"	" " 1928	0·71
	"	" " 1929	0·73

The chemical nature of the constituents of the non-saponifiable fraction of cod liver oil has been the subject of exhaustive investigations. ^{27, 28, 29, 30} About half of the material consists of cholesterol. The remainder is a complex mixture of compounds of which few have been in any way characterised. Small amounts of the curious hydrocarbon squalene are normally present, and there appear to be larger amounts of complex unsaturated alcohols.

This fraction also contains the natural pigment of cod liver oil, the lipochrome nature of which was first established by Salkowski³¹ as long ago as 1887. This pigment has received curiously little attention, mainly because the manufacturers have striven to produce "water white" oils and have tended to regard yellow oils as arising from unsatisfactory methods of preparation. The question of the colour of cod liver oils in relation to processes of manufacture will be discussed more fully in a later chapter (VI), but it can be seen from a perusal of the figures in Tables IX–XII, or more readily from Fig. 4, that there is a definite parallel between the depth of the natural yellow coloration and the vitamin A activity.

²⁷ Drummond, Channon and Coward. *Biochem. J.*, 1925, 19, 1047.

²⁸ Drummond and Baker. *Ibid.*, 1929, 23, 273.

²⁹ Takahashi. *J. Chem. Soc. Japan*, 1922, 43, 826; 1923, 44, 590.

³⁰ Weidemann. *Biochem. J.*, 1926, 20, 685.

³¹ *Zeit. anal. Chem.*, 26, 565.

The data presented in Fig. 4 refer only to oils of known origin and unquestioned purity. Provided that an oil has been prepared from fresh livers by a satisfactory process, and that it has not been treated to lessen its colour, a yellow tint is desirable in indicating a high vitamin content.

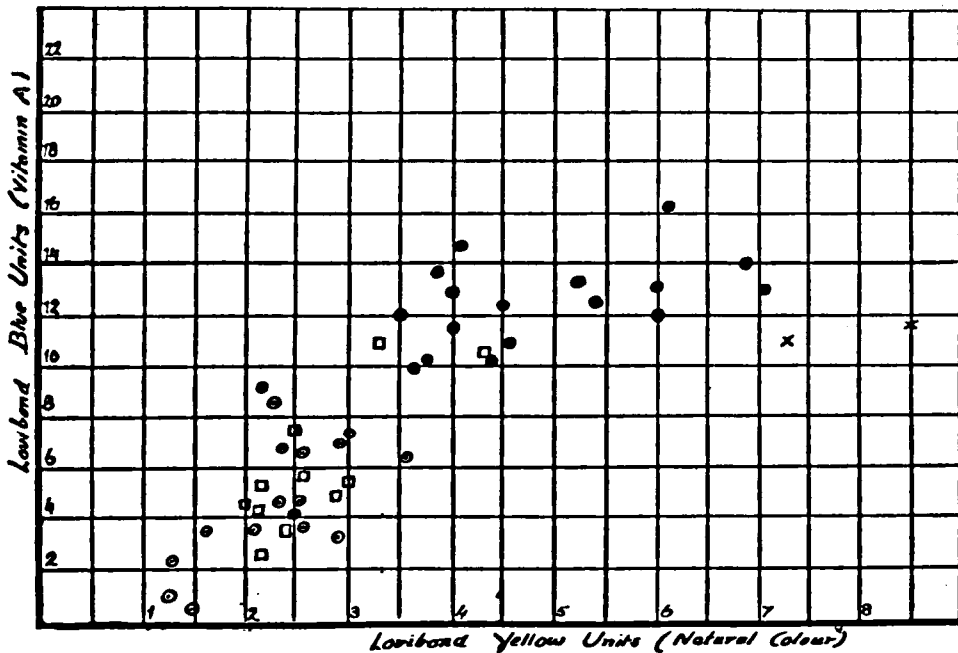

FIG. 4.

A chart showing relation between natural yellow colour of cod liver oils and the intensity of the blue colour produced with antimony trichloride (vitamin A reaction).

Oils ● are Newfoundland oils.
Oils X are Icelandic.

Oils □ are Scottish.
Oils ⊙ are Norwegian.

CHAPTER 5.

BIOLOGICAL FACTORS INFLUENCING THE VITAMIN CONTENT OF COD LIVER OIL.

1. *Origin of Vitamin A and Vitamin D.*

The original studies of Drummond, Zilva and Coward,¹ Hjort,² and Jameson, Drummond and Coward,³ suggested strongly that the ultimate origin of the vitamin A found in the oils derived from fish, and in particular the fish liver oils, was the unicellular marine plants (phytoplankton).

These plants are consumed by a wide variety of zooplankton (copepods, larval decapods, molluscs, etc.) which in turn serve to nourish innumerable forms of marine life, ranging from small fish to whales.

The experimental investigations on which this view was based were carried out before the part played by vitamin D in nutrition was appreciated, and it has been necessary, therefore, to examine the question once again in the light of the recently discovered facts.

(a) *Synthesis of Vitamin A by a Marine Diatom.*

Dr. Ahmad, working in the biochemical department of University College, London, has recently re-examined the question of synthesis of vitamin A by a typical marine diatom (*Nitzschia closterium*) growing in pure culture in artificial or sterilised sea water. Considerable quantities of the organism have been grown in the laboratory, and it has been established that there has been synthesis of vitamin A.⁴ Both the diatom preparation itself, carefully dried and preserved in an inert atmosphere, and the oil extracted from it by ether were found to restore the growth of rats whose development had been retarded on a diet deficient in vitamin A.

Further information on this important point has been furnished by the examination of a series of oils prepared from samples of diatoms and zooplankton collected by Mr. E. R. Gunther, of the staff of the Discovery Expedition, during the spring and summer of 1928, from

¹ *Biochem. J.*, 1922, **16**, 518.

² *Proc. Roy. Soc.*, 1922, B, **93**, 440.

³ *Biochem. J.*, 1922, **16**, 482.

⁴ *Biochem. J.*, 1930, in press.

Port Erin. In collaboration with him these specimens have been submitted to chemical examination and to an assay of their vitamin A and D content. The main conclusions of this examination have been published in a preliminary form^{4a}, but a full account will be given later. The results of these tests are summarised in the following table :—

TABLE XX.
Vitamin A content of Oils from Phytoplankton.

Sample No.	Character.	Dose mg.	Growth Response.
21	Oil extracted from Nitzschia grown in laboratory. Mainly Chaetoceras and Lauderia	0.5	Growth at rate of 7 g. weekly.
		0.5	Nil.
		5.0	Nil.
		20.0	Growth at rate of 3 g. weekly.
24	" " " " " "	50.0	Growth of 8 g. weekly.
		5.0	Nil.
		20.0	Growth at rate of 4 g. weekly.
		50.0	Growth at rate of 9 g. weekly.

From these results it would appear that the green marine plants synthesise appreciable quantities of vitamin A.

(b) *Phytoplankton as a source of Vitamin D.*

Regarding the question of the origin of the vitamin D, found so richly in cod liver oil, there is the work of Leigh Clare, who studied cultures of Nitzschia closterium grown in sterilised sea water, and found that no detectable amount of the vitamin was formed.⁵ This observation has been confirmed by our examination of the green oils separated from preparations of plankton collected by Mr. Gunther. The results are set out below and do not justify the conclusion that the ultimate origin of the vitamin D of cod liver oil is marine plants.

^{4a} Drummond and Gunther. "Nature" (in the press).

⁵ *Biochem. J.*, 1927, 21, 368.

Vitamin D value of Phytoplankton Oils.

Oil.	Dose.	Effect on Rickets.
21	20 mg.	No improvement.
	50 "	" "
24	20 "	" "
	50 "	" "

(c) *Vitamin A and D Content of Zooplankton Oils.*

A number of samples of the oil, separated carefully from catches of zooplankton have been examined both colorimetrically and biologically for vitamin A, and biologically for vitamin D. The results of these are summarised in Table XXI.*

TABLE XXI.

Sample No.	Vitamin A Test.			Vitamin D Test.	
	Dose mg.	Response in Growth.	Colour Test.	Dose mg.	Result.
11	0.5	Nil.	Nil.	20	Severe rickets. No cure.
	1.0	"	"		
	10.0	"	"		
	20.0	"	"		
27	0.5	"	"	20	" "
	1.0	"	"		
	20.0	"	"		
1	0.5	"	"	20	" "
	1.5	"	"		
	20.0	"	"		
X	10.0	"	"	20	" "
	20.0	"	"		

* Dr. S. W. F. Underhill, of the Scientific Staff of the British Drug Houses, also examined a few of these samples of plankton oil for vitamin D. He employed a different technique (McCollum line test) and arrived at the conclusion that the phytoplankton oils were almost deficient in vitamin D, but that the zooplankton oils possessed appreciable, if small, antirachitic action.

The conclusion to be drawn from these results is that the fatty constituents of the minute crustacea and other forms of zooplankton do not contain significant amounts of either vitamin A or vitamin D, when one is considering the rich stores in the liver of the cod.

Such minute forms of marine animal life do not form an important part of the food of the cod, except in the early stages of its life. The very young fish live almost exclusively on this form of food. Graham⁶ describes "Tom-cods", young cod about 4 in. long, devouring enormous quantities of "water fleas" (*calanus, temora*, etc.) in the coastal waters of Newfoundland.

When the fish are bigger they consume a wide variety of food, the nature of which depends on the season and locality.

Off the coast of Scotland and in the North Sea the large fish are found to be consuming other fish (herring, whiting, codlings, etc.) and small crustacea (*nephrops, meganyctiphanes*), whilst off the Newfoundland coast their staple diet during the main fishing season in the summer is either caplin or squid. An examination of a variety of these cod foods has been made, both for vitamin A and vitamin D (Table XXII).

TABLE XXII.

Vitamin A and D content of various Cod Foods.

	Vitamin A.	Vitamin D.
Zooplankton (copepods, etc.)	Little or none ..	Little or none.
Squid	Small amount ..	Very little.
Nephrops norvegicus	Little or none ..	Very little.
Meganyctiphanes norvegicus	Little or none ..	Very little.
Herring	Little or none ..	Small amount.
Caplin	Little or none ..	Very little.

As regards both vitamins these results were somewhat surprising in that they revealed that the commonest foods of the cod were much poorer in these substances than had been suspected. To what, then,

⁶ *Annual Rep. Dept. Marine and Fisheries, Newfoundland, 1923.*

are the relatively large stores of vitamin A normally found in the liver of the cod to be attributed? There are two alternative explanations that come to the mind. In the first place, there is the possibility that, although the amount of both vitamins in the daily food of the cod may be small, it may be retained in the liver so effectively that by the time the fish is mature the accumulation will be considerable. Alternatively, there is the less attractive theory that the organism of the cod possesses the power to synthesise both vitamins A and D. For the time being there is insufficient evidence to enable us to judge between these two theories, or to advance a more satisfactory one, and further investigation is required to throw more light on the matter.

The results of the tests for vitamin D are in accordance with those published by Bills⁷, who has also made a study of the possible origin of this constituent of fish liver oils.

The following information has been abstracted from his paper, and it will be seen that this observer recorded very low antirachitic values for squid and caplin.

TABLE XXIII.

Comparison of Vitamin D potency of various Oils with that of Newfoundland Cod Liver Oil (100).

Source of Oil Sample.	Relative Values as Sources of Vitamin D.
Newfoundland cod liver oil	100
Goosefish liver oil (Boston)	100
Herring, Newfoundland	100
Sardine, California	100
Menhaden (Chesapeake Bay)	75
Shark liver, Newfoundland	75
Coalfish liver (Boston)	40
Haddock liver (Boston)	10
Squid, Newfoundland	6
Caplin, Newfoundland	3
Dogfish liver, Newfoundland	3

⁷ *J. Biol. Chem.*, 1927, **72**, 751.

It will be noted that Bills observed herring oil to possess a much greater antirachitic value than was found in our experiments.

Bills concluded that the principal food of the Newfoundland cod (caplin and squid) does not contain enough vitamin D to account for the amount found in the liver of the cod during the midsummer period of fattening. He made a series of experiments on catfish, kept under laboratory conditions, the results of which suggested that vitamin D was not increased by irradiating the fish, nor decreased by keeping them six months in the dark on a vitamin deficient diet. He was inclined to think that certain fish may possess the power to synthesise vitamin D.

2. *Physiological condition of the fish.*

The researches of the distinguished Norwegian marine biologist, Dr. Johann Hjort, and his colleagues have thrown much light on the life cycle of the fish that form the basis of the Norwegian cod fishing, whilst the investigations of Michael Graham have provided information of a similar character regarding the North Sea fish. On the other hand, there is, as yet, little accurate knowledge of the life history of the Newfoundland and Labrador cod.

(a) *Norwegian cod. Annual cycle.*

The Norwegian cod fishing can be broadly divided into two seasons, which are usually named the Lofoten, or "Skrei" fishing, and the Finmarken fishing. The reason for this differentiation, which is a fairly sharp one, is apparent from a study of the valuable memoirs published by Hjort and other investigators on the life history of the cod (Vol. 20, *Rapports, Conseil Permanent International pour l'Exploration de la Mer*, Copenhagen, 1914).

Their investigations covering a number of years have shown that the spawning grounds of the cod in Norwegian waters are on the coastal banks at depths of 10 to 40 fathoms, extending right up the coast as far north as Soro in the western part of Finmarken, but in particular on the famous Romsdal and Lofoten banks. The mature cod termed "Skrei" visit these banks in enormous numbers at the spawning season from January to April, and are fished there during the "Skrei" fishery. The ova develop over the banks, and by June the small fry are drifting with the current northwards along the Norwegian coast, so that by August and September they are found in

far northern waters. The "Skrei" fishing, which has its chief centre at the Lofoten Islands, therefore covers the whole time during which the fish are on the spawning grounds (January to April or May), and the fish caught are almost solely mature cod; the other gadoids from which liver oils are prepared elsewhere—the haddock (*G. aeglefinus*), and the coalfish or saith, (*G. virens*), etc.—have different spawning habits (see Meek, "Migrations of Fish," 1916, p. 212; also Howell, "Ocean Research and the Great Fisheries," Oxford, 1921). This fact has helped to establish the reputation of the cod liver oil produced at the Lofoten Islands, for the makers have been able to claim that it is prepared from cod livers only.

The later fishing, the Finmarken season, sometimes termed the "lodde" fishing (from "lodde," the local name for the caplin) lasts from May to as late as August and is quite different in character from the "Skrei" fishery. In the spring, as the light becomes more intense, there is a remarkable outburst of plant life in the sea, which is followed by an equally remarkable increase in the minute animals, copepods, amphipods, larval decapods and molluscs, which feed on the microscopic plants and which in their turn form the food supply of large numbers of small fish and other marine animals, salps, squids, and certain molluscs, which are the food of the cod. On the northern shores of Norway the appearance of these vast swarms of living organisms, sometimes so massed as to give the water a cloudy or muddy aspect, usually occurs just before great shoals of a small fish called the capelan or caplin (*Mallotus villosus*) migrate in from the more northerly waters to spawn on the Finmarken coast, after which they proceed in a general direction eastwards along the coasts of Finmarken and Murmansk as far as the White Sea, eventually turning northwards in the Barents Sea. Their appearance at the coast is a signal to the fishermen that the cod will soon appear, for they form an attraction for enormous numbers of larger fish, chiefly cod, haddock, coalfish and pollock, which pursue and devour them in great quantity. These shoals of cod and other fish are, however, not all of one origin, as Hjort has shown (1914, *loc. cit.*). To some large extent they are the immature cod of various ages and size which have followed the caplin from Arctic waters, but these are joined by large numbers of spent "Skrei," which have spawned on the more southerly banks and which, since they feed little during spawning, have proceeded up the coast to intercept the caplin migration and "fatten up." The Finmarken fishing usually moves

along the coast in an easterly direction as the caplin move along and the fish caught are chiefly mixed gadoids. One consequence of this is that mixed cod liver oils are frequently and indeed somewhat generally prepared along this littoral. The composition of these mixed oils is very variable, but it would appear that those prepared in the early part of the season (June) in western Finmarken are mixed oils from cod, haddock and coalfish, but with a strong preponderance of cod. Later in the season on the eastern grounds the proportion of haddock may become very high.

(b) *Annual cycle of North Sea cod.*

Graham⁸ has made a study of the North Sea cod and reports that spawning takes place in February, March and April. The spawning areas are on the Flamborough Head ground, the Ling Bank, the Great Fisher Bank and the Aberdeen Bank. The normal nursery grounds appear to be on the eastern side of the North Sea. After spawning there is a dispersal of the mature fish. Many, probably the majority, seek the rough ground in areas north of the Dogger Bank. Others make inshore and are found on the herring areas on the western side of the North Sea between latitudes 55–59°. During this period there is a marked recovery in conditions. In July and August the cod tend to concentrate on the herring trawling ground, but towards the end of this period their condition falls off. In September they tend again to scatter, and may improve in condition somewhat. From October onwards the condition again falls and there is transference of material to the gonads as these mature.

(c) *Annual cycle of Newfoundland cod.*

Very little is known of the life history of Newfoundland and Labrador cod. Michael Graham has reported the results of a brief study from which he concluded that the cod spawn in these waters mainly in May and June, and that there is little support for the popular view that spawning may take place in September. The location of the spawning banks is unknown.

Graham's observations led him to believe that at least two distinguishable races of cod frequent Newfoundland waters. Those from the Trinity Bay area were sharper snouted than those caught further south at Ferryland and there was also a greater development of bone.

⁸ "Fishery Investigations," Series II, Vol. VI, No. 6, 1924.

If the rings on the scales can be trusted as a guide to age, it would appear that the northern fish grow more slowly than those frequenting the southern shores. The difference is one resembling that between the Icelandic and the North Sea cod. Graham is inclined to attribute the distinction to the difference between the Arctic and the Gulf Stream water, resulting in different temperature conditions for growth and different food. The spawning and feeding migrations of these fish are not known with any certainty, but the great proportion of cod liver oil is normally made during the months of July and August after the spawning is over and when the fish are feeding heavily first on caplin and later on squid.

(d) *Influence of spawning on the vitamin value of cod liver oil.*

In the early studies on Norwegian oils, which one of the writers (J. C. D.) carried out in collaboration with Dr. Zilva in 1921,⁹ it was at first thought that the relatively low vitamin value of the oils prepared from the livers of spawning fish in the Lofoten and Romsdal areas might be due to a transference of vitamin from the liver to the reproductive tissues. It is, of course, well known (Hjort, 1914) that the fat of the liver is utilised during the development of the genital organs prior to spawning. Evidence was soon obtained from an examination of oils prepared from the livers of fish at different stages of spawning¹⁰ to show that there is not a reduction in the vitamin content of the liver oil during spawning, although in all probability there may be a transference of vitamins, together with the oil, from the liver to the gonads. Confirmation of this conclusion has been obtained during the course of the investigation now being reported.

As pointed out in section (b) there are reasons for believing that the cod which spawn off the east coast of Scotland in March and April move south later in the year and may be found feeding actively off the Yorkshire coast about June. A series of samples of oil were prepared from the livers of selected mature male and female cod at Buckie, on the Moray Firth, during the spawning season, March and April, 1929. In the following June another lot of oils were prepared from male and female livers of fish caught off Scarborough which had spawned earlier in the year. The data concerning these samples are set out in Table XXIV.

⁹ *J. Soc. Chem. Ind.*, 1922, **41**, 280T.

¹⁰ *Biochem. J.*, 1924, **18**, 178.

TABLE XXIV.

Locality.	Date.	Sex.	Condition of Fish.	Average wt. of Livers.	Per cent. yield of Oil.	Vitamin A colour test.	Vitamin D test.
Buckie..	27.2.29	Male	Mostly feeding ..	oz. 14	—	4.6	Units. 80
" ..	1.3.29	"	Some stomachs empty	13	39	4.6	—
" ..	4.3.29	"	About half feeding ..	13	39	5.2	90
" ..	8.3.29	"	Few feeding, spawning	12	very little, some lost.	5.3	—
" ..	26.3.29	"	Spent	11	30	5.8	100
Scarboro'	11.6.29	"	Feeding actively, spent	10.5	33	5.7	—
" ..	12.6.29	"	"	—	—	4.8	100
Buckie..	27.2.29	Female	Ready to spawn, but not spawning, mostly feeding.	25	25	3.6	80
" ..	1.3.29	"	Nearly ready to spawn. About half feeding.	19	18	3.4	—
" ..	4.3.29	"	Many not feeding ..	17	11	4.1	100
" ..	5.3.29	"	Majority not feeding, spawning.	17	11	5.5	—
" ..	8.3.29	"	Spawning	15	11	6.1	200
" ..	21.3.29	"	Spent	8½	11	10.0	—
" ..	25.3.29	"	Spent	9	8	10.3	—
Scarboro'	11.6.29	"	Feeding actively ..	12	30	3.1	—
" ..	12.6.29	"	"	11.5	27	3.2	80

In late February of 1929 most of the mature male and female fish caught in the Moray Firth were nearly ready to spawn. A large proportion of them contained food residues in the stomach and apparently had been feeding actively. The livers were large, particularly in the case of the females, and yielded a fairly large amount of oil. Spawning took place in the first fortnight of March, and during this time there was a steady fall in the number of fish taken with food in their stomachs. These observations, made on a large number of fish, tend to confirm the general belief of the fishermen that the cod "goes off its feed" during spawning. The figures in Table XXIV illustrate well the reduction in the size of the livers which normally occurs during spawning, and which is comparatively slight in the male, but may be considerable in the female. The figures for the yield of oil are only approximate, but they indicate that the reduction in fat content tends to run parallel with the drop in weight of the liver. This confirms the results of the investigations of Hjort¹¹ who showed that the yearly fluctuations in weight of Norwegian livers coincide with those of the yield of oil.

¹¹ *Rapports et Procès Verbaux*, Vol. XX. Conseil Permanent International pour l'Exploration de la Mer, 1914.

The most important conclusion to be derived from the figures in Table XXIV is, however, that the vitamin A and D potency tends to vary inversely with the yield of oil. A similar observation regarding vitamin D has been recorded by Hess, Bills, Weinstock, Honeywell and Pirkin¹².

Throughout our lengthy investigations we have observed it to be generally true that when a high yield of oil (e.g. 50 per cent.) is obtained from a batch of cod liver, the oil will possess relatively low vitamin value, whereas when the yield falls, the oil tends to be of higher potency.

While this dilution effect, due to the increased deposition of fat in the liver, seems to be an important factor in causing changes in the vitamin concentration of liver oils, it is obviously not the only one. It is still impossible from the available information to decide whether the organism of the cod can synthesise vitamins A and D, or whether these substances are derived solely from the food. The balance of evidence favours the latter view, and if we adopt it as a working hypothesis, it is apparent that variations in food supply might be responsible for fluctuations in the amounts of vitamins stored in the liver. We are inclined, therefore, to believe that the store of vitamins A and D found in the liver of the cod and related species represents an accumulation of materials derived directly from the food. Variations in the extent to which the vitamins are stored will, therefore, be primarily caused by variations in the quantity and character of the food. In addition, the effect of the relatively rapid accumulation or mobilisation of liver fat must be taken into account.

Prior to spawning, the livers are usually heavily loaded with fat and the vitamin concentrations are correspondingly reduced. With the formation and ripening of the reproductive elements, there is both a transference of fat and vitamins from the liver to the gonads, which occurs to a much larger extent in the female than in the male, and a utilisation of a proportion of the fat. These changes leave the livers of the spent fish poorer in oil, but, apparently, the vitamin stores are not depleted in proportion. In the period of active feeding that follows spawning the fat deposits of the exhausted livers are again gradually built up, so that while the yield of liver oil tends to rise, the concentration of vitamins usually falls. This hypothesis appears to us to provide the most satisfactory explanation of the observations we have made during this study.

¹² *Proc. Soc. Exp. Biol. Med.*, 1928, 25, 652.

CHAPTER 6.

TECHNICAL PRODUCTION OF COD LIVER OIL.

Cod liver oil is usually made by treating the fresh livers with live steam. Sometimes indirect heating with steam is employed, but in most centres, the direct application of live steam is preferred. Before this procedure was generally adopted the oil was extracted by the most primitive methods. The common practice was to allow the livers to rot in large vats open to the sun and air. Gradually, as the mass decomposed, there rose to the surface a layer of golden brown oil, which was separated after weeks or often months of standing. Other methods involved the heating of the livers in pans over open fires or placing them in cloth bags through which the oil would drip as it slowly exuded from the pulpy mass.

It appears that an Englishman, Charles Fox of Scarborough, deserves the credit for first employing a cleaner and more rapid method on which the modern procedure is based. In 1848, he introduced a hot water or steam jacketed pan for the preparation of the oil in St. John's, Newfoundland¹. It was also he who first emphasised the importance of using fresh and sound livers and of removing the gall bladder. The oil was much paler in colour than that to which the public had become accustomed, and for some time there was a prejudice against it on the part of the pharmaceutical chemists. The steaming process was introduced into Norway by Moller in 1853², and soon was widely adopted. It was not many years before the clean, pale and less nauseating oils prepared by the steaming methods had almost entirely replaced the old "rotted" brown oils.

In most factories to-day, care is taken to discard diseased or decomposed livers, and the selected ones are usually freed from the gall bladders and adequately washed. The importance of using only fresh livers is generally recognised although the interpretation of the word "fresh" may cover periods from 1 to 36 hours.

The "cooking" of livers is usually carried out by very empirical methods. Often little attention is paid to the many factors that may influence the yield or quality of the oil. The "cooking" is in

¹ Munn. *Montreal Pharm. J.*, 1914, 25, 192.

² Moller. "Cod Liver Oil and Chemistry."

the majority of cases in the hands of a workman who by experience and "rule of thumb" methods knows when to stop steaming and when to separate the oil. In a few factories, the extraction is carried out with scientific control of temperature and other conditions.

Many forms of extraction plants have been devised to enable the oil to be extracted at temperatures below 100° or at reduced pressures, and a few of these are in operation. They will be referred to again later (see p. 90).

The separated oil, after a preliminary straining through muslin or cloth, is allowed to stand so that traces of liver debris and moisture settle to the bottom. The supernatant oil is then transported to a refinery, occasionally close at hand, but more frequently at a distance involving a long transport of the crude oil. The conditions of this transport are discussed on p. 97.

The refining of medicinal cod liver oil is usually confined to a chilling, which causes "stearin" to separate. This is filtered off at low temperature, and produces the bright "non-freezing" oil for which the pharmaceutical trade asks. The separation of the "stearin" also effects the removal of the last traces of very finely divided tissue debris which remain suspended in the crude oil and thus "brightens" the final product. Sometimes this impurity is removed before freezing by centrifugalising or filtration.

Adsorbents, particularly fuller's earth, are often used in the preliminary purification of cod liver oil. Filtration through these agents tends to lessen the colour of the oil, aids "brightening", and is stated to lessen the amount of "stearin" removed by chilling.

The reduction of colour by bleaching methods, involving the use of air, exposure to light or chemicals, is sometimes attempted, but the practice is tending to disappear with the recognition that the process tends to lower the medicinal value of the produce and, in some cases, to render the oil somewhat less palatable.

The "non-freezing" oil is "tanked" until ready for shipment, when it is transported in tin-lined casks. Sometimes, in an attempt to lessen oxidation during transport, the air space in the tin drums is filled with an inert gas, such as nitrogen or carbon dioxide. These gases are seldom used during the storage of the oil in bulk before shipment, and the replacement of the air in the tin-container is

usually effected after the oil has been run in by blowing in a jet of the inert gas from a cylinder for a few seconds before the brass cap is screwed tightly down.

The greater part of the oil reaches the public either as oil in bottles or in the form of emulsions. The container is usually a clear white glass bottle. One or two brands are advertised as being distributed in amber glass bottles so as to reduce the deleterious action of light, and one is stated to be sent out with the air replaced by an inert gas so that oxidation during storage can be retarded. These various stages in the preparation of medicinal cod liver oil have been considered during the present investigation and will now be dealt with in detail.

INVESTIGATION OF FACTORS INVOLVED IN THE TECHNICAL PREPARATION OF MEDICINAL COD LIVER OIL.

1. *Experimental procedure followed in small-scale and large-scale boilings of Cod Livers.*

A simple form of boiler was designed for the purpose of experimental boilings, and served to deal with up to 14 lbs. of livers at a time. It consisted of a narrow truncated cone constructed of tinned steel, 1 ft. 7 in. in height, 1 ft. $\frac{1}{2}$ in. in internal diameter at the top and 6 $\frac{1}{2}$ in. at the base. Close to the base (in the centre of which was inserted a $\frac{1}{2}$ -in. draw-off cock) there was fitted a circular $\frac{1}{4}$ -in. steam pipe fitted with small perforations on one side; this pipe was coupled up to the steam supply. A sketch and photograph of the vessel are appended.

The vessel was also fitted with a series of $\frac{1}{4}$ -in. gun-metal bib-cocks, the topmost being 3 in. below the top of the vessel and the others spaced successively 1 in. apart downwards; these taps, which were intended to facilitate drawing off the separated oil, were, as a matter of fact, of no great utility as they rapidly became blocked with traces of mucilage and debris. The oil is most conveniently separated by means of a shallow ladle or by siphoning.

In general, the steaming operation could be carried out smoothly by placing the livers directly in the vessel, but in the case of material which was unduly soft or disintegrated exceptionally readily, it was found of some assistance to place a layer of stout iron gauze immediately above the steam inlet ring and another resting on top of the

To face page 78

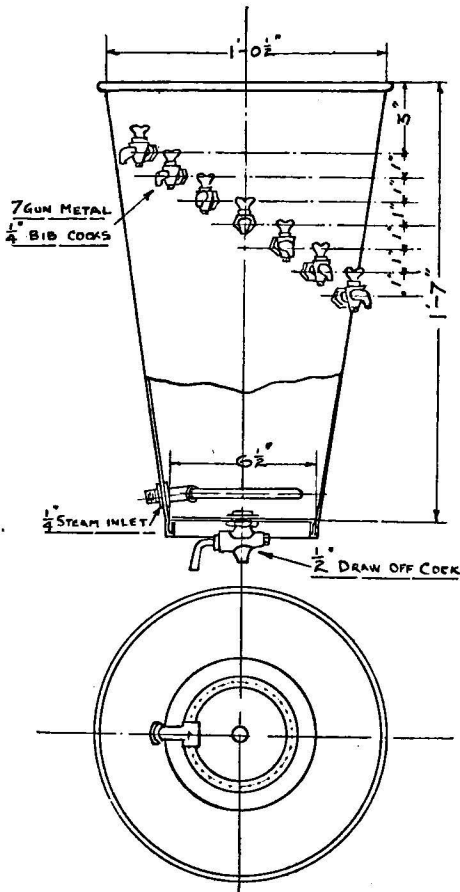

livers. These precautions were, however, rarely employed, due attention to periodical cleaning of the perforations whereby steam was admitted being all that was necessary.

The manipulation of the steaming naturally was found to differ somewhat from that of a large vat, the chief point being to ensure that the flow of steam was not too vigorous, otherwise undue emulsification of the disintegrated livers, oil and water was effected. The best conditions were found to be to admit steam in such quantity that the contents of the vessel reached the boiling point of water in approximately three minutes from the start, after which boiling for about two minutes was usually sufficient to produce the maximum yield of oil in a condition suitable for rapid separation into clear oil and foots.

This boiler was used for all small scale experiments with steam up to pressures of 60 lbs. per sq. in.

In a number of other cases samples were taken from the large vats in which technical preparation of cod liver oil was proceeding. These vats were sufficiently large to take a charge of 5 cwt. of livers; steam was admitted to the large vats by means of a plain vertical pipe which passed down the centre of the vat and terminated in a blank end, but was perforated towards the base on either side at several points so that the steam was admitted into the vat in a series of horizontal jets. A 5-cwt. charge of livers, with steam at about 50-60 lbs. per sq. in. pressure, required 12-15 minutes to reach the boiling point, whilst the operation was usually complete in 20-25 minutes.

Special arrangements had to be made in order to obtain a supply of steam at 100 lbs. per sq. in. pressure. The two experiments conducted under these conditions were carried out in a wooden barrel on 56 lbs. of livers in each case, and steam was admitted by means of a central vertical pipe perforated towards the base and similar in general arrangement to the steam inlet used on the large vats.

The nature of the livers dealt with varied to some extent in accordance with the experimental conditions chosen; details of the particular types of livers will be found in the accounts of the various series of experiments. It may be pointed out here, however, that, especially as regards the small scale boilings, the livers employed were from freshly caught fish, the sound livers being carefully washed free from blood and intestinal debris, and care being taken to remove any adherent gall-bladders, etc.

2. *Relationship between the time of storage of the livers and the quality of the resulting oil.*

Several groups of experiments were carried out to determine the rate at which livers deteriorated after removal from the fish, as measured by increase of free acidity or colour in the oil prepared from them. Experiments were also made on the effect of pickling the livers in salt or brine, and also on the result of adding liver debris in small quantities to medicinal quality oil, as evidenced by its progressive deterioration during storage under controlled conditions.

A summary will first be made of the data which were collected on the quality of the oil obtained from livers in the fresh state and after varying periods of storage.

The first experimental series consisted of large-scale preparations of oil from livers collected at the end of the Moray Firth season of 1928; these livers were for the most part from spent fish, the remainder being from fish in the later stages of spawning. Three batches of livers were examined, the times elapsing between gutting the fish and steaming the livers being respectively approximately one, two and three days. The livers were steamed in 5 cwt. batches and samples of the crude oil were collected for examination with the following results:—

TABLE XXV.

No.	Age of Livers.	Colour of Oil.		Odour.	F.F.A. Per cent.	I.V.	Vitamin B.U.
		Y.	R.				
F	1 day	3.3	0.1	Fresh or meaty	0.45	177.1	11.0
G	2 days	3.8	0.1	Very meaty	0.74	178.4	11.6
H	3 days	4.6	0.2	Slightly sour; meaty	2.20	179.9	10.2

These results indicated very marked deterioration in colour and acidity when the livers were comparatively stale, although the vitamin content had not seriously suffered, nor did the oil offer any evidence of fatty oxidation. The work was therefore repeated in more detail during the Moray Firth season of 1929, when two batches of about 100 lbs. of carefully selected livers, from mature

fish prior to spawning, were collected and stored in barrels at a temperature not exceeding 5° C. The earliest boilings of these livers (marked "fresh") were made on fish caught on the previous night and gutted on the morning of the day during which the steaming in question was carried out. The boilings were carried out in the small tinned steel vessel under the conditions noted in the tables; the results obtained were as follows:—

TABLE XXVI.

Age.	Livers. Wt.	Steam Pressure.	Time of Boiling.	Oil obtained.					Vita- min A. B.U.
				Wt.	Colour.		Per cent. F.F.A.	I.V.	
					Y.	R.			
		lb. per sq. in.	Minutes.						
Fresh	24 lbs.	60	12	5 lbs.	2.2	0.3	0.07	173.6	5.5
5 hours	14 "	60	3½	4 "	2.3	0.1	0.10	169.3	5.5
24 "	14 "	40	5	3½ "	2.3	0.2	0.18	173.3	5.5
48 "	14 "	60	5	3½ "	3.0	0.4	0.30	172.2	5.0
72 "	14 "	60	5	1½ "	3.0	0.4	1.05	174.1	5.4
96 "	14 "	60	5	Trace	8.5	0.8	1.50	174.1	5.7
Fresh	14 "	35	10	3½ "	2.0	Nil.	0.04	185.4	5.4
24 hours	14 "	35	20	2½ "	2.9	Nil.	0.27	183.8	5.9
48 "	14 "	60	5	1½ "	2.8	Nil.	0.89	179.5	5.4
72 "	14 "	60	10	Nil.	—	—	—	—	—

In the first series the livers were observed to be definitely soft for the first time after 72 hours' storage, and gave on boiling an emulsion which only separated with considerable difficulty (sample A5); after a further 24 hours (sample A6) the livers were still more soft and no appreciable amount of oil separated after boiling, the small amount obtained for analysis being secured by squeezing the foots through a muslin bag.

Similarly in the second series appreciable softening set in after 48 hours and after 72 hours the livers were softer and in a worse condition than after 96 hours in the preceding series.

In both cases after about 48 hours' storage the livers commenced to acquire a putrid odour which rapidly increased in intensity.

These tests confirm the earlier series very strikingly and indicate the absolute necessity for employing only the freshest livers in order to produce oil of negligible acidity and optimum colour and odour.

In order to determine to what extent the deterioration of the livers may be retarded by exclusion of air and presence of a mild antiseptic surrounding medium, a number of trials were made in which livers were placed in layers of salt or with brine and left for several days prior to steaming. The results were entirely negative, and it appeared that the rate of increase of acidity of the oil and the development of colour were almost as marked as if no preservative had been employed.

Data from actual experiments (carried out on F.R.S. "Explorer," August-September, 1928) are as follows:—

(i) Saith livers placed in salt on August 29th were steamed on September 4th (6 days' storage) and gave a somewhat dark-coloured, strongly smelling oil containing 5.7 per cent. of free fatty acid; it was noticed that a certain amount of light clear oil had separated on top of the salted livers prior to steaming.

(ii) Saith livers placed in 10 per cent. brine solution on September 17th gave a somewhat off-coloured oil when steamed after 60 hours' storage in the brine, the free acidity of the oil being 4.1 per cent.

It had been proposed to institute a further series of experiments on storage of the livers, e.g., in presence of solutions containing small amounts of substances of an anti-oxidant nature, but, since it had become evident that deterioration of the livers is exclusively conditioned by retrogressive changes proceeding within the organ, further work on these lines was abandoned.

Clear proof that deterioration is due to the action of enzymes, etc., within the liver itself is forthcoming from observations made on cod liver oil which had been stored for a prolonged period either in the refined condition (that is presumably free from traces of liver tissue) in presence of small or comparatively large proportions of well-steamed liver tissue, or in presence of similar proportions of liver tissue which had been steamed insufficiently to destroy all enzymes (as evidenced by the development of vigorous fermentation when the liver debris in question was allowed to stand).

TABLE XXVII.

Development of free acidity and colour in cod liver oil in presence and absence of small quantities of liver tissue.

Our Ref. No.	Source of Oil.	Description.	Liver-Debris Present.	Time of Storage.	Per cent. F.F.A.	Colour.		I.V.
						Y.	R.	
1928 Cd.	Scottish Bulk sample.	Non-freezing medicinal cod liver oil.	None	Fresh ..	0.32	2.5	0.1	170.3
				2 weeks	0.31	2.5	0.1	164.6
				6 weeks	0.30	2.4	0.1	167.8
				6 months	0.40	3.0	0.2	166.3
				13 months	0.87	4.9	0.3	154.0
1928 Bd.	Scottish Bulk sample.	Cleaned crude oil (not frozen).	None (or very minute traces).	Fresh ..	0.24	3.7	0.5	163.7
				2 weeks	0.25	3.7	0.5	157.5
				6 months	0.29			155.0
				13 months	0.29	4.6	0.5	156.8
1928 Ad.	Scottish Bulk sample.	Crude cod liver oil (medicinal grade).	Traces of well-steamed debris in suspension.	Fresh ..	0.28	3.7	0.5	162.7
				2 weeks	0.23	3.7	0.5	157.0
				9 weeks	0.28	4.3	0.3	160.9
				6 months	0.37			155.4
				13 months	0.39	5.5	0.6	157.4
1928 CEd.	Scottish Bulk sample.	Non-freezing medicinal cod liver oil with 1 per cent. separated well-steamed liver debris added.	1 per cent. well steamed debris present.	Fresh ..	0.32	4.1	1.0	167.9
				2 weeks	0.33	4.1	1.0	163.9
				6 months	0.42			166.0
				13 months	0.50	3.7	0.2	164.7
1928 WCE.	Scottish Bulk sample.	As preceding, but in presence of water.	1 per cent. well-steamed debris and moisture present.	Fresh ..	0.32	2.6		167.9
				2 weeks	0.33	2.6		165.8
				6 weeks	0.31	2.4	0.1	166.2
				4 months	0.29	2.2		166.7
				13 months	0.38	2.5		164.1
1928 CLd.	Scottish Bulk sample.	Non-freezing medicinal cod liver oil with 1 per cent. of finely-divided fresh liver added.	1 per cent. fresh liver tissue added.	Fresh ..	0.31	2.5	0.1	170.3
				2 weeks	0.33	2.8	0.2	169.3
				10 weeks	0.39	4.2	0.3	168.3
1928 WBE.	Scottish Bulk sample.	Cleaned crude oil with 1 per cent. separated well-steamed liver debris and water added.	1 per cent. well-steamed debris and moisture present.	Fresh ..	0.20	4.3	0.5	163.5
				2 weeks	0.24	4.3	0.5	159.0
				9 weeks	0.23	3.6	0.4	162.9
				13 months	0.27	5.5	0.7	157.4
1928 Bld.	Scottish Bulk sample.	Cleaned crude oil with 1 per cent. of finely-divided fresh liver added.	1 per cent. fresh liver tissue added.	Fresh ..	0.24	3.7	0.5	163.7
				2 weeks	0.29	5.2	0.9	162.4
				10 weeks	0.30	10.0	1.5	160.3

TABLE XXVII—continued.

Development of free acidity and colour in cod liver oil in presence and absence of small quantities of liver tissue.

Our Ref. No.	Source of Oil.	Description.	Liver-Debris Present.	Time of Storage.	Per cent. F.F.A.	Colour.		I.V.
						Y.	R.	
1928 FLd.	Moray Firth, 1928	Crude cod liver oil with 1 per cent. finely-divided fresh liver added.	1 per cent. fresh liver tissue added.	Fresh ..	0.45	3.3	0.1	177.1
				2 weeks		3.7	0.4	178.2
				10 weeks	0.36	4.7	0.3	172.2
1928 GLd.	Moray Firth, 1928	Crude cod liver oil with 10 per cent. of finely-divided liver (2 weeks old) added.	10 per cent. stale liver tissue added.	Fresh ..	0.74	3.8		178.4
				2 weeks	1.32			
				10 weeks	3.90	24.0	5.2	173.4
1929 F1.	Moray Firth, 1929	Crude cod liver oil with 5 per cent. of actively fermenting "foots" added.	5 per cent. actively fermenting liver debris added.	Fresh ..	0.06	2.3		176.9
				8 weeks	1.90			
				6 months (smell foul).	8.91	10.3	1.5	176.8
1929 G1.	Moray Firth, 1929	Crude cod liver oil taken from large-scale vat after only 5 minutes boiling.	Traces of liver debris in suspension.	Fresh ..	0.15	2.0		179.5
				8 weeks	0.33			
				6 months	0.33	5.1	0.6	175.6
1929 G2.	Moray Firth, 1929	Crude cod liver oil taken from large-scale vat after 10 minutes boiling.	Traces of liver debris in suspension.	Fresh ..	0.06	2.3		179.8
				8 weeks	0.23			
				6 months	0.28	3.4	0.4	176.3
1929 H1.	Moray Firth, 1929	Crude cod liver oil taken from large-scale vat after 3 minutes boiling.	Traces of liver debris in suspension.	Fresh ..	0.32	2.2		173.2
				8 weeks	1.40			
				6 months	3.30	3.0	0.2	177.4
1929 H2.	Moray Firth, 1929	Crude cod liver oil taken from large-scale vat after 10 minutes boiling.	Traces of liver debris in suspension.	Fresh ..	0.30	2.1		176.9
				8 weeks	0.98			
				6 months	1.30	2.8	0.2	175.5
1929 C4.	Moray Firth, 1929	Crude cod liver oil taken from small boiler after 3 minutes boiling.	Traces of liver debris in suspension.	Fresh ..	0.11	2.4		175.3
				8 weeks	0.19			175.4
				6 months	0.25	5.3	0.9	175.4

These results show definitely that an oil from livers which have been steamed for a sufficient length of time can be maintained for a long period without any marked increase in colour or free acidity, even when it is in the crude condition, that is to say, when traces of liver debris left in suspension in the oil after mechanical settling are still present. Further, the deliberate addition of liver debris (which had been collected by centrifuging the oil from correctly steamed livers) did not set up any development of free fatty acid or colour, even in presence of appreciable quantities of moisture. Consequently, it may be taken as established that the materials which cause deterioration of the oil are destroyed by sufficient exposure to steam at 100°C.

On the other hand, the foots which separated from the steamed livers and which contain, here and there, comparatively large portions of liver tissue which has escaped complete disintegration, set up a more or less vigorous fermentation on being left to stand for some little time. In one particular case a large quantity of freshly settled foots, which had been left for three days in a barrel in a shed, the atmospheric temperature of which probably did not exceed 5° C., was at the end of this period fermenting vigorously, evolving considerable quantities of gaseous products including carbon dioxide and ammonia, and it maintained a temperature of about 20–25° C. A portion of this fermenting material was added to a sample of well-steamed crude oil and it was found that development of acidity set in quite definitely in presence of fermenting material (cf. table above).

The activity of the autolytic enzymes of fish livers is truly remarkable. Even at temperatures approaching freezing point appreciable hydrolysis of fat will occur in a few hours. By steaming livers immediately they are removed from freshly caught cod it is possible to obtain oils with an acidity below 0.05 per cent. F.F.A. After the livers have been kept for three or four hours the acidity of the oil will have risen appreciably. The storage of livers overnight, even if the temperature is low, may result in an oil of undesirably high acidity.

As regards the crude oil from steamed livers, therefore, it only remains to outline the conditions under which liver debris present in suspension therein can be relied upon to contain no active enzymes. All the evidence collected goes to show that the normal steaming period employed in practice is sufficient to ensure that enzymes present in the completely disintegrated tissues are all destroyed, and that any left in the active or in a semi-active state are present in the coarser portions of the liver tissue which settle completely away from the clear oil. On the other hand, it is conceivable that a very

short period of boiling might lead to a state of affairs in which enzymes present in the finely-divided particles of the disintegrated tissue (which might be left in suspension in the oil) might not all be destroyed. For this reason, the samples G1, G2, H1, H2, etc., from the Moray Firth, 1929, series were examined after storage over a period of a few months, these oils having all been produced by means of steaming for very short periods.

The definite conclusions to be drawn from this part of the work are therefore as follows :—

(1) It is absolutely essential that medicinal cod liver oil should be produced by steaming fresh livers immediately they have been taken out of the fish. Further, the period between the death of the fish and the removal and steaming of the livers should be reduced to the absolute minimum. There appears to be no likelihood of any simple means by which deterioration of the stored livers can be resisted and we are convinced that the practical method is to organize the industry so that delay in producing the oil after the fish have been caught is as far as possible eliminated. Some suggestions to this end are made in the concluding section of the report.

(2) Deterioration of the livers, and hence of the technical quality of the oil, is due to retrogressive changes effected by the enzymes, etc., present within the liver tissue.

(3) In the normal process of steaming, the liver debris left in suspension in the settled clear oil is extremely finely divided and any enzymes present in this finely divided debris appear to be completely destroyed by the exposure to steam.

(4) It is uncertain whether in the case of very short periods of steaming complete suppression of enzyme activity will be effectively secured.

3. *The effect of the duration of steaming and the pressure of steam employed upon the yield and quality of the oil produced.*

A number of experiments were carried out employing steam at varying pressures from 10–100 lbs. per square inch and using different periods of steaming.

Experiments at 10–60 lbs. per square inch were conducted on 14-lb. batches of selected fresh livers in the small experimental boiler. Two further series at 60 lbs. were taken from vats employed on large-scale production, the first of these being on a 5-cwt. charge of livers of mature fish (series G) whilst the second (series H) was from a charge of 6 cwt. of livers from fish caught somewhat later in the season when the size of the livers had begun to decline. The two

experiments at 100 lbs. per square inch steam pressure were conducted separately in a small improvised vat which held a charge of 56 lbs. of livers.

The times of steaming in the small experimental vessel and in the large vats were naturally widely different in order to reach the same stage of boiling, and broadly speaking, it may be said that 5 minutes' boiling in the small experimental vessel was equivalent to 20 minutes' boiling in the 5-6 cwt. vat at the same pressure of steam.

The yields of oil obtained and the various characteristics of the separated oils, are summarised in the appended table.

TABLE XXVIII.

Relationship between quality of Cod Liver Oil and Time of Steaming and Pressure of Steam Employed.

Our Ref. No.	Livers. Wt.	No.	Steam.		Oil obtained.				Vitamin A. B.U.	
			lb./sq. in.	Time of Boiling.	Weight. lb.	Colour.		Per cent. F.F.A.		Iod. Value.
						Y.	R.			
E2	14 lbs. ..	17	10	15 minutes	1.5	2.5	—	0.10	174.5	5.3
E1	" ..	14	10	30 "	1.5	2.5	—	0.03	176.8	5.3
E3	" ..	20	10	60 "	3.0	2.5	—	0.03	167.1	5.2
E'1	14 lbs. ..	14	10	15 "	3.0	2.5	—	0.31	176.0	—
E'2	" ..	15	10	30 "	3.0	2.5	—	0.33	178.0	7.7
E'3	" ..	15	10	60 "	3.5	2.5	—	0.26	171.7	4.9
D4	14 lbs. ..	12	35	3 minutes	nil.	—	—	—	—	—
D2	" ..	13	35	5 "	2.75	2.5	—	0.13	172.5	4.7
D1	" ..	15	35	10 "	3.75	2.5	—	0.12	171.2	5.4
D3	" ..	12	35	20 "	4.0	2.7	—	0.14	171.9	4.6
N2	14 lbs. ..	17	35	5 minutes	Trace	2.7	—	0.20	182.3	6.5
N1	" ..	17	35	10 "	3.5	2.0	—	0.04	185.4	4.4
N3	" ..	14	35	20 "	3.5	2.5	0.2	0.29	177.5	5.3
C4	14 lbs. ..	15	60	3 minutes	2.5	2.4	—	0.11	175.4	4.8
C1	" ..	?	60	5 "	3.5	2.1	—	0.13	174.9	5.6
C3	" ..	?	60	10 "	4.5	2.1	—	0.16	172.3	4.8
C2	" ..	12	60	20 "	3.5	2.1	—	0.16	168.4	4.7
G1	5 cwt. ..	—	60-45	5 minutes	Not measured.	2.0	—	0.15	179.5	4.8
G2	" ..	—	60-45	10 "	"	2.3	—	0.06	179.8	4.9
G3	" ..	—	60-45	15 "	"	2.2	—	0.07	180.4	5.0
G4	" ..	—	60-45	20 "	"	2.3	—	0.11	179.3	5.5
H1	6 cwt. ..	—	60-45	3 minutes	Not measured.	2.2	—	0.32	173.2	3.8
H2	" ..	—	60-45	10 "	"	2.1	—	0.30	176.9	4.3
H3	" ..	—	60-45	15 "	"	2.1	—	0.29	180.2	5.2
H4	" ..	—	60-45	20 "	"	2.3	—	0.29	179.4	6.2
F1	56 lb. ..	—	100	5 minutes	18.5	2.3	—	0.06	176.9	4.5
F2	" ..	—	100	5 "	18.0	2.3	—	0.06	176.2	5.9

In discussing the above results, attention may well be drawn to the extreme ease with which fish liver oils can be extracted, as compared with the procedure necessary for the majority of vegetable fats, or even with the rendering of animal fats such as premier jus or lard. Whilst the simple steaming process employed for cod livers is doubtless not completely efficient in the sense that some oil is left in the foots, the trade is in a relatively fortunate position when, as frequently happens, a yield of 25–40 per cent. of high quality edible oil can be obtained from the fresh livers by the simple process of steaming for comparatively few minutes.

The figures now presented give the impression that steam at a moderately high pressure is to be preferred to exhaust steam or steam at only a few pounds per sq. in. pressure. The vitamin content of the oil does not appear to suffer in any way when high pressure steam is employed, whilst the yield of oil and, probably, its separation from the foots is better under these conditions. Owing to the higher temperature of steam at the higher pressures the operation is completed more rapidly, and almost certainly more thorough disintegration of the liver tissue will be effected, leading both to a higher yield of oil and to more complete suppression of enzymes present in the tissue. It is recommended that, where local conditions permit, steam at a pressure of about 80–100 lbs. per sq. in. should be used in the manufacture of medicinal cod liver oil. On the other hand, it should be borne in mind that, where circumstances render the use of steam at these pressures incompatible with immediate steaming of the fresh livers, steam at pressures of, say, from 30–60 lbs. per sq. in. is quite efficient, providing that the time taken during the steaming process is correspondingly extended.

We have gained the impression from this series of experiments, although all the figures in Table XXVIII do not support the view, that the vitamin value of the oil is definitely higher when the steaming treatment has been thorough. It is possible that some part of the vitamin stores in the liver is not naturally present in solution in the oil, and that a thorough disintegration of the tissue is necessary for its release. In view of this it seems not unlikely that prolongation of steaming for some little time after the latter point has been reached tends to ensure that the maximum amount of vitamin from a given batch of livers has been carried into the oil. We do not, however, suggest that any very prolonged boiling is desirable, and it is probably sufficient to continue boiling, after the maximum yield point has

been reached, for about 30–50 per cent. of the time taken to reach that point ; for example, in a large-scale vat which gives a full yield of oil in 18–20 minutes steaming it is probably useful to steam for a period of 25–30 minutes in all.

The data obtained also show that steaming for a comparatively short period, in addition to giving a lower yield of oil, tends to produce an oil which may be somewhat lower in vitamin content and one which is certainly liable to develop rancidity more rapidly owing to the presence therein of small quantities of enzymes which have not been completely deactivated by the steam. This is well illustrated by the development of free acidity in samples G1, G2, H1 and H2, which represent oil withdrawn from a large-scale vat after a relatively short period of steaming.

TABLE XXIX.

No.	Period of Steaming.	Per cent. Free Fatty Acid.			Colour.			
		Fresh.	After 8 weeks.	After 6 months.	Fresh.		After 6 months.	
					Y.	R.	Y.	R.
G1	5 minutes ..	0.15	0.33	0.33	2.0	0.0	5.1	0.6
G2	10 " ..	0.06	0.23	0.28	2.3	0.0	3.4	0.4
H1	3 " ..	0.32	1.40	3.30	2.2	0.0	3.0	0.2
H2	10 " ..	0.30	0.98	1.30	2.1	0.0	2.8	0.2

If these figures are compared with the similar results for correctly steamed oil given in Table XXVII (samples 1928 Ad, etc.), the tendency for oils prepared by steaming for a short period to develop free fatty acidity is apparent.

On the whole, therefore, we recommend steaming fresh livers for an adequate period, preferably with high-pressure steam, as the most certain method of producing medicinal oil of high quality. The essential points are to operate under such conditions and for sufficient length of time to ensure that all enzymes contained in liver tissue left in suspension in the oil are completely destroyed, and to continue steaming not only until the maximum yield of oil has been reached but for a little longer in order to produce an oil of maximum vitamin content from a given set of livers. Owing to the higher temperature of steam at higher pressures, it is obvious that the latter, in addition to effecting more rapid separation of the oil, will be more efficient in suppressing enzyme activity.

Low Temperature and Vacuum Extraction.

Plants have been described for extracting the oil from cod livers under diminished pressure and at temperatures below 100° C. For the most part these have proved unpractical or uneconomical, but one or two forms are in operation.

The use of a reduced pressure, sometimes incorrectly described as a vacuum, is believed to lessen the chances of oxidative changes occurring in the oil and extraction at moderate temperatures is recommended for the same reason.

Actually it appears unlikely that any appreciable oxidation occurs in the oil during the usual treatment with live steam, and it is questionable whether there is much to be gained by the more expensive methods of extraction.

Generally speaking, the vacuum-low temperature extraction methods give a slightly higher yield of oil than the common process, but, on the other hand, they require a longer period of extraction and tend to produce darker and somewhat less satisfactory products.

A rather more serious question concerns the low temperature extraction processes. Unless the temperature during extraction has exceeded that at which the fat-splitting enzymes of the liver are destroyed, the oil will not keep well but will develop acidity, probably rather rapidly. It is not sufficient in such cases to remove visible tissue debris, for we have found that the very fine particles which remain suspended in the oil for long periods will effect considerable hydrolysis. Oil separated by a low temperature process must be sterilised promptly after extraction.

Preliminary Cleaning of Crude Oil.

It is quite unnecessary at this stage of the preparation of medicinal oil to do more than run the skimmed oil through a fine fabric strainer to remove liver debris. The lengthy and often repeated filtration of the oil through bags is not only superfluous but actually a source of considerable danger. For one reason, it causes an unnecessarily intimate contact of the oil, drop by drop, with air, and at the same time it is not easy to keep this form of filtering apparatus free from the resinous material that forms, unless scrupulous cleanliness is enforced, and imparts undesirable features to the oil.

Another method of removing the suspended matter is to employ a centrifuge. This involves, in most forms of the machine, considerable

contact of the oil, probably while it is still warm, with air. This is, on all grounds, undesirable, as it might lead to oxidative changes.

The oil skimmed or otherwise separated from the "cooked" liver is usually stored in tanks to allow the liver debris and water to settle. Too frequently these tanks are small and of large cross section in relation to their volume, thus exposing an unnecessarily large surface of oil to contact with the air. Tall, cylindrical tanks represent the best form both from the point of view of settlement and of contact with the atmosphere. Tight fitting or floating lids should always be provided.

Some manufacturers are frightened of leaving the oil in contact for any length of time with tissue debris and water. Our experiments have shown that there is nothing to fear *if the liver has been properly "cooked"*, so that the harmful fat-splitting enzymes are destroyed.

The transport of the crude oil to the refinery presents no difficulties if the ideal conditions exist of the refinery being adjacent to the extraction plant. If any appreciable distance must be traversed the question of the most suitable means of transport may be an important one.

Clean tin-lined barrels or other suitable form of container will suffice, provided they are *absolutely clean*. If they have previously held oil it is a most difficult matter to cleanse them so that they are fit to transport crude oil, even over short distances. The traces of oil left in an empty barrel rapidly oxidise and form a thick resinous gummy material which is very difficult to remove completely. This material, which is the cause of endless trouble in a mismanaged factory, is intensely bitter and nauseous to the taste, and a minute trace of it will seriously affect the quality of any good oil with which it may come in contact.

A barrel may look clean and shining, but there may remain a trace of this resinous material in a join or on the thread of the screw cap that will be sufficient to damage the whole of the contents on refilling.

4. *The Refining of Cod Liver Oil for Medicinal Purposes.*

It is clear, in view of the liability of vitamin A and vitamin D to change by exposure to air and/or light, and possibly to heat under certain conditions, that the less treatment and processing that the crude cod liver oil receives the more likely is its original vitamin content to be left unimpaired. The experimental results which have already been dealt with show that it is a comparatively simple matter,

if the necessary precautions are observed, to produce a crude oil which contains a negligible amount of free fatty acid and which is pale in colour. • Such an oil will, however, invariably contain very small traces of extremely finely-divided liver tissue and will also, of course, deposit, on standing in the cold, a certain amount of "stearin", that is, mixed glycerides which are solid and not held in solution in the remainder of the fatty oil at the ordinary temperature; furthermore, the crude oil possesses a mild, not essentially unpleasant, but still definitely fishy odour and its taste, whilst comparatively clean, is also distinctly fishy.

The procedure to be employed in order to remove stearin and also to improve the colour, flavour and odour, merits very careful consideration, because it is undoubtedly very easy to damage the valuable medicinal constituents of the oil coincidentally with improving its appearance and general selling qualities.

In the first place, it is well to consider the results of gentle agitation of the oil with air at temperatures not greatly exceeding the normal. This process, which under the conditions specified is a very mild type of "blowing" or atmospheric oxidation of a fatty oil, undoubtedly assists in the clarification of the oil and for some reason appears notably to diminish its tendency to deposit stearin; it also appreciably lessens the slight fishy odour of the oil. Nevertheless, since we have obtained ample evidence that agitation of a cod liver oil with air or oxygen results in rapid diminution of the vitamin content, we deprecate most strongly the use of any process of refining in which air is brought into contact with the oil, and we are strongly of the opinion that anything in the nature of "blowing" of cod liver oil with a view to improving its appearance is bound to have a very detrimental result upon the medicinal value of the product, and may actually confer harmful properties on the oil.

For practical purposes, therefore, we are left with the alternatives of removal of stearin and foreign matter by mechanical separation, and of improving the odour, flavour and colour, if necessary, by treatment with adsorbent materials such as fuller's earth, silica gel, charcoal, etc. We feel that the ideal treatment would be merely to separate stearin and other matter by chilling the oil and expressing the liquid portion, but we are also aware that, in some cases at all events, the product so obtained may be sufficiently strongly coloured or flavoured to render some further decolorising and deodorising treatment desirable.

The chilling process is probably best operated by cooling the oil in tanks for a period of 24 hours or more, at a temperature not exceeding -5°C ., and then filtering it through presses which are also maintained between this temperature and 0°C . Under these conditions, the oil suffers minimum exposure to air, whilst the deposited stearin retains with it practically all suspended liver debris and moisture present in the crude oil. The separated oil is clear and considerably brighter and paler than the original crude oil, whilst its odour and flavour are also improved to some extent.

The proportion of oil recovered by the filtration process is somewhat less than could be desired, and the amount of stearin left in the presses may be as much as 20–25 per cent. of the original oil. So far as we have been able to ascertain, there is little selective removal of the vitamins into either portion of the pressed oil, the observed vitamin contents of filtered oil and stearin from crude oils being approximately equal to each other and to that of the crude oil. In an actual comparison carried out on the large scale, a crude oil which gave in the 1-inch cell a colorimeter reading of 3.7 yellow units and 0.5 red units yielded a non-freezing oil after chilling and pressing, with a colour value of 2.5 yellow and 0.1 red units; the iodine value of the original oil was 163, of the filtered oil 170 and of the separated stearin 132, corresponding with the production of an amount of stearin equal to about 18 per cent. of the total crude oil.

It is probable that the yield of non-freezing oil could be materially increased if centrifuging at low temperatures were substituted for filter-pressing, although unfortunately we have not been able to include any direct experimental data on this point. We can, however, state that suspended liver debris and moisture are efficiently removed by centrifuging the crude oil at the ordinary temperature, a procedure which brightens the appearance of the oil considerably although it does not effect any material diminution in colour as measured by the tintometer. It should be noted, however, that the centrifuging process involves considerable, although momentary, agitation of the oil with air, and we are inclined to think, judging from the changed odour of oil centrifuged at room temperature, that a perceptible amount of oxidation may set in under these conditions.

If, however, the centrifuge was maintained at a temperature of, say, -10°C . and the oil was previously chilled at the same temperature for a sufficient period, it is practically certain that the amount of oxidation at this low temperature would be insignificant,

having regard to the short time in which air would have access to the oil; it should further be practicable to design a form of centrifuge from the moving parts of which air was excluded by means, for example, of a current of nitrogen. It may be suggested, again, that it would be a relatively simple matter to design a plant to obviate the necessity for preliminary chilling of large volumes of stationary oil: this would consist of a unit somewhat similar to a soap-cooling machine maintained at about -10°C . by means of a current of chilled brine, the crude oil being passed continuously through the cooler and thence into the similarly cooled, preferably nitrogen-filled centrifuge. The cost for power on the centrifugal system would naturally be greater than in the case of the old filter-pressing method, but this would be offset (especially in the continuous apparatus) by the smaller consumption of power involved in maintaining at any given time a much smaller bulk of oil and apparatus at the reduced temperature than under the old system, and would also be compensated for to some extent by the greater yield of oil of non-freezing medicinal quality. We believe that this suggestion of a continuous system of chilling and chilled centrifuging would repay a careful trial on the manufacturing scale.

A good cod liver oil from which the stearin has been separated at low temperature by either of the methods described above is sufficiently pale in colour for edible purposes and contains a very low percentage of free fatty acid (frequently below 0.1 per cent. and hardly ever reaching as much as 0.3 per cent.); the colour is not water-white, but at the same time it is in general paler than that of refined liquid fats such as ground-nut oil or cottonseed oil which are incorporated directly into margarine and similar edible fats. As discussed later in the present report, it is an open question how far bleaching of a good-coloured oil should be carried in order to meet popular prejudice and whether on the other hand popular opinion should not be educated, to some extent, to appreciate that colour in cod liver oil need be no more objectionable than a similar degree of colour in butter or honey.

As regards the other questions of flavour and odour, it cannot be denied that a chilled oil prepared as described, still possesses a fresh flavour of a fishy character and a certain amount of similar odour. So far as our observations have taken us, it would appear that any processes which remove this flavour and odour are also prone to lead to conditions favourable to the destruction of vitamin. The simplest

way, as already stated, is to agitate the oil gently with air, a process which certainly removes vitamin as well as flavour; the fishy odour of the oil is replaced by a very faint somewhat sharp odour, whilst the taste changes from definitely fishlike to that of an oil which is almost tasteless but possesses a very faint and very slightly bitter type of flavour. Much the same kind of result can be reached without the use of air, if the oil is agitated for about half an hour or an hour with an absorbent material at a slightly elevated temperature (e.g., 50–50° C.). This procedure also effects a certain amount of further decolorisation of the oil, as may be illustrated by the results of some bleaching experiments which were carried out on a relatively dark crude oil (in order better to bring out the relative decolorising values of the various materials employed): the oils were agitated with the materials shown in the following table for an hour at 45–50° C., with the following effects on the colour as measured in the Rosenheim-Shuster colorimeter.

	Yellow	Red
Original oil	10.2	1.0
“ “ + 2 per cent. fuller’s earth	6.3	0.7
“ “ + 5 “ “ “ “	5.4	0.6
“ “ + 2 “ “ silica gel	8.7	1.0
“ “ + 2 “ “ active charcoal	7.9	0.9

These results indicate, that for the particular oil examined, fuller’s earth was the most efficient bleaching material, but it should be remembered that it is frequently found that different types of the same oil respond best to different adsorbent materials, or to different concentrations of one and the same adsorbent material and it may be well to carry out control tests on the spot on different seasons’ makes, etc., of cod liver oil. The colour of the oil from the charcoal experiment may be partially due to the difficulty of removing the last traces of finely-divided charcoal by filtration.

This latter difficulty may be obviated by employing a mixture of fuller’s earth and charcoal, and we may give an instance of another oil which illustrates this point and also what has just been said with reference to the differing behaviour of different oils towards the same adsorbent material:—

	Yellow	Red
Original oil	4.0	0.5
“ “ + 5 per cent. fuller’s earth	4.4	0.0
“ “ + 5 “ “ “ “ + 2 per cent. charcoal	2.3	0.0

It may be added that in other experiments the effect of adding a small amount of caustic soda solution or milk of lime (insufficient to combine with the whole of the free fatty acid present) in addition to 5 per cent. of fuller's earth or charcoal was tested, but it was found that this did not lead to any material improvement in the colour of the refined oil.

The effect of fuller's earth, silica gel or charcoal treatment of the oil on its odour and flavour was much the same in all cases: the fishy odour was almost eliminated but was replaced by a very faint tendency to a slightly sharp odour, whilst the flavour lost for the most part its fishlike taint and commenced to acquire a slight suggestion of the faintly bitter taste already mentioned. An oil after treatment with fuller's earth, etc., will most probably be found to be more susceptible to the action of atmospheric oxygen, and the procedure is therefore not recommended with any confidence.

It may be that the original characteristic fishy taste of the oil masks that of some other component which persists after treatment with adsorbent materials, or alternatively, and as we believe more probably, it is possible that the constituent which confers the fishlike qualities also acts in some way which prevents changes (probably of an oxidative character) setting in in some other constituent of the fatty oil. It seems very likely that the presence of the first-named material (whatever it may be) serves to retard change both in the unsaturated fatty components of the oil and in the vitamin itself; if this be the case, its removal in order to meet the wishes of the public palate is nevertheless calculated to detract from the keeping qualities of the medicinally valuable constituents in the oil.

Summarising this portion of the work, therefore, it is recommended that wherever possible the only refining process employed should consist in intensive chilling followed by filtration or centrifuging at a low temperature; whilst, if any further decolorising or deodorising action is necessary, it should be restricted to agitation at as low a temperature as possible with fuller's earth or similar adsorbent material, fuller's earth and charcoal being indicated as a particularly suitable mixture. In the latter process, and indeed throughout, air should be excluded as far as possible whilst the oil is in agitation and, as a matter of fact, if bleaching be carried out, it is obvious that the use of reduced pressure during the process would tend to assist deodorisation to some extent.

5. *Storage and Bottling of Medicinal Cod Liver Oil.*

Since the vitamins present in cod liver oil are known to be comparatively sensitive to the action of oxygen and to light, the question of the storage of the medicinal oil is important and it has been felt desirable to devote considerable attention to experimental observation of the alterations taking place in oils when stored under various conditions.

The information which has been collected falls into two main divisions, namely, the practicability of excluding oxygen from containing vessels by replacement of air with an inert gas, and the general effects observed on keeping medicinal oil for prolonged periods in plain glass stoppered bottles exposed to light and in the absence of light and in presence or absence of oxygen.

The storage of Cod Liver Oil in vessels filled with Inert Gas.

The practice has sometimes been adopted of filling the air space left in casks of cod liver oil with either nitrogen or carbon dioxide in order to prevent oxygen being absorbed by the oil. It has been previously remarked that in some refineries this operation is carried out in a very casual manner. After the oil has been placed in the barrel or container a blast of nitrogen or carbon dioxide is blown for a few seconds on to the surface of the oil from a cylinder and the cap or stopper quickly fastened. A duplicate series of experiments extending over several months has been made in order to determine how far this procedure is really effective.

Three 12½-gallon tin-lined casks of medicinal cod liver oil were employed for this purpose; the casks were fitted with screw caps, and for the purpose of the investigation the latter were pierced with a ¼-inch metal tube closed by an ordinary gas tap. In commencing an experiment about a gallon of the oil was removed from each cask in order to leave a sufficiently large volume of gas space for sampling purposes, and the air was then displaced by injection of a stream of nitrogen or carbon dioxide from a cylinder for from 2-5 minutes. The screw cap was immediately replaced and made as tight as possible, fresh leather washers being employed to make the joint. By means of the small gas tap, samples of the gas above the oil were withdrawn at intervals and analysed with reference to their content of oxygen and of carbon dioxide. After a sample had been withdrawn the gas space in the cask was placed in connection with a gasholder containing either nitrogen or carbon dioxide, in order to

make up the volume of gas withdrawn in the sampler and thus to avoid any permanent diminution to slightly below atmospheric pressure. Except when samples were actually being taken, the screw caps and the gas tubes mounted thereon were enclosed in a stout rubber seal which obviated the possibility of the ingress of air through any possible defect in the small gas taps. The results of the examination of the composition of the gas in the three casks over intervals extending up to eight months' storage are given in the next table.

TABLE XXX.

	Nitrogen-filled Cask.		Air-filled Cask.	
	Per cent. "CO ₂ ."	Per cent. O ₂ .	Per cent. "CO ₂ ."	Per cent. O ₂ .
Originally	0.5	2.3	0.5	16.4
After 3 days	0.5	2.3	1.0	12.6
After 1 week	1.0	1.0	1.0	10.0
After 2 weeks	1.0	0.4	1.0	7.4
After 8 months	0.7	0.3	0.9	0.4
	Carbon-dioxide-filled Cask.			
			Per cent. "CO ₂ ."	Per cent. O ₂ .
Filled with carbon dioxide for 2 minutes			50.0	—
Filled with carbon dioxide for further 5 minutes			85.0	—
After 3 days			16.2	—
After 3 days (refilled for 5 minutes)			89.7	—
After 5 days			30.0	12.6
After 1 week			16.0	13.4
After 2 weeks			16.2	8.1
After 8 months			21.7	0.3

The vitamin (colorimetric) values were practically constant throughout in each experiment, the final figures for the air-filled and CO₂ filled casks being respectively 9.3 and 9.4 Blue Units.

The following points may be noted in connection with the above data :—

- (1) In presence of air the oil commences to absorb oxygen immediately, and for the first few days the removal of oxygen by the oil is comparatively rapid; about half of the oxygen present disappeared in the course of the first week's storage.

Subsequently, as would be expected, the rate of absorption of oxygen declined, but after the expiration of eight months the amount of oxygen left in the gas space above the oil was negligible.

It will be observed that the figure for carbon dioxide was in general of the order of about 1 per cent., i.e., far greater than that of the original air. This figure, which probably represents in part volatile organic matter rather than carbon dioxide, must be ascribed to slight decomposition of the oil in presence of oxygen with formation of a small proportion of gaseous decomposition products.

(2) The first point which may be noticed about the nitrogen-filled cask is that passage of a rapid current of nitrogen into the bunghole of the cask for a period of 5 minutes resulted in the production of an atmosphere which still contained 2.3 per cent. of oxygen; that is to say, the contents of the gas space were then made up to somewhat less than 90 per cent. of nitrogen with somewhat more than 10 per cent. of the original air. This is not a surprising result, in view of the fact that nitrogen is somewhat lighter than air, but it should be pointed out that the amount of nitrogen released in order to effect this result was many times greater than the actual gas space to be filled and that in practice the operation of efficient filling with nitrogen must be exceedingly wasteful and costly so far as the actual usage of nitrogen is concerned.

The gas analyses show that the small amount of oxygen left in the gas space was slowly but certainly absorbed by the oil—in the course of about a fortnight. The amount of carbon dioxide in the gas was again from 0.5–1.0 per cent., this figure no doubt including volatile organic matter in addition to actual carbon dioxide.

(3) The corresponding figures for the cask filled with carbon dioxide are still more instructive. In the first place a rapid current of carbon dioxide was injected into the gas space for 2 minutes, but this only resulted in displacing half the air therefrom; after admission of the gas for a further 5 minutes the carbon dioxide content of the gas space had reached 85 per cent. These figures afford an excellent illustration of the difficulty of completely replacing air by injection of another gas into the cask, since the process is far from complete after injection of a rapid current of carbon dioxide, the density of which is half as

great again as that of air, and this gas being of course the heaviest inert atmosphere readily obtainable in technical practice.

Furthermore, the succeeding figures show that carbon dioxide very rapidly disappears by solution in the oil ; a partial vacuum must thus be created, and it is not to be expected that the joint at the screw cap will be sufficiently gas-tight to resist the slow ingress of air under these conditions.

The data obtained show, in fact, that this is precisely what happened, and that the carbon dioxide figure remained at about 16-20 per cent. of the total gaseous contents whilst the oxygen content after 5 days was not far short of that to be expected if the balance of the gas were air, and subsequently declined to a negligible amount, the composition of the gas space after 8 months being evidently about 20 per cent. carbon dioxide and the remainder nitrogen. Whilst carbon dioxide may, therefore, hinder the access of oxygen to the oil, the final result is not very different from that obtained by filling the cask with nitrogen—indeed, the total amount of oxygen fixed by the oil was probably greater in the case of the cask filled with carbon dioxide.

The practical conclusions to be drawn from these figures are that neither carbon dioxide nor nitrogen is of any great service in absolutely excluding oxygen from entering into combination with the oil. No method of storage in an inert atmosphere could be considered efficient that did not take into consideration firstly the air dissolved in the oil itself, and secondly the difficulties of preventing gaseous diffusion through the joints of the screw caps of barrels. The oxygen normally dissolved in cod liver oil can bring about a small amount of oxidative change, and it would be necessary to remove this gas under reduced pressure if it were desired to store cod liver oil under the best conditions. To do so would be expensive, and our results indicate that from the practical standpoint it would be superfluous.

We suggest that the most efficient method of securing minimum access of oxygen is to leave as little air space as possible in the cask, and, if the casks employed are of the usual type with the bung-hole in the centre of the side, and the filled casks are stored on end, the air space is sealed automatically from contact with any screw joints, and after the oil has absorbed the small volume of oxygen present in the enclosed air, no further action will take place. A simple calculation will show that the proportion of unsaturated glycerides which can be affected by this small amount of oxygen is trifling, and is

probably of no greater order than the amount which may well suffer combination with oxygen by the contact with air afforded when the oil is necessarily transferred from one vessel to another.

The characteristics of the oils in the three experimental casks before and after the gas tests had been carried out were as follows :—

TABLE XXXI.

	Air-filled.		Nitrogen-filled.		Carbon dioxide-filled.	
	Original.	After Eight Months.	Original.	After Eight Months.	Original.	After Eight Months.
Percentage free fatty acid as oleic.	0.23	0.24	0.24	0.22	0.23	0.25
Iodine value	172.5	171.2	175.4	174.0	176.0	173.6
Vitamin content B.U. (after 4 months).	9.6	9.3	9.6	9.5	9.6	9.4

The very slight changes observable are of much the same order in each case, and go to confirm the general conclusion that displacement of air from casks by inert gas is an unnecessary procedure which is not productive of any definitely good result.

Use of "Anti-oxygens" in storage of Cod Liver Oil.

The work of Moureu³ has shown how a relatively small amount of certain substances, to which the name "anti-oxygens" has been given, will greatly retard the oxidation of many products that are rather prone to this change. The use of such "anti-oxygens" on a technical scale to protect oils against oxidative changes has been several times proposed, and the substance most frequently suggested has been hydroquinone.

Quite recently, the influence of hydroquinone on the vitamin A content of cod liver oil during storage has been studied⁴. In relatively high concentrations (0.1 per cent.) this "anti-oxygen" retarded the destruction of the vitamin by oxidation, but such a concentration would, of course, be quite unpractical in industry. Smaller concentrations were of little value.

³ A good review of the subject of anti-oxygens is given by C. Moureu. *J. Soc. Chem. Ind.*, 1928, 47, 819, 848.

⁴ Huston, Lightbody and Ball. *J. Biol. Chem.*, 1928, 79, 507.

It might be remarked that small doses of hydroquinone are apparently without harmful effects on the animal organism. The observations of the American investigators are confirmed by our own observations.

The curves given in Fig. 5 show the influence of hydroquinone in different concentrations on the uptake of oxygen by cod liver oil. It will be observed that amounts of hydroquinone that might be regarded as practicable on the industrial scale are of little or no value in protecting the oil from oxidation.

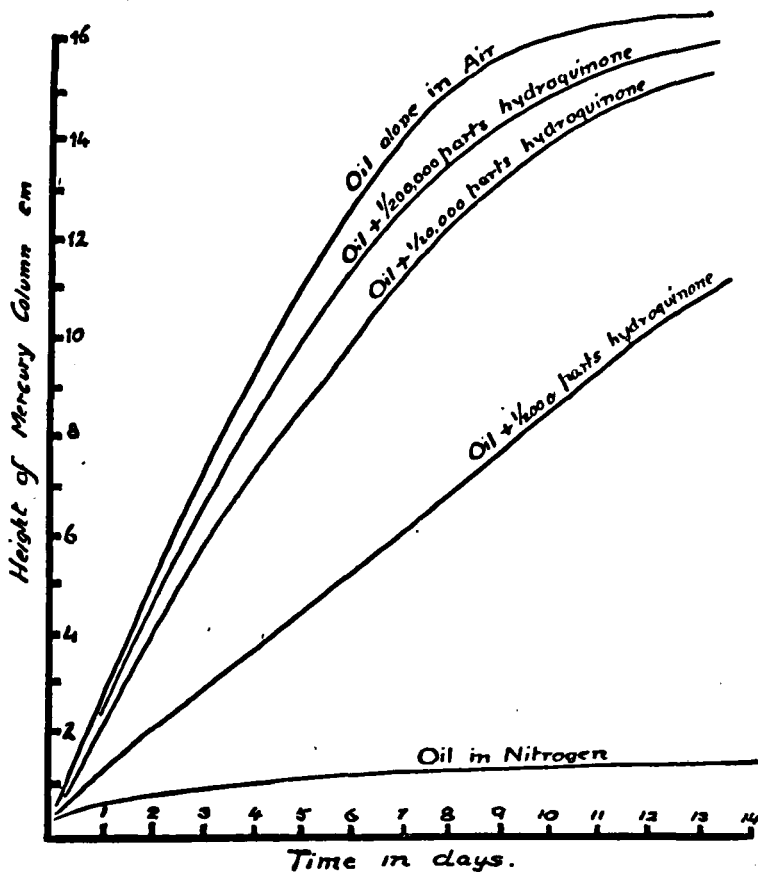

FIG. 5.

Curves representing the uptake of oxygen by cod liver oil and the inhibition of oxidation resulting from the addition of varying amounts of hydroquinone.

Storage of Cod Liver Oil in bottles.

In order to determine the effect of light and of air on cod liver oil stored in plain glass bottles, a quantity of Scottish non-freezing medicinal cod liver oil of excellent quality was placed in a number of clear glass 8-oz. bottles with narrow necks and stored under various conditions as follows, each variant being made up in duplicate, one sample being exposed to full daylight, whilst the duplicate was preserved in a dark cupboard: bottles fitted with ordinary corks (access of air), bottles filled with nitrogen and with carbon dioxide and closed with well-fitting rubber stoppers, bottles exposed to air and containing oil to which was added small quantities respectively, of well-steamed liver tissue and of fresh (fermenting) liver tissue. The results observed are collected in Tables XXXII-XXXIV.

TABLE XXXII.

Per cent. free fatty acid (as oleic acid).

	Original.	After 2 Weeks.	6 Weeks.	9 Weeks.	4 Months.	6 Months.	13 Months.
<i>Stored in daylight:</i>							
In air	0.32	0.32	0.30	..	0.42	..	1.20
In nitrogen	0.32	0.26	..	0.30	0.27
In carbon dioxide	0.32	0.30	0.28	0.29	0.22
<i>Stored in dark:</i>							
In air	0.32	0.31	0.30	0.40	0.87
In nitrogen	0.32	0.25	..	0.28	..	0.28	0.40
In carbon dioxide	0.32	0.25	0.31	..	0.28	..	0.44

TABLE XXXIII.

Iodine values.

	Original.	After 2 Weeks.	6 Weeks.	9 Weeks.	4 Months.	6 Months.	13 Months.
<i>Stored in daylight:</i>							
In air	170.3	164.5	167.4	..	164.9	..	147.1
In nitrogen	170.3	166.9	..	169.6	164.9
In carbon dioxide	170.3	167.1	166.9	..	162.1
<i>Stored in dark:</i>							
In air	170.3	164.6	167.8	166.3	154.0
In nitrogen	170.3	167.4	..	166.2	..	162.4	164.5
In carbon dioxide	170.3	166.2	167.0	..	167.9	164.5	160.4

TABLE XXXIV.
Colour of oils.

	Original.		After 2 Weeks.		6 Weeks.		9 Weeks.		4 Months.		6 Months.		13 Months.	
	Y.	R.	Y.	R.	Y.	R.	Y.	R.	Y.	R.	Y.	R.	Y.	R.
<i>Stored in daylight :</i>														
In air	2.6	..	2.6	..	1.6	1.2	3.6	0.4
In nitrogen	2.6	..	2.6	0.1	2.3	0.1	2.3	2.1	..
In carbon dioxide ..	2.6	..	2.6	..	2.0	2.0	1.9	..
<i>Stored in dark :</i>														
In air	2.6	..	2.5	0.1	2.4	0.1	4.9	0.3
In nitrogen	2.6	2.7	0.2	2.7	3.3	..
In carbon dioxide ..	2.6	2.6	0.2	3.3	0.3	4.6	0.4

Several series of observations were made on the variation of vitamin A potency with time in the case of bottled cod liver oils. Table XXXV shows typical figures obtained for a number of Scottish cod liver oils stored in air in bottles in the light and in a dark cupboard.

TABLE XXXV.

Cod Liver Oil.	Stored in.	Vitamin A Test (B.U.).				
		Fresh.	After 9 Weeks.	After 4 Months.	After 6 Months.	After 12 Months.
Freshly-rendered crude (A)	Light	10.0	7.3	—	—	4.2
Freshly-rendered crude (F)	"	11.0	10.1	9.0	8.2	7.0
Freshly-rendered crude (G)	"	11.6	10.7	—	9.3	5.9
Freshly-rendered crude (H)	"	10.2	9.1	—	—	5.4
Freshly-rendered crude, centrifuged ..	"	10.6	5.8	—	—	3.1
Freshly-rendered crude, centrifuged and 1 per cent. dried liver tissue added.	"	10.6	4.9	—	—	2.8
As last, with water present	"	10.6	4.6	—	—	3.4
Medicinal oil	"	10.0	—	—	8.6	4.8
Medicinal oil + 1 per cent. dried liver tissue.	"	10.0	—	—	—	4.2
Medicinal oil + 1 per cent. dried liver tissue + water.	"	10.0	—	—	—	4.7
Freshly-rendered crude (A)	Dark	10.0	8.2	—	—	5.7
Freshly-rendered crude (F)	"	11.0	10.8	9.7	9.8	8.4
Freshly-rendered crude (G)	"	11.6	11.3	—	10.7	6.9
Freshly-rendered crude (H)	"	10.2	9.1	—	8.7	6.3
Freshly-rendered crude, centrifuged ..	"	10.6	7.6	—	—	4.4
Freshly-rendered crude, centrifuged and 1 per cent. dried liver tissue added.	"	10.6	7.9	—	—	3.7
As last, with water present	"	10.6	5.6	—	—	4.1
Medicinal oil	"	10.0	—	—	9.2	7.6
Medicinal oil + 1 per cent. dried liver tissue.	"	10.0	—	—	—	6.1
Medicinal oil + 1 per cent. dried liver tissue + water.	"	10.0	—	—	—	6.8

In Tables XXXVI-XXXVIII are collected similar data with regard to some of the fresh cod liver oils obtained in the experimental boiler from the Moray Firth catches of March, 1929 (samples C1, C2, C3, C4, D1, D2, D3, E1, E2, E3 already described in Table XXVIII). The samples were bottled (a) in white glass bottles exposed to light, (b) in amber glass bottles exposed to light and (c) in white glass bottles kept in the dark.

TABLE XXXVI.

Per cent. free fatty acid (as oleic acid).

	C1.	C2.	C3.	C4.	D1.	D2.	D3.	E1.	E2.	E3.
(a) <i>Stored in white glass bottles exposed to light.</i>										
Fresh	0.13	0.16	0.16	0.11	0.12	0.13	0.14	0.03	0.10	0.03
After 2 months	0.20	0.21	0.13	0.15	0.33	0.30	0.14	0.15	0.27	0.25
After 6 months	0.34	0.32	0.40	0.39	0.55	0.63	0.31	0.57	0.53	0.48
(b) <i>Stored in amber glass bottles exposed to light.</i>										
Fresh	0.13	0.16	0.16	0.11	0.12	0.13	0.14	0.03	0.10	0.03
After 2 months	0.20	0.21	0.13	0.15	0.20	0.25	0.14	0.16	0.29	0.23
After 6 months	0.29	0.23	0.35	0.38	0.38	0.38	0.30	0.30	0.49	0.45
(c) <i>Stored in white glass bottles in the dark.</i>										
Fresh	0.13	0.16	0.16	0.11	0.12	0.13	0.14	0.03	0.10	0.03
After 2 months	0.26	0.23	0.10	0.10	0.18	0.25	0.15	0.14	0.28	0.23
After 6 months	0.32	0.26	0.34	0.36	0.41	0.26	0.25	0.30	0.40	0.26

TABLE XXXVII.

Colour of oils (Yellow units, Red absent).

	C1. Y.	C2. Y.	C3. Y.	C4. Y.	D1. Y.	D2. Y.	D3. Y.	E1. Y.	E2. Y.	E3. Y.
(a) <i>Stored in white glass bottles exposed to light.</i>										
Fresh	2.1	2.1	2.1	2.4	2.5	2.5	2.7	2.5	2.5	2.5
After 2 months	2.0	1.5	1.3	1.5	1.7	1.7	1.7	1.8	1.8	1.2
After 6 months	0.9	0.9	1.0	1.0	1.1	1.1	1.1	0.9	1.2	1.0
(b) <i>Stored in amber glass bottles exposed to light.</i>										
Fresh	2.1	2.1	2.1	2.4	2.5	2.5	2.7	2.5	2.5	2.5
After 2 months	2.2	1.5	1.6	1.8	2.0	2.1	1.9	2.3	2.1	1.5
After 6 months	1.7	1.3	1.5	1.8	1.8	1.7	1.8	1.8	1.8	1.3
(c) <i>Stored in white glass bottles in the dark.</i>										
Fresh	2.1	2.1	2.1	2.4	2.5	2.5	2.7	2.5	2.5	2.5
After 2 months	2.9	2.1	2.0	2.1	2.3	2.4	2.5	2.7	2.5	2.1
After 6 months	2.8	2.1	2.1	2.1	2.2	2.4	2.3	2.0	2.4	2.0

TABLE XXXVIII.
Vitamin content (B.U.).

				C1.	C2.	C3.	C4.	D1.	D2.	D3.	E1.	E2.	E3.
(a) <i>Stored in white glass bottles exposed to light.</i>													
Fresh	5.6	4.7	4.8	4.8	7.4	4.7	4.6	5.3	5.3	5.2
After 2 months	5.3	4.2	4.6	4.6	7.1	4.0	4.3	4.7	4.7	3.3
After 6 months	1.8	2.4	2.9	2.1	3.1	2.8	3.0	1.9	3.0	1.4
(b) <i>Stored in amber glass bottles exposed to light.</i>													
Fresh	5.6	4.7	4.8	4.8	7.4	4.7	4.6	5.3	5.3	5.2
After 2 months	5.7	4.3	4.8	4.8	7.1	4.1	4.1	4.0	4.5	3.6
After 6 months	5.3	4.3	4.4	4.0	5.9	4.4	3.7	2.2	4.3	2.1
(c) <i>Stored in white glass bottles in the dark.</i>													
Fresh	5.6	4.7	4.8	4.8	7.4	4.7	4.6	5.3	5.3	5.2
After 2 months	6.0	4.7	4.9	4.9	7.4	4.2	4.7	4.4	4.5	3.6
After 6 months	5.3	4.0	4.7	4.5	6.8	4.4	4.8	3.5	4.0	3.3

The most arresting features brought out by these figures are the alteration in colour of the oils and the variation in vitamin content during storage. In presence of light, the oils commence, within a few weeks, to become paler and this bleaching action appears to be more or less indefinitely prolonged if the oil is not in contact with air. In the presence of air, there appears to be some tendency, after very long standing, for the colour to redevelop; in other words, some coloured product is presumably formed, the colour of which overbalances the loss of colour from other constituents of the oil. Parallel with the bleaching action, the vitamin content shows a tendency to decline steadily and after a year's storage with exposure to light, especially if air is present, the vitamin content is much reduced⁵.

The behaviour of the oil stored in absence of light is somewhat different: in general there is little change in colour for the first few months, but subsequently development of colour may occur; the vitamin figures remain practically constant for the first few weeks or months, but eventually commence to decline, although much more slowly than in the cases of the oils exposed to light.

⁵ The destructive action of light and the advisability of storage in the dark or in amber glass containers is pointed out by Evers. *Quart. J. Pharm.*, 1929, 2, 556.

There is no very marked change in the unsaturation or acidity of the oils parallel with the progressive alteration in colour and vitamin potency, although on the whole there is a very slight tendency to diminution in iodine value and in some cases an even more slight indication of a minor increase in the free acidity.

The general conclusions to be drawn from the foregoing storage tests, are that medicinal cod liver oil should be bottled preferably in amber-coloured or dark-coloured containers, that the bottles should be as completely filled with oil as possible and supplied with well-fitting corks of good quality, and that as far as possible instructions should be issued to keep the oil in a dark cool place. Further, the wholesale druggists would be well-advised to organize the trade as far as possible in such a way that supplies would not be left unconsumed for any prolonged period ; it is clearly desirable that the medicinal cod liver oil should be consumed within at most three or four months of its having been refined and bottled. Owing to the seasonal nature of the cod fishing, this is probably to some extent a counsel of perfection, but it nevertheless remains the state of affairs which should be aimed at as a current trade practice.

CHAPTER 7.

COD LIVER OIL MANUFACTURE IN NEWFOUNDLAND.

The main features of cod liver oil manufacture in Newfoundland were described by Zilva and Drummond a few years ago.¹ The system of Government Inspection of Factories and oil was referred to in that publication.

One of the writers visited Newfoundland in the summer of 1929, and made an extensive survey of the industry. There is little to add to what was set out in the paper referred to, except to emphasise the highly satisfactory working of the system of inspection and the marked improvement in quality of oil that has resulted. In practically every factory visited careful attention was paid to the regulations issued by the Department of Marine and Fisheries. Licences to manufacture oil are immediately withdrawn when negligence remains uncorrected.

The following is a copy of the rules and regulations in force in the Dominion :—

RULES AND REGULATIONS

In connection with the Manufacture of Refined Cod Liver Oil, made under and by virtue of "An Act Respecting the Refining of Cod Liver Oil," passed by the Legislature, May, 1916, and amended June, 1919.

FOR REFINERS.

1. Application for Licence for the Manufacture of Refined Cod Liver Oil shall be in the following form :

I, _____ residing at _____ in the
District of _____, do hereby apply for a licence to engage in
the business of refining Cod Liver Oil for the year ending April 30th, 19____, at my
factory, situated at _____, in the district of _____,
of which factory _____ is foreman, style of plant being
steam apparatus, subject to the rules and regulations governing this industry.

Affidavit for Licence.

I hereby take my affidavit that this factory will be laid out in the most approved plan according to the requirements of the Cod Liver Oil Inspector. The outfit will be complete, suitable for the manufacture of High Grade Medicinal Oil.

The foreman has had experience in this work and is thoroughly competent.

¹ *J. Soc. Chem. Ind.*, 1922, 41, 280T.

Unless I make One Thousand Gallons of the High Grade Oil this season, I agree that my licence shall be cancelled.

I hereby furthermore take my affidavit that at the end of this season's operations not later than ten days after the closing of the factory, I will send a Return to the Department of Marine and Fisheries giving the quantity of liver strained and the quantities of the various grades of oil produced, on the forms supplied for the purpose by the above-mentioned Department.

2. Upon receipt of the said application the Minister of Marine and Fisheries may issue the necessary Licence which shall be in the following form :

By virtue of the power vested in me under " An Act Respecting the Refining of Cod Liver Oil," I, _____ do hereby
License _____ residing at _____ in the
District of _____ of which plant
is foreman, style of said plant being steam
apparatus.

3. No fee shall be charged for said Licence.

4. Said Licence shall be renewed yearly from the 1st day of March in each year, upon receipt of application, at the Department of Marine and Fisheries.

5. The Minister of Marine and Fisheries shall refuse at any time to issue a Licence to any person who has violated one or more of the Rules governing this industry, or to any person who has not complied with the instructions of the Inspector or Inspectors appointed under these Rules and Regulations.

6. The owner or manager of every factory or plant operated for the Manufacture of Refined Cod Liver Oil shall cause to be branded on every barrel or other package containing Refined Cod Liver Oil manufactured by him, the number corresponding to the number of the Refined Cod Liver Oil Licence of said refiner. For this purpose he shall obtain through the Department of Marine and Fisheries a suitable branding iron, the cost of the same to be fixed by the Department and defrayed by the Licensee.

No branding irons other than those obtained from the Department of Marine and Fisheries shall be used.

7. Any person in this Colony selling or purchasing or being in any way a party of any transaction in the nature of a sale or purchase of any barrel or other package containing Refined Cod Liver Oil without said barrel or package being branded as above described shall be deemed guilty of an offence against these Rules and Regulations.

All Refined Cod Liver Oil shall be inspected before being placed in Freezer.

8. All Licences shall be kept in factories for examination by Inspector.

9. The Licensee or his foreman shall answer all letters or circulars relating to the manufacture of Refined Cod Liver Oil addressed to them from the Department of Marine and Fisheries, or from Inspectors appointed under these Rules.

10. A Licence shall be cancelled

- (a) If the Licensee or his foreman fails to comply with any Rules and Regulations.
- (b) If the factory is not kept as scrupulously clean as the business demands.
- (c) If it is shown at any time that the liver or oil from any other fish except the cod-fish is utilized and the product is offered for sale as Cod Liver Oil.
- (d) If the Licensee or his foreman be shown to be incapable of manufacturing a good grade of Cod Liver Oil for human consumption.

11. The Governor-in-Council shall appoint an Inspector or Inspectors who shall be under the control of the Department of Marine and Fisheries.

12. The Inspector or Inspectors so appointed acting in conjunction with the Government Analyst, shall establish minimum standards for :

- (a) Non-freezing Cod Liver Oil.
- (b) Refined Cod Liver Oil intended for human consumption.
- (c) In connection with minimum standards, it should be the aim of manufacturers to produce oil containing not over 0.5 per cent. of free fatty acids.

13. Samples of Oil shall be furnished by the official in charge of any factory to the Inspector, Department of Marine and Fisheries or the Government Analyst, or the Inspector may take samples himself from any factory.

14. It shall also be the duty of the Inspector or Inspectors to visit all factories and to instruct manufacturers in the most approved methods of manufacture.

15. It shall be compulsory for all manufacturers to carry out all Rules and Regulations and instructions from the Inspectors.

FOR EXPORTERS.

16. As provided by Section 3 of the " Act Respecting the Refining of Cod Liver Oil," no Refined Cod Liver Oil shall, after July 1st, 1916, be exported from this Colony unless the package containing same shall bear a Government brand or mark, by label, stencil or tag, as may be arranged by the Department of Marine and Fisheries.

There shall be distinct brands :

- (a) Signifying Non-Freezing Cod Liver Oil for human consumption.
- (b) Signifying Refined Cod Liver Oil for human consumption.
- (c) Signifying By-products.

The contents of the packages so branded shall conform to the Standard set by the Government Analyst and Inspector.

17. His Excellency the Governor-in-Council shall appoint as many Sub-Inspectors to carry out the branding, marking, stencilling or tagging as may be found necessary in conformity with the Sections of Chapter 104 of the Consolidated Statutes dealing with the Inspection of fish oils, and upon terms and conditions as may be found necessary for the efficient carrying out of these Regulations.

18. A certificate of Inspection must be produced by the Exporter to the Customs Officer when applying for Export Entry for the exportation of Refined Cod Liver Oil and Non-Freezing Cod Liver Oil.

19. Any person who shall not obey the orders of the Inspectors, or who does not carry out their instructions shall be deemed guilty of a violation of these Rules and Regulations, and may have his Licence forthwith cancelled on complaint of said Inspector, or on complaint of any person who may certify the Instructions or Rules of the Inspectors have not been complied with.

20. No package other than a tin-lined barrel made especially for the purpose to be used to contain Medicinal Cod Liver Oil. All inferior casks shall be condemned by the Inspectors.

Penalty Clause.

For any violation of the Rules and Regulations hereinbefore mentioned, or for any non-compliance with the instructions of an Inspector, the person in default shall be liable to a fine not exceeding One Hundred Dollars and Costs and in default of payment, to imprisonment for a term not exceeding six months, for each offence. Such penalty to be recovered in a summary manner before a Stipendiary Magistrate or Justice of the Peace.

Department of Marine and Fisheries,
St. John's, Newfoundland, April 25th, 1929.

RULES FOR MAKING COD LIVER OIL.

For the Guidance of Manufacturers.

1st. The manager in charge of factory must see that the livers are fresh ; that all brown or poor livers are thrown out ; that there is no gall bladder attached to any livers.

It should be impressed upon the manufacturers the importance of not allowing any livers to be exposed to the air for more than two hours before boiling.

2nd. The good livers must then be washed in a tub of clean water.

3rd. The pan in which the livers are boiled must be perfectly clean inside, before any livers are placed in it.

4th. Before you start to boil any livers you must have sufficient steam.

5th. Turn on the steam and use as much as you need to have for the quantity of livers you have in your pan. Boil UNTIL THE WHITE SCUM FLOATS (which will take about thirty minutes). Don't forget to stir the livers, and see that those in the bottom and those around the sides are brought into direct contact with the steam all the time.

6th. Turn the steam off, and allow all to settle, not exceeding five minutes according to capacity of liver boiler.

Cooling the Oil.

7th. The finest white oil is now dipped off and goes direct to the cooling tank.

This cooling tank must be made of galvanised iron with a specially made floating cover to protect this oil from contact with the air.

The oil enters through a funnel covered with proper straining cloths to catch any pieces of blubber.

Straining the Oil.

8th. The oil remains in the cooling tank for thirty-six hours until it is cold enough for proper straining.

The oil is removed by a faucet near the bottom of this tank, and is strained through double calico bags, placed inside of one another. The oil to go direct by a tin shoot into tin-lined barrels, and is then ready for shipment.

The best results for medicinal oil can only be obtained by the use of tin-lined barrels. Keep all oil in barrels in a cool place and covered from the sun.

RULES FOR BY-PRODUCTS.

9th. After dipping off the No. 1 oil from your liver pan, and while the blubber is still hot, pour in about five gallons of clean water. Turn the steam on again for not longer than five minutes and stir well until the blubber has come to a boil. The blubber acts like a sponge, holding a considerable quantity of oil, but the water and steam loosens it, giving you an increased yield.

10th. In a few minutes the water will have settled to the bottom of the liver pan. **DRAW THIS OFF.** Have press bags ready and allow the blubber to go direct into the bags. These bags must then go at once into the presses while the blubber is perfectly hot. You will get a far larger yield and better quality of oil in this way than formerly. Don't fill these bags full of blubber as it will press quicker by not having too much. Put all the weight you can on the lever and the pressing will be done quickly.

11th. The oil must be placed in oleo barrels, as kerosene barrels would destroy it for feeding poultry. The PRESSINGS are placed at once in iron-bound pork barrels and headed up quickly to keep them from the air which turns them sour.

12th. Have the press bags thoroughly washed in warm water after every pressing and dried perfectly. You cannot strain oil properly through a wet cloth, and it is very much worse to try and strain it through a cloth saturated with oil.

Clean-up.

13th. Then clean your liver pan with warm water and washing powder.

14th. Every bag, cloth, tank, funnel and pan must be washed only with warm water, soap and powder ; soda must not be used.

The efforts of the Government of Newfoundland to improve the quality of the oil are being well rewarded, and the average oil produced to-day is very satisfactory. Progress is so encouraging that there is already talk of lowering the level of permitted acidity below 0.5 per cent.

A certain circulation has been given in recent years to misleading statements suggesting that the darker colour of Newfoundland oil is due to the more rapid decomposition of the livers in the warm weather of July and August than in the cold months of the Norwegian season. It is also suggested that the Newfoundland manufacturers are careless, and may hold livers overnight if sufficient are not available for a boiling at the time.

There is in our opinion no basis whatever for these statements. Medicinal oil is prepared in Newfoundland from the livers of cod caught inshore. Within an hour or two of being caught the fish are gutted and the livers are in practically every case steamed immediately. A factory manager who permitted livers to lie about as is suggested in these statements would soon be penalised by suspension

of the licence. Statements regarding the small quantity of livers normally available are inaccurate. In nearly every factory several boilings a day are carried through.

The following figures of the export of medicinal cod liver oil from Newfoundland enable the production to be estimated.

Exports of Medicinal Cod Liver Oil from Newfoundland.

			<i>Galls.</i>	\$
1920	291,351	726,852.00
1921	45,956	79,982.00
1922	48,559	28,265.00
1923	51,962	36,987.00
1924	41,389	31,462.00
1925	77,484	76,533.00
1926	169,645	197,244.00
1927	276,273	328,123.00
1928	357,028	448,180.00
1929	364,239	492,763.00

It has been stated on reliable authority that a very considerable increase in production would be possible if markets were to extend.

Another type of misleading statement has implied that livers other than cod are employed for the manufacture of liver oil in the Dominion. The manufacturers of the Lofoten district in Norway are rather proud of being able to claim that their oil is produced from livers almost exclusively cod. Unquestionably the Newfoundlanders are able to make the same claim.

Curiously, there is a demand on the part of the pharmacist for an oil guaranteed "pure cod." This is probably a survival from the days when every form of adulteration of liver oils was rife.

Actually it is not a matter of importance from the medicinal point of view whether livers of gadoid fish other than cod enter the steamer or not, as these yield oils of similar character and vitamin activity.

The Cod Liver Industry in Scotland.

A relatively small amount of medicinal oil is actually prepared from the fresh livers in Scotland. The industry is based on Aberdeen. The majority of the oil refined there is derived from livers rendered out on board the trawlers operating in the North Sea and north of Scotland. The production and refining processes are in every way satisfactory.

CHAPTER 8.

COD LIVER OIL FOR HUMAN USE.

There can be no doubt regarding the beneficial influence of cod liver oil in the treatment of many conditions of malnutrition in children and adults. To what extent the recognised factors vitamin A and vitamin D are responsible for this action, it is as yet impossible to say. It is held by some authorities, that the discovery of irradiated ergosterol as a source of vitamin D, and the revelation that carotene may act as a precursor of vitamin A, will render the employment of cod liver oil no longer necessary, as it will now be possible to compound preparations possessing equal or even greater curative properties and comparatively palatable. It is as yet too early to say whether this optimism is justified. Indeed, there are reasons for believing that the beneficial influence of cod liver oil is to be attributed not only to the actions of A and D, but in part to other substances about which little is known at the moment. As a matter of fact, clinical opinion is definitely tending, at the present time, to hold that cod liver oil possesses nutritive properties far superior to any of the substitutes that have yet been offered.

It is obvious from what has been said in the previous chapters, that there is a wide variation in the medicinal value of cod liver oils, expressed in terms of vitamin A and D content, and it is equally apparent that it is advantageous to choose an oil of high vitamin value for use in the treatment of human malnutrition. At the present moment, a considerable proportion of the cod liver oil sold in this country is of relatively low medicinal value, largely because the pharmaceutical trade has a preference for the pale oils—mainly of Norwegian origin. In some cases, these oils are sold with a guarantee of vitamin activity that is virtually worthless, as the figures or "units" given are often based on unreliable methods of testing. Until a method of testing has been officially approved in this country by a competent authority such as the Medical Research Council or the Pharmaceutical Society, statements regarding the "units" of vitamin in an oil should be regarded with extreme caution.

From our enquiry, we are of opinion that a reliable index of the medicinal value of a cod liver oil is the intensity of the blue colour reaction with antimony trichloride. This test is simple to carry out and will give an indication of the order of vitamin A potency of the oil.

Whilst it is probably true that the vitamin A and vitamin D activities of cod liver oil do not always run parallel, we have no hesitation in expressing our opinion that an oil giving a strong antimony trichloride reaction will be found rich both in A and D.

In view of this we are inclined to suggest the following specification for cod liver oil intended for human use.

Specification for Medicinal Cod Liver Oil.

Colour.—Measured in 1-in. cell. Yellow units not greater than 10; Red not greater than 0.5. (Lovibond units).

F.F.A. calculated as per cent. free oleic acid.—Not greater than 0.5 per cent., preferably below 0.3 per cent.

Non-saponifiable matter.—Not greater than 1.5 per cent., preferably below 1 per cent.

Antimony trichloride reaction.—Measured by technique C (p. 32) preferably greater than 7 Lovibond units.

Oils with values below 5 are of inferior value.

We suggest that manufacturers should stamp the labels of the containers at the time of filling with the figures for acidity, expressed as per cent. free oleic acid, the blue units given by technique C (p. 32), and a statement of the date on which the tests were made.

Colour in Medicinal Oil.

It is apparent from this suggested specification that the public must be educated to appreciate the fact that a yellow oil is in all probability richer in vitamins than one that is paler in colour. Unless the deep colour is accompanied by a high acidity there is little reason to fear that the oil has been produced in an unsatisfactory manner or from stale livers. From preliminary experiments that have been made in our laboratory by Dr. Ahmad, it appears that the natural yellow pigment of cod liver oil can be satisfactorily removed without adversely affecting the vitamin value. If such a process can be made commercially possible it will be possible to provide the trade with the "water white" oils they demand and at the same time ensure a high vitamin value. Further investigation in this direction is needed.

Taste and Odour of Medicinal Oil.

Cod liver oil when newly prepared from absolutely fresh livers possesses a very slightly "fishy" smell and is not unpleasant to the palate, apart from its "oiliness". Even a few hours' delay between

removal of the liver from the fish and the extraction of the oil will increase markedly, the "fishy" or "meaty" flavour. Innumerable attempts have been made to remove the constituents of cod liver oil that are responsible for the taste and smell, but none appears to have been successful and at the same time to have left the medicinal properties of the oil unimpaired¹. Processes involving some degree of oxidation, such as partial bleaching or the use of adsorbents, may partly remove the "fishy" flavour and render the oil somewhat more palatable, but they tend to reduce the vitamin content.

Hydrogenated Cod Liver Oils.

Cod liver oil may be converted into a tasteless product by partial or complete hydrogenation, and preparations of this type have been offered in one form or another for human consumption.

The sensitivity of vitamin D to hydrogenation is not known with certainty, although it is believed to be destroyed. Vitamin A is readily destroyed by reduction with hydrogen, even when carried out at low temperatures. Hydrogenated cod liver oils are of no value as substitutes for medicinal cod liver oil.

Toxicity of Cod Liver Oil.

There is reliable evidence to show that cod liver oils prepared from putrid cod livers (see Chapter IX dealing with Cattle and Poultry oils) may be toxic when administered in reasonable doses to animals. This is doubtless due to the presence of toxic substances derived from the decomposition of the liver tissue, and is scarcely a matter for surprise.

There is, on the other hand, a claim that medicinal oils, presumably of satisfactory origin and quality, may give rise to undesirable effects when administered over long periods.

Agduhr² has reported that doses of from 0.10 to 10 c.c. of cod liver oil per kilo of body weight daily produce abnormal conditions of the organs in white mice, rats, rabbits, calves, pigs, cats and dogs when administered for periods of about one year. The most striking pathological changes observed by him were in the heart muscle.

¹ Hjort and Lund. *Tidj. Kemi. Berg.*, 1925, 5, 89.

² *Acta Pædiac.*, 1926, 5, 320 ; 1927, 6, 163.

The explanation of Agduhr's results is not yet quite clear, but Höjer³ criticises his experiments rather seriously and suggests that the diets used may have been unbalanced in respect to other important constituents. This explanation is supported by the highly significant work of Harris and Moore⁴, who found that relatively large doses of vitamins A and D, in the form of cod liver oil or concentrates made from the oil, will produce retardation of growth and abnormal changes unless the diet contains an adequacy of vitamin B. Höjer concludes from his investigation of Agduhr's claims that when large doses of cod liver oil are given together with a balanced diet the changes in the heart muscle will not appear.

If, however, the diet is unbalanced, particularly with reference to vitamin B, the large doses of oil may cause degenerative changes. Our own experiments tend to confirm this view. In a long experience of the administration of cod liver oil to animals of many species one of the writers (J.C.D.) has never observed harmful results to follow the use of reasonable doses.

³ Höjer. *Ibid.*, 1927, 6, 181.

⁴ *Biochem. J.*, 1929, 21, 5.

CHAPTER 9.

COD LIVER OIL FOR ANIMAL FEEDING.

The practice of administering cod liver oil to farm stock is extensive and there is a considerable sale of the oil itself and of preparations containing the oil for this purpose.

A very large literature exists dealing with the effects of cod liver oil on calves, milch cattle, pigs, poultry and other animals. It has been recently reviewed by Manning¹. He draws attention to a fact that must always be borne in mind when the influence of cod liver oil on animals is being discussed, namely, that there is a very wide variation in the quality of the oils sold for veterinary and agricultural purpose. After making an extensive review of the subject he remarks (p. 352) "It is significant that out of all of the feeding experiments mentioned only a few of the investigators make any mention of the type, quality or history of the cod liver oil used in their tests." The differences of quality encountered in examining medicinal cod liver oils are insignificant when compared with those exhibited by oils sold for farm use.

In Table XXXIX are presented data regarding a number of samples of oil purchased in the ordinary way in this country. It will be seen that the colour ranges from pale golden yellow to deep red brown, and that the free acidity may be as high as 8 per cent. Holmes, Moore, Bennett and Piggot² describe a commercial poultry oil purchased by them in the United States with an acidity of 11.65 per cent.

(a) *Second Grade Oils.*

After the fresh livers have been steamed for the preparation of medicinal oil the residue of cooked liver is usually pressed to separate a further quantity of oil.

If the pressing is carried out shortly after the "cooking" and by a satisfactory method, the oil produced is little inferior to the first grade oil. It may be slightly darker in tint, but the acidity is not appreciably higher. The following analyses (Table XLI) refer to oils prepared in this manner. The liver "foots" were pressed in a well cleaned press about eight hours after the first grade oil had been separated.

¹ U.S. Dept. Commerce, Bureau of Fisheries, Document No. 1065, Washington, 1929.

² *Poultry Science*, 1930, 9, 164.

TABLE XXXIX.

Characteristics of Cattle and Poultry Cod Liver Oils.

Origin of Sample.	Free Acidity expressed as per cent. Oleic Acid.	Colour of Oil in I in Cell. Units of		Vitamin A Blue Units given by 0.2 c.c. 10 per cent. Solution.
		Yellow.	Red.	
Newfoundland	0.81	4.5	0.4	8.7
Norwegian	0.43	5.5	0.5	4.4
Unknown	0.17	2.6	0.2	4.7
Scotch } possibly the same	0.07	3.0	—	7.8
Scotch } oil.	0.08	3.0	—	7.9
Newfoundland	0.15	3.1	0.2	7.3
Probably Newfoundland ..	0.85	3.8	0.6	5.7
Probably Newfoundland ..	2.11	15.0	3.0	7.9
Probably Newfoundland ..	3.68	20.0	3.0	4.5
Probably Newfoundland ..	5.8	27.0	4.0	6.6
Probably Norwegian	0.49	5.2	0.7	7.9
Norwegian	0.53	2.5	—	5.2
Norwegian	3.78	14.0	1.8	4.7
Newfoundland	3.90	24.0	3.3	6.9
English	2.8	13.0	2.0	8.7
English	0.69	28.0	5.5	8.5
Norwegian	1.95	4.2	0.7	4.6
English	5.61	29.0	4.5	6.7
English	3.7	20.0	3.0	6.3
English	3.75	25.0	3.5	7.1
Norwegian	7.85	38.0	9.5	4.7
Norwegian	7.78	58.0	17.0	3.9
Norwegian	4.90	12.0	3.2	4.3
Norwegian	7.70	15.6	4.5	5.0

It is possible, therefore, with a little care, to prepare second grade oils suitable for poultry and animal feeding which are only a little inferior in market qualities to those employed for human use. The taste and odour of such oils are definitely more fishy and "meaty" than the first oils, but they are far more palatable than a large proportion of the products on the market, many of which are nauseous in the extreme. Too often, however, care is not taken to press the liver residues promptly and with regard to cleanliness, and frequently

in factories that are scrupulously clean as regards the preparation of medicinal oil one will find the presses for the "foots" and the press rooms in a filthy condition. The consequence is that many second grade oils, although pressed from the liver residues of medicinal oil preparation, possess unnecessarily high colour, acidity and bad smell.

TABLE XLI.

	Expt. I.		Expt. II.	
	First Oil.	Pressed Oil.	First Oil.	Pressed Oil.
Free fatty acid (per cent. oleic) ..	0·14	0·19	0·20	0·26
Colour—Yellow	3·2	4·1	4·0	4·8
Red	—	0·1	—	0·1
Vitamin A. Blue units	10·2	10·4	10·0	11·0
Iodine value	168·0	171·0	169·0	173·0
Non-saponifiable matter	0·70	0·71	0·68	0·70

(b) "Rotted" Oils.

Another type of liver oil often sold for the use of farmers is the "rotted" oil made by the original and primitive process of allowing the livers or sometimes the liver "foots" to undergo spontaneous decomposition in large vats or puncheons until the golden brown oil that rises to the top can be skimmed off. These oils are of high acidity, and very nauseating to the palate. Too frequently the vat receives not only livers but guts and other waste material, and nearly always the "rotted" oils are produced under very dirty and unhygienic conditions.

(c) Cod Oils.

The last type of liver oil that may find its way into the ration of farm animals is what is known technically as "cod" oil. It is produced by steaming the livers—often mixed with guts and other offal—that are unfit for the preparation of medicinal oil.

In the long distance fishing the livers are thrown into barrels when the fish are gutted and are brought back to port in a state of more

or less advanced decomposition. This putrescent material yields a deep golden-brown oil on steaming. The resulting product is a nauseous substance known to the trade as "cod oil". Its main use is in technology, but not inconsiderable quantities are sold for animal feeding, either as oil or, more frequently, in the form of proprietary preparations in which the undesirable features of the oil are to some extent masked by admixture with other ingredients.

Not only is the unwitting farmer faced with these differing products, but he is often the victim of adulteration. Whale oil, herring oil and even sperm oil, are used to adulterate cattle cod liver oils. These adulterants will lower the vitamin value of the oil and, in the case of the last-mentioned, adversely affect its digestibility and food value.

It is scarcely surprising, therefore, to read that the results of administering "cod liver oil" to farm stock have been conflicting, and that agricultural opinion is divided regarding the merits of this foodstuff. During the last few years, however, there has been a definite tendency to favour the use of the oil and to stress the importance of choosing one of high grade.

There is scarcely any doubt that the use of dark-coloured oils of high acidity in the feeding of farm animals is to be deprecated. These oils are naturally more prone to affect adversely the flavour of meat than those of higher grade, and there is an accumulation of evidence to show that they may be definitely toxic. When their method of preparation is borne in mind it is scarcely surprising that they contain appreciable amounts of nitrogen and sulphur-containing products derived from the putrefying liver tissue, and that some of these substances may be harmful to the organism.

The sale of such oils for veterinary or farm purposes, whether as the oil itself or as an ingredient of proprietary foods, should no longer be tolerated.

The best way to protect the farmer would seem to be to suggest maximum limits for the colour and acidity of cattle and poultry oils and a minimum limit for vitamin content. After careful deliberation, we advance the following suggestions regarding a specification of oils sold for the consumption of farm animals.

SPECIFICATION OF POULTRY AND CATTLE OILS.

Colour.—Not deeper than 15 yellow units, Lovibond, and 1 red unit Lovibond, measured in 1-in. cell.

F.F. Acid.—Not greater than 1 per cent. calculated as oleic acid.

Non-saponifiable matter.—Not higher than 1·5 per cent.

Antimony trichloride test.—Should give seven or more blue units when examined by technique C (p. 32). Oils with colour values below 5 are of little value.

We suggest that it would be a great advantage if the label of the container could bear in a prominent position the figures for the acidity, expressed as per cent. free oleic acid, and the antimony trichloride test, together with a statement of the date on which the tests were made.

CHAPTER 10.

GENERAL CONCLUSIONS.

Origin of Vitamins in Cod Liver Oil.

A reinvestigation has been made of the problem of the origin of the important dietary factors, vitamin A and vitamin D, in cod liver oil, as a necessary step in ascertaining the cause of the variations in medicinal value which undoubtedly occur in oils from different localities. Confirmatory evidence was obtained in support of the view that the primary source of vitamin A is the minute green plant life of the sea, which, directly or indirectly, forms the primary food supply of the teeming animal life of the ocean. No evidence was obtained to indicate that vitamin D is formed in appreciable amounts by these microscopic plants.

The small crustacea (copepods) that feed extensively on the microscopic plant life (diatoms), and which in their turn form the main food supply of the cod during its early life and of many other forms of marine life, were found to be curiously deficient in both vitamins, and the same was true concerning a number of other species that form the main food supply of the cod.

This rather surprising observation raises some difficulties in explaining the large stores of vitamins which may be found in the livers of cod. Either the tissues of this and related species possess the power to synthesise both vitamins, or the stores in the liver represent an accumulation of the small amounts that may be present in the daily food of the fish. It must be remembered that the gadoids are voracious feeders, and that the total quantity of food consumed daily when, for example, the cod are ravaging the caplin shoals must be very large. It is feasible, therefore, that the vitamins are retained by the liver so that the liver oil of the mature cod is many times richer in these constituents than the foods upon which the fish live. We are of opinion that the balance of evidence favours this view rather than that which supposes a synthesis to occur in the tissues of the fish.

Variations in Vitamin Content of Cod Liver Oil.

Considerable differences may be encountered in the vitamin activity of cod liver oils. We are inclined to think that these variations are wider in the case of vitamin A than that of vitamin D.

Generally speaking, there appears to be a parallel between the concentration of the two vitamins. In other words, an oil rich in vitamin A will usually be found to be a good source of D. During the investigation exceptions to this parallel were encountered, but it is uncertain whether they are due to the difficulties of assaying the vitamins accurately or whether they indicate that under certain circumstances oils may be definitely richer in one vitamin than the other. We are inclined to support the second view.

The causes of the variations in vitamin potency have been studied. There appear to be two important factors influencing the concentration of vitamin in the liver. The first is the nature of the food supply, and the second is the quantity of oil stored in the liver.

The richness of the food supply of the cod in Icelandic and Newfoundland waters is, we think, responsible for the relatively large amounts of the vitamins A and D found in the livers of fish caught in these areas.

The other factor influencing the vitamin potency of the liver oil is the changes that occur in the quantity of oil stored in the liver of the fish. Wide fluctuations in this quantity may occur, some of which are due to the abundance or scarcity of food, but the more important of which are associated with the annual physiological cycle of the fish.

Apparently the mobilization of fat from the liver that occurs to so marked an extent, particularly in the female, during the formation and ripening of the reproductive tissues, is not necessarily accompanied by a transportation of vitamins. Some of the vitamin stores are, it is believed, transferred to the gonads, but the general effect of the mobilization of fat is to leave the residual liver fat richer in vitamin than before.

In other words, there is evidence that the higher the yield of oil from the livers, the lower, relatively speaking, will be its vitamin content.

The richest vitamin oils will, therefore, be obtained in areas where abundant food supplies for the fish are available and at seasons when the oil content of the livers tends to be low.

This we believe to be the explanation of the undoubtedly high vitamin value of the oil yielded by the cod caught in Newfoundland waters. Of the oils from the important cod areas studied, those from Newfoundland were found to be of richest vitamin potency. Next in order of merit came those of Icelandic origin, although the number of samples investigated in this case was very small. The oils from

Scotland—some proportion of which was derived from fish caught in more northern waters and rendered out on the trawlers—were found to be intermediate in value between the rich Newfoundland oils and the much poorer class of oils of Norwegian origin.

Assay of Vitamins in Cod Liver Oil.

The methods of evaluating cod liver oil in terms of vitamin A and vitamin D activity have been reviewed. It is most unfortunate that at the present time there is a state of confusion in respect to this important matter. Various "units" have been proposed by different authorities, and some have been rather widely and carelessly adopted, in spite of their being based on thoroughly untrustworthy methods of assay. The method of assay of vitamin D employed by Poulsson expresses the antirachitic value of oils in "units" which appear to be from one-half to one-quarter of those which the Pharmaceutical Society of Great Britain employs. Even if the unsatisfactory technique of Poulsson's tests is ignored, it is obvious that this state of affairs is most misleading, since a manufacturer wishing to purchase oil of tested vitamin activity will be assured of two to four times as many "units" of D if the assay is carried out by the Norwegian technique than if the estimation is carried through by the more accurate method now being adopted in Great Britain. The disparity with the American official method is even greater. In approximate figures an average oil assayed by the three chief methods now in use would give the following "unit" values for vitamin D:—

Norwegian assay (Poulsson)	250 units.
British assay (Pharmaceutical Society)	100 "
American official assay	15 "

The present position is, therefore, not only confusing but somewhat serious, in that manufacturers and consumers—who are not all in a position to keep abreast with the rapid changes in this field—are apt to be misled by the apparent superiority of certain oils. Until methods of assay for vitamins A and D are available that are of proven reliability and until there is international agreement regarding the "unit," statements concerning the number of units of these substances in an oil should be regarded with caution.

In our opinion an unfailing indication of the medicinal value of a liver oil is the intensity of the blue colour produced with arsenic or antimony trichloride. The test is comparatively easy to apply, and although in its simplest form it is not as accurate as might be desired it does give a fair indication of the relative value of oils.

Evidence is accumulating that the substance responsible for the blue colour is actually vitamin A itself. If not, it is a substance that accompanies the vitamin very closely. Except in a few cases we have found the A and D value of liver oils to run parallel, so that for ordinary purposes the arsenic or antimony trichloride test can be used for selecting oils of high medicinal value. The deeper the blue colour produced with these reagents, the more valuable will the oil be for medicinal use.

The Colour of Medicinal Cod Liver Oil.

Quite definite evidence was obtained that the natural colour of cod liver oil tends to run parallel in its intensity with the vitamin content. This is in keeping with what is known regarding the storage and transport of the fat-soluble pigments in the animal body and resembles the parallel which has been found to exist between the natural colour and vitamin content of many samples of butter. It is becoming evident that the relation of one or more of these pigments to vitamin A is an intimate one, although it is certain that there is no question of identity. Cod liver oil and butter can be completely decolorised by suitable treatment without appreciably affecting the vitamin content. It indicates that owing to the two classes of compounds possessing certain similar physical properties, the absorption and storage of the fat-soluble pigments (lipochromes) tends to run together with that of the vitamins. Both being, it is thought, primarily of plant origin the richness of the food supply of the cod will also affect the colour of the liver oil. The oils from Newfoundland and Iceland naturally possess a much deeper colour than those from Norway. The prejudice against coloured oils has been born of the belief that colour indicates the use of stale livers or unsatisfactory preparation of the oil. It is true that inattention to the details of preparing medicinal oils will lead to an increased depth of colour, but this is invariably associated with an undesirably high acid value. Medicinal oil is produced in Newfoundland with great care, and it is certain that the yellow colour of this product is natural and associated with a high vitamin activity. The same is true of many Icelandic oils and of some produced in Scotland. The pale oils derived from the Lofoten fishing are generally speaking of low vitamin—certainly vitamin A—activity.

Chemical characteristics of Cod Liver Oil.

A large number of samples of cod liver oil of known origin have been analysed to obtain data regarding the composition of the oils

from various localities. This analytical examination has included a detailed investigation of the fatty acids present in typical oils.

Many of these results will be of considerable value, as reliable information of this character has not been available.

Manufacture of Medicinal Oil.

The various stages in the extraction and refining of medicinal oil have been considered, with reference both to the market qualities of the oil and its medicinal value. Of the greatest possible importance is the use of *absolutely fresh livers*. Even in cold weather a few hours' delay between removal from the fish and steaming may adversely affect the acid value. With very little trouble it is a simple matter to prepare oils with free acidities as low as 0.05 to 0.1 per cent. (oleic acid). There is no excuse for the production of medicinal oils with values higher than 0.5 per cent. Such figures mean carelessness and dirty methods.

The vitamin content of the oil depends on the condition of the livers more than on the method of extraction, although we obtained some evidence that prolonging the steaming, particularly when high pressures (60–100 lbs.) were used, tended to raise the vitamin content somewhat.

The most important point in connection with the cooking of the livers is to ensure that the fat-splitting agents (enzymes) present in the liver are destroyed. For this purpose, temperatures above 70° C. should be reached; again favouring the use of steam from 60–100 lbs. Insufficient "cooking", apart from any question of the yield, produces oils that may show a serious tendency towards rancidity on storage. If, on the other hand, the liver tissue is killed during "cooking", the oil can remain in contact with it for long periods without appreciable increase of acidity.

Throughout the manufacture and refining of medicinal oil contact with air should be reduced to a minimum. The vitamin content is lowered by oxidation and other undesirable changes are brought about. The bleaching of oils by treatment with air is to be discouraged.

The use of inert gases, nitrogen and carbon dioxide, to replace the air in containers used for transport and storage of cod liver oil in the belief that the oil will be protected against oxidation has been studied. This procedure has been shown to have little to recommend it.

The simplest precautions to observe in filling containers with cod liver oil are to leave as small an air space as is practicable and to prevent the action of light. Cod liver oil should not be "put up" in white glass bottles. If glass containers are used, they should be of a dark amber colour.

Cod Liver Oil for Medicinal Use.

It is suggested that cod liver oil for human use might conform with the following requirements.

Colour measured in 1-in. cell.—Yellow Lovibond units not greater than 10. Red Lovibond units not greater than 0·5.

Free acidity (per cent. oleic acid).—Not greater than 0·5 per cent.

Non-saponifiable matter.—Not greater than 1·5 per cent.

Vitamin A reaction.—Preferably greater than 7 blue units when measured by technique B or C (p. 32) i.e. 10 per cent. dilution.

Cod Liver Oil for Administration to Farm Stock.

At the present time many inferior grades of cod liver oil and adulterated oils are sold for farm use. This is highly undesirable and should not be tolerated. Oil intended for the use of cattle and poultry should, in our opinion, be of a quality little inferior to that employed for human consumption. It is a simple matter to prepare second grade oils of this type.

We would suggest that oils sold for veterinary and farm use should conform to requirements little less severe than those proposed for first grade medicinal oil.

Colour (1-in. cell) Lovibond units, not more than 15 units of yellow and 1 unit of red.

Free acidity (per cent. oleic acid) not greater than 1 per cent.

Non-Saponifiable matter not greater than 1·5 per cent.

Vitamin A test preferably more than 7 blue units when examined in 10 per cent. dilution by technique B or C.

Notification of Quality of Cod Liver Oils.

We recommend that containers, both barrels and bottles, of cod liver oil intended for human or animal consumption should bear on the label (1) a statement of the free acidity and response to the colour reaction with antimony trichloride (2) the date at which the tests were made.

In the case of preparations, proprietary foods, emulsions, etc., containing cod liver oil, the label should bear a statement regarding the proportion of oil present, in addition to the above information about the oil itself.

It is a pleasure to acknowledge gratefully the help we have received on every hand from fellow scientists, manufacturers, technical experts and officials. It is impossible for us to name all who have contributed to the success of our investigations, but we would like to take this opportunity of thanking them, and in particular of mentioning how greatly we have been indebted to the following gentlemen: Dr. Alexander Bowman of the Scottish Fishery Board; Mr. Michael Graham, M.A., of the Ministry of Fisheries Laboratory, Lowestoft; Lt.-Cmdr. J. R. A. Richardson, Fisheries Officer, Scarborough; Mr. H. B. Clyde Lake, Minister of Fisheries, Newfoundland; Mr. D. J. Davies, C.B.E., F.I.C., Government Chemist, Newfoundland; Mr. Coyell, Chief Inspector, Department of Marine and Fisheries, St. John's, Newfoundland; Mr. J. Spencer and Mr. Tawse, of the firm of Isaac Spencer, Aberdeen; and Mr. W. A. Munn, of St. John's, Newfoundland.

We also wish to acknowledge with gratitude the work of our scientific assistants Miss Lyster Jameson, Dr. J. A. Lovern, Mr. L. C. Baker, Mr. K. D. Guha and Mr. G. Napier.

Finally, we wish to express our appreciation of the ready assistance we have always been given by the officers of the Empire Marketing Board.

June 20th, 1930.

J. C. DRUMMOND.
T. P. HILDITCH.

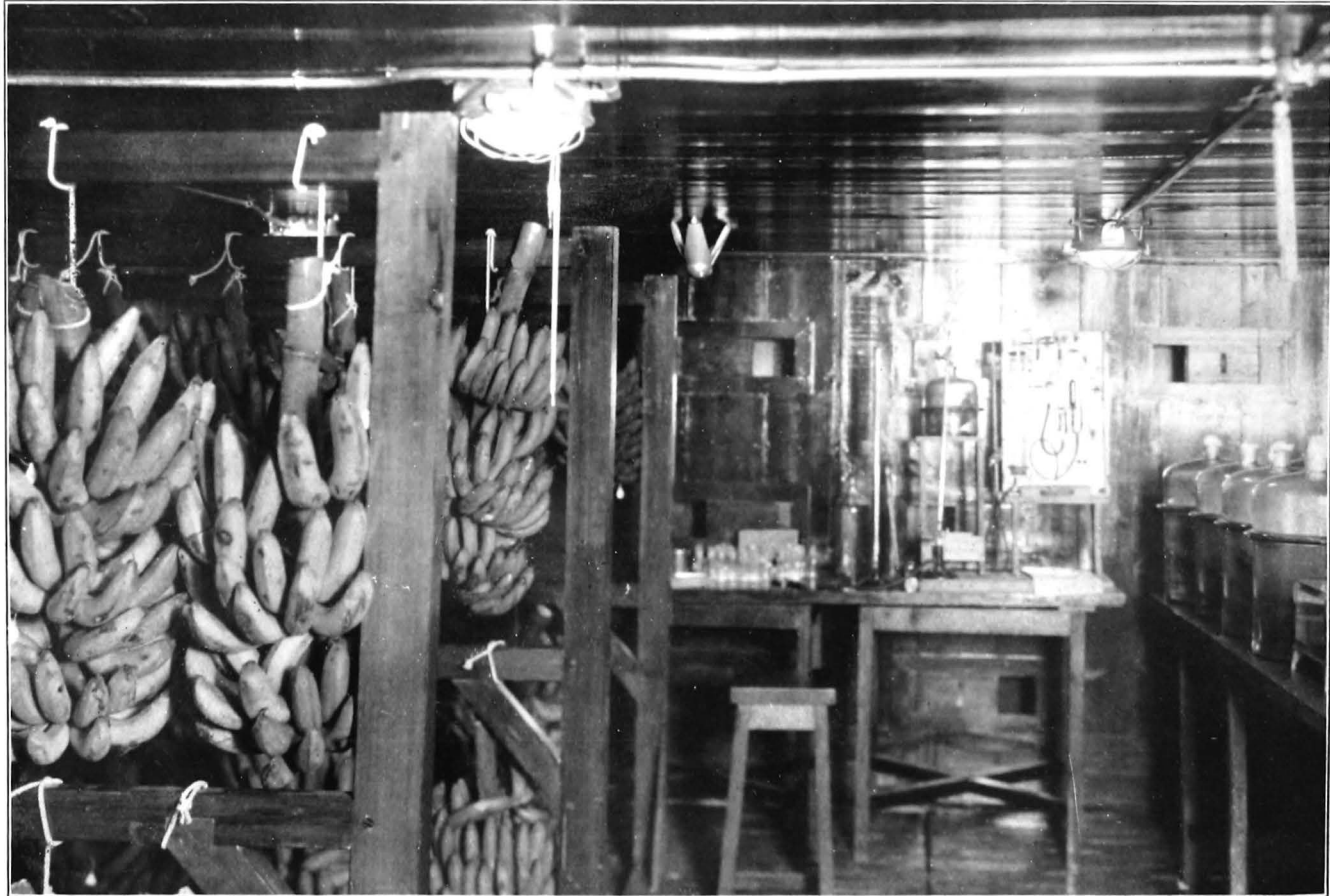

Frontispiece
The Ripening Room during stalk rot investigations. On the left, ripening bunches (note vaselined stems); centre background, the Haldane Gas Analysis Apparatus; right, inoculation jars. (All photographs by the Tucker Picture Co., Trinidad.)