

# THE ANALYSIS OF ECONOMIC TIME SERIES

By  
HAROLD T. DAVIS

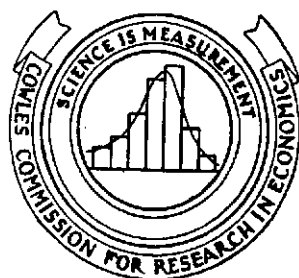

THE PRINCIPIA PRESS, INC.  
BLOOMINGTON, INDIANA  
1941

**COPYRIGHT, 1941  
BY COWLES COMMISSION  
FOR RESEARCH IN ECONOMICS**

**SET UP AND PRINTED IN THE UNITED STATES OF AMERICA  
BY THE DENTAN PRINTING COMPANY  
COLORADO SPRINGS, COLORADO**

**Photo-Lithoprint Reproduction  
EDWARDS BROTHERS, INC., ANN ARBOR, MICHIGAN, U.S.A.**

THE COWLES COMMISSION  
FOR RESEARCH IN ECONOMICS

MONOGRAPH No. 6

# COWLES COMMISSION FOR RESEARCH IN ECONOMICS

THE COWLES COMMISSION FOR RESEARCH IN ECONOMICS is a not-for-profit corporation, founded in 1932 for the purpose of conducting and encouraging investigations into economic problems. A function of the COMMISSION is to issue from time to time papers and monographs of an econometric or economic-statistical nature without, however, assuming responsibility for theories or opinions expressed therein. The COMMISSION is affiliated with the ECONOMETRIC SOCIETY, an international society for the advancement of economic theory in its relation to statistics and mathematics.

## PRESIDENT

ALFRED COWLES

## RESEARCH DIRECTOR

THEODORE O. YNTEMA

## RESEARCH STAFF

FORREST DANSON

OSCAR LANGE

HAROLD T. DAVIS

DICKSON H. LEAVENS

JOEL DEAN

H. GREGG LEWIS

HERBERT E. JONES

JACOB L. MOSAK

JOHN H. SMITH

## ADVISORY COUNCIL

ARTHUR L. BOWLEY

WESLEY C. MITCHELL

IRVING FISHER

CARL SNYDER

RAGNAR FRISCH

JACOB VINEY

THE UNIVERSITY OF CHICAGO



# COWLES COMMISSION MONOGRAPHS

No 1. *Dynamic Economics*, by CHARLES F. ROOS. 1984 275 pages. Price \$8.50.

This book applies mathematical analysis in the investigation of economic theory, especially by differentiating between theories of static and dynamic economics. It contains a series of separate studies, the theoretical parts being chiefly concerned with the modification and extension of classical theories by the introduction of various dynamic elements.

No. 2. *NRA Economic Planning*, by CHARLES F. ROOS. 1937. 596 pages. Price \$5.00.

This book traces the historical background of the NIRA and its administration. The policies of the NRA are described and discussed. An endeavor is made to appraise constructively this great undertaking and to throw light on the important question: What can we expect from economic planning?

No. 3. *Common-Stock Indexes*, by ALFRED COWLES 3RD AND ASSOCIATES. Second edition, 1939. 499 pages. Price \$6.00.

New monthly indexes of (1) stock prices, (2) stock prices adjusted for the reinvestment of cash dividends, and (3) yield expectations; and annual indexes of (4) yields, (5) dividend payments, (6) earnings-price ratios, and (7) earnings; all for 69 industry groups or combinations of groups, and running from 1871 through 1938.

No. 4. *Silver Money*, by DICKSON H. LEAVENS. 1939. 439 pages. Price \$4.00.

A sketch of the history of the silver standard and bimetallism in the nineteenth century is followed by more detailed consideration of the special position of the white metal in India and China, and of the effects of the World War, the depression, and American legislation, on the price and monetary use of silver.

No. 5. *The Variate Difference Method*, by GERHARD TINTNER. 1940. 175 pages. Price \$2.50.

This book gives a full account of the history and use of this method for the analysis of economic time series. It presents certain new devices of treatment and gives extensive tables to facilitate calculations which hitherto required a prohibitive amount of labor.

No. 6. *The Analysis of Economic Time Series*, by HAROLD T. DAVIS. 1941. 620 pages. Price \$5.00.

This work surveys the problem of analyzing economic time series beginning with historical origins and ending with a critical appraisal of what has been accomplished by modern statistical methods. Numerous examples illuminate the text. Many tables and 169 charts illustrate the contents of the book.

Orders should be sent to  
THE PRINCIPIA PRESS, INC.  
BLOOMINGTON, INDIANA

## PREFACE

The object of the present volume is to set forth in some detail the present status of the problem of analyzing and interpreting that very extensive set of data known as economic time series. This perplexing problem has engaged the attention of economists and statisticians for many years, but the extraordinary intensity with which it has been attacked during the past decade attests the importance which it has for modern economic development.

Since its beginning the laboratory of the Cowles Commission for Research in Economics has had as a major interest the investigation of the nature and action of stock price series. In the course of this investigation a number of interesting but difficult problems were encountered concerning the nature of economic time series in general, and the relation of these series to the basic postulates of economic theory in particular. To most of these questions only partial answers were discovered in the literature and in many cases these answers were not accompanied by careful statistical analyses. Therefore, it seemed to the author that a systematic treatise on the nature of economic series might fill a present need.

To one who works with statistical data it soon becomes apparent that the conclusions derived at the end of a process of analysis are intimately related to the postulates which underlie the tools employed in the investigation. The employment of a linear trend for the reference of residuals, or the graduation of a series of production data by means of the logistic curve, implies economic assumptions which must be carefully defined and subjected to realistic criticism. That is to say, conclusions mathematically derived are no better than the postulates upon which they rest. Hence it has seemed necessary to make a careful re-examination of the various mathematical devices which have been used in the study of economic data in order to appraise their weakness and their strength, and to define the range of their validity.

There is a perpetual fascination in economic time series, derived not only from their immense importance in the lives of all of us, but also from their statistical nature. Differing from the series encountered in the experiments of physical science, every economic time series possesses a large random element. But the series themselves are not random, in spite of some popular belief to the contrary, nor are

they sufficiently regular to satisfy most mathematical postulates. Hence, in many instances, the analysis must proceed from a description of the differences between random series and series that are not random. Correlations take the place of functions and serial relationships replace the more familiar functional equations of the exact sciences.

In the course of preparing so extensive a manuscript the author has become indebted to many people. Foremost among these is Mr. Alfred Cowles, president of the Cowles Commission, who for nearly a decade has liberally supported a scientific laboratory devoted to the investigation of problems in economic theory and economic statistics. His personal interest in these investigations and his own scientific contributions to the subject have been a source of inspiration and satisfaction to the author.

From Mr. Dickson H. Leavens, managing editor of *Econometrica* and research associate of the Cowles Commission, the author has received services too numerous to mention. Mr. Leavens assumed full editorial supervision of the manuscript and the planning of the charts is to be credited entirely to him.

During the preparation of the book the author received many suggestions from Dr. C. F. Roos, former research director of the Cowles Commission, and from Professor T. O. Yntema, the present research director. Their broad knowledge of economic problems was placed generously at his disposal.

A special debt of thanks is also due Professor Gerhard Tintner of Iowa State College, who read the entire proof carefully and offered many valuable suggestions. His exceptionally wide acquaintance with economic and statistical literature, especially that of European schools, has made his criticism of great value.

To Mr. Herbert E. Jones, research associate of the Cowles Commission, the author is indebted for a number of essential contributions to the book. Mr. Jones undertook a thorough investigation of problems relating to the theory and application of serial correlation. In particular, he studied the properties of random series and then applied his analysis to the problem of determining the nature of the structural elements in economic time series. Much of the material in Chapters 3 and 4 is derived from his studies.

Throughout the long and arduous calculations presented at many places in the book the laboratory staff of the Cowles Commission has played an indispensable role. The brunt of this work has been assumed by Mr. Forrest Danson, research associate of the Cowles Commission and director of the computing laboratory. The author is especially

indebted to him. In this phase of the work numerous computations were made by Miss Emma Manning, Miss Anne M. Lescisin, Mr. Edward Morris, and Mrs. Martha Belschner Swanson. Miss Kathryn Withers did the arduous work of inking and lettering the charts and Miss Mary Jo Lawley helped in preparing the manuscript for the printer.

To the great experience of Professor Irving Fisher in monetary theory and to the statistical studies of Mr. Carl Snyder on economic trends and the theory of prices the author owes a special debt. From conversations with Professor Ragnar Frisch of Oslo, Norway, and from his writings, more particularly his studies of harmonic analysis, confluence analysis, and the dynamics of cycles, the author has derived many valuable suggestions. Professor J. W. Angell of Columbia University very kindly supplied the author with monetary data which would otherwise have been inaccessible to him.

The author would also like to acknowledge his appreciation of the critical advice received from Dr. John Smith, research associate of the Cowles Commission, who has brought to bear upon the analysis a broad knowledge of statistical sampling. His criticism has been particularly valuable in connection with some of the material in Chapter 5. From other colleagues in the research staff of the Cowles Commission many helpful suggestions have been received. Professor Francis McIntyre, Dr. Abraham Wald, Dr. Edward N. Chapman, and the late Mr. W. F. C. Nelson all brought unique experience to bear upon certain aspects of the problem.

During the preparation of the book a series of conferences on economic problems was held in Colorado Springs under the auspices of the Cowles Commission. Some 200 lectures were given at these conferences and the author received many valuable suggestions both from the lectures and from informal conferences with the speakers. The effects of this unusual experience will be noted in many parts of the book.

The appraisal of the author's debt would not be complete without mention also of the help received in two other statistical laboratories, one at Indiana University and the other at Northwestern University. In the operation of these laboratories the author has been particularly indebted to Dean Fernandus Payne of Indiana University and to Professor E. J. Moulton of Northwestern University, both of whom have taken a personal interest in the work. In both laboratories many of the author's students contributed generously of their time. Colleagues in the departments of both physics and astronomy gave generously of their information at various stages of the writing of the manuscript.

Finally, but not least, the author must acknowledge his debt to the Principia Press and to its editor, Professor J. R. Kantor, who has extended in every way his cordial co-operation. The manuscript has been put into type and printed by the Dentan Printing Company of Colorado Springs, who have met all the unusual requests incidental to the production of a mathematical and statistical treatise with unflinching cheerfulness.

From these acknowledgments it will be apparent that the present work is in many respects a collaborative effort. Such virtues as the work may have are to be shared by those who have been mentioned here; unfortunately, the responsibility for the errors must be assumed only by the author himself.

H. T. DAVIS.

*Northwestern University*  
*Evanston, Illinois*  
*November, 1941*

# TABLE OF CONTENTS

## CHAPTER 1

### HISTORY OF THE PROBLEM

1.	Time Series	1
2.	Astronomical Time Series	1
3.	Economic Time Series	4
4.	Types of Time Series	7
5.	Economic Crises and Their Significance	9
6.	The Problem of Trends	15
7.	The Evidence for Cycles	24
8.	Harmonic Analysis	28
9.	The Advantages and Limitations of Harmonic Analysis	33
10.	The Erratic-Shock Theory of Economic Time Series	36
11.	Historical Summary of Application of Harmonic Analysis	43
12.	The Theory of Business Cycles	44
13.	Mathematical Attempts to Account for Cycles	49
14.	Historical Summary of the Theory of Serial Correlation	52
15.	The Analysis of Random Series	56
16.	The Present Status of the Problem	59

## CHAPTER 2

### THE TECHNIQUE OF HARMONIC ANALYSIS

1.	Harmonic Analysis	60
2.	Fourier Series	61
3.	The Theorems of Bessel and Parseval and Their Significance	64
4.	The Technique of Harmonic Analysis	67
5.	A Mathematical Example	71
6.	The Effect of a Linear Trend in Harmonic Analysis	75
7.	Applications to Economic Time Series	77
8.	Other Methods of Harmonic Analysis	83
9.	The Exact Determination of the Period	87
10.	Orthogonal Functions	89
11.	Minimizing by the Method of Least Squares	95
12.	Relationship to the Theory of Multiple Correlation	97

## CHAPTER 3

### SERIAL CORRELATION ANALYSIS

1.	Introduction	102
2.	Examples of Lag Correlation	104
3.	Inverse Serial Correlation	111
4.	The Lag-Correlation Function for a Harmonic Sum	119
5.	The Lag-Correlation Function and Its Harmonic Analysis for Statistical Data	122
6.	Some Examples Useful in the Analysis of Economic Time Series— Continuous Spectra	123
7.	Yule's Theory of Random Variation	129
8.	Lag Correlation and Its Relation to Supply and Demand Curves	135

# THE ANALYSIS OF ECONOMIC TIME SERIES

## CHAPTER 4

### THE THEORY OF RANDOM SERIES

1.	Definitions and Examples	142
2.	Goutereau's Constant	144
3.	Yule's Theory	149
4.	Generalization of Yule's Theory of the Differences of Random Series	151
5.	Accumulated Random Series	155
6.	Random Series Smoothed by a Moving Average	159
7.	The Theory of Sequences and Reversals	164
8.	An Application to Stock-Market Action	170

## CHAPTER 5

### THE DEGREES OF FREEDOM IN ECONOMIC TIME SERIES

1.	Preliminary Definitions	175
2.	Economic Time Series as a Problem in Inverse Probability	180
3.	Significance Tests and the Problem of Degrees of Freedom	183
4.	Schuster's Significance Test in Harmonic Analysis	186
5.	Walker's Significance Test in Harmonic Analysis	188
6.	R. A. Fisher's Test of Significance	189
7.	Factor Analysis	192
8.	The Method of Elementary Energies	198
9.	Examples Illustrating the Method of Elementary Energies	205

## CHAPTER 6

### THE ANALYSIS OF TRENDS

1.	Introduction	208
2.	Types of Trend	209
3.	Technical Discussion of the Linear Trend	210
4.	Extension of the Foregoing Theory to Polynomial Trends	217
5.	Formulas for the Correlation of Residuals from Polynomial Trends	222
6.	Example of the Reduction of Series to their Random Elements	227
7.	Economic Significance of the Example	234
8.	Seasonal Variation	237
9.	The Variate Difference Method and Its Application	240
10.	The Logistic Trend	247
11.	The Growth of Population	255
12.	The Growth of Production	265
13.	Frequency Distribution of Time Series	271
14.	The Stability of Trends	274
15.	General Critique of the Economic Significance of Trends	275

## CHAPTER 7

### PERIODOGRAM ANALYSIS

1.	Introduction	276
2.	The Constructed Sine-Cosine Series	278
3.	Random Series	280
4.	Random Series Smoothed with a Moving Average	282
5.	Cumulated Random Series (Smoothed)	285
6.	The Cowles Commission All Stocks Index (1880-1896)	286
7.	The Dow-Jones Industrial Averages (1897-1913)	288
8.	The Dow-Jones Industrial Averages (1914-1924)	290
9.	The Dow-Jones Industrial Averages (1925-1934)	292

## TABLE OF CONTENTS

10.	Rail Stock Prices (Monthly, 1831-1855) - - - - -	298
11.	Rail Stock Prices (Monthly, 1856-1880) - - - - -	294
12.	Rail Stock Prices (Annually, 1831-1930) - - - - -	296
13.	Rail Stock Prices (at Four-Month Intervals, 1831-1930) - - - - -	298
14.	American Industrial Activity (Annually, 1831-1930) - - - - -	299
15.	American Wholesale Prices (Annually, 1831-1930) - - - - -	304
16.	Sauerbeck's Index of English Wholesale Prices (1818-1913) - - - - -	305
17.	Commercial-Paper Rates (Annually, 1831-1930) - - - - -	307
18.	Rail Bond Prices (Annually, 1831-1930) - - - - -	309
19.	Business Failures in the United States (1867-1932) - - - - -	310
20.	Wheat Prices in Western Europe (1500-1869) - - - - -	312
21.	Sunspot Numbers (1750-1900) - - - - -	317
22.	Galvanometer Series - - - - -	319
23.	Stock Price Indexes (Daily, 1927) - - - - -	320
24.	Stock Price Indexes (Daily, 1930) - - - - -	321
25.	Stock Price Indexes (Weekly, 1922-1927) - - - - -	323
26.	Stock Price Indexes (Weekly, 1929-1935) - - - - -	324
27.	General Summary - - - - -	325

### CHAPTER 8

#### THE EVIDENCE AND EXPLANATION OF CYCLES

1.	The Enumeration of Theories - - - - -	327
2.	The Maximizing of Profits as an Example of How Cycles May Be Expected to Arise - - - - -	333
3.	The Macrodynamic Theory of Cycles - - - - -	339
4.	The Interest Theory of Cycles - - - - -	348
5.	The Building Cycle and Its Influence - - - - -	351
6.	Other Cycle Theories—Statistical Hysteresis - - - - -	355
7.	The Random-Shock Theory of Cycles—The Galvanometer Experiment - - - - -	366
8.	The Perturbation Theory of Cycles - - - - -	370
9.	The Resonance Theory of Crises - - - - -	378
10.	Generalization of the Perturbation Theory - - - - -	380
11.	Conclusions - - - - -	384

### CHAPTER 9

#### THE NATURE OF WEALTH AND INCOME

1.	The Nature of the Problem - - - - -	386
2.	The Nature of Wealth - - - - -	388
3.	The Nature of Income - - - - -	390
4.	The Distribution of Incomes—Pareto's Law - - - - -	394
5.	Income Data - - - - -	397
6.	The Pareto Distribution - - - - -	400
7.	The Statistical Verification of Pareto's Distribution - - - - -	402
8.	Formulas for the General Distribution Function - - - - -	404
9.	A New General Distribution Function - - - - -	408
10.	Theoretical Derivation of the Distribution Function - - - - -	412
11.	Statistical Verification - - - - -	413
12.	Relationships Between the Distribution of Income and Total Real Income - - - - -	418
13.	Curves of Concentration - - - - -	424
14.	The Generalized Law of Inequality - - - - -	426
15.	Application of the Pareto Distribution of Income to Political Events - - - - -	434



## TABLE OF CONTENTS

16.	Conclusions - - - - -	440
	Selected Bibliography - - - - -	440
<b>CHAPTER 10</b> <b>THE DYNAMICS OF TRENDS FROM THE POINT OF</b> <b>VIEW OF THE EQUATION OF EXCHANGE</b>		
1.	Historical Introduction - - - - -	444
2.	The Variables in the Equation of Exchange - - - - -	447
3.	Circulating Money ( $M$ ) - - - - -	448
4.	Circulating Deposits ( $M'$ ) - - - - -	451
5.	The Velocity of Circulating Deposits ( $V'$ ) - - - - -	454
6.	The Velocity of Circulating Money ( $V$ ) - - - - -	461
7.	Price ( $P$ ) - - - - -	463
8.	Trade ( $T$ ) - - - - -	473
9.	Snyder's Theory of Price - - - - -	476
10.	The Statistical Test of Snyder's Theory - - - - -	478
11.	Modifications of Snyder's Theory - - - - -	481
12.	Gold and Silver and Their Relationship to the Level of Prices - - - - -	484
13.	The Index of Trade from Spanish Treasure Data - - - - -	498
14.	Conclusion - - - - -	496
	Selected Bibliography - - - - -	497
<b>CHAPTER 11</b> <b>FORECASTING ECONOMIC TIME SERIES</b>		
1.	Introduction - - - - -	499
2.	The Present Status of Forecasting Stock Prices - - - - -	501
3.	The Standard Error of Forecast - - - - -	504
4.	The Standard Error of Forecast for Linear Trends - - - - -	517
5.	The Standard Error of Forecast for Harmonic Sums - - - - -	522
6.	Forecasting Logistic Trends - - - - -	524
7.	The Standard Error of Forecast for Polynomial Trends - - - - -	529
8.	Moving-Periodogram Analysis - - - - -	530
9.	The Method of Probable-Error Bands - - - - -	534
10.	The Dow Theory of Forecasting - - - - -	538
11.	General Conclusions - - - - -	544
<b>CHAPTER 12</b> <b>INTERPRETATION AND CRITIQUE</b>		
1.	Introduction - - - - -	546
2.	Probability Evidence for the Forty-Month Cycle - - - - -	546
3.	Probability Evidence for the Ten- and Twenty-Year Cycles - - - - -	550
4.	The Fifty-Year War Cycle - - - - -	552
5.	The Interaction of World Crises - - - - -	557
6.	The Theory of Jevons and Its Present Status - - - - -	561
7.	Economic Time Series and the Interpretation of History - - - - -	571
8.	General Summary - - - - -	576
<hr style="width: 10%; margin: 0 auto;"/>		
	Table 1. Values of the Walker Probability Function, $P_w$ - - - - -	585
	Table 2. Values of the Fisher Probability Function, $P_f$ - - - - -	6'
	Index of Names - - - - -	6
	Index of Subjects - - - - -	6..

THE ANALYSIS OF  
ECONOMIC TIME SERIES

## CHAPTER 1

### HISTORY OF THE PROBLEM

#### 1. *Time Series*

Perhaps one of the most difficult and one of the most important problems confronting the science of econometrics is that of the analysis and the interpretation of time series. By a *time series* we shall mean a series of data observed successively in time. Such a series we may represent for purposes of discussion in the following sequence:

$$(1) \quad y_1, y_2, y_3, \dots, y_t, \dots, y_N.$$

For convenience, we may abbreviate this sequence by writing

$$(2) \quad y = y_t, \quad t = 1, 2, 3, \dots, N.$$

In the development of the subject which we contemplate, the items of the time series will generally refer to economic data, although the arguments, for the most part, can be applied equally well to time sequences studied in the analysis of physical, biological, psychological, and other like phenomena. In economics the items in the time series are usually observations made monthly, quarterly, or yearly, although some series such as the Dow-Jones stock-market averages are given daily, hourly, and even at intervals as short as 20 minutes. When the items are sufficiently closely spaced, it is usually convenient to employ the functional notation

$$y = y(t)$$

instead of series (2), the variable  $t$  being assumed continuous over some basic interval,  $t_0 \leq t \leq t_1$ .

Much of the present literature on the subject of economic time series is to be found classified under the generic title of "the theory of business cycles," where the term *business cycle* is generally assumed to mean the more or less periodic alterations of business between prosperity and depression.

#### 2. *Astronomical Time Series*

Historically the investigation of time series began with the astronomers and it will be well for us to keep this fact in mind as we

proceed. Their problem and that of the economists are essentially the same and the methods which they have employed in untangling the complex motions and interactions of the heavenly bodies contain much that is illuminating in an analysis of the complicated behaviour of economic series.

The astronomers, however, were much more fortunate than the economists in one very important matter. The structure of their series as it applied to planetary motion was determined by one or two dominating causes. The motions of the planets were influenced mainly by the excessive mass of the sun and secondarily by the mass of Jupiter. Thus, assuming that the mass of the earth is unity, the masses of the sun and the other planets are in the following ratios: Sun, 332,000; Jupiter, 318.4; Saturn, 95.2; Neptune, 16.9; Uranus, 14.6; Venus, 0.876; Mars, 0.108; Mercury, 0.037. Yet, in spite of this unusual dominance of the sun, one mathematical equation in the set which determines the motion of the moon reaches the incredible length of 170 pages. The economists may learn patience from the astronomers, who have needed three centuries to attain the control which they now have over the elements of their time series. One should also observe that there is no complete agreement about the masses of the sun and the planets as given above and estimates of values vary considerably.

It is well known that the problem of three bodies, that is to say, the determination of the motions of three bodies moving under their mutual gravitational influences, has never been completely solved. Hence, the general problems of four, five, or more bodies is almost hopelessly difficult. But when one dominating influence exists, such as the dominance of the mass of the sun over the masses of the planets, then the approximation to a complete solution is relatively accurate. It is for this reason, and this alone, that the astronomers have gained so complete a mastery over their time series. Because of this fact, the probable errors in their solutions have been so greatly reduced that an anomaly as small as 40 seconds of arc per century in the precession of the perihelion of Mercury is within the limits of their precision.

The astronomers have had also a second great factor in their favor, namely the possibility of formulating an a priori theory which would explain many of their phenomena, and, by extrapolation, lead to accurate prediction. This theory was due to Sir Isaac Newton (1642-1727) and was called Newton's theory of universal gravitation. The history of its formulation is worth our attention. After the admirable collection of data relating to the motion of the planets had been made by Tycho Brahe (1546-1601), these data were statistically

analyzed by Johannes Kepler (1571-1630). Because of the dominating influence of the sun, as we have previously pointed out, Kepler was able to formulate his three famous laws of planetary motion. The first of these stated that the planets move in elliptical orbits with the sun at the focus; the second that the line which connects the planet with the sun sweeps out equal areas in equal times; the third that the cubes of the mean distances of any two planets from the sun are to each other as the squares of their periods of revolution about the sun. It was Newton's great achievement to show that these laws are consequences of the proposition that two bodies attract one another with a force which varies directly with their masses and inversely as the square of the distance between them.

The following quotation from Harold Hotelling bears pertinently upon this important aspect of the problem of time series:

Sir Isaac Newton set a bad example for statisticians in his mode of establishing the relation which has been the admired model of scientific achievement for two centuries and a half. Were the solar system subject to a complicated set of unknown forces of as great an order of magnitude as the sun's attraction—such a set, for example, as may exist in a nebula or near a multiple star—Newton could not have established gravitation by means of Kepler's laws, which deal with an orbit as a whole. A statistical method would have been necessary; Newton would have been obliged to study the curvature of paths and the acceleration at various points by means of the second differences of the coordinates of the planets' positions, and then to investigate the correlation between the acceleration, thus determined, of one body toward another and the distance between the two.

A great historic method of scientific discovery has thus arisen from an astronomical accident. If only our tyrannical sun were smaller, the family of planets would enjoy some of the chaos of democratic societies, and the astronomer would be closer to the statistician. Science would have arisen later and statistics earlier. Those astronomers who still feel a suspicion of quackery about statistical methods, particularly correlation, may reflect on how narrowly their own science missed having to wait for these very methods before emerging from the embryonic stage.

A feature of Newton's law of gravitation more suitable for emulation by statisticians than its mode of discovery is the determination of the constants. Of the various constants appearing in the integrated equations of motion, not all are of equal importance, and not all are determined finally from the same data. The constants of integration which determine the eccentricity, size and position of the orbit and the times at which the planet passes perihelion are of distinctly less interest than the constants which appear in the differential equation. Of the three latter, the masses of the two bodies are of small importance compared with the value of the universal constant of gravitation. In general the constants in a differential equation expressing a physical law have a different status from constants of integration, which may change as a result of perturbations.<sup>1</sup>

<sup>1</sup> "Differential Equations Subject to Error and Population Estimates," *Journal of the American Statistical Association*, Vol. 22, 1927, pp. 287-288.

The astronomers themselves have from time to time experienced the same pitfalls which await the unwary statistician who attempts generalizations from insufficient data. Kepler himself associated the distances of the planets from the sun with certain geometrical constructions based upon the five regular geometrical solids. He concluded that the knowledge of the planetary system as it existed in his day was closed since only five regular solids existed and these were necessary and sufficient for his cosmology. The discovery of Uranus in 1781 completely destroyed his system. An even more noted example is found in "Bode's law," due originally to Johann D. Titus of Wittenberg, but given prominence in 1772 by Johann E. Bode (1747-1826). Bode's law states that the relative distances of the planets from the sun, the earth being at unit distance, are determined as follows: write down a series of 4's, to these add successively the numbers 0, 3, 6, 12, 24, 48, 96, etc., and finally divide by 10. This interesting statistical observation preceded the discovery of Uranus in 1781, which fitted nicely into the scheme, and called attention to the gap at 2.8, which led to the discovery of the asteroid Ceres at the proper distance. But unfortunately the discovery of Neptune at 30 instead of 39 and Pluto at 40 instead of 77 destroyed the validity of the law. What was needed was some unifying principle from which Bode's law could be deduced as a special case. The explanation of the relative positions of the planets remains today an unsolved and perhaps unsolvable problem of astronomy.

### *3. Economic Time Series*

The time series most interesting to the economists do not have the happy circumstances which attend the time series of the astronomers. One factor does not, in general, dominate an economic series, but there exists on the contrary a complex of factors of approximately equal weights which affects their behavior. These factors are usually interrelated and this interrelation for the most part cannot be determined a priori. At the present stage of economic science the range of the validity of economic laws must be tested and defined by the analysis of statistical data. The conclusions, therefore, must be hedged by probabilities as to their causal significance. With the example of Bode's law before us, we must state the degree of this validity most warily.

In order to have a point of departure for a statement of the problem presented by economic time series, let us consider the graphical representation of data given in Figure 1. These data represent the

Cowles Commission—Standard Statistics index of industrial stock prices from 1871 to 1940. For our present purpose there are four observations to be made about this time series.

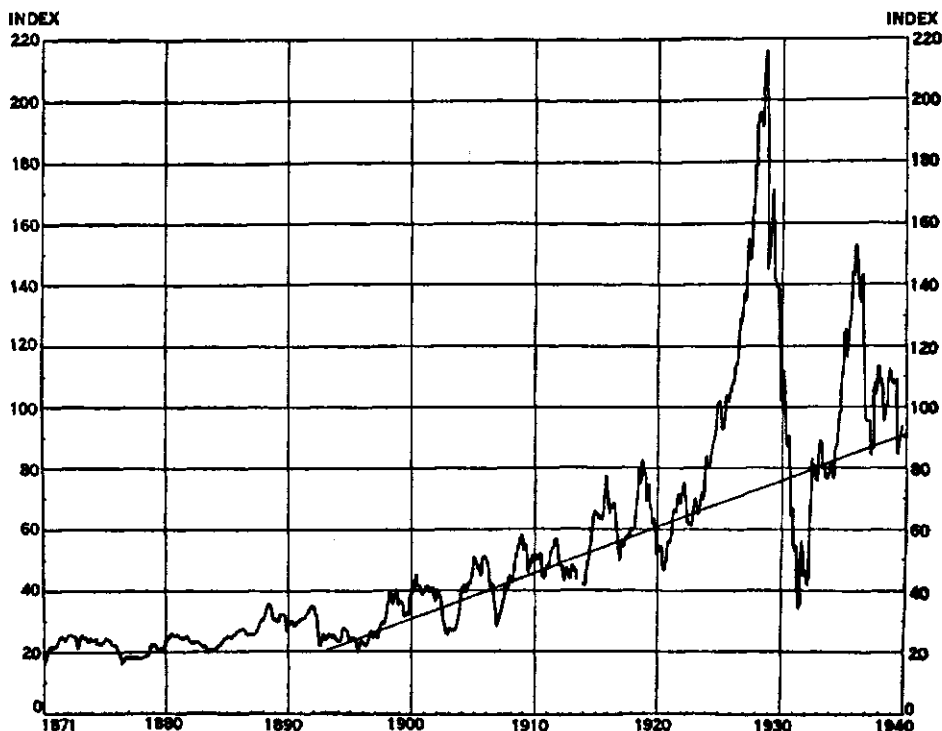

FIGURE 1.—COWLES COMMISSION—STANDARD STATISTICS INDUSTRIAL STOCK PRICE INDEX, 1926 = 100.

In the first place we observe that the series has a *secular trend*, that is to say, there has been a persistent tendency for stock prices to advance throughout the period under observation. This tendency, called by Carl Snyder the *inertia* of economic series, is not always positive, nor is it always represented by a straight line. Thus, if we examine the trend of wholesale commodity prices (see Figure 2) from the period of the Civil War to the period of the panic of the early nineties, we should find a steady decline in the time series which would be accurately described by a straight line with a negative slope. On the contrary, the time series which describes the growth of automobile production in the United States from 1908 to 1929 (see Figure 4) shows an advance that cannot be adequately described by a straight-line trend. The *logistic curve*, which has been widely used

to discuss the growth of population, is both theoretically and practically adapted to the description of the secular characteristics of the automobile production series. This point will be more adequately treated at another place.

The second point to be observed is the existence of numerous small erratic movements in the items of the series. The series does not appear to advance smoothly, and there is sufficient random motion in the differences between successive items to make month-by-month forecasting, without other evidence, a matter of much difficulty. The determination of the magnitude of this erratic element and the attainment of some reasonable explanation of its cause comprise two of the important aspects of the problem of economic time series.

If one will examine carefully the structure of the time series for the period prior to the beginning of the great bull market which culminated in 1929, he will observe that the series has a tendency to a more or less regular periodicity. That is to say, the series tends to oscillate in a fairly constant manner about a linear secular trend, and the time between successive peaks and successive lows does not show abnormal variation from a constant value of approximately 40 months. One of the outstanding problems presented to the statistician by economic time series results from this observation. Is this tendency to oscillation a fundamental characteristic of certain economic time series? Can it be accurately described by means of elementary harmonics such as those represented by series of sines and cosines? If the phenomenon is real in the sense that it can be expected to persist from one long period to another, then what a priori reason can be given for its existence? The theory of business cycles, which has been so intensively developed in recent times, has attempted to give a critical examination of these perplexing problems.

The fourth observation which we should make of the industrial stock price series exhibited in Figure 1 relates to the end of the interval. Here we note a sudden and remarkable effacement of the structures which we observed in the earlier part of the series. A huge peak arises abruptly from the line of trend and this is followed by an abnormal depression, which is, in turn, succeeded by a second, but lower peak. It might almost be believed that one observed in the series the evidence of an elastic dynamical system, oscillating with its characteristic period under a succession of small erratic shocks, to which there had suddenly been delivered a tremendous blow. Such abnormal displacements of the elements of economic time series are called *economic crises*, and a great deal of attention has been paid to them by economic theorists. We might, perhaps, for purposes of description, define as a crisis in an economic series any variation which



exceeds three times the standard deviation of the previous residuals of the series from an established trend.

Ragnar Frisch has commented as follows on this dynamical aspect of economic series:

The majority of the economic oscillations which we encounter seem to be explained most plausibly as free oscillations. In many cases they seem to be produced by the fact that certain exterior impulses hit the economic mechanism and thereby initiate more or less regular oscillations.

The most important feature of the free oscillations is that the length of the cycles and the tendency toward dampening are determined by the intrinsic structure of the swinging system, while the intensity (the amplitude) of the fluctuations is determined primarily by the exterior impulse. An important consequence of this is that a more or less regular fluctuation may be produced by a cause which operates irregularly. There need not be any synchronism between the initiating force or forces and the movement of the swinging system. This fact has frequently been overlooked in economic cycle analysis.<sup>2</sup>

It is perhaps worth our while to dwell a moment upon this intriguing speculation. If this dynamical aspect of economic time series may be regarded as having some validity, particularly since the production of real wealth such as coal, iron, electricity, wheat, etc. lies at the heart of the economic system, then it would be reasonable to employ in the analysis of time series those same mathematical models which have been so efficacious in the domains of engineering and physics. We shall see later as we develop our theme, that certain aspects of our analysis are indeed drawn from these more exact scientific disciplines; and thus, perhaps, the divergencies which develop because of the presence of the erratic element may be a fair measure of the psychic element often referred to as human variability, which exhibits so conspicuous a presence in the vagaries of the time series of economics, and is so conspicuously absent from the data of physical science.

#### 4. Types of Time Series

One cannot go far in the study of economic time series before he observes that he is dealing with many types of these series, which differ widely from one another. Among several great classes two are conspicuous, the first being what we may characterize as the class of price series, and the second as the class of production series. An example of the former is the index of industrial stocks which we discussed in the preceding section; an example of the latter is the production of pig iron. It is obvious, however, that all economic time series cannot be included in one or the other of these classes, as we

<sup>2</sup>"Propagation Problems and Impulse Problems in Dynamic Economics," from *Economic Essays in Honor of Gustav Cassel*, London, 1933, p. 171.

see from the existence of indexes of inventories, of unemployment, of the ratio of stock dividends to stock prices, etc.

However, by far the largest number of time series which are of interest to the economist are connected in one way or another with production and price. The theory of index numbers, to the development of which the notable treatise on *The Making of Index Numbers* by Irving Fisher, published in 1922, contributed greatly, was devised to represent the time series of economics in suitable form for analytical treatment. This subject is now so generally known to the economist and the statistician that we shall not attempt a résumé of it in this book.<sup>3</sup>

The study of economic time series, particularly those series which relate to the price and the production of the same commodity *X*, has afforded considerable insight into the nature of the relationships called *supply and demand*. A vast literature has accumulated around the concepts invoked by these relationships and the idea of curves of supply and curves of demand has been familiar to economists since the days of Augustin Cournot (1801-1877). In his classical treatise entitled *Recherches sur les principes mathématiques de la théorie des richesses* published in Paris in 1838 Cournot developed the concept of a curve of demand intersected by a curve of supply, the point of intersection determining the selling price of the commodity under consideration.

It will be clear that the actual determination of curves of supply and demand must present unusual problems to the statistician. For this computation he should have under observation a set of ideal communities in which the price of a given commodity differed widely and for which the ensuing demand was known. Such an ideal statistical situation obviously cannot be attained, particularly when modern methods of transportation and communication tend to keep prices within reasonably uniform limits. How, then, can he hope to determine approximations to the static supply and demand curves, which occupy so important a position in economic theories that follow the tradition of the schools of Léon Walras (1834-1910) and Alfred Marshall (1842-1924)?<sup>4</sup>

<sup>3</sup> The theory of index numbers is still a lively subject of investigation. For recent developments in this field, particularly as they relate to the economic significance of index numbers, the reader is referred to R. Frisch, "Annual Survey of General Economic Theory: The Problem of Index Numbers," *Econometrica*, Vol. 4, 1936, pp. 1-38.

<sup>4</sup> In order to see the dominance of this concept in Marshallian thought one may refer to Marshall's treatise, *Principles of Economics* (8th edition), London 1936, Book III, Chapter IV, "The Elasticity of Wants," and III of his "Mathematical Appendix."

In order to derive his curves of supply and demand the statistician has only the time series of price and production. From these dynamic data he must derive a static curve of demand with a negative tangent and a static curve of supply with a tangent of the other sign. He is like the stranger in Aesop's fable, who must blow cold with his breath to cool his porridge and then blow hot to warm his hands.

It is a curious fact that the first attempt to construct a statistical demand curve was not made until 1914, when R. A. Lehfeldt published a paper on the demand for wheat<sup>5</sup> and H. L. Moore produced a number of interesting curves in his book on *Economic Cycles: Their Law and Cause*.<sup>6</sup> In his introduction Lehfeldt commented on the situation as follows:

The writer can remember, as a student, meeting with the "entropy" as a mysterious abstraction, enshrined in the writings of Lord Kelvin and others, but which no one dreamed of vulgarizing by the attachment of numerical values. Now every engineer's pocket-book contains tables of the entropy of different substances, and that most useful quantity is made available to the vulgar.

Elasticity of demand, or of supply, as defined in theoretical writings on economics is an equally important quantity; but when, after hearing about curves of demand, the student comes with the question, "How are these curves obtained?" one has to confess that they are not obtained, but rest in the limbo of abstractions. It would seem, therefore, that the roughest attempt to measure a coefficient of elasticity would be better than none, and would serve to make the concept of more real use.

The difficulties which are inherent in this problem will be discussed later in the book. It is sufficient here to show that the determination and interpretation of supply and demand curves, together with all the problems associated with them, may be looked at from the point of view of the theory of time series. It should be pointed out, however, that the determination of supply and demand curves can also be made by means of the data derived from a study of family budgets. An extensive review of the various theories which apply in this situation will be found in Chapter 3 of *The Theory and Measurement of Demand* by Henry Schultz. The reader will also find an account in *Family Expenditure* by R. G. D. Allen and A. L. Bowley.

### 5. Economic Crises and Their Significance

In discussing the four significant characteristics of the industrial stock price series given in Figure 1, attention was called to the remarkable peak which arose abruptly from the trend prior to 1929 and

<sup>5</sup> "The Elasticity, of Demand for Wheat," *Economic Journal*, Vol. 24, 1914, pp. 212-217.

<sup>6</sup> New York, 1914, viii + 149 pp. In particular, Chapters 4 and 5.

which has established such excessive perturbations in the successive parts of the series. Since this crisis is a typical phenomenon of economic time series and since the spectacular character of such events early attracted the attention of students, it will not be out of place to sketch the history of a few of them and to comment on their significance in the general theory of time series.

Historically, economic crises were regarded as unfortunate episodes, which destroyed the rhythm of ideal states of equilibrium. Although their disruptive influence was recognized, these crises were unwelcomed events which tended to disturb the "normal" state of a smoothly organized social order.

Although minor crises are common events in the history of economics, crises as severe as that of 1929 are exceedingly rare, occurring, perhaps, on the average of once a century. The first of these speculative catastrophes of which we have any definite record was the tulip mania, which gripped Holland between the years 1634 to 1637 and which impoverished that state for about half a century thereafter.

Tulips were introduced into Holland toward the end of the sixteenth century and slowly gained favor with horticulturists, who began to vie with one another in the development of rare types of the flower. Just where the mania really started is still a matter of debate, some evidence having been found to indicate that disputes over tulips began as early as 1611. Munting in his book *Beschrijven der Kruiden* says that the origin of the mania was in France where the nobility, particularly in Paris, paid as high as several thousand florins for a single flower.

The tulip mania was a speculation in tulip bulbs, which reached the same fantastic heights as those attained in later years by speculations in stocks. It is difficult, without adequate statistical data, to chart the course and magnitude of the speculative fever, but the following data, which interpret the payment for one "Viceroy" tulip in terms of commodities, furnish excellent evidence as to the extraordinary character of the speculation:<sup>7</sup>

Commodities	Value in Florins	Commodities	Value in Florins
2 loads of wheat	448	4 barrels of beer	32
4 loads of rye	558	2 barrels of butter	192
4 fat oxen	480	1000 pounds of cheese	120
8 fat pigs	240	1 complete bed	100
12 fat sheep	120	1 suit of clothes	80
2 hogsheds of wine	70	1 silver beaker	60
		<b>Total</b>	<b>2500</b>

<sup>7</sup> The author is indebted for this account to an excellent article by W. S. Murray, "The Introduction of the Tulip, and the Tulipmania," *Journal of the Royal Horticultural Society*, Vol. 35, 1909-10, pp. 18-30.

Another example is a bookkeeper's entry:

Sold to N. N. a "Semper Augustus," weighing 123 azen,<sup>8</sup> for the sum of 4600 florins. Above this sum a new and well made carriage and two dapple grey horses and all accessories, to be delivered within four weeks, the money to be paid immediately.

The following schedule of some of the prices paid as given by Munting is also illuminating:

59 azen	Admiral Liefkens	1015 florins
214 "	Van der Eyck	1620 "
523 "	Grebba	1485 "
106 "	Schilder	1615 "
200 "	Semper Augustus	5500 "
410 "	Vicerōy	3000 "
1000 "	Gouda	3600 "

One of the best commentaries on the period was a picture entitled: "*Flora's Fool's Cap*, or Representations of the wonderful year 1637, when one fool hatched another; the people were rich without property, and wise without understanding."

When the inevitable deflation of the speculation finally occurred in 1637 liquidations took place around five to ten per cent of the speculative values.

Nearly a century after the tulip mania we find occurring simultaneously the two great speculations of England and France. The first of these is called the South Sea Bubble and the second the Mississippi Scheme, or the Mississippi Bubble.

The South Sea Bubble originated with the incorporation of the South Sea Company in 1711, which was granted a monopoly of the British trade with South America and the Pacific Islands. After a very successful beginning the company offered in 1719 to assume the national debt of £51,300,000 and to pay £3,500,000 for the privilege. The scheme back of this offer was to persuade the annuitants of the state to exchange their holdings for South Sea stock at a high premium and thus to amortize the debt with a comparatively small issue of stock. The company would still get interest from the government of about £1,500,000. In competition with the Bank of England the company raised its offer to £7,567,000 and this was accepted in 1720.

The speculative boom started immediately thereafter. In a few weeks half the annuitants had exchanged their government securities for the stock of the company and a tremendous inflation of values resulted. The stock of the company was quoted at 128½ at the beginning of the year, but by June it reached 890 and by July the dizzy height of 1000. The maximum quotation seems to have been 1050 on

<sup>8</sup> One gram is slightly more than 20 azen.

June 24, but by July 31 it was still quoted at 930. In August the recession began and from a quotation of 880 on August 18 it had fallen to 150 by September 25. A short recovery raised the level to 200 on November 10, but by November 28 it had reached 135. Thus in the course of a single year the finances of the government had been badly shaken and many thousands of people ruined. It is interesting to note that not alone are the foolish and the greedy engulfed in these terrifying maelstroms of speculation. It is a matter of record that the eminently wise Sir Isaac Newton lost £20,000 in the South Sea Bubble. Extenuating circumstances have been argued in his behalf to show that he was not carried away by the madness of the period; he was nevertheless a victim of it.<sup>9</sup>

The Mississippi scheme, which ran its course simultaneously in France, centered around the romantic figure of John Law (1671-1729), a Scotch financier. On May 20, 1716 Law was authorized to establish a *Banque générale*, later converted into the *Banque royale*, in France with a capitalization of 6,000,000 livres, divided into 1200 shares. The bank was empowered to issue demand notes payable in the money mentioned on the day of issue and in April of the following year the government decreed that these notes would be received in payment of taxes. The popularity of the notes was immediate and the issue soon increased tenfold. The Mississippi scheme was then inaugurated with the founding of the *Compagnie de la Louisiane ou d'Occident* to exploit the riches of the Province of Louisiana and the country bordering on the Mississippi. This company later absorbed the *Compagnies des Indes Orientales et de la Chine* and assumed the name of the *Compagnie des Indes*. The first issue of 200,000 shares was made at 500 livres, but this issue was subsequently supplemented by other issues at 550 livres, 1000 livres, and finally 5000 livres. Back of this extraordinary inflation was the assumption of Law that scarcity of money restricts commerce and that this scarcity can be remedied by the issue of paper currency against physical properties. These physical properties were represented in his project by the unlimited wealth presumed to exist in the undeveloped lands along the Mississippi. Since these lands were pictured as being of untold value it seemed only logical that an almost unlimited currency could be issued against them. This in turn elevated their nominal value, which permitted a new currency, and so the fatal spiral continued.

The speculation reached its climax in November, 1719 when six shares of stock of the royal bank were sold for 10,000 livres. But soon a reaction set in and the desire of speculators grew to convert these

See L. T. More, *Isaac Newton, A Biography*, New York, 1934, pp. 651-655.

paper holdings into the more tangible form of specie. Three wagons were required to remove the metal demanded by Prince de Conti for his paper holdings. The death blow to the scheme was dealt in May, 1720 when a decree was issued by the government with the intent of gradually reducing the notes of the bank to half their value. Panic ensued and by September a single gold mark purchased 1800 livres in bank notes, which had been valued ten months before at 160,000 livres in specie.<sup>10</sup>

Proceeding to the beginning of the nineteenth century, when more accurate statistical data exist for the measurement of these

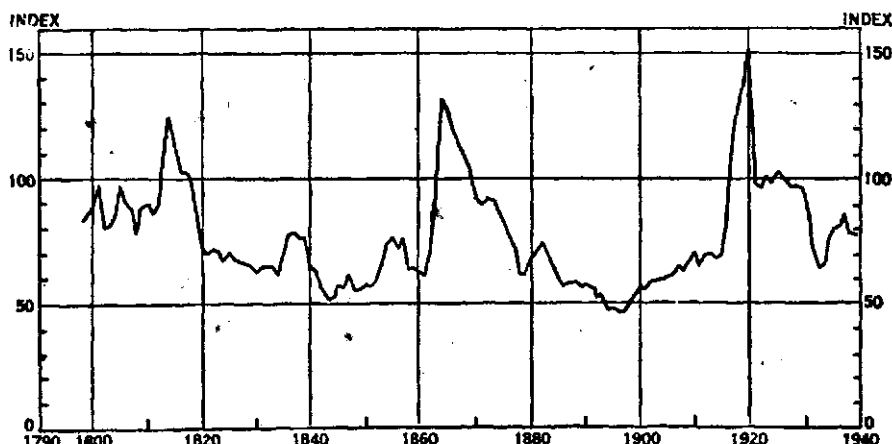

FIGURE 2.—WHOLESALE COMMODITY PRICE INDEX, UNITED STATES BUREAU OF LABOR STATISTICS, 1926 = 100.

financial cataclysms, we observe that the century begins with a commodity inflation. Figure 2 shows the index of wholesale commodity prices for the United States from 1797 to the present time. Three inflationary peaks are observed in the data, all possessing more or less the same characteristic patterns. This is exactly what would be expected since they were all the results of wars. We also note that the three maxima occur at intervals of approximately fifty years, the exact dates being November, 1814, August, 1864, and May, 1920. The intervals are thus 49 years and 9 months and 55 years and 9 months respectively.

This observation, based upon the tenuous example of just three

<sup>10</sup> An excellent account of this inflation together with tables of index numbers of prices and wages will be found in E. J. Hamilton, "Prices and Wages at Paris under John Law's System," *Quarterly Journal of Economics*, Vol. 51, 1936, pp. 42-70. Also "Prices and Wages in Southern France under John Law's System," *Economic History (Supplement)*, 1937, pp. 441-461.

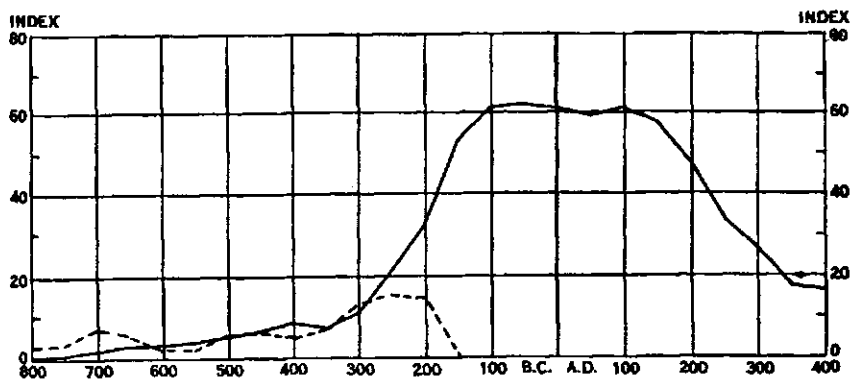

FIGURE 3.—INDEXES OF THE WORLD DOMINANCE OF ROME AND CARTHAGE.

inflations, has led to the assumption of a fifty-year cycle in prices. This assumption rests upon the hypothesis that great upheavals tend to occur at regular intervals of fifty years, since 25 years are necessary for the deflation of the last and 25 years more to build up economic strength for the next. Some additional evidence for this view is furnished by Sir William Beveridge's periodogram of wheat prices in England, an account of which will be given later in the book. But perhaps the most interesting indirect support of the hypothesis is found in the dates of the three Punic wars. These wars were waged between the ancient powers of Rome and Carthage. Here we see two dominant nations struggling for supremacy and we may presume that their economies were essentially closed within the territories over which they held sovereignty. That is to say, there apparently existed no third element which might interfere with the natural processes of inflation and deflation within their respective boundaries. The dates of the three wars were 264-241 B.C., 218-201 B.C., and 149-146 B.C. If we presume that the last date in each case was approximately the date of maximum inflation in prices, then the intervals of the cycle would be 40 and 55 years respectively, a fair agreement with the intervals in the cycles of the past century and a half.<sup>10a</sup>

We may conclude from all of this that economies from time to time experience great inflationary movements which, after running their course, end in sudden and devastating depressions. These critical periods fortunately are fairly rare events occurring probably not more often than once or twice a century.

<sup>10a</sup> The theory of long cycles in economic time series has been extensively discussed by N. D. Kondratieff in his paper, "The Long Waves in Economic Life," *Review of Economic Statistics*, Vol. 17, 1935, pp. 105-115, a translation of an article published in the *Archiv für Sozialwissenschaft und Sozialpolitik*, Vol. 56, 1926, pp. 573-609. Kondratieff reaches the conclusion that "on the basis of the available data, the existence of long waves of cyclical character is very probable."



### 6. *The Problem of Trends*

The problem of defining the trend of an economic series is one of the most difficult matters which we encounter on the threshold of an analysis of economic time series. By a trend, or as it is more commonly called, a *secular trend*, we mean that characteristic of the series which tends to extend consistently throughout the entire period.

Wesley C. Mitchell in his treatise on business cycles appraises the present status of the problem as follows:

Secular trends of time series have been computed mainly by men who were concerned to get rid of them. Just as economic theorists have paid slight attention to the "other things" in their problems which they suppose to "remain the same," so the economic statisticians have paid slight attention to their trends beyond converting them into horizontal lines. Hence little is yet known about the trends themselves, their characteristics, similarities, and differences. Even their relations to cyclical fluctuations have been little considered. Here lies in obscurity a heap of problems, waiting for properly equipped investigators to exploit.<sup>11</sup>

To Carl Snyder, as we shall show in a later chapter of the book, the trend is the dominating characteristic of most economic time series. For him the minor jiggles of the series are but inconsequential vagaries, the importance of which are entirely submerged in the secular sweep of economic development. Thus he says:

The picture that these measures [the per capita growth of production and trade in the United States from about 1800 to 1929 . . . varying but little from an average of about 2.8 per cent per annum . . .] gives is that of an amazingly even rate of growth not merely from generation to generation but actually of *each separate decennium* throughout the last century. As if there was at work a kind of momentum or inertia that sweeps on in spite of all obstacles.<sup>12</sup>

This macroscopic view of the problem of time series tends to minimize the importance of cyclical variations and perhaps denies validity to investigations which focus on the finer structure of the time movements. This view also emphasizes the need for a closer scrutiny of what we shall mean by the term secular trend itself. Thus the data from which Snyder draws his conclusions are time series a century in length. Perhaps, indeed, he is examining only one-quarter of an economic cycle four centuries in length and economists, analyzing the series of industrial production a century hence, may have a

<sup>11</sup> *Business Cycles, The Problem and Its Setting*, New York, 1927, xxii + 489 pp.; in particular, pp. 212-213.

<sup>12</sup> "The Concepts of Momentum and Inertia in Economics," Chapter 4 in *Stabilization of Employment*, Edited by C. F. Roos, Bloomington, Ind., 1933, pp. 76-77. See also *Capitalism the Creator*, New York, 1940, xii + 473 pp., which amplifies the inertial theory.

totally different concept of the pattern. Thus, if one examines the temporal data which show the annual change in the dominance of the Roman people, he will find a secular increase until about the period of Augustus followed by two centuries of prosperity, and then a slowly accelerating decline until the end of the empire. This is graphically portrayed in Figure 3.<sup>12a</sup>

If one wished to examine all economic time series from the point of view of the theory of cycles, he might define trends as portions of harmonic arcs with periods greater than the length of the data under analysis. It is, indeed, significant that the elements of a periodogram are essentially independent of secular trends and that the mathematical investigation of short cycles may be pursued without first removing the trends from the data.

In general, economists have considered four types of trend lines. The first of these is the straight-line trend with the data graphed to an arithmetic scale. This is the true linear trend. Its use may be justified, lacking a priori evidence in favor of a different trend, on the basis of simplicity. Ingenious and simple methods have been devised for fitting it to the data. Residuals from it may be easily calculated; their standard deviations may be computed and their correlations with other residuals found without calculating other constants than the variance and the zeroth and first moments of the raw data.

Extrapolation with linear trends is more common than with other types of trends. For most economic data the slope of the trend is small and unrealistic values do not appear for reasonable extensions of the line. The probable errors of the two parameters  $a$  and  $b$  in the trend

$$y = a + b t,$$

are known and the limitations of an extrapolation based upon them can be computed, as we shall show later in the book. An extensive investigation of this point was undertaken by the laboratory of the Cowles Commission. This experiment, which will be more carefully analyzed later, consisted in the examination of the trends fitted to 100 years of rail stock prices, the period being from 1831 to 1930. A trend of 20 years (1831-1850) was first fitted to the data and then extrapolated for four years as a forecast. A similar period of four years was then deleted from the beginning of the series and the actual data from 1851 to 1854 were added to determine a new trend. This

<sup>12a</sup> This point of view has been expressed by G. U. Yule in his paper, "Why Do We Sometimes Get Nonsense Correlations between Time Series?" *Journal of the Royal Statistical Society*, Vol. 89, 1926, pp. 1-64.

process was continued throughout the entire century, 21 forecasts of secular trends being thus recorded. The resulting 21 determinations of the parameters  $a$  and  $b$  are perhaps the only data in existence which throw light upon the nature of the actual distributions of these parameters in realistic economic time series. Since the interpretation of results is extensively developed in another part of the book, it will suffice here to state that the distribution of the differences in  $a$  and  $b$  from trend to trend, that is to say, the distribution of  $\Delta a$  and  $\Delta b$ , yielded the following values:

For  $\Delta a$ :  $A = 3.3201$ ,  $\sigma = 5.4362$ , Skewness  $= 0.0364$ ,  $\beta_2 = 1.8992$ ,  
 For  $\Delta b$ :  $A = 0.008199$ ,  $\sigma = 0.143544$ , Skewness  $= -0.0184$ ,  $\beta_2 = 2.4644$ .

The small values of  $\beta_2$ , which for normal distributions should equal 3, indicate an excessive disturbance in the trends and one must conclude that the use of linear trends throughout the entire period of 100 years was not warranted without further hypothesis. This example throws vivid light upon the question of why the "normal" lines of one period are not the normal lines for a second and, perhaps, contiguous period.

The second favorite trend of statisticians is a straight line fitted to data which are graphed on a logarithmic scale. Unless warily used this is a dangerous trend to employ, particularly if it is to be extrapolated for any distance or used as the criterion for a normal period. The reason for this is apparent when we write the linear expression

$$\log_{10} y = a + b t,$$

in the form

$$y = A e^{Bt}, \quad \text{where } A = 10^a, \quad B = (\log_e 10)b.$$

The expression on the right of this equation is called the exponential function, or the function of compound interest. For positive values of  $B$ , the quantity increases with rapidly increasing acceleration, and even a moderate extrapolation can lead to completely unrealistic values.

A third trend is the so-called *logistic*, or *curve of growth*, which was given currency in the biological and population studies of Raymond Pearl and L. J. Reed.<sup>13</sup> The logistic curve appears to have been

<sup>13</sup> The use of this curve in population studies is to be found in the following papers by Pearl and Reed: "On the Rate of Growth of the Population of the United States since 1790 and its Mathematical Representation," *Proc. Nat. Academy of Science*, Vol. 6, 1920, pp. 275-288; "On the Mathematical Theory of Population Growths," *Metron*, Vol. 3, 1923, pp. 6-19; "The Probable Error of Certain Constants of the Population Growth Curve," *American Journal of Hygiene*, 1924. An extensive account is given in Chapter 24, *Studies in Human Biology*, by Ray-

employed as early as 1844 by P. F. Verhulst,<sup>14</sup> but its application in economics is subsequent to the work of Pearl and Reed. The most extensive use of this curve as a trend for production data has been made by S. S. Kuznets,<sup>15</sup> who fitted logistics to some 50 or more series such as the production of wheat, corn, potatoes, cotton, pig iron, Portland cement, coal, copper, lead, etc. He also studied by this means the growth of bank clearings in New York City, Boston, Chicago, and Philadelphia, the growth of railroads, and the tonnage cleared from various countries. Modern industrial development, which, as one sees from the conclusions of Snyder, has progressed so uniformly over the past century, has furnished series admirably adapted to graduation by means of the logistic curve.

The logistic curve seems to be especially well designed for the description of the growth of new industries, for population studies, and for production series which depend upon the growth of population itself. The curve has been subjected to numerous biological tests such as the growth of bacterial culture<sup>16</sup> and the growth of a population of drosophila (fruit flies) under controlled experimental conditions.<sup>17</sup> The unusual success of this curve in such varied fields of application has suggested that the basis of this success may be found in the fact that the law of formation of a chemical substance by autocatalysis may in some instances be described by the logistic.<sup>18</sup> Whether this relationship is merely an analogy or a real connection of chemical processes with the process of biological growth is still unknown. An admirable account of the present status of the problem is to be found in Lotka's *Elements of Physical Biology*, Chapter 7.

The characteristics of the logistic curve which make it so attractive to the statisticians who examine modern production data are re-

mond Pearl, Baltimore, 1924. A comprehensive article is also due to H. Hotelling: "Differential Equations Subject to Error, and Population Estimates," *Journal of the Amer. Statistical Association*, Vol. 22, 1927, pp. 283-314. The errors of forecasting from the curve have been estimated by H. Schultz in "The Standard Error of a Forecast from a Curve," *Journal of the American Statistical Association*, Vol. 25, 1930, pp. 135-185. See also, E. B. Wilson (with Ruth R. Puffer), "Least Squares and Laws of Population Growth," *Proceedings of the American Academy of Arts and Sciences*, Vol. 63, 1933, pp. 285-382; Victor S. von Szeliski, "Population Growth Due to Immigration and Natural Increase," *Human Biology*, February, 1936, pp. 25-37.

<sup>14</sup> *Mem. Acad. Roy. Bruxelles*, Vol. 18, 1844, p. 1; Vol. 20, 1846, p. 1.

<sup>15</sup> *Secular Movements in Production and Prices*, Boston, 1930, xxiv + 536 pp.

<sup>16</sup> H. G. Thornton, *Annals of Applied Biology*, 1922, p. 265.

<sup>17</sup> R. Pearl and S. L. Parker, *American Naturalist*, Vol. 55, 1921, p. 503; Vol. 56, 1922, p. 403.

<sup>18</sup> See T. B. Robertson, *Archiv für die Entwickelungsmechanik der Organismen*, Vol. 25, 1907, p. 4; Vol. 26, 1908, p. 108. Also *The Chemical Basis of Growth and Senescence*, 1923; W. Ostwald, *Die zeitlichen Eigenschaften der Entwickelungsvorgänge*, Leipzig, 1908.

vealed in the graph shown in Figure 4, which gives the logistic fitted to the data for automobile production in the United States. As one sees from the graph, the logistic curve may be regarded as a transition trend line intermediate between a lower initial level and an upper stable level. In such a transition curve there must necessarily be a *point of inflection*, where the *rate of increase* of production begins to decline. In the example, this point was midway between 1920 and 1921.

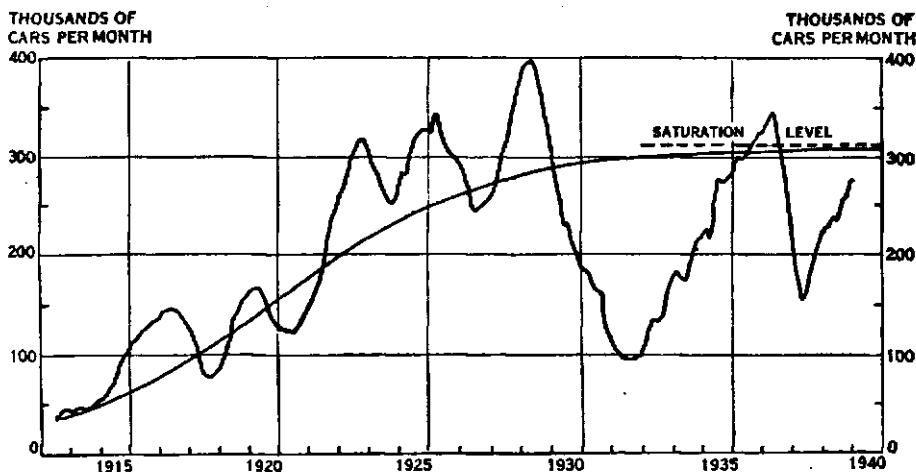

FIGURE 4.—PRODUCTION OF PASSENGER AUTOMOBILES IN THE UNITED STATES (12-MONTH MOVING AVERAGE), FITTED WITH LOGISTIC

The existence of an upper asymptote, the *line of maturity*, is the distinguishing feature of the logistic which makes it superior to the pure exponential function in applications to economic time series. In the example, the data used for fitting the logistic were taken for the years from 1913 to 1927 and the curve was then extrapolated to 1938. The range chosen, since it included the critical inflection point, was probably sufficient for attaining some extrapolation validity. A gross overproduction in 1929 was indicated by the trend and a gross underproduction was similarly shown for the period from 1930 to 1935. Although, as we shall show when we make a more critical examination of the curve later in the book, the extrapolation over so long a period with so short a base is not statistically valid, it is a matter of some interest to note that the forecasted normal production was again attained by 1937.

The curve itself is represented by the formula

$$y = \frac{k}{1 + b e^{-at}}$$

and numerous methods have been devised for determining the three essential parameters. The values of the upper and lower asymptotes are given by the lines  $y = 0$  and  $y = k$ . The point of inflection is defined by the co-ordinates  $t = +(\log_e b)/a$ ,  $y = \frac{1}{2}k$ .

The differential equation of the logistic, namely

$$\frac{dy}{dt} = \alpha y - \beta y^2,$$

where  $\alpha$  and  $\beta$  are positive constants, shows that the growth of  $y$  is stimulated directly by the magnitude of  $y$ , but that it is checked by a factor proportional to the square of  $y$ .

The logistic curve is closely related to the older *Gompertz curve*,

$$y = k a^{b^x}, \quad b < 1,$$

which was used by Benjamin Gompertz to graduate the data of the mortality table. The logistic curve, perhaps, derives some theoretical validity from the arguments used by Gompertz in his original paper presented to the Royal Society in 1825. There Gompertz assumed "that death may be the consequence of two generally coexisting causes; the one, chance, without previous disposition to death or deterioration; the other, a deterioration, or increased inability to withstand destruction." Regarding the second cause Gompertz then proposed to consider the effect of supposing that "the average exhaustion of a man's power to avoid death to be such that at the end of equal infinitely small intervals of time he lost equal portions of his remaining power to oppose destruction which he had at the commencement of these intervals."

If  $l_x$  represents the number out of a given initial population that are alive at age  $x$ , then the probability of death in the interval  $t$  is given by  $-(l_{x+t} - l_x)/l_x$ , or when  $t$  is an infinitesimal, by  $-dl_x/l_x$ . This, by the Gompertz assumption, is equal to  $B b^x dx$ , where  $B$  and  $b$  are constants to be determined from the data. We thus obtain the equation  $-dl_x/l_x = B b^x dx$ , which yields, on integration, the Gompertz curve.

It is of interest to note that if Gompertz had formulated his assumptions as to the probability of death in the form  $-dl_x/l_x = (A + B b^x)dx$ , where  $A$  represents the constant probability due to chance and affecting all ages alike, and  $B b^x$  is the chance due to increasing inability to avoid destruction, then the equation for  $l_x$  would have assumed the form

$$l_x = k r^x a^{b^x}$$

This formula is due to Makeham, who proposed it in 1860.<sup>19</sup>

In appraising the general value of the logistic and Gompertz trends in production data Kuznets reaches the following conclusion:

The simple logistic and Gompertz curves, mostly the former, describe well the long-time movements of growing industries, and, with certain modifications, those of declining industries. . . .

The significance of [this] conclusion should be made clear to prevent overvaluation. The good description of the series yielded by the logistic and Gompertz curves should not lead one to infer that they are the only ones that yield such description, that they embody the law of growth and are for that or for some other reason the superior forecasting curves. In forming a good description of the long-time movements, these curves only corroborate the general assumption concerning the decline in the percentage rate of industrial growth (within specific industries) and lend some weight to the hypothesis which makes this decline a function of the level attained and of a finite limit. The conclusion of the statistical analysis supports therefore only a limited historical generalization. But the specific constants arrived at in the process of fitting have in themselves scarcely any forecasting value, nor are the forms of the equations to be treated as expressions of "a law of growth."<sup>20</sup>

A. F. Burns in his study *Production Trends in the United States Since 1870*<sup>21</sup> has challenged the use of the logistic curve as a complete description of the growth and decline of industry and has replaced it by the exponential

$$(1) \quad y = e^{a + bt + ct^2}.$$

It should be noted, however, that the general logistic, obtained by replacing  $at$  by a polynomial, essentially includes equation (1) for sufficiently large values of  $t$ . The general logistic is able to describe any phenomenon at least as well as equation (1).

Burns' argument against the use of the logistic follows:

It is difficult, therefore, to find any sound rational basis for the notion that industries grow until they approximate some maximum size and then maintain a stationary position for an indefinite period. Nor is the notion at all supported by experience: the production records of our industries practically never evidence a plateau at the apex: once an industry has ceased to advance, it rarely remains at a stationary level for any length of time, but rather soon embarks on a career of decadence. It is possible, of course, to formulate a "law of decline," give it expression in a "senescence curve," splice this curve on to a "growth curve" at the apex, and in this way achieve a complete description of an industry's development. But such procedure is arbitrary, even unsound if it presupposes a break in the underlying causation, and it involves an inelegant mode of

<sup>19</sup> For an account of these matters see the *Institute of Actuaries Text Book*, Part 2, by George King, First edition, London, 1887; in particular, Chapter 6.

<sup>20</sup> *Op. cit.*, pp. 197-198.

<sup>21</sup> New York, 1934, xxxii + 363 pp; see, in particular, Chapter 4.

mathematical expression. Both analysis and history require that if a "law of growth" of industries is to be formulated, it should be sufficiently general to subsume the periods of both advance and decline.<sup>21a</sup>

A fourth type of trend favored by statisticians is a moving average; that is to say, the trend values are computed from the data values by means of the formula

$$(2) \quad y_t = \frac{\sum_{s=-\lambda}^{\lambda} W_s x_{t+s}}{\sum_{s=-\lambda}^{\lambda} W_s}$$

where  $W_s$  is a weight function. Usually  $W_s$  is a constant or the binomial coefficient  $W_s = {}_{2\lambda}C_{\lambda+s}$ . The parameter  $\lambda$  of the moving aver-

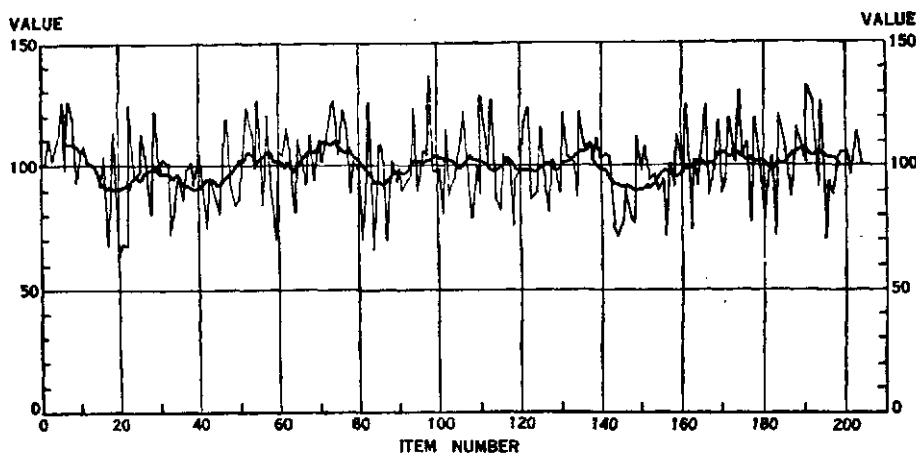

FIGURE 5.—SERIES OF RANDOM ITEMS (————) SMOOTHED BY A MOVING AVERAGE (————) OF TWELVE UNITS.

age is generally chosen sufficiently large to remove minor variations in the data. The quantity  $2\lambda + 1$  is called the length of the moving average and should be chosen equal to, or some multiple of, the periodic movement which is to be removed from the data. Thus seasonal variation can be eliminated by a moving average of 12 months.

It is clear that for continuous data,  $y(t)$ , the equivalent of formula (2) may be written

$$(3) \quad y(t) = \frac{\int_{-\lambda}^{\lambda} W(s) x(t+s) ds}{\int_{-\lambda}^{\lambda} W(s) ds} = \frac{\int_{t-\lambda}^{t+\lambda} W(r-t) x(r) dr}{\int_{-\lambda}^{\lambda} W(s) ds}$$

<sup>21a</sup> *Ibid.*, pp. 170-171.



The moving average has several interesting advantages. It possesses a useful simplicity and can be employed with great advantage in smoothing difference series derived from economic series. Its length may be adjusted to remove certain cycles, such, for example as seasonal variation, without essentially interfering with others. The moving average has been employed advantageously in the technique of the variate difference method to remove from the data the erratic element suggested by that method. The accompanying graph, Figure 5, shows how a series of random elements may be smoothed by the use of moving averages.

It is obvious that numerous other trends might be defined, but the four which we have described above are by far the most common ones in use in the study of economic time series. A natural extension of the linear trend is found in polynomial trends of higher degree. The parabola

$$y = a + b t + c t^2$$

has been occasionally employed and examples may be found where the more general polynomial

$$y = a_0 + a_1 t + a_2 t^2 + a_3 t^3 + \dots + a_n t^n$$

has been used for a trend. Such trends, however, must be employed with great caution and usually only in those cases where they are justified by some a priori consideration. Lacking such a priori validity, one will find extrapolations based upon them an unsound statistical procedure. A theory of the standard error of polynomial trends is helpful as a guide to one's judgment in this connection. Unfortunately such standard errors show that the region of uncertainty for polynomials of higher degree than the first opens up almost explosively at the end of the period of the known data and extrapolation is automatically limited. An extensive account of the theory of the standard error of trends was published in 1929 by H. Working and H. Hotelling.<sup>22</sup> A novel extension of these ideas to the standard error of a forecast from a curve was made the next year by the late Henry Schultz,<sup>23</sup> who applied certain concepts of K. F. Gauss to the interpretation of economic time series. This problem will be more fully discussed in a later chapter of the book.

If the object of the investigator is merely to determine a trend

<sup>22</sup> "Applications of the Theory of Error to the Interpretation of Trends," *Proceedings of the American Statistical Association*, Vol. 24, 1929, pp. 73-85.

<sup>23</sup> "The Standard Error of a Forecast from a Curve," *Journal of the American Statistical Association*, Vol. 25, 1930, pp. 139-185.

for the purpose of describing the historical movement of the series, then one criterion which is employed by some writers in the use of polynomials is to determine the degree of the curve such that the residuals from it form a normal distribution. This determination, unfortunately, is not unique and should be regarded as a necessary rather than a sufficient condition. An interesting example of this is furnished by the data on rail stock prices between 1859-1878. The residuals from a straight-line trend fitted to the series showed a strong

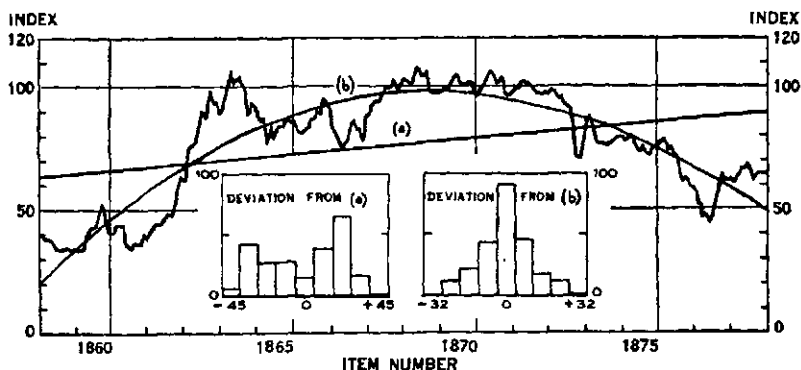

FIGURE 6.—INDEX OF RAIL STOCK PRICES WITH LINEAR (a) AND CUBIC (b) TRENDS FITTED.

This graph shows how the use of a polynomial trend has reduced the distribution of the deviations to a normal form.

tendency to a U-shaped distribution, as one may observe from the graph in Figure 6. The use of a polynomial trend immediately reduces this distribution to normal form.

### 7. The Evidence for Cycles

In the analysis of empirical data in any branch of science, the search is necessarily for relations which may exist between two or more of the measurable quantities which are the object of the investigation. These relationships, if they exist and are to be recognized as valid, must exhibit themselves in more or less well-defined patterns. But this is not enough to give them general recognition. The patterns must persist. If they are discovered in one set of experiments, then they must also be discovered in a second and independent set of experiments performed under identical conditions. In the case of time series, the patterns discovered in one period must again exhibit themselves in another, or else valid reasons be advanced for their effacement. But even this *criterion of continuity* is not sufficient to establish

laws of science. The final stage is to give a priori arguments for the existence of the patterns; that is to say, to explain the nature of the phenomena which have been discovered from the data. It is probably needless to add that in emerging sciences such as that which is the object of this book it is not always possible to give full validity to the relationships discovered or suspected. The laws of economics are for the most part only specious probabilities whose truth must be fortified by more data and further analysis.

To illustrate this point we might consider one of the most interesting discoveries made by V. Pareto in his exploration of economic data. Before the time of Pareto, or for that matter, for as long as history gives us evidence, it has been observed that there have existed in every commonwealth classes of varying degrees of wealth. The poorest class has always far outnumbered the richest and at times, as in the period of the French Revolution (1789-1795), or in that of the more recent Russian Revolution (1917-1919), the misery of the masses has found expression in widespread conflagration. The question proposed by Pareto was essentially this: Does there exist a fixed pattern, or norm, for the distribution of income in stable economies? That is to say, given the  $N$  inhabitants of a country and a scale of income measured by  $x$ , does there exist a function  $\phi(x)$  such that  $N \phi(x)$  gives the distribution of incomes? It was a prime empirical discovery that there does exist such a function, which is perhaps independent of nations, political philosophies, and periods of time. This proposition will be subjected to statistical review in a later chapter. But can we say that the observation of Pareto is a law of economics? Although a liberal interpretation of the evidence discovered to date seems to point to the truth of Pareto's proposition, it would be rash to affirm that this is a law of economics until a priori reasons have been advanced to show why Pareto's function must characterize the distribution.

In economic time series the most plausible structure to be assumed is that of trend, particularly in an increasing economy where biological growth functions appear to have validity. We have already explored these possibilities. And next to trends, the most probable structure to be investigated would be that of cycles, that is to say, the more or less regular variations about established trends. Naturally these movements would not be entirely uniform, since the vagaries of human conduct might be expected to alter both their amplitudes and their periods. But if a genuine cycle is to be observed, this variation should lie within well-defined limits of statistical error.

In a later chapter of the book we shall discuss in more complete

for the purpose of describing the historical movement of the series, then one criterion which is employed by some writers in the use of polynomials is to determine the degree of the curve such that the residuals from it form a normal distribution. This determination, unfortunately, is not unique and should be regarded as a necessary rather than a sufficient condition. An interesting example of this is furnished by the data on rail stock prices between 1859-1878. The residuals from a straight-line trend fitted to the series showed a strong

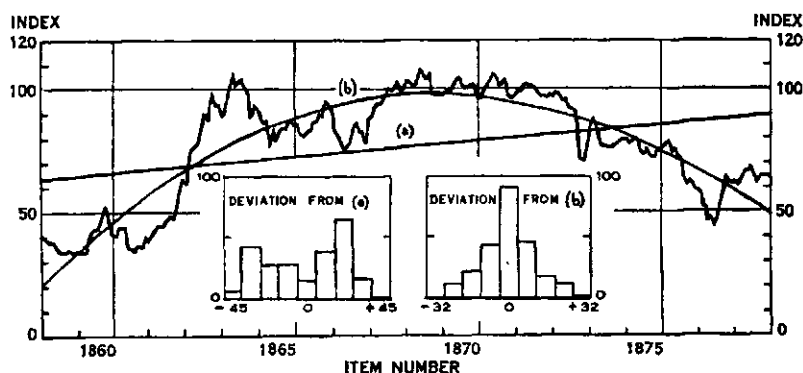

FIGURE 6.—INDEX OF RAIL STOCK PRICES WITH LINEAR (a) AND CUBIC (b) TRENDS FITTED.

This graph shows how the use of a polynomial trend has reduced the distribution of the deviations to a normal form.

tendency to a U-shaped distribution, as one may observe from the graph in Figure 6. The use of a polynomial trend immediately reduces this distribution to normal form.

### 7. The Evidence for Cycles

In the analysis of empirical data in any branch of science, the search is necessarily for relations which may exist between two or more of the measurable quantities which are the object of the investigation. These relationships, if they exist and are to be recognized as valid, must exhibit themselves in more or less well-defined patterns. But this is not enough to give them general recognition. The patterns must persist. If they are discovered in one set of experiments, then they must also be discovered in a second and independent set of experiments performed under identical conditions. In the case of time series, the patterns discovered in one period must again exhibit themselves in another, or else valid reasons be advanced for their effacement. But even this *criterion of continuity* is not sufficient to establish

laws of science. The final stage is to give a priori arguments for the existence of the patterns; that is to say, to explain the nature of the phenomena which have been discovered from the data. It is probably needless to add that in emerging sciences such as that which is the object of this book it is not always possible to give full validity to the relationships discovered or suspected. The laws of economics are for the most part only specious probabilities whose truth must be fortified by more data and further analysis.

To illustrate this point we might consider one of the most interesting discoveries made by V. Pareto in his exploration of economic data. Before the time of Pareto, or for that matter, for as long as history gives us evidence, it has been observed that there have existed in every commonwealth classes of varying degrees of wealth. The poorest class has always far outnumbered the richest and at times, as in the period of the French Revolution (1789-1795), or in that of the more recent Russian Revolution (1917-1919), the misery of the masses has found expression in widespread conflagration. The question proposed by Pareto was essentially this: Does there exist a fixed pattern, or norm, for the distribution of income in stable economies? That is to say, given the  $N$  inhabitants of a country and a scale of income measured by  $x$ , does there exist a function  $\phi(x)$  such that  $N \phi(x)$  gives the distribution of incomes? It was a prime empirical discovery that there does exist such a function, which is perhaps independent of nations, political philosophies, and periods of time. This proposition will be subjected to statistical review in a later chapter. But can we say that the observation of Pareto is a law of economics? Although a liberal interpretation of the evidence discovered to date seems to point to the truth of Pareto's proposition, it would be rash to affirm that this is a law of economics until a priori reasons have been advanced to show why Pareto's function must characterize the distribution.

In economic time series the most plausible structure to be assumed is that of trend, particularly in an increasing economy where biological growth functions appear to have validity. We have already explored these possibilities. And next to trends, the most probable structure to be investigated would be that of cycles, that is to say, the more or less regular variations about established trends. Naturally these movements would not be entirely uniform, since the vagaries of human conduct might be expected to alter both their amplitudes and their periods. But if a genuine cycle is to be observed, this variation should lie within well-defined limits of statistical error.

In a later chapter of the book we shall discuss in more complete

detail the evidence for the assumption of cyclical variation. It will be sufficient here to indicate the present status of the problem.

The first cause of cyclical variation would naturally be found in the seasons of the year. Many economic series exhibit this seasonal fluctuation, while others show little if any variation from this cause. Agricultural production and most industries which depend essentially upon agricultural production will show substantial seasonal variation.

As an example we might consider the index of freight-car loadings. When crops are moving in the fall, loadings reach their peak. In any year there will be a rapid decline in loadings in November and December. The index number for this time series will always end the year below the annual average, while the index for August, September, and October will be above. This seasonal factor, having thus been observed for a number of years, must always be discounted in estimating the general status of business by means of this index. Since freight-car loadings are found to correlate highly with industrial production, this index is watched with interest by those desirous of knowing the condition of the country's economy. The normal seasonal decline in the late fall and the corresponding seasonal rise in the late summer, as we have already stated, must accordingly be discounted in estimating the normal trend of business.

But undue emphasis must not be placed upon the season factor since this variation is frequently a relatively unimportant part of the total variation of economic time series. For such comparative purposes it is convenient to have some measure of cyclical variation, whether this be season or otherwise, and this measure is found in the concept of the *energy* of the series. The measure of energy, which we shall designate by the letter *E*, will be explained later. It is sufficient at present to know that in the index of freight-car loadings over the period from 1919 to 1932 the energy attributable to the seasonal factor was just 11.87 per cent of the total energy observed in the variation of the series. The remainder was concentrated in the trend and in the erratic element and, perhaps, in other longer or shorter cyclical movements.

A second pattern which has been generally observed in economic time series is that of the  $3\frac{1}{2}$ -year cycle, frequently referred to as the 40-month cycle, since its definition is not sharp and it may vary from 36 to 48 months. The evidence for the existence of this cycle is quite clear, although the explanation of its cause is not yet entirely satisfactory. In a later chapter in the book we shall give at length the evidence for the existence of the cycle. It is sufficient for the present exposition to note that for the period from 1897 to 1914, the energy

of this cycle in the prices of industrial stocks was as large as 48 per cent after the trend had been removed and that for the period from 1914 to 1924 the energy increased to 74 per cent. In the disruptive economy of the bull market the 40-month pattern was largely effaced in stock price series, although it was still discernible in production data. In their noteworthy book entitled *Business Annals*, W. L. Thorp and W. C. Mitchell reached the conclusion that in the 127 years of business which they analyzed there had been 32 cycles with an average length of not quite four years. This cycle appears to be a phenomenon of American business, since the corresponding European cycle is somewhat longer with an average length of five years.<sup>23a</sup>

A third cycle with a more or less statistical validity is that of nine or ten years. The reasons for this cycle are as obscure as those which cause the 40-month cycle and the statistical evidence is not quite so clear. The analysis of American industrial activity from 1830 to 1930 shows that 17.36 per cent of the variation is concentrated around 9 years. A very comprehensive analysis of monthly data by E. B. Wilson over the period from 1790 to 1929 confirms the existence of this concentration although the energy in the period from 1790 to 1859 appears to be divided between two periods of 90 and 120 months respectively.<sup>24</sup> A more comprehensive analysis of this phenomenon will be given later. Further confirmation of the reality of the 9-year cycle is found in work by B. Greenstein on business failures between 1867 and 1932.

The building cycle, which appears to fluctuate between fifteen and twenty years, is a fourth pattern that deserves serious consideration. Nearly every production series shows the influence of this cycle and at times it has been the dominating characteristic of the movement of business and industrial production in general. Such, indeed, was the case in the period around 1929 when the logistic growth of automobiles was nearing completion.

A fifth phenomenon of great interest is found in the 50-year war cycle, which is found particularly in the index of commodity prices. Unfortunately our data do not penetrate far enough into the past to confirm with high probability this strange and important pattern. Its origin probably lies hidden somewhere in human psychology and its relationship to the average duration of human life. The energy of this movement is as great as 59.28 per cent in an analysis of American price data from 1830 to 1930 and would be certainly as great or

<sup>23a</sup> Empirical evidence for this will be found in G. Tintner, *Prices in the Trade Cycle*, Vienna, 1935, pp. 46-47.

<sup>24</sup> Wilson, himself, was skeptical as to the validity of the 9-year cycle. His arguments will be given in Chapter 7.

greater if the analysis had extended through the inflationary period of the Napoleonic wars. The energy of this cycle in Sauerbeck's index numbers of general wholesale prices in England from 1818 to 1913 is not less than 24 per cent and the analysis of wheat prices in Europe from 1500 to 1869 by Sir William H. Beveridge shows some concentration of energy in the neighborhood of 50 years.

In an analysis of data pertaining to the trade cycles of France, England, Germany, and the United States, N. D. Kondratieff in the article referred to in Section 5 has reached the conclusion that long waves of an essentially cyclical character exist as a permanent pattern in economic time series. He thus says that the long cycles "are a very important and essential factor in economic development, a factor the effects of which can be found in all the principal fields of social and economic life."

The purposes of this introduction have probably been served by this brief comment on the problem of determining the periodic behavior of economic time series. We shall turn now to a short examination of some of the methods which have proved most useful in such investigations.

### 8. Harmonic Analysis

It is natural in the discussion of cyclical phenomena in economic time series that one should turn to the theories which have been so successfully employed by the astronomers and the physicists for more than a century.

The problem of harmonic analysis, by which we mean the problem of discovering the constituent periodicities which enter into the construction of a given series of data arranged in a time sequence, begins probably with a memoir published by J. L. Lagrange (1736-1813) in 1772.<sup>25</sup>

Although it was known to Leonhard Euler (1707-1783) that an analytic function could be represented by means of a series of sines and cosines, namely, by the series

$$(1) \quad y(t) = \frac{1}{2} A_0 + \sum_{n=1}^{\infty} A_n \cos(n \pi t/a) \\ + \sum_{n=1}^{\infty} B_n \sin(n \pi t/a), \quad -a \leq t \leq a,$$

the full significance of this development and its application to applied

<sup>25</sup> "Recherches sur la manière de former des tables des planètes," *Oeuvres*, Vol. 6, pp. 595-627; "Sur les interpolations," *Oeuvres*, Vol. 7, pp. 535-553, in particular, pp. 541 et seq.



This equation has for its solution the function

$$y = C + \sum_{r=1}^n C_r e^{i r_p (t-t_0)}$$

where the quantities  $r_p$  are the roots of the equation

$$(3) \quad r^{2n} - P_0 r^{2n-2} + P_2 r^{2n-4} - \dots \pm P_{n-2} = 0.$$

The coefficients of (2) are determined from the data by the method of least squares. Hopfner makes an essential contribution when he shows that the method is applicable only when the interval,  $d$ , of the observations is less than  $\lambda_s$ , where  $\lambda_s$  is the smallest frequency observed in the data, that is, that  $d < 2\pi/r_s$ , where  $r_s$  is the largest root of equation (3).

The most widely used method of harmonic analysis, however, is that which employs the idea of *periodogram*. This term was introduced by Sir Arthur Schuster (1851-1934), who developed his theory in a number of papers and applied it successfully in the study of sunspots, the periodicity of earthquakes, terrestrial magnetism, etc.<sup>31</sup>

A periodogram is the graph of either  $y = R_n$  or  $y = R_n^2$ , where  $R$  is computed over either the Fourier or the arithmetic sequence. The theory of Schuster has been somewhat modified by E. T. Whittaker and G. Robinson, who constructed their periodogram from values of the correlation ratio as it relates to each value of the arithmetic sequence.<sup>32</sup>

The significance of the Schuster periodogram has been extensively debated. Schuster himself gave a method for testing the reality of a period revealed by his analysis. This criterion was significantly modified by Sir Gilbert Walker in 1914.<sup>33</sup> R. A. Fisher gave a somewhat different approach to the problem of significance in 1929,<sup>34</sup> and

<sup>31</sup> "On Interference Phenomena," *Philosophical Magazine*, Vol. 37 (5), 1894, pp. 509-545; "On Lunar and Solar Periodicities of Earthquakes," *Proceedings of the Royal Soc. of London*, Vol. 61 (A), 1897, pp. 455-465; "On Hidden Periodicities," *Terrestrial Magnetism*, Vol. 3, 1898, p. 13; "The Periodogram of Magnetic Declination," *Transactions of the Cambridge Philosophical Soc.*, Vol. 18, 1900, pp. 107-135; *The Theory of Optics*, London, 1904; "The Periodogram and its Optical Analogy," *Proceedings of the Royal Soc. of London*, Vol. 77 (A), 1906, pp. 136-140; "On the Periodicities of Sunspots," *Philosophical Transactions of the Royal Soc. of London*, Vol. 206 (A), 1906, pp. 69-100.

<sup>32</sup> *The Calculus of Observations*, London, 1924, Chapter 13. See also Albert Eagle, *Fourier's Theorem and Harmonic Analysis*, London, 1925, Chapter 8.

<sup>33</sup> *Indian Met. Memoirs*, Vol. 21, 1914; "On Periodicity," *Quart. Journal Royal Met. Soc.*, Vol. 51, 1925, pp. 337-346; *Memoirs of the Royal Met. Soc. of London*, Vol. 1, No. 9, 1927; Vol. 3, No. 25, 1930; *Monthly Weather Review*, Vol. 59, 1931, pp. 277-278; *Proceedings of the Royal Soc. of London*, Vol. 131 (A), 1931, pp. 518-532.

<sup>34</sup> "Tests of Significance in Harmonic Analysis," *Proc. Royal Soc. of London*, Vol. 125 (A), 1929, pp. 54-59.

J. Bartels, employing concepts involved in the theory of the "random walk" problem of Karl Pearson,<sup>35</sup> gave still another test.<sup>36</sup> Some of these theories will be extensively discussed in Chapter 5 of this book.

Excellent summaries and examples illustrating the determination of significant periods in statistical data have been given by E. B. Wilson, B. Greenstein, D. Brunt, and K. Stumpff.<sup>37</sup> The last has given an extensive bibliography of the subject.

In a paper of great analytical ingenuity, Norbert Wiener introduced the idea of an *integrated periodogram*.<sup>38</sup> Wiener's method began with the definition of the *lag-correlation function*

$$r(t) = \lim_{a \rightarrow \infty} \frac{1}{2a} \int_{-a}^a y(t+s) y(s) ds,$$

which may be shown to exist for a large class of functions. Then the integrated periodogram of  $y(t)$  is defined to be the function

$$R(u) = \frac{2}{\pi} \int_0^{\infty} r(t) \frac{\sin ut}{t} dt.$$

If  $y(s)$  is defined by the series

$$y(s) = \sum_{n=1}^m (A_n \cos \lambda_n s + B_n \sin \lambda_n s),$$

then it follows that

$$r(t) = \frac{1}{2} \sum_{n=1}^m R_n^2 \cos \lambda_n t.$$

Consequently, noting the integral

$$P(u) = \frac{2}{\pi} \int_0^{\infty} \frac{\sin ut}{t} \cos \lambda t dt = \begin{cases} 0, & \lambda > u, \\ \frac{1}{2}, & \lambda = u, \\ 1, & \lambda < u, \end{cases}$$

we get

<sup>35</sup> "A Mathematical Theory of Random Migration," (*Mathematical Contributions to the Theory of Evolution*, 15), London, 1906; also *Nature*, Vol. 72, 1905, p. 294.

<sup>36</sup> "Random Fluctuations, Persistence, and Quasi-Persistence in Geophysical and Cosmical Periodicities," *Terrestrial Magnetism*, Vol. 40, 1935, pp. 1-60.

<sup>37</sup> E. B. Wilson, "The Periodogram of Business Activity," *Quarterly Journal of Economics*, Vol. 48, 1934, pp. 375-417; B. Greenstein: "Periodogram Analysis with Special Application to Business Failures," *Econometrica*, Vol. 3, 1935, pp. 170-198; D. Brunt, *The Combination of Observations*, Second edition, Cambridge, 1931; K. Stumpff, *Grundlagen und Methoden der Periodenforschung*, Berlin, 1937, vii + 332 pp.

<sup>38</sup> "Generalized Harmonic Analysis," *Acta Mathematica*, Vol. 55, 1930, pp. 117-258.

$$R(u) = \frac{1}{2} \sum_{n=1}^{m-u} R_n^2.$$

$R(u)$  is thus a nondecreasing function, which makes abrupt jumps in the neighborhood of the periods. The magnitude of these jumps determines the significance of the period and measures the energy in the spectrum of the function under analysis.

Wiener generalized his method so that it might be applied to the relationships between several functions. Thus we may replace  $r(t)$  by

$$r_{ij}(t) = \lim_{a \rightarrow \infty} \frac{1}{2a} \int_{-a}^a y_i(s) y_j(s+t) ds,$$

and  $R(u)$  by

$$R_{ij}(u) = \frac{2}{\pi} \int_0^{\infty} r_{ij}(t) \frac{\sin ut}{t} dt.$$

The matrix  $\|R_{ij}(u)\|$  is called by Wiener the *coherence matrix* since it "determines the spectra of all possible linear combinations of  $y_1(t), \dots, y_n(t)$ ." Practical application of the method of Wiener has been made by G. W. Kenrick.<sup>39</sup>

The idea of studying the harmonic behavior of time series by means of their autocorrelations apparently originated with H. H. Clayton in 1917, who used the method in a meteorological study.<sup>40</sup> A similar application was made in 1927 by Dinsmore Alter, who recognized the importance of the method in the analysis of time series and gave considerable currency to correlation periodograms.<sup>41</sup>

### 9. The Advantages and Limitations of Harmonic Analysis

We have seen from the discussion of the preceding section that Fourier series provide us with a very powerful tool for exploring the harmonic structure of economic time series. The theory may be seen to be one of great generality since a series that is entirely erratic can be completely represented by a Fourier series provided a sufficiently large number of terms is used. This, of course, is not a unique characteristic of Fourier series, since many other orthogonal systems have the same properties.

<sup>39</sup> "The Analysis of Irregular Motions with Applications to the Energy-frequency Spectrum of Static and of Telegraph Signals," *Philosophical Magazine*, Vol. 7, Series 7, 1929, pp. 176-196.

<sup>40</sup> "Effect of Short Period Variation of Solar Radiation on the Earth's Atmosphere," *Smithsonian Miscellaneous Collections*, Vol. 68, No. 3, 1917.

<sup>41</sup> "A Group or Correlation Periodogram, with Application to the Rainfall of the British Isles," *Monthly Weather Review*, Vol. 55, 1927, pp. 263-266.

One of the principal advantages enjoyed by the method of Fourier series is that it furnishes us with an accurate measure of the amount of the total movement of the series which may be concentrated in one of the harmonics. The magnitude of the ratio

$$E(T) = \frac{R^2(T)}{2\sigma^2},$$

where  $R^2(T) = A^2(T) + B^2(T)$  and  $\sigma^2$  is the variance of the data, determines the amount of variation which may be attributed to the harmonic of period  $T$ . The quantity  $E(T)$  is called the *energy* of the harmonic. If two periods,  $T$  and  $T'$ , belong to the Fourier sequence, then their energies are strictly additive and the sum is the energy of the two harmonics.

Moreover, by means of the energy of one or more harmonics we may estimate the change in the variance of the data if these harmonics are removed, that is to say, if the data are corrected for them. Thus if  $\sigma^2$  is the variance of the original data,  $\sigma_1^2$  the new variance, and  $\sum E_n$  the total energy of the  $n$  harmonics which are to be removed, then the relationship between the two variances is given by the equation

$$\sigma_1^2 = (1 - \sum E_n) \sigma^2.$$

This equation is strictly true if the harmonics belong to the Fourier sequence, but only approximately so otherwise since the energies associated with periods that do not belong to the Fourier sequence are not additive.

While the magnitude of the energy in any harmonic or series of harmonics is an important measure of the statistical significance of the periods, it is frequently necessary to express this significance in terms of probabilities. Such is the case where the energy observed is small.

We have mentioned in the preceding section the existence of such measures and the underlying theory of them will be developed in a later chapter. One may note, however, that they are attained by comparing the observed distribution of energies with that to be expected from a series of random values. The probability of obtaining by chance a given harmonic of energy  $E(T)$  is expressed in terms of a parameter  $k(T) = \frac{1}{2}N E(T)$ , that is,  $P = P(k)$ .

Thus in the example of the seasonal factor in freight-car loadings discussed in Section 7, the number of items in the data was 168, and  $k$  was accordingly equal to 10.07. It will be shown later that  $P(10.07)$  for  $N = 168$  is approximately 0.004, which means that so

large an energy would be found in a component of a random series only four times in a thousand. This probability would have been increased if the data had first been corrected for trend. Hence, lacking a priori reason for the existence of the seasonal factor, we should still have been able to attribute high significance to the reality of the phenomenon.

One of the principal objections advanced to the use of harmonic analysis in economic data is that the cycles are necessarily very irregular and hence that periodic, or almost periodic, movements observed in one era may fail to appear in another. Even though they may appear their amplitudes will usually alter and the lengths of their periods change. Hotelling has raised the following criticism along these lines:

... we might suspect that each crisis was to be regarded as a distinctive event, with its own oscillations, which were not part of a long-continuing oscillation embracing them all. In these circumstances harmonic analysis of a long economic series resembled harmonic analysis of a man's temperature since his birth. There would be a sharp increase and decrease, with possible oscillations, each time he got a disease; but these would not combine seriatim to give something discernible by means of any of the periodograms.<sup>42</sup>

The objection raised by Hotelling is certainly valid. There is the strongest evidence to show that periods change from one era to another and that significant amplitudes observed in one section of the data fail to appear in another. The periodogram is sometimes too rigid as we have described it in the preceding section to reveal the nature of these changes. Its energies are only the *average energies* found in the whole of the data. Thus Sir Arthur Schuster's periodogram of sun spots from 1750 to 1900 revealed a period of high significance at  $T = 11.25$  years. But the data from 1750 to 1826 showed that the major energy was concentrated in periods of 9.25 and 13.75 years, while the data from 1826 to 1900 reaffirmed the significance of the period shown by the complete periodogram. Even more interesting from our point of view is the history of the 40-month cycle in stock price data. The periodogram of the Cowles Commission All Stocks index (1880-1896) shows a period with energy equal to 0.27 at  $T = 35$ ; the Dow-Jones averages of industrial stock prices reveal that the period has now advanced to  $T = 41$  and the energy to 0.48 in the subsequent data from 1897 to 1913. In the next era from 1914 to 1924 the period has dropped back to 38, while the energy has increased to 0.74. And finally the entire structure is effaced in the disruptive events which developed during and after the great bull mar-

<sup>42</sup> *Econometrica*, Vol. 1, 1933, p. 435.

ket of 1929. It is an interesting question to ask whether or not the pattern of the 40-month cycle will emerge after the disturbances of the great speculation have subsided.

### *10. The Erratic-Shock Theory of Economic Time Series*

If one assumes that the periods observed in many economic time series are real and permanent patterns, effaced at times by unusual events, but recurring again when the effects of the disturbances have died away, then it is necessary to account for them. Those who approach the problem with a training in mechanics are wont to view these oscillations, irregular and varying as they may appear, as evidences of something akin to the vibrations characteristic of elastic solids. A taut string, plucked at the center, will vibrate in a pattern which depends wholly upon the elastic forces to which it is subjected. Weighted at different points with beads, it will oscillate in another manner, but always according to the inherent elasticities and the inertial properties of the loaded string. Can an economic time series be regarded from this point of view, where the elastic constants are more or less permanent characteristics of the economic system itself?

This question has been answered by different people in different ways. Harold Hotelling in a brilliant essay has assumed that "theories of the business cycle fall into two classes, considering respectively what are called in mechanics free and forced oscillations."<sup>43</sup>

Forced oscillations, which depend upon forces external to the system itself, must have origins which are noneconomic. Hotelling cites as such possible origins the theory of H. L. Moore, which attempted to explain the variation in prices and production by the changes in phase of the planet Venus. Another such theory is that of sunspots, which are assumed to cause disturbances in terrestrial phenomena and hence to react upon the economic system. About such external theories Hotelling makes the comment:

The trouble with all such theories is the tenuousness, in the light of physics, of the long chain of causation which they are forced to postulate. Even if a statistical test should yield a very high correlation, the odds thus established in favor of such an hypothesis would have to be heavily discounted on account of its strong a priori improbability.

In contrast to forced oscillations we find the theory of free oscillations, which depends only upon the internal structure of the system. Thus Hotelling cites the case where the high price of hogs and

<sup>43</sup> "Differential Equations Subject to Error, and Population Estimates," *Journal of the American Statistical Association*, 1927, pp. 283-314.

the low price of corn lead to overproduction in the first instance and underproduction in the second. This in turn reverses the price structure and cyclical fluctuations ensue. The causes of variations are here apparent and for this reason any observed correlations derive more significance than those which may have appeared in an attempt to test the theory of forced oscillations. Hotelling cites the variations due to monetary conditions as another example of the free variety.

One objection which can be raised against this general point of view is found in the fact that the variations in economic series do not damp out. In the case of the plucked string there is a constant decrease in the deviations from the equilibrium position and in time the string will come to rest. This is fundamentally true for all elastic systems which are not constantly supplied with new energy from some source external to themselves. It must certainly be true also for an economic time series, if this is to be explained on any satisfactory mechanical basis.

The double observation that economic series appear to be quite erratic and yet in many cases tend to conform to a somewhat irregular cyclical pattern which does not damp out over long periods of time has led to the theory that the energy which maintains the movement is derived from a series of erratic shocks imposed from time to time upon the system. Thus says Ragnar Frisch about this possibility:

There are several alternative ways in which one may approach the impulse problem and try to reconcile the results of the determinate dynamic analysis with the facts. One way which I believe is particularly fruitful and promising is to study what would become of the solution of a determinate dynamic system if it were exposed to a stream of erratic shocks that constantly upsets the continuous evolution, and by so doing introduces into the system the energy necessary to maintain the swings. If fully worked out, I believe that this idea will give an interesting synthesis between the stochastic point of view and the point of view of rigidly determined dynamical laws.<sup>44</sup>

The origin of this interesting idea is attributed by Frisch to Knut Wicksell. We quote Frisch on this historical point:

Knut Wicksell seems to be the first who has been definitely aware of the two types of problems in economic cycle analysis — the propagation problem and the impulse problem—and also the first who has formulated explicitly the theory that the source of energy which maintains the economic cycles is erratic shocks. He conceived more or less definitely of the economic system as being pushed along irregularly, jerkingly. New innovations and exploitations do not come regularly he says. But, on the other hand, these irregular jerks may cause more or

<sup>44</sup> "Propagation Problems and Impulse Problems in Dynamic Economics," in *Economic Essays in Honour of Gustav Cassel*, 1933, pp. 197-198.

less regular cyclical movements. He illustrates it by one of those perfectly simple and yet profound illustrations: "If you hit a wooden rocking-horse with a club the movement of the horse will be very different to that of the club."

Wicksell's idea on this matter was later taken up by Johan Åkerman, who in his doctoral dissertation<sup>45</sup> discussed the fact that small fluctuations may be able to generate larger ones. He used, among others, the analogy of a stream of water flowing in an uneven river bed. The irregularities of the river bed will cause waves on the surface. The irregularities of the river bed illustrate in Åkerman's theory the seasonal fluctuations; these seasonals, he maintains, create the longer cycles. Unfortunately Åkerman combined these ideas with the idea of a *synchronism* between the shorter fluctuations and the longer ones. He tried, for instance—in my opinion in vain—to prove that there always goes an exact number of seasonal fluctuations to each minor business cycle. This latter idea is, to my mind, very misleading. It is also, as one will readily recognize, in direct opposition to Wicksell's profound remark about the rocking-horse.

The erratic-shock theory was made the basis of a penetrating analysis of the nature of the periodicity observed in sunspot data by G. U. Yule.<sup>46</sup> His approach to the subject was through the mechanism of serial correlations and the relationships between the original data and their second differences. A more careful survey of his results will be given later in this book. A similar idea was independently advanced by E. Slutsky, who exhibited a striking similarity between an index of English business for 1855–1877 and a series formed from the 10-term moving average of a series of random numbers.<sup>47</sup> Slutsky's graph is exhibited below in Figure 7.

From a series of ingenious statistical experiments Slutsky arrived at the following general observations: "The summation of random causes generates a cyclical series which tends to imitate for a number of cycles a harmonic series of a relatively small number of sine curves. After a more or less considerable number of periods every regime becomes disarranged, the transition to another regime occurring sometimes rather gradually, sometimes more or less abruptly, around certain critical points."

Yule's point of view, which started from a consideration of just what information one can derive from a Schuster periodogram, merits further comment. His principal interest is in the nature of errors which a statistical series with sinusoidal characteristics may be presumed to have. We quote his observations as follows:

<sup>45</sup> *Det ekonomiska livets rytmik*, Lund, 1928.

<sup>46</sup> "On a Method of Investigating Periodicities in Disturbed Series, with special reference to Wolfer's Sunspot Numbers," *Philosophical Transactions of the Royal Society*, Vol. 226 (A), 1927, pp. 267–298.

<sup>47</sup> "The Summation of Random Causes as the Source of Cyclic Processes," *Econometrica*, Vol. 5, 1937, pp. 105–146; originally printed in Russian in *Problems of Economic Conditions*, edited by The Conjunction Institute, Moskva (Moscow), Vol. 3, No. 1, 1927.



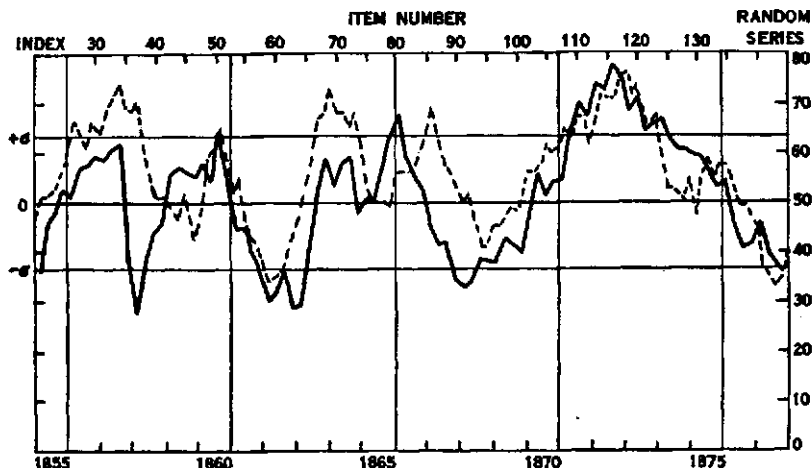

FIGURE 7.—THE ENGLISH BUSINESS INDEX (————) COMPARED WITH SMOOTHED RANDOM SERIES. (----)

The left-hand and lower scales refer to the Business Index; the right-hand and upper scales to the Random Series.

If we take a curve representing a simple harmonic function of the time and superpose on the ordinates *small* random errors, the only effect is to make the graph somewhat irregular, leaving the suggestion of periodicity still quite clear to the eye . . . If the errors are increased in magnitude . . . , the graph becomes more irregular, the suggestion of periodicity more obscure, and we have only sufficiently to increase the "errors" to mask completely any appearance of periodicity. But, however large the errors, periodogram analysis is applicable to such a curve, and, given a sufficient number of periods, should yield a close approximation to the period and amplitude of the underlying harmonic function.

When periodogram analysis is applied to data respecting any physical phenomenon in the expectation of eliciting one or more true periodicities, there is usually, as it seems to me, a tendency to start from the initial hypothesis that the periodicity or periodicities are masked solely by such more or less random *superposed fluctuations* — fluctuations which do not in any way disturb the steady course of the underlying periodic function or functions. It is true that the periodogram itself will indicate the truth or otherwise of the hypothesis made, but there seems no reason for assuming it to be the hypothesis most likely *a priori*.

If we observe at short equal intervals of time the departure of a simple harmonic pendulum from its position of rest, errors of observation will cause superposed fluctuations of the kind supposed . . . But by improvement of apparatus and automatic methods of recording, let us say, errors of observation are practically eliminated. The recording apparatus is left to itself, and unfortunately boys get into the room and start pelting the pendulum with peas, sometimes from one side and sometimes from the other. The motion is now affected, not by *superposed fluctuations* but by true *disturbances*, and the effect on the graph will be of an entirely different kind. The graph will remain surprisingly smooth, but amplitude and phase will vary continuously.

The second assumption attracted the attention of Ragnar Frisch who devised a method, based upon operators, of harmonically analyzing a series so as to detect these changes in phase and amplitude.<sup>48</sup> It is possible also to attain results similar to those of Frisch by a slight modification of Schuster's periodogram analysis. These statistical details will be considered in another chapter.

The concept of a "business cycle of varying length" has been attacked by various statisticians. The question of the "degrees of freedom" to be allowed in the description of a time series is obviously involved. Any set of orthogonal functions which has the closure property can be combined linearly to describe within any specified error the components of any economic time series. But if the allowed error is sufficiently small a large number of functions may be required and the number of degrees of freedom will be large. Does the concept of a changing harmonic analysis remove this difficulty, or does it merely disguise the fact that an essentially large number of degrees of freedom has been employed?

Hotelling, who has been one of the critics of the method, would argue as follows. Let us consider the function

$$(1) \quad y = A(t) \cos\left[-\frac{2\pi}{T(t)}t + a(t)\right],$$

where  $A(t)$ ,  $a(t)$ , and  $T(t)$  all vary independently of one another. It is clear that by a proper choice of the three functions an enormous variation from a simple sinusoid could be effected, let us say, from the exact harmonic obtained by replacing the three variable functions by their mean values. Obviously a changing harmonic of type (1) would have many degrees of freedom under certain choices of the arbitrary functions and the definition of what we meant by degrees of freedom would depend upon the nature of the variations themselves.

But if  $A(t)$ ,  $a(t)$ , and  $T(t)$  vary within a narrow range a harmonic analysis of  $y$  would reveal the average values of these functions. Hotelling holds that such is a legitimate use of this powerful tool, but he warns that "harmonic analysis and the periodogram are not suited either to detect or to use in predicting any tendency to free vibration which is subject to serious disturbance. To detect vibratory tendencies in a time series we must study the correlation of short-term changes of the variable with the magnitude of the variable."<sup>49</sup>

<sup>48</sup> "Changing Harmonics and Other General Types of Components in Empirical Series," *Skandinavisk Aktuarietidskrift*, 1928, pp. 220-236.

<sup>49</sup> "Differential Equations Subject to Error, and Population Estimates," *Journal of the American Statistical Association*, 1927, pp. 283-314; in particular, p. 290.

That is to say, in Hotelling's view, the relationship between  $y$ ,  $y'$ , and  $y''$  is the important measure of time series. He calls attention, however, to the fact that in random series the correlation coefficient between  $y$  and  $y''$  is  $-2/\sqrt{6} = -0.816$  (see Chapter 4, Section 4), a large correlation, so one must be cautious in relying solely upon this relationship. He summarizes with the remark: "The conclusion seems inescapable that the relative importance of free oscillations and mere random wiggles is fairly measured by the coefficient of correlation between a series and its second differences, and that the period may be determined from the regression equation."<sup>50</sup>

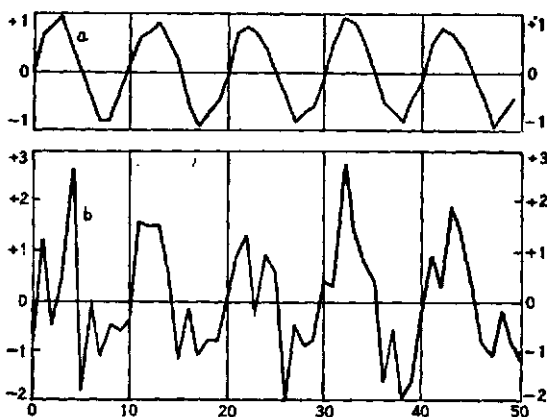

FIGURE 8.—SINE CURVE PLUS RANDOM SERIES: (a) WHEN RANDOM COMPONENT IS OF SMALL AMPLITUDE; (b) WHEN RANDOM COMPONENT IS OF LARGE AMPLITUDE.

It is instructive to observe graphically the difference between the two types of disturbances discussed by Yule, the first a regular sinusoidal wave upon which has been superimposed a set of random fluctuations, the second a sinusoidal curve that has been disturbed by impulses which may change not only the amplitude, but the phase and the period also.

The first type of disturbance is graphically represented in Figure 8, taken from Yule, which shows the ordinates of a true sine curve to which have been added the elements of a random series. In curve (a) the magnitude of the random series is small with respect to the amplitude of the sine curve; in curve (b) the magnitude of the random series is large. But even in the second case the regularity of the movement has not been completely masked and a harmonic analysis of the elements will immediately reveal the existence of the harmonic.

<sup>50</sup> *Ibid.*, p. 291.

In order to illustrate the second type of disturbance a simple experiment was performed by the Cowles Commission. A galvanometer was set up and by means of a system of weights was constrained to oscillate in three separate periods. These were in the ratio 22: 43: 62, to simulate the three periods observed in the Dow-Jones industrial averages. A series of erratic impulses, irregularly spaced and of a magnitude about equal to the momentum of the galvanometer, was then imposed upon the system and motion pictures were taken of the ensuing deflections.

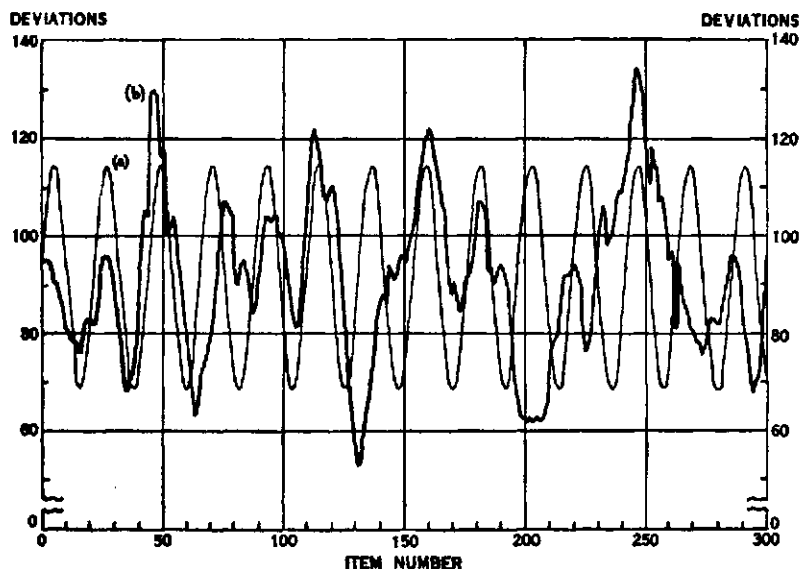

FIGURE 9.—GALVANOMETER OSCILLATIONS: (a) FREE;  
(b) UNDER ERRATIC IMPULSES.

Figure 9 shows the free oscillations, measured from a mean of 91.2, for the period 22, together with the actual deflections observed after erratic impulses were imposed on the motion. It is clear that the magnitude of the impulses was sufficient to cause a large disturbance in the normal swing. Although the phase did not appear to have been changed, the periodogram given later in the book shows that about 29.2 per cent of the energy was moved into a period of 66 units, another 20.22 per cent into a period of 34 units, while only 8.30 per cent remained in the original cycle of period 22 units. It is thus clear that such a set of impulses would largely mask the elastic structure of the system and the true period could not be ascertained by a simple inspection of the periodogram.

### 11. *Historical Summary of Application of Harmonic Analysis*

In former sections we have reviewed somewhat cursorily the trend of reflection about the nature of economic time series and the type of analysis that might be necessary to untangle the structural from the erratic in them. The physicist who has applied so successfully the theory of harmonics to the flow of heat in solids, the conduction of electricity in wires, the vibration of drum heads, and the like, is beset by no such problems as those which confront the meteorologist and the economist. His erratic element is usually of the order of his precision of measurement. Mathematical theory and observation agree to within an insignificant penumbra of uncertainty, which can be reduced at will by merely sharpening the tools of observation. But not so with those whose data consisted of empirical measurements which were subject to unknown errors of such size as to modify not only the amplitudes and the phases of the motion, but even the periods themselves.

In a later chapter some of these series will be subjected to harmonic analysis and the difficulties specifically pointed out. It will be sufficient here to mention one or two of these studies, which have come to play an important part in directing the speculation about the nature of economic time series.

The first and one of the most important of these investigations was the periodogram of Wolfer's sunspot numbers, constructed by Sir Arthur Schuster (1851-1934) in 1906. The mystery of sunspots has plagued the astronomers for many years. Their origin and meaning, their cycles, and their varying amplitude, constitute a subject for perennial speculation. Sir William Herschel thought to find in them the cause of variation in terrestrial crops and hence the secret of fluctuations in business.<sup>51</sup> This led William Stanley Jevons many years later to explore the possibility of explaining crises and depressions in terms of solar variations, a possibility which has never been completely discredited because of a persistent correlation.

The interest for economics in sunspots seems, however, to lie in another direction. In these data we have a phenomenon, expressed as a time series, for which no a priori explanation is universally accepted by the astronomers. That the phenomenon is periodic is unquestionable, but there remains doubt as to the nature of the periodicity. Hence the data on sunspots provide an almost perfect example upon which to test methods of periodogram analysis, which might be applicable to

<sup>51</sup> "Observations Tending to Investigate the Nature of the Sun," *Phil. Transactions of Royal Soc. of London*, 1801, pp. 265-318.

the more variable and less regularly periodic phenomena of economics.

Thus the periodogram of sunspots given by Sir Arthur Schuster is highly instructive to the economist. For the entire period analyzed by Schuster, 1750–1900, about 35 per cent of the total variation is accounted for by a single period of 11.25 years. But in the first half of the period (1750–1826), the importance of this period is entirely lost and we find a concentration of energy occurring at  $T = 9.25$  years and  $T = 13.75$  years. But in the second half of the period (1826–1900) nearly 85 per cent of the variation is found in the 11-year component. What is the cause of this variation? How great is the erratic element? Is the phenomenon itself a regular movement disturbed by random impulses, or is it a regular movement to which random variations have been added? As we have seen in the last section, these questions led Yule to reinvestigate the sunspot periodogram from the instructive point of view of what a periodogram might reveal in a series disturbed by erratic impulses.

One of the most ambitious periodograms ever constructed is that due to Sir William Beveridge, who published his results in 1922. This was a harmonic analysis of wheat prices in western Europe over a range of approximately 300 years from 1545 to 1845.<sup>52</sup> The results of this study will be given later in this book.

The economists were perhaps first introduced to periodogram analysis by H. L. Moore, whose classical study on *Economic Cycles: Their Law and Cause*, published in 1914, contained an account of Fourier series and a periodogram of rainfall in the Ohio valley.

In Chapter 7 an extensive account will be given of the results of these and numerous other periodograms which have been made of economic time series since these classical memoirs first appeared. Thus, it will be sufficient here merely to refer to the following remark of Lord Kelvin:

The first thing that in my opinion ought to be done towards making the observations useful for scientific purposes is to perform that kind of more perfect averaging which is afforded by the harmonic analysis. There is a certain amount of averaging done, but that is chiefly daily averages, with monthly averages, and yearly averages; but the more perfect averaging of the harmonic analysis would give the level of the variation of the phenomenon.<sup>53</sup>

## 12. *The Theory of Business Cycles*

The theory of the *business cycle*, a term applied to the more or

<sup>52</sup> "Wheat Prices and Rainfall in Western Europe," *Journal of the Royal Statistical Society*, Vol. 85, 1922, pp. 412–459.

<sup>53</sup> From testimony given by Lord Kelvin before the Meteorological Committee of the Royal Society, 1876.

less periodic alternations of business between prosperity and depression, was necessarily a product of the present century. On the one hand it required the need of a competent theory of index numbers and more adequate statistical techniques, and on the other hand, a broader knowledge of the various series, the composite variation of which might be regarded as a measure of the fluctuations in business itself. Both of these needs have been supplied in recent years.

The theory of business cycles probably should be regarded as having had its origin in the notable work of J. C. L. de Sismondi (1773-1842) entitled the *Nouveaux principes d'économie politique*, published in 1819. This treatise called attention to the importance of the study of commercial crises and advanced some of the theories concerning them which have been incorporated into modern explanations of these events.

This problem, however, struck little fire in the scientific mind until the era of William Stanley Jevons nearly a half century later, when the awakening of modern commerce and the increasing tempo of industrial activity began to make insistent demands for a better understanding of economic phenomena. The publication of Clement Juglar's *Des crises commerciales et de leur retour périodique* in 1860 furnished new evidence for the roughly periodic character of business activity and called attention to the need for statistical data and their analysis. Philosophical treatises such as the *Inquiry into the Nature and Causes of the Wealth of Nations* (1776) by Adam Smith (1723-1790) or the *Principles of Political Economy* (1848) by John Stuart Mill (1806-1873) could not supply the need for empirical evidence.

It must not be assumed that the author disparages works of speculation. Far from it! But the highest form of speculation is that which is guided by the facts of the world. The great superiority of Newton's cosmology over that of René Descartes was due to the fact that the former's speculation, in contrast to that of the latter, was based upon the tables of Tycho Brahe and the statistical discoveries of Johannes Kepler. Works of speculation written in advance of the accumulation of data often serve to focus attention upon the variables to be examined. It is for this reason that the remarkable work of A. A. Cournot (1801-1877) entitled *Recherches sur les principes mathématiques de la théorie des richesses* (1838) deserves particular attention. Therein one finds careful definitions of those functions and concepts which must be subjected ultimately to the scrutiny of data. Modern economics may perhaps be dated from the time when the contents of Cournot's volume struck fire in the minds of W. S. Jevons (1835-1882), Léon Walras (1834-1910), F. Y. Edgeworth (1845-

1926), V. Pareto (1848–1923), A. Marshall (1842–1924), and others of that time. Attention was finally focused upon the measurable elements and, since the first work of these writers, there has been a remarkable increase in the accumulation and analysis of statistical material bearing upon the phenomena of economics.

The modern theory of business cycles may perhaps be dated from the publication in 1862 of W. S. Jevons' work entitled *On the Study of Periodic Commercial Fluctuations*. Jevons was the father of index numbers. He wrote on secular trend and seasonal variations. His analysis of British prices over a long period of years gave new concepts to the movement of business and suggested many problems, the solution of which has become the goal of modern statistical methods. The work of Jevons was materially forwarded by Edgeworth.

The invention of correlation analysis by Sir Francis Galton (1822–1911) in the last quarter of the nineteenth century and its development through the heroic labors of Karl Pearson (1857–1936) placed a new and powerful tool into the hands of statistical analysts. Therefore, "by the time writers upon business cycles began to make systematic use of statistics—say in the decade beginning in 1900—they could utilize many methods already developed by mathematicians, anthropometrists, biologists, and economists, and many data already collected by public and private agencies."<sup>54</sup>

The problem of secular trend was discussed in 1884 by J. H. Poynting, and in 1901 by R. H. Hooker. The use of correlation was invoked to discuss the relationship between residuals from trends and an extensive investigation was undertaken by numerous people to interpret the significance of the results. An account of the history of this problem will be given in Section 14.

In 1914 H. L. Moore published his stimulating study on *Economic Cycles: Their Law and Cause* in which harmonic analysis and correlations were freely employed. In 1915 Warren M. Persons made the first of his business barometers and in 1917 began his work at Harvard on business cycles, which has exerted so wide an influence both at home and abroad.

The World War stimulated the collection of statistics; from the problems presented by that great struggle it became apparent that the complex economic system of the twentieth century could not be properly understood without a much better knowledge of the past behavior of prices, production, wages, money, and other fundamental constituents of the business cycle. These series have been assembled

<sup>54</sup> Wesley C. Mitchell, *Business Cycles*, New York, 1928, p. 199.



with bewildering rapidity. Whereas in 1900 only the most meager data existed for an understanding of the behavior of economic variables in the nineteenth century, we now possess some series going back as far as the Middle Ages. A reasonably complete understanding of economic variation in the nineteenth century is now possible, and most of the variables have been defined for the twentieth. The work of Carl Snyder on nineteenth-century trends, the data assembled by the Cleveland Trust Company under the direction of Col. Leonard Ayres, recent knowledge about prices in Spain in the fifteenth and sixteenth centuries resulting from the heroic labors of E. J. Hamilton, common-stock indexes from 1871 published by Alfred Cowles, the price studies of G. F. Warren and F. A. Pearson, the index of rail stock prices of F. R. Macaulay, the numerous new series furnished by the Standard Statistics Company, the heroic exploration of early European prices made under the direction of Sir William Beveridge and E. F. Gay,<sup>55</sup> together with the data assembled by numerous government agencies both at home and abroad, constitute an impressive volume of material for the digestion of the economist.

In the analysis of this great body of data one of the principal problems is to find the interactions between different variables. Thus, the periodic advances and declines in industrial production about a "normal" trend should reflect their influence upon the price of stocks. The volume of bank clearings, variations in the rate of interest, the price of wholesale commodities, etc., should all exhibit common interactions significant in interpreting the business cycle. The principal tool for this analysis is found in the theory of multiple regressions.

But here some delicate problems are introduced. Which shall be the independent variables and which the dependent variable? How shall the errors of estimate be determined? What is the magnitude of the erratic elements in the variables considered? The difficulties in the situation can be explained by a simple example. Thus, let us suppose that we have a table of data which gives the values: (1) of  $x$ , the displacements of a swinging pendulum bob from its point of equilibrium; (2) of  $y$ , the velocity of the displacements expressed as the first derivative of  $x$ ; and (3) of  $z$ , the acceleration of the displacements expressed as the second derivative of  $x$ . If the data are observations, a small erratic element will exist in all these measurements. Which of the three variables shall be considered as the dependent variable? If either  $x$  or  $z$  is assumed to have this preference, then the resulting regression will accurately describe the motion. But

<sup>55</sup> See, for example, M. J. Elsas, *Umriss einer Geschichte der Preise und Löhne in Deutschland*, Vol. 1, Leiden, 1936, 808 pp.

if  $y$  is chosen, no answer is possible since we know that in the regression equation the coefficient of  $y$  is nearly zero, unless large frictional forces are present. In ordinary statistical procedure it is difficult to recognize the presence of such a statistical zero among the coefficients, unless something is actually known about the size of the errors in the measurements.

Ragnar Frisch has invented a rather complicated technique for dealing with this problem of linear dependence, a method which he has called *confluence analysis*.<sup>56</sup> In this analysis each variable is treated as having equal errors. Another method, called the method of factor analysis, is due to the psychologists, under the leadership of L. L. Thurstone,<sup>57</sup> who had encountered the same difficulty as that of the economist in attempting to separate his factors in psychological studies. The problem has also been discussed by H. Hotelling,<sup>58</sup> C. F. Roos,<sup>59</sup> H. E. Jones,<sup>60</sup> and others. An extensive account of the difficulties will be found in a work by T. Koopmans on *Linear Regression Analysis of Economic Time Series*,<sup>61</sup> who surveys the various points of view and includes an account of the weighted regression of M. J. van Uven.

In a recent monograph John H. Smith has made a comprehensive survey of the problem of the statistical deflation of an economic series, by which is meant "the process of adjusting a series for the effects of one or more variables which affect it."<sup>61a</sup> In this study special attention is devoted to the problem of the specification of a universe and of conditions of sampling for the data of economic time series.

To the writer it seems impossible by straight statistical methods to answer the question of linear dependence between economic variables. Knowledge must necessarily be introduced from outside of the data themselves. This knowledge must give some estimate of the errors of the respective variates, and should yield an a priori presumption as to the dependence of one of the variables upon the others.

<sup>56</sup> *Statistical Confluence Analysis by Means of Complete Regression Systems*, Oslo, 1934, 192 pp. See also "Correlation and Scatter in Statistical Variables," *Nordic Statistical Journal*, Vol. 1, 1929, pp. 36-102.

<sup>57</sup> *The Vectors of Mind*, Chicago, 1935. See also, "Multiple Factor Analysis," *Psychological Review*, Vol. 38, 1931, pp. 406-427.

<sup>58</sup> "Analysis of a Complex of Statistical Variables into Principal Components," *Journal of Ed. Psychology*, Vol. 24, 1933, pp. 417-441, 498-520.

<sup>59</sup> "A General Invariant Criterion of Fit for Lines and Planes where All Variates Are Subject to Error," *Metron*, Vol. 13, 1937, pp. 3-20.

<sup>60</sup> "The Nature of Regression Functions in the Correlation Analysis of Time Series," *Econometrica*, Vol. 5, 1937, pp. 305-325.

<sup>61</sup> Haarlem, 1936, 132 pp.

<sup>61a</sup> *Statistical Deflation in the Analysis of Economic Series*, A dissertation distributed by the University of Chicago Libraries, 1941, vi + 128 pp.

Otherwise any deduction must be regarded as possessing the same inferential value as if it were derived from an inverse probability judgment.

### 13. *Mathematical Attempts to Account for Cycles*

Once it is decided that cycles of a regular and permanent pattern actually exist in one or more economic series, it becomes a matter of importance to account for their existence. This means essentially that a system of dynamics must be established. Several notable attempts have been made in this direction.

We must observe first that the evidence of the periodogram indicates that no cycle of a reasonably permanent form accounts for a large percentage of the energy of the observed variation. Thus, the well-defined 40-month component contains, for any extensive range of the variable, a total of not more than half the energy of the motion. Hence no simple mechanism can expect to give more than a partial explanation; but any complex mechanism is likely to become too complicated both mathematically and statistically. Such, for example, is the criticism of the equilibrium theory of Léon Walras, which accounts presumably for the entire mechanism of production, but which must be formulated for any real economy in terms of thousands of equations.

In an attempt to find some unifying principle for the great complex of price and production factors which make up the economic system, one turns as always to the model of physics. This science was fortunate in having among its founders men who asked the question: "What does nature minimize?" The following metaphysical speculation of Leonhard Euler contained within it the principle of least action, which was to prove in later years to be the most cherished principle of physics:

As the construction of the universe is the most perfect possible, being the handiwork of an all-wise Maker, nothing can be met in the world in which some maximal or minimal property is not displayed. There is, consequently, no doubt but that all the effects of the world can be derived by the method of maxima and minima from their final causes as well as from their efficient ones.<sup>62</sup>

It is also natural to ask for the phenomena of economics: "Does there exist also a maximizing or a minimizing principle on which the dynamics of time series may be founded?" The answer to this question is still obscure, but an intriguing suggestion has been offered by

<sup>62</sup> *Methodus inveniendi lineas curvas, maximè minimè proprietate gaudentes*, Lausanne, 1744, p. 245.

G. C. Evans and C. F. Roos.<sup>63</sup> This suggestion is merely the simple proposition that the elements of the economic system adjust themselves so that profits may be maximized. This principle may be formulated somewhat as follows: Let us assume that the profits  $\Pi$  over a period of time from  $t = t_0$  to  $t = t_1$  are given by the integral

$$(1) \quad \Pi = \int_{t_0}^{t_1} [p y - Q(u)] dt,$$

where  $p$  is the price,  $y$  the demand, and  $Q(u)$  the cost of manufacturing and marketing  $u$  units. Then the principle of maximum profits asserts that the variable elements in this integral are to be so adjusted that the integral assumes its largest possible value. In the language of the calculus of variations, it is necessary that the first variation of  $\Pi$  shall be zero; that is,

$$\delta \Pi = 0.$$

There are great analytical and statistical difficulties in the way of testing the validity of this principle. In equation (1) it has been formulated for a single commodity and a single price, but obviously it must be extended to take account of the variation in all commodities and all prices. Cost functions are carefully guarded by manufacturing corporations and their nature can only be inferred from profits and production data. The character of price variation with variable demand is also imperfectly known.

Simplifying assumptions such as the propositions (1) that demand varies linearly with price and the rate of change of price, that is,

$$y(t) = \alpha p'(t) + \beta p(t) + \gamma;$$

and (2) that cost is a quadratic function of the number of units produced, lead to a linear differential equation of the second order in price. If the parameters are properly chosen this equation will account for sinusoidal oscillations in price. The further assumption that

<sup>63</sup> See, for example, G. C. Evans, "A Simple Theory of Competition," *American Mathematical Monthly*, Vol. 29, 1922, pp. 371-380; "Dynamics of Monopoly," *ibid.*, Vol. 31, 1924, pp. 77-83; *Mathematical Introduction to Economics*, New York, 1930, xi + 177 pp., in particular, Chapter 15 and Appendix II. See also C. F. Roos; "A Mathematical Theory of Competition," *American Journal of Mathematics*, Vol. 57, 1925, pp. 163-175; "A Dynamical Theory of Economics," *Journal of Political Economy*, Vol. 35, 1927, pp. 632-656; "A Mathematical Theory of Depreciation and Replacement," *American Journal of Mathematics*, Vol. 50, 1928, pp. 147-157; "The Problem of Depreciation in the Calculus of Variations," *Bulletin of The American Math. Soc.*, March-April, 1928; "Fluctuations and Economic Crises," *Journal of Political Economy*, Vol. 38, 1930, pp. 501-522; "Theoretical Studies of Demand," *Econometrica*, Vol. 2, 1934, pp. 73-90; *Dynamic Economics*, Bloomington, Ind., 1934, xvi + 275 pp.

demand also varies with a factor external to the price system itself leads to a linear differential equation of second order with an impulse function for its second term. The general character of this impulse function affords the possibility of accounting for many of the functional as well as erratic characteristics of price series. A more extensive account of the possibilities inherent in this method will be given later in the book.

There are many who decry the principle of maximum profits. It seems a sordid and egocentric maxim for mankind to follow. The collectivist theory would replace it by the principle of maximum production and maximum distribution of the things produced. Others would apply the doctrine of hedonism and maximize human satisfaction, measured, perhaps, by the utility function of Jevons or the ophelimity of Pareto. But unfortunately science can only observe and interpret. It cannot change the nature of its objects of investigation. The physicist, perhaps, was disappointed when he found that nature did not choose to conserve energy, but rather to minimize the much more subtle quantity which we call action. So also, perhaps, the perversity of human nature has established the profit motive as the dominating principle of all enduring economic systems.

Another very suggestive method of accounting mathematically for cycles in the fundamental economic series is found in what has been called the *macrodynamic* theory. This term, suggested by Ragnar Frisch, is applied to those "processes connected with the functioning of the economic system as a whole, disregarding the details of disproportionate development of special parts of that system."

The essential assumption of this theory is that the lag between the orders for goods and their subsequent delivery plays a fundamental role in the creation of cyclical variation in economic series. The theory, as formulated by M. Kalecki in 1933, leads to a mixed difference-differential equation of the form

$$u'(t) + a u(t - \theta) + b u(t) = 0.$$

Since the mathematical and statistical details of this method are difficult to describe, we shall postpone discussion until a later chapter. The possibilities of the method have been explored by Frisch, J. Tinbergen, and others. Tinbergen gave a comprehensive survey of this and other methods in 1935.<sup>44</sup> The preliminary success of this approach to the problem of economic variation affords great promise

<sup>44</sup> "Annual Survey: Suggestions on Quantitative Business Cycle Theory," *Econometrica*, Vol. 3, 1935, pp. 241-308.

provided the necessity of including too many factors does not lead to too much mathematical and statistical complexity.

#### 14. Historical Summary of the Theory of Serial Correlation

The idea associated with the name *serial correlation* apparently had its origin in a paper by the British physicist J. H. Poynting, who attempted to ascertain the relationships between the movements of wheat prices in England, France, and Bengal and of cotton and silk imports into Great Britain.<sup>65</sup> While Poynting did not actually compute a serial correlation his analysis attracted attention to the problem of the interaction of economic time series and the inevitable use of correlations in the study of such relationships. Poynting's method consisted mainly in a use of moving averages to smooth out random fluctuations and a comparison of the residuals with respect to common harmonic terms.

The first actual use of serial correlations seems to have been made by R. H. Hooker, who studied by means of them the relationship between the British marriage rate and the index of trade.<sup>66</sup>

In order to clarify the history let us first define a serial correlation. Thus, let us consider two variates  $\{x_i\}$  and  $\{y_i\}$ , which, for simplicity of exposition, we shall assume have zero means and unit variances. Then their serial correlation can be written in the simple form

$$r_t = \frac{1}{N} \sum_{i=1}^N x_i y_{i+t},$$

where  $t$  may be positive or negative. It is sometimes more convenient to define the correlation in the continuous form

$$r(t) = \frac{1}{2a} \int_{-a}^a x(s) y(s+t) ds.$$

It is customary to call the serial correlation of a variate with itself an *autocorrelation*. When the variates are different we shall speak of the correlation as a *lag correlation*.

The first movement in the use of the new function was in the development of the *variate difference method* of time-series analysis. This method assumes that the elements of a time series consist of two

<sup>65</sup> "A Comparison of the Fluctuations in the Price of Wheat and in the Cotton and Silk Imports into Great Britain," *Journal of the Royal Statistical Society*, Vol. 47, 1884, pp. 34-64.

<sup>66</sup> "Correlation of the Marriage-Rate with Trade," *Journal of the Royal Statistical Society*, Vol. 64, 1901, pp. 485-492.

parts, one containing the structural part and the other the random or stochastic (aleatory) variation. Thus we might write

$$x_i = \xi_i + \varepsilon_i,$$

where  $\xi_i$  is the structural part and  $\varepsilon_i$  is the random variation.

Now it was soon observed that if the differences of increasing order are taken of the elements of a time series, the corresponding variances, when properly defined, diminish to a certain limiting value. This limiting variance is assumed to be the variance of the erratic element, and hence the nature of  $\xi_i$  can be inferred from the order of the difference which first yields this value. A more extensive account of this method will be given later in the book.

The variate difference method was a fruitful field for the development of the calculus of serial correlation. Thus an extensive controversy developed over "Student's" sweeping theorem published in 1914 which asserted that

. . . if we wish to eliminate variability due to position in time or space and to determine whether there is any correlation between the residual variations, all that has to be done is to correlate the 1st, 2nd, 3rd, . . . ,  $n$ th differences between successive values of the other variable. When the correlation between the two  $n$ th differences is equal to that between the two  $(n+1)$ th differences, this value gives the correlation required.<sup>67</sup>

Unfortunately for the generality of the theorem, several restrictive hypotheses were necessary. Although the correlation of the two variates  $\{x_i\}$  and  $\{y_i\}$  was assumed different from zero, their respective autocorrelations as well as their serial correlations were assumed to vanish. Moreover, the time element entered into each variate as a polynomial of the  $n$ th degree.

The possibilities suggested by this analysis were developed variously by Beatrice M. Cave and Karl Pearson,<sup>68</sup> Oscar Anderson,<sup>69</sup> Warren M. Persons,<sup>70</sup> G. U. Yule,<sup>71</sup> and others. The most extensive

<sup>67</sup> "The Elimination of Spurious Correlation Due to Position in Time or Space," *Biometrika*, Vol. 10, 1914, pp. 179-180.

<sup>68</sup> "Numerical Illustrations of the Variate Difference Correlation Method," *Biometrika*, Vol. 10, 1914, pp. 340 et seq.

<sup>69</sup> "Nochmals über die 'Elimination of Spurious Correlation Due to Position in Time and Space,'" *Biometrika*, Vol. 10, 1914, pp. 269 et seq.: "Ueber ein neues Verfahren bei Anwendung der Variate Difference Methode," *Biometrika*, Vol. 15, 1923, pp. 134 et seq.; "Ueber die Anwendung der Differenzenmethode (Variate Difference Method) bei Reihenausgleichungen, Stabilitätsuntersuchungen und Korrelationsmessungen," Part 1, *Biometrika*, Vol. 18, pp. 293 et seq., Part 2, *ibid.*, Vol. 19, 1927, pp. 53 et seq.

<sup>70</sup> "On the Variate Difference Correlation Method and Curve Fitting," *Quarterly Publications of the American Statistical Society*, Vol. 15, 1917, pp. 602-642.

<sup>71</sup> "On the Time-Correlation Problem, with Especial Reference to the Variate-Difference Correlation Method," *Journal of the Royal Statistical Society*, Vol. 84, 1921, pp. 497-526.

account of the theory is to be found in the researches of Anderson, which culminated in a volume entitled *Die Korrelationsrechnung in der Konjunkturforschung*, published in 1929.<sup>72</sup> An extensive application of the methods of the variate difference calculus to economic data has been made by Gerhard Tintner in a work entitled *Prices in the Trade Cycle*.<sup>73</sup> Tintner has also prepared an account of the method in English with tables facilitating its application.<sup>74</sup>

The use of serial correlations as a means of comparing the interactions of economic variables was soon recognized. Thus we find H. L. Moore in 1914 computing the lag correlation between the yield per acre of crops and the production of pig iron. By this means he reached the conclusion ". . . that the cycles in the yield per acre of crops are intimately related to the cycles in the activity of industry, and that it takes between one and two years for good or bad crops to produce the maximum effect upon the activity of the pig-iron industry."<sup>75</sup> Warren Persons in his study of the variate difference method previously referred to made extensive use of serial correlation in studying the relationship between 21 American economic time series, and this method strongly colored his views with regard to the construction of a business barometer.<sup>76</sup> He summarized his technique of analyzing time series in a paper published in 1922, which contained his well-known example of the lag between the production of pig iron and the interest rate on 60- to 90-day commercial paper.<sup>77</sup>

These studies were followed by a series of papers by G. U. Yule, which may be said to have founded the calculus of serial correlations. The first of these was the critique of the variate difference method to which reference has already been made; the second was Yule's classical answer to the question: "Why do we sometimes get nonsense correlations between time series?";<sup>78</sup> the third was an investigation of the periodicities in Wolfer's sunspot numbers, the point of view of which was discussed in Section 10. These papers furnished the stimulus for a number of investigations among which may be mentioned the work of Slutsky on "the summation of random causes as the

<sup>72</sup> *Veröffentlichungen der Frankfurter Gesellschaft für Konjunkturforschung*, Heft 4, Bonn, 1929.

<sup>73</sup> Vienna, 1935, xii + 208 pp. + two sets of graphs.

<sup>74</sup> *The Variate Difference Method*, Cowles Commission Monograph No. 5, Bloomington, 1940, 175 pp.

<sup>75</sup> *Economic Cycles: Their Law and Cause*, New York, 1914, p. 116.

<sup>76</sup> "Construction of a Business Barometer Based upon Annual Data," *American Economic Review*, Vol. 6, 1916, pp. 739-769.

<sup>77</sup> "Correlation of Time Series," *Journal of the American Statistical Association*, Vol. 18, 1922-23, pp. 713-726; republished as Chapter 10 in the *Handbook of Mathematical Statistics*, edited by H. L. Riets, Cambridge, Mass., 1924.

<sup>78</sup> *Journal of the Royal Statistical Society*, Vol. 89, 1926, pp. 1-64.



source of cyclic processes,"<sup>79</sup> the theory of changing harmonics of Ragnar Frisch,<sup>80</sup> a paper by Sir Gilbert Walker on the relationship of periodogram analysis to serial correlations,<sup>81</sup> and a recent extensive work by Herman Wold entitled *A Study in the Analysis of Stationary Time Series*.<sup>82</sup>

The point of view of Yule which seems to have had the greatest influence may be briefly summarized as follows: Let us assume a motion defined by the difference equation

$$(1) \quad \Delta^2 u(t) + \mu u(t+1) = \phi(t+2h),$$

where we employ the notation  $\Delta u(t) = u(t+h) - u(t)$ ,  $\mu = 4 \sin^2 s$ ,  $s = \pi h/T$ , and  $\phi(t)$  is an impressed force defined by erratic impulses.

The solution of this equation can be shown to have the form

$$(2) \quad u(t) = A \sin \frac{2\pi}{T} (t + \tau) + \phi(t) + \frac{\sin 4s}{\sin 2s} \phi(t-h) \\ + \frac{\sin 6s}{\sin 2s} \phi(t-2h) + \frac{\sin 8s}{\sin 2s} \phi(t-3h) + \dots$$

Now Yule observed that if the impressed force was defined by a set of small erratic fluctuations, the simple harmonic motion represented by the first term of the right-hand member of (2) was disturbed. But the disturbed motion was not erratic and the resulting graph (see Chapter 3, Section 7) preserved its sinusoidal appearance. Yule was also struck by the fact that even though the harmonic term were entirely removed, "the graph would present to the eye an appearance hardly different from that of the" complete series. This case, said Yule, "would correspond to that of a pendulum initially at rest, but started into movement by the disturbances."

Sir Gilbert Walker connected the analysis of Yule with that of serial correlation in the following manner: If a motion is defined by the general linear difference equation

$$(3) \quad u(t) = g_1 u(t-1) + g_2 u(t-2) + \dots + g_s u(t-s) + \phi(t),$$

where the  $g_i$  are constants and  $\phi(t)$  is an impressed force defined by random impulses, then the serial-correlation function of the solution is defined by the difference equation

$$(4) \quad r(t) = g_1 r(t-1) + g_2 r(t-2) + \dots + g_s r(t-s).$$

<sup>79</sup> See Section 10.

<sup>80</sup> *Loc. cit.*, Section 10.

<sup>81</sup> "On Periodicity in Series of Related Terms," *Proceedings of the Royal Society of London*, Vol. 131 (A), 1931, pp. 518-532.

<sup>82</sup> Uppsala, 1938, viii + 214 pp.

Walker then employed the graph of  $r(t)$ , which is much smoother in general than the graph of  $u(t)$ , to determine the natural periods of the original series. He illustrated his method by applying it to the quarterly values of pressure at Port Darwin, Australia, a key center of world weather.

Wold in his work referred to above makes a very complete and systematic investigation of the relationships between  $u(t)$  and  $r(t)$  as given by (3) and (4). To equations of type (3) he gives the name *stochastic difference equations*. He emphasizes the important proposition that while  $r(t)$  can be inferred from (3), the inference is not reversible and one cannot then infer (3) from (4). This conclusion is in agreement with the analysis of the author given in Section 3 of Chapter 3, where the problem of inverse lag correlation is considered. Many primary series can have the same serial-correlation function and from this it can be inferred that they are harmonically equivalent. But even when they are harmonically equivalent, they may not be the same for this reason, since they may possess continuous spectra of different intensities. Wold's book gives several illuminating examples of the pitfalls inherent in this method of analysis.

### 15. *The Analysis of Random Series*

It will be clear from the foregoing discussion that the nature of random series should constitute an essential chapter in the analysis of time series. By such a series we mean one whose autocorrelation function is zero, within statistical limits, for every positive and negative lag.

Although the nature of such series had been investigated as early as 1906 by C. Goutereau in studying the variability of temperature,<sup>83</sup> the first systematic theory of random numbers was made by G. U. Yule in his analysis of nonsense correlations published in 1926. Here we learn for the first time that when random numbers are subjected to certain kinds of linear operations, the resulting series are no longer random. Thus, for example, the autocorrelation function of the  $n$ th differences of random series is equal to  $(-1)^t {}_{2n}C_{n-t}/{}_{2n}C_n$ , where  ${}_mC_n$  is a binomial coefficient. Moving averages of random numbers yield significant serial correlations; and more surprising yet, successive accumulations of random series rapidly converge into a perfect sinusoid of period equal to the length of the series itself.

<sup>83</sup> "Sur la variabilité de la température," *Annuaire de la Soc. Mét. de France*, Vol. 54, 1906, pp. 122-127; summarized by E. W. Woolard in *Monthly Weather Review*, Vol. 49, 1921, pp. 132-133.

Such discoveries led E. Slutsky, as we have previously observed, to the development of his thesis that the summation of random causes may be the source of cyclic processes in economic time series. This author stated an interesting result which he called the "sinusoidal limit theorem." Applied to random series, it yields the following result: From the elements of a random series  $\{x_i\}$ , we form a new series by  $n$  iterated summations by 2, followed by the forming of the  $m$ th differences; then if  $m/n$  is kept constant, the difference series will tend to a sine curve of period  $T = 2\pi/(\text{arc cos } r_1)$ , where  $r_1 = (1-m/n)/(1+m/n)$ , as  $n$  tends toward infinity.<sup>84</sup>

The *theory of runs* is closely related to the theory of random series and has been developed by those interested in the nature of time series. Investigations of particular interest in this field have been made by L. Besson,<sup>85</sup> L. Bortkiewicz,<sup>86</sup> and Herbert E. Jones.<sup>87</sup> The last, in particular, has developed a systematic formulation of the problem and, together with Alfred Cowles, has applied the theory to an interpretation of the movements of the stock market.<sup>88</sup>

The theory of runs is concerned with the direction of changes in time series, that is to say, with the signs of the first differences. Obviously these first differences may be plus, minus, or zero. A *run* is then defined as a *sequence of like signs* and its *length* is the *number of like signs*, zero generally being regarded as having the sign of the preceding difference. A *reversal*, as contrasted with a sequence, occurs when a plus sign is followed by a negative, or vice versa. The ratio of sequences to reversals is defined by the fraction

$$\rho = \frac{E(S)}{E(R)},$$

where  $E(S)$  is the expected number of sequences and  $E(R)$  is the expected number of reversals. For a random series it can be shown that  $\rho = \frac{1}{2}$ , while for a cumulated random series  $\rho = 1$ .

The principal problems of the theory of runs are (1) to determine the ratio of sequences to reversals for different types of series; (2) to determine the distribution of the expectation  $E(R)$ ; and (3) to determine the standard errors of the distribution. For example,

<sup>84</sup> Slutsky, *op. cit.*, pp. 130-131, pp. 142-145.

<sup>85</sup> L. Besson, "On the Comparison of Meteorological Data with Results of Chance," translated and abridged by E. W. Woolard, *Monthly Weather Review*, Vol. 48, 1920, pp. 89-94.

<sup>86</sup> L. Bortkiewicz, *Die Iterationen*, Berlin, 1917, p. 83.

<sup>87</sup> H. E. Jones, "The Theory of Runs as Applied to Time Series," in Cowles Commission, *Report of Third Annual Research Conference ... 1937*, pp. 33-36.

<sup>88</sup> Alfred Cowles, 3rd and H. E. Jones, "Some a Posteriori Probabilities in Stock Market Action," *Econometrica*, Vol. 5, 1937, pp. 280-294.

Jones has shown that  $\sigma_{B(R)} = (2n-4)^{1/3}$  for random series and  $\sigma_{B(R)} = (n-2)^{1/2}$  for cumulated random series, where  $n$  is the number of observations. A more extensive account of this theory will be given later in the book.

Another direction in which the theory of random series has moved is that of the definition of functions of random variables. Thus let  $\xi$  be a random, or stochastic variable, which is characterized wholly by its cumulative distribution function,  $F(u)$ . That is to say,  $F(u)$  defines the probability that  $\xi$  is less than or equal to  $u$ . If then,  $y(t)$  is a given function, what meaning can be assigned to the symbol  $y(\xi)$ ? The basis of this new analysis is to assume that the expected value of  $y(\xi)$ , designated by  $E[y(\xi)]$ , is given by

$$E[y(\xi)] = \int_{-\infty}^{\infty} y(u) dF(u).$$

This theory is developed in extenso by H. Cramer in his book entitled *Random Variables and Probability Distributions*, published in 1937.<sup>88</sup> The application of the propositions thus developed to the theory of time series has been made by H. Wold in his work on stationary time series previously referred to.

Closely related to the idea of the random variable is the earlier problem of the random walk first proposed by Karl Pearson in 1905.<sup>89</sup> This problem he states as follows:

A man starts from a point  $O$  and walks a distance  $l$  in a straight line; he then turns through any angle whatever and walks a distance  $l$  in a second straight line. He repeats this process  $n$  times. I require the probability that after these  $n$  stretches he is at a distance between  $r$  and  $(r + dr)$  from his starting point,  $O$ .

The expected distance after  $n$  repetitions,  $E[L(n)]$ , is merely  $l\sqrt{n}$ . If we designate this value by  $M$ , then the desired probability is merely  $\phi(r) dr$ , where the frequency function is given by

$$\phi(r) = \frac{2r}{M^2} e^{-r^2/M^2}.$$

Since random variation is found in many phenomena interesting to the physicist, as in the case of the Brownian movement of small particles; to meteorologists, as in vagaries of the weather; to astronomers, as in the light variations of variable stars; there has been assembled a large collection of special problems in the theory of probability which belong essentially to this field. It would be too far re-

<sup>88</sup> Cambridge, 1937.

<sup>89</sup> "The Random Walk," *Nature*, Vol. 72, 1905, p. 294.

moved from our immediate objectives, however, to do more than to indicate the existence of such problems.

### *16. The Present Status of the Problem*

In the preceding sections of this chapter we have traced the development of the theories about the nature of economic time series. The problem, it will be observed from the historical references, is relatively new in science. The theory of statistics as it applied to frequency distributions had reached a high state of development by the beginning of the twentieth century; the problem of time series was scarcely formulated and even the data which it was to interpret were not available in abundance until after the world war.

The problem of single time series, as it has presented itself above, is concerned with three things: first, the determination of a trend; second, the discovery and interpretation of cyclical movements in the residuals; third, the determination of the magnitude of the erratic element in the data.

This preliminary problem, once solved, leads immediately into the more complex one of discovering valid interactions of one time series with another. Upon the discovery of such relationships the hope of establishing a firm science of economics inevitably rests. From them there will come ultimately the power of prediction, which is the final test of any mature science.

The problems of economic time series are still far from a solution. But only by careful tests and frequent rescrutiny of both statistical methods and basic theories can one hope to make progress in the development of this difficult science.

## CHAPTER 2

### THE TECHNIQUE OF HARMONIC ANALYSIS

#### 1. *Harmonic Analysis*

We have shown in the first chapter the interest which has been taken by mathematical economists in the theory and application of methods of harmonic analysis since the work of H. L. Moore, Sir William Beveridge, and others exhibited its potential usefulness in the analysis of economic time series. The underlying concepts of harmonic analysis, however, present many problems of a difficult mathematical nature and there is not yet a uniformity of opinion regarding the interpretation and the significance of results obtained by these methods. Hence, it would seem not only useful, but quite necessary, to make a careful examination of the assumptions which underlie the basic formulas of the theory. This analysis has been undertaken in the present chapter.

In the beginning it will be useful to examine certain mathematical models in order better to appreciate the exact contents of the theorems which we propose to use in exploring the harmonic constituents of economic time series. The relationship between the method of Fourier and the method of Schuster will be carefully studied. Moreover, since systems of orthogonal functions other than those which appear in Fourier series have been used by certain econometrists in the study of trends and the correlation of the residuals from these trends, it will be useful to indicate the nature of this generalization and the assumptions which underlie it. Considerable misapprehension upon this point seems to exist as has recently been pointed out by C. F. Roos.<sup>1</sup>

No attempt will be made in this chapter to discuss the significance of results obtained by harmonic analysis. This fundamental problem is intimately connected with the concept of the *degrees of freedom* possessed by a time series. It is necessary, therefore, to defer discussion of the question of significance until a later chapter where the problem of the freedom of the oscillation may be more successfully attacked.

<sup>1</sup> See C. F. Roos, *Dynamic Economics*, Bloomington, 1934, Appendix I, pp. 246-250.

## 2. Fourier Series

The problem of Fourier series is that of representing a function, either continuous or with a definite number of finite discontinuities as exhibited by a set of discrete data, by means of a series of fundamental harmonics.

By a *harmonic* we mean a term of the form

$$y = A \cos \frac{2\pi t}{T} + B \sin \frac{2\pi t}{T},$$

an expression which may also be written in the form

$$y = \sqrt{A^2 + B^2} \cos \left( \frac{2\pi t}{T} - \alpha \right)$$

where  $\alpha = \arctan B/A$ .

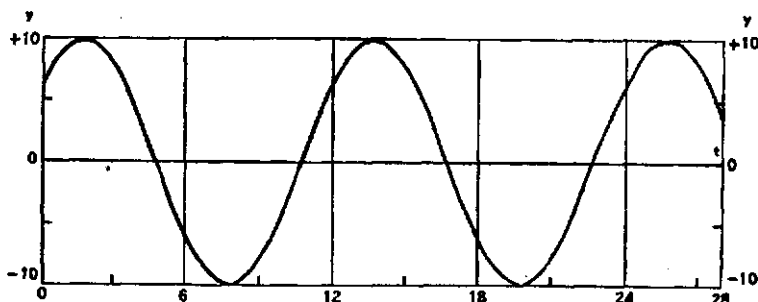

FIGURE 10.—GRAPHICAL REPRESENTATION OF THE HARMONIC TERM:  
 $y = 6 \cos(2\pi t/12) + 8 \sin(2\pi t/12) = 10 \cos[(2\pi t/12) - \alpha]$ ,  
 where  $\alpha = 58^\circ 8' = 0.3019$  radians.

The value  $T$  is called the *period* of the harmonic, the reciprocal,  $1/T$ , the *frequency*, the quantity  $\sqrt{A^2 + B^2}$  the *amplitude*, and  $\alpha$  the *phase angle*. We shall sometimes refer to  $A$  and  $B$  as the *components* of the harmonic. Figure 10 shows a typical harmonic term.

A series of the form

$$(1) \quad y = \frac{1}{2} A_0 + A_1 \cos(\pi t/a) + A_2 \cos(2\pi t/a) + A_3 \cos(3\pi t/a) + \dots \\ + B_1 \sin(\pi t/a) + B_2 \sin(2\pi t/a) + B_3 \sin(3\pi t/a) + \dots$$

is called a *Fourier series*.

The principal theorem of Fourier series may be stated with sufficient generality for the analysis of economic time series as follows:

*If  $f(t)$  is a single-valued function which has a derivative throughout the interval  $-a \leq t \leq a$  except for a finite number of points at*

which it has finite discontinuities, and for other values of  $t$  is defined by the equation

$$f(t + 2a) = f(t),$$

then  $f(t)$  can be represented by means of the Fourier series (1), where the coefficients are determined from the integrals

$$(2) \quad A_n = \frac{1}{a} \int_{-a}^a f(s) \cos(n\pi s/a) ds; \quad B_n = \frac{1}{a} \int_{-a}^a f(s) \sin(n\pi s/a) ds.$$

The Fourier series gives the value

$$\lim_{\epsilon \rightarrow 0} \frac{1}{2} [f(t + \epsilon) + f(t - \epsilon)].$$

For a proof of this theorem, the reader is referred to standard treatments of the subject.<sup>2</sup> The theorem has been stated for much more general types of functions than those which occur in the analysis of statistical data.

As an example of the application of the theorem, let us consider the Fourier representation of the following function:

$$(3) \quad f(t) = \begin{cases} 1 + t/\lambda, & \text{for } -\lambda \leq t \leq 0; \\ 1 - t/\lambda, & \text{for } 0 \leq t \leq \lambda; \\ 0, & \text{for } -a \leq t \leq -\lambda, \lambda \leq t \leq a. \end{cases}$$

This function is represented graphically in Figure 11.

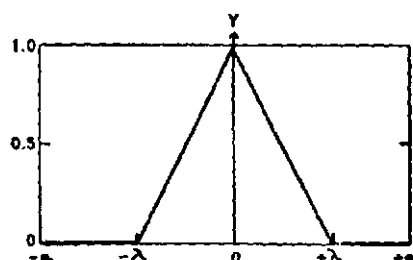

FIGURE 11.—CONTINUOUS FUNCTION WITH DISCONTINUITIES IN DERIVATIVE.

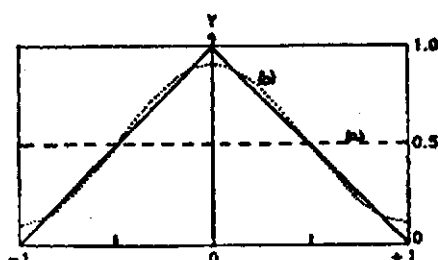

FIGURE 12.—FOURIER APPROXIMATIONS OF CONTINUOUS FUNCTION.  
(a) First approximation,  
(b) Second approximation.

Since the function is symmetric about the origin, no sine terms will appear in its Fourier expansion. Employing formulas (2) for the computation of the

<sup>2</sup> See E. T. Whittaker and G. N. Watson, *A Course in Modern Analysis*, 2nd edition, 1915, pp. 167-169. For modern generalizations see A. Zygmund, *Trigonometrical Series*, Warsaw, 1935, 331 pp.



coefficients of the series, and adopting the convenient abbreviations

$$\mu = \lambda/a, \quad \beta = \frac{1}{2}n\pi\mu,$$

we get

$$A_n = \frac{1}{a} \int_{-a}^a f(t) \cos(n\pi t/a) dt = \mu(\sin^2\beta/\beta^2), \quad A_0 = \mu.$$

The series representing the function is thus

$$(4) \quad f(t) = \frac{1}{2}\mu + \frac{4}{\pi^2\mu} \sum_{n=1}^{\infty} \frac{\sin^2(\frac{1}{2}n\pi\mu)}{n^2} \cos \frac{n\pi t}{a}.$$

If  $\mu = 1$ , we have as a special case the series

$$f(t) = \frac{1}{2} + \frac{4}{\pi^2} \left[ \cos \frac{\pi t}{a} + \frac{1}{9} \cos \frac{3\pi t}{a} + \frac{1}{25} \cos \frac{5\pi t}{a} + \dots \right].$$

The sum of the first  $n$  terms of this series is called the  $n$ th approximation to the function. Successive approximations are given in Figure 12.

Later in our discussion of serial correlation functions, it will be important to refer again to this special example. We shall, therefore, consider one other special case, namely the one for which  $\mu = 1/3$ .

Substituting in formula (1) the values obtained from formulas (2), we obtain the following explicit expansion:

$$\begin{aligned} f(t) &= \frac{1}{6} + \frac{12}{\pi^2} \sum_{n=1}^{\infty} \frac{\sin^2(n\pi/6)}{n^2} \cos \frac{n\pi t}{a} \\ &= \frac{1}{6} + \frac{3}{\pi^2} \left[ \cos \frac{\pi t}{a} + \frac{3}{4} \cos \frac{2\pi t}{a} + \frac{4}{9} \cos \frac{3\pi t}{a} + \frac{3}{16} \cos \frac{4\pi t}{a} + \frac{1}{25} \cos \frac{5\pi t}{a} \right. \\ &\quad + \frac{1}{49} \cos \frac{7\pi t}{a} + \frac{3}{64} \cos \frac{8\pi t}{a} + \frac{4}{81} \cos \frac{9\pi t}{a} + \frac{3}{100} \cos \frac{10\pi t}{a} + \frac{1}{121} \cos \frac{11\pi t}{a} \\ &\quad \left. + \frac{1}{169} \cos \frac{13\pi t}{a} + \frac{3}{196} \cos \frac{14\pi t}{a} + \frac{4}{225} \cos \frac{15\pi t}{a} + \dots \right]. \end{aligned}$$

A few of the approximation curves are shown in Figure 13. One of the interesting observations to be made about this example is that the Fourier series approximates zero over two-thirds of the range. In order to accomplish this approximation, however, it is necessary to use a considerably larger number of terms of the expansion than in the first example.

In the applications which we contemplate it has seemed desirable to define the Fourier coefficients in the symmetric form given in formulas (2). In much of the numerical work in harmonic analysis, however, the data are given over the range of  $0 \leq t \leq 2a$ , in which case the Fourier coefficients assume the form

$$(5) \quad A'_n = \frac{1}{a} \int_0^{2a} g(t) \cos \frac{n\pi t}{a} dt, \quad B'_n = \frac{1}{a} \int_0^{2a} g(t) \sin \frac{n\pi t}{a} dt,$$

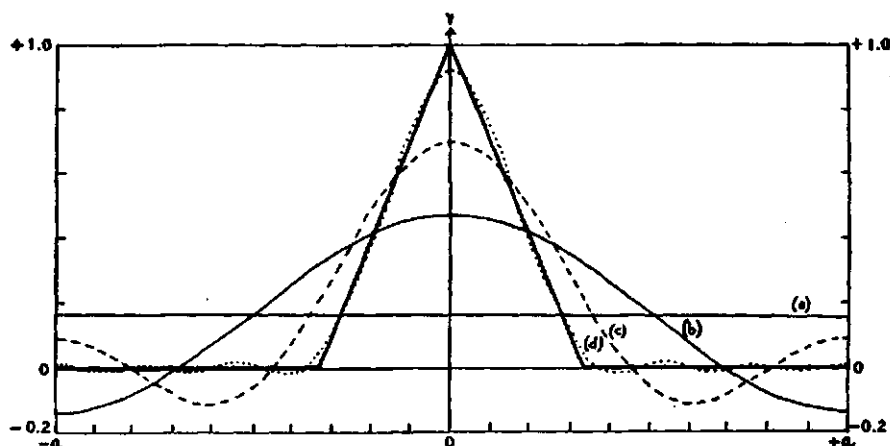

FIGURE 13.—FOURIER APPROXIMATION OF A FUNCTION.

- (a) First approximation, (c) Third approximation,  
 (b) Second approximation, (d) Fourth approximation.

where

$$g(t) = f(t - a).$$

This formulation is particularly advantageous when the data are given in discrete form. Thus, if we have the data  $f_1, f_2, f_3, \dots, f_N$ , it is usually convenient to define the Fourier coefficients in the form

$$(6) \quad A_n = \frac{2}{N} \sum_{t=1}^N f_t \cos \frac{2n\pi t}{N}, \quad B_n = \frac{2}{N} \sum_{t=1}^N f_t \sin \frac{2n\pi t}{N},$$

which are seen to be equivalent to  $A'_n$  and  $B'_n$  in (5).

The relationship between  $A'_n, B'_n$  and  $A_n, B_n$ , as defined by formulas (2), is seen to be one of sign only. That is to say, we have

$$(7) \quad A_n = \cos n\pi A'_n, \quad B_n = \cos n\pi B'_n.$$

This is readily proved by making in the integrals of (2) the transformation  $s = t - a$ . We thus obtain

$$A_n = \frac{\cos n\pi}{a} \int_0^{2\pi} f(t-a) \cos \frac{n\pi t}{a} dt = \cos n\pi A'_n,$$

$$B_n = \frac{\cos n\pi}{a} \int_0^{2\pi} f(t-a) \sin \frac{n\pi t}{a} dt = \cos n\pi B'_n.$$

### 3. The Theorems of Bessel and Parseval and Their Significance

We next introduce two theorems associated with the Fourier co-

efficients, which have special significance in the statistics of trends. These are the so-called inequality of Bessel and the theorem of Parseval, the first of which we have already described in the first chapter.

In order to derive the first of these, let us assume that a function  $f(t)$  has been approximated by the first  $N$  harmonics of a Fourier series, that is,

$$(1) \quad f(t) \approx \frac{1}{2} A_0 + \sum_{n=1}^N A_n \cos \frac{n\pi t}{a} + \sum_{n=1}^N B_n \sin \frac{n\pi t}{a},$$

where the symbol  $\approx$  means "is approximated by."

Let us now represent the right-hand member of (1) by  $f_n(t)$  and consider the integral of the square of the residual, that is,

$$I = \frac{1}{a} \int_{-a}^a [f(t) - f_n(t)]^2 dt = \frac{1}{a} \int_{-a}^a [f^2(t) - 2f(t)f_n(t) + f_n^2(t)] dt.$$

Taking account of the well-known integrals

$$(2) \quad \int_{-a}^a \sin \frac{m\pi t}{a} \sin \frac{n\pi t}{a} dt = \int_{-a}^a \cos \frac{m\pi t}{a} \cos \frac{n\pi t}{a} dt = 0, \quad m \neq n,$$

$$\frac{1}{a} \int_{-a}^a \sin^2 \frac{n\pi t}{a} dt = \frac{1}{a} \int_{-a}^a \cos^2 \frac{n\pi t}{a} dt = 1,$$

$$\int_{-a}^a \sin \frac{m\pi t}{a} \cos \frac{n\pi t}{a} dt = 0,$$

for all integral values of  $m$  and  $n$ , and observing the definitions (2) of Section 2, we readily obtain the following value for the integral  $I$ :

$$I = \frac{1}{a} \int_{-a}^a f^2(t) dt - \left( \frac{1}{2} A_0^2 + R_1^2 + R_2^2 + R_3^2 + \dots + R_N^2 \right),$$

$$R_n^2 = A_n^2 + B_n^2.$$

Moreover, since the integrand of the integral is positive or zero, the integral itself is positive or zero, and we thus obtain the *Bessel inequality* for Fourier coefficients:

$$(3) \quad \frac{1}{2} A_0^2 + R_1^2 + R_2^2 + R_3^2 + \dots + R_N^2 \leq \frac{1}{a} \int_{-a}^a f^2(t) dt.$$

It has been proved that the sign of equality will hold for all functions  $f(t)$  of integrable square, provided  $N = \infty$ . This property of the complete Fourier sequence is known as the *closure property*.

Several interesting statistical conclusions may be derived from

the Bessel inequality. The first of these is the statement that the variance,  $\sigma^2$ , of the function  $f(t)$  is expressible in terms of the Fourier coefficients according to the following formula:

$$(4) \quad \sigma^2 = \frac{1}{2} \sum_{n=1}^{\infty} (A_n^2 + B_n^2) = \frac{1}{2} \sum_{n=1}^{\infty} R_n^2.$$

This is easily proved by noting that the arithmetic average of  $f(t)$  is equal to  $\frac{1}{2}A_0$ . Hence we have

$$\sigma^2 = \frac{1}{2a} \int_{-a}^a [f^2(t) - (\frac{1}{2}A_0)^2] dt = \frac{1}{2} \sum_{n=1}^{\infty} (A_n^2 + B_n^2) = \frac{1}{2} \sum_{n=1}^{\infty} R_n^2.$$

Similarly we may prove that if  $f_n(t)$  is the right-hand member of (1), then the variance,  $\sigma_r^2$ , of the residual function

$$\Delta t = f(t) - f_n(t),$$

is given by

$$(5) \quad \sigma_r^2 = \frac{1}{2} I = \frac{1}{2} (R_{N+1}^2 + R_{N+2}^2 + R_{N+3}^2 + \dots).$$

This is easily proved by noting that the average of  $\Delta(t)$  is zero. Hence its variance is equal to  $\frac{1}{2}I$ , and, from the closure property of the Fourier sequence, this quantity may be identified immediately with half the sum of the squares of the coefficients with subscripts greater than  $N$ .

In illustration, consider the first example given in Section 2. By formula (4) of Section 2 and by expansion (4) of Section 3, we at once obtain for the variance

$$\sigma^2 = \frac{8}{\pi^4 \mu^2} \sum_{n=1}^{\infty} \frac{\sin^4(\frac{1}{2}n\pi\mu)}{n^4} = \frac{1}{3}\mu - \frac{1}{4}\mu^2.^3$$

If we set  $\mu = 1/3$ , and evaluate the first nine coefficients of (4), we shall obtain

$$\begin{aligned} \sigma^2 &= \frac{1}{2} [(0.30396)^2 + (0.22797)^2 + (0.13510)^2 + \dots + (0.015011)^2] \\ &= 0.08325, \end{aligned}$$

a value which is to be compared with the exact variance of 0.08333. It is thus clear that nine terms (note that one is zero) of the Fourier expansion give a very close fit to the original function. We may, in fact, say that there exists an equivalence of 0.08325/0.8333 or 99.90 per cent between the function and the first nine terms of its Fourier representation.

The *theorem of Parseval* is associated with the Fourier coefficients of two functions  $f(t)$  and  $g(t)$ . Thus let us suppose that both

<sup>3</sup> For this reduction see the author's *Tables of the Higher Mathematical Functions*, Vol. 2, 1935, pp. 18-19.

satisfy the conditions of the theorem of Section 2 and that their Fourier coefficients are respectively:

$$f(t) : \frac{1}{2} A_0, A_1, A_2, A_3, \dots; B_1, B_2, B_3, \dots;$$

$$g(t) : \frac{1}{2} a_0, a_1, a_2, a_3, \dots; b_1, b_2, b_3, \dots.$$

Parseval's theorem then states the following equivalence:

$$\frac{1}{a} \int_{-a}^a f(t) g(t) dt = \frac{1}{2} A_0 a_0 + \sum_{n=1}^{\infty} A_n a_n + \sum_{n=1}^{\infty} B_n b_n.$$

This result is derived as an immediate conclusion from the integrals given in (2) above.

The theorem of Parseval has its interest for us in connection with the correlation of the two functions  $f(t)$  and  $g(t)$ . Thus, designating the correlation coefficient by  $r_{fg}$ , the standard deviations by  $\sigma_f$  and  $\sigma_g$ , and noting (4), we immediately derive

$$(6) \quad r_{fg} = \frac{\frac{1}{2a} \int_{-a}^a [f(t) - \frac{1}{2} A_0][g(t) - \frac{1}{2} a_0] dt}{\sigma_f \sigma_g}$$

$$= \frac{\sum A_n a_n + \sum B_n b_n}{\sqrt{\sum (A_n^2 + B_n^2)} \times \sqrt{\sum (a_n^2 + b_n^2)}}.$$

It should be noted that if  $f(t)$  and  $g(t)$  are reduced by subtracting from each function the first  $N$  harmonic terms, then the correlation between the residuals is obtained from formula (6) by summing from  $N+1$  instead of from 1.

#### 4. The Technique of Harmonic Analysis

Harmonic analysis is essentially the technique of determining the principal harmonic elements of a given function or set of data.

Let us first examine the problem from the point of view of the Fourier series

$$(1) \quad f(t) = \frac{1}{2} A_0 + \sum_{n=1}^{\infty} A_n \cos \frac{n\pi t}{a} + \sum_{n=1}^{\infty} B_n \sin \frac{n\pi t}{a},$$

where, as before, the coefficients are determined by the integrals

$$(2) \quad A_n = \frac{1}{a} \int_{-a}^a f(s) \cos \frac{n\pi s}{a} ds, \quad B_n = \frac{1}{a} \int_{-a}^a f(s) \sin \frac{n\pi s}{a} ds.$$

The quantity

$$E_n = \frac{R_n^2}{2\sigma^2} = \frac{A_n^2 + B_n^2}{2\sigma^2}$$

will be called the energy of the  $n$ th harmonic term.<sup>4</sup> The period of the  $n$ th harmonic is obviously equal to  $T = 2a/n$ ; hence, the energy may be regarded as a function which depends upon the period. This dependence we can represent by writing

$$R = R(T), \quad 0 < T < 2a.$$

The graph of this function is called a *periodogram*. Obviously the periodogram constructed from the coefficients of a Fourier series is determined only for the periods

$$T = \frac{2a}{1}, \frac{2a}{2}, \frac{2a}{3}, \frac{2a}{4}, \dots, \frac{2a}{n}, \dots$$

This array of periods, as we have said in the first chapter, is called the *Fourier sequence*. A periodogram constructed over this sequence has the advantage that the sum of the squares of the ordinates equals twice the variance of  $f(s)$ , that is,

$$(3) \quad R_1^2 + R_2^2 + R_3^2 + R_4^2 + \dots = 2\sigma^2.$$

Since, however, the problem of harmonic analysis is to determine the dominating harmonics in a series of data or in a given function, the periods of which may not belong to the Fourier sequence, it is generally desirable to compute the periodogram over the *arithmetic sequence*:  $\tau = 1, 2, 3, 4, \dots, a$ .

In order to understand better the nature of a periodogram, let us construct one for the typical harmonic  $f(t) = A \sin(kt + B)$ .

An easy calculation of  $A_n$  and  $B_n$  yields

$$A_n = A \sin \beta \left[ \frac{\sin(ka + n\pi)}{ka + n\pi} + \frac{\sin(ka - n\pi)}{ka - n\pi} \right],$$

$$B_n = A \cos \beta \left[ \frac{\sin(ka - n\pi)}{ka - n\pi} - \frac{\sin(ka + n\pi)}{ka + n\pi} \right],$$

<sup>4</sup> Strictly speaking, the total energy of a physical system represented by the Fourier series (1) is equal to

$$E = \frac{1}{2} C_0 A_0^2 + \sum_{n=1}^{\infty} C_n R_n^2,$$

where the  $C_n$  are weighting factors determined from the physical conditions of the problem.

from which we derive

$$R_n^2 = A^2 \left[ \frac{\sin^2(ka + n\pi)}{(ka + n\pi)^2} + \frac{\sin^2(ka - n\pi)}{(ka - n\pi)^2} - 2 \cos 2\beta \frac{\sin(ka + n\pi) \sin(ka - n\pi)}{k^2 a^2 - n^2 \pi^2} \right]$$

If we make the abbreviations  $k = 2\pi/P$  and  $n = 2a/T$ , then the value of  $R^2$  can be expressed in terms of the period,  $P$ , of the harmonic and of the trial period  $T$ :

$$(4) \quad R^2(T) = \frac{A^2}{4\pi^2} \left[ \frac{\sin^2 2\pi(a/P + a/T)}{(a/P + a/T)^2} + \frac{\sin^2 2\pi(a/P - a/T)}{(a/P - a/T)^2} - 2 \cos 2\beta \frac{\sin 2\pi(a/P + a/T) \sin 2\pi(a/P - a/T)}{(a/P)^2 - (a/T)^2} \right].$$

For purposes of discussion, it will be convenient to make the further abbreviation  $a/P = \mu$ ,  $a/T = \tau$ . Then  $R^2(T)$  can be written

$$(5) \quad R^2(\tau) = \frac{A^2}{4\pi^2} \left[ \frac{\sin^2 2\pi(\mu + \tau)}{(\mu + \tau)^2} + \frac{\sin^2 2\pi(\mu - \tau)}{(\mu - \tau)^2} - 2 \cos 2\beta \frac{\sin 2\pi(\mu + \tau) \sin 2\pi(\mu - \tau)}{\mu^2 - \tau^2} \right].$$

It is clear that the dominating term in this expression is the function

$$(6) \quad \frac{\sin^2 2\pi(\mu - \tau)}{(\mu - \tau)^2},$$

which has its maximum value of  $4\pi^2$  when  $\tau = \mu$ . For this limit (5) assumes the following value:

$$\lim_{\tau=\mu} R^2(\tau) = A^2 + A^2 \left[ \frac{\sin^2 4\pi\mu}{16\mu^2\pi^2} - \frac{\cos 2\beta \sin 4\pi\mu}{2\mu\pi} \right].$$

Since, in general,  $\mu > 1$ , the second term of this expression will be small compared with the first and  $R^2(\tau)$  will have a maximum value in the neighborhood of  $\tau = \mu$ . This is the fundamental idea which underlies the use of periodogram analysis in the discovery of hidden periodicities.

Since (6) is the dominating term of  $R^2(\tau)$ , it is clear that this function will also have minima in the neighborhood of the value of  $\tau$  which makes (6) zero. Such zero values are obtained from the equation

$$2(\mu - \tau) = m,$$

where  $m$  is an integer, or, in terms of  $T$ ,

$$(7) \quad T = P / (1 - \frac{1}{2}Pm/a).$$

In order to find the breadth of the peak around the maximum ordinate of the periodogram, we compute from formula (7) the values corresponding to  $m = 1$  and  $m = -1$  and form their difference  $\Delta$ . We thus get

$$(8) \quad T_1 = P / (1 - \frac{1}{2}P/a), \quad T_2 = P / (1 + \frac{1}{2}P/a);$$

and hence the approximate breadth of the peak is found to be

$$(9) \quad \Delta = T_1 - T_2 = \frac{P^2}{a[1 - \frac{1}{4}(P/a)^2]} \approx P \cdot (P/a).$$

Thus if a series of 300 items contained periods of 12, 25, 44, and 60 units, the periodogram would reveal four peaks, the widths of which would be respectively 1, 4, 13, and 26 units. It is obvious that very little interference would be encountered in such a periodogram. If, however, the series contained only 200 items, then some interference might be expected between the peaks corresponding to the periods 44 and 60, since the widths would be respectively 21 and 44 units.

If the breadth of the peak,  $\Delta$ , can be accurately determined from the periodogram, it is clear that the value of the period can be determined from formula (9). Thus we should have

$$\frac{\Delta}{a} = \frac{(P/a)^2}{1 - \frac{1}{4}(P/a)^2}.$$

Hence, solving for  $P$ , we get

$$(10) \quad P = a \sqrt{\frac{(\Delta/a)}{1 + \frac{1}{4}(\Delta/a)}}$$

In our later application of harmonic analysis to economic time series it will be convenient to have a standard symbol for the energy attributable to a single harmonic term or to a set of them.

Consequently, we shall say that the energy associated with a single period  $T$  will be

$$E(T) = \frac{R^2(T)}{2\sigma^2},$$

and for a set of  $n$  harmonic terms,



$$(11) \quad \sum E_n = \frac{\sum R^2(T_n)}{2\sigma^2}.$$

From Bessel's theorem cited in the preceding section, it is clear that the variance,  $\sigma_1^2$ , of the series after  $n$  terms have been removed is given by the formula

$$(12) \quad \sigma_1^2 = (1 - \sum E_n)\sigma^2.$$

Similarly, the theorem of Parseval enables us to define the mutual energy of two series,  $f(t)$  and  $g(t)$ , in terms of their correlation coefficient. We shall define the mutual energy of the two series, namely  $E_{fg}$ , by the formula

$$(13) \quad E_{fg} = \frac{\sum (A_n a_n + B_n b_n)}{2\sigma_f \sigma_g} = r_{fg}.$$

If the two series are reduced by  $n$  common harmonics, then we have the reduced mutual energy,  $E^*_{fg}$ , equal to the reduced correlation coefficient,  $r^*_{fg}$ .

This relationship may be put in terms of the original correlation coefficient,  $r_{fg}$ , and the two corresponding energies,  $E_f$  and  $E_g$ , if we employ the abbreviation

$$(14) \quad r_n = \frac{\sum_{s=1}^n (A_s a_s + B_s b_s)}{2\sigma_f \sigma_g r_{fg}}.$$

In terms of this notation, it follows readily that the reduced mutual energy becomes

$$(15) \quad E^*_{fg} = r^*_{fg} = \frac{r_{fg}(1 - r_n)}{\sqrt{(1 - E_f)(1 - E_g)}}.$$

These formulas are exact if the energies are computed strictly over the periods of the Fourier sequence; otherwise, they are only approximate and must be applied with caution.

### 5. A Mathematical Example

As a simple illustration of the application of the theory of the last section and in order to study the characteristics of a pure harmonic term, let us consider the analysis of the function

$$y = 100 \sin \left( \frac{2\pi t}{43} + \frac{\pi}{4} \right),$$

over an assumed range of length  $2a = 204$ .

Employing formula (5) of the preceding section, and noting that  $\cos 2\beta = 0$ , we see that we can write

$$R^2(\tau) = \left(\frac{100}{2\pi}\right)^2 \left[ \frac{\sin^2 2\pi(\mu + \tau)}{(\mu + \tau)^2} + \frac{\sin^2 2\pi(\mu - \tau)}{(\mu - \tau)^2} \right],$$

where  $\mu = a/P = 102/43 = 2.37209$ . It will be more convenient, however, to represent  $R^2$  as a function of fractions of half the range, so we replace  $\tau$  by  $1/x$ , where  $x = T/a$ .

Hence we consider the function

$$R^2(x) = 253.3030 \left[ \frac{\sin^2 2\pi(2.37209 + 1/x)}{(2.37209 + 1/x)^2} + \frac{\sin^2 2\pi(2.37209 - 1/x)}{(2.37209 - 1/x)^2} \right].$$

The two phase components,  $A_n$  and  $B_n$ , the sum of whose squares is  $R^2$ , may be written in terms of the variable  $x$  as follows:

$$A(x) = \frac{100}{2\pi} \sin \frac{\pi}{4} \left[ \frac{\sin 2\pi(2.37209 + 1/x)}{(2.37209 + 1/x)} + \frac{\sin 2\pi(2.37209 - 1/x)}{(2.37209 - 1/x)} \right],$$

$$B(x) = \frac{100}{2\pi} \cos \frac{\pi}{4} \left[ \frac{\sin 2\pi(2.37209 - 1/x)}{(2.37209 - 1/x)} - \frac{\sin 2\pi(2.37209 + 1/x)}{(2.37209 + 1/x)} \right].$$

The values of  $A(x)$ ,  $B(x)$ ,  $R^2(x)$ , and  $R(x)$  are given in the following table and the values of  $R(x)$  are graphically represented in Figure 14.

$x$	$A(x)$	$B(x)$	$R^2(x)$	$R(x)$	$x$	$A(x)$	$B(x)$	$R^2(x)$	$R(x)$
0.10	-0.4072	-1.7170	3.1139	1.76	0.50	23.6238	19.9219	956.1787	30.91
0.15	0.3700	-0.2302	0.1899	0.44	0.51	16.7253	12.2189	429.0872	20.71
0.20	-2.0081	-4.2063	21.7254	4.66	0.52	8.6245	7.1587	125.8004	11.21
0.2222	2.6287	4.9867	31.7772	5.64	0.53	4.7805	-0.4963	23.9995	4.81
0.25	-6.5390	-9.0820	125.2412	11.19	0.54	-0.1189	-5.3713	28.8638	5.37
0.27	8.1222	6.4242	107.2405	10.36	0.55	-4.2491	-9.2479	103.5785	10.18
0.2857	5.8036	8.5632	107.0102	10.34	0.57	-10.3309	-14.2237	309.0411	17.58
0.30	-4.7181	-0.9269	23.1196	4.81	0.60	-14.0834	-15.4362	436.8184	20.90
0.31	-11.6418	-9.3212	222.4163	14.91	0.61	-15.0668	-15.4696	466.3170	21.69
0.32	-14.9072	-14.9822	446.6909	21.14	0.62	-15.0649	-14.5333	438.1680	20.93
0.33	-13.1324	-15.5300	413.6408	20.34	0.63	-14.7164	-13.2820	392.9840	19.82
0.3333	-11.3953	-14.4119	337.5557	18.37	0.64	-14.0808	-11.7952	337.3957	18.37
0.34	-8.3630	-10.2686	145.9319	12.08	0.65	-13.2131	-10.1459	277.5253	16.66
0.35	4.3106	0.0430	18.5831	4.31	0.66	-12.2618	-8.3938	218.3653	14.78
0.36	17.2589	13.7253	486.2535	22.05	0.6667	-11.3831	-7.1983	181.3905	13.47
0.37	30.7717	23.7629	1774.2019	42.12	0.70	-6.9570	-1.3322	50.1746	7.08
0.38	43.3457	43.2423	3748.7462	61.23	0.71	-5.5658	0.2784	31.0556	5.57
0.39	53.3717	55.8505	5999.1382	77.45	0.72	-4.1916	1.7788	20.7336	4.55
0.40	61.6805	65.0067	8030.3551	89.61	0.73	-3.1605	2.8468	13.0930	4.25
0.41	68.4898	70.8276	9437.4424	97.15	0.75	-2.3070	5.5306	80.6818	8.54
0.42	68.1667	72.9013	9861.2985	99.81	0.76	0.8685	6.5125	43.1669	6.57
0.43	67.4651	72.0027	9736.3333	98.67	0.77	1.9706	7.3654	53.0293	7.62
0.44	64.2892	68.1146	8772.7000	93.66	0.80	4.8044	9.1172	106.2056	10.31
0.45	59.3435	62.0795	7375.5153	85.88	0.85	7.9153	9.9209	159.1021	12.61
0.46	53.0989	54.5105	5790.8878	76.10	0.90	9.2441	8.5631	158.7801	12.40
0.47	46.0172	46.0100	4234.5028	65.07	0.95	9.2271	6.2331	123.9909	11.14
0.48	38.5224	37.1258	2862.3008	53.50	1.00	8.3078	3.5024	81.2888	9.02
0.49	30.9623	28.3089	1760.0578	41.95	2.00	-7.1489	-1.5069	53.3775	7.31

We note that the Fourier sequence is given by the values  $x = 2.00, 1.00, 0.6667, 0.50, 0.40, 0.333, 0.2857, 0.25, 0.2222, 0.20$ , etc. Forming the sum of the  $R^2(x)$  for these values, we obtain  $R^2(x) = 9924.8978$ .

Hence, since  $2\sigma^2 = 2(\frac{1}{2}A^2) = 10,000$ , we see that 99.25 per cent of the energy is accounted for by these ten coefficients.

An inspection of the graph of  $R(x)$  clearly shows the existence of the period at  $x = 43/102 = 0.4216$ . One should particularly note the existence of the minor maxima on either side of the major peak. This is a characteristic feature of all

periodograms and one must be careful not to interpret these minor "shadows" of the real period as being evidences of other periodicities.

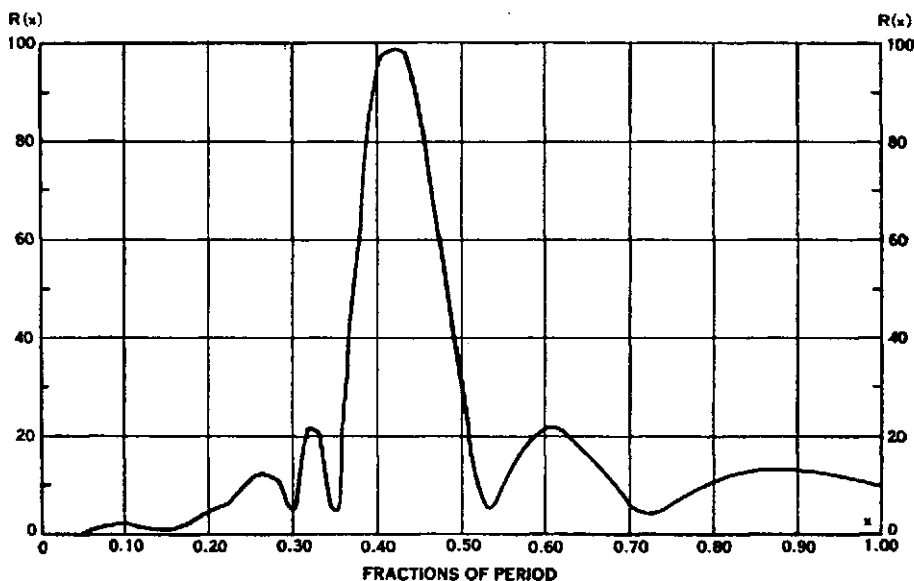

FIGURE 14.—PERIODOGRAM OF SIMPLE HARMONIC.

If in formulas (8) of the preceding section we divide both sides by  $a$  and invert the resulting equations, then we obtain as the minimum points of the periodogram the values

$$x_1 = \frac{a}{T_1} = \frac{1}{\mu - \frac{1}{2}} = \frac{1}{1.87209} = 0.5342,$$

$$x_2 = \frac{a}{T_2} = \frac{1}{\mu + \frac{1}{2}} = \frac{1}{2.87209} = 0.3482.$$

The difference,  $\Delta = x_1 - x_2 = 0.1860$ , gives the breadth of the peak. Since the two minimum points are clearly indicated on the graph at approximately 0.53 and 0.35, we could readily obtain an excellent approximation of the period  $x$  if it were actually unknown. Thus, employing formula (10) of the preceding section, we get  $\Delta/a = 0.53 - 0.35 = 0.18$ , and hence obtain as the desired approximation

$$x = P/a = \sqrt{0.18/(1 + 0.045)} = \sqrt{0.1722} = 0.415.$$

The error is observed to be only 0.007.

In order to illustrate the effect of interference in a periodogram we shall consider the periodograms of the two functions

$$(a) \quad y = 50 \sin\left(\frac{2\pi t}{35.7} + \frac{\pi}{4}\right) + 100 \sin\left(\frac{2\pi t}{43} + \frac{\pi}{4}\right),$$

$$(b) \quad y = 50 \sin\left(\frac{2\pi t}{35.7} + \frac{\pi}{4}\right) + 50 \sin\left(\frac{2\pi t}{43} + \frac{\pi}{4}\right),$$

over an assumed range of length  $2a = 204$ .

We note that for the first component in each function we have  $\mu = 102/35.7 = 2.85714$ , and hence its interference band would extend from  $x_2 = 1/(\mu + 0.5) = 0.2979$  to  $x_1 = 1/(\mu - 0.5) = 0.4242$ . This range seriously overlaps the interference band of the second component which, as we have previously calculated, extends from 0.3482 to 0.5342. The values of the periodograms of (a) and (b) are computed from the phase functions  $A(x)$  and  $B(x)$ , which are equal to the sums of the phase functions of each component separately. These values are given below and the periodograms are represented in Figure 15.

Periodogram Values for Function (a)				Periodogram Values for Function (b)			
$x$	$R(x)$	$x$	$R(x)$	$x$	$R(x)$	$x$	$R(x)$
0.30	2.11	0.40	107.01	0.30	0.52	0.40	62.21
0.31	1.43	0.41	106.48	0.31	8.45	0.41	57.92
0.32	8.39	0.42	102.26	0.32	18.96	0.42	52.37
0.33	14.75	0.43	95.69	0.33	30.57	0.43	46.36
0.34	35.97	0.44	86.75	0.34	41.82	0.44	39.93
0.35	53.10	0.45	76.47	0.35	51.54	0.45	33.54
0.36	70.21	0.46	65.45	0.36	59.24	0.46	27.41
0.37	84.62	0.47	54.25	0.37	63.67	0.47	21.72
0.38	96.09	0.48	43.32	0.38	65.48	0.48	16.58
0.39	103.62	0.49	33.01	0.39	64.89	0.49	12.04
						0.50	8.14

Although the graph of  $R(x)$  in each figure resembles the peak of a genuine period, it is clear that the peak is much too broad to have been derived from a single harmonic. This example illustrates the importance of checking the theoretical breadth of any peak suspected to have arisen from a single component.

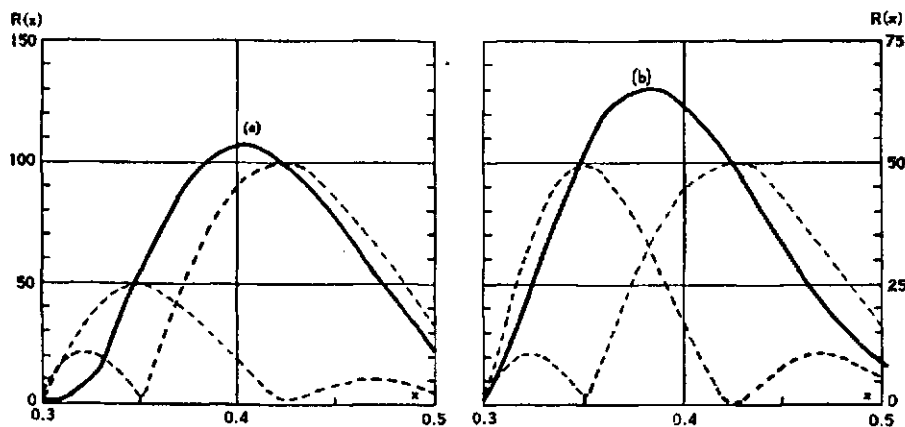

FIGURE 15.—PERIODOGRAMS SHOWING THE EFFECT OF INTERFERENCE BETWEEN COMPONENTS.

In this figure the difference between the periods is small.

Part (a) shows the periodogram of a function with two components of periods equal respectively to  $0.35a$  and  $0.42a$  and with amplitudes equal respectively to 50 and 100. The dotted lines are the periodograms of the two components.

Part (b) shows the periodogram of a function with two components of periods equal respectively to  $0.35a$  and  $0.42a$  but with equal amplitudes of 50. The dotted lines are the periodograms of the two components.

### 6. The Effect of a Linear Trend in Harmonic Analysis

Since many time series may be approximately described by means of a set of harmonic terms and a linear trend, it is important to know how the trend affects the components of the harmonic terms.

In order to investigate this problem we shall assume that a series of data in the interval  $-a \leq t \leq a$  has the trend

$$(1) \quad y = y_0 + mt.$$

Let us assume further that upon analysis the series has been found to have also a harmonic term of the form

$$(2) \quad h(t) = A(T) \cos \frac{2\pi t}{T} + B(T) \sin \frac{2\pi t}{T},$$

where  $A(T)$  and  $B(T)$  are values obtained from the periodogram.

We now expand  $y$  in a Fourier series in the interval  $-a \leq t \leq a$ , and thus obtain

$$(3) \quad y = y_0 + \frac{2ma}{\pi} \left[ \sin \frac{\pi t}{a} - \frac{1}{2} \sin \frac{2\pi t}{a} + \frac{1}{3} \sin \frac{3\pi t}{a} - \dots \right].$$

Now if in  $h(t)$  the period  $T$  belongs to the Fourier sequence, that is, if there is an integer  $n$  such that  $n = 2a/T$ , then the corresponding term in (3) must have been included in the periodogram value  $B(T)$ . Hence the coefficient of  $\sin(2\pi t/T)$  which belongs to the true harmonic, independent of the trend, must be  $B(T)$  diminished by that part due to the trend.

Since the influence of the trend upon the harmonic is the term

$$(-1)^n \frac{2ma}{\pi} \frac{1}{n} = (-1)^n \frac{mT}{\pi},$$

we obtain as the true harmonic the function

$$h'(t) = A(T) \cos \frac{2\pi t}{T} + B'(T) \sin \frac{2\pi t}{T},$$

where we abbreviate

$$(4) \quad B'(T) = B(T) + (-1)^n \frac{mT}{\pi}.$$

If  $\sigma^2$  is the variance of the original series, then the variance  $\sigma_1^2$  of the series reduced by the trend and the harmonic term will be

$$(5) \quad \sigma_1^2 = \sigma^2 - \sigma_T^2 - \sigma_H^2,$$

where  $\sigma_T^2$  is the variance due to the trend and  $\sigma_H^2$  that due to the harmonic term.

We have already shown above that

$$\sigma_H^2 = \frac{1}{2} [A^2(T) + B^2(T)]$$

For the trend we have

$$(6) \quad \sigma_T^2 = \frac{1}{2} \frac{4m^2a^2}{\pi^2} \left[ 1 + \frac{1}{2^2} + \frac{1}{3^2} + \dots \right] = \frac{m^2a^2}{3}.$$

If the series is defined over the interval  $0 \leq t \leq 2a$  instead of the interval  $-a \leq t \leq a$ , then the only modification in the above analysis is merely that  $B'(T)$  as given in (4) is replaced by

$$(7) \quad B'(T) = B(T) + \frac{mT}{\pi}.$$

Obviously in application the period  $T$  will not always belong to the Fourier sequence. In this case the analysis just given will yield only an approximation to the reduced variance  $\sigma_1^2$ .

An application of this theory will be found in the second example of the next section.

The analysis given here for the correction of the harmonic components for linear trend can easily be extended to include corrections for parabolic and higher polynomial trends.

Thus, if the trend is the parabola

$$y = y_0 + mt + pt^2,$$

and the data are given over the interval  $-a \leq t \leq a$ , then the original values of  $A(T)$  and  $B(T)$  must be replaced by the following:

$$(8) \quad A^*(T) = A(T) - (-1)^n pT^2/\pi^2, \quad B^*(T) = B(T) + (-1)^n mT/\pi.$$

Similarly, if the data are given over the interval  $0 \leq t \leq 2a$ , and if the origin of the parabola is at  $t=0$  with respect to this range, then the harmonic components  $A(T)$  and  $B(T)$  are replaced by

$$(9) \quad A^*(T) = A(T) - pT^2/\pi^2, \quad B^*(T) = B(T) + (m + 2ap)T/\pi.$$

Applications of these corrections will be found in Sections 24 and 26 of Chapter 7.

## 7. Applications to Economic Time Series

Since most economic data are given in discrete form, it will be desirable to formulate the technique of harmonic analysis somewhat differently. Thus, let us assume that the data are arranged as a set of equally spaced items:

Time	$t_1$	$t_2$	$t_3$	$\dots$	$t_N$
Data	$y_1$	$y_2$	$y_3$	$\dots$	$y_N$

where  $t_{n+1} - t_n$  is constant.

Then the amplitude of the periodogram corresponding to the trial period  $T$  is given by the function

$$(1) \quad R = R(T),$$

where we write

$$(2) \quad R^2(T) = A^2(T) + B^2(T),$$

$$A(T) = \frac{2}{N'} \sum_{t=1}^{N'} y_t \cos \frac{2\pi t}{T}, \quad B(T) = \frac{2}{N'} \sum_{t=1}^{N'} y_t \sin \frac{2\pi t}{T}.$$

Here the quantity  $N'$  is chosen equal to the largest multiple of  $T$  in the total frequency  $N$ . That is,  $N' = pT$ , where  $p$  is an integer.

The practical procedure is to arrange the data as follows:

$$(3) \quad \begin{array}{cccccc} y_1 & y_2 & y_3 & y_4 & \dots & y_T \\ y_{T+1} & y_{T+2} & y_{T+3} & y_{T+4} & \dots & y_{2T} \\ y_{2T+1} & y_{2T+2} & y_{2T+3} & y_{2T+4} & \dots & y_{3T} \\ \dots & \dots & \dots & \dots & \dots & \dots \\ y_{(p-1)T+1} & y_{(p-1)T+2} & y_{(p-1)T+3} & y_{(p-1)T+4} & \dots & y_{N'} \end{array}$$

Sums:  $M_1 \quad M_2 \quad M_3 \quad M_4 \quad \dots \quad M_T$

The functions  $A(T)$  and  $B(T)$  are then computed as the sums

$$(4) \quad A(T) = \frac{2}{N'} \sum_{t=1}^T M_t \cos \frac{2\pi t}{T}, \quad B(T) = \frac{2}{N'} \sum_{t=1}^T M_t \sin \frac{2\pi t}{T}.$$

As an example let us consider the evaluation of  $R(T)$  for the following data which give the monthly averages of freight-car loadings for the period 1919-1932.

## MONTHLY AND ANNUAL AVERAGES OF MEAN WEEKLY FREIGHT-CAR LOADINGS

(unit, 1,000 cars)

Year	Jan.	Feb.	Mar.	Apr.	May	June	July	Aug.	Sept.	Oct.	Nov.	Dec.	Annual Averages
1919	728	687	697	715	759	809	858	892	960	967	807	758	808
1920	820	776	848	731	862	860	901	968	969	1005	884	723	862
1921	705	683	692	706	757	765	751	810	841	929	761	682	767
1922	702	765	826	723	787	842	825	877	935	992	944	538	838
1923	845	842	917	941	975	1011	986	1041	1037	1078	978	826	966
1924	858	908	916	875	895	906	894	974	1037	1091	976	847	931
1925	921	905	924	941	968	989	986	1080	1074	1107	1024	888	984
1926	923	919	969	958	1037	1028	1049	1104	1148	1205	1068	904	1026
1927	946	956	1002	975	1024	999	979	1062	1097	1115	956	834	995
1928	862	897	951	935	1002	985	986	1058	1117	1175	1061	893	993
1929	893	942	962	996	1051	1052	1038	1117	1135	1169	978	835	1014
1930	837	876	883	912	914	930	895	938	931	950	798	680	879
1931	719	710	755	752	740	748	738	747	737	759	655	555	716
1932	567	561	565	557	522	491	483	525	577	634	549	485	543
Av.	809	816	849	837	878	887	884	942	971	1013	898	767	878

The items in the series are first arranged in horizontal rows for each value of  $T$ , taking  $T = 5, 6, 7, \dots, 26$ . The sums are then found for each column. Thus for  $T = 15$ , one gets the following arrangement:

Columns	1	2	3	4	5	6	7	8	9	10	11	12	13	14	15
Values of the Monthly Averages	728	687	697	715	759	809	858	892	960	967	807	758	820	776	848
	731	862	860	901	968	969	1005	884	723	705	683	692	708	757	765
	751	810	841	929	761	683	702	765	826	723	787	842	825	377	935
	992	944	838	845	842	917	941	975	1011	986	1041	1037	1078	978	826
	858	908	916	875	895	906	894	974	1037	1091	975	847	921	906	924
	941	968	983	986	1080	1074	1107	1024	888	923	919	969	958	1037	1023
	1049	1104	1148	1205	1068	904	946	956	1002	975	1024	999	979	1062	1047
	1116	956	834	862	897	951	935	1002	985	986	1058	1117	1175	1061	893
	893	942	962	996	1051	1052	1038	1117	1135	1169	978	835	837	876	883
	912	914	930	895	938	931	950	798	680	719	710	735	752	740	748
738	747	737	759	655	555	587	561	565	557	522	491	483	525	577	
Sums: ( $M_i$ )	9708	9842	9752	9968	9914	9751	9943	9948	9812	9801	9504	9322	9634	9594	9514

We observe that of the 168 items of the data only 165 are used in the above array. That is to say,  $N = 168$ , while  $N' = 11 \times 15 = 165$ .

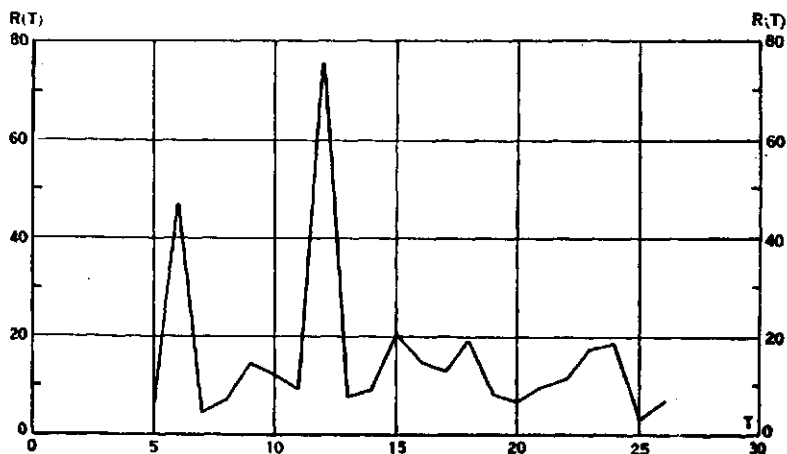

FIGURE 16.—PERIODOGRAM OF FREIGHT-CAR LOADINGS.



Proceeding in this manner 21 arrangements of the data are made and the sums are recorded as in the accompanying table.

## PERIODOGRAM ANALYSIS, FREIGHT-CAR LOADINGS, 1919-1932

Columns	Values of $M_t$ corresponding to the periods $T$										
	5	6	7	8	9	10	11	12	13	14	15
1	<b>28942</b>	23695	21228	18657	16312	14430	13235	11326	10820	10721	9708
2	29107	24619	<b>21234</b>	18890	16031	14417	<b>13079</b>	11426	10891	10486	9542
3	29234	25482	20933	18121	16393	14366	13205	11887	<b>10651</b>	10623	9752
4	<b>25274</b>	<b>23393</b>	21171	17849	16087	14262	13256	11717	10758	10533	<b>9948</b>
5	29229	24731	20986	18557	16069	14195	13179	12293	10742	10622	9914
6		<b>23154</b>	20935	19127	16128	14010	13399	12415	10853	10759	9751
7			21087	18573	15719	14199	13414	12869	10972	10618	9943
8				<b>17800</b>	15555	14385	13367	13193	11056	10607	9948
9					16027	14587	13365	13595	10967	10447	9812
10						14457	13278	14175	10891	10548	9801
11							13109	12438	10760	10402	9504
12								<b>10739</b>	10793	10364	<b>9322</b>
13									10904	10475	9534
14										10459	9594
15											9514
( $\Delta$ ) <sup>*</sup>	412	2739	301	1327	838	577	335	3437	405	395	646
$\Sigma M/\sigma$	0.8959	6.1273	0.7942	2.9065	1.5967	1.0161	0.7198	6.1092	0.6936	0.7184	1.2173
Columns	Values of $M_t$ corresponding to the periods $T$										
	16	17	18	19	20	21	22	23	24	25	26
1	9047	8022	8041	7334	7264	<b>7261</b>	6266	6587	5757	<b>5345</b>	5456
2	9150	8191	8300	7216	7440	7075	<b>6215</b>	6485	5724	5325	5484
3	8895	8246	8731	7206	7085	6947	6317	6246	5929	5463	5397
4	8789	8334	8417	7338	6816	7033	6323	6085	6026	5656	5338
5	9033	8463	8041	7233	7084	7019	6319	5914	6274	<b>5858</b>	5316
6	<b>9396</b>	8242	7680	7205	7185	6927	6397	5960	6373	5768	5394
7	9159	8186	7892	7073	7086	7080	6533	6202	6336	<b>5503</b>	5465
8	8788	8121	8069	7245	7071	7103	6520	6268	6749	5506	5431
9	9088	8254	8418	7286	7378	7060	<b>6548</b>	6500	6331	5493	5445
10	9249	8230	8271	7211	7507	7250	6518	6637	7124	5257	5439
11	8743	8152	7731	7256	7166	7098	6295	6624	6159	<b>5130</b>	5379
12	<b>8536</b>	8164	7662	7307	6977	7050	6314	6519	5379	5186	5434
13	8897	7995	7670	7470	7281	7249	6309	6540	5569	5391	5505
14	9095	8012	8028	7413	7446	7023	6321	6325	5702	5394	5364
15	8845	8139	8448	7275	7111	6864	6367	6221	5958	5418	5457
16	<b>8527</b>	8025	7827	7281	6825	6798	6295	5959	5691	5462	5344
17		8314	7486	7255	7113	6974	6445	5772	6019	5769	5420
18			7609	7266	7314	6804	6359	5780	6042	5780	5426
19				7432	7214	6917	6358	5990	6033	5761	5459
20					6950	7058	6354	6115	6444	5664	5507
21						6984	6235	6247	6714	5442	5625
22							6237	6419	7052	5419	5522
23								6455	6279	5313	5462
24									5360	5211	5381
25										5245	5359
26											5399
( $\Delta$ ) <sup>*</sup>	871	468	1245	397	691	405	333	865	1764	725	318
$\Sigma M/\sigma$	1.5846	0.7986	2.2144	0.5937	1.2244	0.8166	0.6235	1.7028	3.1330	1.3213	0.4442

\* The values  $\Delta$  are obtained by subtracting in each column the smallest value from the largest value. The figures in bold face designate these values. The items  $\Sigma M/\sigma$  are the standard deviations of the columns divided by the standard deviation of the original series, namely,  $\sigma = 154.6$ . For an explanation, see the next section.

These columns of  $M_t$  are now multiplied successively by  $\cos(2\pi t/T)$  and  $\sin(2\pi t/T)$ ,  $t = 1, 2, 3, \dots, T$ , summed, and multiplied by  $2/N'$  to obtain the values of  $A(T)$  and  $B(T)$  as given in formula (3). From these the values of

$R^2(T)$  and  $R(T)$  are finally computed as the elements of the periodogram. The results of these computations are then tabulated as follows:

PERIODOGRAM OF FREIGHT-CAR LOADINGS, 1919-1932  
 $A = 878.42$ ,  $\sigma = 154.50$ ,  $\sigma^2 = 23,870.2441$ ,  $2\sigma^2 = 47,740.4882$

$T$	$N'$	$A(T)$	$B(T)$	$R^2$	$R$	$T$	$N'$	$A(T)$	$B(T)$	$R^2$	$R$
5	165	0.6904	- 5.5544	32.4486	5.70	16	160	-10.8471	10.0918	219.5032	14.82
6	168	-40.1310	-23.8158	2177.6869	46.67	17	153	- 5.0269	11.6832	161.7665	12.72
7	168	0.5473	4.3761	19.4501	4.41	18	162	- 1.7398	18.9802	363.2730	19.06
8	168	4.0634	- 5.7846	49.9723	7.07	19	152	3.7861	- 7.1347	65.2379	8.08
9	162	- 6.4863	12.7100	203.6147	14.27	20	160	- 5.6139	- 3.1933	41.7133	6.46
10	160	11.7245	3.0638	146.8498	12.12	21	168	- 7.0285	6.8333	96.1626	9.81
11	165	- 4.1354	- 7.7980	77.9098	8.83	22	154	-10.4692	4.4188	129.1279	11.36
12	168	-25.0916	-70.9743	5666.9430	75.28	23	161	-11.4123	13.5179	312.9743	17.69
13	156	- 3.5037	- 7.0514	61.9981	7.87	24	168	1.1808	13.8861	353.0776	18.92
14	168	- 4.2985	7.7275	78.1916	8.84	25	150	1.7146	- 2.1002	7.3605	2.71
15	165	-14.1744	14.6379	415.1840	20.38	26	158	- 1.3075	- 6.7452	47.2076	6.87

The values of  $R(T)$  are graphically represented in Figure 16, which clearly shows the existence of periods at  $T = 6$  and  $T = 12$ . Since these two periods belong to the Fourier sequence, the per cent of the total energy of the data contained in these periods may be exactly computed from the formula

$$\text{Per cent of energy} = \left[ \frac{R^2(6) + R^2(12)}{2\sigma^2} \right] = 16.43\% .$$

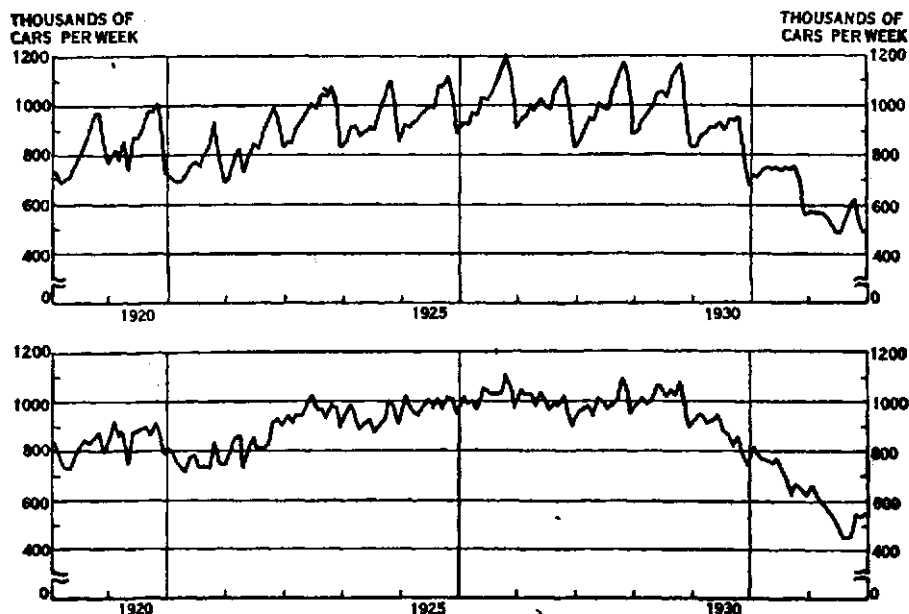

FIGURE 17.—FREIGHT-CAR LOADINGS

Upper curve: Monthly averages of mean weekly loadings, showing seasonal variations; Lower curve: Same with 6- and 12-month cycles removed.

Figure 17 shows the relative unimportance of seasonal variations in comparison with secular moves. The lower curve shows graphically the effect of removing the 6- and 12-month cycles from the original data represented in the upper curve. The residuals,  $Y_i$ , are computed from the formula

$$Y_i = y_i - \left[ A(6) \cos \frac{2\pi t}{6} + B(6) \sin \frac{2\pi t}{6} + A(12) \cos \frac{2\pi t}{12} + B(12) \sin \frac{2\pi t}{12} \right],$$

where  $t$  assumes the values 1, 2, 3, ..., 168.

A second example of the application of harmonic analysis to economic time series will illustrate how a periodogram may be interpreted. The data chosen are the monthly averages of the Cowles Commission All Stocks index from 1880 to 1896. The arithmetic average, variance, and total number of items are respectively  $A = 40.71$ ,  $\sigma^2 = 21.8830$ , and  $N = 204$ .

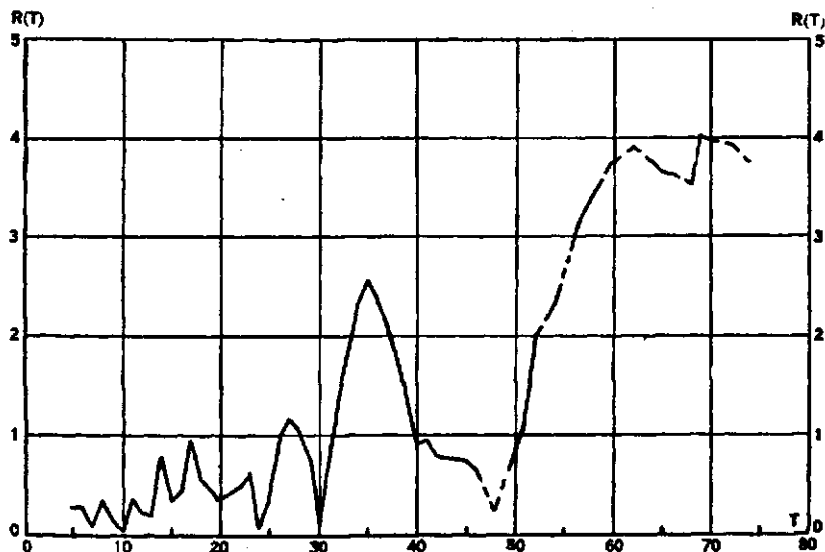

FIGURE 18.—PERIODOGRAM OF COWLES COMMISSION ALL STOCKS INDEX, 1880-1896.

An inspection of the periodogram, Figure 18, reveals two principal periods, one at  $T=35$  and the other at  $T=62$ . The values of the harmonic components for these periods are given respectively by  $A(35) = -1.6127$ ,  $B(35) = 1.9801$ , and  $A(62) = -3.2710$ ,  $B(62) = 2.0969$ . From these we compute  $R^2(35) = 6.5216$  and  $R^2(62) = 15.0964$ . Neither  $T=35$  nor  $T=62$  belongs to the Fourier sequence although the former is within one unit of  $T=34$  and the other 6 units from  $T=68$ , both of which belong to the sequence. However, we may assume that

formula (11) of Section 4 holds approximately and hence we can make the following estimate of the energy of the movement in the series which is accounted for by the two harmonics:

$$E = \frac{R^2(35) + R^2(62)}{2\sigma^2} = 0.4939.$$

Since the components of the energy are not strictly additive, this estimate should be compared with the energy of the adjoining harmonics of the Fourier sequence. This energy is equal to  $E(34) + E(68) = 0.4047$ . Hence from 40 to 49 per cent of the total movement of the series is accounted for by these harmonics.

We note from the graph of the series, however, that there exists a slight secular trend in the data. This trend is represented by the equation

$$(5) \quad y = 45.9403 - 0.052325t,$$

where the origin is at the first item of the data and  $t$  is months.

Since the slope of the trend is not great, we see from the discussion in Section 6 that the harmonic analysis is not seriously affected by it. Hence a good fit to the data should be expected from the function

$$(6) \quad y = y(t) + A(35) \cos \frac{2\pi t}{35} + B(35) \sin \frac{2\pi t}{35} + A(62) \cos \frac{2\pi t}{62} + B(62) \sin \frac{2\pi t}{62},$$

where  $y(t)$  is the trend given by (5).

The values as computed from (6) are recorded below as follows:

$t$	$y$	$t$	$y$	$t$	$y$	$t$	$y$
0	41.1	51	42.0	103	38.3	156	42.0
3	42.9	55	39.8	107	37.9	159	40.8
7	45.8	59	37.9	111	38.3	163	37.4
11	48.3	63	37.2	115	38.6	167	34.2
15	49.4	67	38.2	119	38.3	171	32.2
19	49.1	71	40.6	123	37.5	175	31.8
23	47.7	75	43.8	127	36.5	179	32.8
27	46.0	79	46.4	131	36.1	183	34.4
31	45.1	83	47.7	135	36.8	187	35.7
35	44.7	87	47.1	139	38.7	191	36.2
39	44.7	91	44.9	143	41.2	195	36.0
43	44.6	95	42.2	147	43.4	199	35.8
47	43.8	99	39.7	151	44.3	204	36.5

The graphical representation of equation (6) is shown in Figure 19. The variance of the residuals as computed from the values in the table just given is found to equal 6.7942, which indicates that the trend and the two harmonic terms together have accounted for approximately

$$E = 100[1 - (6.7942/21.8830)] = 69\%$$

of the total variation.

It is illuminating to estimate the residual variance if the refinements suggested by Section 6 are employed to take account of the

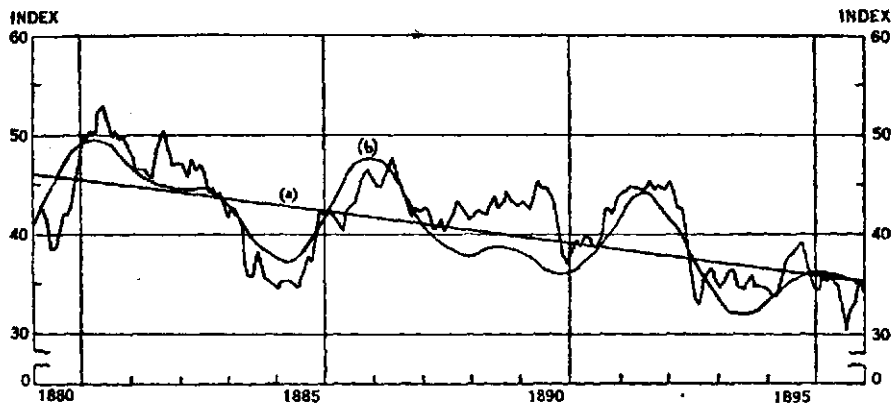

FIGURE 19.—HARMONIC REPRESENTATION OF COWLES COMMISSION ALL STOCKS INDEX, 1880-1896.

- (a) Straight-line trend,  
(b) Fourier approximation.

effect of the trend upon the components of the harmonic terms. Employing formula (7) of Section 6, we see that  $B(34)$  and  $B(62)$  must be replaced by

$$B'(34) = 1.9801 - 0.5829 = 1.3972,$$

$$B'(62) = 2.0969 - 1.0325 = 1.0644.$$

Hence the variance of the harmonic term is 7.0999, and since the variance of the trend is 9.6352, the residual variance will be approximately

$$\sigma_1^2 = 21.8830 - 9.6352 - 7.0999 = 5.1479.$$

A similar computation, using the values for the harmonics  $T = 34$  and  $T = 68$ , gives as the expected variance the values  $\sigma_1^2 = 6.5815$ . The true variance lies between these two estimates. Hence the maximum estimate of the per cent of energy that can be accounted for by the trend and the two harmonics, using the smaller of the two figures just given, is 76 per cent, an increase of only 7 per cent over the estimate attained by neglecting the correction for the trend.

### 8. Other Methods of Harmonic Analysis

Several methods of harmonic analysis have been suggested by various writers, and some of these have already been mentioned in the first chapter. It will be useful to describe four of these in somewhat greater detail.

*The Whittaker-Robinson Periodogram.* An interesting and useful periodogram has been devised by E. T. Whittaker and G. Robinson based upon the variations in the sequence  $M_1, M_2, \dots, M_T$  given in (3) of the preceding section. Thus they replace the ordinates of the Schuster periodogram by the square root of the following ratio:

$$\eta^2(T) = \frac{\sigma_M^2(T)}{\sigma^2},$$

where  $\sigma_M^2(T)$  is the variance of the sequence of the mean values of the  $M$ 's corresponding to the period  $T$ , and  $\sigma^2$  is the variance of the data.

The theory of this method is as follows: Let us assume that the elements of the data may be written

$$y_t = A \sin(2\pi t/P) + B_t,$$

where  $B_t$  is a part which does not contain the period  $P$  and is not correlated with it. The variance of the data is then given by

$$\sigma^2 = \frac{1}{2} A^2 + \sigma_B^2,$$

where  $\sigma_B^2$  is the variance of the elements  $B_t$ .

Similarly we find

$$M_s = A \sum_{n=0}^{(p-1)T} \sin 2\pi(t+n)/P + C_s = A \frac{\sin \frac{p\pi T}{P}}{\sin \frac{\pi T}{P}} \sin \left[ \frac{2\pi s + (p-1)\pi T}{P} \right] + C_s,$$

where  $C_s$  is the sum of the elements  $B_t$ .

The variance of the values  $M_s$  is computed from

$$\sum M^2 = \frac{1}{2} A^2 \frac{\sin^2 \frac{p\pi T}{P}}{\sin^2 \frac{\pi T}{P}} + \sigma_C^2,$$

where  $\sigma_C^2$  is the variance of the elements  $C_s$ .

We now compute  $\eta^2(T)$ , noting that  $p^2 \sigma_M^2 = \sum M^2$ , and thus obtain

$$\eta^2(T) = \frac{\frac{1}{2}(A/p)^2 [\sin^2(p\pi T/P) / \sin^2(\pi T/P)] + \sigma_C^2/p^2}{\frac{1}{2}A^2 + \sigma_B^2}.$$

Since  $\sigma_C^2$  is of the order of  $p \sigma_B^2$ , it is clear that  $\eta^2$  will remain small, when  $p$  is large, provided  $P$  is different from  $T$ , but that it will

tend to increase sharply when  $P$  is close to  $T$  in value. This maximum may be shown actually to equal

$$\text{Max } \eta^2(T) = \frac{\frac{1}{2}A^2 + \sigma_B^2/p}{\frac{1}{2}A^2 + \sigma_B^2}.$$

In the first periodogram of the preceding section the values of  $\Sigma M/\sigma$  have been recorded and from these the Whittaker-Robinson periodogram can be constructed immediately. One notes the large values for  $T = 6$  and  $T = 12$ , results in complete agreement with those obtained from the Schuster periodogram.

*Method of Maximum Differences.* When a preliminary survey of a set of data is desired, this survey may be accomplished with a minimum of computation in the following manner:

A table of the values of  $M_t$  is first constructed and the following differences then computed:

$$\Delta(T) = M(T) - m(T),$$

where  $M(T)$  is the largest value of  $M_t$  corresponding to  $t = T$  and  $m(T)$  is the smallest value of  $M_t$ . The fluctuations of  $\Delta(T)$  will in many cases reveal the essential period in the data if such a period exists. This method is crude, however, and should be applied with caution. No measure of the statistical significance of differences between the various values of  $\Delta(T)$  has been devised.

The values of these differences have been computed for the data on freight-car loadings given in Section 7. The large values observed at  $T = 6$  and  $T = 12$  again accord with the findings of the Schuster periodogram.

*Approximate Schuster Periodogram.* An approximation to the Schuster periodogram can be attained by a simple device, which very much reduces the labor of computation necessary when the technique of the Schuster periodogram is applied to a set of data of any length.

Let us note that the function  $S(t)$  as defined by the graph (a) in Figure 20 is represented by the following Fourier series:

$$S(t) = \frac{4}{\pi} \left[ \sin \frac{2\pi t}{T} + \frac{1}{3} \sin \frac{6\pi t}{T} + \frac{1}{5} \sin \frac{10\pi t}{T} + \dots \right].$$

Similarly, the function  $C(t)$  as defined by the graph (b) is represented by the Fourier series

$$C(t) = \frac{4}{\pi} \left[ \cos \frac{2\pi t}{T} - \frac{1}{3} \cos \frac{6\pi t}{T} + \frac{1}{5} \cos \frac{10\pi t}{T} - \dots \right].$$

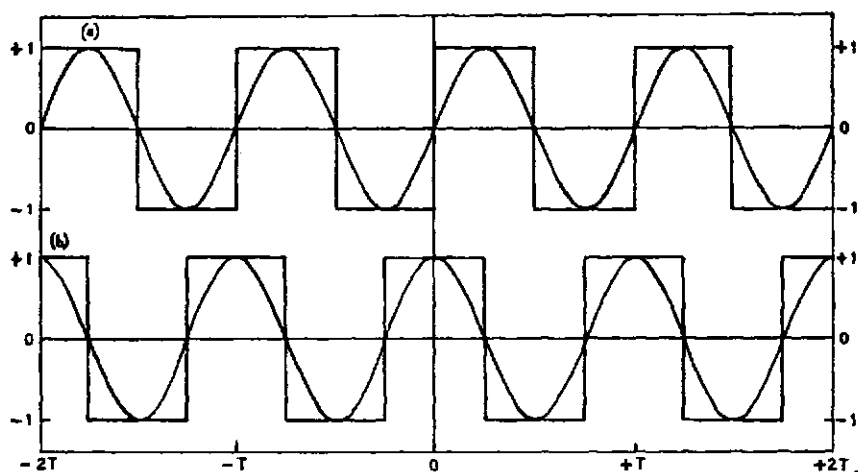

FIGURE 20.—STEP FUNCTION WITH FIRST FOURIER APPROXIMATION.

- (a) Odd function represented by sines,  
 (b) Even function represented by cosines.

Hence we see that to a first approximation  $\sin(2\pi t/T)$  may be replaced by  $S(t)$  and  $\cos(2\pi t/T)$  may be replaced by  $C(t)$  in formulas (2) of Section 4. We should thus have

$$A(T) = \frac{\pi}{4a} \int_{-a}^a C(s) f(s) ds, \quad B(T) = \frac{\pi}{4a} \int_{-a}^a S(s) f(s) ds;$$

and the approximate Schuster periodogram is given by

$$R(T) = \sqrt{A^2(T) + B^2(T)}.$$

The advantage of this method is found in the obvious simplicity of the calculations. The errors, however, may be considerable.

Applying this method to the data on car loadings as given in Section 7, we readily compute  $A(12) = -33.6412$ ,  $B(12) = -50.9199$ , and hence obtain  $R(12) = 61.0292$ . These values may be compared with their Schuster equivalents, namely,  $A(12) = -25.0916$ ,  $B(12) = -70.9743$ , and  $R(12) = 75.28$ .

*The Method of Serial Correlations.* Still another method of harmonic analysis is found in the use of serial correlations. Since, however, the next chapter is devoted to this subject, we shall postpone discussion of this method and its implications until a more adequate treatment can be given.



## 9. The Exact Determination of the Period.

By means of what has been called the *secondary analysis of the periodogram* it is possible to determine with considerable accuracy the value of a period indicated by the periodogram itself.

This determination is made from the analysis of the components  $A_n$  and  $B_n$  for some period  $T$  in the neighborhood of the true period  $P$ . Let us assume that the harmonic term indicated by a peak of the periodogram is actually

$$y = A \sin\left(\frac{2\pi t}{P} + \beta\right),$$

and let  $T$  be some convenient trial period in the neighborhood of  $P$ . Preferably  $T$  should belong to the Fourier sequence, since it is then an exact multiple of the range  $2a$ , although this is not a necessary requirement. Now let the range be divided into  $p$  intervals of length  $mT$ , that is, into the intervals  $(0, mT)$ ,  $(mT, 2mT)$ ,  $(2mT, 3mT)$ , ...,  $[(p-1)mT, pmT]$ , where  $pmT = 2a$ . In case the series is short, or if  $T$  is large, the value of  $m$  may conveniently be assumed to equal 1.

We now consider the  $r$ th interval,  $[(r-1)mT, rmT]$ , and compute for it the corresponding constants,  $A_r$  and  $B_r$ . These are found to be

$$\begin{aligned} A_r &= \frac{1}{mT} \int_{(r-1)mT}^{rmT} A \sin\left(\frac{2\pi s}{P} + \beta\right) \cos \frac{2\pi s}{T} ds \\ &= \frac{A}{\pi m} \frac{PT}{T^2 - P^2} \sin \frac{mT}{P} \cos \left[ \frac{\pi(2r-1)mT}{P} + \beta \right]; \\ B_r &= \frac{1}{mT} \int_{(r-1)mT}^{rmT} A \sin\left(\frac{2\pi s}{P} + \beta\right) \sin \frac{2\pi s}{T} ds \\ &= -\frac{A}{\pi m} \frac{P^2}{T^2 - P^2} \sin \frac{mT}{P} \sin \left[ \frac{\pi(2r-1)mT}{P} + \beta \right]. \end{aligned}$$

From these values we then compute the tangent of the phase constant  $\phi_r$ , that is,

$$\tan \phi_r = \frac{B_r}{A_r} = \frac{-P}{T} \tan \left[ \frac{\pi(2r-1)mT}{P} + \beta \right].$$

Since, by assumption,  $T$  is close to  $P$  we may replace  $P/T$  by 1 and hence may write

$$\tan \phi_r = -\tan \left[ \pi(2r-1) \frac{mT}{P} + \beta \right]$$

$$\tan \phi = \tan \left[ 2\pi m r - \pi (2r-1) \frac{mT}{P} + \beta \right].$$

From this equation we obtain the important result that

$$\phi_r = 2m\pi r - (2r-1) \frac{mT}{P} + \beta.$$

The change in phase from one interval to the next is thus found to be

$$\alpha = \phi_r - \phi_{r-1} = 2m\pi - 2\pi(mT/P).$$

Solving this for  $P$  we then obtain

$$(1) \quad P = \frac{T}{1 - \frac{\alpha}{2m\pi}}.$$

Hence, if the phase change from group to group is known, we can determine the value of the period  $P$  from this formula.

As an example we shall consider the periodogram of the constructed sine-cosine series as given in Chapter 7. In order to determine accurately the period observed between the limits  $T = 38$  and  $T = 52$ , the values of the components are determined for the trial period  $T = 50$ , since this belongs to the Fourier sequence of the 300 items constituting the data.

Since the trial period is large,  $m$  is chosen equal to 1. The following table of the phase constants is then computed by letting  $r$  range from 1 to 6:

$r$	$A_r(T)$	$B_r(T)$	$\tan \phi_r$	$\phi_r$ (in degrees)	$\phi_r$ (in $2\pi$ radians)
1	1.2972	-19.7696	-15.2402	278° 45'	0.7604
2	-13.0164	-14.9048	1.1451	228° 52'	0.6357
3	-14.6296	-0.8978	0.0593	183° 24'	0.5094
4	-9.9284	11.5280	-1.1611	130° 44'	0.3631
5	0.1416	27.1724	191.8950	89° 42'	0.2492
6	12.6028	17.6384	1.3926	54° 27'	0.1512

Fitting a straight line to  $r$  and  $\phi_r$  (in  $2\pi$  radians) we obtain the equation

$$\phi_r = 0.8800 - 0.1243 r.$$

The linear character of the phase is clearly observed in Figure 21.

Substituting the slope value  $\alpha = -0.1243(2\pi)$  in formula (1), we obtain as the value of  $P$

$$P = 50 / (1.1243) = 44.47.$$

Since by construction the period was actually exactly equal to 44.00, this agreement is seen to be excellent, particularly if we observe that  $T/P = 1.14$ .

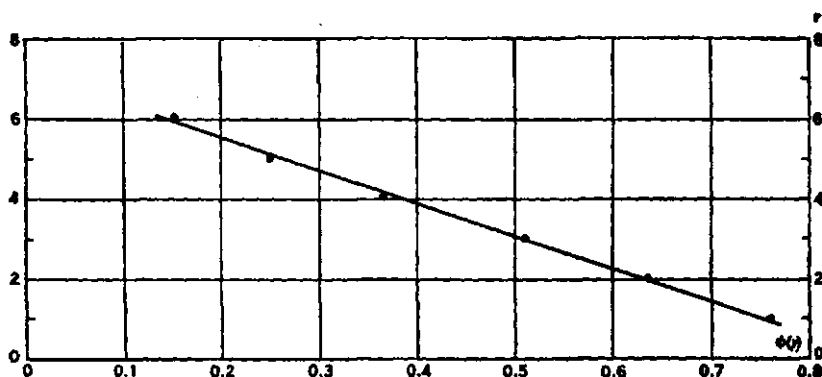

FIGURE 21.—INTERVAL CHANGE OF PHASE.

### 10. Orthogonal Functions

The ideas which we have developed in preceding sections with respect to harmonic analysis are generalized in many ways by the theory of *orthogonal functions*, a class of functions which includes the sine and cosine as special cases. The use of orthogonal functions has become very important in many phases of statistics. The fact that linear combinations of them are frequently used as trends in the study of economic data amply justifies the inclusion of a description of their properties in a volume devoted to time series.<sup>8</sup>

Suppose that we are given a set of functions

$$U_1(t), U_2(t), U_3(t), \dots, U_n(t), \dots,$$

which are defined over some interval  $a \leq t \leq b$ . If there exists a function  $F(t)$ , positive over the given interval, such that

$$(1) \quad \int_a^b F(t) U_i(t) U_j(t) dt = 0, \quad i \neq j,$$

then the functions are said to be *orthogonal* to one another.<sup>9</sup> The

<sup>8</sup> For a discussion of some of the dangers inherent in the blind use of linear combinations of orthogonal functions, see C. F. Roos, *Dynamic Economics*, Bloomington, Ind., 1934, Appendix I. For a comprehensive treatise on the methods of fitting various systems of functions to statistical data the reader is referred to M. Sasuly, *Trend Analysis of Statistics*, Washington, D.C., 1934, xiii + 421 pp.

<sup>9</sup> The origin of the word *orthogonal* (rectangular) may be ascertained from the following geometrical consideration. Let  $A$  and  $B$  be two lines emanating from a common origin, with direction cosines equal respectively to  $(\lambda_1, \lambda_2, \lambda_3)$  and  $(\mu_1, \mu_2, \mu_3)$ . Then the cosine of the angle  $\theta$ , between  $A$  and  $B$ , is given by

$$\cos \theta = \sum_{n=1}^3 \lambda_n \mu_n.$$

If  $A$  is perpendicular (orthogonal) to  $B$ , then  $\theta = \frac{1}{2} \pi$ , and we have the

function  $F(t)$  is called a *weight function* and may be chosen equal to 1 without loss of generality, since we need merely define our orthogonal set as

$$V_1(t), V_2(t), V_3(t), \dots, V_n(t), \dots,$$

where  $V_n(t) = \sqrt{F(t)} U_n(t)$ . There is some advantage, however, in introducing  $F(t)$  explicitly.

The most common orthogonal functions are: (a) the trigonometric functions; (b) the Legendre polynomials; (c) the Hermite polynomials; (d) the Laguerre polynomials; (e) the Bessel functions; (f) the Tchebycheff polynomials.

For ready reference these well-known sets of functions are listed here:

$$(a)^\dagger \quad \int_{-a}^a \sin \frac{m\pi t}{a} \sin \frac{n\pi t}{a} dt = 0, \quad m \neq n,$$

$$\int_{-a}^a \sin^2 \frac{n\pi t}{a} dt = a.$$

$$(a') \quad \int_{-a}^a \cos \frac{m\pi t}{a} \cos \frac{n\pi t}{a} dt = 0, \quad m \neq n,$$

$$\int_{-a}^a \cos^2 \frac{n\pi t}{a} dt = a.$$

$$(b) \quad \int_{-1}^1 P_m(t) P_n(t) dt = 0, \quad m \neq n,$$

$$\int_{-1}^1 P_n^2(t) dt = 2/(2n+1),$$

where  $P_n(t)$ , the Legendre polynomials, are given as follows:

$$P_0(t) = 1, \quad P_1(t) = t, \quad P_2(t) = \frac{1}{2}(3t^2 - 1), \quad P_3(t) = \frac{1}{2}(5t^3 - 3t),$$

orthogonality condition

$$\sum_{n=1}^3 \lambda_n \mu_n = 0.$$

<sup>†</sup> We also note the following biorthogonal relationship:

$$\int_{-a}^a \sin \frac{m\pi t}{a} \cos \frac{n\pi t}{a} dt = 0, \quad \text{for all integral values of } m \text{ and } n.$$

$$P_4(t) = \frac{1}{8}(35t^4 - 30t^2 + 3), \quad P_5(t) = \frac{1}{8}(63t^5 - 70t^3 + 15t), \dots,$$

$$P_n(t) = \frac{(2n)!}{2^n (n!)^2} \left[ t^n - \frac{n(n-1)}{2(2n-1)} t^{n-2} + \frac{n(n-1)(n-2)(n-3)}{2 \cdot 4(2n-1)(2n-3)} t^{n-4} - \dots \right].$$

$$(c) \quad \int_{-\infty}^{\infty} \frac{1}{\sqrt{2\pi}} e^{-t^2} h_m(t) h_n(t) dt = 0, \quad m \neq n,$$

$$\int_{-\infty}^{\infty} \frac{1}{\sqrt{2\pi}} e^{-t^2} h_n^2(t) dt = n!,$$

where  $h_n(t)$ , the Hermite polynomials, are given as follows:

$$h_0(t) = 1, \quad h_1(t) = t, \quad h_2(t) = t^2 - 1, \quad h_3(t) = t^3 - 3t,$$

$$h_4(t) = t^4 - 6t^2 + 3, \quad h_5(t) = t^5 - 10t^3 + 15t, \dots,$$

$$h_n(t) = t^n - \frac{n(n-1)}{2} t^{n-2} + \frac{n(n-1)(n-2)(n-3)}{2 \cdot 4} t^{n-4} - \dots.$$

A second form of the Hermite polynomials is in common use, connected with  $h_n(t)$  by the relation

$$h_n(t) = 2^{-n} H_n(t/\sqrt{2}), \quad H_n(t) = 2^{n/2} h_n(\sqrt{2}t).$$

For  $H_n(t)$  we have the following orthogonality conditions:

$$\int_{-\infty}^{\infty} e^{-t^2} H_m(t) H_n(t) dt = 0, \quad m \neq n,$$

$$\int_{-\infty}^{\infty} e^{-t^2} H_n^2(t) dt = 2^n n! \sqrt{\pi}.$$

Values of  $H_n(t)$  are given explicitly as follows:

$$H_0(t) = 1, \quad H_1(t) = 2t, \quad H_2(t) = 4t^2 - 2, \quad H_3(t) = 8t^3 - 12t,$$

$$H_4(t) = 16t^4 - 48t^2 + 12, \quad H_5(t) = 32t^5 - 160t^3 + 120t, \dots,$$

$$H_n(t) = (2t)^n - \frac{n(n-1)}{1!} (2t)^{n-2} + \frac{n(n-1)(n-2)(n-3)}{2!} (2t)^{n-4} - \dots.$$

$$(d) \quad \int_0^{\infty} e^{-t} L_m(t) L_n(t) dt = 0, \quad m \neq n,$$

$$\int_0^{\infty} e^{-t} L_n^2(t) dt = 1,$$

where  $L_n(t)$ , the Laguerre polynomials, are given as follows:

$$L_0(t) = 1, \quad L_1(t) = -t + 1, \quad L_2(t) = (t^2 - 4t + 2)/2!,$$

$$L_3(t) = (-t^3 + 9t^2 - 18t + 6)/3!,$$

$$L_4(t) = (t^4 - 16t^3 + 72t^2 - 96t + 24)/4!,$$

$$L_5(t) = (-t^5 + 25t^4 - 200t^3 + 600t^2 - 600t + 120)/5!, \dots,$$

$$L_n(t) = (-1)^n \left[ t^n - \frac{n^2}{1!} t^{n-1} + \frac{n^2(n-1)^2}{2!} t^{n-2} - \frac{n^2(n-1)^2(n-2)^2}{3!} t^{n-3} + \dots - n! \right] / n!.$$

$$(e) \quad \int_0^{\alpha} t J_0(\mu_m t) J_0(\mu_n t) dt = 0, \quad m \neq n,$$

$$\int_0^{\alpha} t J_0^2(\mu_n t) dt = \frac{1}{2} \alpha^2 [J_0^2(\mu_n \alpha) + J_1^2(\mu_n \alpha)],$$

where  $J_0(x)$  and  $J_1(x)$  are respectively the Bessel functions of first and second order. The set of values  $\{\mu_n\}$  is determined from either

$$J_0(\mu \alpha) = 0, \quad \text{or} \quad J_1(\mu \alpha) = 0.$$

$$(f) \quad \int_{-1}^1 \frac{1}{\sqrt{1-t^2}} T_m(t) T_n(t) dt = 0, \quad m \neq n,$$

$$\int_{-1}^1 \frac{1}{\sqrt{1-t^2}} T_n^2(t) dt = \pi/2^{2n-1},$$

where  $T_n(t)$  are the Tchebycheff polynomials defined as follows:

$$T_0(t) = 1, \quad T_1(t) = t, \quad T_2(t) = t^2 - \frac{1}{2}, \quad T_3(t) = t^3 - \frac{3}{4}t,$$

$$T_4(t) = t^4 - t^2 + \frac{1}{8}, \quad T_5(t) = t^5 - \frac{5}{4}t^3 + \frac{5}{16}t, \dots,$$

$$T_n(t) = t^n - \frac{n}{2^2 \cdot 1!} t^{n-2} + \frac{n(n-3)}{2^4 \cdot 2!} t^{n-4} - \frac{n(n-4)(n-5)}{2^6 \cdot 3!} t^{n-6} + \dots$$

Functions are also orthogonal with respect to summation, that is to say, the integral (1) may be replaced by the sum

$$(2) \quad \sum_{t=\alpha}^{\beta} F(t) U_m(t) U_n(t) = 0, \quad m \neq n.$$

In the discrete data of economic time series it is, in fact, more usual to employ functions which are orthogonal with respect to summation rather than those orthogonal over some continuous range. It

should be noted, however, that such functions can be included in the previous theory by means of *Stieltjes integrals*.<sup>3</sup>

By a Stieltjes integral we mean an integral of the form

$$I = \int_a^b f(x) dv(x),$$

which is defined as the limit of the sum

$$I_N = f(t_1)[v(x_1) - v(a)] + f(t_2)[v(x_2) - v(x_1)] \\ + \dots + f(t_N)[v(b) - v(x_{N-1})],$$

where  $v(x)$  is a function of limited variation in  $(a, b)$  and  $t_r$  is some value in the interval  $x_r - x_{r-1}$ . If  $v(x)$  is constant, except for a finite number of discontinuities of positive saltus  $\{S_i\}$ , at the points  $\xi_1, \xi_2, \dots, \xi_n$ , then  $I$  is equal to the sum

$$I = S_1 f(\xi_1) + S_2 f(\xi_2) + \dots + S_n f(\xi_n).$$

Hence, introducing a step function  $v(t)$  of the kind just described with a unit saltus at each integer, we can write (2) in the integral form

$$\int_a^b F(t) U_m(t) U_n(t) dv(t) = 0, \quad m \neq n.$$

A few of the functions which are orthogonal with respect to summation are recorded below. The first set includes the sine and cosine functions, the second set the Gram polynomials (the analogue of the Legendre polynomials for discrete summation), the third set the discrete Hermite polynomials. The pertinent formulas follow:

$$(a) \sum_{t=0}^{n-1} \sin \frac{2k\pi}{n} t \sin \frac{2m\pi}{n} t = 0, \quad \text{if neither } k-m \text{ nor } k+m \text{ is divisible by } n, \\ \text{or if both are divisible by } n.$$

$$\sum_{t=0}^{n-1} \sin^2 \frac{2k\pi}{n} t = \frac{1}{2} n, \quad \text{if } 2k \text{ is not divisible by } n.$$

$$\sum_{t=0}^{n-1} \sin \frac{2k\pi}{n} t \sin \frac{2m\pi}{n} t = \frac{1}{2} n, \quad \text{if } k-m \text{ is divisible by } n \text{ and } k+m \text{ is not} \\ \text{divisible by } n;$$

$$= -\frac{1}{2} n, \quad \text{if } k-m \text{ is not divisible by } n \text{ and } k+m \text{ is} \\ \text{divisible by } n.$$

<sup>3</sup> The definition of such integrals is due to T.-J. Stieltjes (1856-1894), "Recherches sur les fractions continues," *Annales de la Faculté des Sciences de Toulouse*, Vol. 8 (Series 1), J, pp. 1-122; in particular, pp. 70-72.

<sup>4</sup> These identities should be supplemented by the following biorthogonal relation:

$$\sum_{t=0}^{n-1} \sin \frac{2k\pi}{n} t \cos \frac{2m\pi}{n} t = 0, \quad \text{for all values of } k \text{ and } m.$$

$$(a') \sum_{t=0}^{n-1} \cos \frac{2k\pi}{n} t \cos \frac{2m\pi}{n} t = 0, \quad \text{if neither } k-m \text{ nor } k+m \text{ is divisible by } n.$$

$$\sum_{t=0}^{n-1} \cos^2 \frac{2k\pi}{n} t = \frac{1}{2}n, \quad \text{if } 2k \text{ is not divisible by } n.$$

$$\sum_{t=0}^{n-1} \cos \frac{2k\pi}{n} t \cos \frac{2m\pi}{n} t = \frac{1}{2}n, \quad \text{if either } k-m \text{ or } k+m \text{ is divisible by } n, \\ \text{but not both;}$$

$$= n, \quad \text{if both } k-m \text{ and } k+m \text{ are divisible by } n.$$

$$(b) \sum_{t=-p}^p \phi_m(t) \phi_n(t) = 0, \quad m \neq n,$$

$$\sum_{t=-p}^p \phi_n^2(t) = S_n,$$

where we abbreviate:<sup>10</sup>

$$\phi_0(t) = A, \quad \phi_1(t) = A't, \quad \phi_2(t) = B + Ct^2, \quad \phi_3(t) = B't + C't^3,$$

$$\phi_4(t) = C + Et^2 + Ft^4, \quad \phi_5(t) = C't + E't^3 + F't^5,$$

$$\phi_6(t) = D + Gt^2 + It^4 + Jt^6,$$

$$\phi_7(t) = D't + G't^3 + I't^5 + J't^7;$$

$$S_0 = A, \quad S_1 = A', \quad S_2 = C, \quad S_3 = C', \quad S_4 = F, \quad S_5 = F', \quad S_6 = J, \quad S_7 = J'.$$

$$\sum_{t=-p}^p C_t \psi_m(t) \psi_n(t) = 0, \quad m \neq n,$$

$$(c) \sum_{t=-p}^p C_t \psi_n^2(t) = s_n = n! 2^p (2p-1)(2p-2) \dots (2p-n+1) / 2^{2n},$$

where we abbreviate:<sup>11</sup>

$$C_t = \frac{(2p)!}{(p+t)! (p-t)!} \left(\frac{1}{2}\right)^{p+t} \left(\frac{1}{2}\right)^{p-t},$$

$$\psi_0 = 1, \quad \psi_1(t) = t, \quad \psi_2(t) = t^2 - p/2, \quad \psi_3(t) = t^3 - \frac{1}{2}(3p-1)t,$$

$$\psi_4(t) = t^4 - (3p-2)t^2 + 3p(p-1)/4, \quad \psi_5(t) = t^5 - 5(p-1)t^3$$

$$+ (15p^2 - 25p + 6)t/4,$$

<sup>10</sup> The notations and the explicit values of the constants are found in the author's *Tables of the Higher Mathematical Functions*, Volume 2, 1935, pp. 307-359. The numerical evaluation of the constants over extensive ranges of  $p$  is also found in this work.

<sup>11</sup> An extensive account of these functions together with tables of their values will be found in H. E. H. Greenleaf, "Curve Approximation by Means of Functions Analogous to the Hermite Polynomials," *Annals of Mathematical Statistics*, Vol. 3, 1932, pp. 204-255.



$$\psi_6(t) = t^6 - 5(2p-4)t^4/2 + (45p^2 - 105p + 46)t^2/4 \\ - 15p(p-1)(p-2)/8,$$

$$\psi_7(t) = t^7 - 7(3p-5)t^5/2 + (105p^2 - 315p^2 + 196)t^3/4 - (105p^4 - 420p^4 \\ + 441p^2 - 90)t/8,$$

$$\psi_8(t) = t^8 - 14(p-2)t^6 + 7(15p^2 - 55p + 44)t^4/2 - (105p^3 - 525p^3 \\ + 742p - 264)t^2/2 + 105p(p-1)(p-2)(p-3)/16.$$

### 11. Minimizing by the Method of Least Squares

Since most work done with regression equations in the theory of economic time series is in one way or another an application of the method of least squares, it will be useful to indicate in this section some basic results about approximation by this method.

Let us consider that a given function,  $u(t)$ , over a range  $a \leq t \leq b$ , is to be approximately represented by means of a known function,  $f(t; a_1, a_2, \dots, a_n)$ , where the parameters  $a_1, a_2, \dots, a_n$  are to be determined. The basic postulate of the method of least squares, in a sufficiently general form for our purpose, affirms that the parameters are to be so computed that the integral

$$I = \int_a^b F(t) [u(t) - f(t; a_1, a_2, \dots, a_n)]^2 dt$$

shall be a minimum. The function  $F(t)$  is a weighting function, positive in the interval  $(a, b)$ .

Equating to zero the partial derivatives of  $I$  with respect to the parameters, we obtain the following system of equations:

$$(1) \quad \int_a^b F(t) f \frac{\partial f}{\partial a_i} dt - \int_a^b F(t) u(t) \frac{\partial f}{\partial a_i} dt = 0, \quad i = 1, 2, \dots, n.$$

In most practical applications in time series, the function  $f(t)$  is assumed to be linear in the parameters, that is,

$$f(t) = a_1 u_1(t) + a_2 u_2(t) + \dots + a_n u_n(t).$$

Introducing this expanded form of  $f(t)$  into equations (1), we then obtain the following set:

$$a_1 \int_a^b F(t) u_1^2 dt + a_2 \int_a^b F(t) u_1 u_2 dt + \dots \\ + a_n \int_a^b F(t) u_1 u_n dt = \int_a^b F(t) u_1(t) u(t) dt,$$

$$a_1 \int_a^b F(t) u_2 u_1 dt + a_2 \int_a^b F(t) u_2^2 dt + \dots$$

$$+ a_n \int_a^b F(t) u_2 u_n dt = \int_a^b F(t) u_2(t) u(t) dt,$$

(2) . . . . .

$$a_1 \int_a^b F(t) u_n u_1 dt + a_2 \int_a^b F(t) u_n u_2 dt + \dots$$

$$+ a_n \int_a^b F(t) u_n^2 dt = \int_a^b F(t) u_n(t) u(t) dt.$$

If the functions  $u_1(t)$ ,  $u_2(t)$ ,  $\dots$ ,  $u_n(t)$  form a set of functions orthogonal with respect to  $F(t)$  over the range  $(a, b)$ , that is to say, if

$$\int_a^b F(t) u_m(t) u_n(t) dt = 0, \quad m \neq n,$$

then system (2) assumes the simpler form

$$a_i \int_a^b F(t) u_i^2(t) dt = \int_a^b F(t) u_i(t) u(t) dt.$$

If we employ the abbreviation

$$\lambda_i = \int_a^b F(t) u_i^2(t) dt,$$

then we can write the approximation of  $u(t)$  in the following convenient form:

$$(3) \quad u(t) \approx \int_a^b K(t, s) u(s) ds.$$

The function,  $K(t, s)$ , called the *kernel* of the integral, will be seen to have the expansion

$$K(t, s) = F(s) \left[ \frac{u_1(t) u_1(s)}{\lambda_1} + \frac{u_2(t) u_2(s)}{\lambda_2} + \dots + \frac{u_n(t) u_n(s)}{\lambda_n} \right].$$

We also note that the right-hand member of (3) furnishes a minimum for  $I$ , since we have by explicit calculation the following:

$$\frac{\partial^2 I}{\partial a_i^2} = \lambda_i > 0, \quad \frac{\partial^2 I}{\partial a_i \partial a_j} = 0, \quad i \neq j.$$

By means of the results established above, it is now possible to

derive *Bessel's inequality* for the general case of orthogonal functions. For this purpose we introduce the value

$$f(t) = a_1 u_1(t) + a_2 u_2(t) + \dots + a_n u_n(t)$$

into the integral  $I$ . Noting that

$$\int_a^b F(t) u_i(t) u(t) dt = a_i \lambda_i,$$

and also that

$$\int_a^b F(t) f^2(t) dt = a_1^2 \lambda_1 + a_2^2 \lambda_2 + \dots + a_n^2 \lambda_n,$$

we readily obtain

$$\begin{aligned} I &= \int_a^b F(t) u^2(t) dt - 2 \int_a^b F(t) u(t) f(t) dt + \int_a^b F(t) f^2(t) dt \\ &= \int_a^b F(t) u^2(t) dt - 2(a_1^2 \lambda_1 + a_2^2 \lambda_2 + \dots) + \int_a^b F(t) f^2(t) dt \\ &= \int_a^b F(t) u^2(t) dt - \int_a^b F(t) f^2(t) dt. \end{aligned}$$

Since the integrand of the integral  $I$  is positive or zero, the integral is positive or zero, that is,  $I \geq 0$ , and hence we have established *Bessel's inequality* in the general case:

$$(4) \quad a_1^2 \lambda_1 + a_2^2 \lambda_2 + \dots + a_n^2 \lambda_n \leq \int_a^b F(t) u^2(t) dt.$$

If the set of orthogonal functions is an infinite set and *closed*, that is to say, if there exists no other function outside the set which is orthogonal to the set, then the sign of equality holds in the Bessel inequality, and the approximation sign in equation (3) is replaced by the sign of equality.

The spectrum of the integral equation is then the set of values:  $\lambda_1, \lambda_2, \dots, \lambda_n, \dots$ .

## 12. Relationship to the Theory of Multiple Correlation

We shall now indicate the relationship which exists between the theory of the last section and the theory of multiple linear correlation.

The problem of multiple-correlation analysis, as one sees from any elementary book on statistics, consists in discussing the relationship between a dependent variable,  $f(t)$ , and  $n$  independent variables,

$u_1(t), u_2(t), \dots, u_n(t)$ . Without loss of generality we can assume that the averages of all these functions over the range ( $a \leq t \leq b$ ) are zero. This merely means that the variables are deviations from their respective averages.

The relationship, assumed linear, may then be written

$$(1) \quad f(t) = a_1 u_1(t) + a_2 u_2(t) + \dots + a_n u_n(t).$$

The first problem in the theory of multiple correlation, and, in fact, its distinguishing characteristic, is to determine the values of the parameters  $a_1, a_2, \dots, a_n$  in terms of the standard deviations,  $\sigma_f, \sigma_1, \sigma_2, \dots, \sigma_n$ , and the elementary correlation coefficients,  $r_{fi}$  and  $r_{ij}$ , defined in the following sums:

$$\sigma_f^2 = \frac{\int_a^b f^2(s) ds}{L}, \quad \sigma_i^2 = \frac{\int_a^b u_i^2(s) ds}{L}, \quad r_{fi} = \frac{\int_a^b f(s) u_i(s) ds}{L \sigma_f \sigma_i},$$

$$r_{ij} = \frac{\int_a^b u_i(s) u_j(s) ds}{L \sigma_i \sigma_j}, \quad L = b - a.$$

In terms of these statistical constants, equations (2) of the preceding section become

$$(2) \quad \begin{aligned} a_1 \sigma_1^2 &+ a_2 \sigma_1 \sigma_2 r_{12} + \dots + a_n \sigma_1 \sigma_n r_{1n} = \sigma_1 \sigma_f r_{f1}, \\ a_1 \sigma_2 \sigma_1 r_{21} + a_2 \sigma_2^2 &+ \dots + a_n \sigma_2 \sigma_n r_{2n} = \sigma_2 \sigma_f r_{f2}, \\ &\cdot \quad \cdot \quad \cdot \quad \cdot \quad \cdot \quad \cdot \quad \cdot \quad \cdot \quad \cdot \quad \cdot \quad \cdot \quad \cdot \quad \cdot \quad \cdot \\ a_1 \sigma_n \sigma_1 r_{n1} + a_2 \sigma_n \sigma_2 r_{n2} &+ \dots + a_n \sigma_n^2 = \sigma_n \sigma_f r_{fn}. \end{aligned}$$

Let us designate by  $D(\lambda)$  the determinant

$$D(\lambda) = \begin{vmatrix} 1 - \lambda & r_{12} & r_{13} & \dots & r_{1n} \\ r_{21} & 1 - \lambda & r_{23} & \dots & r_{2n} \\ \cdot & \cdot & \cdot & \cdot & \cdot \\ \cdot & \cdot & \cdot & \cdot & \cdot \\ r_{n1} & r_{n2} & r_{n3} & \dots & 1 - \lambda \end{vmatrix}$$

The solution of equations (2) can be determined provided  $D(0) \neq 0$ . If we designate by  $b_{ij}$  the cofactor of the element  $r_{ij}$  in the determinant  $D(0)$ , then the solution of the system can be written:

$$(3) \quad a_i = \frac{\sigma_f}{\sigma_i} [b_{i1} r_{f1} + b_{i2} r_{f2} + \dots + b_{in} r_{fn}].$$

Equation (1) can then be written

$$(4) \quad f(t) = \sum_{i=1}^n a_i u_i(t) = \sigma_f \sum_{i,f=1}^n b_{i,f} \frac{u_i(t)}{\sigma_i} = \frac{1}{L} \int_a^b K(t,s) f(s) ds,$$

where we abbreviate

$$(5) \quad K(t,s) = \sum_{i,j=1}^n b_{i,f} \frac{u_i(t)}{\sigma_i} \cdot \frac{u_j(s)}{\sigma_j}.$$

We note that  $K(t,s)$  is a bilinear form in the variables  $u_i(t)/\sigma_i$  and  $u_j(s)/\sigma_j$ . As is well known, its properties are characterized by the matrix  $\|b_{i,f}\|$ .

Now in most applications of multiple-correlation theory to problems in economic time series the variables  $\{u_i(t)\}$  are chosen either because, on a priori grounds, there should be a relationship between them and the primary variable  $f(t)$ , or because the correlation coefficients  $\{\tau_{fi}\}$  have been observed to be high. Obviously the most desirable set of variables to select, if that were possible, would be an orthogonal set, because in that case the correlation coefficients  $\tau_{i,j}$  would all be zero,  $i \neq j$ , except when  $i$  or  $j$  equals  $f$ . But since all the variables are subject to error, and since there are mutual influences shared by most of them, the possibility of finding an orthogonal set is practically excluded. As a matter of fact, the greatest danger in the use of correlation analysis in the theory of economic time series is found in the possibility that one of the variables may be a linear combination, except for the erratic element, of one or more of the others. This linear dependence is sometimes difficult to detect when the number of variables is at all large. In economic time series the possibility is always present since one or more of the variables may share the same set of harmonic terms.

Later in the book the problem of linear dependence will be more fully discussed. At present we shall set up some of the technical machinery useful in obtaining a better understanding of the problem.

We shall recall some results from the theory of higher algebra. Thus, if we designate by  $\lambda_1, \lambda_2, \dots, \lambda_n$  the roots of the equation

$$(6) \quad D(\lambda) = 0,$$

then the roots,  $\mu_1, \mu_2, \dots, \mu_n$ , of the equation

$$(7) \quad B(\mu) = |b_{i,j} - \delta_{i,j}\mu| = 0, \quad \delta_{i,i} = 1, \quad \delta_{i,j} = 0, \quad i \neq j,$$

are the reciprocals of the  $\lambda_i$ ; that is,  $\mu_i = 1/\lambda_i$ .

Also, there exists a transformation

$$(8) \quad \frac{u_i(t)}{\sigma_i} = \sum_{j=1}^n u_{ij} v_j(t), \quad \text{or} \quad v_i(t) = \sum_{j=1}^n u_{ij} \frac{u_j(t)}{\sigma_j}$$

where  $U = ||u_{ij}||$  is a normal, orthogonal matrix,<sup>12</sup> such that

$$(9) \quad K(t,s) = \mu_1 v_1(t) v_1(s) + \mu_2 v_2(t) v_2(s) + \dots + \mu_n v_n(t) v_n(s).$$

The matrix  $U$  is determined in the following manner. From the  $n$  systems of equations

$$(10) \quad \begin{aligned} \sum_{j=1}^n r_{ij} \alpha_j &= \lambda_1 \alpha_i, \\ \sum_{j=1}^n r_{ij} \beta_j &= \lambda_2 \beta_i, \\ &\dots \dots \dots \\ \sum_{j=1}^n r_{ij} \gamma_j &= \lambda_n \gamma_i, \end{aligned}$$

solutions  $(\alpha_1, \alpha_2, \dots, \alpha_n)$ ,  $(\beta_1, \beta_2, \dots, \beta_n)$ ,  $\dots$ ,  $(\gamma_1, \gamma_2, \dots, \gamma_n)$  are determined. These values are then normalized by dividing each element in the first set by  $\sqrt{\sum \alpha_i^2}$ , each element in the second set by  $\sqrt{\sum \beta_i^2}$ , etc. The  $n^2$  quantities thus determined form the elements of the matrix  $U$ .

It is obvious that the magnitude of the coefficients  $\mu_1, \mu_2, \dots, \mu_n$  in (9) gives considerable information about the possible linear dependence between the variables. Moreover, it is possible that the new variables  $\{v_i(t)\}$  may actually be more natural variables for the description of  $f(t)$  than those originally selected.

The multiple-correlation coefficient is defined to be

$$R = \frac{1}{L\sigma_f\sigma} \int_a^b f(s) [a_1 u_1(s) + a_2 u_2(s) + \dots + a_n u_n(s)] ds,$$

where we write

$$(11) \quad \sigma^2 = a_1^2 \sigma_1^2 + a_2^2 \sigma_2^2 + \dots + a_n^2 \sigma_n^2 + 2a_1 a_2 \sigma_1 \sigma_2 r_{12} + \dots$$

That is to say, we have

$$(12) \quad R = \frac{1}{\sigma} [a_1 \sigma_1 r_{f1} + a_2 \sigma_2 r_{f2} + \dots + a_n \sigma_n r_{fn}].$$

<sup>12</sup> By a normal, orthogonal matrix  $U$  we mean one that has the property

$$U U' = ||u_{ij}|| ||u_{ji}|| = \left\| \sum_{k=1}^n u_{ik} u_{jk} \right\| = ||\delta_{ij}||,$$

where  $\delta_{ii} = 1, \delta_{ij} = 0, i \neq j$ .

The standard error of estimate of  $f(t)$  is then given by the formula

$$\text{Standard error of estimate} = \sigma_f \sqrt{1 - R^2}.$$

As an example let us consider the relationship that can be established between  $f(t) =$  the Dow-Jones industrial averages;  $u_1(t) =$  pig-iron production lagged three months;  $u_2(t) =$  building-material prices lagged six months;  $u_3(t) =$  stock sales on the New York Stock Exchange. All data refer to the period from 1897 to 1913. Pertinent values, taken from the table in Section 2 of Chapter 3, are given as follows:

Variable	Mean	$\sigma$	Correlations
$f(t)$	100.72	15.0105	$r_{f1} = 0.684$ , $r_{f2} = 0.777$ , $r_{f3} = 0.539$
$u_1(t)$	100.45	15.3561	$r_{12} = 0.544$ , $r_{13} = 0.361$
$u_2(t)$	100.32	4.9085	$r_{23} = 0.372$
$u_3(t)$	102.44	47.3022	

From the equation  $D(\lambda) = 0.581469 - 2.435959 \lambda + 3\lambda^2 - \lambda^3 = 0$ , we first compute

$$\lambda_1 = 0.455798, \quad \lambda_2 = 0.686851, \quad \lambda_3 = 1.857356.$$

The determinant  $B(0)$ , defined by (7), is next computed and found to be

$$B(0) = \begin{vmatrix} 1.48179 & -0.70461 & -0.27281 \\ -0.70461 & 1.49566 & -0.30202 \\ -0.27281 & -0.30202 & 1.21084 \end{vmatrix}.$$

The normal, orthogonal matrix  $U$  is then determined from the systems of equations (10). We thus obtain

$$U = \begin{vmatrix} 0.69798 & -0.71562 & 0.02660 \\ -0.38611 & -0.34536 & 0.85536 \\ 0.60308 & 0.60714 & 0.51737 \end{vmatrix}.$$

Hence the orthogonal variables  $\{v_i(t)\}$  are defined by means of (8) to be

$$v_1(t) = 0.69798 \frac{u_1(t)}{\sigma_1} - 0.71562 \frac{u_2(t)}{\sigma_2} + 0.02660 \frac{u_3(t)}{\sigma_3},$$

$$v_2(t) = -0.38611 \frac{u_1(t)}{\sigma_1} - 0.34536 \frac{u_2(t)}{\sigma_2} + 0.85536 \frac{u_3(t)}{\sigma_3},$$

$$v_3(t) = 0.60308 \frac{u_1(t)}{\sigma_1} + 0.60714 \frac{u_2(t)}{\sigma_2} + 0.51737 \frac{u_3(t)}{\sigma_3}.$$

In terms of these new variables the quadratic form (5) reduces to (9); that is

$$K(t,s) = 2.19398 v_1(t) v_1(s) + 1.45592 v_2(t) v_2(s) + 0.53840 v_3(t) v_3(s).$$

One may readily show from the values given above that

$$\sigma = 12.9554, \quad R = 0.8631.$$

## CHAPTER 3

### SERIAL CORRELATION ANALYSIS

#### 1. Introduction

Let us assume that we have two series of statistical data,  $x(t)$  and  $y(t)$ , which are distributed over a common interval of time,  $-a \leq t \leq a$ . It will be convenient occasionally in the analysis to suppose that  $a = \infty$ , although this implies neither that the series are actually distributed over an infinite time interval nor that they have any particular analytical behavior with increasing or decreasing time. Any finite series, such as those of economics which are our special concern, will be included by the simple device of assuming that  $x(t)$  and  $y(t)$  are identically zero when  $t > a$ ,  $t < -a$ .

It will be convenient also to make three further assumptions:

- (a) that both  $x(t)$  and  $y(t)$  are residuals from their mean values;
- (b) that both  $x(t)$  and  $y(t)$  have been normalized by division by their respective standard deviations over the range  $-a \leq t \leq a$ .
- (c) that for limited ranges of  $\lambda$ , the averages of  $x(t + \lambda)$  and  $y(t + \lambda)$  are zero and their standard deviations are unity.

It will be observed that the only essential limitation to our analysis is found in the third assumption. In the actual application of the theories of this chapter to statistical data, it is usually desirable to test the validity of (c) and to make proper corrections if these appear to be necessary. The mathematical analysis, however, is much simplified by this assumption and in general no gross errors are introduced by it.

With the limitations thus imposed, we may now define as the serial correlation function the integral

$$(1) \quad r(t) = \frac{1}{2a} \int_{-a}^a x(s) y(s+t) ds.$$

If  $t$  is a positive quantity, then series  $y$  will be said to lag behind series  $x$ ; if, on the contrary,  $t$  is a negative quantity, then series  $x$  will be said to lag behind series  $y$ . The reason for this definition is clearly seen in the lag correlation between pig-iron production,  $x(t)$ ,



and industrial stock prices,  $y(t)$  (represented by the Dow-Jones averages), as shown in Figure 22. The maximum correlation is found for a negative lag of three months, which shows that pig-iron production follows the movements of the stock market, that is to say, the production series lags behind the stock price series, since the items of the first three months hence will correlate with the present items of the second.

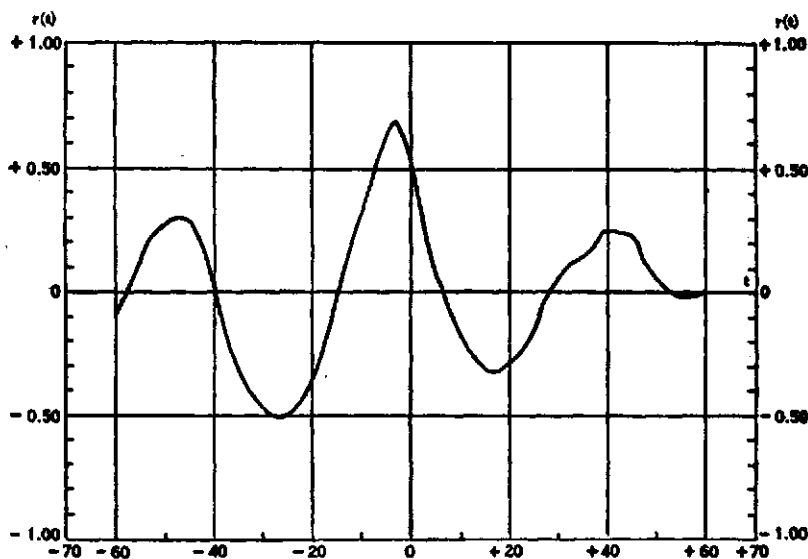

FIGURE 22.—LAG-CORRELATION GRAPH OF PIG-IRON PRODUCTION WITH INDUSTRIAL STOCK PRICES.

In many important applications of serial correlation analysis we are concerned with what is called the *autocorrelation function*. An autocorrelation function is merely the serial correlation of a function with itself, that is,

$$(2) \quad r(t) = \frac{1}{2a} \int_{-a}^a x(s) x(s+t) ds .$$

An example of such an autocorrelation is shown in Figure 23, where  $x(s)$  is the industrial stock price series (represented by the Dow-Jones averages), with trend removed, over the period from 1897 to 1913. It will be observed from the graph that  $r(t)$  is a symmetric function, that is to say,

$$r(t) = r(-t) .$$

This is an important property of the autocorrelation function, from which one derives the fact that the power-series development of  $r(t)$  will be in terms of even degree.

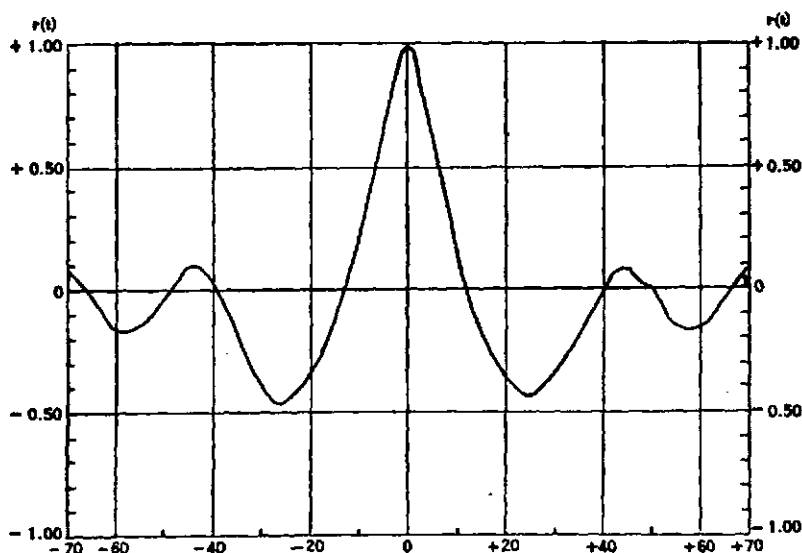

FIGURE 23.—AUTOCORRELATION GRAPH OF INDUSTRIAL STOCK PRICES.

In order to be able to distinguish between an autocorrelation function and a serial correlation between two different functions, we shall apply the term *lag correlation* to the latter case. That is to say, a lag correlation is a serial correlation between two different variables.

## 2. Examples of Lag Correlation

Since a great deal of useful information about the interaction of economic series can be gained from a study of their lag-correlation functions, these functions have been computed for thirteen important time series (each taken as percentage of trend) over the years from 1897 to 1913. This range was chosen because of the unusual stability of the trends, which makes it an especially good range for exploring the interdependence of economic series.

The thirteen series, together with their trends, their arithmetic averages ( $A$ ), and their standard deviations ( $\sigma$ ), are given below as follows:

Series	Trend	<i>A</i>	$\sigma$
$X_1$ . Dow-Jones Industrial Averages	$y = 72.7761 + 0.177873t$	100.7188	15.0151
$X_2$ . Pig-Iron Production	$y = 55.0134 + 0.267732t$	100.4479	15.8561
$X_3$ . Index of High-Grade-Bond Yields	$y = 4.3161 + 0.001607t$	99.6406	3.7131
$X_4$ . Time-Money Rates	$y = 4.0984 + 0.002364t$	101.6250	28.0490
$X_5$ . Industrial Production	$y = 58.8687 + 0.197273t$	100.5104	15.6961
$X_6$ . Index of General Prices	$y = 84.7985 + 0.158694t$	99.9688	1.5375
$X_7$ . Bradstreet's Commodity Prices	$y = 8.0921 + 0.012700t$	100.5677	4.2948
$X_8$ . Commercial-Paper Rates	$y = 4.6518 + 0.004823t$	100.7552	17.8462
$X_9$ . Stock Sales, N.Y. Exchange	$y = 14.6685 - 0.004873t$	102.4375	47.3022
$X_{10}$ . Metals and Metal-Products Prices	$y = 88.5552 + 0.034479t$	101.2844	13.2129
$X_{11}$ . Building-Materials Price Index	$y = 49.3119 + 0.095367t$	100.3177	4.9035
$X_{12}$ . Bank Clearings outside of New York City	$y = 4.1942 + 0.021661t$	100.1615	5.7809
$X_{13}$ . Loans and Discounts of All National Banks	$y = 4009.567 + 22.231t$	99.8594	2.1533

In order to have a basis for the exploration of the interdependence of the series given above, the lag-correlation function for all of them was computed over a lag range from  $-12$  to  $+12$  months. Auto-correlations were also included. The results are given in the following table. The sign ( $-t$ ) indicates that the correlated series precedes the series named at the top of the table by  $t$  months; the sign ( $+t$ ) indicates that the correlated series lags  $t$  months behind. The maximum value of the lag correlation is indicated by the figures in italics. For example, consider the relationship between the Dow-Jones industrial averages and pig-iron production. It will be observed that the maximum correlation comes for  $t = 3$ . This means that pig-iron production follows by three months the industrial averages.

( $X_1$ ) DOW-JONES INDUSTRIAL AVERAGES

Series	$t = -12$	$-9$	$-6$	$-3$	$0$	$3$	$6$	$9$	$12$
$X_1$	-0.014	0.241	0.530	0.804	1.000	0.804	0.530	0.241	-0.014
$X_2$	-0.182	-0.130	-0.036	+0.166	+0.515	0.684	0.568	0.369	0.130
$X_3$	0.007	-0.142	-0.319	-0.455	-0.558	-0.472	-0.295	-0.071	0.115
$X_4$	-0.322	-0.316	-0.271	-0.141	0.183	0.403	0.532	0.565	0.480
$X_5$	-0.184	-0.132	-0.046	0.160	0.514	0.687	0.586	0.369	0.139
$X_6$	-0.439	-0.412	-0.305	-0.141	-0.032	0.177	0.327	0.429	0.459
$X_7$	-0.222	-0.256	-0.245	-0.110	0.276	0.480	0.601	0.632	0.553
$X_8$	-0.338	-0.421	-0.431	-0.311	-0.116	0.215	0.437	0.552	0.501
$X_9$	0.153	0.217	0.327	0.492	0.539	0.318	0.132	-0.002	-0.089
$X_{10}$	-0.241	-0.224	-0.098	0.139	0.500	0.656	0.678	0.605	0.481
$X_{11}$	-0.197	-0.180	-0.801	0.108	0.413	0.651	0.777	0.775	0.678
$X_{12}$	-0.299	-0.207	-0.019	0.263	0.605	0.630	0.532	0.372	0.184
$X_{13}$	-0.330	-0.353	-0.269	-0.111	0.115	0.087	0.163	0.122	0.092

$(X_2)$  PIG-IRON PRODUCTION

Series	$t = -12$	-9	-6	-3	0	3	6	9	12
$X_2$	-0.175	0.062	0.340	0.656	1.000	0.656	0.340	0.062	-0.175
$X_3$	-0.291	-0.439	-0.558	-0.550	-0.429	-0.204	0.006	0.149	0.237
$X_4$	-0.385	-0.280	-0.117	-0.134	0.450	0.677	0.629	0.467	0.350
$X_5$	-0.177	0.046	0.313	0.636	0.994	0.651	0.325	0.060	-0.165
$X_6$	-0.431	-0.321	-0.149	0.031	0.080	0.173	0.154	0.072	-0.005
$X_7$	-0.338	-0.234	0.008	0.315	0.540	0.588	0.544	0.368	0.187
$X_8$	-0.512	-0.410	-0.252	0.026	0.333	0.632	0.701	0.577	0.426
$X_9$	0.166	0.290	0.379	0.361	0.266	0.089	-0.016	-0.106	-0.071
$X_{10}$	-0.330	-0.152	0.084	0.350	0.501	0.485	0.399	0.340	0.253
$X_{11}$	-0.445	-0.329	-0.113	0.187	0.426	0.544	0.552	0.466	0.317
$X_{12}$	-0.167	0.057	0.342	0.608	0.718	0.466	0.235	0.046	-0.057
$X_{13}$	-0.277	-0.161	0.020	0.257	0.460	0.222	0.075	-0.074	-0.115

 $(X_3)$  INDEX OF HIGH-GRADE-BOND YIELDS

Series	$t = -12$	-9	-6	-3	0	3	6	9	12
$X_3$	0.404	0.591	0.782	0.914	1.000	0.914	0.782	0.591	0.404
$X_4$	0.158	0.209	0.207	0.163	-0.155	-0.380	-0.507	-0.553	-0.523
$X_5$	0.218	0.201	0.125	-0.068	-0.433	-0.542	-0.510	-0.399	-0.281
$X_6$	0.440	0.479	0.456	0.362	0.396	0.252	0.148	0.083	0.084
$X_7$	-0.118	-0.052	-0.065	-0.181	-0.549	-0.641	-0.707	-0.709	-0.622
$X_8$	0.172	0.276	0.318	0.263	0.170	-0.249	-0.432	-0.555	-0.566
$X_9$	-0.161	-0.217	-0.350	-0.465	-0.521	-0.447	-0.364	-0.293	-0.196
$X_{10}$	0.038	0.053	-0.001	-0.161	-0.496	-0.584	-0.598	-0.569	-0.492
$X_{11}$	0.242	0.281	0.263	0.163	-0.190	-0.329	-0.409	-0.422	-0.373
$X_{12}$	0.186	0.191	0.069	-0.169	-0.478	-0.493	-0.424	-0.348	-0.249
$X_{13}$	0.551	0.584	0.555	0.423	0.180	0.299	0.234	0.225	0.187

 $(X_4)$  TIME-MONEY RATES

Series	$t = -12$	-9	-6	-3	0	3	6	9	12
$X_4$	0.103	0.265	0.419	0.662	1.000	0.662	0.419	0.265	0.103
$X_5$	0.335	0.441	0.596	0.643	0.445	0.443	-0.106	-0.275	-0.388
$X_6$	-0.273	-0.104	0.053	0.122	0.056	0.011	-0.055	-0.130	-0.167
$X_7$	0.174	0.313	0.436	0.530	0.602	0.515	0.358	0.178	0.008
$X_8$	-0.049	0.138	0.299	0.535	0.872	0.753	0.548	0.364	0.209
$X_9$	0.356	0.346	0.289	0.231	0.219	0.044	-0.038	-0.017	0.068
$X_{10}$	0.220	0.403	0.560	0.625	0.625	0.545	0.417	0.274	0.181
$X_{11}$	0.046	0.235	0.423	0.549	0.615	0.588	0.460	0.267	0.096
$X_{12}$	0.301	0.467	0.597	0.590	0.319	0.063	-0.119	-0.229	-0.290
$X_{13}$	-0.155	-0.001	0.196	0.323	0.274	-0.179	-0.297	-0.321	-0.282

$(X_5)$  INDUSTRIAL PRODUCTION

Series	$t = -12$	-9	-6	-3	0	3	6	9	12
$X_5$	-0.165	0.048	0.311	0.645	1.000	0.645	0.311	0.048	-0.165
$X_6$	-0.409	-0.305	-0.181	0.052	0.192	0.181	0.167	0.090	0.011
$X_7$	-0.352	-0.253	0.004	0.315	0.539	0.539	0.562	0.382	0.143
$X_8$	-0.516	-0.413	-0.259	0.014	0.340	0.619	0.680	0.563	0.406
$X_9$	0.162	0.258	0.370	0.352	0.254	0.061	-0.020	-0.104	-0.085
$X_{10}$	-0.337	-0.167	0.069	0.342	0.500	0.478	0.393	0.338	0.262
$X_{11}$	-0.449	-0.334	-0.115	0.188	0.431	0.542	0.545	0.454	0.313

 $(X_6)$  INDEX OF GENERAL PRICES

Series	$t = -12$	-9	-6	-3	0	3	6	9	12
$X_6$	0.318	0.464	0.684	0.790	1.000	0.790	0.684	0.464	0.318
$X_7$	-0.276	-0.155	0.041	0.234	0.333	0.045	-0.027	-0.104	-0.251
$X_8$	-0.360	-0.277	-0.180	0.030	0.095	0.069	0.035	-0.094	-0.223
$X_9$	-0.025	-0.098	-0.167	-0.176	-0.376	-0.492	-0.502	-0.493	-0.465
$X_{10}$	-0.096	0.013	0.110	0.167	0.022	-0.038	-0.141	-0.278	-0.402
$X_{11}$	0.099	0.187	0.271	0.296	0.176	0.108	-0.005	-0.152	-0.297
$X_{12}$	0.139	0.274	0.354	0.383	0.296	0.065	-0.045	-0.169	-0.278
$X_{13}$	0.205	0.279	0.378	0.437	0.592	0.541	0.464	0.310	0.184

 $(X_7)$  BRADSTREET'S COMMODITY PRICES

Series	$t = -12$	-9	-6	-3	0	3	6	9	12
$X_7$	0.145	0.352	0.590	0.845	1.000	0.845	0.590	0.352	0.145
$X_8$	-0.191	-0.033	0.186	0.393	0.561	0.592	0.545	0.391	0.207
$X_9$	0.359	0.307	0.244	0.194	0.251	0.102	0.050	0.141	0.232
$X_{10}$	0.211	0.468	0.674	0.761	0.791	0.675	0.500	0.328	0.204
$X_{11}$	0.021	0.244	0.443	0.576	0.670	0.623	0.446	0.219	0.021
$X_{12}$	0.287	0.461	0.543	0.534	0.440	0.230	0.011	-0.129	-0.174
$X_{13}$	-0.358	-0.206	-0.001	0.068	0.093	-0.285	-0.309	-0.403	-0.420

 $(X_8)$  COMMERCIAL-PAPER RATES

Series	$t = -12$	-9	-6	-3	0	3	6	9	12
$X_8$	0.070	0.271	0.496	0.726	1.000	0.726	0.496	0.271	0.070
$X_9$	0.381	0.356	0.258	0.150	0.112	-0.037	-0.069	0.036	0.092
$X_{10}$	0.288	0.478	0.618	0.627	0.574	0.431	0.258	0.106	0.043
$X_{11}$	0.091	0.271	0.464	0.581	0.612	0.518	0.338	0.121	-0.048
$X_{12}$	0.358	0.531	0.609	0.489	0.189	-0.090	-0.271	-0.359	-0.381
$X_{13}$	-0.110	0.064	0.227	0.320	0.173	-0.217	-0.333	-0.372	-0.365

$(X_9)$  STOCK SALES ON THE NEW YORK STOCK EXCHANGE

Series	$t = -12$	-9	-6	-3	0	3	6	9	12
$X_9$	0.245	0.190	0.209	0.442	1.000	0.442	0.209	0.190	0.245
$X_{10}$	0.152	0.067	0.021	0.078	0.323	0.424	0.431	0.376	0.341
$X_{11}$	0.073	0.020	-0.001	-0.016	0.148	0.272	0.372	0.412	0.408
$X_{12}$	-0.222	-0.264	-0.190	-0.040	0.373	0.332	0.307	0.172	0.136
$X_{13}$	-0.434	-0.491	-0.424	-0.390	-0.343	-0.193	-0.088	-0.106	-0.127

 $(X_{10})$  METAL AND METAL-PRODUCTS PRICES

Series	$t = -12$	-9	-6	-3	0	3	6	9	12
$X_{10}$	0.243	0.455	0.690	0.891	1.000	0.891	0.690	0.455	0.243
$X_{11}$	0.174	0.306	0.467	0.643	0.814	0.827	0.702	0.470	0.218
$X_{12}$	0.232	0.325	0.445	0.539	0.516	0.299	0.012	-0.176	-0.269
$X_{13}$	-0.372	-0.316	-0.171	-0.029	0.103	-0.185	-0.268	-0.392	-0.415

 $(X_{11})$  BUILDING-MATERIALS PRICE INDEX

Series	$t = -12$	-9	-6	-3	0	3	6	9	12
$X_{11}$	0.201	0.431	0.672	0.857	1.000	0.857	0.672	0.431	0.201
$X_{12}$	0.283	0.418	0.522	0.493	0.384	0.157	-0.061	-0.193	-0.211
$X_{13}$	-0.194	-0.048	0.071	0.162	0.161	-0.116	-0.213	-0.258	-0.219

 $(X_{12})$  BANK CLEARINGS OUTSIDE OF NEW YORK CITY

Series	$t = -12$	-9	-6	-3	0	3	6	9	12
$X_{12}$	-0.072	0.077	0.332	0.620	1.000	0.620	0.332	0.077	-0.072
$X_{13}$	-0.248	-0.183	-0.042	0.179	0.483	0.354	0.172	-0.053	-0.149

 $(X_{13})$  LOANS AND DISCOUNTS OF ALL NATIONAL BANKS

Series	$t = -12$	-9	-6	-3	0	3	6	9	12
$X_{13}$	0.264	0.350	0.523	0.754	1.000	0.754	0.523	0.350	0.264

It is clear that these tables can be used in a number of useful ways and that they reveal numerous interrelations between the economic variables for the period under discussion. Whether or not the period should be regarded as one of typical economic stability is, of course, open to doubt, but there seemed to be during these years a remarkable stability in all the trends. We shall, therefore, think of the relations exhibited by the correlation table as those of a stable economy as opposed to a disruptive or crisis economy such as that since 1926.

One of the conclusions which we may reach by a study of the correlation table is that no economic series in the list forms a significant forecasting series for the behavior of stock prices. With the exception of  $X_9$  (index of general prices) and  $X_{13}$  (loans and discounts), all the lag maxima or minima coincide with or follow the stock-market

averages. This fact is sufficient to account for the failure of all attempts to make a forecaster for the action of stock prices as a whole.

We also note that series  $X_2$  (pig-iron production) and  $X_3$  (industrial production) are essentially equivalent indexes. In their serial correlations with all the other variables one finds an inconsequential difference in the figures, which reveals this economic proposition *that the production of pig iron is an adequate measure of industrial production as a whole.*

There are obvious reasons in the structure of investment for concluding that when the stock market is high yield of bonds will be low, and conversely. This observation would be found in an inverse correlation between a bond-yield index and the index of stock prices. The correlation between  $X_1$  (Dow-Jones industrial averages) and  $X_3$  (index of high-grade-bond yields) reveals the truth of this observation in the period under consideration. We have, however, assumed that the period from 1897 to 1914 was one of comparative economic stability and it is quite possible, therefore, that the assumption of an inverse correlation between these two economic variables would not hold in other periods. In order to test this, the intercorrelations (without lag) were computed for the following five series over 101 years from 1830 to 1930 inclusive and for each quarter of a century:<sup>1</sup>

1. Business Activity
2. Rail Bond Prices
3. Wholesale Prices
4. Rail Stock Prices
5. Commercial Paper Rates.

Employing the symbol  $r_{ij}$  for the intercorrelations, where the subscripts refer to the number of the series, we find the following table of values:

Correlations $r_{ij}$	Entire Period (1830-1930)	First Period (1830-1855)	Second Period (1856-1880)	Third Period (1881-1905)	Fourth Period (1905-1930)
$r_{12}$	0.0843	0.3185	-0.0451	0.0089	0.1308
$r_{13}$	0.1468	0.4088	0.2680	0.4110	0.1517
$r_{14}$	0.2862	0.6027	0.4442	0.5279	0.2579
$r_{15}$	0.1149	0.2046	0.1830	0.1869	-0.0006
$r_{23}$	-0.2854	0.5768	-0.1096	-0.6098	-0.8290
$r_{24}$	0.5983	0.5400	0.2565	0.0983	0.5626
$r_{25}$	-0.4941	0.1089	-0.5505	-0.4194	-0.3610
$r_{34}$	0.2284	0.1867	0.5942	0.6105	-0.4299
$r_{35}$	0.1044	0.3794	0.1887	0.3498	0.3450
$r_{45}$	-0.3778	0.0756	-0.0147	0.0497	-0.2242

<sup>1</sup> The data used in this analysis were compiled by the Cleveland Trust Company on a monthly basis.

The above table serves adequately as an indicator of the stability or lack of stability of the correlation coefficients from one period to another. It is unfortunate that the nonexistence of data prevents a similar set of computations for all the variables included in the table of autocorrelations. This table may be used, however, in some instances in connection with the other, as, for example, in the relationship between  $X_1$  (Dow-Jones industrial averages) and  $X_3$  (index of high-grade-bond yields) which was the object of the discussion. We note above that there exists a fairly permanent positive correlation between (2) and (4) of magnitude around 0.5. Since presumably interest rates on bonds, because of long issues, remained fairly constant over considerable periods of time, the yield index for bonds should fluctuate roughly with the reciprocal of price. Since the price of bonds correlates fairly highly with the price of stocks over the entire period, we should expect an inverse correlation with yields. An exception to this general conclusion would, of course, be observed in the second and third periods, which, as we know, were periods of crisis.

Attention should also be called to the ease with which regressions can be constructed between the different variables. Thus we observe a good correlation between  $X_1$  and  $X_2$ , and  $X_1$  and  $X_3$ , but a low correlation between  $X_2$  and  $X_3$ . Designating the respective means, standard deviations, and intercorrelations by the proper subscripts, we obtain the following data, pertinent for the construction of the desired regression, from the tables:

$$\begin{aligned} \text{For series } X_1, \quad A_1 &= 100.7188, & \sigma_1 &= 15.0151, \\ X_2, \quad A_2 &= 100.4479, & \sigma_2 &= 15.8561, \\ X_3, \quad A_3 &= 102.4375, & \sigma_3 &= 47.3022; \\ r_{12} &= 0.515, & r_{13} &= 0.539, & r_{23} &= 0.266. \end{aligned}$$

Employing the well-known formulas

$$X_i - A_i = b_{ij \cdot k} (X_j - A_j) + b_{ik \cdot j} (X_k - A_k) \pm 0.6745 \sigma_i \sqrt{(1-r_{ij}^2)(1-r_{ik \cdot j}^2)},$$

$$b_{ij \cdot k} = r_{ij \cdot k} \frac{\sigma_{i \cdot k}}{\sigma_{j \cdot k}}, \quad r_{ij \cdot k} = \frac{r_{ij} - r_{ik} r_{jk}}{\sqrt{(1-r_{ik}^2)(1-r_{jk}^2)}},$$

$$\sigma_{i \cdot k} = \sigma_i \sqrt{1 - r_{ik}^2},$$

we readily compute the following regression

$$X_1 = 0.3787 X_2 + 0.1372 X_3 + 48.6248 \pm 7.5630.$$



The agreement between the regression line and the data is revealed in Figure 24.

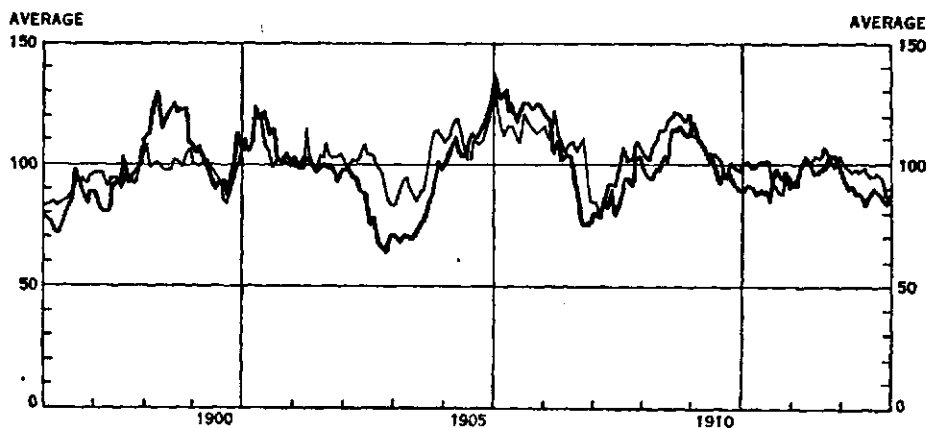

FIGURE 24.—DOW-JONES INDUSTRIAL AVERAGES (——) AND REGRESSION CURVE (——).

### 3. Inverse Serial Correlation

The problem of inverse serial-correlation analysis is the problem of inverting the integral

$$(1) \quad r(t) = \frac{1}{2a} \int_{-a}^a x(s) y(s+t) ds$$

for either  $x(s)$  or  $y(s)$ , assuming that one of these functions, together with  $r(t)$ , is known. The restrictions noted in Section 1 are assumed to hold.

It will be convenient for us first to solve the problem over an infinite range. For this purpose we consider the function

$$(2) \quad R(t) = \int_{-\infty}^{\infty} x(s) y(s+t) ds,$$

where  $x(s)$  and  $y(s)$  are assumed to behave at infinity in such a manner as to give a value to  $R(t)$  and to the sine and cosine transforms of  $R(t)$ . Sufficient conditions for this are well known.

Let us now multiply  $R(t)$  by  $e^{\beta t}$  and integrate over the infinite range. We thus obtain

$$\begin{aligned} \int_{-\infty}^{\infty} R(t) e^{\beta t} dt &= \int_{-\infty}^{\infty} dt \int_{-\infty}^{\infty} x(s) y(s+t) e^{\beta t} ds \\ &= \int_{-\infty}^{\infty} dt \int_{-\infty}^{\infty} x(s) y(s+t) e^{-\beta t} e^{\beta(s+t)} ds. \end{aligned}$$

Making the transformation  $s + t = p$ , we then obtain

$$(3) \quad \int_{-\infty}^{\infty} R(t) e^{\beta t} dt = \int_{-\infty}^{\infty} y(p) e^{\beta p} dp \int_{-\infty}^{\infty} x(s) e^{-\beta s} ds.$$

If we designate by  $\alpha(\beta)$  and  $\alpha'(\beta)$  the integrals

$$\alpha(\beta) = \int_{-\infty}^{\infty} R(t) \cos \beta t dt, \quad \alpha'(\beta) = \int_{-\infty}^{\infty} R(t) \sin \beta t dt,$$

and by  $a_x(\beta)$ ,  $b_x(\beta)$  and  $a_y(\beta)$ ,  $b_y(\beta)$  the corresponding transforms of  $x(t)$  and  $y(t)$  respectively, that is,

$$a_x(\beta) = \int_{-\infty}^{\infty} x(t) \cos \beta t dt, \quad b_x(\beta) = \int_{-\infty}^{\infty} x(t) \sin \beta t dt,$$

$$a_y(\beta) = \int_{-\infty}^{\infty} y(t) \cos \beta t dt, \quad b_y(\beta) = \int_{-\infty}^{\infty} y(t) \sin \beta t dt,$$

then we shall obtain the following identities by equating the real and imaginary parts of (3):

$$(4) \quad \alpha(\beta) = a_x(\beta) a_y(\beta) + b_x(\beta) b_y(\beta),$$

$$\alpha'(\beta) = a_x(\beta) b_y(\beta) - a_y(\beta) b_x(\beta).$$

Since the case of autocorrelation will be the most interesting to us in the application of this theory to economic time series, we shall state the theorem explicitly for the function

$$R(t) = \int_{-\infty}^{\infty} \phi(s) \phi(s+t) ds.$$

We may thus write:

*If the functions  $\phi(s)$  and  $R(s)$  exist over the infinite range from  $-\infty$  to  $+\infty$ , and if the integrals*

$$(5) \quad a(\beta) = \int_{-\infty}^{\infty} \phi(s) \cos \beta s ds,$$

$$(6) \quad b(\beta) = \int_{-\infty}^{\infty} \phi(s) \sin \beta s ds,$$

$$(7) \quad \alpha(\beta) = \int_{-\infty}^{\infty} R(s) \cos \beta s ds,$$

*exist, then the functions  $\alpha(\beta)$ ,  $\alpha'(\beta)$ , and  $b(\beta)$  are connected formally by the relationship*

$$(8) \quad \alpha(\beta) = a^2(\beta) + b^2(\beta)$$

The proof of this theorem is merely to observe that (8) is a corollary of (4). If we set  $x(t) = y(t) = \phi(t)$ , then  $\alpha'(\beta)$  is zero and  $\alpha(\beta)$  reduces to (8).

Two examples of this theorem will illustrate its application:

*Example 1.* Let us assume that

$$\phi(s) = \left(\frac{2a}{\pi}\right)^{1/4} e^{-as^2},$$

so that we obtain

$$R(t) = \sqrt{\frac{2a}{\pi}} \int_{-\infty}^{\infty} e^{-as^2} e^{-a(s+t)^2} ds = e^{-at^2}.$$

Computing the Fourier transforms of  $\phi(s)$  and  $R(t)$ , we get

$$\int_{-\infty}^{\infty} \phi(s) \cos \beta s ds = \left(\frac{2a}{\pi}\right)^{1/4} e^{-(\beta^2/4a)} = \sqrt{\int_{-\infty}^{\infty} R(t) \cos \beta t dt}.$$

*Example 2.* Let us consider the rectangular function

$$\phi(s) = \begin{cases} 1/\sqrt{2\lambda}, & -\lambda \leq s \leq \lambda, \\ 0, & s > \lambda, s < -\lambda, \end{cases}$$

which is graphically represented in Figure 25.

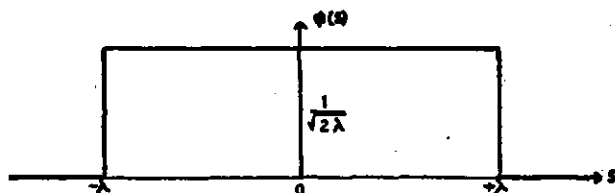

FIGURE 25.—RECTANGULAR FUNCTION.

We readily compute the autocorrelation function to be

$$(9) \quad R(t) = \begin{cases} \int_{-(\lambda-t)}^{\lambda} \phi(s) \phi(s+t) ds = 1 - t/2\lambda, & 0 \leq t \leq 2\lambda, \\ \int_{-\lambda}^{\lambda+t} \phi(s) \phi(s+t) ds = 1 + t/2\lambda, & -2\lambda \leq t \leq 0. \end{cases}$$

The Fourier transform of  $R(t)$  is then found to be

$$(10) \quad \begin{aligned} \int_{-\infty}^{\infty} R(t) \cos \beta t dt &= \int_0^{2\lambda} (1 - t/2\lambda) \cos \beta t dt + \int_{-2\lambda}^0 (1 + t/2\lambda) \cos \beta t dt \\ &= \frac{4 \sin^2 \beta \lambda}{2 \lambda \beta^2}. \end{aligned}$$

Similarly the Fourier transform of  $\phi(s)$  is given by

$$\int_{-\infty}^{\infty} \phi(s) \cos \beta s ds = 2 \int_0^{\lambda} (\cos \beta s / \sqrt{2\lambda}) ds = \frac{2 \sin \beta \lambda}{\beta \sqrt{2\lambda}},$$

which is observed to be equal to the square root of the Fourier transform of  $R(t)$ .

It will be useful later to have several other transforms of special forms of  $R(t)$ . These we give below as follows:

If  $R(t) = e^{-|at|}$ , and if  $\beta = 2\pi t/P$ , then we have

$$\begin{aligned} \alpha(P) &= \int_{-\infty}^{\infty} e^{-|at|} \cos \frac{2\pi t}{P} dt \\ (11) \quad &= \frac{2a}{a^2 + 4\pi^2/P^2}. \end{aligned}$$

If  $R(t) = e^{-|at|} \cos(2\pi t/T)$ , and if  $\beta = 2\pi t/P$ , we get

$$\begin{aligned} \alpha(P) &= \int_{-\infty}^{\infty} e^{-|at|} \cos \frac{2\pi t}{T} \cos \frac{2\pi t}{P} dt \\ (12) \quad &= \frac{a}{a^2 + 4\pi^2(1/T + 1/P)^2} + \frac{a}{a^2 + 4\pi^2(1/T - 1/P)^2}. \end{aligned}$$

If we define

$$(13) \quad R(t) = \begin{cases} (\lambda - t)/(\lambda + t), & 0 \leq t < \lambda, \\ (\lambda + t)/(\lambda - t), & -\lambda < t \leq 0, \\ 0, & |t| > \lambda, \end{cases}$$

then we obtain the transform

$$(14) \quad \alpha(P) = 4\lambda [\cos a \{Ci(2a) - Ci(a)\} + \sin a \{Si(2a) - Si(a)\} - \sin a/2a],$$

where we abbreviate

$$a = 2\pi\lambda/P, \quad Ci(x) = - \int_x^{\infty} \frac{\cos t}{t} dt, \quad Si(x) = \int_0^x \frac{\sin t}{t} dt.$$

If we denote the function in square brackets by  $S(a)$ , so that  $\alpha(R) = 4\lambda S(a)$ , then  $\alpha(P)$  can be defined for practical purposes by the following table of values:<sup>2</sup>

<sup>2</sup> Computed by E. B. Morris.

$\alpha$	$S(\alpha)$	$\alpha$	$S(\alpha)$	$\alpha$	$S(\alpha)$	$\alpha$	$S(\alpha)$
2.0	0.1461	2.7	0.1156	3.4	0.0849	6.3	0.0164
2.1	0.1419	2.8	0.1111	3.5	0.0808	6.9	0.0144
2.2	0.1376	2.9	0.1067	3.6	0.0768	7.5	0.0143
2.3	0.1333	3.0	0.1022	4.0	0.0615	8.4	0.0146
2.4	0.1289	3.1	0.0978	4.4	0.0483	9.4	0.0135
2.5	0.1245	3.2	0.0934	5.0	0.0329	10.8	0.0087
2.6	0.1201	3.3	0.0892	5.8	0.0203	15.1	0.0051

We return now to the question proposed in the first paragraph of this section, namely, the inversion of the integral (2). We shall first consider the case of the inversion of the autocorrelation function from which we have the following elegant result.<sup>3</sup>

If  $R(t)$  is the autocorrelation function

$$(15) \quad R(t) = \int_{-\infty}^{\infty} \phi(s) \phi(s+t) ds,$$

and if  $\alpha(\beta)$  is defined by (7), then  $\phi(s)$  is given by the following inversion:

$$(16) \quad \begin{aligned} \phi(s) = & \frac{1}{2\pi} \int_{-\infty}^{\infty} \sqrt{\alpha(\beta)} \cos p(\beta) \cos \beta s d\beta \\ & + \frac{1}{2\pi} \int_{-\infty}^{\infty} \sqrt{\alpha(\beta)} \sin p(\beta) \sin \beta s d\beta, \end{aligned}$$

where  $p(\beta)$  is an arbitrary odd function of  $\beta$ , that is  $p(-\beta) = -p(\beta)$ .

In order to prove this theorem, let us designate the first integral by  $\phi_1(s)$  and the second by  $\phi_2(s)$ . Then, employing the Fourier transforms:

$$f(x) = \sqrt{\frac{2}{\pi}} \int_{-\infty}^{\infty} \cos xs g(s) ds, \quad g(s) = \sqrt{\frac{2}{\pi}} \int_{-\infty}^{\infty} \cos sx f(x) dx,$$

$$f(x) = \sqrt{\frac{2}{\pi}} \int_{-\infty}^{\infty} \sin xs g(s) ds, \quad g(s) = \sqrt{\frac{2}{\pi}} \int_{-\infty}^{\infty} \sin sx f(x) dx,$$

we get

$$(17) \quad \begin{aligned} \sqrt{\alpha(\beta)} \cos p &= \int_{-\infty}^{\infty} \phi_1(s) \cos \beta s ds = \int_{-\infty}^{\infty} \phi(s) \cos \beta s ds = a(\beta), \\ \sqrt{\alpha(\beta)} \sin p &= \int_{-\infty}^{\infty} \phi_2(s) \sin \beta s ds = \int_{-\infty}^{\infty} \phi(s) \sin \beta s ds = b(\beta), \end{aligned}$$

<sup>3</sup> This result is due to Norbert Wiener.

since  $\phi(s) = \phi_1(s) + \phi_2(s)$ , and  $\phi_1(-s) = \phi_1(s)$ ,  $\phi_2(-s) = -\phi_2(s)$ .

Then from equations (17) we obtain

$$\alpha(\beta) \cos^2 p + \alpha(\beta) \sin^2 p \equiv \alpha(\beta) = a^2(\beta) + b^2(\beta).$$

Since serial-correlation functions of many economic series show a rapid damping, it is probably easier to represent them by means of Gram-Charlier series than by other types of orthogonal series. Hence the following discussion of inverse serial correlation is particularly pertinent. The following result is due to C. Runge:<sup>4</sup>

If  $x(s)$  and  $y(s)$  are functions expansible in a Gram-Charlier series over the infinite range  $-\infty$  to  $+\infty$ , that is, if

$$x(s) = e^{-s^2} [x_0 - x_1 H_1(s) + x_2 H_2(s) - x_3 H_3(s) + x_4 H_4(s) - \dots],$$

$$y(s) = e^{-s^2} [y_0 + y_1 H_1(s) + y_2 H_2(s) + y_3 H_3(s) + y_4 H_4(s) + \dots],$$

where  $H_n(s)$  is the  $n$ th Hermite polynomial defined by

$$H_n(s) = e^{s^2} \frac{d^n}{ds^n} e^{-s^2},$$

then the function

$$R(t) = \int_{-\infty}^{\infty} x(s) y(s+t) ds$$

has the expansion

$$R(t) = \sqrt{\frac{1}{2}\pi} e^{-t^2} [x_0 y_0 + (x_0 y_1 + x_1 y_0) h_1(t) + (x_0 y_2 + x_1 y_1 + x_2 y_0) h_2(t) + \dots],$$

where  $h_n(t)$ , the second form of the  $n$ th Hermite polynomial, is defined by<sup>5</sup>

$$h_n(t) = 2^{-n} H_n(t/\sqrt{2}) = e^{t^2} \frac{d^n}{dt^n} e^{-t^2}.$$

The coefficients  $x_n$  and  $y_n$  are readily computed from the orthogonality property of the Hermite polynomials. Thus, multiplying  $y(s)$  by  $H_n(s)$  and integrating between the limits  $-\infty$  and  $+\infty$ , we obtain

$$\int_{-\infty}^{\infty} y(s) H_n(s) ds = y_n \int_{-\infty}^{\infty} e^{-s^2} H_n(s) ds = y_n 2^n n! \sqrt{\pi}.$$

<sup>4</sup> "Ueber eine besondere Art von Integralgleichungen," *Mathematische Annalen*, Vol. 75, 1914, pp. 130-132. See also G. Polya, "Ueber eine von Herrn. C. Runge behandelte Integralgleichung," *Mathematische Annalen*, Vol. 75, 1914, pp. 376-379.

<sup>5</sup> For a discussion of these functions, see Chapter 2, Section 10.

That is, we have

$$y_n = \frac{1}{2^n n! \sqrt{\pi}} \int_{-\infty}^{\infty} y(s) H_n(s) ds,$$

and similarly,

$$x_n = \frac{1}{2^n n! \sqrt{\pi}} \int_{-\infty}^{\infty} x(s) H_n(s) ds.$$

Assuming that the coefficients  $x_n$  and  $y_n$  are known, then the coefficients,  $r_n$ , of  $h_n(t)$  in the development of  $R(t)$  are connected analytically with  $x_n$  and  $y_n$  in a simple and useful manner.

Thus, let us construct the three functions

$$x^*(t) = x_0 - x_1 t + x_2 t^2 - x_3 t^3 + x_4 t^4 - \dots,$$

$$y^*(t) = y_0 + y_1 t + y_2 t^2 + y_3 t^3 + y_4 t^4 + \dots,$$

$$r^*(t) = r_0 + r_1 t + r_2 t^2 + r_3 t^3 + r_4 t^4 + \dots.$$

From the theorem it is explicitly seen that the coefficients  $r_n$  may be determined from the equation

$$(18) \quad r^*(t) = x^*(-t) y^*(t).$$

In case  $r(t)$  is an autocorrelation function, we then have  $x(t) \equiv y(t)$ , and equation (18) is then replaced by

$$(19) \quad r^*(t) = x^*(-t) x^*(t).$$

If, further,  $x(t)$  is an even function, that is, if  $x(-t) = x(t)$ , then (19) reduces to the simple form

$$(20) \quad r^*(t) = [x^*(t)]^2.$$

The proof of identity (8) is obtained without difficulty from these results. Thus, let us assume  $\phi(s)$  can be expanded in the series

$$\phi(s) = e^{-s^2} \sum_{n=0}^{\infty} \phi_n H_n(s).$$

When this expansion is substituted in (5) and (6), we obtain

$$(21) \quad a(\beta) = \int_{-\infty}^{\infty} e^{-s^2} \cos \beta s \sum_{n=0}^{\infty} \phi_n H_n(s) ds,$$

$$(22) \quad b(\beta) = \int_{-\infty}^{\infty} e^{-s^2} \sin \beta s \sum_{n=0}^{\infty} \phi_n H_n(s) ds.$$

Noting the identities

$$\int_{-\infty}^{\infty} H_{2r}(s) \sin \beta s e^{-s^2} ds = \int_{-\infty}^{\infty} H_{2r+1}(s) \cos \beta s e^{-s^2} ds = 0,$$

$$\int_{-\infty}^{\infty} H_{2r+1}(s) \sin \beta s e^{-s^2} ds = (-1)^r \sqrt{\pi} e^{-\beta^2/4} \beta^{2r+1},$$

$$\int_{-\infty}^{\infty} H_{2r}(s) \cos \beta s e^{-s^2} ds = (-1)^r \sqrt{\pi} e^{-\beta^2/4} \beta^{2r},$$

we are able at once to simplify (21) and (22) as follows:

$$a(\beta) = \sqrt{\pi} e^{-\beta^2/4} \sum_{n=0}^{\infty} (-1)^n \phi_{2n},$$

$$b(\beta) = \sqrt{\pi} e^{-\beta^2/4} \sum_{n=0}^{\infty} (-1)^n \phi_{2n+1}.$$

From these expansions we then obtain in an obvious manner the identities

$$(23) \quad a(\beta) + i b(\beta) = \sqrt{\pi} e^{-\beta^2/4} \phi^*(i\beta),$$

$$(24) \quad a(\beta) - i b(\beta) = \sqrt{\pi} e^{-\beta^2/4} \phi^*(-i\beta),$$

where we abbreviate

$$\phi^*(\beta) = \sum_{n=0}^{\infty} \phi_n \beta^n.$$

In similar manner we derive

$$(25) \quad \alpha(\beta) = \pi e^{-\beta^2/2} \sum_{n=0}^{\infty} (-1)^n r_{2n} \beta^{2n} = \pi e^{-\beta^2/2} r^*(i\beta).$$

Multiplying equation (23) by (24) and taking account of both (19) and (25), we immediately obtain the identity (8) previously derived by other means, namely,

$$\alpha(\beta) = A^2(\beta) + B^2(\beta).$$

In the preceding discussion we have considered the problem of inversion over the infinite range. We now see that the more restricted problem represented by the serial correlation  $r(t)$  defined by (1) is easily included in the theory which we have just developed.

In order to show this we merely assume that both  $x(s)$  and  $y(s)$  are identically zero outside of the range  $-a \leq s \leq a$ . Then we can write

$$(26) \quad 2a r(t) = \lim_{a \rightarrow \infty} \int_{-a}^a x(s) y(s+t) ds = R(t).$$

Similarly, the transforms

$$(27) \quad A(\beta) = \frac{1}{a} \int_{-a}^a \phi(s) \cos \beta s ds, \quad B(\beta) = \frac{1}{a} \int_{-a}^a \phi(s) \sin \beta s ds,$$

are related to the transforms (5) and (6) by the following:

$$(28) \quad a(\beta) = a A(\beta), \quad b(\beta) = a B(\beta).$$



Consequently the fundamental identity (8) becomes

$$(29) \quad \frac{2}{a} \alpha(\beta) = A^2(\beta) + B^2(\beta),$$

where we now define

$$(30) \quad \alpha(\beta) = \int_{-\infty}^{\infty} r(t) \cos \beta s ds.$$

#### 4. The Lag-Correlation Function for a Harmonic Sum

It is frequently important to know the lag-correlation and auto-correlation functions for sums of harmonic terms. These functions are most conveniently constructed by using averages in the mean.

*Definition:* By an *average in the mean* of a function  $f(t)$  we shall understand the limit

$$F = \lim_{\lambda \rightarrow \infty} \frac{1}{2\lambda} \int_{-\lambda}^{\lambda} f(t) dt.$$

Thus, if we consider the pure harmonic

$$y = A \sin(\beta t + \alpha), \quad \beta = 2\pi/T,$$

we have for the average in the mean the value

$$\lim_{\lambda \rightarrow \infty} \frac{1}{2\lambda} \int_{-\lambda}^{\lambda} A \sin(\beta t + \alpha) dt = \lim_{\lambda \rightarrow \infty} \frac{A \sin \alpha \sin \beta \lambda}{\beta \lambda} = 0.$$

*Definition:* By a *product in the mean* of two functions  $f(t)$  and  $g(t)$  we shall understand the limit

$$R = \lim_{\lambda \rightarrow \infty} \frac{1}{2\lambda} \int_{-\lambda}^{\lambda} f(t) g(t) dt;$$

and by the *second moment in the mean* of  $f(t)$  we shall understand the limit

$$G = \lim_{\lambda \rightarrow \infty} \frac{1}{2\lambda} \int_{-\lambda}^{\lambda} f^2(t) dt.$$

Thus for the two harmonics

$$y_1 = A \sin(\beta t + \alpha), \quad \text{and} \quad y_2 = A \sin(\beta t + \alpha + \beta s),$$

we obtain the following product in the mean:

$$R(s) = \lim_{\lambda \rightarrow \infty} \frac{1}{2\lambda} \int_{-\lambda}^{\lambda} A^2 \sin(\beta t + \alpha) \sin(\beta t + \alpha + \beta s) dt = \frac{1}{2} A^2 \cos \beta s.$$

Similarly for  $y_1$ , we compute as the second moment in the mean

$$G = \lim_{\lambda \rightarrow \infty} \frac{1}{2\lambda} \int_{-\lambda}^{\lambda} A^2 \sin^2(\beta t + \alpha) dt = \frac{1}{2} A^2.$$

The same result is obtained for the second moment of the mean of  $y^2$ , that is,  $G = \frac{1}{2} A^2$ .

Since the autocorrelation function for the harmonic  $y$  is given by  $r(s) = R(s)/\sqrt{G_1 G_2}$ , we readily obtain

$$(1) \quad r(s) = \frac{1}{2} A^2 \cos \beta s / \frac{1}{2} A^2 = \cos \beta s.$$

This result can be easily generalized for the lag correlation in the mean between the two harmonic series

$$\begin{aligned} y &= A_1 \sin \frac{2\pi}{T_1} (t + a_1) + A_2 \sin \frac{2\pi}{T_2} (t + a_2) \\ &\quad + \dots + A_n \sin \frac{2\pi}{T_n} (t + a_n), \\ x &= B_1 \sin \frac{2\pi}{T_1} (t + b_1) + B_2 \sin \frac{2\pi}{T_2} (t + b_2) \\ &\quad + \dots + B_n \sin \frac{2\pi}{T_n} (t + b_n). \end{aligned}$$

Employing the average in the mean, we readily find the lag correlation between  $x$  and  $y$  to be

$$(2) \quad r = \frac{A_1 B_1 \cos \frac{2\pi}{T_1} (a_1 - b_1) + \dots + A_n B_n \cos \frac{2\pi}{T_n} (a_n - b_n)}{\sqrt{(A_1^2 + A_2^2 + \dots + A_n^2) (B_1^2 + B_2^2 + \dots + B_n^2)}}.$$

The autocorrelation function for  $y$  can be immediately obtained from this expression by setting  $A_i = B_i$ ,  $a_i = s + b_i$ . We then have

$$(3) \quad r(s) = \frac{A_1^2 \cos \frac{2\pi}{T_1} s + A_2^2 \cos \frac{2\pi}{T_2} s + \dots + A_n^2 \cos \frac{2\pi}{T_n} s}{A_1^2 + A_2^2 + \dots + A_n^2}.$$

It is interesting to observe that formula (8) of the preceding section holds between  $y$  and  $r(s)$ , provided the Fourier transforms are

interpreted as transforms in the mean. Thus we immediately derive

$$\lim_{\lambda \rightarrow \infty} \frac{1}{2\lambda} \int_{-\lambda}^{\lambda} \cos \frac{2\pi}{T_r} t y(t) dt = \frac{1}{2} A_r \sin \left( \frac{2\pi}{T_r} a_r \right) = \alpha_r,$$

$$\lim_{\lambda \rightarrow \infty} \frac{1}{2\lambda} \int_{-\lambda}^{\lambda} \sin \frac{2\pi}{T_r} t y(t) dt = \frac{1}{2} A_r \cos \left( \frac{2\pi}{T_r} a_r \right) = \beta_r,$$

$$\lim_{\lambda \rightarrow \infty} \frac{1}{2\lambda} \int_{-\lambda}^{\lambda} \cos \frac{2\pi}{T_r} s r(s) ds = \frac{1}{2} A_r^2 / (A_1^2 + A_2^2 + \dots + A_n^2) = r_r.$$

Dividing  $\alpha_r$  and  $\beta_r$  by the standard error of  $y$ , that is, by

$$\sigma^2 = \frac{1}{2} \sqrt{A_1^2 + A_2^2 + \dots + A_n^2},$$

we get the desired relationship

$$r_r = (\alpha_r/\sigma)^2 + (\beta_r/\sigma)^2.$$

For experimental purposes a synthetic series was constructed of the form

$$y = \sum_{i=1}^5 A_i \cos \frac{2\pi}{T_i} t + \sum_{i=1}^5 B_i \cos \frac{2\pi}{T_i} t,$$

where the following values were used for the constants:

Subscripts ( $i$ )	$T_i$	$A_i$	$B_i$	$\sqrt{A_i^2 + B_i^2}$
1	12	7	6	9.2195
2	25	4	3	5.0000
3	44	12	14	18.4391
4	60	3	4	5.0000
5	144	4	5	6.4031

Three hundred values of the series were computed so that the first period appeared 25 times, the second 12 times, the third 7 times, the fourth 5 times, and the last 2 times. Substituting the values of  $T_i$ ,  $A_i$ , and  $B_i$  in equation (3), one derived the following autocorrelation function:

$$r(s) = 0.1647 \cos \frac{2\pi}{12} s + 0.0484 \cos \frac{2\pi}{25} s + 0.6589 \cos \frac{2\pi}{44} s \\ + 0.0484 \cos \frac{2\pi}{60} s + 0.0795 \cos \frac{2\pi}{144} s.$$

Since this function was derived on the assumption of limits in the mean, it is of interest to compare values of  $r(s)$  computed directly

from the function with those obtained by direct autocorrelation of the series itself. The discrepancies are exhibited in the following table and are seen to be relatively small. This example, then, justifies the use of limits in the mean in harmonic series of this type.

$s$	$r(s)$ By formula	$r(s)$ Computed	$s$	$r(s)$ By formula	$r(s)$ Computed	$s$	$r(s)$ By formula	$r(s)$ Computed
0	1.0000	1.0000	27	-0.4712	-0.5544	48	0.7366	0.7955
3	0.7571	0.7713	30	-0.4513	-0.5222	51	0.3832	0.4621
6	0.3859	0.4124	33	-0.0563	-0.1167	54	-0.0621	0.0254
9	0.2567	0.2823	36	0.3543	0.3142	57	-0.2117	-0.1330
11	0.1878	0.2124	38	0.4265	0.4110	60	-0.3263	-0.2689
15	-0.3323	-0.2982	39	0.4141	0.4138	63	-0.6748	-0.6362
18	-0.6868	-0.6861	41	0.3890	0.4136	66	-0.8921	-0.8953
20	-0.7187	-0.7097	42	0.4114	0.4450	69	-0.6467	-0.7232
21	-0.6063	-0.6620	43	0.4665	0.5059	72	-0.2960	-0.3767
24	-0.4200	-0.5167	45	0.6367	0.6839	75	-0.2161	-0.3571
25	-0.4135	-0.5053	47	0.7506	0.7491			

The agreement between the two computations is exhibited graphically in Figure 26.

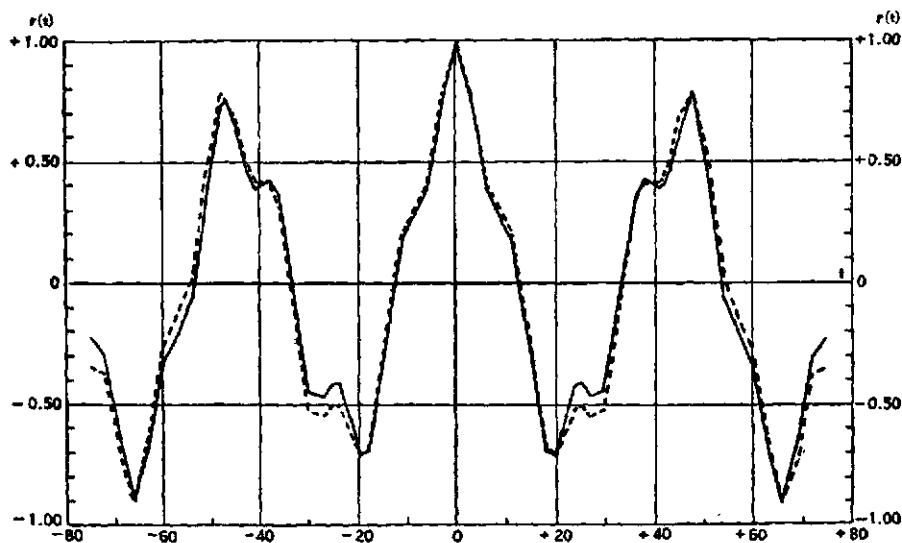

FIGURE 26.—AUTOCORRELATION GRAPH OF A FUNCTION WITH FIVE PERIODIC TERMS.  
 — :  $r(s)$  computed by formula; - - - :  $r(s)$  computed directly from data.

### 5. The Lag-Correlation Function and Its Harmonic Analysis for Statistical Data

In the preceding analysis we have defined the lag-correlation function as an infinite integral or as a limit in the mean. As a matter

of fact, the lag-correlation function which appears in the analysis of statistical data is neither of these quantities, but a set of values computed from data over a finite interval which we may specify as  $-a \leq s \leq a$ .

The arithmetic average is then

$$A = \frac{1}{2a} \int_{-a}^a f(s) ds,$$

and the variance is

$$\sigma^2 = \frac{1}{2a} \int_{-a}^a [f(s) - A]^2 ds.$$

In terms of these quantities the correlation between  $f(s)$  and  $f(s + t)$  is given by the formula

$$r(t) = \frac{1}{2a} \int_{-a}^a \frac{[f(s) - A]}{\sigma} \frac{[f(s + t) - A]}{\sigma} ds.$$

Since the Fourier coefficients  $A(\beta)$  and  $B(\beta)$  are determined by

$$A(\beta) = \frac{1}{a} \int_{-a}^a \frac{[f(s) - A]}{\sigma} \cos \beta s ds,$$

$$B(\beta) = \frac{1}{a} \int_{-a}^a \frac{[f(s) - A]}{\sigma} \sin \beta s ds,$$

the factor 2 which appears in the denominator of  $r(t)$  but not in  $A(\beta)$  and  $B(\beta)$  must be accounted for in formula (8) of Section 3.

Hence, when the preceding theory is applied to statistical data given over a finite range  $-a \leq s \leq a$ , formula (8) of Section 3 must be replaced by [see formula (29) of Section 3]

$$(1) \quad \frac{2}{a} \alpha(\beta) = A^2(\beta) + B^2(\beta) = R^2(\beta).$$

Moreover, the equality sign holds only when limits in the mean are understood. For many problems, however, the relationship expressed in equation (1) is sufficiently close for practical purposes, when  $a$  is large. This may readily be seen from the illustrative example of Section 4.

#### 6. Some Examples Useful in the Analysis of Economic Time Series—Continuous Spectra

It is a matter of statistical observation that the autocorrelation function of certain economic time series may be approximately represented by the function

$$r(t) = \begin{cases} 1 - |t|/\lambda, & |t| < \lambda, \\ 0, & |t| > \lambda, \end{cases}$$

provided  $a$ , where  $2a$  is the range of the data, is sufficiently large.

Hence, the harmonic analysis of this function should throw some light upon the harmonic properties of the time series themselves. But we have seen in Section 3 that, given a certain autocorrelation,  $r(t)$ , the primary function,  $\phi(t)$ , from which it was derived is not unique. There is, as a matter of fact, an infinite set of such functions. Let  $\theta(t)$  be one of these.

But since the harmonic analysis of  $r(t)$  yields also the harmonic analysis of both  $\phi(t)$  and  $\theta(t)$  through the relationship [see formula (1) of Section 5]

$$2a(\beta) = R^2(\beta), \quad \beta = 2\pi/T,$$

it is clear that the harmonic properties of any two functions,  $\phi(t)$  and  $\theta(t)$ , will be the same provided these functions have the same autocorrelation  $r(t)$ . Such functions we shall call *harmonically equivalent*.

This observation greatly simplifies the discussion of certain harmonic analyses since a complex function,  $\phi(t)$ , may frequently be replaced by a simpler function,  $\theta(t)$ , harmonically equivalent to the first, whose properties and spectrum are completely known.

As an example of considerable usefulness, let us consider the function  $\theta(t)$  defined as follows:

$$\theta(t) = \begin{cases} 1, & -\nu \leq t \leq \nu, \\ 0, & \nu < |t| \leq a. \end{cases}$$

The arithmetic average,  $A$ , of this function is equal to  $\mu$ , where  $\mu = \nu/a$ , and the variance,  $\sigma^2$ , is given by  $\sigma^2 = \mu(1 - \mu)$ .

By a direct computation, we readily determine the autocorrelation of  $\theta(t)$  to be the following:

$$r(t) = \begin{cases} 1 - \frac{\mu^2}{2\nu\sigma^2} |t|, & t \leq 2\nu, \\ -\frac{\mu^2}{\sigma^2}, & |t| > 2\nu. \end{cases}$$

We next compute the value of  $\alpha(\beta)$  and thus obtain

$$\alpha(\beta) = \frac{1}{a} \int_{-a}^a r(s) \cos \beta s ds, \quad \beta = 2\pi/T,$$

$$\alpha(\beta) = \frac{2}{a\nu(1-\mu)} \left(\frac{T}{2\pi}\right)^2 \sin^2 \frac{2\pi\nu}{T} - \frac{2}{a(1-\mu)} \left(\frac{T}{2\pi}\right) \sin \frac{2\pi a}{T}$$

If  $a$  is large with respect to  $\nu$ , it is clear that the second term may be neglected and we thus have merely

$$\alpha(\beta) = \frac{2\mu}{(1-\mu)} \left(\frac{T}{2\pi\nu}\right)^2 \sin^2 \frac{2\pi\nu}{T}.$$

Hence, the ordinates of the periodogram of the function  $\theta(t)$  are given by

$$R = R(T) = \sqrt{2\alpha(\beta)}$$

or

$$(1) \quad R(T) = 2\sqrt{\frac{\mu}{(1-\mu)}} \left(\frac{T}{2\pi\nu}\right) \left|\sin \frac{2\pi\nu}{T}\right|$$

If  $T$  is large with respect to  $\nu$ , it is clear that  $R(T)$  will approach the following limit asymptotically:

$$R(T) \approx 2\sqrt{\frac{\mu}{1-\mu}}.$$

We also note that the maximum values of  $R$  are found at the roots of the equation

$$\tan x = x, \quad x = 2\pi\nu/T.$$

The first five of these roots, except the trivial one  $x = 0$ , are

$$x_1 = 4.4934, \quad x_2 = 7.7253, \quad x_3 = 10.9041,$$

$$x_4 = 14.0662, \quad x_5 = 17.2208.$$

If we employ the abbreviation  $k = 2\sqrt{\mu/(1-\mu)}$ , then the values of  $R(T)$  at the roots just given may be computed from the following table:

$x_n$	$T_n = (2\pi\nu)/x_n$	$R(T_n)$
$x_1$	1.3983 $\nu$	0.2172 $k$
$x_2$	0.8133 $\nu$	0.1284 $k$
$x_3$	0.5762 $\nu$	0.0913 $k$
$x_4$	0.4467 $\nu$	0.0709 $k$
$x_5$	0.3649 $\nu$	0.0580 $k$

As an example, we consider the values  $2a = 204$ ,  $2\nu = 12$ . We

then compute  $k = 0.5$ , and the periodogram is given by the function  $R = R(T)$ , where

$$R(T) = 0.5 \frac{T}{12\pi} \left| \sin \frac{12\pi}{T} \right|.$$

The graphs of  $r(t)$  and the periodogram are shown in (a) of Figure 27.

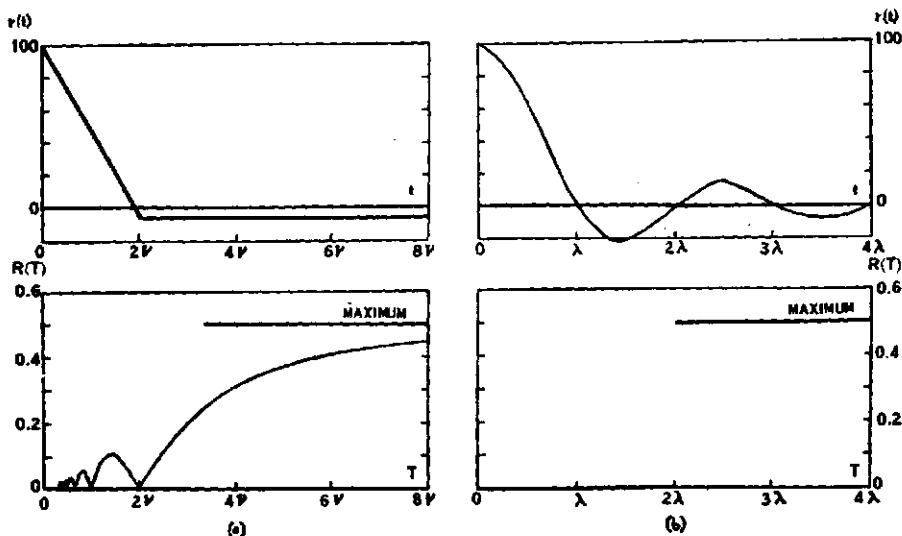

FIGURE 27.—PERIODOGRAMS CORRESPONDING TO DIFFERENT AUTOCORRELATION FUNCTIONS.

Primary functions with these autocorrelations have continuous spectra.

A second autocorrelation function which is closely related to the one which we have just analyzed is the following:

$$r(t) = \frac{\sin(\pi t/\lambda)}{(\pi t/\lambda)}.$$

All functions, or series of statistical data, which are harmonically equivalent through this autocorrelation function are seen to have *continuous spectra* from the following computation of  $2\alpha(\beta)$ :

$$\begin{aligned} 2\alpha(\beta) &= \int_{-\infty}^{\infty} A \frac{\sin(\pi t/\lambda)}{\pi t/\lambda} \cos \beta t \, dt, \quad \beta = 2\pi/T, \\ &= A\lambda \begin{cases} 0, & T < 2\lambda, \\ \frac{1}{2}, & T = 2\lambda, \\ 1, & T > 2\lambda. \end{cases} \end{aligned}$$



Considerations similar to those carried out in the first case show that for data given over a finite range  $A$  must be evaluated so that

$$A\lambda = 4 \frac{\mu'}{1 - \mu'}, \quad \mu' = \lambda/2a,$$

where  $2a$  is the length of the range of the data.

The graphs of  $r(t)$  and the periodogram are shown in (b) of Figure 27 for the values  $2a = 204$ ,  $\lambda = 12$ .

In order to illustrate the application of these ideas to actual economic data, we shall consider two periodograms taken from the data of Chapter 7. The first of these is the periodogram of the industrial stock prices in the disruptive period from 1925 to 1934. Because of the character of the data we know that no real periodicity existed in these prices, and yet an inspection of the periodogram [(B) in the lower part of (a) in Figure 28] indicates a concentration of energy for some period greater than 40. The object of the present analysis is to show that the periodogram is derived from the existence of a continuous spectrum.

We first compute the autocorrelation function of the data, obtaining the following values:

$t$	$r(t)$	$t$	$r(t)$	$t$	$r(t)$
0	1.0000	12	0.6252	22	0.0782
3	0.9288	15	0.4877	28	0.0292
6	0.8588	18	0.3550	24	-0.0163
9	0.7559	21	0.1188	27	-0.1464

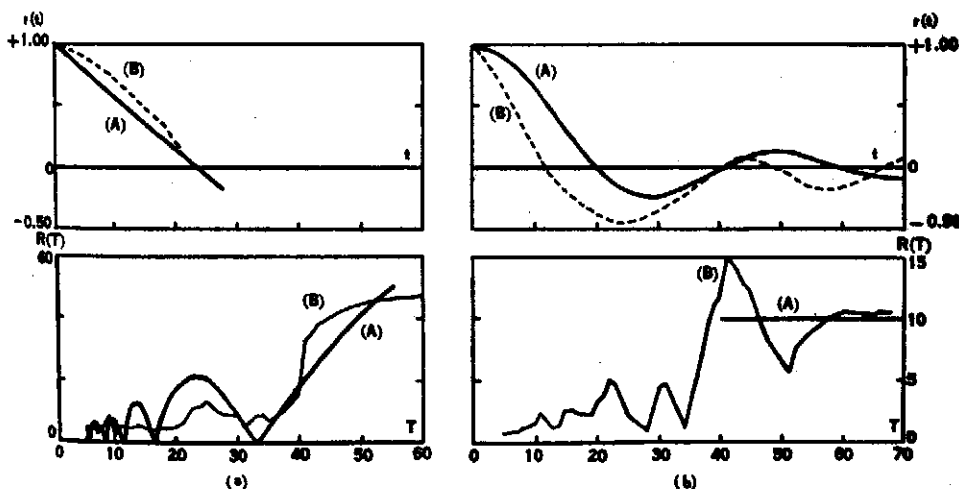

FIGURE 28.—FIGURES SHOWING THE EXISTENCE OF CONTINUOUS SPECTRA IN ECONOMIC TIME SERIES.

We see from the graph [(B) in the upper part of (a) in Figure 28], that the autocorrelation function approximates a straight line which crosses the  $t$ -axis at approximately  $t_0 = 24$ .

Referring to the theory developed earlier in this section, and noting that the series is short, that is  $2a = 120$ , we use as the approximate representation of the autocorrelation the linear function

$$r(t) = 1 - \frac{\mu|t|}{\sigma^2 2\nu} = 1 - \frac{|t|}{(1-\mu)(2\nu)},$$

and compute  $\mu$  from the relationship  $r(t_0) = 0$ . This gives us the equation

$$2\mu^2 - 2\mu + t_0/a = 0.$$

Solving this for  $\mu$  we obtain  $\mu = 0.2764$ , and from this value we compute

$$k = 2 \sqrt{\frac{\mu}{1-\mu}} = 1.236, \quad \nu = 16.58.$$

The periodogram of the resulting continuous spectrum is found from the equation

$$R(T) = 1.236 \sigma \frac{T}{2\pi\nu} \left| \sin \frac{2\pi\nu}{T} \right|,$$

where  $\sigma$ , the standard deviation of the series, is equal to 79.48.

When one appreciates the fact that the actual elements in the data which we are analyzing are unknown, the agreement exhibited between (A) and (B) in the lower part of (a) in Figure 28 is seen to be a remarkable one. The conclusion to be derived from this analysis is that there is no true period in the data and the rise noted in the periodogram after  $T = 40$  is fully accounted for as arising from a continuous spectrum.

The second example relates to the problem of determining whether or not there exists a 40-month cycle in the series of industrial stock prices over the period from 1897 to 1913. This is a much debated proposition to which we shall refer at length later. In the present analysis we are interested in the problem of how much of the peak noted in the periodogram [see (b), Figure 28] at  $T = 41$  might be due to the existence of a continuous spectrum.

Graphical representation of the lag-correlation function of stock prices and the autocorrelation function

$$r(t) = \frac{\sin(\pi t/20)}{(\pi t/20)}$$

shows that the two functions are quite similar. Hence we might reasonably expect the existence of a considerable continuous spectrum in the periodogram of the actual data.

If we assume that  $\lambda = 20$ , and note that  $2a = 204$ , then the value of  $k$  turns out to be

$$k = 2 \sqrt{\frac{\mu'}{1-\mu'}} = 0.66.$$

Hence, since  $\sigma = 15.01$ , the continuous spectrum in the data might be represented by the periodogram

$$R = \begin{cases} k\sigma = 9.91, & T > 40, \\ 0, & T < 40. \end{cases}$$

One sees from the graph [see lower (b), Figure 28] that this function agrees very well with the maximum value observed in the periodogram of the data after  $T = 55$ .

Thus our analysis would indicate that while the peak at  $T = 41$  furnishes real evidence in favor of the existence of a 40-month period in stock prices, the fact that the data may contain a continuous spectrum of amplitude as great as 9.91 makes one cautious in accepting the existence of the 40-month cycle without other evidence than that furnished by the periodogram itself.

### 7. Yule's Theory of Random Variation

In his notable paper of 1927 to which we have referred in the first chapter of this work, G. U. Yule considered the possibility of accounting for the deviations of an empirical time series from its true harmonic motion by means of a random impulse function. Yule's ideas are essentially those of the physicist when he considers the behavior of an elastic system under the influence of an impressed force, except that, in Yule's case, the impressed force is a series of random shocks. Yule also chose to employ the machinery of difference equations instead of the more tractable differential equations of the physicist.

Thus Yule began with the difference equation

$$(1) \quad \Delta^2 u(t) + \mu u(t+1) = \phi(t+2h),$$

where we define

$$\Delta u(t) = u(t+h) - u(t), \quad \mu = 4 \sin^2 s = 2(1 - \cos 2s), \quad s = \pi h/T,$$

and  $\phi(t)$  is an impressed force acting upon  $u(t)$ .

If  $\phi(t)$  is defined as a set of small erratic fluctuations,  $\epsilon_0, \epsilon_1, \epsilon_2, \epsilon_3$ , etc., then  $u(t)$  is a simple harmonic motion disturbed by these random impulses. The solution of equation (1) may be shown to have the form

$$(2) \quad u(t) = A \sin \frac{2\pi}{T} (t + \tau) + \phi(t) + \frac{\sin 4s}{\sin 2s} \phi(t-h) \\ + \frac{\sin 6s}{\sin 2s} \phi(t-2h) + \frac{\sin 8s}{\sin 2s} \phi(t-3h) + \dots$$

Let us examine this solution more carefully. We see that it consists of a simple harmonic term and a series, the particular integral, which we shall for convenience designate by  $\Psi(t)$ . If we assume that  $\phi(t)$  is zero for negative values of the argument, then  $\Psi(nh)$  is a finite sum of harmonic terms defined in the following manner by the erratic fluctuations  $\varepsilon_0, \varepsilon_1, \varepsilon_2, \text{ etc.}$ :

$$\Psi(nh) = \frac{\varepsilon_n \sin 2s + \varepsilon_{n-1} \sin 4s + \varepsilon_{n-2} \sin 6s + \dots + \varepsilon_0 \sin(n+1)2s}{\sin 2s}$$

In order to test his formula, Yule constructed a series of 300 items. He set  $T = 10h$ ,  $u(0) = 0$ ,  $u(h) = \sin 36^\circ = 0.5878$ ,  $\mu = 0.3820$ . The values of  $\phi(t)$  were determined by tossing four dice and computing

$$\phi(t) = \frac{\text{Toss of 4 dice} - 14 (\text{mean value})}{20}$$

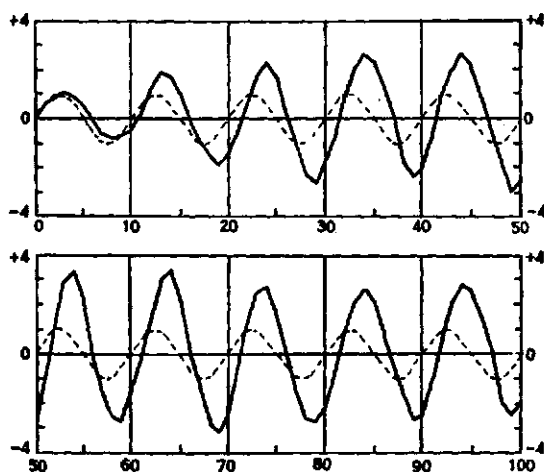

FIGURE 29.—PERIODIC FUNCTIONS SUBJECT TO RANDOM FLUCTUATIONS.  
 ——— : Complete series; ---- : Harmonic component.

Hence  $\phi(t)$  fluctuates between  $+0.5$  and  $-0.5$  and the expected maxima and minima of  $\Psi(t)$  are  $m(+\varepsilon) = 2.7532$  and  $m(-\varepsilon) = -2.7532$ . The first 100 values are graphically shown in Figure 29, together with the harmonic term upon which the particular integral is superimposed. We note that the expected extremal of  $|u(t)|$ , namely,  $1 + m(\varepsilon) = 3.7532$ , is not attained by the function, although it is actually exceeded slightly by five maxima and five minima in the entire series of 300 items.

We note also the significant fact that both the phase and the

amplitude are subject to considerable change over the range shown in the figure. Yule makes the following comments on the experiment: "The series tends to oscillate, since, if we take adjacent terms, most of the periodic coefficients of the  $\varepsilon$ 's are of the same sign, and consequently the adjacent terms are partially correlated; whereas, if we take terms, say 5 places apart, the periodic coefficients of the  $\varepsilon$ 's are of opposite sign, and therefore the terms are negatively correlated—since adjacent terms represent simply differently weighted sums of  $\varepsilon$ 's, all but one of which are the same." A further comment bears upon the situation when the fundamental harmonic term is omitted. In this case "the series would reduce to the fundamental integral alone, but the graph would present to the eye an appearance hardly different from that of the figure. The case would correspond to that of a pendulum initially at rest, but started into motion by the disturbances."

The method of analysis suggested by this study then consists essentially of computing the period of the underlying harmonic by determining that value of  $k$  which gives the best fit of the equation

$$(3) \quad u_x = k u_{x-1} - u_{x-2}$$

to the data. If two underlying harmonics are suspected to exist, then equation (3) is replaced by

$$(4) \quad u_x = k_1(u_{x-1} + u_{x-3}) - k_2 u_{x-2} - u_{x-4}$$

When Yule applied equation (3) to the first 150 items of his own experimental series he obtained the period  $T = 10.087$ . The second 150 items yielded the value  $T = 9.845$ , a very satisfactory agreement.

Applied to Wolfer's sunspot numbers over the period 1749-1924, equation (3) yielded a period of 10.08 years, whereas equation (4) gave a minor period of 1.42 years and a major period of 11.95 years.

The error of more than 1 year, as given by (3), from the generally accepted period of 11.25 (Schuster) led Yule to replace equation (3) by the following:

$$(5) \quad u_x = b_1 u_{x-1} - b_2 u_{x-2}$$

which yielded a period of 10.600 years for the sunspot numbers.

Now if the  $\varepsilon_i$  were all equal to a single positive constant  $\varepsilon$ , we would have

$$\Psi(nh) = \varepsilon \frac{\sin(n+1)s}{\sin s} \frac{\sin(n+2)s}{\sin 2s};$$

which obviously cannot exceed

$$m(\varepsilon) = \frac{\varepsilon}{|\sin s| |\sin 2s|}$$

in absolute value.

But if the  $\varepsilon_i$  are random numbers of either sign with an average value of zero, then  $\Psi(nh)$  might be expected to fluctuate more or less regularly between the values  $m(+\varepsilon)$  and  $m(-\varepsilon)$ , where  $\varepsilon$  is the extreme variation of the random numbers. It might happen, however, that there existed a sequence of values among the  $\varepsilon_i$ , which, for some value of  $n$ , agreed in sign with their corresponding multipliers. Then  $\Psi(nh)$  could exceed by almost any given amount the extremal values just written down. The probability of the existence of such a fortuitous distribution of signs is not high, but if the range for  $n$  is sufficiently large, then the probability may be made as high as one wishes that in some part of the range this extreme variation may take place.

All these observations accord with the actual observed behavior of economic time series. Such series fluctuate about their trends in a manner which, for the most part, may be described as a disturbed sinusoidal pattern. The maxima and minima of such fluctuations as are observed in one period are exceeded, sometimes greatly, by the maxima and minima of another. It is this accord between the solution of Yule and the observed facts about economic time series that makes the former so attractive as an approach to the statistical description of economic variation.

The theory of Yule was extended in some respects by Sir Gilbert Walker and applied by him to the study of atmospheric pressure data at Port Darwin, "one of the most important centers of world weather."<sup>6</sup>

Although the conclusions regarding the existence of harmonic structure in the data turned out to be negative, the method itself is illuminating and furnishes a good illustration of some of the theory developed in this chapter.

It is first assumed that there exists a linear regression between the mean deviations  $u_x$ ,  $u_{x-1}$ , etc. of the data; that is,

$$(6) \quad u_x = g_1 u_{x-1} + g_2 u_{x-2} + \dots + g_s u_{x-s}.$$

If  $u_x$  is normalized by division by  $\sigma$ , and if the series is assumed to be sufficiently long so that neither correlation coefficients nor  $\sigma$  are essentially altered by the neglect of a few terms, then we shall have

<sup>6</sup> "On Periodicity in Series of Related Terms," *Proceedings of the Royal Society of London*, Vol. 131 (A), 1931, pp. 518-532.

$$(7) \quad \frac{1}{2a} \int_{-a}^a u_x u_{x+t} dx \equiv r(t) = g_1 r(t-1) + g_2 r(t-2) + \dots + g_s r(t-s).$$

Hence the autocorrelation function  $r(t)$  is a solution of the difference equation (6) and the interpretation of the data can be made directly from the form of  $r(t)$ . The procedure is either to compute (6) and then solve (7), or first to find (7) and then compute the regression (6).

The theory of this chapter, and in particular Section 3, affords a further interpretation of the data by providing a mechanism for constructing the complete harmonic analysis of the data from the coefficients of (6) whether they are determined initially from (6) or (7).

Walker first determined the autocorrelation of his data over a range of  $N = 177$  quarters (708 months). He then observed that a good approximation to the actually observed values was furnished by the following function:

$$(8) \quad r(t) = 0.19 (0.96)^t \cos \frac{2\pi t}{12} + 0.15 (0.98)^t + 0.66 (0.71)^t \\ = 0.19 e^{-0.0408t} \cos \frac{2\pi t}{12} + 0.15 e^{-0.0202t} + 0.66 e^{-0.3425t}.$$

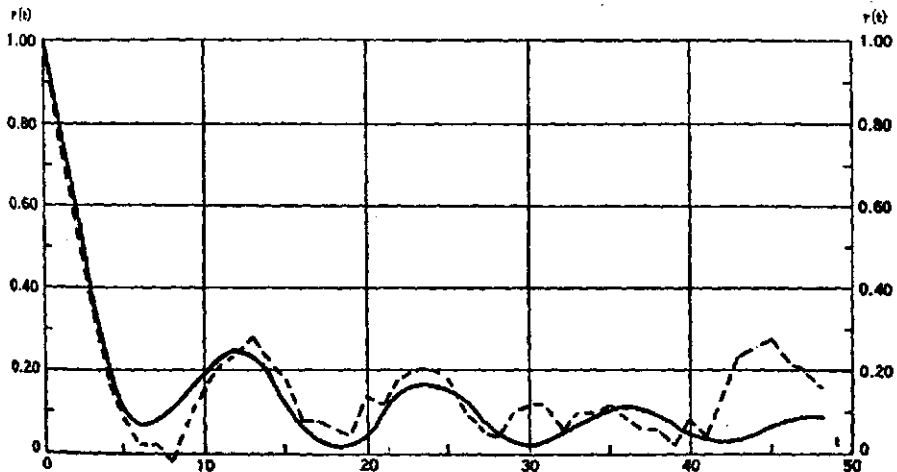

FIGURE 30.—AUTOCORRELATION OF SIR GILBERT WALKER'S ATMOSPHERIC-PRESSURE DATA AT PORT DARWIN.

———— : Autocorrelation determined from function; - - - - : Autocorrelation from actual data.

Both the actual values of the correlation and those computed from (8) are shown in Figure 30.

The corresponding difference equation (6) is readily observed to be

$$u_n = 3.35 u_{n-1} - 4.43 u_{n-2} + 2.71 u_{n-3} - 0.64 u_{n-4}.$$

It is now possible by means of (8) to determine the periodogram of the data. Thus from equation (29) of Section 3 we have

$$(9) \quad R(T) = \sqrt{\frac{2}{a}} a(T) = \frac{2}{\sqrt{177}} \sqrt{a(T)},$$

where we define

$$(10) \quad a(T) = \int_{-\infty}^{\infty} r(t) \cos \frac{2\pi t}{T} dt.$$

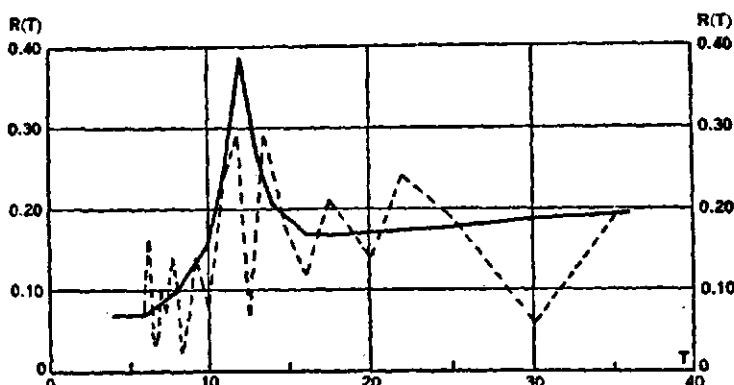

FIGURE 31.—PERIODOGRAMS OF SIR GILBERT WALKER'S ATMOSPHERIC-PRESSURE DATA AT PORT DARWIN.

----- : Actual harmonic analysis of data; ————— : Periodogram determined from autocorrelation function.

But equation (10) is immediately written down from the formulas (11) and (12) of Section 3. We thus obtain

$$a(T) = \frac{4.6569}{1 + 164.6934(1 + 12/T)^2} + \frac{4.6569}{1 + 164.6934(1 - 12/T)^2} \\ + \frac{7.4257}{1 + 96751.18/T^2} + \frac{1.9271}{1 + 336.5606/T^2}.$$

The function  $R(T)$  is graphically represented in Figure 31 together with the actual values of the periodogram as given by Walker. One



will observe that the function  $R(T)$  is a sort of smoothed average of the values of the periodogram computed from the data directly.

The actual values of the ordinates of the periodogram and of  $R(T)$  are given in the following table:

$T$	Periodogram	$T$	Periodogram	$T$	$R(T)$
5.90	0.07	10.5	0.15	4	0.0678
6.12	0.16	11.0	0.24	6	0.0705
6.29	0.05	11.7	0.29	8	0.0983
6.50	0.03	12.5	0.07	10	0.1554
6.67	0.04	13.5	0.29	11	0.2413
7.00	0.10	14.7	0.18	12	0.3867
7.33	0.07	16.0	0.12	13	0.2614
7.66	0.14	17.5	0.21	14	0.2017
8.00	0.11	20.0	0.14	16	0.1696
8.3	0.02	22.0	0.24	18	0.1662
8.8	0.06	25.0	0.19	20	0.1686
9.3	0.14	30.0	0.06	24	0.1768
10.0	0.08	35.0	0.19	30	0.1876
				36	0.1964

### 8. Lag Correlation and Its Relation to Supply and Demand Curves

One of the most fundamental ideas in the classical theory of economics is that of supply and demand. Thus Alfred Marshall comments: "There is . . . a good deal of general reasoning with regard to the relation of demand and supply which is required as a basis for the practical problems of value, and which acts as an underlying backbone, giving unity and consistency to the main body of economic reasoning. Its very breadth and generality mark it off from the more concrete problems of distribution and exchange to which it is subservient; . . ."<sup>68</sup>

But the terms supply and demand are used in classical theory in a sense that is hard to define statistically. Limiting ourselves for the sake of simplicity to a single commodity, let us consider the demand for this commodity in terms of price alone. If the commodity were given away freely, it is clear that the total demand would still be finite, but, in general, considerably larger than if a price were charged for it. An example of such a quantity is water, which, in many communities is so nearly free that it is used without thought as to its cost. Let us designate this *maximum demand* by  $y_0$ .

But if a price is charged for the commodity, then amounts smaller than  $y_0$  would, in general, be demanded, and if the price became sufficiently great then smaller and smaller quantities would be purchased until the demand became zero. Let  $p_0$  designate this price of

<sup>68</sup> *Principles of Economics*, 8th ed., 1920, p. 83.

zero demand. If  $y$ , the quantity of the commodity demanded at a price  $p$ , be plotted against the price, then a curve similar to the one shown in Figure 32 would be obtained. This is the classical curve of demand and it seems but reasonable to assume that it must always have a negative derivative. One will observe that price is plotted as an ordinate (see Figure 32) and  $y$  as an abscissa contrary to custom in mathematics. This method of representing prices has become standard in economic literature.

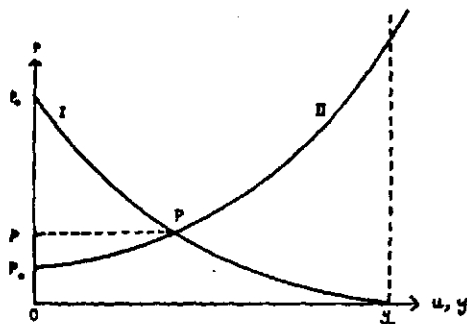

FIGURE 32.—DEMAND AND SUPPLY CURVES.

I. Demand curve,  $y = y(p)$ ;      II. Supply curve,  $u = u(p)$ .

Most studies on demand consider also what is called the *elasticity of demand*. If we denote the demand curve by the function  $y = y(p)$ , then this coefficient is given by the expression

$$\eta = \frac{dy}{dp} \frac{p}{y} = \frac{dy/y}{dp/p} = \frac{d(\log y)}{d(\log p)}.$$

Since in the demand curve the derivative  $dy/dp$  is negative, while  $p/y$  is positive, the elasticity is essentially negative. For this reason some writers, notably those who follow Alfred Marshall, prefer to write the ratio with a negative sign.

If the demand curve is a straight line,

$$\frac{y}{y_0} + \frac{p}{p_0} = 1,$$

then the elasticity is given by the formula

$$\eta = 1 - y_0/y = -p/(p_0 - p).$$

If the elasticity of demand is a constant,  $\eta_0$ , then we have

$$\frac{dy}{y} = \eta_0 \frac{dp}{p},$$

from which we get by integration

$$\log y = \eta_0 \log p + \log C,$$

or

$$y = C p^{\eta_0}.$$

Closely related to the curve of demand is that of supply. This curve represents the amount of supplies available as a function of price. Thus there will exist a price,  $P_0$ , below which it is unprofitable to produce the commodity. Let us call  $P_0$  the *price of zero supply*. In general, the available supply, which we shall designate by  $u$ , will increase with an increasing price, as is exhibited by curve II in Figure 32. This is certainly true for manufactured goods, where natural limitations are not imposed as in the annual growth of agricultural commodities.

*Equilibrium price* is defined as the ordinate of the point  $P$ , where the curves of supply and demand cross, that is to say, where supply equals demand,  $y = u$ . It is obvious from any casual survey of economic data that the point  $P$  is not a stable one, since it varies from one period to another.

In this work we are interested in price, not as a fixed point in a static structure of supply and demand schedules, but rather as a dynamic variable which fluctuates from day to day. The most casual scrutiny of the constantly varying pattern of prices shows that the old classical picture of fixed supply and demand curves must give way to a more realistic interpretation.

In his notable treatise on *The Theory and Measurement of Demand*,<sup>7</sup> the late Henry Schultz devoted a great deal of space to a discussion of fluctuating prices and the determination from them of classical supply and demand curves. It has long been known that realistic demand curves of agricultural commodities can be obtained by graphing the variation in yield against variation in price, proper corrections being made for the growth of population, the change in the general price level, and the magnitude of crop carry-overs. But when these same methods are applied to industrial products, such as the production of pig iron, then the demand curve so obtained has a positive slope and appears to have all the properties of a supply curve. Such a demand(?) curve was first computed by H. L. Moore in his celebrated work on *Economic Cycles: Their Law and Cause*, and the phenomenon of a positively sloping demand curve caused great concern to economists. In Figure 33 we show Moore's curves for the demand for corn compared with his similar computation for the demand

<sup>7</sup> Chicago, 1938, xxxi + 817 pp.

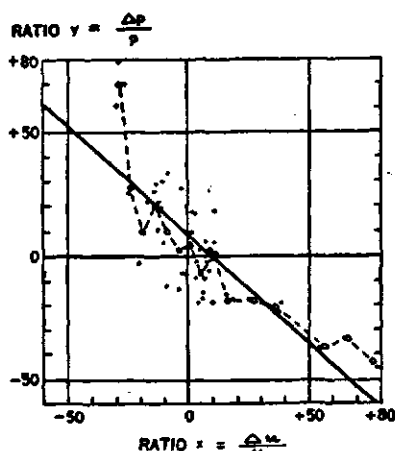

FIGURE 33a.—THE DEMAND CURVE FOR  
CORN:  $y = -0.8896x + 7.79$ .

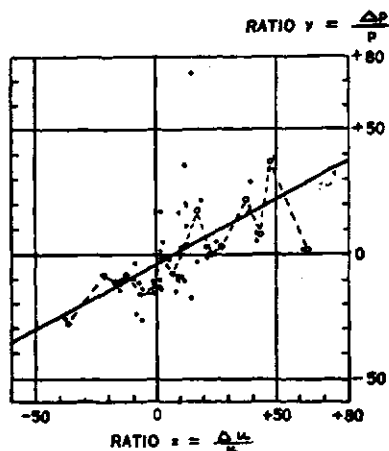

FIGURE 33b.—THE SUPPLY CURVE FOR  
PIG IRON:  $y = 0.5211x - 4.58$ .

for pig iron. Obviously such anomalous results must be explained.

The first satisfactory explanation was advanced by E. J. Working in 1927<sup>8</sup> and an elaboration and extension of his ideas was made by Schultz<sup>9</sup> in his treatise referred to above. The kernel of the explanation lies in the assumption that demand and supply curves, in the sense of classical economics, do not remain fixed, but may vary from time to time. Demand may remain stable, while supply varies, or supply may remain fixed, while demand varies, or both may vary. The consequences from each of these three possibilities are essentially different.

In order to explore the possibilities, let us first observe that if for a given commodity there exists a fixed supply curve and a fixed demand curve, the intersection of the two curves will not vary with time and hence there will be observed one and only one price. Since the most casual inspection of price data shows that this is not the case, it is evident that there is a shifting of either supply or demand with time.

In order to fix our ideas more precisely, let us assume that the supply curve remains fixed, but that the demand curve varies. For simplicity of description, let us assume that the supply curve is the straight line

$$p = u,$$

<sup>8</sup> "What do Statistical 'Demand Curves' Show?" *Quarterly Journal of Economics*, Vol. 41, 1927, pp. 212-235. See, also, in this connection the review by P. G. Wright of Schultz's *Statistical Laws of Demand and Supply*, *Journal of the American Statistical Association*, Vol. 24, 1929, pp. 207-215.

<sup>9</sup> See, in particular, pp. 72-81.

and that prices are observed to be simply periodic with time; that is to say, they may be described by the function

$$p(t) = p_0 + A \sin kt.$$

If, then, the demand curve is also linear, let us say, of the form

$$p + m u = a, \quad m > 0,$$

it is clear that the parameters must be functions of time. Moreover, one observes that if they satisfy the time relation

$$a/(1 + m) = p_0 + A \sin kt,$$

then the intersection of the demand curve with the supply curve will yield the variable price originally postulated. This is illustrated in Figure 34.

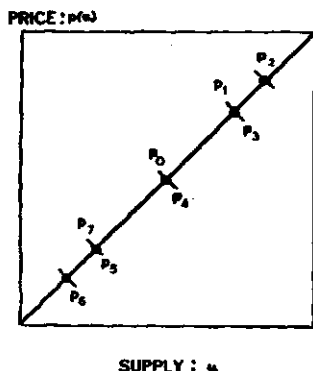

FIGURE 34a.—THE SUPPLY CURVE:  
 $p = u.$

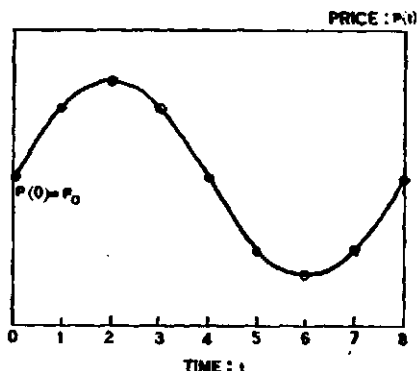

FIGURE 34b.—THE TIME-PRICE CURVE:  
 $p = p_0 + a \sin kt.$

The same argument prevails if the demand curve remains fixed, while the supply curve varies. If the observed price changes with time, then the intersections of the demand curve with the variable supply curve will exhibit the negative slope of the demand curve.

If, however, both supply and demand vary, then the situation becomes indeterminate and there is no possibility of computing either the demand curve or the supply curve from the data of time series.

The question remains as to whether or not both supply and demand curves might not be derived from the same time series by a method of lag correlations. It seems reasonable to suppose that when agricultural prices are high, the farmers will plant more acres during the next season in the hope that they may profit from some carry-over of the prevailing price level. On the other hand, for the same reason, they may reasonably be expected to plant fewer acres during

the season which follows a period of low prices. Hence, in the one case, a surplus is created, and in the other, a deficiency. If this were, indeed, the correct view, then prices of one year, correlated with the production of the *succeeding* year, would produce a high *positive* correlation, whereas the prices of one year, correlated with the production of the *preceding* year, would produce a high *negative* correlation. The regression equation in the first instance would approximate the supply curve, while the regression equation in the second instance would approximate the demand curve.

This attractive idea is scarcely consonant with Working's hypothesis of fixed supply and demand curves. Schultz believed, however, as in the case of the supply and demand functions for sugar, that such a procedure is occasionally possible.

The argument may be stated as follows. We first observe that, with respect to supply and demand curves, there exist four possibilities: (a) the supply curve may be fixed, but the demand curve varies; (b) the demand curve may be fixed, but the supply curve varies; (c) both curves vary; (d) both curves remain fixed. The first three cases have already been discussed, but the fourth remains to be considered.

If both the supply and demand curve were fixed, then the price would be rigidly fixed at their intersection. But since few prices appear to be fixed, their variation in the stream of time might be regarded as positions of disequilibrium. Thus, let us suppose that the demand and supply curves are respectively

$$p = f(q), \quad q = g(p),$$

and that they intersect in one point, which determines the equilibrium price,  $p_0$ , and the equilibrium quantity,  $q_0$ . Then let  $p_1$  be an observed price different from  $p_0$ . We should have  $q_1 = g(p_1)$ , which is also not equal to the equilibrium quantity,  $q_0$ . Continuing the sequence, we obtain the following set of values:

$$p = p_1, \quad q_1 = g(p_1),$$

$$p_2 = f(q_1), \quad q_2 = g(p_2),$$

$$p_3 = f(q_2), \quad q_3 = g(p_3),$$

$$p_4 = f(q_3), \quad q_4 = g(p_4),$$

. . . . .

If, finally, the functions are such that some  $p_r$  corresponds to  $p_1$ , then obviously the sequence,  $p_1, p_2, p_3, \dots, p_r = p_1, \dots$  is cyclical in character. This situation is schematically represented in the accompany-

ing diagram. The formulation given here is commonly referred to as the *cobweb* theory of price.

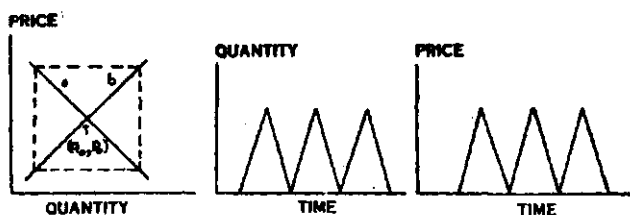

FIGURE 35.—BEHAVIOR OF PRICE AND QUANTITY UNDER FIXED DEMAND (a) AND SUPPLY (b) CURVES.

Schultz remarks about this situation are as follows:

Thus far we have assumed that the two unknown curves [of demand and supply] remain fixed and have shown that, when an interval elapses between changes in price and corresponding changes in supply, it is possible to deduce both curves statistically. This conclusion also holds even when both curves are subject to secular movements, the necessary conditions being: (1) that the curves retain their shape, (2) that each curve shift in some regular manner, and (3) that there exist a time interval between changes in price and changes in supply.

The importance of such a demand-supply relationship lies in that it admits of a straightforward statistical "verification." If by correlating prices and output (consumption) for synchronous years (or other intervals) we obtain a high negative correlation; and if by correlating the same data but with output lagged by, say, one year, we get a high positive correlation; and if these correlations have meaning in terms of the industry or commodity under consideration, the statistical demand and supply curves thus obtained are probably very close approximations to the theoretical curves. It is assumed, of course, that the data have been adjusted for secular changes and other disturbing factors.<sup>10</sup>

<sup>10</sup> *The Theory and Measurement of Demand*, pp. 78-80. See also Mordecai Ezekiel, "Statistical Analyses and the 'Laws' of Price," *Quarterly Journal of Economics*, Vol. 42, 1928, pp. 199-227.

## CHAPTER 4

### THE THEORY OF RANDOM SERIES

#### 1. Definitions and Examples

In the discussion of the nature and the structure of economic time series it is necessary to consider the definition and properties of what we shall call *random series*.

By a *random series* we shall mean a sequence of items

$$(1) \quad y_1, y_2, y_3, y_4, \dots, y_t, \dots, y_N,$$

which has the property that the autocorrelation  $r(t)$  is sufficiently small so that the data may reasonably be assumed to have been drawn at random from an infinite universe.

It will be convenient to assume that the average of series (1) is zero and that the standard deviation is unity, neither assumption imposing an essential restriction upon the series. The autocorrelations for a lag of  $t$  units will then be given by

$$(2) \quad r(t) = \sum_{s=1}^{N-t} y_s y_{s+t} / (N-t).$$

It will also be convenient to write equation (2) in the continuous form

$$(3) \quad r(t) = \lim_{a \rightarrow \infty} \frac{1}{2a} \int_{-a}^a y(s) y(s+t) ds,$$

where the function  $y(s)$  is assumed to be normalized; that is,

$$\lim_{a \rightarrow \infty} \frac{1}{2a} \int_{-a}^a y^2(s) ds = 1.$$

In case the limit in the mean assumed by (3) is not desired, that is to say, if  $y(s)$  is defined over a finite interval  $-a \leq s \leq a$ , then we may employ the following definition of  $r(t)$ :

$$(4) \quad r(t) = R(t) / 2a,$$

where we write

$$(5) \quad R(t) = \int_{-a}^a y(s) y(s+t) ds.$$



For the purposes of illustration, let us consider a random series constructed in the following manner. The percentages of trend of the Dow-Jones industrial averages for the prewar period (1897-1913) were written on cards and these cards were then drawn at random to form a series of 204 items, that is,  $N = 204$ . The standard deviation,  $\sigma$ , was found to equal 15.011, and the arithmetic average,  $A$ , was 99.618. The actual values of the random series thus constructed are given in the following table and the series is graphically represented in Figure 5 of Chapter 1 and in (b) of Figure 38 of this chapter. The items are arranged by months to correspond to the items of the actual time series itself, which is charted in Figure 70 of Chapter 7.

RANDOM SERIES CONSTRUCTED FROM THE DOW-JONES INDUSTRIAL AVERAGES AS PERCENTAGES OF TREND (1897-1913)

Month	1897	1898	1899	1900	1901	1902	1903	1904	1905	1906	1907	1908	1909	1910	1911	1912	1913
Jan.	100	100	97	98	84	103	126	108	104	99	118	102	78	100	117	93	91
Feb.	110	98	113	101	87	114	121	101	137	88	123	88	89	91	89	104	125
Mar.	101	92	108	92	104	106	105	70	98	127	86	121	78	111	93	72	70
Apr.	110	104	90	104	123	81	122	102	99	100	88	107	76	97	119	121	94
May	126	67	122	89	112	110	117	93	80	126	114	109	112	125	101	110	88
June	99	88	96	74	99	98	89	98	114	87	91	106	99	74	130	98	103
July	124	113	101	94	128	92	101	88	87	81	81	111	107	102	104	87	106
Aug.	119	64	100	89	84	113	98	93	95	104	101	103	94	92	108	115	106
Sept.	92	69	72	80	120	94	70	95	112	101	92	105	96	102	76	109	96
Oct.	106	88	84	103	87	110	95	123	121	75	89	103	90	124	119	102	105
Nov.	107	124	94	119	70	101	124	89	104	94	122	75	94	87	109	131	114
Dec.	101	94	86	93	105	111	66	105	78	99	104	71	71	99	77	126	100

In order to test this series for randomness the autocorrelation was computed, the following values being obtained:

$r$	1	2	3	4	5	6	7	8	9	10	11	12	13	14	15
$r(r)$	0.088	0.072	0.155	0.060	-0.051	0.085	-0.114	0.026	-0.027	-0.022	-0.089	-0.088	-0.050	-0.063	0.099

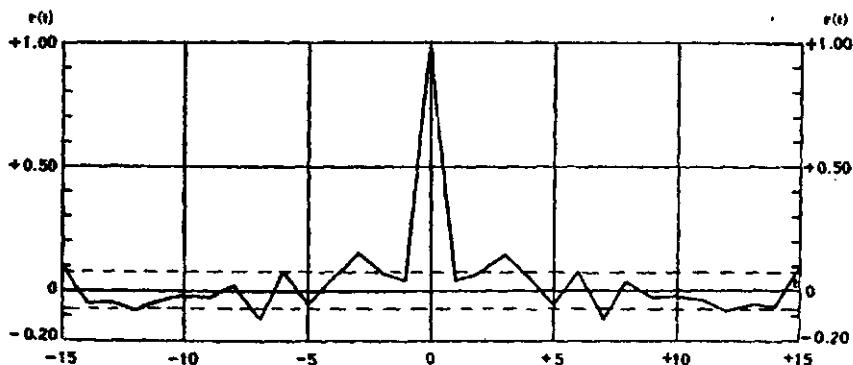

FIGURE 36.—AUTOCORRELATION OF A RANDOM SERIES.  
The dotted lines define the standard-error band.

Since the standard-error band varies from  $\pm 0.070$  at the beginning, where  $N = 204$ , to  $\pm 0.076$  at the end, where  $N = 204 - 30 = 174$ , the distribution of the lagged values is seen to meet the test of randomness in a satisfactory manner. These results are graphically exhibited in Figure 36.

## 2. Goutereau's Constant

If something is known about the distribution of the items of a random series, that is to say, whether the items have been drawn from a normal, a rectangular, or some other type of frequency distribution, then a ratio known as *Goutereau's constant* is useful in testing the randomness of the series. This constant, which we shall designate by  $G$ , may be defined as follows:

If the mean of series (1) is  $m$  and if  $\Delta_i = y_{i+1} - y_i$  and  $x_i = y_i - m$ , then Goutereau's constant is the ratio

$$G = \frac{\sum |\Delta_i|}{\sum |x_i|};$$

that is to say, it is the ratio of the mean variability to the mean deviation of the series.

We shall first prove the following theorem:

**THEOREM 1.** *If the series  $\{y_i\} = y_1, y_2, \dots, y_N$  is a set of normally distributed values arranged in a random sequence, then*

$$(1) \quad G = \sqrt{2} = 1.4142 \dots$$

*If the series  $\{y_i\}$  is a set of rectangularly distributed values arranged in a random sequence, then*

$$(2) \quad G = 4/3 = 1.3333 \dots$$

*Proof:*<sup>1</sup> Let us assume that the values of  $\{y_i\}$  are arranged in a frequency table as follows:

Values	$s_1$	$s_2$	$\dots$	$s_n$
Frequencies	$f_1$	$f_2$	$\dots$	$f_n$

where  $f_1 + f_2 + \dots + f_n = N$ .

The total number of ways in which the variation  $|\Delta_i|$  can be obtained is the number of permutations (with repetitions) of  $N$  things taken two at a time, that is,  $N^2$ . But  $N^2$  can be expanded in terms of the individual frequencies as follows:

<sup>1</sup> This proof follows one due to E. W. Woolard, "On the Mean Variability in Random Series," *Monthly Weather Review*, Vol. 53, 1925, pp. 107-111.

$$\begin{aligned}
 N^2 &= (\sum f_i)^2 = f_1^2 + f_2^2 + \dots + f_n^2 + 2f_1f_2 + 2f_1f_3 + \dots + 2f_1f_n \\
 &\quad + 2f_2f_3 + 2f_2f_4 + \dots + 2f_2f_n + \dots + 2f_{n-1}f_n \\
 &= \sum_{i=1}^n f_i^2 + 2 \sum_{j=1}^{n-1} \sum_{i=1}^{n-j} f_i f_{i+j}.
 \end{aligned}$$

From this we see that the probability of a zero variation is given by

$$\sum_{i=1}^n f_i^2 / N^2,$$

while the probability of the variation  $|\Delta_{i,j}| = |s_i - s_j|$  is  $2 f_i f_j / N^2$ .

If we assume that  $s_i = c + ih$ , where  $c$  is a constant and  $n$  is the class interval, then  $|\Delta_{i,j}| = |i - j| h = mh$ , where  $m$  is an integer. Hence all the  $n-m$  combinations which yield the same value  $mh$  are given by

$$|s_{i+m} - s_i|, \quad i = 1, 2, \dots, n-m,$$

with probabilities

$$\frac{2 f_i f_{i+m}}{N^2}, \quad m \neq 0, \quad i = 1, 2, \dots, n-m.$$

Hence the mathematical expectation of the variability,  $v$ , is given by

$$(4) \quad E(v) = \frac{2h}{N^2} \sum_{m=1}^{n-1} \sum_{i=1}^{n-m} m f_i f_{i+m}.$$

If we have a rectangular distribution, then

$$f_i = f, \quad N = nf,$$

from which we get

$$(5) \quad E(v) = \frac{2h}{n^2} \sum_{m=1}^n m(n-m) = \frac{h(n^2-1)}{3n}.$$

Since table (3) is now of the form

$c + h$	$c + 2h$	$\dots$	$c + nh$
$f$	$f$	$\dots$	$f$

the mean,  $M$ , is given by

$$M = c + hf \sum_{i=1}^n i / N = c + \frac{1}{2}(n+1)h.$$

Consequently the mathematical expectation of the mean deviation,  $\theta$ , becomes

$$(6) \quad E(\theta) = \frac{\sum f_i x_i}{N} = h \sum_{j=1}^n \frac{f_j}{N} \left| j - \sum_{i=1}^n \frac{i f_i}{N} \right|.$$

Since, in the rectangular distribution,  $f_i = f$  and  $N = nf$ , we get

$$\sum_{i=1}^n i f_i / N = \frac{1}{2}(n+1).$$

Consequently the expected mean deviation becomes

$$(7) \quad E(\theta) = \frac{2h^{i(n+1)}}{n} \sum_{j=1} [ \frac{1}{2}(n+1) - j ] = \frac{h}{4n} (n^2 - 1).$$

From (5) and (7) we then obtain the value of  $G$  for rectangular distributions as the ratio

$$(8) \quad G = \frac{E(v)}{E(\theta)} = \frac{h(n^2 - 1)}{3n} \cdot \frac{4n}{h(n^2 - 1)} = 4/3 = 1.3333 \dots$$

From a normal distribution we have the frequencies  $f_i = {}_n C_i$ ,  $N = 2^n$ , where  ${}_n C_i$  is the  $i$ th binomial coefficient.

Hence the mathematical expectation of the variability becomes

$$\begin{aligned} E(v) &= \frac{2h}{N^2} \sum_{m=1}^{n-1} m \sum_{i=1}^{n-m} {}_n C_i {}_n C_{i+m} \\ &= \frac{2h}{N^2} \sum_{m=1}^{n-1} m ({}_{2n} C_{n+m} - {}_n C_m), \end{aligned}$$

that is,

$$(9) \quad E(v) = \frac{hn}{N^2} ({}_{2n} C_n - 2^n).$$

Since the arithmetic mean of the distribution is  $\frac{1}{2}n$ , the expected mean deviation becomes

$$E(\theta) = \frac{h}{N} \sum_{m=0}^n {}_n C_m |m - \frac{1}{2}n|.$$

For simplicity we shall assume that  $n$  is even, an inconsequential assumption, since  $n$  is large. We then obtain

$$(10) \quad E(\theta) = \frac{2h}{N} \sum_{m=0}^n {}_n C_m (\frac{1}{2}n - m) = \frac{hn}{2N} {}_n C_{\frac{1}{2}n}.$$

Goutereau's constant is then given by the ratio of (9) to (10), that is,

$$(11) \quad G = \frac{{}_{2n} C_n - 2^n}{\frac{1}{2}N {}_n C_{\frac{1}{2}n}}.$$

In the formula  ${}_{2n} C_n = (2p)! / (p!)^2$  we now replace the factorials by their Stirling approximation, namely  $n! \sim n^n e^{-n} \sqrt{2\pi n}$ , and thus obtain for sufficiently large values of  $p$  the limiting form

$${}_{2p} C_p \sim \frac{\sqrt{2} 2^{2p}}{\sqrt{2\pi p}}$$

If the appropriate approximations are now introduced into formula (11), we obtain

$$G \approx \frac{2^2 \sqrt{2} - \sqrt{2\pi n}}{N} = \sqrt{2} - \sqrt{2\pi n} \cdot 2^{-n}.$$

If  $n$  is large, as has been assumed above and as is assumed, of course, in the derivation of the normal distribution from its binomial approximation, we shall obtain the desired ratio

$$(12) \quad G = \sqrt{2} = 1.4142 \dots$$

To these values of  $G$  as given by (8) and (12) we must now assign probable errors. This may be done as follows:<sup>2</sup>

If  $n$  is large, then the standard deviation for a rectangular distribution is approximately given by  $\sigma = hn/\sqrt{3}$ .<sup>3</sup> Hence, if  $n$  is large, we can write

$$E(v) = \sigma/\sqrt{3}, \quad \text{and} \quad E(\theta) = \frac{1}{2}\sqrt{3}\sigma.$$

Since the standard error of  $\sigma$  is known, the standard errors of both  $E(v)$  and  $E(\theta)$  are known. But from the fact that  $G$  is a pure number, since both  $v$  and  $\theta$  are functions of  $\sigma$ , the ordinary method of finding the standard error of the ratio fails. But we also note that the mean deviation is independent of the order in which the  $x$ 's occur and, therefore, this coefficient does not give any indication of the randomness of the series. The mean variability, however, does depend upon the order or time occurrence. The Goutereau ratio, therefore, as a test of randomness, depends entirely on the numerator of the ratio. Consequently, if we assume that the mean deviation does not change greatly from one type of rectangular distribution to another, then we can derive the standard error of  $G$ . If there is a deviation in  $v$  due to the randomness of the series, we say that this variation will not affect  $\theta$ . Hence we can write

$$G + \Delta G = \frac{v + \Delta v}{\theta} = \frac{v}{\theta} + \frac{\Delta v}{\theta}.$$

Then, by definition,

$$\Delta v = \sigma_v = \frac{\sigma}{\sqrt{3} \sqrt{2(N-1)}} = \frac{2\sqrt{2}}{3} \frac{\theta}{\sqrt{N-1}}.$$

Hence we obtain as the standard error of  $G$

<sup>2</sup> This argument is due to Herbert E. Jones of the Cowles Commission, who has made an exhaustive study of this problem.

<sup>3</sup> See Davis and Nelson, *Elements of Statistics*, 2nd ed., 1937, p. 319.

$$\sigma_g = \sigma_y / \theta = \frac{2\sqrt{2}}{3} \frac{1}{\sqrt{N-1}} = 0.9428 \frac{1}{\sqrt{N-1}}.$$

A similar computation for the normal distribution shows that the standard error of  $G$  is given by  $\sqrt{(\pi-2)/(N-1)} = 1.0684/\sqrt{(N-1)}$ .

These results we can formulate in the following theorem:

**THEOREM 2.** *If the series  $\{y_i\}$  is a set of normally distributed values arranged in a random sequence, then the standard error of Goutereau's constant is*

$$(13) \quad \sigma_g = \sqrt{\frac{\pi-2}{N-1}} = \frac{1.0684}{\sqrt{N-1}},$$

where  $N$  is the number of items in the set.

*If the series  $\{y_i\}$  is rectangularly distributed, then the standard error is*

$$(14) \quad \sigma_g = \frac{2\sqrt{2}}{3} \frac{1}{\sqrt{N-1}} = \frac{0.9428}{\sqrt{N-1}}.$$

As an example, we may consider the random series given in Section 1. A test shows that the items are essentially distributed normally and hence  $G$  is to be computed from formula (1). We readily find  $\Sigma|\Delta_i| = 3570$ ,  $\Sigma|x_i| = 2486$ , from which it follows that

$$G = 1.4360.$$

Since the probable error as given by (13) equals 0.0702 and since the difference between the actual and expected value of  $G$  is 0.0219, we see that the series very satisfactorily meets the test of randomness.

It is instructive to compare this value with the value of  $G$  obtained from the items of the original Dow-Jones series from which the random series was constructed as explained in Section 1. A computation shows that for the original series  $G = 0.3345$ .

It is interesting also to note that if the series of values  $\{y_i\}$  is derived from a known function  $y = y(t)$ , then the Goutereau constant assumes the following simple form:

$$G = \frac{\int_a^b \left| \frac{dy}{dt} \right| dt}{\int_a^b |y| dt}$$

where  $a \leq t \leq b$  is the range of the data.

For example, if  $y = \sin(2\pi t/T)$  and the range of the integration is from 0 to  $T$ , then we have

$$G = \frac{2\pi \int_0^T |\cos(2\pi/T)| dt}{\int_0^T |\sin(2\pi/T)| dt} = \frac{2\pi}{T} = \frac{6.2832}{T}.$$

The standard error is readily shown to equal

$$\sigma_0 = \frac{\pi}{T\sqrt{2T}} = 2.2214 T^{-3/2}.$$

### 3. Yule's Theory

As we have already explained in Chapter 1, G. U. Yule devoted considerable attention to the correlation of random series in his classical paper on "Why Do We Sometimes Get Nonsense-Correlations Between Time-Series?"<sup>4</sup>

In order to derive some of Yule's most interesting results, let us consider the following series:

$$y_1, y_2, y_3, y_4, \dots, y_t, \dots, y_N.$$

We shall assume that the average of the series is zero, and that  $N$  is sufficiently large so that neither the standard deviation nor the arithmetic average is essentially affected by the omission of a number of terms less than or equal to some number  $k$ , which is very much smaller than  $N$ . If  $\sigma$  represents the standard deviation of the series, then the autocorrelation coefficient,  $r_t$ ,  $|t| \leq k$ , will be given by<sup>4a</sup>

$$(1) \quad r_t = \sum (y_t y_{t+t}) / (N \sigma^2).$$

We now consider the difference,  $\Delta y_t = y_{t+1} - y_t$ , and note that

$$\begin{aligned} \sum (\Delta y_t)^2 &= \sum (y_{t+1})^2 + \sum (y_t)^2 - 2 \sum (y_{t+1} y_t) \\ &= N \sigma^2 + N \sigma^2 - 2 N \sigma^2 r_1. \end{aligned}$$

Since  $\sum (\Delta y_t)^2 = N \sigma_\Delta^2$ ; where  $\sigma_\Delta^2$  is the variance of the series of first differences, we thus obtain the relationship

$$(2) \quad \sigma_\Delta^2 = 2 \sigma^2 (1 - r_1).$$

Let us now compute the autocorrelation coefficient,  $\rho_t$ , for a lag of  $t$  units for the difference series  $\Delta y_t$ . We first evaluate the sum

<sup>4</sup> *Journal of the Royal Statistical Society*, Vol. 89, 1926, pp. 1-64.

<sup>4a</sup> Many of the formulas given in this section will also be found in the work of O. Anderson, to whom reference has been made in Section 14 of Chapter 1.

$$R_t = \sum[\Delta y_s \cdot \Delta y_{s+t}] = \sum(y_{s+1} - y_s)(y_{s+t+1} - y_{s+t}) \\ = \sum(y_{s+1} y_{s+t+1}) + \sum(y_{s+t} y_s) - \sum(y_s y_{s+t+1}) - \sum(y_{s+1} y_{s+t}),$$

which, from (1), is seen to reduce to the following:

$$R_t = N \sigma^2 r_t + N \sigma^2 r_t - N \sigma^2 r_{t+1} - N \sigma^2 r_{t-1}.$$

Since  $R_t$  is itself equal to  $N \rho_t \sigma^2$ , we obtain from formula (2)

$$(3) \quad \rho_t = \frac{2 r_t - r_{t+1} - r_{t-1}}{2(1 - r_1)} = - \frac{1}{2(1 - r_1)} \Delta^2(r_{t-1}).$$

It is clear that the autocorrelation for the second derived series can be written down at once from this formula. If we designate by  $\rho_t^{(2)}$  the autocorrelation function for a lag of  $t$  units of the second difference series  $\Delta^2 y_s$ , then by formula (3) itself, since  $\rho_t^{(2)}$  bears the same relationship to  $\rho_t$  as  $\rho_t$  does to  $r_t$ , we shall obtain

$$\rho_t^{(2)} = \frac{2 \rho_t - \rho_{t+1} - \rho_{t-1}}{2(1 - \rho_1)} = - \frac{1}{2(1 - \rho_1)} \Delta^2(\rho_{t-1}).$$

This process being entirely general, we see that if  $\rho_t^{(n)}$  is the autocorrelation function for a lag of  $t$  units of the  $n$ th difference series  $\Delta^n y_s$ , then  $\rho_t^{(n)}$  can be expressed in terms of the autocorrelation function for the  $(n-1)$ th difference series  $\Delta^{(n-1)} y_s$ , as follows:

$$(4) \quad \rho_t^{(n)} = \frac{2 \rho_t^{(n-1)} - \rho_{t+1}^{(n-1)} - \rho_{t-1}^{(n-1)}}{2(1 - \rho_1^{(n-1)})} = - \frac{1}{2(1 - \rho_1^{(n-1)})} \Delta^2(\rho_{t-1}^{(n-1)}).$$

As an example of this theory let us compute the values of the autocorrelations of the first five derived series of an initial random series. For the random series we know, by definition, that  $r_0 = 1$ ,  $r_t = 0$ ,  $t \neq 0$ . Hence, by successive applications of formula (4), we obtain the following values of the autocorrelations:

Type of Series	Autocorrelations			
$\Delta y_s$	$\rho_0 = 1$ ,	$\rho_1 = -\frac{1}{2}$ ,	$\rho_t = 0$ ,	$t > 1$ ;
$\Delta^2 y_s$	$\rho_0^{(2)} = 1$ ,	$\rho_1^{(2)} = -\frac{2}{3}$ ,	$\rho_2^{(2)} = \frac{1}{6}$ ,	$\rho_t^{(2)} = 0$ , $t > 2$ ;
$\Delta^3 y_s$	$\rho_0^{(3)} = 1$ ,	$\rho_1^{(3)} = -\frac{3}{4}$ ,	$\rho_2^{(3)} = \frac{3}{10}$ ,	$\rho_3^{(3)} = -\frac{1}{20}$ ,
	$\rho_t^{(3)} = 0$ ,	$t > 3$ ;		



$$\Delta^4 y_t \quad \rho_0^{(4)} = 1, \quad \rho_1^{(4)} = -\frac{4}{5}, \quad \rho_2^{(4)} = \frac{2}{5}, \quad \rho_3^{(4)} = -\frac{4}{35},$$

$$\rho_4^{(4)} = \frac{1}{70}, \quad \rho_t^{(4)} = 0, \quad t > 4;$$

$$\Delta^5 y_t \quad \rho_0^{(5)} = 1, \quad \rho_1^{(5)} = -\frac{5}{6}, \quad \rho_2^{(5)} = \frac{10}{21}, \quad \rho_3^{(5)} = -\frac{5}{28},$$

$$\rho_4^{(5)} = \frac{5}{126}, \quad \rho_5^{(5)} = -\frac{1}{252}, \quad \rho_t^{(5)} = 0, \quad t > 5.$$

#### 4. Generalization of Yule's Theory of the Differences of Random Series

The results obtained by Yule for the differences of random series may be generalized in such a way as to lead to the representation of the autocorrelation as a continuous function of the lag parameter.

Let us assume that the series

$$(1) \quad y_1, y_2, y_3, \dots, y_t, \dots, y_N,$$

is random, and that its arithmetic average is zero and its standard deviation is unity. We shall then have

$$(2) \quad \sum y_i = 0, \quad \sum y_i y_{i+j} = \begin{cases} 1, & j = 0, \\ 0, & j \neq 0. \end{cases}$$

The series formed from the  $n$ th differences of (1) may be represented by

$$\Delta^n_1, \Delta^n_2, \Delta^n_3, \dots, \Delta^n_{N-n},$$

where we employ the abbreviation

$$\Delta^n_k = y_k - {}_n C_1 y_{k-1} + {}_n C_2 y_{k-2} - \dots + (-1)^t {}_n C_t y_{k-t} + \dots + (-1)^n y_{k-n}.$$

Then, if  $N$  is sufficiently large with respect to  $n$  so that end values may be neglected, we shall have from condition (2)

$$(3) \quad \sum \Delta^n_k = 0, \quad \sum (\Delta^n_k)^2 = \sum_{i=1}^n {}_n C_i^2 = {}_{2n} C_n = N \sigma_{\Delta}^2.$$

Similarly we evaluate

$$R_t^{(n)} = \sum \Delta^n_k \Delta^n_{k+t} = (-1)^t \sum_{i=1}^{n-t} {}_n C_i {}_n C_{i+t} = (-1)^t {}_{2n} C_{n-t}.$$

Hence, since  $\rho_t^{(n)} = R_t^{(n)} / (N \sigma_{\Delta}^2)$ , we achieve the direct evaluation

$$(4) \quad \rho_t^{(n)} = \frac{(-1)^t {}_{2n} C_{n-t}}{{}_{2n} C_n}.$$

The question naturally arises as to whether or not a continuous representation can be given to the autocorrelation function (4). Proceeding formally, we replace  $(-1)^t$  by  $\cos \pi t$ , and then write the binomial coefficients in terms of Gamma functions as follows:

$${}_n C_{n-t} = \frac{\Gamma(2n+1)}{\Gamma(n+t+1)\Gamma(n-t+1)}, \quad {}_n C_n = \frac{\Gamma(2n+1)}{\Gamma^2(n+1)}.$$

Replacing these values in (4), we then obtain the following as the continuous autocorrelation function for the  $n$ th difference of a random series:

$$(5) \quad \rho_t^{(n)} = \frac{\cos \pi t \Gamma^2(n+1)}{\Gamma(n-t+1)\Gamma(n+t+1)}$$

It is interesting to note that this function, if substituted in the difference equation [see formula (4) of Section 3]

$$2(1 - \rho_1^{(n-1)})\rho_t^{(n)} = 2\rho_t^{(n-1)} - \rho_{t+1}^{(n-1)} - \rho_{t-1}^{(n-1)},$$

furnishes a solution of the equation.

Formula (5) was tested experimentally for the random series described in Section 1. The first three difference series were constructed and the lag correlations computed and compared with those obtained from (5). The results of this experiment are tabulated as follows:

Series	Lagged one unit		Lagged two units		Lagged three units	
	Observed	Expected	Observed	Expected	Observed	Expected
Random	0.0152	0.0000 $\pm 0.0727$	0.0715	0.0000 $\pm 0.0727$	0.1562	0.0000 $\pm 0.0727$
First Difference	-0.3575	-0.5000 $\pm 0.0530$	0.0471	0.0000 $\pm 0.0707$	0.0051	0.0000 $\pm 0.0707$
Second Difference	-0.6265	-0.6667 $\pm 0.0394$	0.1010	0.1667 $\pm 0.0689$	0.0844	0.0000 $\pm 0.0709$
Third Difference	-0.8679	-0.7500 $\pm 0.0311$	0.3012	0.3000 $\pm 0.0647$	-0.1592	-0.0500 $\pm 0.0711$

It will be observed from a comparison of the difference of the observed and expected values with the standard errors given with the expected values, that the assumptions made in the derivation of formula (5) are amply justified.

The graph of function (5) for the case where  $n = 3$ , that is, for

$$\begin{aligned} \rho_t^{(3)} &= \cos \pi t \frac{\Gamma^2(4)}{\Gamma(4-t)\Gamma(4+t)} \\ &= \frac{36}{(9-t^2)(4-t^2)(1-t^2)} \left[ \frac{\sin 2\pi t}{2\pi t} \right] \end{aligned}$$

is given in Figure 37.

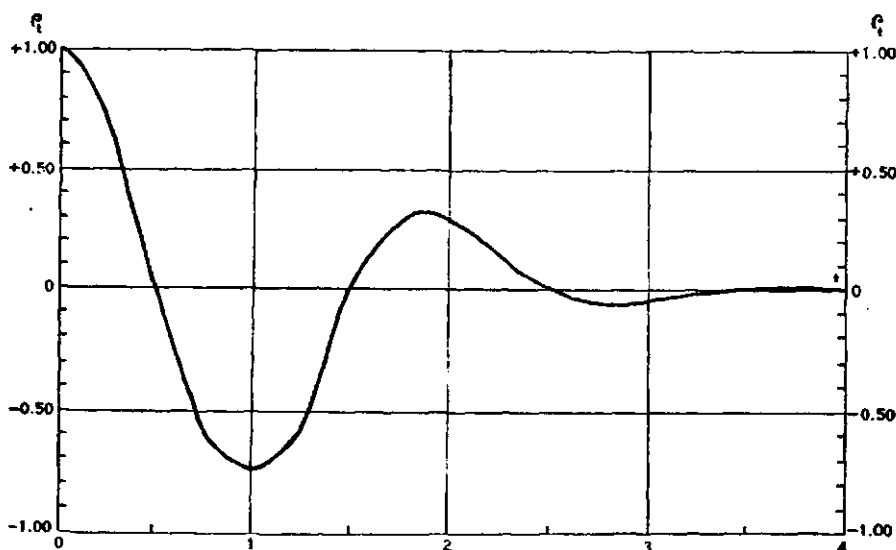

FIGURE 37.—AUTOCORRELATION OF THIRD DIFFERENCES OF A RANDOM SERIES.

In the application of formula (5) for unit lags, the following sum is useful in checking calculations:

$$\sum_{t=0}^n \rho_t^{(n)} = \frac{1}{2}.$$

This is easily established from formula (4), which yields the sum

$$\sum_{t=0}^n \rho_t^{(n)} = (1/2^n C_n) \sum_{t=0}^n (-1)^t {}_{2n}C_{n-t} = {}_{2n-1}C_n / {}_{2n}C_n = \frac{1}{2}.$$

Thus we can verify the computations for  $\rho_t^{(5)}$  as given in Section 3 by finding the sum

$$\sum_{t=0}^5 \rho_t^{(5)} = 1 - \frac{5}{6} + \frac{10}{21} - \frac{5}{28} + \frac{5}{126} - \frac{1}{252} = \frac{126}{252} = \frac{1}{2}.$$

A special case of formula (5), which will be of particular interest to us later, is that for which  $n = 0$ . In this case we find

$$(6) \quad \rho_t^{(0)} = \frac{\cos \pi t}{\Gamma(1-t)\Gamma(1+t)} = \frac{\sin 2\pi t}{2\pi t}.$$

That is to say, *the autocorrelation function of a continuous random series is the unit impulse function frequently encountered in the theory of electric circuits.*<sup>5</sup>

<sup>5</sup> See, for example, H. T. Davis, *The Theory of Linear Operators*, Bloomington, Ind., 1936, pp. 263-268.

It is also interesting to observe that the function

$$(7) \quad y(s) = \frac{\sin 2\pi s}{2\pi s},$$

if introduced into the autocorrelation integral,

$$r(t) = \int_{-\infty}^{\infty} y(s) y(s+t) ds,$$

gives (6). That is to say, the unit impulse function is its own autocorrelation.

In order to prove this, let us first consider the integral<sup>a</sup>

$$p(\beta) = \int_{-\infty}^{\infty} \frac{\sin \pi s}{\pi s} \cos \pi \beta (s+t) ds = \begin{cases} 0, & |\beta| > 1, \\ \frac{1}{2} \cos \beta \pi t, & |\beta| = 1, \\ \cos \beta \pi t, & |\beta| < 1. \end{cases}$$

Let us now define

$$(8) \quad P(\beta) = \int_{-\infty}^{\infty} \frac{\sin \pi s}{\pi s} \frac{\sin \beta \pi (s+t)}{\pi (s+t)} ds,$$

and note that  $P'(\beta) = p(\beta)$ , from which we obtain

$$P(\beta) = P(0) + \int_0^{\beta} p(\beta) d\beta = \int_0^{\beta} p(\beta) d\beta.$$

An immediate consequence of the integration is the following set of values:

$$(9) \quad P(\beta) = \begin{cases} \frac{\sin \beta \pi t}{\pi t}, & \beta \geq 1, \\ \frac{\sin \beta \pi t}{\pi t}, & |\beta| \leq 1, \\ -\frac{\sin \beta \pi t}{\pi t}, & \beta \leq -1. \end{cases}$$

In formula (4) we have obtained the autocorrelation between differences of the same order, but it would be interesting and useful to have an extension of this result for the correlation between differences of orders  $m$  and  $n$ , that is, between the series  $\Delta_k^m$  and  $\Delta_k^n$ .

If we designate this correlation by the symbol  $\rho_t^{(m,n)}$ , then the result may be stated as follows:

<sup>a</sup> See, for example, S. Bochner, *Vorlesungen über Fouriersche Integrale*, Leipzig, 1932, viii + 229 pp.

For discrete series the lag correlation between the differences of orders  $m$  and  $n$  of a random series is given by the formula

$$(10) \quad \rho_t^{(m,n)} = (-1)^{m+n+t} \frac{{}^{m+n}C_{n+t}}{\sqrt{{}_m C_m {}_n C_n}}.$$

The continuous equivalent of this formula, obtained by replacing the factorials in the binomial coefficients by the Gamma-function equivalents, is given by

$$(11) \quad \rho_t^{(m,n)} = \frac{\cos \pi(m+n+t) \Gamma(m+n+1) \Gamma(m+1) \Gamma(n+1)}{\Gamma(n+t+1) \Gamma(m-t+1) \Gamma^{1/2}(2m+1) \Gamma^{1/2}(2n+1)}.$$

The derivation of these formulas will be given in Section 6, where more general results are available.

As an interesting special case, we observe that the lag correlation between a random series and its  $n$ th difference is obtained by setting  $m = 0$ . Thus we obtain

$$\rho_t^{(0,n)} = (-1)^{n+t} \frac{{}^n C_{n-t}}{\sqrt{{}_n C_n}},$$

or, in its continuous form,

$$(12) \quad \rho_t^{(0,n)} = \frac{\cos \pi(n+t) \Gamma^2(n+1)}{\Gamma(n+t+1) \Gamma(1-t) \Gamma^2(2n+1)}.$$

If one notes the identity  $\Gamma(1+t) \Gamma(1-t) = (\pi t) / \sin \pi t$ , then (12) can be put into the form

$$(13) \quad \rho_t^{(0,n)} = (-1)^n \frac{\sin 2\pi t}{2\pi t} \frac{\Gamma^2(n+1)}{(1+t)(2+t) \cdots (n+t) \Gamma^2(2n+1)}.$$

### 5. Accumulated Random Series.

One of the most interesting operators that has been applied to random series is the operator of summation. By the proper use of this operator cycles can be generated in random data, and this interesting fact has focused attention upon summation as a possible cause of the cyclical phenomena noticed in many economic series.

Let us, then, consider the operator

$$(1) \quad S[x(t)] = \int_0^t x(s) ds - \frac{1}{L} \int_0^L (L-s) x(s) ds,$$

where  $x(t)$  is any function of limited variation. In particular, it may be defined by the elements of a random series. We see that  $S(x)$  is the first accumulation of the function  $x(t)$  referred to its mean, its length being  $L$ .

Now let us define a sequence of functions by means of the iteration formulas

$$S^{(2)}(x) = S[S(x)], \quad S^{(3)}(x) = S[S^{(2)}(x)], \dots, \\ S^{(n)}(x) = S[S^{(n-1)}(x)].$$

If  $x(t)$  defines a random series, it is a matter of statistical observation that  $S^{(n)}(x)$  tends toward a cosine function of period equal to the length of the series; that is,

$$(2) \quad S^{(n)}(x) \propto \left(\frac{L}{2\pi}\right)^n A \cos \frac{2\pi}{L} (t + a_n),$$

where  $L$  is the length of the series,  $A$  is a constant amplitude, and  $a_n$  is a phase constant, which depends upon the order of the iteration.<sup>7</sup>

In order to see how the phase depends upon the order of iteration, let us write

$$S^{(n)}(x) = \left(\frac{L}{2\pi}\right)^n A \cos \frac{2\pi}{L} (t + a_n).$$

We then have

$$S^{(n+1)}(x) = \left(\frac{L}{2\pi}\right)^n A \left[ \int_0^t \cos \frac{2\pi}{L} (s + a_n) ds \right. \\ \left. - \frac{1}{L} \int_0^t (L - s) \cos \frac{2\pi}{L} (s + a_n) ds \right] \\ = \left(\frac{L}{2\pi}\right)^{n+1} A \cos \frac{2\pi}{L} (t + a_n - \frac{1}{2}L)$$

Hence, in general, we get

$$S^{(n+r)}(x) = \left(\frac{L}{2\pi}\right)^{n+r} A \cos \frac{2\pi}{L} (t + a_n - \frac{1}{2}rL);$$

that is to say, the phase angle is changed to  $a_n - \frac{1}{2}rL$ .

While the statistical observation that the iteration defined above yields a cosine function of the form given in (2) was first made for random series, it is also true that the iteration converts any function of limited variation in the interval  $0 \leq t \leq L$  into the same form. The proof of this has been given by E. J. Moulton as follows:<sup>8</sup>

<sup>7</sup> See, for example, R. W. Powell, "Successive Integration as a Method for Finding Long Period Cycles," *The Annals of Mathematical Statistics*, Vol. 1, 1930, pp. 123-136.

<sup>8</sup> For this formula see E. J. Moulton, "The Periodic Function Obtained by Repeated Accumulation of a Statistical Series," *The American Mathematical Monthly*, Vol. 45, 1938, pp. 583-586. See also the same volume, pp. 105-106.

**THEOREM:** *If we define the operator*

$$S_1(t) = \frac{2\pi}{L} S[x(t)], \quad S_n(t) = S_1[S_{n-1}(t)],$$

*then there exist constants  $A$  and  $a$  such that*

$$S_n(t) - A \cos \left[ \frac{2\pi}{L} t + a - \frac{1}{2}(n-1) \right]$$

*converges uniformly towards zero in the interval  $0 \leq t \leq L$  as  $n \rightarrow \infty$ .*

*Proof:* The function  $S_1(t)$  is an integral of  $x(t)$  and therefore  $S_1(t)$  is continuous and of bounded variation in the interval  $0 \leq t \leq L$ . Hence  $S_1(t)$  can be developed in a Fourier series in the interval  $0 \leq t \leq L$ ; that is,

$$(3) \quad S_1(t) = \sum_{k=1}^{\infty} A_k \cos \left( \frac{2\pi}{L} kt + a_k \right) + C.$$

The constant  $C$  must be zero since, from formula (1), we have  $\int_0^L S_1(t) dt = 0$ .

Since the left-hand member of (3) is continuous and of bounded variation in the interval  $0 \leq t \leq L$ , the Fourier series must converge uniformly toward  $S_1(t)$ ; hence we can integrate it term by term. We then find

$$S_2(t) = \sum_{k=1}^{\infty} \frac{A_k}{k^2} \cos \left( \frac{2\pi}{L} kt + a_k - \frac{1}{2} \pi \right),$$

and by similar argument

$$S_n(t) = \sum_{k=1}^{\infty} \frac{A_k}{k^n} \cos \left[ \frac{2\pi}{L} kt + a_k - \frac{1}{2}(n-1)\pi \right].$$

Since the sequence of Fourier coefficients  $\{A_k\}$  is bounded, we have

$$\lim_{n \rightarrow \infty} \sum_{k=2}^{\infty} \frac{A_k}{k^n} = 0,$$

and hence the sum

$$\sum_{k=2}^{\infty} \frac{A_k}{k^n} \cos \left[ \frac{2\pi}{L} kt + a_k - \frac{1}{2}(n-1)\pi \right]$$

converges uniformly towards zero in the interval  $0 \leq t \leq L$  as  $n \rightarrow \infty$ .

From this fact the theorem is seen to follow as an immediate consequence.

Two examples will illustrate the application of the theorem. The first of these is the successive application of the operator  $S_1(t)$  to the function  $x(s) = s$  in the interval  $0 \leq s \leq 1$ . The following polynomials are thus obtained:

$$S_1(t) = 2\pi \left[ \int_0^t s ds - \int_0^1 (1-s) ds \right] = 2\pi (t^2/2 - 1/6),$$

$$S_2(t) = 4\pi^2 (t^3/6 - t/6 + 1/24),$$

$$S_3(t) = 8\pi^3 (t^4/24 - t^2/12 + t/24 - 1/720),$$

$$S_4(t) = 16\pi^4 (t^5/120 - t^3/36 + t^2/48 - t/720 - 1/1440).$$

These four polynomials are graphically represented in (a) of Figure 33.

The second example is the application of the theory to the summation of the random series given in Section 1. The reduction of the series to sinusoidal form is observed from (b) of Figure 38 to be very rapid.

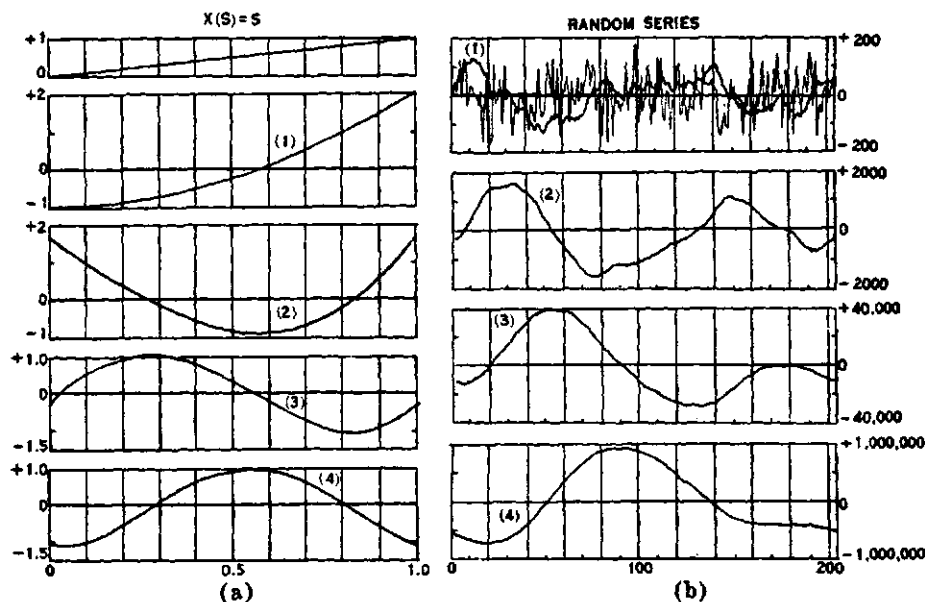

FIGURE 38.—EFFECT OF SUCCESSIVE INTEGRATIONS.

This chart shows how successive integrations (summations) convert functions defined over a limited range into harmonics. In (a) the function successively iterated is  $x(s)$ ; in (b) the function is a random series of 204 items. The numbers represent the first, second, third, and fourth operations.

The analysis considered in this section has also been extended by A. Wald, who proposed the problem of determining "in terms of probability, how fast the repeated integrations of a random series approach a cosine function."<sup>9</sup>

He proved the following theorem:

If the distance between  $S_n(t)$  and its cosine approximation is defined to be

$$\delta_n = \left\{ \frac{1}{L} \int_0^L [D_n(t)]^2 dt \right\}^{\frac{1}{2}},$$

where we write

$$D_n(t) = S_n(t) - A_n \cos \left[ \frac{2\pi}{L} t + a - \frac{1}{2}(n-1) \right],$$

<sup>9</sup> "Long Cycles as a Result of Repeated Integration," *American Mathematical Monthly*, Vol. 46, 1939, pp. 136-141.



then the probability that the ratio  $\delta_n/A_n$  will not exceed  $\lambda\beta_n$  is greater than or equal to  $1 - \lambda^{-2}$ , where  $\lambda$  is an arbitrary positive number and  $\beta_n$  is defined by

$$(4) \quad \beta_n^2 = \frac{1}{2} \sum_{k=2}^{(N-1)} 1/k^{2n}, \quad \beta_n > 0.$$

We shall not give the proof of this theorem here, but may merely indicate that it depends essentially upon the fact that no hypothesis about the distribution of the random series is imposed by the definitions of Section 1. Hence, the well-known inequality of Tchebycheff may be substituted for any postulate regarding the distribution of the series.

Since the value of  $A_n$  may be estimated from the formula,

$$A_n^2 = (N/2n)^{2n} (4/N) \sigma^2,$$

where  $\sigma^2$  is the variance of the original series, the theorem may be used readily in numerical estimates.

For example, in the illustrative series of Section 1, it is found that the distance between the third accumulation and the fundamental term of the approximation is equal to  $\delta_3 = (N/2\pi)^3 \times 0.3516$ . Since  $\sigma = 15.011$ , the value of  $A_3$  is given by  $A_3 = (N/2\pi)^3 \times 2.1020$ . Hence we obtain the ratio  $\delta_3/A_3 = 0.1673$ . The value of  $\beta_3$  is readily obtained from (4), from which we find  $\beta_3 = 0.0931$ . Dividing 0.1673 by 0.0931, we obtain  $\lambda = 1.7970$ , and from this the value  $1 - \lambda^{-2} = 0.6903$ . We may then conclude that the probability that  $\delta_3/A_3$  will not exceed 0.1673 is greater than or equal to 0.6903, a reasonable conclusion.

### 6. Random Series Smoothed by a Moving Average<sup>2a</sup>

Another operator frequently employed in the study of random series is the moving average

$$(1) \quad y_t = \frac{\sum_{s=t-\lambda}^{\lambda} W_s x_{s+t}}{\sum_{s=-\lambda}^{\lambda} W_s},$$

where  $W_s$  is a weight function. Usually  $W_s$  is a constant or the binomial coefficient,  $W_s = {}_{2\lambda}C_{\lambda+s}$ . The parameter  $\lambda$  of the moving average is generally chosen sufficiently large to remove the major harmonic swings in the data, when a trend line is to be established by means of the moving average. The quantity  $2\lambda$  is called the *period of the moving average*.

<sup>2a</sup> Most of the analysis described in this section was done by H. E. Jones to whom the author is especially indebted for undertaking and carrying out the work.

For continuous data,  $y(t)$ , the equivalent of function (1), can be written in the form

$$y(t) = \frac{\int_{-\lambda}^{\lambda} W(s) x(s+t) ds}{\int_{-\lambda}^{\lambda} W(s) ds} = \frac{\int_{t-\lambda}^{t+\lambda} W(r-t) x(r) dr}{\int_{-\lambda}^{\lambda} W(s) ds}$$

In order to simplify the problem of applying formula (1) to random data, without, however, any loss of generality, let us designate the items of a random series by

$$x_1, x_2, x_3, x_4, \dots, x_n,$$

and let us assume that  $n$  is sufficiently large so that the following conditions hold:

$$(2) \quad \sum x_i = 0, \quad \sum x_i^2 = \text{constant} = \sigma_x^2, \quad \sum x_i x_{i+j} = 0, \quad j \neq 0.$$

There will be no loss in generality if we assume further that  $\sigma_x^2 = 1$ .

The difference of any series  $\{y_i\}$  will be designated by  $\Delta^a y_i$ , where  $a$  is the order of the difference. By the symbol  $r_t^{\alpha, \beta}$  we shall mean the lag correlation between the differences of orders  $\alpha$  and  $\beta$ ; that is,

$$r_t^{\alpha, \beta} = r_{\Delta^a y_i, \Delta^b y_{i+t}}.$$

Let us now consider the following moving average:

$$y_i = W_0 x_i + W_1 x_{i+1} + W_2 x_{i-2} + \dots + W_s x_{i+s},$$

where we assume for simplicity that the sum of the weights is unity, that is  $\sum_{k=0}^s W_k = 1$ . The period of the moving average is obviously equal to  $s + 1$ .

The difference  $\Delta^a$  of  $y_i$  can be written

$$\begin{aligned} \Delta^a y_i &= y_{i+a} - {}_a C_1 y_{i+a-1} + {}_a C_2 y_{i+a-2} - \dots + (-1)^a {}_a C_a y_i \\ &= W_0^a x_i + W_1^a x_{i+1} + W_2^a x_{i+2} + \dots + W_{s+a}^a x_{i+s+a}, \end{aligned}$$

where the new weights,  $W_k^a$ , are explicitly determined from the following system:

$$\begin{aligned} W_0^a &= (-1)^a {}_a C_a W_0, \quad W_1^a = (-1)^a [{}_a C_a W_1 - {}_a C_{a-1} W_0], \dots, \\ W_k^a &= (-1)^a [{}_a C_a W_k - {}_a C_{a-1} W_{k-1} + {}_a C_{a-2} W_{k-2} - \dots \\ &\quad + (-1)^k {}_a C_{a-k} W_0]. \end{aligned}$$

We next note the standard deviation

$$(3) \quad \sum (\Delta^\alpha y_i)^2 = (W_0^\alpha)^2 + (W_1^\alpha)^2 + (W_2^\alpha)^2 + \dots + (W_s^\alpha)^2$$

and the covariance

$$(4) \quad \begin{aligned} \sum (\Delta^\alpha y_i) (\Delta^\beta y_{i+t}) &= \sum (W_0^\alpha x_i + W_1^\alpha x_{i+1} + \dots + W_s^\alpha x_{i+s}) \\ &\quad \times (W_0^\beta x_{i+t} + W_1^\beta x_{i+t+1} + \dots + W_s^\beta x_{i+t+s}) \\ &= W_i^\alpha W_0^\beta + W_{i+1}^\alpha W_1^\beta + W_{i+2}^\alpha W_2^\beta \\ &\quad + \dots + W_{i-t}^\alpha W_{-t}^\beta, \end{aligned}$$

where  $W$ 's with negative subscripts are understood to be zero.

From these values the lag correlation between the differences  $\Delta^\alpha y_i$  and  $\Delta^\beta y_{i+t}$  is immediately written in the form

$$(5) \quad r_{i,\alpha,\beta} = \frac{\sum_{j=0}^{s-t} W_{i+j}^\alpha W_j^\beta}{\sqrt{\sum_{j=0}^s (W_j^\alpha)^2 \sum_{j=0}^s (W_j^\beta)^2}}, \quad \alpha \geq \beta, \quad -(\beta + s) \leq t \leq s + \alpha.$$

This general formula can now be specialized in several useful ways. If, for example, we assume that  $\alpha = \beta = 0$ , then we get the autocorrelation function of the original moving average in terms of the weights employed.

Suppose, for example, that we selected the weights as positive binomial coefficients, that is

$$W_k = {}_s C_k.$$

Noting the following identities

$${}_s C_t {}_s C_0 + {}_s C_{t+1} {}_s C_1 + {}_s C_{t+2} {}_s C_2 + \dots + {}_s C_s {}_s C_s = {}_{2s} C_{s-t},$$

and

$${}_s C_0^2 + {}_s C_1^2 + \dots + {}_s C_s^2 = {}_{2s} C_s,$$

we can immediately write the autocorrelation

$$(6) \quad r_{i,0,0} = {}_{2s} C_{s-t} / {}_{2s} C_s.$$

Replacing the binomial coefficients by their continuous equivalents as we did in Section 4, we obtain the following:

$$r_{i,0,0} = \frac{\Gamma^2(s+1)}{\Gamma(s-t+1) \Gamma(s+t+1)}$$

This result may be compared with the autocorrelation obtained by assuming a unit weight for the moving average, that is, by letting  $W_k = 1$ . In this case we immediately obtain

$$(7) \quad r_t^{n,0} = \frac{s+1-|t|}{s+1}.$$

The effect of binomial weights as compared with constant weights upon an autocorrelation is exhibited in the following table, where the period of the moving average is assumed to be 12, that is  $s = 11$ :

$t$	$r_t$ (binomial weights)	$r_t$ (constant weights)	$t$	$r_t$ (binomial weights)	$r_t$ (constant weights)
1	0.9167	0.9167	7	0.01037	0.4167
2	0.7051	0.8333	8	0.002183	0.3333
3	0.4533	0.7500	9	0.0003275	0.2500
4	0.2418	0.6667	10	0.00003119	0.1667
5	0.1058	0.5833	11	0.000001418	0.08333
6	0.03733	0.5000	12	0	0

A statistical example of the application of formula (7), which will be useful for us later, is furnished by the 12-item moving average of the random series described in the first section. The smoothed series, centered upon the middle item of the average, is given in the following table:

Month	1897	1898	1899	1900	1901	1902	1903	1904	1905	1906	1907	1908	1909	1910	1911	1912	1913
Jan.		99	94	91	102	98	109	93	102	102	98	104	91	95	105	98	105
Feb.		94	97	90	101	101	108	93	102	102	98	105	91	95	106	98	104
March		92	98	90	105	97	106	95	104	101	97	105	90	96	104	101	103
April		89	99	92	104	100	105	97	103	98	98	107	89	99	104	100	103
May		91	96	94	100	102	107	94	105	97	100	103	90	98	105	102	102
June	108	90	96	95	101	103	103	97	102	98	101	100	90	100	104	106	100
July	108	90	96	94	103	105	102	97	102	100	99	98	92	102	102	106	106
Aug.	107	91	95	92	105	105	100	100	98	103	97	98	92	102	103	107	107
Sept.	106	92	94	93	105	105	97	102	100	100	99	95	95	100	101	107	107
Oct.	106	90	96	95	101	109	95	102	100	99	101	92	97	102	101	106	106
Nov.	101	95	93	97	101	109	93	101	104	98	101	92	98	100	102	103	103
Dec.	100	95	91	99	101	108	94	102	102	93	102	92	96	105	99	103	103

These data are graphically represented in Figure 5, in Section 6 of Chapter 1. The arithmetic average is 98.96 and the standard deviation is  $\sigma = 4.94$ . The autocorrelation of the series is given as follows:

$t$	$r(t)$	$t$	$r(t)$	$t$	$r(t)$
1	0.9201	6	0.3806	11	-0.0746
2	0.8371	7	0.2632	12	-0.1434
3	0.7312	8	0.1639	13	-0.1233
4	0.6177	9	0.0739	14	-0.0951
5	0.4948	10	-0.0047	15	-0.0608

Referring to (7) we see that the autocorrelation function is theoretically equal to

$$r(t) = 1 - |t|/12, \quad t \leq 12.$$

The graph of this function, together with the actual autocorrelation and the autocorrelation of the original random series, is shown in Figure 39.

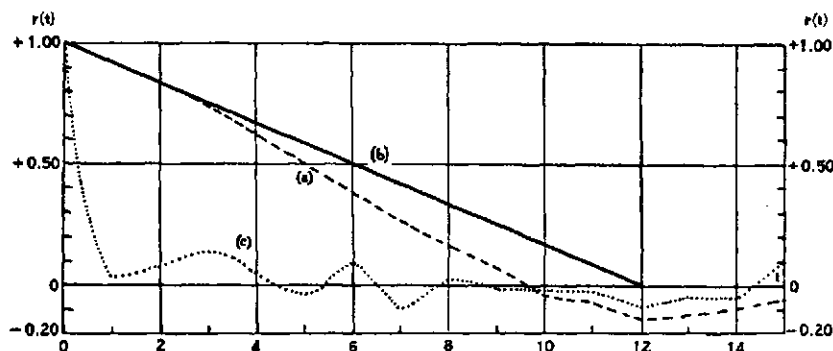

FIGURE 39.—AUTOCORRELATION OF FUNCTIONS.

This chart shows (a) actual  $r(t)$  for 12-month moving average of a random series; (b) theoretical  $r(t)$ ; (c)  $r(t)$  for original random series.

The derivation of formula (10) of Section 4, can be given quite simply in terms of the present theory. Thus, we wish to determine the lag correlation between the differences of orders  $m$  and  $n$  respectively, that is, between the functions

$$\Delta^m y_i = {}_m C_0 x_{i+m} - {}_m C_1 x_{i+m-1} + {}_m C_2 x_{i+m-2} + \dots + (-1)^m {}_m C_m x_i,$$

$$\Delta^n y_i = {}_n C_0 x_{i+n} - {}_n C_1 x_{i+n-1} + {}_n C_2 x_{i+n-2} + \dots + (-1)^n {}_n C_n x_i.$$

By reversing the order of the terms, we may write these expressions in the form

$$\Delta^m y_i = (-1)^m [{}_m C_0 x_i - {}_m C_1 x_{i+1} + \dots + (-1)^m {}_m C_m x_{i+m}],$$

$$\Delta^n y_i = (-1)^n [{}_n C_0 x_i - {}_n C_1 x_{i+1} + \dots + (-1)^n {}_n C_n x_{i+n}].$$

These sums are now in the standard form and we may then readily compute

$$\begin{aligned} W_t^m W_0^n + W_{t+1}^m W_1^n + \dots + W_m^m W_{m-t}^n \\ = (-1)^{m+n+t} [{}_m C_t {}_n C_0 + {}_m C_{t+1} {}_n C_1 + \dots + {}_m C_m {}_n C_{m-t}] \\ = (-1)^{m+n+t} {}_{m+n} C_{n+t}. \end{aligned}$$

The lag correlation,  $\rho_t^{(m,n)}$ , between the two differences is then immediately written down from this identity and is found to be

$$\rho_t^{(m,n)} = (-1)^{m+n+t} \frac{{}_{m+n} C_{n+t}}{\sqrt{{}_m C_m {}_n C_n}}.$$

7. *The Theory of Sequences and Reversals*<sup>10</sup>

As we have stated in the first chapter, the *theory of runs* is closely related to the theory of random series. Moreover, its nonmetrical character, since it depends only upon the distribution of the signs of the terms and not upon their magnitudes, makes it especially simple in application.

The theory of runs is concerned with the signs of the first differences of the elements of a time series. These differences may be plus, minus, or zero, but since zero differences are comparatively rare, it is usually not necessary to differentiate the three classes. A zero difference may generally be regarded as having the sign of the preceding difference.

A *run* is defined as a *sequence of like signs* and its *length* is the number of like signs. A *reversal*, as contrasted with a *sequence*, occurs when a positive sign is followed by a negative one, or vice versa.

The ratio of sequences to reversals is defined by the fraction

$$(1) \quad \rho = \frac{E(S)}{E(R)},$$

where  $E(S)$  is the expected number of sequences, and  $E(R)$  is the expected number of reversals.

For purposes of illustration we shall consider a random series and an economic time series. The random series is the one given in Section 1; the economic time series is the Dow-Jones industrial averages from which the random series was constructed as explained in Section 1. Since there are 204 items in each series, we shall have tables of signs with 203 entries, and a total of 202 sequences and reversals. These tables of signs, sequences ( $S$ ), and reversals ( $R$ ), are given in the accompanying table.

A count of the sequences and reversals shows that for the random series we have  $S = 57$ ,  $R = 145$ , and for the Dow-Jones industrial averages  $S = 113$ ,  $R = 89$ . Hence, designating the ratios respectively by  $\rho_1$  and  $\rho_2$ , we obtain  $\rho_1 = 57/145 = 0.3931$ ,  $\rho_2 = 113/89 = 1.2696$ .

In order to examine these ratios more carefully we shall first state a few of the results which have been obtained in the theory of sequences and reversals and in the closely related theory of runs.

<sup>10</sup> Much of the material in this section is taken from an article by H. E. Jones, "The Theory of Runs as Applied to Time Series," in Cowles Commission for Research in Economics, *Report of Third Annual Research Conference on Economics and Statistics*, 1937, pp. 33-36.

TABLE OF SEQUENCES AND REVERSALS

n	I	II	n	I	II	n	I	II	n	I	II	n	I	II
1	+R	-S	42	+R	+S	83	-R	+R	124	+R	-R	165	+R	+R
2	+R	-S	43	-S	+R	84	+R	-S	125	-R	+S	166	-R	-S
3	+S	-R	44	-R	+R	85	-S	-R	126	-R	+S	167	+R	-S
4	+R	+S	45	+S	+S	86	-R	+S	127	+R	-S	168	+R	-S
5	-R	+S	46	+R	+S	87	+R	+R	128	-S	-S	169	-R	-S
6	+R	+S	47	-S	+R	88	+R	-R	129	-R	-S	170	+R	+R
7	+S	+R	48	-R	-S	89	+R	+S	130	+R	-R	171	+S	+R
8	-R	-S	49	+S	-R	90	-R	+S	131	-S	+S	172	-R	+S
9	+S	-S	50	+S	+S	91	+S	+S	132	-S	+S	173	+R	+R
10	+R	-R	51	+R	+S	92	+S	+S	133	-R	-S	174	+R	+R
11	-S	+S	52	-S	+S	93	+R	+S	134	+R	-R	175	+R	+S
12	-S	+R	53	-R	+R	94	-R	+R	135	-R	+S	176	-R	-S
13	-R	-S	54	+R	+R	95	+R	-R	136	+R	+R	177	+R	+R
14	-R	+S	55	-R	+R	96	-R	+S	137	-R	+R	178	-S	+R
15	+R	+S	56	+R	-S	97	+R	+S	138	+R	+S	179	-R	+R
16	-R	+S	57	-S	-S	98	-R	+R	139	-R	+R	180	+S	-R
17	+R	+S	58	-R	-R	99	+R	-S	140	+R	+R	181	+R	+S
18	+R	+S	59	+R	-R	100	-R	-R	141	-S	+S	182	-R	+S
19	-R	+R	60	-R	+R	101	+R	+S	142	-S	+R	183	+R	+R
20	+R	+R	61	+R	-R	102	-R	+R	143	-R	-S	184	-S	-R
21	-R	+S	62	-S	+R	103	+S	-R	144	+S	-S	185	-S	+R
22	+R	+S	63	-R	-S	104	+S	+S	145	+R	-R	186	-R	+R
23	-R	+S	64	+R	-S	105	+R	+S	146	-S	+S	187	+R	+S
24	+R	+S	65	-S	-R	106	-S	+S	147	-R	+S	188	-S	+R
25	+R	+S	66	-R	+S	107	-R	+S	148	+R	+S	189	-R	+R
26	-S	+S	67	+R	+R	108	+R	+R	149	-R	+S	190	+R	+R
27	-R	+R	68	-R	-S	109	-R	-R	150	+R	+S	191	-S	-S
28	+R	-R	69	+R	-S	110	+R	+R	151	+R	+S	192	-R	-R
29	+R	+S	70	-R	-R	111	-R	-R	152	+R	+R	193	+R	-R
30	+R	+S	71	+S	+S	112	+R	+R	153	-R	-R	194	-R	+R
31	-S	+R	72	+R	+S	113	-S	-R	154	+R	-R	195	+R	-S
32	-R	-R	73	-S	+R	114	-R	+S	155	-R	+R	196	-R	-S
33	+S	+S	74	-R	-S	115	+R	+S	156	+R	-S	197	+S	-R
34	+R	+R	75	+R	-S	116	-S	+R	157	-R	-S	198	+S	+R
35	-R	-S	76	-S	-S	117	-R	+R	158	+R	-S	199	+R	+S
36	+S	-S	77	-R	-S	118	+R	+R	159	-R	-S	200	+S	-S
37	+R	-R	78	+R	-R	119	-R	-S	160	+R	-S	201	-R	-S
38	-R	+R	79	-S	+R	120	+S	-S	161	-R	-R	202	+R	-R
39	+R	-S	80	-R	-S	121	+R	-S	162	+R	-R	203	-	+R
40	-S	-S	81	+S	-S	122	-R	-R	163	-R	+R	204	-	-
41	-R	-R	82	+R	-R	123	+S	+R	164	+S	-R			

Column I gives the signs of the differences of the random series and enumerates the sequences (S) and the reversals (R). Column II refers to the Dow-Jones industrial averages over the period 1897-1913.

For a random series of normally distributed elements, the expected number of reversals is given by the formula

$$(2) \quad E(R) = \frac{2}{3} (n - 2),$$

and the standard error is equal to<sup>11</sup>

<sup>11</sup>See Jones, *loc. cit.*

$$(3) \quad \sigma_R = \frac{1}{3} \sqrt{2(n-2)}.$$

Since the sum of the sequences and reversals is equal to  $n - 2$ , that is,

$$(4) \quad E(R) + E(S) = n - 2,$$

it is clear that  $\rho$ , for a random series of normally distributed elements, is given by

$$(5) \quad \rho = \frac{E(S)}{E(R)} = \frac{1}{2}.$$

If  $v$  is the length of a run in a random series of normally distributed elements, then the expected number of such runs is given by the formula <sup>12</sup>

$$(6) \quad E(v) = \frac{2[(v^2 + 3v + 1)(n - v) + 2(v + 2)]}{(v + 3)!}.$$

We also note that if  $v$  is multiplied by its expected value and if this product is summed over all the runs, this sum should be equal to  $n - 1$ ; that is,

$$(7) \quad \sum_{v=1}^{\infty} v E(v) = n - 1.$$

If we apply these formulas to the random series given in the table, we find that

$$E(R) = \frac{2}{3} (202) = 135, \quad \sigma_R = \frac{1}{3} \sqrt{404} = 6.70.$$

As we have already seen the actual number of reversals was 145, the difference between this figure and the actual value being less than  $2\sigma_R$ .

The following table gives the distribution of runs, both positive

<sup>12</sup> This formula is due to L. Besson, "On the Comparison of Meteorological Data with Results of Chance," (translated from the French and abridged by E. W. Woolard), *Monthly Weather Review*, Vol. 48, 1920, pp. 89-94. The formula as implicitly given by Besson in the table in the second column of page 93 of his article was actually

$$E(v) = \frac{2(v^2 + 3v + 1)(n - v - 2)}{(v + 3)!},$$

which is correct provided "end" runs are not considered. The formula as given here was furnished the writer by P. S. Olmstead. Formula (7) is only approximately correct if the Besson value of  $E(v)$  is used.



and negative sequences being indicated, together with the expected count and the error observed.

TABLE OF RUNS OBSERVED IN A RANDOM SERIES

$v$	Actual Count of Runs			Expected Count of Runs	
	Positive runs	Negative runs	Total	$E(v)$	Error
1	53	45	98	84	14
2	16	24	40	37	3
3	4	3	7	11	-4
4	0	1	1	2	-1
5	0	0	0	0	0
Totals	73	73	146	134	

If we consider next an accumulated random series, that is to say, a series whose first differences are random, we find that the expected number of reversals is given by

$$(8) \quad E(R) = \frac{1}{2} (n - 2),$$

with a standard error of

$$(9) \quad \sigma_R = \frac{1}{2} \sqrt{(n-2)}.$$

The ratio of sequences to reversals is consequently equal to 1; that is,

$$(10) \quad \rho = \frac{E(S)}{E(R)} = 1.$$

We can obtain formula (8) by the following argument: In  $n$  observations there are  $(n-1)$  first differences. In this set of  $(n-1)$  first differences there can be  $S$  sequences and  $(n-2) - S$  reversals, if we assume that the probability of getting a sequence is equal to the probability of getting a reversal. The number of different orders in which  $(n-2)$  things can be arranged in two sets,  $S$  and  $(n-2) - S$ , is  $(n-2)!/S!(n-2-S)! = {}_{n-2}C_S$ . But a sequence can occur when either a rise follows a rise, or a decline follows a decline. The total number of samples containing  $S$  sequences, therefore, will be  $2 \cdot {}_{n-2}C_S$ . Since there are  $2^{n-1}$  possible samples, the probability of obtaining  $S$  sequences will be given by the equation

$$(11) \quad P(S) = \frac{{}_{n-2}C_S}{2^{n-1}}.$$

Now the expected number of sequences,  $E(S)$ , will be that value of  $S$  which makes  $P(S)$  a maximum; that is to say, it will be the value

of  $S$  which satisfies the inequalities

$$P(S) \cong \begin{cases} P(S-1) \\ P(S+1). \end{cases}$$

It is easily seen that the value  $S = \frac{1}{2}(n-2)$  is the desired value, and equation (8) follows immediately from (4).

The distribution of runs in an accumulated series in which, as we have assumed before, the probability of getting a sequence is equal to that of getting a reversal, is given by the formula

$$(12) \quad E(v) = \frac{n-1}{2^{v+1}},$$

with a variance equal to

$$(13) \quad \sigma_v^2 = \frac{n-1}{2^{v+1}} [1 - (2v-3)/2^{v+1}].$$

In the above analysis we have assumed that the probability of getting a plus sign is the same as that of getting a minus sign. This would be the case, for example, if our signs are determined by the toss of a coin, a plus sign for a head and a minus sign for a tail. But the situation is somewhat more complicated if the probability is  $p$  for obtaining a plus sign and  $q$  for obtaining a minus sign,  $p + q = 1$ . L. v. Bortkiewicz has considered the problem of runs under these more general conditions and has obtained the following formulas for the expected number of runs of length  $v$  for an accumulated series:<sup>13</sup>

$$(14) \quad E(v) = (n-1) p^2 q^2 r_{v-2},$$

where we abbreviate

$$r_k = p^k + q^k.$$

The variance of  $v$  is given by the somewhat complex formula

$$(15) \quad \sigma_v^2 = (n-1) [p^2 q^2 r_{v-2} - 2 p^3 q^3 r_{2v-3} - (2v-1) r_v^2 \\ - 4(2v+1) r_{v+1}^2 - (2v+3) r_{v+2}^2 + 8 v r_v r_{v+1} \\ - 2(2v+1) r_v r_{v+2} + 8(v+1) r_{v+1} r_{v+2}].$$

Since the first term is generally dominating, we have as a first approximation for the standard deviation the following:

$$(16) \quad \sigma_v = pq \sqrt{(n-1) r_{v-2}}.$$

<sup>13</sup> See *Die Iterationen*, Berlin, 1917, xii + 206 pp.; in particular, pp. 80-87.

Formulas (12) and (13) are seen to be special cases of (14) and (15) where we set  $p = q = \frac{1}{2}$ .

Since the Dow-Jones industrial averages, whose sequences and reversals we have tabulated above, simulate an accumulated series, we may apply these formulas to the actual count obtained from this economic time series.

Thus for  $n = 204$ , we obtain from (8) and (9) the values

$$E(R) = \frac{1}{2} (202) = 101, \quad \sigma_R = \frac{1}{2} \sqrt{202} = 7.1.$$

As we have already seen the actual number of reversals was 89, the difference between this figure and the actual value being less than  $2\sigma_R$ .

The following table gives the distribution of runs, together with the expected count, the standard deviation of  $v$ , and the error observed.

TABLE OF RUNS OBSERVED IN AN ECONOMIC TIME SERIES

r	Actual Count of Runs			Expected Count of Runs		
	Positive runs	Negative runs	Total	$E(v)$	$\sigma_v$	Error
1	21	18	39	51	7.14	-12
2	13	6	19	25	5.26	-6
3	6	12	18	13	3.54	5
4	3	2	5	6	2.49	-1
5	2	3	5	3	1.75	2
6	1	0	1	2	1.23	-1
7	2	1	3	1	0.87	2
8	0	0	0	0		0
Totals	48	42	90	101		

In the foregoing analysis we have tentatively assumed that the stock price series is an accumulated random series, a conclusion that would be both interesting and important if it could be established. We shall therefore subject the results which we have just obtained to further analysis.

In the first place, we observe that a difference as large as that observed between  $E(R) = 101$  and the actual count of 89 would be observed only about 9 in 100 times since the difference is 1.69 times the standard error. Let us now compare  $E(v)$  with the actual count of runs by means of the Chi-square test of Karl Pearson.<sup>14</sup> Assuming that there are 8 frequency classes, we compute  $\chi^2 = 12.18$ , which yields a Pearson probability of 0.10. This means that in approximately 10 cases out of 100 a fit as poor as this will be obtained by

<sup>14</sup> See Davis and Nelson, *Elements of Statistics*, 2nd ed., 1937, pp. 202-206.

random sampling.<sup>15</sup> Our conclusion is, then, that the economic series under examination probably has more structure than an accumulated random series. This conclusion will be further strengthened by the analysis of the next section.

### 8. An Application to Stock-Market Action

The theory of sequences and reversals has been used by Alfred Cowles and Herbert E. Jones in a study of the structure of stock market indexes.<sup>16</sup> As will be explained later in this book, a number of professional speculators have adopted systems which depend in one way or another upon the principle that there is a tide in the movements of the stock market and when this tide is running, it is highly advantageous to swim with it. The existence of such a movement can

Unit	Index	Period	Number of Observations	$\rho(t)$	Probability of Chance Occurrence
20 Minutes	Harris-Upham	1935-1936	2800	1.44	< 0.000001
1 Hour	Dow-Jones Hourly Avgs.	1933-1934	800	1.29	0.00040
1 Day	Dow-Jones Hourly Avgs.	1931-1935	1200	1.18	0.00094
1 Week	Standard Statistics	1918-1935	938	1.24	0.00386
2 Weeks	Dow-Jones	1897-1935	976	1.02	0.80258
3 Weeks	Dow-Jones	1897-1935	652	1.08	0.30772
1 Month	Index of R. R. Stock Prices	1835-1935	1200	1.66	< 0.000001
2 Months	Index of R. R. Stock Prices	1835-1935	600	1.50	< 0.000001
3 Months	Index of R. R. Stock Prices	1835-1935	400	1.29	0.01242
4 Months	Index of R. R. Stock Prices	1835-1935	300	1.18	0.16452
5 Months	Index of R. R. Stock Prices	1835-1935	249	1.52	0.00120
6 Months	Index of R. R. Stock Prices	1835-1935	208	1.40	0.01778
7 Months	Index of R. R. Stock Prices	1835-1935	178	1.38	0.03486
8 Months	Index of R. R. Stock Prices	1835-1935	156	1.48	0.01640
9 Months	Index of R. R. Stock Prices	1835-1935	138	1.57	0.01016
10 Months	Index of R. R. Stock Prices	1835-1935	124	1.49	0.03000
11 Months	Index of R. R. Stock Prices	1835-1935	113	1.27	0.21870
1 Year	Index of R. R. Stock Prices	1835-1935	100	1.17	0.42952
2 Years	Index of R. R. Stock Prices	1835-1935	50	1.63	0.08726
3 Years	Index of R. R. Stock Prices	1835-1934	33	1.46	0.28914
4 Years	Index of R. R. Stock Prices	1835-1935	25	0.85	0.68180
5 Years	Index of R. R. Stock Prices	1835-1935	20	1.00	1.00000
6 Years	Index of R. R. Stock Prices	1835-1931	16	0.67	0.44130
7 Years	Index of R. R. Stock Prices	1835-1933	14	0.71	0.56192
8 Years	Index of R. R. Stock Prices	1835-1931	12	0.22	0.03486
10 Years	Index of R. R. Stock prices	1835-1935	10	0.60	0.74140

<sup>15</sup> The reader will observe that the Chi-square test actually cannot be applied to the distribution given here. The sum of  $E(v)$  does not equal the frequency of the observed runs, and the conditions of the test are violated. However, the test probability gives a lower bound to the actual probability, and the conclusions may be accepted safely.

<sup>16</sup> "Some a Posteriori Probabilities in Stock Market Action," *Econometrica*, Vol. 5, 1937, pp. 280-294.

be exhibited by means of the ratio of sequences and reversals defined in the last section.

Let us designate by  $\rho(t)$  the ratio of sequences to reversals, where  $t$  designates the time unit to be employed. Thus if  $t$  is one day, we mean that  $\rho(t)$  gives the ratio of sequences to reversals for stock market averages one day apart. The object of such an investigation is to answer the question as to the degree of randomness inherent in the movements of the stock market, and whether or not there is an optimum length of time for which structural inertia may be discerned.

The accompanying table gives the ratio of sequences to reversals over a range varying from 20 minutes to 10 years. In computing the column entitled "Probability of Chance Occurrence," it has been tentatively assumed that the economic time series considered are of the nature of an accumulated random series, an assumption that is not entirely unreasonable as we have seen from the analysis of the preceding section.

The probabilities have been estimated in the following manner: If we designate by  $S$  the actual number of sequences and by  $R$  the number of reversals, then eliminating  $R$  from the equations  $S + R = n - 1$  and  $S = \rho R$ , we shall have

$$S = \frac{\rho - 1}{\rho + 1} (n - 2) .$$

But from the last section the expected number of sequences,  $E(S)$ , is equal to  $\frac{1}{2}(n-2)$  and the standard deviation is  $\frac{1}{2}(n-2)^{\frac{1}{2}}$ . Hence if we consider the difference

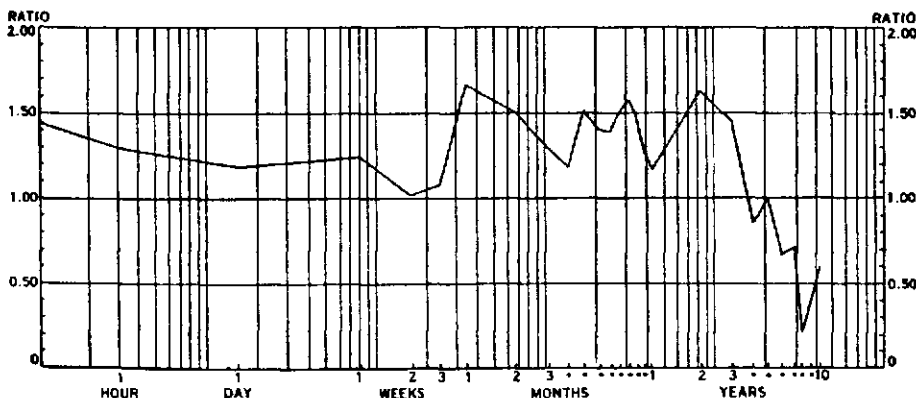

FIGURE 40.—RATIO OF SEQUENCES TO REVERSALS OF STOCK PRICE INDEXES FOR VARIOUS TIME INTERVALS.

(Logarithmic time scale in units of 20 minutes.)

$$\tau = \frac{S - E(S)}{\sigma_s} = \frac{\rho - 1}{\rho + 1} \sqrt{(n-2)},$$

we see that  $\tau$  gives a measure of the variation of the number of sequences from the expected number in terms of standard errors. Consequently the probability of a chance occurrence of the observed ratio, on the assumption that the series is an accumulated random one, is given approximately by the function

$$P(\tau) = 1 - \sqrt{\frac{2}{\pi}} \int_0^\tau e^{-t^2} dt.$$

From the table of averages, it is clear that for some time units, such, for example, as one month, there is a wide variation between the actual and the expected sequences. Hence, as the authors say, "this evidence of structure in stock prices suggests alluring possibilities in the way of forecasting."

#### ABSOLUTE PERCENTAGE CHANGES IN STOCK PRICE INDEXES

Unit	Period	Number of Observations	Average Absolute Change in Per Cent	Standard Deviation of Average
20 Min.	July 9, 1936-July 17, 1936	111	0.12	0.01
1 Hour	Sept. 12, 1935-Oct. 6, 1935	102	0.32	0.03
2 Hours	Aug. 1, 1935-Oct. 6, 1935	103	0.47	0.04
1 Day	Aug. 27, 1934-Dec. 31, 1934	102	0.73	0.07
1 Week	Jan. 6, 1913-Dec. 31, 1934	1128	2.56	0.21
1 Month	Jan. 1, 1897-Dec. 31, 1934	451	3.70	0.46
2 Months	Apr. 1, 1918-Dec. 1, 1934	100	5.02	0.91
3 Months	Jan., 1835-Dec., 1934	400	8.92	0.79
4 Months	Dec., 1900-Dec., 1934	100	10.79	0.99
5 Months	Jan., 1893-Sept., 1934	100	8.62	0.82
6 Months	Dec., 1884-Dec., 1934	100	10.04	1.20
7 Months	June, 1876-Oct., 1934	100	11.81	1.30
8 Months	April, 1868-Dec., 1934	100	11.30	1.13
9 Months	June, 1859-June, 1934	100	12.73	1.29
10 Months	Jan., 1851-Apr., 1934	100	13.00	1.31
11 Months	Dec., 1842-July, 1934	100	13.99	1.25
1 Year	Jan., 1831-Jan., 1934	103	14.70	1.43
2 Years	Jan., 1831-Jan., 1933	51	22.58	2.78
3 Years	Jan., 1831-Jan., 1933	34	28.03	4.81
4 Years	Jan., 1831-Jan., 1931	25	30.59	4.77
5 Years	Jan., 1831-Jan., 1931	20	33.95	5.71
6 Years	Jan., 1831-Jan., 1933	17	38.59	8.90
7 Years	Jan., 1831-Jan., 1929	14	33.54	9.62
8 Years	Jan., 1831-Jan., 1927	12	32.38	9.15
9 Years	Jan., 1831-Jan., 1930	11	45.98	13.64
10 Years	Jan., 1831-Jan., 1931	10	51.64	10.90

In order to explore this matter, an extensive study was undertaken to determine the average percentage change in stock prices for various units of time. Thus the difference between the index at the beginning of one unit and the beginning of the next was divided by the initial value to indicate the percentage change over this unit of time. The results of this study are contained in the accompanying table.

It will be observed from these data that the average absolute change in per cent increased essentially in an exponential manner with the period employed. It must not be assumed from this, however, that the same general expansion will take place in the next century, since our data here describe what has happened to stock prices over one of the most remarkable periods of industrial expansion in the history of the race.

But since it is clear from the analysis that there has been an inertia present in the movement of stock prices, it will be instructive to compute what would have been the net gain to an investor had he made use of this important property of the series. The calculations are taken from the original article.

For this computation let us denote by  $I(t)$  the expected annual net profit in per cent, by  $\rho(t)$  the ratio of sequences to reversals for the time interval  $t$ , by  $C(t)$  the average change per time interval  $t$  in per cent, by  $Y(t)$  the number of time intervals,  $t$ , in one year, and by  $B$  the brokerage cost for one complete trade, in per cent.

We shall assume that the investor changes his position only after the occurrence of each reversal. Hence the average net time in the right direction between changes of position will be  $[\rho(t) - 1]$  time units. Since the average move per unit of time is  $C(t)$ , the gross gain per position will be  $[\rho(t) - 1] C(t)$ , and the net gain will be this amount diminished by  $B$ . To reduce this to a ratio we divide by 100 and the entire quantity we shall designate by  $i(t)$ ; that is

$$i(t) = 0.01 \{ [\rho(t) - 1] C(t) - B \}.$$

Since the investor will be in the market in the right direction  $\rho(t)$  units of time and in the wrong direction 1 unit, the total time per position will be  $\rho(t) + 1$ , and the number of positions taken per year will be  $Y(t)/[\rho(t) + 1]$ . Let us designate this quantity by  $n(t)$ ; that is,

$$n(t) = Y(t)/[\rho(t) + 1].$$

Hence the total net annual gain, in per cent, will be given by the formula

$$(1) \quad I(t) = 100 \{ [1 + i(t)]^{n(t)} - 1 \}.$$

Since the data necessary for the computation of  $I(t)$  have been given in the preceding tables, it is possible for us to test the efficacy of this method of stock investing. The results are given in the following table:

Time Unit	$\rho(t)$	$C(t)$	Expected Annual Net Profit for Brokerage Costs of		
			1%	1½%	2%
1 day	1.18	0.73%	-67.4%	-83.0%	-91.1%
1 week	1.24	2.56	- 8.55	-18.6	-27.6
1 month	1.66	3.70	6.66	4.25	2.00
2 months	1.50	5.02	3.66	2.44	1.23
3 months	1.29	8.92	2.79	1.91	1.03

As one might expect, units as short as one day or one week are associated with too small an average percentage change to show a profit. The average net gain per trade is largest for two months, but the number of changes of position per year reduces the annual net gain below that of one month. The conclusion is thus reached that the optimum period of time for this type of investing is one month. In spite of this positive conclusion that a profit can be made by this method of making use of the inertia of the series, a study of the consistency of the data for short periods of time shows that the method is operative only over very long intervals and could not be used for obtaining annual profits.

However, the analysis clearly shows that the time series for the stock market prices has a structure and that this structure is visible in a predominance of sequences over reversals. Later in the book it will be shown how the Dow theory of forecasting essentially makes use of this property.



## CHAPTER 5

### THE DEGREES OF FREEDOM IN ECONOMIC TIME SERIES

#### 1. *Preliminary Definitions*

From the astronomer and the physicist we have derived the concept of *degrees of freedom* possessed by the elements of a time series. A particle moving in a line in a plane has one degree of freedom, but if it may wander without restraint in the plane then it is said to possess two degrees of freedom. The theory of the kinematics of a rigid body may properly begin with the proposition that such a body has six degrees of freedom. The argument is illuminating and may be reproduced as follows: The position of a rigid body in space is fully determined by the position of three points within it which are not collinear, since the position of any other point is determined by reference to the given points. But the nine co-ordinates necessary for the specification of the three points are not independent, since, in a rigid body, the three distances between the points remain unchanged. Hence the number of degrees of freedom will be the number of co-ordinates diminished by the number of relationships between them, that is to say,  $9 - 3$ , or six degrees of freedom.

In recent years the concept of degrees of freedom has had an increasing importance in statistics. Although the concept was familiar to Gauss, the modern use of it was introduced by "Student" in 1908 and given increasing importance in the writings of R. A. Fisher and his followers. Strange to say, however, there have been few precise statements of the meaning of the term *degrees of freedom* in statistical literature. Recently, however, Helen M. Walker has done statistics a favor by devoting an article to the subject.<sup>1</sup>

In mechanics the term *degrees of freedom* has long had a precise meaning. Thus, if we have a system of  $n$  material points and these points are entirely free to move, then  $3n$  co-ordinates would be required to specify their combined configuration. But generally there will exist a system of restraints between the points, as we have indicated above in the case of a rigid body, and these restraints will be specified by a system of  $k$  equations between the co-ordinate variables.

<sup>1</sup> "Degrees of Freedom," *The Journal of Educational Psychology*, Vol. 31, 1940, pp. 253-269.

These equations may be represented as follows:

$$(1) \quad F_i(x_1, y_1, z_1; x_2, y_2, z_2; \dots; x_n, y_n, z_n) = 0, \quad i = 1, 2, \dots, k.$$

If the particles are free to move in any direction and if  $3n$  coordinates are necessary to specify their configuration, then we say that the system has  $3n$  degrees of freedom; but if there exist  $k$  restraints, then the number of degrees of freedom is  $3n - k$ . Thus if a single particle is constrained by elastic forces and initial boundary conditions to move in a line in a plane, it has  $3 - 2 = 1$  degree of freedom. The actual specification of its motion as a function of time may involve the fitting of a function with  $p$  parameters.

In the statistics of variance a similar concept is invoked by the term *degrees of freedom*. Thus we find the following statement by J. O. Irwin:

We notice that the number of degrees of freedom is equal to the number of observations made, less the number of independent relations between them, account being taken of the fact that the population mean is itself estimated from the sample.<sup>1a</sup>

In the statistics of time series, however, the precise meaning of the term degrees of freedom has not been clearly stated, or, at any rate, it has not been incorporated into the theory to the same extent as it has been in the statistics of variance. We are thus free to formulate the concept in what appears to us to be the most useful form for our present purpose. It will be seen that we are adapting the physical concept to the problem of economic time series.

Let us assume that we are concerned with the  $N$  elements of a time series

$$(2) \quad y(t): \quad y_1, y_2, y_3, \dots, y_N.$$

If the elements of  $y(t)$  are random numbers, then there will obviously exist no relationship between them of the type specified by (1). In this case we shall say that the number of degrees of freedom is  $N$ . But if, on the contrary, the values of  $y(t)$  are given by the curve

$$y(t) = A \sin kt,$$

then only two parameters are necessary for their specification and the number of degrees of freedom is 2. If it should happen, however, that one of the two parameters was specified a priori, then the number of degrees of freedom reduces to 1. This is illustrated by the case

<sup>1a</sup> "Mathematical Theorems Involved in the Analysis of Variance," *Journal of the Royal Statistical Society*, Vol. 94, 1931, pp. 284-300; in particular, p. 287.

of the simple pendulum swinging in a plane. The motion of the bob for small amplitudes is described by the sine function just written down. But the pendulum has only one degree of freedom since the parameter  $k$  is equal to the square-root of  $g/L$ , where  $g$  is the acceleration of gravity and  $L$  is the length of the pendulum; hence  $k$  is not statistically determined. The parameter  $A$ , on the other hand, depends upon the initial displacement of the bob and thus is a statistical observable.

Another aspect of the problem of the pendulum that may be used to guide our thought is found in the fact that the energy of the pendulum system, that is to say the total kinetic energy possessed by the bob at the bottom of the swing or its potential energy at the top, is proportional to  $A^2$ . But we also know that the variance of the function  $y(t) = A \sin kt$  taken over any number of complete cycles is equal to  $\frac{1}{2}A^2$ . Hence, it would be attractive to relate the computation of the number of degrees of freedom to the computation of the energy, or what is the same thing, to the computation of the variance accounted for by the functions used in the description of the time series.

We may then proceed as follows: Let us suppose first that  $y(t)$  may be described completely by a set of  $n$  functions which contain  $p$  statistical parameters. We shall say that  $y(t)$  has  $np$  degrees of freedom. Thus, if  $y(t)$  consists of a set of  $N$  random numbers, these can be completely represented by a Fourier series consisting of  $\frac{1}{2}N$  harmonics each containing two parameters. The number of degrees of freedom is thus  $N$ .

One of the principal problems in the analysis of economic time series is to determine how many parameters and how many functions are necessary for the specification of the elements of the series; that is to say, to determine the number of degrees of freedom involved in the observed variation of the series. But it is easily seen that an improper choice of functions may lead to an excessive estimate of the number of degrees of freedom. For example, if  $k$  in the function  $y = A \sin kt$  does not belong to the Fourier sequence described in Section 4 of Chapter 2, then the description of  $y$  by a Fourier series would require all the  $\frac{1}{2}N$  components and we might reach the erroneous conclusion that the number of degrees of freedom was  $N$  instead of 2. The concept is thus related to the character of the functions selected for the representation of the series. A choice of the components of a Fourier series would lead to one estimate and a choice of a series of Legendrian polynomials would lead in general to another. Although a proper choice of functions is often indicated by the nature of the series itself, we shall assume that the real number of degrees

of freedom is the smallest number possible if all types of functional representation were tried. It is obviously impossible to make such a determination, but the criterion would immediately differentiate one set of functions as better than another. Moreover, in most cases, by the use of harmonic analysis and other statistical devices, it is possible to make a good approximation to the real number of degrees of freedom.

Since the point of view adopted in this book has been strongly colored by classical mechanics, principally because economic time series in many respects resemble series derived from systems of physical variables, it will be convenient to approach the problem in hand through the concept of energy. If this appears strange to the statistical reader, he may translate energy into variance. The mathematical theory of energy is in most regards indistinguishable from the theory of variance. But the latter concept has been associated mainly with static populations, while the former is a concept intrinsic to all dynamic phenomena. Hence, we shall define as the total energy of system (2), a quantity proportional to the variance  $\sigma^2$ , where  $\sigma^2$  is the squared deviation of the elements of the time series from their average value. Symbolically we shall write this in the form

$$E = k \sigma^2,$$

where  $k$  is a factor of proportionality which depends upon the nature of the series itself.

It will be convenient, also, to concern ourselves with linear relationships, and we shall assume that  $y(t)$  can be represented by a linear function of the form

$$(3) \quad y(t) = \alpha_1 u_1(t) + \alpha_2 u_2(t) + \dots + \alpha_n u_n(t),$$

where the  $u_i(t)$  are functions defined either as continuous mathematical quantities such as sines and cosines, or by the statistical elements of an economic time series.

As is well known, any linearly independent set of functions may be replaced by an equivalent set of normalized orthogonal functions of the type described in Chapter 2. The technique for obtaining such a set has already been explained in Section 12 of that chapter. Let us now assume that such a set has been obtained from the functions  $u_i(t)$ , and let the elements of the set be  $v_1(t)$ ,  $v_2(t)$ ,  $\dots$ ,  $v_n(t)$ . In terms of these, equation (3) then becomes

$$(4) \quad y(t) = \beta_1 v_1(t) + \beta_2 v_2(t) + \dots + \beta_n v_n(t).$$

If this set of functions is closed (see Section 3 of Chapter 2), a necessary condition for which is that  $n$  is infinite, then  $y(t)$  can be described completely by the  $v_i(t)$ . In general, however, a finite number of the functions will give a sufficiently close approximation to  $y(t)$  and we can write

$$(5) \quad \beta^2_1 \lambda_1 + \beta^2_2 \lambda_2 + \cdots + \beta^2_n \lambda_n = \sigma^2,$$

where  $\lambda_1, \lambda_2, \dots, \lambda_n$  are proportional to the variances of the functions  $v_1(t), v_2(t), \dots, v_n(t)$  as stated in Section 11 of Chapter 2.

The quantities

$$(6) \quad E_i = k\beta_i^2 \lambda_i$$

will be referred to as the elementary energies associated with the functions  $v_i(t)$ .

It is clear that we shall have from (5) the relationship

$$E_1 + E_2 + \cdots + E_n = E,$$

where  $E$  is the energy of  $y(t)$ .

If the set of functions  $v_i(t)$  is not closed, then the sum of the elementary energies will be less than the total energy as one sees from Bessel's inequality discussed in Section 11 of Chapter 2. This condition is the one that usually applies in the application of this theory to economic time series.

As we have already indicated above, one of the most important problems in the analysis of economic time series is to determine the number of functions and the number of parameters necessary to specify a given series. But the actual determination of the system of functions,  $u_i(t)$ , which accounts for the largest amount of energy with the smallest number of degrees of freedom is the second principal problem of economic dynamics. This choice of functions must also be accompanied by some a priori judgment as to the essential character of the functions thus selected for the approximation. For example, an economic time series may be equally well accounted for by means of a system of Legendrian polynomials or by a system of harmonic terms, since both sets are closed, and the number of degrees of freedom might actually be the same. But the harmonics may be a logical choice for the representation, if cycles are known to be present in the series, whereas the Legendrian functions may have no interpretation at all.

The problem of determining the functions to be employed in the approximation is clearly one of great difficulty, and it cannot be

solved by mathematics alone. Experience and a knowledge of the underlying phenomena are required. Thus the actual construction of a new science is a long and difficult task, since the interrelationships between the observed phenomena must be discovered by the process of experimentation on the one hand and intuition on the other. The difficulties in constructing a social science are even greater than the difficulties encountered in constructing a physical science, since in the former the relationships are seldom functionally exact and must be explored through the medium of correlations instead of complete functional relationships.

Before proceeding to the mathematical details by means of which we may attain a measure of the number of degrees of freedom that exists in the assumed relationships between a set of variables, it will be worth while to consider the nature of the probabilities which are encountered in establishing these relationships. This problem is discussed in the next section.

## *2. Economic Time Series as a Problem in Inverse Probability*

The problem of determining structure, such as a more or less regular periodicity in economic time series, is essentially a problem in inverse probability. We are required to state the probability that a certain structure exists, while we are in complete, or almost complete, ignorance as to the generating causes.

As an illustration of this point of view, let us consider the essential difference between the two observed phenomena of a 12-month cycle in egg prices and a 40-month cycle in the price of industrial stocks. In the first instance we are aware of a satisfactory causal relationship. The change in the seasons has a known and measurable effect upon the production of eggs. Hens lay in the spring and cease laying in the fall. There is thus a large seasonal variability in the supply function and this variability is, in turn, reflected in prices. But what shall we say about the 40-month cycle in the price of industrial stocks? Let us examine the statistical evidence. It can be shown that the same cycle is observed in industrial production, constant in phase but variable in amplitude. At times the influence of the cycle is masked by larger trade trends such as those experienced during the disruptive periods before and after the inflationary stock market of 1929. But since one also observes that the cycle in stock prices precedes the cycle in production, we cannot, as in the case of eggs, attribute the production cycle as the cause of the cycle in the former. As a matter of fact, the reverse seems to be true.

Here, then, we have an economic phenomenon without any clear a priori cause. What, then, shall we mean by the question: Is the 40-month cycle a real economic phenomenon? It will be observed that the answer to this question contains the crux of the problem of the analysis of economic time series.

In order to investigate the problem thus invoked, suppose that we first assume that the periodogram of stock prices has been exhibited over a period in which the phenomenon is evident. Let us then inquire into the nature of the significance of the amplitude  $R$  observed for the period  $T = 40$ .

In a time series for which it is known a priori that cycles should appear, although the actual cycles may not be known explicitly, the relative significance of one amplitude in comparison with others can be stated as a direct probability. The technique for obtaining this probability will be discussed in subsequent sections.

Without invoking questions of statistical procedure, let us assume that we know the distribution of the values of  $R$  as a frequency function of the form  $y = F(R)$ , where  $\int_0^{\infty} F(R) dR = 1$ . Then the probability that  $R$  will have a value between  $R_0$  and  $R_0 + dR$  is given by  $F(R_0) dR$ , and the probability that  $R$  will exceed  $R_0$  in value is

$$(1) \quad P = 1 - \int_0^{R_0} F(R) dR .$$

This probability may be regarded as a measure of the significance of  $R$ .

But in the analysis of the structure of economic time series the problem is seen to be essentially different. Thus, suppose that by (1) we have found that the significance of  $R$  for  $T = 40$  is measured by a probability  $P = 0.005$ . That is to say, the probability of observing a value of  $R$  as large as the one actually observed is five in a thousand. This would naturally imply high confidence in the actual existence of a 40-month cycle in stock prices if we knew that cycles were really present in the series. But unfortunately we have no a priori theory which will account for the existence of such a cycle, and yet we are asked to have high confidence in the reality of the cycle as an economic phenomenon.

But the important question is actually something else. We should ask, as a result of the observation of  $R$ , whether or not the 40-month cycle is to be regarded as a permanent characteristic of stock prices. Obviously one may assume that either it is a permanent characteristic, or it is not. But what probability shall we then assign to these

two mutually exclusive propositions? In other words, having observed a very improbable value of  $R$ , we now ask how this observation affects our belief in the hypothesis that the 40-month cycle is a permanent characteristic of industrial stock prices.

Let us phrase the question in terms of the language of inverse probability, a theory which is clearly indicated as involved in the answer to the question proposed. We may thus say: An event (the observation of the improbable value of  $R$ ) is known to have proceeded from one of two mutually exclusive causes (either the 40-month cycle is a permanent characteristic of stock prices, or it is not). What is the probability,  $p$ , that the event proceeded from the first cause?

We may assume that, if the 40-month cycle is a permanent characteristic of stock prices, then the probability of observing so large an amplitude ratio as that actually observed may be as great as  $p_1 = 0.995$ . If, however, the second is true, then the probability of observing the phenomenon is  $p_2 = 0.005$ . But what probabilities shall we assign to the two mutually exclusive causes? Invoking the principle of insufficient reason we might write  $P_1 = \frac{1}{2}$ ,  $P_2 = 1 - P_1 = \frac{1}{2}$ . Hence the probability,  $p$ , that the event proceeded from the first cause would be

$$p = \frac{0.995 \times \frac{1}{2}}{0.995 \times \frac{1}{2} + 0.005 \times \frac{1}{2}} = 0.995.$$

But a personal inquiry into our belief in this figure shows that it is far from realistic. No one believes that the chances are 995 in 1000 that the 40-month cycle will be revealed by the periodogram of the next, and as yet unknown, ten-year period of industrial stock prices. Who, for example, would wager any considerable amount on this probability by actually adopting a speculative program based on his belief in the permanence of the 40-month pattern?

It is thus clear that the principle of insufficient reason is not satisfactory. That the 40-month cycle, or any other cycle, is a permanent characteristic of stock prices must be regarded as highly improbable in the absence of any a priori reason for its existence. Let us denote this unknown, but small, probability by  $P_1$  and the contrary probability by  $1 - P_1$ . Then the probability,  $p$ , that the observed value of  $R$  appears as a result of the first cause, will be

$$(2) \quad p = \frac{0.995P_1}{0.995P_1 + 0.005(1 - P_1)} = \frac{0.995P_1}{0.990P_1 + 0.005}.$$

This equation may be solved for  $P_1$  and we thus obtain



$$(3) \quad P_1 = \frac{0.005p}{0.995 - 0.990p}.$$

Let us now assume that a survey of the evidence, and, in particular, a reflection upon the magnitude of the observed value  $R$ , has convinced us that the probability that  $R$  has been derived from a true 40-month pattern in stock prices is as great as 0.50. In other words, let us assume that  $p = 0.50$ . We now ask what the probability is that the 40-month cycle is a permanent characteristic of stock prices. Substituting  $p = 0.50$  in (3), we find that  $P_1 = 0.005$ . That is to say, in spite of the fact that we have a half measure of belief that  $R$  must be derived from a permanent pattern of stock price action, nevertheless our belief is only 5 in 1,000 that this permanent characteristic actually exists.

This analysis explains, in part at least, the reluctance of economists to believe in the permanence of the 40-month cycle on the basis of present statistical evidence. Few speculators, perhaps not more than 5 in 1,000, who have observed the 40-month period in a time interval  $A$ , will use this observation as the basis for speculation in the subsequent time interval  $B$ .

The reader at this point should observe that the argument which we have given here depends upon the subjective judgment demanded by the principle of insufficient reason. About this principle there has always existed the greatest doubt and many writers on probability have rejected the theory of inverse probability because of the inevitable intrusion of some assumption about the distribution of probabilities in an unknown universe of objects. This does not mean that the formula of Bayes which we have used is wrong, but that the assumption of a uniformly distributed ignorance of fundamental causes is abhorrent as the basis of a rational theory. The author has merely attempted in this section to point out that there is usually involved in speculation in the stock market a subjective judgment about the movement of price averages, and that this subjective judgment is made for the most part on the basis of insufficient reason since the probabilities depend upon a mechanism about which little is known at the present time.

### *3. Significance Tests and the Problem of Degrees of Freedom*

The problem which we shall consider in the next few sections is that of determining the significance of the parameters in a linear relationship such as that of equation (3) of Section 1; namely,

$$(1) \quad y(t) = \alpha_1 u_1(t) + \alpha_2 u_2(t) + \dots + \alpha_n u_n(t).$$

We shall assume, first, that the independent variables,  $u_1(t)$ ,  $u_2(t)$ ,  $\dots$ ,  $u_n(t)$ , have been determined by some a priori judgment. For example, they might be harmonic terms suggested by a periodogram analysis of  $y(t)$ ; or they might be strictly economic variables which observation shows are related to the dependent variable. Thus, if  $y(t)$  is the price index of common stocks, then  $u_1(t)$  might be the production of pig iron,  $u_2(t)$  the index of building, etc.

We shall assume, second, that the variables  $u_i(t)$  have been expressed as deviations from their averages and that they have been divided by their standard deviations,  $\sigma_i$ . If the number of items is large, the standard error in the values of  $\sigma_i$  is small, and no essential restrictions will have been imposed by this assumption. The case of large samples is one frequently encountered in dealing with economic variables.

Since it is difficult to define the elementary energies associated with each of the variables in (1) because of their intercorrelations, we shall next transform this equation into its equivalent in terms of the normalized, orthogonal variables  $v_1(t)$ ,  $v_2(t)$ ,  $\dots$ ,  $v_n(t)$ . We thus obtain

$$(2) \quad y(t) = \beta_1 v_1(t) + \beta_2 v_2(t) + \dots + \beta_n v_n(t),$$

where the  $\beta_i$  are obtained from the  $\alpha_i$  by means of the equations

$$(3) \quad \beta_i = \sum_{j=1}^n u_{ij} \alpha_j.$$

The matrix,  $U = ||u_{ij}||$ , is the unit, orthogonal matrix defined in Section 12, Chapter 2.

The problem, then, is to determine the significance of the elementary energies

$$(4) \quad E_i = k \beta_i^2 \lambda_i,$$

defined by equation (6) of Section 1. This measure of significance can be made, of course, only by determining the distribution function for the elementary energies  $E$ .

Fortunately this distribution function has been the object of considerable study for the case where the  $v_i(t)$  are sines and cosines, and a satisfactory theory has been achieved through the studies of Sir Arthur Schuster, Sir Gilbert Walker, R. A. Fisher, and others. An account of these researches in their relationship to the problem of harmonic analysis has already been given in Section 8 of Chapter 1.

It will be found upon examination that much of the theory will also carry over to the case where the variables are any set of normalized orthogonal functions.

The following definition of the number of degrees of freedom observed in a function  $y(t)$ , whose regression equation is (2), appears to be a logical consequence of the point of view which we have adopted above. If we define the quantity  $E_R = \sigma^2/N$  as the energy of a random element, then the number of degrees of freedom possessed by the variable  $y(t)$  is given by the expression

$$(5) \quad n' = p + 1 + \frac{(1 - \sum E_p)}{E_R} \sigma^2,$$

where  $\sum E_p$  is the energy accounted for by the  $p$  elements of the original  $n$  variables, which have been judged to be significant by some test depending upon the distribution function for  $E$ . Equation (5) may be written more simply

$$(6) \quad n' = p + 1 + N(1 - \sum E_p).$$

In this formula  $p + 1$  is used instead of  $p$  since one degree of freedom is required in the specification of the arithmetic average.

Some objection may be raised to this definition of the number of degrees of freedom, since it will yield a rather large estimate for most economic time series. It must be remembered, however, that the number of degrees of freedom contributed by the second term is the number of degrees attributable to the random element. Thus, to account for this random element a Fourier series of  $N(1 - \sum E_p)$  terms would probably be required. It seems reasonable, therefore, to attribute that number of degrees of freedom to this element. We shall refer to  $p$  as the number of significant degrees of freedom and to  $N(1 - \sum E_p)$  as the number of random degrees of freedom in the residual element.

Thus, in the example of Section 2 of Chapter 7, a total energy  $E = 0.8866$  is accounted for by four harmonics each containing two terms. Since the series is composed of 300 items the number of degrees of freedom is estimated to be

$$n' = 9 + 300(1 - 0.8866) = 43.$$

But we know from the character of the series itself that the addition of one more harmonic term, containing two degrees of freedom, will exactly account for all the energy. Hence the number of degrees of freedom is actually 11 instead of 43, but this could not be known without a further study of the residuals. Hence the estimate of 43 is not unrealistic.

We now turn to a discussion of the significance tests for harmonic analysis as they have been evolved by Schuster, Walker, and Fisher.

#### 4. Schuster's Significance Test in Harmonic Analysis

In order to understand the problem of determining significance in harmonic analysis, let us consider the time series,  $y(t)$ . Let the values  $A_n$  and  $B_n$  be computed by the formulas

$$A_n = \frac{2}{N} \sum_{t=0}^{N-1} y(t) \cos \frac{n\pi t}{N}, \quad B_n = \frac{2}{N} \sum_{t=0}^{N-1} y(t) \sin \frac{n\pi t}{N},$$

and let the squares of the amplitudes of the Fourier sequence be defined as before by

$$R^2 = A_n^2 + B_n^2.$$

Schuster's test of significance may then be formulated as follows: Let  $R_M^2 = 4\sigma^2/N$  be the mean value of the squares of the amplitudes of the periodogram sequence  $R_n^2$ . Then the Schuster probability,  $P_s$ , that any squared amplitude,  $R^2$ , chosen at random, will exceed  $\kappa R_M^2$  is given by

$$P_s = e^{-\kappa}.$$

We may reconstruct the argument as follows: Suppose, first, that the original observations,  $y(t)$ , are normally distributed. Then, since the  $A_n$  and  $B_n$  are linear functions of the observations, they will also be normally distributed. Hence the probability that  $A_n$  lies between  $A$  and  $A + dA$  is

$$dI_A = \frac{1}{\sigma_A \sqrt{2\pi}} e^{-A^2/\sigma_A^2} dA,$$

where we define

$$\sigma_A^2 = \frac{4}{N^2} \sigma^2 \sum_{t=0}^{N-1} \cos^2 \frac{2\pi t n}{N} = \frac{2}{N} \sigma^2.$$

That is to say, the probability  $dI_A$  may be written

$$dI_A = \sqrt{\frac{N}{\pi}} \frac{1}{2\sigma} e^{-N A^2/4\sigma^2}.$$

Similarly, the probability that  $B_n$  lies between  $B$  and  $B + dB$  is given by

$$dI_B = \sqrt{\frac{N}{\pi}} \frac{1}{2\sigma} e^{-NB^2/4\sigma^2} dB.$$

Hence, the joint probability that  $A_n$  lies between  $A$  and  $A + dA$ , while  $B_n$  lies between  $B$  and  $B + dB$  is given by

$$dP = \frac{N}{\pi} \frac{1}{4\sigma^2} e^{-NR^2/4\sigma^2} dA dB.$$

Replacing  $dA dB$  by  $R dR d\theta$ , we may write this probability in the form

$$dP = \frac{N}{\pi} \frac{1}{8\sigma^2} e^{-NR^2/4\sigma^2} dR^2 d\theta.$$

Now integrating over the area between the circles centered at the origin with radii  $R$  and  $R + dR$ , we get as the probability that  $R^2$  shall lie between  $R^2$  and  $R^2 + dR^2$

$$dP = \frac{N}{4\sigma^2} e^{-NR^2/4\sigma^2} dR^2.$$

Hence, integrating this expression between the limits of  $R_s^2$  and  $\infty$ , we obtain as the probability that  $R^2$  shall exceed the assigned value  $R_s^2$  the quantity

$$P_s = \frac{N}{4\sigma^2} \int_{R_s^2}^{\infty} e^{-NR^2/4\sigma^2} dR^2 = e^{-NR_s^2/4\sigma^2}.$$

But the mean value of  $R^2$  is equal to  $4\sigma^2/N$  so that we can write

$$P_s = e^{-R_s^2/R_M^2}.$$

Hence, if we assume that  $R_s^2 = \kappa R_M^2$ , then the Schuster probability becomes

$$P_s = e^{-\kappa}.$$

As an example, let us apply this test to the periodogram of the Dow-Jones industrial stock averages (1897-1914), which we have previously discussed. For the original data we have the variance,  $\sigma^2 = 225.3154$ , and since  $N = 204$ , we have as the mean of the Fourier sequence the value  $R_M^2 = 4\sigma^2/N = 4.4179$ . Since Schuster arbitrarily chose as his significant probability,  $P_s = 0.005$ , we would have for the corresponding multiplier,  $\kappa = 5.30$ . Hence Schuster's test would say that there are 5 chances in 1000 that any squared amplitude,  $R^2$ , chosen at random would exceed

$$5.30 \times 4.4179 = 23.4149.$$

Upon inspection of the periodogram we find three values which exceed this limit, namely  $R^2(68) = 109.78$ ,  $R^2(51) = 34.30$ , and  $R^2(41) = 216.74$ . A fourth value,  $R^2(23) = 22.28$  nearly equals the limit. From this we would conclude that the probability favors the belief that there exists more than a random structure in the original series.

### 5. Walker's Significance Test in Harmonic Analysis

Sir Gilbert Walker was the first to call attention to the inadequacy of Schuster's test for significance. His argument ran as follows: Suppose that a large value of  $R^2$  has been found in the total Fourier sequence of the  $\frac{1}{2}N$  independent terms necessary to represent  $N$  observations. Schuster's test merely gives the probability that an  $R^2$  chosen at random shall exceed  $\kappa R_M^2$ . But what is really required is the probability that some  $R^2$  among the total number in the Fourier sequence shall exceed  $\kappa R_M^2$ .

We may state Walker's test as follows:

*The Walker probability,  $P_w(\kappa)$ , that at least one  $R^2$  among the total Fourier sequence of  $\frac{1}{2}N$  independent values representing  $N$  observations will exceed  $\kappa R_M^2$  is given by*

$$P_w(\kappa) = 1 - (1 - e^{-\kappa})^{1N}.$$

The argument is merely this: The probability that any squared amplitude,  $R^2$ , selected at random will yield a value in excess of  $\kappa R_M^2$  is by the Schuster theorem equal to  $e^{-\kappa}$ . Hence the probability that any randomly chosen value of  $R^2$  shall be less than  $\kappa R_M^2$  is  $1 - e^{-\kappa}$ , and the probability that all the values will be less than  $\kappa R_M^2$  is  $(1 - e^{-\kappa})^{1N}$ .

Thus the probability,  $P_w(\kappa)$ , that at least one  $R^2$  shall exceed the specified limit is

$$P_w(\kappa) = 1 - (1 - e^{-\kappa})^{1N}.$$

One deficiency in the Walker theory is immediately observed. We know that  $P_w(1)$  must equal 1.00, since some  $R^2$  must necessarily equal the average  $R_M^2$ . But unless  $N$  is infinite, this is not the case. However, since for values of  $N$  exceeding 20 we have  $P_w(1) > 0.9825$ , this defect is not likely to cause difficulty in actual application of the significance criterion.

Tables of the function  $P_w(\kappa)$  have been prepared for values of  $N$  from  $N = 10$  to  $N = 600$  by intervals of 10 and for  $\kappa$  from 0.1 to 10.0 by intervals of 0.1. These are recorded in Table 1 at the end of the book.

As an example of the application of Walker's test, let us consider the periodogram of the Dow-Jones industrial stock averages (1897-1914), which we discussed in the example of the previous section. Employing the same criterion of

significance, namely,  $P_w = 0.005$ , we find that this corresponds to the value  $\kappa = 9.9$  when  $N = 204$ . Noting that  $R_w^2 = 4.4179$ , we see that by Walker's test there are 5 chances in 1000 that some  $R^2$  among the total Fourier sequence will exceed

$$9.9 \times 4.4179 = 43.7372.$$

Since the values for  $R^2(68)$  and  $R^2(41)$  exceed this limit, we are justified by this test in assuming that they indicate a significant variation from the expected distribution.

### 6. R. A. Fisher's Test of Significance

The tests of Schuster and Walker were derived on the assumption that the  $R^2$  to be tested is derived from a series whose observations are random selections from a normal universe with known variance equal to  $\sigma^2$ . But when the unknown variance must itself be estimated from samples then these tests must be modified to take account of this fact. The analysis necessary to establish the criterion in this case was carried out by R. A. Fisher. The test may be formulated as follows:

Let  $g'$  be defined by the ratio

$$g' = \frac{R^2}{2\sigma^2},$$

where  $R^2$  is the largest among the squares of the amplitudes of the Fourier sequence. Then, if  $n = \frac{1}{2}(N - 1)$ , where  $N$  is the number of observations, the Fisher probability,  $P_f$ , that  $g'$  will exceed some critical value  $g$  is given by the formula

$$P_f = n(1-g)^{n-1} - \frac{n(n-1)}{2!} (1-2g)^{n-1} + \dots \\ + (-1)^{m-1} \frac{n!}{m!(n-m)!} (1-mg)^{n-1},$$

where  $m$  is the greatest integer less than  $1/g$ .

Before examining the argument by means of which this formula is derived, let us first observe that the difference between  $P_f$  and  $P_w$  is not great within the usual range of application. In order to see this, let us note that if  $N$  is sufficiently large so that we may disregard the difference between  $N$  and  $N-1$ , then the  $\kappa$  of Walker's test is related to the  $g$  of Fisher's test by the formula  $\kappa = ng$ . Hence we may write

$$P_w(\kappa) = 1 - (1 - e^{-\kappa})^n = 1 - (1 - e^{-ng})^n, \\ = ne^{-ng} - \frac{n(n-1)}{2!} e^{-2ng} + \frac{n(n-1)(n-2)}{3!} e^{-3ng} - \dots$$

This series, for sufficiently small values of  $g$ , will converge very rapidly to  $P_w(\kappa)$ . Moreover, if  $g$  is small enough, then the term  $e^{-rg}$  may be replaced by  $(1 - rg)^n$ . Hence, the Walker probability function is seen to approximate closely the Fisher function. As an example of the closeness of the agreement, let us assume that  $g = 0.19784$ ,  $n = 30$ . We thus obtain  $P_f = 0.0500$ , which is to be compared with  $P_w = 0.0813$ , computed for  $\kappa = 30g$ ,  $N = 61$ .

A number of values of  $P_f$  have been computed and will be found in Table 2 at the end of the book. The argument  $\kappa = ng$  has been used instead of  $g$  to correspond to the argument used in the table for  $P_w$ . This table has been computed in terms of  $n = \frac{1}{2}(N - 1)$  instead of for  $N$  as in the case of the table for  $P_w$ . Hence comparable values for  $P$  as given by both tables will correspond to the same argument  $\kappa$ , but for  $N$  and  $n = \frac{1}{2}(N - 1)$  respectively. Thus if  $\kappa = 7.5$ ,  $N = 100$ , we get  $P_w = 0.027283$  from Table 1 and  $P_f = 0.01737$  from Table 2. The latter value corresponds to  $n = 50$  (neglecting  $\frac{1}{2}$ ).

The general derivation of the formula for  $P_f$  is difficult and requires an analysis of the distribution of the values of  $R^2$  in a hyper-space of  $n$  dimensions. The following discussion of the problem has been furnished the author by John H. Smith and is included because of the light which it throws upon an essentially difficult argument:

Walker's and Schuster's tests are exact tests of significance for an  $R^2$  derived from a series whose observations are random selections from a normal universe whose variance is known to be  $\sigma^2$ . When the unknown variance must be estimated from samples, the test criterion,  $\chi$ , is not distributed exactly as  $\frac{1}{2}\chi^2$  with two degrees of freedom as implied by Schuster's test, but as  $\frac{1}{2}N$  times the square of a measure of correlation with 2 and  $N-2$  degrees of freedom. Hence its exact probability integral corresponding to Schuster's approximate test is

$$P'_s = \left(1 - \frac{2\kappa}{N}\right)^{1(N-2)}$$

This approaches the value  $e^{-\kappa}$  given in Section 4 as  $N$  increases without bound and it may be identified with the incomplete Beta-function,  $I_x[\frac{1}{2}(N-2), 1]$ ,  $x = 1 - 2\kappa/N$ , defined in Section 8 of this chapter.

In order to derive Fisher's formula, let us consider the case where  $n = 3$ . The squared amplitudes,  $R^2_i$ , are then represented in one octant of a three-dimensional space in which  $R^2_1$  is the vertical co-ordinate. Since the  $R^2_i$  are proportional to  $\chi^2$  with two degrees of freedom the frequency density is constant along planes of the form

$$R^2_1 + R^2_2 + R^2_3 = K$$

of which the region in the octant considered is an isosceles triangle.

The condition that  $g'$  exceeds  $g$  is



$$R^2_1 > g \sum_{i=1}^n R^2_i,$$

a condition which is fulfilled by all points above the plane

$$(1 - g)R^2_1 = g(R^2_2 + R^2_3).$$

This plane divides any plane of constant frequency density into two sections, the section in which  $R^2_1$  is greatest being an isosceles triangle whose sides are  $(1-g)$  times as large as those of the entire region in the octant. Since all planes of constant frequency density are divided in the same proportion the probability integral of  $g'$  can be identified with proportions of any such plane. If  $R^2_1$  were chosen at random it would be necessary to consider only the region in which  $R^2_1$  is greatest as a proportion of the region in the octant. Since similar areas are to each other as the squares of their like dimensions, the probability integral for this case is

$$P = (1 - g)^2.$$

This corresponds to Schuster's test when estimates of variance are used and when  $N = 7$  so that  $n = 3$ .

When  $g'$  is greater than  $\frac{1}{3}$  and  $R_1$  is the largest  $R^2$ , the probability integral is simply three times its value for  $R^2_1$  selected at random, or the sum of three regions, one in each corner of planes of constant frequency density. When the value of  $g'$  is between  $1/3$  and  $1/2$  these three regions intersect and it is necessary to subtract three smaller regions of the same shape. Sides of these smaller regions are  $(1 - 2g)$  times as large as those of planes of constant frequency density and hence, when  $1/3 < g' < 1/2$ , we have

$$P_p = 3(1 - g)^2 - 3(1 - 2g)^2.$$

Although  $g'$  must equal or exceed  $1/3$  when  $R^2_1$  is chosen because it is largest, if such impossible values of  $g'$  are considered geometrically it is found that the smaller regions also intersect in the center of each plane of constant density and the addition of the common area  $(1 - 3g)^2$  reduces  $P_p$  to unity as it should.

In the general case, the probability integral  $(1-g)^{n-1}$  for the case in which  $R^2_1$  is selected at random is multiplied by  $n$  because there are  $n$  regions with which this integral may be identified. These regions have  $n-1$  variable dimensions and hence all exponents are  $n-1$ . The first term is the complete probability integral when  $g'$  exceeds  $\frac{1}{3}$ . When  $g'$  is less than  $\frac{1}{3}$ , regions common to each pair of regions of the first order must be subtracted to avoid duplication. There are  $nC_2$  such regions of the second order. Similarly, regions of the second order intersect when  $g'$  is less than  $1/3$ , and regions of the third order must be added.

Thus the general integral is derived by adding the relative volumes of the regions each of which is equal to the simple probability integral, subtracting volumes of common regions, if any, adding corrections of second order, if necessary, and continuing the process as long as the volumes of common regions as indicated by Fisher's formula are positive. In the  $m$ th term there is one common region for each set of  $m$  hyperplanes and hence the coefficient is the number of combinations of  $n$  things taken  $m$  at a time.

## 7. Factor Analysis

By factor analysis we shall understand the calculus by means of which we can determine the number of significant components which account for the energy observed in a statistical variable. Otherwise stated, it is the calculus which determines the number of degrees of freedom possessed by the statistical variable.

The term *factor analysis* appears to have originated in psychology, where the difficulties of mental measurement are increased by the difficulties of defining what is to be measured and by the large number of tests which are frequently employed to measure mental faculties. Economics also is faced by many of the problems inherent in psychology. Therefore, it is important for us to consider some of the problems of those who began the measurement of mental factors.

C. Spearman, in an attempt to explain the relationships generally observed in the intercorrelation of mental tests, proposed the theory that any intellectual ability may be regarded as due to a general factor common to all such abilities plus an additional factor specific to the trait in question and not observed in any other except closely related traits. This proposition is known as Spearman's general factor theory, or alternatively, as his theory of two factors.<sup>2</sup>

The general idea of what we may call the tetrad-difference criterion may be explained briefly as follows: If we have a set of  $n$  mental tests, and if there is a factor,  $g$ , common to all of them, then the correlation between any two of the tests, with  $g$  held constant, will be given by the classical formula

$$r_{ij \cdot g} = \frac{r_{ij} - r_{ig} r_{jg}}{\sqrt{(1 - r_{ig}^2)(1 - r_{jg}^2)}}.$$

If we assume that the correlation between different tests is zero when the common factor is held constant, we obtain the equations

$$(1) \quad r_{ij} - r_{ig} r_{jg} = 0.$$

If  $n \geq 4$ , then  $r_{ig}$  and  $r_{jg}$  can be eliminated from the set (1) and a system of zero tetrad differences obtained which are equivalent to (1). That is to say, we have

<sup>2</sup> For a discussion of this theory see C. Spearman, *The Abilities of Man*, New York, 1927, 415 + xxxiii pp.; in particular, the mathematical appendix. Also J. Holzinger, *Statistical Résumé of Spearman's Two-Factor Theory*, Chicago, 1937, vi + 102 pp.; William Brown and G. H. Thompson, *The Essentials of Mental Measurement*, Cambridge University, 1921, x + 216 pp.; in particular Chapter 9.

$$(2) \quad \rho_{ijkl} \equiv r_{ij} r_{kl} - r_{il} r_{kj} = 0.$$

If there are  $n$  tests, then the number of tetrads,  $\tau$ , is equal to

$$\tau = 3 {}_n C_4 = n(n-1)(n-2)(n-3)/8.$$

For  $n = 4$ , we get  $\tau = 3$ ; for  $n = 5$ ,  $\tau = 15$ ; etc. The three tetrads corresponding to the case  $n = 4$  are the following:

$$(3) \quad \begin{aligned} \rho_{1324} &= r_{13}r_{24} - r_{23}r_{14}, \\ \rho_{1234} &= r_{12}r_{34} - r_{23}r_{14}, \\ \rho_{1243} &= r_{12}r_{34} - r_{13}r_{24}. \end{aligned}$$

It is also possible to compute the elementary correlations  $r_{ij}$  provided (2) holds rigorously. Thus for  $r_{12}^2$  we get

$$(4) \quad r_{12}^2 = r_{12} r_{13} / r_{23} = r_{12} r_{14} / r_{24} = r_{13} r_{14} / r_{34}.$$

Similar equations hold also for  $r_{23}$  and  $r_{34}$ .

Because of the necessity of proving that the tetrad differences are actually zero much attention has been given to the problem of obtaining the standard error of a tetrad. Several solutions of this problem have been given and the reader is referred to the literature for a more extensive account of this still debatable question. For the case where  $n=4$ , the following estimate of the variance of  $\rho_{1324}$  will be found practical:

$$(5) \quad \sigma^2_{\rho} = \frac{1}{N} [r_{13}^2 + r_{14}^2 + r_{23}^2 + r_{24}^2 - 2(r_{13}r_{24}r_{23} + r_{13}r_{14}r_{24} + r_{14}r_{23}r_{24} + r_{13}r_{23}r_{24}) + 4r_{13}r_{14}r_{23}r_{24}].$$

As an example of this theory, let us consider the relationship exhibited by the example in Section 12 of Chapter 2, where the four related variables are: (1) the Dow-Jones industrial averages; (2) pig-iron production lagged three months; (3) building-material prices lagged six months; (4) stock sales on the New York Stock Exchange.

It is not unreasonable to assume that the four series may be dominated by a single element, the exact nature of which is unknown. To test this we compute the three tetrads and obtain for them the values  $-0.012719$ ,  $-0.038768$ ,  $-0.026049$ . The variance, as computed by (5), is found to equal  $\sigma^2 = 0.00183616$ , from which we have  $\sigma = 0.04285$ . Since all the tetrads are smaller than this standard deviation, we may assume that they are statistically zero. Hence, we reach the conclusion that the correlations observed between the four series is due to

a single factor. Such a conclusion is not unrealistic, since, as we shall see later, a large number of the time series which relate to economic phenomena share a considerable variation in common. We may also observe that this variation appears to be related to the variation in the index of total real national income. Employing the first of the formulas in (4), we find that the correlation between this unknown factor,  $g$ , and the Dow-Jones industrial averages is as great as 0.988.

This very interesting conclusion might be interpreted to mean that economic phenomena, like psychological phenomena, are bound together by a common, universal thread, which contributes to them their observed intercorrelations.

E. C. Rhodes in a paper of considerable interest has employed the technique of factor analysis to construct an index of business activity.<sup>3</sup> Thus he assumes that the various series which are ordinarily combined, with suitable weights to form the index of business activity may be written

$$X_i = r_i I_i + g_i G_i + X'_i,$$

where  $I$  is the common factor (business activity),  $G$  the group factor, and  $X'$  the specific factor. The parameters  $r$  and  $g$  are constants, which depend primarily upon the special units employed in the definition of  $X_i$ . Rhodes' problem was to distill by means of factor analysis the common factor from the various special economic time series, which are assumed to contain the factor  $I$ . The methods which he employed in this problem are ingenious and suggestive and it is not unlikely that the future development of the analysis of economic time series may turn in this direction.

A number of objections, however, have been raised by the psychologists and others to Spearman's theory, and undoubtedly the economists will accept it with similar reluctance into their science. Several alternative methods have been proposed for determining the factors in a set of variables. Prominent among these are the matrix technique of L. L. Thurstone,<sup>4</sup> the confluence analysis of Ragnar Frisch,<sup>5</sup> and the method of principal components due to H. Hotelling.<sup>6</sup>

<sup>3</sup> "The Construction of an Index of Business Activity," *Journal of the Royal Statistical Society*, Vol. 100, 1937, pp. 18-39; Discussion, pp. 40-66.

<sup>4</sup> *The Vectors of Mind*, Chicago, 1935, xv + 266 pp. See also "Multiple Factor Analysis," *Psychological Review*, Vol. 38, 1931, pp. 406-427.

<sup>5</sup> *Statistical Confluence Analysis by Means of Complete Regression Systems*, Oslo, 1934, 192 pp.

<sup>6</sup> "Analysis of a Complex of Statistical Variables into Principal Components," *Journal of Educational Psychology*, Vol. 24, 1933, pp. 417-441.

Mention should also be made to the weighted-regression method due to M. J. van Uven.<sup>7</sup>

The method of Thurstone depends essentially upon the possibility of being able to factor the matrix of the elementary correlation coefficients into the product of a matrix by its conjugate. Its principal advantage appears to be that it affords a practical method for handling the factor problem when the number of variables is large. The reader is referred to the original sources for a more complete account of the ingenious devices introduced by Thurstone to make this complex problem tractable.

The theory of principal components introduced by Hotelling has much in common with the method to be introduced in the next two sections of the present work. Hotelling encounters trouble, however, in establishing a satisfactory significance test for his components owing in large measure to the mathematical difficulties inherent in the problem of establishing a manageable distribution for a set of simultaneous correlation coefficients. These difficulties are surmounted in another manner by the theory of significance given in the next few pages.

Since the confluence analysis of Frisch has been employed by economists in recent studies, we shall give a brief summary of its salient features. This method approaches the problem by means of a computation of all possible regressions between the variables. The principal tool is what is called the *bunch*, that is to say, the totality of all vectors having the slopes determined by the regression coefficients.

If the addition of a variable to a regression does not sensibly affect the bunch, then this variable is called *superfluous*; if its addition widens the bunch, it is called *detrimental*; if, however, its inclusion tends to tighten the bunch, then it is useful.

The method of Frisch has several advantages and several disadvantages. Of the latter we shall speak first. One of the principal difficulties with confluence analysis, especially if it is applied to five or more variables, is the excessive labor of calculation involved. All elementary regressions must be formed between all the variables. Although Frisch has invented a technique for this calculation, the labor is still excessive. Thus for a five-variable system some 1386 multiplications are involved in a complete tilling, while for 12 variables the number is 565,236. A second objection is found in the fact that no

<sup>7</sup> See T. Koopmans, *Linear Regression Analysis of Economic Time Series*, Haarlem, 1936, 132 pp.

measure in terms of probability has been given to determine when a bunch is affected usefully or detrimentally. Hence a variable must be included or excluded by a personal judgment as to the observed effect upon the bunch.

The advantage of the method is found in the fact that it requires an actual observation of all the possible effects produced by the introduction of new variables into the regression. The visual aspect of these effects from a study of bunch maps will give unquestionably a deeper insight into the nature of the included variables than can be obtained otherwise.

If the tilling table has once been constructed, the application of confluence analysis is very simple. Thus let  $X_i$  and  $X_j$  be two normalized variables<sup>6</sup> in the set  $X_a, X_b, \dots, X_n$ . We now form the regression between them by minimizing in the direction of the  $k$ th component. This regression can then be written

$$X_i = B_{ij(abc\dots n)}^{(k)} X_j + \dots = -\frac{r_{kj}(abc\dots n)}{r_{ki}(abc\dots n)} X_j + \dots,$$

where  $k$  assumes in turn the values  $a, b, c, \dots, n$ . These numbers are, of course, the elements of the tilling table. This same technique applies equally well to any subset.

The bunch is constructed by drawing through the origin for every value of  $k$  lines with slopes equal to  $B_{ij(abc\dots n)}^{(k)}$  and with the lengths  $[\tau_{kj(abc\dots n)}^2 + \tau_{ki(abc\dots n)}^2]^{\frac{1}{2}}$ .

As an example illustrating his method, Frisch considers the following regression system:

$$\begin{aligned} X_1 &= y_1 + 0.1 y_3, \\ X_2 &= y_2 + 0.1 y_5, \\ (6) \quad X_3 &= y_1 + y_2 + 0.1 y_5, \\ X_4 &= y_1 - y_2 + 0.1 y_5, \end{aligned}$$

where the values of  $y_i$  are determined by independent drawings from a set of random numbers. The small terms introduce a system of random errors into the data.

It is clear that the variable  $X_1$  is approximately equal to  $-X_2 + X_3$ , and also to  $X_2 + X_4$ . In other words, the complete system of variables contains linearly dependent subgroups. Consequently any attempt to form a single regression equation between the four variables would lead to spurious results.

<sup>6</sup>It is essential that bunch analysis be carried through in normalized variables, that is to say, variables with means equal to zero and standard deviations equal to unity. Such variables are

$$X_i = \frac{x_i}{\sigma_i}.$$

A computation of the bunches reveals this situation clearly. From the tilling tables of Frisch the bunches for (12), (123), and (124) are easily constructed in the following manner:

We first compute:

$$B_{12(12)}^{(1)} = -0.121551/1.000, \quad B_{12(12)}^{(2)} = -1.000/0.121551,$$

$$B_{12(123)}^{(1)} = -\frac{0.553533}{0.567433}, \quad B_{12(123)}^{(2)} = -\frac{0.568602}{0.553533}, \quad B_{12(123)}^{(3)} = -\frac{0.737534}{0.736753},$$

$$B_{12(124)}^{(1)} = +\frac{0.429929}{0.462913}, \quad B_{12(124)}^{(2)} = +\frac{0.433741}{0.429929}, \quad B_{12(124)}^{(3)} = +\frac{0.641395}{0.663422}.$$

The bunches corresponding to these three cases are now graphically constructed as shown in Figure 41. It is obvious that the introduction of either the variable  $X_1$  or the variable  $X_2$  to the system (12) closes the bunch. Hence either, by itself, is a useful variable, and the tightness of the bunches (123) and (124) indicates that a satisfactory regression has been attained.

In order to explore the situation further we now examine the bunch for the case (1234). The following regression coefficients are first obtained:

$$B_{12(1234)}^{(1)} = -\frac{0.001832}{0.016273}, \quad B_{12(1234)}^{(2)} = -\frac{0.016355}{0.001832},$$

$$B_{12(1234)}^{(3)} = -\frac{0.012116}{0.011739}, \quad B_{12(1234)}^{(4)} = +\frac{0.010782}{0.010733}.$$

From the bunch map it is immediately seen that the introduction of the fourth variable explodes the bunch, and hence the introduction of either  $X_3$  to (124) or  $X_4$  to (123) is detrimental. We thus reach the inescapable conclusion that two linear dependencies exist.

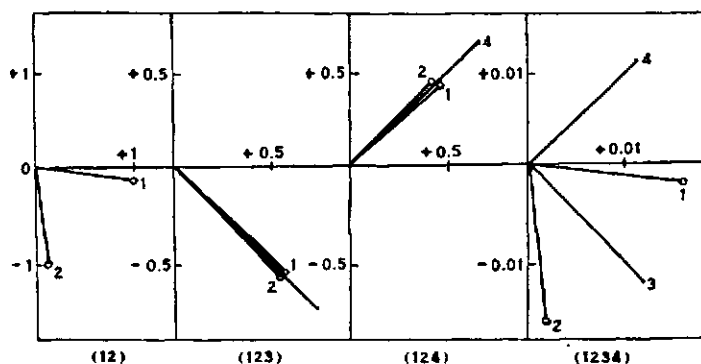

FIGURE 41.—PARTIAL BUNCH MAP.

This chart illustrates how useful and detrimental variables in a regression analysis may be detected. Vectors corresponding to the primary variables are indicated by circles.





it is a linear function of a set of normalized, orthogonal functions, it is reasonable to suppose that a test can be found for the significance of the coefficients, which is comparable with the Schuster and Walker tests for harmonic analysis.

An examination of the argument given in Section 4 shows that some modification is necessary, since there the joint distribution function for the coefficients of the sine and cosine components is developed. This led to the distribution of the energy,  $R^2$ , associated with these two components. But in the present instance we are dealing with an orthogonal system, instead of a biorthogonal one, as in the case of harmonic analysis.

In order to test the significance of the elementary component  $E_i = \beta_i^2 \lambda_i$  it is necessary to place some restrictions on the sampling process. Assuming that observations on the dependent variable  $y(t)$  are affected by random normally distributed errors of sampling but that values of the independent variables  $u_i(t)$  do not vary from sample to sample, the sampling distributions of the coefficients of the orthogonal functions  $v_i(t)$  are easily derived. If observations on the independent variables  $u_i(t)$  are constant from sample to sample, observations on the orthogonal variables  $v_i(t)$  will, of course, remain constant. Under these conditions the linear function

$$\beta_i \sqrt{\lambda_i} = \frac{\sum y(t) v_i(t)}{\sqrt{\lambda_i}}$$

will also be normally distributed.

It is now our purpose to discuss the distribution of the square of the quantity we have just written down, that is to say, the distribution of the elementary component  $E_i = \beta_i^2 \lambda_i$ . For this we shall need the following analysis:

Using the abbreviation  $A$  for a normally distributed variable, let us now consider the probability

$$(5) \quad P = \frac{1}{\sqrt{2\pi} \sigma_A} \int_{-A}^A e^{-\frac{1}{2}(A/\sigma_A)^2} dA = \frac{2}{\sqrt{2\pi} \sigma_A} \int_0^A e^{-\frac{1}{2}(A/\sigma_A)^2} dA,$$

where  $\sigma_A^2$  is the variance of  $A$ .

If we now make the transformation  $t = \frac{1}{2}(A/\sigma_A)^2$  and in the limit of the integral write  $\kappa = A^2/\sigma_A^2$ , then  $P$  assumes the form

$$P = \frac{1}{\sqrt{\pi}} \int_0^{\kappa} e^{-t} \frac{dt}{\sqrt{t}}.$$

The incomplete Gamma function is defined by the integral

$$\Gamma_x(p) = \int_0^x e^{-t} t^{p-1} dt.$$

Hence, noting that  $\Gamma(\frac{1}{2}) = \sqrt{\pi}$ , we can write  $P$  in the form

$$P = \frac{\Gamma_{\kappa}(\frac{1}{2})}{\Gamma(\frac{1}{2})}.$$

Since tables have been provided by Karl Pearson for the incomplete Gamma function in the form<sup>9</sup>

$$I(u, p) = \frac{\Gamma_x(p+1)}{\Gamma(p+1)}, \quad u = \frac{x}{\sqrt{p+1}},$$

we now write  $P$  as follows:

$$P = \frac{\Gamma_{\kappa}(-\frac{1}{2}+1)}{\Gamma(-\frac{1}{2}+1)} = I(\kappa/\sqrt{2}, -\frac{1}{2}).$$

This function gives the distribution of  $A^2/\sigma_A^2$  in terms of the parameter  $\kappa$ , and hence we obtain the following as the distribution comparable with the Schuster distribution  $e^{-\kappa}$  for  $R^2$ :

$$(6) \quad P_s = 1 - I(\kappa/\sqrt{2}, -\frac{1}{2}).$$

If the exact value of  $\sigma_A$  is not known, then the probability integral given in (6) must be considered as an approximation. If an unbiased estimate of  $\sigma_A^2$  derived from the residuals from the regression of  $y(t)$  on the  $v_i(t)$  is used instead of the exact value of the preceding formulas, the quantity  $\kappa$  is distributed as the square of "Student's"  $t$ . Hence, an exact test of significance can be applied to the ratio  $A/\sigma_A$  by entering a table of  $t$  with this ratio. The argument may be reviewed as follows:

Instead of the normal frequency function we begin with "Student's" distribution function

$$F = \frac{\Gamma(\frac{1}{2}N' + \frac{1}{2})}{\Gamma(\frac{1}{2}N') \Gamma(\frac{1}{2})} \frac{1}{\sqrt{N'}} \left(1 + \frac{t^2}{N'}\right)^{-(N'+1)}$$

where  $N'$  is the number of degrees of freedom.

The probability  $P$  defined by (5) is replaced by

<sup>9</sup> See Karl Pearson, *Tables of the Incomplete  $\Gamma$ -Function*, Cambridge University and the *Biometrika* Office, London, 1934, xxxi + 164 pp.

$$P = \frac{2C}{\sqrt{N'} \sigma_A} \int^A \left(1 + \frac{t^2}{N' \sigma_A^2}\right)^{-1(N'+1)} dt, \text{ where } C = \frac{\Gamma(\frac{1}{2}N' + \frac{1}{2})}{\Gamma(\frac{1}{2}N') \Gamma(\frac{1}{2})}.$$

Making the transformation  $s = t^2/(N' \sigma_A^2)$ ,  $\kappa = A^2/\sigma_A^2$ , we get

$$P = C \int_0^{\kappa N'} (1+s)^{-1(N'+1)} s^{-1} ds;$$

or, introducing the second transformation  $x = s/(1+s)$ , we obtain

$$(7) \quad P = C \int_0^R (1-x)^{-1N'-1} x^{1-1} dx, \quad R = \frac{\kappa}{N' + \kappa}.$$

Employing the following notation for the incomplete Beta-function:<sup>10</sup>

$$B_x(p, q) = \int_0^x x^{p-1} (1-x)^{q-1} dx,$$

$$B(p, q) = \int_0^1 x^{p-1} (1-x)^{q-1} dx = \frac{\Gamma(p) \Gamma(q)}{\Gamma(p+q)},$$

$$I_x(p, q) = \frac{B_x(p, q)}{B(p, q)} = 1 - I_{1-x}(q, p),$$

we can write

$$\begin{aligned} P &= \frac{B_R(\frac{1}{2}, \frac{1}{2}N')}{B(\frac{1}{2}, \frac{1}{2}N')} = I_R(\frac{1}{2}, \frac{1}{2}N') \\ &= 1 - I_{1-R}(\frac{1}{2}N', \frac{1}{2}). \end{aligned}$$

Hence the probability corresponding to (6) assumes the form

$$(8) \quad P_S = I_{1-R}(\frac{1}{2}N', \frac{1}{2}), \quad R = \frac{\kappa}{N' + \kappa}.$$

The practical application of these criteria is immediately seen to depend upon the possibility of determining the value of the variance of  $A$ , that is to say,  $\sigma_A^2$ , either exactly, in which case formula (6) applies, or as an unbiased estimate, for which we may then use formula (8).

But in the case of the elementary energies,  $E_i = \beta_i^2 \lambda_i$ , we see that the variance is immediately estimated from the variance of the original data provided the original orthogonal system is closed. This

<sup>10</sup> See Karl Pearson, *Tables of the Incomplete Beta-Function*, Cambridge University Press and the Proprietors of *Biometrika*, London, 1934, lix + 494 pp.

is by virtue of Bessel's inequality given in Section 11 of Chapter 2, from which we derive

$$N \sigma_A^2 = (\beta_1^2 \lambda_1 + \beta_2^2 \lambda_2 + \cdots + \beta_n^2 \lambda_n) = \sum_{t=1}^N y^2(t) = N \sigma^2,$$

that is to say,

$$\sigma_A^2 = \sigma^2.$$

Hence, in order to test the significance of a particular value of  $E_i = \beta_i^2 \lambda_i$ , chosen at random from a closed set, we form the ratio

$$\kappa = \frac{\beta_i^2 \lambda_i}{\sigma^2}$$

and introduce this value into either formula (6), if  $\sigma^2$  is known exactly, or into formula (8), if  $\sigma^2$  is an estimated value.

This result may be stated in the following theorem: *Let the quantity  $E_i = \beta_i^2 \lambda_i$  be defined by equations (3) and (4), where the functions  $v_i(t)$  form a closed set of orthogonal functions. Then if observations on  $y(t)$  are not correlated with  $v_i(t)$ , the probability,  $P_s$ , that any  $E_i$  chosen at random will exceed  $\kappa \sigma^2$  is given by equation (8), or if  $\sigma^2$  is known exactly, by equation (6).*

The results obtained from equation (6) approach those obtained from equation (8) as  $N$  increases without bound and (8) may thus be replaced by (6) when  $N$  is large. The probability function corresponding to Walker's probability for  $R^2$  as previously given in Section 5 is simple when the exact value of  $\sigma$  is known. This may be written

$$P_w = 1 - (1 - P_s)^N$$

where  $N$  is the number of orthogonal functions. The corresponding function for use when  $\sigma$  must be estimated from small samples is not known, but it will be asymptotic to the function just written down as  $N$  increases without bound.

The content of the theorem just given may be more clearly understood by the following examples:

*Example 1.* Let us assume that the closed system of variables,  $v_i(t)$ , is defined as follows:

$$\begin{array}{lll} v_1(t) = \cos \frac{2\pi t}{N}, & v_3(t) = \cos \frac{4\pi t}{N}, & v_5(t) = \cos \frac{6\pi t}{N}, \dots \\ v_2(t) = \sin \frac{2\pi t}{N}, & v_4(t) = \sin \frac{4\pi t}{N}, & v_6(t) = \sin \frac{6\pi t}{N}, \dots \end{array}$$

Referring to the formulas in Section 10 of Chapter 2, we see that

$$\lambda_m = \sum_{t=0}^N \sin^2 \frac{2m\pi t}{N} = \sum_{t=0}^N \cos^2 \frac{2m\pi t}{N} = \frac{1}{2}N.$$

Moreover, noting the definitions employed in Section 7 of Chapter 2, we have

$$\beta_{2m-1} = \frac{2}{N} \sum_{t=0}^{N-1} \cos \frac{2m\pi t}{N} y(t) = A_m,$$

$$\beta_{2m} = \frac{2}{N} \sum_{t=0}^{N-1} \sin \frac{2m\pi t}{N} y(t) = B_m.$$

Referring to formula (4), Section 3 of Chapter 2, we readily find

$$\sigma_A^2 = \frac{\sum \beta_i^2 \lambda_i}{N} = \frac{1}{2} \sum (A_i^2 + B_i^2) = \sigma^2.$$

Hence, to test the significance of either  $A_1^2$  or  $B_1^2$  separately instead of the sum  $R_1^2 = A_1^2 + B_1^2$ , as discussed in Section 4, we write

$$\kappa = \frac{E_{2i-1}}{\sigma_A^2} = \frac{\beta_{2i-1}^2}{\sigma_A^2} = \frac{NA_1^2}{2\sigma^2}, \quad \text{or } \kappa = \frac{E_{2i}}{\sigma_A^2} = \frac{NB_1^2}{2\sigma^2}.$$

The probability of obtaining a  $\kappa$  as large as the observed one is then obtained from either formula (6) or formula (8), according to whether  $\sigma^2$  is known exactly or by estimate from the data.

*Example 2.* As a second example let us consider the simple regression equation

$$(9) \quad y = r \frac{\sigma_y}{\sigma_x} x$$

for which we seek the significance of the regression coefficient,  $\beta = r \sigma_y / \sigma_x$ .

From the point of view of the theory given above we assume that  $x$  is a member of a set of orthogonal functions,  $v_1(t), v_2(t), \dots, v_N(t)$ , a set which accounts exactly for the variance  $\sigma_y^2$ . But since these functions, except for the first which we can identify with  $x$ , are unspecified, we must modify the theory just given by estimating  $\sigma_{\beta^2}$  directly. This estimate is well known to be

$$(10) \quad \sigma_{\beta^2} = \sigma_y^2 (1 - r^2) \frac{N}{N'}$$

where  $N' = N - 2$  is the number of degrees of freedom.<sup>11</sup>

Since  $\lambda = \sum x^2 = N\sigma_x^2$ , we have  $E = \beta^2 \lambda = Nr^2 \sigma_y^2$ . The value of  $\kappa$  thus becomes

$$(11) \quad \kappa = \frac{E}{\sigma_{\beta^2}} = \frac{N' r^2}{1 - r^2},$$

<sup>11</sup> See, for example, R. A. Fisher, "Applications of 'Student's Distribution,'" *Metron*, Vol. 5, No. 3, Dec. 1, 1925, pp. 90-104. Also P. R. Rider, "A Survey of the Theory of Small Samples," *Annals of Mathematics*, Series 2, Vol. 31, 1930, pp. 577-628; in particular, p. 587.

If  $\sigma_v^2$  is assumed to be exactly known, we enter formula (6) with this value of  $\kappa$ , but if the variance is an estimate then we use formula (8).

If we substitute  $\kappa$  as defined by (11) in the formula  $R = \kappa / (N' + \kappa)$ , then it is found that  $R = r^2$ , a well-known result.<sup>12</sup>

Since  $\kappa$  is a function of  $r^2$  alone, it is clear that the significance level for  $r$  corresponding to any preassigned values of  $N$  and  $P$  can be immediately computed. Thus if we assume  $N = 100$ ,  $P = 0.05$ , we obtain from formula (6) the value  $r = 0.1942$ , and from formula (8) the value  $r = 0.1946$ .

*Example 3.* As a third example, let us consider the regression

$$y = \beta_1 v_1(t) + \beta_2 v_2(t) + \dots + \beta_p v_p(t),$$

where  $v_1(t), v_2(t), \dots, v_p(t)$  are orthogonal functions, but do not form a complete set. It is clear that the example just given is a special case of this system.

As in the case of the closed system considered previously, we shall have  $\lambda_i = \sum v_i^2(t)$  and  $E_i = \beta_i^2 \lambda_i$ , but  $\sigma_v^2$  must be estimated from the equation

$$\sigma_v^2 = \frac{1}{N'} \sum [y - (\beta_1 v_1 + \beta_2 v_2 + \dots + \beta_p v_p)]^2.$$

Making use of the notation introduced in formula (5) of Section 3, we can write this variance in the form

$$\sigma^2 = \frac{1 - \sum E_p}{N'}$$

where  $N'$ , the number of degrees of freedom, is specifically defined by  $N' = N - p - 1$ .

Hence, in order to determine the significance of any observed value  $E_i$ , we enter formulas (6) or (8) with the value

$$(12) \quad \kappa = \kappa(p) = \frac{N' E_i}{1 - \sum E_p}.$$

It is both interesting and important to inquire how this formula agrees with the one previously obtained for a closed system of orthogonal functions, where  $\kappa$  was defined by the equation

$$(13) \quad \kappa = \frac{N E_i}{\sigma_v^2}$$

or merely,  $\kappa = N E_i$ , provided  $\sigma_v^2 = 1$ , as is assumed in equation (12).

Referring to equation (6) of Section 3, and observing that a set of  $N$  orthogonal variables belonging to a complete set will completely specify a function defined over a range of  $N$  items, or if one degree of freedom is used for the specification of the arithmetic average, then  $N - 1$  variables will suffice for the definition of the function, we see that the following limit holds:

$$(14) \quad \lim (1 - \sum E_p) = 0,$$

as  $p \rightarrow N - 1$ . That is to say,  $n'$ , as defined by equation (6) of Section 3, approaches the limit  $N$  as  $p$  approaches  $N - 1$ .

<sup>12</sup> See, for example, Pearson's *Tables of the Incomplete Beta-Function*, p. liv.

Hence, we can write (12) in the form

$$\kappa(p) = \frac{N - p - 1}{n' - p - 1} N E_i,$$

and thus we have, from the considerations just given, the limit  $\kappa(p) \rightarrow N E_i$  as  $p \rightarrow N - 1$ . This limit is observed to be the same as (13) when  $\sigma_s^2 = 1$ .

### 9. Examples Illustrating the Method of Elementary Energies

As our first example illustrating the method of elementary energies, we shall consider the problem discussed in Section 12 of Chapter 2. This problem considers the regression between: (1) the Dow-Jones industrial averages; (2) pig-iron production lagged three months; (3) building-material prices lagged six months; (4) stock sales on the New York Stock Exchange. The question to be discussed here is the significance of the regression equation between the industrial averages and the other three variables.

By means of the actual correlation coefficients, the three values of  $\alpha_i$  [equation (1) of Section 8] are computed from system (2) of Section 8, and found to equal

$$\alpha_1 = 0.319019, \quad \alpha_2 = 0.517385, \quad \alpha_3 = 0.231367.$$

The fraction of the variance accounted for by the regression is found from these values to be 0.744908.

By means of the transformation (3) of Section 3, and the table of values  $u_{ij}$ , computed in Section 12 of Chapter 2, the parameters  $\beta_i$  are readily found to be

$$\beta_1 = -0.141428, \quad \beta_2 = -0.103959, \quad \beta_3 = 0.626222.$$

Now introducing the characteristic numbers, evaluated in Section 12 of Chapter 2, we compute the three elementary energies

$$\begin{aligned} E_1 &= \beta_1^2 \lambda_1 = 0.009117, \\ E_2 &= \beta_2^2 \lambda_2 = 0.007423, \\ E_3 &= \beta_3^2 \lambda_3 = 0.728368. \end{aligned}$$

The first two energies are very much smaller than the third, but we cannot, for this reason alone, reject them. To test their significance we first multiply them by  $N/[1 - (E_1 + E_2 + E_3)] = 200/0.2551$ , and thus obtain

$$\kappa_1 = 7.1478, \quad \kappa_2 = 5.8197.$$

The Schuster probabilities computed from formula (6) of Section 8 are found to be respectively  $P_1 = 0.0075$ , and  $P_2 = 0.0142$ , which indicates that the two variables play more than the role of random variables in the regression. However, we see from the Walker probability that if  $N = 204$  items of a random series are represented by a closed system of orthogonal variables, then the probabilities that at least one coefficient will have a higher significance than those attributed to  $E_1$  and  $E_2$  by the Schuster probability are respectively 0.7847 and 0.9459. It is possible to infer from this that there are two linear dependencies between the variables. In other words, there exists a common factor which is the

cause of the observed correlation between the variables, a conclusion which we have already reached in the analysis of this same example in Section 7.

With this knowledge before us we may now return to the relationships given in Section 12 of Chapter 2 between the variables  $v_i$  and the variables  $u_i$ . Since the energies associated with  $v_1$  and  $v_2$  are essentially zero, the dependencies between the  $u$ 's may be studied by setting both  $v_1$  and  $v_2$  equal to zero. The most easily observed conclusion from this is that the production of pig iron and the price of building material, except for the factor peculiar to each individual series, are essentially the same variable.

For our second example, we shall analyze the regression system (6) of Section 8, which Frisch employed in the illustration of confluence analysis.

We first compute the secular determinant of the correlation coefficients for the entire system. This is found to be the following:

$$D(\lambda) = \begin{vmatrix} 1 - \lambda & -0.121551 & 0.656809 & 0.752502 \\ -0.121551 & 1 - \lambda & 0.657698 & -0.732862 \\ 0.656809 & 0.657698 & 1 - \lambda & 0.014385 \\ 0.752502 & -0.732862 & 0.014385 & 1 - \lambda \end{vmatrix}$$

$$= 0.000262838495 - 0.06818088401\lambda + 4.01770773344\lambda^2 - 4\lambda^3 + \lambda^4.$$

The roots of the equation  $D(\lambda) = 0$  are found to be  $\lambda_1 = 0.007736$ ,  $\lambda_2 = 0.0085963$ ,  $\lambda_3 = 1.870086$ ,  $\lambda_4 = 2.113582$ .

The fact that the first two roots are very small indicates that there are probably two linearly independent relationships between the variables. But since the distribution for the roots is not known we cannot safely assume this without further investigation.

The regression of  $X_1$  on the other three variables is now computed and found to be

$$(1) \quad X_1 = -0.112626 X_2 + 0.721395 X_3 + 0.659584 X_4.$$

The coefficients of the components are the values of  $a_i$  in equation (1) of Section 8.

The next step is the computation of the  $\beta_i$ . In order to accomplish this the values of the associated characteristic numbers are first found from the secular equation  $\Delta(\lambda) = 0$ , where  $\Delta(\lambda)$  is the cofactor of the first element in the determinant  $D(\lambda)$ . From the equation

$$\Delta(\lambda) \equiv 0.016272507679 - 2.030139701527\lambda + 3\lambda^2 - \lambda^3 = 0,$$

we compute the three roots

$$\lambda_1 = 0.00811245, \quad \lambda_2 = 1.01430115, \quad \lambda_3 = 1.97757435.$$

By means of these values and the theory of Section 12 of Chapter 2, the fundamental unitary matrix  $U$  is now computed and found to be

$$U = \begin{vmatrix} 0.704534 & -0.474810 & 0.527435 \\ 0.001575 & 0.667893 & 0.744256 \\ 0.709673 & 0.469731 & -0.525088 \end{vmatrix}.$$

From this and the values of  $a_i$ , we now compute the coefficients by means of formula (3) of Section 3. These turn out to be



$$\beta_1 = -0.0739867, \quad \beta_2 = 0.972537, \quad \beta_3 = -0.0874057.$$

It is now possible finally to compute the three elementary energies.

$$E_1 = 0.000045, \quad E_2 = 0.959356, \quad E_3 = 0.015108.$$

In order to test the significance of  $E_1$  and  $E_3$  we apply formula (12) of Section 8 and thus obtain  $\kappa_1 = 0.1695$  and  $\kappa_2 = 56.895$ . Clearly the significance of  $E_1$  is very small, but that of  $E_2$  is high. From this we may conclude that one linear dependence exists between the variables and this is approximated by setting  $v_1$  equal to zero.

It is observed by Frisch that in the regression equation (1) the coefficient of  $X_2$  exceeds its standard error of 0.10, and hence on the basis of the usual theory this coefficient would be regarded as significant. The present analysis indicates the complete insignificance of this parameter, since  $X_2$  is a linear function of  $X_3$  and  $X_4$  by the dependence just established.

From the matrix  $U$  we have the relationship

$$v_1 = 0.704534 X_2 - 0.474810 X_3 + 0.527435 X_4;$$

but since  $v_1$  is without significance, we set it equal to zero and thus obtain the regression

$$X_2 = 0.673935 X_3 - 0.748630 X_4.$$

This equation is seen to be practically identical with the actual regression

$$X_2 = 0.668378 X_3 - 0.742477 X_4.$$

If one computes the number of degrees of freedom in the relationship between  $X_1$ ,  $X_2$ ,  $X_3$ , and  $X_4$  in the first example using formula (6) of Section 3, there is obtained

$$n' = 2 + 204(1 - 0.7449) = 2 + 52 = 54.$$

That is, out of the 204 degrees of freedom in a series of the length observed, there are actually 54 degrees of freedom present. One of these is due to the systematic element, probably the 40-month harmonic component, a second to the displacement of the series defined by its average value, and the remaining 52 to the erratic element.

## CHAPTER 6

### THE ANALYSIS OF TRENDS

#### 1. Introduction

In the opinion of some of the keenest students of the problem of time series, the analysis and interpretation of trends is one of the most difficult problems in economics. We have, for example, J. A. Schumpeter, who says:

There would be little overstatement in saying that trend-analysis will be the central problem of our science in the immediate future and the center of our difficulties as well . . . If trend analysis is to have any meaning, it can derive it only from previous theoretical considerations, which must not only guide us in interpreting results, but also in choosing the method. Failing this, a trend is no more than a descriptive device summing up past history with which nothing can be done. It lacks economic connotation . . . The trends we want are very different from those we get by fitting a curve through unanalyzed material. But this opens up a host of questions, for example, . . . Whether it is the trend which is the "generating" phenomenon of cycles or the cycles which generate the trend; whether or not the trend is a distinct economic phenomenon at all, attributable to one factor, or a well-defined set of factors; whether all the points on our raw graphs have on principle equal right to exerting an influence on its slope, and, if not, what credentials we are to ask of every one point before admitting it.<sup>1</sup>

The nature of trends was discussed at some length in Section 6 of Chapter 1 and the general features of the problem were examined there. In the present chapter we shall consider, first, some of the technical statistical aspects of trends, since the interpretation of trends is intimately related to the statistical methods employed in their computation. This discussion will be followed by a study of the economic implications of trend analysis.

As has been pointed out in the first chapter the *inertial theory of economics*, as it has been presented in the writings of Carl Snyder, gives to trends a supreme importance. The destiny of governments, the happiness or the despair of large groups of people, depend much more upon the trend of economic series than upon cyclical variations, which are essentially minor movements in the major inertial tendency of events. Hence trends belong to what we might call the *macroscopic theory of economics* and the interpretation of their origin is thus the

<sup>1</sup> See Schumpeter's review, "Mitchell's Business Cycles," *Quarterly Journal of Economics*, Vol. 45, 1930-31, pp. 150-172.

principal factor in forecasting the future state of nations. From this point of view the theory of trends is a theory "in the large."

But in the application of statistics to economic time series, the word trend has been frequently used in a much more restricted sense than that implied by the inertial concept. Thus the variations of some economic time series are to be examined over a given period of time, which may vary from a few weeks to many years. The trend, then, is defined as that characteristic of the series which tends to extend consistently throughout the entire period. Hence we see that the concept of a trend depends both upon the nature of the data examined and upon the range to which it is to be applied. Thus it is one thing to say that the trend of stock prices is down and quite another to say that the trend of building is up, since the movement of the former is dominated by a short cycle of around 40 months, while the latter is dominated by a cycle of from 15 to 20 years. The trend of industrial production in the United States has been upward for approximately a century, although there have been reversals of the main movement on the average of once every ten years and some of these have established trends several years in length. It is thus seen that the definition of a trend is inherent in the economic problem itself and there is no such thing as a theory of pure trend.

The final desideratum, of course, is for a theory of economics, which, as is now the case in such disciplines as physics, engineering, and the like, will determine the characteristics of the trend from fundamental principles and laws. Until this happy situation is attained, however, it will be necessary to supply the lack of such derived trends by trends which appear reasonable, or which are suggested by actual forms inherent in the data. A great deal of progress has been made in recent years in understanding the inertial characteristics of a number of economic series and an indication of the progress in some of these will be discussed in later chapters.

## 2. *Types of Trend*

In the first chapter we discussed at some length the types of trends which have been most frequently used in the analysis of time series. These trends were the following:

(1) Linear trends; (2) the exponential trend, that is, the trend  $y = Ae^{Bt}$ , which is essentially a linear trend fitted to the logarithms of the data, since  $\log_e y = \log_e A + Bt$ ; (3) the logistic trend; (4) the moving average.

In addition to these there was discussed the theory of the Gom-

pertz curve, intimately related to the logistic, and the general polynomial trend, which included the straight line as a special case.

Since the application of trends to economic time series is intimately related to the statistical properties of the trends themselves, it will be important for us to examine some of the technical aspects of the subject. We shall find it convenient to show how the parameters of some of these trends are determined from the data and how the standard deviation of the residuals may be computed from the parameters without a complete reduction of the series.

By far the most useful trend is the straight line because of its ready computation and the fact that many time series over extended intervals appear to be characterized by linear movements. Hence the statistics of this trend will be fully developed as a basis for the more complicated analysis of the parabola, the cubic, and other polynomials.

In recent statistics, the logistic curve has come into high favor because it appears to fit the needs of an expanding economic system. Special attention will be given to this curve and applications made of it to population and production data. This curve is particularly useful in extrapolation and tends to define realistic lines of saturation.

No attempt will be made in this chapter to define the probable error of the trends themselves, since this subject requires some special considerations which are more properly treated in connection with the problem of forecasting economic time series.

### *3. Technical Discussion of the Linear Trend*

Before proceeding to the more general discussion of polynomial trends, it will be useful to consider the case of the simple linear trend because of its frequent use in the analysis of time series. We shall write the straight line in the form

$$(1) \quad y = a_0 + a_1 t,$$

and assume that the data to which it is to be fitted are given as equally spaced items,  $N = 2p + 1$  in number. No essential restriction is implied by this assumption, since, in general, if the data are not given in this form, it is usually possible by interpolation to approximate them by a series of equally spaced items. Moreover, in practical analysis, the inclusion or omission of a single item to obtain a series in which  $N$  is odd is usually of negligible significance.

We shall therefore assume that the data are arranged in the following form:

(2)

$$\begin{array}{c} \hline \hline -p, -p+1, \dots, -2, -1, 0, 1, 2, \dots, p \\ \hline y_{-p}, y_{-p+1}, \dots, y_{-2}, y_{-1}, y_0, y_1, y_2, \dots, y_p \\ \hline \hline \end{array}$$

By the zeroth and first moments we shall mean<sup>1a</sup>

$$M_0 = \sum_{t=-p}^p y_t, \quad M_1 = \sum_{t=-p}^p t y_t.$$

Numerous devices and tables have been developed for determining the coefficients of equation (1) so that the straight line will fit the data. We shall adopt as most suitable for our purpose the method of least squares, which yields the coefficients in the following simple form:

$$(3) \quad a_0 = AM_0, \quad a_1 = A'M_1,$$

where we abbreviate  $A = 1/(2p+1)$ ,  $A' = 3/p(p+1)(2p+1)$ .

These coefficients have been extensively calculated and will be found to 10 significant figures for values of  $p$  from 0.5 to 150.0 in the author's *Tables of the Higher Mathematical Functions*, Vol. 2, 1935, pp. 325-329.

We may now observe that *the average of the deviations of the data from the linear trend is zero*.

In order to prove this, we represent the right-hand member of equation (1) by  $y(t)$  and compute the sum

$$\begin{aligned} S_1 &= \sum_{t=-p}^p [y_t - y(t)] \\ &= M_0 - a_0(2p+1). \end{aligned}$$

But from the definition of  $a_0$  as given in (3), this is seen to be zero, which establishes the proposition.

If the variance of the series of data be represented by  $\sigma^2$ , that is,

$$\sigma^2 = \frac{1}{N} \left[ \sum_{t=-p}^p y_t^2 - \frac{M_0^2}{N} \right], \quad N = 2p + 1,$$

<sup>1a</sup> We have adopted here as a convenient name for the sum  $\sum t^n y_t$  in the variable  $t$  the term moment of order  $n$ , or more simply, the  $n$ th moment. The word moment, originating in mechanics, was introduced later into statistics in connection with frequency distributions. It is hoped that the present adaptation of the name will appear useful. It should be noted that in statistics the term moment is frequently used for a mean value based on a product sum instead of for the product sum itself as here.

then the variance of the deviations from trend, that is, the variance of the residuals, may be shown to equal

$$(4) \quad \sigma_1^2 = \sigma^2 - \frac{A' M_1^2}{N}.$$

Since the mean deviation is zero, we have for  $\sigma_1^2$  the following:

$$\begin{aligned} \sigma_1^2 &= \frac{1}{N} \sum_{t=-p}^p [y_t - y(t)]^2, \quad N = 2p + 1, \\ &= \frac{1}{N} \sum_{t=-p}^p [y_t^2 - 2 y_t y(t) + y^2(t)] \\ &= \frac{1}{N} \sum_{t=-p}^p [y_t^2 - 2 y_t (a_0 + a_1 t) + (a_0^2 + 2a_0 a_1 t + a_1^2 t^2)] \\ &= \frac{1}{N} \left[ \sum_{t=-p}^p y_t^2 - 2 a_0 M_0 - 2 a_1 M_1 + (2p + 1) a_0^2 \right. \\ &\quad \left. + p(p + 1) (2p + 1) a_1^2 / 3 \right] \\ &= \frac{1}{N} \left[ \sum_{t=-p}^p y_t^2 - \frac{M_0^2}{N} \right] + \frac{M_0^2}{N^2} - 2a_0 \frac{M_0}{N} - 2a_1 \frac{M_1}{N} \\ &\quad + a_0^2 + p(p + 1) a_1^2 / 3. \end{aligned}$$

Introducing the explicit values of  $a_0$  and  $a_1$  into this expression and noting that the first term is  $\sigma^2$ , we find by a simple algebraic manipulation that the terms combine to yield equation (4).

A third consideration appropriate to our discussion relates to the correlation of the residuals of two series which have been reduced by linear trends. For the purpose of this discussion let us assume that we have, in addition to series (2), the elements of a second series,  $\{Y_t\}$ ,  $t$  ranging from  $-p$  to  $+p$ , and let us assume further that the first two moments of the second series (based upon  $N = 2p + 1$  items) are

$$\mu_0 = \sum_{t=-p}^p Y_t, \quad \mu_1 = \sum_{t=-p}^p t Y_t.$$

Let  $\sigma$  be the standard deviation of the first series and  $\bar{\sigma}$  the standard deviation of the second, and let  $R$  denote the correlation coefficient of the two series before they have been corrected for trend.

Under the assumptions stated above, it can be proved that the correlation coefficient of the residuals from the linear trends of the two series is given by the expression

$$(5) \quad r = \left\{ R \sigma \bar{\sigma} - \frac{A' M_1 \mu_1}{N} \right\} / \sigma_1 \bar{\sigma}_1,$$

where  $\sigma_1$  and  $\bar{\sigma}_1$  are respectively the standard deviations of the residuals of the first and second series as computed by formula (4).

In order to prove this we first observe that the averages of the residuals of the two series from their trends are zero, and hence that the desired correlation coefficient will be

$$(6) \quad r = \frac{\sum_{t=p}^p [y_t - y(t)][Y_t - Y(t)]}{N \sigma_1 \bar{\sigma}_1},$$

where  $y(t)$  and  $Y(t)$  are respectively the two trends, that is,  $y(t)$  is the right-hand member of equation (1) and  $Y(t)$  may be written  $Y(t) = A_0 + A_1 t$ .

Expanding the numerator, which we shall designate by  $I$ , we get

$$\begin{aligned} I &= \sum_{t=p}^p [y_t - y(t)][Y_t - Y(t)] \\ &= \sum_{t=p}^p [y_t Y_t - Y_t y(t) - y_t Y(t) + y(t) Y(t)] \\ &= \sum_{t=p}^p y_t Y_t - a_0 \mu_0 - a_1 \mu_1 - A_0 M_0 - A_1 M_1 + a_0 A_0 N \\ &\quad + p(p+1)(2p+1) a_1 A_1 / 3. \end{aligned}$$

But this may also be written

$$\begin{aligned} I &= \sum_{t=p}^p y_t Y_t - \frac{M_0 \mu_0}{N} + \left\{ \frac{M_0 \mu_0}{N} - a_0 \mu_0 \right\} - a_1 \mu_1 - A_0 (M_0 - a_0 N) \\ &\quad - A_1 (M_1 - p(p+1)(2p+1) a_1 / 3). \end{aligned}$$

Noting from equations (3) that the expressions in braces vanish, and also observing that

$$\sum_{t=p}^p y_t Y_t - \frac{M_0 \mu_0}{N} = NR \sigma \bar{\sigma},$$

we reduce the expression for  $I$  to the following:

$$I = NR \sigma \bar{\sigma} - a_1 \mu_1.$$

Replacing this value in the formula for  $r$  and replacing  $a_1$  by  $A' M_1$  from (3), we immediately obtain the desired formula (5).

It is important, also, to observe that formula (5) can be employed to compute the serial correlations of the residuals by the device of correcting one of the moments. The corrected moment is then inserted in (5).

Let us assume that the series which is to be lagged with respect to the other is  $Y_t$  and let us assume also that it is moved ahead of the series  $y_t$  by  $m$  units; that is to say, we shall compare the terms  $Y_{t-m}$  with the terms  $y_t$ .

Hence we can obtain the desired serial correlation of the residuals by first correcting  $\mu_0$  and  $\mu_1$  for the assumed lag, and then employing these corrected moments in place of  $\mu_0$  and  $\mu_1$  in formula (5). This correction we shall now compute for the first moment.

We shall designate by  $\mu_1$  the unlagged moment,

$$\mu_1 = \sum_{t=-p}^p t Y_t,$$

and by  $\mu_1(m)$  and  $\mu_1(-m)$  the moments of the series after it has been moved respectively  $m$  units ahead and  $m$  units behind the first series; that is,

$$(7) \quad \mu_1(m) = \sum_{t=-p}^p t Y_{t-m}, \quad \mu_1(-m) = \sum_{t=-p}^p t Y_{t+m}.$$

We note that  $\mu_1(0) = \mu_1$ .

The first of these moments can be written

$$\begin{aligned} \mu_1(m) &= \sum_{t=-p}^p t Y_{t-m} = \sum_{s=-p-m}^{p-m} (s+m) Y_s, \\ &= \sum_{s=-p}^p (s+m) Y_s + \Delta_1(m), \end{aligned}$$

where we abbreviate

$$\Delta_1(m) = \left\{ \sum_{s=-p-m}^{-(p+1)} - \sum_{s=-p-m+1}^p \right\} (s+m) y_s.$$

It is thus clear that the desired corrected moment becomes

$$(8) \quad \mu_1(m) = \mu_1 + m \mu_0 + \Delta_1(m),$$

where, it will be observed,  $\Delta_1(m)$  may actually be large with respect to the other two moments.

Similarly we obtain for the negative lag the corrected moment

$$(9) \quad \mu_1(-m) = \mu_1 - m \mu_0 + \Delta_1(-m),$$

where we abbreviate

$$\Delta_1(-m) = \left\{ \sum_{s=-p-1}^{p+m} - \sum_{s=-p}^{-p+m-1} \right\} (s-m) Y_s.$$



As an example of the application of the formulas of this section, we shall compute some of the pertinent constants of the postwar Dow-Jones industrial stock price averages and the index of pig-iron production. These series, in four-month averages, are given below as follows:

Year	t	Industrial Stock Price Averages	Pig-Iron Production	Year	t	Industrial Stock Price Averages	Pig-Iron Production
1914	-25	81.66	69.9	1923	2	100.62	110.8
	-24	74.16	64.8		3	91.44	119.3
	-23	60.90	54.9		4	91.07	99.1
1915	-22	61.24	62.2	1924	5	95.38	105.8
	-21	72.82	81.2		6	98.39	67.6
	-20	95.62	100.1		7	109.78	81.9
1916	-19	91.16	106.1	1925	8	120.67	111.8
	-18	90.72	105.7		9	133.99	89.2
	-17	102.12	108.2		10	151.93	98.5
1917	-16	93.91	103.1	1926	11	149.02	109.3
	-15	92.10	107.9		12	154.86	106.8
	-14	76.34	102.7		13	155.58	104.9
1918	-13	78.60	93.5	1927	14	160.66	107.9
	-12	81.21	110.4		15	177.90	100.7
	-11	83.38	112.3		16	194.98	89.4
1919	-10	86.79	98.5	1928	17	204.59	100.5
	-9	106.10	76.3		18	221.69	102.2
	-8	110.29	76.9		19	271.24	107.5
1920	-7	97.87	100.1	1929	20	315.76	116.9
	-6	88.96	99.5		21	339.81	123.2
	-5	78.97	98.9		22	276.10	107.5
1921	-4	76.43	59.6	1930	23	275.90	101.1
	-3	69.46	33.4		24	243.96	92.3
	-2	75.67	43.4		25	184.06	65.4
1922	-1	87.14	61.5				
	0	96.60	72.3				
	1	96.45	86.9				

We first compute the following constants:

## (I) Stock Price Averages

$$M_0 = 6,626.05,$$

$$M_1 = 41,920.02,$$

$$\sigma^2 = 4,802.0908,$$

$$\sigma = 69.2971,$$

$$R = 0.40835,$$

## (II) Pig-Iron Production

$$\mu_0 = 4,709.9,$$

$$\mu_1 = 4,161.9,$$

$$\bar{\sigma}^2 = 412.06,$$

$$\bar{\sigma} = 20.2962,$$

$$2p + 1 = 51.$$

Since, for  $p = 25$ ,  $A = 0.01960784314$ ,  $A' = 0.00009049773756$ , we compute the trend lines from (3) and thus obtain

$$(I) \quad y = 129.9226 + 3.79367 t;$$

$$(II) \quad y = 92.3510 + 0.376643 t.$$

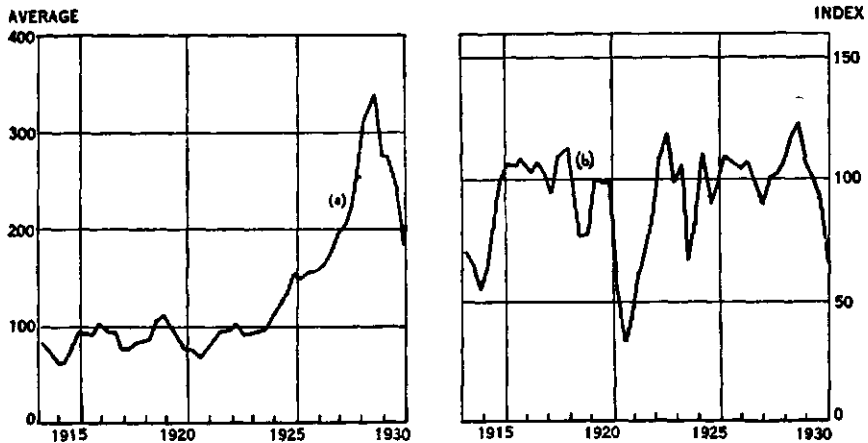

FIGURE 42.—DOW-JONES INDUSTRIAL AVERAGES (a) AND INDEX OF PIG-IRON PRODUCTION (b), 1914–1930.

Now, employing formula (4), we obtain as the residual variances the following values:

$$\begin{aligned}
 \text{(I)} \quad \sigma_1^2 &= 4802.0908 - 3118.2470 & \text{(II)} \quad \bar{\sigma}_1^2 &= 412.06 - 30.74 \\
 &= 1683.8438; & &= 381.32; \\
 \sigma_1 &= 41.0347; & \bar{\sigma}_1 &= 19.5274.
 \end{aligned}$$

The correlation between the residuals is then obtained from formula (5) and is found to be  $r = 0.330$ . This correlation, although small, is interesting in showing that the persistent relationship between the production of pig iron and the price of industrial stocks prevailed even during the explosive inflation caused, as we shall show later, by an unusual increase in the velocity of money over the latter part of this period.

We should also note that the effect of reducing the two series by trends is to decrease substantially the variance of (I), while the variance of (II) is essentially unaffected.

In order to illustrate the application of the formulas to lag correlations, we shall augment the pig-iron production data by adding the items for the years 1913 and 1931. These values are

$$1913: \quad 90.9, \quad 85.8, \quad 76.0; \quad 1931: \quad 62.3, \quad 51.8, \quad 36.3.$$

Hence we compute

$$\begin{aligned}
 \Delta_0(3) &= 90.9 + 85.8 + 76.0 - 101.1 - 92.3 - 65.4 = -6.1, \\
 \Delta_0(-3) &= 62.3 + 51.8 + 36.3 - 69.9 - 64.8 - 54.9 = -39.2, \\
 \Delta_1(3) &= 1098.1, & \Delta_1(-3) &= 5411.9.
 \end{aligned}$$

From these values we obtain the corrected moments

$$\begin{aligned}
 \mu_0(3) &= 4709.9 - 6.1 = 4703.8, & \mu_0(-3) &= 4709.9 - 39.2 = 4670.7, \\
 \mu_1(3) &= 4161.9 + 1098.1 = 5260.0, & \mu_1(-3) &= 4161.9 - 5411.9 = -1250.0.
 \end{aligned}$$

The values of  $\bar{\sigma}$  and  $\bar{\sigma}_1$  adjusted for lag, which we shall designate by  $\bar{\sigma}_r(m)$ , are found to be

$$\bar{\sigma}(3) = 20.0419, \quad \bar{\sigma}_1(3) = 18.7771, \quad \bar{\sigma}(-3) = 21.6795, \quad \bar{\sigma}_1(-3) = 21.6154.$$

When these quantities are substituted in (5), we obtain as the desired serial correlations the following values:

$$r(3) = \frac{498.262 - 391.268}{770.513} = 0.139, \quad r(-3) = \frac{-20.372 + 92.982}{886.981} = 0.082.$$

#### 4. Extension of the Foregoing Theory to Polynomial Trends

The formal theory which we have developed in the preceding section for linear trends may be extended without essential difficulty to the general polynomial

$$(1) \quad y = a_0 + a_1 t + a_2 t^2 + a_3 t^3 + \dots + a_n t^n.$$

Referring to (2) of Section 3, we shall define in terms of these data the first  $n$  moments as follows:

$$(2) \quad M_r = \sum_{t=-j}^p t^r y_t, \quad r = 0, 1, 2, \dots, n.$$

If the normal equations for the polynomial (1) are set up in terms of the moments (2) then by reference to Section 11 of Chapter 2, it will be seen that they assume the following simple form:

$$(3) \quad \begin{aligned} (2p+1)a_0 + 2s_2 a_2 + 2s_4 a_4 + \dots &= M_0, \\ 2s_2 a_0 + 2s_4 a_2 + 2s_6 a_4 + \dots &= M_2, \\ 2s_4 a_0 + 2s_6 a_2 + 2s_8 a_4 + \dots &= M_4, \\ \cdot & \quad \cdot \quad \cdot \quad \cdot \quad \cdot \quad \cdot \end{aligned}$$

and for the odd moments

$$(4) \quad \begin{aligned} 2s_2 a_1 + 2s_4 a_3 + 2s_6 a_5 + \dots &= M_1, \\ 2s_4 a_1 + 2s_6 a_3 + 2s_8 a_5 + \dots &= M_3, \\ 2s_6 a_1 + 2s_8 a_3 + 2s_{10} a_5 + \dots &= M_5, \\ \cdot & \quad \cdot \quad \cdot \quad \cdot \quad \cdot \end{aligned}$$

where  $s_2, s_4, s_6, \dots$  are the sums of second, fourth, sixth, etc., powers of the integers from 1 to  $p$  inclusive; that is,

$$s_r = 1^r + 2^r + 3^r + 4^r + \dots + p^r.$$

The solutions of these equations have been explicitly determined for polynomials through the seventh degree (the septic) and the coefficients of the moments have been numerically determined for various ranges of the parameter  $p$ . These results and tables will be found in the author's *Tables of the Higher Mathematical Functions*, Vol. 2, 1935, pp. 307-359.

For the sake of reference and the understanding of symbols we shall record the various cases below. The reader will understand that the values of  $A, B, C, \dots, A', B', C', \dots$  for these various cases are different functions of  $p$ , and that their numerical values are to be found in the *Tables* referred to above.

- (1) *The straight line:*  $y = a_0 + a_1 t$ ,  
 $a_0 = AM_0$ ,  $a_1 = A'M_1$ .
- (2) *The parabola:*  $y = a_0 + a_1 t + a_2 t^2$ ,  
 $a_0 = AM_0 + BM_2$ ,  $a_1$  as in case (1),  
 $a_2 = BM_0 + CM_2$ .
- (3) *The cubic:*  $y = a_0 + a_1 t + a_2 t^2 + a_3 t^3$ ,  
 $a_1 = A'M_1 + B'M_3$ ,  $a_0$  and  $a_2$  as in case (2),  
 $a_3 = B'M_1 + C'M_3$ .
- (4) *The quartic:*  $y = a_0 + a_1 t + a_2 t^2 + a_3 t^3 + a_4 t^4$ ,  
 $a_0 = AM_0 + BM_2 + CM_4$ ,  $a_1$  and  $a_3$  as in case (3),  
 $a_2 = BM_0 + DM_2 + EM_4$ ,  
 $a_4 = CM_0 + EM_2 + FM_4$ .
- (5) *The quintic:*  $y = a_0 + a_1 t + a_2 t^2 + a_3 t^3 + a_4 t^4 + a_5 t^5$ ,  
 $a_1 = A'M_1 + B'M_3 + C'M_5$ ,  $a_0$ ,  $a_2$ , and  $a_4$  as in case (4),  
 $a_3 = B'M_1 + D'M_3 + E'M_5$ ,  
 $a_5 = C'M_1 + E'M_3 + F'M_5$ .
- (6) *The sextic:*  $y = a_0 + a_1 t + a_2 t^2 + a_3 t^3 + a_4 t^4 + a_5 t^5 + a_6 t^6$ ,  
 $a_0 = AM_0 + BM_2 + CM_4 + DM_6$ ,  $a_1$ ,  $a_3$ , and  $a_5$  as in case (5),  
 $a_2 = BM_0 + EM_2 + FM_4 + GM_6$ ,  
 $a_4 = CM_0 + FM_2 + HM_4 + IM_6$ ,  
 $a_6 = DM_0 + GM_2 + IM_4 + JM_6$ .
- (7) *The septic:*  $y = a_0 + a_1 t + a_2 t^2 + a_3 t^3 + a_4 t^4 + a_5 t^5 + a_6 t^6 + a_7 t^7$ ,  
 $a_1 = A'M_1 + B'M_3 + C'M_5 + D'M_7$ ,  $a_2$ ,  $a_4$ , and  $a_6$  as in case (6),  
 $a_3 = B'M_1 + E'M_3 + F'M_5 + G'M_7$ ,  
 $a_5 = C'M_1 + F'M_3 + H'M_5 + I'M_7$ ,  
 $a_7 = D'M_1 + G'M_3 + J'M_5 + J'M_7$ .

We first prove the following theorems:

**THEOREM 1.** *The average of the deviations of the data from a polynomial trend is zero.*

*Proof:* If we designate the polynomial (1) by  $y(t)$ , then we must show that

$$S_1 = \sum_{t=-p}^p [y_t - y(t)]$$

is zero. But we see by explicit calculation that

$$S_1 = \sum_{t=-p}^p y_t - \sum_{t=-p}^p y(t) \\ = M_0 - a_0(2p+1) - 2s_2a_2 - 2s_4a_4 - 2s_6a_6 - \dots$$

Referring to the first equation in (3), we see that this last quantity is zero, which establishes the proposition.

**THEOREM 2.** *The variance ( $\sigma_{\Delta}^2$ ) of the deviations of the data from a polynomial trend is given by the formula*

$$(5) \quad \sigma_{\Delta}^2 = \sigma^2 + M_0^2/N^2 - (a_0M_0 + a_1M_1 + a_2M_2 + a_3M_3 + \dots)/N,$$

where  $N = 2p+1$  is the number of items in the data and  $\sigma^2$  is the variance of the original series.

*Proof:* The variance of the deviations from trend may be explicitly written in the form

$$(6) \quad \sigma_{\Delta}^2 = \frac{1}{N} \sum_{t=-p}^p [y_t - y(t)]^2, \\ = \frac{1}{N} \sum_{t=-p}^p [y_t^2 - 2y_t y(t) + y^2(t)], \\ = \frac{1}{N} \left\{ \sum_{t=-p}^p y_t^2 - 2a_0M_0 - 2a_1M_1 - 2a_2M_2 - \dots + \sum_{t=-p}^p y^2(t) \right\}.$$

Referring to the data as tabulated in (2) of Section 3, we see that the last sum in the above expression can be expanded as follows:

$$\sum_{t=-p}^p y^2(t) = a_0^2N + 2a_0a_2s_2 + 2a_0a_4s_4 + 2a_0a_6s_6 + \dots \\ + 2a_1^2s_2 + 2a_1a_3s_4 + 2a_1a_5s_6 + 2a_1a_7s_8 + \dots \\ + 2a_2a_0s_2 + 2a_2^2s_4 + 2a_2a_4s_6 + 2a_2a_6s_8 + \dots \\ + \dots \dots \dots$$

This expression may then be written in the form

$$\sum_{t=-p}^p y^2(t) = a_0 \{ a_0N + 2a_2s_2 + 2a_4s_4 + 2a_6s_6 + \dots \} \\ + a_1 \{ 2a_1s_2 + 2a_3s_4 + 2a_5s_6 + 2a_7s_8 + \dots \} \\ + a_2 \{ 2a_0s_2 + 2a_2s_4 + 2a_4s_6 + 2a_6s_8 + \dots \} \\ + \dots \dots \dots$$

Referring to equations (3) and (4), we see that this sum may be written in the following form:

$$\sum_{t=-p}^p y^2(t) = a_0M_0 + a_1M_1 + a_2M_2 + a_3M_3 + \dots$$

Introducing this expression into (6) and noting that the variance of the original data is given by

$$\sigma^2 = \frac{1}{N} \sum_{t=-p}^p y_t^2 - \frac{M_0^2}{N^2},$$

we obtain for the desired variance of the deviations from trend the following expression:

$$\sigma_{\Delta}^2 = \sigma^2 + M_0^2/N^2 - (a_0M_0 + a_1M_1 + a_2M_2 + a_3M_3 + \dots)/N,$$

which is seen to establish the theorem.

In the practical application of this theorem to actual time series, it is convenient to have an explicit expression for the variance in terms of the tabulated coefficients. The following table gives the variance of the residuals for each of the tabulated cases, the residual variance being indicated by a subscript equal to the degree of the trend:

**Straight line:**

$$\sigma_1^2 = \sigma^2 - (A'M_1^2)/N.$$

**Parabola:**

$$\sigma_2^2 = \sigma^2 + M_0^2/N^2 - (A'M_1^2 + AM_0^2 + 2BM_0M_2 + CM_2^2)/N.$$

**Cubic:**

$$\sigma_3^2 = \sigma^2 + M_0^2/N^2 - (AM_0^2 + 2BM_0M_2 + CM_2^2 + A'M_1^2 + 2B'M_1M_3 + C'M_3^2)/N.$$

**Quartic:**

$$\sigma_4^2 = \sigma^2 + M_0^2/N^2 - (A'M_1^2 + 2B'M_1M_3 + C'M_3^2 + AM_0^2 + 2BM_0M_2 + 2CM_0M_4 + DM_2^2 + 2EM_2M_4 + FM_4^2)/N.$$

**Quintic:**

$$\sigma_5^2 = \sigma^2 + M_0^2/N^2 - (AM_0^2 + 2BM_0M_2 + 2CM_0M_4 + DM_2^2 + 2EM_2M_4 + FM_4^2 + A'M_1^2 + 2B'M_1M_3 + 2C'M_1M_5 + D'M_3^2 + 2E'M_3M_5 + F'M_5^2)/N.$$

**Sextic:**

$$\sigma_6^2 = \sigma^2 + M_0^2/N^2 - (A'M_1^2 + 2B'M_1M_3 + 2C'M_1M_5 + D'M_3^2 + 2E'M_3M_5 + F'M_5^2 + AM_0^2 + 2BM_0M_2 + 2CM_0M_4 + 2DM_0M_6 + EM_2^2 + 2FM_2M_4 + 2GM_2M_6 + HM_4^2 + 2IM_4M_6 + JM_6^2)/N.$$

**Septimic:**

$$\sigma_7^2 = \sigma^2 + M_0^2/N^2 - (AM_0^2 + 2BM_0M_2 + 2CM_0M_4 + 2DM_0M_6 + EM_2^2 + 2FM_2M_4 + 2GM_2M_6 + HM_4^2 + 2IM_4M_6 + JM_6^2 + A'M_1^2 + 2B'M_1M_3 + 2C'M_1M_5 + 2D'M_1M_7 + E'M_3^2 + 2F'M_3M_5 + 2G'M_3M_7 + H'M_5^2 + 2I'M_5M_7 + J'M_7^2)/N.$$

It is intuitively evident that the value of  $\sigma_{\Delta}^2$  should decrease as the number of moments used in its computation increases, that is to say, with the degree of the polynomial used as the trend. The analytical proof, however, can be given as follows:

We first express  $y(t)$  in terms of the Gram polynomials described in Section 10 of Chapter 2; that is,

$$(7) \quad y(t) = a_0\phi_0(t) + a_1\phi_1(t) + \dots + a_n\phi_n(t).$$

This representation is identical with those given above, the only difference being that the approximation of a polynomial of  $n$ th degree is exhibited in terms of a linear combination of orthogonal polynomials.

Since the Gram polynomials are orthogonal over the range  $-p$  to  $+p$ , the evaluations of the coefficients  $a_i$  are independent of one another. We next take note of Bessel's inequality (see Section 11 of Chapter 2),

$$a_1^2\lambda_1 + a_2^2\lambda_2 + \dots + a_n^2\lambda_n \leq \sum_{t=-p}^p y_t^2,$$

where we abbreviate

$$\lambda_i = \sum_{t=-p}^p \phi_i^2(t).$$

We may easily show that the variance of the difference is given by the formula

$$N\sigma_{\Delta}^2 = \sum_{t=-p}^p y_t^2 - (a_1^2\lambda_1 + a_2^2\lambda_2 + \dots + a_n^2\lambda_n).$$

Thus it is clear that  $\sigma_{\Delta}^2$  cannot increase, but will, in general, decrease for each successive addition of a Gram polynomial to the sum (7). The truth of the theorem is thus evident.

As an example of the application of the formulas given in this section, we shall successively reduce the standard deviations of the two series used illustratively in Section 3. The following moments are first computed:

(I) Stock Price Averages

$M_0 =$	6,626.05
$M_1 =$	41,920.02
$M_2 =$	1,725,204.66
$M_3 =$	17,006,574.60
$M_4 =$	696,835,797.18
$M_5 =$	7,759,714,372.92

(II) Pig-Iron Production.

$\mu_0 =$	4,709.9
$\mu_1 =$	4,161.9
$\mu_2 =$	1,020,459.5
$\mu_3 =$	1,798,139.7
$\mu_4 =$	379,292,961.5
$\mu_5 =$	904,311,762.9

When these moments are substituted in the formulas of this section, the following values of  $\sigma_n$  are readily computed:

(I) $\sigma = 69.2971,$	(II) $\sigma = 20.2962,$
$\sigma_1 = 41.0347,$	$\sigma_1 = 19.5274,$
$\sigma_2 = 28.7142,$	$\sigma_2 = 19.5274,$
$\sigma_3 = 28.2349,$	$\sigma_3 = 19.4544,$
$\sigma_4 = 24.1490,$	$\sigma_4 = 15.8537,$
$\sigma_5 = 19.4158,$	$\sigma_5 = 15.7882.$

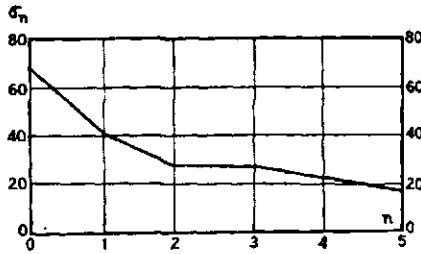

FIGURE 43.—STANDARD DEVIATION OF RESIDUALS AS A FUNCTION OF THE DEGREE ( $n$ ) OF THE POLYNOMIAL TREND.

We note that for pig-iron production little change is effected in the standard deviation by the use of polynomials of higher degree, but that for stock prices the standard deviation was substantially decreased. This decrease is graphically represented in Figure 43.

### 5. Formulas for the Correlation of Residuals from Polynomial Trends

The problem of computing the correlation between the residuals of two series reduced by linear trends has already been solved in Section 3. We shall now give the corresponding results for the correlation between the residuals of two series reduced by polynomial trends of the same or different degrees.

We shall designate the elements of the two series by  $\{y_i\}$  and  $\{Y_i\}$  respectively,  $i$  ranging from  $-p$  to  $+p$ . Let us assume that the moments of the first (based upon  $N = 2p + 1$  items) are  $M_0, M_1, M_2$ , etc., and of the second (also based upon  $N = 2p + 1$  items) are  $\mu_0, \mu_1, \mu_2$ , etc.

Let us assume further that  $\sigma$  is the standard deviation of the first series and  $\bar{\sigma}$  the standard deviation of the second. Moreover, let  $R$  denote the coefficient of correlation between the two series before they have been corrected for trend.

If  $y_n(t)$  and  $Y_m(t)$  represent the two polynomial trends of degrees  $n$  and  $m$  ( $n \geq m$ ) respectively, then the correlation between the two residuals can be written

$$(1) \quad r = I / (N\sigma_n\bar{\sigma}_m),$$

where  $\sigma_n^2$  and  $\bar{\sigma}_m^2$  are the reduced variances already defined in Section 4, and where we have employed the abbreviation

$$(2) \quad I = \sum_{i=-p}^p [y_i - y_n(t)][Y_i - Y_m(t)]$$



$$I = \sum_{t=p}^q y_t Y_t - (M_0 \mu_0)/N + (M_0 \mu_0)/N - (a_0 \mu_0 + a_1 \mu_1 + a_2 \mu_2 + \dots + a_n \mu_n).$$

Noting the identity

$$\sum y_t Y_t - (M_0 \mu_0)/N = NR\sigma\bar{\sigma},$$

we can reduce the above expression to the following form:

$$(3) \quad I = NR\sigma\bar{\sigma} + (M_0 \mu_0)/N - (a_0 \mu_0 + a_1 \mu_1 + \dots + a_n \mu_n).$$

The correlation coefficient,  $r$ , is then obtained by substituting this value in (1); that is,

$$(4) \quad r = R \left( \frac{\sigma \bar{\sigma}}{\sigma_n \bar{\sigma}_n} \right) + \frac{1}{N^2} \frac{M_0 \mu_0}{\sigma_n \bar{\sigma}_n} - \frac{1}{N \sigma_n \bar{\sigma}_n} [a_0 \mu_0 + a_1 \mu_1 + \dots + a_n \mu_n].$$

For convenience in application this coefficient will be specialized in terms of the coefficients of the regression equations given in Section 4. From the tables of their values it is then possible to compute  $r$  readily as soon as the original parameters  $R$ ,  $\sigma$ , and  $\bar{\sigma}$  are known. These specialized formulas follows:

(a) Both series reduced by straight-line trends ( $m = n = 1$ ):

$$r = \left( R\sigma\bar{\sigma} - \frac{A'M_1\mu_1}{N} \right) / \sigma_1\bar{\sigma}_1.$$

(b) Both series reduced by parabolas ( $m = n = 2$ ):

$$r = \left[ R\sigma\bar{\sigma} - \frac{A'}{N} M_1\mu_1 + \left( \frac{1}{N^2} - \frac{A}{N} \right) M_0\mu_0 - \frac{B}{N} (M_0\mu_2 + M_2\mu_0) - \frac{C}{N} M_2\mu_2 \right] / \sigma_2\bar{\sigma}_2.$$

(c) First series reduced by a parabola, second series by a straight line, ( $n = 2, m = 1$ ):

Preceding formula with  $\bar{\sigma}_2$  replaced by  $\bar{\sigma}_1$ .

(d) Both series reduced by cubics ( $m = n = 3$ ):

$$r = \left[ R\sigma\bar{\sigma} + \left( \frac{1}{N^2} - \frac{A}{N} \right) M_0\mu_0 - \frac{B}{N} (M_0\mu_2 + M_2\mu_0) - \frac{C}{N} M_2\mu_2 - \frac{A'}{N} M_1\mu_1 - \frac{B'}{N} (M_1\mu_3 + M_3\mu_1) - \frac{C'}{N} M_3\mu_3 \right] / \sigma_3\bar{\sigma}_3.$$

(e) First series reduced by cubic, second series by a parabola ( $n = 3, m = 2$ ):

Preceding formula with  $\bar{\sigma}_3$  replaced by  $\bar{\sigma}_2$ .

(f) First series reduced by a cubic, second series by a straight line ( $n=3$ ,  $m=2$ ):

Formula (d) with  $\bar{\sigma}_2$  replaced by  $\bar{\sigma}_1$ .

(g) Both series reduced by quartics ( $m=n=4$ ):

$$r = \left[ R\sigma\bar{\sigma} - \frac{A'}{N} M_1\mu_1 - \frac{B'}{N} (M_1\mu_3 + M_3\mu_1) - \frac{C'}{N} M_3\mu_3 + \left( \frac{1}{N^2} - \frac{A}{N} \right) M_0\mu_0 \right. \\ \left. - \frac{B}{N} (M_0\mu_2 + M_2\mu_0) - \frac{C}{N} (M_0\mu_4 + M_4\mu_0) - \frac{D}{N} M_2\mu_2 \right. \\ \left. - \frac{E}{N} (M_2\mu_4 + M_4\mu_2) - \frac{F}{N} M_4\mu_4 \right] / \sigma_4 \bar{\sigma}_4.$$

(h) First series reduced by a quartic; second series by (1) a cubic, (2) a parabola, (3) a straight line:

In the formula of (g): (1) replace  $\bar{\sigma}_4$  by  $\bar{\sigma}_3$ , (2) replace  $\bar{\sigma}_4$  by  $\bar{\sigma}_2$ , (3) replace  $\bar{\sigma}_4$  by  $\bar{\sigma}_1$ .

(i) Both series reduced by quintics ( $m=n=5$ ):

$$r = \left[ R\sigma\bar{\sigma} + \left( \frac{1}{N^2} - \frac{A}{N} \right) M_0\mu_0 - \frac{B}{N} (M_0\mu_2 + M_2\mu_0) - \frac{C}{N} (M_0\mu_4 + M_4\mu_0) \right. \\ \left. - \frac{D}{N} M_2\mu_2 - \frac{E}{N} (M_2\mu_4 + M_4\mu_2) - \frac{F}{N} M_4\mu_4 - \frac{A'}{N} M_1\mu_1 - \frac{B'}{N} (M_1\mu_3 + M_3\mu_1) \right. \\ \left. - \frac{C'}{N} (M_1\mu_5 + M_3\mu_1) - \frac{D'}{N} M_3\mu_3 - \frac{E'}{N} (M_3\mu_5 + M_5\mu_3) - \frac{F'}{N} M_5\mu_5 \right] / \sigma_5 \bar{\sigma}_5.$$

(j) First series reduced by a quintic; second series by (1) a quartic, (2) a cubic, (3) a parabola, (4) a straight line.

In the formula of (i); (1) replace  $\bar{\sigma}_5$  by  $\bar{\sigma}_4$ , (2) replace  $\bar{\sigma}_5$  by  $\bar{\sigma}_3$ , (3) replace  $\bar{\sigma}_5$  by  $\bar{\sigma}_2$ , (4) replace  $\bar{\sigma}_5$  by  $\bar{\sigma}_1$ .

(k) Both series reduced by sextics ( $m=n=6$ ):

$$r = \left[ R\sigma\bar{\sigma} - \frac{A'}{N} M_1\mu_1 - \frac{B'}{N} (M_1\mu_3 + M_3\mu_1) - \frac{C'}{N} (M_1\mu_5 + M_3\mu_1) - \frac{D'}{N} M_3\mu_3 \right. \\ \left. - \frac{E'}{N} (M_3\mu_5 + M_5\mu_3) - \frac{F'}{N} M_5\mu_5 + \left( \frac{1}{N^2} - \frac{A}{N} \right) M_0\mu_0 - \frac{B}{N} (M_0\mu_2 + M_2\mu_0) \right. \\ \left. - \frac{C}{N} (M_0\mu_4 + M_4\mu_0) - \frac{D}{N} (M_0\mu_6 + M_6\mu_0) - \frac{E}{N} M_2\mu_2 - \frac{F}{N} (M_2\mu_4 + M_4\mu_2) \right. \\ \left. - \frac{G}{N} (M_2\mu_6 + M_6\mu_2) - \frac{H}{N} M_4\mu_4 - \frac{I}{N} (M_4\mu_6 + M_6\mu_4) - \frac{J}{N} M_6\mu_6 \right] / \sigma_6 \bar{\sigma}_6.$$

(1) *First series reduced by a sextic; second series by (1) a quintic; (2) a quartic, (3) a cubic, (4) a parabola, (5) a straight line.*

In the formula of (k): (1) replace  $\bar{\sigma}_6$  by  $\bar{\sigma}_5$ , (2) replace  $\bar{\sigma}_6$  by  $\bar{\sigma}_4$ , (3) replace  $\bar{\sigma}_6$  by  $\bar{\sigma}_3$ , (4) replace  $\bar{\sigma}_6$  by  $\bar{\sigma}_2$ , (5) replace  $\bar{\sigma}_6$  by  $\bar{\sigma}_1$ .

(m) *Both series reduced by septimics ( $m = n = 7$ ):*

$$\begin{aligned} r = & \left[ R\sigma\bar{\sigma} + \left( \frac{1}{N^2} - \frac{A}{N} \right) M_0\mu_0 - \frac{B}{N} (M_0\mu_2 + M_2\mu_0) - \frac{C}{N} (M_0\mu_4 + M_4\mu_0) \right. \\ & - \frac{D}{N} (M_0\mu_6 + M_6\mu_0) - \frac{E}{N} M_2\mu_2 - \frac{F}{N} (M_2\mu_4 + M_4\mu_2) - \frac{G}{N} (M_2\mu_6 + M_6\mu_2) \\ & - \frac{H}{N} M_4\mu_4 - \frac{I}{N} (M_4\mu_6 + M_6\mu_4) - \frac{J}{N} M_6\mu_6 - \frac{A'}{N} M_1\mu_1 - \frac{B'}{N} (M_1\mu_3 + M_3\mu_1) \\ & - \frac{C'}{N} (M_1\mu_5 + M_5\mu_1) - \frac{D'}{N} (M_1\mu_7 + M_7\mu_1) - \frac{E'}{N} M_3\mu_3 - \frac{F'}{N} (M_3\mu_5 + M_5\mu_3) \\ & \left. - \frac{G'}{N} (M_3\mu_7 + M_7\mu_3) - \frac{H'}{N} M_5\mu_5 - \frac{I'}{N} (M_5\mu_7 + M_7\mu_5) - \frac{J'}{N} M_7\mu_7 \right] / \sigma_7\bar{\sigma}_7. \end{aligned}$$

(n) *First series reduced by a septimic; second series reduced by (1) a sextic, (2) a quintic, (3) a quartic, (4) a cubic, (5) a parabola, (6) a straight line.*

In the formula of (m): (1) replace  $\bar{\sigma}_7$  by  $\bar{\sigma}_6$ , (2) replace  $\bar{\sigma}_7$  by  $\bar{\sigma}_5$ , (3) replace  $\bar{\sigma}_7$  by  $\bar{\sigma}_4$ , (4) replace  $\bar{\sigma}_7$  by  $\bar{\sigma}_3$ , (5) replace  $\bar{\sigma}_7$  by  $\bar{\sigma}_2$ , (6) replace  $\bar{\sigma}_7$  by  $\bar{\sigma}_1$ .

The serial correlations of the residuals of the two series can also be computed from the above formulas by the device of correcting the moments of one of the series and inserting these corrected moments in the appropriate formula. The method is merely an extension of that explained at the end of Section 3 for the linear trend.

Let us assume that the second series is shifted  $m$  units ahead or  $m$  units behind the first series. We shall designate by  $\mu_r$  the original moments,

$$\mu_r = \sum_{t=-p}^p t^r Y_t,$$

and by  $\mu_r(m)$  and  $\mu_r(-m)$  the moments of the series after it has been moved respectively  $m$  units ahead and  $m$  units behind the first series; that is

$$(5) \quad \mu_r(m) = \sum_{t=-p}^p t^r Y_{t-m}, \quad \mu_r(-m) = \sum_{t=-p}^p t^r Y_{t+m}.$$

The first of these formulas can then be written

$$\begin{aligned}\mu_r(m) &= \sum_{t=-p}^p t^r Y_{t-m} = \sum_{s=-p-m}^{p-m} (s+m)^r Y_s \\ &= \sum_{s=-p}^p (s+m)^r Y_s + \Delta_r(m),\end{aligned}$$

where we abbreviate

$$\Delta_r(m) = \left\{ \sum_{s=-p-m}^{-(p-1)} - \sum_{s=p-m+1}^p \right\} (s+m)^r Y_s.$$

Expanding  $(s+m)^r$  we then obtain

$$(6) \quad \begin{aligned}\mu_r(m) &= \mu_r + rm\mu_{r-1} + \frac{r(r-1)}{2!} m^2 \mu_{r-2} \\ &\quad + \frac{r(r-1)(r-2)}{3!} m^3 \mu_{r-3} + \dots + m^r \mu_0 + \Delta_r(m).\end{aligned}$$

Similarly the second formula of (5) can be written

$$(7) \quad \begin{aligned}\mu_r(-m) &= \mu_r - rm\mu_{r-1} + \frac{r(r-1)}{2!} m^2 \mu_{r-2} \\ &\quad - \frac{r(r-1)(r-2)}{3!} m^3 \mu_{r-3} + \dots + m^r \mu_0 + \Delta_r(-m),\end{aligned}$$

where we abbreviate

$$\Delta_r(-m) = \left\{ \sum_{s=p+1}^{p+m} - \sum_{s=-p}^{-p+m-1} \right\} (s-m)^r Y_s.$$

As an example, let us consider the two series given in Section 3, namely, (I) stock price averages, and (II) pig-iron production, and let us compute the correlation of their residuals after the first has been reduced by a cubic and the second by a straight line. The following pertinent values are taken from the computations given at the end of Section 4:

(I) Stock Price Averages	(II) Pig-Iron Production
$M_0 = 6,626.05$	$\mu_0 = 4,709.9$
$M_1 = 41,920.02$	$\mu_1 = 4,161.9$
$M_2 = 1,725,204.66$	$\mu_2 = 1,020,459.5$
$M_3 = 17,006,574.60$	$\mu_3 = 1,798,139.7$
$\sigma_0 = 69.2971$	$\sigma_0 = 20.2962$
$\sigma_3 = 28.2349$	$\sigma_1 = 19.5274.$
$R = 0.40835,$	$N = 2p + 1 = 51.$

From the coefficients in *Tables of the Higher Mathematical Functions*, Vol. 2, we first compute the values:

$$A/N = 0.0008656070641,$$

$$A'/N = 0.00001112036381,$$

$$B/N = -0.000002220644084,$$

$$B'/N = -0.00000002397613742,$$

$$C/N = 0.00000001024912654,$$

$$C'/N = 0.0000000006150881842.$$

When these values are substituted in formula (d), where  $\bar{\sigma}_3$  is replaced by  $\bar{\sigma}_1$ , we obtain the desired correlation

$$\begin{aligned} r &= (574.3396 - 15,015.4190 + 33,059.0773 - 18,043.6025 - 1,940.1357 \\ &\quad + 3,504.2975 - 1,880.9518) / 551.3542 \\ &= 0.4672. \end{aligned}$$

### 6. Example of the Reduction of Series to their Random Elements

In order to show the efficacy of the methods which we have previously developed for the analysis of economic series into their various components, we shall apply the various techniques to the following four series:

$X_1$  = The Dow-Jones Industrial Stock Price Averages.

$X_2$  = Pig-Iron Production.

$X_3$  = Stock Sales on the New York Stock Exchange.

$X_{14}$  = The Cowles Commission—Standard Statistics Index of Industrial Stock Prices.

The actual values of these four series over the period of exploration (1897–1913) are given below and they are graphically represented in Figure 44.

( $X_1$ ) THE DOW-JONES INDUSTRIAL STOCK PRICE AVERAGES

Year	Jan.	Feb.	Mar.	Apr.	May	June	July	Aug.	Sept.	Oct.	Nov.	Dec.	Av.
1897	42.56	41.71	39.47	38.96	39.91	44.10	47.88	54.81	50.98	49.03	47.46	49.41	45.52
1898	50.01	46.17	45.42	46.00	52.74	52.62	54.20	60.35	53.44	55.43	57.20	60.52	52.84
1899	64.35	66.78	74.33	76.71	67.51	70.38	73.73	75.66	72.87	74.97	75.55	66.08	71.58
1900	66.13	63.96	66.02	61.33	59.10	54.93	56.80	57.81	54.27	59.04	66.59	70.71	61.39
1901	66.81	67.00	69.92	75.80	75.77	77.94	71.63	73.47	66.66	64.45	65.01	64.56	69.92
1902	64.95	64.81	67.19	67.01	66.42	64.31	65.82	66.28	66.15	66.06	62.05	64.29	65.44
1903	65.18	66.19	63.64	63.78	60.27	59.08	50.76	53.19	45.80	45.13	44.33	49.11	55.54
1904	48.91	47.53	49.12	48.80	48.18	49.25	52.13	54.57	57.59	63.03	72.02	69.61	55.06
1905	71.33	75.15	80.02	76.08	74.32	76.87	81.70	80.63	81.90	83.77	89.89	96.20	80.36
1906	100.69	93.94	96.95	90.53	93.75	87.01	92.41	94.01	94.84	92.91	95.12	94.35	93.88
1907	91.70	90.54	80.15	84.30	78.10	80.36	78.87	72.28	67.72	57.70	58.41	58.75	74.91
1908	62.70	60.54	67.51	69.55	72.76	72.59	80.34	84.66	79.93	82.53	87.30	86.15	75.55
1909	84.09	81.85	86.12	88.29	92.18	92.28	96.79	97.90	99.55	99.07	96.02	99.05	92.77
1910	91.31	91.34	89.71	86.20	86.32	81.18	76.48	79.68	79.72	84.77	82.52	81.36	84.27
1911	84.93	85.02	83.27	83.65	85.55	85.98	86.02	79.25	76.31	75.79	80.97	81.68	82.37
1912	80.19	81.40	88.27	90.30	88.01	90.92	89.71	91.57	94.15	90.71	91.40	87.87	88.71
1913	83.72	80.32	80.92	78.54	78.38	74.89	78.48	81.81	80.37	78.30	75.94	78.78	79.20

$(X_2)$  PIG-IRON PRODUCTION

Year	Jan.	Feb.	Mar.	Apr.	May	June	July	Aug.	Sept.	Oct.	Nov.	Dec.	Av.
1897	22.6	23.4	24.1	24.3	24.1	23.7	23.2	24.6	27.1	29.1	30.9	31.8	25.7
1898	31.4	32.0	32.3	32.2	31.5	30.3	29.8	29.5	30.2	31.4	32.8	33.9	31.4
1899	33.3	32.4	33.0	34.5	35.0	35.9	37.1	37.4	38.2	39.6	40.8	41.2	36.5
1900	41.4	41.4	40.8	40.9	41.4	40.5	36.5	32.8	31.3	30.2	30.7	33.2	36.8
1901	37.5	40.5	41.3	41.9	43.2	43.9	43.9	43.1	43.3	44.6	45.4	40.9	42.5
1902	46.1	44.9	46.6	49.2	49.8	48.2	46.5	47.4	47.3	47.8	47.8	49.6	47.6
1903	47.5	49.7	51.3	53.6	55.3	55.8	49.9	50.7	51.8	46.0	34.7	27.3	47.8
1904	29.8	41.7	46.8	52.0	49.6	43.2	36.2	37.8	45.3	46.9	49.6	52.1	44.3
1905	57.5	57.1	62.5	64.1	63.4	59.8	56.2	59.5	63.3	66.2	67.1	66.0	61.9
1906	66.7	68.0	69.9	69.1	67.7	65.9	65.0	62.2	65.7	70.9	72.9	72.1	68.0
1907	71.2	73.0	71.8	74.0	74.1	74.5	72.8	72.6	72.8	75.4	60.9	39.8	69.4
1908	33.7	37.2	39.6	38.3	37.6	36.4	39.3	43.9	47.3	50.6	52.6	56.2	42.7
1909	58.0	61.0	59.2	58.0	60.8	64.4	67.8	72.6	79.5	83.9	84.9	85.0	69.6
1910	84.2	85.6	84.4	82.8	77.1	75.5	69.3	68.0	68.5	67.5	63.7	57.4	73.7
1911	56.8	64.1	70.0	68.8	61.1	59.6	57.8	62.2	65.9	67.8	66.7	65.9	63.9
1912	66.4	72.4	77.6	79.2	81.1	81.4	77.7	81.1	82.1	86.8	87.7	89.8	80.3
1913	90.2	92.4	89.2	91.8	91.0	87.6	82.6	82.1	83.5	82.1	74.5	64.0	84.3

 $(X_3)$  STOCK SALES ON THE NEW YORK STOCK EXCHANGE

Year	Jan.	Feb.	Mar.	Apr.	May	June	July	Aug.	Sept.	Oct.	Nov.	Dec.	Av.
1897	3.37	2.82	5.07	3.54	4.21	6.42	7.01	11.46	13.09	8.01	5.76	7.44	6.52
1898	9.22	8.98	9.95	6.00	9.17	9.10	4.78	12.01	9.37	7.42	10.94	15.22	9.35
1899	24.14	15.98	17.68	16.98	14.79	10.88	8.02	12.81	12.35	10.80	13.58	17.05	14.59
1900	9.86	10.21	14.45	14.65	9.49	7.29	6.27	4.01	5.16	10.90	22.65	23.38	11.53
1901	30.21	21.88	27.00	41.69	35.20	19.82	15.92	10.77	14.03	14.02	18.36	16.67	22.13
1902	14.76	12.95	11.95	26.58	13.49	7.81	16.32	14.32	20.95	16.35	17.12	15.72	15.69
1903	16.01	10.93	15.02	12.24	12.46	15.54	14.78	14.46	10.71	12.67	10.74	15.18	13.40
1904	12.24	8.57	11.42	8.16	5.26	4.99	12.13	12.44	18.70	32.48	31.96	28.18	15.54
1905	20.77	25.36	29.06	29.37	20.54	12.54	13.02	20.25	16.09	17.74	26.88	31.41	21.92
1906	38.55	21.69	19.33	24.30	23.95	20.28	16.30	31.72	26.12	21.80	19.41	20.26	23.64
1907	22.89	16.48	32.25	19.22	15.76	9.73	12.80	14.50	12.14	17.31	9.65	12.54	16.27
1908	16.62	9.92	15.80	11.61	20.92	9.54	13.87	18.85	17.50	14.27	24.88	22.96	16.40
1909	17.27	12.34	13.65	18.97	16.51	20.36	12.81	24.51	20.05	21.71	18.74	17.49	17.87
1910	24.12	15.99	14.99	14.07	11.95	16.28	14.30	10.22	7.68	13.43	10.81	9.89	13.64
1911	10.38	10.17	6.92	5.04	10.69	10.43	5.44	15.04	17.37	11.05	14.90	9.07	10.54
1912	10.91	7.09	14.55	15.99	13.66	7.20	7.17	8.97	10.06	14.15	8.71	12.60	10.92
1913	8.73	6.64	7.18	8.46	5.46	9.59	5.12	6.08	7.68	7.41	3.77	7.15	6.94

The source and interpretation of the four series which form the basis of our investigation are given as follows:

$(X_1)$  The items in this series are the closing quotations on the last day of each month, representing the average price per share in dollars for 12 representative industrial stocks. Source: *The Wall Street Journal*.

$(X_2)$  This series gives the average daily production of pig iron in units of 1,000 gross tons. Source: *Standard Trade and Securities*.

(X<sub>14</sub>) THE COWLES COMMISSION—STANDARD STATISTICS INDEX OF INDUSTRIAL STOCK PRICES

Year	Jan.	Feb.	Mar.	Apr.	May	June	July	Aug.	Sept.	Oct.	Nov.	Dec.	Av.
1897	22.4	22.0	21.9	21.4	21.4	22.5	23.7	25.4	26.3	25.1	23.9	24.7	23.4
1898	25.1	25.4	24.3	24.2	26.4	27.7	28.4	29.4	29.1	28.3	30.1	32.8	27.6
1899	35.1	35.6	37.7	38.8	36.6	35.3	36.3	38.3	38.4	38.6	39.2	34.8	37.1
1900	35.5	36.2	35.5	35.3	32.6	31.0	31.6	32.4	31.6	32.9	36.5	37.9	34.1
1901	37.8	38.5	39.8	43.2	39.6	44.9	42.1	41.9	40.9	39.3	39.1	37.9	40.4
1902	39.3	39.9	40.0	41.1	40.5	39.4	40.6	40.6	40.7	39.5	37.6	36.1	39.6
1903	38.5	39.6	38.5	36.8	35.6	33.2	30.4	29.0	27.7	25.8	25.2	26.6	32.2
1904	27.5	26.8	26.6	26.9	26.2	26.3	27.6	28.6	30.3	33.0	36.8	37.4	29.5
1905	38.1	40.0	41.3	41.7	39.0	38.8	40.6	42.2	41.7	43.0	43.8	47.5	41.5
1906	50.3	49.9	47.8	47.7	45.9	46.0	44.3	48.5	50.5	50.7	49.7	50.2	48.5
1907	49.3	48.1	43.2	42.7	40.9	39.7	41.5	37.2	35.2	29.7	27.8	29.1	38.7
1908	30.9	30.0	32.6	34.5	36.5	36.4	38.8	41.8	40.2	41.0	44.5	44.5	37.6
1909	44.4	42.1	42.2	45.2	48.3	50.2	51.3	53.6	54.5	55.0	56.3	56.8	50.0
1910	55.5	51.6	53.6	52.4	50.5	47.6	44.7	46.3	46.5	49.4	50.2	47.7	49.7
1911	48.5	50.0	49.1	48.6	50.0	50.8	50.4	47.4	43.5	42.5	44.8	46.1	47.6
1912	46.5	45.5	47.9	51.0	51.1	52.2	52.3	53.8	54.8	55.1	53.8	50.8	51.2
1913	50.2	47.5	46.4	46.5	45.2	42.0	42.8	45.2	46.1	44.0	42.5	42.9	45.1

(X<sub>9</sub>) The items represent the monthly totals of shares traded on the New York stock exchange in units of 1,000,000 shares. Source: *The New York Times*.

(X<sub>14</sub>) This series gives the index numbers of the prices of all quoted industrial stocks with 1926 = 100 as a base. Source: The Cowles Commission.<sup>2</sup>

In the analysis which follows it is assumed that the total variance  $\sigma^2$  of an economic time series can be regarded as the sum of three variances which are essentially independent of one another. The first of these,  $\sigma_T^2$ , is the variance due to secular trend; the second,  $\sigma_H^2$ , is the variance due to harmonic, or quasi-harmonic, elements; the third,  $\sigma_E^2$ , is the variance of the erratic element. In times of great inflation, a fourth variance may also be included, namely that of the disruptive element, which we may represent by  $\sigma_D^2$ . In the period around 1929 this became the dominating part of the total variance and the harmonic and trend elements were completely effaced by the inflation. In the stable period, which is the subject of the present investigation, however, this disruptive variance was zero.

Hence the total variance may be represented by the sum

$$(1) \quad \sigma^2 = \sigma_T^2 + \sigma_H^2 + \sigma_E^2.$$

The independence of the three elements may be argued in the fol-

<sup>2</sup> This analysis was made before the index numbers were finally revised. Some slight variation will be found between these values and the published ones. The conclusions are not affected.

lowing way: If the secular trend is essentially linear, then it may be regarded as part of the arc of a harmonic term with period longer than the series under analysis. Such harmonic terms are themselves almost independent of harmonic terms with periods which lie within the limits of the data, and hence the two variances will be essentially additive.

It is obvious that the erratic element, if it is truly erratic, will have a zero correlation both with the harmonic components and with the trend. The erratic element may be *strictly erratic*, that is to say, it may meet the test of randomness, or it may be *relatively erratic*, by which we mean that it will have a zero correlation with the structural components of the series.

The linear combination of the three variances as given in equation (1) can be justified analytically in the following way. Let us consider the function

$$y = mt + A \sin at + B \cos at + \varepsilon(t)$$

over the range from  $-p$  to  $+p$ , where  $p$  is sufficiently large with respect to the period  $2\pi/a$  of the harmonic element so that the average of this term may be assumed to be zero. The erratic element,  $\varepsilon(t)$ , is assumed also to have a zero average over the interval; that is,

$$\frac{1}{2p} \int_{-p}^p \varepsilon(t) dt = 0.$$

Under these conditions the variance of  $y(t)$  is explicitly found to be

$$(2) \quad \sigma_y^2 = \frac{1}{2p} \int_{-p}^p y^2(t) dt = \frac{1}{2} m^2 p^2 + \frac{1}{2} (A^2 + B^2) \\ + \frac{1}{2p} \int_{-p}^p \varepsilon^2(t) dt + \eta(p),$$

where we employ the abbreviation

$$\eta(p) = - \frac{(A^2 - B^2)}{4ap} \sin 2ap + \frac{2m}{a^2 p} (A \sin ap + B \cos ap) \\ + \frac{2m}{a} (-A \cos ap + B \sin ap) + \frac{m}{p} \int_{-p}^p t \varepsilon(t) dt \\ + \frac{1}{p} \int_{-p}^p \varepsilon(t) (A \sin at + B \cos at) dt.$$



Since by assumption  $ap$  is large, all terms in  $\eta(p)$  will be small except the third. But if  $(m/a)$  is of the order of unity, which is a realistic assumption for most economic time series, then this remainder term may usually be disregarded also. It vanishes, of course, if  $\tan ap = A/B$ . Under these conditions the variance  $\sigma_y^2$  consists of the first three terms, which are respectively the variances of the trend, the harmonic component, and the erratic element.

To proceed now to the actual computation of the erratic elements of the four series chosen for exploration, we first evaluate the zeroth and first moments about the center of the time range, that is, assuming  $N = 203$  and  $p = 101$ , the four mean values, the standard deviations, and the variances. These values are tabulated below as follows:

Series	$M_0$	$M_1$	Mean ( $A$ )	$\sigma$	$\sigma^2$
$X_1$	14672.73	129206.24	72.2795	15.3143	234.5278
$X_2$	11051.4	189313.3	54.4404	18.5004	342.2648
$X_9$	2955.47	1053.93	14.5590	7.0961	50.3546
$X_{14}$	8042.90	77827.91	39.6202	8.8608	78.5138

We shall also need the correlation coefficients between the four series before they have been corrected for trend. The coefficients,  $R_{ij}$ , are given below as follows:

	$X_1$	$X_2$	$X_9$	$X_{14}$
$X_1$	1.0000	0.7697	0.3961	0.9516
$X_2$	0.7697	1.0000	0.1167	0.8152
$X_9$	0.3961	0.1167	1.0000	0.3128
$X_{14}$	0.9516	0.8152	0.3128	1.0000

From the moments, employing formula (3) of Section 3, we readily compute the four trends as follows:

$$y_1 = 72.2795 + 0.18535t,$$

$$y_2 = 54.4404 + 0.27157t,$$

$$y_3 = 14.5590 + 0.00151t,$$

$$y_{14} = 39.6202 + 0.11164t.$$

These trends are graphically represented by (E) in Figure 44.

The variances due to the trend are now computed from the formula

$$(3) \quad \sigma_T^2 = A'M_1^2/N,$$

as one observes from formula (4) of Section 3. The residual variance,  $\sigma_1^2$ , is then obtained by subtracting the trend variance from the original variance. The trend variances, the residual variances, and the standard deviations for the four series are given below as follows:

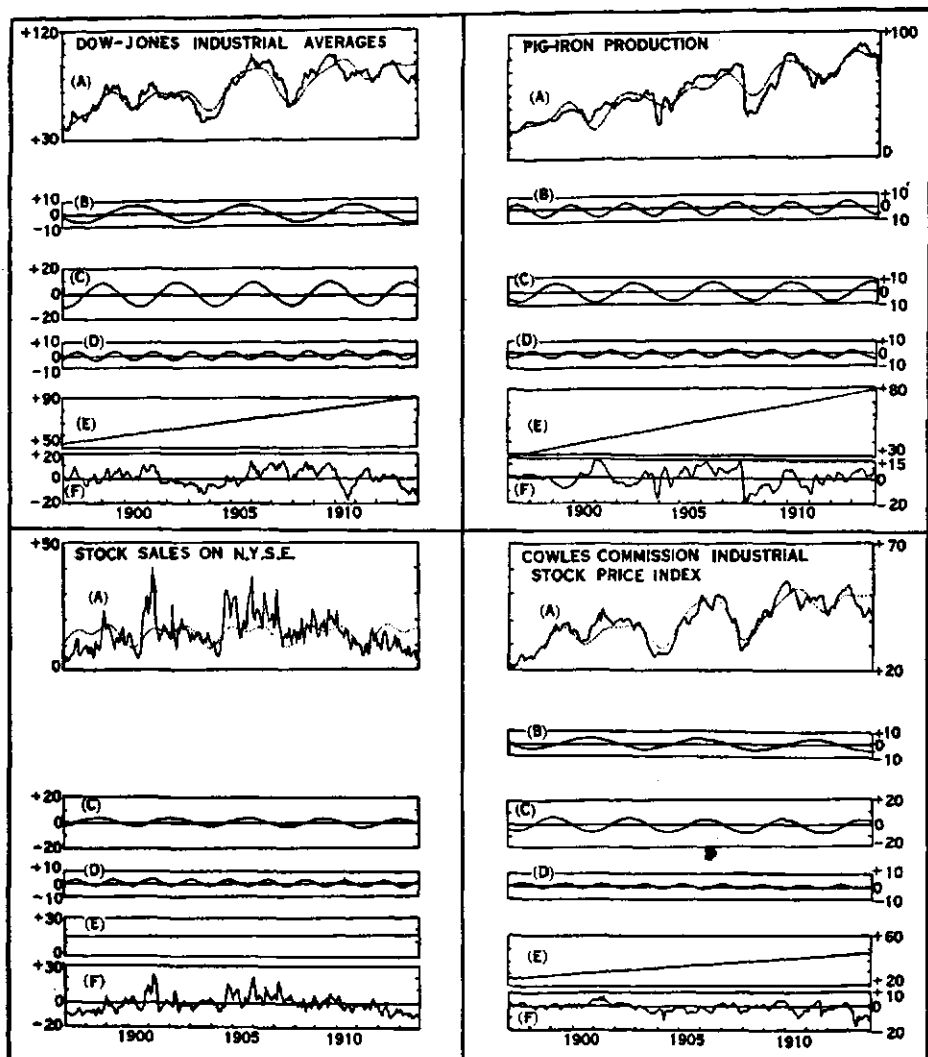

FIGURE 44.—REDUCTION OF TIME SERIES TO RANDOM ELEMENT.

This chart shows how harmonic components and trend are removed from economic time series. (A) = original series; (B), (C), (D) = harmonic elements; (E) = trend; (F) = Residuals.

Series	Trend Variance ( $\sigma_T^2$ )	Residual Variance ( $\sigma_1^2$ )	$\sigma_1$
$X_1$	117.9708	116.5570	10.7961
$X_2$	253.2619	89.0029	9.4341
$X_9$	0.007849	50.3468	7.0955
$X_{14}$	42.8034	35.7104	5.9758

The correlations of the trend residuals are now easily computed by means of formula (5) of Section 3. Thus, making use of the values previously recorded, we get for  $r_{12}$ , the correlation coefficient between the Dow-Jones averages and pig-iron production, the following value:

$$r_{12} = \frac{(0.7697 \times 15.3143 \times 18.5004 - 0.18534768 \times 932.577832)}{10.7961 \times 9.4341} \\ = 0.4440.$$

We note that the quantity 0.18534768 is the value of  $A'$  computed for  $p = 101$  multiplied by the moment 129206.24, and the quantity 932.577832 is the value of the second moment 189313.3 divided by  $N = 203$ .

In this manner all the trend residuals are correlated and the coefficients are recorded in the following table:

	$X_1$	$X_2$	$X_9$	$X_{14}$
$X_1$	1.0000	0.4440	0.4363	0.9001
$X_2$	0.4440	1.0000	0.0182	0.5236
$X_9$	0.4363	0.0182	1.0000	0.4502
$X_{14}$	0.9001	0.5236	0.4502	1.0000

The next problem is to remove the harmonic elements from the four series. For this purpose we consult the periodograms for significant periods, and for these significant periods we compute from the data of the periodograms the values of the parameters,  $A$ ,  $B$ ,  $R$ , and  $R^2$ , where  $A$  and  $B$  are the coefficients respectively of the cosine and sine components, and where  $R^2 = A^2 + B^2$ . The table on page 234 is thus constructed for the four series.

We now assume that the harmonic variance is given by the following formula:

$$\sigma_H^2 = \frac{1}{2} [(A_1^2 + B_1^2) + (A_2^2 + B_2^2) + \dots + (A_n^2 + B_n^2)],$$

where  $A_i$  and  $B_i$  refer to the values for significant periods.

The value of  $\sigma_H^2$ , subtracted from the residual variance  $\sigma_1^2$ , should give, to a close approximation, the variance of the erratic element,  $\sigma_E^2$ ; that is,

$$(4) \quad \sigma_E^2 \approx \sigma_1^2 - \sigma_H^2.$$

Series	Parameters	Lengths of Significant Periods			
		22 Months	30 Months	43 Months	62 Months
$X_1$	$A$	-3.2466		-8.7279	-1.1963
	$B$	1.2210		-4.4564	-6.7914
	$R$	3.47		9.80	6.90
	$R^2$	12.0409		96.0400	47.6100
$X_2$	$A$	-1.3312	1.4380	-4.2334	
	$B$	-2.2398	4.7671	-6.1268	
	$R$	2.61	4.98	7.45	
	$R^2$	6.8121	24.8004	55.5025	
$X_9$	$A$	-1.3438		-3.1493	
	$B$	2.0935		0.2594	
	$R$	2.49		3.16	
	$R^2$	6.2001		9.9856	
$X_{14}$	$A$	-1.6335		-4.7092	-0.1514
	$B$	0.4500		-3.2827	-4.2426
	$R$	1.69		5.74	4.25
	$R^2$	2.8561		32.9476	18.0625

In the following table we give the values of the harmonic variance, the erratic variance as computed by (4), the standard deviation of the erratic element, and the actual value of this standard deviation computed directly from the final residuals:

Series	$\sigma_H^2$	$\sigma_E^2$	$\sigma_E$ by (4)	$\sigma_E$ (Exact)	Error
$X_1$	77.8454	38.7116	6.2219	6.7354	0.5135
$X_2$	43.5575	45.4454	6.7413	6.8394	0.0981
$X_9$	8.0929	42.2539	6.5003	6.7457	0.2454
$X_{14}$	26.9331	8.7773	2.9627	3.7126	0.7499

The errors in the standard deviation of the erratic element arise out of the approximate character of formula (4) as has been explained previously. Except in the last instance, they are all less than three times the probable errors of  $\sigma_E$ , these probable errors being respectively 0.2249, 0.2284, 0.2252, and 0.1240.

### 7. Economic Significance of the Example

In order to interpret the significance of the analysis given in the preceding section, we compute the correlation coefficients between the erratic elements of the four series and obtain the following table:

	$X_1$	$X_2$	$X_9$	$X_{14}$
$X_1$	1.0000	0.0778	0.4057	0.7092
$X_2$	0.0778	1.0000	0.2575	0.0608
$X_9$	0.4057	0.2575	1.0000	0.2654
$X_{14}$	0.7092	0.0608	0.2654	1.0000

One of the most significant facts to be noted from a comparison of the three tables of correlation coefficients is that the high correlation of 0.7697 between  $X_1$  and  $X_2$  has been reduced to the insignificant correlation of 0.0778. In other words, we have been able to account for nearly all the interrelationship between these two series by similar trends and two common harmonics. The remarkable permanence of this periodic relationship between these two series was observed previously in the chapter on serial correlation. There it was established that pig-iron production moves three months after the stock price averages.

This close correlation between the two series can be exhibited very simply in another way. Since in both series the 43-month cycle dominates the other significant cycles, we can represent most of the cyclical movement in the two series by this single harmonic. Thus from the table of periods we have for the stock price averages the dominating cycle

$$\begin{aligned} X_1 &= -8.7279 \cos \frac{2\pi t}{43} - 4.4564 \sin \frac{2\pi t}{43} \\ &= 9.7998 \sin \frac{2\pi}{43} (t + 29.0190) ; \end{aligned}$$

and for pig-iron production,

$$\begin{aligned} X_2 &= -4.2334 \cos \frac{2\pi t}{43} - 6.1268 \sin \frac{2\pi t}{43} \\ &= 7.4471 \sin \frac{2\pi}{43} (t + 25.6368) . \end{aligned}$$

Computing the lag-correlation function for these two harmonics by means of formula (2) of Section 4 of Chapter 3, we obtain

$$r(t) = \cos \frac{2\pi}{43} (3.382 - t) .$$

Hence the lag between the two series, determined from this very simple analysis, is equal to about 3.38 months.

This same conclusion can be derived from the data of the periodograms of the two series expressed as percentages of trend. In this case we obtain for the two harmonic elements the following values:

$$X_1 = -8.5319 \cos \frac{2\pi}{43} - 4.7624 \sin \frac{2\pi}{43}$$

$$= 9.7711 \sin \frac{2\pi}{43} (t + 28.766);$$

$$X_2 = -4.5647 \cos \frac{2\pi}{43} - 6.2364 \sin \frac{2\pi}{43}$$

$$= 7.7078 \sin \frac{2\pi}{43} (t + 25.838).$$

The lag-correlation function is then found to be

$$r(t) = \cos \frac{2\pi}{43} (2.928 - t),$$

which shows a fundamental lag of three months between the two series.

Another interesting conclusion to be derived from the final table of correlation coefficients is that the relationship between  $X_1$  and  $X_2$  does not depend upon either trend or harmonic elements. This is an important conclusion to establish since it discloses a connection between these two series which does not depend upon the existence of common trends or common periodic movements. Since the relationship between the stock price averages and the production of pig iron is established through common periods, the existence of an essentially different type of correlation is a matter worthy of special comment. Obviously the simple explanation is found in the fact that the volume of sales on the stock exchange increases whenever the market shows an unusual movement in either a positive or a negative direction.

A final observation from the table of correlation coefficients relates to the series  $X_1$  and  $X_{11}$ , which are designed to measure essentially the same economic phenomenon. By the removal of trends and common periods, the initial correlation of 0.9516 has been reduced to 0.7092. While this is not to be regarded as a large change, it is certainly sufficiently great to excite attention. The first series is derived from a sample of the end-of-the-month quotations of 12 stocks, while the second series measures the complete action of the market as it is determined by an index based upon the monthly averages of all the listed stocks.

### 8. Seasonal Variation

In Section 7 of Chapter 2 the use of harmonic analysis was illustrated by removing a twelve-month cycle from the data of freight-car loadings. The twelve-month cycle is generally called the *cycle of seasonal variation* and it is recognized as an important characteristic of many economic time series.

While the use of harmonic analysis seems to recommend itself in the study of seasonal variations because it yields at one computation both the relative energy in the seasonal cycle and the technique for removing it from the data, the *method of link relatives* is widely employed to compute the indexes of seasonal variation.

We shall illustrate this method by means of the data on freight-car loadings previously used.

If  $y_i$  represents the data and  $S_i$  the *indexes of seasonal variation*, then the new series

$$(1) \quad x_i = y_i/S_i$$

is called the data corrected for seasonal variation. The indexes of seasonal variation are computed in three steps.

The monthly *link relatives* of the data are first found and arranged in a table in order of magnitude. By a series of link relatives we mean the ratios of each item in the series to the one just preceding it. Thus referring to the data (Section 7 of Chapter 2), we compute as the Jan./Dec. ratio for 1920 the fraction  $820/758 = 1.08$ . In this manner the table on page 238 is readily obtained.<sup>3</sup>

In the present instance the arithmetic averages are seen to agree closely with the medians. In general the median is to be preferred in this computation since it is free from extreme variations in the data which might affect the average. The fact that unusual departures from a normal trend are thus excluded by the method of link relatives seems to the writer to be one advantage possessed by this method over that of harmonic analysis. Another argument for the use of link relatives is found in the fact that the method automatically eliminates the trend from the computation.

<sup>3</sup> It will be observed that, if the available data begin with January and end with December, then the number of link relatives for the Jan./Dec. ratio will be one less than the number of link relatives for the other ratios.

Several methods have been devised for correcting data for seasonal variation differing from the one presented in this section. Some of these adapt the technique of moving averages to the problem. For a more extensive account than can be given here of other methods the reader is referred to F. C. Mills, *Statistical Methods* (Revised edition), New York, 1938, pp. 284-298, and to F. E. Croxton and D. J. Cowden, *Applied General Statistics*, New York, 1939, Chapter 18.

Ratio	Jan.	Feb.	Mar.	Apr.	May	June	July	Aug.	Sept.	Oct.	Nov.	Dec.
	Dec.	Jan.	Feb.	Mar.	Apr.	May	June	July	Aug.	Sept.	Oct.	Nov.
Link Rela- tives	109	109	109	104	118	107	106	110	110	110	95	94
	108	106	109	103	109	107	105	109	108	110	93	90
	106	105	108	103	108	104	102	109	107	106	91	89
	105	105	106	103	107	102	100	108	106	105	90	88
	104	104	105	102	107	102	100	108	106	105	89	87
	104	100	105	102	106	101	99	107	104	104	89	87
	103	101	104	102	106	101	99	108	104	105	88	87
	103	101	102	99	105	101	99	108	103	105	87	85
	102	99	102	99	104	100	98	106	102	103	86	85
	101	99	101	98	103	100	98	106	100	103	86	85
	101	98	101	97	102	99	98	105	100	103	84	85
	100	97	101	96	100	98	98	105	99	102	84	84
98	95	101	88	98	98	98	104	99	102	83	83	
	94	101	86	94	94	96	101	99	101	82	82	
Median Arithmetic Mean	104	101	103	100	106	101	99	108	104	105	88	86
	103	101	104	99	105	101	100	107	103	105	88	86

The next step in the computation is to set the link relative for Jan./Dec. equal to 100 and "chain" each median to this standard. If the medians of the columns are represented respectively by the symbols  $m_1, m_2, m_3, \dots, m_{12}$ , then the *chain relatives* will be computed from the formulas

$$c_1 = 100, \quad c_i = c_{i-1}m_i, \quad i = 2, 3, \dots, 12.$$

Since it will turn out that  $c_{12}m_1$  is not equal, in general, to  $c_1$ , as should be the case if the chain relatives are to be periodic, a ratio to correct for this discrepancy is computed from the equation

$$c_1(1+d)^{11} = c_{12}m_1.$$

A new set of adjusted chain relatives is then determined by

$$C_i = \frac{c_i}{(1+d)^{i-1}}, \quad i = 1, 2, \dots, 12.$$

It is clear that our objective in the adjustment is attained since we have  $C_1 = C_{12}m_1 = c_{12}m_1(1+d)^{-11} = c_1 = 100$ .

The final indexes of seasonal variation are obtained by dividing the chain relatives by the average value,  $C$ , of the adjusted chain relatives; that is to say,

$$S_i = C_i/C.$$

From the data we readily obtain the following values:



Medians	Chain relatives	Adjusted chain relatives	Indexes of seasonal variation
$M_t$	$c_t$	$C_t$	$s_t$
104	100	100	92
101	101	101	93
103	104	104	95
100	104	103	94
106	110	109	100
101	111	110	101
99	110	109	100
108	119	118	108
104	124	122	112
105	130	128	117
88	114	112	103
86	98	96	88
	Averages	109	100

Applying formula (1) we readily obtain the values of the series corrected for seasonal variation. These values are given in the following table:

MONTHLY AVERAGES OF MEAN WEEKLY FREIGHT-CAR LOADINGS  
CORRECTED FOR SEASONAL VARIATION  
(Unit, 1,000 cars)

Year	Jan.	Feb.	Mar.	April	May	June	July	Aug.	Sept.	Oct.	Nov.	Dec.
1919	791	739	734	761	759	801	858	826	857	826	784	861
1920	891	834	893	778	862	851	901	896	865	859	858	821
1921	766	734	729	751	757	757	751	750	751	794	739	776
1922	763	822	870	769	787	834	825	812	835	848	917	952
1923	919	905	966	1001	975	1001	986	964	926	921	950	938
1924	933	976	965	931	895	897	894	902	926	932	947	962
1925	1001	973	973	1001	968	979	986	1000	959	946	994	1009
1926	1003	988	1020	1019	1037	1018	1049	1022	1025	1030	1037	1027
1927	1028	1028	1055	1037	1024	989	979	983	980	953	928	947
1928	937	964	1001	995	1002	975	986	980	997	1004	1030	1003
1929	971	1013	1013	1060	1051	1042	1038	1034	1013	999	950	949
1930	910	942	930	970	914	921	895	868	831	812	775	772
1931	782	762	774	800	740	741	738	692	658	649	636	630
1932	616	603	595	593	522	486	483	486	515	542	533	551
Av.	879	877	894	890	878	878	884	873	867	865	863	871

It is instructive to compare the results of this analysis with that given in Section 7, of Chapter 2, where the seasonal influence was removed by means of harmonic analysis. The two deflated series are graphically compared in the accompanying figure. The principal difference appears to be that the method employed in this section tends to give a greater smoothness than that of the previous method. This is due to the fact that in the first instance only two major harmonics

were removed, whereas the present method removes all the harmonic variation attributable to the interval  $T = 1$  to  $T = 12$ .

This conclusion is further substantiated by computing the percentage of energy accounted for from the formula

$$100E = 100(1 - \sigma_1^2/\sigma^2),$$

where  $\sigma^2 = 23,870$  is the variance of the original series and  $\sigma_1^2 = 17,292$  is the variance of the corrected series. We thus obtain  $100E = 27.56$  per cent, which is to be compared with 16.43 per cent obtained by the previous method.

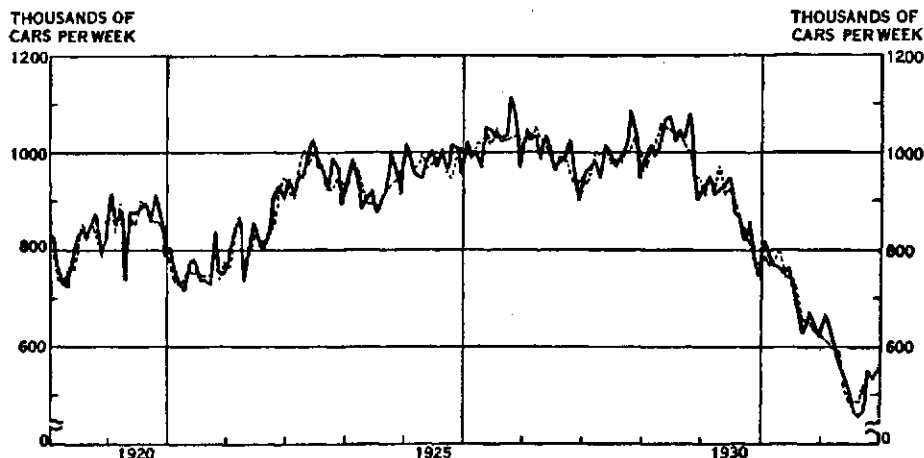

FIGURE 45.—FREIGHT-CAR LOADINGS, 1919-1932 (MONTHLY AVERAGES OF WEEKLY DATA.)

- : Residual after seasonal has been removed by means of harmonic analysis  
 - - - - : Residual after seasonal has been removed by the method of link relatives

### 9. The Variate Difference Method and Its Application<sup>4</sup>

The variate difference method is a statistical procedure designed to remove the random element from the items of a time series. The origin of the theory is apparently to be found in a paper written by J. H. Poynting as early as 1884,<sup>5</sup> but its development as a tool in the

<sup>4</sup>The author is greatly indebted in this account to *The Variate Difference Method*, by G. Tintner, published as a monograph of the Cowles Commission and Iowa State College, 1940. Tintner's admirable work, *Prices in the Trade Cycle*, Vienna, 1935, xii + 204 pp. employs the technique of the variate difference method and gives a résumé of its salient features.

<sup>5</sup>"A Comparison of the Fluctuations in the Price of Wheat and in the Cotton and Silk Imports into Great Britain," *Journal of the Royal Statistical Society*, Vol. 47, 1884, pp. 34-64.

analysis of time series belongs to the more recent period. Among those who have contributed to the subject may be mentioned the names of R. H. Hooker, Miss F. E. Cave, L. March, "Student" (W. S. Gosset), Miss E. M. Elderton, Karl Pearson, G. U. Yule, A. Ritchie-Scott, Warren M. Persons, R. A. Fisher, A. L. Bowley, Oscar Anderson, G. Tintner, A. Wald, and R. Zaycoff. But it is probable that the present state of the theory and the general interest in its application are due to the extensive work of Anderson, whose treatise *Die Korrelationsrechnung in der Konjunkturforschung*, published in 1929, may be considered as definitive of the subject. More recently Tintner has produced a monograph setting forth in much detail the applications of the method to economic data.

It is somewhat aside from our purpose to enter into a discussion of the merits and the difficulties of the theory, but we believe that the method has considerable utility in determining the nature of the erratic element in many economic time series.

The basic postulate of the variate difference method is found in the assumption that the elements  $y_i$  of a time series may be resolved linearly into two parts, the first a mathematical expectation  $x_i$ , and the second a random element  $\varepsilon_i$ ; that is,

$$y_i = x_i + \varepsilon_i.$$

The second postulate of the variate difference method is that  $x_i$  is a systematic or functional variable and that its  $k$ th difference approaches zero as  $k$  increases, that is,  $\Delta^k x_i \rightarrow 0$  for large values of  $k$ . It is well known, of course, that the third difference of a parabola is zero, that the fourth difference of a cubic is zero, etc. Hence if  $x_i$  can be represented by a polynomial of  $n$ th degree, then its difference of order  $n + 1$  will vanish. But since this is not the case with the random element  $\varepsilon_i$ , the residual left in the series  $y_i$  after the difference of order  $n + 1$  must be that attributable to the random element.

The scheme, then, is to determine the value of  $k$ , let us say,  $k_0$ , for which  $\Delta^k x_i = 0$ . The value so determined then indicates the functional character of  $x_i$ . If, for example,  $k_0$  is 2, then  $x_i$  is essentially linear; if  $k_0$  is 3, then  $x_i$  is parabolic, etc.

Having once determined the nature of the functional variable, we can then proceed to eliminate the random element by smoothing the data by a moving average indicated by the analysis. The method employed is the moving average of Sheppard's graduation theory.

The first problem is to determine  $k_0$ . For this purpose the second moments of the  $k$ th differences are computed; that is,

$$(1) \quad \mu_2^{(k)} = \sum [\Delta^k y_i]^2.$$

The variances of the  $k$ -differences are then obtained from the formula

$$(2) \quad \sigma_k^2 = \frac{\mu_2^{(k)}}{(N-k) {}_{2k}C_k},$$

where  ${}_{2k}C_k \equiv (2k)! / (k!)^2$  is the  $k$ th binomial coefficient.

The reason for the divisor  ${}_{2k}C_k$  is found in formula (3), Section 4, Chapter 4, where the variance of a random series is computed. Since by hypothesis the  $k$ th difference is the difference of a random series, we must compute the variance on this assumption.

The next question is to determine the significance of the differences between successive variances as defined by (2); that is, to compute the expectation,  $E(\delta_k)$ , of the difference

$$(3) \quad \delta_k = | \sigma_{k+1}^2 - \sigma_k^2 |.$$

This is the most difficult part of the analysis both theoretically and practically and the criterion is achieved through several steps which will be stated without proof. The reader is referred to the original articles for the justification of the procedure.<sup>9</sup>

The variance of  $\delta_k$ , which we shall designate by  $\sigma^2(\delta_k)$ , is given by the formula

$$(4) \quad \sigma^2(\delta_k) = \sigma_k^2 / Q_k,$$

where  $Q_k$  is a complicated function defined by the following ratio:

$$Q_k = \frac{H(k, N)}{\sqrt{1 + G_k J(k, N)}}.$$

The functions  $H(k, N)$  and  $J(k, N)$  are due to R. Zaycoff and are defined as follows:

$$H(k, N) = \frac{(N-k)(N-k-1)}{\sqrt{(b'_k N + b''_k)(N-k)(N-k-1) - N}},$$

$$J(k, N) = \frac{(N-k)(N-k-1)b_k - Nc_k - c'_k}{(b'_k N + b''_k)(N-k)(N-k-1) - N},$$

where  $b_k$ ,  $b'_k$ ,  $b''_k$ ,  $c_k$ , and  $c'_k$  are given in the table on page 243.

The remaining parameter,  $G_k$ , in  $Q_k$  is defined in terms of the kurtosis of the  $k$ th difference; thus

$$G_k = D_k / \sigma_k^4,$$

<sup>9</sup> See R. Zaycoff, "Ueber die Ausschaltung der zufälligen Komponente nach der 'Variate Difference' Methode," *Publications of the Statistical Institute for Economic Research*, State University of Sofia, 1937, No. 1

$k$	$d_k$	$d'_k$	$d''_k$	$c_k$	$c'_k$
0	0.500000	1.000000	1.000000	0.500000	0.000000
1	0.277778	0.222222	1.111111	0.555556	0.444444
2	0.254444	0.108889	1.093333	0.134444	0.286667
3	0.209592	0.067347	1.080817	0.101837	0.384490
4	0.187314	0.046838	1.072058	0.094092	0.415470
5	0.169365	0.034973	1.065577	0.084752	0.462166
6	0.156063	0.027391	1.060548	0.078301	0.500876

where  $D_k$ , the kurtosis, is given by

$$D_k = \frac{\sum (\Delta_i^{(k)})^4 / (N - k) - B_k \sigma_k^4}{P_k}, \quad k > 0.$$

The constants  $B_k$  and  $P_k$  are given in the following table:

$k$	$B_k$	$P_k$
1	12	2
2	108	18
3	1200	164
4	14700	1800
5	190512	21252
6	2561328	263844

For  $k=0$ , the kurtosis takes the form

$$D_0 = \frac{m_4 - 3\left(\frac{N-1}{N}\right)^2 \sigma_0^4}{1 - 4/N + 6/N^2 - 3/N^3},$$

where  $m_4$  is the fourth moment about the mean. It may be computed in terms of the average means,  $N_r$ , about any other convenient value from the formula

$$m_4 = N_4 - 4N_3N_1 + 6N_2N_1^2 - 3N_1^4.$$

Since we now have an estimate of the variance of the difference of the  $k$ -variances, we may now establish the criterion for  $k_0$  in the usual manner. Thus we form the ratio

$$R_k = \frac{\delta_k}{\sigma^2(\delta_k)} = Q_k \frac{|\sigma^2_{k+1} - \sigma_k^2|}{\sigma_k^2}.$$

Then  $k_0$  is the first value of  $k$  for which  $R_k$  is less than 3 and, within possible minor variations, remains so.

The final step in the analysis consists in determining the fundamental structure of the original series by computing a new series from which all or most of the random variation of the original data

has been removed. This is accomplished by means of *Sheppard's smoothing formula*, which consists essentially of fitting a *moving parabola* to the data.<sup>7</sup>

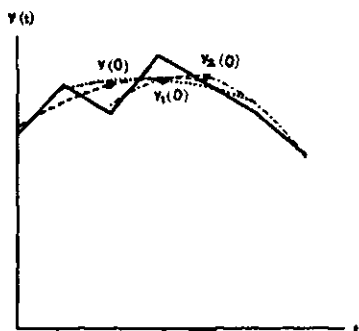

FIGURE 46.—APPLICATION OF SHEPPARD'S SMOOTHING FORMULA.

In order to illustrate this method let us consider that a moving parabola is to be fitted to the data. If the data consisted of five values only, we might select the central value as the origin and then fit a parabola to the five points by means of the formulas given in Section 4. We note that if  $y = a_0 + a_1t + a_2t^2$  is the parabola, then the central value is given by

$$y(0) = a_0 = AM_0 + BM_2 = A \sum_{-p}^p y_s + B \sum_{-p}^p s^2 y_s = \sum_{-p}^p \alpha_s y_s,$$

where we write

$$\alpha_s = A + s^2 B.$$

Now if we move to the next point as origin, we could repeat the process and thus obtain  $y_1(0) = \sum_{-p}^p \alpha_s y_{s+1}$ , and hence in general

$$y_t(0) = \sum_{-p}^p \alpha_s y_{s+t}.$$

This expression is immediately seen to define a moving average with the weights given by  $\alpha_s$ .

<sup>7</sup> The reader may consult for this: W. F. Sheppard, (1) "Reduction of Errors by Means of Negligible Differences," *Proceedings of the Fifth International Congress of Mathematicians*, Cambridge, 1912, Vol. 2, p. 348; (2) "Fitting of Polynomials by the Method of Least Squares," *Proceedings of the London Math. Soc.*, (2nd series), Vol. 13, 1914, p. 97; (3) "Graduation by Reduction of Mean Square of Error," *Journal of the Institute of Actuaries*, Vol. 48, 1914, p. 171, 390; *ibid.*, Vol. 49, 1915, p. 148. See also E. T. Whittaker and G. Robinson, *The Calculus of Observations*, London, 1924, p. 291; O. Anderson, *Die Korrelationsrechnung in der Konjunkturforschung*, Bonn, 1929, pp. 74 and 117 et seq.; M. Sasuly, *Trend Analysis of Statistics*, Washington, D. C., 1934, Chapter 9.

For the problem originally considered, namely where  $p = 2$ , we obtain the following values for  $\alpha_s$ :<sup>8</sup>

$$\alpha_2 = \alpha_2 = A + 4B = -0.0857143, \quad \alpha_1 = \alpha_1 = A + B = 0.3428572, \\ \alpha_0 = A = 0.4857143.$$

We note also that since  $\alpha_0$  is the same for the cubic as for the parabola, the data by this process may be said to be smoothed by the moving least-squares parabola or cubic. The extension to polynomials of higher degree is obvious.

It is clear that the amount of the random variation removed by the process described above depends both upon  $k_0$  and  $p$ , the parameter of the moving average. That is, the per cent of the random variation removed is a function of the two variables  $n$  and  $p$ , where  $n = \frac{1}{2}k_0$ , if  $k_0$  is even, and  $n = \frac{1}{2}(k_0 + 1)$ , if  $k_0$  is odd. We shall designate this per cent by  $100 - 100 L(n,p)$ , where  $L(n,p)$  is defined by the following table:

Values of  $L(n,p)$

$n$	$p=1$	2	3	4	5	6	7	8
1	0.3333	0.2000	0.1429	0.1111	0.0909	0.0769	0.0667	0.0588
2		0.4857	0.3333	0.2554	0.2075	0.1748	0.1511	0.1331
3			0.5671	0.4172	0.3333	0.2785	0.2395	0.2103
4				0.6193	0.4759	0.3911	0.3333	0.2911

Thus in our previous example we should have had the values  $n = 2$  and  $p = 2$ . We may note that this implies that the random element is eliminated in the third or fourth difference since  $k = 3$  or  $k = 4$  leads to a value of 2 for  $n$ . Entering the table of  $L(n,p)$ , we find that  $100 L(2,2) = 48.57\%$  and hence we conclude that the order of smoothing employed by this choice would remove  $100\% - 48.57\% = 51.43\%$  of the randomness of the series.

Extensive tables of the functions described in this section, together with an alternative method for determining the order of the difference in which the mathematical expectation is eliminated, will be found in the volume by Tintner already mentioned.

As an example of the application of the variate difference method, we shall consider the data for the Cowles Commission All Stocks index (1880-1896). From these data we have the values  $A = 41.4270$ ,  $\sigma = 4.7450$ ,  $\sigma^2 = 22.5149$ ,  $N = 204$ .

The first step is the computation of the variances of the first six differences and their squares together with the corresponding fourth moments. These values are given in the following table:

<sup>8</sup> Note that the values of  $A$  and  $B$  are tabulated in H. T. Davis, *Tables of the Higher Mathematical Functions*, Vol. 2, Bloomington, Ind., 1935, pp. 307-359; in particular, pp. 331-335.

Order of Difference ( $k$ )	$\sigma_k^2$	$M_k^{(k)}$	$M_k^{(k)}/(N-K)$	$\sigma_k^4$
0	22.5149	230,836.6080	1,131.5520	506.9252
1	0.73347	1,513.6183	7.45625	0.53798
2	0.34848	2,374.3676	11.75430	0.12144
3	0.25999	14,088.9195	70.09313	0.06759
4	0.22173	125,622.9648	628.11482	0.04916
5	0.20158	1,405,821.2822	7,064.42855	0.04063
6	0.18856	17,201,798.5201	86,877.77030	0.03555

We next compute the kurtosis ( $D_k$ ) of each difference, the values of  $G_k$ ,  $H(k, N)$ ,  $J(k, N)$ , and hence finally  $Q_k$ . These computations are given below:

Order of Difference ( $k$ )	$D_k$	$G_k - D_k/\sigma_k^4$	$H(k, N)$	$J(k, N)$	$Q_k$
0	-381.7504	-0.75307	14.213189	0.002427	14.22621
1	0.50023	0.92982	29.715297	0.005922	29.63382
2	-0.07562	-0.62271	41.742692	0.010890	43.23440
3	-0.06719	-0.99405	52.091766	0.014112	52.46103
4	-0.05257	-1.06922	61.212589	0.017588	61.79673
5	-0.03185	-0.78388	69.340589	0.020612	69.90765
6	-0.01588	-0.44669	.....	.....	.....

The final step is then to compute the values of  $R_k$ , which are given as follows:

Order of Difference ( $k$ )	$ \sigma_{k+1}^2 - \sigma_k^2 $	$ \sigma_{k+1}^2 - \sigma_k^2 /\sigma_k^2$	$R_k = Q_k  \sigma_{k+1}^2 - \sigma_k^2 /\sigma_k^2$
0	21.7814	0.96742	13.76272
1	0.38499	0.52489	15.55444
2	0.08849	0.25394	10.97899
3	0.03826	0.14714	7.71901
4	0.02015	0.09089	5.61689
5	0.01302	0.06459	4.51535

It is clear from the last table that the random element has not been eliminated from the first five differences since  $R_k$  is still significantly greater than 3. However, the computation indicates that for  $k=7$  or 8 the value of  $R_k$  would not greatly exceed 3. Hence we may assume that  $n=4$  will give a sufficient reduction in the random element. Thus we may select  $n=4$ ,  $p=5$  for the smoothing formula and hence we shall obtain a reduction of 100 per cent — 47.59 per cent = 52.41 per cent in the random element.

The coefficients of the moving average are found from the formula

$$\alpha_s = \alpha_s = A + s^2 B + s^4 C,$$

where  $A$ ,  $B$ , and  $C$  are the values corresponding to the quartic in Section 4. The numerical values of the coefficients are as follows:

$$\alpha_5 = \alpha_5 = 0.0419580, \quad \alpha_4 = \alpha_4 = -0.1048951, \quad \alpha_3 = \alpha_3 = -0.0233100, \\ \alpha_2 = \alpha_2 = 0.1398601, \quad \alpha_1 = \alpha_1 = 0.2797203, \quad \alpha_0 = 0.3333333.$$

By the use of these weights the expected values of the index may now be computed. For illustrative purposes the following 55 items (Cowles Commission



All Stocks index, 1880-1884, preliminary values) have been obtained and they are graphically compared with the original items in the accompanying table and in Figure 47.

Item	Original	Computed	Item	Original	Computed	Item	Original	Computed	Item	Original	Computed
1	41.1	.....	16	50.1	51.2	31	48.3	48.1	46	43.3	43.6
2	41.9	.....	17	52.3	51.6	32	49.7	49.3	47	43.9	43.2
3	42.6	.....	18	52.9	52.0	33	50.2	49.6	48	43.0	42.9
4	41.7	.....	19	51.1	51.4	34	48.9	49.0	49	41.7	42.8
5	38.4	.....	20	49.9	50.7	35	46.8	47.7	50	42.8	42.9
6	38.5	39.3	21	50.3	49.9	36	47.0	46.6	51	42.6	41.9
7	40.3	39.6	22	49.5	49.7	37	46.8	46.2	52	40.9	40.0
8	41.8	40.9	23	49.8	49.4	38	45.7	46.3	53	37.4	37.8
9	41.7	42.1	24	48.4	48.5	39	46.3	46.4	54	35.0	36.4
10	42.9	43.4	25	47.6	47.6	40	47.3	46.8	55	35.9	36.2
11	45.2	45.1	26	46.6	47.0	41	46.4	46.9	56	38.2	36.6
12	47.0	47.3	27	46.5	46.3	42	46.9	46.6	57	36.9	37.0
13	49.8	48.9	28	46.5	45.9	43	46.1	45.7	58	35.7	36.3
14	49.6	49.7	29	45.9	45.9	44	44.0	44.8	59	35.0	35.1
15	50.2	50.4	30	45.7	46.7	45	44.5	44.3	60	34.9	34.5

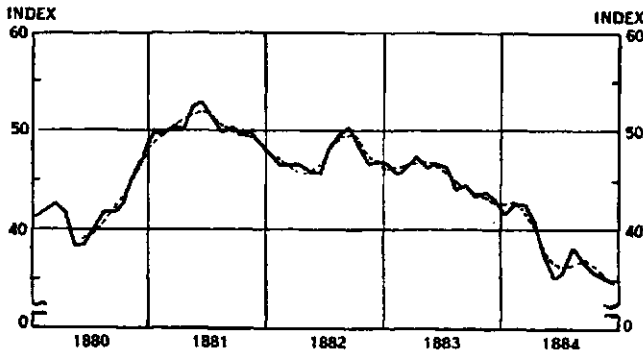

FIGURE 47.—COWLES COMMISSION ALL STOCKS INDEX, 1880-1884.

The original items (—) are smoothed by a moving average (-----) which removes 50 per cent of the random element.

### 10. The Logistic Trend

We have previously explained in Chapter 1 the economic significance of the law of growth as it has been applied to population and production data. In this section we shall survey briefly some of the analytic properties of the logistic curve and its generalization.

By the *logistic curve* we shall mean the curve represented by the function.

$$(1) \quad y = \frac{k}{1 + be^{-at}}$$

where  $a$ ,  $b$ , and  $k$  are parameters to be determined from the data. A fourth parameter,  $c$ , may be introduced into the equation by replacing  $y$  by  $y' - c$ , provided the growth to be analyzed starts at some level greater than zero. Since this is not often the case, it will be more convenient to consider the curve in the form given above.

We shall first discuss the properties of this curve from the somewhat more general function

$$(2) \quad y = \frac{k}{1 + be^{\phi(t)}},$$

where  $\phi(t)$  is an arbitrary function. If we set  $\phi(t) = -at$ , then we obtain the logistic given in equation (1).

The first derivative of  $y$ , as defined by (2), is found to be

$$(3) \quad \frac{dy}{dt} = \phi'(t)y \frac{(y - k)}{k},$$

and the second derivative is given by

$$\frac{d^2y}{dt^2} = \{k\phi''(t) + [\phi'(t)]^2(2y - k)\} \frac{y(y - k)}{k^2}.$$

From the first equation we see that horizontal asymptotes exist, which are the lines  $y = 0$  and  $y = k$ . These values are attained when  $\phi(t)$  is respectively  $+\infty$  and  $-\infty$ .

Maxima and minima of the curve between these limiting values are given for the values of  $t$  which satisfy the equation

$$\phi'(t) = 0.$$

Points of inflection are found for the values of  $t$  which satisfy the equation

$$k\phi''(t) + [\phi'(t)]^2(2y - k) = 0,$$

or, if the value of  $y$  is substituted from (2), for values of  $t$  which satisfy

$$\phi''(t) + [\phi'(t)]^2 + b\{\phi''(t) - [\phi'(t)]^2\}e^{\phi(t)} = 0.$$

For the special case,  $\phi(t) = -at$ , we see that the two asymptotes exist, but that no maximum or minimum value is attained by the function between them.

Only one point of inflection exists for this case and it is determined from the equation

$$e^{-at} = \frac{1}{b},$$

which yields as the co-ordinates of the point the values

$$(4) \quad t = \frac{1}{a} \log_e b, \quad y = \frac{1}{2} k.$$

This we shall call the *critical point* of the logistic curve.

If  $a$  is a positive quantity, then the curve represents growth, proceeding from the asymptote  $y = 0$ , through the point of inflection defined by (4), to the asymptote  $y = k$ . This is the true logistic curve. If  $a$  is negative, then the curve represents a declining function, which drops from the asymptote  $y = k$  to the asymptote  $y = 0$ .

For the special case,  $\phi(t) = at^2$ ,  $a < 0$ , we see that the curve has but one asymptote, namely  $y = 0$ . It also possesses one maximum value, namely, at the point  $t = 0$ . Points of inflection are determined from the equation

$$be^{4at^2} = \frac{(1 + at^2)}{(1 - at^2)}.$$

Closely related to the theory of the logistic is that of the *Gompertz curve*,

$$(5) \quad y = ka^{b^t}, \quad b < 1,$$

the theory of which we have discussed in the first chapter.

From the condition that  $b$  is less than 1, it is seen that  $y$  will approach the value  $k$  as  $t$  tends towards plus infinity. If  $a$  is likewise less than 1, then as  $t$  approaches negative infinity the value of  $y$  will approach zero. The curve thus lies between a lower asymptote,  $y = 0$ , and an upper asymptote,  $y = k$ . It thus resembles the logistic curve in this respect.

The first derivative of (5) is given by

$$(6) \quad \frac{dy}{dt} = (\log a) (\log b) b^t y = \log b \cdot \log \frac{y}{k} \cdot y,$$

which shows that there exists no maximum or minimum value between the asymptotes.

The second derivative of the curve is given by

$$\frac{d^2y}{dt^2} = \log^2 b (\log a) b^t y [(\log a) b^t + 1],$$

$$\frac{d^2y}{dt^2} = \log^2 b \, y \log \frac{y}{k} \left[ \log \frac{y}{k} + 1 \right].$$

Setting this derivative equal to zero, we see that a point of inflection exists when we have

$$\log \frac{y}{k} + 1 = 0.$$

Solving this equation for  $t$  and  $y$  we obtain as the point of inflection

$$t = \frac{-\log(-\log a)}{\log b}, \quad y = \frac{k}{e}.$$

It is interesting to observe that both the logistic and the Gompertz curves belong to the family of curves defined by a differential equation of the form

$$\frac{dy}{dt} = g(t)F(y/k)y,$$

where  $F(z)$  is a function such that  $F(1) = 0$ . The logistic and the Gompertz curves are derived respectively from the assumptions  $F(z) = z - 1$ , and  $F(z) = \log z$ .

The maxima and minima between the two asymptotes  $y = 0$  and  $y = k$  are determined from the zeros of  $g(t)$ .

A number of statistical methods have been developed for fitting the logistic to data. The first of these is due to Raymond Pearl and L. J. Reed.<sup>9</sup> This method consists essentially of a preliminary estimate of the parameters from three equally spaced points and the adjustment of the parameters by computing the errors of the estimated values by means of least squares. This method is effective, but tedious when the series is long. Henry Schultz has given an alternative procedure for correcting the preliminary estimates of the parameters.<sup>10</sup> His solution yields the true least-squares logistic in the sense that the sum of the squares of the differences between the data and the curve is minimized. Unfortunately, however, the method is difficult to apply and because of the fact that differences of second order in the parameters are neglected, it is usually necessary to apply the method several times before a better fit is obtained than that obtained by the

<sup>9</sup> See, for example, Raymond Pearl, *Studies in Human Biology*, Baltimore, 1924, Chapter 24; also Davis and Nelson, *Elements of Statistics*, 2nd ed., 1937, pp. 244-252.

<sup>10</sup> "The Standard Error of a Forecast from a Curve," *Journal of the American Statistical Association*, Vol. 25, 1930, pp. 139-185.

Pearl-Reed procedure. A third method, the "method of the rate of increase," has been suggested by H. Hotelling.<sup>11</sup> This method is simple to apply and yields results which are in close agreement with the other two described above. An adaptation of Hotelling's ideas will be described below.

Although it is somewhat apart from our purpose in this chapter to describe the purely statistical methods of adjusting the logistic to data, this problem frequently arises in practical work and it is useful to have at hand a reasonably simple technique for computing the parameters. The author has found the present method very easy to apply and the graduation quite satisfactory. It is an adaptation of Hotelling's method.

We note from formula (3) that we can write

$$(7) \quad \frac{1}{y} \frac{dy}{dt} = a - (a/k)y .$$

Hence, if we replace  $dy$  and  $dt$  by their increments  $\Delta y$  and  $\Delta t$ , and assume that the latter is equal to unity, then we can write (7) in the form

$$(8) \quad R = p + qy ,$$

where we abbreviate

$$(9) \quad R = \Delta y / y, \quad p = a, \quad q = -a/k .$$

Since (8) is a linear function in  $y$  the parameters  $p$  and  $q$  may be obtained very simply by the method of least squares from the known values of  $R$ . Consequently  $a$  and  $k$  are immediately computed from the last two equations in (9).

The graduation of the data is then immediately accomplished by adding increments successively to any assumed arbitrary value  $y_0$ . These increments are computed from the parabola

$$(10) \quad \Delta y = py + qy^2 .$$

The value of  $b$ , if it is desired, may be estimated for a number of points along the range by means of the formula

$$(11) \quad b = \frac{k - y}{y} e^{-at}$$

and the average of these determinations used as the desired value.

<sup>11</sup> "Differential Equations Subject to Error and Population Estimates," *Journal of the American Statistical Association*, Vol. 22, 1927, pp. 283-314.

As an example of the application of this method we shall graduate the Standard Statistics index of industrial production from 1894 to 1937. The data and computations are given in the following table:

Year	Class Mark ( $t$ )	$y$	$\Delta y$	$1/y$	$R = \Delta y/y$	$y^2$
1884	1	8.7	— 0.1	0.1149	—0.0115	75.69
1885	2	8.6	3.6	0.1163	0.4187	73.96
1886	3	12.2	1.4	0.08197	0.1148	148.84
1887	4	13.6	— 0.1	0.07353	—0.0074	184.96
1888	5	13.5	2.4	0.07407	0.1778	182.25
1889	6	15.9	3.3	0.06289	0.2075	252.81
1890	7	19.2	— 2.1	0.05208	—0.1094	368.64
1891	8	17.1	1.9	0.05848	0.1111	292.41
1892	9	19.0	— 4.2	0.05263	—0.2210	361.00
1893	10	14.8	— 0.9	0.06757	—0.0518	219.04
1894	11	13.9	6.0	0.07194	0.4316	193.21
1895	12	19.9	— 2.1	0.05025	—0.1055	396.01
1896	13	17.8	2.3	0.05618	0.1292	316.84
1897	14	20.1	4.4	0.04975	0.2189	404.01
1898	15	24.5	4.9	0.04082	0.2000	600.25
1899	16	29.4	— 0.9	0.03401	—0.0306	864.36
1900	17	28.5	5.9	0.03509	0.2070	812.25
1901	18	34.4	3.4	0.02907	0.0988	1183.36
1902	19	37.8	— 1.0	0.02646	—0.0265	1428.84
1903	20	36.8	— 2.7	0.02717	—0.0734	1354.24
1904	21	34.1	13.7	0.02933	0.4018	1162.81
1905	22	47.8	— 4.9	0.02092	—0.1025	2284.84
1906	23	52.7	— 0.1	0.01898	—0.0019	2777.29
1907	24	52.6	—17.2	0.01901	—0.3270	2766.76
1908	25	35.4	18.2	0.02825	0.5142	1253.16
1909	26	53.6	2.2	0.01866	0.0411	2872.96
1910	27	55.8	— 5.1	0.01792	—0.0914	3113.64
1911	28	50.7	12.1	0.01972	0.2386	2570.49
1912	29	62.8	2.0	0.01592	0.0318	3943.84
1913	30	64.8	—12.7	0.01543	—0.1960	4199.04
1914	31	52.1	14.1	0.01919	0.2706	2714.41
1915	32	66.2	18.8	0.01511	0.2841	4382.44
1916	33	85.0	1.8	0.01176	0.0212	7225.00
1917	34	86.8	— 4.6	0.01152	—0.0530	7534.24
1918	35	82.2	—10.5	0.01217	—0.1278	6756.84
1919	36	71.7	8.4	0.01395	0.1172	5140.89
1920	37	80.1	—22.8	0.01248	—0.2845	6416.01
1921	38	57.3	20.6	0.01745	0.3595	3283.29
1922	39	77.9	15.0	0.01284	0.1926	6068.41
1923	40	92.9	— 5.8	0.01076	—0.0624	8630.41
1924	41	87.1	8.6	0.01148	0.0987	7586.41
1925	42	95.7	4.3	0.01045	0.0449	9158.49

Year	Class Mark ( <i>t</i> )	<i>y</i>	$\Delta y$	$1/y$	$B = \Delta y/y$	$y^2$
1926	43	100.0	— 2.8	0.01000	—0.0280	10000.00
1927	44	97.2	3.8	0.01029	0.0391	9447.84
1928	45	101.0	7.1	0.009901	0.0703	10201.00
1929	46	108.1	—21.9	0.009251	—0.2026	11685.61
1930	47	86.2	—16.0	0.01160	—0.1856	7430.44
1931	48	70.2	—15.4	0.01425	—0.2195	4928.04
1932	49	54.8	— 6.5	0.01825	—0.1186	3003.04
1933	50	61.3	2.9	0.01631	0.0473	3757.69
1934	51	64.2	9.7	0.01558	0.1511	4121.64
1935	52	73.9	14.7	0.01353	0.1989	5461.21
1936	53	88.6	7.4	0.01129	0.0835	7849.96
1937	54	96.0	—21.7	0.01042	—0.2261	9216.00
Totals		2851.5	42.8		2.6579	198657.11

From the totals given in this table the following normal equations are immediately written down:

$$54p + 2851.5q = 2.6579$$

$$2851.5p + 198657.11q = 42.8.$$

From the solutions,  $p = 0.1563555$ ,  $q = -0.00202886$ , we obtain the desired parameters:  $a = p = 0.1563555$ ,  $k = -p/q = 77.06564$ .

In order to compute successive increments, we now select  $y_0 = 8.7$  as origin and employ formula (10), which now has the numerical form

$$\Delta y = 0.15636y - 0.00202886y^2.$$

The table of values on page 254, with the exception of the second and third columns, which will be explained later, is then computed.

The final problem is the determination of  $b$ , or what is essentially the same thing, the location of the class marks with respect to the graduated values. This may be accomplished in several ways. Since the critical point has an ordinate equal to  $\frac{1}{2}k = 38.53$ , the values of the data may be smoothed by a moving average and the year when this critical value was attained may be estimated. Such a procedure shows that the critical year for the production series was about 1903.

Or, otherwise, one may select several values of  $t$  and then estimate  $b$  for each of these by means of formula (11). Using the class marks  $t$ , and selecting the points  $t = 10$ ,  $t = 15$ ,  $t = 20$ , and  $t = 30$ , we obtain as an estimate of  $b$  the value 22.5978. Substituting this in the first formula of (4) as a check, we obtain  $t = 19.94$  as the class mark of the critical year. From the original data we see that this corresponds to the year 1903 in agreement with our previous estimate.

The data and the logistic are graphically represented in Figure 48.

The values attained by the method which we have just described should not be accepted without some reservation. Apparently a value for  $k$  is often attained which is somewhat lower than the value which one gets by applying the Pearl-Reed method. Thus in the data for the production of pig iron over the period from 1855 to 1925, the method

Year	Class Mark (t)	Graduated Value (y)	$y^2$	$xy$	$xy^2$	$\Delta y = xy + xy^2$
1899	6	8.70	75.69	1.3603	— 0.1536	1.2067
1890	7	9.90	98.01	1.5480	— 0.1988	1.3492
1891	8	11.25	126.56	1.7591	— 0.2568	1.5023
1892	9	12.75	162.56	1.9936	— 0.3298	1.6638
1893	10	14.41	207.65	2.2531	— 0.4213	1.8318
1894	11	16.24	263.74	2.5393	— 0.5351	2.0042
1895	12	18.00	324.00	2.8145	— 0.6574	2.1571
1896	13	20.16	406.43	3.1522	— 0.8246	2.3276
1897	14	22.49	505.80	3.5165	— 1.0262	2.4903
1898	15	24.98	624.00	3.9059	— 1.2660	2.6399
1899	16	27.58	760.66	4.3124	— 1.5433	2.7691
1900	17	30.35	921.12	4.7455	— 1.8688	2.8767
1901	18	33.23	1104.23	5.1958	— 2.2403	2.9555
1902	19	36.19	1309.72	5.6587	— 2.6572	3.0015
1903	20	39.19	1535.86	6.1277	— 3.1160	3.0117
1904	21	42.20	1780.84	6.5984	— 3.6131	2.9853
1905	22	45.19	2042.14	7.0659	— 4.1432	2.9227
1906	23	48.11	2314.57	7.5225	— 4.6959	2.8266
1907	24	50.94	2594.88	7.9650	— 5.2646	2.7004
1908	25	53.64	2877.25	8.3872	— 5.8375	2.5497
1909	26	56.19	3157.32	8.7859	— 6.4058	2.3801
1910	27	58.57	3430.44	9.1580	— 6.9599	2.1981
1911	28	60.77	3692.99	9.5020	— 7.4926	2.0094
1912	29	62.78	3941.33	9.8163	— 7.9964	1.8199
1913	30	64.60	4173.16	10.1009	— 8.4668	1.6341
1914	31	66.23	4386.41	10.3557	— 8.8994	1.4563
1915	32	67.69	4581.94	10.5840	— 9.2961	1.2879
1916	33	68.98	4758.24	10.7857	— 9.6538	1.1319
1917	34	70.11	4915.41	10.9624	— 9.9727	0.9897
1918	35	71.10	5055.21	11.1172	—10.2563	0.8609
1919	36	71.96	5178.24	11.2517	—10.5059	0.7458
1920	37	72.71	5286.74	11.3689	—10.7261	0.6428
1921	38	73.35	5380.22	11.4690	—10.9157	0.5533
1922	39	73.90	5461.21	11.5550	—11.0800	0.4750
1923	40	74.37	5530.90	11.6285	—11.2214	0.4071
1924	41	74.78	5592.05	11.6926	—11.3455	0.3471
1925	42	75.13	5644.52	11.7473	—11.4519	0.2954
1926	43	75.43	5689.68	11.7942	—11.5436	0.2506
1927	44	75.68	5727.46	11.8333	—11.6202	0.2131
1928	45	75.89	5759.29	11.8662	—11.6848	0.1814
1929	46	76.07	5786.64			

gives as the upper saturation level for this series a value of 34,290,000 long tons, while the Pearl-Reed method, after one approximation, yields an estimate of 43,021,000 long tons. The first value is undoubtedly a minimum estimate, while the second appears to be optimistic in the light of actual production during the last decade.



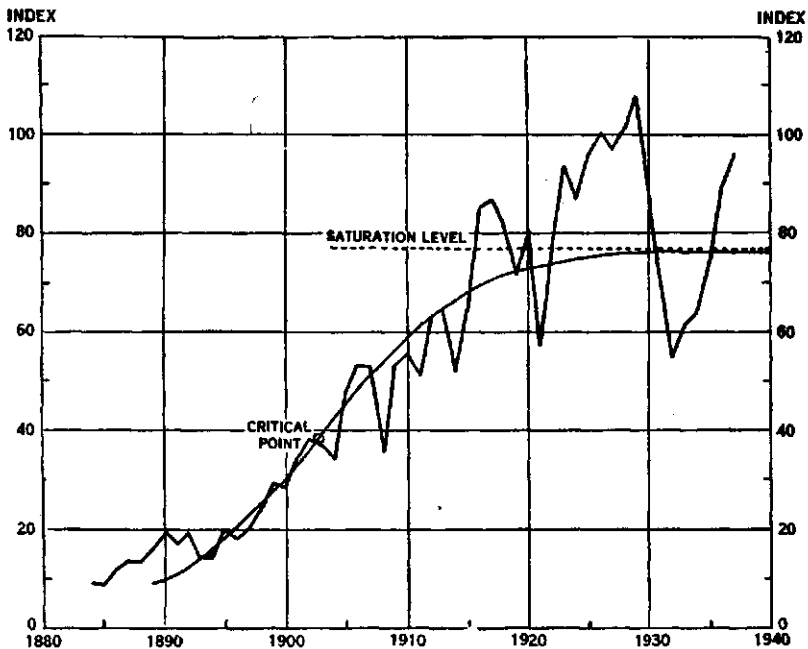

FIGURE 48.—GROWTH OF INDUSTRIAL PRODUCTION, 1884—1937.

### 11. *The Growth of Population*

Among all the series with which economics deals probably the most uniform is that of population. Here we observe the operation of a steady law of growth which is so uniform from one period to another that forecasts of exceptional accuracy are possible not only by years but by decades. This makes the data of population growth unusually attractive to statisticians.

It is obvious that the exponential law of growth,  $y = ae^{bt}$ , should apply with some exactness to a young population, since this law is merely another way of stating the reasonable proposition that the rate of growth is proportional to the population; that is,  $dy/dt = by$ .

But it is equally apparent that some mechanism must eventually operate to decelerate growth, if for no other reason than that territorial limitations must eventually put a bound upon the number of people who can be supported within them. This is another way of stating the famous proposition first argued by the English economist, Thomas R. Malthus (1766-1834), who thought to find this controlling agency of population growth in the assumption "that population has a tendency to increase faster than food." Data for modern populations

do not tend to confirm this explanation. The population of France has reached a stable state without any apparent relationship to the supply of food, and there are strong indications that the rate of growth of the population of the United States is decelerating, while the available food supply far exceeds the population's needs. As a matter of fact, the critical point (see Section 10) in the population figures of the United States is in the year 1914, when the country was entering one of the most spectacular periods of abundance in recorded history.

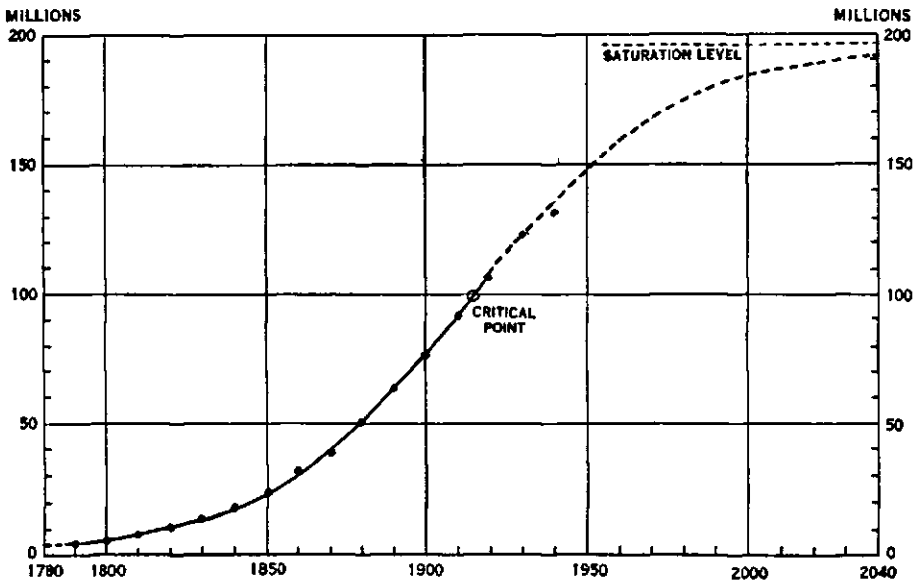

FIGURE 49.—GROWTH OF POPULATION OF THE UNITED STATES, 1790-1920.

Since the mechanism of the deceleration of the rate of growth is thus obscure, we shall not attempt an explanation of the phenomenon. What is important here is to note that the exponential law of growth can apply only at the beginning of a population growth and must be modified by another law such as that of the logistic which imposes an ultimate limitation upon the population.

In the following table we have recorded estimates of the parameters of the logistic

$$y = \frac{k}{1 + be^{-at}}$$

as they have been computed by Pearl-Reed, H. Schultz, and H. Hotelling:<sup>12</sup>

CONSTANTS OF THE LOGISTIC OF POPULATION FOR THE UNITED STATES

Constants	Pearl-Reed	H. Schultz	H. Hotelling
<i>a</i>	0.031396	0.031352	0.031482
<i>b</i>	67.6315	67.1750	67.5352
<i>c</i>	196.5968	196.2624	195.868

These values refer to an origin in 1780 with the time taken in years. The following table gives the estimates of population obtained from the three determinations, although it is obvious that only inconsequential variations exist between the ordinates of the logistic as given by the three computers. The graphical representation of these values is given in Figure 49.

POPULATION ESTIMATES FOR THE UNITED STATES  
(Unit = 1 million)

Year	<i>t</i>	Observed	Pearl-Reed	Schultz	Hotelling
1780	0		2.879	2.879	2.858
1790	10	3.929	3.900	3.918	3.885
1800	20	5.308	5.300	5.321	5.271
1810	30	7.240	7.183	7.209	7.134
1820	40	9.638	9.702	9.732	9.621
1830	50	12.866	13.043	13.076	12.917
1840	60	17.069	17.427	17.463	17.236
1850	70	23.192	23.100	23.135	22.820
1860	80	31.443	30.307	30.337	29.949
1870	90	38.558	39.252	39.273	38.710
1880	100	50.156	50.045	50.047	49.330
1890	110	62.948	62.624	62.598	61.719
1900	120	75.995	76.709	76.647	75.614
1910	130	91.972	91.792	91.685	90.526
1920	140	105.711	107.188	107.036	105.792
1930	150	122.775	122.157	121.958	120.682
1940	160	131.410	136.037	135.794	134.539
1950	170		148.350	148.072	146.878
1960	180		158.854	158.549	157.443
1970	190		167.520	167.196	166.191
1980	200		174.473	174.137	173.233
1990	210		179.929	179.585	178.776
2000	220		184.136	183.788	183.062
2020	240		189.744	189.396	188.797
2040	260		192.879	192.534	192.018
2060	280		194.595	194.253	193.788
2080	300		195.523	195.184	194.749
2100	320		196.022	195.685	195.267

<sup>12</sup> R. Pearl, *Studies in Human Biology*, Chapter 25; H. Schultz, "The Standard Error of a Forecast from a Curve," *Journal of the American Statistical Association*, Vol. 25, 1930, pp. 139-185; H. Hotelling, "Differential Equations Subject to Error, and Population Estimates," *Journal of the American Statistical Association*, Vol. 22, 1927, pp. 283-314.

It is instructive next to inquire when the acceleration of growth of the population became negative, since this critical value is a highly important point on the curve. It seems to the writer a hazardous procedure to forecast from the logistic curve until the actual growth has passed this critical value. From the Pearl-Reed estimates we at once compute

$$t = (\log_e 67.6315) / 0.031396 = 134.2232 ;$$

since the origin was in 1780, this gives approximately March, 1914.

We also observe from the table of values given above that the curve of population growth is an unusually stable one when compared with other time series which describe the historical behavior of such economic variables as price and production. This stability is a fortunate matter since it undoubtedly contributes a great deal to the stability of other series. If per capita estimates of economic variation can be approximately predicted, then it is clear that the total variation can be estimated without essential loss of accuracy.

Another significant thing that we should notice is the essential difference between the growth of a population which is subject to no central mechanism of control and the growth of a population subject to such a mechanism. The first may be illustrated by a colony of fruit flies (*drosophila melanogaster*), which is allowed to grow freely within the limits of a pint bottle, or of a population of yeast cells. The second is illustrated by the growth of the cells of a pumpkin, or of the increase in weight of an animal from birth to maturity. Analytically the difference between the two types of growth is found in the observation that in the first instance  $\phi(t)$  in equation (2) of Section 10 is a linear function of  $t$ , namely  $-at$ , whereas, in the second instance,  $\phi(t)$  is the cubic function  $a_1t + a_2t^2 + a_3t^3$ .

The question of the growth of population of biological organisms has been extensively studied by Pearl, who used as his experimental material colonies of the fruit fly. In the experiment whose data are recorded below, a colony of fruit flies, a mutant from *quintuple*, was started with 2 males, each 15 days old, one male and 3 females each 2 days old, 12 pupae and a small number of eggs and larvae. Population counts were made 10 times until the problems of managing the food supply became difficult. The data, together with their graduated values computed from the logistic

$$y = \frac{346.14}{1 + e^{8.34 - 0.23t}}$$

are recorded in the following table:

## GROWTH OF POPULATION OF QUINTUPLE STOCK OF DROSOPHILA IN A PINT BOTTLE.\*

Date of Census	Obs. Pop.	Cal. Pop.	Date of Census	Obs. Pop.	Cal. Pop.
Oct. 6	6	6.0	Oct. 24	163	162.6
Oct. 9	10	11.3	Oct. 27	226	218.0
Oct. 13	21	25.9	Oct. 30	265	265.0
Oct. 15	52	38.5	Nov. 3	282	306.8
Oct. 18	67	67.0	Nov. 7	319	324.5
Oct. 21	104	109.2			

\* Data from Pearl, *The Biology of Population Growth*, p. 224.

The excellent agreement between the observed and calculated population is exhibited in Figure 50.

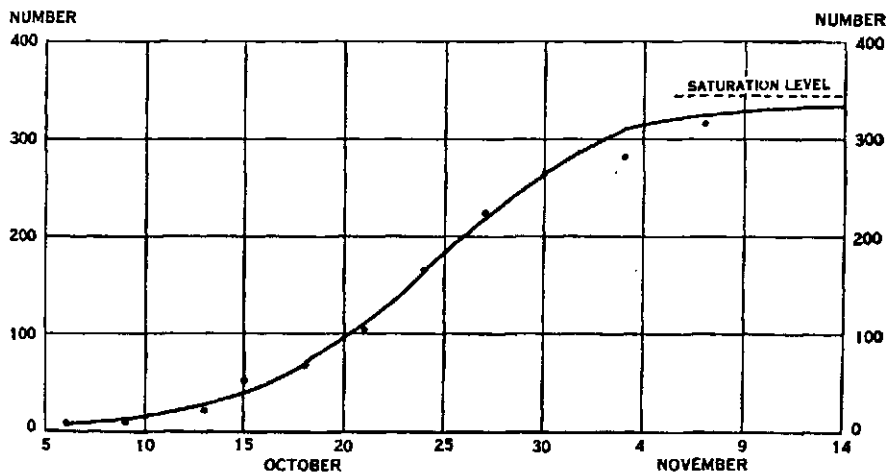

FIGURE 50.—GROWTH OF POPULATION OF FRUIT FLIES.

A similar phenomenon is observed in the growth of yeast cells, a population which might be regarded as being somewhere between a population of independent organisms such as the fruit flies and a population of cells controlled by a central mechanism. The following data are due to T. Carlson.<sup>13</sup> In the experiment from which these data were obtained a few cells of yeast were dropped into a proper medium for their development and the entire colony kept at a moderately warm temperature. The census was taken daily until the asymptotic value of the growth was attained.

The data are given below. Their graphical representation, together with their logistic of growth computed from the equation

$$y = \frac{66.5}{1 + e^{4.1898 - 0.5255t}}$$

is shown in Figure 51.

<sup>13</sup> "Ueber Geschwindigkeit und Grösse der Hefevermehrung in Würze," *Biochem. Zeitschrift*, Vol. 57, 1913, pp. 313-334.

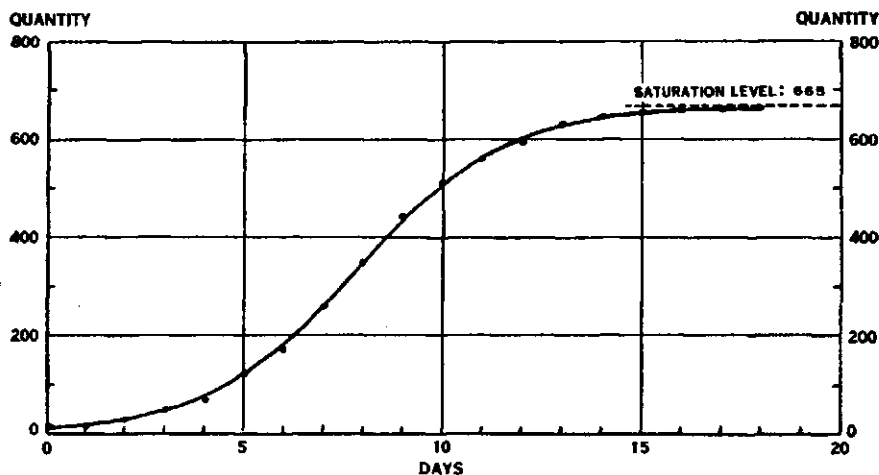

FIGURE 51.—GROWTH OF POPULATION OF YEAST CELLS.

## GROWTH OF A POPULATION OF YEAST CELLS

Age in Days	Quantity of Yeast		Age in Days	Quantity of Yeast	
	Obs.	Cal.		Obs.	Cal.
0	9.6	9.9	10	513.3	506.9
1	18.3	16.8	11	559.7	562.3
2	29.0	28.2	12	594.8	600.8
3	47.2	46.7	13	629.4	625.8
4	71.1	76.0	14	640.8	641.5
5	119.1	120.1	15	651.1	651.0
6	174.6	181.9	16	655.9	656.7
7	257.3	260.3	17	659.6	660.1
8	350.7	348.2	18	661.8	662.1
9	441.0	433.9			

$\sigma = 3.59$

We now compare the growth of individual organisms with the growth of a population subject to a central mechanism in order to establish the essential difference between the two phenomena. For this purpose we consider the growth of a white rat from infancy to maturity after an experiment by Donaldson. In the following table there is recorded the actual weight in grams of the male white rat over the period of a year, together with the calculated weight as graduated by the curve

$$y = 7 + \frac{273}{1 + e^{4.3204 - 7.2196t + 30.0876t^2 - 0.5291t^3}}$$

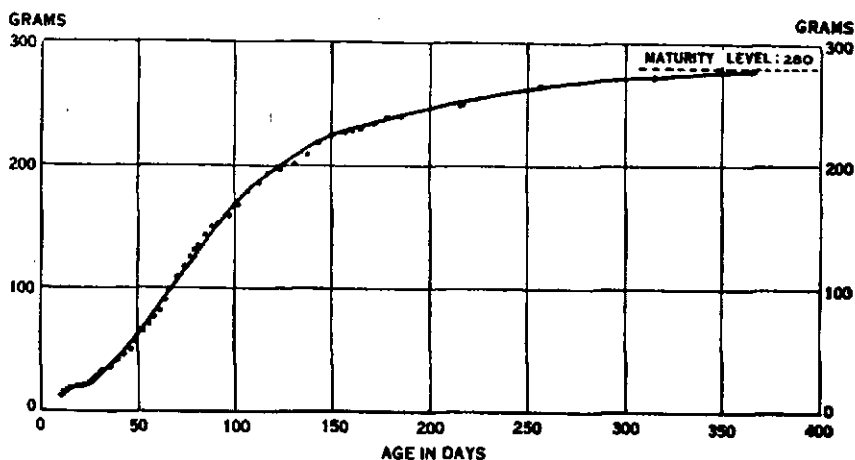

FIGURE 52.—GROWTH IN BODY WEIGHT OF MALE WHITE RATS.

## OBSERVED AND CALCULATED VALUES FOR THE GROWTH IN WEIGHT OF THE MALE WHITE RAT\*

Age in days	Obs. Wt. in grams	Cal. Wt. in grams	Age in days	Obs. Wt. in grams	Cal. Wt. in grams	Age in days	Obs. Wt. in grams	Cal. Wt. in grams
10	13.5	14.1	46	50.5	52.8	107	177.6	178.1
11	13.3	14.5	49	56.7	58.3	112	183.3	185.6
12	14.8	15.0	52	62.5	64.2	117	191.4	192.2
13	15.3	15.5	55	68.5	70.4	124	197.3	200.6
14	15.2	16.1	58	73.9	76.8	131	202.5	208.1
15	16.5	16.7	61	81.7	83.4	138	209.7	214.5
17	17.8	17.9	64	89.1	90.1	143	218.3	218.6
19	19.5	19.3	67	99.3	97.0	150	225.4	228.7
21	21.2	20.8	70	106.3	103.8	157	227.0	228.2
23	22.9	22.4	73	113.8	110.7	164	231.4	232.1
25	25.3	24.2	76	121.3	117.6	171	235.8	235.7
27	27.4	26.1	79	128.2	124.3	178	239.4	238.9
29	29.5	28.2	82	135.0	130.9	185	239.8	241.9
31	31.8	30.5	85	143.8	137.4	216	252.9	252.7
34	34.9	33.2	88	148.4	148.7	256	265.4	264.4
37	37.8	38.3	92	152.3	151.7	365	279.0	279.6
40	42.2	42.7	97	160.0	161.2			
43	46.3	48.6	102	168.8	170.0			

 $\sigma = 4.96$ \* See H. H. Donaldson, *The Rat*, Philadelphia, Wistar Institute, 1915.

It is clear from the data and from the graduation curve (see Figure 52) that the growth of organisms subject to a central mechanism does not conform strictly to the logistic. The exponent is a cubic function of the time, which indicates that the initial growth is more rapid than in those data for which the logistic holds.

This conclusion is also confirmed by the following data on the growth of the pumpkin (*cucurbita pepo*) and its graduation curve (see Figure 53):

$$y = 174 + \frac{5190}{1 + e^{10.3149 - 16.3399t + 8.1028t^2 - 1.6667t^3}}$$

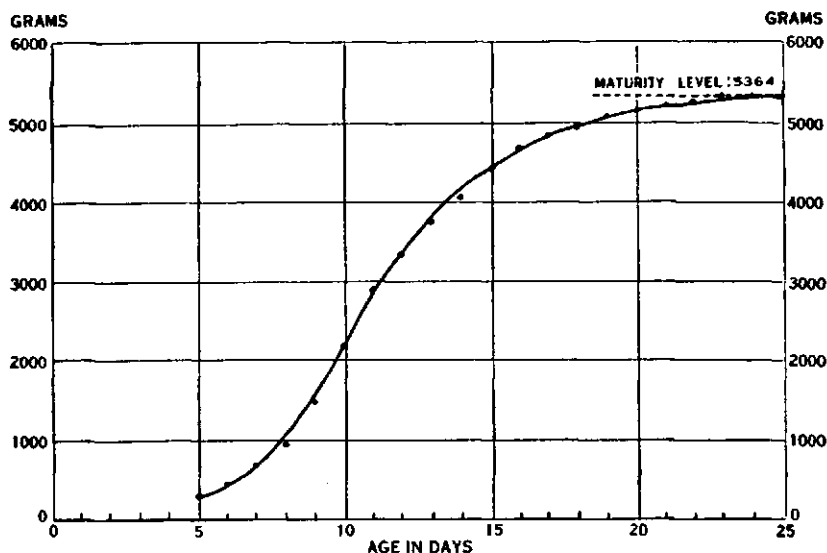

FIGURE 53.—GROWTH IN WEIGHT OF THE PUMPKIN.

OBSERVED AND CALCULATED VALUES FOR THE GROWTH IN WEIGHT OF THE PUMPKIN\*

Age in days	Obs. Wt. in grams	Cal. Wt. in grams	Age in days	Obs. Wt. in grams	Cal. Wt. in grams	Age in days	Obs. Wt. in grams	Cal. Wt. in grams
5	267	267	12	3366	3378	19	5114	5089
6	443	399	13	3758	3829	20	5176	5172
7	658	645	14	4092	4186	21	5242	5236
8	961	1044	15	4488	4464	22	5298	5282
9	1498	1586	16	4720	4680	23	5352	5315
10	2200	2210	17	4864	4850	24	5360	5337
11	2920	2829	18	4980	4984	25	5366	5350

\* Data from T. B. Robertson, *The Chemical Basis of Growth and Senescence*, Philadelphia, 1923.

The biological reasons for this observed difference between the growth of population of independent organisms and the growth of colonies of individual cells subject to a central mechanism are still obscure. But the difference itself is clearly established by these empirical studies and must be taken into account in the application of the logistic to population data. The question naturally arises as to whether the growth of cities, themselves subjected to central planning, the direction of Chambers of Commerce, etc., may not be more closely related to the growth of individual organisms than to the growth of colonies of individuals. It is too early yet to answer this question since American cities have been growing rapidly until recent years. However, the following data, which are graphically represented in Figure 54, indi-



cate that the growth of New York City and Chicago is more rapid than the growth of the population of the country itself and that probably the graduation of the data by the simple logistic would not be satisfactory. The answer will be much clearer, however, when the populations get closer to their asymptotic limits. The data are given in the following table:

THE GROWTH OF POPULATION IN NEW YORK CITY AND CHICAGO

New York City					Chicago				
Year	Pop.	Year	Pop.	Year	Pop.	Year	Pop.	Year	Pop.
1790	33,131	1840	348,943	1890	2,507,414	1840	4,853	1890	1,099,850
1800	63,787	1850	612,385	1900	3,437,202	1850	29,963	1900	1,698,575
1810	100,775	1860	1,174,779	1910	4,766,883	1860	109,260	1910	2,185,233
1820	130,881	1870	1,478,103	1920	5,620,048	1870	298,977	1920	2,701,705
1830	217,985	1880	1,911,698	1930	6,930,446	1880	503,185	1930	3,376,438
				1940	7,380,259	1940		1940	3,384,556

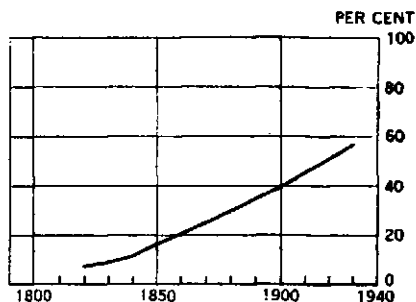
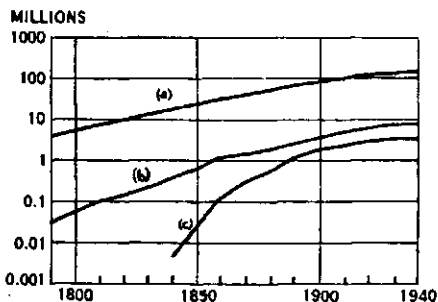

FIGURE 54.—POPULATION GROWTH OF CITIES AS COMPARED WITH POPULATION GROWTH OF THE UNITED STATES: (a) United States, (b) New York, (c) Chicago.

FIGURE 55.—URBAN CONCENTRATION. This chart shows the nearly linear shift from rural to urban living

But it is evident that another factor has been at work in accelerating the growth of cities. As scientific development has progressed there has been an astonishing shift of the population from rural to urban living. How great this movement has been is revealed in the following table showing urban concentration in places of 2500 inhabitants or more since 1820. The data are due to L. E. Truesdell.<sup>14</sup>

URBAN CONCENTRATION IN PER CENT

Year	1820	1830	1840	1850	1860	1870	1880	1890	1900	1910	1920	1930
Per Cent Urban	7.0	8.4	11.6	16.8	20.8	26.2	29.6	35.4	40.0	45.8	51.4	56.2

<sup>14</sup> *Growth of Urban Population in the United States of America*, U. S. Dept. of Commerce, 1937.

Figure 55 shows that the percentage increase has been essentially linear since 1830, the average increase for the 110 years being 4.5 per cent per decade. Since 1890 the average has increased slightly to 5.2 per cent. We thus see that cities have tended to grow faster than the population and estimates of their future size must take into account this general movement of the population.

It seems quite reasonable to suppose, however, that, as industrial production levels off around its equilibrium position, this tendency toward urban concentration will cease. In fact, this deceleration may come rather abruptly, and in this case, we might expect to see cities attain their maturity more rapidly than the country itself. These phenomena, if interpreted analytically, would appear to show that the growth of American cities may be governed by a mechanism which more nearly resembles the growth of individual organisms than the growth of colonies of individuals.

In order to account for the logistic character of population growth Pearl has made a rather elaborate study of the influence of the density of population on the birth rate and has found a small negative correlation,  $r = -0.175$  with a probable error of  $\pm 0.057$ , after other influences have been accounted for. This confirmed a study made by J. L. Brownell in 1894.<sup>15</sup> Pearl reaches the conclusion: "The bearing of the results set forth in this chapter on the general problem of the causes lying back of the logistic curve is evident. As any population confined within definite spatial limits goes up on the logistic curve its density automatically becomes greater and greater. But if, as the evidence indicates, increasing density has associated with it the biological effect of a reduction in the rate of reproduction of the population exhibiting it, then obviously there is in this relationship a factor which may appear as a *vera causa* in damping the time rate of growth in the upper half of the logistic curve."<sup>16</sup>

Factors extraneous to normal growth by the logistic law are observable also in other population statistics. A notable example of this is the growth of educational institutions, which has been considerably greater than the normal growth of the population. This has been due in part to urban concentration, to increased standards of living, and, perhaps, also to an increase in general belief in the virtues of education itself.

<sup>15</sup> "The Significance of a Decreasing Birth-rate," *Annals of the Academy of Political and Social Science*, Vol. 5, 1894-95, pp. 48-49.

<sup>16</sup> *The Biology of Population Growth*, p. 157.

### 12. *The Growth of Production*

The great wealth of the United States and the remarkably high standard of living attained by its population are due in the final analysis to the growth of production and trade over the past century and a half. We have already cited the remarks of Carl Snyder, who has observed a per capita growth of about 2.8 per cent per annum for production and trade.

But the last decennium has revealed a somewhat different picture. Beginning with the collapse of the great bull market in 1929, industrial production indexes declined to unprecedented lows. The secular advance of 2.8 per cent was abruptly halted. The saturation level of automobile production clearly had been reached, and the recurring difficulties of the steel industry may be traced to the apparent fact that its development has surpassed society's capacity to absorb its production. Like other organisms, the mechanism of industrial production is subject to the laws of organic growth and Snyder's annual average of increase must finally give way to the leveling process of the logistic law.

One of the best indexes to reveal the astonishing growth of the production of the United States is that of pig iron. The data are given in the table on page 266 and they are graphically represented in Figure 56c.

It will be observed from a comparison of the production of pig iron with the index of industrial production (Figure 48) that the astonishing increase in the productive activities of the American economy is associated with the use of iron.

In a very suggestive work published in 1930 and using data for the most part prior to the year 1925, S. S. Kuznets gave a number of logistics pertaining to industrial, agricultural, and other indexes.<sup>17</sup> Hence, in his work we have essentially a series of forecasts into the very interesting period which followed 1925. It is probable that Kuznets' logistics were not corrected by the method of least squares and are to be regarded as approximations to the trend rather than curves fitted with sufficient care to form a basis for forecasting. In particular, the parameter  $k$  in equation (1) of Section 10, which measures the asymptotic level, is especially sensitive to the data and should always be adjusted carefully if it is to be employed as the basis of a forecast.

The parameters of the logistic curves for the production of wheat,

<sup>17</sup> *Secular Movements in Production and Prices*, Boston, 1930, xxiv + 536 pp.

## PRODUCTION OF PIG IRON

Year	Production in 1000 long tons	Per Capita Production in long tons	Year	Production in 1000 long tons	Per Capita Production in long tons	Year	Production in 1000 long tons	Per Capita Production in long tons
1855	700	0.0256	1884	4098	0.0740	1913	30966	0.3209
1856	789	0.0280	1885	4045	0.0714	1914	23332	0.2383
1857	713	0.0246	1886	5683	0.0981	1915	29916	0.3011
1858	630	0.0211	1887	6417	0.1084	1916	39435	0.3914
1859	751	0.0245	1888	6490	0.1073	1917	38621	0.3780
1860	821	0.0261	1889	7604	0.1231	1918	39055	0.3770
1861	653	0.0203	1890	9203	0.1459	1919	31015	0.2954
1862	703	0.0214	1891	8280	0.1286	1920	36926	0.3466
1863	846	0.0252	1892	9157	0.1394	1921	16688	0.1542
1864	1014	0.0295	1893	7125	0.1064	1922	27220	0.2477
1865	832	0.0237	1894	6657	0.0975	1923	40361	0.3619
1866	1206	0.0337	1895	9446	0.1358	1924	30406	0.2686
1867	1305	0.0358	1896	8623	0.1216	1925	36116	0.3144
1868	1431	0.0385	1897	9653	0.1337	1926	38698	0.3321
1869	1711	0.0451	1898	11774	0.1602	1927	35858	0.3215
1870	1665	0.0431	1899	13621	0.1821	1928	37402	0.3120
1871	1707	0.0429	1900	13789	0.1811	1929	41757	0.3436
1872	2549	0.0622	1901	15878	0.2042	1930	29905	0.2430
1873	2561	0.0608	1902	17821	0.2245	1931	17813	0.1435
1874	2401	0.0555	1903	18009	0.2224	1932	8550	0.0684
1875	2024	0.0455	1904	16497	0.1997	1933	13001	0.1034
1876	1869	0.0410	1905	22992	0.2730	1934	16139	0.1275
1877	2067	0.0442	1906	25307	0.2948	1935	21373	0.1676
1878	2301	0.0480	1907	25781	0.2948	1936	30712	0.2391
1879	2742	0.0559	1908	15936	0.1789	1937	36600	0.2830
1880	3835	0.0763	1909	25795	0.2844	1938	18763	0.1441
1881	4144	0.0804	1910	27304	0.2959	1939	31532	0.2404
1882	4623	0.0875	1911	23650	0.2525	1940	41786	0.3162
1883	4596	0.0850	1912	29727	0.3127			

corn, pig iron, and copper are given in the following table, the variable  $t$  being taken in units of five years:

Constants	Wheat	Corn	Pig Iron	Copper
$a$	+0.28700	+0.21168	+0.40137	+0.60928
$b$	3.1339	3.4667	64.546	9.7499
$k$	1,012.8	3,971.2	50,403	699.5
Origin	1870	1865	1860	1885

But an inspection of Figure 56 shows that these values are unduly optimistic except in the case of copper. The production of corn and pig iron, in particular, has fallen far short of the saturation estimates of 3,971.2 and 50,403 respectively in the face of the observation that saturation levels have apparently been attained for this era of the industrial evolution.

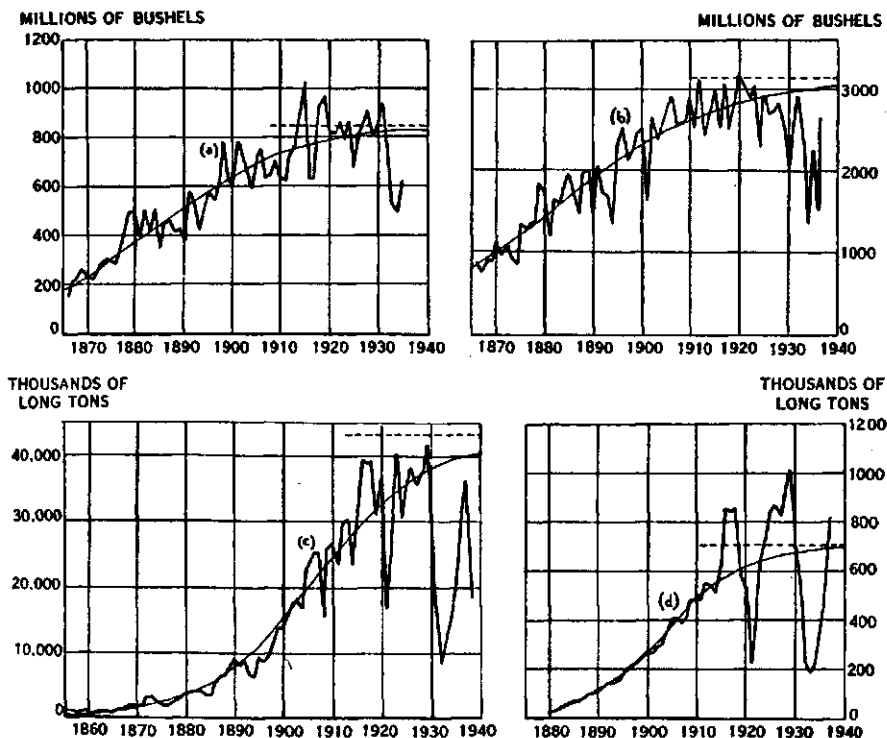

FIGURE 56.—PRODUCTION CURVES AND LOGISTICS.

(a) Wheat, (b) Corn, (c) Pig Iron, (d) Copper.

For this reason, it was deemed advisable to recompute the parameters (except in the case of copper) by the method of Pearl and Reed, which gives approximately an adjustment by least squares. In order to obtain comparable results only data through 1925 were employed. The following estimates of the parameters were then obtained, the variable  $t$  being taken as before in units of five years:

Constants	Wheat	Corn	Pig Iron
$a$	0.35075	0.30230	0.44905
$b$	3.6702	2.9168	66.1102
$k$	845.4	3,128.2	43,021
Origin	1865	1865	1860

The logistics based upon these values are graphically represented in Figure 56 and seem to describe with some accuracy the actual behavior of the series in the years after 1925. Both the production of wheat and the production of corn have been affected adversely by the

drought period in the middle of the present decade and by governmental restrictions upon acreage planted. That both series will tend to oscillate about the established equilibrium lines in the future may be expected.

An inspection of the logistic for the production of pig iron shows an optimum which the events of the last few years have denied. Saturation production is seen to be around 43,000,000 long tons annually. It is interesting to speculate when, if ever, the production of pig iron will attain this asymptotic value. An inspection of the graph reveals three maxima in the production curve, one due to the use of pig iron in the World War, a second around 1924 due probably to the rapid expansion of the automobile industry during this period, and the third in 1929 when the building cycle reached its maximum. We next inspect the table of per capita production of pig iron and observe that there has been a steady increase since 1855 in the use of iron. This per capita use reached the incredible value of 0.39 tons in 1916, due of course to the war, another maximum of 0.36 in 1923, due to the expansion of the automobile industry, and a third maximum of 0.34 in 1929, due to building. The amazing magnitude of the depression is clearly shown from the fact that in 1932 the per capita use of pig iron dropped to 0.068 tons, a value lower than any since 1879. Since it is improbable that another industry like that of automobiles will be developed in the next few years, we cannot expect a large per capita production from such a source. But war is not improbable, and building booms seem to follow a somewhat irregular cycle of from 17 to 20 years in length. Hence we may expect to see again a per capita production around 0.35 tons from one or the other of these two sources. But a per capita production of 0.35 tons for a population of 123,000,000 people will yield a total in excess of 43,000,000 long tons. Hence we may expect to see the asymptotic figure exceeded during the next war or during the next building cycle. In fact, the present rearmament program of the government has greatly increased the demand for steel and the asymptotic limit will undoubtedly be exceeded while this program is being carried out.

From the table of parameters given above it is interesting to compute the dates of the respective critical points by means of formula (4) of Section 10. These are found to be the following: wheat, 1885; corn, 1882; pig iron, 1907; copper, 1904. It is interesting to observe that the critical points for the grains agree and that the critical points for the metals are also essentially the same. The latter, in particular, are seen to be in agreement with the critical point for industrial production which, in Section 10, we estimated to be around 1903.

The actual data from which the logistics have been computed, with the exception of those for the production of pig iron which were given earlier in this section, are contained in the following tables:

PRODUCTION OF WHEAT  
(Unit = 1,000,000 bushels)

Year	Prod.	Year	Prod.	Year	Prod.	Year	Prod.	Year	Prod.	Year	Prod.
1865	.....	1877	364.2	1889	434.4	1901	788.6	1913	763.4	1925	676.4
1866	152.0	1878	420.1	1890	378.1	1902	724.8	1914	891.0	1926	831.0
1867	212.4	1879	496.4	1891	584.5	1903	663.9	1915	1025.8	1927	878.4
1868	224.0	1880	498.6	1892	528.0	1904	596.9	1916	636.3	1928	914.9
1869	260.1	1881	383.3	1893	427.6	1905	726.8	1917	636.7	1929	812.6
1870	235.9	1882	504.2	1894	516.5	1906	756.8	1918	921.4	1930	857.4
1871	230.7	1883	421.1	1895	569.5	1907	638.0	1919	968.0	1931	932.2
1872	250.0	1884	512.8	1896	544.2	1908	644.7	1920	833.0	1932	745.8
1873	281.3	1885	357.1	1897	610.3	1909	700.4	1921	814.9	1933	529.0
1874	308.1	1886	457.2	1898	772.2	1910	635.1	1922	867.6	1934	496.6
1875	292.1	1887	456.3	1899	636.1	1911	621.3	1923	797.4	1935	626.3
1876	289.4	1888	415.9	1900	602.7	1912	730.3	1924	864.4	1936	636.5
										1937	874.0

PRODUCTION OF CORN  
(Unit = 1,000,000 bushels)

Year	Prod.	Year	Prod.	Year	Prod.	Year	Prod.	Year	Prod.	Year	Prod.
1865	.....	1877	1342.6	1889	1998.7	1901	1613.5	1913	2447.0	1925	2917.0
1866	867.9	1878	1388.2	1890	1460.4	1902	2619.5	1914	2672.8	1926	2692.2
1867	768.3	1879	1823.2	1891	2055.8	1903	2346.9	1915	2994.8	1927	2763.1
1868	906.5	1880	1717.4	1892	1713.7	1904	2528.7	1916	2566.9	1928	2818.9
1869	874.3	1881	1194.9	1893	1707.6	1905	2748.9	1917	3065.2	1929	2535.4
1870	1094.3	1882	1617.0	1894	1339.7	1906	2897.7	1918	2502.7	1930	2059.6
1871	991.9	1883	1551.1	1895	2311.0	1907	2512.1	1919	2811.3	1931	2588.5
1872	1092.7	1884	1795.5	1896	2503.5	1908	2545.0	1920	3208.6	1932	2906.9
1873	932.3	1885	1936.2	1897	2144.6	1909	2572.3	1921	3068.6	1933	2350.7
1874	850.1	1886	1665.4	1898	2261.1	1910	2886.3	1922	2906.0	1934	1377.1
1875	1321.1	1887	1456.2	1899	2454.6	1911	2531.5	1923	3053.6	1935	2296.7
1876	1283.8	1888	1987.8	1900	2505.1	1912	3124.7	1924	2309.4	1936	1524.3
										1937	2645.0

PRODUCTION OF COPPER  
(Unit = 1000 long tons)

Year	Prod.	Year	Prod.	Year	Prod.	Year	Prod.	Year	Prod.	Year	Prod.
1880	27.0	1890	116.0	1900	270.6	1910	482.2	1920	530.8	1929	1006.2
1881	32.0	1891	126.8	1901	268.8	1911	489.8	1921	225.7	1930	690.5
1882	40.5	1892	154.0	1902	294.4	1912	555.0	1922	424.2	1931	528.9
1883	51.6	1893	147.0	1903	311.6	1913	546.7	1923	640.6	1932	238.1
1884	64.7	1894	158.1	1904	362.7	1914	513.4	1924	729.6	1933	190.7
1885	74.1	1895	169.9	1905	402.6	1915	619.6	1925	842.1	1934	239.3
1886	70.4	1896	205.4	1906	409.8	1916	860.6	1926	872.4	1935	369.5
1887	81.0	1897	220.6	1907	387.9	1917	842.0	1927	830.0	1936	592.2
1888	101.1	1898	235.1	1908	420.8	1918	852.0	1928	909.1	1937	812.0
1889	101.2	1899	253.9	1909	487.9	1919	574.3				

A much more fundamental lesson is learned from these logistics. The era of the great scientific revolution which began approximately with the discoveries of Galileo (1564-1642), Tycho Brahe (1546-1601), Johann Kepler (1571-1630), and Sir Isaac Newton (1642-1727) is reaching its maturity. The amazing energies of science, directed by the patterns set by these great leaders, have given us in rapid succession the steam engine, the dynamo, the telegraph and telephone, the automobile, the airplane, the radio, and all the other wonders of the modern world. This transition from the past to the present regime may be estimated by the per capita increase in the use of iron. If we are attaining the upper asymptote of the production of this basic commodity, then also the maturity of technological science must be close at hand. But there can be no real regrets if this should happen to be true, since in the process of scientific growth the lot of the human race has been immeasurably elevated. The standards of living in America and in those of other nations which desired to profit by the new knowledge have been greatly raised.

Another question that may be raised concerning the validity of the logistic to describe production data relates to the growth of industry in special centers as compared with the growth of industry for the country as a whole.

In the last section we observed that cities have grown more rapidly than total population, a phenomenon which is closely related to the steady shift from rural to urban living. For this reason, the growth of cities has resembled more the growth of organisms controlled by a central mechanism, than it has the growth of colonies of organisms. The question naturally arises as to whether industrial production does not exhibit a similar phenomenon.

Strong evidence for the truth of this thesis is furnished by the investigations of the Bureau of Business Research of the University of Pittsburgh under the direction of R. J. Watkins. This study shows the trend of industrial production for the Pittsburgh district and is based upon 12 statistical series covering manufacturing and coal mining.

In Figure 57 the trend for the Pittsburgh district has been compared with the trend of industrial production for the United States for the period 1884-1937. The index used has been constructed from the Warren M. Persons indexes of manufacturing and mining for the period 1884-1930 and from the Federal Reserve Board indexes for the subsequent period. Weights were assigned in the ratio of seven for manufacturing to one for mining.

The phenomenon to be observed is that production in the Pitts-



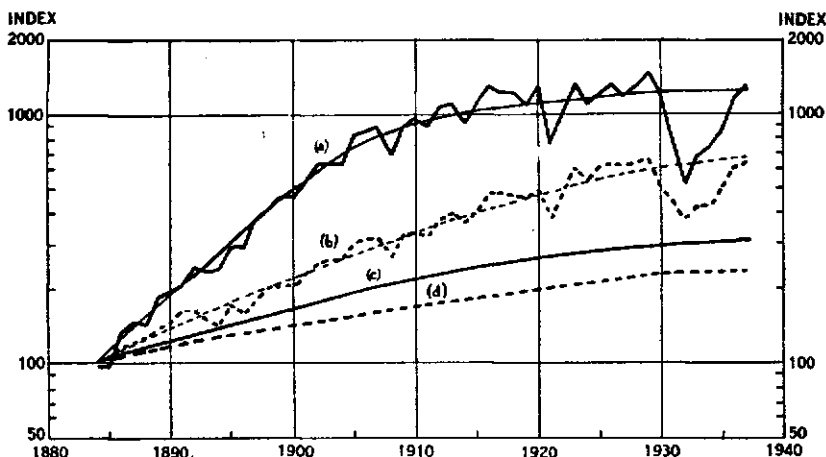

FIGURE 57.—INDUSTRIAL PRODUCTION AND POPULATION: PITTSBURGH DISTRICT AND UNITED STATES:

(a) Production, Pittsburgh District, (b) Production, United States, (c) Population, Pittsburgh District, (d) Population, United States. January, 1884 = 100. (Data from Bureau of Business Research, University of Pittsburgh).

burgh district grew more rapidly and attained maturity earlier than production for the country as a whole. There is observed here, perhaps, the same difference noted between the growth of male white rats and the growth of colonies of fruit flies. In the first instance a central mechanism governed the growth, while in the second the growth and the maturity of the population appeared to be a mechanism of the population itself. It seems reasonable, arguing by analogy only, to assume that the production growth of a district with its centralized government and its civic organizations might resemble more closely the growth of a self-contained organism than the growth of separate units controlled only by the population itself. At least the hypothesis is worth stating and might be verified or disproved by the study of a sufficient number of unified areas of production.

### 13. Frequency Distributions of Time Series

One important aspect of the problem of trends concerns the distribution of the residuals of a time series. Can the distribution be assumed to be a normal one provided the proper trend has been employed in the reduction? To this question no categorical answer can be given, but since the trend plays much the same role in the theory of time series as the mean does in the theory of ordinary frequency statistics, it seems reasonable to expect that under most conditions the residuals would form a normal distribution.

D. H. Leavens, considering the problem of the frequency distributions which correspond to time series, has made the following pertinent comments:

Biometric and educational statisticians have made much use of frequency distributions but have not been greatly interested in time series. Economic and business statisticians, on the other hand, have concerned themselves chiefly with time series and have done comparatively little with frequency distributions. Thus the two theories have grown up more or less independently of each other. Sometimes, however, frequency distributions are made of items from a time series. Moreover, in the analysis of business cycles, the cycle relatives sometimes are expressed in units of their standard deviation, a concept borrowed from frequency distributions.

It is the purpose of this paper to consider what types of frequency curves will correspond to certain types of time series curves, and in particular to investigate the meaning of the standard deviation of items in a time series. For simplicity, we shall deal with curves that fluctuate around a horizontal axis, corresponding to time series from which trend and seasonal have been removed. Moreover, we shall assume that random fluctuations have been eliminated, leaving purely cyclical curves which rise steadily from the bottom to the top of the cycle.<sup>18</sup>

The mathematical technique for the computation of the frequency distribution corresponding to the time series may be described as follows:

Let us suppose that  $y = f(x)$  is a symmetric distribution function. Then

$$(1) \quad A(x) = \int_0^x f(x) dx$$

is the cumulative frequency curve, and the original function is derived from the relationship

$$(2) \quad f(x) = \frac{dA}{dx} .$$

Now if  $x = g(t)$  is a time series, then the cumulative frequency curve will be given by the inverse of  $g(t)$ , namely,

$$(3) \quad t = g^{(-1)}(x) ,$$

where  $g^{(-1)}(x)$  designates the inverse of the function  $g(x)$ . It may be remarked incidentally that this inverse can be constructed graphically by reflecting the function  $g(t)$  in the 45° line through the origin of co-ordinates.

<sup>18</sup> "Frequency Distributions Corresponding to Time Series," *Journal of the American Statistical Association*, Vol. 26, 1931, pp. 407-415.

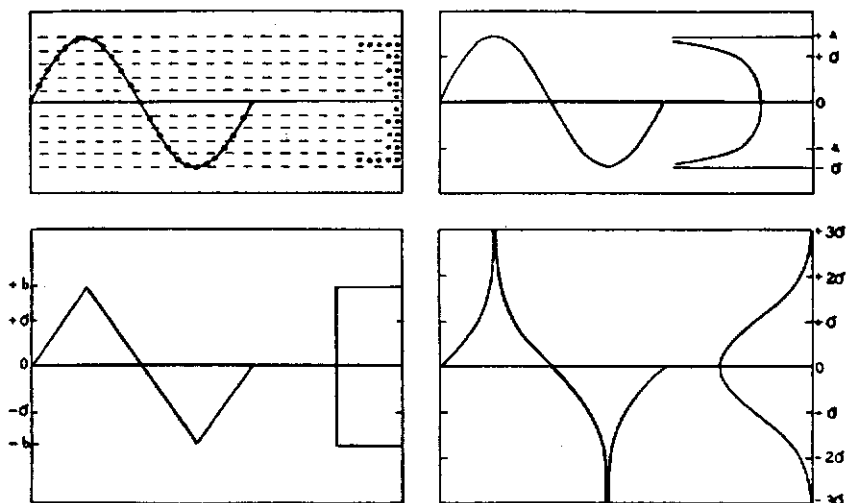

FIGURE 57a.—FREQUENCY DISTRIBUTIONS CORRESPONDING TO TIME SERIES.

The upper left-hand part shows how points equidistant in time on a sine curve may be slid along to pile up in a U-shaped distribution.

The other three parts show the types of frequency distributions corresponding to three types of smooth cyclical time series curves: U-shaped frequency distribution for curves always concave toward central axis; rectangular frequency distribution for linear curves; unimodal frequency distribution for curves always convex toward central axis. For comparison, all frequency curves are drawn with same standard deviation and same area.

From this we derive

$$(4) \quad y = f(x) = \frac{d}{dx} g^{(-1)}(x)$$

as the desired distribution function.

As an example, let us assume that the residuals of the time series form a pure sinusoidal curve about the normal line; that is to say the residuals,  $x$ , are given by

$$x = a \sin kt.$$

Solving this equation for  $t$ , we then obtain

$$t = \frac{1}{k} \arcsin (x/a),$$

which is the inverse given in equation (3).

The desired distribution function is then obtained from (4) and is found to be

$$y = \frac{2}{k(a^2 - x^2)^{\frac{1}{2}}}.$$

We thus obtain the important result that the distribution of a set of residuals which form a sinusoidal curve is U-shaped with vertical asymptotes at  $x = a$  and  $X = -a$ . Figure 57a illustrates this and also the frequency distributions for other types of time series.

#### 14. *The Stability of Trends*

Since the erratic element in economic time series is generally large, this tendency to lack of structure must inevitably affect the stability of trend lines. Thus a trend established for one period of data may, and often does, lead to grossly erroneous conclusions when it is extrapolated into the future. One of the best examples of this is found in the series of rail stock prices over the century from 1830 to 1930. It is a curious fact that the trend of these prices over this long period of time has been strictly linear as one may see from Figure 150 (Chapter 11). But the characteristic feature of this series is its long cycles, which average approximately 20 years in length. Hence any trend of this or shorter length, fitted to the series of items, would show extreme variation and would be a very dangerous instrument to use in extrapolation.

The experiment of fitting linear trends to the data of rail stock prices, using a base of 20 years, was actually performed and the results will be extensively discussed in Section 3, of Chapter 11. The century was divided into 21 overlapping periods of twenty years, each period containing 16 years of the preceding one, and a straight line  $y = a + bt$  was fitted to each period. The graphical representation of the slope constant,  $b$ , (Figure 58) shows the unusual variation which appears in this parameter.

It is thus clear that the stability of trends, where this stability is to be relied upon for forecasting future movements of the series, can be greatly affected by harmonic or quasi-harmonic structures in the data. It is for this reason that a knowledge of the cyclical character of the series is of much importance in connection with the problem of determining and interpreting trends.

To this problem we shall return in Chapter 11 where more powerful analytical tools are at our disposal.

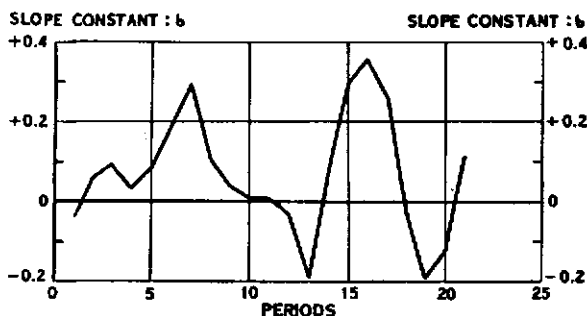

FIGURE 58.—SLOPE CONSTANTS.

Values of slope constant for a series of overlapping trends of 20 years in length for rail stock prices.

### 15. *General Critique of the Economic Significance of Trends*

From the analysis set forth in the preceding sections of this chapter it is evident that the problem of trends is as difficult as it is important.

From our point of view, a trend may be regarded as the residual variation which remains after the harmonic structure has been removed from the data. But unfortunately from this point of view the trend may itself be merely the evidence of a longer harmonic term which the limitations of the data prevent us from recognizing.

Hence, as we have stated in the beginning, there is always need in the determination of a trend to formulate an a priori theory about the nature of the series to which the trend is to be fitted. It is for this reason that the logistic trend is superior to others in its description of the data of population growth, industrial production, etc. Although no real a priori foundation for the logistic exists as yet, the success which this curve has had in describing biological phenomena argues strongly for it as a general interpreter of any phenomenon which depends upon the enlargement of the factors of environment for its increase.

Price series have as yet no such general trend for their interpretation. They are for the most part characterized by large and partially erratic swings, which suggest that dynamic forces, imposed upon an inertial system described in terms of a set of elastic constants, may be the pattern most useful in interpreting them. In such a situation, trends are of slight use and probably can best be established by a combination of linear terms or by moving averages of sufficiently long base. The analysis of prices given in Chapter 10 may throw some light on the situation.

## CHAPTER 7

### PERIODOGRAM ANALYSIS

#### 1. Introduction

Since we have developed extensively in the early chapters the statistical methods which are useful in harmonic analysis, it will be important for us to examine some of the actual periodograms which have been constructed and to interpret their significance. In this review we shall examine all periodograms known to the author which bear upon the problems of economics. The number is not large since, unfortunately, the excessive statistical labor which must go into the computation of a periodogram has strictly limited the supply.

In this interpretation of the periodogram we shall be guided by two quantities. The first of these we shall call the *energy* associated with any given trial period  $T$ . This energy, designated by the symbol  $E(T)$ , is defined by the equations

$$(1) \quad E(T) = \frac{2}{N} \frac{R^2(T)}{R_M^2}, \quad R_M^2 = \frac{4\sigma^2}{N},$$

where  $N$  is the number of items used to compute  $R^2(T)$  and  $\sigma^2$  is the variance of the original data. The significance of these equations has been discussed in Chapter 5.

Associated with the energy is a probability function

$$(2) \quad P = P(\kappa), \quad \kappa(T) = R^2(T)/R_M^2,$$

where  $P(\kappa)$  may be either the Walker or the Fisher probability discussed in Sections 5 and 6 of Chapter 5. Although the Fisher probability is asymptotic to the Walker probability for large values of  $\kappa$ , it deviates significantly for small values of  $\kappa$  and should be employed in making conservative estimates.

We also note the relationship

$$(3) \quad E(T) = \frac{2}{N} \kappa(T).$$

Let us observe that if  $N = 100$ , then  $P(10) = 0.0030$  (Fisher) or 0.0023 (Walker), which means that only 30 (or 24) squared amplitudes,  $R^2(T)$ , in 10,000 would be as large as the one observed. Hence,

if  $N \geq 100$ , we shall consider any period significant which corresponds to a value  $\kappa \geq 10$ . For smaller values of  $\kappa$ , the significance can be obtained directly from the tables.

We have called attention earlier in the book to the sum

$$(4) \quad \sum_{n=1}^{\infty} R^2(T_n) = 2\sigma^2,$$

which is rigorously true provided the periods,  $T_n$ , belong to the Fourier sequence.

It thus follows that

$$(5) \quad \sum_{n=1}^{\infty} E(T_n) = 1,$$

where the sum is taken over the Fourier sequence.

For periods other than those in the Fourier sequence, the sum of the energies is not equal to the actual energy associated with the periods. But since in most of the examples the energy is concentrated in two or three fundamental frequencies, and since these frequencies are often small with respect to the range and hence belong to a region in which the Fourier frequencies cluster, it is probable that the total energy is not greatly different from the sums of the individual energies. This sum, at least, has some significance in determining the importance of the periods considered even though the energies are not strictly additive.

Some of the series which we shall examine have not been corrected for trend. Individual energies are not sensibly affected by linear trends, unless the slope is large, although the measure of their significance is affected, since this measure depends upon the variance of the data. Hence in these cases where the trend is a factor, it is necessary to correct the variance for trend.

Referring to Section 3 of Chapter 6, we see that the variance of the data corrected for trend is given by the formula

$$(6) \quad \sigma_1^2 = \sigma^2 - \frac{A' M_1^2}{N}.$$

In these cases the formulas (1) and (2) are replaced by the following:

$$(7) \quad \bar{E}(T) = \frac{\sigma^2}{\sigma_1^2} E(T), \quad \bar{R}_M^2 = \frac{4\sigma_1^2}{N} = \frac{\sigma_1^2}{\sigma^2} R_M^2,$$

$$(8) \quad P = P(\bar{\kappa}), \quad \bar{\kappa} = \frac{\sigma^2}{\sigma_1^2} \kappa.$$

For fairly large trends the value of  $R^2(T)$  may itself need correction. This is accomplished by means of the formulas in Section 6 of Chapter 2. Thus, if the slope of the trend is  $m$ , then the corrected value of  $R^2(T)$ , namely,  $\bar{R}^2(T)$ , becomes

$$\bar{R}^2(T) = A^2(T) + B'^2(T),$$

where  $B'(T)$  is defined by  $B'(T) = B(T) + (-1)^n mT/\pi$ , if the series is given over the interval  $-a \leq t \leq a$ ; but where we write  $B'(T) = B(T) + mT/\pi$ , if the series is given over the interval  $0 \leq t \leq 2a$ . The latter is the case with the periodograms corrected for trend in this chapter.

If a series of periods,  $T_1, T_2, \dots, T_n$  belong to the Fourier sequence, it is possible to compute the reduced variance,  $\sigma^2$ , of the original series in terms of the total energy  $\sum E_n$  associated with the periods. Thus we can write

$$(9) \quad \bar{\sigma}^2 = (1 - \sum E_n) \sigma^2,$$

where  $\sigma^2$  is the variance of the original series.

This is derived from the proposition that, for the Fourier sequence,

$$2\sigma^2 = \sum_{i=1}^n R^2(T_i) + 2\bar{\sigma}^2,$$

or,

$$1 = \frac{\sum_{i=1}^n R^2(T_i)}{2\sigma^2} + \frac{\bar{\sigma}^2}{\sigma^2} = \sum E_n + \frac{\bar{\sigma}^2}{\sigma^2},$$

from which equation (9) is immediately derived.

## 2. The Constructed Sine-Cosine Series

In order to illustrate our analysis more fully we shall consider first a series of 300 items which was constructed by forming a linear combination of five harmonic terms. This series has been fully described in Section 4 of Chapter 3, and its graphical representation is given in Figure 59. The energies were concentrated in five periods, namely, at  $T = 12, 25, 44, 60,$  and  $144$ . These energies were exactly the following:

$$E(12) = 0.209241, \quad E(25) = 0.113477,$$

$$E(44) = 0.418484, \quad E(60) = 0.113477,$$

$$E(144) = 0.145321.$$



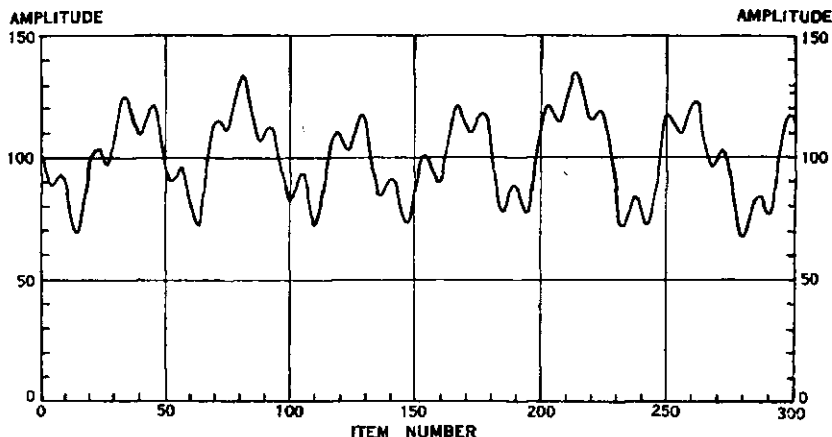

FIGURE 59.—CONSTRUCTED SINE-COSINE SERIES.

From an inspection of the periodogram, Figure 60, we observe that maxima occur at  $T = 12, 25, 44,$  and  $60$ . The peaks broaden as we proceed from the origin, and are regular except for the peak at  $T = 60$ . Employing the value,  $R_M^2 = 3.6875$ , we compute the corresponding values of  $E(T)$  and  $\kappa(T)$ .

$T$	12	25	43	44	60
$E(T)$	0.1591	0.0370	0.6065	0.6937	0.0840
$\kappa(T)$	23.8736	5.5512	90.9696	104.0520	12.6046

In order to interpret these results, we first observe that 12, 25, and 60 belong to the Fourier sequence, but that the nearest member of the Fourier sequence to 44 is  $42.9 = 300/7$ . Since a great deal of the energy is concentrated in this period, and since there is a significant difference between  $E(44)$  and  $E(43)$ , one must employ caution in interpreting the energy content of this component. Erring on the conservative side, we then ascribe the lower figure, namely, 0.6065, to the cycle whose peak is found at  $T = 44$ . The sum of the four significant energies is then found to be

$$E(12) + E(25) + E(43) + E(60) = 0.8866,$$

the difference between this value and 1.0000 being the amount of energy still unaccounted for. Most of this will be found in the period  $T = 144$ , which is outside the range of the periodogram.

It is clear from the example that there has been considerable interference between the four periods and particularly between those

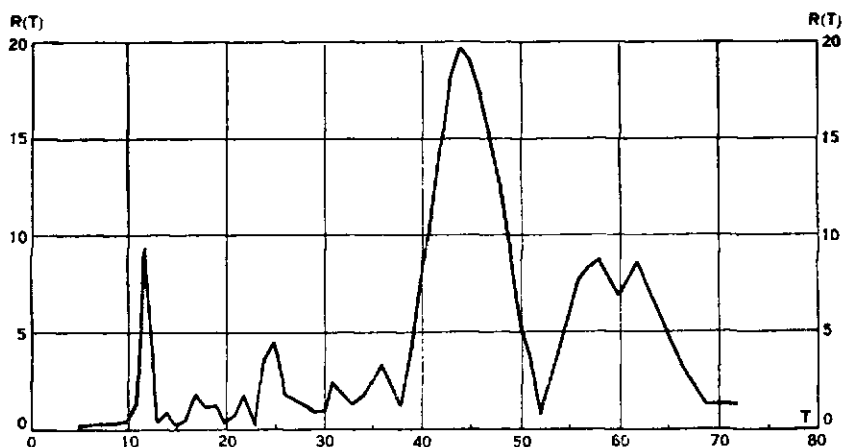

FIGURE 60.—PERIODOGRAM OF THE CONSTRUCTED SINE-COSINE SERIES.

at  $T = 43$  and  $T = 60$ . By formulas (8) in Section 4 of Chapter 2 we compute that the interference band for  $T = 43$  extends from 35.54 to 54.48 and that for  $T = 60$ , it extends from 46.36 to 85.00.

Except for  $T = 25$ , there is obviously a high significance in the peaks recognized in the periodogram. Hence we compute  $\kappa(25) = 5.55$  and the corresponding Walker probability,  $P(5.55) = 0.4590$ .

Our conclusions from the evidence afforded by the periodogram are these: (1) That highly significant peaks are in evidence at  $T = 12$ ,  $T = 44$ , and  $T = 60$ . The probability is better than  $\frac{1}{2}$  that  $T = 25$  is also a significant period. (2) That the total energy associated with these peaks is approximately 0.89, which means that the total variance of the original series will be reduced by 89 per cent if these harmonics are subtracted from the original data.

If we wish to examine more closely into the significance of the peak at  $T = 25$ , we can do this by first removing the other components from the data and then recomputing the value of  $R$  at  $T = 25$ . We know from the construction of the series itself, that the period will emerge with high significance.

### 3. Random Series

In the analysis of the preceding section we have discussed the periodogram of a series in which significant periods were known to exist. This analysis exhibited the powers and limitations of the method. Before proceeding to the periodograms of actual economic time series, it will be illuminating to compare our previous results with those of random series in order to establish a norm for the lower

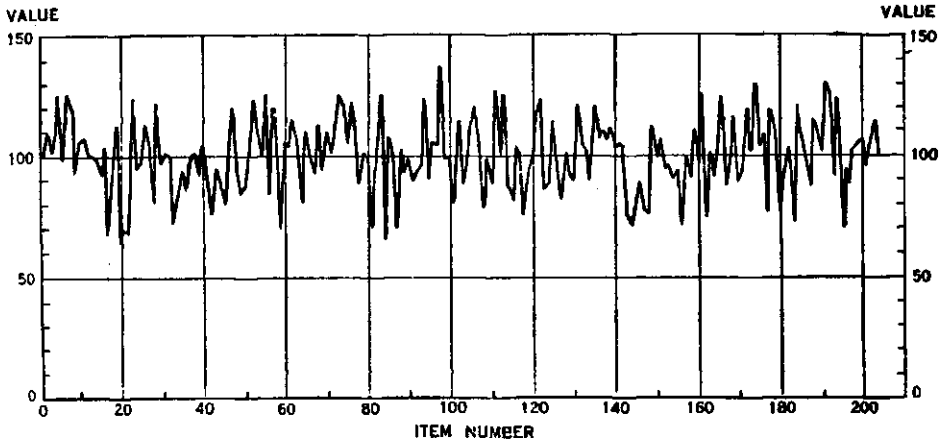

FIGURE 61.—RANDOM SERIES.

limits of significant variation. We consider first the unsmoothed random series which is graphically represented in Figure 61.

Let us first observe that 102 harmonics will completely represent the series and that of these only 39 are within the range of the periodogram. The average value of  $R^2$  is equal to 4.42. Representing by  $e(m)$  the integral

$$e(m) = \int_0^m e^{-\kappa} d\kappa,$$

we see by Schuster's theory that the number of values of  $R^2$  between  $4.42(a + k)$  and  $4.42a$  is given by  $39[e(a + k) - e(a)]$ . Hence there will be 25 values below 4.42, 9 between 4.42 and 8.84, 3 between 8.84 and 13.26, and 2 exceeding this value, but not exceeding 22.10.

Since the periodogram is not computed over the Fourier sequence, we are not able to check this distribution, but we note only four peaks of significant size, namely at  $T = 21$ ,  $T = 33$ ,  $T = 58$ , and  $T = 70$ . The corresponding values of  $R^2$  are 18.07, 13.21, 23.99, and 19.82. One of these is observed to exceed slightly the maximum value given above; two are between 13.26 and 22.10, and one slightly below 13.36. From this we may properly infer that the distribution of the Fourier coefficients, if they were known, would conform to Schuster's theory.

Let us now examine the significance of the value  $R^2 = 23.99$ . Dividing  $R^2$  by 4.42, the average value, we obtain  $\kappa = 5.4$ . Entering the table of Walker probabilities with this value of  $\kappa$  and  $N = 200$ , we see that  $P(5.4) = 0.36$ . Hence the chance is 36 in 100 that in another example we should obtain a value of  $R^2$  as large as the observed one. On the other hand, the Fisher probability is greater than 0.5. We may

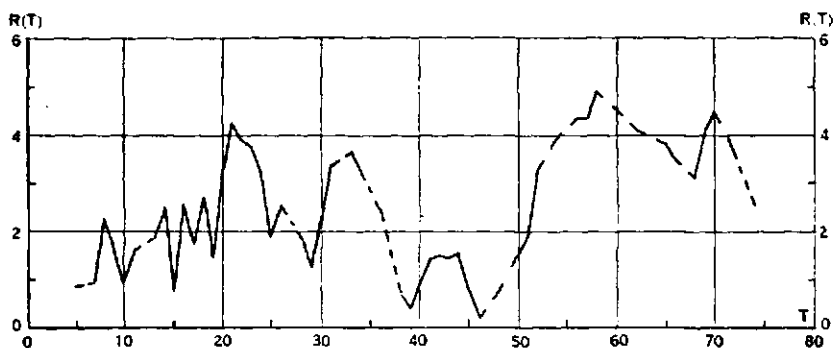

FIGURE 62.—PERIODOGRAM OF RANDOM SERIES.

therefore conclude that the significance attributable to this particular value is slight. The corresponding energy is only 0.053.

Our conclusions are that the techniques which we have employed give correct bounds to the statistical interpretation of the periodogram of a purely random series.

#### 4. Random Series Smoothed with a Moving Average

We examine next the periodogram of the series obtained by smoothing the series of the preceding section by a moving average of length 12. The object of this investigation was to determine whether or not smoothing random data introduced fixed periods into the new series.

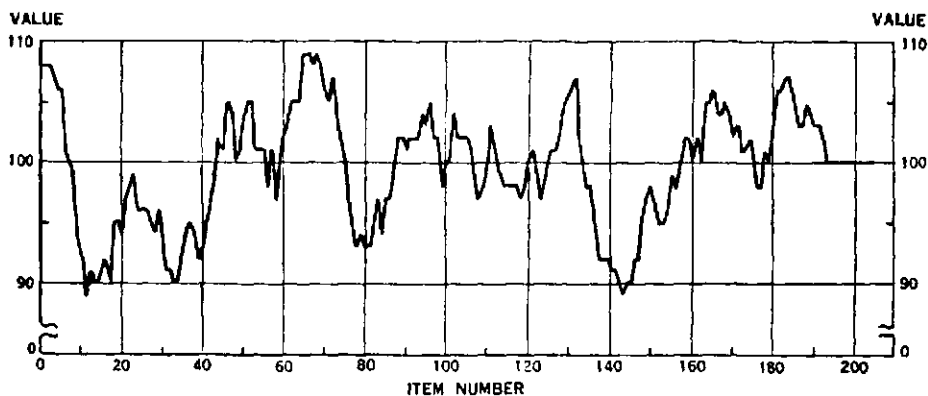

FIGURE 63.—SMOOTHED RANDOM SERIES.

The periodogram shows three distinct peaks, one at  $T = 21$ , a second at  $T = 32$ , and a third at  $T = 58$ . Obviously the smoothing has removed most of the variation in the original series, since the

variance has dropped from 225.32 to 23.21. The average value of  $R^2$  is 0.4551, from which we compute

$T$	21	32	58
$E(T)$	0.1280	0.1710	0.3390
$\kappa(T)$	13.0534	17.4450	34.5799

It will be observed that these periods coincide nearly with those existing in the original data, which indicates their spurious character. The smoothing has merely tended to amplify the energies of a small, but insignificant, structure in the original random series.

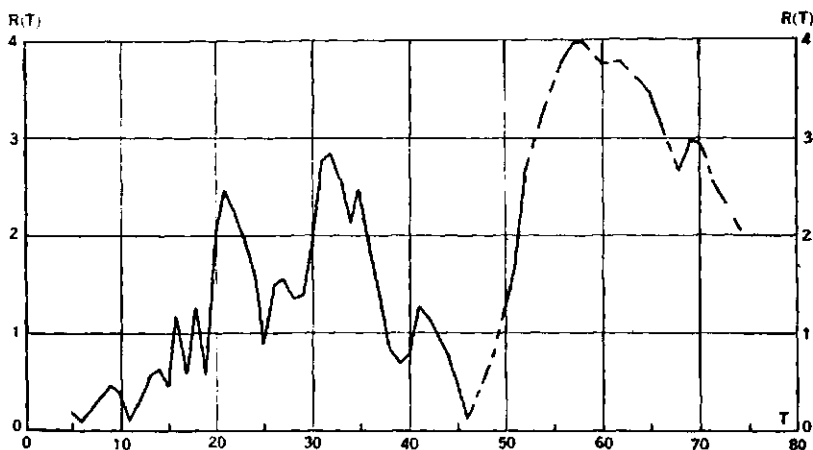

FIGURE 64.—PERIDOGRAM OF SMOOTHED RANDOM SERIES.

But we note here a rather disturbing matter. Although the periods observed are spurious in origin by the nature of the data, we nevertheless have detected periods of high significance. Approximately 64 per cent of the energy is contained in them and they can clearly be seen in the graphical representation of the data as shown in Figure 63. This same observation is the basis of the paper by E. Slutsky on "The Summation of Random Causes as the Source of Cyclic Processes,"<sup>1</sup> on which we have commented earlier in this volume.

But in Chapter 4 we have seen that the characteristic spectrum of a random series smoothed by a moving average of length  $\lambda$  is continuous. Hence if we multiply the ordinates of the lower graph of (a) in Figure 27, Section 6 of Chapter 3, by  $\sigma = 4.8179$ , noting that  $2\nu = 12$ , we obtain the following theoretical values of the periodogram:

<sup>1</sup> Originally published in Russian in *Problems of Economic Conditions*, edited by The Conjecture Institute, Moskva (Moscow), Vol. 3, No. 1, 1927; reprinted in English in *Econometrica*, Vol. 5, 1937, pp. 105-146.

$T$	$R$	$R^2$	$T$	$R$	$R^2$
2.0	0.00	0.0000	4.9	0.31	0.0961
2.2	0.14	0.0196	6.0	0.00	0.0000
2.4	0.00	0.0000	8.4	0.52	0.2704
2.7	0.17	0.0289	12.0	0.00	0.0000
3.0	0.00	0.0000	21.0	1.31	1.7161
3.4	0.22	0.0484	32.0	1.89	3.5721
4.0	0.00	0.0000	58.0	2.24	5.0476

The most significant deviations from these values are found in the periods  $T = 21$ ,  $T = 32$ , and  $T = 58$ . Since we know a priori that a continuous spectrum of the amplitude indicated by the above table exists for the smoothed random series, we must investigate the real periodicity of the data from the difference between the observed and theoretical amplitude. Thus, considering the last period where the greatest difference occurs, we compute the true energy to be

$$E(58) = (3.97 - 2.24)^2 / (2\sigma^2) = 0.0645.$$

This value is essentially equal to that observed in the random data themselves, and hence we may conclude that a small period actually existed by chance in the original random series.

Since this conclusion is very important in our contemplated application, let us see whether the proposition can be verified by a study of the autocorrelation of the smoothed series. The following table gives the values of the autocorrelation coefficients of this series over the range from  $t = 0$  to  $t = 75$ :

AUTOCORRELATION OF THE 12-MONTH MOVING AVERAGE OF THE  
RANDOM DOW-JONES SERIES (1897-1913, 204 ITEMS)

Lag	$r$	Lag	$r$	Lag	$r$	Lag	$r$
0	1.0000	16	-0.1238	32	-0.2955	48	-0.2196
1	0.9201	17	-0.0772	33	-0.2949	49	-0.2353
2	0.8371	18	-0.0498	34	-0.2935	50	-0.2369
3	0.7371	19	-0.0129	35	-0.2909	51	-0.2536
4	0.6177	20	0.0100	36	-0.2632	52	-0.2348
5	0.4948	21	0.0116	37	-0.2419	53	-0.2051
6	0.3806	22	0.0142	38	-0.2265	54	-0.2561
7	0.2632	23	0.0010	39	-0.1943	55	-0.2303
8	0.1639	24	-0.0212	40	-0.2042	56	-0.1512
9	0.0740	25	-0.0530	41	-0.1860	57	-0.0797
10	-0.0047	26	-0.0968	42	-0.1620	58	0.0276
11	-0.0746	27	-0.1417	43	-0.1454	60	0.2158
12	-0.1434	28	-0.1496	44	-0.1562	65	0.3562
13	-0.1233	29	-0.1999	45	-0.1662	70	0.0346
14	-0.0951	30	-0.2393	46	-0.1591	75	-0.3362
15	-0.0608	31	-0.2789	47	-0.1888		

The graphical representation of these data as shown in Figure 65 clearly indicates that a significant variation exists in the auto-

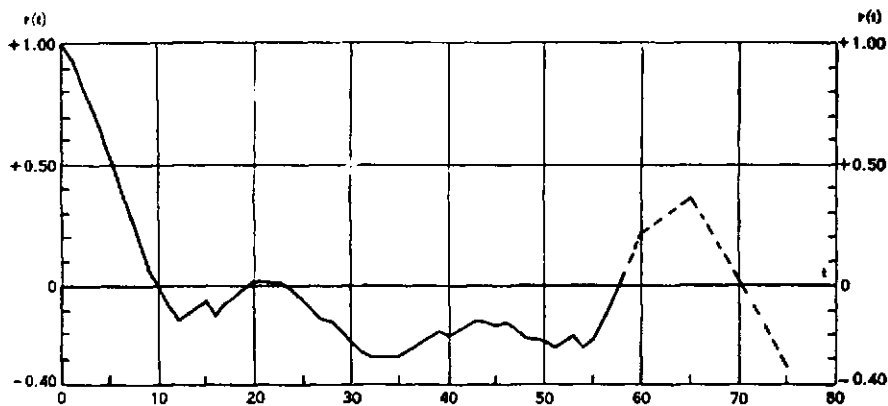

FIGURE 65.—AUTOCORRELATION FUNCTION OF SMOOTHED RANDOM SERIES.

correlation function, since 68 per cent of the values should lie within the standard-error band once the correlation function has reached the zero line; that is, after  $t = 10$ .

The lesson to be learned from this analysis is *that, wherever possible, the significance of periods discovered in economic series by the technique of periodogram analysis should be checked by an estimate of the energy in the continuous spectrum of the series. This estimate is ascertainable from the autocorrelation function of the series.*

### 5. Cumulated Random Series (Smoothed)

We consider next the periodogram of a cumulated random series which has been smoothed with a moving average of length 12 as shown in Figure 66. From the discussion in Section 5 of Chapter 4, we see that most of the energy tends to accumulate in the period equal to the

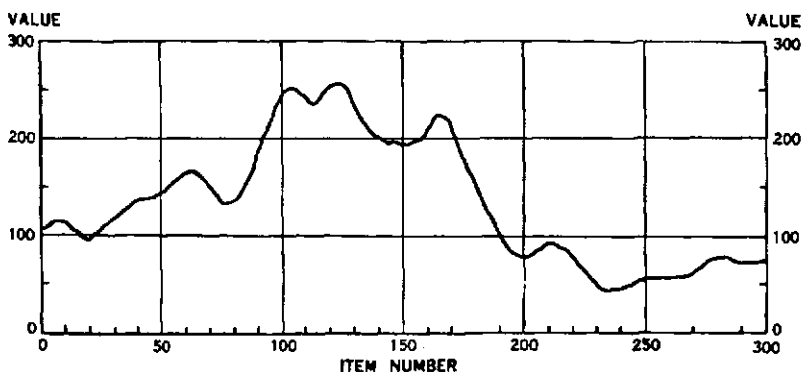

FIGURE 66.—CUMULATED SMOOTHED RANDOM SERIES.

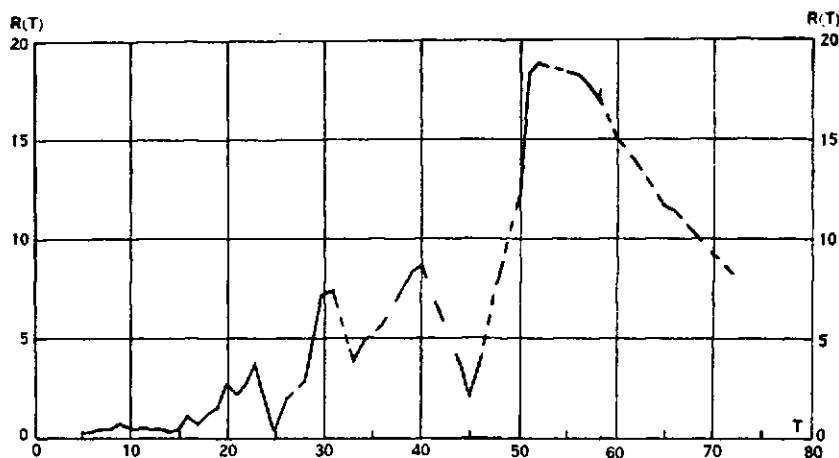

FIGURE 67.—PERIODOGRAM OF CUMULATED SMOOTHED RANDOM SERIES.

length of the series. Hence, in the range considered, from  $T = 5$  to  $T = 72$ , no significant periods should be expected. This is verified by the computation.

Thus we see that the greatest observed amplitude in the periodogram is at  $T = 72$ . But since  $R_M^2 = 55.5854$ , we obtain  $\kappa(52) = 6.4687$ ,  $P(52) = 0.20$ , and  $E(52) = 0.0431$ . The graph of the data reveals clearly that the principal energy is concentrated in a single harmonic of period equal to 300.

#### 6. The Cowles Commission All Stocks Index (1880-1896)

The data showing the price of all stocks listed on the New York Stock Exchange from 1880 to 1896 are taken from *Common-Stock Indexes*, by Alfred Cowles and Associates, Second Edition, 1939.

A preliminary computation gives  $R_M^2 = 0.4415$ , from which we evaluate  $\kappa(T)$  and  $E(T)$  for the two maxima at  $T = 35$  and  $T = 62$ , together with their adjacent Fourier periods at  $T = 34$  and  $T = 68$ :

$T$	34	35	62	68
$E(T)$	0.1193	0.1448	0.3352	0.2740
$\kappa(T)$	12.1726	14.7715	34.1934	27.9447

Since we have  $E(34) + E(68) = 0.3933$  and  $E(35) + E(62) = 0.4800$ , it is clear that between 39 and 48 per cent of the total energy of the series is accounted for by the two peaks of the periodogram. The significance is obviously high.



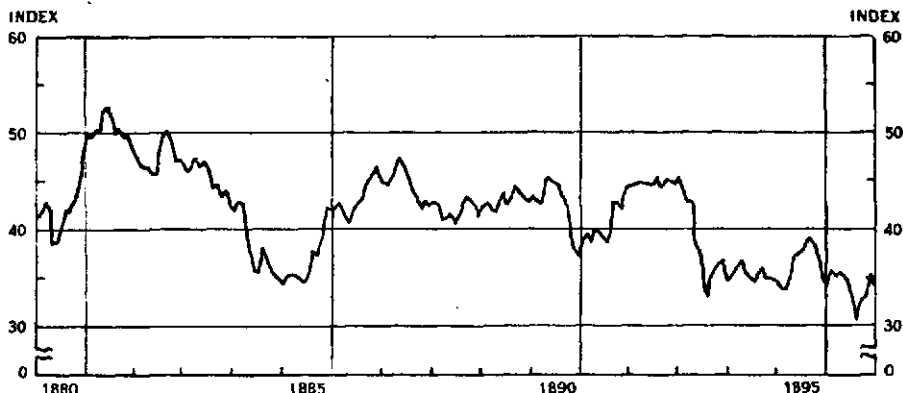

FIGURE 68.—COWLES COMMISSION ALL STOCKS INDEX, 1880-1896.

But an inspection of the data shows that there is a secular trend which must be taken into account. Computing the first moment about the 102nd item, we obtain  $M_1 = -37564.8$ , from which we obtain by formula (4) in Section 3 of Chapter 6, the variance corrected for trend, namely  $\sigma_1^2 = 12.5921$ .

Since the values of the amplitudes of the periodogram are essentially independent of trend, we now recompute  $\kappa(T)$  and  $E(T)$  using the corrected variance. From the value  $R_{\mu}^2 = 0.2469$  we now obtain the following:

$T$	34	35	62	68
$E(T)$	0.2134	0.2590	0.5994	0.4899
$\kappa(T)$	21.7667	26.4139	61.1438	49.9700

From this table we infer that between 70 and 86 per cent of the variation is accounted for by the two maxima of the periodogram.

But we also note that the periodogram resembles strikingly that one obtained for a series with a continuous spectrum of type (b), Figure 28 in Section 6 of Chapter 3. We may tentatively assume that  $\lambda = 12$ , so that the maximum value of  $R$  for the continuous spectrum is given by

$$R = 2\sigma \sqrt{\frac{\mu}{1-\mu}}; \quad \mu = 12/204, \quad \sigma = 4.7450,$$

that is,  $R = 2.37$ . Since the value of  $R(35) = 2.55$ , we see that this analysis denies all significance to this period. On the other hand,  $R(62) = 3.89$ , so that, using the corrected variance, we obtain as the

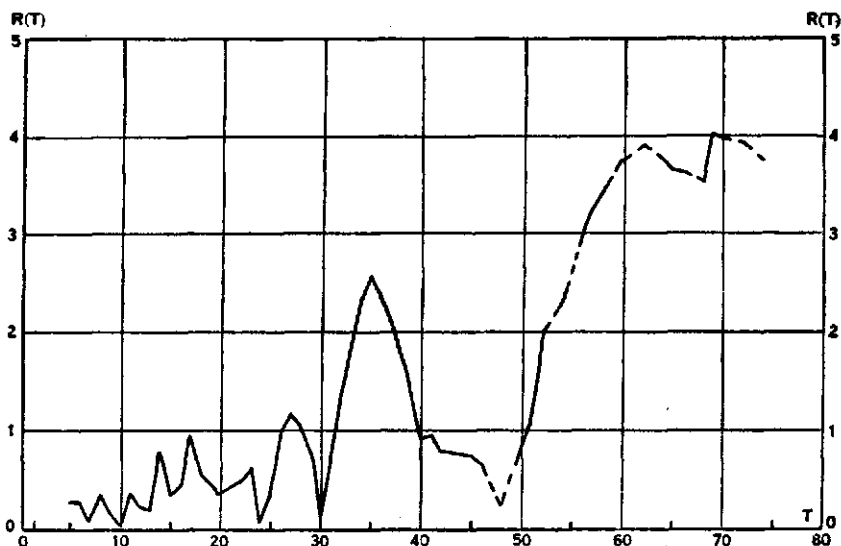

FIGURE 69.—PERIODOGRAM OF COWLES COMMISSION ALL STOCKS INDEX, 1880-1896.

energy attributable to this period the value  $(3.89 - 2.34)^2/25.1842 = 0.0954$ .

We have in this analysis, however, assumed the tentative estimate of  $\lambda = 12$ , since the autocorrelation of many economic series appears to indicate this value. The significance of periods in the range between  $2\lambda$  and  $3\lambda$  is very sensitive to changes in this parameter, however, because of the discontinuity of the periodogram at  $T = 2\lambda$ . Hence in estimating the significance of a period in the sensitive range it is probably better to use the value of  $R$  given by formula (1) in Section 6 of Chapter 3. For  $T = 35$ , we get  $R = 1.84$  and the energy is given by  $(2.55 - 1.84)^2/25.1842 = 0.0200$ .

Our conclusions must be, therefore, that, while most of the energy of the series is concentrated around the periods  $T = 35$  and  $T = 62$ , this energy belongs to a continuous rather than to a discrete spectrum. However, there is residual energy of about 2 per cent to be attributed to  $T = 35$  and of about 10 per cent to be attributed to  $T = 62$ . Interpreted in the light of economic forecasting, we should expect to find similar energies in the data contiguous to that examined here.

### 7. The Dow-Jones Industrial Averages (1897-1913)

In the last section we investigated the periodic structure of stock prices prior to the interval now to be examined and found a small ener-

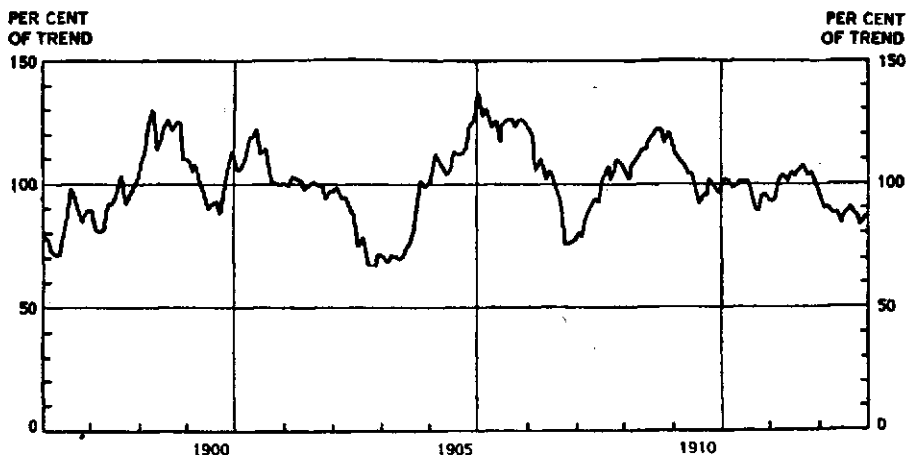

FIGURE 70.—DOW-JONES INDUSTRIAL AVERAGES, 1897-1913, AS PERCENTAGES OF TREND.

gy in two real periods. It will be interesting to see whether this permanent structure is affirmed. We use as data the monthly closing quotations of the Dow-Jones industrial stock price averages given as percentages of trend.

Computing  $R_M^2 = 4.4179$ , we obtain the following values for  $\kappa(T)$  and  $E(T)$  :

$T$	22	41	43	68
$E(T)$	0.0560	0.4810	0.4810	0.2436
$\kappa(T)$	5.7137	49.0599	44.1677	24.8483

Using  $T = 41$ , instead of the maximum,  $T = 43$ , since the former period belongs to the Fourier sequence, we see that we have accounted

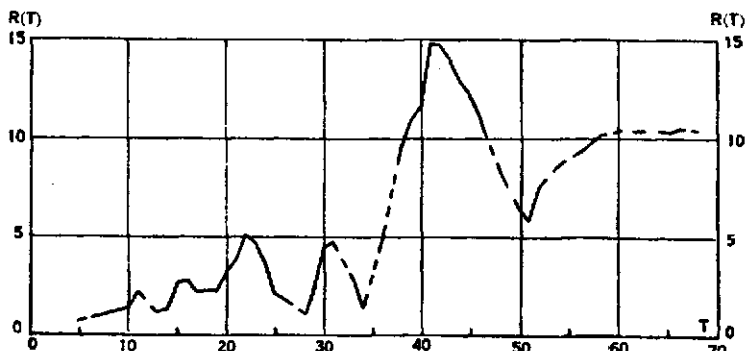

FIGURE 71.—PERIODOGRAM OF DOW-JONES INDUSTRIAL AVERAGES, 1897-1913, AS PERCENTAGES OF TREND.

for 73 per cent of the total energy in these three periods. The significance of all except the first period is obviously high.

We first note that the component at  $T = 35$  in the series discussed in Section 6 is now replaced by a component of higher energy and with increased period. The relative energy of the longer component has dropped and its period has increased slightly. This would certainly agree with the conclusions in the preceding section where only tenuous validity was proved for these periods.

These observations have led to the conclusion adopted by most students of the business cycle that there is a genuine cycle of period close to 40 months in industrial stock prices together with the possibility of periods of less permanence around 20 and 60 months.

But we have seen in Section 6 of Chapter 3, that it is possible to ascribe the large observed energies to a continuous spectrum indicated by the lag-correlation function. If this proposition be admitted, let us see what conclusions follow.

Since most of the energy is concentrated at  $T = 41$ , we examine this for significance after the amplitude,  $R$ , of the continuous spectrum has been subtracted. Since  $R = 9.91$ , the residual energy is then

$$E(41) = (14.72 - 9.91)^2 / 450.6308 = 0.0513.$$

The corresponding values of  $\kappa(T)$  becomes 5.1326, which indicates a significance measured by the probability  $P(41) = 0.46$ .

Hence, a cautious answer to the problem of the significance of the period  $T = 41$  would be that *the probability favors the existence of a small permanent energy in industrial stock prices associated with the period in question*. This conclusion is fully confirmed by the auto-correlation function shown in Figure 23, Chapter 3.

### 8. The Dow-Jones Industrial Averages (1914-1924)

The dominating feature of this periodogram is the high concentration of energy in the region around  $T = 38$ . We find that  $R_{\kappa}^2 = 5.2209$ , in terms of which we then obtain the following values:

$T$	33	38	44
$E(T)$	0.2257	0.7410	0.3686
$\kappa(T)$	14.8980	48.9043	24.3277

Since the period of maximum energy is flanked by the periods 33 and 44, which belong to the Fourier sequence of the series, we may use their sum to provide a conservative estimate of the total energy

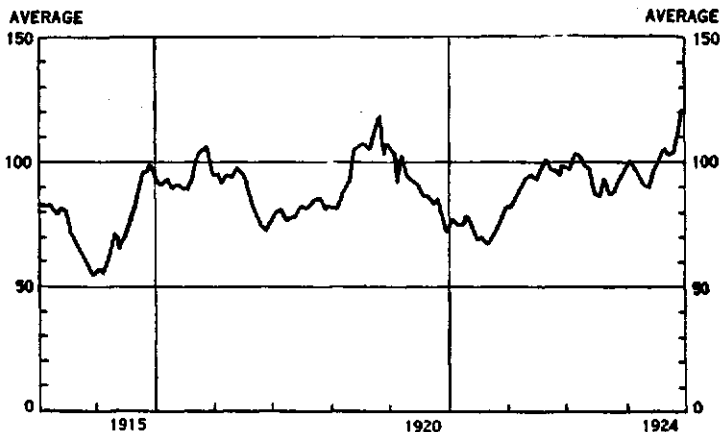

FIGURE 72.—DOW-JONES INDUSTRIAL AVERAGES, 1914-1924.

attributable to the region under investigation. We thus find  $E(33) + E(44) = 0.5943$ , which shows an obviously high concentration.

Since the series itself was not originally corrected for trend we reduce the variance by removing the effect of the secular movement. Thus, computing the moment about the 66th item, we obtain  $M_1 = 28466.9$ , and the variance reduces to 140.9738. This yields the new average  $R_{\nu}^2 = 4.2719$ , in terms of which we find

$T$	33	38	44
$E(T)$	0.2758	0.9056	0.4505
$\kappa(T)$	18.2074	59.7677	29.7318

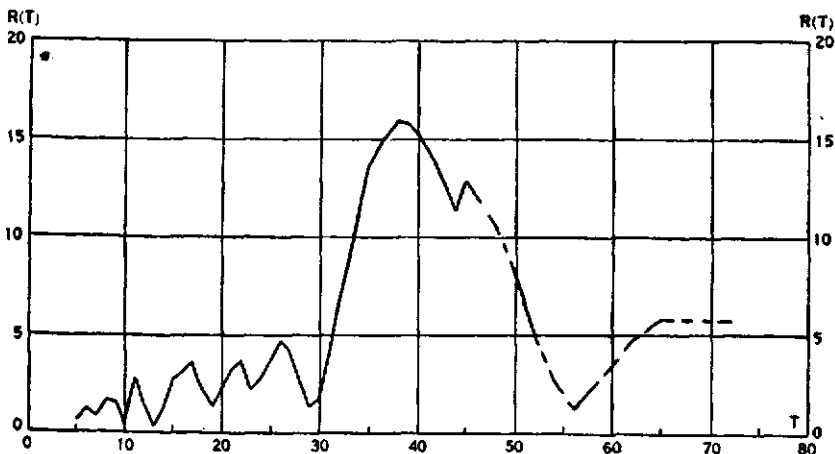

FIGURE 73.—PERIODOGRAM OF DOW-JONES INDUSTRIAL AVERAGES, 1914-1924.

The new estimate of the total energy, as given by the periods of the Fourier sequence, is found to be  $E(33) + E(44) = 0.7263$ , an extraordinarily high value for economic time series.

*The conclusion is inescapable that the 40-month component in the years from 1914 to 1924 was a very dominating pattern of the stock price series and large profits could have been made by forecasting with this single cycle.*

### 9. The Dow-Jones Industrial Averages (1925-1934)

The data given here cover the period of the great bull market, which reached its top in 1929.

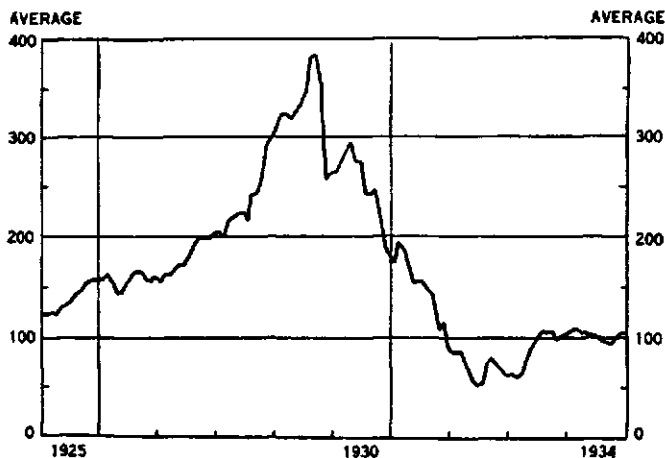

FIGURE 74.—DOW-JONES INDUSTRIAL AVERAGES, 1925-1934.

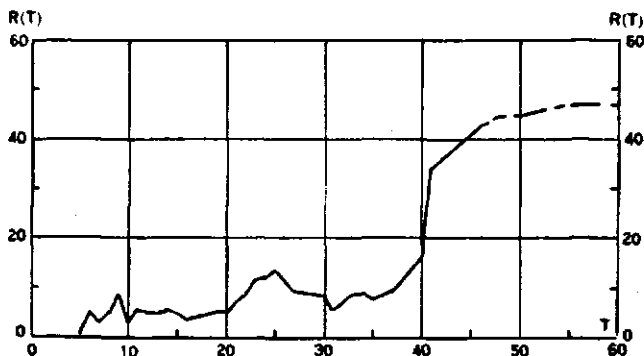

FIGURE 75.—PERIODOGRAM OF DOW-JONES INDUSTRIAL AVERAGES, 1925-1934.

The reasons for the effacement of the 40-month cycle in this era and its possible relationship to the spectacular phenomenon will be commented upon in another chapter of the book. It is obvious from the analysis given in Section 6 of Chapter 3, that the continuous spectrum completely dominated the periodogram.

### 10. Rail Stock Prices (Monthly, 1831-1855)

The data for this series are taken from indexes prepared by the Cleveland Trust Company. Since only a slight trend is apparent in the series, no correction is made for this factor.

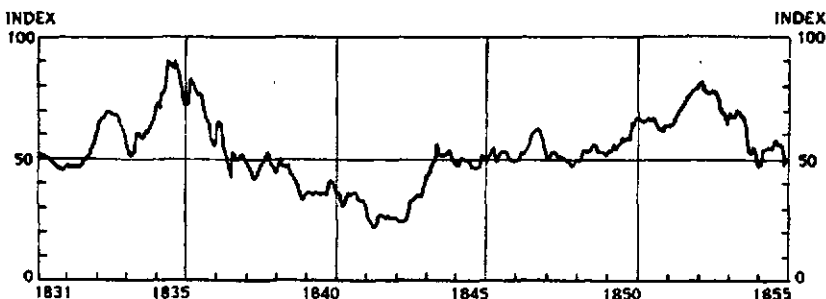

FIGURE 76.—RAIL STOCK PRICES, MONTHLY, 1831-1855.

The dominating values are found at  $T = 34$  and  $T = 68$ . Computing the mean,  $R_M^2 = 2.6333$ , we obtain the following estimates:

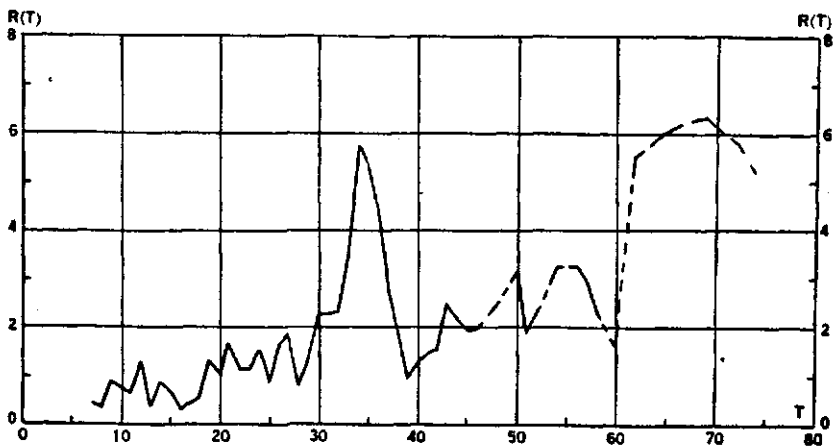

FIGURE 77.—PERIODOGRAM OF RAIL STOCK PRICES, MONTHLY, 1831-1855.

$T$	34	68
$E(T)$	0.0830	0.1003
$\kappa(T)$	12.4465	15.0488

A very small portion of the energy is thus seen to be concentrated in this part of the periodogram. An inspection of the graph of the data themselves shows that the dominating cycle is of the order of 18 years.

The period at  $T = 34$  is of some interest, however, since it may actually be an indication of the existence of the component which became, in later times, the 40-month cycle. The relative prominence of this peak in the periodogram is more significant than the actual energy which it contains.

### 11. Rail Stock Prices (Monthly, 1856-1880)

The data are again those of the Cleveland Trust Company. The period itself was one of disruption since it included the Civil War, so that short periods such as that of the 40-month cycle might well be expected to have been masked by cyclical and extraordinary factors. How small a part of the energy is contained in the range investigated is seen from the computation:  $R_M^2 = 7.6289$ ,  $E(60) = 0.0575$ ,  $\kappa(60) = 8.6184$ .

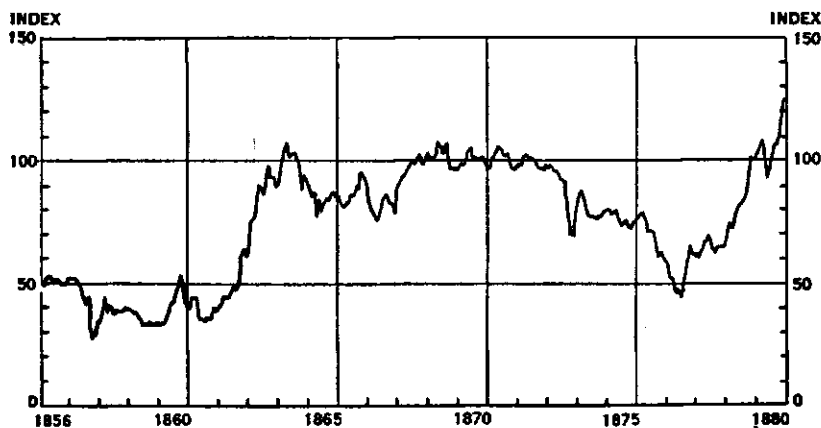

FIGURE 78.—RAIL STOCK PRICES, MONTHLY, 1856-1880.

Since so small a part of the energy is accounted for by the periodogram, it is instructive to inquire within what range it is concen-



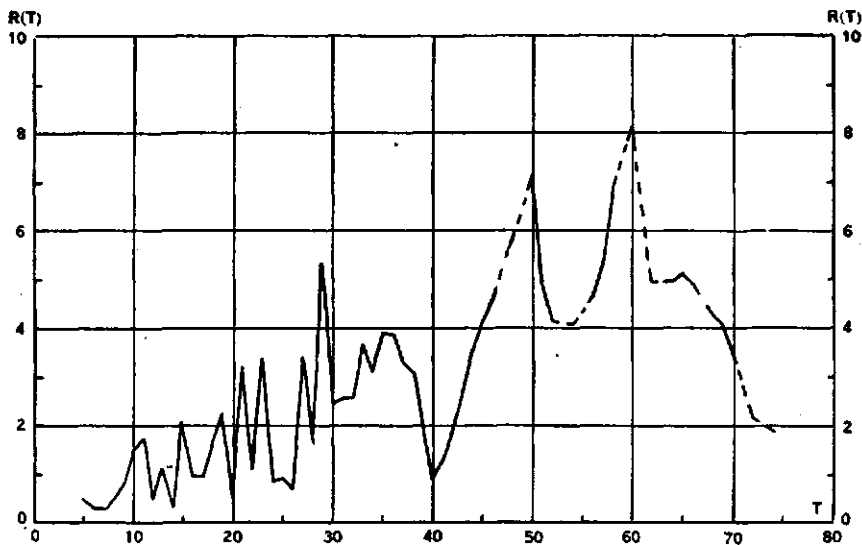

FIGURE 79.—PERIODOGRAM OF RAIL STOCK PRICES, MONTHLY, 1856-1880.

trated. An inspection of the data shows that the period is approximately 20 years.

A brief study of the distribution of the averages was undertaken to ascertain whether the deviations from a harmonic of period  $T = 240$  (months) would be normal. This test for the normality of deviations has been urged by some statisticians. The period used was from 1859 to 1878. The original frequency of the data was as follows:

Class Interval	Frequency	Class Interval	Frequency
33.0-39.9	23	75.0- 81.9	34
40.0-46.9	16	82.0- 88.9	27
47.0-53.9	12	89.0- 95.9	23
54.0-60.9	6	96.0-102.9	52
61.0-67.9	20	103.0-109.9	16
68.0-74.9	11		
			$N = 240$

A computation shows that the *kurtosis* for this distribution is  $-0.958$ , which indicates a violent distortion from the normal.<sup>2</sup>

The function (referred to the linear trend),

$$y = \sqrt{2} \sigma \cos [(2 \pi t/T) + \pi],$$

is then introduced on the assumption that all the cyclical energy is in

<sup>2</sup> See Davis and Nelson, *Elements of Statistics*, 2nd ed., 1937. p. 318.

this harmonic. The standard deviation,  $\sigma$ , is the deviation of the data from the linear trend. The following table gives the frequencies:

Class Interval	Frequency	Class Interval	Frequency
-24 to -18	6	11 to 17	8
-17 to -11	31	18 to 24	9
-10 to -4	42	25 to 31	6
-3 to 3	90	32 to 38	1
4 to 10	47		
$N = 240$			

The kurtosis, namely,  $\beta_2 - 3$ , for this distribution is now found to be 0.930, which shows a more than normal concentration of the frequencies around the average.

Our conclusion is then that the disruptive inflation of rail stock prices in the period of the Civil War can be accounted for by a linear secular trend plus a harmonic term of period equal to 20 years.

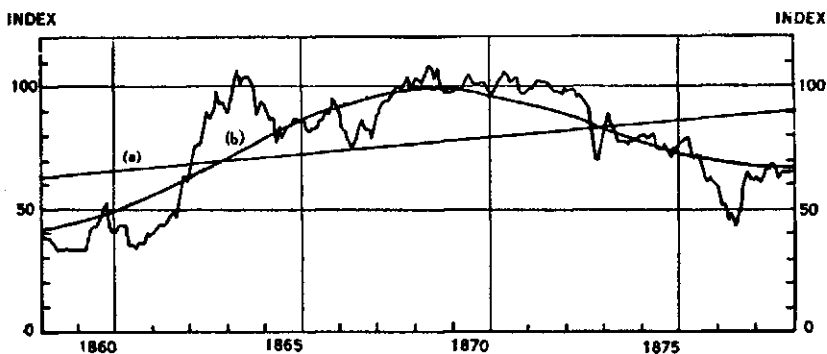

FIGURE 80.—RAIL STOCK PRICES, MONTHLY, 1859-1878, FITTED WITH LINEAR TREND (a) AND WITH HARMONIC CURVE (b).

### 12. Rail Stock Prices (Annually, 1831-1930)

The data for this analysis were compiled by the Cleveland Trust Company. Since a considerable linear trend is evident in the prices of rail stocks over the century considered (see Figure 83), this is first removed. Choosing the origin at the 50th item, we obtain as the first moment the value 73,267 and from this the corrected variance:  $\sigma_1^2 = 415.5230$ .

Using the mean value  $R_x^2 = 16.6209$ , we compute the following table:

$T$	9	10	11	12	14	16	20
$E(T)$	0.1102	0.0024	0.0509	0.0175	0.0237	0.0627	0.3085
$\kappa(T)$	5.51	0.12	2.55	0.88	1.19	3.13	15.42

$T$	25	28	33	44	50	60
$E(T)$	0.1646	0.2679	0.0215	0.5606	0.4142	0.7051
$\kappa(T)$	8.23	13.39	1.07	28.03	20.71	35.25

First, summing the energies of the exact and approximate Fourier periods, we obtain

$$E(10) + E(11) + E(12) + E(14) + E(16) + E(20) \\ + E(25) + E(33) + E(50) = 1.0660 .$$

Hence it is clear that, within the inevitable error of the statistical approximations involved, we have accounted for all the energy.

From the form of the periodogram it is evident that a large continuous spectrum is the dominating characteristic. Although no auto-correlation function is available, it is probable that the first zero value,  $\lambda$ , of this function is not smaller than 12. Hence we may look for true periods in the range below  $2\lambda = 24$ .

Only two significant peaks are observed below 24, namely one at  $T = 9$  and the other at  $T = 20$ . The first accounts for 11 per cent of the energy and the second for 31 per cent of the energy, the Walker probability in the first case being 0.74 and in the second in excess of 0.97.

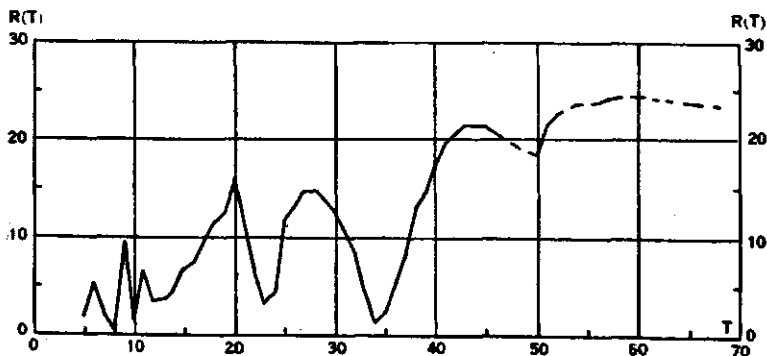

FIGURE 81.—PERIODOGRAM OF RAIL STOCK PRICES, ANNUALLY, 1831-1930.

The first value, namely  $T = 9$ , has been observed by many students of business-cycle theory, and because the most probable value of the period lies somewhere between 9 and 10, the corresponding harmonic is frequently referred to as the 10-year component. Other evidence of its reality will be presented later.

The second value, namely  $T = 20$ , has been observed in the two 25-year periods which we have previously examined. Its reality is argued by this continuity. Although the inflationary era of the Civil War was sufficient to account for the long cycle in the second 25 years of the century under examination, its persistence perhaps argues for a more basic cause. This may be found, perhaps, in the long component of the building cycle, which, in recent data, appears to have had an average period of around 18 years.

### 13. Rail Stock Prices (at Four-Month Intervals, 1831-1930)

Because of the coarseness of annual averages, it seemed desirable to confirm the results of the previous section and to examine shorter periods by an analysis of the same data taken at intervals of four months. Removing the trend, we first compute  $R_{\mu}^2 = 6.0273$ . The following table is then obtained:

$T$	10	18	23	28	33	46
$E(T)$	0.0162	0.0286	0.0328	0.0601	0.0425	0.0620
$\kappa(T)$	2.4305	4.2946	4.9208	9.0120	6.3781	9.3054

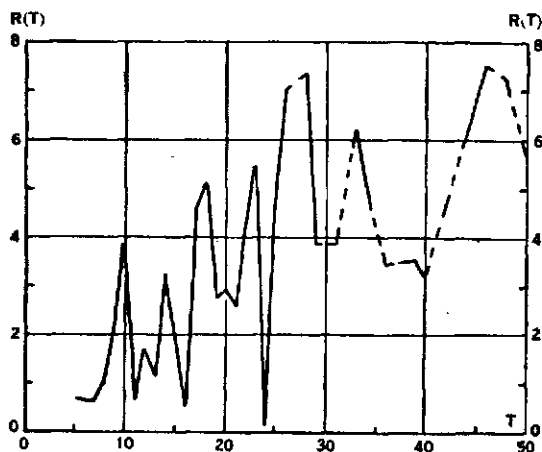

FIGURE 82.—PERIODOGRAM OF RAIL STOCK PRICES, 4-MONTH INTERVALS, 1831-1930.

It is obvious that only a small part of the energy is accounted for in this range of values, but this agrees with the previous analysis which showed that the concentration of energy began around 20 years, whereas this periodogram ends at  $50/3 = 16.67$  years.

A concentration of energy at  $T = 28$  argues again for the nine-year cycle, where presumably for  $T = 27$  we should have found about 11 per cent of the energy. There is apparently no significance to be attached to the concentration observed at  $T = 46$ .

Our final conclusion from this and the preceding section is that most of the energy in the prices of rail stocks is concentrated in the continuous spectrum. However, significant periods are found at  $T = 9$  years and  $T = 20$  years and these probably belong to a permanent structure.

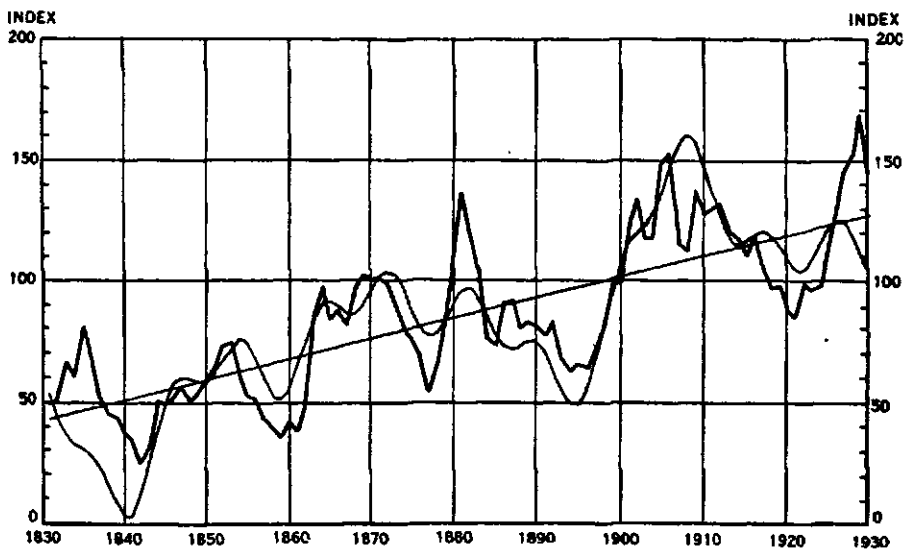

FIGURE 83.—RAIL STOCK PRICES, 1831-1930, FITTED WITH LINEAR TREND AND WITH HARMONIC CURVE.

In order to exhibit graphically how much of the variation of the annual series is contained in a few components, Figure 83 was prepared by the linear addition of the four harmonics of periods  $T = 9$ , 20, 28, and 44 years.

#### 14. American Industrial Activity (Annually, 1831-1930)

In the preceding sections we have examined the harmonic structure of stock price series. We turn now to an analysis of one of the

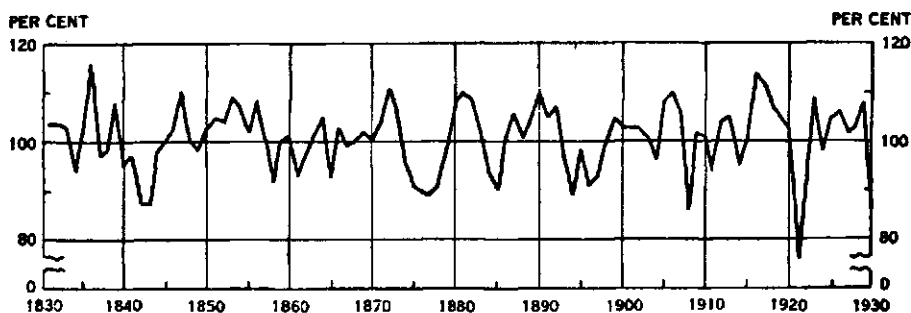

FIGURE 84.—AMERICAN INDUSTRIAL ACTIVITY, ANUALLY, 1831-1930,  
AS PER CENT OF NORMAL.

most important economic time series, namely that of American industrial activity. The data were compiled by Leonard P. Ayres for the Cleveland Trust Company and measure the fluctuations of industry about a normal value. Since industry grew logistically during the century under analysis, the trend itself was probably a more important economic phenomenon than the variations themselves. Our problem, however, is concerned only with the determination of such harmonic structure as may be discernible in the deviations.

A very comprehensive study of the monthly series from January, 1790 to December, 1929 inclusive, a total of 1680 months, was published in 1933 by E. B. Wilson.<sup>3</sup> In this section we shall relate the details of Wilson's investigation to our own more modest analysis of the annual averages.

An inspection of our periodogram shows only two significant peaks, one at  $T=9$  and the other at  $T=17$ . From the mean value,  $R_M^2 = 1.9027$  we obtain the following estimates:

$T$	9	17
$E(T)$	0.1736	0.1254
$\kappa(T)$	8.6788	6.2721

The total energy in these two components does not exceed the sum  $E(9) + E(17) = 0.2990$ .

It is evident, however, that the two periods have considerable a priori validity, since they both appear in the analysis of rail stock prices. The nine-year component is the long cycle of American busi-

<sup>3</sup> "The Periodogram of American Business Activity," *Quarterly Journal of Economics*, Vol. 48, 1933-34, pp. 375-417. See also, "Are there Periods in American Business Activity?" *Science*, Vol. 80, 1934, pp. 193-199.

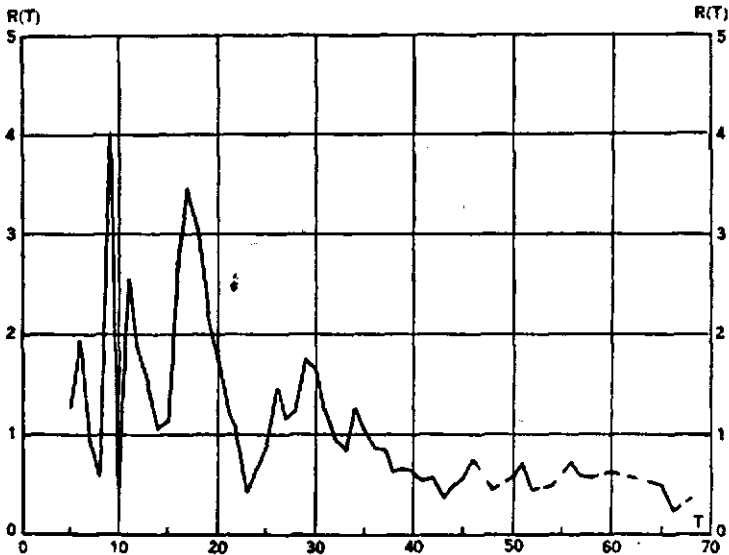

FIGURE 85.—PERIODOGRAM OF AMERICAN INDUSTRIAL ACTIVITY, 1831-1930.

ness and the 17-year component is probably accounted for by the building cycle.

Since our analysis extends only to the period  $T = 5$  years, it is fortunate that we have Wilson's periodogram of the monthly data over a range from 30 to 240 months.

Wilson divided the range of 1680 months into four equal sections in order to test the continuity of such significant values of  $T$  as might be revealed. The basic averages for the four sections and the total range are given below as follows:

	1790-1824	1825-1859	1860-1894	1895-1929	1790-1929
Mean	1.09	0.54	0.00	1.16	0.70
$\sigma$	9.95	7.26	7.66	8.77	8.41
$\sigma^2$	99.0025	52.7076	58.6756	76.9129	71.8247
$2\sigma^2$	198.0050	105.4152	117.3512	153.8258	143.6494
$R^2_M$	0.9429	0.5020	0.5588	0.7325	0.1710
$N$	420	420	420	420	1680

These four sections were then combined into three overlapping series of 840 months as follows: I (1790-1859); II (1825-1894); III (1860-1929). The periodograms of each of these sections of the data as well as that for the entire range are shown in Figure 86. The scale for  $T$ , it will be observed, is reciprocal.

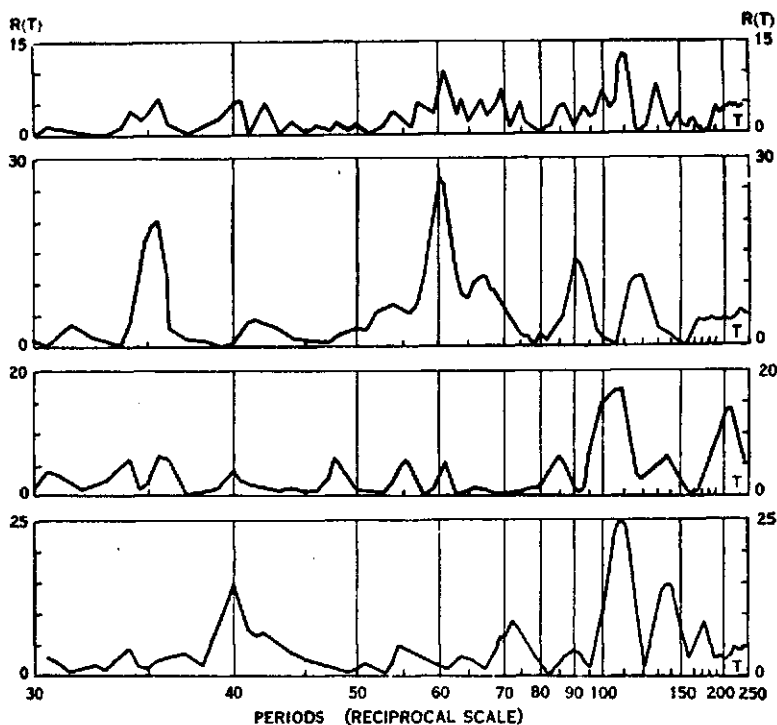

FIGURE 86.—WILSON'S PERIODOGRAM OF BUSINESS ACTIVITY:

Top curve, 1790-1929; Second curve, 1790-1859; Third curve, 1825-1894; Fourth curve, 1860-1929.

The most characteristic pattern observable from the periodograms as a whole is the tendency for a concentration of energy in the region around 108 months. One remarks also the 35-month cycle in I, discovered also in the rail stock price series of approximately the same time, the 18-year cycle of the second section, also characteristic of the rail price series, and the 40-month cycle of the third section, which has been so persistent a pattern in modern data.

To the values for  $R^2(T)$  reported by Wilson the author has added estimates of the corresponding energies; both are tabulated at the top of page 303.

For all these values the significance, as measured by the Walker probability, is very high. The small peaks revealed in the second period have an amplitude of approximately 6, with an energy content of 0.0396. These peaks are found at  $T = 34, 35.5, 48, 55.5, 61, 86,$  and 134.

In order to test the stability of the periods Wilson examined the period  $T = 35$  at intervals of 105 months over the range of the data,



Period $T$	I (1790-1869)		II (1825-1894)		III (1890-1929)		1790-1929	
	$R^2$	$R(T)$	$R^2$	$R(T)$	$R^2$	$R(T)$	$R^2$	$R(T)$
35	19.6	0.1292	.....	.....	.....	.....	.....	.....
40	.....	.....	.....	.....	14.8	.1092	.....	.....
60	27.5	0.1813	.....	.....	.....	.....	.....	.....
61	.....	.....	.....	.....	.....	.....	10.0	0.0696
90	14.3	0.0943	.....	.....	.....	.....	.....	.....
106	.....	.....	17.9	0.1607	.....	.....	.....	.....
108	.....	.....	.....	.....	25.4	.1873	.....	.....
110	.....	.....	.....	.....	.....	.....	12.5	0.0870
120	12.5	0.0824	.....	.....	.....	.....	.....	.....
138	.....	.....	.....	.....	14.8	.1092	.....	.....
216	.....	.....	15.7	0.1410	.....	.....	.....	.....

and the period  $T = 60$  at intervals of 240 months. The results of these computations are contained in the following table:

$T = 35$

Months	A	B	$R^2$	Months	A	B	$R^2$
1- 105	-0.42	-1.26	1.77	841- 945	-1.29	2.94	10.30
106- 210	2.48	-4.14	23.29	946-1050	-0.75	3.06	9.92
211- 315	2.80	-7.53	64.34	1051-1155	2.52	0.50	6.60
316- 420	5.47	-0.74	30.47	1156-1260	0.85	5.45	30.42
421- 525	1.60	1.09	3.75	1261-1365	-0.33	0.27	0.17
526- 630	6.56	-4.92	67.24	1366-1470	4.70	1.83	26.35
631- 735	-0.54	-5.86	36.63	1471-1575	-3.42	3.76	25.84
736- 840	3.17	-3.85	24.87	1576-1680	-3.37	-8.80	88.80

$T = 60$

Months	A	B	$R^2$	Months	A	B	$R^2$
1- 240	2.42	9.37	93.2	961-1200	-3.43	-0.38	12.0
241- 480	1.23	4.06	78.0	1201-1440	0.14	4.43	19.6
481- 720	-0.37	3.40	11.7	1441-1680	-1.25	-3.12	11.3
721- 960	0.81	-0.65	1.1				

It is interesting to observe that Wilson's conclusion from his long study of the data is that no permanent structure is observable in American business activity. Thus he remarks:

When the test of Schuster's was applied we found that it showed that the oscillations of Ayres' Index of American Business Activity were essentially fortuitous.<sup>4</sup>

In order to confirm his negative conclusions Wilson applied the test of forecasting by both backward and forward extropolations. The results were not encouraging and he says:

On the whole the forecasts were of average merit just about zero. Moreover, we did not get from the work any expression which would at all satisfactorily

<sup>4</sup> *Science*, Vol. 80, 1934, pp. 193-199.

forecast the period 1930 to date. This did but confirm our inference that there were no effective periods in American business activity.

About this failure, and the failure in general of forecasting economic series, Wilson makes the statement:

The reason we have so many failures in forecasting is that we presume to forecast the as yet unforecastable or attempt to control the as yet uncontrollable.

With all these conclusions the author is not in complete agreement. Significant and reasonably stable energy is actually found in the components at 9 and 17 years. But the total energy in these two components actually accounts for less than 30 per cent of the total observed variation. Hence any forecast from these two periods alone would not explain a substantial part of the future variation of the series. When to this is added the loss due to the probable error of forecast, we see that a negligible result might very easily have been attained. This, of course, is very far from admitting that the observed periods and the observed energies are fortuitous.

### 15. American Wholesale Prices (Annually, 1831-1930)

An inspection of the periodogram reveals the fact that most of the energy concentration is around the period  $T = 50$ . This observation has led to the proposition that there is a 50-year cycle in prices, and since the great disturbances which have generated the cycle during the past century and a half have been major wars, this periodic or

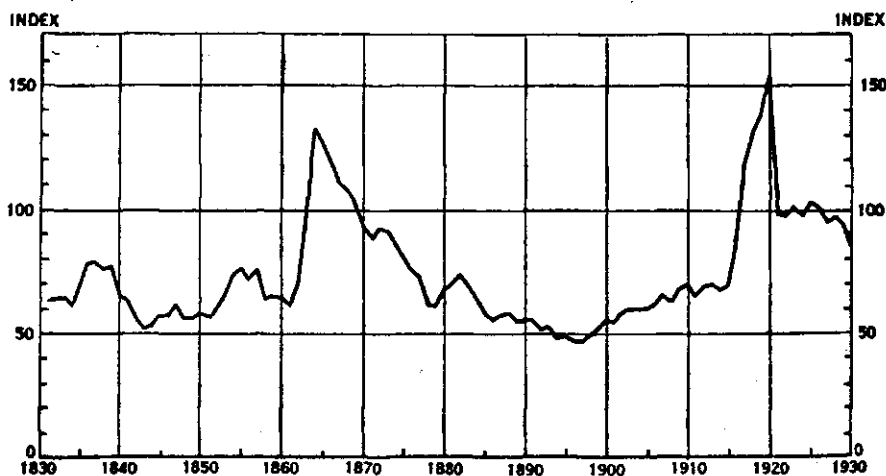

FIGURE 87.—AMERICAN WHOLESALE PRICES, ANNUALLY, 1831-1930.

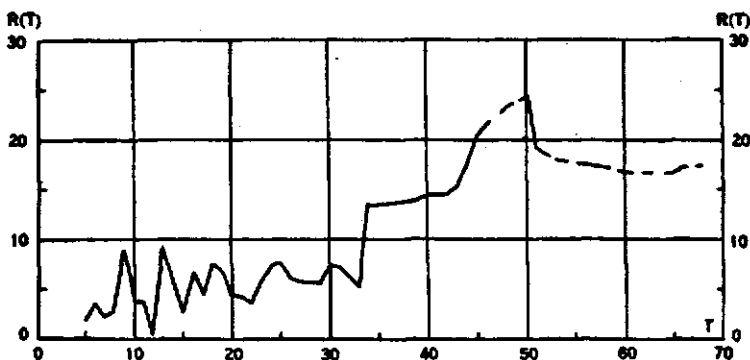

FIGURE 88.—PERIODOGRAM OF AMERICAN WHOLESALE PRICES, ANNUALLY, 1881-1930.

quasi-periodic movement in prices has been called the *war cycle*. We shall comment upon this point more fully in Chapter 12.

Since the secular change in prices is slight, we need not correct the periodogram for trend. Hence computing  $R_{\mu}^2 = 19.5810$ , we obtain the following table of values:

$T$	9	13	50
$E(T)$	0.0819	0.0882	0.5928
$\alpha(T)$	4.0946	4.4078	29.6422

There is undoubtedly a considerable continuous spectrum in wholesale prices, but this will probably not seriously impair the significance of the 50-year cycle, which seems to be one of the most permanent of economic patterns. Unfortunately only three such cycles have been observed in modern data. We have commented in Chapter 1 upon the curious fact that the Punic Wars between Rome and Carthage were spaced approximately 50 years apart and price data from that distant period, if they are ever reliably available, will doubtless reveal the same interesting pattern observed in modern data.

As to the periods at  $T = 9$  and  $T = 13$ , it is possible that the first is real, since it coincides with one of the primary business cycles and price changes are characteristics of large disturbances in the index of business.

#### 16. Sauerbeck's Index of English Wholesale Prices (1818-1913)

The periodogram of Sauerbeck's index numbers of English wholesale prices over the period from 1818 to 1913 is due to H. L. Moore,

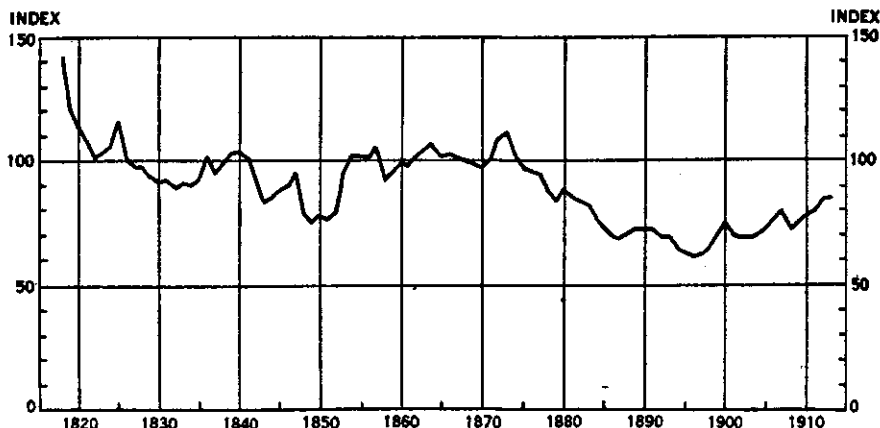

FIGURE 89.—SAUERBECK'S INDEX OF ENGLISH WHOLESALE PRICES, 1818-1913.

who published the data in his classical work *Generating Economic Cycles*.<sup>5</sup>

The periodogram was computed over the Fourier sequence so that no detail of the fluctuations in  $R(T)$  is given much after  $T = 24$ . However, in the periods examined, the computer has accounted for most of the energy since the sum of  $R^2(T)$  is equal to 428.57, which is to be compared with  $2\sigma^2 = 459.00$ .

An inspection of the data themselves would appear to indicate that the values of  $R^2(T)$  should be corrected for a trend. But this is an illusion if we admit the thesis advanced in the preceding section that there exists in wholesale prices a war cycle of approximately fifty years. We know that prices prior to 1818 were greatly inflated by the wars of Napoleon, and the unrolling scroll of history has revealed that the secular advance noted from 1896 culminated in another inflation due to the World War. The intermediate inflationary period between 1855 and 1875 was much smaller in England than in the United States, and somewhat smaller than in Germany where the Franco-Prussian War of 1870-1871 caused a relatively sharp increase in prices.

Noting the value  $R_M^2 = 9.5622$ , we compute the following table of values:

$T$	8.7	19.2	48
$E(T)$	0.0316	0.0615	0.4148
$\kappa(T)$	1.5184	2.9522	19.911

<sup>5</sup> New York, 1923, xi + 141 pp. For the data, see p. 66.

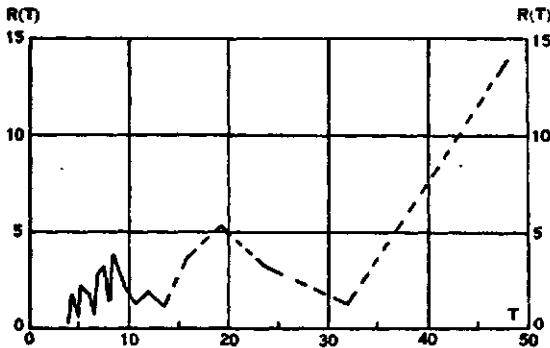

FIGURE 90.—PERIODOGRAM OF SAUERBECK'S INDEX OF ENGLISH WHOLESALE PRICES, 1818-1913

The most obvious pattern is that of the 50-year war cycle on which we have just commented. Minor cycles around 9 and 19 years are also observed, both of which are also found in Beveridge's analysis of wheat prices in western Europe (see Section 20). The first cycle is also found in the American wholesale index, but the second is replaced by a cycle of 13 years.

### 17. Commercial-Paper Rates (Annually, 1831-1930)

Another series for which we are indebted to the Cleveland Trust Company is that of commercial-paper rates. This series, a century in length, has been analyzed for significant periods. Apparently the only one that might be regarded as having a priori validity is found at  $T = 17$ . Computing  $R_{17}^2 = 0.3208$ , we obtain  $E(17) = 0.1505$  and  $\sigma(17) = 7.5243$ . If we neglect the contribution of the continuous spec-

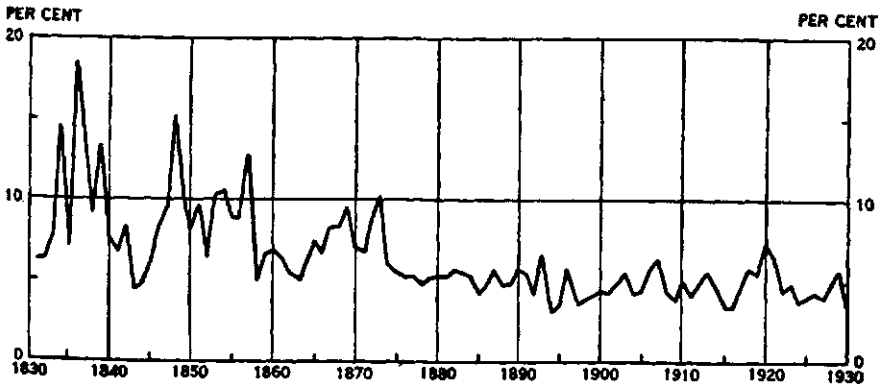

FIGURE 91.—COMMERCIAL-PAPER RATES, ANNUALLY, 1831-1930.

trum to the periodogram, the Walker probability of the observed period is 0.03. An observed trend in the data would undoubtedly, if removed, increase the significance of the period. It is probable that this 17-year cycle in commercial-paper rates is closely related to the building cycle of similar length, upon which we have commented previously.

Since our analysis extends only to periods of five years or longer, it would be interesting to know whether or not the 40-month cycle in so many business series also appears in commercial-paper rates. Fortunately this question can be answered by a periodogram constructed by W. L. Crum over monthly data for New York City from 1874 to 1913.<sup>6</sup>

Crum constructed his periodogram over the range of trial periods from  $T = 2$  to  $T = 48$ . He examined the data from 1874 to 1913 and the separate halves: I. From 1874 to 1893; and II. From 1894 to 1913. Consistent results were obtained for these three series, significant amplitudes appearing in each series in the neighborhood of  $T = 40$ . Crum noticed a slight tendency for the maximum to shift and estimated that the maximum was at  $T = 39.1$  for the range 1874 to 1913, at  $T = 38.5$  for 1884 to 1907, and at  $T$  between 42 and 43 for 1900 to 1913.

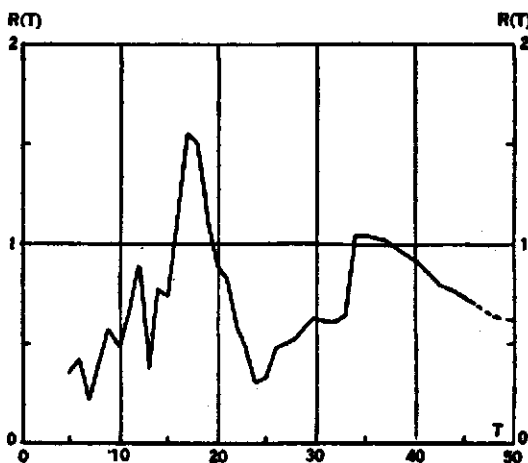

FIGURE 92.—PERIODOGRAM OF COMMERCIAL-PAPER RATES, 1881-1930.

The constants of the periodogram are given numerically only for  $T = 40$ , from which the author has constructed the following table:

<sup>6</sup> "Cycles of Rates on Commercial Paper," *The Review of Economic Statistics*, Vol. 5, 1923, pp. 17-29. This article gives the data for the monthly rates from 1866 to 1923 citing the following sources: Data from 1866 to 1880, W. M. Persons; from 1881 to 1889, American Telephone and Telegraph Co.; from 1890 to 1915, W. C. Mitchell; from 1916 to 1918, W. M. Persons; from 1919 to 1923, *Review of Economic Statistics*.

Period of analysis	$N$	$A$	$B$	$R^2$	$E$	$2\sigma^2$	$F(40)$	$\kappa(40)$
1874-1918	240	0.4242	-0.3667	0.3144	0.56	2.4720	0.1272	19.2640
1874-1893	120	0.5392	-0.0558	0.2939	0.54	2.1244	0.1388	8.2980
1894-1918	120	0.3483	-0.5700	0.4462	0.67	2.3768	0.1677	11.2620

It appears from this that the 40-month cycle is again in evidence and with unusual consistence for an economic time series.

We may, therefore, conclude that this analysis indicates that interest rates on commercial paper reflect both the 40-month cycle found in various related series of this same period and also the 17-year building cycle.

### 18. Rail Bond Prices (Annually, 1831-1930)

The data employed in this analysis are those computed by the Cleveland Trust Company. A casual inspection of the graph of the series shows a strong trend, so this must first be removed before any significance can be attributed to the periodogram. For this purpose we compute the first moment about the fiftieth item, namely,  $M_1 = 53300$ , and thus find the reduced variance to equal  $\sigma_1^2 = 377.7272$ . Hence the energy attributable to the trend is given by

$$E = 1 - \sigma_1^2/\sigma^2 = 0.4670.$$

The only amplitude in the periodogram which appears of significant size is that at  $T = 35$ . From the mean value  $R_M^2 = 15.1091$  we compute the corresponding energy and find that  $E(35) = 0.3428$ .

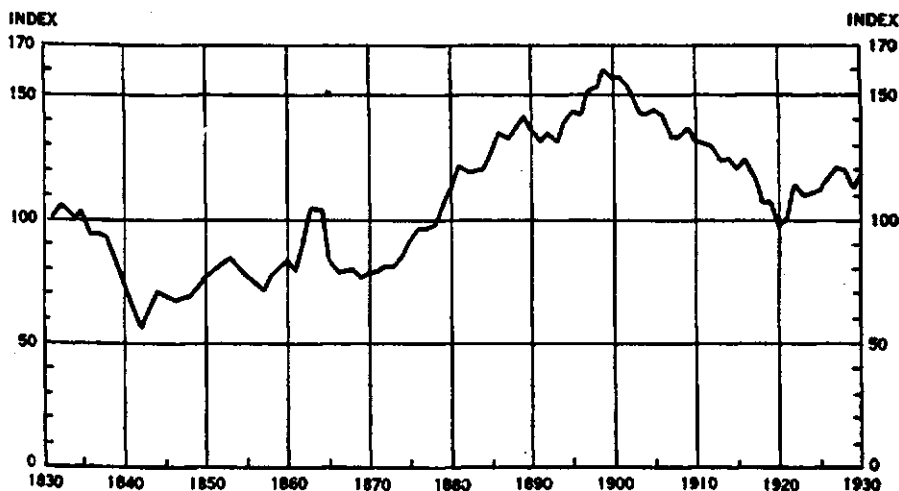

FIGURE 93.—RAIL BOND PRICES, ANNUALLY, 1831-1930.

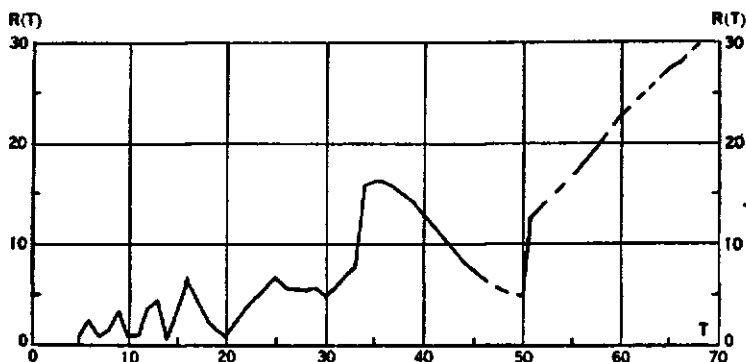

FIGURE 94.—PERIODOGRAM OF RAIL BOND PRICES, ANNUALLY, 1831-1930.

Although this energy is large, there is no a priori reason why a period of 35 years should be observed in rail bond prices. Moreover, less than three cycles appear in the 100 years covered by the data. Hence, while there is no doubt that a period of 35 years with significant amplitude has existed in the past 100 years, a lag correlation of rail bond prices would probably show that most of this significance can be absorbed by the continuous spectrum of the series.

Since other series exhibit 9- and 17 year cycles, it is worth noting that evidences of both these cycles appear in the present data. However, not more than 2 per cent of the energy may be attributed to the first nor more than 12 per cent to the second.

Our conclusion must be, therefore, that *the most significant movement in the price of rail bonds over the century under examination has been the trend.*

### 19. Business Failures in the United States (1867-1932)

A very complete harmonic analysis of business failures in the United States over a period of 64 years was made by Benjamin Greenstein.<sup>7</sup> The data examined were the ratios of business failures to the total number of business concerns, annual averages being used. The analysis is complete since the entire energy is accounted for by the Fourier coefficients computed.

Two peaks are observed, one near  $T = 9$  and the other near  $T = 16$ . The first is the more sharply defined and its significance is higher. Thus from the value  $R_M^2 = 0.0032586$ , we obtain  $E(9.14) = 0.2200$  and  $\kappa(9.14) = 7.0396$ . The Walker probability is found to equal 0.028 in spite of the fact that  $N$  is as small as 64. For the long-

<sup>7</sup> "Periodogram Analysis with Special Application to Business Failures," *Econometrica*, Vol. 3, 1935, pp. 170-198.



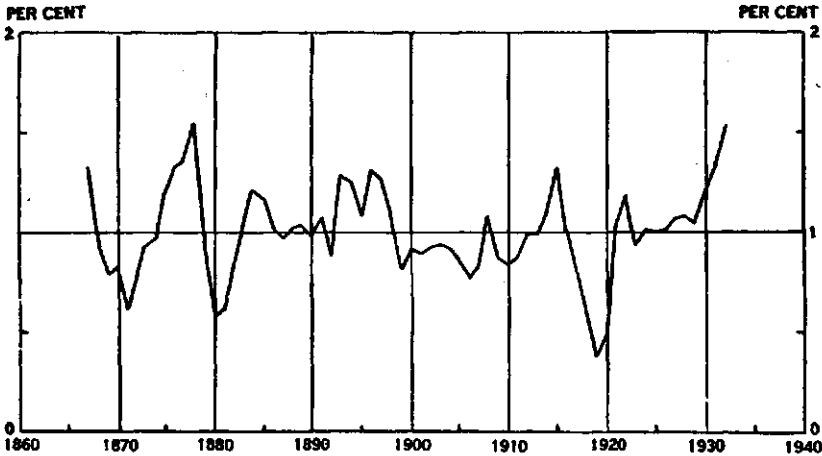

FIGURE 95—BUSINESS FAILURES IN THE UNITED STATES, 1867-1932, AS PER CENT OF THE TOTAL NUMBER OF BUSINESS CONCERNS.

er period we also obtain  $E(16) = 0.1489$  and  $\kappa(16) = 4.7662$  with a Walker probability equal to 0.247. The two periods together account for 36.89 per cent of the total energy in the spectrum.

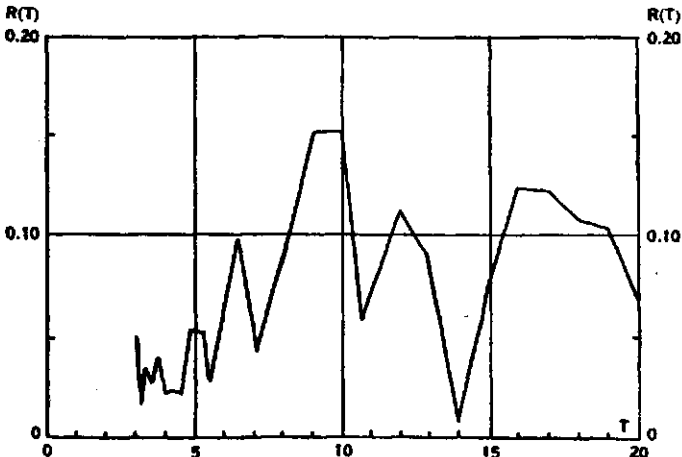

FIGURE 96.—PERIODOGRAM OF BUSINESS FAILURES IN THE UNITED STATES, 1867-1932.

Since business failures are obviously connected with the fluctuations in business, we have here again an added confirmation of the reality of the 9-year cycle and of the building cycle of nearly twice this period.

### 20. Wheat Prices in Western Europe (1500-1869)

One of the most heroic computations in the history of periodogram analysis was made by Sir William H. Beveridge in an attempt to determine whether or not there were permanent cycles in wheat prices in western and central Europe.\*

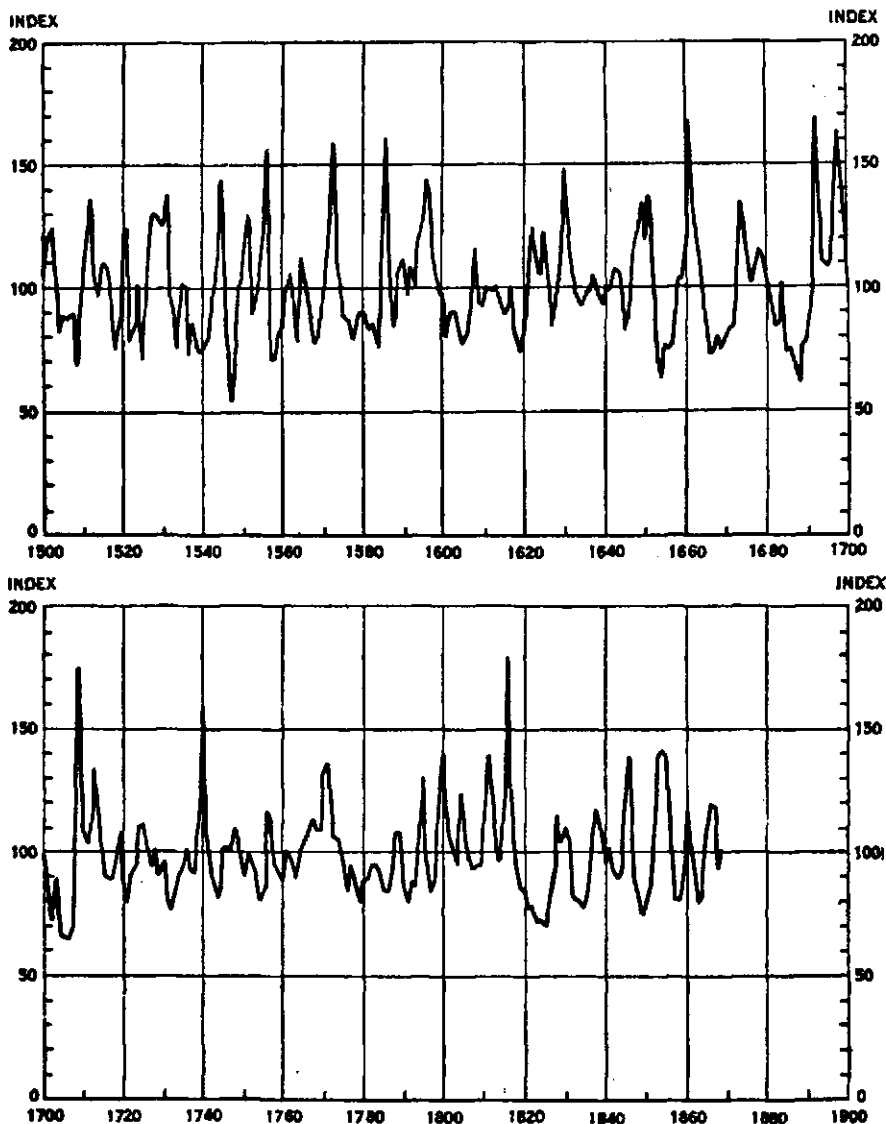

FIGURE 97.—WHEAT PRICES IN WESTERN EUROPE, 1500-1869.

\* "Wheat Prices and Rainfall in Western Europe," *Journal of the Royal Statistical Society*, Vol. 85, 1922, pp. 412-459.

The data employed in the analysis were index numbers of wheat prices from 1500 to 1869 so constructed that the trend, which was considerable in the period of transition from medieval to modern prices, has been removed.<sup>9</sup> These data were subjected to a harmonic analysis over a range of approximately 300 years, from 1545, the origin, to around 1844. A secondary analysis was described by Beveridge as follows:

Whenever, for any trial period, examination of the whole sequence . . . yields a high intensity, a further examination has been made of each half of the whole sequence taken separately, in order to determine whether the apparent period has persisted in each half. The second half sequence in all cases follows immediately on the first half; thus, at 5.667 . . . the first half sequence embraces the years 1545 to 1697, and the second half those from 1698 to 1850; at 5.714 . . . the two halves are 1545-1704 and 1705-1864. The origin for the different half sequences thus varies considerably.

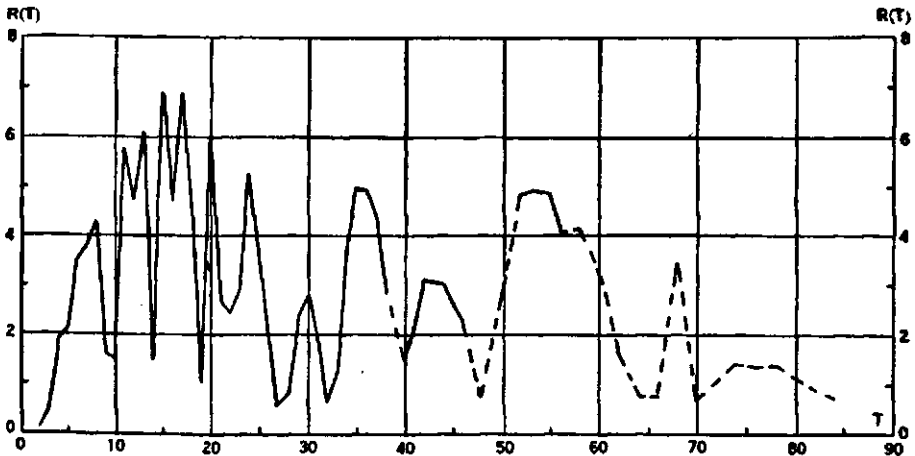

FIGURE 98.—PERIODOGRAM OF WHEAT PRICES IN WESTERN EUROPE, 1500-1869.

In Beveridge's study the values of the periodogram were given in the form  $I = (N/300)R^2$ , where  $N$  varies from 280 to 340. In order to keep the periodogram comparable with those previously given in this work, Beveridge's values have been reduced to  $R^2$  in the periodogram recorded here. The table given below is an abbreviation of the original, since Beveridge interpolated many additional values particularly in the neighborhood of significant peaks.

From the mean value  $R_m^2 = 5.8980$ , the following table of values of  $E(T)$  and  $\kappa(T)$  have been derived:

<sup>9</sup> "Weather and Harvest Cycles," *Economic Journal*, Vol. 31, 1921, pp. 429-452.

$T$	$E(T)$	$\kappa(T)$	$T$	$E(T)$	$\kappa(T)$
2.735	0.0095	1.4257	12.000	0.0253	3.7985
3.417	0.0154	2.3138	12.800	0.0488	7.3133
4.417	0.0176	2.6360	15.250	0.0849	12.7028
5.100	0.0469	7.0379	17.333	0.0593	8.8932
5.400	0.0168	2.5213	20.000	0.0401	6.0211
5.667	0.0363	5.4388	36.000	0.0274	4.1133
5.933	0.0225	3.3762	54.000	0.0273	4.0958
7.417	0.0207	3.1033	68.000	0.0135	2.0316
9.750	0.0368	5.5250			
11.000	0.0373	5.5885	Total	0.5862	

We see both from this table and from an inspection of the periodogram that the energy is concentrated in the earlier periods. Although the total of 0.5862 is not strictly correct since the sum is not taken over the Fourier sequence, it is nevertheless true that probably more than half the total energy is in the periods included in the table.

We also observe that there is no striking periodicity since the largest single concentration of energy is at  $T = 15.250$  and this is only 8.5 per cent. For a series as long as 300 items, however, a value of  $\kappa$  greater than 10 indicates a Walker probability as small as 0.007, while for  $\kappa = 5.4$  the probability is less than 0.50.

It would thus appear that some significance might be attributed to the periods at  $T = 5.100$ ,  $T = 5.667$ ,  $T = 9.750$ ,  $T = 11.000$ ,  $T = 12.800$ ,  $T = 15.250$ ,  $T = 17.333$ , and  $T = 20.000$ . About the nature of these periods we shall refer to Beveridge's analysis as follows:

*5.100 years.*—If there were no true period here, harmonic analysis would indeed be a sorry guide. Fortunately, there is no room for doubt. A period of just this length and closely agreeing in phase has been found independently not in one but in three or more other records by Mr. Baxendell in the direction of the wind and in the rainfall at Southport and elsewhere, and by Captain Brunt in the temperature at Greenwich. It is inconceivable that in each of four distinct analyses the same period should appear by chance or unless there was the same reality behind all four appearances.

A second, and perhaps more convincing, argument for the reality of the period is found in the intensities 34.05 and 57.09 in each of the half sequences of the data. This consistency is rather striking in view of the long periods of time involved in the analysis.

A third argument, not mentioned by Beveridge, is found in the rather curious fact that the length of the European business cycle which is the counterpart of the American cycle of 40 months, is approximately 5.2 years.<sup>10</sup> Jevons' original theory about the European cycle was that it correlates highly with the cycle in crops and the present argument would tend to strengthen belief in this relationship.

<sup>10</sup> See Section 2 of Chapter 12 of this book.

*5.671 years.*—At 5.667 the intensity is high . . . and the period is found equally strongly and with continuity of phase in each of the two halves. . . . There is no demonstrated parallel to this period in meteorological records. Many writers, however, have found, or have thought they had found, cycles of half the sunspot period of eleven years; the most precise of those in recent years is perhaps G. Hellmann, who, in the rainfall of Europe from 1851 to 1905, traced a periodicity of between five and six years. . . .

*9.750 years.*—At 9.750 years is a well-defined peak, . . . and each half-sequence yields a high intensity (38.44 and 29.72) with continuity of phase. . . . No certain meteorological parallel to this period can be traced. One or two writers have traced a period of just over ten years in the rainfall. More important and better fitting my requirements is the period of about 9.5 years which Captain Brunt in 1919 found indicated in the Greenwich temperatures. The evidence of my periodogram is clear and consistent, and stronger than in several other cases where confirmation by meteorological records compels belief. Provisionally, therefore, I have felt bound to treat this period as real, though differing from other periods as apparently not influencing the rainfall.

Since Beveridge is inclined to believe in the significance of this period, and since the evidence certainly does not indicate a meteorological explanation, one may more profitably attribute it to the influence of the nine-year period which we have so consistently observed in American data. Some evidence for this is found in Moore's periodogram of Sauerbeck's index of English wholesale prices, where there is indication of a tendency for an energy concentration around  $T = 9$ . The nine-year period is probably due to inherent elasticities in the economic system rather than to external causes.

*11.000 and 5.4 years.*—With these periods we come to one of the classic mysteries of cosmical meteorology. . . . There seems at first sight to be no question that the eleven-year cycle, which has dominated the sunspots and the minds of meteorologists for so long, must be accepted as one of the principal factors in the harvests and the weather of Western Europe.

At the test of continuity, however, the eleven-year cycle in wheat prices breaks down. Its intensity in the first 154 years (1545–1698) is 96.01; in the next 154 years (1699–1852) it is only 3.47. The importance of the period is seen to be due entirely to its vigour before 1700. From thence to the middle of the nineteenth century it is almost inoperative.

. . . . there seems to be a curious arithmetical relation between the fluctuating length of the sunspot period and another cycle suggested by my periodogram, to which a length of 5.423 years may be assigned, but which it is prudent to specify less exactly as 5.4 years. This cycle, in direct contrast to the 11.000-year cycle, is almost invisible before 1700 and very strong after it. . . . Whether there is physical reality behind this apparent relation of the 11.0-year and the 5.4-year periods, and if so of what nature, I cannot pretend to say. For practical purposes it is clearly unsafe to treat either period as operative at the present time.

*12.840 years.*—On the evidence of the periodogram the period between 12.800 and 13.000 years ranks second only to that near 15.250. Its intensity alike in the

whole sequence . . . and in each half (44.82 + and 72.16 +) is greater than that of the established 5.1-year period, and it does not show the anomalies which mar the period near 17.500 years described below.

Beveridge discovers no meteorological parallel or other external reason for the existence of a period of this length in prices.

*15.225 years.*—My investigation began two and a half years ago with the appearance, in statistics of exports and of barometric pressure, of a cycle which I named "as between 15.2 and 15.4 years" in length . . . In the fuller analysis now presented . . . this period is still the leading feature. . . .

It is impossible to doubt that this striking feature of the periodogram corresponds to some physical facts, and, in spite of the failure of meteorologists to discover an independent cycle of about fifteen years in weather records, such a cycle may exist. But I am inclined to attribute certainly the importance, and possibly the very existence, of the peak at 15.250 in my periodogram, not to any single cycle of that length, but to a combination of smaller cycles of lengths which are all close sub-multiples of 15.250 or its double. Of the seven cycles under eight years of length found in my present analysis, two (5.100, 7.417) are close sub-multiples of 15, and four more (2.735, 3.415, 4.415, 5.960) are close sub-multiples of 30 or 31. With the single exception of 5.671, all the seven shortest cycles found by me have exact multiples between 29.7 and 30.9; the average of these six multiples is 30.37, which is almost exactly twice the main period of 15.225. . . .

*17.400 years.*—At 17.500 and 17.333 are intensities surpassed only by those near 15.250; and the natural course is to assume a real period between these points—say, at 17.400 . . . examination of the two half-sequences yields puzzling results. For 17.500 we get high intensities in both halves (69.34 from 1545 to 1684, and 55.53 from 1685 to 1824). For 17.333 we get an extremely high intensity in the first half (136.19 from 1545 to 1700), followed by practical disappearance of the period in the next half (11.94 from 1701 to 1856). . . The sequence for 17.333, it will be seen, covers thirty-two years (1824–56) not used for 17.500; the explanation of the discrepancy between the intensities must apparently be that in those years the cycle disappeared or changed its phase completely.

It will be observed that this cycle, if its reality be admitted, is probably associated with the 17-year building cycle and hence has no meteorological origin.

*19.900 years.*—The intensity at 20.000 years is high both in the whole sequence . . . and in each half (50.07, 23.97) . . . The period is seen by examination of neighboring intensities, and of progression of phases, to lie between 20.000 and 19.750. The actual length shown, 19.900, accords well with all the indications. . . No meteorological parallel has been found; but the evidence of the periodogram is strong.

Among the other periods not explicitly discussed here, Beveridge attributes high significance to the period around 35.500, which appears to be derived from "the well-known thirty-five-year cycle discovered by Dr. Eduard Bruckner in 1890, as causing a regular alternation of dry and warm periods with wet and cold ones."<sup>11</sup>

<sup>11</sup> "Klimaschwankungen seit 1700," published in *Geographische Abhandlungen*, Vol. 4, part 2, 1890, Vienna.

The period at  $T = 54.00$  also merits consideration, although it is unconfirmed by meteorological parallel. We would say that this indicates the existence of the war cycle in wheat prices.

### 21. Sunspot Numbers (1750-1900)

One of the most intriguing mysteries of astronomy is that associated with the cause and the cyclical variation of sunspots. The possibility of some ancillary effect upon terrestrial phenomena has made the analysis of sunspot data of interest not only to the meteorologist, but also to the economist and psychologist. It is for this reason that the harmonic analysis of the data, the sunspot numbers of Wolf and Wolfer, as made by Sir Arthur Schuster,<sup>12</sup> is given in this volume.

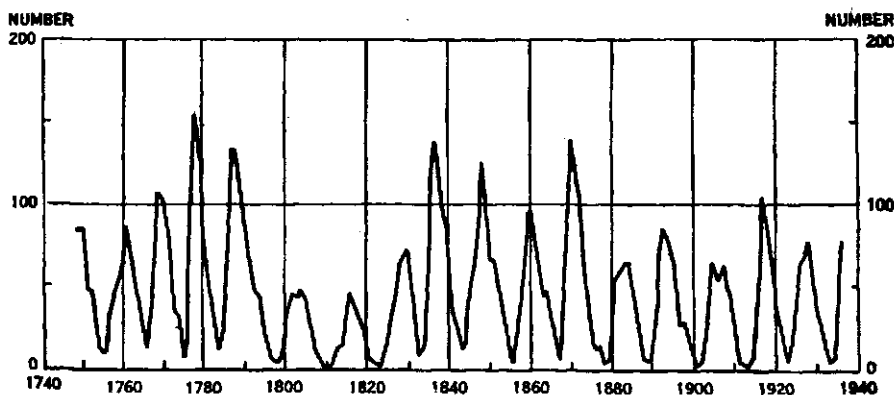

FIGURE 99.—SUNSPOT NUMBERS, 1749-1937 (AVERAGE MONTHLY).

The complete periodogram shows only one well-defined peak, namely that at  $T = 11.25$ . In order to compute the corresponding energy and to reduce the elements of Schuster's periodogram to the standard form adopted in this book, it was necessary to divide Schuster's  $R^2$  by  $157 = (12.53)^2$ , the area number for sunspots, and to make certain estimates for the value of  $N$ . From these adjusted values, we then compute  $R_{\mu}^2 = 30.8824$  and hence obtain the values  $E(11.25) = 0.3462$ ,  $\kappa(11.25) = 25.9651$ .

The significance of the cycle is obviously so high that there can be little doubt as to its actual and permanent existence, a conclusion which is amply justified in the observations made on the phenomenon since the time of the computation of Schuster's periodogram.

<sup>12</sup> "On the Periodicities of Sunspots," *Philosophical Transactions of the Royal Soc. of London*, Vol. 206 (A), 1906, pp. 69-100.

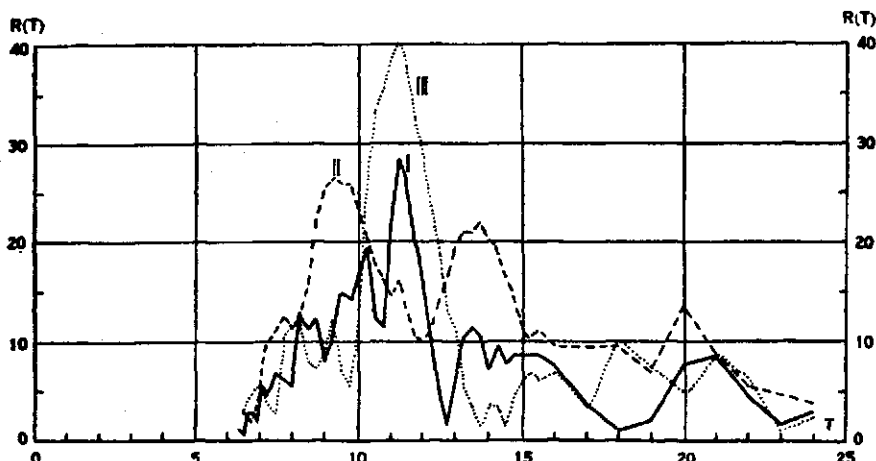

FIGURE 100.—PERIODOGRAM OF SUNSPOT NUMBERS.  
I. 1750-1900, II. 1750-1825, III. 1826-1900.

In order to confirm the reality of the phenomenon, Schuster divided the data roughly into two equal parts, one from 1750 to 1825, and the other from 1826 to 1900. A comparison of the two periodograms is both surprising and important. In the first period the 11-year cycle has disappeared, but has been replaced by two major periods, one at  $T = 9.25$  and another at  $T = 13.75$ . In the second period, 84.74 per cent of the energy is concentrated at  $T = 11.25$ , while about 8.67 per cent is found in a period  $T = 8.25$ . The pertinent computations are found in the following table:

First Half			Second Half		
$R_M^2 = 46.7005$			$R_M^2 = 52.4470$		
$T$	$E(T)$	$\kappa(T)$	$T$	$E(T)$	$\kappa(T)$
9.25	0.2700	10.1262	8.25	0.0867	3.2495
13.75	0.1903	7.1345	11.25	0.8474	31.7781
Total	0.4603		Total	0.9341	

One's conclusion from these computations is that there has undoubtedly been a high concentration of energy in sunspot data in the interval between  $T = 8$  and  $T = 14$ , but that the distribution of this energy tends to be bimodal. The periodogram, even without an explanation of the cause of sunspots, affords almost conclusive evidence that the sunspot cycle is a real phenomenon and that the recurrence of sunspots can be forecast with high accuracy.



Even the fact that the second half of the data does not agree with the first half should not seriously impair the use of the periodogram in forecasting the movement of sunspots. The change of period is not abrupt and if in the future the energy of the data should again begin to distribute itself more evenly between a longer and a shorter period, this change could doubtless be ascertained by means of a moving periodogram in time to make accurate forecasting possible.

There is much to be learned from this example by those who employ periodogram analysis in the study of economic series. Here, although we have a higher energy concentration than in any of the economic series yet analyzed, this concentration is subject to disturbances from one period to another. And, more significant yet, there is no doubt among astronomers as to the reality of the phenomenon even though no a priori cause has yet been fully demonstrated.

### 22. Galvanometer Series

In connection with the investigation of the "erratic-shock theory" of economic cycles, an extensive experiment was made by the Cowles Commission relative to the periodic behavior of a galvanometer which was subjected to a series of random shocks. The conclusions to be derived from this experiment will be stated later. It will suffice here to give the results observed.

The erratic shocks were imposed upon the galvanometer which, by a system of weights, was constrained to oscillate with three periods in the ratio of 22 to 43 to 62. Moving pictures of the deviations of the galvanometer were taken and the data were then subjected to harmonic analysis. The following results were obtained:

22-item period			43-item period			62-item period		
$R_M^2 = 3.5128$			$R_M^2 = 7.7969$			$R_M^2 = 12.3877$		
$T$	$E(T)$	$\kappa(T)$	$T$	$E(T)$	$\kappa(T)$	$T$	$E(T)$	$\kappa(T)$
23	0.0830	12.4462	42	0.2839	42.5805	56	0.1860	27.8951
34	0.2022	30.3325	62	0.4626	69.3973	62	0.1164	17.4589
66	0.2992	44.8812				72	0.5181	77.7134
Total	0.5844		Total	0.7465		Total	0.8205	

It is clear from this table that the largest disturbance was given to the shortest period, but that for the longest period the energy concentrated around the free period of the galvanometer. This would imply that the disturbance was dependent upon the inertia of the system as this was related to the magnitude of the shocks imposed.

We might infer from this that quite probably the erratic shocks which disturb an economic system would tend also to cause more variation in the shorter cycles than in the longer ones.

### 23. Stock Price Indexes (Daily, 1927)

An exploration was started to see whether very short cycles might not exist in stock price averages. For this purpose two daily series and two weekly series were harmonically analyzed. The results of this study are given in this and the next three sections. Since it was possible that the structure of a bull market might be different from that of a bear market, the series were chosen so that one daily and one weekly series would contain a bull market and the other daily and the other weekly series would contain a bear market.

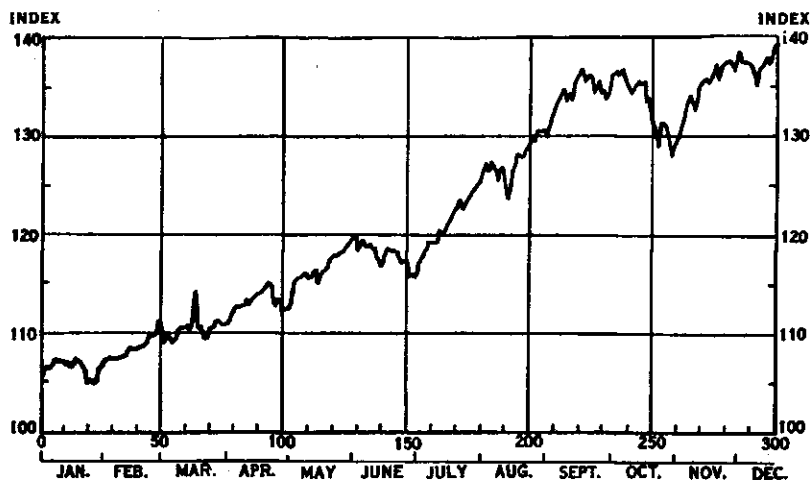

FIGURE 101.—STOCK PRICE INDEX, DAILY, 1927.

Figures for holidays are interpolated and Sundays are not counted on time scale.

The daily series analyzed in this section contained the bull market of 1927. Since the characteristic feature of this series is the trend, the variance must be corrected for this. Employing formula (6) of Section 1, we thus obtain

$$\sigma_1^2 = 114.8970 - 107.6209 = 7.2761,$$

from which we compute  $R_z^2 = 0.0970$ .

From the periodogram we see that the principal amplitudes are at  $T = 36$  and  $T = 48$ . But since we are also interested in the possibility of a cycle in the neighborhood of 5 or 6 days we shall also test

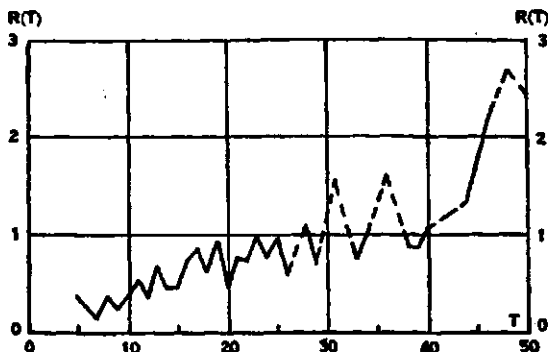

FIGURE 102.—PERIODOGRAM OF STOCK PRICE INDEX, DAILY, 1927.

the period  $T = 5$ . But since the trend is so great, the slope being equal to 0.12039, it is necessary also to correct the values of  $R^2$  by the method described in Section 1.

These corrected values of the squared amplitudes, together with the energies both for the corrected series,  $E(T)$ , and for the series uncorrected for trend,  $E'(T)$ , are given in the following table:

$T$	$R^2(T)$	$E(T)$	$E'(T)$
5	0.0628	0.0043	0.0002
36	0.0528	0.0036	0.0045
48	0.7799	0.0536	0.0124

From this we see that the evidence for cyclical components in these daily series is very tenuous. Most of the energy during this year was concentrated in the trend.

#### 24. Stock Price Indexes (Daily, 1930)

We see from the graph of the data that the trend is again the dominating characteristic, but this time it is essentially parabolic instead of linear. Therefore, it will be necessary to correct the values of the variance and the harmonic components for this trend. The formulas for this are given in Section 4 of Chapter 6, and in (9) of Section 6 of Chapter 2.

Selecting the first item of the data as origin, we first compute the least-squares parabola and thus obtain

$$y = 178.26 + 0.22715 t - 0.001467 t^2.$$

The corrected variance is found to equal  $\sigma_y^2 = 88.3626$ , from which we find  $R_y^2 = 1.1782$ . For our analysis we shall select the amplitudes at  $T = 7$  and  $T = 40$ .

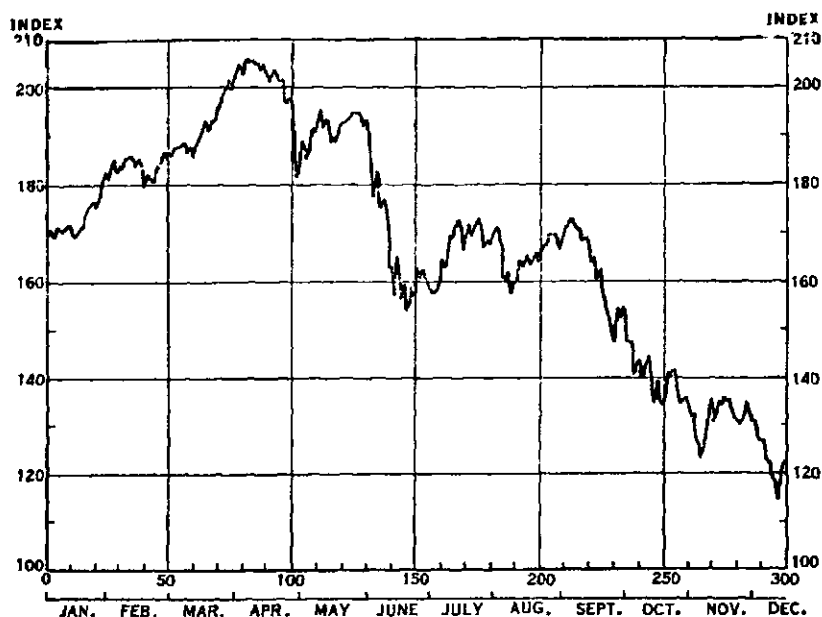

FIGURE 103.—STOCK PRICE INDEX, DAILY, 1930.

Figures for holidays are interpolated and Sundays are not counted on time scale.

In the following table we have listed the original values of the harmonic components,  $A$  and  $B$ , the corrections to these due to the parabolic trend, the corrected values,  $A'$  and  $B'$ , the new squared amplitudes  $R^2(T)$ , the corrected energy,  $E(T)$ , and the original energy uncorrected for the trend,  $E'(T)$ :

$T$	$A$	$B$	Correc- tion for $A$	Correc- tion for $B$	$A'$	$B'$	$R^2(T)$	$E(T)$	$E'(T)$
7	-0.9716	0.5642	0.0073	-1.4522	-0.9643	-0.8880	1.7184	0.0097	0.0012
40	1.0187	4.4126	0.2379	-8.2981	1.2566	-3.8855	16.6762	0.0944	0.0196

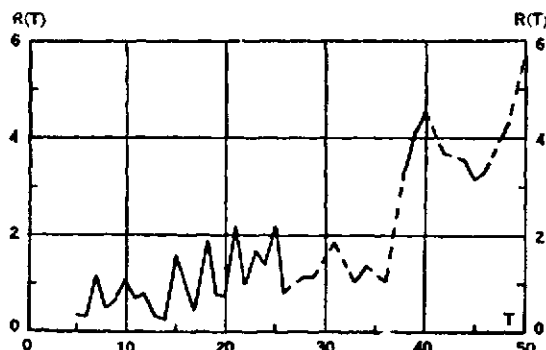

FIGURE 104.—PERIODOGRAM OF STOCK PRICE INDEX, DAILY, 1930.

From these data we see that the main energy of the movement is contained in the trend and that small significance is to be attached to the two harmonics analyzed here. These results are consistent with those obtained for the daily moves in the bull market investigated in the preceding section. It is to be observed, however, that the significance of the periods was increased by the removal of the trend.

### 25. Stock Price Indexes (Weekly, 1922-1927)

The graph of these data shows that the series was dominated by an approximately linear trend with a slope equal to 0.18643. The amplitudes chosen for examination were those at  $T = 8$ ,  $T = 24$ ,  $T = 36$ ,  $T = 42$ .

Corrections were first made for the trend. Thus by means of formula (6) of Section 1, we obtain  $\sigma_1^2 = 41.9494$ , and from this we compute the average  $R_M^2 = 0.5593$ .

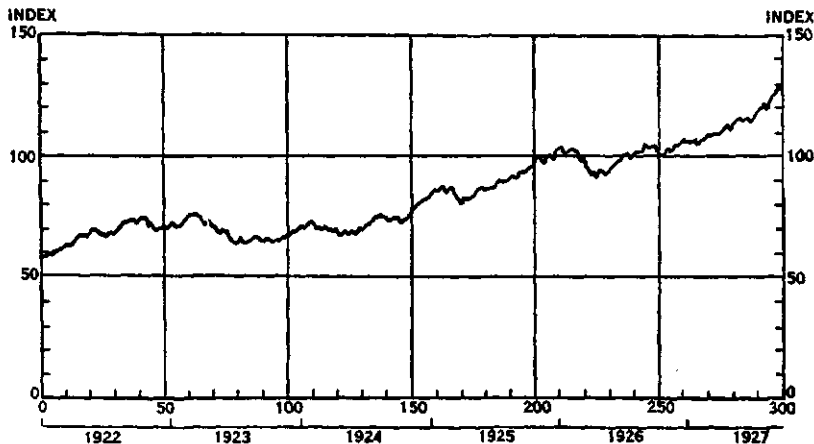

FIGURE 105.—STOCK PRICE INDEX, WEEKLY, 1922-1927.

The harmonic components are now corrected for trend by means of the formulas in Section 1, and from these the corrected values of the squared amplitudes are obtained. These are then employed to find the energies,  $E(T)$ , which are compared in the following table with the energies obtained from the original periodogram. These energies are designated by  $E'(T)$ .

$T$	Corrected Value of $E^2(T)$	$E(T)$	$E'(T)$
8	0.0313	0.0004	0.0004
24	1.6909	0.0202	0.0124
36	2.0566	0.0245	0.0202
42	2.1458	0.0256	0.0257

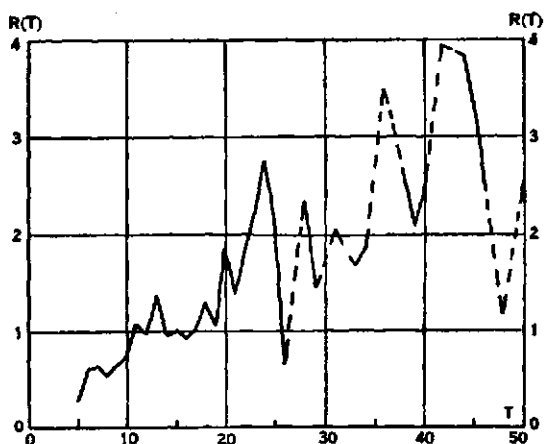

FIGURE 106.—PERIODOGRAM OF STOCK PRICE INDEX, WEEKLY, 1922-1927.

It is at once apparent that the periodogram reveals no essential structure in this series.

#### 26. *Stock Price Indexes (Weekly, 1929-1935)*

Our final analysis concerns the weekly stock price averages in a bear market. Here again we see from the graph of the data that a strong trend prevails and that it is essentially parabolic.

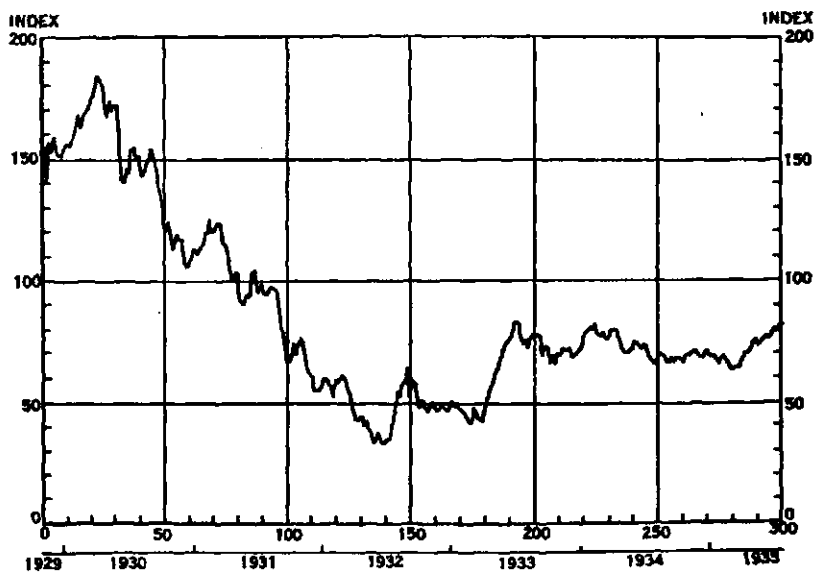

FIGURE 107.—STOCK PRICE INDEX, WEEKLY, 1929-1935.

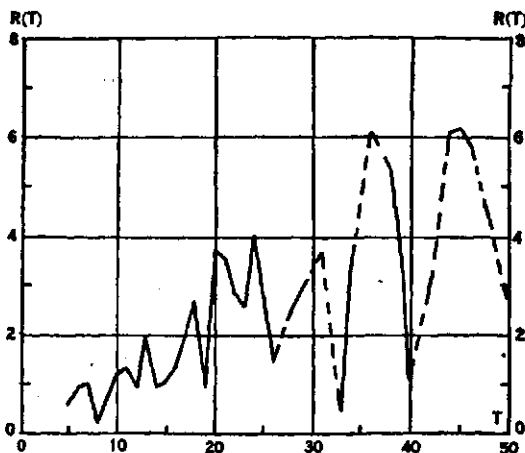

FIGURE 108.—PERIODOGRAM OF STOCK PRICE INDEX, WEEKLY, 1929-1935.

Hence we employ the technique described in Section 24 and correct all the parameters for the effects of the trend. To do this we first find the least-squares parabola whose initial point,  $t = 0$ , coincides with the first item of the series. This parabola is found to be

$$y = 112.6720 - 1.39107 t + 0.0036318 t^2 .$$

The variance is next corrected for trend and found to equal  $\sigma^2 = 171.8648$ . From this value we obtain  $R^2 = 2.2915$ . The values of  $R^2(T)$  are next corrected for  $T = 36$  and  $T = 45$ , and from them the energy,  $E(T)$ , is found. This is compared with the energy,  $E'(T)$ , obtained at the same periods from the uncorrected periodogram, in the following table:

$T$	Corrected Values of $E^2(T)$	$E(T)$	$E'(T)$
36	12.2260	0.0356	0.0126
45	17.3599	0.0505	0.0133

Although the correction for trend is observed to increase the original energies obtained from the periodogram, it is clear that small significance is to be attached to the observed periods. Most of the energy in the original series is in the trend and in higher periods or in the continuous spectrum.

### 27. General Summary

In the preceding sections of this chapter we have presented the periodograms of numerous time series. The first four were introduced

to illustrate exactly what information might be expected to emerge from such an analysis, since the structures of the series analyzed were known. The first was the periodogram of a series of regular harmonic terms, and such a periodogram reveals clearly how much information can be obtained under optimum conditions. The next three were periodograms relating to random series, particularly when such series are subjected to the operational processes of smoothing and accumulation.

Of the remaining periodograms, nineteen apply to actual economic time series. The most searching investigation was made for structure in the series of stock prices on the theory that the activity of this time series lies at the heart of most economic variation. Stock prices were analyzed from intervals of one day to intervals of 50 years, so that a complete spectrum of this series is now available.

The remaining periodograms pertained to sunspot numbers and to the deviations of an oscillating galvanometer subjected to a series of random shocks. The first series is important because it concerns a phenomenon of great regularity for which no a priori explanation is yet available. It thus represents to a certain extent the same type of series which we might expect to find in economics under optimum conditions of variability; that is to say, when the random element is a minimum. The galvanometer series are useful in testing the hypothesis that economic series are essentially movements of an elastic system, which is subjected to a series of random shocks.

The conclusions to be derived from this long analysis will be stated later in the book. This chapter, then, is to be regarded as a working summary of all that we know at the present time about the harmonic variation of economic time series, when the analysis is confined to a rigid periodogram of the type first extensively used by Sir Arthur Schuster. All variants of this method, which strive to give greater freedom to the analysis of harmonic patterns, must derive their first approximations of structure from such periodograms as those presented in this chapter.



## CHAPTER 8

### THE EVIDENCE AND EXPLANATION OF CYCLES

#### 1. *The Enumeration of Theories*

We have seen from the data presented in previous chapters that the evidence points clearly to the existence of a certain amount of variation in many of the time series examined. This variation, to be sure, is frequently irregular and any attempt to interpret it in terms of mathematical cycles must take full account of the erratic element, which is everywhere observed in phenomena that depend upon the vagaries of the human spirit and the uncertainties of nature.

Our first observation concerned the cycle which depends upon the seasons. This cycle, called the *seasonal variation*, is found in many economic time series, and, as is evident from the name, can always be accounted for by a priori means. Thus the movement of crops in the fall of the year is clearly the cause of seasonal variation observed in freight-car loadings. The price of eggs depends upon the production of eggs, and this is well known to vary with the seasons, reaching a high point in March and a minimum in October. Not all economic series show the seasonal factor, as one may observe by testing the series of industrial stock prices over several years, or, for that matter, most price series which are based upon nonseasonal production.

Since the adjustment for the seasonal variation is one of the first statistical procedures employed in the analysis of economic time series, it is interesting to inquire into the significance of this correction. We have already cited in an earlier chapter the example of freight-car loadings as a series with an exceptionally prominent seasonal variation. From the periodogram of freight-car loadings (Section 7 of Chapter 2) we see that the per cent of energy attributable to this cycle is given by

$$\text{Per cent of energy} = 100 \times \frac{R^2(12)}{2\sigma^2} = 11.87 .$$

Thus we observe that even in a series in which the seasonal is as pronounced as it is in the data for freight-car loadings, the energy attributable to this factor is only 12 per cent of the total. *Hence we*

*conclude that the seasonal variation is, in general, relatively insignificant when compared with secular changes, or the longer, although essentially irregular, movements which are generically called the business cycles.* For example, in the stock price series analyzed in Section 6 of Chapter 6, the energy left in the erratic element after three major cycles and the secular trend had been removed was as great as eight per cent.

We must, therefore, seek to discover the significant secrets of most economic time series, not in seasonal variations, but in the longer cycles and the secular trends. To this analysis and interpretation we now proceed.

In order to simplify the problem we shall investigate four phenomena which have been observed and commented upon by others. These phenomena are, first, the forty-month cycle observed in many series; second, the nine-year cycle characteristic of the data of business; third, the 15- to 18-year cycle of real estate; fourth, the 50-year war cycle observed in prices. For all of these we lack an a priori theory and doubts as to their essential reality have been expressed frequently by critics of the business cycle. Where, in observable phenomena which might conceivably affect the human spirit, do we find cycles of these periods? How can human action and human judgments, from which the time series of economics are generated, conform to regular patterns? This is the puzzling aspect of the problem and one of the most cogent reasons advanced by those economists who are reluctant to ascribe reality to the periodic or semi-periodic movements, described by proponents of the business cycle.

Hence, if we are to assume that reasonably regular patterns can be observed in the economic time series, it is necessary to ascribe causes to the variations. Wesley Mitchell in his classical treatise on *Business Cycles, the Problem and its Setting*, New York, 1927, enumerates three types of theory which have been formulated to explain the existence of cycles: (I) Theories which trace business cycles to *physical* processes; (II) Theories which trace business cycles to *emotional* processes; (III) Theories which trace business cycles to *institutional* processes.

In the first category must be placed such sensational theories as those of H. S. Jevons and H. L. Moore, the first attributing the variations in business to sunspot activity, which has a well-defined period of about eleven years, and the second affirming a belief that the eight-year period in the conjunction of Venus produces sufficient variation in the weather and in crop yields to affect business.

It is obvious that if business is influenced by conditions external

to its own institutions, a correlation must first be observed between the external and the internal cycles. But the establishment of such correlations is not sufficient to prove such influences without the ad-  
duction of a priori evidence to show the causal nature of the postulated relationship. The argument which we introduced in Section 2 of Chapter 5, to show that empirical relationships discovered in economic time series are essentially problems in inverse probability, is valid here. Even though a high correlation may be observed between historical crises and the maxima or minima of sunspots, this is totally insufficient to prove scientifically that the observed relationship is real and that it may be relied upon for the forecasting of business depressions. Those who now favor the theory, realizing the weakness of the correlation argument, have attempted to establish a direct relationship between sunspots and psychic factors such as optimism and pessimism. If it could be demonstrated, for example, that a highly ionized atmosphere exerted a direct influence upon the human spirit, then there might be a valid basis for accepting the thesis that sunspot activity may lead to group optimisms or group pessimisms with their ancillary reactions upon the business cycle. A review of the evidence supporting the Jevons hypothesis will be given in a later chapter.

Most of the theories of the cause of business cycles, however, center around institutional explanations. These theories may be classified under two heads: (1) changes in institutions themselves; (2) the functioning of the institutions. The assumption is made in the first case that changes in social processes, innovations, inventions, and discoveries are not uniform, but come in irregular patterns which disturb the existing equilibrium and cause crises and depressions. This explanation is quite similar to that theory of evolution, initiated by Hugo de Vries, which attributes change in species to sudden and discontinuous *mutation*. The evidence in either theory is not clearly categorical. In the second case, namely that which is concerned with the functioning of institutions, perturbations are attributed to various processes in the economic system such as: (a) the technical phases of money making; (b) the lack of equilibrium in the processes of distributing and spending incomes; (c) the lack of equilibrium in the factors of production and in the consumption of goods; (d) the lack of equilibrium in the processes of consuming, saving, and investing capital in new enterprises; (e) the processes of banking.

Ragnar Frisch in an illuminating monograph, entitled "Propagation Problems and Impulse Problems in Dynamic Economics,"<sup>1</sup> seeks

<sup>1</sup> From *Economic Essays in Honour of Gustav Cassel*, London, 1933.

to answer the question as to how oscillations can be introduced into economic processes. He finds at least four causes. The first of these, attributed to J. M. Keynes, distinguishes between saving and investment. Since these are distinct and different processes, there is a tendency toward disequilibrium which results either in a depression or in an expansion.<sup>1a</sup>

The second cause is found in the profound influence exerted upon the behavior of both consumers and producers by the existence of debts. This explanation of booms and depressions is essentially due to Irving Fisher.<sup>2</sup> Thus he estimates the existence of a total debt in the United States in 1929 of 234 billions of dollars, an amount equal to 65 per cent of the total estimated wealth of 362 billions for the entire country. "Billions of debts and a gold base that was slippery," said Fisher, "these two conditions had now set the stage for the collapse of 1929."

The third mechanism which might lead to business fluctuations is the distribution of income. "This idea," says Frisch, "may—with a slight change of emphasis—be expressed by saying that under private capitalism production will not take place unless there is a prospect for profit, and the existence of profits tends to create a situation where those who have consumption power do not have the purchasing power, and *vice versa*. Thus, under private capitalism, production must more or less periodically kill itself."

The fourth cause, which is the main object of Frisch's investigation, is attributed to A. Aftalion. This affirms that a principal cause of oscillation in the economic system is the "distinction between the quantity of capital goods whose production is *started* and the activity needed in order to carry to *completion* the production of those capital goods whose production was started at an earlier moment." This theory, in its precise mathematical formulation, has been called a *macrodynamic theory* of business cycles. An account of the basic postulates and its present statistical status will be discussed in Section 3 of this chapter.

Irving Fisher in his book on *Booms and Depressions*, in which he argues for the theory of overindebtedness as a cause of business cycles, lists thirteen other theories which are related in one way or another to the debt cycle. We quote *in extenso* from Fisher:

<sup>1a</sup> This theory has been rejected by Keynes in his more recent work, *The General Theory of Employment, Interest, and Money*, New York, 1936, xii + 403 pp. Unfortunately the arguments are not formulated in such a way that they can be tested by statistical data.

<sup>2</sup> From *Booms and Depressions*, New York, 1932, xxi + 258 pp.

1. **PRICE-DISLOCATION THEORY.** There is, for instance, the "price dislocation" theory. This holds that when among prices (of commodities, rent, interest, and taxes) some are unduly low and others unduly high, the exchange of goods is retarded; and that this involves the retardation of production and employment.

Evidently the deflation stressed in this book dislocates prices, and when it arrives, it finds some prices, such as rent, interest, taxes, salaries and wages, more unyielding than others. If we add principal as well as interest, we may think of the increased debt and interest burden as a sort of "dislocation" due to inflation. Doubtless, any other sort of price-dislocation will cause disturbances. Moreover these dislocations often tend to be cumulative. The more unyielding one group of prices the more other prices must yield. In the depression of 1932 some writers maintain that the area of "rigid" prices was the largest in history. If, as seems likely, there is going on a gradual progressive freezing of large parts of the price structure, the instability of the rest will become greater and greater, and will tend more and more to bring about a crash from time to time.

2. **INEQUALITY-OF-FORESIGHT THEORY.** Then there is the theory on the inequality of foresight as between lender and borrower. In *The Theory of Interest*, I have worked out some of the oscillatory tendencies resulting from such inequality. During inflation, the borrower sees (or feels), better than the lender, the fact that real interest is low; and this tempts him to borrow too freely, and leads him into over-indebtedness.

3. **CHANGES-IN-INCOME THEORY.** Some theories stress the changes in income. The fluctuations of real income and the re-distribution of income are, of course, of supreme importance; and some of these changes have been included in the analysis of this book, especially as to their bearing on profits and unemployment.

4. **FLUCTUATIONS-IN-DISCOUNT THEORY.** There is the theory of fluctuations in the rate of discount at which income is capitalized. Such fluctuations are important in many ways. A changed rate of discount affects the value of collateral against debts, and so affects solvency.

5. **VARIATIONS-OF-CASH-BALANCE THEORY.** Then there is the theory of the variation of people's cash balances in the banks. This is already included, to some extent, in the analysis of the present book, under the head of velocity of circulation. The variations of cash balances are especially important in relation to bank reserves. Hawtrey has pointed out that the lags between depositors' balances and the reserves of the banks make for instability.

6. **OVER-CONFIDENCE THEORY.** There is also the theory of over-confidence and over-optimism. These factors are clearly embodied to a large extent in the analysis of this book. They are especially important in an industrial society, with its long lags between production and consumption. Each producer has to guess about the future—future consumption and future competition; and he cannot always be right. His miscalculations and mistakes cause disturbances, one of which is over-indebtedness. Perhaps over-indebtedness is the chief disturbance resulting from over-confidence. Certainly, without over-indebtedness, over-confidence could scarcely produce bankruptcy!

7. **OVER-INVESTMENT THEORY.** The theory which, perhaps, comes nearest to covering the same ground as the one set forth in this book is the over-investment theory. But, if over-investment be accomplished without borrowing, there would seem to be no reason to imagine that it would be followed by any-

thing so severe as a stock market crash, or an epidemic of bankruptcies, or vast unemployment. Doubtless, however, over-investment, even *without* borrowed money, would tend to set up some appreciable oscillations.

8. OVER-SAVING THEORY. The same applies to "over-saving." In fact, saving is usually preliminary to investing. Over-saving leads to over-investment and to over-indebtedness.

9. OVER-SPENDING THEORY. Instead of over-investment and over-saving, there are theories of *under-investment* and *under-saving*, or (what amounts to the same thing) *over-spending*. The oscillations set up by over-spending would naturally be opposite, in their initial direction, from those set up by over-investment. Why, then, do we find both saving and spending accused of the same thing? It is true that we do, in boom periods, encounter both over-investment and over-spending at one and the same time; but what reconciles the two is over-indebtedness. Nor is it easy to see any other way of reconciling them. If a man borrow enough, he can both over-invest and over-spend, whereas, without borrowing, he could scarcely make *both* mistakes at the same time.

10. DISCREPANCY-BETWEEN-SAVINGS-AND-INVESTMENT THEORY. The discrepancy between savings and investments has by some students been emphasized as causing trouble—and very likely it does, especially by investing out of borrowed money instead of out of savings. This discrepancy is caused largely by debts.

11. OVER-CAPACITY THEORY. As to over-construction and over-capacity, these are natural consequences of over-investment, whether the over-investment be caused by too much debt or otherwise. And sudden cessation of construction, as Professor J. M. Clark so well shows,\* causes very violent oscillations. These are still further magnified if the over-construction is financed with borrowed money.

12. UNDER-CONSUMPTION THEORY. As to the theory of "under-consumption," and changes in the demand for "consumer goods," these mal-adjustments must have at least some oscillatory effects. But under-consumption appears to be much the same thing as over-production.

13. OVER-PRODUCTION THEORY. The over-production theory, despite the skepticism of most economists, seems to me to have, at least in the boom period, some theoretical possibilities. I do not accept the hoary tradition that "general over-production is impossible and inconceivable." But the point need not be debated here.

According to the important statistical researches of Carl Snyder, production seems to have progressed with such steadiness that it seems difficult to imagine how it could become a leading cause of major depressions; and the large inventory accumulations which have characterized many depressions (like that of 1920-21) seem to be rather symptoms of depression, or incidental *consequences*, than important causes.

Certainly many debts are contracted for production purposes; and if the judgment of the debtor is wrong as to what is a safe margin for his debts, this may be because his judgment was first wrong as to how much of his commodity would find a profitable market. Over-production can scarcely be itself the lasting force which keeps a depression going year after year. Were it merely a matter of over-production, it would seem to me to be likely to correct itself more promptly and almost automatically.

\* *The Economics of Overhead Cost*, by J. M. Clark, Chicago, 1923.

But it may still be true that over-production may precipitate liquidation of debts. The borrower's disappointment in the market for his goods may be one of the first symptoms to alarm both him and his creditors, as to the state of his debts. Perhaps that is why, in 1929, as we shall see, production and payroll and transportation began to slacken two or three months before the debt-structure crumbled. But thereafter the wisest producers were hit—not by over-production, but by the liquidation-spiral into which they were sucked; so that they were compelled, for the sake of liquidation, to turn *all* production into *under*-production.

This epitome of theories clearly shows the complex nature of the problem of business cycles and the wide divergences of opinion which prevail as to the essential causes of oscillation. Where then shall we begin? The answer to this question is relatively simple. Our principal hope of discovering the dominating causes of cyclical fluctuation must lie in those mathematical formulations, where the assumptions are so framed that they are within the range of statistical verification. Only a few such formulations have been attempted and to them we shall devote our attention in the ensuing pages. Undoubtedly there is much truth in the theories so lucidly set forth by Professor Fisher; but the relative importance of each must be measured since their formulation is vague and unsatisfactory until each theory has been reduced to precise mathematical form. Thus great problems still remain for the mathematician and the statistical expert.

Special mention should be made of an extensive study of the cause of the trade cycle which was made by G. von Haberler for the League of Nations. This work, *Prosperity and Depression*, which was issued in Geneva in 1937, gives an excellent review of the theories of the business cycle as well as an appraisal of the international aspects of the phenomenon.

## 2. *The Maximizing of Profits as an Example of How Cycles May Be Expected to Arise.*

One very attractive method of approaching problems in the dynamics of price is due originally to G. C. Evans and C. F. Roos.<sup>3</sup> This method considers the problem of maximizing profits when demand is a linear function of price and the rate of change of price.

Thus we assume that the profits,  $\Pi$ , over a period of time from  $t = t_0$  to  $t = t_1$  are given by the integral

<sup>3</sup> See, for example, G. C. Evans, *Mathematical Introduction to Economics*, New York, 1930, xi + 177 pp., in particular, Chapter 15. The first application of this kind in economics was made by C. F. Roos in 1925. "A Mathematical Theory of Competition," *American Journal of Mathematics*, Vol. 47, 1925, pp. 163-175. See also, Roos, *Dynamic Economics*. Bloomington. Ind.. 1934. xvi + 275 nn.

$$(1) \quad \Pi = \int_{t_0}^{t_1} [pu - Q(u)] dt .,$$

where  $p$  is the price,  $u$  the demand, and  $Q(u)$  the cost of manufacturing and marketing  $u$  units.

It is obvious that the problem, as stated, is in its simplest form and that  $\Pi$  is the profit of a manufacturer who is concerned with the marketing of a single commodity. It is possible, however, to regard the values involved as averages. In the application which we contemplate it is perhaps possible to regard the quantities in (1) as pertaining to a basic industry such as that of the production of steel. If this extension is possible, then the deductions which we shall make may form a *rationelle* for the theory of business cycles. At any rate the simplicity of the formulation as exhibited in equation (1) is necessary if the mathematics is to be tractable.

For simplicity of treatment we shall assume that demand may be written

$$(2) \quad u = \alpha p' + \beta p + \gamma ;$$

and that the cost function is a quadratic function of the demand, namely,

$$(3) \quad Q(u) = A u^2 + B u + C .$$

That either of these assumptions is realistic is debatable, since little supporting statistical evidence is available on this point. Evans argues as follows for the first equation: "Whether the price is going up or down is itself an important factor in the demand for the quantity. In actual cases the demand is often not merely a function of the price alone but is stimulated or depressed by the mere fact that the price is rising or falling. We know that business is usually good when prices are rising and usually not so good when prices are falling; the number of shoes that will be bought at three dollars a pair will be greater if it is known that the price is increasing at the rate of ten cents a week than if the price is supposed to be decreasing at the rate of fifty cents a week." Mathematical convenience suggests the form of (3), although a quadratic form for the production function may be strongly argued. But since statistical data are at present lacking, it is perhaps best not to claim too much for these assumptions, but rather to regard the theory as schematic and a possible mode of approach to the perplexing difficulties of the subject of business cycles.<sup>34</sup>

<sup>34</sup> Considerable information has recently become available about the actual form of the cost function. Thus in the evidence before the Temporary National Economic Committee, in particular, the United States Steel Corporation, *T.N.E.C.*



We now set the first variation of (1) equal to zero, that is  $\delta \Pi = 0$ , which is analytically equivalent to Euler's equation

$$(4) \quad \frac{\partial F}{\partial p} - \frac{d}{dt} \frac{\partial F}{\partial p'} = 0.$$

where we abbreviate  $F = pu - Q(u)$ .

A simple calculation shows that (2) reduces, because of the explicit equations (3) and (4), to the following linear equation

$$(5) \quad p''(t) + m^2 p(t) = P_0,$$

where we employ the abbreviations

$$m^2 = \frac{\beta - A\beta^2}{\alpha^2 A}, \quad P_0 = \frac{2A\beta\gamma - \gamma + B\beta}{2A\alpha^2}.$$

Now we know that in ordinary demand, where the dynamic element is disregarded, that is to say, when  $\alpha = 0$ , the value of  $\beta$  is negative and the value of  $\gamma$  is positive. Also, ordinarily in the theory of static production, it is assumed that  $A$  is positive. If this were the actual case in a dynamic economy, then  $m^2$  would be negative, that is to say,  $m$  would be imaginary, and there could actually be no cyclical fluctuations. But in dynamic economics, there is no essential reason, supported by statistical evidence, to show that  $\beta$  and  $A$  must be of opposite sign. Let us, on the contrary, assume that  $\beta - A\beta^2 > 0$ . Hence we shall have  $m^2 > 0$ , and the solution of (5) is well known to be

$$P(t) = P_0 + K \cos \frac{2\pi}{T}(t + \mu),$$

where  $T = 2\pi/m$ . The constants  $K$  and  $\mu$  are arbitrary.

This solution represents a function which oscillates about  $P_0$  as a fixed price. This fixed price is the one obtained on the assumption that demand is a static rather than a dynamic variable.

The principal objection to this simple explanation of cyclical fluctuation is found in the lack of supporting statistical evidence. No general form for  $Q(u)$  is empirically known. Moreover a study made by R. H. Whitman<sup>4</sup> seems to show that the assumption  $u = \alpha p' + \beta p$

*Papers*, Vol. 1, 1940, we find the cost function for this large steel-producing corporation. The statistical work was done by T. O. Yntema. In this report the cost curve appears to be linear and hence is represented by equation (3) if we set  $A = 0$ . Other studies for various industries made by Joel Dean seem to confirm the linear character of costs over a wide range of production, although in some cases a slight curvature would indicate that  $A$  is not always identically zero.

<sup>4</sup>"The Statistical Law of Demand for a Producer's Goods as Illustrated by the Demand for Steel," *Econometrica*, Vol. 4, 1936, pp. 138-152.

+  $\gamma$  is doubtful as a description of demand unless a term is added to measure the fluctuation of business itself. The data employed by Whitman related to the demand for steel over the 29 years from 1902 to 1930, inclusive, this interval being divided into the three sections: (I), 1902-1915; (II), 1916-1920; and (III), 1921-1930.

Among the five types of dynamic demand equations evaluated by Whitman were the three following:

$$(a) \quad u = \beta p(t) + \gamma + \delta t,$$

$$(b) \quad u = \alpha p'(t) + \beta p(t) + \gamma,$$

$$(c) \quad u = \alpha p'(t) + \beta p(t) + \gamma + \delta t + \varepsilon I,$$

where  $I$  is an index of general business activity.

Our interest is not in the data, but in the final regressions and the degree of correlation attained. These results are contained in the following table, which gives the type of equation, the numerical values of the coefficients, the correlation coefficient,  $R$ , and the probable error of estimate,  $S$ :

$$u = \beta p(t) + \gamma + \delta t$$

Period	$\beta$	$\gamma$	$\delta$
1902-1915	$-0.11 \pm 0.41$	1.35	$0.0090 \pm 0.0015$
1916-1920	$-0.35 \pm 0.16$	4.93	$-0.0012 \pm 0.0006$
1921-1930	$0.095 \pm 0.42$	2.05	$0.0180 \pm 0.0024$

$$u = \alpha p'(t) + \beta p(t) + \gamma$$

Period	$\alpha$	$\beta$	$\gamma$	$R$	$S$
1902-1915	$3.19 \pm 0.28$	$-1.00 \pm 0.32$	3.64	0.66	0.47
1916-1920	$0.63 \pm 0.11$	$-0.38 \pm 0.12$	4.61	0.65	0.62
1921-1930	$3.15 \pm 0.26$	$0.60 \pm 0.29$	0.90	0.74	0.57

$$u = \alpha p'(t) + \beta p(t) + \gamma + \delta t + \varepsilon I$$

Period	$\alpha$	$\beta$	$\gamma$	$\delta$	$\varepsilon$	$R$	$S$
1902-1915	$7.99 \pm 1.06$	$-1.56 \pm 0.31$	4.20	$0.0041 \pm 0.0012$	$0.036 \pm 0.005$	0.81	0.45
1916-1920	$0.48 \pm 0.21$	$-0.55 \pm 0.08$	3.84	$0.0015 \pm 0.0004$	$0.12 \pm 0.011$	0.88	0.39
1921-1930	$6.27 \pm 0.94$	$-1.27 \pm 0.23$	1.49	$-0.0003 \pm 0.0017$	$4.64 \pm 0.35$	0.92	0.41

We see from an inspection of the accompanying figure that such correlation as is obtained by means of formula (a) is derived mainly from the trend. The cyclical fluctuations are in no way accounted for by means of this formula and hence it must be rejected as a description of the demand for steel. The second formula is considerably better and the correlations attained by its use attain significant size. One notes, however, the inconsistency in the sign of  $\beta$ , which is neg-

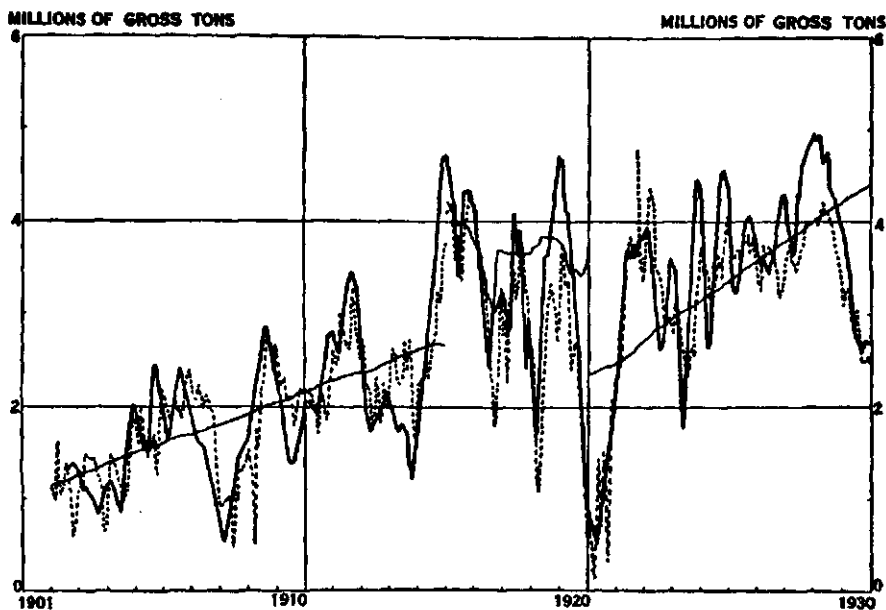

FIGURE 109.—DEMAND FOR STEEL.

This chart shows the relationship between the actual demand (—) for steel and the computed demand estimated by formula (a) (---) and by formula (c) (· · · · ·).

ative in the first two periods and positive in the third. Therefore, one may well hesitate to affirm a strong belief in the realistic character of this formula in so far as the present problem is concerned.

It is only when the term  $I$ , measuring business fluctuations, is added that essential significance and consistency are attained. The sign of  $\beta$  is uniformly negative and the correlations are high for each period. It should be observed that the apparent inconsistency of the coefficient of  $\varepsilon$ , which is much larger in the third period than in the other two, is due to the fact that in the first two periods business fluctuations were measured by the index of the American Telephone and Telegraph Company, while in the third period the Standard Statistics index of industrial production was used.

What is significant for our purpose here is the observation that the simple assumption for dynamic demand, namely that  $u = \alpha p'(t) + \beta p(t) + \gamma$ , while adequate to explain part of the fluctuations of demand, is not entirely satisfactory. To it there must be added another term, which, as will be seen later, acts as an *impressed force* in the price system and at times profoundly modifies the problem of maximizing profits.

In order to see how this term affects the problem, let us assume that demand has the form

$$U(t) = u(t) + \phi(t),$$

where  $u(t)$  is defined as in (2) and where  $\phi(t)$  is a term which measures the external influences derived from business itself upon the demand for steel.

Substituting the function  $F = pU - Q(U)$  in equation (4), we then obtain equation (5) with an additional term, namely,

$$(6) \quad p''(t) + m^2 p(t) = P_0 + f(t),$$

where we employ the abbreviation

$$(7) \quad f(t) = \frac{2A\beta - 1}{2A\alpha^2} \phi(t) - \frac{1}{\alpha} \phi'(t).$$

If we assume as before that  $m^2 > 0$ , then the solution of (6) takes the form

$$(8) \quad p(t) = P_0 + K \cos \frac{2\pi}{T} (t + \mu) + \frac{1}{m} \int_0^t \sin m(t-s) f(s) ds.$$

The function  $f(t)$  acts as an impressed force on the system and will obviously modify the character of the oscillations defined by the harmonic term. In particular, if  $f(t)$  has the form

$$f(t) = f_0 \cos \lambda t,$$

then the solution can be written

$$(9) \quad p(t) = P_0 + K \cos \frac{2\pi}{T} (t + \mu) + \frac{f_0}{m^2 - \lambda^2} [\cos \lambda t - \cos mt].$$

It is well known in dynamics<sup>5</sup> that resonance occurs whenever the period of the impressed force coincides with the period of the system itself, that is to say, when  $\lambda = m$ . In this case the last term of (9) reduces to

$$\frac{f_0 t \sin mt}{2m},$$

and as  $t$  increases the prices are observed to oscillate with greater and greater amplitude.

It is quite pertinent to ask at this point whether profits are actually maximized under this scheme. Now the second variation in

<sup>5</sup> For a discussion of resonance, see Section 9 of this chapter.

the calculus of variations can be put into such a form as to yield a very simple sufficiency test for the existence of a maximum or a minimum. This test is merely that a maximum is attained by the integral provided the function

$$R = \frac{\partial^2 F}{\partial p^2}$$

is negative throughout the interval  $t_0 \leq t \leq t_1$ . Similarly a minimum is attained provided  $R$  is positive throughout the interval.

In the present instance a simple calculation shows that

$$R = -A\alpha^2,$$

which leads to the condition that the profit integral is maximized provided  $A > 0$ . But when we consider the quantity  $m^2 = (\beta - A\beta^2)/A\alpha^2$ , we see that this can be positive, and hence  $m$  real, only when  $\beta - A\beta^2 > 0$ , that is, provided  $\beta$  is positive but less than  $1/A$ .

The computations of Whitman show that the best expectation is that  $\beta$  is negative. In this case, the solution of the Euler equation would be exponential and hence would lead either to explosive prices, or to constant prices. Since neither of these situations is observed, but rather that prices follow a more or less well-defined fluctuation, we may assume that the profit integral is not always maximized. This seems to be a realistic observation in the light of frequent crises and large swings of the business cycle.<sup>6</sup>

### 3. The Macrodynamic Theory of Cycles

We have commented earlier on the intriguing theory which proposes to explain business cycles by means of a scheme of lags between different economic variables. Apparently the first suggestion of this type of analysis was published by M. Kalecki in Polish in 1933 and this was followed a few months later by Ragnar Frisch's paper on "Propagation Problems and Impulse Problems."<sup>7</sup> J. Tinbergen published a similar scheme in 1934<sup>8</sup> and the following year made an extensive résumé of the business-cycle theory in *Econometrica* in which the various suggestions were compared with one another.<sup>9</sup> In the same number of *Econometrica* Kalecki gave a restatement of his

<sup>6</sup> See footnote 3a.

<sup>7</sup> *Economic Essays in Honour of Gustav Cassel*, 1933.

<sup>8</sup> *Zeitschrift für Nationalökonomie*, Vol. 5, 1934, pp. 289-319; in particular pp. 299 et seq.

<sup>9</sup> "Annual Survey: Suggestions on Quantitative Business Cycle Theory," *Econometrica*, Vol. 3, 1935, pp. 241-308.

theory of business cycles,<sup>10</sup> a theory which he now designated by the term *macrodynamic* following a suggestion of Frisch. This terminology was adopted to apply to those "processes connected with the functioning of the economic system as a whole, disregarding the details of disproportionate development of special parts of that system."

Kalecki's theory has the following elements. Let us suppose that  $I(t)$  is the total volume of orders for capital goods per unit of time at the time  $t$  and that  $L(t)$  is the corresponding volume of deliveries of orders for capital goods. It is clear that the relationship between these two quantities is expressed by the equation

$$(1) \quad L(t) = I(t - \theta),$$

where  $\theta$  is the lag between orders and delivery. This quantity, which is assumed on the average to be constant, is extremely fundamental in the oscillation theory and variations in the numerical estimate of it make fundamental differences in the final results. In Kalecki's theory,  $\theta$  is assumed to be as small as 0.6 of a year on the basis of German data which appear to show that "the lag between the curves of the beginning and termination of building schemes (dwelling houses, industrial and public buildings) can be fixed at 8 months; the lag between orders and deliveries in the machinery-making industry can be fixed at 6 months." Frisch, on the other hand, assumes a value as large as 3 years, or, if one considers the time from the actual inception of the idea of building to the completed stage, as much as twice this estimate, or six years. In defense of this Frisch says: "It seems that we would strike a fair average if we say that the actual production activity needed in order to complete a typical plant . . . will be distributed over time in such a way that in general it takes place around three years after the planning began. Some work will of course frequently be done before and some after this time, but three years can, I believe, tentatively be taken as an average. In making this guess I have taken account of an important factor that tends to pull the average up, namely, the fact that in a given individual case the activity will as a rule not be distributed evenly over the period (as assumed in the simplified theoretical set-up), but the peak activity will be concentrated near the *end* of the period."

The next assumption of the Kalecki theory is concerned with the demand for the restoration of industrial equipment used in unit time. This demand, designated by  $U$ , is assumed to be constant. Hence, if we represent the total volume of industrial equipment at time  $t$  by

<sup>10</sup> "A Macrodynamic Theory of Business Cycles," *Econometrica*, Vol. 3, 1935, pp. 327-344.

$K(t)$ , and if  $K'(t)$  then represents its increase (or decrease) per unit of time, we should have

$$(2) \quad K'(t) = L(t) - U.$$

We further define  $W(t)$  as the total number of orders completed over a length of time equal to the lag,  $\theta$ , that is to say, from an actual time  $t - \theta$  to time  $t$ . Symbolically this may be written

$$(3) \quad W(t) = \int_{t-\theta}^t I(s) ds.$$

Designating by  $A(t)$  the volume of orders completed per unit of time, we shall have

$$(4) \quad A(t) = W(t)/\theta.$$

So far in the analysis no essential assumption has been made except that relating to the existence of the lag  $\theta$ . The fundamental postulate is now introduced that  $I(t)$  is a linear function of  $K(t)$  and  $A(t)$ ; that is to say, we assume that

$$(5) \quad I(t) = mC + mA(t) - nK(t),$$

where  $C$ ,  $m$ , and  $n$  are constants. The quantity  $C$  is assumed to be "the constant part of the consumption of capitalists." More explicitly, Kalecki assumes that the gross income from capital ( $B$ ) is equal to that consumed ( $\bar{C}$ ) plus that added to capital ( $A$ ); that is,  $B = \bar{C} + A$ . But  $\bar{C}$  varies with  $B$  and hence may be written  $C + \lambda B$ , where  $C$  is the constant part of the consumption.

Hence, interpreting equation (5), we see that we have assumed that the total volume of orders per unit time is a certain fraction of the constant consumption, plus the incrementary part of capital per unit time, diminished by another fraction of existing equipment. In the statistical determination of the constants, it will turn out that  $m$  is nearly unity, while  $n$  is approximately 12.

Differentiating equation (5), we have

$$I'(t) = mA'(t) - nK'(t);$$

then, noting (1), (2), (3), and (4), we get

$$\begin{aligned} I'(t) &= \frac{m}{\theta}[I(t) - I(t - \theta)] - n[L(t) - U] \\ &= \frac{m}{\theta}[I(t) - I(t - \theta)] - n[I(t - \theta) - U] \end{aligned}$$

If we employ the abbreviation,  $J(t) = I(t) - U$ , then this equation may be written

$$(6) \quad J'(t) = \frac{m}{\theta} [J(t) - J(t - \theta)] - n J(t - \theta)$$

A solution of this equation is readily seen to be

$$J(t) = J(0) e^{rt},$$

where  $r$  is any root of the characteristic equation

$$(7) \quad (m + n\theta) e^{-r\theta} = m - r\theta.$$

Obviously no conclusion can be drawn regarding the economic realism of this equation until a determination has been made of the statistical parameters  $m$ ,  $n$ , and  $\theta$ . Moreover, it must be shown that  $r$  is a complex number if  $J(t)$  is to have cyclical components.

For this purpose we now assume that  $r$  may be written

$$r = \frac{m - x}{\theta} - i \frac{y}{\theta}, \quad i = \sqrt{-1};$$

from which we have from (7)

$$(m + n\theta) e^{-(m-x)} e^{yi} = m - (m - x) + iy = x + iy.$$

Replacing  $e^{yi}$  by  $\cos y + i \sin y$ , and equating real and imaginary parts, we obtain the two equations

$$(8) \quad (m + n\theta) e^{-(m-x)} \cos y = x, \quad (m + n\theta) e^{-(m-x)} \sin y = y.$$

One of the most characteristic features of economic time series is the observed lack of damping in most of them. If the solution of equation (6) is to preserve this important aspect of time series, then it will be necessary in (8) to set  $m = x$ . Equations (8) then assume the simpler form

$$(x + n\theta) \cos y = x, \quad (x + n\theta) \sin y = y,$$

from which, noting that  $x = m$ , we get

$$m = y / \tan y.$$

Another relationship between  $m$  and  $n$  is derived by taking a single-cycle average of equation (5), where the assumption is made that such an average of both  $I(t)$  and  $A(t)$  is numerically equal to  $U$ . Hence, designating the cycle average of  $K(t)$  by  $K_0$ , we obtain the new relationship

$$(9) \quad U = m(C + U) - nK_0.$$



Hence, for the determination of the three unknown values,  $m$ ,  $n$ , and  $y$ , we shall have the system

$$\begin{aligned} m &= y / \tan y . \\ (10) \quad m / (m + n\theta) &= \cos y , \\ n &= (m - 1) (U/K_0) + m (C/K_0) . \end{aligned}$$

For the determination of the parameters  $m$ ,  $n$ , and  $y$ , we may argue as follows: If we assume that the fixed capital in the United States in 1922 was roughly 120 billions of dollars, that national income was 70 billions of dollars, and that the ratio of amortization to national income was 0.08, then we may compute the ratio

$$U/K_0 = 0.08 \times 70/120 = 0.05 .$$

In order to determine  $\bar{C}$ , we first assume, using the data of 1913, that 11 billions of the total 36 billions of national income reported in that year would be that consumed by capitalists.<sup>10a</sup> Hence  $\bar{C}$  is approximately equal to 11/36, or about 0.3 of the total income. Assuming that this is constant over time, we may compute that the consumption by capitalists for the year 1922 would equal  $0.3 \times 70 = 21$  billions of dollars. The constant part of this, that is to say,  $C$ , may be roughly estimated to equal about 0.75 of  $\bar{C}$ , or  $0.75 \times 21 = 16$  billions. Hence we may assume for the evaluation of  $m$  and  $n$ , that

$$C/K_0 = 16/120 = 0.13 .$$

Employing, now, the former estimate of  $\theta = 0.6$ , we may compute from equations (10) the following estimates for  $m$ ,  $n$ , and  $y$ :

$$m = 0.95, \quad n = 0.121, \quad y = 0.378 .$$

The cycle is at once observed to have the period

$$T = \frac{2\pi\theta}{y} = \frac{2\pi}{0.378} \times 0.06 = 10.0 \text{ years} .$$

We thus see that the present estimates and the present theory yield an explanation of the 10-year cycle of business. The weakness of the argument is found, of course, in the simplifications which were employed to make the mathematics tractable and in the admittedly crude estimates of the statistical parameters.

<sup>10a</sup> The estimates used in this analysis are very rough. Thus the national income in 1922 was nearer 60 billions than 70 billions of dollars and, in 1913 was nearer 30 than 36 billions of dollars.

It seems evident, however, that this method points the way to a highly important attack upon the problem of cycle analysis, and that the final theory must be formulated in a system of the general type described by Kalecki. The question remains as to how complex the ultimate system will prove to be and how many elements must be introduced into it.

The theory of Frisch, while similar to that of Kalecki, has certain variations which make it possible for him to account for cycles other than the long cycle explained by Kalecki.

Employing the notation given above, we may write the two fundamental postulates of Frisch in the following form:

$$(11) \quad I(t) = m X(t) + \mu X'(t),$$

$$(12) \quad X'(t) = c - \lambda[r X(t) + s A(t)],$$

where  $X(t)$  is the volume of consumption goods per unit of time.

The first of these equations is derived from the assumption that the orders for capital goods,  $I(t)$ , depend, first, upon consumption and, second, upon the rate of consumption, and that this dependence is linear. The second equation states that the rate of change in the volume of consumers' goods diminishes proportionately to what Frisch, borrowing the term from Walras, calls the *encaisse désirée* (cash needs). Neither proposition has been determined by statistical means.

To these two new equations Frisch adjoins Kalecki's equation

$$(13) \quad \theta \cdot A(t) = \int_{t-\theta}^t I(s) ds.$$

Solutions are then assumed of the form

$$X(t) = a_0 + \sum a_k e^{\rho_k t},$$

$$I(t) = b_0 + \sum b_k e^{\rho_k t},$$

$$A(t) = c_0 + \sum c_k e^{\rho_k t}.$$

Substituting these series in equations (11), (12), and (13), we obtain

$$b_0 + \sum b_k e^{\rho_k t} = m [a_0 + \sum a_k e^{\rho_k t}] + \mu \sum a_k \rho_k e^{\rho_k t},$$

$$\sum \rho_k a_k e^{\rho_k t} = c - \lambda r [a_0 + \sum a_k e^{\rho_k t}] - \lambda s [c_0 + \sum c_k e^{\rho_k t}],$$

$$\theta (c_0 + \sum c_k e^{\rho_k t}) = \int_{t-\theta}^t (b_0 + \sum b_k e^{\rho_k s}) ds.$$

Equating the coefficients of like terms, we get from these equations the following relationships between the coefficients:

$$b_k/a_k = m + \mu \rho_k, \quad c_k/a_k = -(\rho_k + \lambda \tau)/(\lambda s),$$

$$c_k/b_k = (1 - e^{-\rho_k \theta})/(\theta \rho_k),$$

$$b_0 = m a_0, \quad c = \lambda \tau a_0 + \lambda s c_0, \quad c_0 = b_0.$$

Elimination of the three ratios shows that  $\rho_k$  must satisfy the characteristic equation

$$(14) \quad \frac{\theta \rho}{1 - e^{-\rho \theta}} = -\lambda s \frac{m + \mu \rho}{\tau \lambda + \rho}.$$

Before equation (14) can be solved, a numerical estimate is necessary for the constants. These values are assumed by Frisch to be the following:

$$\theta = 6, \quad \mu = 10, \quad m = 0.5, \quad \lambda = 0.05, \quad \tau = 2, \quad \text{and} \quad s = 1.$$

We have already discussed the assumption of a lag,  $\theta$ , as large as 6 years. The estimate of  $\mu = 10$ , means that 10 times the amount produced in a year is needed as a capital stock. Similarly the assumption that  $m = 0.5$  implies that the depreciation of capital stock is about one-half the amount consumed. The estimates for  $\lambda$ ,  $\tau$ , and  $s$  are admittedly guesses unsupported by statistical evidence.

These values are now introduced into (14) and  $\rho$  is written,  $\rho = -\beta + i\alpha$ , where  $\beta$  is the damping coefficient,  $\alpha$  the frequency coefficient, and  $i$  is the imaginary unit. It will be found that the even roots of the equation

$$\tan \theta \alpha = \theta \alpha,$$

which are tabulated in Section 6 of Chapter 3, yield good first approximations for  $\alpha$ . More accurate determinations show that the first three cycles possess the following characteristics:

Characteristic	First cycle	Second Cycle	Third Cycle
Frequency: ( $\alpha$ )	0.73355	1.79775	2.8533
Period: $T = 2\pi/\alpha$	8.5654	3.4950	2.2021
Damping exponent: ( $\beta$ )	0.37134	0.5157	0.59105

The significant result from these estimates is found in the observation that the analysis reveals the existence of a primary period of 8.57 years, a secondary period of 3.50 years, and a tertiary period of 2.20 years. The first two periods have been observed in business series, but the third is certainly not strongly in evidence. The periodogram of the Dow-Jones averages over the period from 1897 to 1914

shows that the 40-month cycle (3.5-year cycle) has approximately 48 per cent of the entire energy of the series, while the 22-month cycle (2.2-year cycle) contains but 6 per cent.

From this analysis we observe that there is an essential difference between the theory of Frisch and the theory of Kalecki. In the latter the damping factor was explicitly removed, while in the former it remains. How, then, are we to reconcile this formulation with the observed fact that the principal characteristic of economic time series is a complete lack of damping? According to Frisch the key to the problem is found in the assumption that the economic system is subjected to a series of erratic shocks which continually renew the energy lost by the damping coefficient. Frisch also admits the existence in the system of a more or less continuous source of energy supplied by the orderly introduction of new inventions, new technical procedures, etc. Thus he says:

The idea of erratic shocks represents one very essential aspect of the impulse problem in economic analysis, but probably it does not contain the whole explanation. There is also present another source of energy operating in a more continuous fashion and being more intimately connected with the permanent evolution in human societies. The nature of this influence may perhaps be best exhibited by interpreting it in the light of Schumpeter's theory of the innovations and their role in the cyclical movement of economic life. Schumpeter has emphasized the influence of new ideas, new initiatives, the discovery of new technical procedures, new financial organizations, etc., on the course of the cycle. He insists in particular on the fact that these new ideas accumulate in a more or less continuous fashion, but are put into practical application on a larger scale only during certain phases of the cycle. It is like a force that is released during these phases, and this force is the source of energy that maintains the oscillations.<sup>11</sup>

What all of this means dynamically is merely that the energy of the economic system is renewed by an *impressed force*. This force consists partly of erratic shocks, and partly of a continuous introduction of new ideas into commercial activity. We have already introduced a similar concept into the problem of maximizing profits and we shall return to it again in Section 8.

It is obvious that many other schemes of the sort just described are possible. Thus Tinbergen has considered a system constructed from the following variables:<sup>12</sup>

<sup>11</sup> "Propagation Problems . . . ," p. 33. This idea is amplified in Schumpeter's recent work, *Business Cycles. A Theoretical, Historical, and Statistical Analysis of the Capitalist Processes*, two volumes, New York, 1939, xvi + 1095 pp. See, in particular, Chapter 3.

<sup>12</sup> "Annual Survey: Suggestions on Quantitative Business Cycle Theory," *Econometrica*, Vol. 3, 1935, pp. 241-308.

(1) Price of finished consumers' goods,  $P + p(t)$ ; (2) Number of products started (consumers' goods),  $Z + z(t)$ ; (3) Number of products sold (consumers' goods),  $Y + y(t)$ ; (4) Income spent by consumers,  $X + x(t)$ ; (5) Increase of stocks of products,  $V + v(t)$ .

The following system is then set up:

$$\begin{aligned}x(t) &= (2k/a) z(t-1), \\ \epsilon v(t) &= z(t-2) - y(t), \quad \epsilon = 1 \text{ or } 0, \\ \epsilon[z(t-2\eta) - a p(t)] &= 0, \quad \epsilon = 1 \text{ or } 0, \\ z(t) &= \epsilon' a p(t) + (1 - \epsilon') y(t), \quad 0 \leq \epsilon' \leq 1, \\ [Y + y(t)] [P + p(t)] &= X + x(t).\end{aligned}$$

It is clear that the theory which occasions this form of the system postulates that cycles are set up by overproduction and overinvestment.

If it be assumed that  $\epsilon = 0$  and if all the variables except  $z(t)$  be eliminated, then the following difference equation is obtained:

$$z(t) - 2k \epsilon' z(t-1) + (\epsilon' a + \epsilon' - 1) z(t-2) = 0.$$

Solutions of this equation are periodic provided  $k^2 \epsilon'^2 + 1 < \epsilon'(a + 1)$ .

If it be assumed that  $\epsilon = 1$ , then the difference equation in  $z(t)$  becomes

$$z(t) - \frac{2k}{a} z(t-1) + \left( \frac{1}{a} - \frac{\epsilon'}{1 - \epsilon'} \right) z(t-2\eta) = 0.$$

When  $\eta = 1$ , the condition that the solutions of this equation are oscillatory is found to be

$$\frac{k^2}{a^2} - \frac{1}{a} + \frac{\epsilon'}{1 - \epsilon'} < 0.$$

It is clear that many systems could be developed similar to the models discussed above, the question being merely one of selecting the time series which show the highest relationship with one another. The difficulty with this mode of approach is, first, that the system must be oversimplified in order to make the mathematical analysis tractable; and, second, that sufficient data are not yet available to make possible a careful statistical determination of the parameters involved.

The main gain from this analysis is to exhibit ways in which true cycles can be generated in economic time series. The question is thus answered as to whether the observed cycles are merely accidental variations in a sequence of random fluctuations, or whether the series are real sinusoidal movements disturbed by a series of random shocks. The evidence seems to point clearly to the latter as the correct interpretation of the fluctuations in economic time series.

#### 4. The Interest Theory of Cycles

The role of interest in the business cycle has long been a source of argument, one school contending that it exerts a profound influence upon the cycle and the other that it has relatively little to do with major upswings and downswings of business.

Part of the difficulty is found in the fact that several kinds of interest are to be reckoned with in business transactions. All of these perform different functions and correlate differently with the primary series. It will be necessary, therefore, to review these varied types of interest.

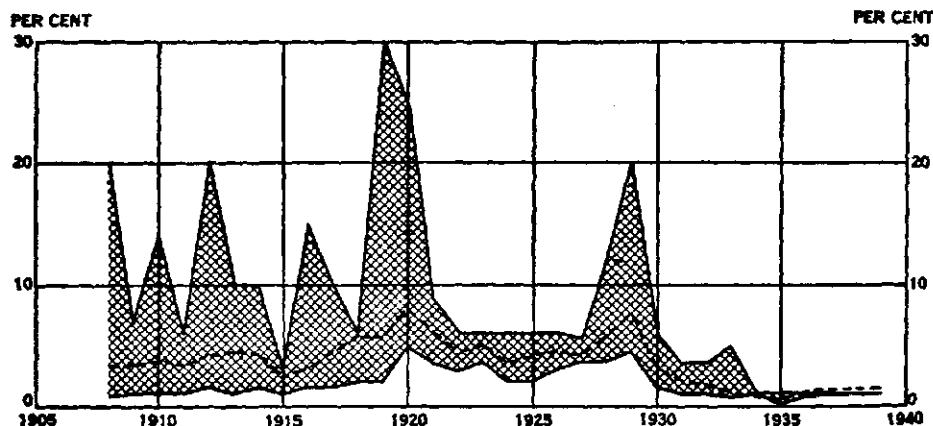

FIGURE 110.—RATES OF INTEREST.

Shaded areas show the range of rates on call money; the dotted curve is the rate on 60-90-day commercial paper.

The first rate of interest is that on "call money," where the loans are for short periods of time. The fluctuations in this rate are large and rapid. For example, in 1919 the rate on call money varied from less than 2 per cent to approximately 30 per cent during the course of 12 months. A similar period of instability is found in 1929 when the range of variation was from less than 4 per cent to approximately 20 per cent. It is quite obvious that this rate can exert no permanent effect upon more stable series, but is itself a result of current events rather than a cause of them.

By the phrase "the market rate of interest" is usually meant the rate on 60- to 90-day commercial paper. This also has a large fluctuation, although it is much more stable than the rate on call money. For example, the coefficient of variation in the annual average of this rate, that is, the ratio  $\sigma/A$ , was 0.4423 for the period from 1831 to

1930. The magnitude of this quantity may be appreciated by comparing it with the coefficient of variation of 0.3782 for the highly volatile railroad stock prices, with 0.2497 for railroad bond prices, and with 0.0686 for industrial production over the same century.

Much more stable than commercial-paper rates is the yield on high-grade bonds, which over the period from 1897 to 1913 had a coefficient of variation of only 0.0373. During the same period, one of comparative economic stability, the coefficient of variation in commercial-paper rates was 0.1771, or nearly five times that of the yield on high-grade bonds.

As to the harmonic character of commercial-paper rates, we have already seen in Section 17 of Chapter 7 that between 13 and 19 per cent of the energy of the movement was in the 40-month commercial cycle and that another 17 per cent can be accounted for by the 17-year cycle of building. Since these energies are significant, it is clear that there must exist a real relationship between the variations in the rate of interest and the variations in certain parts of the business cycle. How great this is can be estimated by means of serial correlations.

In Figure 111 we show the lag correlations between the interest rate on 60- to 90-day commercial paper and industrial stock prices, industrial production, and commodity prices. The maximum correlation is in all cases significant and in all cases interest rates lag behind the other series. This lag is about nine months for industrial stock prices, six months for industrial production, and two months for commodity prices. In the first two cases, the correlation is unquestionably due to the fact that all three series exhibit the 40-month cycle in their variation, but the reason for the system of lags can be learned only by a deeper study of the real economic relationships.<sup>13</sup>

Irving Fisher, in his exhaustive treatise on *The Theory of Interest*, New York, 1930, xxvii + 566 pp., has associated interest rates with the level of prices. Using yearly data for Great Britain and the United States he has shown that there is a distinct lag with high correlation between both price  $P$  and the rate of change of price,  $P'$ , and the rate of interest. Since for the most part his computations are based on annual averages, there is no clear resolution of the cor-

<sup>13</sup> A very penetrating analysis has been made by R. N. Owens and C. O. Hardy of the relationship between interest rates and stock prices in a book entitled *Interest Rates and Stock Speculation*, Washington, D. C., 1925; second edition, 1930, xiv + 219. These authors, observing the same lag-correlation function as that given in Figure 111, reach the conclusion that "the data for both periods [1874-1897 and 1898-1922] show clearly that there is a pronounced tendency for interest rates to lag behind stock prices in their upward and downward movements, with an interval of about 12 months."

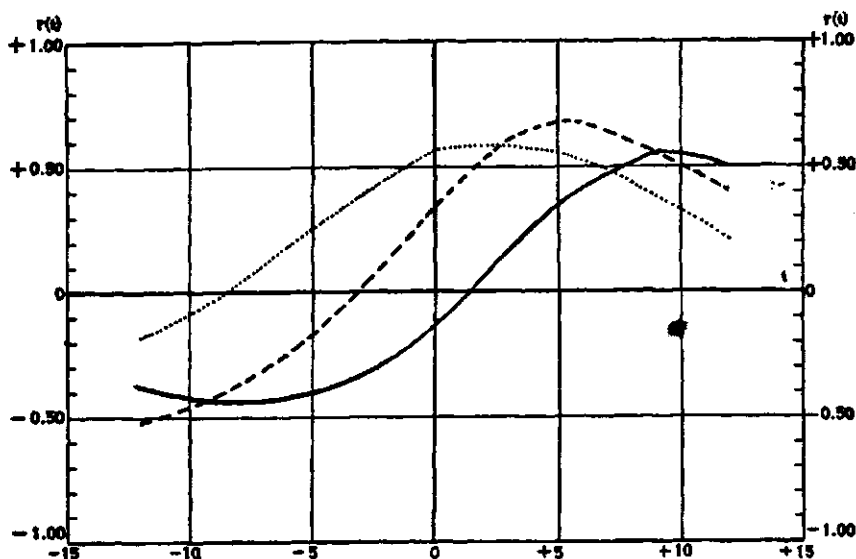

FIGURE 111.—LAG CORRELATIONS.

- : 60-90-day commercial paper with industrial stock prices,  
 - - - - - : 60-90-day commercial paper with industrial production,  
 . . . . . : 60-90-day commercial paper with commodity prices.

relation range and one cannot infer the actual value of the lag except approximately.

Although one may reach Fisher's general conclusion that "the rate of interest tends definitely to be high with a high price level and low with a low price level," the phenomenon of recent months when fairly high prices prevail with an exceedingly low interest rate shows that there are other considerations in the problem. What these are will be discussed more completely in connection with the variables of the equation of exchange in Chapter 10.

The observed correlation between interest rates and industrial production is a natural consequence of the well-established relationship between this series and the series of industrial stock prices. The observed lag is also of the right order of magnitude.

Our conclusion is, then, that there is no such thing as an interest cycle. While high correlations may prevail between interest rates and the three primary series examined above, these correlations prevail only during periods of comparatively stable monetary conditions, or, at least, when the velocity of money is not violently fluctuating. Moreover, interest rates lag behind the other series and thus are consequences rather than causes of economic fluctuations.



### 5. *The Building Cycle and Its Influence*

One of the economic factors which appears to show the largest variability is that of building activity. Great fluctuations occur in all trades which depend upon this industry. Thus, according to C. F. Roos: "The cycle of the residential building industry is the largest and most extensive of any. The building peak may be 1500 per cent above the trough."<sup>14</sup>

It is an interesting question to ask whether or not building activity follows a cyclical pattern. Roos says: "Typical major swings last from 10 to 20 years with a mean of about fifteen years. It has been maintained by some that these typical swings are brought about by the financial custom of extending five and ten year mortgages. This is hardly a correct statement . . . but it must be admitted that most building is done at the highest prices and the mortgages placed then usually run for five or ten years."

A very extensive investigation of the building cycle was published in 1939 by J. Tinbergen for the League of Nations.<sup>15</sup> In this study data were analyzed for the United States (1919-1935), the United Kingdom (1923-1935), Germany (Hamburg) (1878-1913), Sweden (Stockholm) (1884-1913), Sweden (1924-1936). In the German data a very distinct period of around 15 years is visible, while in the data for Stockholm the period seems to be of the order of 20 years.

The conclusion that there is a distinct building cycle, which has an average length considerably greater than that of the business cycle, is also substantiated by a study of J. R. Riggleman based upon annual building permits per capita over the period from 1875 to 1932.<sup>16</sup> Three well-defined cycles are visible in his data, the first from a minimum in 1878 to a minimum in 1900 having a length of 22 years, the second from a minimum in 1900 to a minimum in 1918 having a length of 18 years, and the third from 1918 to 1934 (not included in Riggleman's data) having a length of 16 years. A numerical estimate shows that 58.08 per cent of the energy of the entire series is concentrated in the harmonic of period  $T = 18$ .

Very extensive data relating to the building cycle and its influence upon other economic patterns have been published by G. F. War-

<sup>14</sup> *Dynamic Economics*, Bloomington, Ind., 1934. Much of this section is derived from Chapter 6 of this book, a chapter which is based upon a study made for the NRA by C. F. Roos, Roy Wenzlick, and Victor von Szeliski.

<sup>15</sup> *A Method and its Application to Investment Activity*, Geneva, 1939, 164 pp.

<sup>16</sup> "Building Cycles in the United States, 1875-1932," *Journal of the American Statistical Association*, Vol. 28, 1933, pp. 174-183.

ren and F. A. Pearson in *World Prices and the Building Industry*.<sup>17</sup> The evidence which they exhibit shows clearly both the great length and the violence of the building cycle not only in the United States but in other countries as well. Their conclusion is interesting: "The most important single business indicator is the index of prices of basic commodities. The second most important is the building cycle. Construction is important because of the large amount of basic materials that it uses, and the large amount of labor employed."

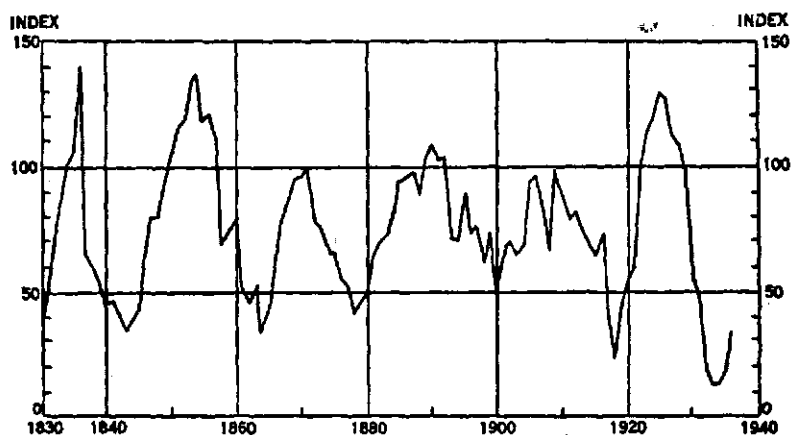

FIGURE 112.—COMPOSITE INDEX OF BUILDING ACTIVITY, 1830-1936.

Warren and Pearson have constructed a composite index of building activity over the period 1830-1936 by combining (a) an index of building permits per capita by J. R. Riggleman over the period 1830 to 1936, 1926-1930 = 100, (b) an index of annual volume of new building from 1875-1936, Normal = 100, prepared by Roy Wenzlick, and (c) an index of the monthly volume of construction per capita in 120 cities in the United States, 1899-1936, 1926-1930 = 100. This composite index is graphically reprinted, in Figure 112. It will be observed that the peaks of construction came 17, 18, 19, 19, and 16 years apart and averaged 18 years. "On this basis," say the authors, "the next peak would be expected 16 to 19 years after the last peak, which came in 1925, or 1941 to 1944."

We turn next to an analysis of the components which have been suggested as comprising the important factors in the building cycle. In this we shall compare the study by Roos and his collaborators, previously referred to, with the study by Tinbergen.

The analysis made by Roos was based upon residential building

<sup>17</sup> New York, 1937, v + 240 pp.

in St. Louis over the period from 1890 to 1933. In his study the factors which influenced the building series were contained in the following formula:

$$B(t) = b [A_0 I^a W - A_1 F + A_2],$$

where  $B(t)$ , the volume of construction, is the number of new dwellings building in a community at time  $t$ . The quantities  $A_0$ ,  $A_1$ ,  $A_2$ ,  $a$ , and  $b$  are statistical parameters depending upon the community studied. The other quantities are variables defined as follows:

$I(t) = (Rp - T)/C$ , where  $R$  = gross rental,  $p$  = rate of occupancy,  $T$  = taxes, and  $C$  = cost:

$W = (1 - g) + g 10^{-Af}$ , where  $f$  is the foreclosure rate, that is, the number of foreclosures per unit time per 100,000 families,  $g$  and  $A$  being statistical constants;

$$F(t) = 1 - 129.6/f.$$

The quantity  $E(t) = I^a W$  is called the incentive coefficient, since it contains those elements which either persuade one to build, or which dissuade him from it.

Although  $B(t)$  does not appear to be strictly cyclical in character, it contains the elements of variation. In times of boom,  $p$ ,  $C$ , and  $R$  increase, while  $f$  diminishes. Statistical computations show that  $I$  increases as business increases, and decreases with depression. Obviously  $W(t)$  changes inversely with  $f$ , while  $F(t)$  changes directly as  $f$  changes. Hence, in times of boom, when  $f$  is small, the first term of  $B(t)$  increases, and the absolute value of the second term diminishes, so that less is subtracted. The converse is clearly true in times of depression. Thus, it will be observed that the fluctuations depend in considerable part upon the foreclosure rate,  $f$ , which appears to measure with much accuracy the important factor of available credit.

The study of Roos leads to the following evaluation of the parameters, the data applying to St. Louis:

$$B = 2400 [16.63 I^{0.86} W - 1.022 F + 0.207],$$

from which the table of values on page 354 is computed.

These data are at the left of Figure 113. It will be observed that the dominating variable in the computed new building is the foreclosure rate,  $f$ , which is included in both the incentive factor and in the foreclosure factor. This regression, of course, does not explain the reason for the long cycle in building activity.

Year	B		Year	B		Year	B	
	Actual	Calculated		Actual	Calculated		Actual	Calculated
1900	1287	1951	1912	3636	3571	1924	5284	6689
1901	1850	1431	1913	3378	2853	1925	8712	7876
1902	2208	1041	1914	3490	2295	1926	7504	7327
1903	2179	1961	1915	3455	2230	1927	5609	7465
1904	3424	2770	1916	2435	1961	1928	7160	5528
1905	5128	4881	1917	1077	1384	1929	4139	3931
1906	6413	6857	1918	196	1089	1930	1590	2857
1907	5511	6605	1919	590	1053	1931	1474	1897
1908	6619	6381	1920	585	1314	1932	550	1052
1909	6256	5737	1921	1500	1724	1933	300	527
1910	4897	4676	1922	3607	3293			
1911	4509	4179	1923	5384	5529			

Tinbergen's analysis of building in the United States contains five components: (1) rent, designated by  $m_R$ ; (2) building costs,  $q_b$ ; (3) bond yields,  $m_{Lb}$ ; (4) the number of houses (deviations from trend) lagged  $3\frac{1}{2}$  years,  $h_{-3\frac{1}{2}}$ ; and (5) profits measured by the net income of corporations,  $z^c$ . The regression equation in terms of these variables for the years 1920 to 1935 is the following:

$$B = 1.23 m_R - 0.90 q_b - 0.12 m_{Lb} - 25.1 h_{-3\frac{1}{2}} + 0.06 z^c,$$

and the correlation between the building activity as computed from this equation and the actual observed building activity is 0.98. It must be observed, however, that the series is very short and that the regression equation has five parameters.

Although at first sight it might appear that the two formulations of the problem which we have discussed above are different, Tinbergen calls attention to the fact that the foreclosure rate of Roos is "highly correlated with the number of unoccupied houses a short time before." Since Roos accounts for most of the variance in the building series through the foreclosure rate lagged two years, and since Tinbergen accounts for about the same amount by means of his "available houses" index lagged  $3\frac{1}{2}$  years, it appears that both explanations are essentially the same.

The final conclusion seems to be that the building cycle is one of the most regular and the most important in economics. Major depressions begin to develop a short time after the maximum of the cycle has been reached, and business recovery follows the upturn in the building series. No real explanation is apparent, however, as to why the cycle should be so long, although this is probably closely related to the relative durability of building in comparison with other goods.

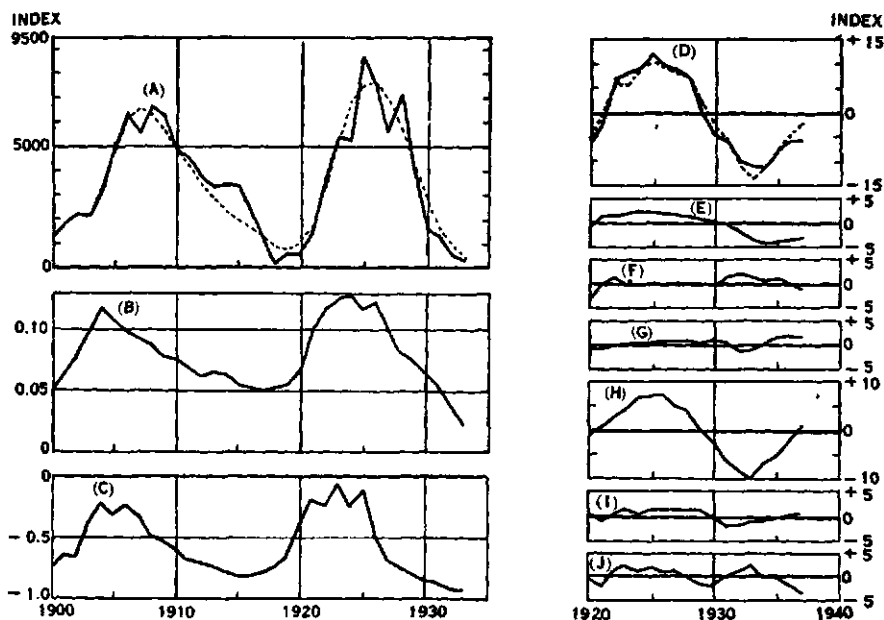

FIGURE 113.—FACTORS AFFECTING NEW BUILDING.

The left-hand curves are for building in St. Louis, from the point of view of Roos. (A) Actual (—) and computed (---) building; (B) Incentive factor,  $I^{0.86}W$ ; (C) Foreclosure factor,  $F$ .

The right-hand curves are for new residential building in the United States, in per cent of normal, from the point of view of Tinbergen. (D) Actual (—) and computed (---); (E) Rent; (F) Building Costs; (G) Bond Yields; (H) Housing need; (I) Profits; (J) Residuals.

### 6. Other Cycle Theories—Statistical Hysteresis

In other sections of the book we have commented upon the existence of lags between fundamental time series and the great importance in economic theory of such lag relationships. In fact, the calculus of serial correlations has been developed mainly to provide a tool for the more critical examination of these phenomena in economic time series. Thus we have seen in Section 3 that the most important postulate underlying the macrodynamic theory of cycles is the assumption of a lag between the beginning of an enterprise and its completion.

This phenomenon of lag is not unknown in other realms of science and important theories have been founded upon it. Thus in the theory of magnetism, we find the concept of *hysteresis*, due originally

to J. A. Ewing, which may be defined as follows: when two variables  $x$  and  $y$  exist, such that cyclical variations in  $x$  cause cyclical variations in  $y$ , and if the changes in  $y$  lag behind those of  $x$ , then there is *hysteresis* in the relationship between them.

The word *hysteresis* is derived from the Greek word for lag and hence refers aptly to the phenomena treated by means of serial correlation. The first use of the word in connection with economic problems was probably by C. F. Roos in 1925, who set up the relationship between demand,  $y(t)$ , and price,  $p(t)$ , in the form of an integral equation

$$(1) \quad y(t) = a p(t) + b + \int_{-\infty}^t \phi(t-s) p(s) ds,$$

where  $p(-\infty)$  is finite and  $\phi(z)$  is small when  $z$  is large and negative.<sup>18</sup>

Equations of type (1) had been studied by V. Volterra, who showed that they belonged to the class of the closed cycle<sup>19</sup> and were admirably adapted to the investigation of what he called *hereditary* phenomena. Such phenomena include magnetic hysteresis and other types of lag relationships.

The actual investigation of hysteresis phenomena in economic time series from the point of view of the present section was carried out by H. E. Jones in 1937, who exhibited hysteresis in the relationship between (a) industrial stock prices and total deposits of national banks; (b) the price and production of eggs; (c) new-mortgage financing and the inhibiting influence of foreclosures.<sup>20</sup> Jones differentiated between "lag hysteresis" which depends primarily upon the sinusoidal characteristics of the sines and "skew hysteresis" which depends upon the lack of symmetry in the various cycles of the component series. One of the principal conclusions of Jones was that "lag hysteresis" could be corrected for by serial correction, but that "skew hysteresis" could not be handled in this manner.

The object of the present section is to set up three mathematical models for the investigation of hysteresis phenomena. The first is a

<sup>18</sup> "A Mathematical Theory of Competition," *American Journal of Mathematics*, Vol. 47, 1925, pp. 163-175; in particular, p. 173.

<sup>19</sup> It is beyond the scope of this work to consider the general problem of the closed cycle, but the concept may be explained as follows: let  $F$  be an operator such, for example, as the integral in (1), and consider the relationship  $g(x) = F \rightarrow u(x)$ . Now let  $u(x+T) = U(x)$  and  $g(x+T) = G(x)$ . Then if  $G(x) = F \rightarrow U(x)$ , the operator  $F$  is an operator of the closed cycle. The reader may consult V. Volterra, *Leçons sur les équations intégrales*, Paris, 1913; or H. T. Davis, *The Theory of Linear Operators*, Bloomington, Ind., 1936.

<sup>20</sup> "The Nature of Regression Functions in the Correlation Analysis of Time Series," *Econometrica*, Vol. 5, 1937, pp. 305-325. See also Ragnar Frisch, "Note on the Phase Diagram of Two Variates," *ibid.*, pp. 326-328.

classical method employed for many years by physicists; the second is comparatively new and has been developed mainly by biologists in an endeavor to reduce the Darwinian postulate of the "survival of the fittest" to a mathematical form; the third is based upon the concept of inverse serial correlation.

First we shall define more precisely what we mean by hysteresis as the relationship between two variables. Thus, if we consider  $x$  and  $y$  as depending upon a parameter  $t$ ,

$$(2) \quad x = x(t), \quad y = y(t), \quad t_0 \leq t \leq t_1,$$

such that  $x(t_0) = x(t_1)$ ,  $y(t_0) = y(t_1)$ , then if the point  $P = P(x, y)$  traces a nonintersecting curve from  $P_0 = P(x_0, y_0)$  to  $P_1 = P(x_1, y_1)$ , we shall say that hysteresis exists between the variables  $x$  and  $y$ . The amount of hysteresis will be proportional to the area of the curve so traced.

In mechanics, and more roughly so in economic phenomena, there is frequently observed a relationship between  $x$  and  $y$  which may be defined by the differential equations:

$$\frac{dx}{dt} = \alpha x - \beta y,$$

(3)

$$\frac{dy}{dt} = \gamma x - \alpha y,$$

where  $\Delta = \beta\gamma - \alpha^2 > 0$ , and all the parameters are positive quantities.

These equations state that the growth of both variables is stimulated directly by the magnitude of one of them, but is adversely affected by the magnitude of the second. For example, the rate of increase of business tends to be proportional to the level of business. But, unfortunately, prices also advance and these increasing prices exert an adverse influence upon business.

In order to find the relationship between  $x$  and  $y$  we observe the following relationship:

$$(4) \quad 2\gamma xx' - 2\alpha(xy' + yx') + 2\beta yy' = 0,$$

where  $x'$  and  $y'$  indicate the derivatives of  $x$  and  $y$  respectively.

Integrating (4) we immediately obtain

$$(5) \quad \gamma x^2 - 2\alpha xy + \beta y^2 = K,$$

where  $K$  is a constant. From the condition that  $\beta\gamma - \alpha^2 > 0$ , we see that (5) is the equation of an ellipse. A graphical example, due to H. E. Jones, is shown in Figure 114.

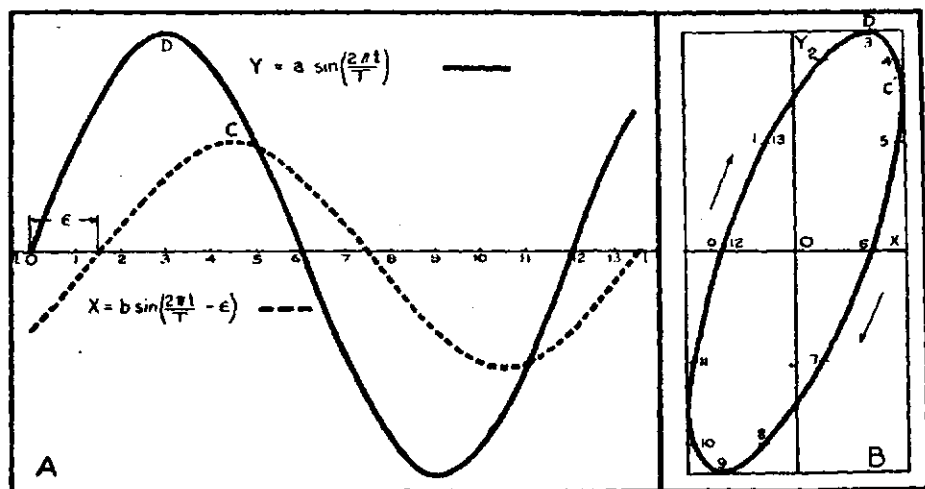

FIGURE 114.—EFFECT OF LAG HYSTERESIS IN THE CORRELATION OF TWO SINE CURVES.

If we differentiate the first equation in (3) and eliminate  $x'$  and  $y'$  by substituting their values as defined by the system, we shall obtain

$$\frac{d^2y}{dt^2} + (\beta\gamma - \alpha^2)x = 0.$$

This defines the harmonic

$$(6) \quad x = A \cos\left(\frac{2\pi}{T}t + a\right),$$

where  $(2\pi/T)^2 = \beta\gamma - \alpha^2$ , and where  $A$  and  $a$  are arbitrary constants. In a similar fashion we also obtain

$$(7) \quad y = B \cos\left(\frac{2\pi}{T}t + b\right).$$

Eliminating  $t$  between (6) and (7) we obtain

$$(8) \quad B^2x^2 = 2 \cos(a-b) ABxy + A^2y^2 - A^2B^2 \sin^2(a-b).$$

This equation is observed to be essentially the same as (5) defining also an ellipse. If  $a = b$ , then the ellipse degenerates into two coincident lines and there is no hysteresis between the variables. Maximum hysteresis is obtained when  $a - b = \pi/2$ , that is to say, when the two components are completely out of phase.

If the two variables  $x(t)$  and  $y(t)$  are defined statistically, and



if they are approximately sinusoidal, then (8) can be written in terms of statistical parameters in the form

$$(9) \quad \sigma_x^2 x^2 - 2 \sigma_x \sigma_y r_{xy} xy + \sigma_y^2 y^2 = 2 \sigma_x^2 \sigma_y^2 (1 - r_{xy}^2) .$$

A system of intersecting variables such as the one which we have described above is very common in physics and other applied fields where harmonic, or almost harmonic, motions are observed. It is quite reasonable to suppose that such a system would also apply in economics. The postulates which underly (3) are simple and have a priori validity. A further discussion of such systems will be given in the last section of this chapter.

The biologists, on the other hand, have found another system of equations which applies more directly to the phenomena of their science and which might also apparently have some validity in explaining some of the observed interactions between economic variables.

We have already seen in Chapter 6 the debt which economics owes to biology in the introduction of the theory of the logistic curve. We saw there that phenomena of growth for the most part conform to the pattern of a curve defined by

$$(10) \quad \frac{dy}{dt} = \alpha y - \beta y^2 ,$$

where  $\alpha$  and  $\beta$  are positive numbers.

This equation says, in fact, that the growth of  $y$  is stimulated directly by the magnitude of  $y$ , but that there exists also a deterrent to growth, which is proportional to  $y^2$ .

One may now consider two variables  $N_1$  and  $N_2$  which are assumed to work in opposition to one another. In biology  $N_1$  might measure the population of an organism ( $A$ ) which preys upon a second organism ( $B$ ), whose population is measured by  $N_2$ . If  $N_2$  is large, then ( $A$ ), in the presence of so much prey, will flourish and  $N_1$  will increase. But as  $N_1$  increases, the prey will diminish, that is to say,  $N_2$  will decrease, and there will set in a period of starvation. Then, as  $N_1$  diminishes, the prey will again begin to increase and so the cycle continues.

It is clear that the situation described above can be formulated in terms of the following system of equations:

$$(11) \quad \frac{dN_1}{dt} = \alpha N_1 - \beta N_1 N_2 , \quad \frac{dN_2}{dt} = -\gamma N_2 + \delta N_1 N_2 .$$

If we change to the new variables  $x = N_1 \delta / \gamma$ ,  $y = N_2 \beta / \alpha$ , then system (11) assumes the simpler form

$$\frac{dx}{dt} = \alpha x(1 - y)$$

(12)

$$\frac{dy}{dt} = -\gamma y(1 - x)$$

This formulation of the "struggle for life" is the work of a number of people, among whom must be mentioned principally A. J. Lotka and Vito Volterra. The reader will find an excellent account of Lotka's point of view in his very stimulating work, *Elements of Physical Biology*, Baltimore, 1925. A comprehensive discussion of the problem, not only from the mathematical point of view, but also from that of the origin and significance of the problem, will be found in Volterra's treatise entitled *Leçons sur la théorie mathématique de la lutte pour la vie*, Paris, 1931. This work extends Volterra's original investigations which were originally published in the memoirs of the *Accademia dei Lincei* in 1926. Actual applications of the mathematical theory to biological material are given by G. F. Gause in *The Struggle for Existence*, Baltimore, 1934.

Before describing the methods for the solution of system (12), it will be useful to see in what manner such a system might be applied in economics. A specific example may be found, perhaps, in the relationship between the inventory of finished goods and industrial production. It is obvious that the former "feeds" on the latter, since high production, that is to say, production above normal consumption needs, is always attended by growing inventories. But when inventories become too great, there ensues a period of low demand, which reacts upon industrial production. Hence, as this diminishes, inventories decline until they are below the needs of consumer demand. When this stage is reached, orders again increase, production grows, and the cycle is once more in its ascendant phase.

Although the problem stated above has not been subjected to statistical analysis, the reasonableness of the conjecture and the possibility of applying system (12) to this and other economic problems warrants an inclusion here of some account of the mathematical content of the system.

We first observe that we can write

$$(13) \quad \gamma x' + \alpha y' - \gamma x'/x - \alpha y'/y = 0.$$

This may be proved by substituting the values of  $x'$  and  $y'$  from system (12) into the left-hand member of equation (13) and noting that this member is then identically equal to zero.

Integrating (13) we then obtain

$$(14) \quad \gamma x + \alpha y - \gamma \log x - \alpha \log y = K,$$

where  $K$  is an arbitrary constant.

This equation can then be written in the somewhat more useful form

$$(15) \quad x^{-\gamma} e^{\gamma x} = C y^{\alpha} e^{-\alpha y}, \quad C = e^K.$$

This equation is the hysteresis diagram comparable with (5) for the harmonic system (3).

In order to represent (15), we first graph the two functions

$$(16) \quad \eta = (x^{-1} e^x) \gamma, \quad \xi = (y e^{-y})^{\alpha}.$$

Values of  $x$  and  $y$  are then obtained from the linear relationship  $\eta = C\xi$ .

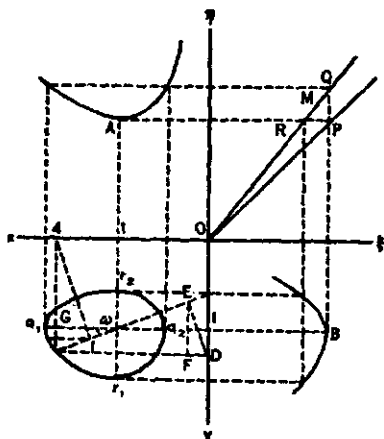

FIGURE 115.—VOLTERRA METHOD OF OBTAINING HYSTERESIS DIAGRAM.

As an example of the construction let us examine Figure 115.<sup>21</sup> In the second and fourth quadrants of the diagram we have represented the functions  $\eta = x^{-1}e^x$  and  $\xi = (y e^{-y})^{\alpha}$ ; that is to say, in equation (16) we have chosen  $\gamma = 1, \alpha = 2$ .

Now let the tangents be drawn from  $A$  and  $B$ , the minimum and maximum points of  $\eta$  and  $\xi$  respectively, and let these tangents intersect in  $P$ . The line  $\eta = C\xi$  is now drawn and if  $C$  exceeds the slope of  $OP$ , then (16) will represent a real locus. The points  $Q$  and  $R$  determine the points  $q_1, q_2$ , and  $r_1, r_2$  respectively of the desired locus, by the simple construction given in the figure. Other points are similarly determined by means of an identical construction originating from a variable point  $M$  in the interval  $RQ$ .

The next, and somewhat more difficult step, is to construct the curves

$$(17) \quad x = x(t), \quad y = y(t).$$

In order to do this we first note that by means of equations (12) we can write

$$(18) \quad \left[ (x-1) \frac{dy}{dt} - (y-1) \frac{dx}{dt} \right] = [\gamma(x-1)^2 y + \alpha(y-1)^2 x].$$

<sup>21</sup>The example and diagrams are taken from Volterra's book, *Leçons sur la théorie mathématique de la lutte pour la vie*.

Let us now change to the polar co-ordinates,  $(\rho, \omega)$ , referred to the point  $(1,1)$ ; that is, where we define

$$x - 1 = \rho \cos \omega, \quad y - 1 = \rho \sin \omega.$$

Equation (18) then assumes the form

$$(19) \quad \frac{d\omega}{dt} = \alpha \sin^2 \omega x + \gamma \cos^2 \omega y.$$

The value of  $\omega$  is then defined by the integral

$$(20) \quad \omega = \int_0^t \phi(\omega) dt,$$

where we employ the abbreviation

$$\phi(\omega) = \alpha \sin^2 \omega x + \gamma \cos^2 \omega y.$$

In order to obtain the values of  $\phi(\omega)$  we note from Figure 115 that  $ED = x \sin \omega$  and hence  $FD = x \sin^2 \omega$ . Similarly we have  $HG = y \cos^2 \omega$ . Multiplying these values respectively by  $\alpha$  and  $\gamma$  and adding them together, we obtain the value of  $\phi(\omega)$  for the assumed value of  $\omega$ . Hence, by continuing this graphical process for a sufficient number of values of  $\omega$  in the interval from 0 to  $2\pi$  we can construct the graph of  $\phi(\omega)$ . For the example given above this graph is represented in Figure 116(a).

The function

$$\omega = \omega(t)$$

defined by the integral (20) is now constructed by some form of numerical or graphical integration, the graph for the example being exhibited in Figure 116(b).

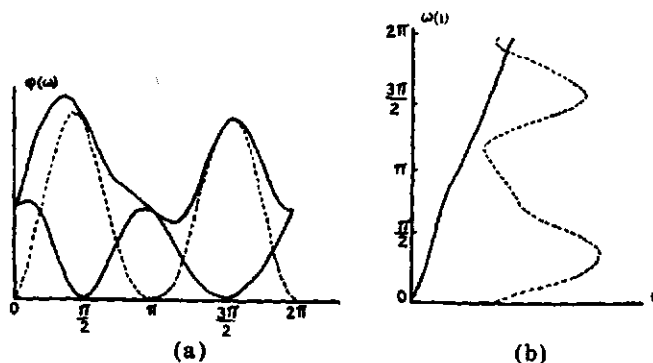

FIGURE 116.—CONSTRUCTION OF COMPONENTS OF HYSTERESIS DIAGRAM.

It is now possible from Figure 116(a) and Figure 116(b) to determine the values of  $x$  and  $y$  which correspond to values of  $t$  and hence to construct the desired curves defined by (17). These, for the example, are shown in Figure 117.

We see from this analysis that the actual form of the curves  $y = y(t)$  and  $x = x(t)$  will not, in general, differ greatly from harmonic motions in applications to economic time series which are, for the most part, quasi-harmonic in character.

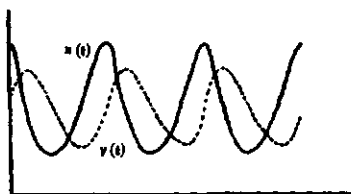

FIGURE 117. — COMPONENTS OF HYSTERESIS DIAGRAM.

Another method for investigating the hysteresis in economic phenomena may be described as follows: Suppose that  $r_x(t)$  is the autocorrelation of the variable  $x$  and  $r_y(t)$  is the autocorrelation of the variable  $y$ . Suppose, further, that  $r_{xy}(t)$  is the serial correlation of the two variables  $x$  and  $y$ . From the graph of  $r = r_{xy}(t)$  we determine the lag  $\alpha$  between the two primary functions  $x$  and  $y$ .

We then compute the harmonically equivalent variables

$$\xi(t) = \frac{1}{2\pi} \int_{-\infty}^{\infty} \sqrt{\alpha_1(\beta)} \cos \beta t d\beta, \quad \alpha_1(\beta) = \int_{-\infty}^{\infty} r_x(t) \cos \beta t dt, \quad (21)$$

$$\eta(t) = \frac{1}{2\pi} \int_{-\infty}^{\infty} \sqrt{\alpha_2(\beta)} \cos \beta(\alpha - t) d\beta, \quad \alpha_2(\beta) = \int_{-\infty}^{\infty} r_y(t) \cos \beta t dt.$$

The curve obtained from the parametric system

$$(22) \quad \xi = \xi(t), \quad \eta = \eta(t),$$

is then the hysteresis diagram of the original variables.

This system will not yield, in general, a closed curve and hence the loop generated will not be a true hysteresis diagram in the sense defined earlier in this section. Moreover, the loops may contract in area as  $t$  carries  $\xi$  and  $\eta$  through succeeding cycles, since the functionals defined by (21) will not belong, in general, to the group of the closed cycle.

An example of this type of hysteresis diagram is furnished by the observed relationship between the Dow-Jones industrial averages and pig-iron production. Thus the autocorrelation functions of these two variables are reasonably well described by the same function, namely,

$$r_s(t) = \frac{\sin \lambda t}{\lambda t}, \quad \lambda = \frac{\pi}{20},$$

where  $t$  is measured in months.

Also it is observed statistically that the serial correlation between the two variables shows a lag of three months between the two series, the stock averages preceding the production of pig iron.

Our analysis would then proceed as follows:

$$\alpha(\beta) = \int_{-\infty}^{\infty} \frac{\sin \lambda t}{\lambda t} \cos \beta t dt = \begin{cases} \pi/\lambda, & \beta < \lambda, \\ 0, & \beta > \lambda. \end{cases}$$

Hence we obtain

$$\begin{aligned} \xi(t) &= \frac{1}{2\pi} \int_{-\infty}^{\infty} \sqrt{\alpha(\beta)} \cos \beta t d\beta, \\ &= \sqrt{\frac{\lambda}{\pi}} \frac{\sin \lambda t}{\lambda t}. \end{aligned}$$

For the lagged variable (pig-iron production) we obtain similarly

$$\begin{aligned} \eta(t) &= \frac{1}{2\pi} \int_{-\infty}^{\infty} \sqrt{\alpha(\beta)} \cos \beta(\alpha - t) d\beta \\ &= \sqrt{\frac{\lambda}{\pi}} \frac{\sin \lambda(\alpha - t)}{\lambda(\alpha - t)}. \end{aligned}$$

Setting  $\lambda = \pi/20$  and  $\alpha = 3$ , we then compute the hysteresis diagram from the function

$$\xi(t) = S\left[\frac{\pi t}{20}\right], \quad \eta(t) = S\left[\frac{\pi(3-t)}{20}\right],$$

where we abbreviate

$$S(x) = \frac{\sin x}{x}.$$

We observe from the diagram, Figure 118, how successive loops rapidly diminish in area, showing the relative impermanence of the hysteresis relationship. In order to test this further we finally compute the autocorrelation between  $\xi(t)$  and  $\eta(t)$ . This is found to be

$$\begin{aligned} r(t) &= \frac{\pi}{\lambda} \int_{-\infty}^{\infty} \frac{\sin \lambda s}{\lambda s} \frac{\sin[\lambda(\alpha - t - s)]}{\lambda(\alpha - t - s)} ds \\ &= \frac{\sin \lambda(\alpha - t)}{(\alpha - t)}. \end{aligned}$$

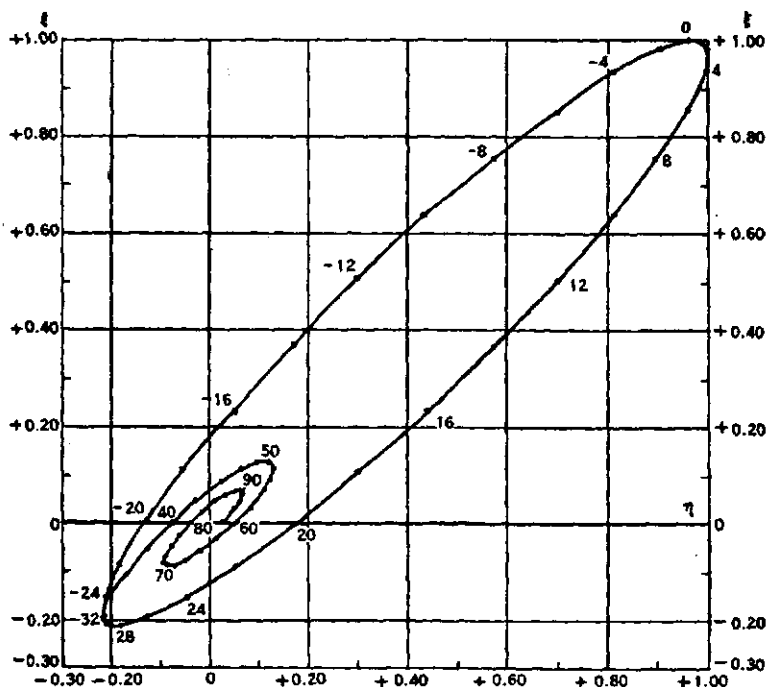

FIGURE 118.—HYSTERESIS CURVE COMPUTED FROM INVERSE SERIAL CORRELATION FUNCTIONS.

The actual serial correlation function between the two variables exhibits the damping implied by this formula, as we have seen previously in Figure 22 of Chapter 3.

An analysis similar to the one just described in the fact that it leads to nonperiodic loops was described in 1923 by A. J. Lotka.<sup>22</sup> In this theory, applicable to the problem of the prey and the predator, Lotka considered a differential system of the form

$$\frac{dx}{dt} = -y + Bxy + Cy^2 + Ex^2y + Fxy^2 + Gy^3 + \dots, \quad (23)$$

$$\frac{dy}{dt} = x + A'x^2 + B'xy + D'x^3 + E'x^2y + F'xy^2 + \dots$$

The problem of finding the integral,  $F(x, y) = 0$ , for such a system has been the subject of intensive study since many of the problems concerning the stability of dynamical systems, especially in

<sup>22</sup> "Contribution to Quantitative Parasitology," *Journal of the Washington Academy of Sciences*, Vol. 13, 1923, pp. 152-158.

astronomy, are thus formulated. The discussion of this deep mathematical problem would carry us far afield and must be omitted here, but the curious reader may appreciate some of the difficulties by consulting the following references: H. Poincaré, "Sur les courbes définies par les équations différentielles," *Journal des Mathématiques*, Vol. 1 (4th Series), 1885, pp. 167-244, and É Picard, *Traité d'analyse*, Vol. 3, Paris, 1896, p. 217 *et seq.* The former, commenting on the problem presented by system (23), says:

Considering  $x$  and  $y$  as the coordinates of a variable point, and  $t$  as the time, one seeks the motion of a point to which one gives the velocity as a function of the coordinates. Thus in the motion which we have studied, we have sought to answer such questions as these: Does the moving point describe a closed curve? Does it always remain in the interior of a certain portion of the plane? In other words, and speaking in the language of astronomy, we have inquired whether the orbit of this point is stable or unstable.

### 7. *The Random-Shock Theory of Cycles — The Galvanometer Experiment*

In Section 10 of Chapter 1 the origin and the history of the so-called "random-shock theory" of cycles was given. This theory assumes that the economic system is a fundamentally stable configuration, which, if we were sufficiently wise, could be characterized by a set of elastic constants. But the system cannot oscillate according to its fundamental frequencies unless it is set in motion by some initial forces. Moreover, as in mechanical systems, the motion will not be maintained unless new energy is introduced into the system from time to time. The theory of random shocks assumes that the system is kept in motion by a series of impulses which are random in their nature but sufficiently frequent to maintain a continual motion in the system.

In the language of mechanics, the erratic shocks play the role of an impressed force. But it is a well-known fact, which will be demonstrated in Section 8, that the motion of a system of the kind considered here will assume the period of the impressed force if this force is periodic, but that otherwise it will tend to assume its natural period subject to the disturbances of the impressed force.

In Section 7 of Chapter 3, we have already examined Yule's theory of a harmonic motion disturbed by random shocks and it will be unnecessary to repeat his arguments here.

In Section 2 of this chapter we found that the motion defined by the equation



$$(1) \quad p''(t) + m^2 p = f(t)$$

appeared explicitly in the form

$$(2) \quad p(t) = K \cos m(t + \mu) + \frac{1}{m} \int_0^t \sin m(t-s) f(s) ds.$$

Hence, if  $f(s)$  is constant, or nearly constant, the motion will retain the period defined by the homogeneous equation:

$$(3) \quad p''(t) + m^2 p = 0.$$

Moreover, if  $f(s)$  is an impulsive force, that is to say, very great for a very brief interval of time, the same motion is again attained. But it must be remembered also that for large amplitudes equation (3) is more exactly represented by

$$p''(t) + m^2 \sin p = 0.$$

In this case the period  $T$  is given by the formula

$$(4) \quad T = 4K/m,$$

where  $K$  is the complete elliptic integral of first kind.<sup>23</sup> This function depends upon the initial amplitude  $p(0) = \alpha$  and is greater than  $\pi/2$  when  $\alpha > 0$ . Hence *the observed period of a harmonic motion created by a sufficiently great impulse should increase over the natural period of the system.*

In order to test the effect of random shocks upon a system an experiment was tried by the laboratory of the Cowles Commission. This experiment, some features of which were discussed in Section 10 of Chapter 1, may be described as follows: A galvanometer was constrained to oscillate in three separate periods which were in the ratios 22:43:62, to simulate the three periods observed in the Dow-Jones industrial averages in the interval from 1897 to 1913. A series of erratic impulses, irregularly spaced and of a magnitude about equal to the momentum of the galvanometer, were then imposed upon the system and motion pictures taken of the ensuing deflections.

The resulting motion, as analyzed by periodograms (see Section 22 of Chapter 7), showed the smallest disturbance for the longest period and the greatest for the shortest. All periods were lengthened. Thus for the first only 8 per cent of the energy remained in the period

<sup>23</sup> A definition of this function and a description of its properties will be found in any advanced calculus. When  $\alpha$  is not too large and if it is expressed in radians, then  $K$  can be written approximately in the form

$$K = \frac{1}{2}\pi(1 + \alpha^2/16).$$

$T = 22$ , while 20 per cent of the energy had been shifted to the period 34 and 30 per cent to the period 66. For the second, only 28 per cent of the energy remained in the original period, while 46 per cent was shifted to the period 62. For the longest period, the shift was relatively short and took place in two directions. Thus only 12 per cent remained in the original period, while 18 per cent went into the period  $T = 56$  and 52 per cent into the period  $T = 72$ .

For the purpose of observing the effects of the random shocks upon an actual time series consisting of several harmonics, a synthetic series was constructed from the galvanometer readings in the following manner: The phases of the three cycles were put into initial agreement with the phases of the three components of the industrial stock price averages as these were observed from the periodogram analysis of Section 7 of Chapter 7. The elements of the three cycles were then divided by their respective standard deviations and multiplied by the amplitudes observed for the corresponding components of the industrial stock price series. The elements of the three cycles were then combined by addition and a random element added to the sum to form the final elements of the synthetic series.

In Figure 119 we may compare the variation of the synthetic time series with the elements of the actual series of industrial stock prices. It is obvious that the erratic shocks imposed upon the galvanometer were sufficiently great to cause a substantial increase in the average length of the period of the synthetic series, while the average period of series (B) is somewhere between  $3\frac{1}{2}$  and 5 years, the average period of (A) is between 5 and 10 years.

If we assume that in series (A) the length of the observed period,  $T$ , was in the neighborhood of twice the normal period,  $T_0$ , then we can obtain some estimate of the actual average displacement,  $\alpha$ , caused by the shocks, if we write equation (4) in the form

$$(5) \quad \frac{T}{T_0} = \frac{2K}{\pi}.$$

If the ratio  $T/T_0 = 2$ , then  $K = \pi$ , and we find from a table of elliptic integrals that  $\alpha = 1.395$ . This means that the average erratic impulse was sufficiently great to displace the galvanometer 1.395 radians or  $79^\circ 56'$  from its zero or equilibrium position. This implies that the average erratic impulse was very large.

It is interesting to apply this analysis to the movement of industrial stock prices before and after 1929. In the years preceding the inflation the average period was about 38 months. Now, if we regard the period of the next cycle as extending from the maximum in

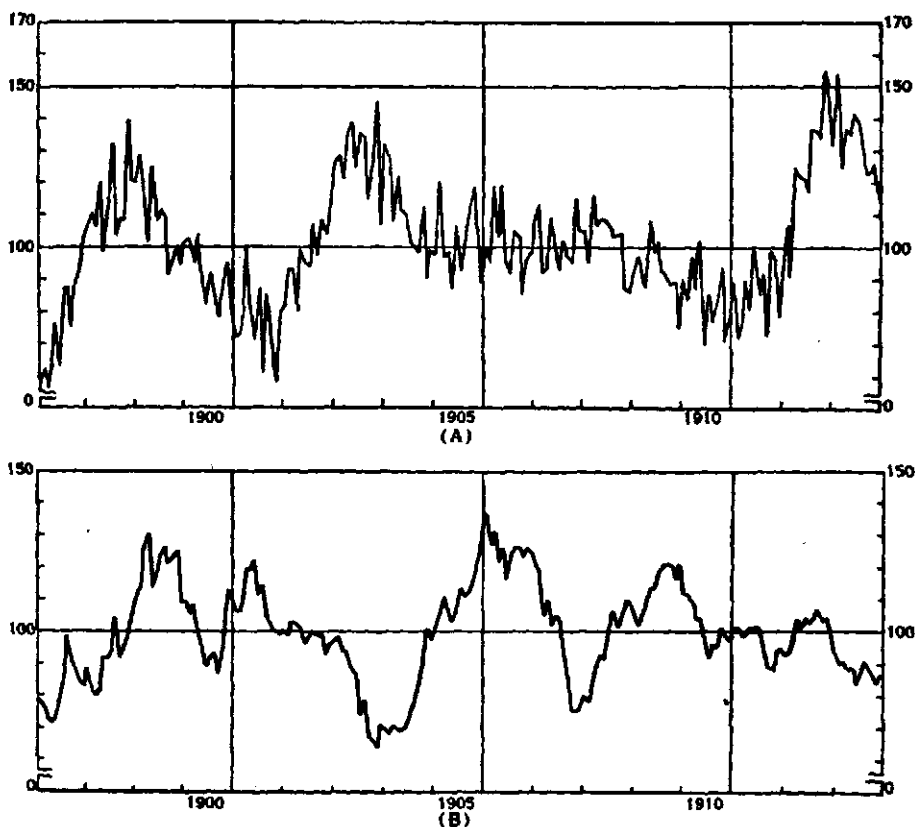

FIGURE 119.—THE EFFECT OF RANDOM SHOCKS IN INCREASING THE PERIOD OF A TIME SERIES

(A) is a synthetic series constructed by combining the three periodic movements in the industrial stock price series (B) after these have been disturbed by large random shocks.

1929 to the maximum in 1937, we see that the effect of the great bull market was to increase the period from 38 months to 96 months. Thus we find  $T/T_0 = 2.56$  and the corresponding value of  $\alpha$  is 1.500. That is to say, an equivalent blow delivered to the galvanometer would have deflected it through  $85^\circ 57'$  from its equilibrium position. This would be regarded in mechanics as a very great impulse.

While we appear here to be dealing with analogies, the fact that many economic time series exhibit cyclical patterns with considerable energy concentration in certain periods, the evidence presented above seems to argue strongly for the reality of the general concept of the theory of random shocks. Other evidence will be presented in the next section.

### 8. *The Perturbation Theory of Cycles*

We shall consider in this section another way of looking at the problem of oscillations in economic time series. If the harmonic terms which have been observed, however irregular they may be, are genuine and permanent characteristics of time series, it is possible to account for at least a part of their energy by assuming a fixed elastic structure in the economic system. Thus the indexes may be thought of as varying, under erratic impulses, about a figure of equilibrium and the problem of their individual and group motions may be studied by the methods of J. Lagrange (1736-1813), who first examined the dynamics of small variations.<sup>24</sup>

As the basis of the theory we find a set of variables,  $X_1, X_2, X_3, \dots, X_n$ , which represent the elements of  $n$  standard economic time series. For example,  $X_1$  might be the average price of industrial stocks;  $X_2$ , pig-iron production;  $X_3$ , stock sales on the New York Stock Exchange;  $X_4$ , high-grade bond yields, etc.

We shall postulate that these elements oscillate about normal positions determined by some reasonably stable trend. In fact, the variables written above will be assumed to be such deviations, and they may be normalized by division by their respective standard deviations.

We shall make the further hypothesis that there exist two types of force in an economic system, which cause the observed fluctuations in the series.

(1) Normal, conservative elasticities which are inherent in the institutional structure of an economy. These natural strains and stresses create the permanent patterns observed in the regular oscillations of the series.

(2) Nonconservative forces, which are impressed upon the system by external events. The forces may be either regular or disruptive influences.

The first set of forces is normal and creates the rhythmic oscillation characteristic of stable periods. This set acts, however, only after displacements have been made in the variables either above or below their normal positions of equilibrium.

The second set of forces will be found in abnormal or unusual occurrences, which may be considered to be essentially unpredictable. For example, these forces are occasioned by major wars, by protracted periods of drought, by new legal regulations, by changes in foreign exchange, by large business or banking failures, by the psychological

<sup>24</sup> The reader may orient himself in this problem by consulting A. G. Webster, *The Dynamics of Particles*, First ed., New York, 1904, 2nd ed., 1912, xii + 588 pp. In particular, see Chapter 5.

aberrations of groups of people, such as appear in major periods of speculation. They are the forces found in random shocks which impinge from time to time upon the system.

One may find an analogy to our dynamical picture in the motion of the ocean. The tides are stable and predictable movements, but the waves themselves are created by the random variations of the wind. They are functions not only of these unpredictable motions, but also of the constant viscosity of the water. Except in severe storms, and even there, the waves preserve an even rhythm which a harmonic analysis would show consisted of a partition of the energy of the water among a comparatively few harmonic terms.

If we now look more closely at the economic problem, we see that the creation of goods is accomplished for the most part by an expenditure of real energy. Thus, a certain number of ergs of energy are used in the creation of a ton of pig iron, or in the erection of a house, or in the planting and harvesting of an acre of corn. Attempts have been made to create a theory of economics on the basis of the energy content of material things, such, for example, as the "labor exchange system" of currency adopted in one of the socialistic experiments of Robert Owen (1771-1858).

But all such attempts are doomed to failure since prices are not direct functions of the energy necessary to create goods. One may observe the truth of this in the prices of rare paintings and jewelry, in the price differentials between identical commodities sold by fashionable and nonfashionable firms, and in many other forms of price phenomena.

In modern economics the concept of *utility*, or *ophelimity*, to use the term employed by V. Pareto, has become a fundamental part of the theory of prices. In order to formulate our perturbation theory of cycles it will be necessary to recall a few of the pertinent characteristics of utility.

By utility, or ophelimity, we shall mean a measure of the satisfaction which an individual, or more generally, a group of individuals has in the possession of given quantities of goods and services. We may represent this by means of the symbol  $U(x_1, x_2, \dots, x_n)$  where  $x_1, x_2, \dots, x_n$  are the given quantities of the goods and services considered.

The actual measure of utility has never been satisfactorily defined in terms of statistical parameters, and perhaps it can never be so defined, although several attempts have been made in this direction. Utility is thus seen to be a psychological concept, with a large measure of intangibility about it.

The origin of the idea is apparently found in a postulate made by Daniel Bernoulli (1700-1782) in his *Specimen Theoriae Novae de Mensura Sortis*, published in 1738, in which he stated that the satisfaction,  $dU$ , of a man in adding an increment  $dx$  to his wealth,  $x$ , was directly proportional to the increment, and inversely proportional to his wealth; that is,

$$(1) \quad dU = \mu \frac{dx}{x}.$$

The parameter  $\mu$  may be regarded as a psychic factor, which measures the openhandedness, or the generosity, of an individual.

Even this simple proposition is difficult to demonstrate statistically and we find Charles Jordan<sup>25</sup> suggesting  $dU = \mu dx/x^2$  and Ragnar Frisch<sup>26</sup>  $dU = \mu dx/\log(x/x_0)$  as the more realistic expression for the utility of money. The formula of Jordan assumes that we reach money satiation more rapidly than is assumed by the formula of Bernoulli, while the formula of Frisch assumes that the approach to money satiation is relatively low.

It is easily proved that in a static economy the relationship between the utility function and the prices of the various goods and services included in it is given by the following system of equations:

$$(2) \quad \frac{\partial U}{\partial x_i} = \lambda p_i,$$

where  $\lambda$  is the marginal utility of money. The quantity  $\partial U/\partial x_i$  is called the marginal utility of the  $i$ th good.

Since equations (2) refer to a static equilibrium, one may assume that they hold for each point of time. Hence each variable may be regarded as depending upon time and each may vary independently except for the single restraint imposed by (2).

Our theory of economic dynamics will be founded upon the proposition that the major fluctuations of the business cycle must be accounted for by the behavior of all the elements in the economy rather than by a part of them. Thus we must modify the postulate that the major part of the movement of prices can be accounted for by the endeavor of the entrepreneur to maximize profits. This does not mean that we deny the importance of the profit motive in business enterprise, nor that we reject the mathematical theory based upon the premise that business seeks to maximize profits. The evidence before

<sup>25</sup> "On Daniel Bernoulli's 'Moral Expectation' and on a New Conception of Expectation," *American Mathematical Monthly*, Vol. 31, 1924, pp. 183-190.

<sup>26</sup> *New Methods of Measuring Marginal Utility*, Tübingen, 1932, 142 pp.

the T.N.E.C.<sup>22a</sup> on the activities of the United States Steel Corporation shows clearly that the location of the *break-even point*, that is to say, the point where total revenue equals total cost, is a more important matter than the location of a *point of maximum profits*. In fact, under the realistic observation that the cost function of the United States Steel Corporation is linear within the range of actual production, such a point of maximum profits does not exist. One will readily observe that to say that a corporation seeks to maximize its profits in the sense of maximizing the profit function is quite a different thing from saying that a corporation strives to get as far above the break-even point as possible. It is in this sense that we shall modify the principle of maximum profits.

We shall assume first, therefore, that in any economy the primary desire of buyers and seller alike is to maximize their utility functions, subject, of course, to the budgetary restraint. This statement, it will be observed, is really equivalent to assuming the principle of maximizing profits provided the marginal utility of money is not negative. Hence we do not discard the mathematical theory which underlies most of the formulation of modern economic arguments. As will become apparent, we merely seek to show that the realistic description of the activities of business enterprise must be modified by the introduction of other factors.

In the second place we shall assume that one major source of movement in economic time series is found in erratic shocks. Wars, large commercial failures, general strikes, extreme droughts, and other such factors are all reflected by strong movements in the series, and especially in those of price. The more orderly changes occasioned by new laws, changes in political administration, and the like are also sources of movement in economic variables.

We propose to represent this erratic and dynamic element in the economy by the bilinear form

$$A = \sum x'_i p'_i,$$

where the primes indicate differentiation with respect to time. Since selling means a reduction in the variables  $x_i$  in the utility function, we shall assume that the sign of  $x'_i$  is negative when selling is taking place. A contraction in orders by merchants, a reduction of normal building, a decline in the index of retail trade, the cancellation of contracts for steel, and similar occurrences imply a negative value of  $x'_i$ .

<sup>22a</sup> See United States Steel Corporation, *T.N.E.C. Papers*, 1940, Vol. 1, pp. 223-323. The analysis in these pages was done under the supervision of T. O. Yntema.

There are numerous arguments both logical and statistical to show that  $A$  is a positive function of time. Thus, in the great bull market, prices and consumption rose together and, in the subsequent collapse, consumption declined with prices. Irving Fisher has shown that the correlation between the change in prices and in the employment index is positive and of the order of 0.85.

The third element in the formulation of our theory is that of surpluses, which may, of course, be negative as well as positive. In recent years it has been the existence of positive surpluses which has given most concern to business and to government. In other times it has been scarcity which has most affected the national economy. The sharpest declines in the index of business have followed the accumulation of great inventories, and the strongest recoveries from depression have come after a protracted decline in production. We shall assume, therefore, that this surplus situation can be measured by the following positive function:

$$B = \frac{1}{2} \sum (x_i - u_i)^2,$$

where the  $x_i$  represent the goods consumed or owned, namely, the variables which appear in the utility function, and where the  $u_i$  represent those goods available either through potential production, as in manufacturing, or through inventories and carry-overs, as in merchandising and in the production of crops.

Our formulation of the dynamic problem, then, reduces to the simple proposition that we strive, in our accumulation and use of goods, to maximize the following integral:

$$(3) \quad J = \int_{t_0}^{t_1} (U - \kappa A - \nu B) dt,$$

where  $\kappa$  and  $\nu$  are positive constants so determined that the dimensions of the three quantities are the same. The principal defense of this formulation will be found in its agreement with the observed facts.

Let us now designate the integrand of (3) by  $F$  and then compute the Euler condition for the integral  $J$ , namely, the equation

$$\frac{\partial F}{\partial x_i} - \frac{d}{dt} \frac{\partial F}{\partial x_i'} = 0.$$

Noting equation (2), we first obtain

$$\frac{\partial F}{\partial x_i} = \frac{\partial U}{\partial x_i} - \kappa \frac{\partial A}{\partial x_i} - \nu \frac{\partial B}{\partial x_i} = \lambda p_i - \nu \sum (x_i - u_i),$$



$$\frac{\partial F}{\partial x_i'} = \frac{\partial U}{\partial x_i'} - \kappa \frac{\partial A}{\partial x_i'} - \nu \frac{\partial B}{\partial x_i'} = -\kappa p_i'.$$

When these quantities are substituted in the Euler condition, the following equation results:

$$\kappa \frac{d^2 p_i}{dt^2} + \lambda p_i = \nu \sum (x_i - u_i).$$

Without loss of generality we can set  $\kappa = 1$ . Since the right-hand member is a function of time, let us represent it by the quantity  $U_i(t)$ . Hence we obtain as the general formulation of the dynamics of prices in the economic system the following:

$$(4) \quad \frac{d^2 p_i}{dt^2} + \lambda p_i = U_i(t).$$

It is clear that the function  $U_i(t)$  will be a fluctuating variable, perhaps periodic in character, about some mean value of the difference between the volume of consumption and the volume of current inventory. It is certainly neither a monotonically increasing nor a monotonically decreasing function of the time.

If we assume that consumption and production are essentially in equilibrium, then  $U_i(t)$  would be a constant, which, without essential loss of generality, could be set equal to zero. Equation (4) is then replaced by

$$(5) \quad \frac{d^2 p_i}{dt^2} + \lambda p_i = 0.$$

If  $\lambda$  is a constant, this equation will define a simple harmonic motion of period equal to  $2\pi/\sqrt{\lambda}$ . Moreover, even though  $\lambda$  varies, if this variation differs but little from a constant over a given period of time, then the motion will be nearly harmonic.

The nature of  $\lambda$  is not yet clearly defined in economics, but if we assume the Bernoulli formulation given above, then it is not difficult to believe that, within approximate limits,  $\lambda$  may be inversely proportional to the available per capita money and directly proportional to the velocity of this money. This very rough assumption is based upon the proposition that  $x$  in Bernoulli's formula is proportional to the average available supply of money and that the  $\mu$  is proportional to the velocity of money, since it represents the average openhandedness of people, which varies with times and economic conditions. Hence, under equilibrium conditions, the length of cycles would tend to increase when the supply of money is great and the velocity low. Con-

versely, the cycles would have a shorter period in times of money tightness accompanied by a high velocity. No statistical evidence is offered here to support the correctness of this conjecture.

In order to make a statistical test of equation (5), let us consider prices in the relatively stable period of American economy between 1897 and 1914. For simplicity of analysis we shall examine the behavior of one dominating price, such, for example, as the price of industrial stocks, and we shall assume that this price satisfies a differential equation of the form

$$(6) \quad A \frac{d^2 p}{dt^2} + B \frac{dp}{dt} + C p = 0 .$$

The solution of (6) has the form

$$p(t) = K e^{-at} \sin\left(\frac{2\pi t}{T} + \omega\right) ,$$

where we abbreviate

$$(7) \quad a = \frac{B}{2A} , \quad T = \frac{4\pi A}{\sqrt{4AC - B^2}} .$$

The amplitude,  $K$ , and the phase angle,  $\omega$ , are constants of integration.

Let us now determine the parameters of (6) from the actual values of the industrial stock price averages over the stable period from 1897 to 1914. For the sake of simplicity we shall assume that most of the energy of the system is concentrated in the major harmonic. This assumption is certainly not in violent disagreement with the facts as we see from an inspection of the periodogram of Section 7 of Chapter 7. There we find that 48 per cent of the energy is concentrated in the harmonic of period  $T = 41$ . Even more remarkable was the situation for the interval 1914-1924, where 74 per cent of the energy was in the 38-month cycle.

If the differential equation (6) is fitted by the method of multiple correlations to the data for the Dow-Jones industrial stock prices (1897-1913), there is obtained

$$(8) \quad \frac{d^2 X_1}{dt^2} + 0.00004 \frac{dX_1}{dt} + 0.01865 X_1 = 0 .$$

We first note the significant fact that the coefficient of  $dX_1/dt$  is essentially zero. This means that no damping factor was present in the motion of the series, a fact which has been commented upon by other students of the theory of economic time series. This furnishes

statistical justification for the omission of the first derivative term from equation (5).

The period is readily found from the parameters of (8) by means of the second formula in (7) to be  $T = 46.0$ , a value sufficiently close to the 41-month period obtained from the periodogram to justify the theory which led to equation (5).

Unfortunately, however, the fact that the coefficient of  $dX_1/dt$  is zero leads to the curious conclusion that the economic system operates without frictional forces, a conclusion certainly far from realistic. It is much more reasonable to suppose that the lack of damping is due to the presence in the system of an impressed force, which supplies the motive power for the observed variations. This impressed force, of course, is found in the function  $U_i(t)$  in equation (4). The economic nature of this function we have already discussed.

Let us now assume that the impressed force  $U_i(t)$  is simply periodic and can be represented by

$$(9) \quad U_i(t) = E_i \cos q_i t.$$

In order to investigate the dynamics of the situation, let us study the motion defined by equation (6) with an impressed force added to the right-hand member; that is to say, let us study the equation

$$(10) \quad A \frac{d^2 p}{dt^2} + B \frac{dp}{dt} + Cp = E \cos qt.$$

It is readily proved that the solution has the form

$$(11) \quad p(t) = K e^{-at} \sin\left(\frac{2\pi t}{T} + \omega\right) + L \cos(qt - \alpha),$$

where  $a$  and  $T$  are defined by (7),  $K$  and  $\omega$  are arbitrary constants, and  $\alpha$  and  $L$  are given by the equations:

$$(12) \quad \tan \alpha = \frac{Bq}{C - Aq^2}, \quad L = \frac{E}{\sqrt{(C - Aq^2)^2 + B^2q^2}}.$$

It will be observed that when frictional forces are present in the system, that is to say, when  $a > 0$ , the first term in (11) damps to zero. Hence in its steady state, the oscillation will have the same period as that of the impressed force.

But since, in equation (4), the friction term is zero, the motion will consist of a combination of harmonic terms, one having the natural period of the system and the other the period of the impressed force.

In order to see what the actual statistical situation is with respect to the industrial stock price averages considered above, we shall fit to them and their first and second derivatives the linear regression

$$(13) \quad AX''_1 + BX'_1 + CX_1 + D \cos qt = 0, \quad q = 2\pi/41.$$

By a simple application of the theory of multiple correlation we obtain the following differential equation:

$$(14) \quad X''_1 + 0.00004 X'_1 + 0.01744 X_1 = 0.07032 \cos qt,$$

which is to be compared with equation (8).

The solution of this equation is

$$(15) \quad X_1 = K \sin\left(\frac{2\pi t}{47.6} + \omega\right) + 11.6424 \cos qt.$$

The variance of  $X_1$  from the actual data is 225.3154 and the variance of  $X_1$  from (15) is approximately  $\frac{1}{2}(K^2 + 135.5455)$ . But since only 48 per cent of the energy of  $X_1$  is in the 41-month component, we may then estimate  $K$  from the equation  $K^2 + 135.5455 = 0.96 \times 225.3154$ . We thus obtain  $K = 8.9809$ . It would thus appear that the harmonic energy observed in the original series is divided between the impressed period of 41 months and the natural period of 48 months in the ratio of 5 to 3.<sup>27</sup>

### 9. The Resonance Theory of Crises

The reality of the theory given in the preceding section is argued for by another unusual circumstance. If we examine the graph of the price of industrial stocks after 1914, the end of the period to which the regression equations of the preceding section apply, we observe a regular sinusoidal fluctuation up to the year 1926 and then a tremendous upsurge now known as the great bull market of 1929. No dynamic theory of prices would be adequate which could not account for this phenomenon.

If we re-examine the theory of Section 8, we see that the formulation which led to equation (5) would not be able to account for the crisis of 1929 without drastic, and probably unwarranted, assumptions about the nature of the marginal utility of money represented by  $\lambda$ .

But if we refer to the second formulation represented by equation (4), then it is possible to give a fairly simple theory of crises by introducing the concept of *resonance*. By resonance we mean the phe-

<sup>27</sup> To compare energies we compare 135.5455 with  $K^2 = 80.6573$ .

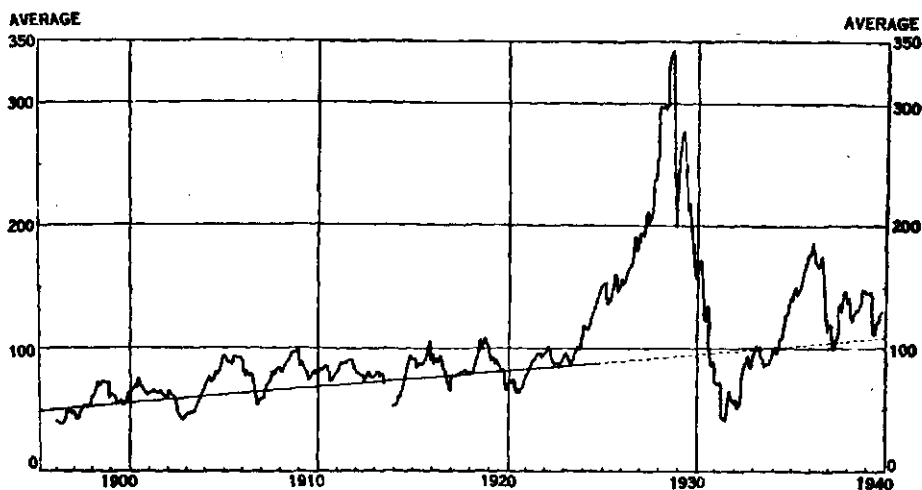

FIGURE 120.—RESONANCE IN ECONOMIC TIME SERIES.

The inflationary peak of 1929 rose abruptly from a regular harmonic movement easily observable in the series, namely the Dow-Jones Industrial stock averages. Unit: Monthly low of daily averages in dollars per share, trend extended to 1940.

nomenon in which large vibrations are caused by small forces. Thus, a large ship will sometimes roll heavily in a light sea when the period of the waves is equal to the natural period of the ship. Similarly a bridge may be badly damaged by a column of marching men.

If we refer to equations (11) and (12) of Section 8, we see that  $p(t)$  will be large if  $L$  is large, and  $L$  is large when the quantity

$$(C - Aq^2)^2 + B^2q^2$$

is small.

For equation (4), this condition reduces to the simple proposition that resonance will occur when  $q$  is nearly equal to the marginal utility of money,  $\lambda$ .

Was the inflation of 1929 a resonance phenomenon? If we examine the parameters of equation (14), Section 8, we see that the quantity  $|C - Aq^2|$  has the value 0.00604. Hence it is obvious that very little change in any one of the parameters would have led to the phenomenon of resonance. Or put in another way, the difference between the period  $T = 41$  of the impressed force and the natural period  $T = 48$  of the system itself was relatively so small that a change in either one of them would have produced an inflation in  $p(t)$ .

Another and perhaps more cogent argument is provided in the subsequent history of the inflation. In October, 1929, prices began to

fall rapidly and by 1931 the country was in the throes of a major depression. This phenomenon of a great loss in amplitude after a great gain is characteristic of resonance. As a matter of fact, it is difficult to explain the inflation on any other basis.

The following statement by A. G. Webster in his classical treatise *The Dynamics of Particles*, second edition, 1912, p. 153, bears pertinently upon the important question as to what happens to the energy of the system during resonance:

Although in the phenomenon of resonance the excursion [amplitude] and consequently the kinetic energy becomes very large, it is of course not to be supposed that this energy comes from nothing as has been frequently contended by inventive charlatans proposing to obtain vast stores of energy from sound vibrations . . . Of these the United States has produced more than its share. The ignorance of the above-mentioned principle enabled John Keely to abstract in the neighborhood of a million dollars from intelligent (!) American shareholders.

The decrementary decline which follows a resonance phenomenon is due to the failure of the primary source of energy to maintain the great amplitudes with their consequent increase in the energy of the motion. The phenomena which we have described are seen clearly in Figure 120.

Had this explanation of the inflation of 1929 been recognized, then there would have been fewer to prophesy that the American economy had reached a new and permanent level of prosperity.

#### 10. Generalization of the Perturbation Theory

In Section 8 there was derived a theory of dynamic prices which was formulated as the system of equations

$$(1) \quad \frac{d^2 p_i}{dt^2} + \lambda p_i = U_i(t) .$$

By this formulation all prices, regarded as dynamic variables, were bound together by a common parameter,  $\lambda$ , the well-known, but somewhat intangible, quantity known as the marginal utility of money. The natural movement of prices was also assumed to be disturbed by an impressed force peculiar to the price itself.

Now these somewhat unusual deductions do not seem to be unrealistic. Prices on the whole appear to share major movements of the business cycle, although individual differences frequently occur because of the production or distribution conditions peculiar to the goods and services to which they are attached. Moreover, quite unlike production series, prices generally do not exhibit trends unless

unusual events produce monetary inflations or deflations, which affect the general price level itself.

The question naturally arises whether or not a similar theory might apply to other economic variables, expressed as deviations from trend. The suggestion follows from the observation of an apparently close connection between the cyclical behavior of many of them. But the answer to this question is not clear and must await a much more careful examination of the data than is available at the present time.

The dynamical equivalent, however, of equations (1) for any set of related variables,  $X_1, X_2, \dots, X_n$ , can be written down. Thus we assume the existence of three quadratic forms

(2)

$$\begin{aligned} k(\dot{X}_1, \dot{X}_2, \dots) &= \frac{1}{2}(A_{11} \dot{X}_1^2 + 2A_{12} \dot{X}_1 \dot{X}_2 + \dots), \text{ Kinetic energy;} \\ f(\dot{X}_1, \dot{X}_2, \dots) &= \frac{1}{2}(B_{11} \dot{X}_1^2 + 2B_{12} \dot{X}_1 \dot{X}_2 + \dots), \text{ Dissipation function;} \\ h(X_1, X_2, \dots) &= \frac{1}{2}(C_{11} X_1^2 + 2C_{12} X_1 X_2 + \dots), \text{ Potential energy.} \end{aligned}$$

In these expressions we employ the customary notation,  $\dot{X}$ , to mean differentiation with respect to time, that is,  $\dot{X} = dX/dt$ .

The quadratic form  $h$  is the potential energy of the economic system, the quadratic form  $k$  is the kinetic energy, and the quadratic form  $f$  is the dissipation function, which takes account of the nonconservative resistance to which the system is subjected.

We shall assume that these forces are connected by the following system of dynamical equations, which finds its justification in the arguments advanced in the preceding section about the relationship of the variables with real energy transforms:

$$(3) \quad \frac{d}{dt} \frac{\partial k}{\partial \dot{X}_i} + \frac{\partial h}{\partial X_i} + \frac{\partial f}{\partial \dot{X}_i} = F_i(t).$$

In this system of equations the functions  $F_i(t)$  represent impressed, or impulsive forces.

Substituting the quadratic forms in (3), we obtain the following system of equations:

(4)

$$\sum_{m=1}^n A_{im} \frac{d^2 X_m}{dt^2} + \sum_{m=1}^n B_{im} \frac{dX_m}{dt} + \sum_{m=1}^n C_{im} X_m = F_i(t), \quad i = 1, 2, 3, \dots, n.$$

In order to obtain the characteristic oscillations of the system, we make the substitution

$$X_i = \alpha_i e^{\lambda t}.$$

and suppress the impressed forces. After division by the common factor  $e^{\lambda t}$ , we obtain the following set of equations:

$$\sum_{j=1}^n \alpha_j Z_{ij}(\lambda) = 0,$$

where we abbreviate

$$Z_{ij}(\lambda) = A_{ij}\lambda^2 + B_{ij}\lambda + C_{ij}.$$

In order that these equations may be consistent it is both necessary and sufficient that the determinant of the coefficients vanish. We thus obtain the *characteristic equation*

$$D(\lambda) \equiv \begin{vmatrix} Z_{11}(\lambda) & Z_{12}(\lambda) & \cdots & Z_{1n}(\lambda) \\ Z_{21}(\lambda) & Z_{22}(\lambda) & \cdots & Z_{2n}(\lambda) \\ \cdot & \cdot & \cdot & \cdot \\ Z_{n1}(\lambda) & Z_{n2}(\lambda) & \cdots & Z_{nn}(\lambda) \end{vmatrix} = 0.$$

The roots of this equation furnish us with the *characteristic frequencies*, and hence the *characteristic periods* of the system. These periods are called free periods in dynamics since they are the normal periods of the variables when no impressed forces are present.

Unfortunately, at the present stage of economic theory, we have no way to determine a priori the coefficients of the three quadratic forms. We do not know, in fact, whether the apparent oscillations of economic series about their trend lines are due mainly to fortuitous circumstances, or whether the assumptions which have been taken from the dynamics of particles oscillating under elastic forces can actually form a basis for the interpretation of empirical facts.

In order to test the assumptions empirically, an actual computation of the quadratic forms (2) for the industrial stock price ( $X_1$ ) and pig-iron production ( $X_2$ ) was made. These quadratic forms were the following:

$$(5) \quad \begin{aligned} k &= \frac{1}{2} (0.9833 \dot{X}_1^2 - 0.1819 \dot{X}_1 \dot{X}_2 + 0.9898 \dot{X}_2^2), \\ f &= \frac{1}{2} (-0.0334 \dot{X}_1^2 + 0.0226 \dot{X}_1 \dot{X}_2 - 0.0204 \dot{X}_2^2), \\ h &= \frac{1}{2} (0.0127 X_1^2 - 0.0065 X_1 X_2 - 0.0321 X_2^2), \end{aligned}$$

From these values we immediately derive the value of  $D(\lambda)$  to be



$$D(\lambda) \equiv 0.96500753 \lambda^4 - 0.05106430 \lambda^3 \\ + 0.04408812 \lambda^2 - 0.00125664 \lambda + 0.00039678 .$$

The roots of the equation  $D(\lambda) = 0$  are found to be

$$\lambda_1 = 0.03602006 - 0.11183363 i, \quad \lambda_3 = -0.00956208 - 0.17924845 i, \\ \lambda_2 = 0.03602006 + 0.11183363 i, \quad \lambda_4 = -0.00956208 + 0.17924845 i .$$

Considering only the imaginary parts of these roots, we can now compute the two interaction periods as follows:

$$T_1 = 2\pi/0.1792 = 35.05, \quad T_2 = 2\pi/0.1118 = 56.18 .$$

What interpretation can we now give to these results? An examination of the periodograms of the two series (see Section 6 of Chapter 6) shows a concentration of energy of 41 per cent at  $T = 43$  months and of 20 per cent at  $T = 62$  for industrial stock prices and a concentration of 14 per cent at  $T = 30$  and of 31 per cent at  $T = 43$  for pig-iron production. The free periods of the system as computed above appear to lie between the observed periods of 30 and 43, and 43 and 62.

Since we know by previous analysis that the correlation between industrial stock prices and pig-iron production is essentially a result of the existence of the common harmonic term, the 40-month component, it is not surprising to find that the free periods of the dynamic system should lie on each side of this common period. Moreover, this result would indicate that any analysis of the actual interaction between the price of industrial stocks and pig-iron production must take account also of the two significant periods which are not common to the series.

One should also observe that the quadratic form  $f$  in (5) is essentially zero, which indicates again that the dissipation function for economic series may be neglected. Although the coefficients of  $h$  are of the same order of magnitude as those of  $f$ , they cannot be neglected since the variances of the series are more than 25 times the variance of the derivative series.

Probably the picture of the interaction between industrial stock prices and pig-iron production would be complete, if impressed forces with 40-month periods were introduced into the analysis. We should then visualize a system whose motion was dominated by the impressed forces with a period lying somewhere between the free periods of the variables. This result is certainly not in disagreement with the results which we obtained in Section 8, where we found that the motion of

the Dow-Jones industrial averages was explained by a force with a 40-month period impressed upon a system whose free period was of the order of 4 years.

### *11. Conclusions*

In the preceding sections we have examined a number of theories to account for the existence of cycles in economic time series. But, since the harmonic energy observed in most of the series which may be regarded as dominating economic activity is in the neighborhood of 20 per cent of the total variation, there exists a real problem to establish a priori reasons for the existence of this harmonic component. It is probable that no simple reason will be found to contain the answer.

For some of the theories mathematical models can be constructed. Thus we have found that under certain assumptions regarding demand and cost, cycles can be generated in price series if it is assumed that the economic system is dominated by the principle that profits are to be maximized. The analysis appears to show that while the extremals of the profit integral are harmonic functions, these extremals do not necessarily maximize the integral.

From another point of view the macrodynamic theory attempts to establish the existence of cycles by certain assumptions regarding the lag between primary series. This approach is highly suggestive, but still needs more statistical applications.

From the empirical side, the relationships between interest and primary series on the one hand and building activity and primary series on the other tend to show a fundamental pattern, which deserves further study. Interest rates are apparently related to the shorter movements in time series, while building activity seems to be the principal force behind the very long cycles in business.

The concept of hysteresis has been formulated in two somewhat similar systems of equations, the first derived from ordinary mechanics and the second from the biologist's "war of the species." This theory is closely related to the postulates behind the macrodynamic theory since the fundamental principle is that of a lag between the variables. There is as yet little statistical investigation of the hysteresis theory as it applies to economic phenomena.

The random-shock theory of the generation of cycles has many intriguing possibilities, but the theory is difficult to appraise since there exists as yet no satisfactory measure of the shocks which set up and maintain the motion in economic systems. In our formulation of

the dynamics of time series, we have made the assumption that their effects are imposed upon the economic system through a function which plays a role quite similar to that of kinetic energy in ordinary mechanics.

The perturbation theory of cycles is a purely dynamical theory based upon the fundamental quadratic forms of the Lagrangian problem of small oscillations. It has two principal strengths. The first of these is found in the fact that it can be related directly to the concept of marginal utility. The second is observed in the natural explanation which it offers of economic crises such as the great inflation of 1929. The theory is also amenable to statistical verification.

Many other explanations of cycles have been offered by numerous authors, but those explained above have seemed to the present writer to provide the best mathematical formulation. Without this formulation and the ultimate test by the final arbiter of all theories, the data themselves, no theory can hope to attain scientific validity.

## CHAPTER 9

### THE NATURE OF WEALTH AND INCOME

#### *1. The Nature of the Problem*

In preceding chapters we have examined time series from various points of view. All of these, however, might be characterized generically as structural. That is to say, we have attempted to show the existence of fundamental cycles and to exhibit trends which have significance in understanding the development of the modern economic status. But in the final analysis the problem of economics is the problem of the nature and distribution of wealth and income. No discussion about time series would be complete without some survey of the characteristic features of this domain of the general theory of economics. How has wealth increased? How is it related to income? How is income distributed among the individuals in society? What leads to this distribution and how does it affect the general behavior of economic time series?

The answers to these questions, if they could be completely given, would have immense significance in the construction of a general theory of economic time series. Many answers have been given but few will bear the scrutiny of a careful statistical analysis. The tenets of socialism, if a single word can cover the many interpretations which have been given to this term, are grounded in the answers to the questions which we have just proposed. There are some who believe that the difficulties of the capitalistic system, if this phrase, like socialism, can actually be defined, are found in the problems of the distribution of wealth and income.

A second closely related problem considers the flow of income and its ancillary variable, the flow of capital. This problem is essentially the problem of the equation of exchange, which will be treated in some detail in the next chapter. From it we may learn more about the general theory of trends, the causes of economic variation, the reason for industrial advance, and the relationship of the problem of wealth and income to the perplexing problem of money.

On the one hand we see that individuals in an economic state develop natural resources, create machines, raise crops, and employ available sources of energy. On the other hand we are confronted by an essentially psychological problem, the creation and use of money

which of and by itself is essentially valueless. This is certainly true in those states which have abandoned metallic standards and it is approximately true in others when the intrinsic value of the metals is compared with the intrinsic values of the remaining goods.

In this chapter, then, we shall consider the nature of wealth and income, the distribution of material goods and of the services necessary for their creation and consumption. One of the outstanding problems in all of this is the determination of a curve which will measure the actual distribution of income among the individuals of the economic state over a range which begins with those who have incomes only large enough to sustain life and which ends with those who have control of vast capital resources. The famous *law of Pareto*, which will be extensively discussed, gives a partial answer to this question about the curve of income. But it is unable to throw light on many questions, since it fails as a measure of the largest income group, namely that which clusters about the mode. Hence we see that a more complete law, which includes that of Pareto for the higher income classes, is necessary if we are to understand more completely the phenomena associated with the distribution of total income.

The problem is also of great political importance, since many social phenomena are consequences of the distribution of income. In the final section of this chapter we shall state some of the conclusions which appear to be indicated by the nature of the distribution function.

The problems considered in this chapter appear to the author to have a very deep-seated connection with the problem of economic time series in general. Thus the behavior of the financial pattern, the growth of industrial production, and the movements observed in other vital time series cannot be appreciated fully without some knowledge of the nature of wealth and income.

As will be seen from the data analyzed in this chapter, both wealth and income fluctuate from year to year. And this fluctuation is of great importance in interpreting the behavior of other economic variables. Thus, we shall observe in the next chapter, that there is an average fixed ratio between total income and total expenditure of money, and when this ratio, for any period, exceeds or falls short of the average value, then serious economic dislocations ensue.

The curve of the distribution of income is a pattern of great consequence in the interpretation of the movements of economic time series. We shall see later in this chapter how certain parameters in this curve are connected with changes in total real income, and hence,

how this pattern must be taken into account in the development of a theory of economic kinetics.

## 2. *The Nature of Wealth*

At the basis of every economic system lies the concept of wealth. Although at first thought one would assume that the wealth of a man consisted of his possessions of material goods, it is clear that this definition is too narrow for many purposes. The possession of a factory which is operating at a loss is a liability difficult to construe as wealth. On the other hand, the possession of a special ability may earn a good livelihood for the possessor, and a computation of the present value of the income which may be derived from it shows that it is convertible into material goods and hence into material wealth. Much wealth is also psychic in its character as, for example, the value that is given to paintings, jewelry, and other possessions which have little material usefulness.

We shall define wealth to be all "consumable utilities, which require labour for their production and can be appropriated and exchanged."<sup>1</sup> It is clear that this definition is sufficiently broad to include the wealth which is psychic in its character, as well as the wealth of material possession. It excludes the natural wealth which all of us possess in the free benefits of nature, since this, not being the product of labor, is scarcely to be considered part of the subject matter of economics.

Since further classification is desirable in arguments about wealth, it will be useful to consider wealth as consisting of *goods*, the word being used in a general sense, which are of two categories. Thus we have (1) goods which are material and external, and (2) goods which are personal. Material goods may also be subdivided into two classes, namely, those which are transferable, and those which are not transferable. Personal goods are of two classes also, one being external and the other internal. External goods may be either transferable or not transferable, but internal personal goods may never be transferred.

Marshall, adopting the ideas of earlier economists, has also defined goods as belonging to different orders. Thus *goods of the first order* are those which satisfy wants directly, such as food, clothing, dwellings, etc. Such goods are conveniently designated as *consumers' goods*. *Goods of the second order* are then those which contribute to the manufacture of consumers' goods. Thus farms, which produce

<sup>1</sup> See the *Encyclopaedia Britannica*, 11th edition, Vol. 28, p. 438.

food, factories, which make clothing, lumber mills, which contribute to the construction of dwellings, are goods of second order. In the field of psychic wealth we would classify the possession of a voice for singing as a good of first order. The conservatory, which trains the voice, would be classified under the category of goods of second order. It is clear that *goods of third order* would be those which contribute to the manufacture of goods of second order; *goods of fourth order*, those which contribute to the creation of goods of third order, etc. Generically it is convenient to refer to goods of second and higher orders as *production or producers' goods*.

The word *capital* has been introduced into economics to designate that part of wealth which has been reserved to increase wealth. Capital thus is almost synonymous with what we have called producers' goods, since it is only through producers' goods that wealth may be created.

It is rather difficult to estimate the actual value of wealth and consequently much more attention has been paid to the statistics of income. However, certain approximations have been made for the wealth of the United States for the years from 1912 to 1935. In the table which gives these estimates there is also shown the ratio of wealth to annual income and the ratio of annual income to wealth. The second coefficient might be called the *efficiency of wealth*, since it measures the power of wealth to produce income.<sup>2</sup>

Year	Wealth in Billions of Dollars	Ratio of Wealth to Income	Ratio of Income to Wealth	Year	Wealth in Billions of Dollars	Ratio of Wealth to Income	Ratio of Income to Wealth
1912	186.3	5.86	0.171	1924	337.9	4.85	0.206
1913	192.5	5.71	0.175	1925	362.7	4.70	0.213
1914	192.0	6.00	0.167	1926	356.5	4.54	0.220
1915	200.2	5.80	0.172	1927	346.4	4.49	0.223
1916	251.6	5.69	0.176	1928	360.1	4.47	0.224
1917	351.7	6.61	0.151	1929	361.8	4.57	0.219
1918	400.5	6.65	0.150	1930	323.1	4.48	0.223
1919	431.0	6.40	0.156	1931	275.1	4.58	0.219
1920	488.7	6.58	0.150	1932	246.4	5.30	0.189
1921	317.2	6.03	0.166	1933	252.3	5.68	0.176
1922	320.8	5.20	0.192	1934	289.2	5.74	0.174
1923	339.9	4.87	0.205	1935	308.9	5.63	0.178

In order that one may get a more precise idea as to exactly what is meant by wealth in this table, let us consider the distribution for

<sup>2</sup> The estimates of total wealth to the year 1930 are made by the National Industrial Conference Board; thereafter they are taken from Standard Statistics, who modified the estimates to take account of the change in the price level.

1922. This estimate was made by the United States Bureau of the Census, which allocated wealth to 21 separate categories as shown in the following table:

Type of Wealth	Value in Millions of Dollars	Per Cent of total	Type of Wealth	Value in Millions of Dollars	Per Cent of total
Real property taxed	155,909	48.60	Pipe lines	500	0.16
Real property exempt	20,506	6.39	Shipping canals	2,951	0.92
Livestock	5,807	1.81	Privately owned water works	361	0.11
Farm implements, etc.	2,605	0.81	Privately owned electric light and power	4,229	1.32
Gold and silver coins and bullion	4,278	1.33	Agricultural products	5,466	1.71
Manufactured machinery, tools, etc.	15,783	4.92	Manufactured products	28,423	8.86
Railroads and their equipment	19,951	6.22	Imported merchandise	1,549	0.48
Motor vehicles	4,567	1.42	Clothing, personal ornaments, furniture, etc.	39,816	12.41
Street railways	4,878	1.52	Other products	730	0.23
Telegraph systems	204	0.07			
Telephone systems	1,746	0.54			
Pullman and other private property not owned by railroads	545	0.17	Totals	320,804	100.00

There is no reason to believe that the percentages as given above have appreciably changed during the past few years.

### 3. The Nature of Income

The definition of income is not easily attained as one may see from the constant controversy that is waged over what is to be included in income-tax returns.<sup>3</sup> It will be sufficient for our purposes to define the income of an individual as that quantity of goods and services measured in terms of a money unit, which he has received during some period of time as a result of the expenditure of disutility or the employment of capital during that time. It is customary to denote the first category of income as *wages and salaries* and the second category as the *return from investment*. The total income of all its citizens is known as the *total income of the state*.

*Capital gains*, that is to say, that part of the earnings of capital which is returned to capital, are not to be regarded as income. Capital gains increase the wealth of a country, but they do not increase the income until such time as they have been used or distributed.

It will be seen readily that income may be estimated in two ways.

<sup>3</sup> A very penetrating analysis of this problem has been given by Irving Fisher in his extensive monograph, "Income in Theory and Income Taxation in Practice," *Econometrica*, Vol. 5, 1937, pp. 1-55.



The first and most obvious way would be to determine income from reports on income received by individuals. Such an estimate would be constructed from income-tax returns, from studies on the wages and salaries paid by corporations, schools, government bureaus, factories, etc., from the profits of agriculture, from fisheries, and from other similar enterprises.

But income in the last analysis can never be greater than the actual wealth produced. Hence we can also estimate income from the total value of goods and services produced in a given period of time. This estimate would be made from reports on the amount of raw materials which have been manufactured and transported, from the estimates of coal and metals which have been mined, from crop reports, from the production of the lumber industry, from the statistics of the building trades, and from similar data on other enterprises.

These estimates are naturally difficult to obtain with any degree of completeness and considerable error may be anticipated in arriving at the total income of a country from either of these methods. Comprehensive attempts, however, have been made to evaluate the income of the United States by both of these means and unusually consistent results have been attained.

The following figures on the income in the United States were obtained from estimates made by the National Industrial Conference Board,<sup>4</sup> the data for the years 1929-1935 being revisions by J. A. Slaughter in his volume, *Income Received in the Various States 1929-1935*, New York City, 1937.

Year	Income in Billions of Dollars	Population in Thousands	Per Capita Income in Dollars	Year	Income in Billions of Dollars	Population in Thousands	Per Capita Income in Dollars
1909	27.2	90,691	300	1924	69.6	112,079	615
1910	30.1	91,072	326	1925	77.1	114,867	671
1911	29.4	93,682	314	1926	78.5	116,532	674
1912	31.8	95,097	334	1927	77.2	118,197	653
1913	33.7	96,512	350	1928	80.5	119,861	671
1914	32.0	97,927	327	1929	79.1	121,526	651
1915	34.5	99,343	347	1930	72.2	122,775	588
1916	44.2	100,758	439	1931	60.1	124,070	484
1917	53.2	102,173	521	1932	46.5	124,822	373
1918	60.2	103,588	581	1933	44.4	125,693	353
1919	67.4	105,003	642	1934	50.4	126,425	399
1920	74.3	105,711	697	1935	54.9	127,172	432
1921	52.6	107,833	486	1936	62.4	128,429	486
1922	61.7	109,248	562	1937	67.8	129,257	525
1923	69.8	110,664	626	1938	64.2	130,215	493

<sup>4</sup> Except for the years 1936, 1937, and 1938, which are from the U. S. Department of Commerce.

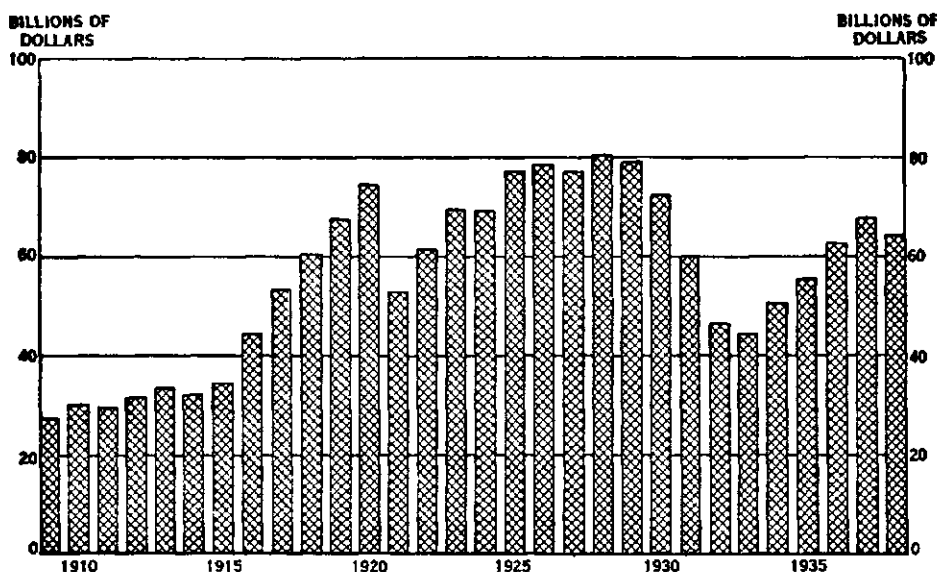

FIGURE 121.—INCOME IN THE UNITED STATES, 1909-1938.

But data on total income, however interesting they may be as indicators of the prosperity of a nation and of its relative economic importance, must be exhibited in terms of their partial origins in order to show the nature of income and the part which it plays in the well-being of groups in different social orders. The following table shows the distribution of the total income for the years 1929-1935 according to income types:

INCOME DISTRIBUTED ACCORDING TO TYPE\*  
Unit: Millions of Dollars

Type of Income	1929	1930	1931	1932	1933	1934	1935
Salaries and wages	50,611	46,201	38,643	29,752	27,858	31,225	34,223
Entrepreneurial income	13,118	11,277	8,955	6,712	7,018	8,127	9,247
Dividends	5,763	5,631	4,179	2,626	2,102	2,338	2,648
Interest	3,994	4,156	4,024	3,756	3,361	3,154	2,945
Net rents and royalties	1,188	884	618	448	473	589	693
Other accountable income	4,561	4,163	3,736	3,232	3,608	5,063	5,284
Net adjustment for international balance of payments of dividends and interest	-133	-127	-37	-20	-31	-69	-96
Total accountable income	79,101	72,186	60,117	46,506	44,389	50,426	54,944

\* This table is adapted from Slaughter, *op. cit.*, p. 5. The item "Other accountable income" includes pensions, compensation for injuries, interest on mortgages on owned homes, net rent of rented homes, relief payments, and governmental rental and benefit payments to farmers.



INCOME DISTRIBUTED ACCORDING TO PRODUCTION  
Percentage of origin to total income

Industrial Origin	1929	1930	1931	1932	1933	1934	1935
Agriculture	11.02	9.37	7.45	6.54	8.50	9.21	10.01
Mining and quarrying	2.59	2.36	1.98	1.74	1.80	2.03	1.95
Electric light, power, etc.	1.64	2.04	2.33	2.73	2.45	2.04	1.82
Manufacturing	22.83	22.11	20.59	18.34	18.99	20.21	21.34
Construction	4.08	4.03	3.24	2.00	1.72	1.72	1.87
Transportation	8.25	8.38	8.56	8.65	8.41	7.96	7.74
Communications	1.17	1.34	1.50	1.69	1.60	1.46	1.36
Trade	14.47	14.93	15.52	15.36	14.00	13.65	13.31
Finance	3.97	4.02	4.38	4.39	3.34	2.68	2.40
Service	10.59	10.92	11.46	11.63	11.30	10.70	10.76
Government	7.83	8.85	10.71	13.68	13.66	12.60	12.28
Miscellaneous	5.96	6.06	6.13	6.34	6.17	5.84	5.71
Other income less net adjustments	5.60	5.59	6.15	6.91	8.06	9.90	9.44
Totals	100.00	100.00	100.00	100.00	100.00	100.00	100.00

#### 4. The Distribution of Incomes—Pareto's Law

The first extensive discussion from the statistical point of view of the problem of how income is distributed among the citizens of a state was made by Vilfredo Pareto (1848–1923), disciple of Léon Walras (1834–1910), and his successor in the chair of Political Economy at the University of Lausanne. The first chapter of the second book of Pareto's *Cours d'économie politique*, published in 1897, is devoted to this problem.<sup>5</sup> By ingenious reasoning and on the basis of data collected from numerous sources, Pareto arrived at a formulation of his famous law of the distribution of incomes. This law we have cast somewhat precisely in the following statement:

*In all places and at all times the distribution of income in a stable economy, when the origin of measurement is at a sufficiently high income level, will be given approximately by the empirical formula*

$$(1) \quad y = a x^{-v},$$

where  $y$  is the number of people having the income  $x$  or greater, and  $v$  is approximately 1.5.<sup>6</sup>

Pareto was well aware of the importance of this discovery as is proved by the following comment about it:

<sup>5</sup> Volume 2, pp. 299–345.

<sup>6</sup> The phrase "in a stable economy" has been interpolated by the present writer and should not be ascribed to Pareto. By a stable economy is meant one that is not verging upon revolution or civil war, as measured by political disturbances, civil riots, and the like. The consequences of this interpolation will be developed in Section 15 of this chapter.

These results are very remarkable. It is absolutely impossible to admit that they are due only to chance. There is most certainly a *cause*, which produces the tendency of incomes to arrange themselves according to a certain curve. The form of this curve seems to depend only tenuously upon different economic conditions of the countries considered, since the effects are very nearly the same for the countries whose economic conditions are as different as those of England, of Ireland, of Germany, of the Italian cities, and even of Peru.<sup>7</sup>

The law of Pareto, because of its rigid and uncompromising form and because also of the great generality of its statement, has been vigorously attacked. It obviously strikes at the most fundamental tenets of socialism and must be reckoned with in all propositions which underlie attempts to formulate a regimented social order. The law has been subjected to careful scrutiny by a number of scientific investigators, and considerable objection has been raised to it in its rigid form. No one, however, has yet exhibited a stable social order, ancient or modern, which has not followed the Pareto pattern at least approximately.

The problem of the distribution of incomes may be formulated in three questions as follows:

*First.* What is the frequency function for the total distribution of incomes from the poorest member of society to the wealthiest?

*Second.* Does this distribution appear to be an inevitable one, or may its form be governed by the type of society from which the income is derived?

*Third.* Can any a priori reason be given for the form of the frequency function?

In order to formulate our ideas with precision, let us assume that a population of  $N$  individuals is to be distributed with respect to their possession of a quantity of a variable  $x$ , and let the distribution function be designated by  $\phi(x)$ . Furthermore, we shall let the lowest measure of the range of  $x$  be  $A$  and the highest  $B$ .

If we define  $\phi(x)$  to be the total number of individuals who possess the measure between  $x$  and  $x + dx$ , then the number of those who have the measure  $x$  or lower is given by the integral

$$Y(X) = \int_A^X \phi(x) dx.$$

Obviously we have  $Y(B) = N$ ; moreover,  $N - Y(X)$  is the accumulated frequency of the population. That is to say, this function gives the number of individuals who have the measure  $X$  or greater. If we designate this accumulated frequency by  $y(X)$ , we shall have

<sup>7</sup> *Cours*, Vol. 2, p. 312.

INCOME DISTRIBUTED ACCORDING TO PRODUCTION  
Percentage of origin to total income

Industrial Origin	1929	1930	1931	1932	1933	1934	1935
Agriculture	11.02	9.37	7.45	6.54	8.50	9.21	10.01
Mining and quarrying	2.59	2.36	1.98	1.74	1.80	2.03	1.95
Electric light, power, etc.	1.64	2.04	2.33	2.73	2.45	2.04	1.82
Manufacturing	22.83	22.11	20.59	18.34	18.99	20.21	21.34
Construction	4.08	4.03	3.24	2.00	1.72	1.72	1.87
Transportation	8.25	8.38	8.56	8.65	8.41	7.96	7.74
Communications	1.17	1.34	1.50	1.69	1.60	1.46	1.36
Trade	14.47	14.93	15.52	15.36	14.00	13.65	13.31
Finance	3.97	4.02	4.38	4.39	3.34	2.68	2.40
Service	10.59	10.92	11.46	11.63	11.30	10.70	10.76
Government	7.83	8.85	10.71	13.68	13.66	12.60	12.28
Miscellaneous	5.96	6.06	6.13	6.34	6.17	5.84	5.71
Other income less net adjustments	5.60	5.59	6.15	6.91	8.06	9.90	9.44
Totals	100.00	100.00	100.00	100.00	100.00	100.00	100.00

#### 4. The Distribution of Incomes—Pareto's Law

The first extensive discussion from the statistical point of view of the problem of how income is distributed among the citizens of a state was made by Vilfredo Pareto (1848–1923), disciple of Léon Walras (1834–1910), and his successor in the chair of Political Economy at the University of Lausanne. The first chapter of the second book of Pareto's *Cours d'économie politique*, published in 1897, is devoted to this problem.<sup>5</sup> By ingenious reasoning and on the basis of data collected from numerous sources, Pareto arrived at a formulation of his famous law of the distribution of incomes. This law we have cast somewhat precisely in the following statement:

*In all places and at all times the distribution of income in a stable economy, when the origin of measurement is at a sufficiently high income level, will be given approximately by the empirical formula*

$$(1) \quad y = a x^{-v},$$

where  $y$  is the number of people having the income  $x$  or greater, and  $v$  is approximately 1.5.<sup>6</sup>

Pareto was well aware of the importance of this discovery as is proved by the following comment about it:

<sup>5</sup> Volume 2, pp. 299–345.

<sup>6</sup> The phrase "in a stable economy" has been interpolated by the present writer and should not be ascribed to Pareto. By a stable economy is meant one that is not verging upon revolution or civil war, as measured by political disturbances, civil riots, and the like. The consequences of this interpolation will be developed in Section 15 of this chapter.

These results are very remarkable. It is absolutely impossible to admit that they are due only to chance. There is most certainly a *cause*, which produces the tendency of incomes to arrange themselves according to a certain curve. The form of this curve seems to depend only tenuously upon different economic conditions of the countries considered, since the effects are very nearly the same for the countries whose economic conditions are as different as those of England, of Ireland, of Germany, of the Italian cities, and even of Peru.<sup>7</sup>

The law of Pareto, because of its rigid and uncompromising form and because also of the great generality of its statement, has been vigorously attacked. It obviously strikes at the most fundamental tenets of socialism and must be reckoned with in all propositions which underlie attempts to formulate a regimented social order. The law has been subjected to careful scrutiny by a number of scientific investigators, and considerable objection has been raised to it in its rigid form. No one, however, has yet exhibited a stable social order, ancient or modern, which has not followed the Pareto pattern at least approximately.

The problem of the distribution of incomes may be formulated in three questions as follows:

*First.* What is the frequency function for the total distribution of incomes from the poorest member of society to the wealthiest?

*Second.* Does this distribution appear to be an inevitable one, or may its form be governed by the type of society from which the income is derived?

*Third.* Can any a priori reason be given for the form of the frequency function?

In order to formulate our ideas with precision, let us assume that a population of  $N$  individuals is to be distributed with respect to their possession of a quantity of a variable  $x$ , and let the distribution function be designated by  $\phi(x)$ . Furthermore, we shall let the lowest measure of the range of  $x$  be  $A$  and the highest  $B$ .

If we define  $\phi(x)$  to be the total number of individuals who possess the measure between  $x$  and  $x + dx$ , then the number of those who have the measure  $x$  or lower is given by the integral

$$Y(X) = \int_A^X \phi(x) dx.$$

Obviously we have  $Y(B) = N$ ; moreover,  $N - Y(X)$  is the accumulated frequency of the population. That is to say, this function gives the number of individuals who have the measure  $X$  or greater. If we designate this accumulated frequency by  $y(X)$ , we shall have

<sup>7</sup> *Cours*, Vol. 2, p. 312.

$$y(X) = N - Y(X) = \int_X^B \phi(x) dx.$$

It is this function which Pareto assumed has the form  $y = aX^{-\nu}$ ,  $\nu = 1.5$ , provided  $X$  is sufficiently large. Under this assumption we should then obtain

$$\phi(X) = -dy/dX = a\nu X^{-\nu-1}.$$

Taking logarithms of both  $y(X)$  and  $\phi(X)$ , we have

$$(2) \quad \log y = \log a - \nu \log X,$$

$$(3) \quad \log \phi = \log(a\nu) - (\nu + 1) \log X.$$

Hence, if the functions are graphically represented on double logarithmic paper, or what is the same thing, if their logarithms are graphed against the logarithms of  $X$ , then the graphs will be straight lines and the ratios of the respective slopes will be  $\nu/(\nu + 1)$ .

Since the actual data for incomes is given in terms of classes of unequal size, as for example, the number of people having incomes between \$1,000 and \$1,100 and the number of people having incomes between \$1,000,000 and \$1,500,000, it is statistically much easier to determine the parameters in equation (2) than in equation (3).

Since  $\phi(X)$  would be a small number if increments on the  $X$  range are dollars, it is more convenient to express  $\phi(X)$  in terms of a broader income class, as for example, the number of people having incomes between  $X$  and  $X + m$ , where  $m = \$100$ . If  $X$  is sufficiently large so that the Pareto law is effective as a description of the income distribution, then the following method may be used to determine the frequency distribution from the accumulated distribution.

Let us assume that the number of people having incomes in the range from  $X$  to  $X + d$  is  $\Delta$ . Thus, we might have  $X = \$100,000$ ,  $d = \$50,000$ ,  $\Delta = 3494$ .

Let us assume further that the accumulated frequency is given at the point  $X$  by the Pareto formula

$$y(X) = aX^{-\nu}.$$

We should then have

$$y(X) - y(X + d) = a[X^{-\nu} - (X + d)^{-\nu}] = \Delta,$$

from which we obtain

$$a = \Delta/[X^{-\nu} - (X + d)^{-\nu}].$$

Obviously the number of people in the income class,  $X$  to  $X + m$ , would then be

$$y(X) - y(X + m) = a[X^{-\nu} - (X + m)^{-\nu}] = \frac{\Delta[X^{-\nu} - (X + m)^{-\nu}]}{[X^{-\nu} - (X + d)^{-\nu}]}.$$

Thus, using the figures just given, and assuming that  $m = 100$ ,  $\nu = 1.69$ ,



we obtain as the number who have incomes between \$100,000 and \$100,100 the following:

$$\phi(X') = \frac{3494 [(100,000)^{-1.69} - (100,100)^{-1.69}]}{[(100,000)^{-1.69} - (150,000)^{-1.69}]}$$

$$= 11.90.$$

In a table of income frequencies this number would correspond to the income  $X' = \$100,050$ . That is to say, approximately 12 people in the distribution considered would have incomes between \$100,000 and \$100,100.

### 5. Income Data

For the purposes of statistical description we shall use the following data, which show the distribution of income among personal-income recipients in the United States in 1918. These estimates are taken from an elaborate study made by the National Bureau of Economic Research, which will long remain one of the most comprehensive sources of information on this important subject.<sup>8</sup>

The following table, which excludes the income of 2,500,000 soldiers, sailors, and marines, gives a carefully determined estimate of the income of 37,569,060 persons, somewhat more than one-third of the total population, from the class of negative incomes,<sup>9</sup> to the class having incomes in excess of \$4,000,000.

<sup>8</sup> *Income in the United States, Its Amount and Distribution, 1909-1919*. National Bureau of Economic Research, Vol. I, New York, 1921, 152 pp.; Vol. II, 1922, 440 pp. For the data, see Vol. I, pp. 132-133.

<sup>9</sup> The distribution given in the table was estimated somewhat differently for those who had incomes above and below \$2000. The determination of the numbers in the lower class was naturally a more difficult problem to solve than that pertaining to the upper class where income-tax returns were available. Moreover, the definition of income received is also difficult to state precisely for the class below the median. Thus one may assume that the poorest person in an economy is the vagabond, who exists by pilferage and begging. His income is the lowest possible for existence and no one should be regarded as having a lower economic status measured in terms of income than such a man. This was Pareto's point of view, but the fact that negative incomes are included in the table shows that the estimators assumed otherwise. Thus it is said (see p. 347, Vol. 2): "Children receive in general negligible money incomes. Many other persons in the community are in the same position. A business man may 'lose money' in a given year, in other words he may have a negative money income. There seems no essential absurdity in assuming that a large number of persons receive money incomes less than necessary to support existence. When in 1915 Australia took a census of the incomes of all persons 'possessed of property, or in receipt of income,' over 14 per cent of the returns showed incomes 'deficit and nil.'"

Obviously the matter depends primarily upon the definition employed for income as it refers to the lowest income class. In this study it will be convenient to hold to Pareto's view and we shall assume that the lowest admissible income is that of subsistence. For a business man, who has a net loss, we can assume that he still has a positive real income, which, even in bad years, is far above the subsistence level. This income is derived either from a transfer of savings into the income stream, or from the use of borrowed funds. Thus no one in the economy will be represented as having had an income less than that of the vagabond. Obviously our graduation of the data, on this assumption, will diverge sharply from that reported in the frequency range below the mode.

Income Class		Number of Persons	Total Income
Under Zero		200,000	\$ -125,000,000
\$0-	\$100	62,809	3,368,863
100-	200	103,704	16,047,939
200-	300	209,087	53,701,566
300-	400	489,963	173,747,705
400-	500	961,991	437,421,733
500-	600	1,549,974	857,666,411
600-	700	2,154,474	1,405,213,223
700-	800	2,668,466	2,005,009,301
800-	900	3,013,034	2,563,100,947
900-	1,000	3,144,722	2,987,688,735
1,000-	1,100	3,074,351	3,226,729,363
1,100-	1,200	2,850,526	3,275,784,572
1,200-	1,300	2,535,285	3,166,235,800
1,300-	1,400	2,205,728	2,973,220,322
1,400-	1,500	1,832,230	2,653,820,477
1,500-	1,600	1,512,649	2,342,101,155
1,600-	1,700	1,234,397	2,034,621,765
1,700-	1,800	999,996	1,748,225,207
1,800-	1,900	811,236	1,499,396,953
1,900-	2,000	663,789	1,293,303,255
2,000-	2,100	549,787	1,126,240,869
2,100-	2,200	463,222	995,402,469
2,200-	2,300	395,115	888,501,304
2,300-	2,400	340,141	798,920,154
2,400-	2,500	295,490	723,614,676
2,500-	2,600	258,650	659,277,149
2,600-	2,700	227,731	603,250,834
2,700-	2,800	201,488	553,889,766
2,800-	2,900	178,901	509,693,726
2,900-	3,000	154,499	455,622,047
3,000-	3,100	142,802	435,416,064
3,100-	3,200	128,217	403,770,475
3,200-	3,300	115,583	375,547,256
3,300-	3,400	104,504	350,001,254
3,400-	3,500	94,803	326,995,740
3,500-	3,600	86,405	306,672,255
3,600-	3,700	79,023	288,376,342
3,700-	3,800	72,562	272,057,360
3,800-	3,900	66,900	257,520,712
3,900-	4,000	61,894	244,442,121
4,000-	5,000	430,474	1,913,291,198
5,000-	6,000	234,721	1,280,426,762
6,000-	7,000	143,330	926,352,841
7,000-	8,000	94,927	708,947,016
8,000-	9,000	66,511	563,480,394
9,000-	10,000	48,335	457,976,300
10,000-	11,000	36,432	381,732,274
11,000-	12,000	28,306	324,954,833
12,000-	13,000	22,473	280,498,570
13,000-	14,000	18,174	245,042,041
14,000-	15,000	14,951	216,555,666

Income Class	Number of Persons	Total Income
\$15,000- 20,000	46,869	\$805,775,269
20,000- 25,000	24,857	553,731,410
25,000- 30,000	15,205	415,329,030
30,000- 40,000	17,063	589,416,333
40,000- 50,000	8,851	394,040,324
50,000- 60,000	5,220	285,043,633
60,000- 70,000	3,389	219,188,048
70,000- 80,000	2,361	176,418,311
80,000- 90,000	1,730	146,629,939
90,000- 100,000	1,311	124,249,646
100,000- 150,000	3,494	421,980,443
150,000- 200,000	1,451	249,585,378
200,000- 250,000	771	171,676,103
250,000- 300,000	460	125,604,380
300,000- 400,000	497	170,757,868
400,000- 500,000	248	101,980,849
500,000- 750,000	265	139,293,673
750,000-1,000,000	104	80,826,726
1,000,000-1,500,000	79	94,956,294
1,500,000-2,000,000	30	51,697,546
2,000,000-3,000,000	24	57,818,419
3,000,000-4,000,000	9	30,846,960
4,000,000 and over	10	81,000,000
Totals	37,569,060	\$57,954,722,341

From these data one computes that the average income is \$1543 and that the modal income is \$957. The extraordinary spread of incomes is readily seen from the fact that if these data were graphed on an arithmetic scale with one-eighth of an inch equal to \$1000, a chart 42 feet in length would be required for their representation.

The almost fantastic spread of the income from the average is revealed in a computation of the second, third, and fourth moments about the mean, the unit being \$1,000. These values are as follows:

$$\mu_2 = 32.1367, \quad \mu_3 = 40165.4694, \quad \mu_4 = 77,281,288.7.$$

From these moments we compute the standard error, the skewness, and the kurtosis of the distribution to be respectively

$$\sigma = 5.6689, \quad S = \mu_3 / (2\sigma^3) = 11.0235, \quad E = \beta_2 - 3 = 74,826,$$

where we use the customary notation  $\beta_2 = \mu_4 / \sigma^4$ .

These values show how hopeless is the task of attempting to graduate the data by any of the curves of Pearson type. This comment is quite significant, since the problem invoked by the distribution of incomes is thus shown to be essentially different from that of the usual frequency distributions which arise in biology for which the Pearson types were primarily designed. The extraordinary difference between

biometric frequencies and income frequencies is found in the general observation that in the former, even in cases of extreme skewness, it is unusual to find any member of the distribution more than  $4\sigma$  from the mean. In the case of income data, extreme individuals are found more than  $700\sigma$  from the mean.

This difference can be illustrated by considering the distribution of height, which is governed by glandular secretions, whose variation in individuals follows the normal curve. Thus the data on the measurement of nearly a million men, as reported by the medical division of the United States army during the World War, show that the average height is 67.49 inches, and that the standard error is 4.03 inches. From this we see that the probability of a man attaining a height of  $67.49 + 4\sigma = 83.61$  inches is very small, approximately 6 in 100,000. But if the hormones of growth were distributed according to the law of incomes, essentially the same probability would lead one to expect giants as tall as  $67.49 + 2827.00 = 2894$  inches = 241 feet.

### 6. The Pareto Distribution

We shall refer to that part of the distribution of income frequencies which lies sufficiently far beyond the mode to be graduated by the curve

$$(1) \quad y = aX^{-\nu},$$

as the Pareto distribution.

Taking logarithms of both sides of (1) we obtain

$$(2) \quad \log y = \log a - \nu \log X;$$

from which it is observed that if the logarithms of the frequencies are plotted against the logarithms of the incomes, or what is the same thing, if the data are graphed on double-logarithmic paper, the Pareto distribution will appear as a straight line with negative slope.

In order to exhibit the technique of fitting (1) to the income data given in the preceding section, we first consider the abbreviated table at the top of page 401.

From these data the second table on page 401, showing cumulative frequencies, is formed, the two highest classes being omitted.

Employing the method of least squares, we form from the above totals the following normal equations for the determination of  $\log a$  and  $\nu$ :

Income Class	Class Mark	Number of Persons	Total Income
Under zero'	. . . .	200,000	\$ —125,000,000
\$0— \$500	250	1,827,554	685,287,806
500— 1,000	750	12,530,670	9,818,678,617
1,000— 1,500	1,250	12,498,120	15,295,790,534
1,500— 2,000	1,750	6,222,067	8,917,648,335
2,000— 3,000	2,500	3,065,024	7,314,412,994
3,000— 5,000	4,000	1,383,167	5,174,090,777
5,000— 10,000	7,500	587,824	3,937,183,313
10,000— 25,000	17,500	192,062	2,808,290,063
25,000— 50,000	37,500	41,119	1,398,785,687
50,000— 100,000	75,000	14,011	951,529,576
100,000— 200,000	150,000	4,945	671,565,821
200,000— 500,000	250,000	1,976	570,019,200
500,000—1,000,000	750,000	369	220,120,399
1,000,000 and over	. . . . .	152	316,319,219
<b>Totals</b>		<b>37,569,060</b>	<b>\$57,954,722,341</b>

Income in Dollars (x)	Cumulative Frequency, y (unit 1,000)	log x	log y	(log x) · (log y)	(log x) <sup>2</sup>
500	35,541	2.69897	4.55073	12.28228	7.28444
1,000	23,010	3.00000	4.36192	13.08576	9.00000
1,500	10,512	3.17609	4.02169	12.77325	10.08755
2,000	5,290	3.30103	3.72346	12.29125	10.89680
3,000	2,225	3.47712	3.34733	11.63907	12.09036
5,000	842	3.69897	2.92531	10.82063	13.68238
10,000	254	4.00000	2.40483	9.61932	16.00000
25,000	62	4.39794	1.79239	7.88282	19.34188
50,000	21	4.69897	1.52222	6.21307	22.08032
100,000	7	5.00000	0.84510	4.22550	25.00000
200,000	2	5.30103	0.30103	1.59577	28.10092
<b>Totals</b>		<b>42.75012</b>	<b>29.59601</b>	<b>102.42872</b>	<b>173.56465</b>

$$11 \log a - 42.75012 \nu = 29.59601,$$

$$42.75012 \log a - 173.56464 \nu = 102.42873.$$

From these equations we compute

$$\log a = 9.28462, \quad \nu = 1.69672;$$

and the desired curve, in logarithmic form, is thus found to be

$$\log y = 9.28462 - 1.69672 \log X.$$

The following table of values has been computed to exhibit the closeness with which the cumulative frequency is represented by the curve. Both the computed and the observed values are graphically represented on double logarithmic paper in Figure 122.

Income $X$	$\nu$ observed	$\nu$ computed
\$500	35,541	50,722
1,000	23,010	15,648
1,500	10,512	7,864
2,000	5,290	4,827
3,000	2,225	2,426
5,000	842	1,020
10,000	254	315
25,000	62	66
50,000	21	21
100,000	7	6
200,000	2	2

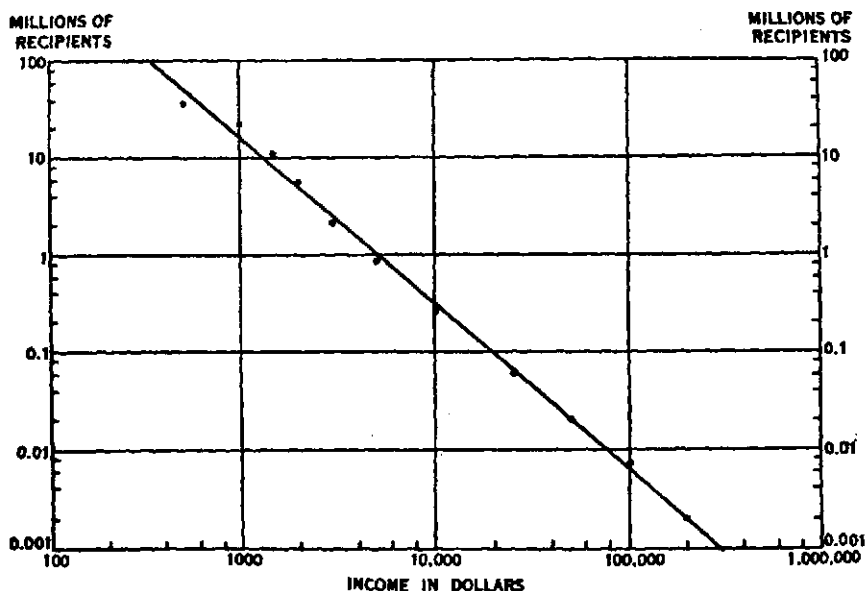

FIGURE 122.—CUMULATIVE FREQUENCY DISTRIBUTION OF INCOMES IN UNITED STATES, 1918, ON DOUBLE LOGARITHMIC GRID.

### 7. The Statistical Verification of Pareto's Distribution

In view of the great economic importance of the Pareto distribution and of its social significance, it will be worth while to consider how far it may be regarded as having been verified by statistical use.

Since Pareto's formulation assumes a statistical constancy for  $\nu$ , it is interesting to examine the data from which he derived his law. We now have much better statistics about the distribution of income in modern societies than were available to Pareto, but his data with respect to older states have never been surpassed. The following table summarizes his computations, which, it will be observed, extend

in time from 1471 to 1894 and in geographical distribution from Peru at the end of the eighteenth century to the highly developed commonwealths of Europe.

Country	$\nu$	Country	$\nu$	Country	$\nu$
England (1843)	1.50	Saxony (1880)	1.58	Basel	1.24
(1879-80)	1.35	(1886)	1.51	Paris (rents)	1.57
(1893-94)	1.50	Florence	1.41	Augsburg (1471)	1.43
Prussia (1852)	1.89	Perugia (city)	1.69	(1498)	1.47
(1876)	1.72	Perugia (country)	1.37	(1512)	1.26
(1881)	1.73	Ancona, Arezzo, Parma, Pisa	1.32	(1526)	1.18
(1886)	1.68	Italian cities	1.45	Peru (at the end of the 18th century)	1.79
(1890)	1.60				
(1894)	1.60				

The following table exhibits the stability of the coefficient  $\nu$  for data on incomes in the United States over the period from 1914 to 1919:<sup>10</sup>

Year	1914	1915	1916	1917	1918	1919	$\nu = 0.12$
$\nu$	1.56	1.42	1.42	1.54	1.69	1.73	Average = 1.56

These figures may be supplemented by a computation on the income data for 1929, where the value of  $\nu$  was found to equal 1.48. There is no reason to believe that a significant change has occurred in this parameter during the depression or afterwards, although there has been a tendency for it to increase as the tax burden has grown since 1933.

N. O. Johnson, in an elaborate investigation of the Pareto law, plotted income-tax data on double-logarithmic paper for the years from 1914 to 1933. The value of the slopes of the lines as shown in Figure 123 are given in the following table:<sup>11</sup>

Year	$\nu$	Year	$\nu$	Year	$\nu$	Year	$\nu$
1914	1.54	1919	1.71	1924	1.67	1929	1.42
1915	1.40	1920	1.82	1925	1.54	1930	1.62
1916	1.34	1921	1.90	1926	1.55	1931	1.71
1917	1.49	1922	1.71	1927	1.52	1932	1.76
1918	1.65	1923	1.78	1928	1.42	1933	1.70

It is evident from these data and also from the accompanying graph that the variation of  $\nu$  from Pareto's estimate of 1.5 was slight

<sup>10</sup> From F. R. Macaulay's study on *Incomes in the United States—Its Amount and Distribution*, Vol. 2, New York, 1922, Publication No. 2 of the National Bureau of Economic Research, Inc.

<sup>11</sup> Taken from N. O. Johnson, "The Pareto Law," *The Review of Economic Statistics*, Vol. 19, 1937, pp. 20-26.

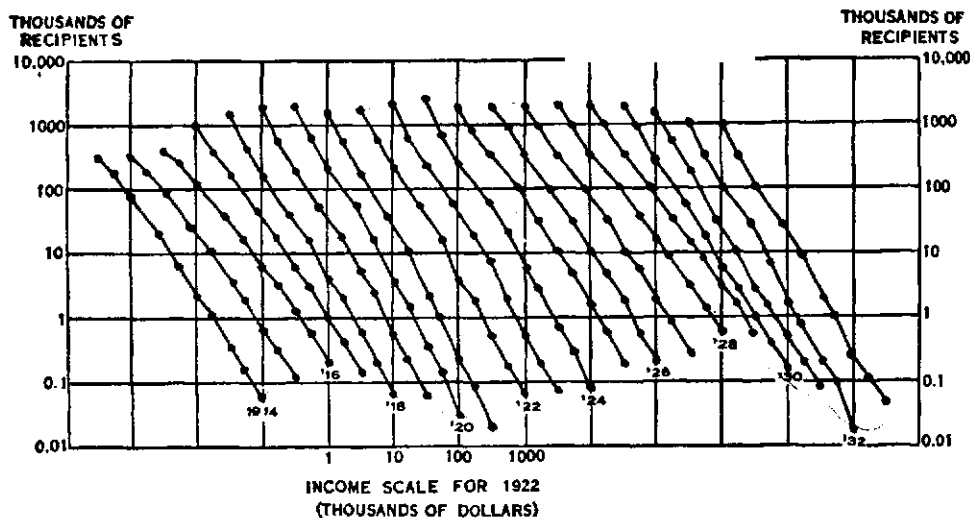

FIGURE 123.—COMPARISON OF INCOME DISTRIBUTIONS IN THE UNITED STATES, 1914-1933.

Cumulated frequencies, both scales logarithmic. The vertical lines are one cycle apart, as are the horizontal ones, the scale shifting one-half cycle to the right for each successive year. The point nearest the date in each case measures the number of incomes in excess of \$1,000,000 in that year.

and within statistical error. One also notes that there was a tendency for the distribution of incomes to become more concentrated in times of prosperity and less concentrated in times of depression. The data include only about 2,000,000 income recipients per year, perhaps one-twentieth of the total, but their combined income was perhaps a quarter of the total amount.

The evidence from these varied sources seems to make the conclusion inescapable that the distribution of incomes in stable societies conforms closely to the Pareto pattern. The reader should be warned, however, that this conclusion is not universally concurred in by economists. For arguments bearing upon the weakness of the law of Pareto the reader is referred to the discussions by Pigou, Dalton, Macaulay, and Shirras as cited in the Bibliography at the end of this chapter.

### 8. Formulas for the General Distribution Function

A number of attempts have been made to state formulas which would represent not merely the tail of the distribution of incomes, but which would also graduate the distribution down to a threshold value. This value, which we shall designate by  $c$ , is very small when



compared with the total range and may be introduced into the formula for the Pareto distribution without essentially affecting the graduation.

The problem, then, is to determine the function  $\phi(x)$  of Section 4, which has the following properties:

(A)  $\phi(c) = 0$ , where  $c$  is a positive value, which may be assumed to represent the income on which one could maintain and tolerate life. In the data of Section 5, we find negative incomes recorded, but there is certainly considerable argument as to what such incomes really mean. This point has been extensively discussed in footnote 9 to Section 5. In this study we shall disregard negative incomes and all incomes below a threshold value which will be determined later. This minimum value we shall call the *wolf point*, since it is the real income necessary for existence. Below this point the wolf, which lurks so close to the doors of those in the neighborhood of the modal income, actually enters the house.

(B) There exists a modal income,  $x_0$ , small in comparison with the range, such that  $\phi(x_0)$  is a maximum.

(C) For large values of  $x$ , the distribution function is approximately represented by Pareto's formula; that is to say,

$$\phi(x) \sim A(x - c)^{-\mu},$$

where  $\mu$  is approximately 2.5, since  $\mu = \nu + 1$ , and where the symbol  $\sim$  means "is asymptotic to."

(D) The integral  $\phi(x)$  over the total range of income ( $A, B$ ) is equal to the total income population,  $N$ ; that is,

$$(1) \quad \int_A^B \phi(x) dx = N.$$

Pareto, himself, made some study of this more general problem and suggested for the frequency accumulation the function

$$(2) \quad y = A e^{-\beta x} (x - c)^{-\nu}.$$

The derivative of this function, namely,  $\phi(x)$ , does not meet all the requirements of the problem, however, and it must be rejected. Pareto, moreover, found only one case where  $\beta$  had a significant value.

L. Amoroso, in an extensive paper published in the *Annali di Matematica* in 1925, suggested the formula

$$(3) \quad y = A e^{-\gamma(x-a)^{1/\alpha}} (x - h)^{(p-1)/\alpha}$$

as a possible graduation function. He illustrated its application to

Italian income data, but offered no reason why this function should represent the distribution of incomes. Moreover, it apparently does not furnish a close graduation of American income data.

D. G. Champernowne has suggested the function

$$(4) \quad y = \frac{A}{B \cosh(x-C) - D},$$

where  $x$  is what he calls "income power," namely, the logarithm of money income. The parameter  $A$  is adjusted to give the correct number of incomes;  $B$  gives the slope of the Pareto tail,  $C$  is the average income power, and  $D$  is adjusted to give the correct kurtosis of the distribution. No reason is given for the choice of this function except that it gives a good fit.<sup>12</sup>

One of the most extensive studies on this problem has been made by R. Gibrat in a volume entitled *Les inégalités économiques*, published in 1931. Gibrat's formula for representing the accumulated frequencies is

$$(5) \quad y = \frac{N}{\sqrt{2\pi}} e^{-z^2},$$

$$z = a \log(x-k) + b.$$

The genesis of Gibrat's formula, which he calls the *law of proportional effect*, may be obtained from the following observation. We first note that by means of a transformation of the scale variable  $x$ , we can throw any distribution into normal form. Thus we need merely assume that

$$(6) \quad y = \int_A^x \phi(x) dx = \int_{-\infty}^z \phi_0(t) dt,$$

where we write

$$\phi_0(t) = \frac{N}{\sqrt{2\pi}\sigma} e^{-1/2(t-t_0)^2/\sigma^2}.$$

Theoretically equation (6) can be inverted so that  $T$  appears explicitly as a function of  $X$ . Numerically the inversion can be accomplished by means of a table of the probability integral.

It should be observed that  $\phi_0(t)$  can be replaced by its simpler form

$$\frac{N}{\sqrt{2\pi}} e^{-t^2},$$

<sup>12</sup> See *Econometrica*, Vol. 5, 1937, pp. 379-380.

without loss of generality, since  $T$  is then merely replaced by its linear transform:  $(T - t_0)/\sigma$ .

We now employ the table of Section 6 to compute the first integral in equation (6). We may assume that  $A = -1,000$ , which will, of course, correspond to  $T = -\infty$ . Then from the equation

$$y = \int_{-1000}^X \phi(x) dx = \frac{N}{\sqrt{2\pi}} \int_{-\infty}^T e^{-t^2} dt = N \Phi(T),$$

and by means of a table of the function  $\Phi(T)$ ,<sup>12</sup> the relationship between the  $X$ -range and the  $T$ -range is readily computed. These values are given in the following table:~

Value of $X$	Value of $T$	$\Phi(T)$	Value of $X$	Value of $T$	$\Phi(T)$
-\$1,000	$-\infty$	0.000000	10,000	2.47	0.993223
0	-2.56	0.005324	25,000	2.94	0.998335
500	-1.61	0.053969	50,000	3.23	0.999429
1,000	-0.29	0.387506	100,000	3.54	0.999802
1,500	0.59	0.720177	200,000	3.82	0.999934
2,000	1.08	0.859176	500,000	4.18	0.999987
3,000	1.56	0.940760	1,000,000	...	0.999997
5,000	2.01	0.977577			

The relationship of the two scales is graphically represented in the accompanying figure. It is evident to the eye that this relationship between  $X$  and  $T$  is approximately logarithmic, and hence considerable empirical validity is given to Gibrat's graduation formula.

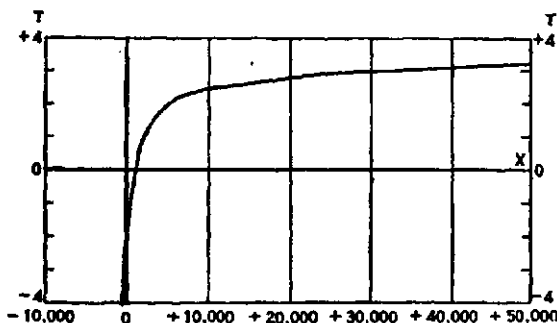

FIGURE 124.—RELATION OF SCALES OF PARETO DISTRIBUTION AND EQUIVALENT NORMAL DISTRIBUTION UNDER LOGARITHMIC TRANSFORMATION.

Unfortunately the asymptotic value of Gibrat's formula does not lead to the Pareto graduation of the tail of the distribution, which is admittedly the most interesting part of the phenomenon of income. Thus for the Pareto formula we have

<sup>12</sup> See, for example, Davis and Nelson, *Elements of Statistics*, Second edition, 1937, p. 404.

$$y'/y = -v/(x - c),$$

while Gibrat's formula gives

$$y'/y = \frac{ab}{(x - k)} + \frac{a^2 \log(x - k)}{(x - k)}.$$

Computation shows that the second term is not negligible when the formula is applied to the income data used in this chapter.

The order of the discrepancy between Gibrat's formula and the data is revealed by the closeness with which  $T$  may be approximated by means of an equation of the following form:

$$T = \alpha + \beta \log(X + 1000).$$

Determining the two parameters  $\alpha$  and  $\beta$  from the table given above by means of least squares, we obtain the following approximation:

$$T = -7.795 + 2.161 \log(X + 1000).$$

The comparison between the actual and the computed values of  $T$  is given in the following table:

$X + 1000$	$T$ (actual)	$T$ (computed)	$X + 1000$	$T$ (actual)	$T$ (computed)
0	....	$-\infty$	\$ 6,000	2.01	0.38
\$1,000	-2.56	-1.31	11,000	2.47	0.94
1,500	-1.61	-0.92	26,000	2.94	1.76
2,000	-0.29	-0.66	51,000	3.23	2.38
2,500	0.59	-0.35	101,000	3.54	3.01
3,000	1.08	-0.28	201,000	3.82	3.66
4,000	1.56	-0.02	501,000	4.18	4.52

### 9. A New General Distribution Function

In this section we shall introduce another function for the graduation of the income distribution. This function meets the postulates of Section 8 and has the merit of being derivable from probability considerations.

Thus we shall assume that  $\phi(x)$  has the form

$$(1) \quad \phi = \frac{a}{z^n} \frac{1}{(e^{b/z} - 1)}, \quad n > 1,$$

where we employ the abbreviation  $z = x - c$ .

From the well-known expansion

$$\frac{t}{e^t - 1} = 1 - \frac{1}{2}t + B_1 t^2/2! - B_2 t^4/4! + B_3 t^6/6! - \dots,$$

where  $B_1 = 1/6$ ,  $B_2 = 1/30$ ,  $B_3 = 1/42$ ,  $B_4 = 1/30$ , ..., are the *Bernoulli numbers*, we see that (1) can be written in the form

$$(2) \quad \phi = \frac{a}{b} z^\mu \left[ 1 - \frac{b}{2z} + \frac{1}{6} \left( \frac{b}{z} \right)^2 - \dots \right],$$

in which we write  $\mu = n-1$ .

If  $z$  is sufficiently large, we obviously obtain

$$(3) \quad \phi \approx \frac{a}{b} z^\mu,$$

which shows that formula (1) will graduate the Pareto tail of the income distribution.

Moreover, if  $z$  is a small positive value, then 1 in the denominator of equation (1) can be neglected in comparison with  $e^{b/z}$ , and we have the following approximation when  $x$  is close to the threshold value  $c$ :

$$(4) \quad \phi \approx \frac{a}{z^n} e^{-b/z}.$$

The limiting value is seen to equal zero as  $z \rightarrow 0$ , that is to say, when  $x$  approaches  $c$ .

The maximum value of  $\phi$  is obtained by equating the derivative of (1) to zero. Thus we get

$$(5) \quad \frac{d\phi}{dz} = z^\mu (\phi^2/a) [e^{b/z} (b/z - n) + n] = 0.$$

From this equation we then derive the condition that  $\phi$  have a maximum value. It is seen that  $z$  must satisfy the equation

$$(6) \quad z = \frac{b}{n - p},$$

where  $p$  is the real nontrivial solution of the equation

$$p e^{-p} = n e^{-n}.$$

If we abbreviate the right-hand member of this equation by  $m$ , that is, if  $n e^{-n} = m$ , then  $p$  may be approximated by the series

$$(7) \quad p = m + m^2 + \frac{3}{2} m^3 + \frac{8}{3} m^4 + \frac{125}{24} m^5 + \dots.$$

Designating the value obtained from (6) by  $z_0$  and the corresponding value of  $\phi$  by  $\phi_0$ , we then obtain as the value of the maximum frequency the quantity

$$(8) \quad \phi_0 = a b^{-n} p (n-p)^{\mu} = \frac{ap}{n-p} z_0^{-n} = \frac{ap}{b} z_0^{-n}.$$

Returning to equation (1) let us multiply numerator and denominator by  $b/z$ . Then if we use the abbreviation  $b/z = t$ , the function can be written in the following convenient form

$$(9) \quad \phi = N(z) \frac{t}{e^t - 1},$$

where we write

$$(10) \quad N(z) = \frac{a}{b} z^{\mu}.$$

Equation (6) then takes the form

$$t = n - p.$$

The total distribution is obtained from the integral of (1). The value of this integral may be shown to equal

$$(11) \quad \int_0^{\infty} \phi(z) dz = a b^{-\mu} \Gamma(\mu) \zeta(\mu) = N,$$

where  $\Gamma(\mu)$  is the Gamma function and  $\zeta(\mu)$ , the Riemann Zeta function, is defined by the series

$$\zeta(\mu) = 1 + \frac{1}{2^{\mu}} + \frac{1}{3^{\mu}} + \frac{1}{4^{\mu}} + \dots.$$

Similarly the total income is given by the following integral:

$$(12) \quad \int_0^{\infty} \phi(z) z dz = a b^{-\nu} \Gamma(\nu) \zeta(\nu) = I.$$

In the evaluation of the parameters for an actual graduation of income data, it is necessary to know the values of  $\Gamma(x)$  and  $\zeta(x)$ . The brief table of the two functions on page 411 is sufficient for this purpose.

It will be observed from equations (9) and (10) that the significant parameters for the actual evaluation of the frequency function are  $b$  and  $a/b$ . But these are readily computed by means of equations (11) and (12). Thus eliminating  $a$  between these two equations, we obtain

$$(13) \quad b = \frac{\Gamma(\mu) \zeta(\mu) I}{\Gamma(\nu) \zeta(\nu) N}.$$

$x$	$\Gamma(x)$	$\Delta$	$x$	$\zeta(x)$	$\Delta$
1.1	0.95135	-0.03318	1.1	10.58445	-4.99287
1.2	0.91817	-0.02070	1.2	5.59158	-1.65963
1.3	0.89747	-0.01021	1.3	3.93195	-0.82640
1.4	0.88726	-0.00103	1.4	3.10555	-0.49317
1.5	0.88623	0.00729	1.5	2.61238	-0.32661
1.6	0.89352	0.01512	1.6	2.28577	-0.23148
1.7	0.90864	0.02274	1.7	2.05429	-0.17206
1.8	0.93138	0.03039	1.8	1.88223	-0.13248
1.9	0.96177	0.03823	1.9	1.74975	-0.10482
2.0	1.00000	0.04649	2.0	1.64493	-0.08471
2.1	1.04649	0.05531	2.1	1.56022	-0.06978
2.2	1.10180	0.06491	2.2	1.49054	-0.05812
2.3	1.16671	0.07546	2.3	1.43242	-0.04908
2.4	1.24217	0.08717	2.4	1.38334	-0.04185
2.5	1.32934	0.10028	2.5	1.34149	-0.03601
2.6	1.42962	0.11507	2.6	1.30548	-0.03122
2.7	1.54469	0.13180	2.7	1.27426	-0.02723
2.8	1.67649	0.15087	2.8	1.24703	-0.02390
2.9	1.82736	0.17264	2.9	1.22313	-0.02107
3.0	2.00000	0.19762	3.0	1.20206	-0.01868

Using this value we then obtain from equation (12)

$$(14) \quad \frac{a}{b} = \frac{N b^{\nu}}{\Gamma(\mu) \zeta(\mu)}$$

It is also instructive to observe that both the modal income and the modal frequency, given respectively by equations (6) and (8), are evaluated directly by these formulas. Replacing (13) in (6) we obtain

$$(15) \quad z_0 = \frac{\Gamma(\mu) \zeta(\mu)}{(n-p) \Gamma(\nu) \zeta(\nu)} \frac{I}{N}$$

Moreover, eliminating  $a$  and  $b$  from the first equation in (8), we obtain

$$(16) \quad \phi_0 = \frac{\Gamma(\nu) \zeta(\nu)}{[\Gamma(\mu) \zeta(\mu)]^2} p(n-p)^{\mu} \frac{N^2}{I}$$

If we assume that the distribution is strictly Paretian, namely, that  $\nu = 1.5$ , then these formulas can be simplified. Substituting numerical values for the Gamma and Zeta functions in (13), we obtain

$$(17) \quad b = 0.77023 \frac{I}{N}$$

Similarly, equation (14) reduces to the numerical form

$$(18) \quad \frac{a}{b} = 0.37915 I \sqrt{I/N}.$$

In order to evaluate the numerical coefficient in (15), we must first compute  $p$ . This is readily found from equation (7) to be  $p = 0.11905$ . Substituting this value in (15), we then obtain

$$(19) \quad z_0 = 0.29578 b = 0.22782 \frac{I}{N}.$$

Similarly equation (16) reduces to

$$(20) \quad \phi_0 = 1.82135 \frac{N^2}{I}.$$

### 10. Theoretical Derivation of the Distribution Function

In order to derive the distribution function (1) of Section 9, let us consider that there are  $N$  individuals in a population and that they are to be distributed into income classes  $z_1, z_2, z_3, \dots$ , the potential number in each class being  $N_1, N_2, N_3, \dots$ . If the division is sufficiently small between classes and if  $N$  is sufficiently large, then the distribution may be regarded as being essentially a continuous one.

Now let us consider a typical class  $z$ , to which  $N_z$  individuals aspire to belong. If the total income for the class is  $I_z$ , then there will be  $P_z = I_z/z$  places in the class to be filled. It will be observed later in the argument, that no actual specification as to the amount or relative size of  $I_z$  is made.

But we know from the theory of probability that the number of ways in which  $P$  places can be assigned to  $N$  individuals is given by

$$Q = \frac{(N + P - 1)!}{N!(P - 1)!}.$$

For example, if  $N = 5$  and  $P = 3$ , there are  $Q = 7!/(5! \cdot 2!) = 21$  ways in which the individuals can be assigned to the three places. Some of these assignments are 5 in the first place and none in the other two; 4 in the first place, 1 in the second, 0 in the third, etc.

Introducing Stirling's approximation

$$n! \approx n^n e^{-n} \sqrt{2\pi n}$$

for the evaluation of the factorials in  $Q$ , we readily compute

$$\begin{aligned} \log Q &\approx (N+P-1) \log(N+P-1) - (N+P-1) + \frac{1}{2} \log(N+P-1) \\ &\quad - N \log N + N - \frac{1}{2} \log N - (P-1) \log(P-1) \\ &\quad - \frac{1}{2} \log(2\pi) - \frac{1}{2} \log(P-1). \end{aligned}$$



Taking derivatives of both sides of this expression with respect to  $P$ , we obtain

$$\frac{1}{Q} \frac{dQ}{dP} \approx \log(N + P - 1) - \log(P - 1) + \frac{1}{2(N + P - 1)} + \frac{1}{2(P - 1)}.$$

Since, by assumption, both  $N$  and  $P$  are large we may neglect the last two terms of this expression and we may also replace  $P - 1$  by  $P$  without essentially altering the relationship. Thus, replacing the approximation symbol with the sign of equality, we write

$$(1) \quad \frac{1}{Q} \frac{dQ}{dP} = \log(N + P) - \log P.$$

We now introduce the assumption that the rate of change of  $Q$  with respect to  $P$  varies directly with  $Q$ , but inversely as the size of the income class  $z$ , measured from the wolf point; that is

$$(2) \quad \frac{dQ}{dP} = \frac{bQ}{z}, \quad z = x - c.$$

There is no direct statistical evidence to support this assumption, except the actual form of the distribution curve itself. However, it seems reasonable to believe that the shifting of income recipients from one income class to another takes place more rapidly in numerically large income groups than in numerically small income groups, and that there is a rather remarkable class stability at high income ranges. Equation (2) expresses these assumptions in the simplest possible mathematical form. If the formulation of the distribution problem should prove unsatisfactory for data other than those used in this chapter, it is upon this question that more careful investigation should be made.

Eliminating  $(1/Q)(dQ/dP)$  between (1) and (2), solving for  $P$ , and introducing the subscript  $z$ , we finally obtain

$$P_z = \frac{N_z}{e^{b/z} - 1}.$$

But we know that as  $z$  increases  $P_z$  approaches the Pareto distribution  $(a/b)z^{-\mu}$ , which means that  $N_z = a z^{-n}$ ,  $n = \mu + 1$ .

### 11. Statistical Verification

In order to verify the distribution function derived in the preceding section, we may test its reality by applying it to the problem of graduating the data given in Section 5.

From the formulas given in Section 9, in particular (13), (14), (15), and (16), it is clear that the parameters of the general distribution function can be determined as soon as we know  $I$ ,  $N$ , and  $\nu$ . It may be readily suspected, however, that the practical adjusting of the parameters to an actual distribution could be improved by some statistical considerations.

We begin with formula (10) in Section 9, which we now write in the form

$$(1) \quad N(z) = \alpha z^{-\mu}, \quad \alpha = a/b, \quad z = x - c.$$

The parameter  $\mu$  is sufficiently determined from the graduation of the Pareto distribution given in Section 6. Since  $\mu = \nu + 1$ , we may then assume with sufficient accuracy that

$$\mu = 2.69672.$$

Since formula (1) gives the frequencies, rather than the accumulated frequencies, for large values of  $z$ , we must form next a frequency table for incomes above \$4,000. Since the unit in our basic data of Section 5 is \$100 for incomes lower than \$4,000, we shall use this same unit for higher incomes. The difference method of Section 4 is then employed. It will be convenient also to let a unit in the  $z$  scale equal \$100, so that  $z = 100.5$  will be equivalent to \$10,050 and the frequency for this value of  $z$  will represent the number of people who have incomes between \$10,000 and \$10,100. Although fractional "frequencies" are thus introduced, we know that they express probabilities, since there exist recipients of incomes in the neighborhood of the assumed classes. The following table is thus obtained:

INCOME FREQUENCIES FOR CLASS INTERVALS OF \$100  
 $z$  (unit = 100) taken at middle of class interval

Value of $z$	Frequency, $N(z)$	Value of $z$	Frequency, $N(z)$
40.5	56,040	400.5	118
50.5	29,152	500.5	66
60.5	17,228	600.5	41
70.5	11,139	700.5	28
80.5	7,652	800.5	20
90.5	5,481	900.5	15
100.5	4,087	1000.5	11.76
110.5	3,143	1500.5	4.23
120.5	2,476	2000.5	2.15
130.5	1,984	2500.5	1.11
140.5	1,624	3000.5	0.72
150.5	1,368	4000.5	0.34
200.5	664	5000.5	0.18
250.5	385	7500.5	0.06
300.5	249	10000.5	0.02

Since  $c$  will make a very small change in the value of  $z$  at high income levels, we assume that  $z$  is approximately equal to  $x$  over the range of the above table. Hence, employing formula (1), we may approximate the value of  $\log a = \log(a/b)$  from the formula

$$\log a = \log N(z) + \mu \log z.$$

For this computation the following table is obtained:

$x$	$\log z$	$\mu \log z$	$\log N(z)$	$\log a$	$z$	$\log z$	$\mu \log z$	$\log N(z)$	$\log a$
400.5	2.60260	7.01848	2.07188	9.09036	2000.5	3.30114	8.90225	0.33244	9.23469
500.5	2.69940	7.27953	1.81954	9.09907	2500.5	3.39803	9.16354	0.04532	9.20886
600.5	2.77851	7.49286	1.61278	9.10564	3000.5	3.47719	9.37701	9.85733	9.23434
700.5	2.84541	7.67327	1.44716	9.12043	4000.5	3.60211	9.71388	9.53148	9.24536
800.5	2.90336	7.82955	1.30103	9.13058	5000.5	3.69901	9.97519	9.25527	9.23046
900.5	2.95448	7.96741	1.17609	9.14350	7500.5	3.87509	10.45003	8.77815	9.22818
1000.5	3.00022	8.09075	1.07041	9.16116	10000.5	4.00002	10.78693	8.30103	9.08796
1500.5	3.17624	8.56543	0.62634	9.19177				AVER.	9.16749

This average value, namely 9.16749, we shall use as our estimate of  $\log a$ . For the computation of  $a$  and  $b$  separately we employ formulas (6) and (8) of Section 9, which, it will be recalled, evaluate the modal income,  $z_0$ , and the modal frequency,  $\phi_0$ . These formulas we shall write in the form

$$(2) \quad \log b = \log z_0 + \log(n - p),$$

$$(3) \quad \mu \log z_0 = \log(a/b) - \log \phi_0 + \log p.$$

From  $n = \mu + 1 = 3.69672$ , we find  $m = n e^{-\mu} = 0.09170$  and hence from formula (7) of Section 9, we compute  $p = 0.10148$ . From the table in Section 5, we see that the modal frequency, which is at  $x = 9.57$ , is equal to 3,144,722. Hence, substituting  $\log \phi_0 = 6.49758$  and the value of  $p$  given above in formulas (2) and (3), we compute

$$\log z_0 = 0.62160,$$

$$\log b = 1.17733,$$

$$z_0 = 4.18,$$

$$b = 15.043.$$

From  $\log a$  and  $\log b$ , we immediately obtain  $\log a = 10.34482$ .

Since the modal income is actually  $x = 9.57$ , we find that  $c = x - z_0$  is equal to 5.39, that is to say, \$539. This value is the minimum income, that is to say, the wolf point, which we have defined above. One may argue its reality in the following manner. Since the estimated population in 1918 was 103,588,000, and since our data report the income of 37,569,060 persons, there is an average of 2.75 people depending upon the subsistence income. Hence the per capita wolf point is \$196. It does not seem unrealistic to believe that the poorest

surviving person in the economy of 1918 could not have maintained existence on a smaller amount of real goods and services. In a recent study of income levels carried out under the auspices of the Division of Social Research in Washington, estimates were made for various cities of an *emergency level* of income, which "allows more exclusively, though not entirely, for material wants," but which "might be questioned on grounds of health hazards if families had to live at this level for a considerable period of time."<sup>14</sup> It is interesting to observe that the lowest per capita estimate of this emergency-level income was \$202.82, which compares with the value of the wolf point which we have just obtained by other means. Since the study cited was made for the year 1935 some correction is necessary, of course, for the level of prices which was 157 in 1918 and 145 in 1935. It is also probable that the emergency level is not exactly the wolf point, although a close approximation to it.

It is interesting to compare the values which we have obtained above with those given directly by formulas (13), (14), (15), and (16) of Section 9. We observe that  $I = \$57,954,722,341$  and that  $N = 37,569,060$ . The value of  $\nu$  we have already found to equal 1.69672. From the table of Section 9 we then determine the following values:  $\Gamma(\nu) = 0.9081$ ,  $\zeta(\nu) = 2.0582$ ,  $\Gamma(\mu) = 1.5408$ ,  $\zeta(\mu) = 1.2753$ . The value of  $b$  is then determined from formula (13) and found to be

$$b = 1622.$$

This computation assumes, of course, that the unit of income is one dollar instead of 100 dollars. To compare with our first determination we divide by 100 and thus find  $b = 16.22$ , which is slightly larger than our original estimate of 15.043.

Computing the logarithm of  $\alpha = a/b$  by means of equation (14), we obtain

$$\log \alpha = 12.72803.$$

This figure assumes dollar units of income. To reduce it to 100-dollar units we must subtract  $2\nu$ , as indicated by formula (14) of Section 9. This yields the value  $\log \alpha = 9.33459$ , which is somewhat higher than our previous estimate of 9.16749.

Using these values we obtain from formula (15) of Section 9 a modal income of  $z_0 = \$451$  and a wolf point of \$506, the per capita

<sup>14</sup> Margaret L. Stecker, "Intercity Differences in Costs of Living in March 1935, 59 Cities," *Research Monograph XII*, WPA, Division of Social Research, 1937, Washington, D. C., xxvi + 216 pp.

value of which is \$184. From formula (16) of Section 9 we find the equivalent modal frequency to be

$$\phi_0 = 3,771,000,$$

which is to be compared with the observed frequency of 3,144,722. The discrepancy in these figures may be attributed principally to the fact that the data used assume the existence of incomes below the wolf point, which would tend to reduce the frequencies in the neighborhood of the mode.

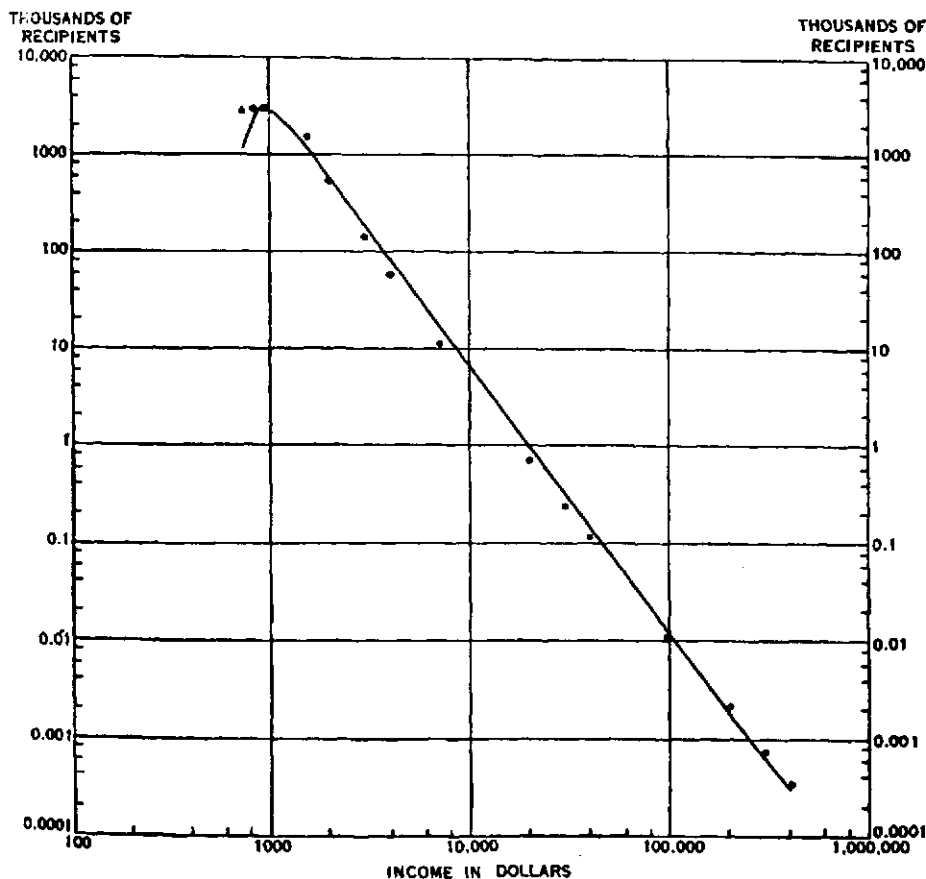

FIGURE 125.—FREQUENCY DISTRIBUTION OF INCOMES IN THE UNITED STATES, 1918.

Returning now to our original computations of  $a$  and  $b$ , we substitute these values in equation (9) of Section 9 and compare the

estimated frequencies with the observed frequencies. These estimates of  $\phi(x)$ , made at various points of the income range from  $x = 7.5$  to  $x = 4000.5$ , are given in the following table. The closeness of the fit in the neighborhood of the mode and beyond it is graphically represented in Figure 125. The discrepancy below the mode is again to be attributed to the definition of income for low income classes.

$x$	$\phi$ (computed)	$\phi$ (observed)	$x$	$\phi$ (computed)	$\phi$ (observed)
7.5	1,122,435	2,668,466	200.5	942	663
8.5	2,667,070	3,013,034	300.5	313	248
9.5	3,143,365	3,144,722	400.5	143	118
15.5	1,245,979	1,512,649	1000.5	12.04	11.90
20.5	566,752	549,787	2000.5	1.84	2.09
30.5	180,277	142,802	3000.5	0.61	0.73
40.5	80,079	55,904	4000.5	0.28	0.33
70.5	16,806	11,118			

### 12. Relationships Between the Distribution of Income and Total Real Income

If one examines attentively the Johnson diagram of incomes (Figure 123), he is struck by a rather significant fact, namely, that the points on the lower end of the successive lines of distribution show a large variation which tends to follow the business cycle, whereas, those at the upper end exhibit the variation to a much less degree. It will be interesting to have an explanation of this phenomenon.

In order to examine this question more closely, let us consider the Pareto approximation given by (3), Section 9, namely,

$$(1) \quad \phi = \frac{a}{b} z^{-\mu}.$$

Since, for a fixed value of  $z$ ,  $\phi$  tends to vary with the business cycle, let us assume that  $a/b$  is proportional to some power of the total real income. That is to say, let us write

$$(2) \quad a/b = k I^\gamma,$$

where  $I$  is the total national income corrected for changes in the price level.

Taking logarithms of both sides of (1), we shall then have

$$(3) \quad \log \phi = \gamma \log I + (\log k - \mu \log z).$$

Now the row of points at the extreme lower end of the Johnson diagram corresponds to the number of people who have an income of a million dollars or over. That is to say,  $z$  is fixed and equal to \$1,000,000. Hence in formula (3), for any given row of points,  $z$  would be a constant and formula (3) affirms that the logarithm of the

number of people making million-dollar incomes is a linear function of the logarithm of real income.

But the Johnson diagram is formed from the accumulated frequency,  $y$ , instead of  $\phi$ , and hence we integrate (1) from  $z$  to  $\infty$ ; that is,

$$y = \int_z^{\infty} \phi(z) dz = \frac{a}{b} \frac{z^{-\mu+1}}{\mu-1}.$$

Taking logarithms of both sides, we obtain

$$(4) \quad \log y = \gamma \log I + [\log k - \log(\mu - 1) - (\mu - 1) \log z],$$

a formula more easily handled statistically than (3).

In order to test (4) we use the following data over the period from 1917 to 1934 inclusive, where  $I'$  is the total income (in billions),  $I$  the total real income (in billions),  $P$  the general price index (1913 = 1.00),  $N_1$  the number of people having incomes over \$1,000,000,  $N_2$  the number having incomes over \$500,000,  $N_3$  the number having incomes over \$300,000,  $N_4$  the number having incomes over \$150,000, and  $N_5$  the number having incomes over \$100,000:

Year	$I'$	$P$	$I=I'/P$	$\log I$	$N_1$	$N_2$	$N_3$	$N_4$	$N_5$
1917	53.2	1.39	38.3	1.583	141	456	1015	3362	6664
1918	60.2	1.57	38.3	1.583	67	245	627	2141	4499
1919	67.4	1.73	39.0	1.591	65	254	679	2543	5526
1920	74.3	1.93	38.5	1.585	33	156	395	1458	3649
1921	52.6	1.63	32.2	1.508	21	84	246	985	2352
1922	61.7	1.58	39.1	1.592	67	228	537	1860	4031
1923	69.8	1.65	42.3	1.626	74	215	542	1843	4182
1924	69.6	1.66	41.9	1.622	75	317	774	2650	5715
1925	77.1	1.70	45.4	1.657	207	636	1578	4801	9560
1926	78.5	1.71	45.9	1.662	231	699	1591	4858	9582
1927	77.2	1.71	45.1	1.654	290	847	1938	5861	11122
1928	80.5	1.76	45.7	1.660	511	1494	3250	8928	15977
1929	79.1	1.79	44.2	1.645	513	1489	3130	8440	14816
1930	77.2	1.68	46.0	1.663	150	468	1020	3091	6202
1931	60.1	1.50	40.1	1.603	77	226	494	1550	3184
1932	46.5	1.32	35.2	1.547	20	106	246	841	1836
1933	44.4	1.29	34.4	1.537	50	131	272	867	2051
1934	50.4	1.37	36.8	1.566	33	119	235	925	1907

From these quantities we now compute the averages and the standard deviations of the logarithms of  $I$  and of the  $N$ 's. These values are given below as follows:

	$\log I$	$\log N_1$	$\log N_2$	$\log N_3$	$\log N_4$	$\log N_5$
Average	1.60467	1.96333	2.49767	2.86567	3.38594	3.70383
$\sigma$	0.04578	0.41654	0.36855	0.35671	0.31526	0.28697

From the data the correlation coefficients  $r_{In}$  are now computed, where  $r_{In}$  means the correlation between  $\log I$  and  $\log N_n$ . The following values are thus obtained:

$$r_{11} = 0.8538, \quad r_{12} = 0.8657, \quad r_{13} = 0.8602, \\ r_{14} = 0.8494, \quad r_{15} = 0.8495.$$

These correlations are observed to be high and consistent.

The value of  $\gamma$  in equation (4) is now obtained from the regression coefficient

$$\gamma_n = \frac{\sigma_n}{\sigma_I} r_{In},$$

where  $\gamma_n$  is used to designate the value of  $\gamma$  obtained from the data for  $\log N_n$ . The quantities  $\sigma_n$  and  $\sigma_I$  are the standard deviations of  $\log N_n$  and  $\log I$  respectively. The five determinations of  $\gamma_n$  are given in the following table:

$n$	1	2	3	4	5
$\gamma_n$	7.768	6.969	6.702	5.849	5.325

We note from this table a tendency for the values of  $\gamma_n$  to decrease as lower income levels are introduced, a fact in keeping with the observation that the line of upper points on the Johnson diagram exhibits a much smaller variation than the line of points at the lower end of the lines of distribution. Since the first income class, namely that of those who obtain an income of a million or over, is probably too unstable for an accurate determination of  $\gamma$ , we shall assume as the desired value that corresponding to the second income class. Thus, we obtain

$$\gamma = 6.969.$$

In order to test these conclusions graphically, the values of  $\log N_2$  are plotted against those of  $\log I$ , and the two regression lines,  $\log N_2 = 6.969 \log I - 8.686$ ,  $\log N_2 = 9.299 \log I - 12.425$ , are drawn through the points. The character of the fit is exhibited in Figure 126.

The next problem is to determine the respective variations of  $a$  and  $b$  with  $I$ . For this determination we consider formula (12) of Section 9, namely

$$(5) \quad a b^{-\mu} \Gamma(\mu) \zeta(\mu) = N,$$



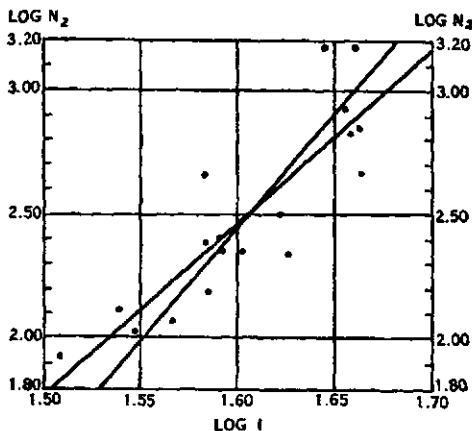

FIGURE 126.—RELATION BETWEEN REAL INCOME AND NUMBER OF VERY LARGE INCOMES.

This chart shows the regressions between the logarithm of real national income ( $I$ ) and the logarithm of the number of people ( $N_2$ ) having incomes of over half a million dollars.

which gives the relationship between  $a$ ,  $b$ , and  $N$ , the total number of receivers of income.

We shall assume that  $N$  varies as some power of  $I$ , and hence we can write

$$(6) \quad a b^{-\mu} \Gamma(\mu) \zeta(\mu) = k_1 I^\delta = N.$$

Taking logarithms of both sides of this equation, we get

$$(7) \quad \log a - \mu \log b = \delta \log I + \log k_1 - \log \Gamma(\mu) - \log \zeta(\mu) \\ = \log N + a \text{ constant}.$$

In order to compute  $\delta$  we correlate  $\log N$  with  $\log I$  from the following data:<sup>15</sup>

Year	$\log I$	$N$	$\log N$
1929	1.645	43,979,000	7.643
1930	1.663	41,880,000	7.622
1931	1.603	38,529,000	7.586
1932	1.547	34,986,000	7.543
1933	1.537	35,200,000	7.547
1934	1.566	37,306,000	7.572
1935	1.579	38,139,000	7.581

<sup>15</sup> These data are from *National Income in the United States, 1929-35*, by the U. S. Dept. of Commerce, Bureau of Foreign and Domestic Commerce, 1936, p. 31.

We then obtain as the co-ordinates of the point of intersection of the two lines  $A_I = 1.59142$ ;  $\sigma_I = 0.04450$ ,  $A_N = 7.58486$ ,  $\sigma_N = 0.03407$ , and the correlation  $r = 0.9499$ . Hence the value of  $\delta$  is given by

$$\delta = \frac{\sigma_N}{\sigma_I} r = 0.7273.$$

Since the available series is very short, there is undoubtedly a considerable error in this value of  $\delta$ . It is reasonable to suppose, however, that  $N$  varies approximately linearly with  $I$ , so that the value obtained is certainly of the right order of magnitude and we shall use it without further change.

In order, finally, to obtain the values of  $a$  and  $b$  respectively in terms of  $I$ , we now consider the equations

$$\log a - \log b = \gamma \log I + c_1,$$

$$\log a - \mu \log b = \delta \log I + c_2.$$

From these it follows that

$$\log a = \frac{(\mu \gamma - \delta)}{\mu - 1} \log I + c_3,$$

$$\log b = \frac{(\gamma - \delta)}{\mu - 1} \log I + c_4.$$

Hence, substituting numerical values for  $\gamma$ ,  $\delta$ , and  $\mu = 2.5$ , we obtain

$$(8) \quad a = k_2 I^{11.6152}, \quad b = k_3 I^{4.1612}.$$

Since the exponents of  $I$  probably contain a considerable error, we may neglect the fractional parts and conclude that  $b$  varies directly as the fourth power of the total real income, while  $a$  varies directly as the twelfth power of total real income.

This conclusion has special significance with respect to the value of the modal income for any given distribution, since we see from formula (6), Section 9, that  $z_0 = x_0 - c$ , where  $x_0$  is the modal income, must satisfy the equation

$$(9) \quad z_0 = b/(n-p).$$

If we assume that  $k_3$  in (8) above varies only with the price index, and if  $x'_0$ ,  $c'$ , and  $I'$  refer to some comparison year, then we have from (9) the relationship

$$x_0 = P(I/I')^4 x'_0 + [c - Pc'(I/I')^4].$$

If the expression in brackets may be assumed to be small, then we reach the remarkable proposition that *the modal income varies directly as the fourth power of the real income.*

Unfortunately the data necessary to verify this conclusion do not exist. Some supporting evidence, however, can be obtained from the following distribution data for the year 1929 due to V. von Szeliški:<sup>16</sup>

Income Class	Number in each class	Cumulative Frequency	Per Cent of Total	Income in Millions	Cumulative	Per Cent of Total
Under \$1,000	15,472,560	48,500,000	100.0	\$ 9,567	\$90,500	100.0
1,000- 2,000	20,117,510	33,027,440	68.1	29,487	80,933	89.4
2,000- 3,000	8,962,940	12,909,930	26.6	21,462	51,446	56.8
3,000- 4,000	1,994,920	3,946,990	8.13	6,773	29,984	33.1
4,000- 5,000	720,210	1,952,070	4.02	3,216	23,211	25.6
5,000- 10,000	770,909	1,231,860	2.54	5,339	19,995	22.1
10,000- 25,000	339,871	460,951	0.950	5,032	14,656	16.2
25,000- 50,000	77,039	121,080	0.250	2,623	9,624	10.6
50,000- 100,000	28,021	44,041	0.0909	1,908	7,001	7.73
100,000- 250,000	11,648	16,020	0.0330	1,749	5,093	5.63
250,000- 500,000	2,842	4,372	0.00891	911	3,334	3.70
500,000-1,000,000	973	1,530	0.00316	663	2,433	2.68
1,000,000 and over	557	557	0.00115	1,770	1,770	1.96

From these data we compute the modal income to be \$1579, which, based upon 48,500,000 income earners out of a population of 121,526,000, gives a per capita modal income of \$630. Similarly, from the data of 1918 we obtain a modal income of \$957 based on 37,569,060 income earners out of a population of 103,588,000. This gives a per capita income of \$347. Since the real income for 1918 was 38.3 (in billions) and that for 1929 was 44.2, we multiply \$347 by  $(44.2/38.3)^4 = 1.77$ . This gives an unadjusted per capita income of \$614. For  $P$  we use the ratio between the two indexes of the cost of living, which were respectively 94 and 100. Hence, we obtain as the computed per capita modal income the value  $\$614 \times 1.06 = \$651$ . Considering the errors which exist in the data and the character of the assumptions made, the agreement must be regarded as excellent.

A similar computation is also possible for the income data for the years 1935-36 from a distribution table prepared by the National Resources Committee.<sup>17</sup> From this table one finds a mode, based on 39,458,300 incomes, of \$1097, or a per capita mode of \$340. Deflating the actual incomes for 1935 and 1936 by the general price index, we

<sup>16</sup> See *Econometrica*, Vol. 2, 1934, pp. 215-216.

<sup>17</sup> See *Consumer Incomes in the United States: Their Distribution in 1935-36*, National Resources Committee, Washington, D. C., 1938, p. 6.

obtain respectively 37.9 and 40.5 billions. Comparing the average of these two values, namely 39.2, with the real income of 38.2 for 1918, we obtain as the multiplying factor for \$347, the modal income of 1918, the value  $(1.026)^4 = 1.11$ . Hence the per capita modal income is \$385. But this must be corrected by the factor 0.8936 to take account of the difference in cost of living between the two years. We thus obtain the value \$344, which is approximately the same as that obtained from the distribution table.

It will be observed, however, that the differences between the two years was not large as in the previous example, and a close agreement was to have been expected.

### 13. Curves of Concentration

A very useful formulation of the distribution problem can be made even when the precise law of distribution is not known. This method is attained by means of *curves of concentration*.

Thus, let us assume that  $p_x$  is the amount, expressed as a ratio, of a population  $N$  which possesses at least  $x$  of a characteristic, and let  $q_x$  be the amount, also expressed as a ratio, of the characteristic possessed. Then, if there exists a functional relationship between the two variables  $p$  and  $q$ , the equations

$$(1) \quad p = p_x, \quad q = q_x,$$

form a parametric system for determining it.

If the law of distribution is sufficiently well known, then  $x$  may be eliminated from (1) and we have the equation

$$(2) \quad q = f(p).$$

The straight line,  $q = p$ , is called the *line of equal distribution*. Since the range of  $p$  and  $q$  is from 0 to 1, this is the diagonal of a square with unit sides.<sup>18</sup>

Another formulation, which is often useful in application to income data, may be given to (1). Let us designate by  $N_x$  that part of the population which possesses  $x$  or more of the characteristic, and let  $I_x$  be the amount of the characteristic possessed by  $N_x$ . If  $N$  is the total population and  $I$  the total amount, then we have

$$(3) \quad p_x = \frac{N - N_x}{N}, \quad q_x = \frac{I - I_x}{I}.$$

<sup>18</sup> In case negative amounts of  $x$  are possessed,  $q$  may have a value smaller than zero. Such negative amounts are apt to be small compared with the total and can usually be neglected.

Curves of this form were suggested for the representation of the distribution of income almost simultaneously by M. O. Lorenz, C. Gini, and others (see Bibliography at the end of this chapter).

In order to illustrate the application of (3), let us assume that  $N_x$  is represented by a Pareto distribution; that is to say,

$$(4) \quad \log N_x = A - \nu \log x .$$

Since  $-dN_x/dx$  is the frequency, it is clear that we shall have

$$I_x = \int_x^{x_1} \left( -\frac{dN_x}{dx} \right) x dx ,$$

where  $x_1$  is the limit of the distribution. Applying this to the Pareto distribution and assuming that  $x_1 = \infty$ , we get

$$(5) \quad \log I_x = B - (\nu - 1) \log x .$$

Eliminating  $\log x$  from (4) and (5), we obtain the relationship

$$\frac{N_x}{N} = \left( \frac{I_x}{I} \right)^\delta , \text{ where } \delta = \frac{\nu}{\nu - 1} .$$

This is derived, of course, upon the assumption that (4) applies over the entire range of incomes, an assumption that obviously is not warranted for incomes below the mode.

Upon using (3), we find the following relationship between  $p$  and  $q$ :

$$(6) \quad q = 1 - (1 - p)^{1/\delta} .$$

Assuming the Pareto value of 1.5 for  $\nu$ , we have  $\delta = 3$ ; hence, equation (6) reduces to

$$q = 1 - (1 - p)^{1/3} .$$

The graph of this function is compared with the line of equal distribution in Figure 127.

As a measure of the difference between distributions, Gini has proposed a concentration ratio, which we designate as  $\rho$ . This ratio is defined as the area between the line  $OA$  and the curve  $OCA$ , divided by the area of the triangle  $OBA$ ; that is,

$$\begin{aligned} \rho &= \text{Area } ACOD / \text{Area } AOB , \\ &= 2 \text{ Area } ACOD . \end{aligned}$$

Using (6) to define  $OCA$ , we have

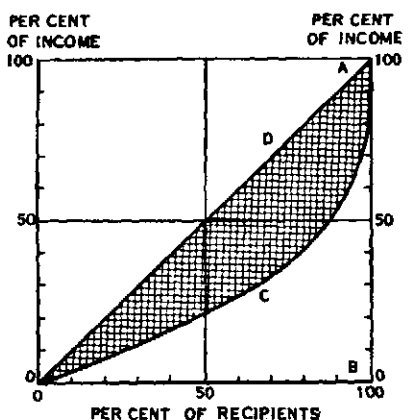

FIGURE 127.—DIAGRAM OF INCOME CONCENTRATION.

$$ACOB = \int_0^1 q dp = \int_0^1 [1 - (1-p)^{1/\delta}] dp = 1/(1+\delta).$$

Hence we get

$$\begin{aligned} \rho &= 2 \left[ \frac{1}{2} - 1/(1+\delta) \right] \\ &= \frac{\delta - 1}{\delta + 1} = \frac{1}{2\nu - 1}. \end{aligned}$$

This function is observed to vary from 0 to 1 as  $\delta$  varies from 1 to  $\infty$ . For the Pareto value  $\delta = 3$ , the concentration ratio equals  $1/2$ .<sup>19</sup>

#### 14. The Generalized Law of Inequality

Having in a measure answered the first of the three questions proposed in Section 4, we now turn to a consideration of the other two. Does the distribution of incomes appear to be an inevitable one? Can any a priori reason be given for the form of the frequency function? Attempts to answer these questions lead us to a consideration of the problem of human abilities.

<sup>19</sup> H. Mendershausen has suggested as an alternative measure of concentration the expression  $\beta = 1 - M/E$ , where  $M$  is the median income and  $E$  is the "equatorial income." If incomes, ordered by size, are cumulated, the equatorial income is the one which divides the total income into two equal parts. For the distribution of Section 5,  $M = 1140$  and  $E = 1647$ . Hence we get  $\beta = 0.3078$ , which may be compared with  $\rho = 0.4271$  for the same data. See Cowles Commission for Research in Economics, *Report of Fifth Annual Research Conference on Economics and Statistics Held at Colorado Springs July 3 to 28, 1939*, pp. 63-65.

At the Research Conference of the Cowles Commission for Research in Economics held at Colorado College in 1936, Carl Snyder advanced the thesis that the distribution of incomes, as approximately represented by the Pareto law, is only one example of a much more general law of inequality, which we might refer to as the *law of the distribution of special abilities*. This interesting generalization had also occurred to the author and an attempt has been made to formulate it precisely. In his recent book on *Capitalism the Creator* Snyder has amplified the theory and has devoted two chapters to its discussion.

The generalized law makes the following assumptions:

(1) The variable  $x$  is the measure of a measurable ability possessed by a total group of  $N$  individuals.

(2) The variable  $x$  has a range, which, for practical measurements, may be regarded as infinite at one end. For example, in the case of incomes, there is no upper bound to one's possible income and the actual range from near zero to more than \$4,000,000 may be regarded statistically as essentially an infinite one.

(3) Each unit of  $x$  is comparable with every other unit. Thus, in playing billiards, the addition of one billiard to a run of  $x$  is no more difficult than the addition of one billiard to a run of  $x'$ . In golf, however, the reduction of a stroke at the level 125 is very much simpler than the reduction of a stroke at the level 70. In the case of income, while it may be argued that the addition of one dollar at a level of \$100,000 is obviously easier than the addition of one dollar at the level of \$1,000, it is not improbable that to *earn and keep* a dollar, that is, to add one dollar to actual income, is approximately the same at each level. At least, since the Pareto law holds for income distributions, it would appear that this proposition has an empirical validity. One of the strongest arguments against the use of the Binet I. Q. test of intelligence for high levels is found in the fact that abilities measured by it conform to the normal curve. It seems clear that the addition of a unit to a score at a high level is considerably more difficult than the addition of a unit at a low level.

The proposition may then be stated that, *under the assumptions given above, the distribution of  $N$  individuals will approximate a Pareto distribution when  $x$  is sufficiently large.*

In support of this thesis we shall submit data from the game of billiards, data showing the ability to write mathematical papers, and data showing the distribution of values to a corporation of the members of its executive staff as measured in terms of salary incomes.

This evidence will be further supported by some significant results obtained by A. J. Lotka in a study of scientific productivity.<sup>20</sup>

Records kept over a number of years by Dean C. E. Edmondson of Indiana University on the ability of the members of the faculty to play billiards were kindly put at the disposal of the author. The group, consisting of 79 members, had played billiards for a sufficiently long period to have reached approximately the upper bound of their curves of learning. It is obvious that the upper range of the data is infinite, that the ability to make billiards is measured by the average number made in a given number of innings, and that the difficulty of adding one billiard to a score is the same at any level. Hence, the 79 members of the group should be distributed in a Pareto curve. The unit used is the number of billiards made in 50 innings; the mode is around 50, and the standard error approximately 10. The data are given in the following table:

No. of billiards in 50 innings	Accumulated Frequency	Per Cent of total	No. of billiards in 50 innings	Accumulated Frequency	Per Cent of total
20	79	100.00	80	9	11.39
30	66	83.54	90	7	8.86
40	41	51.90	100	5	6.33
50	27	34.18	110	3	3.80
60	19	24.05	160	2	2.53
70	11	13.95	280	1	1.27

When these data are graduated by the parabolic curve, we get

$$\log y = 4.44919 - 1.867 \log x.$$

It will be seen from the chart (Figure 128) that the fit is reasonably good except at the upper end. But this is to be expected since a score of 20 billiards is far below the modal class.

An accumulation similar to that observed in the billiard data is furnished by a distribution submitted by Arnold Dresden at the twenty-fifth anniversary meeting of the Chicago section of the American Mathematical Society. Dresden's paper exhibited the productivity of 278 authors in the writing of mathematical papers. In all, 1102 papers were produced. The data are themselves interesting and they are reproduced in the table on page 429.<sup>21</sup>

To simplify the computations, these data were collected into intervals of 7, centering on the central value, and a parabolic curve was fitted to their accumulation. We thus obtained

<sup>20</sup> "The Frequency Distribution of Scientific Productivity," *Journal of the Washington Academy of Sciences*, Vol. 16, 1926, pp. 317-323.

<sup>21</sup> "A Report on the Scientific Work of the Chicago Section, 1897-1922," *Bulletin of the American Math. Soc.*, Vol. 28, 1922, pp. 303-307.



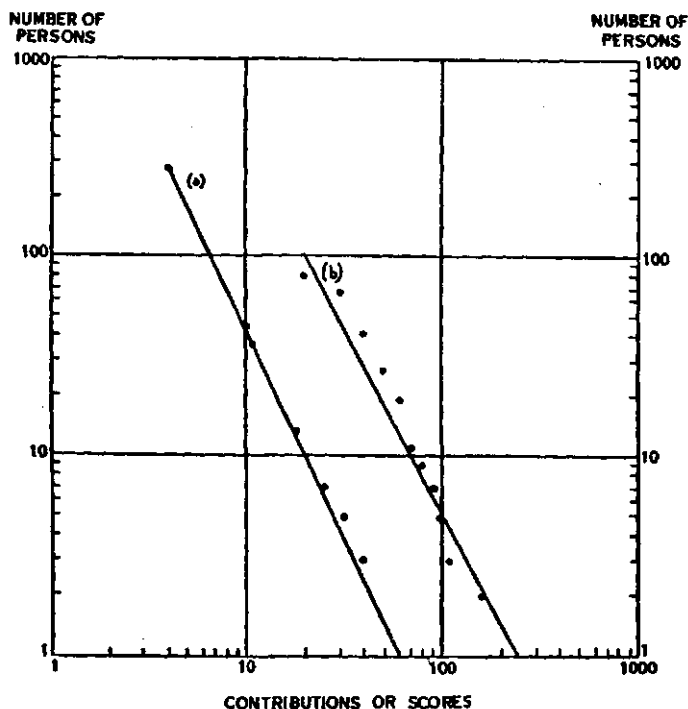

FIGURE 128.—CUMULATIVE FREQUENCY DISTRIBUTIONS OF MATHEMATICAL CONTRIBUTIONS (a) AND OF BILLIARD SCORES (b).

No. of Contributions ( $x$ )	No. of Persons Contributing	Per Cent of total	No. of Contributions ( $x$ )	No. of Persons Contributing	Per Cent of total
1	133	47.84	14	1	0.36
2	43	15.47	15	1	0.36
3	24	8.63	16	2	0.72
4	12	4.32	19	1	0.36
5	11	3.96	20	1	0.36
6	14	5.04	21	1	0.36
7	5	1.80	24	1	0.36
8	3	1.08	27	1	0.36
9	9	3.24	32	1	0.36
10	1	0.36	35	1	0.36
11	3	1.08	39	1	0.36
12	5	1.80	42	1	0.36
13	1	0.36	70	1	0.36
			Totals	278	100.02

$$\log y = 3.74877 - 2.11012 \log x .$$

The agreement between the graduated and the actual frequencies is exhibited in Figure 128 and in the table on page 430.

Lotka in the study to which reference has previously been made counted the number of names in the decennial index of *Chemical Ab-*

$x$	$y$ (actual)	$y$ (computed)	$x$	$y$ (actual)	$y$ (computed)
4	278	301	39	3	2
11	36	36	46	1	2
18	13	13	53	1	1
25	7	6	60	1	1
32	5	4	67	1	1

*stracts*, 1907–1916, against which appeared 1, 2, 3, etc. entries. The letters *A* and *B* of the alphabet only were considered. A second count (of the entire alphabet) was also made for the name index of Auerbach's *Geschichtstafeln der Physik* (J. A. Barth, Leipzig, 1910), which covered the entire range of history up to and including 1900. A summary of these counts is given on page 431.

Lotka found that the parabolic function

$$f = 56.69/n^{1.858}$$

gave an excellent graduation of the percentage of people contributing articles to chemical literature, and that the function

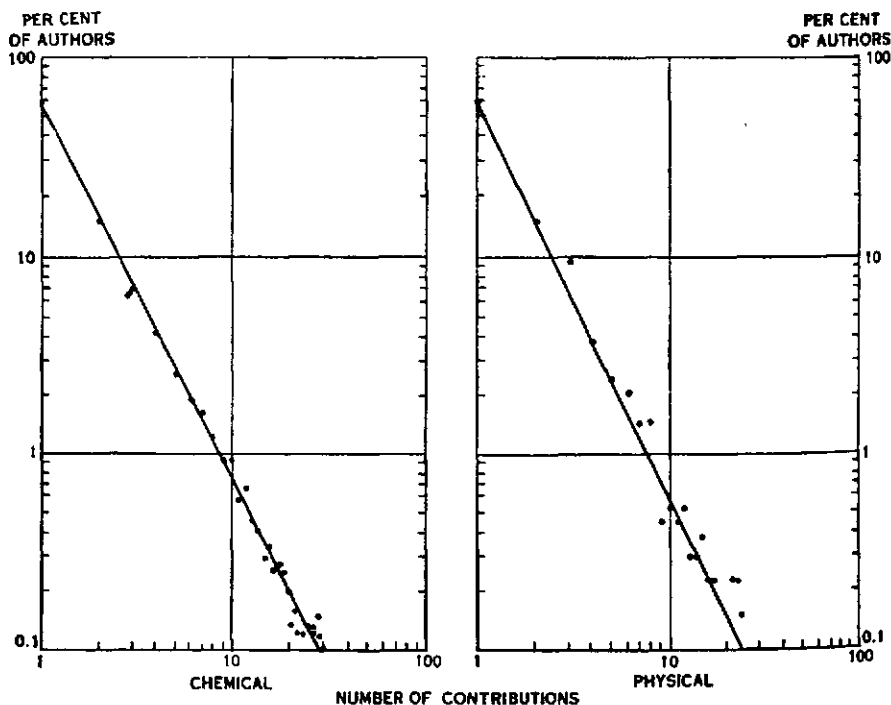

FIGURE 129.—CUMULATIVE FREQUENCY DISTRIBUTIONS OF CONTRIBUTIONS TO CHEMICAL AND PHYSICAL LITERATURE.

## CHEMICAL ABSTRACTS

No. of Contributions (%)	No. of Persons Contributing	Per Cent of total	No. of Contributions (%)	No. of Persons Contributing	Per Cent of total
1	3,991	57.92	36	1	0.01
2	1,059	15.37	37	1	0.01
3	493	7.15	38	4	0.06
4	287	4.16	39	3	0.04
5	184	2.67	40	2	0.03
6	131	1.90	41	1	0.01
7	113	1.64	42	2	0.03
8	85	1.23	44	3	0.04
9	64	0.93	45	4	0.06
10	65	0.94	46	2	0.03
11	41	0.59	47	3	0.04
12	47	0.68	49	1	0.01
13	32	0.46	50	2	0.03
14	28	0.41	51	1	0.01
15	21	0.30	52	2	0.03
16	24	0.35	53	2	0.03
17	18	0.26	54	2	0.03
18	19	0.28	55	3	0.04
19	17	0.25	57	1	0.01
20	14	0.20	58	1	0.01
21	9	0.13	61	2	0.03
22	11	0.16	66	1	0.01
23	8	0.12	68	2	0.03
24	8	0.12	73	1	0.01
25	9	0.13	78	1	0.01
26	9	0.13	80	1	0.01
27	8	0.12	84	1	0.01
28	10	0.15	95	1	0.01
29	8	0.12	107	1	0.01
30	7	0.10	109	1	0.01
31	3	0.04	114	1	0.01
32	3	0.04	346	1	0.01
33	6	0.09			
34	4	0.06	Total	6,891	

## AUERBACH'S TABLES

No. of Contributions (%)	No. of Persons Contributing	Per Cent of total	No. of Contributions (%)	No. of Persons Contributing	Per Cent of total
1	784	59.17	15	5	0.38
2	204	15.40	16	3	0.23
3	127	9.58	17	3	0.23
4	50	3.77	18	1	0.08
5	33	2.49	21	1	0.08
6	28	2.11	22	3	0.23
7	19	1.43	24	3	0.23
8	19	1.43	25	2	0.15
9	6	0.45	27	1	0.08
10	7	0.53	30	1	0.08
11	6	0.45	34	1	0.08
12	7	0.53	37	1	0.08
13	4	0.30	48	2	0.15
14	4	0.30	Totals	1,325	

$$f = 600 / (\pi^2 n^2)$$

similarly fitted the frequency distribution (in percentage) for the production of papers in physics. A least-squares determination of the coefficient of  $n$  in the second function gave a value of 2.021.

On the basis of these results Lotka was led to speak of the "inverse-square law of scientific production," according to which "the proportion of all contributors who contribute a single item should be just over 60 per cent." Lotka's data are graphically represented in Figure 129.

An interesting verification of the general thesis of the Pareto distribution of special abilities is given in the following data published in the 28th annual report of the General Motors Corporation for the year ending December 31, 1936. This report shows the salary schedule for the executive administrative staff of the corporation.

Salary Group	No. of Individuals	Salary Group	No. of Individuals
\$ 5,000- 9,999	1,363	\$50,000-59,999	8
10,000-14,999	173	60,000-69,999	1
15,000-19,999	67	70,000-79,999	8
20,000-29,999	42	80,000-99,999	1
30,000-39,999	9	100,000 and over	2
40,000-49,999	4	Total	1,678

Arranging the data in the following accumulated frequency table:

Salary ( $x$ )	Number ( $y$ )	Salary ( $x$ )	Number ( $y$ )
\$ 5,000	1,678	\$ 50,000	20
10,000	315	60,000	12
15,000	142	70,000	11
20,000	75	80,000	3
30,000	33	100,000	2
40,000	24		

we find for the graduation the following curve:

$$\log y = 10.83006 - 2.067 \log x .$$

An interesting attempt has recently been made by C. H. Boissevain to give a genetic basis to the thesis which has been advanced in this section.<sup>22</sup> Boissevain's assumption is that special abilities are the products of several genetic factors and hence their deviation from the normal distribution comes about through the combination of independent factors derived from the compounding of two or more normal distributions. We quote his argument as follows:

<sup>22</sup> "Distribution of Abilities Depending upon Two or More Independent Factors," *Metron*, Vol. 13, No. 4, December, 1939, pp. 49-58.

If a simple physical attribute like eyesight or muscular coordination is graduated according to the classmarks  $0 - 1 - 2 - \dots - n$ , the frequency of each class is given by the binomial coefficients  ${}_n C_r$ . We may assume that the classmark for the ability of an individual to play baseball or billiards is given by the product of the classmarks for each of the separate factors (eyesight and muscular coordination) that are essential for the development of such skill. Adoption of the product rather than the sum for this purpose represents the fact that a man with excellent eyesight but very poor muscular coordination will undoubtedly be inferior as a baseball player to a man with average eyesight and average muscular coordination. In other professions, a man with great energy and very low intelligence may be inferior to a man of average intelligence and energy.

If the classmark for baseball ability is  $n_1 n_2$  when  $n_1$  is the classmark for eyesight and  $n_2$  that for muscular coordination, we can form  $n$  classes by dividing the range from 0 to  $n^2$  in  $n$  equal intervals and giving them the classmarks 0 to  $n-1$ . If the number of individuals with the classmark  $r_1$  for eyesight be  ${}_n C_{r_1}$ , the number of those individuals having the classmark  $r_2$  for muscular coordination is  ${}_n C_{r_2}$ , divided by  $2^n$ : By forming the sums of all such products for which  $r_1 r_2$  falls between 0 and  $n$ ,  $n$  and  $2n$ , etc. the number of individuals in each of these classes of baseball ability is found.

By repeating this process the distribution can be found that may be expected for skills depending upon more than two factors. The frequencies to be expected for skills depending upon 2, 3 and 4 independent factors were computed, using the binomial coefficients for  $n = 15$ . [These are recorded in the accompanying table] . . . .

BINOMIAL DISTRIBUTION COMPUTED FOR 1, 2, 3, AND 4 INDEPENDENT FACTORS  
( $n = 15$ )

Classmarks	One factor	Two factors	Three factors	Four factors
0	1	264.1748	7,913.4647	25,154.8971
1	15	3,276.5144	14,953.3004	6,587.7740
2	105	7,377.4345	7,270.9252	913.2319
3	455	9,135.1783	2,180.8799	93.4260
4	1365	6,952.8644	354.3069	16.9316
5	3003	4,149.1951	81.7110	1.5262
6	5005	959.6597	10.9779	0.1880
7	6435	510.9387	2.2251	0.0208
8	6435	118.9015	0.1717	0.0039
9	5005	17.9984	0.0319	0.0005
10	3003	4.2490	0.0047	0.0001
11	1365	0.7808	0.0005	0.000009
12	455	0.1025	0.00003	0.0000013
13	105	0.0078	0.0000003	0.00000003
14	15	0.00003	0.000000001	0.000000001
15	1			
Total	32,768	32,767.9999	32,767.9999	32,768.0001

The compound binomial distribution, depending upon two or more independent binomial distributions, shows two important changes from the simple binomial distribution. The number of individuals in the modal class is increased with each successive combination, and the modal class is shifted to the lower classmarks. In the binomial distribution for  $n = 15$ , the classmarks 7 and 8 rep-

represent the modal class with 6,435 individuals in each. For the compound binomial distribution, involving two factors, the classmark of the modal class is 3 and the number of individuals in it 9,135; for three factors these figures are 1 and 14,953, and for four factors 0 and 25,155.

If a skill depends upon two factors, the modal class represents a fairly low degree of skill, with considerable numbers in the lowest classes. On the other hand, the number of individuals per class falls off rapidly for the higher degrees of skill. The number in the lowest class is  $1/40$ th of the number in the modal class, but the number in the highest class is only  $1/100,000,000$ th of the mode. In other words, we can expect the supreme type of ball player or billiards player to occur only once in a century, while players of very little ability must be fairly common.

### *15. Application of the Pareto Distribution of Income to Political Events*

It is quite apparent that in the varied political and economic fortunes of large states, the distribution of incomes should not hold rigidly to the Pareto pattern. Thus we observe from the data given in Section 7 that our own economy has shown a variation in  $\nu$  from 1.34 in 1916 (Johnson's estimate) to 1.90 in 1921. This means that the concentration ratio,  $\rho$ , (Section 13) has varied from 0.5952 in the first instance to 0.3571 in the second.

It is an interesting speculation to inquire into the possible political effects of an abnormal deviation of the Pareto index from its assumed normal value of 1.5, or, perhaps, of the more descriptive ratio of concentration from its norm of 0.5. Thus we observe in the critical years 1920 and 1921, when one of the most spectacular price declines in economic history occurred, that the concentration ratio was far below normal. Again in the abnormal inflationary years 1928 and 1929 the concentration ratio was substantially above normal. The depression decade since the collapse of the great bull market in 1929 has witnessed a persistent decline in the concentration ratio. From the great sensitivity of the incomes of the upper Pareto classes to fluctuations in the business cycle, as described in Section 12, it is not unreasonable to suppose that disturbances in the Pareto index and the concentration ratio may be accompanied by economic and political disturbances. Whether the variation in these values is the cause or the effect of the observed events is a question for debate, although some indication of the causal relationships may be learned from the events of the last decade. Thus we may observe that the main effect of the legislation of the New Deal era was to lower the concentration ratio by transferring funds by taxation from the upper income classes to the lower. As this transfer has taken place, business has failed to recover to the levels established around 1926, when the concentration

ratio was approximately normal. We shall tentatively assume, therefore, that critical values of these parameters exist for which we may expect major economic and political disturbances.

Unfortunately for the statistical verification of this thesis data are lacking from those national economies which have been disrupted by revolution and civil war. However, it is quite plausible to infer from historical sources that the French Revolution and the more recent Russian Revolution were both aggravated, if not actually caused, by an undue concentration of wealth and income. Similarly, the socialistic trends of the Spanish Government after the overthrow of the monarchy must certainly have lowered greatly the ratio of concentration from its Pareto norm. The civil war was thus a direct consequence of this disruption. The American Civil War was largely a result of the question of slavery in the Southern states. The distribution of slave holdings in this region was approximately Paretian and hence a large disturbance was caused in the concentration ratio when the slaves were freed. It is not unreasonable to suppose that the slow economic recovery of the South, when compared with that of the North, was not so much due to the fact that the North was victorious as to this dislocation of the concentration parameter.

We shall advance the tentative hypothesis that revolution is likely in any economy where the concentration ratio exceeds a certain critical value,  $\rho_0 > 0.5$ , and that a civil war is likely in any economy where the concentration ratio falls below a certain critical value,  $\rho_1 < 0.5$ . Since the mass of the people is affected adversely in the first instance, the revolution will be rapid and overwhelming. In the second instance, the upper economic classes, numerically small, but powerful in resources, are affected. Hence the civil war is slow to start and must be long in duration, since it must be waged to a considerable extent by mercenary means.

What these critical values are we have at present no way of estimating. In the United States, if we exclude the period of the World War, the concentration ratio has varied from approximately 0.40 to approximately 0.60 without an undue amount of political unrest. Hence we may assume that any values within these ranges are not politically dangerous.

Considerable unrest has recently been observed in France, so it becomes a matter of some interest to inquire into the income distribution of that republic. Unfortunately such data are not available, but the figures on page 436 on the French declaration of estates in the year 1935 may throw some light on the matter:

Since the average value is found to equal 45,579 we see that these

Range of net values in francs	Number	Accumulated Frequency (%)	log $x$	log $y$
1 to 500	26,382	370,150	0.00000	5.56838
501 to 2,000	46,103	343,768	2.69984	5.53627
2,001 to 10,000	121,581	297,665	3.30125	5.47373
10,001 to 50,000	127,694	176,084	4.00004	5.24571
50,001 to 100,000	25,529	48,390	4.69898	4.68476
100,001 to 250,000	14,789	22,861	5.00000	4.35910
250,001 to 500,000	4,637	8,072	5.39794	3.90698
500,001 to 1,000,000	2,004	3,435	6.69897	3.53593
1 million to 2 millions	891	1,431	6.00000	3.15564
2 millions to 5 millions	418	540	6.30103	2.73239
5 millions to 10 millions	83	122	6.69897	2.08636
10 millions to 50 millions	37	39	7.00000	1.59106
over 50 millions	2	2	7.69897	0.30103

data do not carry us a long way into the Pareto tail. Hence the slopes must be approximated from the last items of the data rather than from the data as a whole. Thus, employing the last three items only in our calculation, we obtain as the Pareto index the numbers 1.62, 1.65, and 1.85. The latter corresponds to a concentration ratio of 0.3704. The obvious socialistic tendency of the French economy is thus apparent and there are reasons to believe that it has progressed in this direction during the years since 1935 to which the above data pertain. Thus we find that the Chamber of Deputies had 100 socialists in 1928, 131 in 1932, and 149 in 1936. The inquiry may well be raised as to whether or not social disturbances may not be expected to occur as the concentration ratio continues to diminish? Recent political events seem to confirm this observation.<sup>23</sup>

The a priori reason for these deductions is found in the general assumption that a Pareto concentration of wealth and income is essential in supplying the necessary capital to provide employment for an optimum number of workers. The drop in income concentration is symptomatic of a drop in capital concentration and this reacts upon employment. Those affected then assume that the concentration of wealth is responsible for their difficulties and the urge toward socialism is accelerated with its ensuing troubles. Some further observations upon this point with regard to the economy of the United States will be made in the next chapter.

<sup>23</sup> Since these lines were written we have witnessed the disruptive events of the war and the easy victory won by the Germany army over the French. The great fortresses of the Maginot line were taken with scarcely a blow. Why this curious weakness! It seems to be the conclusion of careful political observers that the French collapse was internal. Industry was inefficient and a lack of unity was evident in the government. It is not difficult to infer that the industrial dislocations, inevitable when there prevails a low index of the concentration of wealth, furnish a partial if not a major interpretation of the situation.



Since the interpretation of the significance of the concentration ratio that we have given above rests upon a tenuous statistical basis, it seems appropriate that we should attempt to present a further justification for our conclusions. Hence, we shall consider briefly the events which have been associated with significant changes in the ratio in the United States, and we shall give a theoretical reason for expecting labor and production difficulties when unusual variations occur in the ratio over any extended period of time.

The following table gives the values of the concentration ratio,  $\rho$ , as they have been determined from income-tax returns in the United States for the years from 1914 to 1938 inclusive:

VALUES OF THE CONCENTRATION RATIO,  $\rho$ .

Year	$\rho$	Year	$\rho$	Year	$\rho$	Year	$\rho$	Year	$\rho$
1914	0.481	1919	0.413	1924	0.427	1929	0.543	1934	0.427
1915	0.556	1920	0.379	1925	0.481	1930	0.446	1935	0.436
1916	0.595	1921	0.357	1926	0.476	1931	0.413	1936	0.442
1917	0.505	1922	0.413	1927	0.490	1932	0.397	1937	0.420
1918	0.435	1923	0.407	1928	0.543	1933	0.417	1938	0.400

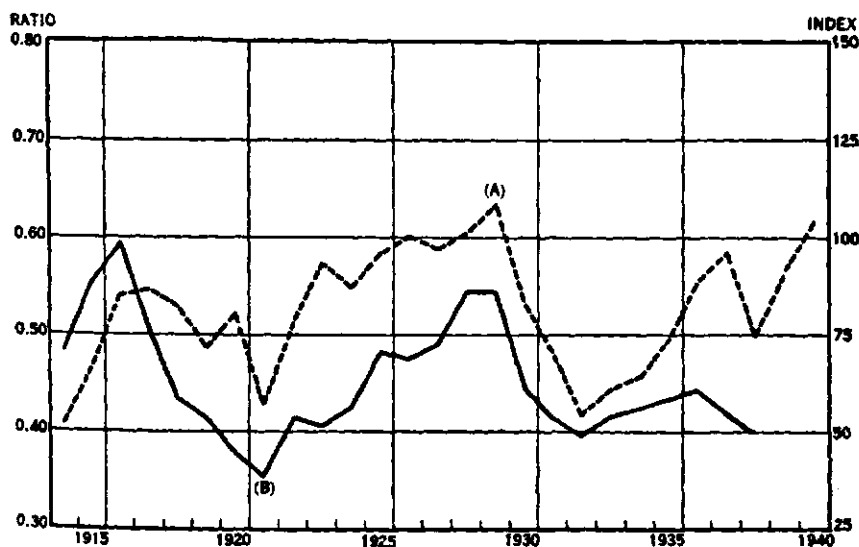

FIGURE 129a.—(A) INDUSTRIAL PRODUCTION. (B) CONCENTRATION RATIO.

These values, together with the index of production, are graphically represented in Figure 129-a. From this figure we see that long declines of the concentration ratio occurred between 1916 and 1921 and between 1929 and 1932. Although war expenditures tended to cushion the effects of the decline of the ratio in the first period, it is

noticeable that industrial production fell off sharply during these years and reached a minimum in 1921. In the second instance the country sank into the trough of a severe depression from which it has never fully recovered. Although industrial production was more than normally high in 1937, it is especially significant that the concentration ratio never returned to its normal Paretian value throughout the period from 1932 to 1938. On the other side of the picture we observe the regular advance of the concentration ratio from 1921 to 1928, an advance that was accompanied by increasing production and general economic well-being. Unfortunately the ratio overshot its mark, and for this reason, or perhaps for others, this prosperous period was short-lived.

In order to give a theoretical explanation of these phenomena, we shall attempt to relate the variations of the concentration ratio to the variations of production by means of a function proposed by P. H. Douglas and C. W. Cobb.<sup>24</sup> This function asserts that Production ( $P$ ), Labor ( $L$ ), and Capital ( $C$ ) are connected in the following manner:

$$(1) \quad P = A L^p C^q, \quad p + q = 1,$$

where  $A$  is a constant. Douglas and Cobb have found that  $p$  is approximately equal to 0.75 and  $q$  is 0.25 for the economy of the United States.

It will be convenient for our purpose to write equation (1) in the form

$$(2) \quad \frac{\Delta P}{P} = p \frac{\Delta L}{L} + q \frac{\Delta C}{C},$$

since it is the variation from a Paretian economy which concerns us here.

Presumably the effects of a change in the concentration ratio are reflected directly in the capital structure of the economy and from it are carried to production and labor by means of the relationship given in equation (2). Let us indicate this by writing

$$(3) \quad \frac{\Delta C}{C} = \Delta(\rho),$$

where  $\Delta(\rho)$  is a function to be determined.

<sup>24</sup> "A Theory of Production," *American Economic Review*, Vol. 18 (Supplement), 1928, pp. 139-165. This function has been the subject of much debate since it was first proposed, but its general validity seems pretty well established. For a discussion of it the reader is referred to a recent study by P. H. Douglas and Grace Gunn, "The Production Function for American Manufacturing in 1919," *American Economic Review*, Vol. 31, 1941, pp. 67-80.

In order to compute  $\Delta(\rho)$  we shall assume that a change in capital is directly proportional to a change in the average income per income receiver. This proposition is essentially equivalent to the assumption that savings increase linearly with income and that capital increase is proportional to savings. If we define  $I$  as the value given by formula (12) of Section 9 and  $N$  as the value given by formula (11) of that section, then we can write

$$(4) \quad C = k \left( \frac{I}{N} - \frac{I_0}{N_0} \right),$$

where  $k$  is a factor of proportionality and  $I_0/N_0$  is the ratio at some arbitrary origin. Since we are discussing the variation from a Paretian economy, this comparison ratio will be computed for the concentration ratio,  $\rho_0 = 0.5$ .

Making use of the values of  $I$  and  $N$  as given by the formulas cited and noting from Section 13 that  $\mu = (1 + 3\rho)/2\rho$ , we readily obtain

$$(5) \quad \frac{I}{N} = b \frac{\zeta(R)}{R \zeta(1+R)}, \quad R = \frac{1+\rho}{2\rho},$$

where  $\zeta(R)$  is the function defined in Section 9.

If, in this equation, we designate the multiplier of  $b$  by  $F(\rho)$  and if we assume further that in a Paretian economy  $C$  is proportional to  $I_0/N_0$ , namely,  $C = k I_0/N_0$ , then we obtain the desired formula

$$(6) \quad \frac{\Delta C}{C} = \Delta(\rho) = \frac{F(\rho) - F(\rho_0)}{F(\rho_0)}.$$

In order to observe the effects of a change in the concentration ratio upon the capital structure of the economy we compute  $\Delta(\rho)$  for the two extreme values  $\rho = 0.3$  and  $\rho = 0.7$ , assuming, of course, that  $\rho_0 = 0.5$ . We thus obtain  $\Delta(0.3) = -0.5528$  and  $\Delta(0.7) = 1.4079$ .

Returning now to formula (2) and assuming the Douglas-Cobb values for  $p$  and  $q$ , we find that, when  $\Delta P = 0$ , the ratio  $\Delta L/L$  is equal to 0.1843 when  $\rho = 0.3$  and is equal to  $-0.4693$  when  $\rho = 0.7$ . That is to say, when  $\rho$  is as low as 0.3, labor must be increased as much as 18 per cent to maintain the normal production of a Paretian concentration of income, but if  $\rho$  is as high as 0.7, and there is no increase in production, then labor must be reduced by 47 per cent. What this means in practical terms is that, when capital is reduced, production can be maintained only by replacing machines by labor, but when capital is too plentiful, machines will be used to replace labor. During

the last ten years we have seen, through government projects, an increase in labor at the expense of machines and a maintenance of production under low income concentration. The phenomenon of a reduction of labor under an increase in machines might have occurred during the years 1921 to 1929 except that production itself was accelerated.

Returning to our main thesis, we are now able to conclude that rapid changes in the concentration ratio can easily lead to changes both in production and labor. If these changes are too rapid or too extended, then violent political repercussions may be expected.

### 16. Conclusions

From many varied sources we have found that the accumulated frequency curve of distributions of people arranged according to some special ability can be graduated by a parabolic curve, whose exponent is nearly 2. From this we may safely conclude that such distributions cannot be described in terms of the theory of the normal probability curve and that the ordinary laws of chance are disturbed by another law operative in the case of special abilities.

Since the data which pertain to incomes are also graduated by a parabolic curve it is reasonable to assume that the ability to accumulate wealth is an ability not dissimilar to those which appear in games of skill and in the production of scientific literature. The fact that the essential exponent in the latter cases is approximately 2, while the exponent in income distributions is approximately 1.5 is no argument against the general thesis. This discrepancy may be accounted for easily by denying the strict equivalence of one dollar earned and kept at any level of the income distribution.

Our general conclusion would be, then, that the Pareto distribution of income is a necessary phenomenon of any stable economic state. The reason for the distribution must be sought in the mysterious realm of human psychology which accounts for the existence and distribution of special abilities.

### SELECTED BIBLIOGRAPHY OF THE DISTRIBUTION OF INCOME

- D'ADDARIO, R. "Sulla curva dei redditi di Amoroso," *Annali dell' Istituto di Statistica*, Bari, Vol. 10, 1936, pp. 1-57.
- AMMON, O. *Die Gesellschaftsordnung und ihre natürlichen Grundlagen*. First ed., Jena, 1895; 3rd ed., 1900, viii + 408 pp.
- AMOROSO, L. "Ricerche intorno alla curva dei redditi," *Annali di matematica*, Vol. 2, 4th series, 1924-25, pp. 123-160.
- BAXTER, R. D. *National Income: The United Kingdom*. London, 1868, 100 pp.

- BORTKIEWICZ, L. VON. "Die Disparitätsmasse der Einkommensstatistik," *Bulletin de l'institut international de statistique*, Vol. 25, 1931, pp. 189-298.
- BRESCIANI-TURRONI, C. (1). "On Pareto's Law," *Journal of the Royal Statistical Society*, Vol. 100, 1937, pp. 421-432.
- (2) "Annual Survey of Statistical Data: Pareto's Law and the Index of Inequalities of Incomes," *Econometrica*, Vol. 7, 1939, pp. 107-133.
- CASTELLANO, V. "Sulle relazioni tra curve di frequenza e curve di concentrazione e sui rapporti di concentrazione corrispondenti a determinate distribuzioni," *Metron*, Vol. 10, No. 4, 1933, pp. 3-60.
- CZUBER, E. *Beitrag zur Theorie der statistischer Reihen*. Versicherungswissenschaftliche Mitteilungen. Neue Folge, 9 Band, 2 Heft, Wien, 1914.
- DALTON, H. (1) "The Measurement of the Inequality of Incomes," *Economic Journal*, Vol. 30, 1920, pp. 348-361.
- (2) *Inequality of Incomes*. First ed., London, 1920; 2nd ed., 1925, xii + 360 pp. + appendix of 16 pp.
- DARMOIS, G. "Distributions statistiques rattachées a la loi de Gauss et la répartition des revenus," *Econometrica*, Vol. 1, 1933, pp. 159-161.
- DAVIS, H. T. (1) "The Significance of the Curve of Income," Cowles Commission for Research in Economics, *Report of Fourth Annual Research Conference . . . 1938*, pp. 19-22.
- (2) "Relationship between the Distribution of Income and Total Real Income," Cowles Commission for Research in Economics, *Report of Fifth Annual Research Conference . . . 1939*, pp. 76-77.
- FRÉCHET, M. "Sur les formules de répartition des revenus," *Revue de l'institut international de statistique*, 7 année, 1939, pp. 32-38.
- GALTON, SIR FRANCIS. *Hereditary Genius. An Inquiry into its Laws and Consequences*. New York, 1869, xxvii + 379 pp.
- GIBRAT, R. *Les inégalités économiques*. Paris, 1931, 296 pp.
- GINI, C. (1) "The Contributions of Italy to Modern Statistical Methods," *Journal of the Royal Statistical Society*, Vol. 89, 1926, pp. 703-724.
- (2) "Sul massimo degli indici di variabilità assoluta e sulle sue applicazioni agli indici di variabilità relativa e al rapporto di concentrazione," *Metron*, Vol. 8, 1930, No. 3, pp. 3-65.
- (3) "Intorno alle curve di concentrazione," *Metron*, Vol. 9, 1932, Nos. 3-4, pp. 3-76.
- (4) "Di una estensione del concetto di scostamento medio," *Atti del R. Istituto Veneto*, 1917-18.
- (5) "On the Measure of Concentration with Special Reference to Income and Wealth," *Abstracts of Papers Presented at the Research Conference . . . Held by the Cowles Commission . . . 1936*, (Colorado College Publication, General Series No. 208) pp. 73-80.
- JOHNSON, N. O. (1) "The Brookings Report on Inequality in Income Distribution," *Quarterly Journal of Economics*, Vol. 49, 1935, pp. 718-724.
- (2) "The Pareto Law," *Review of Economic Statistics*, Vol. 19, 1937, pp. 20-26.
- KING, W. I. (1) *The National Income and its Purchasing Power*. National Bureau of Economic Research, New York, 1930, 394 pp.
- (2) *Wealth and Income of the People of the United States*, New York, 1915, xxiv + 278 pp.
- KUZNETS, S. *The National Income, 1929-1932*. Sen. Doc. 124, 73rd Congress, 2nd

- Session, Washington, D.C., 1934, xi + 261 pp. Summarized in *Bulletin 49*, National Bureau of Economic Research, 1934.
- LEVEN, M. (with H. G. MOULTON and C. WARBURTON), *America's Capacity to Consume*. The Brookings Institution, Washington, D. C., 1934, xi + 272 pp.
- LORENZ, M. O. "Methods of Measuring the Concentration of Wealth," *Publications of the American Statistical Association*, Vol. 9 (New series), 1905, pp. 209-219.
- MACAULAY, F. R. "The Personal Distribution of Income in the United States," Part 3, pp. 341-425 of *Income in the United States—Its Amount and Distribution*, Vol. 2, New York, 1922, Publication No. 2 of the National Bureau of Economic Research, xiv + 440 pp.
- MARCH, L. "Quelques exemples de distribution de salaires," *Journal de la Société de Statistique de Paris*, 1898.
- MARSCHAK, J. *Elastizität der Nachfrage*. Tübingen, 1931, p. 83 et seq.
- MACGREGOR, D. H. "Pareto's Law," *Economic Journal*, Vol. 46, 1936, pp. 80-87.
- MOULTON, H. G. (see Leven, M.).
- PARETO, V. (1) "Aggiunta allo studio sulla curva delle entrate," *Giornale degli Economisti*, 1897.  
 (2) *Cours d'économie politique*. Lausanne, 1897. Tome 2, Livre 3, Chapter 1.  
 (3) *Manuel d'économie politique*. Paris, 1909; 2nd ed., 1927. Chapter 7; in particular, pp. 390 et seq.
- PIETRA, G. "Delle relazioni tra gli indici di variabilità," *Atti del R. Istituto Veneto*, 1914-15 (two notes).
- PIGOU, A. C. *The Economics of Welfare*. First ed., London, 1920; 4th, ed., 1932, Part 4, Chapter 2, pp. 647-655.
- POWERS, L. G. "Factors Producing Unequal Wealth Distribution and Ownership and Measurements of their Influence," *Journal of the American Statistical Association*, Vol. 23, 1928, pp. 417-428.
- RICCI, U. "L'indice di variabilità e la curva dei redditi," *Giornale degli Economisti*, 1916.
- SAIBANTE, M. (1) "I profitti delle società per azioni e la concentrazione dei capitali industriali," *Metron*, Vol. 6, No. 1, 1926, pp. 165-201.  
 (2) "La concentrazione della popolazione," *Metron*, Vol. 7, No. 2, 1928, pp. 53-99.
- SHIRRAS, G. F. "The Pareto Law and the Distribution of Income," *Economic Journal*, Vol. 45, 1935, pp. 663-681.
- SNYDER, C. (1) "The Pareto Curve and its Significance for our Time," Cowles Commission for Research in Economics, *Report of Third Annual Research Conference . . . 1937*, pp. 60-62.  
 (2) *Capitalism the Creator*. New York, 1940, xii + 473 pp. In particular, Chapters 14 and 15.
- STAEHLE, H. "Short-Period Variations in the Distribution of Incomes," *Review of Economic Statistics*, Vol. 19, 1937, pp. 133-143.
- TUCKER, R. S. "The Distribution of Income Among Income Taxpayers in the United States, 1863-1935," *Quarterly Journal of Economics*, Vol. 52, 1938, pp. 547-587.
- VINCI, F. (1) "La concentrazione dei capitali delle nostre società ordinarie per azioni," *Rivista della società commerciali*, Anno 8, Fasc. 3, 1918.  
 (2) "Recenti vedute sulla legge di distribuzione dei redditi," in *Problemi di finanza fascista*, Bologna, 1937, p. 332.

WARBURTON, C. (see Leven, M.)

WIJK, J. VAN DER. *Incomens- en Vermogensverdeling. (Distribution of Incomes and Fortunes)*. Haarlem, 1939. Publication No. 26 of the Netherlands Economic Institute, xv + 295 pp. This contains a five-page summary in English.

WOLD, H. "A Study on the Mean Difference, Concentration Curves, and Concentration Ratio," *Metron*, Vol. 12, No. 2, 1935, pp. 39-58.

YNTEMA, D. B. "Measures of the Inequality in the Personal Distribution of Wealth or Income," *Journal of the American Statistical Association*, Vol. 28, 1933, pp. 423-433.

YOUNG, A. A. "Do the Statistics of the Concentration of Wealth in the United States Mean What they are Commonly Assumed To Mean?" *Journal of the American Statistical Association*, Vol. 15 (new series), 1917, pp. 476-484.

## CHAPTER 10

### THE DYNAMICS OF TRENDS FROM THE POINT OF VIEW OF THE EQUATION OF EXCHANGE

#### 1. *Historical Introduction*

A casual survey of the data of time series reveals at once a striking difference between those series which measure production and those which measure prices. From the macroscopic point of view the trend of prices tends to remain constant, whereas the trend of production is logistic in its general structure.<sup>1</sup> But we also observe that both series have cyclical movements, which, when properly analyzed with an eye to fundamental differences in their trends, exhibit a persistent correlation. One of our most striking observations, for example, is found in the fact that the serial correlation between industrial stock prices and pig-iron production does not damp out in the same degree as autocorrelations tend to do.

The purpose of the present chapter is to inquire more deeply into the interrelationships between price and production which we have observed. It is obvious that this inquiry cannot be entirely a statistical one, but must go back to some fundamental postulates of the theory of economics. It is natural that we should begin with an investigation of the relationship of money to price, and then proceed from this to the more fundamental one of the production of wealth and income.

Many fallacious views have been held about the relationship of money to prices and disastrous experiments have been tried from time to time based upon monetary theories that have proved to be false. The result has been, however, that we are gradually accumulating a body of statistical data which bear upon this important problem. It has long been noted that money has a certain psychological value, which is measured, at least approximately, by its marginal utility. It is also a matter of common observation that great business depressions are heralded by a fall in the index of prices. Does money also decrease during these periods? What is the relationship of money to trade crises?

<sup>1</sup> At least the average level of prices has changed but little since the level of present times was established at the end of the sixteenth century. See, for example Figure 135.



One of the central theories used in attacking these interesting and vital problems is called the *quantity theory of money*. This is formulated mathematically in what has been called the *equation of exchange*, which assumes that money,  $M$ , and credit,  $M'$ , are related to price,  $P$ , and trade,  $T$ , by the equation

$$(1) \quad MV + M'V' = PT.$$

The parameters  $V$  and  $V'$  are called respectively the *velocities* of money and credit and the equation is regarded as being essentially an identity in the tautological sense.

This equation was first written down by Simon Newcomb (1835–1909), that prolific genius who not only established a high reputation in economics, but was also the leading astronomer of his time. The equation and its implications appear in Newcomb's *Principles of Political Economy* published in 1886. This historical passage (p. 346) we quote below as follows:

The law which would determine the amount of variation in wages and prices in every case, after things had been readjusted on the new basis, can be got at by considering that in the industrial circulation nothing would really be changed except the scale of prices. The quantities purchased being the same as before,  $K$  [the industrial circulation] remains unchanged. In the equation  $K \times P = V \times R$ ,  $R$  [the rapidity of circulation] also would be unchanged; whence it follows that the rise in the price  $P$  would be proportional to the increase in the total volume  $V$  of the currency. For example, if in the beginning the total volume of the currency had averaged \$10 per capita, then a gift of \$5 to every person would add 50 per cent to the volume of currency. To restore the equilibrium, the scale of prices, represented by  $P$ , would have to be increased 50 per cent also. If, instead of adding 50 per cent to the currency, it had been doubled, prices would double. After the equilibrium was restored every two dollars would do the same work which one dollar had done before. Leaving out the case of debtors and creditors, and the temporary disturbance before equilibrium was restored, everything would be readjusted on this basis of double prices.

Since the volume of currency and the prices would be increased in the same proportion, it follows that the quantity of goods whose value would equal the total volume of the currency would remain unchanged. We may express this result in the following form:

*When the volume of the currency fluctuates, other conditions being equal, the purchasing power of each unit of money varies inversely as the whole number of units, so that the total absolute value of the whole volume of currency remains unaltered by changes in that volume.*

The question now arises, What fixes this absolute value of the total volume of currency? To answer this let us return to the equation of society circulation,  $V \times R = K \times P$ . Here  $R$  represents the number of times that a dollar changes hands in a year. If we divide the year by  $R$ , we shall have the average length of time that a dollar remains in one man's hands. If we take this period instead of one year as our unit of time, we shall have  $R = 1$ .  $K$  will then be the total value of

the exchanges during this period, measured on the unit scale for which  $P = 1$ . Thus the equation will become  $V = K$ . We conclude:

*The absolute value of the total volume of currency circulating in a social organism is equal to that of the total industrial circulation of the organism during the average time that a piece of money remains in one man's hands.*

Although this interesting relationship between money, trade, velocity, and prices attracted the immediate attention of economists, it was not until 1895 that any attempt was made to examine independently the different variables and to subject them to statistical scrutiny. In that year Pierre des Essars published a study based upon the observed velocity of deposits in certain individual banks in different European countries.<sup>1a</sup>

The next attempt to measure the variables was made by E. W. Kemmerer, who published in 1909 his notable work, *Money and Credit Instruments in their Relations to General Prices*. About this study Irving Fisher says: "Professor Kemmerer's calculation is, I believe, the first serious attempt ever made to test statistically the so-called 'quantity theory' of money. The results show a correspondence which is very surprising when we consider the exceedingly rough and fragmentary character of the data employed." Kemmerer considered the value of the variables over the period from 1879 to 1908, but the lack of adequate data, particularly with respect to trade, seriously impaired the conclusions.

A new scrutiny of the problem was called for. This appeared in 1911 in the now classical study on *The Purchasing Power of Money*, published by Irving Fisher with the assistance of H. G. Brown.<sup>2</sup> This elaborate work is essentially an examination into the constituents of the equation of exchange in the form in which it has been given above in equation (1).

These important works attracted the renewed attention of the economists to the *quantity theory of money*, and a vigorous debate has progressed since that time over the fundamental interpretation of the variables. Strange to say, most of the debate has been on a priori principles; until recently, few serious attempts were made to appraise the statistical relationships between the variables.

A notable exception to this is found in the work of Carl Snyder. This statistician, over a period of years, assembled data from many sources in order to measure the variables in the equation of exchange. His theory and the contributing data are given in his work, *Business*

<sup>1a</sup> "La vitesse de la circulation de la monnaie," *Journal de la Société de Statistique de Paris*, 1895, p. 143.

<sup>2</sup> New York, 1911, xxii + 505 pp.; second edition, 1931.

*Cycles and Business Measurements.*<sup>3</sup> A summary of his theory will be found in a paper, "Industrial Growth and Monetary Theory," published in the *Economic Forum*.<sup>4</sup> The postulates of Snyder's theory have recently been formulated in mathematical terms by E. V. Huntington.<sup>5</sup>

Current data are now available through The Standard Statistics Company<sup>5a</sup> which give the velocity of bank deposits by months, the series extending to 1919. A fairly adequate series on bank debits also exists to 1919. J. W. Angell in his book on *The Behavior of Money*, published in 1936, gives comprehensive data on circulating currency and circulating deposits from 1890 to 1934 inclusive.

## 2. *The Variables in the Equation of Exchange*

Before considering the constituents of equation (1), let us inquire into the nature of a somewhat similar equation in the theory of electricity. This equation,

$$(2) \quad E = IR,$$

expresses the relationship between  $E$ , the electromotive force,  $I$ , the current, and  $R$  the resistance, when electricity is flowing through a simple circuit. This equation may be regarded as a *law of nature*, provided the three symbols are measured in proper units. Moreover any two of the variables is sufficient to define the third. One of the first problems in the history of electricity was that of devising methods for the independent measurement of  $E$ ,  $I$ , and  $R$ . The first quantity was associated with the battery, or other source of electromotive force; the second was the quantity driven through the wire; the third was associated with the wire itself.

But if one approaches the problem without reference to preconceived images of the three quantities, it is obvious that the force which drives something through the wire must be equal to what is driven multiplied by some parameter representing the retarding influence of the wire. The equation in this sense is a mere tautology and it emerges into a law of nature only after a careful independent definition has been given to the three variables involved.

A similar remark applies to the equation of exchange, since what we spend, as represented by the symbols on the left-hand side, must

<sup>3</sup> New York, 1927, xv + 326 pp.

<sup>4</sup> 1933, pp. 275-290.

<sup>5</sup> "On the Mathematical Hypotheses Underlying Carl Snyder's Trade-Credit Ratio Theorem," *Econometrica*, Vol. 6, 1938, pp. 177-179.

<sup>5a</sup> This company is now Standard & Poor's Corporation.

be precisely equal to what we purchase, as defined by the product  $PT$ . But this futile tautology disappears, just as it does in equation (2) above, as soon as we have given precise and independent meaning to the six parameters.

A great deal of the mystery associated with this equation disappears when the variables have been independently described and statistical methods devised for their measurement. We shall proceed, therefore, to a careful consideration of the six quantities and the meanings that are to be associated with them.

### 3. *Circulating Money (M)*

The quantity  $M$  in the equation of exchange denotes circulating money. Since a penumbra of uncertainty surrounds this definition, just as it does most definitions in economics which are unsupported by statistical data, we shall give it a more precise meaning through the elements of a statistical series.

Circulating money has meant different things at different times and in different countries. Before the institution of banking, circulating money was for the most part gold and silver coins. At times it has been principally paper notes, supported by the credit of the issuing government, as is the case with most countries with modern banking systems. It is interesting to note that the internal circulating currency of Germany, after the great inflation of 1922-23, with a metal base of perhaps 0.3 of one per cent of the world's monetary gold, possessed approximately the same stability as the circulating currency in the United States, backed by more than 60 per cent of the world's monetary gold supply.

Following J. W. Angell, who gives excellent statistical summaries in his book on *The Behavior of Money*, we shall define  $M$  to be the total currency issued and not yet redeemed, diminished by the currency held in the Federal treasury, the currency in Federal Reserve banks, the currency with Federal Reserve agents, and the currency in the vaults of all banks.

In the table on page 449 we give the series for  $M$  (outside currency), the population as of July 1, the per capita value of  $M$ , the vault cash,  $M_v$ , and the ratio  $K = M_v/M$ , these data referring to continental United States. From 1890 to 1934 the monetary data are taken from Angell's book; for the subsequent years they are Angell's estimates based upon Treasury data. The values of  $M$  prior to 1909 differ slightly from those computed by Irving Fisher and published in his book on *The Purchasing Power of Money*, to which reference has pre-

Year	$M$ (in millions of dollars)	Population as of July 1	Per Capita $M$ (in dollars)	$M_v$ = Vault Cash (in millions of dollars)	$K = M_v/M$
1890	941	63,056,438	14.92	488	0.519
1891	1,000	64,361,124	15.54	498	0.498
1892	1,016	65,665,810	15.47	586	0.576
1893	1,081	66,970,496	16.14	516	0.477
1894	972	68,275,182	14.24	689	0.709
1895	971	69,579,868	13.96	631	0.650
1896	974	70,884,554	13.74	532	0.546
1897	1,013	72,189,240	14.03	628	0.620
1898	1,150	73,493,926	15.65	688	0.598
1899	1,181	74,798,612	15.79	723	0.612
1900	1,305	76,129,408	17.14	750	0.575
1901	1,368	77,747,402	17.60	808	0.590
1902	1,401	79,365,396	17.65	848	0.605
1903	1,510	80,983,390	18.65	857	0.568
1904	1,529	82,601,384	18.51	991	0.648
1905	1,594	84,219,378	18.93	994	0.624
1906	1,720	85,837,372	20.04	1,016	0.591
1907	1,659	87,445,366	18.97	1,114	0.672
1908	1,670	89,073,360	18.75	1,368	0.820
1909	1,644	90,691,354	18.13	1,452	0.884
1910	1,678	92,267,080	18.24	1,424	0.849
1911	1,660	93,682,189	17.72	1,554	0.936
1912	1,712	95,097,298	18.00	1,573	0.919
1913	1,703	96,512,407	17.65	1,561	0.917
1914	1,820	97,927,516	18.59	1,639	0.901
1915	1,862	99,342,625	18.74	1,458	0.783
1916	2,163	100,757,735	21.47	1,486	0.687
1917	2,564	102,172,845	25.09	1,502	0.588
1918	3,585	103,587,955	34.61	897	0.250
1919	3,879	105,003,065	36.94	997	0.257
1920	4,391	106,543,031	41.21	1,076	0.245
1921	3,964	108,207,853	36.63	947	0.239
1922	3,633	109,872,675	33.07	830	0.228
1923	4,026	111,537,497	36.10	797	0.198
1924	3,964	113,202,319	34.79	912	0.232
1925	3,864	114,867,141	33.64	951	0.246
1926	3,890	116,531,963	33.38	998	0.256
1927	3,843	118,196,785	32.51	1,008	0.262
1928	3,909	119,861,607	32.61	888	0.227
1929	3,926	121,526,429	32.31	820	0.209
1930	3,656	123,091,000	29.70	866	0.237
1931	3,938	124,113,000	31.73	884	0.224
1932	4,904	124,974,000	39.24	792	0.162
1933	5,048	125,770,000	40.14	676	0.134
1934	4,660	126,626,000	36.80	714	0.153
1935	4,784	127,521,000	37.51	785	0.164
1936	5,222	128,429,000	40.66	1,019	0.195
1937	5,489	129,337,000	42.44	958	0.175
1938	5,417	130,245,000	41.59	1,044	0.193

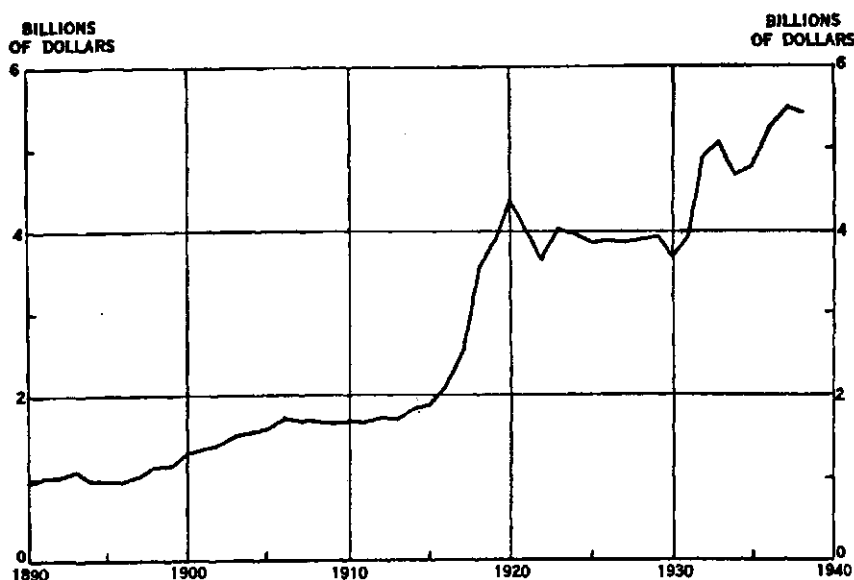

FIGURE 130.—CIRCULATING MONEY IN THE UNITED STATES, 1890-1938.

viously been made. Fisher's values from 1896 to 1909 inclusive, in billion-dollar units, were the following: 0.87, 0.88, 0.96, 1.03, 1.17, 1.22, 1.26, 1.38, 1.37, 1.45, 1.59, 1.63, 1.63, 1.63.

The series for  $M$  is graphically represented in Figure 130, with respect to which some rather interesting observations may be made. From 1890 to 1915 there was a steady and essentially uniform increase in  $M$ , which could be attributed mainly to the growth of population. During this time the per capita value of  $M$  changed from approximately \$15.00 to approximately \$18.00, an annual increase of one per cent. The major fluctuation in this period is observed in the depression years from 1894 to 1897, when both  $M$  and per capita  $M$  were lower than in 1893. The stability of the series from 1897 to 1915 was reflected in all the other series of this period, which makes it one of the best for the exploration of the interrelationships between production and price indexes. For this reason this period may be taken as an almost perfect example of a stable economic system operating under a mild positive trend.

But the World War put an end to this stable economy and we find an abrupt change in all the series of the next period, including that for  $M$ . We note a sharp increase in circulating money from 1915 to 1920 and violent fluctuations from that time on around an average of something like four billion dollars until 1930 when the amount again

increased. The establishment of the Federal Reserve System in 1914, designed to give greater elasticity to credit, is seen to have profoundly affected the ratio of vault cash to circulating money. The value of  $K$ , which was over 0.900 in 1914, dropped abruptly to 0.250 by 1918, and has slowly but uniformly declined since that time.

One interesting observation that is to be made with respect to  $M$  in the depression periods of 1893 and 1932 is that, while in the former circulating money dropped about 11 per cent, in the latter it increased 25 per cent over 1929.

#### 4. *Circulating Deposits ( $M'$ )*

The symbol  $M'$  designates the total amount of circulating deposits, that is to say, deposits subject to check. It is probably true that some part of time deposits are also used to pay accounts and hence should be included in  $M'$ . Unfortunately there are at present no available data for estimating this part of time deposits, which should be added to  $M'$ , but since the amount is presumably small it is probable that no essential error will be introduced into our calculations by neglecting it.

The table on page 452 gives the values of circulating deposits ( $M'$ ), total deposits ( $M_t'$ ), total money ( $M + M_t'$ ), circulating money ( $M + M'$ ), and the ratios  $h = M/M_t'$  and  $H = M/M'$ . The figures for  $M'$  from 1890 to 1908 inclusive are from W. C. Mitchell's *Business Cycles*, published in 1913; the values from 1908 to 1934, excepting the per capita figures, are from Angell's book cited above, and the subsequent values are estimates kindly furnished the author by Angell. Mitchell's estimates from 1896 to 1909 show a slight variation from those computed by Irving Fisher.<sup>6</sup>

The series for  $M'$  is graphically represented in Figure 131 and the ratios  $h$ ,  $H$ , and  $K$  are shown in Figure 132. Some rather instructive observations may be made with regard to them.

We note that the ratio  $H$  showed a steady and uniform decrease over the forty-year period from 1890 to 1930. This meant that there was a steady increase in the use of checks in the trading habits of the people. But in 1931, as the depression deepened, the ratio showed a violent reversal. As  $M'$  decreased from its peak of 23,408 in 1929 to its minimum of 15,484 in 1933, circulating money increased to 5,048. Thus in a period of four years  $H$  regained most of what it had lost in the preceding four decades.

<sup>6</sup> Fisher's values (expressed in billions of dollars) were: 2.68, 2.80, 3.19, 3.90, 4.40, 5.13, 5.43, 5.70, 5.80, 6.54, 6.84, 7.13, 6.60, 6.75.

Year	Circulating Deposits, $M'$		Total Deposits, $M'$		Total Money ( $M + M'$ ) \$000,000	Total Circulating Money ( $M + M'$ ) \$000,000	$h = M/M'$	$H = M/M'$
	Total	Per cap.	Total	Per cap.				
	\$000,000	\$	\$000,000	\$				
1890	2,295	36.40	3,993	63.32	4,934	3,236	0.236	0.410
1891	2,351	36.53	4,126	64.11	5,126	3,351	0.242	0.425
1892	2,629	40.04	4,572	69.63	5,588	3,645	0.222	0.386
1893	2,524	37.69	4,516	67.43	5,597	3,605	0.239	0.423
1894	2,592	37.96	4,587	67.18	5,559	3,564	0.212	0.375
1895	2,744	39.44	4,838	69.53	5,809	3,715	0.201	0.354
1896	2,703	38.13	4,841	68.29	5,815	3,677	0.201	0.360
1897	2,763	38.27	4,979	68.97	5,992	3,776	0.203	0.367
1898	3,251	44.23	5,615	76.40	6,765	4,401	0.205	0.354
1899	3,941	52.69	6,545	87.50	7,726	5,122	0.180	0.299
1900	4,304	56.54	7,104	93.31	8,409	5,609	0.184	0.303
1901	5,054	65.01	8,097	104.14	9,465	6,422	0.169	0.271
1902	5,491	69.19	8,910	112.27	10,311	6,892	0.157	0.255
1903	5,687	70.22	9,416	116.27	10,926	7,197	0.160	0.266
1904	5,963	72.19	9,880	119.61	11,409	7,492	0.155	0.256
1905	6,634	78.77	11,126	132.11	12,720	8,228	0.143	0.240
1906	6,953	81.00	11,862	138.19	13,582	8,673	0.145	0.247
1907	7,290	83.37	12,870	147.18	14,529	8,949	0.129	0.228
1908	6,652	74.68	12,565	141.06	14,235	8,322	0.133	0.251
1909	6,886	75.93	13,669	150.72	15,313	8,530	0.120	0.239
1910	7,707	83.53	14,710	159.43	16,388	9,385	0.114	0.218
1911	8,192	87.44	15,547	165.95	17,207	9,852	0.107	0.203
1912	8,204	86.27	16,683	175.43	18,330	9,916	0.103	0.209
1913	8,089	83.81	17,133	177.52	18,836	9,792	0.099	0.211
1914	9,356	95.54	18,108	184.91	19,928	11,176	0.101	0.195
1915	9,265	93.26	18,875	190.00	20,738	11,127	0.099	0.201
1916	11,784	116.95	22,230	220.63	24,393	13,947	0.097	0.184
1917	13,021	127.44	26,106	255.51	28,670	15,585	0.098	0.197
1918	15,050	145.29	28,606	276.15	32,190	18,635	0.125	0.238
1919	17,697	168.53	32,790	312.27	36,669	21,576	0.118	0.219
1920	18,656	175.10	36,657	344.05	41,047	23,047	0.112	0.235
1921	17,270	159.60	34,628	320.01	38,592	21,234	0.114	0.229
1922	16,507	150.24	36,388	331.18	40,021	20,140	0.100	0.220
1923	17,311	155.20	39,551	354.60	43,577	21,337	0.102	0.232
1924	18,174	160.54	41,864	369.82	45,802	22,112	0.094	0.217
1925	19,934	173.54	45,486	395.99	49,350	23,798	0.083	0.194
1926	20,178	173.15	47,719	409.49	51,608	24,068	0.082	0.193
1927	22,861	193.41	50,305	425.60	54,148	26,704	0.076	0.168
1928	23,356	194.86	52,639	439.16	56,548	27,265	0.074	0.167
1929	23,408	192.62	52,549	432.41	56,475	27,334	0.075	0.168
1930	22,661	184.10	52,325	425.09	55,981	26,317	0.070	0.161
1931	20,506	165.22	49,996	402.83	53,934	24,444	0.079	0.192
1932	16,124	129.02	41,249	330.06	46,153	21,028	0.119	0.304
1933	15,484	123.11	37,138	295.29	42,186	20,532	0.136	0.326
1934	18,903	149.28	42,011	331.77	46,671	23,563	0.111	0.247
1935	22,092	173.24	45,994	360.68	50,778	26,876	0.104	0.217
1936	25,876	201.48	50,656	394.43	55,878	31,098	0.103	0.202
1937	26,257	203.01	52,162	403.30	57,651	31,743	0.105	0.209
1938	26,086	200.28	52,277	401.37	57,694	31,503	0.104	0.208



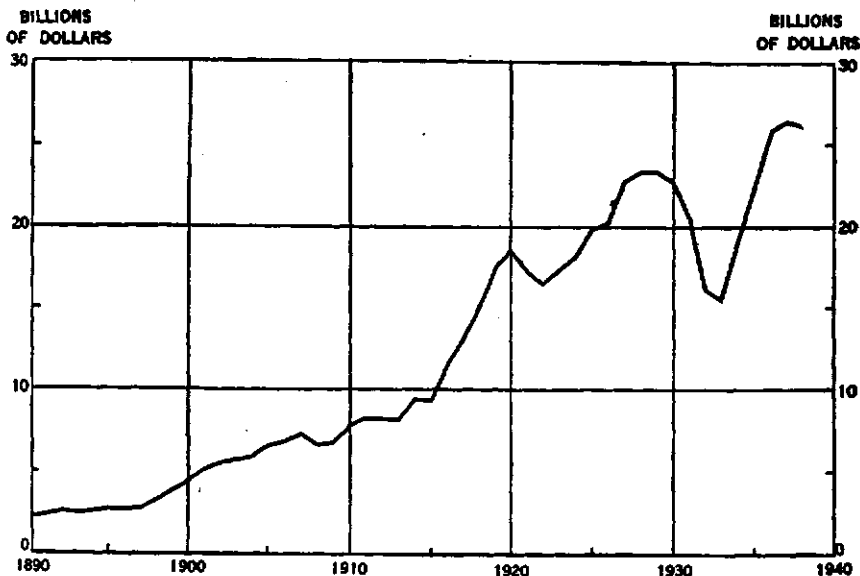

FIGURE 131.—CIRCULATING DEPOSITS IN THE UNITED STATES, 1890-1938.

A large credit expansion is also to be noticed in the period from 1920 to 1930. Prior to that time the curves for  $M$  and  $M'$  showed a remarkable similarity to one another and after 1910 the ratio  $H$  re-

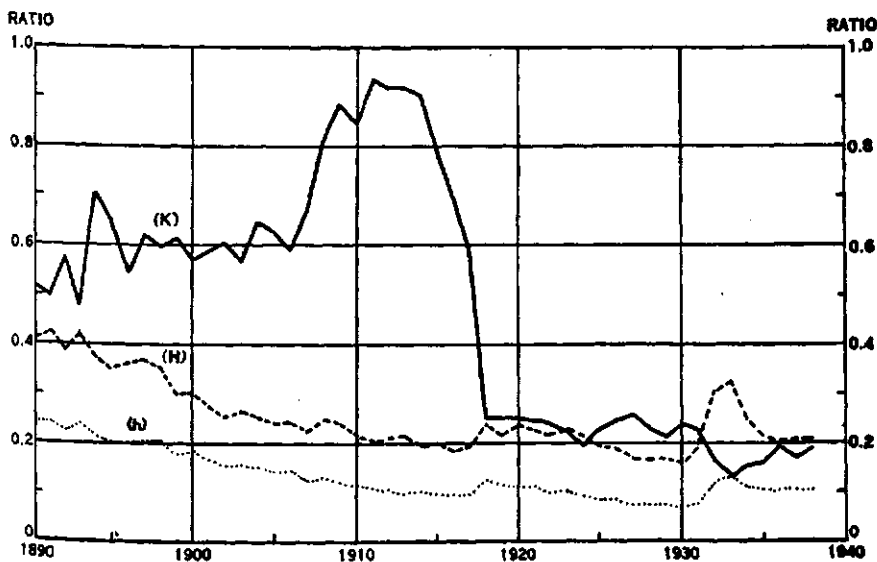

FIGURE 132.—MONETARY RATIOS.

Ratios of vault cash to circulating money ( $K$ ), of circulating money to total deposits ( $h$ ), and of circulating money to circulating deposits ( $H$ ).

mained reasonably stable around an average of approximately 0.2. But in the inflationary period which began shortly after the price collapse of 1920, the ratio suffered a sudden drop. While  $M$  remained essentially unchanged,  $M'$  rose rapidly from a low of 16,507 in 1922 to its peak of 23,408 in 1929.

The spectacular rise of both  $M$  and  $M'$  from 1914 to 1920 is attributable to the war. During this period there was a great increase in trade and an expanding currency was needed to meet the demand. We have already commented upon the spectacular drop in the ratio  $K$  as the result of the establishment of the Federal Reserve System in 1914, which released large holdings of vault cash and allowed a concomitant increase in  $M$ . It is rather a pity from the standpoint of the theory of economics that this remarkable phenomenon should have taken place at the beginning of the World War, when trade inflation masked the natural results of so drastic a change in the banking system of the nation.

### 5. *The Velocity of Circulating Deposits ( $V'$ )*

The symbol  $V'$  in the equation of exchange means the velocity of circulating deposits. Since this parameter plays a more important role in the theory of trade and prices than does  $V$ , the velocity of circulating currency, and since its statistical determination is much easier, we shall give to it our primary attention.

The term velocity, which may be either  $V$  or  $V'$ , and which we shall designate for the moment by  $v$ , is used in the following sense: Suppose that  $e$  is the total amount of money spent by an individual in some unit of time and that  $m$  is the average amount of money which he possesses during that time. Then  $v$ , which is obviously a function of the interval of time, is the ratio of  $e$  to  $m$ ; that is,

$$v = e/m.$$

For example, if an individual earns \$300 per month and spends it during the subsequent month, he will have \$300 on the first day of the month and nothing on the last day. His average bank account will be less than \$300. If he spends his money uniformly, that is to say, the same amount each day, then his average bank account will be \$150, and his monthly velocity will be

$$v = \$300/\$150 = 2.$$

On the assumption just made the yearly velocity would be  $12 \times 2 = 24$ , a velocity which is not far from the velocity of currency, but

which is lower, on the average, than the observed velocity of circulating deposits. We shall find later that the average value of  $V'$  over a long period of time was 43.4, a value which includes the data from New York City where the velocity is normally higher than in other parts of the country.

If we refer to the example just given, we see that certain modifications must be made in the calculations because of the fact that debts are generally paid at the beginning of the month. Hence the individual with an income of \$300 per month may, for example, pay \$160 on the first day of the month; he may then spend perhaps \$110 uniformly over the remainder of the month, and transfer the remaining \$30 to his savings account, where it is removed from circulating deposits. Under this schedule the individual would then spend \$270. His average bank account would be  $\$30 + \frac{1}{2} \times \$110 = \$85$ , and the monthly velocity is computed as the ratio

$$v = \$270/\$85 = 3.2.$$

Hence we reach a more realistic value for the yearly velocity, namely,  $12 \times 3.2 = 38.4$

It is obvious that a study of family cash accounts would permit one to compute with some accuracy the value of  $V'$ . Since such budgetary data have not been available, the computation has been made by a study of bank deposits and the data for bank debits.<sup>7</sup>

If we consider, then, the data available from banks, it is clear that the velocity of deposits can be computed by dividing the total amount of checks drawn each month in any given center by the average of the demand deposits for the same period. The actual procedure in the calculation has been described by W. R. Burgess in his careful study on the velocity of bank deposits.<sup>8</sup> We quote from this article as follows:

Certain adjustments were necessary before a direct comparison could be made of demand deposits of individuals and checks drawn against such deposits. From the figures for checks drawn, or debits, certain deductions had to be made for withdrawals of time and government deposits. Withdrawals of time deposits

<sup>7</sup> It is of some interest to know the relationship between bank debits, namely the total exchange of money by checks, and bank clearings, that is, the total exchange of money by checks which pass through the clearing house. A statistical study by the author's student, E. L. Godfrey, based upon annual debits and clearings from 1900 to 1937 inclusive, indicates that the ratio

$$u = \frac{\text{Bank debits}}{\text{Bank clearings}}$$

has the value  $u = 2.00$  with a standard error of  $+0.24$ .

<sup>8</sup> "Velocity of Bank Deposits," *Journal of the American Statistical Association*, 1923, pp. 727-740.

were estimated by computations made for six New York City banks for a number of different periods, which showed an average rate of turnover of time deposits at the rate of two times a year. Exact figures were available for Government withdrawals. Net demand deposit reports were amended by subtracting from them the net amounts due to banks, which were shown in New York City by the records but for other cities were estimated from the relative proportion of net amounts due to banks to net demand deposits shown by the total figures reported for all reporting banks in the different cities. A sample computation, which indicates the various adjustments necessary before arriving at a ratio between checks drawn and demand deposits of individuals, is shown in (the table). As the table indicates, the figures were converted to an annual rate of turnover.

**METHOD OF COMPUTING VELOCITY OF BANK DEPOSITS**  
42 New York City Reporting Banks  
(000 omitted except in columns 6 and 12)

	1	2	3	4	5	6
Week ended 1922	Debits to Individual accounts total for each week	Time deposits ÷ 26 (to be subtracted)	Government withdrawals each week (to be subtracted)	Revised debits for each week	Total debits each month	Number of working days in each month
Jan. 4	\$4,529,355	\$7,120	.....	\$4,522,235	.....	.....
11	4,592,367	7,370	\$ 5,884	4,579,113	.....	.....
18	4,766,247	7,196	16,884	4,742,167	.....	.....
25	3,933,296	7,367	6,233	3,919,696	\$18,571,486	25
Feb. 1	4,233,272	7,333	.....	4,225,939	.....	.....

	7	8	9	10	11	12
Week ended 1922	Average daily debits	Annual rate of debits col. 7 × 302 (working days in year)	Net demand deposits	Net due to banks (to be subtracted)	Revised demand deposits (average)	Annual rate of turnover of deposits (col. 8 ÷ col. 11)
Jan. 4	.....	.....	\$3,866,822	\$804,960	.....	.....
11	.....	.....	3,850,902	799,187	.....	.....
18	.....	.....	3,788,338	781,546	.....	.....
25	\$742,859	\$224,343,418	3,754,903	782,753	\$3,023,130	74.2
Feb. 1	.....	.....	.....	.....	.....	.....

**Comments:**

Column 2: An analysis in New York City showed that time deposits turned over on the average about twice a year. Checks drawn against time deposits each week therefore amount to about 2/52, or 1/26, of the amount of time deposits.

Column 5: In arriving at the monthly figures, the debits for weeks at the beginning and end of the month are included in proportion to the number of working days falling within the month. For example, 2/5 of the debits of the week ended January 4 and 5/6 of the debits of the week ended February 1, are included in January.

Column 10: This column is the excess of "Due to Banks" over "Due from Banks." If there is no excess, no correction is made.

What value of  $V'$  shall we employ in the equation of exchange? This question is an important one since the velocity of circulating deposits exhibits an unusually wide variation. Thus the following table<sup>o</sup> shows an average of 9.5 for Syracuse, while the velocity for New York

<sup>o</sup> Summarized from Carl Snyder, *Business Cycles and Business Measurements*, New York, 1927, xv + 326 pp., in particular, pp. 294-298.

City is 77.1. The average for the nine cities listed was 33.5 with a probable error of 11.2, which gives a coefficient of variation,  $\sigma/A$ , as large as 0.50.

AVERAGE ANNUAL VELOCITY OF BANK DEPOSITS

Year	1919	1920	1921	1922	1923	1924	1925	Av.
141 cities	42.3	41.9	38.5	40.5	41.4	40.9	44.2	41.4
Chicago	46.3	48.0	44.1	44.7	45.2	42.7	44.0	45.0
New York City	75.2	74.1	68.3	75.8	79.1	79.6	87.7	77.1
Boston	36.6	37.2	30.7	31.7	34.8	35.2	38.3	34.9
San Francisco	40.3	40.5	40.1	38.9	40.2	38.0	39.0	39.6
Albany	35.3	31.5	27.7	25.8	26.2	26.4	28.5	28.8
Rochester	18.4	20.7	20.7	20.7	22.5	23.8	30.3	22.4
Syracuse	10.3	11.6	8.9	8.6	9.6	8.9	8.9	9.5
Binghamton, N. Y.	21.0	24.9	22.7	22.1	23.0	20.8	20.6	22.2
Buffalo	18.1	20.7	18.7	20.6	26.2	24.9	26.2	22.2

The following estimates of the velocity of bank deposits are obtained from several sources. From 1896 to 1912 the values are taken from Irving Fisher's *The Purchasing Power of Money*; from 1912 to 1918 they are computed from the formula

$$(1) \quad V' = 12.3 I/M',$$

where  $I$  is the total national income; for 1919 and 1920 they are taken from Carl Snyder; from 1921 to 1934 they are Angell's estimates based upon the data on bank debits for 141 cities including New York City; since 1934 they are estimates by the author.

Year	V'	Year	V'	Year	V'	Year	V'
1896	36.6	1907	45.3	1918	48.8	1929	71.7
1897	39.4	1908	44.8	1919	42.3	1930	48.6
1898	40.6	1909	52.8	1920	41.9	1931	36.3
1899	42.0	1910	52.7	1921	36.1	1932	28.7
1900	38.3	1911	49.9	1922	38.7	1933	26.7
1901	40.6	1912	53.4	1923	43.4	1934	24.5
1902	40.5	1913	50.8	1924	41.4	1935	24.2
1903	39.7	1914	41.8	1925	43.7	1936	24.1
1904	39.6	1915	45.4	1926	45.5	1937	23.4
1905	42.7	1916	45.8	1927	49.6	1938	20.0
1906	46.3	1917	49.9	1928	58.6		

Av. of  $V' = 41.79$ ,  $\sigma_{V'} = 10.00$ .

Formula (1), by means of which values of  $V'$  were interpolated between the estimates of Fisher and Snyder, was empirically derived. It would seem, however, that there should be some reasonably fixed ratio between the total exchange of money (bank debits) in a year and the total annual income. This assumption would imply, merely, that each exchange of money would add its percentage to national income

and that income is thus derived as a necessary concomitant of the total exchange of money.

The test of this thesis is found in the following table of values of the quantity

$$k = M'V'/I.$$

The values of the income,  $I$ , are taken from the table given in Section 3 of Chapter 9; the values of the product  $M'V'$  are taken for the year 1909 to 1912 from Fisher, and for the years from 1919 to 1936 they are computed from the data in Sections 4 and 5 of this chapter. The unit is in billions.

Year	$M'V'$	$I$	$k$	Year	$M'V'$	$I$	$k$
1909	353	27.2	12.98	1926	918	78.5	11.69
1910	381	30.1	12.66	1927	1134	77.2	14.69
1911	388	29.4	13.20	1928	1369	80.5	17.01
1912	436	31.8	13.40	1929	1678	79.1	21.21
.....	.....	.....	.....	1930	1101	72.2	15.25
1919	749	67.4	11.11	1931	744	60.1	12.38
1920	782	74.3	10.52	1932	463	46.5	9.96
1921	623	52.6	11.84	1933	413	44.4	9.30
1922	639	61.7	10.36	1934	463	50.4	9.19
1923	751	69.8	10.76	1935	535	54.9	9.74
1924	752	69.6	10.80	1936	624	62.4	10.00
1925	871	77.1	11.30				

Av. of  $k = 12.27$ ,  $\sigma_k = 2.55$ .

It is clear from this table that  $k$  is not entirely independent of the velocity, since the large velocities which prevailed in the inflationary period around 1929 gave an abnormal increase to  $k$  and the sub-

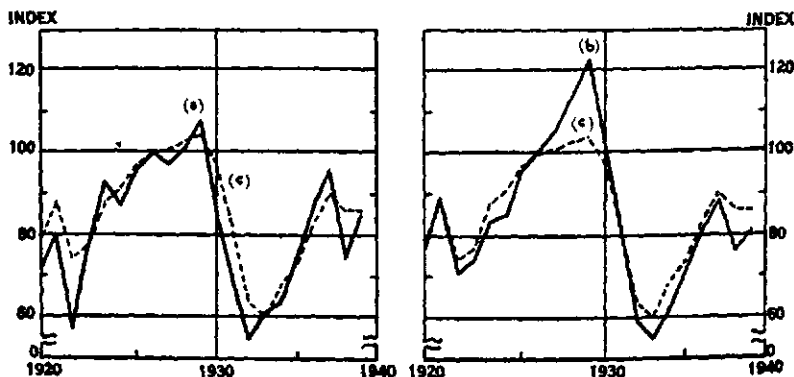

FIGURE 183.—INDEX NUMBERS (1926 = 100) OF INDUSTRIAL PRODUCTION (a) AND BANK DEBITS (b) COMPARED WITH NATIONAL INCOME (c).

The speculative factor is shown to be measured by the bank debits series.

sequent depression abnormally reduced the value of  $k$ . In spite of these difficulties, however, formula (1) would appear to give a value of  $V'$  in stable periods, which would probably not be in error in excess of the error that exists in the values as directly computed.

In order to exhibit this highly important relationship between bank debts and national income, index numbers of both series were computed with 1926 = 100 as base. These indexes are graphically represented in Figure 133, together with similar indexes for industrial production and national income. We see from this figure that bank debts, while highly correlated with the national income, tend to rise higher in speculative periods and drop lower in depressions than national income. This difference is probably a good measure of the psychic factor which essentially enters into all price phenomena, since the variation between bank debts and national income is considerably greater than the variation between actual industrial production and national income. The optimism of the speculative period around 1929 and the pessimism of the deflationary period around 1932 were clearly not justified by the national incomes of the two periods.

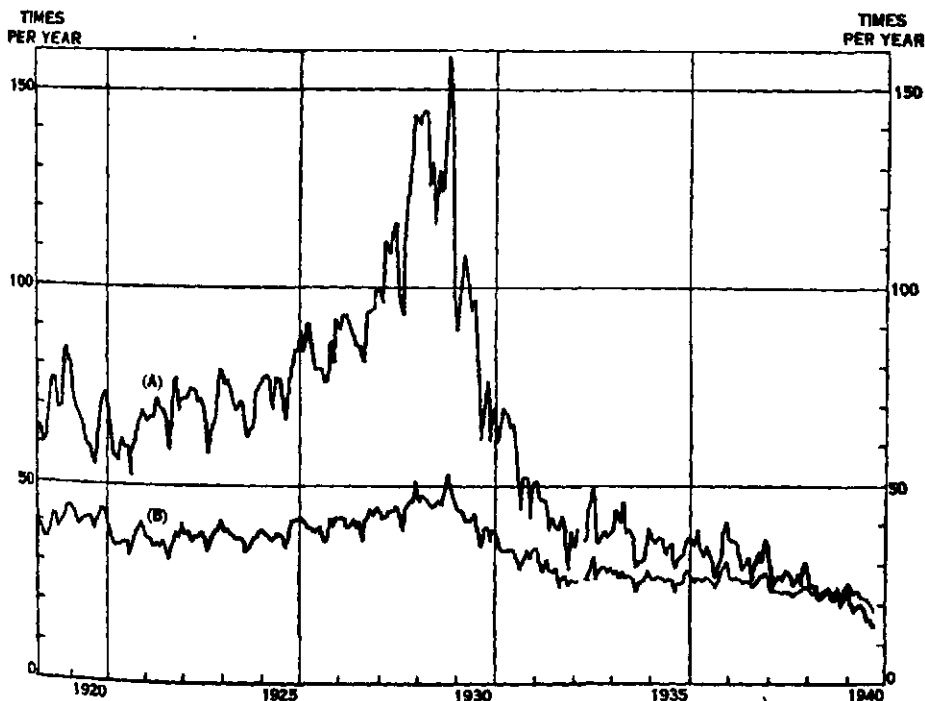

FIGURE 134.—VELOCITY OF BANK DEPOSITS.

(A) in New York City; (B) in 100 cities outside of New York City.

One may observe that much of the speculative activity in debit figures is revealed more clearly in the banking data for New York City than in the similar data for other cities. Hence it is instructive

## MONTHLY VELOCITY OF BANK DEPOSITS IN NEW YORK CITY

Year	Jan.	Feb.	Mar.	Apr.	May	June	July	Aug.	Sept.	Oct.	Nov.	Dec.	Av.
1919	64.7	63.8	60.0	61.7	69.2	76.2	76.4	68.8	69.5	77.6	84.7	80.8	71.3
1920	74.3	68.4	67.5	65.2	61.6	59.9	58.4	54.5	57.5	66.4	70.4	72.7	64.7
1921	69.3	60.9	57.4	56.4	61.2	58.9	59.3	52.3	58.7	63.3	67.4	68.4	61.1
1922	66.1	67.3	67.4	71.7	69.7	68.5	66.7	58.4	66.5	76.9	68.9	71.8	68.9
1923	71.9	73.2	74.5	73.7	71.0	71.3	65.2	57.6	63.7	65.9	73.4	79.0	70.0
1924	75.8	76.6	73.2	69.5	69.9	71.0	65.7	62.3	63.4	64.5	73.2	75.1	69.8
1925	77.0	77.8	76.1	69.1	77.3	77.2	71.8	66.6	72.9	81.4	84.0	83.7	76.2
1926	88.8	83.6	90.9	84.6	78.9	79.3	79.6	76.5	76.4	86.6	81.2	92.3	83.2
1927	89.5	92.9	92.6	88.4	87.5	85.4	85.0	81.9	93.2	94.7	94.9	98.1	90.3
1928	99.6	96.3	112.0	108.3	113.2	116.4	96.2	92.7	114.8	123.6	130.8	143.3	112.2
1929	141.0	143.3	144.6	125.4	131.2	116.2	129.1	124.6	144.3	158.4	128.6	98.4	131.7
1930	89.6	97.2	107.7	98.3	94.4	96.8	74.8	62.3	72.4	76.3	61.4	69.7	83.1
1931	61.1	62.5	68.9	67.6	64.9	65.4	52.6	44.0	51.5	52.2	42.3	50.3	57.0
1932	50.6	47.2	46.4	46.1	38.8	42.4	39.7	38.6	42.5	38.5	29.5	37.9	41.7
1933	34.7	38.8	.....	35.8	37.4	44.5	49.5	35.1	35.8	38.5	37.2	37.7	38.7
1934	38.9	43.8	40.2	45.6	37.8	38.7	36.3	29.3	30.3	30.4	31.4	39.0	36.6
1935	36.4	35.4	36.9	36.5	32.5	34.7	35.2	29.5	31.2	32.5	35.4	36.7	34.3
1936	36.1	34.8	38.8	38.8	31.8	34.4	30.3	26.7	29.9	31.7	37.7	41.0	33.9
1937	36.0	36.0	35.1	31.4	28.6	30.2	32.1	26.1	29.6	32.9	30.2	36.6	32.1
1938	29.0	24.9	26.2	27.5	26.1	28.8	27.6	25.1	25.8	27.4	24.7	30.4	27.0
1939	25.0	24.1	24.6	21.6	22.2	23.1	21.6	20.9	23.6	19.7	20.7	23.9	22.6
1940	20.2	18.2	19.7	19.9	18.4	16.7	16.3	15.5	17.3	17.6	19.9	20.6	18.4

## MONTHLY VELOCITY OF BANK DEPOSITS OUTSIDE NEW YORK CITY

Year	Jan.	Feb.	Mar.	Apr.	May	June	July	Aug.	Sept.	Oct.	Nov.	Dec.	Av.
1919	39.3	37.9	35.7	35.6	37.8	42.0	41.1	37.8	39.8	42.3	44.0	44.1	39.9
1920	42.7	41.2	39.5	40.3	40.9	41.1	41.6	37.9	41.2	43.7	43.2	43.2	41.3
1921	38.8	36.1	34.0	34.9	35.1	35.4	35.4	32.3	36.4	38.9	40.1	38.9	36.3
1922	36.5	36.6	34.6	35.0	34.2	35.5	34.4	30.8	34.3	37.7	36.7	40.1	35.5
1923	37.2	37.8	36.1	37.4	36.9	37.6	36.3	33.4	36.3	38.2	38.7	41.2	37.2
1924	37.6	38.3	37.4	36.8	36.2	36.9	35.3	32.8	34.2	36.7	36.9	38.0	36.4
1925	38.2	37.4	36.5	36.1	37.1	37.8	37.1	34.0	37.2	40.4	40.7	40.7	37.7
1926	41.5	40.3	38.9	39.0	38.1	38.4	39.6	35.2	37.4	41.5	39.6	41.8	39.3
1927	42.0	41.9	39.3	39.4	41.2	39.2	40.2	35.8	40.6	43.5	42.4	43.9	40.8
1928	43.0	41.4	42.1	43.4	43.2	44.9	41.7	38.3	44.6	46.3	46.1	51.3	43.9
1929	46.0	47.5	46.6	45.0	44.3	46.3	46.8	45.0	49.1	52.7	50.1	46.4	47.1
1930	43.7	43.7	42.5	40.8	40.7	42.6	37.6	34.6	39.2	39.4	36.5	39.0	39.8
1931	36.3	34.3	33.1	33.2	33.2	33.6	31.4	28.7	31.1	34.1	31.6	33.8	32.9
1932	34.2	31.0	28.7	31.2	28.5	27.8	28.9	24.9	26.4	27.5	25.0	26.9	28.4
1933	25.6	25.9	.....	26.6	26.5	28.8	32.4	26.7	27.9	29.7	28.0	29.7	28.0
1934	27.5	28.4	26.8	28.4	26.4	27.3	26.2	23.1	26.0	26.3	26.9	28.7	26.8
1935	26.3	26.9	27.4	27.0	25.6	26.4	26.0	23.3	25.2	25.7	27.8	28.5	26.3
1936	25.8	26.1	26.5	25.9	25.4	27.1	25.8	23.5	25.0	26.8	28.5	30.1	26.4
1937	27.2	26.7	27.3	26.2	26.0	26.3	26.4	24.0	25.7	27.5	27.3	27.9	26.5
1938	24.7	23.3	23.5	23.1	23.2	22.7	22.9	22.3	22.9	23.3	24.5	24.9	23.4
1939	23.1	22.6	22.7	22.2	22.6	22.4	21.9	21.9	22.8	22.6	23.5	24.2	22.6
1940	22.4	22.0	22.4	21.6	21.4	21.0	20.3	20.1	20.8	20.6	23.2	23.3	21.6



to consider separately the velocity of deposits for this financial center compared with the same velocity for cities outside of New York City. The table on page 460 gives the actual monthly velocities and these are graphically represented in Figure 134. We note the incredible increase of the New York velocity at the time of the bull-market inflation from an average of 68.77 (1919 through 1925) to an average of 131.7 in 1929, and a comparable violent drop during the depression period, when the average fell to 34.90 (1932 through 1938). The outside velocity showed a much smaller fluctuation, rising from an average of 37.76 before the inflation to 47.1 for 1929, and then falling to an average of 26.54.

### 6. *The Velocity of Circulating Money (V)*

The symbol  $V$  in the equation of exchange means the velocity of circulating money. This value is difficult to estimate and the first serious attempt made to approximate it was by Irving Fisher, who obtained values for the years from 1896 to 1912. W. S. Jevons recognized the difficulties of the computation in his *Money and the Mechanism of Exchange*<sup>10</sup> where he says:

I have never met with any attempt to determine in any country the average rapidity of circulation, nor have I been able to think of any means whatever of approaching the investigation of the question, except in the inverse way. If we know the amount of exchanges effected, and the quantity of currency used, we might get by division the average number of times the currency is turned over; but the data, as already stated, are quite wanting.

Fisher's theory is based upon the assumption that most money does not circulate many times before it returns to the bank, but for the most part only once. He thus assumes that

... [much] money circulates in general only once outside of banks; but that when it passes through the hands of nondepositors (which practically means wage-earners) it circulates once more, thus adding the volume of wage payments to the volume of ordinary money circulation, which, as we have seen, is equal to the flow of money through banks.

We falsely picture the circulation of money in modern society when we allow ourselves to think of it as consisting of a perpetual succession of transfers from person to person. Were it such a succession it would be, as Jevons said, beyond the reach of statistics. But we may form a truer picture by thinking of banks as the home of money, and the circulation of money as a temporary excursion from that home. If this description be true, the circulation of money is not very different from the circulation of checks. Each performs one transaction or, at most, a few transactions outside of the bank, and then returns home to report its circuit.<sup>11</sup>

<sup>10</sup> Published in New York in 1876, xviii + 349 pp. This work is an unusually clear treatment of the problem of money and exchange. See, in particular, p. 336.

<sup>11</sup> *The Purchasing Power of Money*, Second edition, New York, 1931, pp. 287-288.

Fisher divides those who circulate money into three classes: (1) commercial depositors, who handle money once; (2) other depositors, such as salaried and professional classes; and (3) nondepositors, who are wage earners for the most part.

Obviously the largest term in the computation of the velocity of money would be given by the total money deposited in banks during some unit of time. If we designate by  $C_b$ ,  $O_b$ , and  $N_b$  the money deposited respectively by the three classes, then the total deposit would be the sum of these three terms, namely  $C_b + O_b + N_b$ . Figures were available for making an estimate of this total deposit for July 1, 1896 and for March 16, 1909. Thus in 1896 the daily deposit was 37.4 millions, which, when multiplied by the 305 settling days for the year, gives a total annual deposit of 11.4 billions. A similar estimate for 1909 yields the value 19.1. It was deemed necessary by Fisher, however, to correct these figures for the time of the month since "on July 1, 1896 many June bills must have been paid by cash as well as by check and on March 16, 1909, the middle of a month, there must have been slackness of settlements by cash as well as by check." Hence, the first estimate was multiplied by 0.68 and the second by 1.17, giving new estimates of 7.8 and 22.3 billions respectively. The average of 11.4 and 7.8, namely, 9.6 billions, was assumed to be the total annual money deposits for the year 1896, and a similar average of 19.1 and 22.3, namely, 20.7 billions, was the estimated annual money deposits for the year 1909.

The second term in the computation of  $V$  would be that money which would circulate once outside of banks, that is to say, the total expenditure of nondepositors. This would be the sum of the expenditures of the nondepositors to commercial depositors,  $N_c$ , and to other depositors,  $N_o$ . This sum,  $N_c + N_o$ , Fisher estimated to be between 5 and 6.5 billions of dollars in 1896 and 13.1 billions in 1909. Thus the estimates for the second figure are distributed as follows:

Trade and transportation	4.3 millions at \$640	\$ 2,752 millions
Manufacturing and mechanical pursuits	6.9 millions at \$550	3,790 millions
Agricultural pursuits	12.4 millions at \$300	3,720 millions
Domestic and personal service	7.4 millions at \$250	1,850 millions
Clerks, etc. having no bank account		1,000 millions
<b>Total</b>		<u>\$13,112 millions</u>

To the sum,  $C_b + O_b + N_b + N_c + N_o$ , must now be added an estimate of other money circulations such as interclass circulations and money exchanges not accounted for by the two large classes just de-

scribed. This correction term is probably small and is estimated by Fisher to be 0.9 billions in 1896 and 1.3 billions in 1909. Hence one obtains for the total estimate of money circulated the following:

Circulation Classes	1896	1909
Money deposited ( $C_b + O_b + N_b$ )	9.6	20.7
Expenditure of nondepositors ( $N_c + N_o$ )	5.7	13.1
Other circulation	0.9	1.3
Total (in billions)	16.2	35.1

Since total circulating money in 1896 was 0.87 billions and in 1909 was 1.63 billions (Fisher's estimates), the velocity of money would then be for the two years respectively  $16.2/0.87 = 18.6$  and  $35.1/1.63 = 21.5$ .

Having once established these two velocities, Fisher then interpolated velocities for the intervening years. He first made a table giving the linearly interpolated values of  $V$  between the velocities 18.6 and 21.5. A second table was then constructed so that the ratio of  $MV$  to  $M'V'$  between the two dates was linearly interpolated. From the fluctuations in  $M$  new determinations of  $V$  were made, which were averaged with the ones given in the first table.

The following table of  $V$  and  $MV$  is taken from the second edition of Fisher's *The Purchasing Power of Money*, in which certain minor corrections were made in his first table and estimates for the years 1910, 1911, and 1912 were added:

Year	V	MV	Year	V	MV	Year	V	MV
1896	18.8	16	1902	21.6	27	1908	19.7	32
1897	19.9	18	1903	20.9	29	1909	21.1	34
1898	20.2	20	1904	20.4	28	1910	21	34
1899	21.5	22	1905	21.6	31+	1911	21	34
1900	20.4	24	1906	21.5	34	1912	22	38
1901	21.8	27	1907	21.3	35			

The average value of  $V$  is found to be 20.9, with a standard deviation of 0.94. We thus infer that the velocity of money is much more stable than the velocity of deposits and that on the average it is about half the value of  $V'$ .

### 7. Price ( $P$ )

We turn next to a consideration of the concept of price,  $P$ , which appears in the right-hand member of the equation of exchange. In its simplest form price may be regarded as the ratio of exchange between

two commodities such as, for example, wheat and corn. If one bushel of wheat may be exchanged for two of corn, then the ratio of exchange is two; we may then say that the price of a bushel of wheat is two bushels of corn. If, however, two bushels of wheat may be exchanged for three of rye, then the price of wheat may be said to equal 1.5 bushels of rye. But in order to simplify exchange, a common unit is chosen to which all commodities may be referred, and this unit is designated as money. In ordinary parlance, then, the price of a commodity means the exchange ratio between a unit of the commodity and a unit of money. Thus we say that the price of a bushel of wheat is \$1.50, that of corn is \$0.75, and that of rye is \$1.00.

In earlier periods, before the advent of banking, the precious metals, principally gold and silver, were coined into convenient units and used as the common standard for determining price. Thus it is possible in the modern world to speak of the price of wheat in the middle ages by giving the number of grains of gold for which a bushel was then exchanged. To say that the price of wheat in the year 1420 was 19 cents merely means that one bushel of wheat was exchanged for 4.41 grains of gold. This is on the assumption that 480 grains = 1 Troy ounce = \$20.67+, the old standard definition of the equivalence of dollars and gold.

It is a curious fact that the gold equivalence of money can be changed abruptly without any essential repercussions on price. On January 31, 1934 the United States President changed the gold content of the dollar from 23.22 grains to 13.7143 grains. That is to say, the price of an ounce of gold changed abruptly from \$20.67+ to \$35.00. All monetary gold was redeemed at the former figure and newly-mined gold was purchased at the latter figure. There were immediate effects of this abrupt change in the price of gold in international exchange. Prior to the first indications in 1933 that the United States contemplated a change in the gold standard, the pound had fallen from its par value of \$4.8665 to \$3.280 in December, 1932. But pronouncements by the President in March, 1933 that a new standard was imminent caused an immediate rise in the value of the pound. By February, 1934, the Gold Reserve Act having been approved by Congress on January 30, 1934, the pound had risen as high as \$5.033. But the effect on internal prices was unimportant. From March, 1933 to February, 1934 the sensitive index of wholesale commodity prices moved from 60.2 to 73.6, the difference being only 61 per cent of the standard deviation of this series. Prices had fallen to a low level as a result of the business decline, which began in 1929, and they were certain to rebound somewhat from their lows as the result

of the natural elastic stresses in the price structure. The subsequent history of prices, particularly the decline which began in the fall of 1937, furnishes complete evidence that prices are not functionally related to the price of gold, except as this price affects international exchange and except as trade in gold, a somewhat unimportant commodity, affects the general level. The production of gold, however, received an unprecedented stimulus, as one might expect from a consideration of the curve of supply.

In order to compare the prices of one period with those of another, it is obvious that it would be more convenient to have a measure which is independent of the monetary unit employed and the various arbitrary units characteristically used in the trade in commodities, namely, bushels, tons, pounds, etc. Such a measure is found in index numbers.

By an *index number of prices* we shall understand a ratio, generally expressed as a percentage, which is designed to indicate the level of prices at any given date. Some arbitrarily chosen year is designated for the comparison level.

Without entering fully into the theory of index numbers, which presents many interesting theoretical problems,<sup>12</sup> we shall merely indicate prices by  $p$  and quantities by  $q$ . The prices and quantities of the base year will be designated by the subscript 0, and those of the year whose price level is to be compared with the base year will be designated by the subscript 1. Thus we have

Prices of the base year:	$p_0, p'_0, p''_0, \dots, p_0^{(n-1)}$ ;
Quantities of the base year:	$q_0, q'_0, q''_0, \dots, q_0^{(n-1)}$ ;
Prices of the comparison year:	$p_1, p'_1, p''_1, \dots, p_1^{(n-1)}$ ;
Quantities of the comparison year:	$q_1, q'_1, q''_1, \dots, q_1^{(n-1)}$ .

If we employ the abbreviations

$$I = \sum p_0 q_0, \quad I' = \sum p_1 q_0, \quad J = \sum p_0 q_1, \quad \text{and} \quad J' = \sum p_1 q_1,$$

Fisher's *ideal index number* may be written

$$k = \sqrt{\frac{I'J}{IJ}}.$$

Within the range of variation usually found in the quantities  $p$

<sup>12</sup> For a résumé of problems associated with index numbers see Ragnar Frisch, "Annual Survey of General Economic Theory: The Problem of Index Numbers," *Econometrica*, Vol. 4, 1936, pp. 1-38. See also a recent paper by A. Wald, "A New Formula for the Index of Cost of Living," *Econometrica*, Vol. 7, 1939, pp. 319-331.

and  $q$ , this formula may be replaced, without essential statistical error, by the more easily calculated one

$$k' = \frac{I' + J'}{I + J}.$$

It is obvious that both  $k$  and  $k'$  are independent of the units employed. That is to say,  $k$  and  $k'$  are pure numbers, which give the ratio of the price level of one year in terms of the price level of the second.

We are now ready to examine some price series. The most extensive of these is the series for the price of wheat in England, which is based upon the remarkably comprehensive studies of J. E. T. Rogers (1823-1890), published in his seven-volume work, *A History of Agriculture and Prices in England*.<sup>13</sup>

Since the average value of wheat prices is closely correlated with the average price of commodities, that is to say, the variation of one price level is reflected in the variation of the other, we can use the wheat price series as an indication of the price level which prevailed in those centuries for which more general series are not available. Since the phenomenon of general price variation over a long period of time is of peculiar significance in connection with the equation of exchange, we shall consider a ten-year average of wheat prices, which will sufficiently smooth out the annual variation and will provide us with a series that indicates the major price fluctuations of the last seven centuries. These ten-year averages are given in the following table and are graphically represented in Figure 135.<sup>14</sup>

TEN-YEAR AVERAGES OF ENGLISH WHEAT PRICES IN CENTS PER BUSHEL

Year	Price	Year	Price	Year	Price	Year	Price	Year	Price	Year	Price
1260	14.5	1380	16.0	1500	17.1	1620	108.2	1740	99.2	1860	163.2
1270	16.2	1390	13.9	1510	15.7	1630	119.9	1750	107.3	1870	165.1
1280	16.4	1400	17.6	1520	19.6	1640	118.8	1760	107.3	1880	136.8
1290	16.5	1410	15.8	1530	24.8	1650	134.5	1770	137.6	1890	93.1
1300	15.7	1420	17.1	1540	24.5	1660	137.1	1780	153.7	1900	83.8
1310	17.9	1430	17.5	1550	40.3	1670	114.1	1790	143.8	1910	97.8
1320	27.4	1440	19.0	1560	45.2	1680	115.0	1800	228.3	1920	188.5
1330	16.4	1450	17.0	1570	41.1	1690	104.9	1810	284.5	1930	108.4
1340	13.2	1460	15.9	1580	52.0	1700	123.2	1820	209.1		
1350	18.8	1470	16.4	1590	63.6	1710	121.8	1830	184.6		
1360	19.8	1480	20.2	1600	100.6	1720	97.0	1840	172.9		
1370	23.8	1490	16.6	1610	101.3	1730	103.3	1850	156.7		

<sup>13</sup> Oxford, Vols. 1, 2 (1866); Vols. 3, 4, 5, 6, (1887); Vol. 7 (1902).

<sup>14</sup> These data, reduced to equivalent cents per bushel based on equivalent values of gold and silver, are from N. C. Murray, *Wheat Prices in England*, Clement, Curtis, and Company, Chicago, 1931.

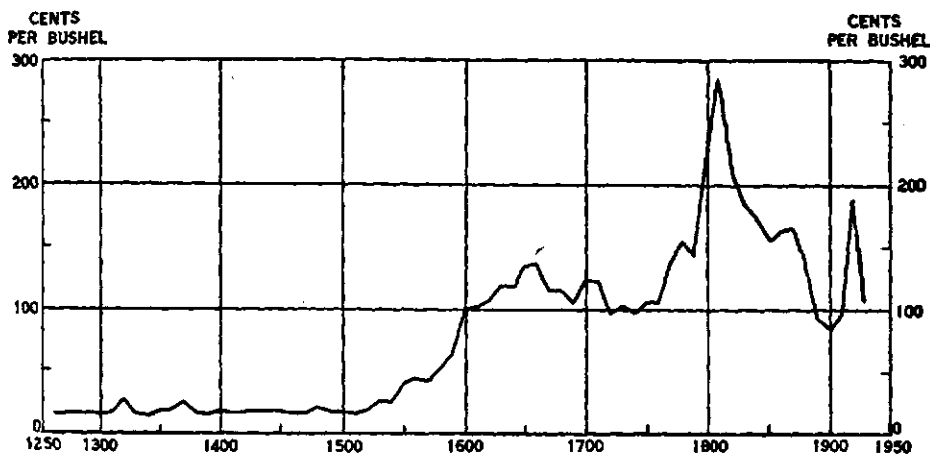

FIGURE 135.—TEN-YEAR AVERAGES OF WHEAT PRICES IN ENGLAND, 1260-1940.

The most interesting observation that we can make from a study of the graph of this long series is that the great price revolution began in the early part of the sixteenth century and reached its culmination about the middle of the seventeenth century. The cause of this revolution has been attributed to the discovery of the abundant mines in America, which added large quantities of gold and silver first to the meager supply in Spain, and thence to all of Europe. It is a point worthy of special comment that the rise of prices in Spain was almost immediately transferred to other countries. Thus, if we form from wheat prices in England an index number with 1600 as the base year, we may compare the rise in price in England with prices in Spain as recently computed by E. J. Hamilton.<sup>15</sup> The price increase in England was concomitant with that of Spain as shown in Figure 136. The same phenomenon is exhibited in other European countries as one may see from the recent study on prices in Germany by M. J. Elsas.<sup>16</sup> An index based upon wheat prices in Munich is also shown in the Figure 136 and this tends to confirm the opinion that prices rose more rapidly on the continent than they did in England. The flow of treasure into Continental countries was not impeded by ocean barriers as it was in England, and not until the time of Sir Francis Drake, who returned with his first spoils in 1573, and the buccaneers of the Spanish Main, was sufficient treasure diverted into England to cause a spectacular rise in prices.

<sup>15</sup> *American Treasure and the Price Revolution in Spain, 1501-1650*, Cambridge, Mass., 1934, xxxv + 428 pp.

<sup>16</sup> *Umriss einer Geschichte der Preise und Löhne in Deutschland*, Vol. 1, Leiden, 1936, x + 808 pp.

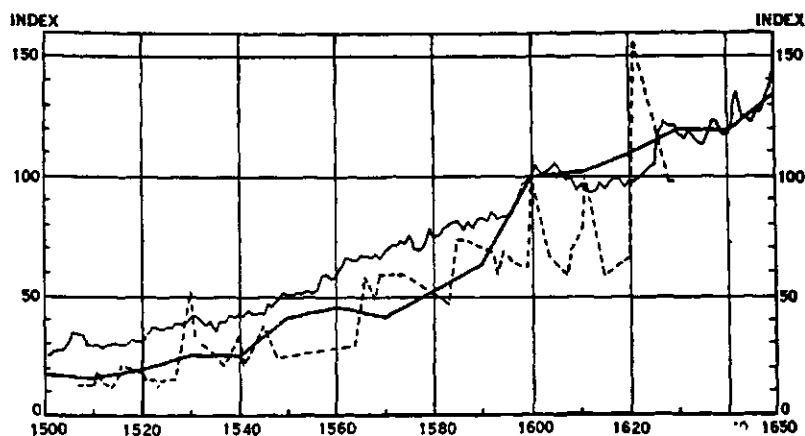

FIGURE 136.—COMPARATIVE PRICES, BASE 1600 = 100.

- : wheat prices in England,  
 - - -: wheat prices in Munich,  
 - · -: general price index in Spain (adapted from Hamilton).

A second observation may be made with respect to the series of wheat prices. The price revolution reached its end by the middle of the seventeenth century and from that time until the beginning of the nineteenth century prices remained unusually stable at the high level which had been attained. Only a moderate fluctuation is apparent in the series and the economic history of that long period reveals no evidence of anything but a stable economic development, with the possible exception of the speculative fury of the South Sea Bubble around 1720.

On the contrary, the price history of the nineteenth and twentieth centuries is one of great disturbance. The nineteenth century was ushered in with the wars of the Napoleonic era and the consequent disruption of world economy. Tremendous surges were set up in the price structure, although the average level was not materially changed from that which had been attained in the price revolution. Although the price of wheat for the decennium centering around 1900 had reached the lowest value in three centuries, the World War introduced another violent perturbation in prices.

The story told by wheat prices is amply confirmed when we broaden our range to include a more general index of prices. Since the study contemplated in the present chapter concerns American indexes rather than those of England, we shall change, at the beginning of the nineteenth century, to the general commodity price index



for the United States. This index has been constructed by G. F. Warren and F. A. Pearson for the years 1797-1889, and thereafter by the U. S. Bureau of Labor Statistics. It is graphically represented in Figure 2, Chapter 1.

From the graph of this index we note one important fact. War is the great price inflator. Thus, peaks appear as the result of the War of 1812, the Civil War, and the World War. These peaks are approximately fifty years apart and there is a striking similarity of price action in each of the three subsequent periods. After the cessation of hostilities there is an abrupt drop in prices, presumably occasioned by the collapse in farm values which have been inflated by war demand. For a brief period prices move along a small shelf, which was longer after the World War than after either of the other two wars, a phenomenon which may perhaps have been due to the large influx of gold during that time. The respite from deflation is short-lived, however, and prices again take their long drop to the first deflation minimum. The fall of prices is then halted and a mild inflation occurs, which is probably monetary in its origin. When the force of this inflation has been exhausted, the prices then continue to fall and reach their minimum value approximately twenty-five years after the beginning of the deflation. It is a melancholy reflection that prices then continue to rise, stimulated doubtless by a long period of increasing trade, until the era of economic prosperity culminates in another war and the creation of a new price cycle. A more extended analysis of this phenomenon of the *fifty-year war cycle* will be given in Chapter 12.

But the question naturally arises: Can commodity prices be substituted for  $P$  in the equation of exchange? It is obvious that this equation is far more inclusive in its character, since all goods and services, of which commodities are only a part, are purchased by the total  $MV + M'V'$  of the left-hand member.

In order to obtain a price index which would reflect changes in the *general level* of prices, Carl Snyder constructed for the Federal Reserve Bank of New York City a comprehensive series, which is entirely adequate to represent the parameter  $P$  in the right-hand member of the equation of exchange. This index contains the following elements:<sup>17</sup>

- (1) Industrial commodity prices at wholesale, U. S. Department of Labor. (Weight 10).
- (2) Farm prices of 30 commodities, U. S. Department of Agriculture. (Weight 10).

<sup>17</sup> See Carl Snyder, "The Measure of the General Price Level," *Review of Economic Statistics*, Vol. 10, 1928, pp. 40-52.

(3) Forty-three articles of food in 51 cities, U. S. Department of Labor. (Weight 10).

(4) Cost of housing in 32 cities, U. S. Department of Labor. (Weight 5).

(5) Cost in 32 cities of clothing (weight 4), fuel and light (weight 1), home furnishing goods (weight 1), miscellaneous (weight 4), U. S. Department of Labor.

(6) Transportation costs, Federal Reserve Bank of New York. Railway freight receipts per ton mile, U. S. Interstate Commerce Commission and U. S. Department of Commerce. (Weight 5).

(7) Realty values—Urban, Federal Reserve Bank of New York (weight 8); Farm, estimated value per acre, U. S. Department of Agriculture (weight 2).

(8) Security prices. Preferred stocks (weight 1), common stocks (weight 4), inverted yield on 60 high-grade bonds (weight 5), Federal Reserve Bank of New York, from data of the Standard Statistics Company.

(9) Equipment and machinery prices: (a) Railway equipment, (b) electric-car costs, (c) farm machinery, (d) telephone equipment, (e) electrical appliances, (f) electrical machinery, (g) heating appliances, Federal Reserve Bank of New York. (Weight 10).

(10) Hardware prices, index of National Retail Hardware Association. (Weight 3).

(11) Automobile prices. Weighted price index of six makes of cars. (Weight 2).

(12) Composite wages, Federal Reserve Bank of New York. (Weight 15).

The table on page 471 gives the values of the *index of general prices* as described above over the period from 1890 to date. The base year is 1913 = 100.

An examination of the table shows that the monthly change in general prices is relatively small. Even the inflationary effects of the World War were unable to alter the index more than a point or two per month, and the rapid business recession of 1929 forced general prices down at a relatively sluggish rate. A comparison of the graph of the annual averages (see Figure 137) with the corresponding graph of commodity prices (see Figure 2, Chapter 1) shows the tendency of general prices to remain relatively stable, while commodity prices are suffering rapid changes.

Some interesting observations can be made about prices and their correlation with other economic variables. Thus Irving Fisher has shown that the rate of change of prices, namely  $P' = dP/dt$ , correlates highly with unemployment. For example, in the period from 1919 to 1932 inclusive the correlation between  $P'$  and the monthly index of

## INDEX OF GENERAL PRICES

Year	Jan.	Feb.	Mar.	Apr.	May	June	July	Aug.	Sept.	Oct.	Nov.	Dec.	Av.
1890	77	77	77	77	78	78	77	78	79	78	77	77	78
1891	77	77	78	78	77	77	77	78	76	76	76	76	77
1892	75	76	75	75	76	76	75	76	76	76	76	77	76
1893	78	78	78	77	76	75	73	74	73	74	74	73	75
1894	72	71	71	71	70	71	71	71	72	71	71	71	71
1895	71	71	71	72	73	73	73	73	73	73	72	72	72
1896	72	72	71	71	71	71	71	70	70	71	72	72	71
1897	71	71	71	71	71	71	71	72	73	73	73	73	72
1898	73	74	73	73	74	73	73	73	73	74	74	74	73
1899	75	75	75	76	77	77	77	77	79	79	79	79	77
1900	80	80	80	80	79	79	79	79	79	80	80	80	79
1901	80	80	80	81	81	81	81	81	81	82	82	83	81
1902	82	82	82	83	84	84	84	84	85	87	85	86	84
1903	86	86	86	86	86	86	85	85	85	85	85	84	86
1904	85	86	86	85	85	85	86	86	86	87	87	87	86
1905	88	88	88	89	87	87	88	88	88	89	89	89	88
1906	90	90	90	90	90	90	90	90	91	92	92	93	91
1907	93	93	93	94	93	93	93	93	93	93	91	91	93
1908	91	90	90	90	91	91	91	91	91	91	92	92	91
1909	93	93	93	93	94	95	95	95	95	96	97	97	94
1910	97	97	98	97	98	97	98	97	97	96	96	96	97
1911	96	96	96	96	96	96	96	96	96	97	96	97	96
1912	97	98	99	100	100	100	100	100	100	101	100	100	100
1913	100	100	100	100	100	99	100	100	101	101	100	100	100
1914	100	100	100	100	100	100	100	101	101	100	99	100	100
1915	100	100	100	101	101	101	102	103	104	107	107	108	108
1916	110	111	113	114	114	115	115	117	120	122	126	127	117
1917	128	130	132	136	139	142	141	142	142	142	141	143	139
1918	144	146	147	149	151	153	155	158	160	162	162	164	157
1919	163	161	162	164	167	170	174	176	176	178	181	184	173
1920	188	189	192	196	198	199	198	195	195	192	187	180	193
1921	177	172	170	167	164	162	160	160	159	159	159	158	163
1922	156	155	155	156	158	158	159	160	160	161	162	163	158
1923	163	164	165	165	166	166	165	165	165	166	166	166	165
1924	167	167	166	165	165	164	165	166	165	165	166	168	166
1925	169	169	169	168	168	170	170	171	171	172	173	173	170
1926	173	172	171	171	171	171	171	171	172	171	172	171	171
1927	170	170	170	169	170	171	170	171	173	173	173	173	171
1928	173	173	174	175	177	176	176	176	178	177	178	178	176
1929	179	179	180	179	179	179	181	182	183	181	174	174	179
1930	174	173	173	174	172	169	167	166	167	163	161	158	168
1931	157	157	157	155	153	150	149	149	147	144	144	140	150
1932	138	136	137	134	132	129	129	132	132	131	130	128	132
1933	127	124	123	124	127	128	132	132	133	133	133	132	129
1934	133	136	136	137	136	137	138	138	139	139	140	140	137
1935	141	142	141	142	143	144	145	146	147	148	149	149	145
1936	150	151	151	150	150	152	154	156	156	156	158	159	154
1937	161	162	163	162	162	162	163	163	161	158	156	155	161
1938	155	154	152	152	152	152	155	154	154	155	154	155	154
1939	155	154	153	152	152	152	153	152	155	155	155	155	154

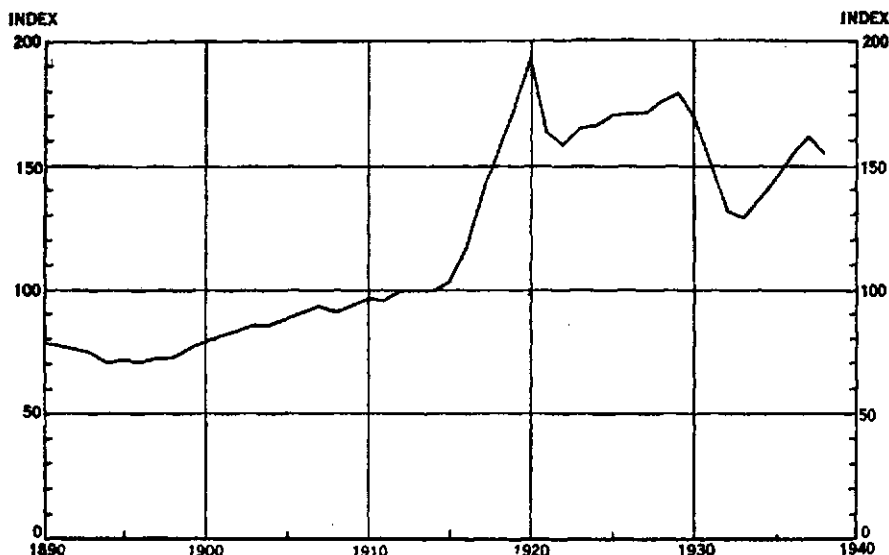

FIGURE 137.—GENERAL INDEX OF PRICES IN THE UNITED STATES, 1913 = 100.

manufacturing employment computed by the Federal Reserve Board was 0.84.<sup>18</sup>

In his *Treatise on Money* (Vol. 2, p. 154) J. M. Keynes made the suggestion that "by far the larger proportion of the world's greatest writers and artists have flourished in the atmosphere of buoyancy, exhilaration, and the freedom from economic cares felt by the governing class, which is engendered by profit inflations." The late W. F. C. Nelson of the Cowles Commission subjected this proposition to a preliminary statistical investigation using in his analysis the rate of change of wheat prices from 1260 to 1900 and an index of the 100 greatest painters weighted according to their importance over the same period. He reached the conclusion "that the chances of a great painter appearing during a period of rising wheat prices appeared to be almost twice as great as during periods of stable or declining prices."<sup>19</sup>

A similar conclusion has been reached by P. A. Sorokin, who has devoted considerable attention to the reaction of economic changes upon cultural levels in his analysis of social dynamics. Thus he says: "So far as the Graeco-Roman and the Western cultures are concerned, we discover the existence of a definite association between the rise and fall of economic well-being and the type of the dominant culture."<sup>20</sup>

<sup>18</sup> "The Relation of Employment to the Price Level," Chapter 10 in *Stabilization of Employment*, edited by C. F. Roos, Bloomington, Ind., 1933.

<sup>19</sup> *Econometrica*, Vol. 3, 1935, pp. 475-476.

<sup>20</sup> See *Social and Cultural Dynamics*, Vol. 3, New York, 1937, Chapter 8.

8. Trade ( $T$ )

We come finally to a consideration of the remaining variable in the equation of exchange, namely trade, which we have indicated by  $T$ . Since price has been represented by an index number, which is a ratio having the dimensions of pure number, it is clear that trade must be dimensionally the same as total  $MV$ , that is to say, it must be expressed in terms of dollars per year.

Total trade is clearly not equal to the total annual value of production and services. This is equivalent to total income and we have already shown that this quantity is approximately one-twelfth of bank debits, that is to say, of  $M'V'$ . If goods were transferred directly from the producer to the consumer in one transaction, then obviously  $PT$  would be exactly equal to total income. But the stream of goods passing from production to consumption flows through many hands and in each exchange there is involved the ancillary exchange of money, which equals in annual total the total quantity  $MV$ . Hence, if we wish to represent  $PT$  more explicitly, we must write

$$PT = p_1q_1 + p_2q_2 + \dots + p_nq_n,$$

where  $q_1, q_2, \dots, q_n$  are the individual quantities of goods and services which are purchased during a year, and where  $p_1, p_2, \dots, p_n$  are their corresponding prices. But it is clear that many of these  $q_i$  are the same. Thus, if  $q_1$  is wheat sold to the miller, then  $q_2$  may be the same wheat sold as flour to the wholesaler,  $q_3$  the same wheat sold to the baker, and  $q_4$  the same wheat sold once more to the ultimate consumer as bread. In these transactions the prices will not be the same and in each transaction there will be added a quantity of service with its corresponding price.

The quantity  $T$  is, therefore, a kind of mathematical index of the volume of transactions per year, expressed in the units of dollars per year. Statistics are not available for its direct evaluation. It must be computed by dividing  $MV$  by  $P$ .

However, its trend must be that of the trend of production and its fluctuations should coincide with those of production. This follows from the fact that there must be a reasonably high stability in the number of transactions which take place for each commodity in its progress from production to consumption.

If, as in Figure 138, we compare the volume of trade with the index of industrial production, we note that the two curves are strikingly similar. The two trends show the same logistic characteristics, which we have noticed earlier in the production of pig iron. The in-

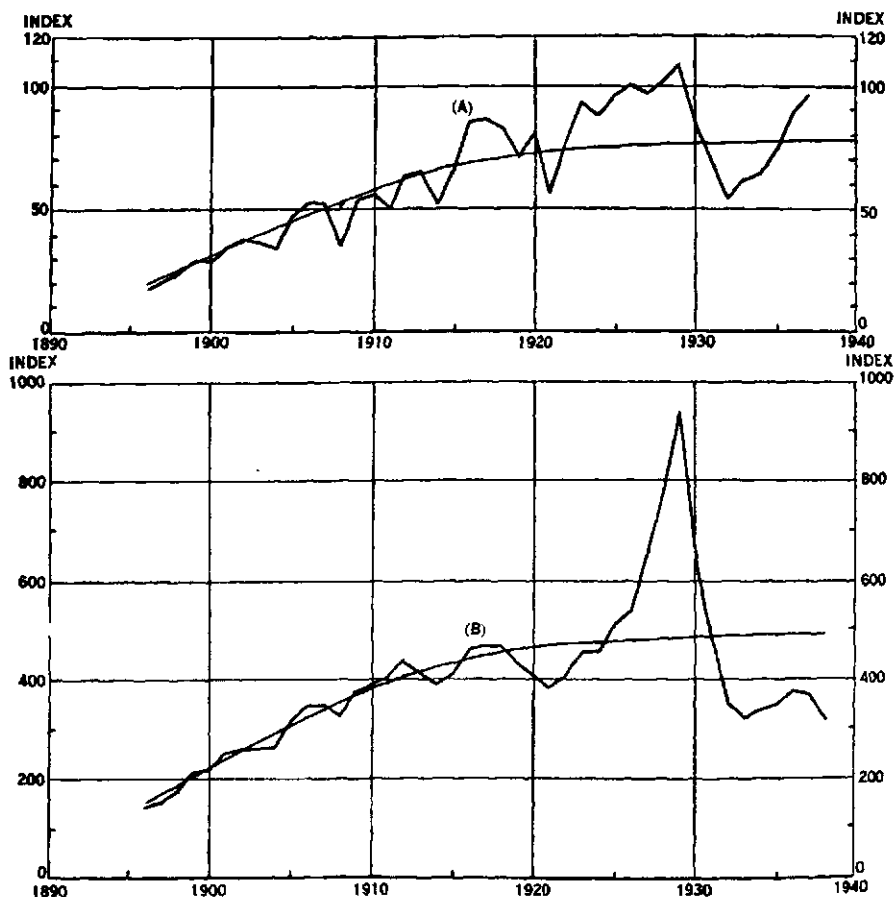

FIGURE 138.—INDEXES OF (A) INDUSTRIAL PRODUCTION AND  
(B) TRADE, WITH TRENDS.

dustrial booms of 1906, 1917, and 1929, with the subsequent depressions of 1908, 1921, and 1932 are revealed in both graphs. The most striking difference is found in the abnormal rise of trade around 1929, which far exceeded in magnitude the industrial boom of the same period. This inflation we know was created by a great increase in stock speculation. Industrial production was unable to sustain the values which developed in the trade index and the depression followed.

Carl Snyder has constructed an index of the volume of trade by the combination of some fifty-six series by months back to the beginning of 1919. In this index 28 different factors were combined, divided into five separate categories as follows: (1) productive activity; (2) distribution to consumers; (3) primary distribution; (4) general business activity; (5) financial activity.

Snyder makes the following illuminating comment on the total volume of trade:

To sum up, the total trade of this nation now mounts up to unimaginable sums. According to our computation the aggregate value of all checks drawn exceeds 700 billions of dollars a year. This means a total volume of transactions in checks and money exceeding 800 billions. And by far the larger part of this vast trade relates to the production and distribution of food, clothing, and the astonishing variety of common needs and luxuries of everyday life, and to the command of human service which all this involves. Relatively but a minor part goes for new construction; and it seems, therefore, difficult to believe that those quantity series which relate chiefly to basic production can furnish us with an adequate measure of the trade or exchanges of a hundred and more millions of people.<sup>20</sup>

The values of trade ( $T$ ) given below are computed from the formula

$$(1) \quad T = M'V'/P.$$

It is obvious that this value of  $T$  is smaller than the actual trade since the factor  $MV$  has been omitted. With the increased use of banks during the past half century, this error has become relatively negligible. The ratio of  $MV$  to  $M'V'$  has steadily diminished from a value of 0.162 in 1896 to a value of 0.087 in 1912. It is safe to assume that the error in computing trade from formula (1) is not more than 10 per cent over the period under analysis.

A trend,  $T(t)$ , is fitted to the trade values obtained from formula (1) on the assumption that the trend is logistic in character. The actual statistical procedure was to compute the parameters in the equation

$$R = p + qT,$$

where  $R$  is defined to be the ratio  $\Delta T/T$ . We then know that the constants  $a$  and  $k$  in the logistic

$$T = \frac{k}{1 + be^{-at}},$$

are given by the relationships,  $a = p$ , and  $k = -p/q$ .

It is thus found that

$$R = 0.144069 - 0.00029136T,$$

and hence that  $a = 0.144069$ , and  $k = 494.47$ .

Assuming an initial value for  $T$  of 139, incrementary changes are then successively computed from the formula

$$\Delta T = TR = pT + qT^2,$$

<sup>20</sup> *Business Cycles and Business Measurements*, New York, 1927, p. 180.

and the values of the logistic are thus successively constructed. The true initial value is then determined by comparing graphically the computed curve with the actual data.

The values of  $T$ , and the estimates of  $T(t)$ , together with the associated values of  $M'V'$ , are given in the following table:

Year	Trade ( $T$ )	Trend Values $T(t)$	$M'V'$	Year	Trade ( $T$ )	Trend Values $T(t)$	$M'V'$
1896	139	154	99	1918	468	455	734
1897	156	169	112	1919	433	460	749
1898	179	185	131	1920	405	465	782
1899	212	202	163	1921	382	469	623
1900	215	219	170	1922	404	472	639
1901	256	237	208	1923	455	475	751
1902	261	255	219	1924	453	478	752
1903	264	273	227	1925	512	480	871
1904	265	290	228	1926	537	482	918
1905	317	307	279	1927	663	484	1134
1906	347	324	315	1928	778	485	1369
1907	347	340	323	1929	937	486	1678
1908	323	355	294	1930	655	487	1101
1909	375	369	353	1931	496	488	744
1910	393	382	381	1932	351	489	463
1911	404	395	388	1933	320	490	413
1912	438	406	438	1934	338	491	463
1913	411	416	411	1935	342	491	535
1914	391	426	391	1936	374	492	624
1915	409	434	421	1937	368	492	614
1916	462	442	540	1938	317	493	522
1917	468	449	650				

### 9. Snyder's Theory of Price

As a result of a long study of the variables in the equation of exchange, Carl Snyder has evolved a theory of price which merits careful attention, not only because of its apparent statistical validity, but because of the possibility which it offers of a possible mechanism for the stabilization of prices.

Although the general features of the theory have been set forth in many of Snyder's writings, a precise mathematical formulation was wanting. This formulation has been provided recently by E. V. Huntington, whose notable work in the field of mathematical logic gave him ideal qualifications for the task of postulation.<sup>21</sup>

Snyder's theorem as stated by Huntington follows:

*"In order to preserve the stability of the general price level ( $P$ ), we must keep the quantity of money ( $M$ ) proportional to the long-*

<sup>21</sup> *Econometrica*, Vol. 6, 1938, pp. 177-179.



time trend,  $T(t)$ , of the volume of trade; that is, we must make  $M = kT(t)$ ."

In this formulation the simpler form of the equation of exchange is used, namely,

$$(1) \quad MV = PT,$$

where  $M$  is the total circulating money, mainly circulating deposits, and  $V$  is its velocity. For the statistical verification of Snyder's theorem it will be convenient to think of  $M$  as essentially equivalent to  $M'$  as defined in Section 4, and  $V$  as equivalent to  $V'$ .

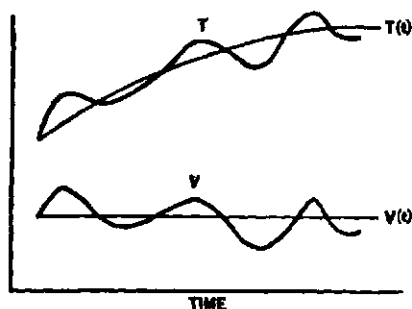

FIGURE 139.—SCHEMATIC REPRESENTATION OF VELOCITY AND TREND FACTORS.

We shall assume that  $V$  and  $T$  are plotted against time and that  $V(t)$  is the ordinate of the secular trend of  $V$ . Hence, if  $\Delta V$  is the deviation of  $V$  from  $V(t)$ , we have  $V = V(t) + \Delta V$ . Similarly we represent the trend of trade by  $T(t)$ , and the deviation of  $T$  from  $T(t)$  by  $\Delta T$ . That is, we have  $T = T(t) + \Delta T$ .

The first postulate of Snyder's theory is that the secular trend of  $V$  is nearly horizontal; that is,

$$(2) \quad V(t) = \text{constant}.$$

The second postulate of Snyder's theory states that, within statistical error, the percentage variation in  $T$  equals the percentage variation in  $V$ . This may be formulated symbolically as follows:

$$(3) \quad \frac{\Delta T}{T(t)} = \frac{\Delta V}{V(t)},$$

or by adding 1 to both sides,

$$1 + \frac{\Delta T}{T(t)} = 1 + \frac{\Delta V}{V(t)},$$

we may write

$$\frac{T}{T(t)} = \frac{V}{V(t)}.$$

By the direct substitution of (2) and (3) in the equation of exchange, that is, in equation (1), we obtain

$$(4) \quad \frac{M}{T(t)} = \frac{P}{V(t)}.$$

Then, since by the first postulate  $V(t)$  is a constant, it follows that  $P$  will be constant provided  $M$  is proportional to  $T(t)$ ; that is

$$(5) \quad M = kT(t),$$

where  $k$  is the proportionality factor.

Huntington points out that the second postulate may be weakened without impairing the validity of the theorem. Thus he writes (3) in the form

$$(6) \quad \frac{T}{T(t)} = c \frac{V}{V(t)},$$

and hence replaces (4) by the equation

$$(7) \quad \frac{M}{T(t)} = c \frac{P}{V(t)}.$$

### 10. The Statistical Test of Snyder's Theory

The important question next to be considered is that of the statistical validity of Snyder's theory. Two essential postulates must be examined: (1) that  $V(t)$  is constant; (2) that the ratio

$$c = \frac{T}{T(t)} \cdot \frac{V(t)}{V}$$

is a constant, which is approximately equal to 1. The velocity we shall

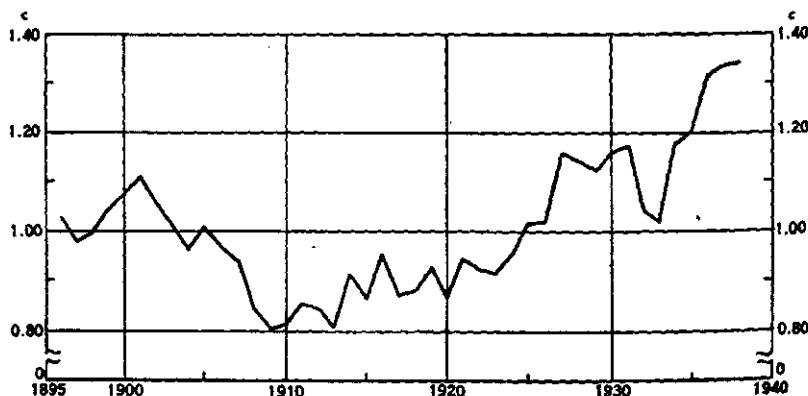

FIGURE 140.—VARIATIONS IN SNYDER'S CONSTANT  $c$ .  
In this chart a constant velocity trend is assumed.

understand to be the velocity of deposits, the prime being dropped for convenience.

The first assumption, namely, that the trend of velocity,  $V(t)$ , is a constant, is difficult to establish directly. The range of the data is short and as one observes from the graph (Figure 141), velocity has been subjected to violent fluctuations during the past decade and a half. Thus one observes a decline from a maximum of more than 70 in 1929 to a minimum of around 20 in 1938. The average velocity, however, has remained relatively constant. Thus the average to 1917 inclusive was 44.50 with a standard error of  $\pm 9.86$ , while for the subsequent period the average was 38.96 with a standard error of  $\pm 12.72$ . We can say with reasonable certainty that there has been neither a secular increase nor a secular decrease over the period of 43 years under examination, although this is far from saying that there has not been something of a sinusoidal variation in the trend. This point will be examined more carefully in the next section. We may say, however, that the proposition that the trend of velocity is a constant is certainly a first approximation to the actual observed situation.

The validity of the second postulate may be observed from the following table, which gives the values of the ratios,  $T/T(t)$ , and  $V(t)/V$ , together with their product, that is, the quantity  $c$ .

The average value of  $c$  is found to be 1.0103 with a standard error of  $\pm 0.1378$ . The largest value of  $c$  is for the year 1938, where  $c$

Year	$a = t/T(t)$	$b = V(t)/V$	$c = a \cdot b$	Year	$a = t/T(t)$	$b = V(t)/V$	$c = a \cdot b$
1896	0.9026	1.1418	1.0306	1918	1.0286	0.8564	0.8809
1897	0.9231	1.0607	0.9791	1919	0.9413	0.9879	0.9299
1898	0.9676	1.0293	0.9960	1920	0.8710	0.9974	0.8687
1899	1.0495	0.9950	1.0443	1921	0.8145	1.1576	0.9429
1900	0.9817	1.0911	1.0711	1922	0.8559	1.0798	0.9242
1901	1.0802	1.0293	1.1118	1923	0.9579	0.9629	0.9224
1902	1.0235	1.0319	1.0561	1924	0.9477	1.0094	0.9566
1903	0.9670	1.0526	1.0179	1925	1.0667	0.9563	1.0201
1904	0.9138	1.0558	0.9643	1926	1.1141	0.9185	1.0233
1905	1.0326	0.9787	1.0106	1927	1.3698	0.8425	1.1541
1906	1.0710	0.9026	0.9667	1928	1.6041	0.7131	1.1439
1907	1.0206	0.9225	0.9415	1929	1.9280	0.5828	1.1236
1908	0.9099	0.9328	0.8488	1930	1.3450	0.8599	1.1566
1909	1.0163	0.7915	0.8044	1931	1.0164	1.1512	1.1701
1910	1.0288	0.7930	0.8158	1932	0.7178	1.4561	1.0452
1911	1.0228	0.8375	0.8566	1933	0.6531	1.5652	1.0222
1912	1.0788	0.7826	0.8443	1934	0.6884	1.7057	1.1742
1913	0.9880	0.8226	0.8127	1935	0.6965	1.7269	1.2028
1914	0.9178	0.9998	0.9176	1936	0.7602	1.7340	1.3182
1915	0.9424	0.9205	0.8675	1937	0.7480	1.7859	1.3359
1916	1.0452	0.9124	0.9536	1938	0.6430	2.0895	1.3435
1917	1.0423	0.8375	0.8729				

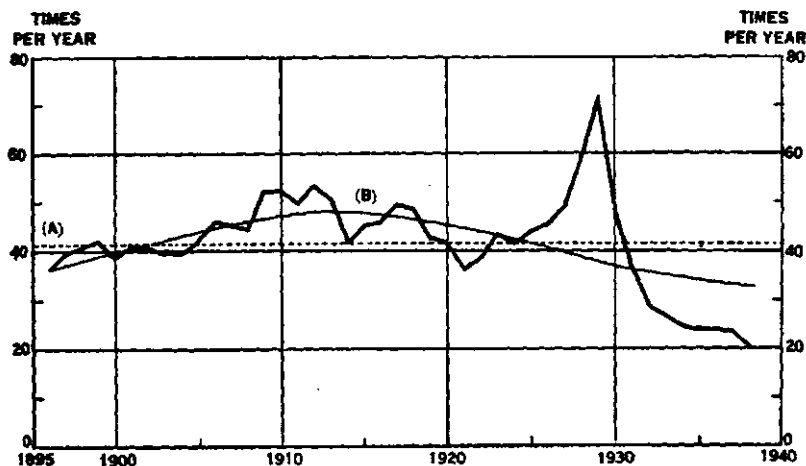

FIGURE 141.—VELOCITY OF DEPOSITS, FITTED WITH (A) CONSTANT TREND, (B) SINUSOIDAL CURVE.

equals 1.3435. Hence, the difference between  $c$  and its assumed value of 1.0000 exceeds twice the standard error in this case, and suggests that some modification in the theory may be necessary to explain this discrepancy.

A final check on the theory may be obtained by making a direct computation of the general price index, using for this purpose the formula

$$(1) \quad P = \frac{V(t)}{c} \cdot \frac{M}{T(t)} = 41.36 \frac{M}{T(t)}.$$

Substituting in this formula the values of  $M'$  for  $M$ , we obtain estimates of the general price index,  $P_c$ , which are compared with the

Year	$P_c$	$P$	$P_c - P$	Year	$P_c$	$P$	$P_c - P$	Year	$P_c$	$P$	$P_c - P$
1896	73	71	2	1911	86	96	-10	1926	178	171	7
1897	68	72	-4	1912	84	100	-16	1927	195	171	24
1898	73	73	0	1913	80	100	-20	1928	199	176	23
1899	81	77	4	1914	91	100	-9	1929	199	179	20
1900	81	79	2	1915	88	103	-15	1930	192	168	24
1901	88	81	7	1916	110	117	-7	1931	174	150	24
1902	89	84	5	1917	120	139	-19	1932	186	132	54
1903	86	86	0	1918	137	157	-20	1933	131	129	2
1904	85	86	-1	1919	159	173	-14	1934	159	137	22
1905	89	88	1	1920	166	193	-33	1935	186	145	41
1906	89	91	-2	1921	152	163	-11	1936	218	154	64
1907	89	93	-4	1922	145	158	-13	1937	221	162	59
1908	77	91	-14	1923	151	165	-14	1938	219	154	65
1909	77	94	-17	1924	157	166	-9				
1910	83	97	-14	1925	172	170	2				

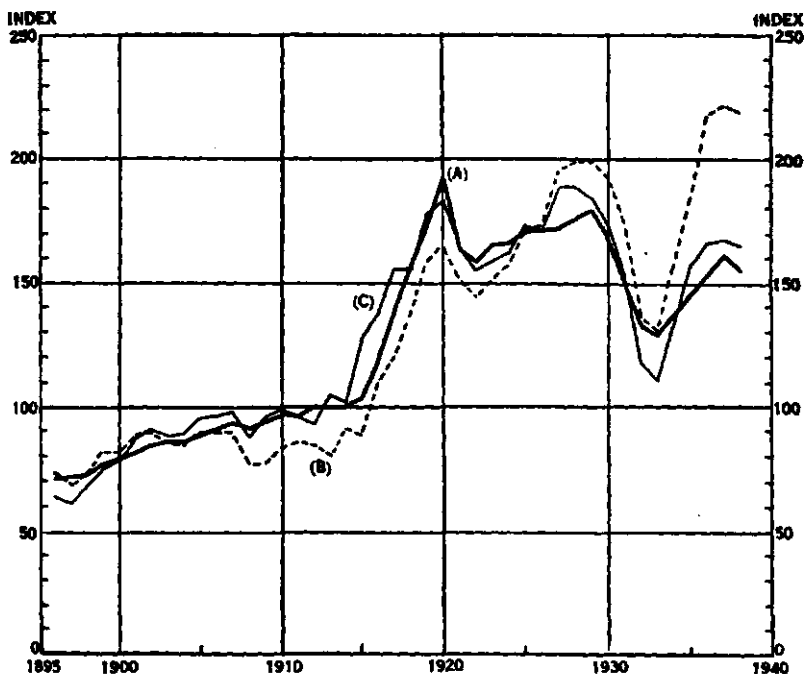

FIGURE 142.—COMPARISON BETWEEN REAL PRICES AND COMPUTED PRICES.

(A) is the general price index; (B) the price level computed for a constant-velocity trend; (C) the price level computed for a variable-velocity trend.

actual values of the index computed by the Federal Reserve Bank of New York,  $P$ , in the table on page 480.

The general agreement between  $P_c$  and  $P$  is revealed in Figure 142, although large discrepancies are to be observed, particularly in 1920, in the period 1927–1930, and after 1932. It is clear that further analysis of the situation is called for, and this will be given in the next section.

### 11. Modifications of Snyder's Theory

In the last section we found that, while Snyder's theory provided a general agreement with actual price data, the variations in the inflationary period after the World War called for a further analysis.

In scrutinizing the postulates of Snyder's system, it is upon the first one that suspicion falls because of its rigid and uncompromising character. In a world of change, it seems strange, indeed, that the trend of velocity should be a constant. Particularly in a series where one witnesses such violent fluctuations as those which appear in the

velocity factor and in which the psychic element seems to be so great, it strains belief to assume that one will find an unchanging pattern. Of course, the assumption is derived from an observation that the general spending mechanism is regimented by the institution of banking. Hence, it seems reasonable to suppose that in the long run about the same velocity of exchange will prevail in spite of the occasional extreme optimisms which can produce a velocity of 70, or the subsequent pessimisms which can reduce the velocity to 20.

An analysis of the discrepancies between Snyder's price and the observed price indicates that the trend of velocity is not constant, but that *it is of a sinusoidal character about a constant value*. This observation is easily made if one determines from equation (1) of Section 10 the values of  $V(t)$  which will actually give the observed price. It is found from this that if a sine curve of period approximately equal to 50 years and of amplitude equal to 7.17 is added to the average value of the velocity, then a much better agreement is obtained between the computed and the observed series.

In the following table we give the new values of  $V(t)$ , the resulting value of  $c$ , the values of Snyder's price,  $P_c$ , and the deviations,  $P_c - P$ , between it and the observed price. The graph of the trend of velocity is given in Figure 141, the values of  $c$  are graphically represented in Figure 143, and the new computations of  $P_c$  are compared with the observed price in Figure 142.

Year	$V(t)$	$c$	$P_c$	$P_c - P$	Year	$V(t)$	$c$	$P_c$	$P_c - P$
1896	36.5	0.9002	64	- 7	1918	46.8	0.9864	155	- 2
1897	37.2	0.8716	61	-11	1919	46.2	1.0281	178	5
1898	38.0	0.9057	67	- 6	1920	45.6	0.9479	183	-10
1899	38.9	0.9720	76	- 1	1921	44.9	1.0131	165	2
1900	39.8	1.0228	78	- 1	1922	44.2	0.9775	155	- 3
1901	40.7	1.0829	87	6	1923	43.4	0.9579	158	- 7
1902	41.6	1.0513	90	6	1924	42.5	0.9729	162	- 4
1903	42.5	1.0352	88	2	1925	41.6	1.0154	173	3
1904	43.3	0.9991	89	3	1926	40.7	0.9966	171	0
1905	44.1	1.0665	95	7	1927	39.8	1.0991	188	17
1906	44.9	1.0387	96	5	1928	39.0	1.0675	188	12
1907	45.6	1.0273	98	5	1929	38.1	1.0245	184	5
1908	46.2	0.9384	87	- 4	1930	37.3	1.0323	173	5
1909	46.7	0.8989	87	- 7	1931	36.5	1.0220	153	3
1910	47.2	0.8956	95	- 2	1932	35.8	0.8954	118	-14
1911	47.6	0.9756	99	3	1933	35.2	0.8610	111	-18
1912	47.7	0.9637	96	- 4	1934	34.7	0.9750	133	- 4
1913	47.9	0.9316	93	- 7	1935	34.2	0.9843	156	11
1914	47.9	1.0517	95	5	1936	33.8	1.0662	166	12
1915	47.8	0.9923	102	- 1	1937	33.7	1.0773	167	6
1916	47.5	1.0840	127	10	1938	33.6	1.0802	165	11
1917	47.2	0.9859	136	- 3	Av.	41.7	0.9947		0.52

With the new determination of prices, there still remain one or two disagreements. The first of these is in the inflationary period of the bull market. It is possible that this discrepancy can be accounted for partially by the rigid system of weights used in the general index of prices. Thus, the dominating characteristics of the period around 1929 was the spectacular rise in the price of stocks. The velocity of deposits also increased in a remarkable manner, as we have seen, and there was a corresponding rise in the volume of trade, which was only partially accounted for by the increase in industrial production. This great expansion of trade is undoubtedly to be explained by the increase in stock-market transactions, which reached unprecedented heights. But in the computation of the general price index this spectacular increase in the price of stocks and its reaction upon the general level of prices were probably not sufficiently accounted for by the original weighting of five per cent, which was not changed over this period.

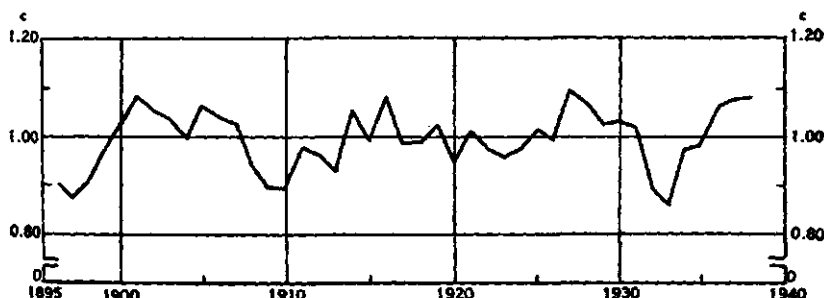

FIGURE 143.—VARIATIONS IN SNYDER'S CONSTANT  $c$ .  
In this chart a sinusoidal change of velocity is assumed.

In connection with this revision of Snyder's first postulate, the question naturally arises as to the justification for introducing the new trend of velocity. The hypothesis has admittedly been advanced *ad hoc* in order to explain the major discrepancies of the Snyder theory, and until more evidence is adduced as to the reality of the observed cycle, the hypothesis must remain a tentative one. However, we have seen that prices themselves are intimately related to the war cycle, and the fact that the period in the velocity is also the average length of this phenomenon, may, perhaps, tentatively suggest a connection between the two phenomena.

One may observe in passing that there appears in recent years to be a relationship between the velocity of money and the rate of interest, which has been created by the exigencies of large governmental

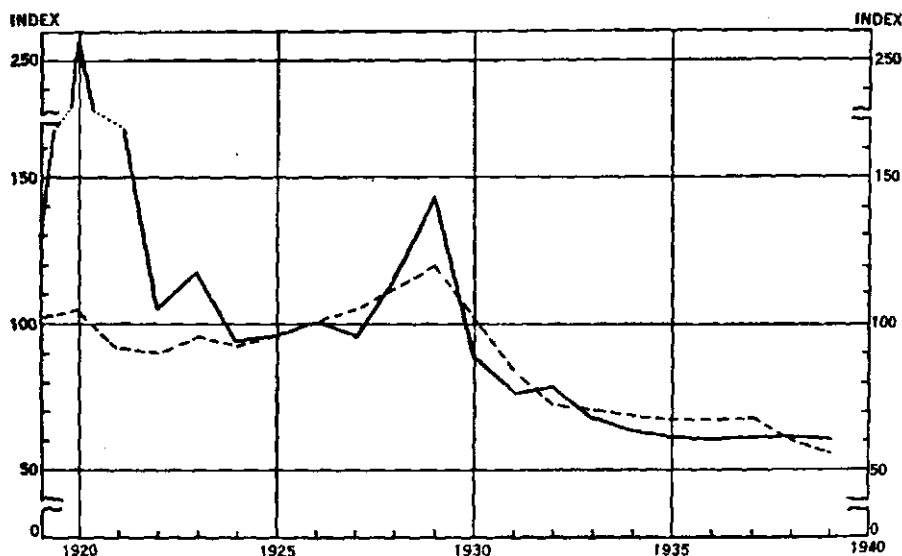

FIGURE 144.—COMPARISON OF THE INDEX OF "MONEY TENSION" WITH THE INDEX OF THE VELOCITY OF DEPOSITS.

deficit spending. If we consider the curve of money tension as measured by the reciprocal of the Standard Statistics Company's inverted interest rate over the period from 1919 to date, we note that a high correlation exists between the velocity factor (expressed as an index number with 1926 = 100) and a similar index of money tension. The high tension observed in 1920 had no counterpart in the velocity index, but at this time there occurred one of the major readjustments of prices following the great war inflation.

Our final conclusion from this study is that the agreement between computed and real prices appears to be quite satisfactory, when one considers the nature of the data, and the long range of time involved in the analysis. Certainly the major part of the variation in price can be accounted for by this theory.

## 12. Gold and Silver and Their Relationship to the Level of Prices

The next question concerns the relationship between world stocks of gold and silver and the variables in the equation of exchange. A complete discussion of this interesting but complicated question involves a consideration of world prices and the ratios of the currencies of the chief industrial countries. This problem we shall not consider here, since this would involve an analysis of the mechanism of foreign exchange, which would carry us too far from the objectives of this chapter.



We may, however, see to what extent internal prices are presumably affected by gold and silver as the holdings of these metals affect the amount of currency in actual circulation. We have previously seen that money,  $M$ , which is for the most part fiduciary currency with a theoretical gold base, is about 25.9 per cent of circulating deposits, that is,

$$M = 0.259M'$$

This percentage is obtained by averaging the ratio  $H$  of Section 4.

Moreover, since the average velocity of  $M$  is about 50 per cent of the velocity of  $M'$ , that is,

$$V = 0.50V',$$

it is clear that  $MV$  would be on the average about  $25.9 \times 0.50 = 12.9$  per cent of  $M'V'$ . Hence, any small increase in actual currency, caused by its issue against an increase in holdings of gold and silver, would have a negligible effect upon trade and prices. Any large increase would necessarily, have profound repercussions upon the price system.

An instructive example of this is the great German inflation, which began with the World War and culminated in 1923. A comprehensive study of this unusual phenomenon has been given by C. Bresciani-Turroni, whose data we employ.<sup>22</sup> We note from the accompanying table the rapid increase in the issuance of paper marks as the financial condition of the government became more desperate. The total  $M'$  became submerged in the enormous issue of  $M$  and all business was of necessity transacted in the depreciated marks. The index number of wholesale prices, which was around 1.00 in 1914 and 2.45 at the end of the war, rose rapidly to 8.03 in December, 1919, to 14.4 a year later, to 34.9 in December, 1921, to 1,475 in December, 1922,

CIRCULATION OF THE REICHSBANK  
(Billions of paper marks)

Year	Jan.	Feb.	Mar.	Apr.	May	June	July	Aug.	Sept.	Oct.	Nov.	Dec.
1914	2.1	2.0	2.4	2.1	2.0	2.4	2.9	4.2	4.5	4.2	4.2	5.0
1915	4.7	4.9	5.6	5.3	5.3	5.8	5.5	5.6	6.2	5.9	6.0	6.9
1916	6.5	6.6	7.0	7.0	6.7	7.2	7.0	7.1	7.4	7.3	7.3	8.1
1917	7.9	8.1	8.6	8.3	8.3	8.7	8.9	9.3	10.2	10.4	10.6	11.5
1918	11.1	11.3	12.0	11.8	12.0	12.5	12.7	13.6	15.3	16.7	18.6	22.2
1919	23.6	24.1	25.5	26.6	28.2	30.0	29.3	28.5	29.8	30.9	31.9	35.7
1920	37.4	41.0	45.2	47.9	50.0	54.0	55.8	58.4	61.7	63.6	64.3	68.8
1921	66.6	67.4	69.4	70.8	71.8	75.3	77.4	80.1	86.4	91.5	100.9	118.6
1922	115	120	131	140	152	169	190	238	317	469	754	1280
1923	1984	3513	5518	6546	8564	17291	45594	663*	28229*	2.5†	400.3†	496.5†

\* Trillions of marks; † Quadrillions of marks.

<sup>22</sup> *The Economics of Inflation*, London, 1937, 464 pp. (First issued in Italian in 1931).

and to the fantastic level of 1,262 billion at the end of the deflation in 1923.

The lesson to be learned from this is not that there is virtue in a gold basis for currency, but merely that the ratio between  $M$  and  $M'$  should be held reasonably constant and that the issuance of  $M$ , or the expansion of  $M'$ , should follow the trend of trade and not be governed by the exigencies of the national credit.

A period worth examining from the point of view of the relationship of gold and silver to the level of prices was the sixteenth century and the first half of the seventeenth century. During these 150 years a phenomenal increase in prices took place owing principally to the importation into Europe of vast quantities of gold and silver from the mines in America.

Our data for the examination of the relationships between prices and money in the century and a half under consideration are from three reliable sources. We have a record of wheat prices in England by J. E. T. Rogers, previously referred to, an admirable index of Spanish commodity prices computed by E. J. Hamilton, also mentioned in Section 7, and a table showing the total importation of gold and silver into Spain in terms of a standard peso, provided also by Hamilton.<sup>23</sup> To these we may add the estimates of the world's production of gold and silver from 1493 to 1890 made by Adolf Soetbeer, whose studies on this question are generally accepted as the most reliable and authoritative.<sup>24</sup>

The accompanying table gives (1) Hamilton's index of Spanish prices, and (2) the accumulated production since 1500 of precious metals reduced to a gold "value equivalent" in ounces by means of the formula

$$\text{Treasure Production} = (\text{Gold Production}) \\ + (1/R) (\text{Silver Production}),$$

where  $R$  has the value 10.75 from 1501 to 1520, 11.25 from 1521 to 1540, 11.30 from 1541 to 1560, 11.50 from 1561 to 1580, 11.80 from 1581 to 1600, 12.25 from 1601 to 1620, 14.00 from 1621 to 1640, and 14.50 from 1641 to 1650. It is clear that the accumulated production of

<sup>23</sup> "Imports of American Gold and Silver in Spain, 1503-1660," *Quarterly Journal of Economics*, Vol. 43, 1929.

<sup>24</sup> For data from 1493 to 1880 see Soetbeer, *Materialien zur Erläuterung und Beurteilung der wirtschaftlichen Edelmetallverhältnisse und der Währungsfrage*. Zweite Vervollständigte Ausgabe, Berlin, 1886. For data from 1881 to 1890 see Soetbeer: "Edelmetallgewinnung und Verwendung in den Jahren 1881 bis 1890," *Hildebrand's Jahrbücher für Nationalökonomie und Statistik*, Vol. 56, 1891, pp. 537, 538, 561. Soetbeer's estimates, together with their equivalents in dollars, are given by J. D. Magee, "The World's Production of Gold and Silver from 1493 to 1905," *Journal of Political Economy*, Vol. 18, 1910, pp. 50-58.

Year	Index of Spanish Prices	Accumulated Production of Treasure (oz. of gold)	Year	Index of Spanish Prices	Accumulated Production of Treasure (oz. of gold)
1501	33.26	327,040	1551	69.40	26,368,867
1502	36.41	654,080	1552	71.32	27,529,036
1503	37.34	981,120	1553	70.24	28,689,205
1504	38.15	1,308,160	1554	71.77	29,849,374
1505	40.59	1,635,200	1555	71.02	31,009,543
1506	46.89	1,962,240	1556	72.28	32,169,712
1507	46.42	2,289,280	1557	79.74	33,329,881
1508	44.78	2,616,320	1558	80.92	34,490,050
1509	39.33	2,943,360	1559	77.86	35,650,219
1510	38.76	3,270,400	1560	79.09	36,810,388
1511	39.78	3,597,440	1561	86.83	37,867,616
1512	37.92	3,924,480	1562	91.49	38,924,844
1513	39.41	4,251,520	1563	89.66	39,982,072
1514	40.48	4,578,520	1564	88.67	41,039,300
1515	41.16	4,905,600	1565	92.38	42,096,528
1516	40.55	5,232,640	1566	90.29	43,153,756
1517	40.18	5,559,680	1567	90.91	44,210,984
1518	43.46	5,886,720	1568	92.44	45,268,212
1519	43.24	6,213,760	1569	90.18	46,325,440
1520	42.06	6,540,800	1570	93.84	47,382,668
1521	46.48	7,028,777	1571	97.53	48,439,896
1522	50.61	7,516,754	1572	97.32	49,497,124
1523	48.84	8,004,731	1573	99.94	50,554,352
1524	49.24	8,492,708	1574	98.29	51,611,580
1525	50.39	8,980,685	1575	103.71	52,668,808
1526	49.83	9,468,662	1576	95.65	53,726,036
1527	53.12	9,956,639	1577	94.00	54,783,264
1528	51.20	10,444,616	1578	97.84	55,840,492
1529	53.49	10,932,593	1579	107.77	56,897,720
1530	56.78	11,420,570	1580	102.77	57,954,948
1531	57.06	11,908,547	1581	103.95	59,012,176
1532	54.99	12,396,524	1582	106.57	60,069,404
1533	51.36	12,884,501	1583	108.51	62,091,060
1534	53.81	13,372,478	1584	110.36	63,469,764
1535	48.95	13,860,455	1585	111.35	64,848,468
1536	53.94	14,348,432	1586	106.62	66,227,172
1537	53.21	14,836,409	1587	111.31	67,605,876
1538	57.05	15,324,386	1588	107.62	68,984,580
1539	56.41	15,812,363	1589	113.09	70,363,284
1540	58.20	16,300,340	1590	113.97	71,741,988
1541	56.02	16,787,176	1591	112.73	73,120,692
1542	60.49	17,274,012	1592	117.12	74,499,396
1543	58.06	17,760,848	1593	113.43	75,878,100
1544	60.09	18,247,684	1594	114.24	77,256,804
1545	59.48	19,047,853	1595	114.08	78,635,508
1546	64.75	20,568,022	1596	116.61	80,014,212
1547	62.64	21,728,191	1597	123.75	81,392,916
1548	66.32	22,888,360	1598	132.55	82,771,620
1549	70.63	24,048,529	1599	134.92	84,150,324
1550	69.05	25,208,698	1600	137.24	85,529,028

Year	Index of Spanish Prices	Accumulated Production of Treasure (oz. of gold)	Year	Index of Spanish Prices	Accumulated Production of Treasure (oz. of gold)
1601	143.56	86,912,870	1626	162.17	120,230,332
1602	138.16	88,296,712	1627	169.43	121,401,076
1603	139.73	89,680,554	1628	166.65	122,571,820
1604	142.25	91,064,396	1629	166.51	123,742,564
1605	144.34	92,448,238	1630	160.84	124,913,308
1606	139.63	93,832,080	1631	158.94	126,084,052
1607	135.64	95,215,922	1632	163.95	127,254,796
1608	136.12	96,599,764	1633	159.52	128,425,540
1609	129.61	97,983,606	1634	156.85	129,596,284
1610	132.86	99,367,448	1635	154.83	130,767,028
1611	127.92	100,751,290	1636	160.54	131,937,772
1612	127.53	102,135,132	1637	169.74	133,108,516
1613	128.77	103,518,974	1638	169.51	134,279,260
1614	133.85	104,902,816	1639	161.71	135,450,004
1615	130.41	106,286,658	1640	161.80	136,620,748
1616	135.40	107,670,500	1641	170.75	137,714,896
1617	136.72	109,054,342	1642	186.07	138,809,044
1618	136.41	110,438,184	1643	172.25	139,903,192
1619	131.23	111,822,026	1644	171.71	140,997,340
1620	134.77	113,205,868	1645	168.36	142,091,488
1621	133.93	114,376,612	1646	173.98	143,185,636
1622	136.05	115,547,356	1647	175.00	144,279,784
1623	137.67	116,718,100	1648	183.14	145,373,932
1624	142.04	117,888,844	1649	188.03	146,468,080
1625	143.09	119,059,588	1650	198.47	147,562,228

treasure is not known to the accuracy implied by the number of figures used in the table. Annual data are linearly interpolated in the estimates of Soetbeer and the figures kept to give a constant annual difference.

Hamilton's index, base = 1571-1580, is not given directly by him, but may be obtained by dividing his index of money wages by his index of real wages.

From these data it is clear that a good index of money might be constructed if the total amount of treasure that was necessary to sustain the price level of the Middle Ages could be approximated. From the data of Rogers on the price of wheat in England, it is observed that prices were remarkably stable over the long period from 1250 to 1500. Hence the amount of treasure in England, in particular, and in Europe, in general, must have changed but little in this long period.

W. Jacob, in a comprehensive study of the question of treasure in Europe, reaches the conclusion "that no very great increase or decrease in the stock of the precious metals occurred during those centuries [between the time of the Norman conquest and that of the discovery of America]; or it may be presumed that the supply from the mines was nearly equal to the consumption by friction on the circula-

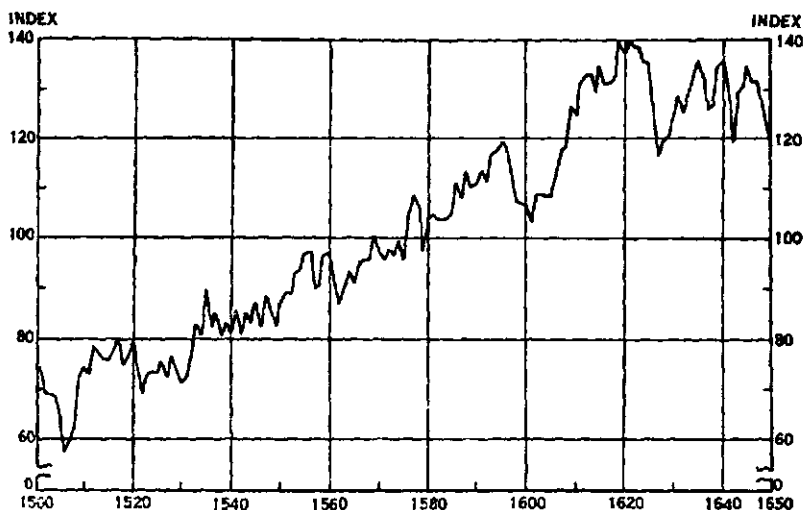

FIGURE 145.—INDEX OF SPANISH TRADE, BASED ON SOETBEER'S TREASURE SERIES, 1501-1650.

tion, and to that portion which either had been lost from being buried in the ground and not again found, or that had been lost by shipwrecks."<sup>25</sup>

If we take Jacob's estimate for the year 806 of circulating treasure, namely treasure valued in British pounds at £ 33,674,256, we shall probably not be far wrong in assuming that the prices of the Middle Ages were maintained by a circulating coinage equivalent approximately to 8,500,000 ounces of gold. Since our figures on accumulated treasure given above include not only that directed to currency, but also that employed in arts and industry, we should probably double Jacob's figures before adding them to the accumulation data in order to obtain the probable amount of treasure in Europe in any given year of the sixteenth century.<sup>26</sup> Hence, entirely aware of the large error that is probably contained in these estimates, we shall assume that there existed at the beginning of the sixteenth century in Europe a treasure of precious metals approximately equal to 17,000,000 ounces of gold.

In order to compute an index of money for the century and a half under consideration, we shall first designate the items of the accumulated treasure by  $m_i$ , its average value between 1571 and 1580 by  $m$ ,

<sup>25</sup> *An Historical Inquiry into the Production and Consumption of Precious Metals*, London, 1831, Vol. 1, xvi + 380 pp.; Vol. 2, xi + 415 pp.; especially p. 348.

<sup>26</sup> The average amount of gold production added to monetary stocks from 1850 to 1929 was 56%. See G. F. Warren and F. A. Pearson, *Gold and Prices*, New York, 1935, p. 125.

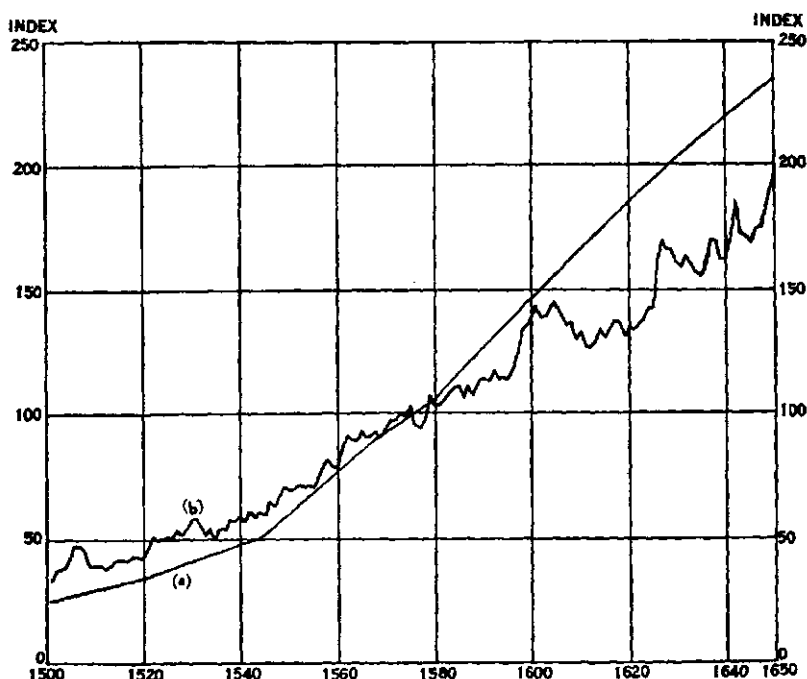

FIGURE 146.—INDEXES OF (a) TOTAL TREASURE (SOETBEER) AND  
(b) SPANISH PRICES (HAMILTON).

and the estimate just given of total treasure in Europe prior to 1500 by  $x$ .

Then an index of money, referred to 1571–1580 as base, would be approximately furnished by the ratio

$$(1) \quad I_m^{(i)} \approx 100 \frac{m_s + x}{m + x}.$$

We then have the relationship from the equation of exchange

$$I_m^{(i)} = KPT,$$

where  $K$  is a constant, which includes the average velocity of money for which no estimates are available, and a factor, which takes care of the fact that  $I_m^{(i)}$  is an index number.

Since  $K$  is assumed to be a constant, an index of trade, referred to the period 1571–1580 as base, is obviously obtained from the ratio

$$(2) \quad I_T^{(i)} = I_m^{(i)} / P.$$

The values of  $I_m^{(i)}$  and  $I_T^{(i)}$  computed from formulas (1) and (2) are given in the following table:

Year	$I^{(1)}_m$	$I^{(1)}_T$	Year	$I^{(1)}_m$	$I^{(1)}_T$	Year	$I^{(1)}_m$	$I^{(1)}_T$
1601	148.03	103.11	1551	61.78	89.02	1501	24.68	74.20
1602	150.00	108.57	1552	63.43	88.94	1502	25.15	69.07
1603	151.97	108.76	1553	65.09	92.67	1503	25.62	68.61
1604	153.94	108.22	1554	66.74	92.99	1504	26.08	68.36
1605	155.91	108.02	1555	68.39	96.30	1505	26.55	65.41
1606	157.89	113.08	1556	70.04	96.90	1506	27.01	57.60
1607	159.86	117.86	1557	71.70	89.92	1507	27.48	59.20
1608	161.83	118.89	1558	73.35	90.65	1508	27.94	62.39
1609	163.80	126.38	1559	75.00	96.33	1509	28.41	72.23
1610	165.77	124.77	1560	76.66	96.93	1510	28.88	74.51
1611	167.74	131.13	1561	78.16	90.01	1511	29.34	73.76
1612	169.71	133.07	1562	79.67	87.08	1512	29.81	78.61
1613	171.69	133.33	1563	81.17	90.53	1513	30.27	76.81
1614	173.66	129.74	1564	82.68	93.24	1514	30.74	75.94
1615	175.63	134.68	1565	84.19	91.13	1515	31.21	75.83
1616	177.60	131.17	1566	85.69	94.91	1516	31.67	78.10
1617	179.57	131.34	1567	87.20	95.92	1517	32.14	79.99
1618	181.54	133.08	1568	88.70	95.95	1518	32.60	75.01
1619	183.51	139.84	1569	90.21	100.03	1519	33.07	76.48
1620	185.49	137.63	1570	91.72	97.74	1520	33.54	79.74
1621	187.15	139.74	1571	93.22	95.58	1521	34.23	73.64
1622	188.82	138.79	1572	94.73	97.34	1522	34.93	69.15
1623	190.49	138.37	1573	96.23	96.29	1523	35.62	72.93
1624	192.16	135.29	1574	97.74	99.44	1524	36.32	73.76
1625	193.82	135.45	1575	99.25	95.70	1525	37.01	78.45
1626	195.49	120.55	1576	100.75	105.33	1526	37.71	75.68
1627	197.16	116.37	1577	102.26	108.79	1527	38.40	72.29
1628	198.83	119.31	1578	103.77	106.06	1528	39.10	76.37
1629	200.50	120.41	1579	105.27	97.68	1529	39.79	74.39
1630	202.16	125.69	1580	106.78	103.90	1530	40.49	71.31
1631	203.83	128.24	1581	108.74	104.61	1531	41.18	72.17
1632	205.48	125.33	1582	110.71	103.88	1532	41.88	76.16
1633	207.17	129.87	1583	112.67	103.33	1533	42.57	82.89
1634	208.83	133.14	1584	114.63	103.87	1534	43.27	80.41
1635	210.50	135.96	1585	116.60	104.71	1535	43.96	89.81
1636	212.17	132.16	1586	118.56	111.20	1536	44.66	82.80
1637	213.84	125.98	1587	120.53	108.28	1537	45.35	85.23
1638	215.51	127.14	1588	122.49	113.82	1538	46.05	80.72
1639	217.17	134.30	1589	124.45	110.05	1539	46.74	82.86
1640	218.84	135.25	1590	126.42	110.92	1540	47.44	81.51
1641	220.40	129.08	1591	128.38	113.88	1541	48.13	85.92
1642	221.96	119.29	1592	130.35	111.30	1542	48.83	80.72
1643	223.52	129.76	1593	132.31	116.64	1543	49.52	85.29
1644	225.08	131.08	1594	134.27	117.53	1544	50.21	83.56
1645	226.63	134.61	1595	136.24	119.42	1545	51.86	87.19
1646	228.19	131.16	1596	138.20	118.51	1546	53.52	82.66
1647	229.75	131.29	1597	140.17	113.27	1547	55.17	88.07
1648	231.31	126.30	1598	142.13	107.23	1548	56.82	85.68
1649	232.87	123.85	1599	144.09	106.80	1549	58.48	82.80
1650	234.43	118.12	1600	146.06	106.43	1550	60.13	87.08

An inspection of the index of Spanish trade indicates that a continuous rise took place from the beginning of the sixteenth century to about 1625 and that this was followed by a slow decline in the subsequent years. Unfortunately no independent measure of trade exists to confirm this general picture, although Spanish history itself tends toward these conclusions. Spain's rise to power began with the voyages of Columbus and continued uninterruptedly to the defeat of the Spanish armada in 1588, the consequences of which are noted in the sharp decline in trade in the following decade. The years from 1609 to 1621 formed the period of the truce with Holland and might reasonably be assumed to have been a time of economic prosperity. After the resumption of hostilities the power and prestige of Spain steadily declined during the remainder of the century.

If we return for a moment to our estimate of  $x$ , the value of total treasure in Europe prior to 1500, we may readily find that if  $x$  is assumed to be as large as 32,000,000 ounces of gold, the index of total treasure will form a good trend for prices from 1500 to 1580, although it subsequently diverges. Such an assumption would lead to the conclusion that trade did not increase during the first 80 years of the century and thereafter rose very moderately.

That trade was not constant in the first half of the sixteenth century is clearly indicated by the following data, which give the total number of registered vessels sailing to and from the Indies from the ports of Spain during this period.<sup>27</sup>

Year	No. of Vessels	Year	No. of Vessels	Year	No. of Vessels	Year	No. of Vessels	Year	No. of Vessels
1506	34	1516	52	1526	96	1536	151	1546	144
1507	51	1517	94	1527	109	1537	70	1547	158
1508	67	1518	98	1528	72	1538	104	1548	162
1509	47	1519	92	1529	104	1539	116	1549	174
1510	27	1520	108	1530	112	1540	126	1550	157
1511	34	1521	64	1531	87	1541	139	1551	162
1512	54	1522	43	1532	84	1542	150	1552	125
1513	61	1523	54	1533	97	1543	128	1553	79
1514	76	1524	70	1534	121	1544	76	1554	27
1515	63	1525	110	1535	128	1545	135	1555	109

We may therefore conclude that the assumption of a value of  $x$  as large as 32,000,000 ounces of gold is untenable and that the more mod-

<sup>27</sup> Data from Appendix 8 of C. H. Haring's *Trade and Navigation Between Spain and the Indies in the Time of the Hapsburgs*, Cambridge, Mass., 1918, xxvii + 371 pp. The author says: "The figures in these tables were secured from a volume in the Archivo de Indias (30.2.1/3) entitled: 'Libro de registros de las naos que han ido y venido a las Indias desde el año de 1504 en adelante.' It seems to be a sort of index or calendar of the registers which passed through the Casa de Contratacion. Whether the list is complete or not there is no means of knowing."



est figure of Jacob is probably nearer the truth, since it insures a reasonable increase in the index of trade.

### 13. *The Index of Trade from Spanish Treasure Data*

In the foregoing discussion we have employed as our money series the total treasure as reported by the careful statistical studies of Soetbeer. This was done since Soetbeer's data could be related directly to Jacob's estimate of total European treasure prior to 1500, which supported the price structure of the Middle Ages.

It is obvious that a better series to use for the computation of Spanish trade would be that of the actual treasure importations into Spain itself. The figures on total European treasure, used as the basis of a money series for Spain, would assume that the Spanish increment was proportional to the total, which is clearly not correct when one compares the lag in English prices behind those of Spain.

Fortunately the heroic studies of E. J. Hamilton provide us with the Spanish treasure data.<sup>28</sup> The following table gives us the total importation of gold and silver into Spain in terms of a standard peso, which is equivalent to 42.29 grams of pure silver.

TOTAL IMPORTS OF TREASURE INTO SPAIN IN PESOS

Years	Amount	Years	Amount	Years	Amount
1503-1505	371,056	1556-1560	7,998,999	1611-1615	24,528,121
1506-1510	816,237	1561-1565	11,207,536	1616-1620	30,112,460
1511-1515	1,195,554	1566-1570	14,141,216	1621-1625	27,010,679
1516-1520	993,197	1571-1575	11,906,610	1626-1630	24,954,527
1521-1525	134,171	1576-1580	17,251,942	1631-1635	17,110,855
1526-1530	1,038,438	1581-1585	29,374,612	1635-1640	16,314,602
1531-1535	1,650,232	1586-1590	23,832,631	1641-1645	13,763,803
1536-1540	3,937,892	1591-1595	35,184,863	1646-1650	11,770,548
1541-1545	4,954,006	1596-1600	34,428,501	1651-1655	7,293,767
1546-1550	5,508,712	1601-1605	24,403,329	1656-1660	3,361,111
1551-1555	9,865,532	1606-1610	31,405,207	Total	447,820,951

It is instructive to observe that if we convert the total importation into equivalent ounces of gold, using 12 arbitrarily as the silver equivalent of gold, we obtain 50,740,000 as the total importation. This, it will be observed, is only 35 per cent of the accumulation of European treasure as reported by Soetbeer. This, however, is quite consistent with the observed rise in prices in other European countries as described in Section 7.

Let us now assume that the index of total Spanish treasure is 100 when referred to the base 1571-1580. Then, in terms of this base, an

<sup>28</sup> "Imports of American Gold and Silver into Spain, 1503-1660," *Quarterly Journal of Economics*, Vol. 43, 1929.

estimate similar to that already employed for total European treasure shows that an index approximately equal to 26 in 1505 would account for the level of prices in medieval Spain.

Employing these figures and the same analysis used in the preceding section, we may now compute the money and trade indexes for Spain over the period from 1505 to 1650 given below.

The graph of the trade index is given in Figure 147 and may be compared with that of the preceding section. We see that, in general, the two computations agree in exhibiting a rapidly advancing trade, which reached its upper asymptote some time after the beginning of the seventeenth century. The two curves show the major depression

MONEY AND TRADE INDEXES FOR SPAIN, 1505-1650

Year	Money	Trade	Year	Money	Trade	Year	Money	Trade	Year	Money	Trade
1505	26.00	64.06	1542	36.35	60.10	1579	104.56	97.02	1616	291.94	215.61
1506	26.14	55.76	1543	37.23	64.11	1580	107.60	104.70	1617	297.24	217.41
1507	26.29	56.63	1544	38.10	63.40				1618	302.55	221.79
1508	26.43	59.03	1545	38.97	65.52	1581	112.78	108.49	1619	307.86	234.59
1509	26.58	67.57				1582	117.96	110.68	1620	313.16	232.37
1510	26.72	68.94	1546	39.94	61.69	1583	123.13	113.48			
			1547	40.91	65.31	1584	128.31	116.26	1621	317.92	237.38
1511	26.93	67.70	1548	41.88	63.15	1585	133.49	119.88	1622	322.68	237.18
1512	27.14	71.48	1549	42.85	60.68	1586	137.69	129.14	1623	327.45	237.85
1513	27.35	69.40	1550	43.83	63.47	1587	141.89	127.47	1624	332.21	233.88
1514	27.56	68.09	1551	45.56	65.65	1588	146.09	135.74	1625	336.97	235.49
1515	27.77	67.48	1552	47.30	66.33	1589	150.29	132.89	1626	341.36	210.50
			1553	49.04	69.82	1590	154.49	135.55	1627	345.76	204.07
1516	27.95	68.92	1554	50.78	70.75	1591	160.69	142.54	1628	350.16	210.12
1517	28.12	69.99	1555	52.52	73.95	1592	166.89	142.50	1629	354.56	212.94
1518	28.30	65.11				1593	173.09	152.60	1630	358.96	223.18
1519	28.47	65.85	1556	53.93	74.61	1594	179.30	156.95	1631	361.97	227.74
1520	28.65	68.11	1557	55.34	69.40	1595	185.50	162.60	1632	364.99	222.62
			1558	56.75	70.13	1596	191.57	164.28	1633	368.00	230.69
1521	28.67	61.69	1559	58.16	74.70	1597	197.63	159.70	1634	371.02	236.54
1522	28.70	56.81	1560	59.57	75.32	1598	203.70	153.68	1635	374.04	241.58
1523	28.72	58.80				1599	209.77	155.47	1636	376.91	234.78
1524	28.74	58.37	1561	61.54	70.88	1600	215.83	157.27	1637	379.79	223.75
			1562	63.52	69.43	1601	220.13	153.34	1638	382.66	225.75
1525	28.77	57.09	1563	65.49	73.05	1602	224.44	162.45	1639	385.54	238.41
1526	28.95	58.10	1564	67.47	76.09	1603	228.74	163.70	1640	388.41	240.06
1527	29.13	54.84	1565	69.44	75.17	1604	233.04	163.82			
1528	29.32	57.26				1605	237.34	164.43	1641	390.84	228.89
1529	29.50	55.15	1566	71.94	79.67	1606	242.87	173.94	1642	393.26	211.35
1530	29.68	52.27	1567	74.43	81.87	1607	248.41	183.14	1643	395.69	229.72
			1568	76.92	83.21	1608	253.94	186.56	1644	398.12	231.85
1531	29.97	52.53	1569	79.41	88.06	1609	259.48	200.20	1645	400.54	237.91
1532	30.26	55.03	1570	81.91	87.28	1610	265.01	199.47			
1533	30.55	59.49	1571	84.00	86.13	1611	269.34	210.55	1646	404.49	232.49
1534	30.84	57.32	1572	86.10	88.47	1612	273.66	214.58	1647	408.45	233.40
1535	31.14	63.61	1573	88.20	88.25	1613	277.98	215.87	1648	412.40	225.18
			1574	90.30	91.87	1614	282.31	210.91	1649	416.35	221.43
1536	31.83	59.01	1575	92.40	89.09	1615	286.63	219.79	1650	420.30	207.04
1537	32.52	57.01									
1538	33.22	58.23									
1539	33.91	60.12	1576	95.44	99.78						
1540	34.61	59.46	1577	98.48	104.77						
1541	35.48	63.33	1578	101.52	103.76						

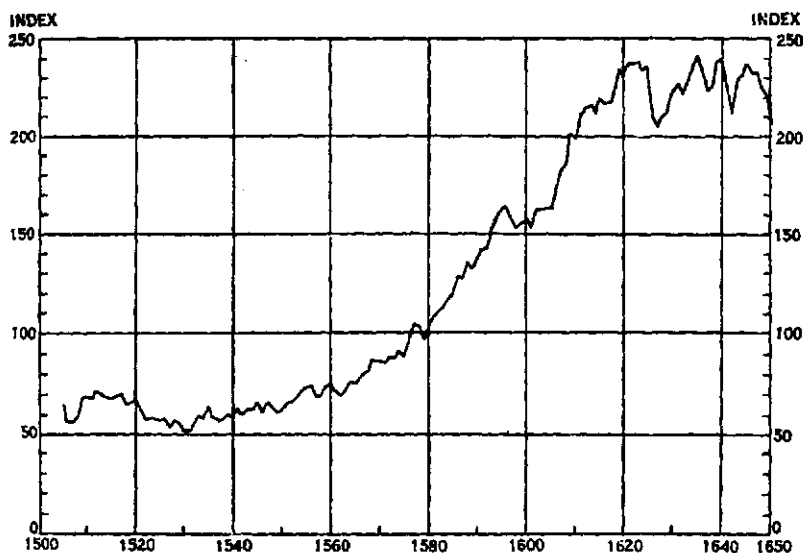

FIGURE 157.—INDEX OF SPANISH TRADE, BASED ON HAMILTON'S TREASURE SERIES.

which developed between 1620 and 1630 and both forecast the probable decline which history tells us took place between 1650 and 1700. It is interesting in interpreting the chart to observe that the *Encyclopaedia Britannica* says about Philip IV, who succeeded to the Spanish throne at the death of his father in 1621, that "his reign, after a few passing years of barren successes, was a long story of political and military decay and disaster. The king has been held responsible for the fall of Spain, which was, however, due in the main to internal causes beyond the control of the most despotic ruler, however capable he had been."<sup>28a</sup>

The present graph differs from the first in showing that the effect of the colonization of America did not react immediately upon the trade of Spain as a whole, but began somewhere between 1550 and 1560. The shipping data of C. H. Haring, previously quoted, would tend to support the reality of this observation.

#### 14. Conclusion

In the preceding sections of this chapter we have surveyed the most important aspects of the theory of exchange and have subjected the variables to statistical scrutiny. What conclusions can be drawn from these studies?

<sup>28a</sup> *Encyclopaedia Britannica*, 11th edition, Vol. 21, p. 385.

In the first place, we have learned that the equation of exchange is no more tautological than the equation of electrical conduction, since the variables are independent quantities subject to the one restraint imposed by the equation itself. This fact is illustrated interestingly by the different behavior of the variables in the Spanish expansion from 1500 to 1600 and in the period of our own industrial revolution from 1800 to date. In the Spanish period, money increased with great rapidity. The result of this was to cause an immediate rise in prices, which would have resulted in a spectacular inflation had not trade finally increased as the new American colonies became important trade factors with Europe. The industrial revolution, on the contrary, was a spectacular increase in trade resulting from the fruits of scientific achievement. This was accompanied and aided by the opening of rich, new lands in North America. That the industrial revolution was the principal factor in this vast trade advance, however, is readily seen from the fact that the trade increased long after most of the land had been occupied. The decline in the relative number of those in agriculture as compared with those employed in industrial activity also argues for the correctness of this observation. During this period of trade advance, the level of prices changed but slightly if at all despite a slow increase in the per capita supply of money.

In the second place, we may conclude that the theorem advanced by Carl Snyder is substantially correct. This theorem in its essential essence assumes that prices will remain constant provided the money supply is increased, or decreased uniformly with the increase or decrease of trade. It must be modified slightly by assuming not a constant secular trend for the velocity of money, but a trend which oscillates about a constant value in a sinusoidal pattern of small amplitude and long period. Although this conclusion is distilled from empirical studies of American trade and prices, its correctness is strongly argued by the behavior of the Spanish data. An unassailable argument from this source, of course, must await an independent measurement of the increase of Spanish trade during the century and a half considered.

A third conclusion which we may draw is that dangerous economic difficulties develop at the top of the trade cycle. The American troubles in this period are well known to everyone. Let us turn for a moment to the corresponding period in Spanish data. From the figures given in Sections 12 and 13, it is obvious that a great depression developed in Spanish trade shortly after the series reached the top of the trade advance. What were the actual economic and political situations in this period?

Although we lack direct statistical evidence on this point the following paragraph quoted in the eleventh edition of the *Encyclopedia Britannica*, published in 1911, is pertinent:<sup>29</sup>

Encouragement of industry was not wanting; the state undertook to develop the herds of merino sheep, by issuing prohibitions against inclosures, which proved the ruin of agriculture, and gave premiums for large merchant ships, which ruined the owners of small vessels and reduced the merchant navy of Spain to a handful of galleons. *Tasas*, fixed prices, were placed on everything. The weaver, the fuller, the armourer, the potter, the shoemaker were told exactly how to do their own work. All this did not bear its full fruit during the reign of the Catholic sovereigns but by the end of the 16th century it had reduced Spain to a state of Byzantine regulation in which every kind of work had to be done under the eye and subject to the interference of a vast swarm of government officials, all ill paid, and often not paid, all therefore necessitous and corrupt. When the New World was opened, commerce with it was limited to Seville in order that the supervision of the state might be more easily exercised. The great resource of the treasury was the *alcabalas* or excises—taxes (farmed by contractors) of 5 or 10% on an article every time it was sold—on the ox when sold to the butcher, on the hide when sold to the tanner, on the dressed hide sold to the shoemaker and on his shoes. All this also did not bear its full fruit till later times, but by the 17th century it had made Spain one of the two "most beggarly nations in Europe"—the other being Portugal.

It is interesting and significant to note in that distant period, related, however, to the phenomena of our own times by the first of the two most spectacular trade developments in history, the establishment of something resembling our AAA experiment, our NRA experiment, and the transactions tax, not yet attempted here.

It is our final conclusion from these studies, that the equation of exchange is one of the most powerful and deep-seated propositions for the exploration and interpretation of economic phenomena. Its validity, like that of the laws of Newton and Kepler, which are valid to the most remote star within our observation, is universal; it can be employed as an interpreter of the history and the economic well-being of ancient nations, wherever money and price data are available.

#### SELECTED BIBLIOGRAPHY ON THE EQUATION OF EXCHANGE

ANGELL, J. W. (1) *The Theory of International Prices*. Cambridge, Mass., 1926, xiv + 571 pp.

(2) *The Behavior of Money*. New York, 1936, xiv + 207 pp.

BRESCIANI-TURRONI, C. *The Economics of Inflation*. (English Translation). London, 1937, 464 pp. Italian edition, published by the University of Bocconi in 1931. See in particular, Chapter 4.

BURGESS, W. R. "Velocity of Bank Deposits," *Journal of the American Statistical Association*, 1923, pp. 727-740.

<sup>29</sup> From an article on *Spain*, prepared by the English scholar W. A. Phillips. See, in particular, Vol. 25, p. 549.

- ESSARS, PIERRE DES. "La vitesse de la circulation de la monnaie," *Journal de la Société de Statistique de Paris*, 1896, p. 143.
- EVANS, G. C. *Mathematical Introduction to Economics*. New York and London, 1930, xi + 177 pp. In particular, Chapter 9.
- FISHER, IRVING. *The Purchasing Power of Money*. New York, 1911, xxii + 505 pp.; second edition, 1931.
- (2) "Our Unstable Dollar and the So-Called Business Cycle," *Journal of the American Statistical Association*, 1925, pp. 179-202.
- (3) *Booms and Depressions*. New York, 1932, xxi + 258 pp.
- HAMILTON, E. J. *American Treasure and the Price Revolution in Spain, 1501-1650*. Cambridge, Mass., 1934, xxxv + 428 pp.
- HAWTREY, R. G. *Currency and Credit*. London, 1934, ix + 477 pp.
- HUNTINGTON, E. V. "On the Mathematical Hypotheses Underlying Carl Snyder's Trade-Credit-Ratio Theorem," *Econometrica*, Vol. 6, 1938, pp. 177-179.
- KEMMERER, E. W. *Money and Credit Instruments in their Relations to General Prices*. New York, 1909.
- KEYNES, J. M. *A Treatise on Money*. Vol. 1, New York, 1930, xvii + 363 pp.; Vol. 2, viii + 424 pp. In particular, Chapters 10 and 24.
- MARGET, A. W. (1) "The Relation between the Velocity of Circulation of Money and the Velocity of Circulation of Goods," *Journal of Political Economy*, Vol. 40, 1932, pp. 477-512, especially p. 502.
- (2) *The Theory of Prices*. Vol. 1, New York, 1938, xxv + 624 pp.
- MARSCHAK, J. *Elastizität der Nachfrage*. Tübingen, 1931, xix + 143 pp.
- MISES, L. VON. *The Theory of Money and Credit*. English translation by H. E. Batson, London, 1934, 445 pp. First German edition, 1912; second edition, 1924.
- NEWCOMB, SIMON. *Principles of Political Economy*. New York, 1886.
- ROOS, C. F. *Dynamic Economics*. Bloomington, Ind., 1934, xvi + 275 pp. In particular, Chapter 13.
- SNYDER, CARL. (1) *Business Cycles and Business Measurements*. New York 1927, xv + 326 pp.
- (2) "Industrial Growth and Monetary Theory," *Economic Forum*, 1933, pp. 275-290.
- (3) "New Measures in the Equation of Exchange," *American Economic Review*, Vol. 14, 1924, pp. 699-713.
- (4) "New Measures of the Relations of Credit and Trade," *Proceedings of the Academy of Political Science*, 1930,
- (5) "Further Measures of the General Price Level and the Trade-Credit Relations for Great Britain," *La revue de l'institut de statistique*, 2nd year, book 3, 1934.
- (6) "Deposits Activity as a Measure of Business Activity," *Review of Economic Statistics*, Vol. 6, 1924, pp. 253-259.
- (7) "A New Index of the General Price Level from 1875," *Journal of the American Statistical Association*, Vol. 19, 1924, pp. 189-195.
- (8) "The Problem of Money and Economic Stability," *Quarterly Journal of Economics*, 1925.
- SPRAGUE, O. M. W. "Fisher's Purchasing Power of Money," *Quarterly Journal of Economics*, Vol. 26, 1911.
- STAMP, SIR JOSIAH. (1) *Papers on Gold and the Price Level*. London, 1932.
- (2) *The Present Position of Monetary Science*.
- VINER, JACOB. *Studies in the Theory of International Trade*, New York, 1937, xv + 650 pp.

## CHAPTER 11

### FORECASTING ECONOMIC TIME SERIES

#### 1. *Introduction*

It is obvious that the principal objective of a scientific study of time series is to forecast the future of these series, or, at any rate, to understand the elements which affect them, so that such a forecast would be possible. Thus astronomy, the oldest of the sciences, is the envy of other disciplines because of its ability to foretell the future. Eclipses are forecasted years in advance and the position of a planet such as Jupiter can be computed to within a phenomenally small error at a moment two centuries from the present time.

By forecasting we shall mean the ability, first, to tell, from the data of the past and the observations of the present, the most probable value of the time series at some future time, and, second, to define the limits within which the actual value has an even chance of being found.

The history of economic forecasting is replete with failures. This is in striking contrast with the physical sciences, where failure is the exception rather than the rule. It is thus necessary for us to give most careful attention to this question and to determine wherein lies the difficulty with economic time series and how the probable errors may be computed.

It must be observed in the beginning, however, that all economic time series do not show variability in the same degree. Thus the logistic curve fitted to population data gives an amazingly accurate forecast of population growth through one and even two decades of time. Logistic curves fitted to such data as those of automobile production show similar stability, although in a lesser degree. Here the situation is complicated by other factors that show violent and erratic variations. These factors pertain to the fluctuations of the business index, which are occasioned by the great complex of causes that affect the structure of credit.

Occasionally a time series itself may show wide variation, while some fundamental aspect of it may show stability. An example of this is furnished by the time series showing the total annual income for some large economic unit such as a state or a country. Thus, in the United States during the last quarter of a century, this series

shows a large annual variation, the range of per capita income having been from about \$300 in the prewar period to approximately \$670 in the boom period of the twenties. But in spite of this great variation the Pareto constant discussed in Chapter 9 has remained remarkably stable.

Another example, which we shall examine with greater attention later, is the price of railroad stocks over the century beginning with 1830. Price series by their nature are subject to many violent fluctuations, and the price of railroad stocks has been especially variable during the century under investigation. Thus the coefficient of variability, that is, the ratio  $\sigma/A$ , was 0.3782 over this period, a value which may be compared with 0.0686 for industrial production over the same century. But in spite of the great bull and bear movements which so violently affected these prices, the actual trend was one of remarkable stability, the average advancing uniformly at the rate of about 8.6 points per decade. This one can observe in Figure 83 of Chapter 7.

But perhaps even more unusual than the last two examples is the case of wholesale commodity prices since the American Revolution and even before that disruptive period. Despite the three war inflations and several minor ones which one observes in the series, the average level of commodity prices has changed but little during the past century and a half. And even more remarkable than this is the fact that the level of world prices, established by the Spanish importation of gold and silver into Europe in the sixteenth century, has tended to remain unchanged in spite of the great political and industrial revolutions of the past three centuries.

From these remarks it will be clear that there exist some permanent structures in economic time series and it is upon the recognition of these structures that success in forecasting must ultimately depend. The problem then resolves itself into the possibility of separating the random element from the structural component, and, finally, the determination of the statistical errors of the parameters which describe the structural character of the series.

Many ingenious devices have been suggested for the solution of this problem, but unfortunately no conspicuous success has attended these methods of forecasting. In the next section we shall show the results which have been attained in the case of perhaps the most sturdily assailed problem in economics, that of forecasting the movement of the prices of industrial stocks. But in spite of the lack of success which we must report here, it does not seem necessary to the writer to abandon this problem, nor, indeed, the problem of forecast-



ing the future of other economic time series. Each year sees the addition to our knowledge of more and better data. Slowly we are beginning here and there to recognize the nature of the series with which we deal, the interrelations between them, and the structural tendencies which, over long periods of time, determine the long-term trends.

A new statistics must be developed to cope with this problem and the older "frequency statistics," which has been so conspicuously successful in certain fields, must be severely modified or replaced by this newer discipline. The problem, thus, is probably not unsolvable, but merely unsolved.

Some of the difficulties of the problem of forecasting will be dealt with in other sections of this chapter. In particular, a modification of the "standard error of forecast," a concept defined by the late Henry Schultz, will throw considerable light upon the question of why forecasters have experienced so much difficulty in defining the future behavior of some time series.

## *2. The Present Status of Forecasting Stock Prices*

That problem of forecasting economic time series which has most intrigued the interest of economists is the one which relates to the prediction of the movement of stock prices. Since much of our economic well-being depends upon business activity and since business activity must be related essentially to the action of the stock market, it is but natural that those elements which influence this fundamental economic time series should have been subjected to careful and systematic scrutiny. How far have we been successful in forecasting the action of stock prices?

On the threshold of the problem we turn first to a table of lag-correlations to see what elements might seem to have the most promising relationship with the movement of the stock market. From the table for  $(X_1)$  in Section 2 of Chapter 3, we observe that both High-Grade Bond Yields and Stock Sales on the New York stock exchange are influenced synchronously, with correlations respectively of  $-0.558$  and  $0.539$ , by some of the same elements which influence the level of stock prices. But other series, such as Pig-Iron Production, or its equivalent Industrial Production, Time-Money Rates, Commercial-Paper Rates, Metal-Prices, Building-Material Prices, and Bank Clearings, while correlating significantly with stock prices, lag from three to nine months behind the market.

This fundamental observation would seem to indicate that any

attempt to forecast the action of stock prices from available time series is doomed to failure. As far as existing data are concerned, the movements of the stock market precede the significant movements in the other series. Hence, unless other causes can be ascertained, or unless general equations of equilibrium can be set up whose parameters may be determined from available data, the problem of forecasting the movement of stock prices must await a deeper insight into the structure of our economic system.

It is, however, both interesting and important to ask the question whether or not professional agencies, with all the careful technical investigations which they have made of this problem, have attained any measure of proficiency in forecasting the action of stock prices. Such a study of the forecasting powers of professional agencies was made by Alfred Cowles for the following groups and periods:<sup>1</sup>

(A) Sixteen leading financial agencies over the 4½ years ending July, 1932. The analysis included about 7500 separate recommendations requiring approximately 75,000 entries.

(B) Twenty leading fire-insurance companies from 1928 to 1931 inclusive. This analysis considered the common-stock investments of the companies, representing between 20 and 30 per cent of their total investments.

(C) Twenty-four financial publications over the 4½ years ending May, 1932. Approximately 3,300 forecasts were tabulated in this study.

The technique employed in appraising the ability of the three groups to forecast the trend of the investment market may be summarized as follows:

(A) The first step was to record each week the name and price of each stock recommended for purchase or sale by each service. Next came the tabulation of the advice to sell or cover the commitment previously advised. Reiterated advice was not considered, action being assumed to have been taken as of the date when the recommendation was first published. The percentage gain or loss on each transaction was recorded and, in a parallel column, the gain or loss of the stock market for the identical period. A balance was struck every six months which summarized the total results secured by each service as compared with the action of the stock market. Proper corrections were, of course, made to offset the effect of changes in capital structure resulting from the issue of rights, stock dividends, etc. Since a

<sup>1</sup> "Can Stock Market Forecasters Forecast?" *Econometrica*, Vol. 1, 1933, pp. 309-324.

tendency existed among some services to emphasize their conspicuously successful stock recommendations and ignore more unfortunate commitments, a practice was adopted of dropping automatically a stock from the list six months after it had been last recommended, when specific advice to sell was not given.

A redistribution of funds in equal amounts among all stocks recommended was assumed for each service at the beginning of every six-month period analyzed. It could be maintained, of course, that this equalizing process should take place as often as once a week, but this would increase the labor of computation to overwhelming proportions. Provisional experiments demonstrated that it would yield conclusions practically identical with those secured by the shorter method. Compounding the successive six-month records gave the percentage by which each service's recommendations have exceeded, or fallen behind, the stock market.

(B) Fire insurance dates from the Great London Fire of 1666, and active investment in stocks developed during the nineteenth century. The fire-insurance companies are much older hands at the business of investment than either the financial services, which are a twentieth-century product, or American investment trusts, which are largely a development of the last few years. The investment policies of these companies are based on the accumulated knowledge of successive boards of directors whose judgments might be presumed, over the years, to have been well above that of the average investor. The twenty companies which were selected for analysis hold assets totaling \$785 millions, and seem a fair sample of their kind.

Fire-insurance companies carry between 20 and 30 per cent of their total investments in common stocks. Their average turnover amounts only to some 5 per cent a year. For this reason it was thought best to confine the analysis to the record of the actual purchases and sales made during the period under examination, rather than to compute the record of the entire common-stock portfolio. To simplify the labor, all items of stock purchases were given equal weights, regardless of the amounts involved. While the conclusion does not exactly reflect the actual investment results secured by these companies, it should, however, provide a satisfactory test of the success of these organizations in selecting stocks which performed better than the average.

The method employed in the analysis is similar to that used in the case of the investment services except that a balance was struck annually, instead of semi-annually. A second purchase of an item was

omitted from the record unless a sale of this item intervened. A record of the sale of an item, of course, determined the date as of which it was dropped from the list. Also, any item of which there had been no purchase recorded for 12 months was automatically considered sold.

(C) The method used in the case of the 24 financial publications was to have each of three readers ask himself the question, "In the light of what this particular bulletin says, would one be led to buy stocks with all the funds at his disposal, or place a portion only of his funds in stocks, or withdraw entirely from the market?" The reader graded the advice in each instance by means of one of nine possible entries: 100 per cent of funds in the market,  $87\frac{1}{2}$ , 75,  $62\frac{1}{2}$ , 50,  $37\frac{1}{2}$ , 25,  $12\frac{1}{2}$ , or 0 per cent. The great majority of forecasters confine themselves to general discussions of the investment situation, leaving to the reader the decision as to what proportion of his funds he shall place in the market. The tabulation, therefore, cannot be mathematically conclusive. Marginal commitments were not incorporated in the tabulations because in no case were they advised by the forecasters. Similarly, short commitments were not in general assumed because, of the entire 24 forecasters, only one recommended them. His record has been computed on a special basis.

The tabulated forecasts were tested in the light of the actual fluctuations of the stock market as reflected by the Standard Statistics Company index of 90 representative stocks. If a forecast was 100-per-cent bullish and the market rose 10 per cent in the subsequent week, the forecaster was scored as 10 per cent. If the forecaster, after weighing the favorable and unfavorable factors, left the decision hanging in the balance, the score was 5 per cent or one-half of the market advance. This was on the assumption that the investor, being in doubt as to the future course of the market and being, by definition, committed to common stocks as a possible investment medium, would be led to adopt a hedged position with half of his funds in stocks and half in reserve. If the forecast was 100-per-cent bearish, the score was zero, regardless of the subsequent action of the market, on the assumption that, under such conditions, the investor would withdraw all of his funds from stocks. On the other hand, if the forecast was 100-per-cent bullish and the market dropped 10 per cent in the ensuing week, the score was -10 per cent. If the forecast was doubtful when the market dropped 10 per cent, the score was -5 per cent. The compounding of all these weekly scores for the period covered gave a cumulative record for each forecaster. This permitted comparisons which revealed relative success and average

performance. While it may be thought that accurate week-to-week forecasting is a hopeless ideal, it should be emphasized that the analysis of weekly results also measured accurately the efficiency of long-swing forecasts.

A figure representing the average of all possible forecasting results for the period was attained by compounding one-half of every weekly percentage change in the level of the stock market.

The attainment of the three groups is given in the following table:

GROUP (A)			GROUP (B)		GROUP (C)		
Service	No. of Weeks	Per Cent	Company	Per Cent	Forecaster	No. of Weeks	Per Cent
1	234	20.8	1	27.35	1	105	72.4
2	234	17.2	2	25.11	2	230	31.5
3	234	15.2	3	18.34	3	230	29.3
4	234	12.3	4	10.38	4	21	24.2
5	234	8.4	5	10.12	5	157	9.0
6	26	6.1	6	3.20	6	53	3.0
7	52	0.0	7	-2.06	7	126	2.4
8	104	-0.5	8	-3.63	8	53	1.3
9	234	-1.9	9	-5.06	9	105	-1.7
10	52	-2.2	10	-6.67	10	157	-2.1
11	52	-3.0	11	-10.44	11	230	-3.6
12	52	-8.3	12	-10.55	12	43	-6.0
13	78	-16.1	13	-11.76	13	53	-6.7
14	104	-28.2	14	-12.92	14	131	-6.9
15	104	-31.2	15	-13.82	15	230	-12.5
16	156	-33.0	16	-14.96	16	230	-13.5
			17	-18.03	17	53	-17.2
			18	-21.89	18	230	-21.5
			19	-23.44	19	69	-29.4
			20	-33.72	20	230	-33.0
					21	230	-35.3
					22	230	-41.5
					23	157	-45.3
					24	230	-49.1

In each group we find one or more forecasters who have creditable records. It is both interesting and instructive to ask the question whether they exhibit real forecasting skill, or whether they have their advantageous positions as the result of the distribution by chance of any  $n$  forecasters whose records must lie partly above and partly below the market average.

Let us answer this question for group (A). Since the forecasters recommended stocks for various periods of time, it is necessary to have some basis for comparing long forecasts with short ones. Suppose that a service recommends  $N$  stocks for a period of time  $t$ . The devia-

tion of these stocks from the market, whether it be plus or minus, is an important factor in determining the achievement of the forecaster. Let us assume as a measure of this deviation, the standard deviation of the market as a whole regarded as a function of time. It is obvious that for  $t = 0$  (the time of forecast), the function assumes the value of the standard deviation of the distribution of the market; moreover, the function will be monotonically increasing with time, since the dispersion of any set of  $N$  stocks will in general increase with respect to any initial distribution. Let us express this as follows:

$$(1) \quad \sigma(t) = \sigma^{(0)} + \sigma^{(1)}t + \sigma^{(2)}t^2 + \dots, \quad \frac{d}{dt} \sigma(t) > 0.$$

In order to determine the constants in (1), a list of 60 stocks chosen at random from an active list was divided into two groups of 30 each, one of these groups being studied during the relatively quiet months of 1928, the other during the mercurial period from July 1, 1929 to July 7, 1930. The fluctuations of each stock were measured by recording its closing price in the first week, second week, first month, second month, etc. of the periods analyzed. The successive percentage changes were compared with the concurrent changes in the weekly market averages, and the deviations thus secured were plotted and a trend line fitted by the method of least squares.

It was thus found that  $\sigma(t)$  was essentially a linear function and that (1) can be explicitly written in the form

$$\sigma(t) = 5.42 + 1.58t,$$

where the unit of time is four weeks.

Let us now see how this information can be utilized. For this investigation we shall assume that a service recommends  $N$  stocks for a period of  $4m$  weeks. Let the average gain (or loss) of the service as compared with the market averages be denoted by  $s$ . But the actual gain or loss of a set of  $N$  stocks chosen at random will be equal to

$$R(m) = 0 \pm 0.6745 \sigma(m) / \sqrt{N}.$$

Let us now assume that  $R(m)$ , for any given value of  $m$ , is a measure of the probable error of an average deviation from the stock market. More precisely, if  $d(m)$  is the observed deviation of a group of  $N$  stocks from the market at the end of  $4m$  weeks, the sign being chosen positive, and if

$$I(s) = \frac{1}{\sqrt{2\pi}} \int_{-\infty}^s e^{-t^2} dt,$$

then the probability of obtaining by random chance the same or greater deviation would be

$$P(m) = 1 - I(z) ,$$

where we employ the abbreviation

$$z = d(m) \sqrt{N}/\sigma(m) .$$

Since we are concerned mainly with positive deviations, we compute the probability that the deviation will be both positive and of the magnitude  $d(m)$ . This probability is then  $p(m) = \frac{1}{2} P(m)$ .

For example, in the first six months of 1928, Service No. 1 held one stock for 13 weeks, 3 stocks for 20 weeks, and 38 stocks for 26 weeks. The average stock was thus held for 24.8 weeks. The deviation from the market was positive and equal to 3 per cent. We may then ask the question: "What is the probability that a random service could attain this record?"

The standard deviation corresponding to 24.8 weeks, namely,  $t = 6.2$ , is found to be  $\sigma(6.2) = 15.1$ , and hence we compute

$$d(m) \sqrt{N}/\sigma(m) = 3\sqrt{42}/15.1 = 1.287 .$$

From this we find  $p(6.2) = 0.10$ , or 10 chances in a hundred.

Proceeding in this way computations were made for each of the nine six-month periods for Service No. 1. It was thus found that a random service in the same nine periods would have had the following schedule of probabilities of achievement:

Period 1	900 chances in 1000 to do worse
Period 2	890 chances in 1000 to do worse
Period 3	980 chances in 1000 to do worse
Period 4	870 chances in 1000 to do better
Period 5	998 chances in 1000 to do better
Period 6	514 chances in 1000 to do worse
Period 7	1000 chances in 1000 to do worse
Period 8	832 chances in 1000 to do worse
Period 9	776 chances in 1000 to do worse

From this table we compute the average "chance in 1000 to do worse" to be 841.7 and the average "chance in 1000 to do better" to be 934. The use of average probabilities is justified here by considerations which underlie the theory of Lexis and Poisson distributions.

The next question is to decide how to arrive at a composite measure of the success of the service, which was well on the positive side of the market seven times and rather badly wrong twice. Some

assumptions have to be made since we must now argue by a priori reasoning and are essentially faced by a problem in inverse probabilities.

By the theory of probabilities the probability that a single service will be right at least 7 times in 9 is equal to the sum of the first three terms of the binomial  $(\frac{1}{2} + \frac{1}{2})^9$ , that is

$$p = \frac{1}{2^9} + \frac{9}{2^8} + \frac{36}{2^7} = \frac{46}{512} = 0.090 .$$

The probability that a random service could in 9 predictions be 7 times on the positive side and in these forecasts equal the achievement of Service No. 1 is

$$P = 0.090 \times (1 - 0.842) = 0.014 .$$

But the record of the best service is marred by two bad forecasts. Hence  $P$  cannot be regarded as any more than the upper bound of the achievement of this service. It is reasonable to assume that the probability of a random service that was 7 times right should have a worse record than No. 1 is equal to

$$Q = (7/9) \times 0.842 + (2/9) \times (1 - 0.934) = 0.670 .$$

Hence the probability that a random service will be 7 times right and achieve the record of Service No. 1 is approximately equal to

$$P = 0.090 \times (1 - 0.670) = 0.030 .$$

This means that in 16 services we should expect to find  $16 \times 0.030 = 0.48$  services which will equal the record of Service No. 1. That is to say, the chance is about even that we should get at least one service as good as No. 1.

As a final justification of the conclusion that the distribution of the records of forecasters is largely governed by chance, records were compiled, identical with those of the 24 forecasters of group (C), but having purely fortuitous advices applied to random intervals within these periods. For example, to compile a purely chance record to compare with the actual record of a forecaster whose operations covered 230 weeks from January 1, 1928 to June 1, 1931, a determination was first made of the average number of changes of advice for such a period, which was 33. Cards numbered from 1 to 230 were shuffled, drawn, reshuffled, drawn, etc., in all 33 times. Thus 33 random dates were selected as of which forecasts were to be changed. The investment policies which were to apply to the intervals between those



dates were derived in similar fortuitous fashion by drawing 33 times from cards on which the nine possible investment policies were noted.

It only remained to relate these random advices to a stock-market index, cumulate the results, relate them, as had been done with the services, to the average of all chances for the period, and subtract 100. Thus a list of 24 purely chance forecasting records was secured for comparison with the records of the actual prophets. This record follows:

Forecasting Experiments	No. of Weeks	Per Cent	Forecasting Experiments	No. of Weeks	Per Cent	Forecasting Experiments	No. of Weeks	Per Cent
1	230	71.1	9	131	1.3	17	230	-10.5
2	230	37.2	10	230	1.1	18	21	-10.9
3	230	24.2	11	53	-0.1	19	157	-11.0
4	157	19.1	12	54	-0.6	20	105	-18.0
5	230	13.2	13	157	-2.5	21	230	-18.1
6	105	9.2	14	230	-4.6	22	230	-14.2
7	230	2.7	15	43	-5.4	23	69	-18.7
8	53	2.5	16	53	-6.1	24	126	-27.1

This verification of the thesis that the distribution of the records of a group of forecasters is fortuitous and not by skill, is shown in Figure 148.

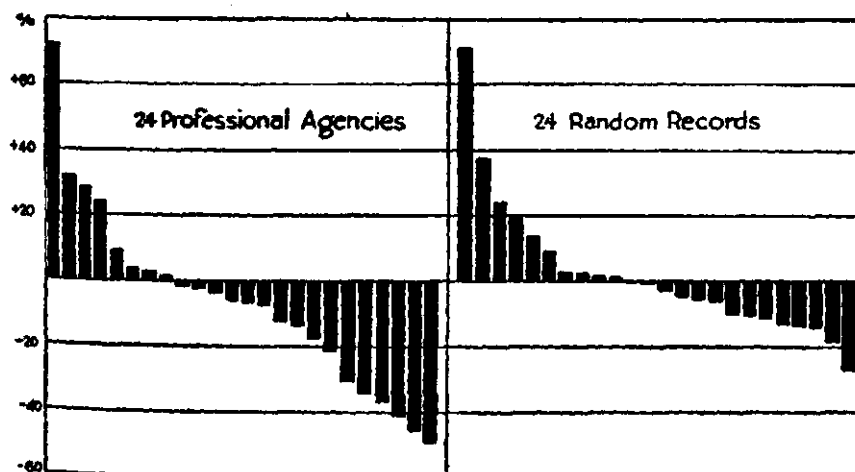

FIGURE 148.—STOCK MARKET FORECASTING.

### 3. The Standard Error of Forecast

If the variations of an economic time series from the average value of the series are normally distributed, it is clear that an assumption of "all other things remaining equal" permits an estimate of the

probable variation in a subsequent period. Thus, if in the period  $t_0 \leq t \leq t_1$  the standard deviation is  $\sigma$ , then the probability,  $P(x)$ , that a variation equal to  $x\sigma$  will be found in the next period of equal length, is

$$P(x) = \frac{1}{\sqrt{2\pi}} e^{-x^2/2}.$$

This forecast, however, depends upon the assumptions that the average value does not change, that the distribution remains normal, and that the standard deviation remains unaltered. Such assumptions are entirely without warrant where trends are present, as one may see from the following averages and standard deviations for the four 25-year periods of railroad stock averages over the period from 1831 to 1930:

Periods	Period I 1831-1855	Period II 1856-1880	Period III 1881-1905	Period IV 1906-1930
Average	53.48	74.24	93.76	119.68
$\sigma$	14.05	23.09	24.27	21.68

We see from this table that the average values rose continuously from 1831, but that the standard deviations, after the first period, remained essentially constant. Moreover, an inspection of the frequency graphs would show that the deviations from the trend are not normally distributed. The most remarkable case is that of the averages in the second period, where the distribution is essentially U-shaped. An inspection of the actual prices (see Figure 6 in Chapter 1) over the period shows that the variates assume the form of an irregular sine curve, which may be readily shown to yield a U-shaped distribution.

Obviously an assumption such as that proposed above would yield totally erroneous predictions. Since the series under discussion is an erratic one, it is good for experimental purposes. The causes of variation in rail stock prices are many and complex. The cyclical nature of the series is not readily apparent, nor is there a definite linear trend from one period to another. The question invoked is whether or not anything can be said about the probable structure of the series in one period from its behavior in the preceding.

In order to answer this question we shall assume that the series as a whole tends to follow a linear trend. There is no a priori reason for this assumption except that a new industry was being developed in a large country and the progress of development would not be static. The series, of course, is one of price and not of physical pro-

duction, but the tendency in a period of expansion is for prices to increase with the development of the industry. Hence, on this basis, we shall assume that the trend is linear.

We first fit to the data a series of overlapping linear trends, using the central item each time as origin. We shall assume a base of 20 years. The accompanying table gives the values of the coefficients of the trend

$$y = a + bt,$$

as well as the interval and the standard deviations of the original data:

Period	a	b	$\sigma$	Period	a	b	$\sigma$
1. 1831-1850	50.48117	-0.04737	13.5262	12. 1875-1894	84.15900	-0.03013	20.4198
2. 1835-1854	52.94979	0.05573	15.2468	13. 1879-1898	84.84519	-0.19289	19.6552
3. 1839-1858	49.78661	0.09167	13.3059	14. 1883-1902	85.05858	0.07897	19.1532
4. 1843-1862	51.00418	0.03073	12.0935	15. 1887-1906	94.43515	0.29492	27.6905
5. 1847-1866	59.56904	0.08018	18.4667	16. 1891-1910	102.46444	0.35312	29.7035
6. 1851-1870	67.74477	0.19425	23.0768	17. 1895-1914	112.89958	0.26083	26.2426
7. 1855-1874	72.62343	0.29114	25.2551	18. 1899-1918	120.43933	-0.02724	16.3494
8. 1859-1878	76.61506	0.10727	22.3383	19. 1903-1922	116.24268	-0.19202	19.0409
9. 1863-1882	90.51464	0.03549	19.0449	20. 1907-1926	110.88285	-0.12464	15.8842
10. 1867-1886	90.19665	0.00567	20.0340	21. 1911-1930	116.88285	0.11660	23.2667
11. 1871-1890	88.02092	0.00593	19.7957				

The question which we now propose to discuss is this: Is it possible from these data to determine the limits of forecast from one period to another, not only of the trend, but also of the individual quotations? In other words, do these data contain intrinsic information regarding their own future?

In the first place we observe from the data that there has been an unusual fluctuation in the values of both  $a$  and  $b$ . A survey of the series as a whole, that is, over the entire century covered by the data, shows that the trend has been strictly linear with a positive slope given by  $b = 0.850$  per annum. Hence, the assumption that the trend is linear is amply justified by the empirical fact even though there may exist no a priori judgment regarding it. For this reason, the fluctuations of this trend from period to period will supply us with an example in which are embodied most of the difficulties of forecasting economic time series.

We shall begin our investigation with an examination of the criterion established by the late Henry Schultz in a paper entitled "The Standard Error of a Forecast from a Curve," which appeared in 1930.<sup>2</sup> This very suggestive paper followed a discussion of the

<sup>2</sup> *Journal of the American Statistical Association*, Vol. 25, 1930, pp. 139-185.

problem of determining the error of trend lines published by Holbrook Working and Harold Hotelling in 1929, a discussion which not only served to bring to light the difficulties of the problem, but which also set forth certain criteria for judging the errors.<sup>3</sup> These criteria were in agreement with those previously established by R. A. Fisher<sup>4</sup> for linear and higher polynomial regressions.

But the differences in the point of view between the theory of the errors in a linear regression and that of the errors in a trend determined from the data of a time series is inherently great. The first theory postulates a system of errors which are normally distributed in the usual case, or are distributed according to some fixed non-normal frequency pattern in the exceptional case. But with time series the system of errors cannot be assumed to have a fixed pattern, normal or otherwise. The pattern changes with the time and the distribution of errors in one period may bear slight resemblance to the distribution in another. In fact, the trend itself is a device to surmount the difficulties of this changing pattern.

In the following analysis we shall make two assumptions which differ essentially from those of Schultz, Fisher, and others whose estimates for the errors of regression lines are valid within the framework of a sampling technique based upon an invariant frequency pattern for the errors. In our theory we shall assume, first, that the error of the trend is a function of the range of forecast. This somewhat radical hypothesis attempts to surmount the difficulties of the postulate that the fundamental character of the regression function is known a priori. Schultz, for example, does not measure the error occasioned by the choice of a wrong curve, but rather the error arising from the statistical determination of the parameters. Our assumption, then, attempts to take some account of the error in the choice of the curve itself, and it is justified principally by its realistic description of the data of time series, rather than by its derivation from principles of statistical sampling.

The second postulate is closely related to the first, since it connects the maximum range of forecast with the error of the trend. This postulate merely states that the range of forecast cannot exceed an interval greater than the interval of the data themselves. Beyond the range of forecast the error is infinite. As in the case of the first assumption, this postulate is justified, also, by the empirical evidence.

<sup>3</sup> "Applications of the Theory of Error to the Interpretation of Trends," *Proceedings of the American Statistical Association*, Vol. 24, 1929, pp. 73-85.

<sup>4</sup> See *Statistical Methods for Research Workers*, 4th ed., 1932, Chapter 5, Section 28.

In order to attack the problem we shall assume that we have determined the approximate character of the trend. This may be expressed as the function

$$(1) \quad y = f(t; a, b, c, \dots, m),$$

where the parameters of the function,  $a, b, c, \dots, m$ , are to be determined from the data either by the method of least squares or by some similar approximation. Let us assume that these values are  $a_0, b_0, c_0, \dots, m_0$ , so that our best function, representing the data within the given range of  $t$ , may be written

$$(2) \quad y_0 = f(t; a_0, b_0, c_0, \dots, m_0).$$

But for any given value of  $t$ , there will exist a value  $y_0(t)$  which differs from the actual observed value,  $y_t$ , by the amount  $y_t - y_0(t)$ . Let us now represent these residuals by  $\Delta(t)$ , that is,  $\Delta(t) = y_t - y_0(t)$ , and designate by  $\sigma_1^2$  the sum

$$(3) \quad \sigma_1^2 = \frac{\sum \Delta^2(t)}{N},$$

where  $N$  is the number of items in the data. But since  $m$  relations exist between the variables because of the determination of the  $m$  parameters, we shall measure the error variance by

$$(4) \quad \varepsilon^2 = \frac{N}{N - m} \sigma_1^2.$$

We next observe that  $y$  can be expanded in terms of the differences between the computed values of the parameters and their *true* values by writing (1) in the expanded form

$$(5) \quad y = f(t; a_0, b_0, c_0, \dots, m_0) + \left(\frac{\partial f}{\partial a}\right)_0 \Delta a + \left(\frac{\partial f}{\partial b}\right)_0 \Delta b + \dots + \left(\frac{\partial f}{\partial m}\right)_0 \Delta m + \dots$$

The derivatives, of course, are computed for the initial values of the parameters. Moreover, terms of higher order in the differences are omitted as being of inconsequential size, an assumption that is not always justified.

Equation (5), by means of (2), can now be written in the more convenient form

$$(6) \quad \left(\frac{\partial f}{\partial a}\right)_0 \Delta a + \left(\frac{\partial f}{\partial b}\right)_0 \Delta b + \dots + \left(\frac{\partial f}{\partial m}\right)_0 \Delta m = \delta(t)$$

where we use the abbreviation  $\delta(t) = y(t) - y_0(t)$ .

We now observe from equation (11) in Section 12 of Chapter 2 that the variance of the regression

$$(7) \quad f(t) = a_1 u_1(t) + a_2 u_2(t) + \dots + a_n u_n(t)$$

is given by the expression

$$(8) \quad \sigma^2 = a_1^2 \sigma_1^2 + a_2^2 \sigma_2^2 + \dots + a_n^2 \sigma_n^2 + 2a_1 a_2 \sigma_1 \sigma_2 r_{12} + \dots,$$

where  $\sigma_1^2, \sigma_2^2, \dots, \sigma_n^2$  are the variances respectively of  $u_1(t), u_2(t), \dots, u_n(t)$ , and  $r_{ij}$  is the correlation coefficient between  $u_i(t)$  and  $u_j(t)$ .

We next observe that (7) is symmetric in  $a_i$  and  $u_i$  so that their roles could be interchanged in (8) if meaning could be given to the resulting variance. This is the essence of the contribution of Schultz to the forecasting problem. The argument might be reconstructed as follows: The variance (8) is an *internal variance* since it applies to the regression (7) when  $t$  is confined to the range of the data. It is a constant since the values of the terms are constant estimates obtained from the data, and it may be used in establishing the probable error of estimate of any value  $y_0(t)$  obtained for a value of  $t$  within the known range. But if the role of the  $a_i$  and the  $u_i(t)$  are interchanged, then we obtain a variance expressed as a function of  $t$  which may be used for extrapolation beyond the known range of the data. It thus becomes a kind of *external variance*, whose primary purpose is to estimate the errors of forecasting with the trend defined by (2).

Hence, appreciating the boldness of the step, we may write as the *external or forecasting variance* the function

$$(9) \quad \sigma_f^2(t) = \left[ \left(\frac{\partial f}{\partial a}\right)_0 \sigma_a^2 + \left(\frac{\partial f}{\partial b}\right)_0 \sigma_b^2 + \dots + \left(\frac{\partial f}{\partial m}\right)_0 \sigma_m^2 + 2 \left(\frac{\partial f}{\partial a}\right)_0 \left(\frac{\partial f}{\partial b}\right)_0 \sigma_a \sigma_b r_{ab} + 2 \left(\frac{\partial f}{\partial a}\right)_0 \left(\frac{\partial f}{\partial c}\right)_0 \sigma_a \sigma_c r_{ac} + \dots \right],$$

where  $\sigma_a^2, \sigma_b^2$ , etc. are the variances of the errors in the parameters and where  $r_{ab}, r_{ac}$ , etc. are the correlations between these errors.

The next problem is the determination of the error variances, a problem that cannot be solved empirically since it would involve a knowledge of the variations in the parameters in the range beyond the known data.

In order to make an estimate of these errors, Schultz now made

another bold assumption. This was that the error variances are given by the expressions

$$(10) \quad \sigma_a^2 = \varepsilon^2[\alpha, \alpha], \quad \sigma_b^2 = \varepsilon^2[\beta, \beta], \dots, \sigma_a \sigma_b r_{ab} = \varepsilon^2[\alpha, \beta], \dots,$$

where the bracket symbols are to be determined from the inverse of the system

$$(11) \quad \begin{aligned} [f_a f_a] \Delta a + [f_a f_b] \Delta b + \dots + [f_a f_m] \Delta m &= [f_a \delta], \\ [f_b f_a] \Delta a + [f_b f_b] \Delta b + \dots + [f_b f_m] \Delta m &= [f_b \delta], \\ \dots &\dots \\ [f_m f_a] \Delta a + [f_m f_b] \Delta b + \dots + [f_m f_m] \Delta m &= [f_m \delta]. \end{aligned}$$

In this system we mean that

$$[f_a f_b] = \sum_i \left( \frac{\partial f}{\partial a} \right)_0 \left( \frac{\partial f}{\partial b} \right)'_0, \quad [f_a \delta] = \sum_i \left( \frac{\partial f}{\partial a} \right)_0 \delta(t).$$

The inverse of system (11) has the form

$$(12) \quad \begin{aligned} \Delta a &= [\alpha, \alpha] [f_a \delta] + [\alpha, \beta] [f_b \delta] + \dots + [\alpha, \mu] [f_m \delta] \\ \Delta b &= [\beta, \alpha] [f_a \delta] + [\beta, \beta] [f_b \delta] + \dots + [\beta, \mu] [f_m \delta] \\ \dots &\dots \\ \Delta m &= [\mu, \alpha] [f_a \delta] + [\mu, \beta] [f_b \delta] + \dots + [\mu, \mu] [f_m \delta]. \end{aligned}$$

As an example to clarify these formulas, let us assume that  $y$  has the form

$$(13) \quad y = au_1(t) + bu_2(t) + \dots + mu_m(t),$$

where the  $u_i(t)$  are orthogonal functions; that is,

$$\sum_i u_i(t)u_j(t) = [u_i u_j] = \lambda_i \delta_{ij}, \quad \delta_{ij} = 0, \quad i \neq j, \quad \delta_{ii} = 1.$$

We see at once from (11) and (12) that we shall have

$$[\alpha, \alpha] = 1/\lambda_1, \quad [\beta, \beta] = 1/\lambda_2, \text{ etc., and } [\alpha, \beta] = [\alpha, \gamma] = \text{etc.} = 0.$$

Hence  $\sigma_f^2(t)$ , as defined by (9), becomes

$$(14) \quad \sigma_f^2(t) = \varepsilon^2 \left[ \frac{u_1^2(t)}{\lambda_1} + \frac{u_2^2(t)}{\lambda_2} + \dots + \frac{u_m^2(t)}{\lambda_m} \right].$$

From this simple example we can now advance several objections to the theory. Thus, if the orthogonal functions are sines and cosines, then (14) reduces to a constant and hence we may conclude that the standard error of a forecast for a Fourier series is a constant for all

values of  $t$ . This is obviously a doubtful conclusion unless we know in the beginning a priori that the trend is the sum of sines and cosines.

On the other hand, if the orthogonal functions are polynomials, then  $\sigma^2(t)$  is a polynomial and the variance increases with  $t$ , but another objection can be raised. The coefficients are functions of the number of items in the data and  $\sigma^2(t)$  is not invariant with respect to a change in the scale factor. Thus, for the straight line (see the next section), we have

$$(15) \quad \sigma^2(t) = \varepsilon^2 \left[ \frac{1}{N} + \frac{12}{N(N^2 - 1)} t^2 \right].$$

It is clear that  $\sigma^2(t)$  will be one thing for annual data and quite another thing for monthly data. If the data do not have a seasonal factor, then  $\varepsilon^2$  will be essentially unchanged, but  $\sigma^2(t)$  at any point either inside or outside of the range will be approximately one-twelfth the value that it is for annual data. This also is a doubtful proposition.

The theory as advanced by Schultz makes no assumption as to the range of application of the forecast variance. He merely says that  $\varepsilon^2(t)$  "may be called 'the standard error of a forecast' if we remember that it does not measure the error due to a choice of the wrong curve, but only that arising from the substitution of probable values of the parameters, found by the method of least squares, for the true values."

The difficulty with the theory may be traceable, perhaps, to the fact that no account is taken of the autocorrelation of the items in economic time series. Some consideration of this point would show immediately that the determination of  $\sigma_f^2(t)$  by monthly data, rather than by annual averages, would not essentially reduce its value, unless a seasonal factor were present.

Although a proper modification of the Schultz theory seems possible from a consideration of autocorrelations, a simpler hypothesis appears to give realistic results and also provides a method of defining a range of forecast. This hypothesis may be stated as follows: If  $\sigma_f^2(t)$  has been computed from a set of  $N$  items, then the forecast of the trend is valid for one unit beyond the range of the data.

In order to be more precise, let us assume that the mid-point of the range is chosen as origin and that the data are known over  $2p + 1 = N$  units. But suppose that we wish to explore  $m$  units into the future. The range is then effectively given as  $2p + 1 = N/m$  units and the value of  $\sigma_f^2(t)$  must be computed upon this assumption as to the effective number of degrees of freedom involved.



Thus formula (15) would become

$$(16) \quad \sigma_f^2(t) = \varepsilon^2 \frac{m}{N} \left[ 1 + \frac{12}{N^2 - m^2} t^2 \right],$$

where  $t$  is measured in terms of the original units.

One important fact may be observed with respect to this formula. For  $N = m$ , the coefficient of  $t^2$  becomes infinite, which means that we cannot forecast a full length beyond the data. This result seems realistic when it is applied to economic time series, where the hazards of prediction are so well known.

It will be convenient also to define a new function  $\sigma^2(m)$ , which we might call the *range variance*. This variance is defined to be

$$(17) \quad \sigma^2(m) = \sigma_f^2 \left( \frac{N + 2m}{2} \right), \quad 0 \leq m \leq N.$$

If the number of items to be forecast is  $m$ , then  $\sigma_f^2(t)$  is computed on the assumption that the number of degrees of freedom is  $2p + 1 = N/m$ . From the midpoint of the range, where  $t = 0$ , the total range of applicability of  $\sigma_f^2(t)$  is to  $t = (p + \frac{1}{2}) + m$ , that is, to  $t = \frac{1}{2}(N + 2m)$ . Hence, if this value is substituted in  $\sigma_f^2(t)$  we shall have the limiting value of the variance for a forecast of  $m$  units.

In order to illustrate the application of this theory to the analysis of economic time series we shall consider in the next three sections some special examples.

#### 4. The Standard Error of Forecast for Linear Trends

We shall first apply the theory of the preceding section to the linear trend

$$(1) \quad y = a + bt,$$

the data being assumed to be distributed at unit intervals over the range  $-p \leq t \leq p$ . As in Section 3 of Chapter 6, the values of  $a$  and  $b$  are given by the formulas

$$(2) \quad a = AM_0, \quad b = A'M_1,$$

where  $A(p) = 1/(2p + 1)$ ,  $A'(p) = 3/p(p + 1)(2p + 1)$ . If the number of intervals is  $N = 2p + 1$ , we then have  $A(p) = 1/N$ ,  $A'(p) = 12/N(N^2 - 1)$ .

Moreover, by formula (4) in Section 3 of Chapter 6, we can compute

$$(3) \quad \epsilon^2 = \frac{N}{N-2} \sigma_1^2,$$

where we write

$$(4) \quad \sigma_1^2 = \sigma^2 - \frac{A'M_1^2}{N}.$$

Since by the theory of the last section we have

$$\left(\frac{\partial f}{\partial a}\right) = 1, \quad \left(\frac{\partial f}{\partial b}\right) = t,$$

formula (9) becomes

$$(5) \quad \sigma_f^2(t) = [\sigma_a^2 + \sigma_a\sigma_b r_{ab}t + \sigma_b^2 t^2].$$

But a simple computation shows that

$$(6) \quad \sigma_a^2 = \epsilon^2 A(p), \quad \sigma_a\sigma_b r_{ab} = 0, \quad \sigma_b^2 = \epsilon^2 A'(p);$$

and hence (5) becomes

$$(7) \quad \begin{aligned} \sigma_f^2(t) &= \epsilon^2 [A(p) + A'(p)t^2] \\ &= \frac{\sigma_1^2}{N-2} \left[ 1 + \frac{12}{N^2-1} t^2 \right]. \end{aligned}$$

If we assume that the forecast range is  $m$  units, then (7) becomes

$$(8) \quad \sigma_f^2(t) = \frac{\sigma_1^2}{N-2} \left[ m + \frac{12m}{N^2-m^2} t^2 \right],$$

where  $t$  is measured in the original units of the data.

The range variance, formula (17) of Section 3, then becomes

$$(9) \quad \sigma^2(m) = \sigma_f^2\left(\frac{N+2m}{2}\right) = \frac{\sigma_1^2}{N-2} m \left[ 1 + \frac{3(N+2m)^2}{N^2-m^2} \right].$$

We shall first apply these formulas to the data on railroad stock prices mentioned in Section 3. We shall first forecast the trend fitted to the first 20 years, by months, of the data, that is for the years from 1831 to 1850 inclusive. The moments are  $M_0 = 12,065$ ,  $M_1 = -53,890$ , from which we compute the trend

$$y = 50.48117 - 0.04737t,$$

and the reduced variance

$$\sigma_1^2 = 171.95.$$

We now assume that we wish to explore the trend over the four years (48 months) beyond the period of the data; that is, we assume  $m = 48$ ,  $N = 240$ . Formula (8) gives us the variance

$$\sigma_f^2(t) = 34.68 + 0.0075258t^2$$

where  $t$  is in units of one month.

Now the correspondence of the two values

$$\sigma_a^2 = 34.68, \quad \sigma_b^2 = 0.0075258$$

with the variances of the empirical distribution can be directly tested from the table of values of  $a$  and  $b$  given in Section 3, since the variations in these two parameters are readily discernible for the twenty-one overlapping periods from 1831 to 1930. If then we compute  $\Delta_a$  and  $\Delta_b$  and compute the variances of these differences, we find

$$\sigma^2_{\Delta a} = 29.59, \quad \sigma^2_{\Delta b} = 0.020592.$$

The standard deviations  $\sigma_a = 5.44$ ,  $\sigma_{\Delta a} = 5.86$ , and  $\sigma_b = 0.0864$ ,  $\sigma_{\Delta b} = 0.1435$  agree almost too well when one considers the truly great extent of the data and the nature of the extrapolations that have been assumed.

The range variance for the example is given by the formula

$$\sigma^2(m) = 0.7225m \left[ 1 + 3 \frac{(240 + 2m)^2}{240^2 - m^2} \right].$$

In Figure 149 we find the graph of the data and the fitted trend line (A).

During this period the trend was negative, so the example furnishes a rather extreme case of the application of the theory. It will be observed that the trend line (B) for the next interval (1835-1854) lies partly above and partly below the upper bound of  $\sigma_f(t)$  in the shaded region to which our extrapolation applies. The rapid widening of  $y(t) \pm \sigma(m)$  is to be observed as we approach the limits of the region of forecasting.

In order to obtain a general statistical appraisal of the theory, the standard

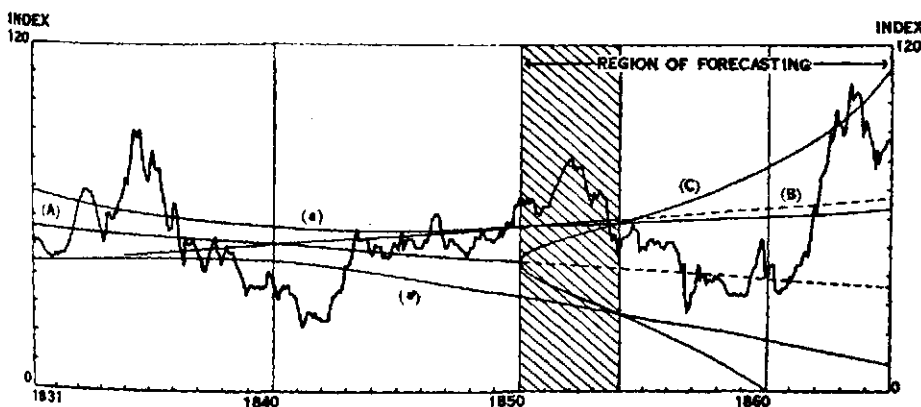

FIGURE 149.—FORECASTING OF RAIL STOCK PRICES.

This chart shows the highly explosive character of trend extrapolations where the basic data are highly variable. The shaded region is the region of forecast corresponding to the standard error of the trend shown in the chart. (a)  $y(t) + \sigma_f(t)$ ; (a')  $y(t) - \sigma_f(t)$ ; (C)  $y(t) \pm \sigma(m)$ .

It will be observed from Figure 151 that this standard error, due to the unusual stability of the trend, will serve as a boundary for forecasting far beyond that indicated by the standard error of the range. The reason for this is easily seen if one compares the insignificant variation of the initial trend (1896-1914) from the long-term trend (1896-1936) with the same variation in the case of rail stock prices. The need for the concept of the standard error of the range is not evident in Schultz's example, although it becomes apparent at once in the second example.

### 5. The Standard Error of Forecast for Harmonic Sums

If we assume a trend of the form

$$y = \frac{1}{2} A_0 + A_1 \cos \frac{\pi t}{a} + A_2 \cos \frac{2\pi t}{a} + \dots + A_n \cos \frac{n\pi t}{a} \\ + B_1 \sin \frac{\pi t}{a} + B_2 \sin \frac{2\pi t}{a} + \dots + B_n \sin \frac{n\pi t}{a},$$

then it can be seen from formula (14) of Section 3, that

$$\sigma_f^2(t) = \varepsilon^2 \left\{ \frac{1}{a} + \frac{1}{a} \cos^2 \frac{\pi t}{a} + \frac{1}{a} \sin^2 \frac{\pi t}{a} + \dots + \frac{1}{a} \cos^2 \frac{n\pi t}{a} + \frac{1}{a} \sin^2 \frac{n\pi t}{a} \right\} \\ (1) \quad = \varepsilon^2 \frac{(n+1)}{a},$$

where we have

$$(2) \quad \varepsilon^2 = \frac{N}{N-n-1} \left\{ \sigma^2 - \frac{1}{2} (R_1^2 + R_2^2 + \dots + R_n^2) \right\}.$$

Since in formula (1)  $N = 2a + 1$ , we may also write the trend variance in the form

$$(3) \quad \sigma_f^2(t) = \varepsilon^2 \frac{2(n+1)}{N-1}.$$

By means of an application of the argument given in Section 4, it is possible to show that the trend variance has the form

$$(4) \quad \sigma_f^2(t) = \varepsilon^2 \frac{2(n+1)m}{N-m},$$

when  $t$  is assumed to vary  $m$  units beyond the range of the data.

Since the range variance  $\sigma^2(m)$  is the trend variance for  $t = \frac{1}{2}(N + 2m)$ , it is clear that (4) is also the range variance.

As an example, let us compute the standard error of the range for the Dow-Jones industrial stock price averages (1897-1913) uncorrected for trend. The pertinent data are given in Section 6 of Chapter 6, in which periods are recognized at  $T = 22$  months, 43 months, and 62 months. We shall assume that the linear trend is without error and confine our attention to the standard error of the harmonic components.

From the data given in Chapter 6, we readily compute

$$\begin{aligned} s^2 &= \frac{204}{200}(116.5570 - \frac{1}{2}(12.0409 + 96.0400 + 47.6100)) \\ &= 39.4857. \end{aligned}$$

Hence we obtain from (4) the standard error of the range

$$\sigma_r(m) = \sqrt{8} \times 39.4857 \sqrt{\frac{m}{204 - m}} = 17.7732 \sqrt{\frac{m}{204 - m}}.$$

One observes from Figure 152 the rapid increase in the error of forecast as one proceeds from the region of the known data. It is a matter of observation that

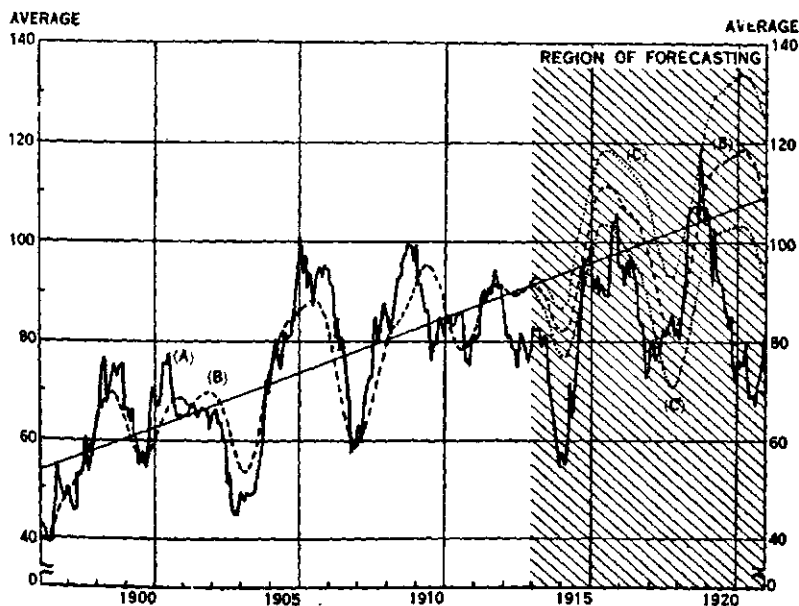

FIGURE 152.—FORECASTS OF THE BEHAVIOR OF INDUSTRIAL STOCK PRICES BY HARMONIC ANALYSIS.

This chart shows the standard error of the range,  $\sigma(m)$ , for a series of harmonic terms. (A) = data; (B) = sine-cosine curve; (C), (C') = harmonic forecast band.

the length of the period of the 40-month component decreased rather sharply in the interval from 1914 to 1926 so that the forecast by the harmonics became increasingly less exact. But for the first four years, when the standard errors were small, the forecast was exceptionally good.

### 6. Forecasting Logistic Trends.

As has been indicated earlier in this book, the logistic trend has a thoroughly tested application in population and production series. It is of particular interest, therefore, to establish boundaries for its forecast. In order to estimate these limits we first write the logistic in the form

$$(1) \quad y = \frac{k}{1 + be^{-at}}.$$

Equation (6) of Section 3 may then be explicitly written

$$(2) \quad \left\{ t y_0 \frac{(k_0 - y_0)}{k_0} \right\} \Delta a + \left\{ \frac{y_0}{k_0 b_0} (y_0 - k_0) \right\} \Delta b + \frac{y_0}{k_0} \Delta k = \delta t.$$

Substituting these functional coefficients in formula (9) of Section 3, we readily obtain

$$(3) \quad \sigma_t^2(t) = \varepsilon^2 \left( \frac{y_0}{k_0} \right)^2 \left\{ [\alpha, \alpha] t^2 (y_0 - k_0)^2 + [\beta, \beta] \frac{(y_0 - k_0)^2}{b_0^2} + [\kappa, \kappa] \right. \\ \left. - 2[\alpha, \beta] \frac{t}{b_0} (y_0 - k_0)^2 - 2[\alpha, \kappa] t (y_0 - k_0) + 2[\beta, \kappa] \frac{(y_0 - k_0)}{b_0} \right\}.$$

The bracket symbols are then obtained as the coefficients of  $\delta_1$ ,  $\delta_2$ ,  $\delta_3$  in the solution of the following system of equations:

$$\begin{aligned} & \sum t^2 y_0^2 \left( 1 - \frac{y_0}{k_0} \right)^2 \Delta a - \sum t \frac{y_0^2}{b_0} \left( 1 - \frac{y_0}{k_0} \right)^2 \Delta b + \sum t \frac{y_0^2}{k_0} \left( 1 - \frac{y_0}{k_0} \right) \Delta k = \delta_1, \\ - \sum t \frac{y_0^2}{b_0} \left( 1 - \frac{y_0}{k_0} \right)^2 \Delta a + \sum \frac{y_0^2}{b_0^2} \left( 1 - \frac{y_0}{k_0} \right)^2 \Delta b - \sum \frac{y_0^2}{k_0 b_0} \left( 1 - \frac{y_0}{k_0} \right) \Delta k = \delta_2, \\ (4) \quad & \sum t \frac{y_0^2}{k_0} \left( 1 - \frac{y_0}{k_0} \right) \Delta a - \sum \frac{y_0^2}{k_0 b_0} \left( 1 - \frac{y_0}{k_0} \right) \Delta b + \frac{y_0^2}{k_0^2} \Delta k = \delta_3. \end{aligned}$$

If the forecast variance is desired over a range of  $m$  units then the sums in these equations are to be extended over  $N/m$  equally spaced points,  $t$  in (3) being kept in the original units.

As an example, we shall consider the logistic for the production of pig iron,

(5)

$$y = \frac{43,021}{1 + 66.1102e^{-0.44905t}}$$

origin at the year 1860,  $t$  measured in units of five years, the data and computations for which are given in Section 12, Chapter 6.

For the determination of the parameters in formula (3), the accompanying data (5-year averages) were employed.

Year	$t$	$y$ (obs.)	$y_0$ (comp.)	$y - y_0$	$(y - y_0)^2$	$y_0/k_0$	$(1 - y_0/k_0)$
1860	0	712	641	71	5041	0.01490	0.98510
1865	5	1041	996	45	2025	0.02215	0.97685
1870	10	1818	1540	278	74529	0.03580	0.96420
1875	15	2164	2365	- 181	32761	0.05497	0.94503
1880	20	3529	3594	- 65	4225	0.08354	0.91646
1885	25	4968	5877	- 409	167281	0.12499	0.87501
1890	30	8147	7867	280	78400	0.18286	0.81714
1895	35	8801	11169	-2868	8225424	0.25982	0.74018
1900	40	14577	15255	- 678	459684	0.36459	0.63541
1905	45	21717	19902	1815	3294225	0.48261	0.51739
1910	50	24482	24704	- 222	49284	0.57428	0.42572
1915	55	32454	29202	3252	10576504	0.67878	0.32122
1920	60	40181	38042	-2861	8185321	0.76804	0.23196
1925	65	-----	36069	-----	-----	0.83840	0.16160
1930	70	-----	33309	-----	-----	0.89047	0.10953
1935	75	-----	39889	-----	-----	0.92720	0.07280
1940	80	-----	40968	-----	-----	0.95228	0.04772

After a somewhat lengthy calculation based upon these data through the year 1920 the following system of equations equivalent to (4) is obtained for the determination of  $[\alpha, a]$ ,  $[\alpha, \beta]$ , etc.:

$$\begin{aligned}
 &1,281,459,306,400\Delta a - 414,848,497\Delta b - 1,500,753.31067\Delta c = \delta_1, \\
 (6) \quad &-414,848,497\Delta a + 141,841.40749\Delta b - 470.81533\Delta c = \delta_2, \\
 &1,500,753.31067\Delta a - 470.81533\Delta b + 1.84862970\Delta c = \delta_3.
 \end{aligned}$$

The solution of this system is found to be

$$\begin{aligned}
 (7) \quad \Delta a &= 0.(10)686589\delta_1 + 0.(6)1021428\delta_2 - 0.(4)297247\delta_3, \\
 \Delta b &= 0.(6)1021428\delta_1 + 0.(3)1975549\delta_2 - 0.0326080\delta_3, \\
 \Delta c &= -0.(4)297247\delta_1 - 0.0326080\delta_2 + 16.367384\delta_3,
 \end{aligned}$$

where the figures in parentheses represent the number of zeros between the decimal point and the first significant digit.

From the squared differences,  $(y - y_0)^2$ , the value of  $\epsilon^2$ , and  $\epsilon$  are found to be

$$\epsilon^2 = 31153704 / (13 - 8) = 3,115,370; \quad \epsilon = 1765.04.$$

Since from (7) we obtain  $[\alpha, a] = 0.(10)686589$ ,  $[\alpha, \beta] = 0.(6)1021428$ , etc., we can obtain  $\sigma_f^2(t)$ ; that is,

$$\begin{aligned}
 \sigma_f^2(t) &= 3,115,370 \left( \frac{y_0}{k_0} \right)^2 \left\{ (0.(10)686589\epsilon^2 (y_0 - k_0)^2 + 0.(3)1975549 \left( \frac{y_0 - k_0}{b_0} \right)^2 \right. \\
 &\quad + 16.367384 - 0.(6)2042856 \frac{t}{b_0} (y_0 - k_0)^2 + 0.(4)594494t (y_0 - k_0) \\
 &\quad \left. - 0.(2)652160 \left( \frac{y_0 - k_0}{b_0} \right) \right\}.
 \end{aligned}$$

Since this standard error of forecast is valid only for 5 years beyond the interval of the data, the calculations were repeated for a new system where the sums in (4) were taken over only the values corresponding to  $t = 0, 15, 30, 45,$  and 60.

This new system was the following:

$$481,422,184,425\Delta a - 151,060,104\Delta b + 612,939.3578\Delta c = \delta_1,$$

$$-151,060,104\Delta a + 50,301.94066\Delta b - 183.66098\Delta c = \delta_2,$$

$$612,939.3578\Delta a - 183.66098\Delta b + 0.840575\Delta c = \delta_3.$$

The solution is found to be

$$\Delta a = 0. (8) 1783499\delta_1 + 0. (6) 3004265 \delta_2 - 0. (4) 6440956\delta_3,$$

$$\Delta b = 0. (6) 3004265\delta_1 + 0. (3) 6043609 \delta_2 - 0.08701867\delta_3,$$

$$\Delta c = -0. (4) 6440956\delta_1 - 0.08701867\delta_2 + 29.14341 \delta_3.$$

If we assume that  $\epsilon^2$  is essentially unchanged, then it is evident that the errors have been increased. The new variance thus becomes

$$\begin{aligned} \sigma_f^2(t) = & 3,115,370 \left( \frac{y_0}{k_0} \right)^2 \left\{ 0. (8) 1783499t^2 (y_0 - k_0)^2 + 0. (3) 6043609 \left( \frac{y_0 - k_0}{b_0} \right)^2 \right. \\ & + 29.14341 - 0. (6) 6008530 \frac{t}{b_0} (y_0 - k_0)^2 + 0. (3) 12881912t (y_0 - k_0) \\ & \left. - 0.17403734 \left( \frac{y_0 - k_0}{b_0} \right) \right\}. \end{aligned}$$

The accompanying table gives the values for the functions  $y_0 \pm \sigma_f(t)$  corresponding to the two determinations of  $\sigma_f(t)$ . The first set of values are valid only to  $t = 65$ , while the second extend to  $t = 80$ .

VALUES OF  $y_0 \pm \sigma_f(t)$

First Computation					Second Computation				
t	$y_0 - \sigma_f$	$y_0 + \sigma_f$	$y_0 - \sigma_f$	$y_0 + \sigma_f$	t	$y_0 - \sigma_f$	$y_0 + \sigma_f$	$y_0 - \sigma_f$	$y_0 + \sigma_f$
0	331	951	122	1,160	45	18,910	20,894	18,203	21,601
5	586	1,406	307	1,685	50	23,738	25,670	22,976	26,432
10	1,601	2,651	653	2,427	55	27,815	30,589	27,692	30,712
15	1,736	2,994	1,271	3,459	60	31,515	34,569	31,280	34,804
20	2,853	4,335	2,327	4,861	65	33,313	38,825	32,731	39,407
25	4,583	6,171	4,000	6,754	70	34,767	41,851	34,219	42,399
30	7,076	8,658	6,493	9,241	75	35,472	44,356	34,224	45,554
35	10,378	11,960	9,825	12,513	80	35,752	46,184	34,232	47,704
40	14,374	16,136	13,788	16,722					

The standard error of forecast for the second computation is portrayed graphically in Figure 153. From the two computations it is possible to estimate the standard error of the range. We note that there is not a great difference between the respective values of the two computations.

A similar computation has been made by Schultz for the logistic of the population of the United States. For the data given in Section



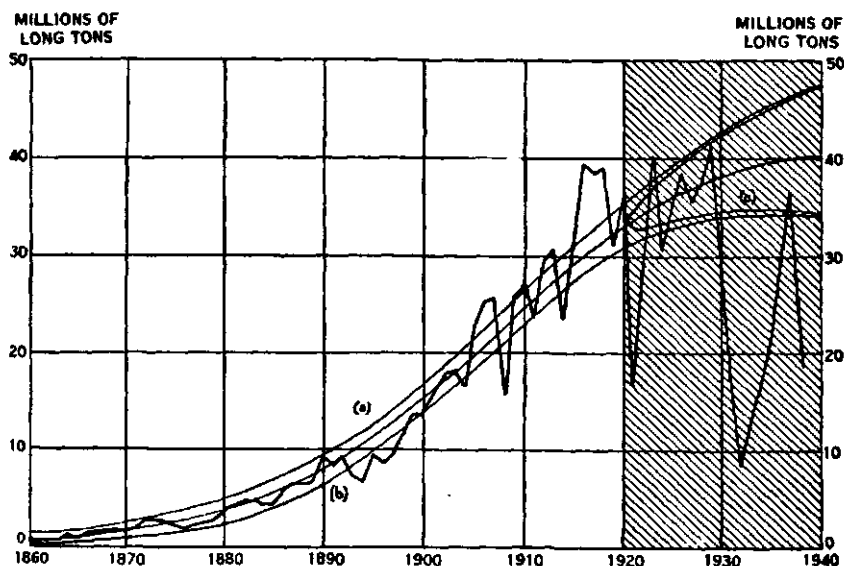

FIGURE 153.—TREND OF THE PRODUCTION OF PIG IRON, 1860-1940.

This chart shows the standard error of the logistic trend for a highly variable series. (a):  $y(t) + \sigma_f(t)$ ; (b):  $y(t) - \sigma_f(t)$ ; (c):  $y(t) \pm \sigma(m)$ .

11 of Chapter 6,  $\varepsilon$  has the extremely small value of 0.5088 (unit = one million).

Employing the values  $B_0 = 2.921661$ ,  $C_0 = 0.0148865$ , Schultz obtained as the standard error of forecast the function

$$\begin{aligned} \sigma_f(t) = & 0.175040 y_0 (10^{-4}) \{ 151.60 t^2 (B_0 - C_0 y_0)^2 \\ & - 57.446 t y_0 (B_0 - C_0 y_0) + 77.816 y_0^2 - 58.552 (B_0 - C_0 y_0) \\ & + 973.56 y_0 + 6.042110 \}^{\frac{1}{2}}. \end{aligned}$$

In Figure 154 the values of the functions  $y_0 \pm 2\sigma_f(t)$  are graphically represented over the incredibly long period from 1910, the last census figures used in the computation, to the year 2100.

It is obvious from our analysis given in Section 3, that this extrapolation is entirely unwarranted. It is also apparent however, from our last example, that the correction for the range of forecast is small for a rather extended extrapolation, and hence the computed standard error of the logistic would probably be essentially correct for several decades beyond 1920. The standard error of the range, however, would be infinite at 2060.

Schultz also extended his logistic into the past and estimated the

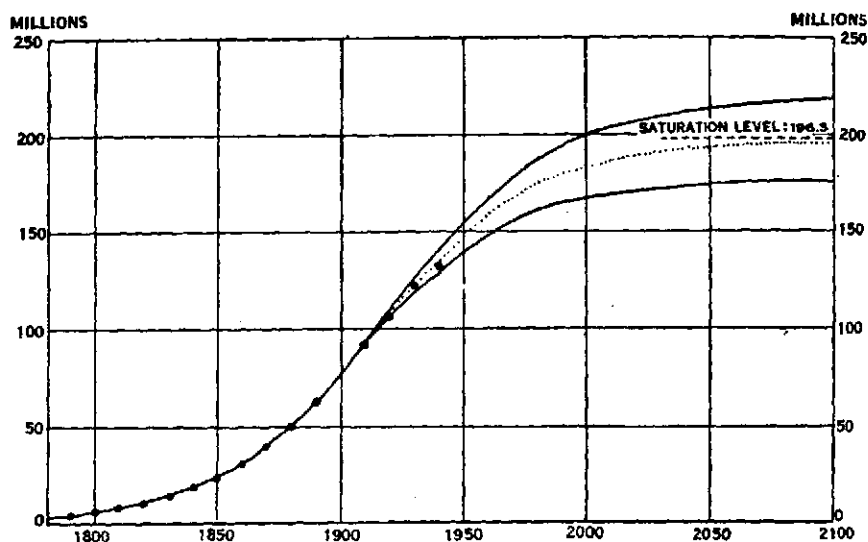

FIGURE 154.—UNITED STATES POPULATION LOGISTIC.

This chart shows the population of the United States as forecast by the logistic with twice its standard error. The envelope is given by  $y_0 \pm 2\sigma_y(t)$ . (Schultz).

population of the American Colonies to the year 1600. It is in this extrapolation that the need for the restraining influence of the standard error of the range is clearly seen.

The accompanying table gives the estimated<sup>5</sup> and calculated values of the population of the Colonies prior to the American Revolution.

POPULATION OF THE AMERICAN COLONIES  
Unit = one million

Year	Estimated	Calculated	Year	Estimated	Calculated	Year	Estimated	Calculated
1610	0.000210	0.0142	1670	0.114	0.0928	1730	0.655	0.607
1620	0.00250	0.0194	1680	0.156	0.127	1740	0.889	0.830
1630	0.00570	0.0265	1690	0.214	0.174	1750	1.207	1.134
1640	0.0279	0.0363	1700	0.275	0.238	1760	1.610	1.548
1650	0.0517	0.0496	1710	0.358	0.325	1770	2.205	2.112
1660	0.0848	0.0679	1720	0.474	0.444	1780	2.781	2.879

Since the standard error of the range would have been infinite for the year 1640, it is clear that no validity would have been ascribed to the logistic estimates beyond this date.

<sup>5</sup> Estimate is taken from W. S. Rossiter, *A Century of Population Growth in the United States, 1790-1900*, Table 1, p. 9.

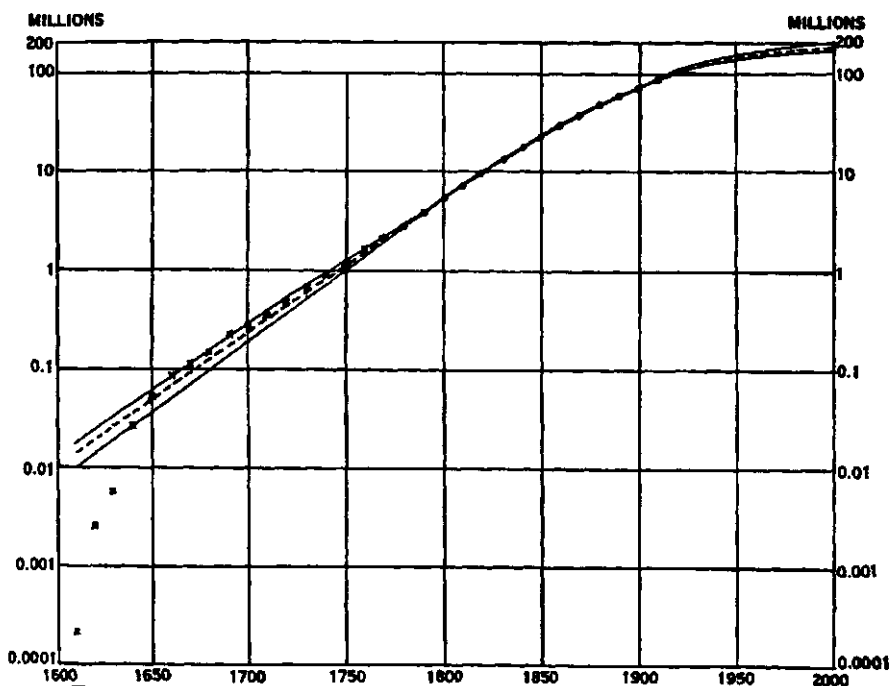

FIGURE 155.—UNITED STATES POPULATION LOGISTIC EXTRAPOLATED.

This chart shows on a ratio scale the logistic calculation of the population of the American Colonies prior to the Revolution. (Schultz).

### 7. The Standard Error of Forecast for Polynomial Trends

It is a matter of common observation that extrapolation by polynomial trends of higher degree than the straight line is fraught with great danger. In fact, a polynomial trend should be used for forecasting only when the strongest evidence exists that it is the true trend. Although an excellent fit may be obtained to the data over the known range, the rapid variation of the polynomial beyond the data makes its use highly inadvisable for extrapolation.

The reason for this inaccuracy is easily observed from the formula for the standard error of forecast. Thus, for the parabola

$$y = a_0 + a_1t + a_2t^2,$$

fitted to data over the range  $-p \leq t \leq p$  by the methods of Section 4 of Chapter 6, we find

$$\sigma_f^2(t) = \epsilon^2 \{ A(p) + [2B(p) + A'(p)]t^2 + C(p)t^4 \}$$

where  $A(p)$ ,  $B(p)$ ,  $C(p)$  are the parameters of the parabola given in

Section 6 of Chapter 6, and  $A'(p)$  is the parameter of the straight line.

Since  $\sigma_f^2(t)$  is a quartic in  $t$ , it is obvious that it will increase rapidly with  $t$  and thus indicate a hopelessly wide region of error for forecasting.

This same explosive character of higher polynomials is indicated by the fact that for the polynomial of  $n$ th degree, the forecast variance is given by

$$\sigma_f^2(t) = \varepsilon^2[A_0 + A_1t^2 + A_2t^4 + \dots + A_nt^{2n}].$$

### 8. Moving-Periodogram Analysis

We have indicated in the first chapter and in Section 7 of Chapter 8 how periodic movements may be set up in a system, governed by elastic restraints with natural periods inherent in them, by means of a series of erratic shocks imposed upon the system.

Let us assume, as we did in Section 6 of Chapter 6, that an economic series such as the Dow-Jones stock price averages consists of (1) a secular trend, (2) a harmonic element, and (3) an erratic element. Let us assume further, however, that the harmonic terms do not have fixed sine and cosine components, but that both the phase angle and the amplitude vary with time. Presumably this variation is slight for sufficiently small intervals.

In order to subject the data to investigation for the changing character of the harmonic coefficients, we introduce the concept of a *moving periodogram*. In order to define this we first assume that some period,  $T$ , has been discovered from the Schuster periodogram analysis or otherwise, which has sufficient average significance to make it the object of special investigation. Then the *moving periodogram associated with the period  $T$* , is the graph of the function

$$R = R_T(t),$$

where we abbreviate

$$(1) \quad R_T(t) = \sqrt{A_T^2(t) + B_T^2(t)},$$

in which we define

$$A_T(t) = \frac{2}{T} \sum_{s=0}^{\tau} y_{s+t} \cos \left[ \frac{2\pi}{T} (s+t) \right],$$

$$(2) \quad B_T(t) = \frac{2}{T} \sum_{s=0}^{\tau} y_{s+t} \sin \left[ \frac{2\pi}{T} (s+t) \right].$$

As an illustration, let us consider the moving periodogram associated with the period  $T = 43$ , which was discovered from the Schuster periodogram of the Dow-Jones averages over the period from 1897 to 1913. Section 8 of Chapter 7 shows that the average value of the ordinate  $R$  is 9.91. We now ask how great the variation is in  $R$  from one part of the series to the other, that is to say, how permanent the 43-month period has been throughout the range of the series. To answer this question the moving periodogram was computed by means of formula (1), the pertinent values being recorded in the accompanying table:

$t$	$A(t)$	$B(t)$	$R(t)$	$t$	$A(t)$	$B(t)$	$R(t)$
1	-3.06	-13.93	14.26	101	-10.49	-9.41	14.10
2	-2.37	-13.83	14.03	105	-11.24	-8.61	14.16
3	-1.84	-13.66	13.79	109	-12.15	-8.44	14.79
4	-0.90	-13.27	13.61	113	-12.53	-8.69	15.25
5	0.09	-12.56	12.56	117	-12.75	-8.83	15.51
9	2.57	-9.38	9.72	121	-12.94	-6.64	14.54
13	2.75	-4.52	5.29	125	-13.31	-5.84	14.53
17	0.84	-1.28	1.53	129	-12.21	-6.17	13.68
21	-0.88	-0.41	0.97	133	-7.78	-5.07	9.29
25	-2.58	-0.55	2.64	137	-6.14	-3.47	7.06
33	-1.71	1.57	2.33	141	-5.90	-2.59	6.44
37	-2.61	3.98	4.76	145	-6.25	-1.59	6.45
41	-5.14	5.88	7.81	149	-7.28	-0.82	7.33
45	-6.70	5.99	8.99	153	-5.16	-0.66	5.20
49	-8.74	4.66	9.90	157	-1.96	1.47	2.45
53	-9.48	3.39	10.07	161	-1.19	3.29	3.50
57	-9.63	3.23	10.16	165	-1.06	3.16	3.34
61	-11.10	4.87	12.12	169	-1.63	3.63	3.98
65	-14.33	5.77	15.44	173	-5.44	4.49	7.06
69	-19.74	4.12	20.16	177	-10.17	2.82	10.55
73	-22.82	0.38	22.83	181	-11.03	1.57	11.14
77	-23.39	-5.00	23.92	185	-11.04	2.77	11.38
81	-20.63	-10.49	23.15	189	-11.26	3.32	11.74
85	-15.19	-13.63	20.41	193	-11.16	3.23	11.61
89	-12.38	-13.61	18.40	197	-14.86	2.48	15.07
93	-10.68	-12.29	16.28	201	-17.08	0.57	17.09
97	-10.14	-10.88	14.88	205	-17.83	-2.33	17.99

The graph of the function  $R = R(t)$ , as constructed from the table, is given in Figure 156, from which some interesting observations can be made by an inspection of the graph. Thus we note in the sector which includes items from 21 to 63 that the 43-month cycle has essentially disappeared, since the amplitude has fallen to 0.97. On the other hand the cycle has become dominant for items from 77 to 119, where the amplitude reaches a value of 23.92. The standard deviation of the amplitude diagram is 6.004, which gives a measure of the variation that is inherent in this particular harmonic term.

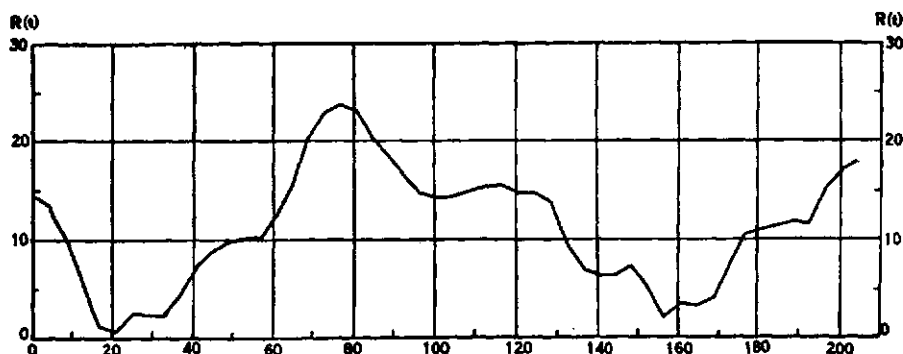

FIGURE 156.—MOVING PERIODOGRAM OF DOW-JONES AVERAGES, 1897-1914.  
Period  $t = 43$ , with  $t$  measured in months from beginning of 1897.

It is obvious that the use of a moving periodogram instead of a Schuster periodogram for the analysis of an economic time series would permit one to make a material reduction in the variance of the erratic element. As an example, we shall apply this technique to the data for the Dow-Jones averages previously analyzed in Section 6 of Chapter 6. The reduction of the series to its random element is accomplished by removing the three observed harmonics by means of the elements of the moving periodogram.

The results of this analysis are shown in (b) of Figure 157, and may be compared profitably with the reduction exhibited graphically in Figure 44 of Chapter 6.

The method of the moving periodogram closely resembles, and in fact was suggested to the author, by a technique invented by Ragnar Frisch.<sup>6</sup> The principle involved is stated in a paper published in 1928, but the details of its application have not yet appeared in print.

The theory may be described briefly as follows:

Let  $L$  be a linear operator of the closed-cycle type.<sup>7</sup> Such an operator has the general properties that

$$(3) \quad L(\phi_1 + \phi_2) = L(\phi_1) + L(\phi_2),$$

$$(4) \quad L(c\phi) = cL(\phi),$$

where  $c$  is a constant, and the particular property that

$$L(e^{at}) = Ke^{at}$$

where  $K$  is a constant.

If  $L$  is expanded, as all such operators can be, into the series

<sup>6</sup> "Changing Harmonics and Other General Types of Components in Empirical Series," *Skandinavisk Aktuarietidskrift*, 1928, pp. 220-236.

<sup>7</sup> See H. T. Davis, *The Theory of Linear Operators*, Bloomington, Indiana, 1936.

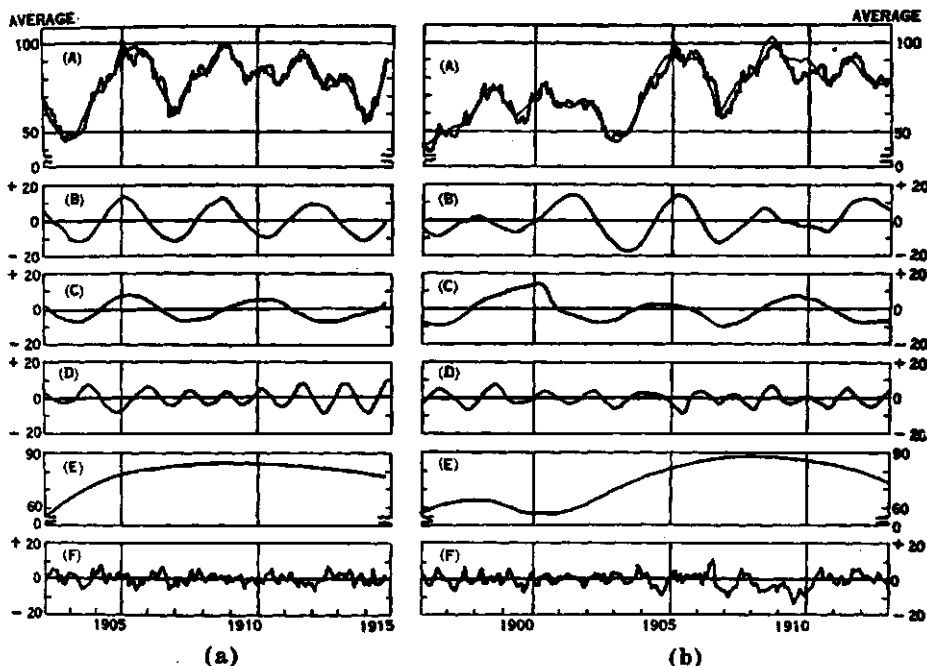

FIGURE 157.—REDUCTION OF TIME SERIES TO RANDOM ELEMENTS.

This chart shows how periodic components and trends are removed from an economic time series by the techniques based on the assumption of changing harmonics: (a) Method of Frisch; (b) Method of the moving periodogram.

$$L(D) = a_0 + a_1 D + a_2 D^2 + a_3 D^3 + \dots, \quad D^n = d^n/dt^n,$$

then  $K = L(a)$ .

It may be readily shown that

$$L[A \sin(kt + a)] = A \sqrt{L_1^2 + L_2^2} \sin(kt + a + b)$$

where we abbreviate

$$b = \arccos(L_1 / \sqrt{L_1^2 + L_2^2})$$

and where  $L_1$  and  $L_2$  are defined by the equation

$$L(kt) = L_1(k) + iL_2(k).$$

Hence we conclude that when the operator  $L$  operates upon a sine function, the effect is to multiply the amplitude by  $\sqrt{L_1^2 + L_2^2}$  and to change the phase angle by the quantity designated by  $b$ .

By making proper choices of the operator, Frisch was able to separate from the data the effects of a changing harmonic much in the same way as that accomplished by the moving periodogram.

The deflation obtained by him for the Dow-Jones industrial stock price series is shown in (a) of Figure 157.

We now observe that the erratic element as found by these methods has been considerably reduced when compared with the erratic element obtained in Section 6 of Chapter 6. The respective variances are 39 and 16. But unfortunately these techniques introduce into the analysis an unknown number of degrees of freedom. Although we can measure accurately by the methods of Chapter 5 the actual reduction in the *random* degrees of freedom, we cannot then say that we know anything at all about the most important question: What are the *significant* degrees of freedom?

But, in spite of this difficulty, there still exists some possibility of using the information obtained from a moving periodogram to improve a forecast. At the end of the known data we know the magnitude of the energy that is at that moment found in the cycle under observation. This estimate is probably a safer one to use in extrapolating into the unknown future than the estimate obtained from the average of the Schuster periodogram. Some preliminary investigations along this line appear to confirm this opinion.

### 9. The Method of Probable-Error Bands

It is clear that the technique of the moving periodogram is capable of a generalization which might be useful in forecasting the future of economic time series.

Thus, if the function

$$(1) \quad y = f(t; a_0, b_0, \dots, m_0)$$

is the trend established for a given interval of time, then a subsequent value of the trend will be

$$(2) \quad y + \Delta y = f_0 + \left(\frac{\partial f}{\partial t}\right)_0 \Delta t + \left(\frac{\partial f}{\partial a}\right)_0 \Delta a + \dots + \left(\frac{\partial f}{\partial m}\right)_0 \Delta m.$$

Since  $\Delta a$ ,  $\Delta b$ ,  $\dots$ ,  $\Delta m$  are unknown, we may assume that the best extrapolation into the future period of time,  $\Delta t$ , which can be furnished by the known data is given by the first two terms of the right-hand member of (2). But when the actual value of  $y + \Delta y$  is finally known, as the future flows into the present, then the unknown errors in  $a$ ,  $b$ ,  $\dots$ ,  $m$  can be determined. Hence we can continuously construct a *moving trend* which may be used for forecasting purposes.

Obvious refinements suggest themselves. For example, if the trend (1) is the straight line

$$(3) \quad y = a + bt,$$



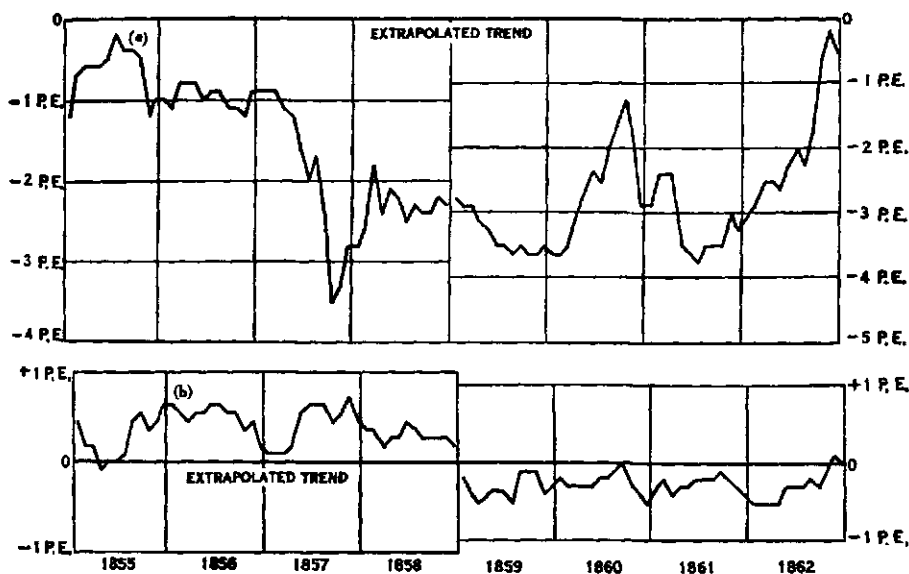

FIGURE 158.—EXTRAPOLATION OF TRENDS.

(a) shows the extrapolated trend of rail stock prices and the probable-error bands; (b) shows the same for the constructed random series. The discontinuity in both parts could be eliminated if continuous trends, instead of trends at intervals of four years, were used.

where  $t$  has the range  $(-p, p)$ , then  $a$  and  $b$  are computed from the formulas

$$(4) \quad a = \frac{M_0}{2p + 1}, \quad b = \frac{3M_1}{p(p + 1)(2p + 1)}.$$

The moving trend is obtained by correcting continuously the values of the two moments. This correction can be made in several ways. For example, it may be assumed logically that the present exerts a greater influence than the past upon the future of the trend and the moments may be constructed by assigning to the observations a series of weights which diminish as one introduces the items of the past. Or an operator might be applied to the data, such, for example, as a moving average, to diminish the influence of regular cyclical variations.

In order to make a crude test of the possible efficacy of such a scheme of moving trends, the Cowles Commission performed the following experiment. The 21 linear trends described in Section 3 were employed as forecasters for the movement of the price of rail-

road stocks, the unit of extrapolation being four years. These extrapolated trends were then united and four bands constructed about them (see Figure 158), the distances above or below the trend being respectively 1, 2, 3, and 4 times the probable error of the durations of the series, namely  $0.6745\sigma$ , where  $\sigma$  is the standard error of the deviation from trend over the base period.

Three methods of analysis were then used as follows: *Method I*. Using the designated band, stocks were sold when the average crossed the lower band going down. *Method II*. Using the designated band, stocks were sold whenever the average crossed either the upper or lower band going down, and stocks were bought whenever the average crossed either band going up. *Method III*. Using the designated band, stocks were sold whenever the averages crossed the upper band going down, and stocks were bought when the average crossed either the upper or lower band going up.

In all cases the results were compared with a long position throughout the entire forecasted period, namely, from January, 1851 to December, 1930. Corrections were also made for dividend income, the first assumption being that an annual yield of 5 per cent would be obtained during a long position. It was also assumed that a return of 5 per cent would be obtained during the period when the forecast was out of the market by putting the capital out on call, since call-loan rates for the period 1866-1930 inclusive averaged 5.35 per cent. No correction was considered necessary for brokerage charges, since changes in position were relatively few, and at the most such a correction would amount to something less than  $1/10$  of 1 per cent annually.

It will be observed also, from the practical point of view, that an investor operating under Method II would be protected against both inflation and the danger of stock prices assuming a permanently lower level. Method I, on the other hand, affords no protection against either of these contingencies, while Method III protects against inflation, but not against the second possibility.

The results of this study are summarized in the table at the top of page 537.

It is clear from this study that the optimum band is 3 probable errors from the trend and that consistent gains are obtained by all three methods.

Although the results obtained above are encouraging as suggesting the actual possibility of forecasting by the methods which have been set forth, another question must be answered before one can have real assurance as to the correctness of one's views. What would be the result of this analysis if it were applied to a random series?

SUMMARY OF RESULTS OBTAINED BY OPERATING ON RAILROAD STOCK PRICES  
BY THE METHOD OF PROBABLE ERROR BANDS

Method	Deviation of Band from Trend in Probable Errors	Total Percentage Gain	Annual Gain in Per Cent	Adjustment for Dividend of 5%	Per Cent Better or Worse than Rail Averages Held Outright
I	1	140.0	1.10	6.10	0.44
	2	394.0	2.02	7.02	1.36
	3	478.0	2.42	7.42	1.76
	4	59.7	0.59	5.59	-0.07
II	1	- 5.1	-0.07	4.93	-0.73
	2	87.0	0.79	5.79	0.13
	3	339.0	1.87	6.87	1.21
	4	16.1	0.19	5.19	-0.47
III	1	33.8	0.37	5.37	-0.29
	2	346.0	1.89	6.89	1.23
	3	489.0	2.24	7.24	1.58
	4	17.2	0.20	5.20	-0.46

In order to answer this question the method was applied to a random series constructed as follows: A straight line was fitted to the entire 100-year railroad stock price series and the percentage deviation of each item from this trend was computed. The link relatives of this series of percentage deviations were then computed and the items redistributed by random selection. The desired random series was obtained finally by setting the initial element equal to 100 and multiplying successively by the random link relatives.

The same method of forecasting used on the railroad stock prices was then applied to the random series. The results of this analysis summarized in the following table, speak for themselves.

SUMMARY OF RESULTS OBTAINED BY OPERATING ON A RANDOM SERIES  
BY THE METHOD OF PROBABLE-ERROR BANDS

Method	Deviation of Band from Trend in Probable Errors	Total Percentage Gain	Annual Gain in Per Cent	Adjustment for Dividend of 5%	Per Cent Better or Worse than Averages Held Outright
I	1	39.7	0.42	5.42	-0.57
	2	81.1	0.75	5.75	-0.24
	3	121.5	1.00	6.00	0.01
	4	7.1	0.09	5.09	-0.90
II	1	-89.7	-2.80	2.20	-3.79
	2	68.1	0.65	5.65	-0.34
	3	276.5	1.67	6.67	0.68
	4	70.1	0.67	5.67	-0.32
III	1	34.5	0.37	5.37	-0.62
	2	146.8	1.14	6.14	0.15
	3	351.9	1.90	6.90	0.91
	4	56.8	0.57	5.57	-0.42

### 10. *The Dow Theory of Forecasting*

An empirical method of forecasting the movements of the stock market has been formulated under the title of the "Dow theory." This theory had its origin in a set of editorials written by Charles H. Dow, one of the owners of the *Wall Street Journal*, which he edited until his death in 1902. The methods of Dow were first formulated by S. A. Nelson, who published *The ABC of Stock Speculation* in 1902. These methods were further interpreted by William Peter Hamilton, who wrote from 1903 until his death in 1929 a series of editorials in the *Wall Street Journal*, which contained many shrewd observations about the action of the stock market. In 1922 Hamilton collected his ideas into a book called *The Stock Market Barometer*. Since Hamilton's editorials contained many accurate interpretations of the movements of the stock-market averages, they attracted a considerable following among speculators. After the death of Hamilton, his mantle fell upon the shoulders of the late Robert Rhea of Colorado Springs, who set forth an extensive account of the methods of his predecessors in a book entitled *The Dow Theory*, Barron's, 1932.

There are critics of the method of Dow and Hamilton, who say that there is no such thing as a Dow theory, since the methods employed in forecasting are nothing more than a set of rules, mainly subjective in application, which permits a speculator to "swim with the tide" if there is a tide. When the tide is flowing the speculators assume a long position, and when the tide ebbs, the speculators are short. The rules are designed to detect two of these tides, one called *the primary trend*, and the other *the secondary trend*, or the reaction from the primary trend.

Fundamentally the first postulate of the Dow theory appears to be sound, namely, that if the stock market can be forecasted, then the averages must forecast their own future. It would appear from the analysis of other parts of this volume, that no time series yet discovered precedes the stock-market averages. Thus, while industrial production appears to depend upon the movement of the stock market behind which it lags about three months, the converse does not appear to be true. Hence, with present data, it would seem that any theory of forecasting market action would necessarily be an internal theory.

The second postulate of the Dow theory appears to be that, when a movement of the market has been for a given time in one direction, the probability is greater than one-half that the next move will also be in this direction. That is to say, there is a kind of inertia which tends to make the averages move for a time in one direction or another.

The second postulate is a very important one and must be carefully understood and statistically defined. For this purpose one might compare with the time series of the stock averages a second series constructed by the accumulation of random tosses of a coin. Thus, if a head appears, one unit is added to the series, and if a tail appears, one unit is subtracted from the series. A series constructed in this manner bears considerable resemblance to some economic time series. But it is obvious from its construction, that the probability of a move up after one advance is exactly  $\frac{1}{2}$  and that the probability of a sequence of  $n$  moves up is  $(\frac{1}{2})^n$ . Moreover, if a sequence of  $n$  moves in one direction has been observed, this observation in no way affects the probability that the next move will be with or against the trend.

The question pertinent to this is whether or not the movements of an economic time series such as that of the market averages are similarly subject to the laws of random chance. In order to test this matter statistically a series of 1200 items was constructed by random chance for comparison with the 1200 items which comprise the time series of rail stock prices by months over the century from 1830 to 1930. Four students working independently of one another tossed successively 300 pennies and recorded in a time sequence whether the pennies fell heads or tails. An accumulated time series was then formed in the following manner. If a head appeared, then a unit mark upward was made; if the next toss was also a head, then another unit mark upward was made; if this was followed by a tail, then a unit mark downward was made; and so on. By thus accumulating the random tosses, four time series were constructed and these four series were put together to form a composite series of 1200 items which would correspond to the 1200 items of the series of railroad stock prices.

The question involved here is whether or not the two series showed any significant differences. In the first place we know that in matching pennies one can lose or gain any predetermined finite number provided he plays the game long enough. Hence one would expect to find larger and larger swings in the series as he proceeds from the origin. In other words, the series would tend to have a standard deviation increasing with length.

If we designate by  $H(t)$  the number of heads after  $t$  tosses, and if  $T(t)$  represents the corresponding tails, then the elements of the time series are computed from the statistically determined function

$$y = H(t) - T(t) .$$

The variance of this function, measured from the origin to  $t$ , may

be shown to equal  $\sigma^2 = t$ ; hence the probable error of the function is given by

$$\text{p.e. of } y = 0.6745\sqrt{t}.$$

If a band equal in width to twice this value is then constructed about the zero line with  $t$  as the abscissa over the range of 1200 items, this parabola will define the region of probable error for the series. That is to say, we should expect to find half the series within this band and half outside the band, a conclusion which is amply justified as one may verify from Figure 159.

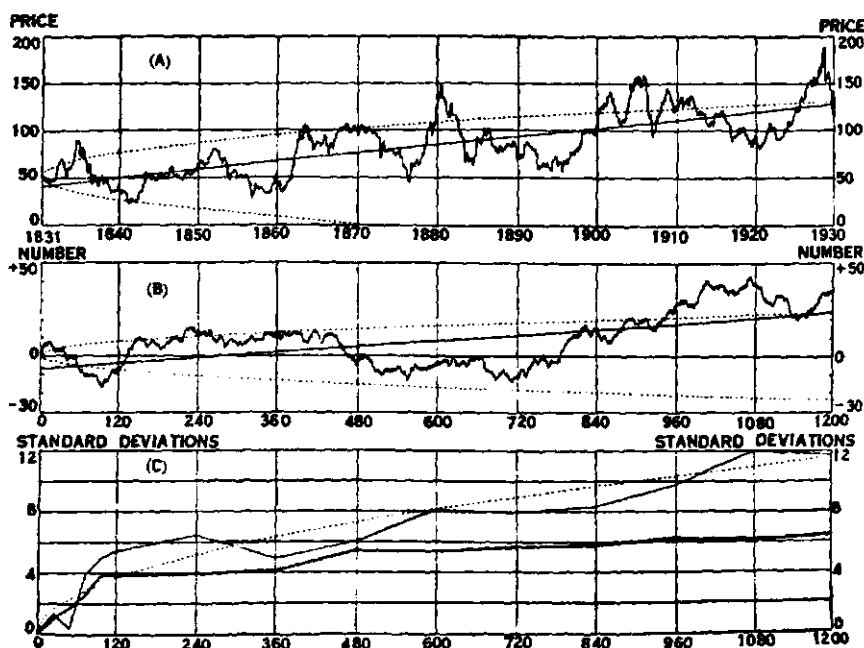

FIGURE 159.—DIFFERENCES BETWEEN RAIL STOCK PRICES AND A RANDOM PENNY-TOSSING SERIES.

This chart is designed to show the essential difference which exists between an accumulated random series and an economic time series. The standard deviation of the random series increases with time, while that of the rail stock prices does not.

(A) shows rail stock prices, monthly, 1831-1930, with linear trend and probable-error band [adjusted to conform with (B)].

(B) shows random penny-tossing series with linear trend and probable-error band (ordinate =  $0.6745\sqrt{n}$ ).

(C) shows standard deviation from trend of rail stock prices (——) and of random penny-tossing series (-----) compared with theoretical standard deviation of a random series ( $\sigma_n = \sqrt{n + 1/3}$ ) (- - - - -).

It can be shown that the same conclusion cannot be drawn with respect to the rail stock series. In the first place, the variance does not increase parabolically with the number of items, but it rapidly reaches an asymptotic value about which it oscillates. In the second place, one observes cyclical variations of much greater amplitude than those found in the accumulated series. From this we may conclude that the sequences and reversals which are noted in the rail stock series are not of the same statistical character as those observed in the synthetic series; that is to say, if a trend has once been established in the rail stock series, the probability is greater than  $\frac{1}{2}$  that it will continue. Such success as the Dow theory has had in forecasting is due, in the writer's opinion, to this significant fact. Those who doubt may try the simple experiment of forecasting the accumulated series by means of the technique of the Dow theory. It is evident a priori that there could be no success in such prediction.

The Dow theory, as we have noted above, attempts to define two principal movements. The first is called the primary movement, either bullish or bearish, which extends over periods that have varied from less than a year to several years in length. It is interesting to note that the Dow theory recognizes an average length of 25 months for bull markets and an average length of 17 months for bear markets. These estimates would confirm the opinion of the critics of the theory, who assert that the success of the Dow theory in forecasting is derived mainly from the fact that the market has a primary cycle of approximately 40 months.

The second principal movement recognized by the Dow theory is called the secondary reaction, which is an important decline in a bull market, or an important advance in a bear market. This movement generally retraces from a third to two-thirds of the primary move since the preceding reaction.

The method of forecasting by the Dow theory is simplicity itself. One observes, let us say, that the industrial averages have turned down. If they penetrate the previous low, established by a secondary reaction in the primary trend, then the signal is given for the beginning of a bear market. *But this signal must be confirmed by a similar reaction of the rail stock series.* If this confirmation fails to be secured, then no change in position is indicated.

Except for this simple technique, there are no conspicuous patterns to be followed in forecasting the primary trends. When a bull market has reached its top, it is not usual to find violent declines; the averages simply stop advancing and jiggle inconsequentially from day to day. The same comment applies to the bottom of bear markets,

which tend to advance slowly with frequent minor recessions. This fact created much suspicion of the bull market which started so abruptly in June of 1938. The sequence of events proved that this was indeed an unusually short bull market, since it terminated in September of 1939.

Rhea describes the end of a bear market as follows:

At the end of the bear period the market seems to be immune to further bad news and pessimism. It also appears to have lost its ability to bounce back after severe declines and has every appearance of having reached a stage of equilibrium where speculative activities are at a low ebb, where offerings do little to depress prices, but where there appears to be no demand sufficient to lift quotations. The market is a dragging affair with but little public participation. Pessimism is rampant, dividends are being passed, some important companies are usually in financial difficulties, and a certain amount of political unrest is generally apparent. Because of all these things, stocks make a 'line.' Then when this 'line' is definitely broken on the upside, the daily fluctuations of the railroad and industrial averages show a definite tendency to work to slightly higher ground on each rally, with the ensuing declines failing to go through the last immediate low. It is then, and not before, that a speculative position on the long side is clearly indicated. This period is one requiring patience, but when a sizable reaction has occurred after a considerable advance, with the reaction failing to break through the bear market lows and the next series of rallies going through the high point of the last major reaction of the preceding bear market, then stocks may be purchased with reasonable safety.

It appears that the top of a bull market is more difficult to recognize than the bottom of a bear market. The only signal worthy of note appears to be the increase of volume on a reaction. If the volume increases on the down side, then the market has probably reached the top. When the bear market has been definitely established, then the old saw of Wall Street "do not sell a dull market" does not apply. Obviously the time to sell is "when the market dries up after a sharp rally, but increases on declines."

The actual mechanism by means of which one "swims with the tide" is easily explained by means of Figure 160, which gives the Dow-Jones industrial averages from April 24 to the end of August, 1938, the corresponding averages for railroad stocks, and the volume of trading in millions of shares (Saturday volume doubled).

Beginning with the point *B*, we await developments. If the averages penetrate *A*, that is to say, if they exceed the level of the averages established at the previous high point *A*, and if the rails confirm this penetration by themselves penetrating *a*, then the forecast is bullish. The first rally after *B*, namely *C*, fails to penetrate *A*, so there is no forecast. But beginning with June 19 there is a substantial rally on large volume, which on June 20 penetrates *A* for the industrials. This



penetration is confirmed on June 22 by the rails. Hence a bull market is affirmed. The first top is reached by July 25, namely *E*, and a reaction establishes a minor low at *F*. However, the volume *dries up*, that is to say, diminishes on the reaction. We now await the next signal, which is given at *G*, when the industrials break through *E*. This rise, however, is not confirmed by the rails, and a reaction follows which carries the averages through *H* for the industrials and through *h* for the rails. This would be a decided bearish signal were it not for the fact that the volume has continuously diminished with the declines. Hence we again swim with the tide.

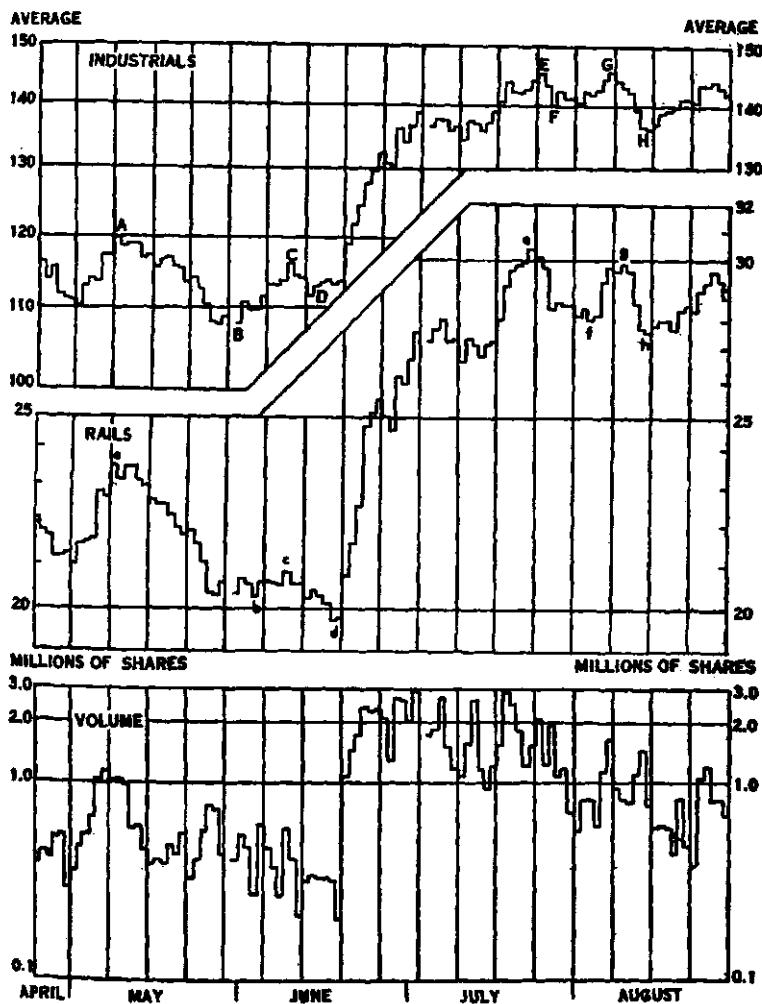

FIGURE 160.—DAILY CHANGES IN PRICES AND VOLUME OF COMMON STOCKS TRADED.

One important question that is involved here concerns the major trend. A survey of the averages over the period beginning with January, 1937 shows that a primary bearish trend was established in September of that year and the decline apparently ended in March of 1938 after a drop of about 90 points in the industrial averages. Since bearish markets have an average length of 17 months, this decline appears to have been completed in an unusually short period of time. Hence a proper inquiry may be made as to whether the bullish market which we have just examined is merely a major reversal in an uncompleted primary bear market, or whether it is a new primary bull market. One suspicious aspect of the upturn was the suddenness with which the movement started, a sign that is regarded with distrust by the Dow theory. Subsequent events have proved that, like the bullish reversal in 1930, which retraced a substantial part of the loss sustained in the crash of 1929, the bull market of 1938 was also merely a secondary reaction in a primary bear market.

### *11. General Conclusions*

In the preceding sections of this chapter we have described various devices for investigating the future of economic time series. The most conspicuous result has been to show the magnitude of the standard errors of forecast and the consequent limitations upon present methods.

But the possibility of narrowing the limits of the existing errors does not seem to be excluded by our analysis. New knowledge is urgently needed and a deeper insight must be gained as to the interrelationships between the primary variables that together comprise the business cycle.

In attempting to analyze the future of any economic time series, our major concern is to establish for the series some a priori relationships with other measurable quantities. Unfortunately the complexity of the economic problem precludes this possibility except in a few conspicuous cases, where considerable advance has already been made. When such relationships have been carefully defined and reduced to mathematical terms, then obviously the errors of forecasting are comparable with those in physics and other exact disciplines of knowledge.

But when an a priori theory is lacking, the data must then be scrutinized for possible partial relationships characterized by correlations. In this investigation, the danger of observing spurious connections between variables is always present, and this danger increases

rapidly with the number of variables examined. Tragic examples can be cited, which the wary will heed.

If neither an a priori theory nor correlations exist, the possibility still exists that the series may contain an inner structure which permits a limited extrapolation. Here the recognition of trends and harmonic movements is of primary importance. The danger consists in not recognizing the amount of significance which can be attached to these internal forms.

## CHAPTER 12

### INTERPRETATION AND CRITIQUE

#### 1. *Introduction*

The analysis which we have attempted to give in the preceding pages of this volume would not be complete unless we arrived at some interpretation of the methods and the results. This chapter will be devoted to a critical summary of certain aspects of the subject of time series and to the bearing of these upon the general economic problem.

In particular, it will be instructive to survey the evidence for the existence of cyclical variation in general economic time series, and to indicate what meaning this might have for the interpretation of the future.

The relationship between the events of different economies is also a problem of profound importance and some indication of this, as we observe it from modern data, should throw some light upon the general economic balance of the world. It is a matter of common observation that great crises like that of 1929-1932 afflict all modern commercial countries. Hence, the question of how the disaster enters one country from another is worth careful investigation. Does it travel along the path of gold, through the medium of international exchange, as some have argued, or is there a more profound connection between the economies than this?

These and other questions, such as the structure of the war cycle, and the economic interpretation of political history, will be discussed in this chapter. Let it be added, however, that the conclusions reached are not categorical, but merely the results of an excursion into the philosophy of time series. In all of this one must not be unmindful of the White Queen's reply to Alice: "Why sometimes I've believed as many as six impossible things before breakfast."

#### 2. *Probability Evidence for the Forty-Month Cycle*

There is a persistent belief among students of the theory of business cycles that, aside from seasonal fluctuations the a priori causes for which are known and the reality of which is thus established, the next cycle for which evidence exists is the cycle of 40 months. This movement is often referred to as the cycle of three and a half years,

but the lack of any sharp definition of the period makes any average around 40 months equally acceptable. The most curious aspect of this cycle is found in the fact that no a priori cause has yet been generally accepted for it. Weather data, with their inevitable impingement upon the data of agricultural production, have been carefully scrutinized, but the evidence that a 40-month cycle can be accounted for on this basis is tenuous at best.

It will be important first to examine carefully the evidence that has been presented to establish the reality of the 40-month cycle. Thus we find the following statement by Wesley C. Mitchell in his treatise on *Business Cycles: The Problem and Its Setting* (p. 343):

The conclusion is clear that within the period and country represented by our indexes, business cycles, while varying in length from a year and a half to nearly seven years, have a modal length in the neighborhood of three to three and one half years. They are far from uniform in duration, but their durations are distributed about a well marked central tendency in a tolerably regular fashion. This distribution differs from the type described by the "normal curve" in being prolonged toward the upper end of the time scale somewhat farther than toward the lower end.

The evidence upon which Mitchell bases his conclusion is contained in *Business Annals* by W. L. Thorp and W. C. Mitchell, published by the National Bureau of Economic Research in 1926. The pertinent passage is the following: (p. 43)

Counting business cycles now as the intervals between recessions, noting the quarters in which turns came, and reckoning to the nearest whole year, we get the following results:

	1 cycle about 1 year long	(1845-46)
	4 cycles " 2 years "	
10	" " 3 " "	
5	" " 4 " "	
6	" " 5 " "	
4	" " 6 " "	
1	" " 7 " "	(1815-1822)
0	" " 8 " "	
1	" " 9 " "	(1873-1882)

In all we have 32 cycles in 127 years, which yields an average length of not quite 4 years. The commonest length is about three years; and two-thirds of the cases fall within the limits of three to five years. There is no indication that the average duration of business cycles is changing. There were 16 cycles in the first 64 years covered by the table (1796-1860) and 16 cycles in the following 63 years (1860-1923). Of 3-year cycles, there were five in the first period and five in the second.

The 40-month cycle appears to be a characteristic feature of American business rather than a general phenomenon, since the aver-

age European cycle is slightly in excess of five years. The following frequency distribution is a composite of the observation of the duration of 166 business cycles in 17 countries as given in *Business Annals*:<sup>1</sup>

Duration in Years of cycles	Frequencies	Percentage	Duration in Years of cycles	Frequencies	Percentage
1	3	1.8	7	17	10.2
2	17	10.2	8	12	7.2
3	30	18.1	9	7	4.2
4	25	15.1	10	6	3.6
5	23	13.9	11	3	1.8
6	22	13.3	12	1	0.6
			Totals	166	100.0

Average = 5.2;  $\sigma = 2.4$ ; variability = 47%.

These data are graphically represented in Figure 161.

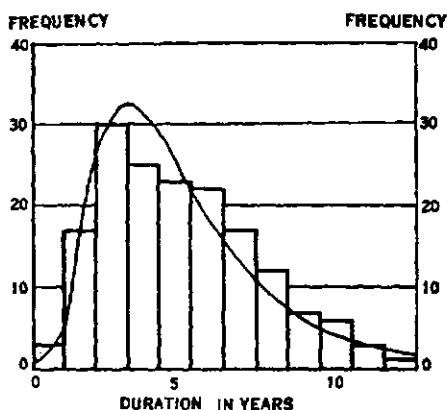

FIGURE 161.—LENGTH OF BUSINESS CYCLES IN THE UNITED STATES. Histogram and Frequency Curve from *Business Annals*, p. 70.

If we turn to the periodograms of Chapter 7 for further evidence as to the existence of the 40-month cycle, we find the following facts:

The Cowles Commission All Stocks index over the interval (1880–1896) shows a distinct period of 35 months (practically 3 years), which contained 14.5 per cent of the energy of the series. Even when

<sup>1</sup> These countries, together with the period covered and the number of cycles, are the following:

United States (1796–1923) 32; England (1793–1920) 22; France (1838–1920) 15; Germany (1848–1925) 15; Austria (1866–1922) 10; Russia (1891–1925) 7; Sweden (1892–1920) 5; Italy (1888–1920) 5; Argentina (1890–1920) 6; Australia (1890–1924) 6; Brazil (1889–1924) 7; Canada (1888–1924) 7; Netherlands (1891–1920) 5; China (1888–1920) 5; South Africa (1890–1920) 6; India (1889–1920) 6; Japan (1890–1920) 7.

this period is considered in connection with the evidently large continuous spectrum of the series, it still retains its identity.

Continuing to the next time interval (1897-1913), we again find a dominating period in the Dow-Jones industrial averages of length equal to 41 months ( $3\frac{1}{2}$  years). This period contained about 48 per cent of the total energy of the series, an exceptionally high value for an economic time series. Even when the continuous energy level of the spectrum of the periodogram is analyzed, this period again retains its identity.

In the third time interval (1914-1924), a period is found at 38 months (3.17 years). This period accounts for 74 per cent of the total energy and is thus one of the most remarkable patterns ever observed in economic data. Even the well-established period of 11.25 years in sunspot data contained only 85 per cent of the energy in the most favorable time interval in which it has been observed.

In the time interval of the great bull market the 40-month cycle was completely effaced by the violence of that era. But we have attempted to show earlier in this book that the bull market itself may be accounted for dynamically as a resonance phenomenon due to the interaction of the natural period of the system with the impressed period, which is the 40-month cycle itself.

Let us turn next to the series of pig-iron production, which we have already noted is highly correlated with the items of the series of industrial stock prices. Here again we find strong evidence for the existence of the 40-month cycle. In the time interval 1897-1913 we observe a period of 43 months with an energy content of 22 per cent, even in the presence of a considerable energy due to trend. When corrections are made for the trend, the actual energy that may be ascribed to this component is 13 per cent with a high probability of significance. Since we have demonstrated elsewhere in the book that pig-iron production lags about 3 months behind industrial stock prices and is highly correlated with them, it is not surprising to find this evidence for the existence of the 40-month cycle.

Again, if we consider Wilson's periodogram of business activity we find further evidence for the 40-month component in the two adjoining time intervals (1790-1859) and (1860-1929). In the first of these there is a component of 35 months with an energy of 13 per cent and in the second a component of 40 months with an energy of 11 per cent, an observation that is entirely in accord with the results which we have found for pig-iron production. It is interesting to observe that Wilson's periodogram shows slight evidence of the 40-month component in the interval 1860-1894 and in the total range (1790-1929).

The length of the cycle has quite evidently tended to shift from around 35 months to something over 40 months. During time intervals when this shifting was most pronounced, the interference between the shorter and the longer periodic movements could easily efface the evidence for an energy content in either period. One may observe, for example, what happened to the energy in the sunspot cycle over the time interval 1750-1826, when there was interference between a cycle of 9.25 years and a cycle of 13.75 years. The total energy revealed by the periodogram was as low as 46 per cent. It is quite probable that a moving periodogram would exhibit this shifting length of the period and would restore the evidence for a significant energy in the average component.

F. D. Newbury, economist for the Westinghouse Company, has found strong evidence for the regularity of the 40-month cycle over long periods of time in series which pertain to the fluctuations of the heavy-goods industry. He concludes that this particular component has survived the disturbances of the great inflation of 1929 and the subsequent depression and has emerged into the quieter period of recent months without even an essential change in phase.<sup>2</sup>

In another direction, we may also observe that W. L. Crum has exhibited evidence for the 40-month cycle in commercial-paper rates, and the author has computed the energies to be 13 per cent for the time interval 1874-1913, 14 per cent for 1874-1893, and 19 per cent for 1894-1913.

From this it may be seen that the evidence is very strong that business activity has a cyclical component of about  $3\frac{1}{2}$  years, which at times contributes a large part of the energy in the series, and probably at all times contributes as much as 12 per cent. This cycle is undoubtedly associated with the activities of the durable-goods industry.

### *3. Probability Evidence for the Ten- and Twenty-Year Cycles*

There is a persistent belief that major economic movements have a cycle of approximately ten years. It is this belief, perhaps, which has led to some credence for the theory that the 11.25-year cycle of sunspots exerts some influence upon economic time series. Thus we find W. S. Jevons stating that "there is more or less evidence that trade reached a maximum of activity in or about the years 1701, 1711, 1732, 1742, 1753, 1763, 1772, 1784, 1793, 1805, 1815, 1825, 1837, 1847,

<sup>2</sup> These conclusions are derived from unpublished reports of the Westinghouse statistical laboratory. See also F. D. Newbury, "The Structure and Nature of Business Cycles," in Cowles Commission, *Report of the Fourth Annual Research Conference . . . 1938*, pp. 64-65.



1857, 1866. These years, whether marked by the bursting of a commercial panic or not, are, as nearly as I can judge, corresponding years and the intervals vary from nine to twelve years."

In order to get a better measure of this assumed phenomenon in American data, let us turn to the evidence as it is furnished us from the periodograms of Chapter 7.

Wilson's periodogram of business activity in the United States shows that for the time interval 1790-1859 there was a distinct period of 120 months, which accounted for 8.24 per cent of the energy of the series. In the time interval 1825-1894 there was a period of 106 months with an energy of 16.07 per cent, and in the time interval 1860-1929, there was a period of 108 months with an energy of 18.73 per cent. For the total range 1790-1929 the average was 110 months with an energy of 8.70 per cent. From this, and from the comparatively large Walker probabilities associated with these energies,<sup>3</sup> it seems fairly clear that there exists a permanent cyclical pattern in business indexes of around 10 years. The energy, however, is not large, but averages something between 10 and 20 per cent.

Supporting evidence for this conclusion is furnished also by Greenstein's periodogram of business failures in the United States over the time interval 1867-1932. This analysis shows the existence of a period of 9.14 years with an energy content of 22 per cent.

Also in the periodogram of rail stock prices over the century 1831-1930, we find a concentration of energy of 11 per cent in a harmonic component with a period of 9 years. The Walker probability that this component is significant is 0.26.

If we turn next to a consideration of the probability of the existence of a period around 20 years in length in American business series, we are led inevitably to the influence of the building cycle. We have commented earlier upon the magnitude and the permanence of this pattern in industrial time series. The length of this cycle is approximately 18 years and major business depressions appear to follow the crests of the building booms. Thus the tops of building cycles are found in the years 1836, 1854, 1871, 1890, 1907, and 1926, while industrials slumps of considerable magnitude began to develop in the years 1839, 1857, 1873, 1893, 1909, and 1930. The lag is observed to be approximately 3 years.

The effect of this cycle is readily observed in the Wilson periodogram, where for the time interval 1825-1894 there is obtained a concentration of energy equal to 14 per cent for the period of 216 months. In the author's periodogram of industrial production over the century

<sup>3</sup> For an energy as low as 5 per cent, the Walker probability is 0.01.

1831-1930 a period of 17 years is observed with an energy of 12.5 per cent. The Walker probability is 0.09.

Again in the periodogram of rail stock prices over the time interval 1831-1930, we find a concentration of energy of 31 per cent at 20 years with a Walker probability in excess of 0.03.

Hence, we seem to reach the conclusion that periods of around 10 and 20 years (perhaps 9 and 18 years) are observed in American industrial series and that the energies contained in them are of the order of from 10 to 20 per cent. It is not unlikely that there is a relationship between these two periods since one is exactly half of the other. No clear a priori reason appears to exist to account for the cycle of from 9 to 10 years in industrial activity, but the longer component is certainly identified with the building cycle.

Although there is no complete agreement as to the reason for the existence of the long cycle in building activity, it is probably related to the life of buildings themselves. Buildings may be roughly assumed to depreciate at the rate of 2 per cent per annum, and hence in 18 or 20 years they will have lost from 36 per cent to 40 per cent of their value. Perhaps this average percentage forms a sort of critical value for the depreciation curve, and at this point the needs of reconstruction and renovation are added to the normal demand for new building. Hence an increased activity ensues and the cycle begins its ascendant phase. Although this is a plausible explanation of the building cycle, we must await further developments in the theory of economics before we can show more certainly what influences are at work to create cycles of this great length.

#### *4. The Fifty-Year War Cycle*

Unfortunately the limitations of data prevent us from giving high mathematical probability to one of the most prominent cycles observed in economic data, namely, the fifty-year war cycle.

War is the great inflator and in periods of extensive conflict, commodity prices exhibit abnormal values. A survey of Figure 2 in Chapter 1, will indicate the characteristic features of these inflations.

Important wars often appear to start near the top of a long period of advancing trade. Thus, in the economy of the United States, the three major wars started after the series of price and trade had developed a long positive slope. Minor conflicts, it is true, have occurred in other phases of the trade cycle, but these conflicts exerted essentially little influence upon general economic trends. As a matter of fact, it

seems statistically justifiable to define the importance of wars by their impact upon economic time series.

When war is declared, prices immediately rise under the stimulus of an increased money supply occasioned by the needs of the moment. This may be more precisely formulated through a consideration of the equation of exchange (see Chapter 10)

$$MV = PT,$$

where  $M$  is money (mainly bank credits),  $V$  is the velocity of those credits (roughly measured by the ratio of total bank debits to circulating deposits),  $P$  is the price index, and  $T$  is the total volume of trade. At the beginning of a war period there is an immediate increase in  $M$ . Since trade and velocity grow at a much slower rate, it is inevitable that prices should increase almost as rapidly as do the new money credits.

The intensity of a war may be measured by this increase in prices. Some wars, such as the Japanese invasion of China, may have little appreciable effect upon the price structure of the United States, although they will greatly affect prices in both of the belligerent countries. Thus the wholesale price index in China rose from a monthly average in 1936 of 103.5 to 623 by January, 1941, and that of Japan from 89.9 to 143 over the same period, while prices in the United States showed almost no change. Such a conflict is thus a local war. The World War, on the other hand, caused a profound change in the prices of all countries, and thus, in so far as their economies were concerned, was as much a war to neutral nations as it was to actual belligerents.

Since, among the variables of the equation of exchange, the most immediate and characteristic aspect of war is found in changing prices, it would seem that a fair estimate of the intensity of the war might be found in the action of this variable. Hence we may introduce as the coefficient of war intensity at time  $t$  after the beginning of hostilities, the ratio

$$W(t) = \frac{P(t) - P_0}{P_0},$$

where  $P_0$  is the secular average of prices in the period prior to the declaration of war. Since economies are fairly stable and in the ascendant phase of the trade cycle before major conflicts are declared, prices are also stable so that  $W(t)$  is zero for  $t = 0$ .

During the American Civil War, the wholesale price index rose from approximately 62 at the beginning to 132 at the end of the war.

Hence the intensity of the war was  $(132 - 62)/62 = 1.13$ . Similar data for the period of the World War, in so far as the United States was concerned, was  $(154 - 69)/69 = 1.23$ . We may then reach the reasonable conclusion that the effect upon the economy of the United States was approximately the same for the World War as for the Civil War. The accompanying table gives the value of the war-intensity ratio for various periods of conflict:

Conflict	Period	Country	$P_0$	$P(t)$	$W(t)$
Napoleonic	1797-1810	England	152	227	0.49
War of 1812	1811-1814	U. S.	86	125	0.45
Civil War	1861-1864	U. S.	62	132	1.13
Franco-Prussian	1870-1873	Germany	92	120	0.30
Franco-Prussian	1870-1873	England	96	111	0.16
World War	1914-1920	U. S.	69	154	1.23
World War	1914-1920	England	85	251	1.95
World War	1914-1926	France	100	703	7.03
Sino-Japanese	1936-Jan., 1941	China	103	623	5.05
Sino-Japanese	1936-Jan., 1941	Japan	90	143	0.59

We see from the above table that the World War much more seriously affected the economy of France than it did that of England if we regard the inflationary period that followed the actual cessation of hostilities as part of the conflict. For Germany the war intensity became almost infinite. We may note also that the Napoleonic wars, while more intense than the Franco-Prussian war a half century later, were very much less severe than the World War.

If we examine with more precise scrutiny any one of the war inflation periods, we note that the movement of prices, after the conflict is terminated, follows six main phases.

(a) The first of these phases is a violent and precipitous drop in prices some time after peace has been declared. This lag between the termination of the conflict and the top of the price rise may be several years in length as was the case both in Germany and France after the World War, where violent disruptions took place in the monetary system. In England and the United States the lag was approximately two years. This drop appears to be associated in the United States mainly with farm commodities and farm values and is ruinous to agriculture. The *farm problem*, so frequently referred to by politicians, dates from this period.

(b) The second characteristic of the postwar structure is the *price shelf*, which halts for a time the precipitous decline. During the most recent phase of the cycle in this country this shelf was called the era of the "Coolidge prosperity." The duration of this period of stable prices may vary from two to eight years. It is a time of pros-

perity for business, although the farm problem is frequently mentioned.

(c) The third phase of the price movement is a second deflation, which is nearly as long as the first and about as severe. It is during this decline that business suffers its worst depression. This is generally a period of bank failures, unemployment, business reorganizations, and the like. In the United States this decline, after the War of 1812, the Civil War, and the World War, terminated in 1820, 1878, and 1932 respectively. The three periods showed a great decline in industrial activity. The second period began with the panic of 1873 and the third period terminated with the severe depression of 1932. The first period did not show financial distress to the same degree as the other two, doubtless owing to the fact that American trade was increasing at a lively rate because of the opening of new western lands. We see from the equation of exchange that a fall in prices can be cushioned by a rise in trade and this is apparently what took place in the 1920 era.

(d) The third phase of the war cycle is followed by a price reaction, which for a time is accompanied by a relative prosperity. This reaction never recovers more than part of the loss suffered during the second deflation. This reversal of trend is usually caused by some type of monetary inflation. The period of 1835-1840 was featured by great land speculations and a rapid increase in bank credit. The following table tells the story of this tempestuous period:

Year	No. of Banks	Capital in millions	Circulation in millions	Loans in millions
1829	329	\$110.2	\$ 48.2	\$137.0
1834	506	200.0	94.8	324.1
1836	718	251.9	140.3	457.5
1837	788	290.8	149.2	525.1
1843	691	228.9	58.6	254.5

The period ended with the panic of 1837 and the collapse of the United States Bank, caused in no small part by the hostility of Andrew Jackson to the expanding power of this institution.

In 1933 the inflation in prices began with the inauguration of the New Deal under the leadership of President F. D. Roosevelt. This inflation was created by a large increase in the public debt, which rose sharply from a minimum of 16 billions to well over 40 billions. This increase was accompanied by a sharp drop in commercial-paper rates, which fell from around 5 per cent to less than 1 per cent, and a corresponding decline in the velocity of bank deposits. Many corporations with callable bonds availed themselves of this cheap money to refi-

nance their obligations. This was in sharp contrast to the Jacksonian period where wild land and bank speculations drove the interest rates to over 18 per cent.

(e) The last phase of the deflation is the final collapse of prices, which carries the index to the bottom of the war cycle. This is the period of major financial distress. Business reaches a place of complete stagnation. The credit of the government may be impaired; banks fail; unemployment is acute and misery widespread. The periods around 1843 and 1893 are examples of the economic situation at the bottom of the war cycle.

(f) But deflationary periods are both necessary and salutary, since they are the great debt-annihilators. Dead capital is finally eliminated and institutions arise from the wreck strengthened by reorganization. Hence a period of steady increase in trade necessarily follows the last phase of the price decline. A period of approximately 20 years of moderately advancing prices may be expected to ensue. Trade is good; prosperity returns; business makes profits; unemployment reaches a minimum and wages increase. These are the brightest epochs in the history of the country.

Unfortunately this advance in trade culminates in war. During the two decades of prosperity the nations have built large credit reserves and the competition for markets has become keen. Prosperity must be maintained and this leads to conflicts in national policies. Slackening in trade, such as that which marked the beginning of the fateful year 1914, leads to political unrest. War follows on the slightest pretext.

The characteristics of the war cycle which we have just discussed are based upon the observed behavior of prices within the boundaries of the United States. But the three wars which caused the inflationary movements described above were of essentially different origins. The first arose out of conflicting commercial interests between the United States and England, a conflict which in some respects was an outgrowth of the turbulent conditions in Europe under the regime of Napoleon. The second war resulted from the rivalry between the Northern and Southern States. The question of slavery, apart from its moral aspects, was one of economics. Great wealth was concentrated in the slaves and the South was able to keep step with the economic progress of the North because of this source of cheap commercial power. The resistance of the South to the moral issue of emancipation can be attributed mainly to the great force of the economic argument. The third war resulted from the European struggle which began in 1914. Although the United States was not seriously affected by the actual tides of battle, the economic repercussions

through the vast credits extended to European governments created an inflation which compared in severity with those suffered by governments involved from the beginning of the war.

How permanent and stable is the war pattern which we have described above? The events which have transpired in Europe since the fall of 1939 would seem to bring the matter into serious question. Twenty years after the great inflation of the World War we witness again a savage conflict, developing this time not from a rising trend of trade, but from one where the indexes had scarcely started to recover from the third phase of the war cycle described in (c) above. But can we say that the present conflict will be of the inflationary order of the World War? In the United States, whose indexes are the ones under analysis, the economic repercussions have been relatively mild. Credits were refused to foreign governments because the debts of the last war remained unpaid. And how could they be paid during two decades of declining prices! As a result of this denial of credit, the inflation of prices in the United States from 1939 to 1941 did not exceed the ordinary standard deviation of the index.

Our conclusion must then be this. The will of men to declare wars does not appear to be a matter subject to statistical determination; *but the industrial capacity of nations to wage wars is indicated clearly by the structure of economic time series.* The present conflict does not seem to be a fundamental violation of the proposition that a quarter of a century is necessary for the liquidation of the losses of one conflict, and another quarter of a century is necessary for the building up of economic resources for a sustained struggle.

### 5. *The Interaction of World Crises*

In other sections of this book we have emphasized the essential differences between time series which are themselves price indexes, or which depend upon prices, and time series which measure physical production, or which depend upon such measures. Although there exists in most cases a high correlation between associated prices and production, the two series nevertheless are essentially different.

Price series, for the most part, depend upon a large psychological element. They are intimately related, as we have seen, to the marginal utility of goods; and marginal utility, in the last analysis, is principally a psychological concept. This fact is probably the main reason why governments have never succeeded in controlling prices for any length of time. If prices are pegged at too high a level, then people tighten their belts until overproduction has broken the peg.

Production series, on the other hand, except in so far as they depend upon the price element in the general theory of supply and demand, are dependent upon physical rather than psychological factors. Production, in all of its operations, involves the expenditure of energy units used in connection with physical plants. There is no upper limit to possible prices, as one may observe from the German inflation, but the limits of production are well defined. Agricultural production in a mature country can never exceed a certain maximum value, except under very fortuitous conditions of the weather, or by scientific improvement in methods of fertilization. Industrial production is limited by the size and efficiency of factories, and by the available supply of raw materials.

With these differences before us, we can now turn to the consideration of an intriguing problem. Why are there world crises, which appear to react more or less equally upon all nations? The data to support the original hypothesis that such world crises exist are not entirely satisfactory, but such evidence as we do possess seems to be in agreement with the proposition. Was it accidental, for example, that the unrelated inflations of the South Sea Bubble in England and the Mississippi Bubble in France should have developed concurrently and should have collapsed almost within the same month? And was it a strange coincidence that the collapse of the American securities market in October, 1929 should have been accomplished without appreciable lag in the decline of the prices and the commerce of all the other nations in the world?

In Figures 162 and 163 we have exhibited the annual averages of wholesale prices and of total exports (expressed as index numbers with 1929 = 100) for several leading countries. In the graph of exports the data for Japan are not shown since the trade of this country was greatly affected by its contemplated invasion of China. Incidentally, it should be remarked, the sudden reversal of trend in the commerce of Japan, visible by the end of 1932, should have been warning to the world, four years in advance of the actual conflict, that aggressive plans were being formulated by this nation.

The astonishing thing to be observed in these figures is that wholesale prices and total exports for all the countries follows the same pattern. Could this have been occasioned by the collapse of the American stock market, or is it evidence of something which was the cause, among other things, of the American deflation itself? Why, for example, should the beginning of the American depression have reacted so violently upon German prices and German trade? During the past ten years the American connection with the trade and financial



structure of Germany has been tenuous and inconsequential. Less than 7 per cent of German trade in 1930 was with the United States. And yet both the wholesale price index and the index of total exports show an almost instantaneous reaction to, or should we say with, the events in the United States.

We have seen in preceding sections that, in addition to the short cycle of 40 months, which is not common to all economies, there is strong evidence to support the belief that cycles of 10, 20, and 50 years exist in the data for most, if not all, commercial countries. If to this we now add the fact that great movements of price, such as those which we have witnessed in the last decade, tend to occur simultaneously in all the countries, then we must reach the conclusion that

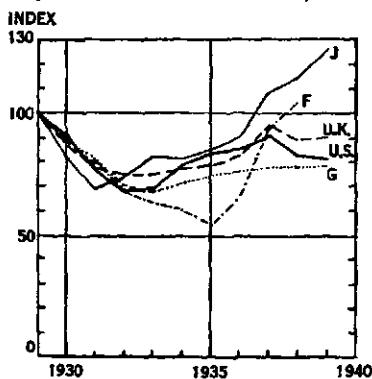

FIGURE 162.—INDEXES OF WHOLESALE PRICES, 1929 = 100.

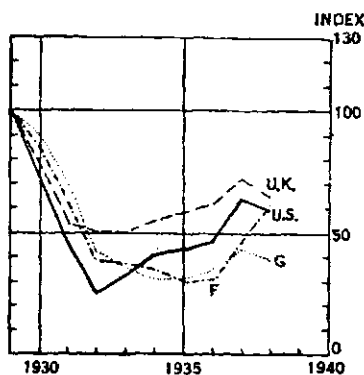

FIGURE 163.—INDEXES OF TOTAL EXPORTS, 1929 = 100.

there exists a central mechanism, which either creates these great crises, or which transmits their effects from one economy to another.

If one admits the existence of such a mechanism, then the next question concerns its nature. Is it an internal mechanism, or is it one external to the economies? If it is internal, or intrinsic, then its function must be one of transmission. A crisis of unusual magnitude, such as the collapse of the American stock market, originates in one country and its repercussions spread rapidly from one economy to another. But such an explanation would certainly lead to the conclusion that an economy far removed from the one in which the crisis occurred, would be affected after an appreciable length of time, and that the effect would be much less than in economies closely related by trade with the originally affected country. That is to say, the results of the economic crisis should roughly obey the laws of propagation which we observe in the spread of epidemics, and in the transmission of such physical effects as one finds in the flow of heat. But the facts

seem to be otherwise. As we have observed before, a world depression rapidly developed after the collapse of the American bull market, and its effect was apparently felt in all commercial countries alike, and without a noticeable lag. This was quite different from the observed behavior of prices after the World War, where the price inflation broke in the United States and England in 1920, in Germany in 1923, and in France in 1926. In any discipline other than that of economics, one would infer that the entire phenomenon, including the American deflation, was the result of some common cause, external to the economies, but strongly affecting them.

But if the mechanism is not an intrinsic one, then a search must be made for one external to the economic system. The puzzle resides in the apparent lack of such an external mechanism. We have already commented in Chapter 1 (see Section 10) about the difficulties of discovering and establishing the existence of such a cause of economic variation. The words of Hotelling are worth repeating here: "The trouble with all such theories (of external mechanisms) is the tenuousness, in the light of physics, of the long chain of causation which they are forced to postulate. Even if a statistical test should yield a very high correlation, the odds thus established in favor of such a hypothesis would have to be heavily discounted on account of its strong a priori improbability."

But there is no question that we do observe a cycle of approximately ten years, to which it is very difficult to assign a cause. The 20-year building cycle is probably a function of the average annual depreciation of buildings, and the 50-year war cycle is undoubtedly connected with the average duration of human life. But for the ten-year cycle there does not appear to be any such simple explanation. If we assume, as we have done in the case of the short  $3\frac{1}{2}$ -year cycle in American economics, that there are intrinsic elasticities in the economic structure which tend, under erratic shocks, to give a characteristic movement to basic time series, this assumption fails to account for the simultaneous movement of prices in economies tenuously connected with one another. It also fails to explain why all systems appear to have the same elasticities, a fact not observed for the short cycle, which is  $3\frac{1}{2}$  years in American economics and something over 5 years in European economies.

Since the most universal concomitant of all economies is gold, one might suspect that crises are transmitted throughout the world along the thread of gold. The universal rise of prices in European countries in the sixteenth century may be attributed quite clearly to this cause. But is this factor as important as it was in the sixteenth

century? The following table, which shows the central gold reserves for five countries from 1929 to 1938 inclusive, throws some light upon this question:<sup>4</sup>

CENTRAL GOLD RESERVES IN MILLIONS OF OLD GOLD DOLLARS, 23.22 GRAINS FINE

Country	1929	1930	1931	1932	1933	1934	1935	1936	1937	1938*
United States	3900	4225	4051	4045	4012	4865	5980	6649	7536	7656 <sup>(1)</sup> 8571 <sup>(2)</sup>
Germany	560	544	251	209	109	36	37	16	17	17
France	1631	2099	2683	3257	3015	3218	2598	1769	1516	1435
Great Britain	710	718	588	583	928	936	974	1526	1588	1589†
Japan	542	412	234	212	212	232	251	273	154	154

\* The reserves are given in 1938 for the two half-year periods.

† The gold in the Exchange Equilisation Fund is not included.

Only a casual examination of these data is sufficient to show that there is little, if any, relationship between the gold reserves of the five countries represented and their general price movements. In both Japan and Germany the gold reserves diminished steadily from 1929, but by 1938 there was a price inflation in the former and an abnormally constant price level in the latter. The gold reserves of the United States increased almost fantastically from 1929 to 1938, far beyond any possible need or usefulness, but the prices in this country first fell sharply, then recovered moderately, and finally declined again.

The theory of prices has already been treated extensively in Chapter 10, where it was finally concluded that the psychic nature of prices is to be attributed, in considerable part, to the velocity factor in the equation of exchange. This factor is largely independent of gold reserves, potential or actual supplies of raw materials, the size of harvests, and other concomitants of national wealth.

Our conclusion follows, then, that the a priori cause of the ten-year cycle must be sought for in some external mechanism, which affects the psychology of all people at approximately the same time. There is no other way, it seems to the writer, in which the phenomena which we have discussed above can be explained in rational terms.

In the next section we shall discuss, with all those reservations which must necessarily accompany a scientific study of such obscure phenomena, the postulate of William Stanley Jevons, which seeks, in the variations of solar activity, to account for the mysterious ten-year cycle of business.

### 6. *The Theory of Jevons and Its Present Status*

Earlier in this book, and more completely in the preceding section, we have had occasion to refer to the external causes of economic varia-

<sup>4</sup> Data are from *Statistical Year-Book of the League of Nations, 1938-39*.

tions; that is to say, causes which are not inherent in the actual economic relationships between the time series themselves. Among these suggested external causes which have attracted the attention of economists one of the most interesting is that originally proposed by Sir William Herschel at the beginning of the nineteenth century.<sup>5</sup> This proposition posits a relationship between the sunspot cycle and the economic activities of society on the earth. Herschel's suggestion was not subjected to statistical investigation, however, until the time of William Stanley Jevons (1835-1882). This economist devoted three papers to the subject, which are reprinted in his *Investigations in Currency and Finance*, published in 1884 two years after the author's death.<sup>6</sup> The proposed relationship is now generally referred to as the theory of Jevons.

Jevons' first paper began with the following observation:

There is no doubt that the energy poured upon the earth's surface in the form of sunbeams is the principal agent in maintaining life here. It has lately been proved, too beyond all reasonable doubt, that there is a periodic variation of the sun's condition, which was first discovered in the alternate increase and decrease of the area of sun-spots, but which is also marked by the occurrences of auroras, magnetic storms, cyclones, and other meteorological disturbances. Little doubt is now entertained, moreover, that the rainfall and other atmospheric phenomena of any locality are more or less influenced by the same changes in the sun's condition, though we do not know either the exact nature of the solar variations nor the way in which they would act upon the weather of any particular country.

It is clear from this that Jevons was seeking to explain economic variations in terms of meteorological reactions upon agricultural production. This was the original suggestion of Herschel and it was a logical point of view. He finally came, however, to the following conclusion:

... in 1875 I made a laborious reduction of the data contained in Professor Thorold Rogers' admirable "History of Agriculture and Prices in England from the Year 1259." I then believed that I had discovered the solar period in the prices of corn and various agricultural commodities, and I accordingly read a paper to that effect at the British Association at Bristol. Subsequent inquiry, however,

<sup>5</sup> *Philosophical Transactions*, Vol. 19, 1801, pp. 265-318.

<sup>6</sup> These papers are "The Solar Period and the Price of Corn," *Investigations in Currency and Finance*, pp. 194-205; "The Periodicity of Commercial Crises and its Physical Explanations," *ibid.*, pp. 206-220; "Commercial Crises and Sun-Spots," *ibid.*, pp. 221-243. The first paper was read at a meeting of the British Association at Bristol in 1875, but withdrawn from publication since, in Jevons' words, "subsequent inquiry convinced me that my figures would not support the conclusions I derived from them." The second paper was read at the Dublin meeting of the British Association in 1878 and published in the *Journal of the Statistical and Social Inquiry Society of Ireland*, Vol. 7, 1878, pp. 334-342. The third paper, largely a repetition of the second, was printed in *Nature*, Vol. 19, 1878, pp. 33-37.

seemed to show that periods of three, five, seven, nine, or even thirteen years would agree with Professor Rogers' data just as well as a period of eleven years; in disgust at this result, I withdrew the paper from further publication.

This adverse opinion has been confirmed amply by more recent analysis. Thus the periodogram of Sir William H. Beveridge (see Section 20 of Chapter 7) for wheat prices in Western Europe (1500-1869) shows a maximum influence at 15.25 years. Although about 4 per cent of the total energy of the spectrum is concentrated around 11 years, this concentration does not meet Beveridge's "test of continuity." Thus he says: "Its intensity in the first 154 years (1545-1698) is 96.01; in the next 154 years (1699-1852) it is only 3.47." We must, therefore, reject the hypothesis that variations in the business cycle are due to secondary effects generated in agricultural production and prices by reactions of meteorological phenomena to the sun spot cycle.

But in his first article Jevons makes another observation. Thus he says:

Before concluding I will throw out a surmise, which, though it is a mere surmise, seems worth making. It is now pretty generally allowed that the fluctuations of the money market, though often apparently due to exceptional and accidental events, such as wars, great commercial failures, unfounded panics, and so forth, yet do exhibit a remarkable tendency to recur at intervals approximating to ten or eleven years. Thus the principal commercial crises have happened in the years 1825, 1836-39, 1847, 1857, 1866, and I was almost adding 1879, so convinced do I feel that there will, within the next few years, be another great crisis. Now if there should be, in or about the year 1879, a great collapse\* comparable with those of the years mentioned, there will have been five such occurrences in fifty-four years, giving almost exactly eleven years (10.8 years) as the average interval, which sufficiently approximates to 11.11, the supposed exact length of the sun-spot period, to warrant speculation as to their possible connection.

\* The collapse here anticipated actually did occur; but it must be assigned to the autumn of the year 1878.

A comprehensive re-examination of Jevons' hypothesis was made in 1934 by C. Garcia-Mata and F. I. Shaffner in a long monograph entitled "Solar and Economic Relationships: A Preliminary Report." These writers reached the following conclusion:

For more than half a century orthodox economists preferred to treat the Jevonian hypothesis more as an intellectual speculation than as a scientific theory. Tho the theory has recently gained so much attention that economists have not been able to ignore it completely, it was not difficult to prove that the supposed close relation between the solar cycle and agricultural fluctuations did not in fact exist. But when the analysis was extended to economic phenomena other than

<sup>1</sup> *The Quarterly Journal of Economics*, Vol. 49, 1934, pp. 1-51.

agricultural fluctuations, the evidence disclosed a resemblance between the solar cycle and business activity so close as to command serious consideration. Indeed, this evidence was so striking that we thought it necessary to conduct further investigations to prove the resemblance accidental. In this we were unsuccessful, and therefore we were obliged to seek in the literature of solar-terrestrial relations all the available material which could be used to sustain the hypothesis of some direct connection between them.

These authors, having readily disposed of the original conjecture that sunspots affected agricultural production and hence general economic conditions then compared sunspot series with W. M. Persons' index of the physical production of manufacturers.<sup>8</sup> From this investigation they reached the following conclusion:

Persons' index of physical production of manufactures, after the same smoothing process used previously for the crop index, showed a surprising result. Five cycles appeared clearly between the actual bottoms of 1876 and 1932, making an average of 11.20 years. The average of the last five sunspot cycles (not counting the present minimum, which is not clearly established) is 11.16 years. But a graphic correlation of both curves showed that the correlation should be inverse, i. e. increase of sun spots correlating with decrease in business. The main explanation is in the known fact that the solar cycle takes longer to fall than to rise; and the 11-year business cycles of our smoothed curve showed clearly a rise much slower and longer than the fall in the depression periods. A graphic comparison with the solar curve inverted showed, nevertheless, that to get a high correlation through agreement of tops and bottoms a lag of three or more years was necessary, i. e. the solar curve three years ahead of the business curve. The necessity of introducing such a long lag to produce the best correlation seemed to us more an indication of the correlation's being accidental than a proof of the true relationship between both curves. Notwithstanding this, the fact that the varying length of the five individual solar cycles showed individual resemblances to those of the respective business cycles was a strong argument against closing the investigation at this stage.

Because of the lag mentioned above and the apparent inverse relationship between sunspots and business the authors decided to use the variations in the solar curve as given by the first differences. The graphical representation of their results is observed in Figure 164. The correlation between the difference curve (smoothed) and the index of manufacturing production, reached the significant value of  $0.690 \pm 0.049$ .

In order to ascertain some a priori reason for this otherwise uninterpretable correlation, the authors then sought an explanation in the effect upon human beings of the variation in the ultraviolet radiation in the sun, which is believed to accompany and to correlate highly with the sunspot numbers, or their rate of change. Unfortunately

<sup>8</sup> Data from *Forecasting Business Cycles*, New York, 1931, p. 192.

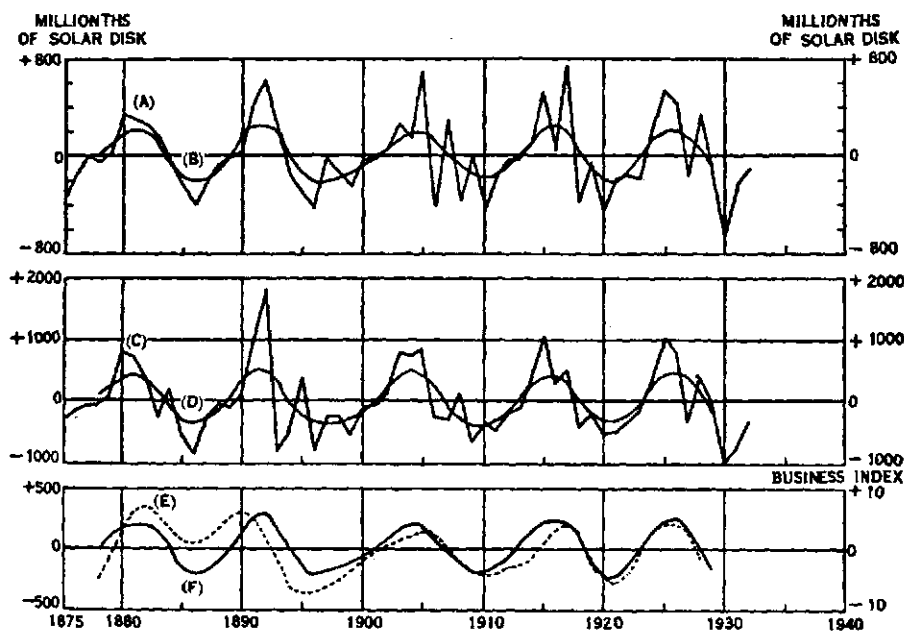

FIGURE 164.—SUNSPOTS AND MANUFACTURING PRODUCTION.

(A) First differences of sunspot areas; (B) same, smoothed; (C) first differences of areas of solar faculae; (D) same, smoothed; (E) index of products of manufacturers, smoothed; (F) first differences of sunspot areas, smoothed.

the ultraviolet series is very short, and it is probably an unsatisfactory measure of the total ultraviolet radiation over the therapeutic range of frequencies. The data, which include only a single observation for 1924, but are more complete thereafter, give the ratio of the ultraviolet line  $\lambda = 0.32\mu$  to the green line  $\lambda = 0.50\mu$ . They are taken from computations of the Mt. Wilson Observatory, published in the *Bulletin for Character Figures of Solar Phenomena* of the International Astronomical Union. The technique of observation and other details were discussed by E. Pettit in 1932.<sup>9</sup>

For the spectacular year 1929, the authors found a correlation of  $0.886 \pm 0.042$  between the ultraviolet series and stock prices on the New York Stock Exchange, and a correlation of  $0.909 \pm 0.034$  for the corresponding prices of the London Stock Exchange.

A comparison was also made of the variation in the "solar constant"<sup>10</sup> with the Index of American Business Activity (Cleveland

<sup>9</sup>"Measurements of Ultra-Violet Solar Radiation," *Astrophysical Journal*, Vol. 75, 1932, pp. 185-221.

<sup>10</sup>*Annals of the Astrophysical Observatory of the Smithsonian Institute*, Vol. 5, 1932, p. 252, C. G. Abbot and others.

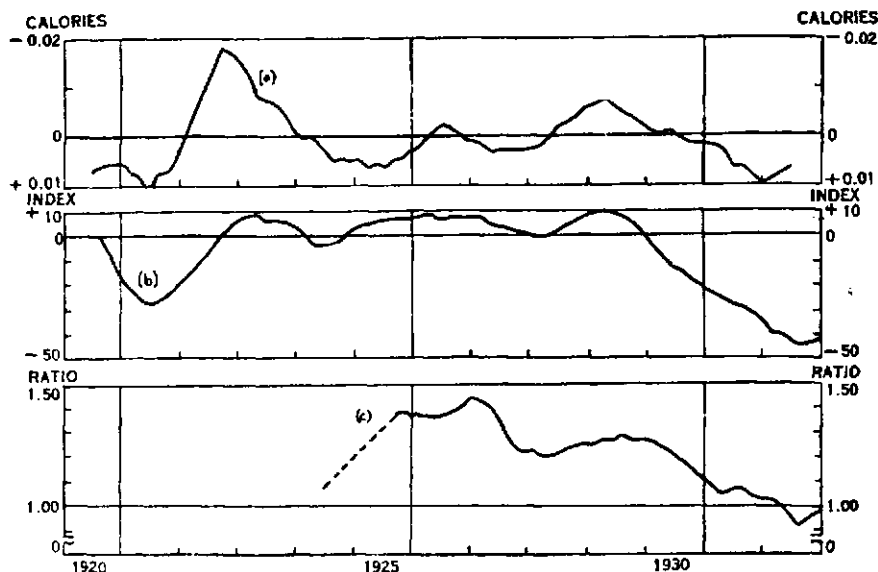

FIGURE 165.—SOLAR PHENOMENA AND BUSINESS ACTIVITY.

(a) Solar radiation (variation of the "solar constant") measured in calories per square centimeter per minute. Data better after 1925. (b) Ayres' Index of American Business Activity. (c) Ultraviolet solar radiation ratios.

Trust Company) over the period from 1920 to 1932. As one may see from Figure 165 the observed correlation is again high.

The question must now be asked: Are these correlations spurious? If they are not, then we must inquire further as to the measure of belief which should be placed in a correlation founded upon such a tenuous chain of induction.

In the first place, it seems necessary to take a longer view of the problem. In Figure 166 we have shown the actual sunspot data and the conjectured sunspot variation over the period from 1600 to 2000 with indications of (1) the principal modern business crises, (2) those crises mentioned by Jevons, and (3) the inflations of the tulip mania and the South Sea and Mississippi Bubbles. For the most part the crises seem to develop near the top or to the right of the sunspot curve. Of the 24 crises studied, 17 seem to be comparable with one another, while 7 are in different phases of the cycle. It is perhaps significant that such major panics as the South Sea and Mississippi Bubbles, the American collapse of 1837, the Black Friday of 1873, and the stock-market crash of 1929 are at almost identical points on the curve. The tulip mania was not properly placed in the cycle, but we observe that we have made an unwarranted extrapolation of the sun-



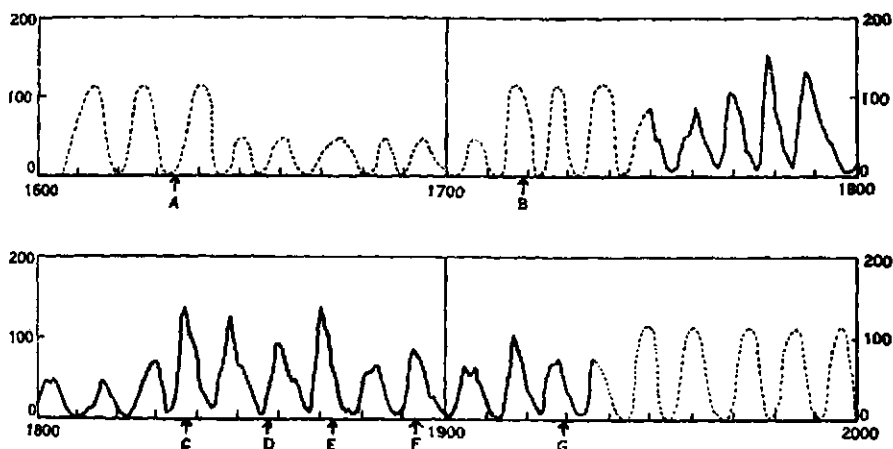

FIGURE 166.—SUNSPOT NUMBERS, 1600-2000 (PARTLY EXTRAPOLATED).

Actual observations are shown in solid lines, extrapolations in dotted lines. Principal financial crises are indicated by letters:

A. Tulip mania; (B) South Sea and Mississippi Bubble; (C) Panic of 1837; (D) Panic of 1857; (E) Panic of 1873; (F) Panic of 1893; (G) Stock-Market Crash of 1929.

spot curve by carrying it from known data to such a remote period. Our conclusion from this crude comparison would be that there is nothing here in striking disagreement with the original theory.

We next examine the modern phase more closely by comparing American industrial activity (5-year moving total) with the differences of the sunspot data (5-year moving total) over the interval from 1790 to 1938. This comparison is graphically represented in Figure 167. A striking observation is now found in the fact that while

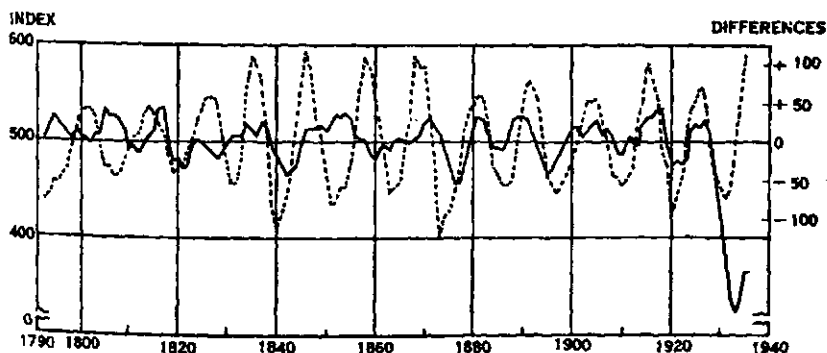

FIGURE 167.—(——): AMERICAN INDUSTRIAL ACTIVITY; (----): DIFFERENCES OF SUNSPOT NUMBERS (FIVE-YEAR MOVING TOTALS).

a significant agreement between the movements of the two series appears in the interval from 1870 to date, there is a striking disagreement between the two curves in the interval prior to 1870. The correlations are actually 0.195 for the total range, 0.096 for the interval 1790-1870, and 0.258 for the interval 1870-1936. This disagreement might be partially explained on the argument that prior to 1870 the United States was largely an agricultural economy, and this factor, rather than the more psychological financial factor, would dominate industrial production. But the situation was reversed after 1870, when the influence of the stock market became greater as the industrialization of the country increased. Hence, we should expect a significant increase in the correlation. We must observe, however, that we find a correlation of only 0.258 (or 0.286 if a one-year lag is introduced), whereas Garcia-Mata and Shaffner find a correlation more than twice as great. It should be pointed out however, that, although the actual correlation is small, the agreement in phase between the two curves is striking. It will be observed that the two curves remain in phase throughout the entire second part of the range.

Another point should be mentioned in this connection. The periodogram of E. B. Wilson for the industrial production index (see Section 14 of Chapter 7) revealed only 8 per cent of the energy in a cycle of 120 months for the interval from 1790 to 1859, but energies of 19 per cent and 11 per cent respectively in cycles of 108 and 138 months in the subsequent interval. Hence there was small concentration of energy in the 10-year component in the first interval, but a considerable concentration in the neighborhood of the 10-year component during the second. Hence, the observed disagreement is confirmed by the periodogram. But the periodogram says nothing about the phase, and we must admit that the agreement of phase, even though the energy is small, is a strong argument in favor of the existence of some real connection between the two curves.

The third point in the argument, the assumption of an a priori cause of relationship through ultraviolet radiation, is not clearly demonstrated by the data, nor does there seem to be much probability in the near future of giving a satisfactory answer. Although a vast literature has been accumulated on the effects of ultraviolet radiation upon human beings, the specific results appear to be quite controversial and inconclusive. The following statement, however, seems to bear specifically upon the psychological problem with which we are concerned and is probably in agreement with the best authority.

Sunlight is unquestionably one of the various climatic factors having to do with the sensations of bodily and mental well-being. Striking results also have been reported following irradiation with mercury and carbon arc lamps. Even

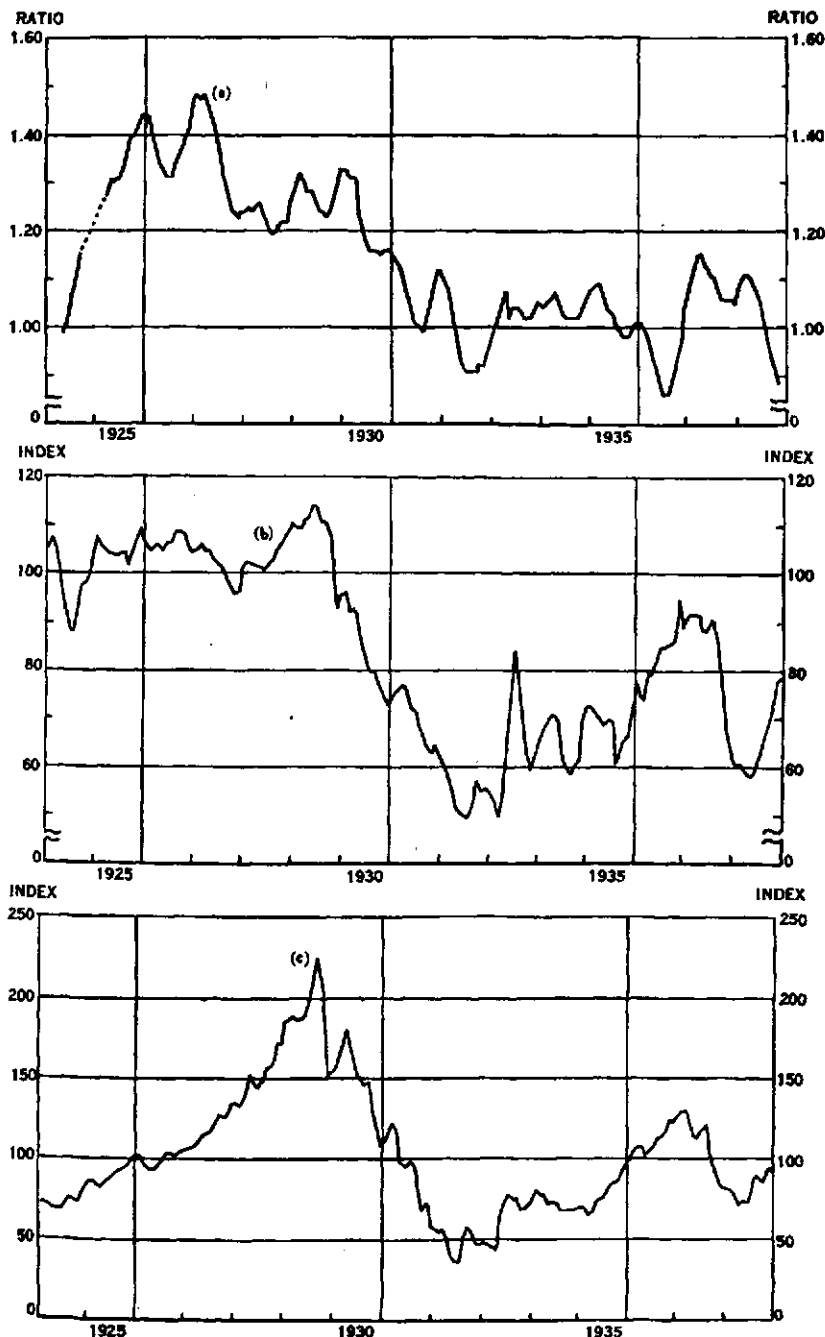

FIGURE 168.—(a) SOLAR ULTRAVIOLET RADIATION (MT. WILSON), (b) INDEX OF INDUSTRIAL PRODUCTION (CLEVELAND TRUST COMPANY), AND (c) INDEX OF STOCK PRICES (COWLES COMMISSION).

after a mild, non-erythema producing dose there is a feeling of exhilaration expressing itself in the joy of work and of living. . . . Hasselbalch (1905) described his sensations following a two-hour irradiation with a strong carbon arc which produced a marked erythema, and noted that instead of the usual evening fatigue with frequent yawning he felt lively and indefatigable. The feeling of exhilaration and of desire and ability to work usually lasted two days, the "light mania" being followed by deeper depression than usual. Hasselbalch suggested that the "light mania" may be a kind of immunity against depression. The action on the nervous system is evidently indirect and consequent to improvement in circulatory and metabolic conditions.<sup>11</sup>

Now if this is the actual effect of ultraviolet upon the psychological behavior of human beings, and if this ultraviolet varies substantially in the solar cycle, then there should be some evidence of this effect in those economic series which are influenced by the psychic factor. This effect would presumably appear in the variation in the prices of stocks and in the concomitant variations in industrial production. Figure 168 shows the three curves (1) the ultraviolet variation in the sun (the Mt. Wilson data smoothed with a 6-month moving average), (2) the index of industrial production (Cleveland Trust Company), and (3) the Cowles Commission-Standard Statistics index of all stock prices. When we recall the incomplete character of our measure of ultraviolet radiation, the general agreement between the three curves in their most conspicuous parts is rather striking. The correlation, however, is far from perfect and over the entire range of the data would not compare with that given above for the year 1929.

With the data available to us at the present time, our final conclusions must be the following. The theory of Jevons is not proved by the evidence which we have presented, nor, on the other hand, is there any conspicuous disagreement which would warrant us in disregarding it. There is need, as we have said above, for explaining the 10-year cycle, and nothing has yet been discovered intrinsic to the system, which would account for the phenomenon, nor explain its existence in most, if not all, commercial economies. Hence, this need for an extrinsic cause has turned attention to variations in solar radiation as a natural explanation.

The greatest stumbling block to the acceptance of the theory has been the lack of evidence to indicate the kind of mechanism, which would convert solar variation into economic variation. The best clew is now found in the ultraviolet curve, but one must freely admit that the data are meager and that the chain of causation, through the effects upon human psychology, is tenuous indeed.

<sup>11</sup> From H. Laurens, *Physiological Effects of Radiant Energy*, New York, 1933, pp. 283-284.

The theory, however, is suggestive enough to warrant further study. It is to be hoped that we may have in time more adequate data regarding, first, the variation of ultraviolet in the sun throughout a wider range of frequencies, and, second, a more thorough understanding of the effect that this may have upon human behavior.

### 7. *Economic Time Series and the Interpretation of History*

In 1857 Henry Thomas Buckle (1821-1862) published the first volume of what was to have been a comprehensive *History of Civilization*. This book advanced the thesis, among others, that history must be interpreted in the light of economic factors. The author's train of reason did not, as is generally believed, make these factors the dominating influences of history, since he assumed the idealistic position that in the long run the advance of civilization is accompanied "by a diminishing influence of physical laws and an increasing influence of mental laws." But this intellectual progress is itself generated and nurtured by climate, soil, food, and the aspects of nature. Buckle insisted upon the use of statistical evidence, although his own knowledge of statistical technique was necessarily limited, and his inferences were often outrageous extrapolations from meager data. Professional historians have been reluctant or unable to follow the path thus opened up by Buckle, and a science of history is as yet only a kind of philosophical hope.

Ten years before Buckle's *History of Civilization* appeared, Karl Marx (1818-1883), the father of communism, had formulated his "economic theory of history" in a book entitled the *Misère de la philosophie*, but the idea received scant attention until the third volume of *Das Kapital* was published in 1894. Unfortunately, as was Buckle, Marx was a poor statistician and his "inferences" are for the most part a priori assumptions made specious by an unsystematic and unscientific marshalling of unreliable data. This lack of scientific inference, however, was the fault of neither Buckle nor Marx, since the science of statistics was not extensively developed until the twentieth century, and the statistics of economic time series is still in process of formulation.

But the time has come, it seems to the writer, when historians may hope to test the thesis that there is an economic basis to history, and to measure with some accuracy the actual significance of this factor in the march of historical events. Such questions as these may reasonably be asked. Do great commoners, champions of the common people, the Gracchi in Rome, Andrew Jackson in the United States,

arise in periods of great economic distress, their names and personalities being but inconsequential matters compared with the trend of economic events which created them? Are golden ages of art and literature generated by rising tides of prosperity, rather than by a mysterious concentration of genius in one century as compared with another? Are wars created by the whims of national rulers, or are they generated by uncontrollable rivalries in trade and commerce in periods of expanding prosperity? Can political changes be foretold by a knowledge of the trends of production and of price?

There is certainly no categorical answer to these questions, and inferences must still be drawn from data that are inaccurate in detail and meager in their range. But clear it is that the ebb and flow of economic time series will illuminate many problems in history.

We have already commented at some length upon the significance of the distribution of income upon political events. The terrifying periods of revolution and civil war may be explained rationally upon this basis. On this assumption, the writings of Voltaire were not among the causes of the French Revolution, but were rather symptoms of an economic condition, which only the conflagration of such a revolution could correct.

And similarly the phenomenon of war, condemned by all people and wholly inexplicable in a world enriched by the gifts of science, with resources of food and energy at present more than ample for its needs, has its roots not wholly in racial and national hatreds. The collapse of the price structures of nations in the period after the World War led to economic dislocations. From economic disorder came dictatorships, from dictatorships aggression, and from aggression political conflict. But since the cause of conflict had its roots in the need for raw materials, the conflict that resulted from this chain of events was singularly free from the destruction of large supplies of these natural resources.

"The golden age of Spanish literature," so we read, "belongs to the 16th and 17th centuries, extending approximately from 1550 to 1650."<sup>12</sup> Is this information strange to one who has studied the time series of these centuries, and who has observed the spectacular increase of trade and prices over this period? Art and literature flourish in a rising economy, but they wither and perish in one that declines. Was it accidental that Cervantes (1547-1616), the greatest of Spanish writers, and Shakespeare (1564-1616), the supreme dramatist of English literature, should have flourished as contemporaries? Was it

<sup>12</sup> *The Encyclopaedia Britannica*, 11th edition, 1911, Vol. 25, p. 582.

strange that science, dead for fourteen centuries after Ptolemy (150 A. D.), should suddenly have come to life through the work of the three contemporaries Tycho Brahe (1546-1601), Kepler (1571-1630), and Galileo (1564-1642)? One glance at the time series of prices in their respective countries tells the tale. Or conversely, from the time series themselves we could have forecast the existence of more genius in this period than in any one of equal length during the Middle Ages, where prices remained at their low and moderately fluctuating level established at the fall of the Roman Empire. P. A. Sorokin, who has devoted considerable attention to this problem in his analysis of cultural dynamics, reaches the conclusion: "So far as the Graeco-Roman and the Western cultures are concerned, we discover the existence of a definite association between the rise and fall of economic well being and the type of the dominant culture."<sup>13</sup>

It will be instructive for us to survey very cursorily a few aspects of American history from the economic point of view as revealed by time series. In Figure 169 we have exhibited five primary series of sufficient length to give us significant information about the course of political events. The range from 1790 to 1940 is divided into periods corresponding to the various presidential administrations.

We first note that changes in administrative control by political parties occur, for the most part, at the bottom of a severe drop in prices, or during a protracted decline. Of the 15 such changes since 1800, 10 occurred during or at the bottom of such depression periods. It will be observed, also, that four of the most thoroughly repudiated American presidents, Van Buren, Buchanan, Johnson, and Hoover, had the misfortune of holding office during severe declines of the price index. Van Buren and Hoover, who had been elected by handsome majorities, were finally rejected by electoral votes of 60 to 234 and 59 to 472 respectively. Neither Buchanan, nor Johnson was renominated, and in the case of Buchanan his party went out of power. Why should this not also have been the case with Johnson? A survey of this stormy period indicates that Johnson, in spite of his election by the Republican party, had had a long political career as a Democrat, and in the impeachment proceedings against him, he was sustained in office principally by the vote of 12 Democrats. In a political sense, therefore, the election of the Republican Grant to succeed him was essentially a reversal of party.

The curious failure of the Democratic party to gain control after the spectacular decline of prices during Grant's administration needs explanation. This is found in the confusion which surrounded the

<sup>13</sup> See *Social and Cultural Dynamics*. Vol. 3, New York, 1937, Chapter 8.

election of Hayes. In the electoral college Tilden, his opponent, received 184 uncontested votes, one short of election, to 163 for Hayes. Two conflicting ballots were sent in by the states of South Carolina, Florida, Oregon, and Louisiana. The "Electoral Commission," appointed specially to settle this controversy, decided by a vote of 8 to 7, that each contested ballot was to be given to Hayes. Can we say that in this instance we have witnessed a genuine exception to the law of the economic reversal of party?

It is in these apparent exceptions to the economic forecast of events that we find illuminating historical incidents. Such is the case with the reversals of party control in 1853 and 1913. The first instance was a definite forecasting of the coming conflict, economic in large measure, between the slavery and anti-slavery interests. Favoring compromise on slavery, Fillmore failed to obtain the nomination and Pierce was elected by the comfortable majority of 254 to 42. The more vital issue involving the wealth in slaves was sufficient to outweigh the favorable trend of the price index. In 1912 the split in the Republican party, occasioned by the feud between Roosevelt and Taft, allowed the Democratic minority party to win in spite of the long upward trend of prices and production. The popular vote at that time for Roosevelt and Taft was 7,610,000 and that for Wilson was 6,286,000. In the electoral college, 435 votes were cast for Wilson, 88 for Roosevelt, and 8 for Taft.

The re-election of Monroe in 1820, during a protracted period of price deflation, is another curious incident in history, since he was elected almost unanimously. His second term was called the "era of good feeling." But it is clear from the curve of industrial production that the movement of prices was probably secondary to the expansion of trade during this period. That this expansion did not carry on into the next administration is observed from the party reversal which occurred in 1829.

Many other things may be read from the five time series which we have shown, the violent financial movements which accompanied the land expansion and the wildcat speculation of Jackson's administration, the glorification of Lincoln, who died at the top of the war inflation, the loss of prestige by Wilson, who died at the bottom of his postwar deflation, the drama of the development of railroads as shown in the fluctuations of the prices of their stocks. The great increase in the wealth, prestige, and well-being of the United States since 1880 is told more eloquently by the production curve for pig iron than by pages of special incident. No period in history, with the exception of the sixteenth century in Spain, has shown so remarkable an advance in culture and well-being as that which has taken place in



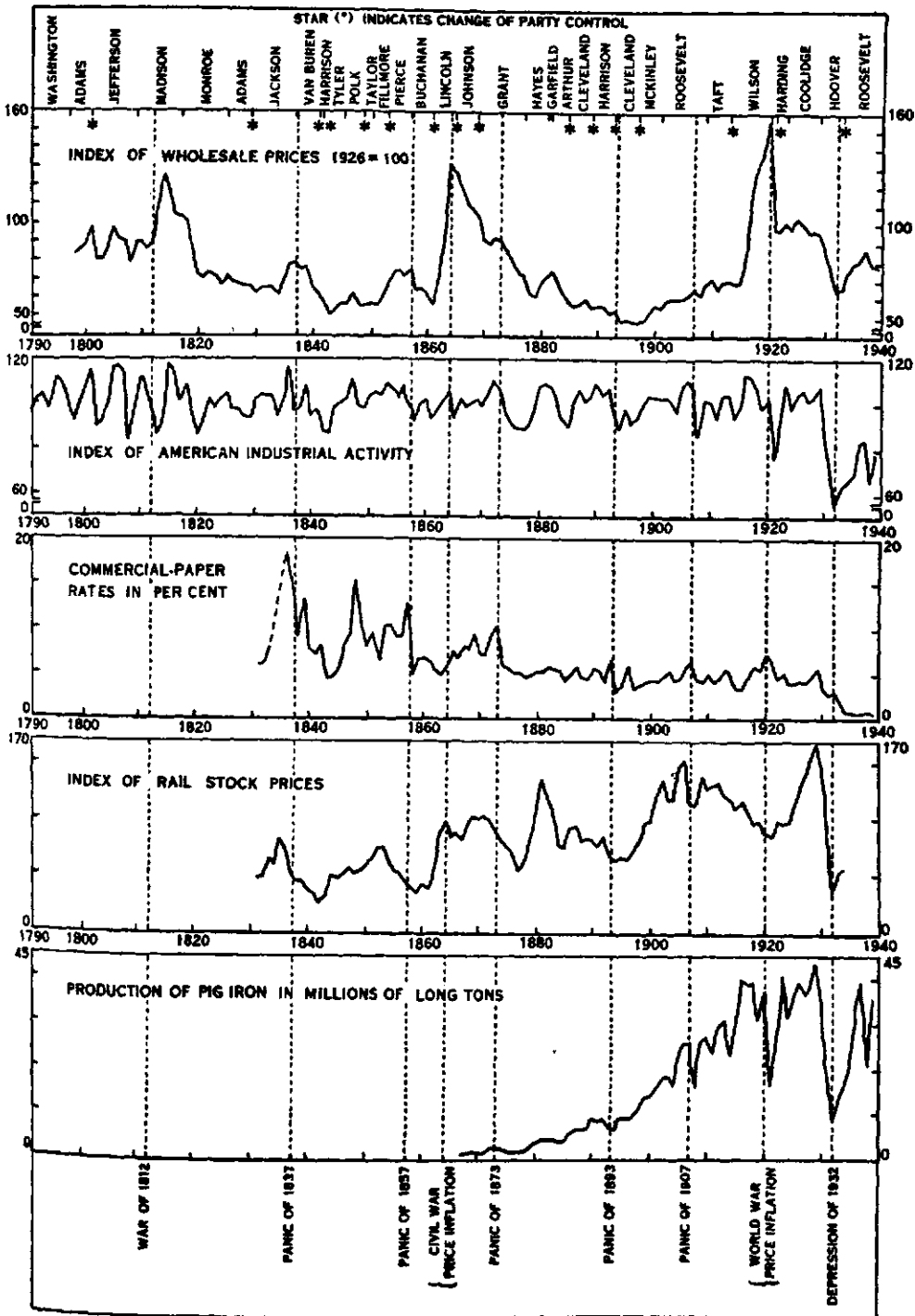

FIGURE 169.—POLITICAL CHANGES AS INTERPRETED BY TIME SERIES.

the United States during the half century from 1880 to 1930. The golden age of science, accelerated by the founding and development of a great public school system and the construction and endowment of numerous colleges and universities, will undoubtedly be attributed by history to this period.

This brief survey can do no more than to indicate the rich illumination that an analysis of economic time series can throw upon the events of history. If it has accomplished this, then its purpose has been achieved.

### 8. General Summary

We have finally reached the end of our long analysis of the problems presented by economic time series, and it might be useful to pass in review some of the main results which have been attained.

It will be observed that one central idea has persisted throughout the book. This idea centers around the proposition that economic time series are to be regarded fundamentally as dynamical quantities, and that their motions, whether interpreted in the light of trends, or as evidences of an erratic cyclical structure in the underlying economic forces, must be examined with an eye to their constituent energies.

Physical science is postulated on the assumption that transfers of energy constitute the kernel of all dynamical transformations. The concept of energy is the thread by means of which chemistry is related to physics, and physics to engineering. The physiologist finds it in the complex problem of the flexure of muscles, the transmission of impulses over nerves, the mechanics of metabolism, and the like; the biologist meets it in the mysterious processes of growth, and in the numerous biochemical and biophysical reactions with which he deals. Because of its universality and the many forms in which it may be found, energy usually furnishes the key to perplexing problems in fields far removed from physics and astronomy, where it was originally defined.

Another aspect of the concept of energy that makes it useful is the fact that the same mathematical equations where it is involved carry over from one science to another. Thus the physicist finds the pages of Lotka's *Elements of Physical Biology* easier to read than does the biologist for whom it was written, because on every page appear the old, familiar equations. The thread of energy thus correlates the phenomena of widely different origins.

It is for this reason that the phenomena of economics were envisaged from this useful point of view. Historically there was ample

precedent. Thus the *Manuel d'économie politique* of V. Pareto was highly colored by his early training in electrical engineering. It was for this reason doubtless that Pareto seized upon the concept of utility, or ophelimity as he chose to call it, as the analogue in economics of the potential function in classical electromagnetism. His pages are reasonably easy reading for the physicist, who readily grasps his point of view, but they present great difficulties to those who are untrained in physical concepts. Thus, indifference surfaces are merely equipotential surfaces under new guise, and lines of preference are the ordinary line of electric and magnetic forces.

Irving Fisher, under the stimulus of the great mathematical physicist, Josiah Willard Gibbs, wrote his now classical work on *Mathematical Investigations in the Theory of Value and Prices*, published in 1892.<sup>14</sup> In this penetrating treatise, Fisher gave a table of mechanical analogies a few of which are reproduced here as follows:

<i>In Mechanics</i>	<i>In Economics</i>
A particle	An individual
Space	Commodity space
Force	Marginal utility or disutility
Work	Disutility
Energy	Utility
Total work	Total disutility, or the integral of marginal disutility
Total energy	Total utility, or the integral of marginal utility
Net energy	Net utility
Equilibrium of forces	Equilibrium of utility

But we observe immediately from the table, that these are the concepts of a static, rather than a dynamic, economics. Utility is the analogue of potential, rather than kinetic energy. But in 1892 the problem of economic time series was scarcely formulated. Data were limited and unsatisfactory. Economics, following the tradition set by A. A. Cournot in his notable *Recherches sur les principes mathématiques de la théorie des richesses*, published in 1838, had developed about the static picture afforded by curves of supply and demand, the concept of surfaces of indifference, and the complex equilibrium conditions of the Walrasian theory of production.

Hence, on the precedent of the historical development of economic theory, there was ample justification for approaching the problem of economic time series as a problem closely related to the energy theory

<sup>14</sup> Reprinted, 1926, New Haven, Yale University Press, xii + 11-126 pp.

of physical phenomena. But this energy is the energy of dynamics rather than of statics.

The most natural beginning of such an investigation was found in the theory of Fourier series, which is admirably adapted to, and in fact originated in, the investigation of energies associated with cyclical or quasi-cyclical motions. By means of significance tests recently formulated it has proved possible to distinguish between structural components of a cyclical character and the erratic element found in all phenomena which depend upon the vagaries of human behavior.

Moreover, by extending the energy concept to orthogonal systems other than those of sines and cosines, it has been found possible to establish a satisfactory significance test for general linear regressions. From this point of view linear relationships between *natural* economic variables can be regarded as linear relationships between *orthogonal components*, or *principal factors*; and the energy associated with these factors has been shown to furnish a satisfactory measure of the empirically observed correlations.

The energy of harmonic motions may also be described by the wave lengths of the constituent harmonic terms, and the elementary energies associated with them. The totality of such wave lengths is called the spectrum of the motion. A method has been devised through the technique of serial-correlation analysis for describing and analyzing the spectra of economic time series. With the continuous spectrum of a random series to serve as a comparison mode, one may then readily distinguish between the energy which belongs to a significant point spectrum, if it actually exists, and that part of the energy which must be attributed to a continuous spectrum.

Although much of the analysis has thus centered around the problem of recognizing and measuring the energy in the motion of time series, the actual economic aspects of the series have not been neglected. Just as the concept of energy has been central in the statistical analysis, so the concept of the distribution and the efficiency of wealth and income has been introduced as the most significant aspect of the variables from the point of view of economics itself. From the solution of the static problem of the distribution of incomes in a stable economy, the analysis has proceeded to the dynamical problem, which considers how the elements of the distribution function change from one period to another. The specific results attained by this study will not be reviewed here. But those students of social philosophy who hope to see an amelioration of the economic status of mankind, either within the limitations of the present capitalistic scheme, or by some modification of its present elements, must indicate in some manner the

mechanism by which the present behavior of these vital series can be altered. And as a corollary, it must be proved that this alteration will actually achieve the desired amelioration. Neither wishful thinking nor utopian schemes can ever take the place of a careful appraisal of the situation as it is revealed uncompromisingly by the time series themselves.

The efficiency of wealth, measured in terms of the total volume of trade which it produces, is the true secret to the well-being and prosperity of an economy. This efficiency, studied over one of the most dramatic eras in the history of the world, has revealed a number of significant properties of the variables in the equation of exchange. The relationships between prices and circulating money, between the velocity of money and industrial production, between interest rates and monetary factors, have been exhibited as they actually are, and not as preconceived theories have thought they should be. The equation of exchange has emerged from the investigation as one of the most powerful tools in our hands for exploring, not only the mysteries of our own economic system, but also the historical events in periods remote from our own times.

The analysis of time series has also revealed the present status of economics as a science. Since the distinguishing characteristic of science is its ability to forecast the future behavior of the variables with which it deals, the scientific attainments of the theory of economics must be appraised in the light of the control which it has gained over the future of its own data. Although the situation cannot be described at present as wholly satisfactory, techniques have been established which give much promise for future developments.

These techniques assume three forms. In the first place, the concept of trends has been clarified in recent times, and considerable forecasting ability in a general sense has been acquired by recognizing certain stable forms which these trends assume. Thus, the logistic curve, as applied to population and production data, has given rather deep insight into the future behavior of certain fundamental series. In the second place, the concept of the statistical limits of forecast from a trend has established well-defined boundaries to the reliability of trends. Hence, in the future, our limitations may be clearly recognized, and those erratic guesses which have so frequently cast suspicion upon general economic theory may be reasonably avoided by a wary application of the new techniques. The third advance that has been achieved is found in the attempts which have been made to establish a priori theories to account for the observed harmonic energies in certain fundamental time series. Here much remains to be

done. The success which we so much admire in physics was not won in a day, and there is no reason to believe that the economic problem will attain its own more perfect formulation with any less effort. Old theories must be tested against the data, and rejected or corrected by the results. New factors must be added and others altered until the principal elements of the mechanism have been revealed, and their final behavior characterized by a complete mathematical formulation.

And finally we reach the philosophical aspects of the analysis of time series. In our desire to find a logical integration of the different stories told by the time series of economics, we must not be unmindful of a conversation between Alice and the White King. Alice had been asked by the King to look down the road and tell him if she could see his two messengers. "I see nobody on the road," said Alice. "I only wish *I* had such eyes," the King remarked in a fretful tone. "To be able to see Nobody! and at that distance too." A few speculations have been advanced, but these must be regarded as extrapolations far beyond the limits of the data. But if we are fully aware of the point where science stops and fancy starts, then these speculations may prove to be both interesting and useful. They afford a philosophical integration of the subject as a whole, and as such they have been offered to the reader.

## TABLES

TABLE 1.

VALUES OF THE WALKER PROBABILITY FUNCTION,  $P_w$ .

Values of the function

$$P_w = 1 - (1 - e^{-\kappa})^{1/N}$$

are tabulated to six decimal places for  $\kappa$  from 0.1 to 10.0 at intervals of 0.1 and for  $N$  from 10 to 600 at intervals of 10. Values of the function  $P_s = e^{-\kappa}$  are also included to 7 decimal places over the same range of  $\kappa$ . Examples illustrating the use of this table will be found in Sections 4 and 5 of Chapter 5.



$x$	$e^{-x}$	$N=10$	$N=20$	$N=30$	$N=40$	$N=50$	$N=60$	$N=70$	$x$
0.1	0.9048374	0.999992	1.000000	1.000000	1.000000	1.000000	1.000000	1.000000	0.1
0.2	0.8187308	0.999804	1.000000	1.000000	1.000000	1.000000	1.000000	1.000000	0.2
0.3	0.7408182	0.998830	0.999999	1.000000	1.000000	1.000000	1.000000	1.000000	0.3
0.4	0.6703200	0.996105	0.999985	1.000000	1.000000	1.000000	1.000000	1.000000	0.4
0.5	0.6065307	0.990569	0.999911	0.999999	1.000000	1.000000	1.000000	1.000000	0.5
0.6	0.5488116	0.981301	0.999650	0.999993	1.000000	1.000000	1.000000	1.000000	0.6
0.7	0.4965853	0.967668	0.998955	0.999966	0.999999	1.000000	1.000000	1.000000	0.7
0.8	0.4493290	0.949364	0.997436	0.999870	0.999993	1.000000	1.000000	1.000000	0.8
0.9	0.4065697	0.926405	0.994584	0.999601	0.999971	0.999998	1.000000	1.000000	0.9
1.0	0.3678794	0.899075	0.989814	0.998972	0.999896	0.999990	0.999999	1.000000	1.0
1.1	0.3328711	0.867856	0.982538	0.997692	0.999695	0.999960	0.999995	0.999999	1.1
1.2	0.3011942	0.833359	0.972231	0.995372	0.999229	0.999871	0.999979	0.999996	1.2
1.3	0.2725318	0.796263	0.958491	0.991543	0.998277	0.999649	0.999928	0.999985	1.3
1.4	0.2465970	0.757263	0.941079	0.985698	0.996528	0.999157	0.999795	0.999950	1.4
1.5	0.2231302	0.717029	0.919928	0.977342	0.993588	0.998186	0.999487	0.999856	1.5
1.6	0.2018965	0.676186	0.895144	0.966046	0.989005	0.996440	0.998847	0.999627	1.6
1.7	0.1826835	0.635287	0.866984	0.951487	0.982307	0.993547	0.997647	0.999142	1.7
1.8	0.1652989	0.594814	0.835824	0.933478	0.973046	0.989079	0.995575	0.998207	1.8
1.9	0.1495686	0.555168	0.802124	0.911978	0.960845	0.982583	0.992252	0.996554	1.9
2.0	0.1353353	0.516676	0.766398	0.887094	0.945430	0.973625	0.987252	0.993839	2.0
2.1	0.1224564	0.479593	0.729176	0.859061	0.926654	0.961830	0.980136	0.989663	2.1
2.2	0.1108032	0.444109	0.690985	0.828222	0.904510	0.946918	0.970492	0.983597	2.2
2.3	0.1002588	0.410359	0.652323	0.794995	0.879121	0.928725	0.957973	0.975219	2.3
2.4	0.0907180	0.378426	0.613645	0.759852	0.850730	0.907218	0.942329	0.964153	2.4
2.5	0.0820850	0.348353	0.575356	0.723282	0.819678	0.882494	0.923427	0.950102	2.5
2.6	0.0742736	0.320150	0.537804	0.685776	0.786374	0.854767	0.901263	0.932874	2.6
2.7	0.0672055	0.293797	0.501277	0.647800	0.751275	0.824350	0.875955	0.912399	2.7
2.8	0.0608101	0.269253	0.466009	0.609787	0.714853	0.791630	0.847734	0.888732	2.8
2.9	0.0550232	0.246461	0.432179	0.572125	0.677579	0.757044	0.816923	0.862044	2.9
3.0	0.0497871	0.223352	0.399920	0.535149	0.639904	0.721052	0.783913	0.832609	3.0
3.1	0.0450492	0.205846	0.369319	0.499142	0.602241	0.684118	0.749141	0.800779	3.1
3.2	0.0407622	0.187859	0.340427	0.464334	0.564964	0.646689	0.713062	0.766966	3.2
3.3	0.0368832	0.171305	0.313264	0.430905	0.528394	0.609182	0.676131	0.731611	3.3
3.4	0.0333733	0.156094	0.287823	0.398990	0.492804	0.571974	0.638786	0.695170	3.4
3.5	0.0301194	0.142139	0.264075	0.368679	0.458414	0.535395	0.601434	0.658086	3.5
3.6	0.0273237	0.129854	0.241976	0.340029	0.425399	0.499726	0.564438	0.620780	3.6
3.7	0.0247235	0.117654	0.221466	0.313064	0.393885	0.465197	0.528119	0.583638	3.7
3.8	0.0223708	0.106960	0.202480	0.287782	0.363961	0.431992	0.492746	0.547002	3.8
3.9	0.0202419	0.097194	0.184942	0.264161	0.335680	0.400248	0.458541	0.511168	3.9
4.0	0.0183156	0.088284	0.168775	0.242159	0.309065	0.370063	0.425677	0.476381	4.0
4.1	0.0165727	0.080162	0.153898	0.221723	0.284111	0.341498	0.394285	0.442841	4.1
4.2	0.0149956	0.072763	0.140231	0.202790	0.260797	0.314584	0.364456	0.410700	4.2
4.3	0.0135686	0.066027	0.127694	0.185289	0.239082	0.289322	0.336246	0.380071	4.3
4.4	0.0122773	0.059898	0.116208	0.169145	0.218911	0.265697	0.309680	0.351029	4.4
4.5	0.0111090	0.054325	0.105698	0.154280	0.200224	0.243671	0.284758	0.323614	4.5
4.6	0.0100518	0.049259	0.096091	0.140617	0.182949	0.223196	0.261461	0.297840	4.6
4.7	0.0090953	0.044657	0.087319	0.128076	0.167013	0.204212	0.239749	0.273699	4.7
4.8	0.0082297	0.040477	0.079316	0.116582	0.152340	0.186651	0.219673	0.251162	4.8
4.9	0.0074466	0.036683	0.072019	0.106060	0.138852	0.170441	0.200871	0.230185	4.9
5.0	0.0067379	0.033239	0.065373	0.096439	0.126472	0.155507	0.183577	0.210714	5.0

$x$	$e^{-x}$	$N=10$	$N=20$	$N=30$	$N=40$	$N=50$	$N=60$	$N=70$	$x$
5.1	0.0060967	0.030114	0.059322	0.087650	0.115124	0.141772	0.167617	0.192683	5.1
5.2	0.0055166	0.027280	0.053816	0.079628	0.104736	0.129159	0.152916	0.176024	5.2
5.3	0.0049916	0.024710	0.048810	0.072313	0.095237	0.117593	0.139398	0.160663	5.3
5.4	0.0045166	0.022380	0.044259	0.065648	0.086559	0.107001	0.126987	0.146524	5.4
5.5	0.0040868	0.020268	0.040124	0.059579	0.078639	0.097312	0.115608	0.133532	5.5
5.6	0.0036979	0.018353	0.036369	0.054055	0.071416	0.088458	0.105188	0.121610	5.6
5.7	0.0033460	0.016618	0.032960	0.049031	0.064834	0.080375	0.095658	0.110686	5.7
5.8	0.0030276	0.015046	0.029866	0.044463	0.058841	0.073002	0.086950	0.100688	5.8
5.9	0.0027394	0.013622	0.027059	0.040313	0.053386	0.066281	0.079001	0.091547	5.9
6.0	0.0024788	0.012332	0.024513	0.036543	0.048425	0.060160	0.071751	0.083198	6.0
6.1	0.0022429	0.011164	0.022204	0.033120	0.043914	0.054588	0.065143	0.075580	6.1
6.2	0.0020294	0.010106	0.020110	0.030013	0.039816	0.049519	0.059125	0.068633	6.2
6.3	0.0018363	0.009148	0.018212	0.027193	0.036092	0.044910	0.053647	0.062304	6.3
6.4	0.0016616	0.008280	0.016492	0.024636	0.032712	0.040721	0.048664	0.056541	6.4
6.5	0.0015034	0.007495	0.014933	0.022316	0.029643	0.036916	0.044134	0.051297	6.5
6.6	0.0013604	0.006783	0.013521	0.020212	0.026859	0.033460	0.040016	0.046528	6.6
6.7	0.0012309	0.006139	0.012241	0.018305	0.024332	0.030323	0.036276	0.042192	6.7
6.8	0.0011138	0.005556	0.011082	0.016577	0.022041	0.027475	0.032879	0.038253	6.8
6.9	0.0010078	0.005029	0.010032	0.015011	0.019964	0.024892	0.029796	0.034675	6.9
7.0	0.0009119	0.004551	0.009081	0.013591	0.018081	0.022549	0.026998	0.031426	7.0
7.1	0.0008251	0.004119	0.008220	0.012305	0.016373	0.020425	0.024459	0.028477	7.1
7.2	0.0007466	0.003727	0.007441	0.011140	0.014826	0.018498	0.022157	0.025802	7.2
7.3	0.0006755	0.003373	0.006735	0.010085	0.013424	0.016752	0.020069	0.023374	7.3
7.4	0.0006113	0.003053	0.006096	0.009130	0.012154	0.015170	0.018176	0.021173	7.4
7.5	0.0005531	0.002762	0.005517	0.008264	0.011004	0.013736	0.016460	0.019177	7.5
7.6	0.0005005	0.002500	0.004993	0.007481	0.009962	0.012436	0.014905	0.017368	7.6
7.7	0.0004528	0.002262	0.004519	0.006771	0.009018	0.011259	0.013496	0.015728	7.7
7.8	0.0004097	0.002047	0.004090	0.006128	0.008163	0.010193	0.012219	0.014241	7.8
7.9	0.0003707	0.001852	0.003701	0.005547	0.007389	0.009227	0.011063	0.012895	7.9
8.0	0.0003355	0.001676	0.003350	0.005020	0.006688	0.008353	0.010015	0.011674	8.0
8.1	0.0003035	0.001517	0.003031	0.004543	0.006053	0.007561	0.009066	0.010569	8.1
8.2	0.0002747	0.001373	0.002743	0.004112	0.005479	0.006844	0.008207	0.009568	8.2
8.3	0.0002485	0.001242	0.002482	0.003721	0.004959	0.006194	0.007429	0.008661	8.3
8.4	0.0002249	0.001124	0.002246	0.003368	0.004488	0.005607	0.006724	0.007840	8.4
8.5	0.0002035	0.001017	0.002033	0.003048	0.004062	0.005074	0.006086	0.007097	8.5
8.6	0.0001841	0.000920	0.001840	0.002758	0.003676	0.004592	0.005508	0.006424	8.6
8.7	0.0001666	0.000833	0.001665	0.002496	0.003326	0.004156	0.004986	0.005814	8.7
8.8	0.0001507	0.000753	0.001506	0.002259	0.003010	0.003762	0.004512	0.005262	8.8
8.9	0.0001364	0.000682	0.001363	0.002044	0.002724	0.003404	0.004084	0.004763	8.9
9.0	0.0001234	0.000617	0.001233	0.001850	0.002465	0.003081	0.003696	0.004310	9.0
9.1	0.0001117	0.000558	0.001116	0.001674	0.002231	0.002788	0.003345	0.003901	9.1
9.2	0.0001010	0.000505	0.001010	0.001515	0.002019	0.002523	0.003027	0.003530	9.2
9.3	0.0000914	0.000457	0.000914	0.001370	0.001827	0.002283	0.002739	0.003195	9.3
9.4	0.0000827	0.000414	0.000827	0.001240	0.001653	0.002066	0.002479	0.002891	9.4
9.5	0.0000749	0.000374	0.000748	0.001122	0.001496	0.001870	0.002243	0.002616	9.5
9.6	0.0000677	0.000339	0.000677	0.001015	0.001354	0.001692	0.002030	0.002368	9.6
9.7	0.0000613	0.000306	0.000613	0.000919	0.001225	0.001531	0.001837	0.002143	9.7
9.8	0.0000555	0.000277	0.000554	0.000831	0.001108	0.001385	0.001662	0.001939	9.8
9.9	0.0000502	0.000251	0.000502	0.000752	0.001003	0.001254	0.001504	0.001755	9.9
10.0	0.0000454	0.000227	0.000454	0.000681	0.000908	0.001134	0.001361	0.001588	10.0

$x$	$N=80$	$N=90$	$N=100$	$N=110$	$N=120$	$N=130$	$N=140$	$N=150$	$x$
0.1	1.000000	1.000000	1.000000	1.000000	1.000000	1.000000	1.000000	1.000000	0.1
0.2	1.000000	1.000000	1.000000	1.000000	1.000000	1.000000	1.000000	1.000000	0.2
0.3	1.000000	1.000000	1.000000	1.000000	1.000000	1.000000	1.000000	1.000000	0.3
0.4	1.000000	1.000000	1.000000	1.000000	1.000000	1.000000	1.000000	1.000000	0.4
0.5	1.000000	1.000000	1.000000	1.000000	1.000000	1.000000	1.000000	1.000000	0.5
0.6	1.000000	1.000000	1.000000	1.000000	1.000000	1.000000	1.000000	1.000000	0.6
0.7	1.000000	1.000000	1.000000	1.000000	1.000000	1.000000	1.000000	1.000000	0.7
0.8	1.000000	1.000000	1.000000	1.000000	1.000000	1.000000	1.000000	1.000000	0.8
0.9	1.000000	1.000000	1.000000	1.000000	1.000000	1.000000	1.000000	1.000000	0.9
1.0	1.000000	1.000000	1.000000	1.000000	1.000000	1.000000	1.000000	1.000000	1.0
1.1	1.000000	1.000000	1.000000	1.000000	1.000000	1.000000	1.000000	1.000000	1.1
1.2	0.999999	1.000000	1.000000	1.000000	1.000000	1.000000	1.000000	1.000000	1.2
1.3	0.999997	0.999999	1.000000	1.000000	1.000000	1.000000	1.000000	1.000000	1.3
1.4	0.999988	0.999997	0.999999	1.000000	1.000000	1.000000	1.000000	1.000000	1.4
1.5	0.999959	0.999988	0.999997	0.999999	1.000000	1.000000	1.000000	1.000000	1.5
1.6	0.999879	0.999961	0.999987	0.999996	0.999999	1.000000	1.000000	1.000000	1.6
1.7	0.999687	0.999886	0.999958	0.999985	0.999994	0.999998	0.999999	1.000000	1.7
1.8	0.999273	0.999706	0.999881	0.999952	0.999980	0.999992	0.999997	0.999999	1.8
1.9	0.998467	0.999318	0.999697	0.999865	0.999940	0.999973	0.999988	0.999995	1.9
2.0	0.997022	0.998561	0.999304	0.999664	0.999837	0.999921	0.999962	0.999982	2.0
2.1	0.994620	0.997200	0.998543	0.999242	0.999605	0.999795	0.999893	0.999944	2.1
2.2	0.990882	0.994931	0.997182	0.998434	0.999129	0.999516	0.999731	0.999850	2.2
2.3	0.985388	0.991384	0.994920	0.997005	0.998234	0.998959	0.999386	0.999638	2.3
2.4	0.977718	0.986150	0.991391	0.994649	0.996674	0.997933	0.998715	0.999201	2.4
2.5	0.967484	0.978811	0.986192	0.991002	0.994137	0.996179	0.997510	0.998377	2.5
2.6	0.954364	0.968974	0.978907	0.985660	0.990251	0.993372	0.995494	0.996937	2.6
2.7	0.938136	0.956311	0.969147	0.978211	0.984613	0.989134	0.992326	0.994581	2.7
2.8	0.918691	0.940584	0.956582	0.968272	0.976815	0.983058	0.987619	0.990953	2.8
2.9	0.896045	0.921666	0.940972	0.955520	0.966483	0.974743	0.980968	0.985659	2.9
3.0	0.870331	0.899552	0.922188	0.939723	0.953307	0.963829	0.971980	0.978294	3.0
3.1	0.841788	0.874355	0.900219	0.920758	0.937070	0.950024	0.960311	0.968481	3.1
3.2	0.810743	0.846297	0.875171	0.898622	0.917666	0.933134	0.945695	0.955897	3.2
3.3	0.777588	0.815688	0.847261	0.873426	0.895109	0.913077	0.927968	0.940307	3.3
3.4	0.742752	0.782907	0.816794	0.845391	0.869525	0.889891	0.907079	0.921583	3.4
3.5	0.706685	0.748377	0.784142	0.814824	0.841145	0.863724	0.883095	0.899711	3.5
3.6	0.669834	0.712542	0.749726	0.782100	0.810286	0.834826	0.856192	0.874794	3.6
3.7	0.632625	0.675848	0.713986	0.747637	0.777328	0.803527	0.826643	0.847039	3.7
3.8	0.595455	0.638725	0.677367	0.711876	0.742694	0.770215	0.794793	0.816742	3.8
3.9	0.558679	0.601573	0.640298	0.675259	0.706822	0.735317	0.761043	0.784268	3.9
4.0	0.522608	0.564755	0.603180	0.638213	0.670153	0.699273	0.725823	0.750029	4.0
4.1	0.487504	0.528586	0.566376	0.601136	0.633110	0.662520	0.689573	0.714458	4.1
4.2	0.453579	0.493338	0.530204	0.564388	0.596084	0.625474	0.652726	0.677994	4.2
4.3	0.421003	0.459232	0.494937	0.528285	0.559431	0.588520	0.615688	0.641063	4.3
4.4	0.389900	0.426444	0.460799	0.493096	0.523458	0.552002	0.578836	0.604063	4.4
4.5	0.360358	0.395106	0.427967	0.459042	0.488429	0.516220	0.542501	0.567355	4.5
4.6	0.332428	0.365312	0.396576	0.426300	0.454560	0.481427	0.506972	0.531258	4.6
4.7	0.306133	0.337119	0.366721	0.395001	0.422019	0.447829	0.472487	0.496044	4.7
4.8	0.281473	0.310557	0.338463	0.365240	0.390934	0.415587	0.439242	0.461940	4.8
4.9	0.258424	0.285627	0.311832	0.337076	0.361394	0.384819	0.407386	0.429124	4.9
5.0	0.236949	0.262312	0.286831	0.310536	0.333453	0.355608	0.377027	0.397734	5.0

$x$	$N=80$	$N=90$	$N=100$	$N=110$	$N=120$	$N=130$	$N=140$	$N=150$	$x$
5.1	0.216995	0.240575	0.263444	0.285625	0.307138	0.328003	0.348240	0.367867	5.1
5.2	0.198503	0.220368	0.241636	0.262324	0.282448	0.302023	0.321064	0.339586	5.2
5.3	0.181403	0.201631	0.221359	0.240599	0.259364	0.277665	0.295514	0.312922	5.3
5.4	0.165625	0.184298	0.202554	0.220400	0.237848	0.254904	0.271580	0.287881	5.4
5.5	0.151093	0.168298	0.185155	0.201670	0.217850	0.233702	0.249233	0.264449	5.5
5.6	0.137732	0.153557	0.169092	0.184341	0.199311	0.214006	0.228432	0.242592	5.6
5.7	0.125465	0.139998	0.154290	0.168344	0.182165	0.195756	0.209121	0.222264	5.7
5.8	0.114219	0.127547	0.140674	0.153604	0.166339	0.178883	0.191238	0.203407	5.8
5.9	0.103922	0.116129	0.128169	0.140046	0.151760	0.163316	0.174713	0.185956	5.9
6.0	0.094505	0.105672	0.116701	0.127594	0.138353	0.148979	0.159475	0.169840	6.0
6.1	0.085900	0.096105	0.106197	0.116175	0.126042	0.135799	0.145447	0.154988	6.1
6.2	0.078046	0.087363	0.096586	0.105716	0.114754	0.123700	0.132556	0.141323	6.2
6.3	0.070882	0.079382	0.087803	0.096148	0.104416	0.112609	0.120727	0.128770	6.3
6.4	0.064354	0.072101	0.079784	0.087404	0.094960	0.102454	0.109886	0.117256	6.4
6.5	0.058408	0.065465	0.072469	0.079420	0.086319	0.093167	0.099963	0.106709	6.5
6.6	0.052996	0.059420	0.065800	0.072137	0.078431	0.084682	0.090891	0.097058	6.6
6.7	0.048073	0.053917	0.059726	0.065498	0.071236	0.076938	0.082605	0.088237	6.7
6.8	0.043597	0.048911	0.054196	0.059451	0.064677	0.069874	0.075043	0.080182	6.8
6.9	0.039529	0.044359	0.049165	0.053946	0.058704	0.063438	0.068147	0.072833	6.9
7.0	0.035834	0.040222	0.044590	0.048938	0.053267	0.057575	0.061864	0.066134	7.0
7.1	0.032479	0.036464	0.040432	0.044384	0.048320	0.052240	0.056144	0.060031	7.1
7.2	0.029433	0.033050	0.036655	0.040245	0.043823	0.047387	0.050937	0.054475	7.2
7.3	0.026669	0.029952	0.033224	0.036485	0.039735	0.042974	0.046202	0.049420	7.3
7.4	0.024161	0.027140	0.030109	0.033070	0.036022	0.038964	0.041898	0.044822	7.4
7.5	0.021886	0.024588	0.027283	0.029970	0.032649	0.035322	0.037986	0.040644	7.5
7.6	0.019824	0.022274	0.024718	0.027156	0.029588	0.032014	0.034434	0.036847	7.6
7.7	0.017954	0.020176	0.022392	0.024603	0.026810	0.029011	0.031208	0.033399	7.7
7.8	0.016259	0.018273	0.020282	0.022288	0.024289	0.026287	0.028280	0.030269	7.8
7.9	0.014723	0.016548	0.018370	0.020188	0.022003	0.023815	0.025623	0.027428	7.9
8.0	0.013331	0.014985	0.016636	0.018284	0.019930	0.021573	0.023213	0.024850	8.0
8.1	0.012070	0.013568	0.015065	0.016559	0.018050	0.019540	0.021027	0.022512	8.1
8.2	0.010928	0.012285	0.013641	0.014994	0.016346	0.017696	0.019045	0.020391	8.2
8.3	0.009893	0.011122	0.012350	0.013577	0.014802	0.016026	0.017248	0.018468	8.3
8.4	0.008955	0.010069	0.011182	0.012293	0.013403	0.014512	0.015619	0.016725	8.4
8.5	0.008107	0.009115	0.010123	0.011130	0.012135	0.013140	0.014143	0.015146	8.5
8.6	0.007338	0.008251	0.009164	0.010076	0.010987	0.011897	0.012806	0.013714	8.6
8.7	0.006642	0.007469	0.008295	0.009121	0.009946	0.010771	0.011594	0.012417	8.7
8.8	0.006012	0.006761	0.007509	0.008257	0.009004	0.009751	0.010497	0.011242	8.8
8.9	0.005441	0.006119	0.006797	0.007474	0.008150	0.008827	0.009502	0.010178	8.9
9.0	0.004925	0.005538	0.006152	0.006765	0.007378	0.007990	0.008602	0.009214	9.0
9.1	0.004457	0.005013	0.005568	0.006123	0.006678	0.007232	0.007787	0.008340	9.1
9.2	0.004034	0.004537	0.005039	0.005542	0.006044	0.006546	0.007048	0.007550	9.2
9.3	0.003650	0.004106	0.004561	0.005016	0.005471	0.005925	0.006380	0.006834	9.3
9.4	0.003304	0.003716	0.004128	0.004540	0.004951	0.005363	0.005774	0.006185	9.4
9.5	0.002990	0.003363	0.003736	0.004109	0.004481	0.004854	0.005226	0.005598	9.5
9.6	0.002706	0.003043	0.003381	0.003718	0.004056	0.004393	0.004730	0.005067	9.6
9.7	0.002448	0.002754	0.003060	0.003365	0.003670	0.003976	0.004281	0.004586	9.7
9.8	0.002216	0.002492	0.002769	0.003045	0.003322	0.003598	0.003874	0.004150	9.8
9.9	0.002005	0.002255	0.002506	0.002756	0.003006	0.003256	0.003506	0.003756	9.9
10.0	0.001814	0.002041	0.002267	0.002494	0.002720	0.002947	0.003173	0.003399	10.0

$\kappa$	$N=160$	$N=170$	$N=180$	$N=190$	$N=200$	$N=210$	$N=220$	$N=230$	$\kappa$
0.1	1.000000	1.000000	1.000000	1.000000	1.000000	1.000000	1.000000	1.000000	0.1
0.2	1.000000	1.000000	1.000000	1.000000	1.000000	1.000000	1.000000	1.000000	0.2
0.3	1.000000	1.000000	1.000000	1.000000	1.000000	1.000000	1.000000	1.000000	0.3
0.4	1.000000	1.000000	1.000000	1.000000	1.000000	1.000000	1.000000	1.000000	0.4
0.5	1.000000	1.000000	1.000000	1.000000	1.000000	1.000000	1.000000	1.000000	0.5
0.6	1.000000	1.000000	1.000000	1.000000	1.000000	1.000000	1.000000	1.000000	0.6
0.7	1.000000	1.000000	1.000000	1.000000	1.000000	1.000000	1.000000	1.000000	0.7
0.8	1.000000	1.000000	1.000000	1.000000	1.000000	1.000000	1.000000	1.000000	0.8
0.9	1.000000	1.000000	1.000000	1.000000	1.000000	1.000000	1.000000	1.000000	0.9
1.0	1.000000	1.000000	1.000000	1.000000	1.000000	1.000000	1.000000	1.000000	1.0
1.1	1.000000	1.000000	1.000000	1.000000	1.000000	1.000000	1.000000	1.000000	1.1
1.2	1.000000	1.000000	1.000000	1.000000	1.000000	1.000000	1.000000	1.000000	1.2
1.3	1.000000	1.000000	1.000000	1.000000	1.000000	1.000000	1.000000	1.000000	1.3
1.4	1.000000	1.000000	1.000000	1.000000	1.000000	1.000000	1.000000	1.000000	1.4
1.5	1.000000	1.000000	1.000000	1.000000	1.000000	1.000000	1.000000	1.000000	1.5
1.6	1.000000	1.000000	1.000000	1.000000	1.000000	1.000000	1.000000	1.000000	1.6
1.7	1.000000	1.000000	1.000000	1.000000	1.000000	1.000000	1.000000	1.000000	1.7
1.8	0.999999	1.000000	1.000000	1.000000	1.000000	1.000000	1.000000	1.000000	1.8
1.9	0.999998	0.999999	1.000000	1.000000	1.000000	1.000000	1.000000	1.000000	1.9
2.0	0.999991	0.999996	0.999998	0.999999	1.000000	1.000000	1.000000	1.000000	2.0
2.1	0.999971	0.999985	0.999992	0.999996	0.999998	0.999999	0.999999	1.000000	2.1
2.2	0.999917	0.999954	0.999974	0.999986	0.999992	0.999996	0.999998	0.999999	2.2
2.3	0.999786	0.999874	0.999926	0.999956	0.999974	0.999985	0.999991	0.999995	2.3
2.4	0.999504	0.999691	0.999808	0.999881	0.999926	0.999954	0.999971	0.999982	2.4
2.5	0.998943	0.999311	0.999551	0.999707	0.999809	0.999876	0.999919	0.999947	2.5
2.6	0.997917	0.998584	0.999137	0.999346	0.999555	0.999698	0.999794	0.999860	2.6
2.7	0.996173	0.997297	0.998091	0.998652	0.999048	0.999328	0.999525	0.999665	2.7
2.8	0.993389	0.995169	0.996470	0.997420	0.998115	0.998622	0.998993	0.999264	2.8
2.9	0.989193	0.991857	0.993864	0.995376	0.996516	0.997374	0.998022	0.998509	2.9
3.0	0.983186	0.986975	0.989910	0.992184	0.993945	0.995310	0.996367	0.997185	3.0
3.1	0.974969	0.980121	0.984213	0.987463	0.990044	0.992093	0.993721	0.995013	3.1
3.2	0.964182	0.970911	0.976375	0.980813	0.984418	0.987345	0.989722	0.991653	3.2
3.3	0.950533	0.959007	0.966029	0.971848	0.976671	0.980667	0.983979	0.986724	3.3
3.4	0.933823	0.944153	0.952871	0.960227	0.966436	0.971675	0.976096	0.979827	3.4
3.5	0.913966	0.926195	0.936686	0.945685	0.953405	0.960028	0.965710	0.970584	3.5
3.6	0.890990	0.905091	0.917368	0.928057	0.937363	0.945465	0.952519	0.958661	3.6
3.7	0.865035	0.880915	0.894926	0.907288	0.918196	0.927821	0.936313	0.943806	3.7
3.8	0.836343	0.853848	0.869480	0.883441	0.895908	0.907042	0.916984	0.925864	3.8
3.9	0.805236	0.824166	0.841256	0.856685	0.870614	0.883190	0.894543	0.904793	3.9
4.0	0.772097	0.792217	0.810561	0.827286	0.842534	0.856436	0.869110	0.880666	4.0
4.1	0.737347	0.758402	0.777769	0.795584	0.811970	0.827043	0.840907	0.853661	4.1
4.2	0.701424	0.723149	0.743294	0.761972	0.779292	0.795351	0.810242	0.824049	4.2
4.3	0.664763	0.686897	0.707570	0.726878	0.744912	0.761754	0.777485	0.792177	4.3
4.4	0.627779	0.650074	0.671034	0.690738	0.709262	0.726677	0.743048	0.758439	4.4
4.5	0.590858	0.613084	0.634103	0.653981	0.672778	0.690554	0.707365	0.723262	4.5
4.6	0.554347	0.576300	0.597171	0.617014	0.635879	0.653815	0.670868	0.687081	4.6
4.7	0.518549	0.540049	0.560589	0.580212	0.598958	0.616867	0.633977	0.650322	4.7
4.8	0.483719	0.504616	0.524668	0.543908	0.562369	0.580083	0.597080	0.613389	4.8
4.9	0.450065	0.470238	0.489671	0.508391	0.526425	0.543797	0.560531	0.576652	4.9
5.0	0.417753	0.437106	0.455816	0.473904	0.491391	0.508296	0.524640	0.540440	5.0

$x$	$N=160$	$N=170$	$N=180$	$N=190$	$N=200$	$N=210$	$N=220$	$N=230$	$x$
5.1	0.386903	0.405366	0.423273	0.440641	0.457486	0.473823	0.489669	0.505037	5.1
5.2	0.357602	0.375127	0.392173	0.408755	0.424884	0.440573	0.455835	0.470680	5.2
5.3	0.329899	0.346458	0.362607	0.378357	0.393718	0.408699	0.423310	0.437560	5.3
5.4	0.303819	0.319399	0.334631	0.349522	0.364079	0.378311	0.392224	0.405826	5.4
5.5	0.279357	0.293963	0.308272	0.322292	0.336027	0.349485	0.362669	0.375586	5.5
5.6	0.256493	0.270139	0.283534	0.296683	0.309591	0.322263	0.334701	0.346911	5.6
5.7	0.235189	0.247898	0.260397	0.272688	0.284775	0.296660	0.308349	0.319843	5.7
5.8	0.215393	0.227198	0.238826	0.250279	0.261559	0.272670	0.283614	0.294393	5.8
5.9	0.197045	0.207983	0.218772	0.229414	0.239911	0.250266	0.260479	0.270553	5.9
6.0	0.180078	0.190190	0.200177	0.210041	0.219783	0.229405	0.238908	0.248294	6.0
6.1	0.164421	0.173750	0.182974	0.192096	0.201115	0.210034	0.218853	0.227574	6.1
6.2	0.150000	0.158591	0.167094	0.175511	0.183844	0.192092	0.200256	0.208339	6.2
6.3	0.136740	0.144637	0.152462	0.160215	0.167897	0.175509	0.183051	0.190525	6.3
6.4	0.124566	0.131814	0.139003	0.146132	0.153203	0.160214	0.167168	0.174064	6.4
6.5	0.113404	0.120049	0.126643	0.133189	0.139685	0.146133	0.152532	0.158884	6.5
6.6	0.103183	0.109267	0.115309	0.121310	0.127270	0.133190	0.139070	0.144910	6.6
6.7	0.093835	0.099398	0.104927	0.110423	0.115884	0.121312	0.126707	0.132068	6.7
6.8	0.085293	0.090376	0.095430	0.100456	0.105455	0.110425	0.115368	0.120283	6.8
6.9	0.077496	0.082135	0.086751	0.091343	0.095913	0.100459	0.104983	0.109484	6.9
7.0	0.070384	0.074615	0.078826	0.083019	0.087192	0.091346	0.095482	0.099598	7.0
7.1	0.063902	0.067758	0.071598	0.075422	0.079230	0.083022	0.086799	0.090560	7.1
7.2	0.057999	0.061510	0.065008	0.068494	0.071966	0.075425	0.078871	0.082304	7.2
7.3	0.052626	0.055822	0.059006	0.062181	0.065344	0.068497	0.071639	0.074770	7.3
7.4	0.047738	0.050645	0.053543	0.056432	0.059312	0.062184	0.065046	0.067900	7.4
7.5	0.043294	0.045937	0.048572	0.051200	0.053821	0.056435	0.059041	0.061641	7.5
7.6	0.039255	0.041657	0.044052	0.046442	0.048825	0.051203	0.053575	0.055941	7.6
7.7	0.035586	0.037767	0.039944	0.042116	0.044283	0.046444	0.048601	0.050754	7.7
7.8	0.032254	0.034235	0.036212	0.038185	0.040153	0.042118	0.044079	0.046036	7.8
7.9	0.029229	0.031027	0.032822	0.034614	0.036402	0.038187	0.039969	0.041747	7.9
8.0	0.026484	0.028116	0.029745	0.031372	0.032995	0.034616	0.036234	0.037850	8.0
8.1	0.023994	0.025475	0.026953	0.028429	0.029902	0.031374	0.032843	0.034310	8.1
8.2	0.021736	0.023078	0.024419	0.025758	0.027095	0.028431	0.029764	0.031096	8.2
8.3	0.019687	0.020905	0.022121	0.023335	0.024548	0.025760	0.026970	0.028178	8.3
8.4	0.017831	0.018934	0.020037	0.021138	0.022238	0.023337	0.024435	0.025531	8.4
8.5	0.016147	0.017148	0.018147	0.019146	0.020143	0.021140	0.022135	0.023130	8.5
8.6	0.014622	0.015529	0.016435	0.017340	0.018244	0.019147	0.020050	0.020952	8.6
8.7	0.013240	0.014061	0.014882	0.015702	0.016522	0.017341	0.018159	0.018977	8.7
8.8	0.011987	0.012732	0.013475	0.014219	0.014961	0.015704	0.016445	0.017186	8.8
8.9	0.010853	0.011527	0.012201	0.012874	0.013547	0.014220	0.014892	0.015563	8.9
9.0	0.009825	0.010436	0.011046	0.011656	0.012266	0.012875	0.013484	0.014093	9.0
9.1	0.008894	0.009447	0.010000	0.010553	0.011105	0.011657	0.012209	0.012760	9.1
9.2	0.008051	0.008552	0.009053	0.009553	0.010054	0.010554	0.011053	0.011553	9.2
9.3	0.007288	0.007741	0.008195	0.008648	0.009101	0.009554	0.010007	0.010459	9.3
9.4	0.006596	0.007007	0.007418	0.007828	0.008239	0.008649	0.009059	0.009469	9.4
9.5	0.005970	0.006342	0.006714	0.007086	0.007458	0.007829	0.008200	0.008571	9.5
9.6	0.005404	0.005741	0.006077	0.006414	0.006750	0.007087	0.007423	0.007759	9.6
9.7	0.004891	0.005196	0.005500	0.005805	0.006110	0.006414	0.006719	0.007023	9.7
9.8	0.004426	0.004702	0.004978	0.005254	0.005530	0.005806	0.006081	0.006357	9.8
9.9	0.004006	0.004256	0.004506	0.004755	0.005005	0.005255	0.005504	0.005754	9.9
10.0	0.003625	0.003852	0.004078	0.004304	0.004530	0.004756	0.004982	0.005208	10.0

$\kappa$	$N=240$	$N=250$	$N=260$	$N=270$	$N=280$	$N=290$	$N=300$	$N=310$	
0.1	1.000000	1.000000	1.000000	1.000000	1.000000	1.000000	1.000000	1.000000	0.1
0.2	1.000000	1.000000	1.000000	1.000000	1.000000	1.000000	1.000000	1.000000	0.2
0.3	1.000000	1.000000	1.000000	1.000000	1.000000	1.000000	1.000000	1.000000	0.3
0.4	1.000000	1.000000	1.000000	1.000000	1.000000	1.000000	1.000000	1.000000	0.4
0.5	1.000000	1.000000	1.000000	1.000000	1.000000	1.000000	1.000000	1.000000	0.5
0.6	1.000000	1.000000	1.000000	1.000000	1.000000	1.000000	1.000000	1.000000	0.6
0.7	1.000000	1.000000	1.000000	1.000000	1.000000	1.000000	1.000000	1.000000	0.7
0.8	1.000000	1.000000	1.000000	1.000000	1.000000	1.000000	1.000000	1.000000	0.8
0.9	1.000000	1.000000	1.000000	1.000000	1.000000	1.000000	1.000000	1.000000	0.9
1.0	1.000000	1.000000	1.000000	1.000000	1.000000	1.000000	1.000000	1.000000	1.0
1.1	1.000000	1.000000	1.000000	1.000000	1.000000	1.000000	1.000000	1.000000	1.1
1.2	1.000000	1.000000	1.000000	1.000000	1.000000	1.000000	1.000000	1.000000	1.2
1.3	1.000000	1.000000	1.000000	1.000000	1.000000	1.000000	1.000000	1.000000	1.3
1.4	1.000000	1.000000	1.000000	1.000000	1.000000	1.000000	1.000000	1.000000	1.4
1.5	1.000000	1.000000	1.000000	1.000000	1.000000	1.000000	1.000000	1.000000	1.5
1.6	1.000000	1.000000	1.000000	1.000000	1.000000	1.000000	1.000000	1.000000	1.6
1.7	1.000000	1.000000	1.000000	1.000000	1.000000	1.000000	1.000000	1.000000	1.7
1.8	1.000000	1.000000	1.000000	1.000000	1.000000	1.000000	1.000000	1.000000	1.8
1.9	1.000000	1.000000	1.000000	1.000000	1.000000	1.000000	1.000000	1.000000	1.9
2.0	1.000000	1.000000	1.000000	1.000000	1.000000	1.000000	1.000000	1.000000	2.0
2.1	1.000000	1.000000	1.000000	1.000000	1.000000	1.000000	1.000000	1.000000	2.1
2.2	0.999999	1.000000	1.000000	1.000000	1.000000	1.000000	1.000000	1.000000	2.2
2.3	0.999997	0.999998	0.999999	0.999999	1.000000	1.000000	1.000000	1.000000	2.3
2.4	0.999989	0.999993	0.999996	0.999997	0.999998	0.999999	0.999999	1.000000	2.4
2.5	0.999966	0.999978	0.999985	0.999990	0.999994	0.999996	0.999997	0.999998	2.5
2.6	0.999905	0.999935	0.999956	0.999970	0.999980	0.999986	0.999991	0.999994	2.6
2.7	0.999763	0.999833	0.999882	0.999917	0.999941	0.999958	0.999971	0.999979	2.7
2.8	0.999462	0.999507	0.999713	0.999790	0.999847	0.999888	0.999918	0.999940	2.8
2.9	0.998877	0.999153	0.999362	0.999519	0.999638	0.999727	0.999794	0.999845	2.9
3.0	0.997820	0.998311	0.998692	0.998986	0.999215	0.999392	0.999529	0.999635	3.0
3.1	0.996040	0.996855	0.997502	0.998016	0.998425	0.998749	0.999007	0.999211	3.1
3.2	0.993221	0.994495	0.995529	0.996369	0.997051	0.997605	0.998055	0.998420	3.2
3.3	0.988998	0.990883	0.992444	0.993739	0.994811	0.995700	0.996437	0.997047	3.3
3.4	0.982976	0.985634	0.987876	0.989769	0.991366	0.992713	0.993851	0.994811	3.4
3.5	0.974765	0.978352	0.981429	0.984069	0.986333	0.988276	0.989942	0.991372	3.5
3.6	0.964009	0.968664	0.972718	0.976247	0.979319	0.981994	0.984324	0.986351	3.6
3.7	0.950417	0.956251	0.961398	0.965940	0.969947	0.973483	0.976603	0.979356	3.7
3.8	0.933793	0.940875	0.947199	0.952847	0.957890	0.962394	0.966416	0.970009	3.8
3.9	0.914047	0.922401	0.929943	0.936752	0.942899	0.948449	0.953460	0.957983	3.9
4.0	0.891201	0.900806	0.909564	0.917548	0.924827	0.931464	0.937514	0.943031	4.0
4.1	0.865391	0.876182	0.886107	0.895237	0.903655	0.911360	0.918466	0.925002	4.1
4.2	0.836852	0.848723	0.859730	0.869937	0.879401	0.888176	0.896312	0.903857	4.2
4.3	0.805899	0.818714	0.830684	0.841863	0.852305	0.862056	0.871164	0.879671	4.3
4.4	0.772908	0.786510	0.799298	0.811319	0.822621	0.833246	0.843234	0.852624	4.4
4.5	0.738296	0.752513	0.765957	0.778671	0.790695	0.802065	0.812818	0.822987	4.5
4.6	0.702495	0.717150	0.731082	0.744329	0.756923	0.768897	0.780281	0.791104	4.6
4.7	0.665937	0.680856	0.695107	0.708723	0.721730	0.734157	0.746029	0.757370	4.7
4.8	0.629038	0.644053	0.658461	0.672286	0.685550	0.698278	0.710491	0.722210	4.8
4.9	0.592182	0.607142	0.621553	0.635435	0.648808	0.661691	0.674101	0.686056	4.9
5.0	0.555715	0.570483	0.584760	0.598562	0.611905	0.624805	0.637276	0.649332	5.0

$\kappa$	$N = 240$	$N = 250$	$N = 260$	$N = 270$	$N = 280$	$N = 290$	$N = 300$	$N = 310$	$\kappa$
5.1	0.519942	0.534399	0.548420	0.562019	0.575209	0.588001	0.600408	0.612441	5.1
5.2	0.485119	0.499166	0.512828	0.526118	0.539046	0.551621	0.563853	0.575751	5.2
5.3	0.451458	0.465012	0.478232	0.491125	0.503699	0.515963	0.527923	0.539588	5.3
5.4	0.419124	0.432124	0.444833	0.457257	0.469404	0.481278	0.492887	0.504236	5.4
5.5	0.388241	0.400640	0.412788	0.424689	0.436349	0.447773	0.458965	0.469931	5.5
5.6	0.358898	0.370664	0.382214	0.393552	0.404683	0.415608	0.426334	0.436862	5.6
5.7	0.331146	0.342261	0.353191	0.363940	0.374510	0.384905	0.395127	0.405179	5.7
5.8	0.305010	0.315467	0.325767	0.335911	0.345904	0.355745	0.365439	0.374987	5.8
5.9	0.280490	0.290291	0.299959	0.309495	0.318902	0.328180	0.337332	0.346359	5.9
6.0	0.257565	0.266721	0.275764	0.284696	0.293517	0.302230	0.310835	0.319334	6.0
6.1	0.236198	0.244725	0.253157	0.261495	0.269740	0.277892	0.285954	0.293926	6.1
6.2	0.216339	0.224259	0.232099	0.239859	0.247541	0.255146	0.262673	0.270125	6.2
6.3	0.197930	0.205267	0.212537	0.219741	0.226878	0.233951	0.240969	0.247902	6.3
6.4	0.180903	0.187685	0.194411	0.201082	0.207697	0.214258	0.220764	0.227216	6.4
6.5	0.165188	0.171444	0.177654	0.183817	0.189934	0.196005	0.202031	0.208012	6.5
6.6	0.150711	0.156472	0.162194	0.167877	0.173521	0.179128	0.184696	0.190226	6.6
6.7	0.137397	0.142693	0.147956	0.153187	0.158386	0.163553	0.168688	0.173792	6.7
6.8	0.125172	0.130033	0.134867	0.139674	0.144454	0.149208	0.153935	0.158636	6.8
6.9	0.113962	0.118418	0.122851	0.127262	0.131651	0.136017	0.140362	0.144685	6.9
7.0	0.103696	0.107775	0.111836	0.115878	0.119902	0.123907	0.127894	0.131863	7.0
7.1	0.094306	0.098036	0.101751	0.105451	0.109135	0.112804	0.116458	0.120097	7.1
7.2	0.085725	0.089133	0.092528	0.095910	0.099280	0.102637	0.105982	0.109315	7.2
7.3	0.077891	0.081002	0.084101	0.087191	0.090270	0.093339	0.096397	0.099445	7.3
7.4	0.070746	0.073582	0.076410	0.079229	0.082040	0.084842	0.087636	0.090421	7.4
7.5	0.064233	0.066818	0.069395	0.071966	0.074530	0.077086	0.079636	0.082178	7.5
7.6	0.058301	0.060655	0.063003	0.065345	0.067681	0.070012	0.072337	0.074656	7.6
7.7	0.052901	0.055043	0.057181	0.059314	0.061442	0.063565	0.065683	0.067796	7.7
7.8	0.047989	0.049937	0.051882	0.053823	0.055760	0.057693	0.059622	0.061546	7.8
7.9	0.043522	0.045294	0.047062	0.048827	0.050589	0.052348	0.054103	0.055855	7.9
8.0	0.039463	0.041073	0.042680	0.044285	0.045887	0.047486	0.049082	0.050676	8.0
8.1	0.035775	0.037237	0.038697	0.040156	0.041611	0.043065	0.044516	0.045966	8.1
8.2	0.032426	0.033754	0.035080	0.036404	0.037727	0.039047	0.040366	0.041683	8.2
8.3	0.029385	0.030591	0.031795	0.032997	0.034198	0.035398	0.036596	0.037792	8.3
8.4	0.026626	0.027720	0.028813	0.029904	0.030994	0.032083	0.033171	0.034258	8.4
8.5	0.024123	0.025115	0.026107	0.027097	0.028087	0.029075	0.030062	0.031049	8.5
8.6	0.021852	0.022753	0.023652	0.024550	0.025448	0.026345	0.027241	0.028136	8.6
8.7	0.019793	0.020610	0.021425	0.022240	0.023054	0.023868	0.024680	0.025492	8.7
8.8	0.017927	0.018667	0.019406	0.020145	0.020883	0.021621	0.022358	0.023095	8.8
8.9	0.016235	0.016905	0.017575	0.018245	0.018915	0.019583	0.020252	0.020920	8.9
9.0	0.014701	0.015309	0.015916	0.016523	0.017130	0.017736	0.018342	0.018948	9.0
9.1	0.013311	0.013862	0.014412	0.014963	0.015513	0.016062	0.016611	0.017160	9.1
9.2	0.012052	0.012551	0.013050	0.013548	0.014047	0.014545	0.015042	0.015540	9.2
9.3	0.010911	0.011363	0.011815	0.012267	0.012718	0.013170	0.013621	0.014071	9.3
9.4	0.009878	0.010288	0.010697	0.011106	0.011515	0.011924	0.012332	0.012741	9.4
9.5	0.008942	0.009313	0.009684	0.010054	0.010425	0.010795	0.011165	0.011535	9.5
9.6	0.008095	0.008431	0.008766	0.009102	0.009438	0.009773	0.010108	0.010443	9.6
9.7	0.007327	0.007631	0.007935	0.008239	0.008543	0.008847	0.009151	0.009454	9.7
9.8	0.006632	0.006908	0.007183	0.007458	0.007733	0.008008	0.008283	0.008558	9.8
9.9	0.006003	0.006252	0.006502	0.006751	0.007000	0.007249	0.007498	0.007747	9.9
10.0	0.005433	0.005659	0.005885	0.006110	0.006336	0.006562	0.006787	0.007012	10.0



$\kappa$	$N=320$	$N=330$	$N=340$	$N=350$	$N=360$	$N=370$	$N=380$	$N=390$	$\kappa$
0.1	1.000000	1.000000	1.000000	1.000000	1.000000	1.000000	1.000000	1.000000	0.1
0.2	1.000000	1.000000	1.000000	1.000000	1.000000	1.000000	1.000000	1.000000	0.2
0.3	1.000000	1.000000	1.000000	1.000000	1.000000	1.000000	1.000000	1.000000	0.3
0.4	1.000000	1.000000	1.000000	1.000000	1.000000	1.000000	1.000000	1.000000	0.4
0.5	1.000000	1.000000	1.000000	1.000000	1.000000	1.000000	1.000000	1.000000	0.5
0.6	1.000000	1.000000	1.000000	1.000000	1.000000	1.000000	1.000000	1.000000	0.6
0.7	1.000000	1.000000	1.000000	1.000000	1.000000	1.000000	1.000000	1.000000	0.7
0.8	1.000000	1.000000	1.000000	1.000000	1.000000	1.000000	1.000000	1.000000	0.8
0.9	1.000000	1.000000	1.000000	1.000000	1.000000	1.000000	1.000000	1.000000	0.9
1.0	1.000000	1.000000	1.000000	1.000000	1.000000	1.000000	1.000000	1.000000	1.0
1.1	1.000000	1.000000	1.000000	1.000000	1.000000	1.000000	1.000000	1.000000	1.1
1.2	1.000000	1.000000	1.000000	1.000000	1.000000	1.000000	1.000000	1.000000	1.2
1.3	1.000000	1.000000	1.000000	1.000000	1.000000	1.000000	1.000000	1.000000	1.3
1.4	1.000000	1.000000	1.000000	1.000000	1.000000	1.000000	1.000000	1.000000	1.4
1.5	1.000000	1.000000	1.000000	1.000000	1.000000	1.000000	1.000000	1.000000	1.5
1.6	1.000000	1.000000	1.000000	1.000000	1.000000	1.000000	1.000000	1.000000	1.6
1.7	1.000000	1.000000	1.000000	1.000000	1.000000	1.000000	1.000000	1.000000	1.7
1.8	1.000000	1.000000	1.000000	1.000000	1.000000	1.000000	1.000000	1.000000	1.8
1.9	1.000000	1.000000	1.000000	1.000000	1.000000	1.000000	1.000000	1.000000	1.9
2.0	1.000000	1.000000	1.000000	1.000000	1.000000	1.000000	1.000000	1.000000	2.0
2.1	1.000000	1.000000	1.000000	1.000000	1.000000	1.000000	1.000000	1.000000	2.1
2.2	1.000000	1.000000	1.000000	1.000000	1.000000	1.000000	1.000000	1.000000	2.2
2.3	1.000000	1.000000	1.000000	1.000000	1.000000	1.000000	1.000000	1.000000	2.3
2.4	1.000000	1.000000	1.000000	1.000000	1.000000	1.000000	1.000000	1.000000	2.4
2.5	0.999999	0.999999	1.000000	1.000000	1.000000	1.000000	1.000000	1.000000	2.5
2.6	0.999996	0.999997	0.999998	0.999999	0.999999	0.999999	1.000000	1.000000	2.6
2.7	0.999985	0.999990	0.999993	0.999995	0.999996	0.999997	0.999998	0.999999	2.7
2.8	0.999956	0.999968	0.999977	0.999983	0.999988	0.999991	0.999993	0.999995	2.8
2.9	0.999883	0.999912	0.999934	0.999950	0.999962	0.999972	0.999979	0.999984	2.9
3.0	0.999717	0.999781	0.999830	0.999869	0.999898	0.999921	0.999939	0.999953	3.0
3.1	0.999373	0.999502	0.999605	0.999686	0.999751	0.999802	0.999843	0.999875	3.1
3.2	0.998717	0.998958	0.999154	0.999315	0.999442	0.999547	0.999632	0.999701	3.2
3.3	0.997553	0.997972	0.998320	0.998607	0.998846	0.999044	0.999207	0.999343	3.3
3.4	0.995621	0.996304	0.996881	0.997368	0.997779	0.998126	0.998418	0.998665	3.4
3.5	0.992598	0.993650	0.994553	0.995327	0.995991	0.996561	0.997050	0.997469	3.5
3.6	0.988117	0.989654	0.990992	0.992157	0.993172	0.994055	0.994824	0.995494	3.6
3.7	0.981785	0.983928	0.985819	0.987487	0.988959	0.990258	0.991404	0.992416	3.7
3.8	0.973216	0.976081	0.978640	0.980924	0.982965	0.984787	0.986414	0.987867	3.8
3.9	0.962067	0.965754	0.969082	0.972087	0.974800	0.977250	0.979461	0.981457	3.9
4.0	0.948060	0.952646	0.956826	0.960638	0.964113	0.967281	0.970170	0.972803	4.0
4.1	0.931014	0.936544	0.941630	0.946310	0.950613	0.954572	0.958214	0.961564	4.1
4.2	0.910853	0.917339	0.923354	0.928931	0.934102	0.938897	0.943343	0.947465	4.2
4.3	0.887616	0.895036	0.901967	0.908439	0.914485	0.920131	0.925405	0.930330	4.3
4.4	0.861451	0.869750	0.877552	0.884886	0.891781	0.898263	0.904357	0.910086	4.4
4.5	0.832603	0.841697	0.850296	0.858429	0.866120	0.873393	0.880271	0.886775	4.5
4.6	0.801394	0.811177	0.820478	0.829321	0.837729	0.845722	0.853322	0.860547	4.6
4.7	0.768205	0.778556	0.788445	0.797893	0.806918	0.815540	0.823778	0.831647	4.7
4.8	0.733454	0.744243	0.754595	0.764528	0.774060	0.783205	0.791980	0.800400	4.8
4.9	0.697572	0.708666	0.719353	0.729647	0.739565	0.749118	0.758321	0.767186	4.9
5.0	0.660988	0.672256	0.683150	0.693682	0.703864	0.713707	0.723223	0.732423	5.0

$\kappa$	$N=320$	$N=330$	$N=340$	$N=350$	$N=360$	$N=370$	$N=380$	$N=390$	$\kappa$
5.1	0.624112	0.635432	0.646411	0.657059	0.667386	0.677403	0.687117	0.696540	5.1
5.2	0.587325	0.598582	0.609533	0.620185	0.630547	0.640625	0.650429	0.659965	5.2
5.3	0.550965	0.562061	0.572882	0.583436	0.593730	0.603769	0.613560	0.623109	5.3
5.4	0.515331	0.526178	0.536782	0.547149	0.557284	0.567192	0.576878	0.586347	5.4
5.5	0.480674	0.491199	0.501511	0.511615	0.521513	0.531211	0.540712	0.550021	5.5
5.6	0.447198	0.457343	0.467303	0.477079	0.486677	0.496098	0.505346	0.514424	5.6
5.7	0.415064	0.424784	0.434343	0.443743	0.452988	0.462078	0.471017	0.479808	5.7
5.8	0.384391	0.393654	0.402777	0.411763	0.420614	0.429332	0.437918	0.446376	5.8
5.9	0.355263	0.364046	0.372709	0.381254	0.389683	0.397997	0.406198	0.414287	5.9
6.0	0.327728	0.336019	0.344208	0.352295	0.360283	0.368172	0.375964	0.383660	6.0
6.1	0.301809	0.309603	0.317311	0.324933	0.332469	0.339922	0.347291	0.354578	6.1
6.2	0.277501	0.284802	0.292030	0.299185	0.306267	0.313278	0.320218	0.327088	6.2
6.3	0.254782	0.261599	0.268354	0.275047	0.281679	0.288250	0.294761	0.301213	6.3
6.4	0.233615	0.239961	0.246254	0.252495	0.258685	0.264823	0.270910	0.276947	6.4
6.5	0.213947	0.219838	0.225685	0.231489	0.237248	0.242965	0.248639	0.254270	6.5
6.6	0.195719	0.201175	0.206594	0.211976	0.217321	0.222630	0.227904	0.233141	6.6
6.7	0.178865	0.183906	0.188916	0.193896	0.198845	0.203763	0.208652	0.213510	6.7
6.8	0.163311	0.167960	0.172584	0.177181	0.181753	0.186300	0.190821	0.195317	6.8
6.9	0.148986	0.153266	0.157524	0.161760	0.165976	0.170170	0.174343	0.178495	6.9
7.0	0.135814	0.139747	0.143662	0.147560	0.151439	0.155301	0.159145	0.162972	7.0
7.1	0.123721	0.127331	0.130925	0.134504	0.138069	0.141619	0.145145	0.148675	7.1
7.2	0.112635	0.115942	0.119237	0.122520	0.125791	0.129049	0.132296	0.135530	7.2
7.3	0.102483	0.105510	0.108527	0.111534	0.114531	0.117518	0.120495	0.123461	7.3
7.4	0.093197	0.095965	0.098725	0.101476	0.104219	0.106953	0.109679	0.112397	7.4
7.5	0.084713	0.087242	0.089763	0.092277	0.094785	0.097285	0.099779	0.102266	7.5
7.6	0.076969	0.079276	0.081578	0.083874	0.086164	0.088448	0.090737	0.093000	7.6
7.7	0.069905	0.072009	0.074108	0.076203	0.078293	0.080377	0.082458	0.084533	7.7
7.8	0.063467	0.065385	0.067298	0.069207	0.071112	0.073014	0.074911	0.076805	7.8
7.9	0.057604	0.059350	0.061092	0.062831	0.064567	0.066300	0.068030	0.069756	7.9
8.0	0.052268	0.053856	0.055442	0.057025	0.058606	0.060184	0.061759	0.063332	8.0
8.1	0.047413	0.048858	0.050300	0.051741	0.053179	0.054615	0.056049	0.057481	8.1
8.2	0.042999	0.044312	0.045624	0.046934	0.048242	0.049548	0.050853	0.052155	8.2
8.3	0.038987	0.040181	0.041373	0.042563	0.043753	0.044940	0.046126	0.047311	8.3
8.4	0.035343	0.036427	0.037510	0.038592	0.039672	0.040752	0.041830	0.042906	8.4
8.5	0.032034	0.033018	0.034002	0.034984	0.035965	0.036946	0.037925	0.038903	8.5
8.6	0.029030	0.029923	0.030816	0.031708	0.032599	0.033489	0.034378	0.035267	8.6
8.7	0.026304	0.027115	0.027925	0.028734	0.029543	0.030351	0.031158	0.031965	8.7
8.8	0.023831	0.024566	0.025301	0.026035	0.026769	0.027502	0.028235	0.028967	8.8
8.9	0.021587	0.022254	0.022921	0.023587	0.024253	0.024918	0.025583	0.026247	8.9
9.0	0.019553	0.020158	0.020762	0.021366	0.021970	0.022574	0.023177	0.023779	9.0
9.1	0.017709	0.018257	0.018805	0.019353	0.019900	0.020447	0.020994	0.021541	9.1
9.2	0.016037	0.016534	0.017031	0.017527	0.018024	0.018520	0.019015	0.019511	9.2
9.3	0.014522	0.014972	0.015423	0.015873	0.016322	0.016772	0.017221	0.017671	9.3
9.4	0.013149	0.013557	0.013965	0.014373	0.014781	0.015188	0.015595	0.016002	9.4
9.5	0.011905	0.012275	0.012645	0.013014	0.013383	0.013753	0.014122	0.014491	9.5
9.6	0.010778	0.011113	0.011448	0.011783	0.012118	0.012452	0.012786	0.013121	9.6
9.7	0.009758	0.010061	0.010364	0.010668	0.010971	0.011274	0.011577	0.011880	9.7
9.8	0.008833	0.009108	0.009383	0.009657	0.009932	0.010206	0.010481	0.010755	9.8
9.9	0.007996	0.008245	0.008494	0.008742	0.008991	0.009240	0.009488	0.009737	9.9
10.0	0.007238	0.007463	0.007688	0.007914	0.008139	0.008364	0.008589	0.008814	10.0

$\kappa$	$N=400$	$N=410$	$N=420$	$N=430$	$N=440$	$N=450$	$N=460$	$N=470$	$\kappa$
0.1	1.000000	1.000000	1.000000	1.000000	1.000000	1.000000	1.000000	1.000000	0.1
0.2	1.000000	1.000000	1.000000	1.000000	1.000000	1.000000	1.000000	1.000000	0.2
0.3	1.000000	1.000000	1.000000	1.000000	1.000000	1.000000	1.000000	1.000000	0.3
0.4	1.000000	1.000000	1.000000	1.000000	1.000000	1.000000	1.000000	1.000000	0.4
0.5	1.000000	1.000000	1.000000	1.000000	1.000000	1.000000	1.000000	1.000000	0.5
0.6	1.000000	1.000000	1.000000	1.000000	1.000000	1.000000	1.000000	1.000000	0.6
0.7	1.000000	1.000000	1.000000	1.000000	1.000000	1.000000	1.000000	1.000000	0.7
0.8	1.000000	1.000000	1.000000	1.000000	1.000000	1.000000	1.000000	1.000000	0.8
0.9	1.000000	1.000000	1.000000	1.000000	1.000000	1.000000	1.000000	1.000000	0.9
1.0	1.000000	1.000000	1.000000	1.000000	1.000000	1.000000	1.000000	1.000000	1.0
1.1	1.000000	1.000000	1.000000	1.000000	1.000000	1.000000	1.000000	1.000000	1.1
1.2	1.000000	1.000000	1.000000	1.000000	1.000000	1.000000	1.000000	1.000000	1.2
1.3	1.000000	1.000000	1.000000	1.000000	1.000000	1.000000	1.000000	1.000000	1.3
1.4	1.000000	1.000000	1.000000	1.000000	1.000000	1.000000	1.000000	1.000000	1.4
1.5	1.000000	1.000000	1.000000	1.000000	1.000000	1.000000	1.000000	1.000000	1.5
1.6	1.000000	1.000000	1.000000	1.000000	1.000000	1.000000	1.000000	1.000000	1.6
1.7	1.000000	1.000000	1.000000	1.000000	1.000000	1.000000	1.000000	1.000000	1.7
1.8	1.000000	1.000000	1.000000	1.000000	1.000000	1.000000	1.000000	1.000000	1.8
1.9	1.000000	1.000000	1.000000	1.000000	1.000000	1.000000	1.000000	1.000000	1.9
2.0	1.000000	1.000000	1.000000	1.000000	1.000000	1.000000	1.000000	1.000000	2.0
2.1	1.000000	1.000000	1.000000	1.000000	1.000000	1.000000	1.000000	1.000000	2.1
2.2	1.000000	1.000000	1.000000	1.000000	1.000000	1.000000	1.000000	1.000000	2.2
2.3	1.000000	1.000000	1.000000	1.000000	1.000000	1.000000	1.000000	1.000000	2.3
2.4	1.000000	1.000000	1.000000	1.000000	1.000000	1.000000	1.000000	1.000000	2.4
2.5	1.000000	1.000000	1.000000	1.000000	1.000000	1.000000	1.000000	1.000000	2.5
2.6	1.000000	1.000000	1.000000	1.000000	1.000000	1.000000	1.000000	1.000000	2.6
2.7	0.999999	0.999999	1.000000	1.000000	1.000000	1.000000	1.000000	1.000000	2.7
2.8	0.999996	0.999997	0.999998	0.999999	0.999999	0.999999	0.999999	1.000000	2.8
2.9	0.999988	0.999991	0.999993	0.999995	0.999996	0.999997	0.999998	0.999998	2.9
3.0	0.999963	0.999972	0.999978	0.999983	0.999987	0.999990	0.999992	0.999994	3.0
3.1	0.999901	0.999921	0.999937	0.999950	0.999961	0.999969	0.999975	0.999980	3.1
3.2	0.999757	0.999803	0.999840	0.999870	0.999894	0.999914	0.999930	0.999943	3.2
3.3	0.999456	0.999549	0.999626	0.999690	0.999743	0.999787	0.999824	0.999854	3.3
3.4	0.998873	0.999049	0.999198	0.999323	0.999429	0.999518	0.999593	0.999657	3.4
3.5	0.997829	0.998138	0.998402	0.998629	0.998824	0.998991	0.999135	0.999258	3.5
3.6	0.996077	0.996584	0.997026	0.997411	0.997746	0.998037	0.998291	0.998512	3.6
3.7	0.993308	0.994095	0.994790	0.995403	0.995944	0.996421	0.996842	0.997214	3.7
3.8	0.989165	0.990324	0.991359	0.992283	0.993108	0.993846	0.994504	0.995092	3.8
3.9	0.983259	0.984886	0.986355	0.987682	0.988879	0.989960	0.990936	0.991817	3.9
4.0	0.975204	0.977393	0.979389	0.981209	0.982868	0.984380	0.985759	0.987017	4.0
4.1	0.964645	0.967479	0.970086	0.972484	0.974690	0.976718	0.978585	0.980301	4.1
4.2	0.951288	0.954832	0.958119	0.961166	0.963992	0.966612	0.969041	0.971294	4.2
4.3	0.934930	0.939226	0.943239	0.946987	0.950487	0.953756	0.956809	0.959661	4.3
4.4	0.915471	0.920535	0.925294	0.929769	0.933976	0.937930	0.941648	0.945143	4.4
4.5	0.892926	0.898742	0.904243	0.909445	0.914365	0.919017	0.923416	0.927576	4.5
4.6	0.867416	0.873947	0.880156	0.886060	0.891672	0.897008	0.902082	0.906905	4.6
4.7	0.839165	0.846348	0.853209	0.859764	0.866027	0.872010	0.877725	0.883186	4.7
4.8	0.808479	0.816232	0.823670	0.830807	0.837656	0.844227	0.850532	0.856582	4.8
4.9	0.775727	0.783954	0.791879	0.799513	0.806867	0.813952	0.820777	0.827351	4.9
5.0	0.741316	0.749915	0.758227	0.766264	0.774033	0.781544	0.788805	0.795825	5.0

$\kappa$	$N = 400$	$N = 410$	$N = 420$	$N = 430$	$N = 440$	$N = 450$	$N = 460$	$N = 470$	$\kappa$
5.1	0.705678	0.714541	0.723138	0.731475	0.739562	0.747405	0.755011	0.762389	5.1
5.2	0.669242	0.678265	0.687042	0.695579	0.703884	0.711962	0.719820	0.727463	5.2
5.3	0.632422	0.641504	0.650363	0.659002	0.667429	0.675646	0.683661	0.691478	5.3
5.4	0.595605	0.604655	0.613503	0.622152	0.630609	0.638876	0.646957	0.654858	5.4
5.5	0.559140	0.568076	0.576830	0.585406	0.593809	0.602042	0.610107	0.618009	5.5
5.6	0.523336	0.532084	0.540672	0.549102	0.557377	0.565501	0.573475	0.581303	5.6
5.7	0.488453	0.496954	0.505313	0.513534	0.521618	0.529568	0.537386	0.545074	5.7
5.8	0.454706	0.462910	0.470992	0.478951	0.486791	0.494513	0.502119	0.509610	5.8
5.9	0.422265	0.430136	0.437898	0.445556	0.453109	0.460558	0.467907	0.475155	5.9
6.0	0.391261	0.398768	0.406183	0.413506	0.420739	0.427883	0.434939	0.441907	6.0
6.1	0.361783	0.368908	0.375954	0.382921	0.389810	0.396622	0.403359	0.410020	6.1
6.2	0.333889	0.340620	0.347284	0.353881	0.360410	0.366874	0.373272	0.379606	6.2
6.3	0.307605	0.313939	0.320215	0.326433	0.332595	0.338700	0.344750	0.350744	6.3
6.4	0.282934	0.288872	0.294760	0.300600	0.306391	0.312134	0.317830	0.323478	6.4
6.5	0.259859	0.265406	0.270911	0.276375	0.281799	0.287181	0.292524	0.297826	6.5
6.6	0.238343	0.243509	0.248641	0.253738	0.258800	0.263828	0.268821	0.273781	6.6
6.7	0.218339	0.223138	0.227907	0.232648	0.237359	0.242041	0.246694	0.251319	6.7
6.8	0.199788	0.204235	0.208656	0.213054	0.217426	0.221775	0.226099	0.230399	6.8
6.9	0.182626	0.186737	0.190826	0.194895	0.198944	0.202972	0.206981	0.210968	6.9
7.0	0.166782	0.170574	0.174349	0.178106	0.181847	0.185570	0.189277	0.192966	7.0
7.1	0.152182	0.155674	0.159151	0.162615	0.166063	0.169498	0.172919	0.176325	7.1
7.2	0.138752	0.141962	0.145161	0.148347	0.151521	0.154684	0.157835	0.160974	7.2
7.3	0.126418	0.129365	0.132302	0.135228	0.138145	0.141053	0.143950	0.146838	7.3
7.4	0.115106	0.117808	0.120501	0.123185	0.125862	0.128530	0.131190	0.133842	7.4
7.5	0.104746	0.107219	0.109685	0.112144	0.114597	0.117043	0.119482	0.121914	7.5
7.6	0.095267	0.097529	0.099784	0.102035	0.104280	0.106519	0.108752	0.110980	7.6
7.7	0.086604	0.088670	0.090732	0.092789	0.094841	0.096888	0.098931	0.100970	7.7
7.8	0.078695	0.080581	0.082463	0.084341	0.086215	0.088086	0.089952	0.091815	7.8
7.9	0.071479	0.073199	0.074916	0.076629	0.078340	0.080047	0.081751	0.083452	7.9
8.0	0.064902	0.066469	0.068034	0.069596	0.071156	0.072713	0.074267	0.075819	8.0
8.1	0.058911	0.060338	0.061763	0.063186	0.064607	0.066026	0.067443	0.068857	8.1
8.2	0.053456	0.054756	0.056053	0.057349	0.058642	0.059934	0.061225	0.062513	8.2
8.3	0.048494	0.049676	0.050856	0.052035	0.053212	0.054388	0.055563	0.056736	8.3
8.4	0.043982	0.045056	0.046130	0.047202	0.048272	0.049342	0.050410	0.051477	8.4
8.5	0.039881	0.040857	0.041833	0.042807	0.043780	0.044753	0.045724	0.046695	8.5
8.6	0.036155	0.037042	0.037928	0.038813	0.039698	0.040581	0.041464	0.042346	8.6
8.7	0.032771	0.033576	0.034381	0.035185	0.035988	0.036791	0.037593	0.038394	8.7
8.8	0.029699	0.030430	0.031161	0.031890	0.032620	0.033349	0.034077	0.034805	8.8
8.9	0.026911	0.027574	0.028237	0.028900	0.029562	0.030223	0.030885	0.031545	8.9
9.0	0.024381	0.024983	0.025585	0.026186	0.026787	0.027387	0.027987	0.028587	9.0
9.1	0.022087	0.022633	0.023178	0.023724	0.024269	0.024813	0.025358	0.025902	9.1
9.2	0.020006	0.020501	0.020996	0.021490	0.021985	0.022479	0.022972	0.023466	9.2
9.3	0.018120	0.018568	0.019017	0.019465	0.019913	0.020361	0.020809	0.021256	9.3
9.4	0.016409	0.016816	0.017223	0.017629	0.018035	0.018442	0.018847	0.019253	9.4
9.5	0.014859	0.015228	0.015597	0.015965	0.016333	0.016701	0.017069	0.017437	9.5
9.6	0.013455	0.013789	0.014123	0.014457	0.014790	0.015124	0.015457	0.015791	9.6
9.7	0.012182	0.012485	0.012787	0.013090	0.013392	0.013695	0.013997	0.014299	9.7
9.8	0.011029	0.011304	0.011578	0.011852	0.012126	0.012399	0.012673	0.012947	9.8
9.9	0.009985	0.010233	0.010482	0.010730	0.010978	0.011226	0.011474	0.011722	9.9
10.0	0.009039	0.009264	0.009489	0.009714	0.009938	0.010163	0.010388	0.010613	10.0

$x$	$N=480$	$N=490$	$N=500$	$N=510$	$N=520$	$N=530$	$N=540$	$N=550$	$x$
0.1	1.000000	1.000000	1.000000	1.000000	1.000000	1.000000	1.000000	1.000000	0.1
0.2	1.000000	1.000000	1.000000	1.000000	1.000000	1.000000	1.000000	1.000000	0.2
0.3	1.000000	1.000000	1.000000	1.000000	1.000000	1.000000	1.000000	1.000000	0.3
0.4	1.000000	1.000000	1.000000	1.000000	1.000000	1.000000	1.000000	1.000000	0.4
0.5	1.000000	1.000000	1.000000	1.000000	1.000000	1.000000	1.000000	1.000000	0.5
0.6	1.000000	1.000000	1.000000	1.000000	1.000000	1.000000	1.000000	1.000000	0.6
0.7	1.000000	1.000000	1.000000	1.000000	1.000000	1.000000	1.000000	1.000000	0.7
0.8	1.000000	1.000000	1.000000	1.000000	1.000000	1.000000	1.000000	1.000000	0.8
0.9	1.000000	1.000000	1.000000	1.000000	1.000000	1.000000	1.000000	1.000000	0.9
1.0	1.000000	1.000000	1.000000	1.000000	1.000000	1.000000	1.000000	1.000000	1.0
1.1	1.000000	1.000000	1.000000	1.000000	1.000000	1.000000	1.000000	1.000000	1.1
1.2	1.000000	1.000000	1.000000	1.000000	1.000000	1.000000	1.000000	1.000000	1.2
1.3	1.000000	1.000000	1.000000	1.000000	1.000000	1.000000	1.000000	1.000000	1.3
1.4	1.000000	1.000000	1.000000	1.000000	1.000000	1.000000	1.000000	1.000000	1.4
1.5	1.000000	1.000000	1.000000	1.000000	1.000000	1.000000	1.000000	1.000000	1.5
1.6	1.000000	1.000000	1.000000	1.000000	1.000000	1.000000	1.000000	1.000000	1.6
1.7	1.000000	1.000000	1.000000	1.000000	1.000000	1.000000	1.000000	1.000000	1.7
1.8	1.000000	1.000000	1.000000	1.000000	1.000000	1.000000	1.000000	1.000000	1.8
1.9	1.000000	1.000000	1.000000	1.000000	1.000000	1.000000	1.000000	1.000000	1.9
2.0	1.000000	1.000000	1.000000	1.000000	1.000000	1.000000	1.000000	1.000000	2.0
2.1	1.000000	1.000000	1.000000	1.000000	1.000000	1.000000	1.000000	1.000000	2.1
2.2	1.000000	1.000000	1.000000	1.000000	1.000000	1.000000	1.000000	1.000000	2.2
2.3	1.000000	1.000000	1.000000	1.000000	1.000000	1.000000	1.000000	1.000000	2.3
2.4	1.000000	1.000000	1.000000	1.000000	1.000000	1.000000	1.000000	1.000000	2.4
2.5	1.000000	1.000000	1.000000	1.000000	1.000000	1.000000	1.000000	1.000000	2.5
2.6	1.000000	1.000000	1.000000	1.000000	1.000000	1.000000	1.000000	1.000000	2.6
2.7	1.000000	1.000000	1.000000	1.000000	1.000000	1.000000	1.000000	1.000000	2.7
2.8	1.000000	1.000000	1.000000	1.000000	1.000000	1.000000	1.000000	1.000000	2.8
2.9	0.999999	0.999999	0.999999	0.999999	0.999999	1.000000	1.000000	1.000000	2.9
3.0	0.999995	0.999996	0.999997	0.999998	0.999998	0.999999	0.999999	0.999999	3.0
3.1	0.999984	0.999988	0.999990	0.999992	0.999994	0.999995	0.999996	0.999997	3.1
3.2	0.999954	0.999963	0.999970	0.999975	0.999980	0.999984	0.999987	0.999989	3.2
3.3	0.999879	0.999900	0.999917	0.999931	0.999943	0.999953	0.999961	0.999968	3.3
3.4	0.999710	0.999755	0.999794	0.999826	0.999853	0.999876	0.999895	0.999912	3.4
3.5	0.999363	0.999454	0.999531	0.999598	0.999655	0.999704	0.999746	0.999782	3.5
3.6	0.998705	0.998872	0.999018	0.999145	0.999256	0.999352	0.999436	0.999509	3.6
3.7	0.997542	0.997831	0.998086	0.998311	0.998510	0.998685	0.998840	0.998976	3.7
3.8	0.995617	0.996086	0.996504	0.996878	0.997212	0.997510	0.997777	0.998014	3.8
3.9	0.992612	0.993330	0.993978	0.994564	0.995092	0.995569	0.996000	0.996389	3.9
4.0	0.988163	0.989208	0.990161	0.991029	0.991821	0.992543	0.993202	0.993802	4.0
4.1	0.981881	0.983333	0.984669	0.985898	0.987028	0.988068	0.989025	0.989905	4.1
4.2	0.973383	0.975319	0.977115	0.978780	0.980324	0.981756	0.983084	0.984314	4.2
4.3	0.962325	0.964812	0.967136	0.969305	0.971332	0.973225	0.974993	0.976644	4.3
4.4	0.948429	0.951518	0.954422	0.957152	0.959719	0.962131	0.964400	0.966532	4.4
4.5	0.931511	0.935231	0.938750	0.942077	0.945224	0.948200	0.951014	0.953675	4.5
4.6	0.911491	0.915851	0.919996	0.923937	0.927683	0.931246	0.934632	0.937852	4.6
4.7	0.888402	0.893386	0.898147	0.902695	0.907041	0.911192	0.915158	0.918946	4.7
4.8	0.862387	0.867957	0.873302	0.878430	0.883351	0.888073	0.892603	0.896950	4.8
4.9	0.833684	0.839785	0.845662	0.851324	0.856778	0.862031	0.867092	0.871968	4.9
5.0	0.802611	0.809172	0.815515	0.821647	0.827575	0.833307	0.838847	0.844204	5.0

$\kappa$	$N=480$	$N=490$	$N=500$	$N=510$	$N=520$	$N=530$	$N=540$	$N=550$	$\kappa$
5.1	0.769545	0.776485	0.783216	0.789744	0.796076	0.802217	0.808173	0.813949	5.1
5.2	0.734898	0.742130	0.749165	0.756008	0.762664	0.769138	0.775436	0.781562	5.2
5.3	0.699102	0.706537	0.713788	0.720861	0.727758	0.734485	0.741046	0.747445	5.3
5.4	0.662583	0.670134	0.677516	0.684733	0.691789	0.698686	0.705430	0.712023	5.4
5.5	0.625751	0.633336	0.640768	0.648049	0.655182	0.662170	0.669017	0.675725	5.5
5.6	0.588988	0.596531	0.603936	0.611205	0.618341	0.625345	0.632221	0.638971	5.6
5.7	0.552634	0.560068	0.567379	0.574569	0.581639	0.588591	0.595428	0.602151	5.7
5.8	0.516989	0.524256	0.531415	0.538465	0.545409	0.552249	0.558986	0.565622	5.8
5.9	0.482305	0.489357	0.496313	0.503175	0.509943	0.516618	0.523203	0.529698	5.9
6.0	0.448790	0.455588	0.462302	0.468933	0.475482	0.481951	0.488339	0.494650	6.0
6.1	0.416606	0.423119	0.429560	0.435928	0.442226	0.448453	0.454610	0.460699	6.1
6.2	0.385876	0.392082	0.398226	0.404307	0.410328	0.416287	0.422186	0.428025	6.2
6.3	0.356683	0.362568	0.368400	0.374177	0.379902	0.385575	0.391195	0.396765	6.3
6.4	0.329080	0.334635	0.340145	0.345609	0.351027	0.356401	0.361730	0.367015	6.4
6.5	0.303089	0.308312	0.313496	0.318641	0.323747	0.328815	0.333846	0.338838	6.5
6.6	0.278708	0.283600	0.288460	0.293287	0.298080	0.302842	0.307571	0.312268	6.6
6.7	0.255916	0.260484	0.265024	0.269536	0.274021	0.278478	0.282908	0.287310	6.7
6.8	0.234675	0.238928	0.243157	0.247362	0.251544	0.255703	0.259838	0.263951	6.8
6.9	0.214936	0.218884	0.222812	0.226721	0.230609	0.234478	0.238328	0.242158	6.9
7.0	0.196639	0.200296	0.203935	0.207558	0.211165	0.214755	0.218328	0.221886	7.0
7.1	0.179718	0.183096	0.186461	0.189812	0.193149	0.196472	0.199781	0.203077	7.1
7.2	0.164101	0.167217	0.170321	0.173413	0.176494	0.179564	0.182622	0.185669	7.2
7.3	0.149715	0.152583	0.155442	0.158291	0.161130	0.163960	0.166780	0.169590	7.3
7.4	0.136486	0.139122	0.141750	0.144370	0.146982	0.149586	0.152182	0.154770	7.4
7.5	0.124340	0.126759	0.129171	0.131576	0.133975	0.136367	0.138753	0.141132	7.5
7.6	0.113202	0.115419	0.117630	0.119836	0.122036	0.124231	0.126420	0.128604	7.6
7.7	0.103003	0.105032	0.107057	0.109077	0.111092	0.113103	0.115109	0.117111	7.7
7.8	0.093674	0.095530	0.097381	0.099229	0.101073	0.102913	0.104749	0.106582	7.8
7.9	0.085150	0.086844	0.088536	0.090224	0.091909	0.093592	0.095271	0.096946	7.9
8.0	0.077368	0.078914	0.080458	0.081999	0.083538	0.085074	0.086608	0.088139	8.0
8.1	0.070269	0.071680	0.073088	0.074494	0.075897	0.077299	0.078699	0.080096	8.1
8.2	0.063800	0.065085	0.066368	0.067649	0.068929	0.070207	0.071483	0.072757	8.2
8.3	0.057907	0.059077	0.060246	0.061413	0.062579	0.063743	0.064906	0.066067	8.3
8.4	0.052543	0.053608	0.054672	0.055734	0.056795	0.057855	0.058914	0.059972	8.4
8.5	0.047664	0.048632	0.049600	0.050566	0.051532	0.052496	0.053460	0.054423	8.5
8.6	0.043227	0.044108	0.044987	0.045866	0.046744	0.047621	0.048498	0.049373	8.6
8.7	0.039195	0.039995	0.040794	0.041593	0.042391	0.043189	0.043985	0.044781	8.7
8.8	0.035532	0.036259	0.036985	0.037710	0.038435	0.039160	0.039884	0.040607	8.8
8.9	0.032206	0.032865	0.033523	0.034184	0.034842	0.035500	0.036158	0.036815	8.9
9.0	0.029186	0.029785	0.030383	0.030981	0.031579	0.032177	0.032774	0.033370	9.0
9.1	0.026445	0.026989	0.027532	0.028075	0.028617	0.029159	0.029701	0.030243	9.1
9.2	0.023959	0.024452	0.024945	0.025437	0.025929	0.026421	0.026913	0.027405	9.2
9.3	0.021704	0.022151	0.022598	0.023045	0.023491	0.023937	0.024383	0.024829	9.3
9.4	0.019659	0.020064	0.020469	0.020875	0.021279	0.021684	0.022089	0.022493	9.4
9.5	0.017805	0.018172	0.018540	0.018907	0.019274	0.019641	0.020008	0.020375	9.5
9.6	0.016124	0.016457	0.016790	0.017123	0.017456	0.017789	0.018121	0.018454	9.6
9.7	0.014601	0.014903	0.015205	0.015506	0.015808	0.016109	0.016411	0.016712	9.7
9.8	0.013221	0.013494	0.013768	0.014041	0.014314	0.014588	0.014861	0.015134	9.8
9.9	0.011970	0.012218	0.012466	0.012713	0.012961	0.013209	0.013456	0.013704	9.9
10.0	0.010837	0.011062	0.011286	0.011510	0.011735	0.011959	0.012183	0.012408	10.0

$\kappa$	N = 560	N = 570	N = 580	N = 590	N = 600	$\kappa$
0.1	1.000000	1.000000	1.000000	1.000000	1.000000	0.1
0.2	1.000000	1.000000	1.000000	1.000000	1.000000	0.2
0.3	1.000000	1.000000	1.000000	1.000000	1.000000	0.3
0.4	1.000000	1.000000	1.000000	1.000000	1.000000	0.4
0.5	1.000000	1.000000	1.000000	1.000000	1.000000	0.5
0.6	1.000000	1.000000	1.000000	1.000000	1.000000	0.6
0.7	1.000000	1.000000	1.000000	1.000000	1.000000	0.7
0.8	1.000000	1.000000	1.000000	1.000000	1.000000	0.8
0.9	1.000000	1.000000	1.000000	1.000000	1.000000	0.9
1.0	1.000000	1.000000	1.000000	1.000000	1.000000	1.0
1.1	1.000000	1.000000	1.000000	1.000000	1.000000	1.1
1.2	1.000000	1.000000	1.000000	1.000000	1.000000	1.2
1.3	1.000000	1.000000	1.000000	1.000000	1.000000	1.3
1.4	1.000000	1.000000	1.000000	1.000000	1.000000	1.4
1.5	1.000000	1.000000	1.000000	1.000000	1.000000	1.5
1.6	1.000000	1.000000	1.000000	1.000000	1.000000	1.6
1.7	1.000000	1.000000	1.000000	1.000000	1.000000	1.7
1.8	1.000000	1.000000	1.000000	1.000000	1.000000	1.8
1.9	1.000000	1.000000	1.000000	1.000000	1.000000	1.9
2.0	1.000000	1.000000	1.000000	1.000000	1.000000	2.0
2.1	1.000000	1.000000	1.000000	1.000000	1.000000	2.1
2.2	1.000000	1.000000	1.000000	1.000000	1.000000	2.2
2.3	1.000000	1.000000	1.000000	1.000000	1.000000	2.3
2.4	1.000000	1.000000	1.000000	1.000000	1.000000	2.4
2.5	1.000000	1.000000	1.000000	1.000000	1.000000	2.5
2.6	1.000000	1.000000	1.000000	1.000000	1.000000	2.6
2.7	1.000000	1.000000	1.000000	1.000000	1.000000	2.7
2.8	1.000000	1.000000	1.000000	1.000000	1.000000	2.8
2.9	1.000000	1.000000	1.000000	1.000000	1.000000	2.9
3.0	0.999999	1.000000	1.000000	1.000000	1.000000	3.0
3.1	0.999998	0.999998	0.999998	0.999999	0.999999	3.1
3.2	0.999991	0.999993	0.999994	0.999995	0.999996	3.2
3.3	0.999973	0.999978	0.999982	0.999985	0.999987	3.3
3.4	0.999925	0.999937	0.999947	0.999955	0.999962	3.4
3.5	0.999813	0.999840	0.999863	0.999882	0.999899	3.5
3.6	0.999572	0.999628	0.999676	0.999718	0.999754	3.6
3.7	0.999097	0.999203	0.999297	0.999380	0.999453	3.7
3.8	0.998227	0.998416	0.998586	0.998737	0.998872	3.8
3.9	0.996740	0.997056	0.997343	0.997601	0.997834	3.9
4.0	0.994349	0.994848	0.995303	0.995717	0.996096	4.0
4.1	0.990714	0.991458	0.992143	0.992773	0.993352	4.1
4.2	0.985456	0.986514	0.987495	0.988405	0.989249	4.2
4.3	0.978186	0.979626	0.980972	0.982228	0.983401	4.3
4.4	0.968537	0.970421	0.972193	0.973859	0.975424	4.4
4.5	0.956191	0.958571	0.960822	0.962950	0.964963	4.5
4.6	0.940914	0.943824	0.946591	0.949222	0.951723	4.6
4.7	0.922566	0.926024	0.929327	0.932483	0.935499	4.7
4.8	0.901122	0.905124	0.908964	0.912649	0.916185	4.8
4.9	0.876664	0.881189	0.885547	0.889745	0.893790	4.9
5.0	0.849382	0.854389	0.859229	0.863908	0.868431	5.0

$x$	$N = 560$	$N = 570$	$N = 580$	$N = 590$	$N = 600$	$x$
5.1	0.819552	0.824986	0.830257	0.835368	0.840326	5.1
5.2	0.787521	0.793318	0.798956	0.804441	0.809776	5.2
5.3	0.753686	0.759772	0.765708	0.771497	0.777144	5.3
5.4	0.718467	0.724768	0.730928	0.736950	0.742837	5.4
5.5	0.682298	0.688737	0.695045	0.701226	0.707281	5.5
5.6	0.645597	0.652102	0.658487	0.664754	0.670907	5.6
5.7	0.608763	0.615264	0.621658	0.627945	0.634128	5.7
5.8	0.572158	0.578595	0.584936	0.591181	0.597332	5.8
5.9	0.536105	0.542424	0.548658	0.554806	0.560871	5.9
6.0	0.500882	0.507037	0.513117	0.519121	0.525051	6.0
6.1	0.466720	0.472673	0.478561	0.484382	0.490138	6.1
6.2	0.433806	0.439528	0.445192	0.450799	0.456349	6.2
6.3	0.402283	0.407751	0.413169	0.418537	0.423856	6.3
6.4	0.372256	0.377454	0.382609	0.387721	0.392791	6.4
6.5	0.343793	0.348712	0.353593	0.358437	0.363246	6.5
6.6	0.316933	0.321567	0.326169	0.330739	0.335279	6.6
6.7	0.291686	0.296035	0.300356	0.304652	0.308921	6.7
6.8	0.268041	0.272108	0.276153	0.280175	0.284174	6.8
6.9	0.245969	0.249761	0.253534	0.257288	0.261023	6.9
7.0	0.225427	0.228952	0.232461	0.235954	0.239432	7.0
7.1	0.206360	0.209628	0.212884	0.216126	0.219354	7.1
7.2	0.188704	0.191728	0.194741	0.197742	0.200732	7.2
7.3	0.172391	0.175183	0.177965	0.180738	0.183501	7.3
7.4	0.157350	0.159922	0.162486	0.165043	0.167591	7.4
7.5	0.143505	0.145871	0.148230	0.150583	0.152929	7.5
7.6	0.130782	0.132955	0.135122	0.137284	0.139441	7.6
7.7	0.119108	0.121101	0.123089	0.125073	0.127052	7.7
7.8	0.108410	0.110235	0.112057	0.113874	0.115688	7.8
7.9	0.098619	0.100289	0.101955	0.103619	0.105279	7.9
8.0	0.089667	0.091193	0.092717	0.094237	0.095756	8.0
8.1	0.081491	0.082884	0.084275	0.085664	0.087051	8.1
8.2	0.074030	0.075301	0.076570	0.077838	0.079103	8.2
8.3	0.067227	0.068385	0.069542	0.070698	0.071852	8.3
8.4	0.061028	0.062084	0.063138	0.064190	0.065242	8.4
8.5	0.055384	0.056345	0.057304	0.058263	0.059221	8.5
8.6	0.050248	0.051122	0.051995	0.052867	0.053739	8.6
8.7	0.045577	0.046371	0.047165	0.047959	0.048751	8.7
8.8	0.041330	0.042052	0.042774	0.043495	0.044216	8.8
8.9	0.037471	0.038128	0.038783	0.039439	0.040094	8.9
9.0	0.033967	0.034563	0.035158	0.035753	0.036348	9.0
9.1	0.030784	0.031325	0.031866	0.032407	0.032947	9.1
9.2	0.027896	0.028387	0.028878	0.029368	0.029859	9.2
9.3	0.025275	0.025721	0.026166	0.026611	0.027056	9.3
9.4	0.022897	0.023302	0.023705	0.024109	0.024513	9.4
9.5	0.020741	0.021108	0.021474	0.021840	0.022206	9.5
9.6	0.018786	0.019118	0.019450	0.019782	0.020114	9.6
9.7	0.017014	0.017315	0.017616	0.017917	0.018218	9.7
9.8	0.015407	0.015680	0.015953	0.016226	0.016498	9.8
9.9	0.013951	0.014198	0.014446	0.014693	0.014940	9.9
10.0	0.012632	0.012856	0.013080	0.013304	0.013528	10.0



TABLE 2

VALUES OF THE FISHER PROBABILITY FUNCTION,  $P_F$ .

Values of the function

$$P_F = n \left(1 - \frac{\kappa}{n}\right)^{n-1} - \frac{n(n-1)}{2!} \left(1 - \frac{2\kappa}{n}\right)^{n-1} + \dots$$

$$+ (-1)^{m-1} \frac{m!(n-m)!}{n!} \left(1 - \frac{m\kappa}{n}\right)^{n-1},$$

where  $m$  is the greatest integer less than  $n\kappa$ , are tabulated to five decimal places for  $\kappa = 0.1, 0.2, \dots, 10.0$ ,  $n = 10, 20, \dots, 70$ ;  $\kappa = 5.1, 5.2, \dots, 10.0$ ,  $n = 80, 90, \dots, 150, 160, 180, \dots, 300$ .

$\alpha$	$n=10$	$n=20$	$n=30$	$n=40$	$n=50$	$n=60$	$n=70$
0.1	1.00000	1.00000	1.00000	1.00000	1.00000	1.00000	1.00000
0.2	1.00000	1.00000	1.00000	1.00000	1.00000	1.00000	1.00000
0.3	1.00000	1.00000	1.00000	1.00000	1.00000	1.00000	1.00000
0.4	1.00000	1.00000	1.00000	1.00000	1.00000	1.00000	1.00000
0.5	1.00000	1.00000	1.00000	1.00000	1.00000	1.00000	1.00000
0.6	1.00000	1.00000	1.00000	1.00000	1.00000	1.00000	1.00000
0.7	1.00000	1.00000	1.00000	1.00000	1.00000	1.00000	1.00000
0.8	1.00000	1.00000	1.00000	1.00000	1.00000	1.00000	1.00000
0.9	1.00000	1.00000	1.00000	1.00000	1.00000	1.00000	1.00000
1.0	1.00000	1.00000	1.00000	1.00000	1.00000	1.00000	1.00000
1.1	1.00000	1.00000	1.00000	1.00000	1.00000	1.00000	1.00000
1.2	1.00000	1.00000	1.00000	1.00000	1.00000	1.00000	1.00000
1.3	0.99998	1.00000	1.00000	1.00000	1.00000	1.00000	1.00000
1.4	0.99979	1.00000	1.00000	1.00000	1.00000	1.00000	1.00000
1.5	0.99881	1.00000	1.00000	1.00000	1.00000	1.00000	1.00000
1.6	0.99563	0.99999	1.00000	1.00000	1.00000	1.00000	1.00000
1.7	0.98811	0.99993	1.00000	1.00000	1.00000	1.00000	1.00000
1.8	0.97399	0.99965	1.00000	1.00000	1.00000	1.00000	1.00000
1.9	0.95153	0.99870	0.99997	1.00000	1.00000	1.00000	1.00000
2.0	0.92003	0.99627	0.99983	0.99999	1.00000	1.00000	1.00000
2.1	0.87985	0.99118	0.99935	0.99995	1.00000	1.00000	1.00000
2.2	0.83225	0.98207	0.99809	0.99980	0.99998	1.00000	1.00000
2.3	0.77900	0.96772	0.99530	0.99932	0.99990	0.99999	1.00000
2.4	0.72208	0.94725	0.99001	0.99811	0.99964	0.99993	0.99999
2.5	0.66341	0.92030	0.98118	0.99556	0.99895	0.99975	0.99994
2.6	0.60468	0.88707	0.96783	0.99084	0.99739	0.99926	0.99979
2.7	0.54726	0.84821	0.94925	0.98305	0.99434	0.99811	0.99937
2.8	0.49218	0.80472	0.92512	0.97131	0.98901	0.99579	0.99839
2.9	0.44019	0.75776	0.89549	0.95495	0.98058	0.99163	0.99639
3.0	0.39174	0.70858	0.86080	0.93356	0.96830	0.98488	0.99278
3.1	0.34709	0.65832	0.82176	0.90709	0.95158	0.97478	0.98686
3.2	0.30630	0.60805	0.77926	0.87578	0.93012	0.96069	0.97789
3.3	0.26933	0.55863	0.73428	0.84016	0.90388	0.94220	0.96525
3.4	0.23604	0.51078	0.68780	0.80093	0.87310	0.91912	0.94846
3.5	0.20623	0.46496	0.64073	0.75893	0.83829	0.89155	0.92727
3.6	0.17967	0.42176	0.59389	0.71502	0.80009	0.85979	0.90167
3.7	0.15609	0.38121	0.54795	0.67005	0.75926	0.82437	0.87189
3.8	0.13525	0.34350	0.50348	0.62481	0.71659	0.78593	0.83836
3.9	0.11689	0.30867	0.46088	0.57997	0.67286	0.74526	0.80165
4.0	0.10075	0.27668	0.42048	0.53611	0.62881	0.70303	0.76244
4.1	0.08662	0.24746	0.38246	0.49370	0.58506	0.65999	0.72142
4.2	0.07427	0.22089	0.34693	0.45309	0.54217	0.61681	0.67931
4.3	0.06351	0.19679	0.31393	0.41454	0.50058	0.57406	0.63676
4.4	0.05416	0.17505	0.28346	0.37822	0.46065	0.53223	0.59436
4.5	0.04605	0.15544	0.25543	0.34421	0.42262	0.49174	0.55264
4.6	0.03904	0.13787	0.22977	0.31255	0.38667	0.45289	0.51202
4.7	0.03300	0.12210	0.20636	0.28323	0.35290	0.41591	0.47284
4.8	0.02780	0.10800	0.18506	0.25619	0.32137	0.38096	0.43537
4.9	0.02334	0.09542	0.16574	0.23136	0.29207	0.34812	0.39979
5.0	0.01953	0.08420	0.14826	0.20861	0.26497	0.31743	0.36622

$\kappa$	$n=10$	$n=20$	$n=30$	$n=40$	$n=50$	$n=60$	$n=70$	$\kappa$
5.1	0.01628	0.07423	0.13248	0.18785	0.23998	0.28890	0.33473	5.1
5.2	0.01353	0.06536	0.11825	0.16896	0.21704	0.26247	0.30534	5.2
5.3	0.01119	0.05750	0.10545	0.15179	0.19602	0.23809	0.27803	5.3
5.4	0.00922	0.05053	0.09396	0.13623	0.17683	0.21567	0.25275	5.4
5.5	0.00757	0.04436	0.08365	0.12215	0.15935	0.19511	0.22943	5.5
5.6	0.00618	0.03890	0.07441	0.10944	0.14345	0.17631	0.20798	5.6
5.7	0.00503	0.03409	0.06614	0.09797	0.12902	0.15915	0.18832	5.7
5.8	0.00407	0.02984	0.05875	0.08764	0.11594	0.14352	0.17032	5.8
5.9	0.00327	0.02609	0.05215	0.07834	0.10412	0.12932	0.15390	5.9
6.0	0.00262	0.02279	0.04626	0.06999	0.09343	0.11643	0.13894	6.0
6.1	0.00209	0.01989	0.04101	0.06249	0.08379	0.10476	0.12532	6.1
6.2	0.00165	0.01734	0.03634	0.05576	0.07510	0.09419	0.11296	6.2
6.3	0.00130	0.01510	0.03217	0.04973	0.06727	0.08463	0.10175	6.3
6.4	0.00102	0.01314	0.02847	0.04433	0.06023	0.07601	0.09160	6.4
6.5	0.00079	0.01142	0.02518	0.03950	0.05390	0.06822	0.08241	6.5
6.6	0.00061	0.00992	0.02226	0.03518	0.04821	0.06121	0.07411	6.6
6.7	0.00046	0.00860	0.01966	0.03131	0.04310	0.05489	0.06661	6.7
6.8	0.00035	0.00745	0.01736	0.02786	0.03852	0.04920	0.05984	6.8
6.9	0.00026	0.00645	0.01532	0.02478	0.03442	0.04409	0.05374	6.9
7.0	0.00020	0.00558	0.01351	0.02203	0.03073	0.03949	0.04824	7.0
7.1	0.00015	0.00482	0.01190	0.01958	0.02744	0.03536	0.04329	7.1
7.2	0.00011	0.00415	0.01049	0.01739	0.02449	0.03165	0.03883	7.2
7.3	0.00008	0.00358	0.00923	0.01544	0.02184	0.02832	0.03482	7.3
7.4	0.00005	0.00308	0.00812	0.01370	0.01948	0.02533	0.03122	7.4
7.5	0.00004	0.00265	0.00714	0.01216	0.01737	0.02266	0.02801	7.5
7.6	0.00003	0.00227	0.00628	0.01078	0.01548	0.02026	0.02507	7.6
7.7	0.00002	0.00195	0.00551	0.00956	0.01379	0.01810	0.02246	7.7
7.8	0.00001	0.00167	0.00484	0.00847	0.01228	0.01618	0.02011	7.8
7.9	0.00001	0.00143	0.00425	0.00750	0.01094	0.01445	0.01801	7.9
8.0	0.00001	0.00122	0.00372	0.00664	0.00973	0.01291	0.01612	8.0
8.1	0.00000	0.00104	0.00326	0.00588	0.00866	0.01152	0.01442	8.1
8.2	0.00000	0.00089	0.00286	0.00520	0.00771	0.01028	0.01290	8.2
8.3	0.00000	0.00075	0.00250	0.00460	0.00685	0.00918	0.01154	8.3
8.4	0.00000	0.00064	0.00219	0.00407	0.00609	0.00819	0.01032	8.4
8.5	0.00000	0.00054	0.00191	0.00360	0.00542	0.00730	0.00923	8.5
8.6	0.00000	0.00046	0.00167	0.00318	0.00481	0.00651	0.00825	8.6
8.7	0.00000	0.00039	0.00146	0.00280	0.00427	0.00581	0.00737	8.7
8.8	0.00000	0.00033	0.00127	0.00248	0.00380	0.00518	0.00659	8.8
8.9	0.00000	0.00028	0.00111	0.00218	0.00337	0.00461	0.00589	8.9
9.0	0.00000	0.00023	0.00097	0.00193	0.00299	0.00411	0.00526	9.0
9.1	0.00000	0.00020	0.00084	0.00170	0.00265	0.00366	0.00470	9.1
9.2	0.00000	0.00016	0.00073	0.00150	0.00235	0.00326	0.00419	9.2
9.3	0.00000	0.00014	0.00064	0.00132	0.00209	0.00290	0.00374	9.3
9.4	0.00000	0.00012	0.00055	0.00116	0.00185	0.00258	0.00334	9.4
9.5	0.00000	0.00010	0.00048	0.00102	0.00164	0.00230	0.00298	9.5
9.6	0.00000	0.00008	0.00042	0.00090	0.00145	0.00204	0.00266	9.6
9.7	0.00000	0.00007	0.00036	0.00079	0.00129	0.00182	0.00237	9.7
9.8	0.00000	0.00006	0.00031	0.00070	0.00114	0.00162	0.00212	9.8
9.9	0.00000	0.00005	0.00027	0.00061	0.00101	0.00144	0.00189	9.9
10.0	0.00000	0.00004	0.00023	0.00054	0.00089	0.00128	0.00168	10.0

$\kappa$	$n=80$	$n=90$	$n=100$	$n=110$	$n=120$	$n=130$	$n=140$	$n=150$	$\kappa$
5.1	0.37765	0.41783	0.45543	0.49062	0.52353	0.55433	0.58314	0.61009	5.1
5.2	0.34576	0.38386	0.41975	0.45357	0.48542	0.51542	0.54368	0.57029	5.2
5.3	0.31592	0.35185	0.38591	0.41819	0.44879	0.47778	0.50525	0.53128	5.3
5.4	0.28812	0.32185	0.35400	0.38464	0.41383	0.44164	0.46815	0.49339	5.4
5.5	0.26233	0.29386	0.32406	0.35298	0.38068	0.40719	0.43258	0.45688	5.5
5.6	0.23849	0.26785	0.29566	0.32328	0.34942	0.37455	0.39872	0.42196	5.6
5.7	0.21652	0.24378	0.27011	0.29554	0.32009	0.34379	0.36667	0.38876	5.7
5.8	0.19634	0.22156	0.24602	0.26972	0.29269	0.31494	0.33650	0.35739	5.8
5.9	0.17783	0.20112	0.22377	0.24579	0.26720	0.28801	0.30824	0.32789	5.9
6.0	0.16091	0.18236	0.20328	0.22368	0.24357	0.26296	0.28186	0.30028	6.0
6.1	0.14547	0.16518	0.18446	0.20331	0.22174	0.23975	0.25735	0.27454	6.1
6.2	0.13140	0.14948	0.16721	0.18459	0.20161	0.21829	0.23463	0.25063	6.2
6.3	0.11860	0.13516	0.15144	0.16742	0.18312	0.19852	0.21365	0.22849	6.3
6.4	0.10697	0.12212	0.13704	0.15171	0.16615	0.18035	0.19432	0.20805	6.4
6.5	0.09643	0.11027	0.12391	0.13736	0.15062	0.16368	0.17655	0.18923	6.5
6.6	0.08687	0.09950	0.11197	0.12428	0.13643	0.14842	0.16026	0.17193	6.6
6.7	0.07822	0.08973	0.10111	0.11236	0.12349	0.13448	0.14534	0.15607	6.7
6.8	0.07040	0.08088	0.09125	0.10153	0.11170	0.12176	0.13172	0.14156	6.8
6.9	0.06333	0.07286	0.08231	0.09168	0.10097	0.11017	0.11928	0.12830	6.9
7.0	0.05695	0.06561	0.07422	0.08275	0.09122	0.09962	0.10795	0.11621	7.0
7.1	0.05119	0.05906	0.06688	0.07466	0.08237	0.09004	0.09764	0.10519	7.1
7.2	0.04600	0.05314	0.06025	0.06732	0.07435	0.08133	0.08827	0.09516	7.2
7.3	0.04132	0.04780	0.05426	0.06069	0.06708	0.07344	0.07976	0.08604	7.3
7.4	0.03711	0.04299	0.04885	0.05469	0.06050	0.06628	0.07204	0.07776	7.4
7.5	0.03331	0.03864	0.04396	0.04926	0.05454	0.05980	0.06504	0.07025	7.5
7.6	0.02990	0.03473	0.03955	0.04436	0.04916	0.05393	0.05869	0.06344	7.6
7.7	0.02683	0.03120	0.03557	0.03993	0.04429	0.04863	0.05295	0.05726	7.7
7.8	0.02406	0.02802	0.03199	0.03594	0.03989	0.04383	0.04776	0.05168	7.8
7.9	0.02158	0.02517	0.02875	0.03234	0.03592	0.03950	0.04306	0.04662	7.9
8.0	0.01935	0.02260	0.02584	0.02909	0.03234	0.03558	0.03882	0.04205	8.0
8.1	0.01735	0.02028	0.02322	0.02617	0.02911	0.03205	0.03498	0.03791	8.1
8.2	0.01555	0.01820	0.02086	0.02353	0.02619	0.02886	0.03152	0.03418	8.2
8.3	0.01393	0.01633	0.01874	0.02115	0.02357	0.02598	0.02839	0.03080	8.3
8.4	0.01248	0.01465	0.01683	0.01901	0.02120	0.02339	0.02557	0.02776	8.4
8.5	0.01118	0.01314	0.01511	0.01709	0.01907	0.02105	0.02303	0.02501	8.5
8.6	0.01001	0.01179	0.01357	0.01535	0.01715	0.01894	0.02073	0.02252	8.6
8.7	0.00896	0.01057	0.01218	0.01379	0.01542	0.01704	0.01866	0.02029	8.7
8.8	0.00802	0.00947	0.01093	0.01239	0.01386	0.01533	0.01680	0.01827	8.8
8.9	0.00718	0.00849	0.00981	0.01113	0.01246	0.01378	0.01511	0.01645	8.9
9.0	0.00643	0.00761	0.00880	0.00999	0.01119	0.01240	0.01360	0.01480	9.0
9.1	0.00575	0.00682	0.00789	0.00897	0.01006	0.01115	0.01223	0.01333	9.1
9.2	0.00514	0.00611	0.00708	0.00806	0.00904	0.01002	0.01101	0.01199	9.2
9.3	0.00460	0.00547	0.00635	0.00723	0.00812	0.00901	0.00990	0.01079	9.3
9.4	0.00411	0.00490	0.00569	0.00649	0.00729	0.00810	0.00890	0.00971	9.4
9.5	0.00368	0.00439	0.00510	0.00582	0.00655	0.00728	0.00801	0.00874	9.5
9.6	0.00329	0.00393	0.00457	0.00523	0.00588	0.00654	0.00720	0.00786	9.6
9.7	0.00294	0.00352	0.00410	0.00469	0.00528	0.00588	0.00647	0.00707	9.7
9.8	0.00263	0.00315	0.00367	0.00421	0.00474	0.00528	0.00582	0.00636	9.8
9.9	0.00235	0.00282	0.00329	0.00377	0.00426	0.00474	0.00523	0.00572	9.9
10.0	0.00210	0.00252	0.00295	0.00338	0.00382	0.00426	0.00470	0.00514	10.0

$x$	$n = 160$	$n = 180$	$n = 200$	$n = 220$	$n = 240$	$n = 260$	$n = 280$	$n = 300$	$x$
5.1	0.63498	0.68094	0.72087	0.75581	0.78638	0.81312	0.83651	0.85698	5.1
5.2	0.59536	0.64119	0.68183	0.71788	0.74984	0.77818	0.80332	0.82560	5.2
5.3	0.55564	0.60145	0.64231	0.67897	0.71188	0.74152	0.76793	0.79173	5.3
5.4	0.51744	0.56218	0.60278	0.63961	0.67303	0.70336	0.73087	0.75583	5.4
5.5	0.47985	0.52374	0.56368	0.60028	0.63381	0.66452	0.69267	0.71845	5.5
5.6	0.44430	0.48644	0.52539	0.56139	0.59466	0.62541	0.65383	0.68010	5.6
5.7	0.40982	0.45053	0.48821	0.52332	0.55601	0.58647	0.61484	0.64127	5.7
5.8	0.37762	0.41620	0.45240	0.48636	0.51822	0.54810	0.57613	0.60243	5.8
5.9	0.34675	0.38359	0.41814	0.45076	0.48156	0.51063	0.53808	0.56398	5.9
6.0	0.31823	0.35277	0.38557	0.41671	0.44628	0.47435	0.50100	0.52630	6.0
6.1	0.29113	0.32380	0.35477	0.38433	0.41255	0.43947	0.46516	0.48968	6.1
6.2	0.26630	0.29667	0.32579	0.35372	0.38049	0.40616	0.43076	0.45435	6.2
6.3	0.24288	0.27138	0.29865	0.32491	0.35019	0.37452	0.39795	0.42050	6.3
6.4	0.22155	0.24788	0.27333	0.29792	0.32168	0.34465	0.36684	0.38828	6.4
6.5	0.20156	0.22611	0.24978	0.27273	0.29497	0.31656	0.33748	0.35776	6.5
6.6	0.18345	0.20601	0.22796	0.24931	0.27007	0.29026	0.30990	0.32899	6.6
6.7	0.16655	0.18749	0.20779	0.22759	0.24691	0.26574	0.28410	0.30201	6.7
6.8	0.15130	0.17046	0.18920	0.20752	0.22543	0.24294	0.26006	0.27679	6.8
6.9	0.13713	0.15485	0.17210	0.18901	0.20558	0.22181	0.23772	0.25330	6.9
7.0	0.12439	0.14054	0.15640	0.17198	0.18727	0.20229	0.21703	0.23150	7.0
7.1	0.11258	0.12747	0.14202	0.15635	0.17043	0.18429	0.19791	0.21131	7.1
7.2	0.10200	0.11553	0.12887	0.14202	0.15497	0.16772	0.18029	0.19268	7.2
7.3	0.09221	0.10465	0.11686	0.12890	0.14079	0.15252	0.16409	0.17550	7.3
7.4	0.08345	0.09474	0.10590	0.11692	0.12782	0.13858	0.14922	0.15972	7.4
7.5	0.07537	0.08573	0.09591	0.10599	0.11597	0.12583	0.13559	0.14523	7.5
7.6	0.06816	0.07753	0.08683	0.09603	0.10515	0.11418	0.12311	0.13197	7.6
7.7	0.06151	0.07010	0.07856	0.08696	0.09529	0.10354	0.11172	0.11982	7.7
7.8	0.05558	0.06335	0.07106	0.07871	0.08631	0.09384	0.10132	0.10874	7.8
7.9	0.05013	0.05723	0.06425	0.07122	0.07814	0.08502	0.09184	0.09862	7.9
8.0	0.04527	0.05169	0.05807	0.06441	0.07072	0.07698	0.08321	0.08940	8.0
8.1	0.04080	0.04667	0.05247	0.05824	0.06398	0.06968	0.07536	0.08100	8.1
8.2	0.03683	0.04212	0.04739	0.05264	0.05786	0.06305	0.06822	0.07336	8.2
8.3	0.03318	0.03801	0.04280	0.04756	0.05231	0.05703	0.06174	0.06642	8.3
8.4	0.02994	0.03429	0.03864	0.04296	0.04728	0.05157	0.05585	0.06011	8.4
8.5	0.02696	0.03093	0.03487	0.03880	0.04272	0.04662	0.05051	0.05438	8.5
8.6	0.02432	0.02790	0.03147	0.03504	0.03859	0.04214	0.04567	0.04919	8.6
8.7	0.02189	0.02516	0.02839	0.03163	0.03486	0.03807	0.04128	0.04448	8.7
8.8	0.01974	0.02268	0.02561	0.02855	0.03147	0.03439	0.03731	0.04021	8.8
8.9	0.01776	0.02044	0.02310	0.02576	0.02842	0.03107	0.03371	0.03635	8.9
9.0	0.01601	0.01842	0.02083	0.02325	0.02565	0.02805	0.0304	0.03285	9.0
9.1	0.01441	0.01660	0.01879	0.02097	0.02315	0.02533	0.02750	0.02968	9.1
9.2	0.01298	0.01496	0.01694	0.01891	0.02089	0.02287	0.02484	0.02681	9.2
9.3	0.01168	0.01348	0.01527	0.01706	0.01885	0.02064	0.02243	0.02421	9.3
9.4	0.01052	0.01214	0.01376	0.01538	0.01701	0.01863	0.02025	0.02187	9.4
9.5	0.00946	0.01094	0.01240	0.01387	0.01534	0.01681	0.01828	0.01974	9.5
9.6	0.00852	0.00985	0.01118	0.01251	0.01384	0.01517	0.01650	0.01783	9.6
9.7	0.00766	0.00887	0.01007	0.01128	0.01248	0.01368	0.01489	0.01609	9.7
9.8	0.00690	0.00799	0.00907	0.01016	0.01125	0.01235	0.01344	0.01453	9.8
9.9	0.00620	0.00719	0.00818	0.00916	0.01015	0.01114	0.01212	0.01311	9.9
10.0	0.00558	0.00647	0.00736	0.00826	0.00915	0.01004	0.01094	0.01183	10.0

## INDEXES

## INDEX OF NAMES

- Abbot, C. G., 565  
 d'Addario, R., 440  
 Aftalion, A., 330  
 Akerman, J., 38  
 Allen, R. G. D., 9  
 Alter, D., 33  
 Ammon, O., 440  
 Amoroso, L., 405, 440  
 Anderson, O., 53, 54, 149, 241, 244  
 Angell, J. W., 447, 448, 451, 457, 497  
 Auerbach, 430  
 Augustus, 16  
 Ayres, L. P., 47, 300, 303
- Bartels, J., 32  
 Barth, J. A., 430  
 Baxendell, 314  
 Baxter, R. D., 440  
 Bayes, Th., 183  
 Bernoulli, D., 372, 375, 409  
 Bessel, F. W., 64, 66, 71, 90, 92, 97,  
 179, 202, 221  
 Besson, L., 57, 166  
 Beveridge, Sir William H., 14, 28, 44,  
 47, 60, 307, 312, 313, 314, 315, 316,  
 563  
 Bochner, S., 154  
 Bode, J., 4  
 Boissevain, C. H., 432  
 Bortkiewicz, L. v., 57, 168, 441  
 Bowley, A. L., 9, 241  
 Brahe, Tycho, 2, 45, 270, 573  
 Bresciani-Turroni, C., 441, 485, 497  
 Brown, H. G., 446  
 Brown, W., 192  
 Brownell, J. L., 264  
 Bruckner, E., 316  
 Brunt, D., 32, 314, 315  
 Buchanan, James, 573  
 Buckle, H. T., 571  
 Burgess, W. R., 455, 497  
 Burns, A. F., 21
- Carlson, T., 259  
 Cassel, G., 7, 37, 329, 339  
 Castellano, V., 441  
 Cave, Beatrice M., 53  
 Cave, Miss F. E., 241  
 Cervantes, 572  
 Champernowne, D. G., 406  
 Charlier, C., 116  
 Clark, J. M., 332  
 Clayton, H. H., 33  
 Cobb, C. W., 438, 439  
 Columbus, Christopher, 492
- Conti, Prince de, 13  
 Coolidge, Calvin, 554  
 Cournot, A., 8, 45, 577  
 Cowden, D. J., 237  
 Cowles, A., 47, 57, 170, 286, 502  
 Cramer, H., 58  
 Croxton, F. E., 237  
 Crum, W. L., 308, 550  
 Czuber, E., 441
- Dale, J. B., 30  
 Dalton, H., 404, 441  
 Darmois, G., 441  
 Davis, H. T., 147, 153, 169, 245, 250,  
 295, 356, 407, 441, 532  
 Dean, J., 335  
 Descartes, R., 45  
 Donaldson, H. H., 260, 261  
 Douglas, P. H., 438, 439  
 Dow, C. H., 538  
 Drake, Sir Francis, 467  
 Dresden, A., 428
- Eagle, A., 31  
 Edgeworth, F. Y., 45, 46  
 Edmondson, C. E., 428  
 Elderton, Miss E. M., 241  
 Elsas, M. J., 47, 467  
 Essars, P. des, 446, 498  
 Euler, L., 28, 49, 335, 339, 374, 375  
 Evans, G. C., 50, 333, 498  
 Ewing, J. A., 355  
 Ezekiel, M., 141
- Fillmore, Millard, 574  
 Fisher, Irving, 8, 330, 333, 349, 350,  
 374, 390, 446, 448, 450, 451, 457, 458,  
 461, 462, 463, 470, 498, 577  
 Fisher, R. A., 31, 175, 184, 186, 189,  
 190, 191, 203, 241, 276, 512  
 Fourier, J. B. J., 29, 33, Chap. 2, 177,  
 185, 277-279, 515, 578  
 Fréchet, M., 441  
 Frisch, R., 7, 8, 37, 40, 48, 51, 55, 194,  
 195-197, 206, 207, 329, 330, 339, 340,  
 344, 346, 356, 372, 465, 532, 533
- Galileo, 270, 573  
 Galton, Sir Francis, 46, 441  
 Garcia-Mata, C., 563, 568  
 Gause, G. F., 360  
 Gauss, K. F., 23, 175  
 Gay, E. F., 47  
 Gibbs, J. W., 577  
 Gibrat, R., 406, 407, 408, 441  
 Gini, C., 425, 441

- Godfrey, E. L., 455  
 Gompertz, B., 20, 21, 249-250  
 Gosset, W. S., (see "Student")  
 Goutereau, C., 56, 144, 146, 147, 148  
 Gracchi, the, 571  
 Gram, J. P., 93, 116, 220, 221  
 Grant, Ulysses S., 573  
 Greenleaf, H. E. H., 94  
 Greenstein, B., 27, 32, 310, 551  
 Gunn, Grace, 439  
  
 Haberler, G. von, 333  
 Hamilton, E. J., 13, 47, 467, 468, 486, 488, 490, 493, 498  
 Hamilton, W. P., 538  
 Hardy, C. O., 349  
 Haring, C. H., 492, 495  
 Hasselbalch, 570  
 Hawtrey, R. G., 331, 498  
 Hayes, Rutherford B., 574  
 Hellman, G., 315  
 Hermite, C., 90, 91, 93, 94, 116-118  
 Herschel, Sir William, 43, 562  
 Holzinger, K. J., 192  
 Hooker, R. H., 46, 52, 241  
 Hoover, Herbert, 573  
 Hopfner, F., 30, 31  
 Hotelling, H., 3, 18, 23, 35-37, 40, 41, 48, 191, 195, 251, 257, 500, 512, 520  
 Huntington, E. V., 447, 476, 498  
  
 Irwin, J. O., 176  
  
 Jackson, Andrew, 555, 571, 574  
 Jacob, W., 488, 489, 493  
 Jevons, W. S., 43, 45, 46, 51, 314, 328, 329, 366, 461, 550, 561, 562, 563, 570  
 Johnson, Andrew, 573  
 Johnson, N. O., 403, 418-420, 434, 441  
 Jones, H. E., 48, 57, 58, 147, 159, 164, 165, 170, 356, 357  
 Jordan, C., 372  
 Juglar, C., 45  
  
 Kalecki, M., 51, 339, 340, 341, 344, 346  
 Keely, John, 380  
 Kelvin, Lord, 9, 44  
 Kemmerer, E. W., 446, 498  
 Kenrick, G. W., 33  
 Kepler, Johannes, 3, 4, 45, 270, 497, 573  
 Keynes, J. M., 330, 472, 498  
 King, G., 21  
 King, W. I., 441  
 Kondratieff, N. D., 14, 28  
 Koopmans, T., 48, 195  
 Kuznets, S. S., 18, 21, 265, 441  
  
 Lagrange, J. L., 28, 30, 370  
 Laguerre, E., 90, 91  
 Laurens, H., 570  
 Law, John, 12, 13  
 Leavens, D. H., 272  
  
 Legendre, A. M., 90, 93  
 Leheldt, R. A., 9  
 Leven, M., 442, 443  
 Lexis, W., 507  
 Lincoln, Abraham, 574  
 Lorenz, M. O., 425, 442  
 Lotka, A. J., 18, 360, 365, 428, 429, 430, 432, 576  
  
 Macaulay, F. R., 47, 403, 404, 442  
 Macgregor, D. H., 442  
 Magee, J. D., 486  
 Makeham, W. M., 21  
 Malthus, T. R., 255  
 March, L., 241, 442  
 Marget, A. W., 498  
 Marschak, J., 442, 498  
 Marshall, A., 8, 46, 135, 136, 388  
 Marx, Karl, 571  
 Mendershausen, H., 426  
 Mill, John Stuart, 45  
 Mills, F. C., 237  
 Mises, L. von, 498  
 Mitchell, W. C., 15, 27, 46, 208, 308, 328, 451, 547  
 Monroe, James, 574  
 Moore, H. L., 9, 36, 44, 46, 54, 60, 137, 305, 315, 328  
 More, L. T., 12  
 Morris, E. B., 114  
 Moulton, E. J., 156  
 Moulton, H. G., 442  
 Munting, 10, 11  
 Murray, N. C., 466  
 Murray, W. S., 10  
  
 Napoleon, 306, 556  
 Nelson, S. A., 538  
 Nelson, W. F. C., 147, 169, 250, 295, 407, 472  
 Newbury, F. D., 550  
 Newcomb, S., 445, 498  
 Newton, Sir Isaac, 2, 3, 12, 45, 270, 497  
  
 Olmstead, P. S., 166  
 Oppenheim, S., 30  
 Ostwald, W., 18  
 Owen, R., 371  
 Owens, R. N., 349  
  
 Pareto, V., 25, 46, 51, 352, 371, 387, 394-397, 400, 402-407, 409, 414, 418, 425-428, 432, 434-436, 442, 500, 576, 577  
 Parker, S. L., 18  
 Parseval, M. A., 64-67  
 Pearl, R., 17, 18, 250, 251, 253, 254, 257-259, 264, 267  
 Pearson, F. A., 47, 532, 469, 489  
 Pearson, Karl, 32, 46, 53, 58, 169, 200, 201, 204, 241, 399



- Persons, W. M., 46, 53, 54, 241, 270,  
 308, 564  
 Pettit, E., 565  
 Philip IV (Spain), 495  
 Phillips, W. A., 497  
 Picard, E., 366  
 Pierce, Franklin, 574  
 Pietra, G., 442  
 Pigou, A. C., 404, 442  
 Poincaré, H., 366  
 Poisson, S. D., 507  
 Polyá, G., 116  
 Powell, R. W., 156  
 Powers, L. G., 442  
 Poynting, J. H., 46, 52, 240  
 Ptolemy, C., 573  
 Puffer, Ruth R., 18  
  
 Reed, L. J., 17, 18, 250, 251, 253, 254,  
 257, 267  
 Rhea, R., 538, 542  
 Rhodes, E. C., 194  
 Ricci, U., 442  
 Richie-Scott, A., 241  
 Rider, P. R., 203  
 Riemann, G. F. B., 410  
 Rietz, H. L., 54  
 Riggelman, J. R., 351, 352  
 Robertson, T. B., 18, 262  
 Robinson, G., 30, 31, 84, 85, 244  
 Rogers, J. E. T., 466, 486, 488, 562,  
 563  
 Roos, C. F., 15, 48, 50, 60, 89, 333,  
 351, 352, 353, 354, 355, 356, 472, 498  
 Roosevelt, Franklin D., 555  
 Roosevelt, Theodore, 574  
 Rossiter, W. S., 528  
 Runge, C., 116  
  
 Saibante, M., 442  
 Sasuly, M., 89, 244  
 Sauerbeck, A., 28, 305-307, 315  
 Schultz, H., 9, 18, 23, 137, 138, 140,  
 141, 250, 257, 501, 511, 512, 514,  
 516, 520, 522, 526, 527  
 Schumpeter, J. A., 208, 346  
 Schuster, Sir Arthur, 31, 35, 38, 40,  
 43, 44, 60, 84-86, 131, 184-191, 199-  
 200, 205, 303, 317, 318, 326, 530, 531,  
 534  
 Shaffner, F. I., 563, 568  
 Shakespeare, William, 572  
 Sheppard, W. F., 241, 244  
 Shirras, G. F., 404, 442  
 Sismondi, J. C. L. de, 45  
 Slaughter, J. A., 391, 392, 393  
 Slutzky, E., 38, 54, 57, 283  
 Smith, Adam, 45  
 Smith, J. H., 48, 190  
 Snyder, Carl, 5, 15, 18, 47, 208, 265,  
 332, 427, 442, 446, 447, 456, 457, 469,  
 474-478, 481, 482, 483, 496, 498  
 Soetbeer, A., 486, 488, 489, 490, 493  
 Sorokin, P. A., 472, 573  
 Spearman, C., 192, 194  
 Sprague, O. M. W., 498  
 Staehle, H., 442  
 Stamp, Sir Josiah, 498  
 Stecker, Margaret L., 416  
 Stieltjes, T. J., 93  
 Stirling, J., 412  
 "Student," 53, 175, 200, 241  
 Stumpff, K., 32  
  
 Taft, William H., 574  
 Tchebycheff, P. L., 90, 92, 159  
 Tilden, S. J., 574  
 Tinbergen, J., 51, 339, 351, 352, 354,  
 355  
 Tintner, G., 27, 54, 240, 241, 245  
 Titus, J. D., 4  
 Thompson, G. H., 192  
 Thornton, H. G., 18  
 Thorp, W. L., 27, 547  
 Thurstone, L. L., 48, 194, 195  
 Truesdell, L. E., 263  
 Tucker, R. S., 442  
 Turner, H. H., 29  
  
 Uven, M. J. van, 48, 195  
  
 Van Buren, Martin, 573  
 Verhulst, P. F., 18  
 Vinci, F., 442  
 Viner, J., 498  
 Voltaire, 572  
 Volterra, V., 356, 360, 361  
 von Szeliski, V. S., 18, 351, 423  
 Vries, H. de, 329  
  
 Wald, A., 158, 241, 465  
 Walker, Sir Gilbert, 31, 55, 56, 132-  
 134, 184, 186, 188, 189, 190, 199, 205,  
 276, 551, 552  
 Walker, Helen M., 175  
 Walras, L., 8, 45, 49, 344  
 Warburton, C., 442, 443  
 Warren, G. F., 47, 351, 352, 469, 489  
 Watkins, R. J., 270  
 Watson, G. N., 62  
 Webster, A. G., 370, 380  
 Wenzlick, R., 351, 352  
 Whitman, R. H., 335, 336, 339.  
 Whittaker, E. T., 30, 31, 62, 84, 85, 244  
 Wicksell, K., 37, 38  
 Wiener, N., 32, 33, 115  
 Wijk, J. van der, 443  
 Wilson, E. B., 18, 27, 32, 300, 301, 302,  
 303, 304, 549, 551, 568  
 Wilson, Woodrow, 574  
 Wold, H., 55, 56, 58, 443  
 Wolf, R., 317  
 Wolfer, A., 38, 43, 54, 131, 317  
 Woolard, E. W., 56, 57, 144, 166

Working, E. J., 138, 140

Working, H., 23, 512

Wright, P. G., 138

Yntema, D. B., 443

Yntema, T. O., 335, 373

Young, A. A., 443

Yule, G. U., 16, 38, 41, 53, 54, 55, 56,  
129, 130, 131, 132, 149, 151, 241, 366

Zaycoff, R., 241, 242

Zygmund, A., 62

## INDEX OF SUBJECTS

- Ability, billiard, 428-429; executive, 432; mathematical, 428-429; scientific, 430-432
- Accumulated random series, 155-159; runs in, 167-168; variance of runs in, 168
- Aleatory variation, 53
- All Stocks index of Cowles Commission, 35, 81-83, 245, 247, 548-549
- American industrial activity, *see* Industrial activity
- Amplitude of harmonic, 61
- Approximate Schuster periodogram, 85
- Arithmetic sequence, 29, 68
- Autocorrelation, definition of, 52; function, 103; of a random series, 150-155; of moving average of random series, 284-285; in hysteresis, 363-365; of atmospheric pressure data, 133; inverse, 112, 115; periodograms, 33; of series derived from random series, 149-155; table of, 150-151.
- Automobile production, 19; logistic of, 17
- Average, moving, 22-23; length of moving, 22; in the mean, 119; random series smoothed by moving, 159-163; period of moving, 159; as trend, 209
- Bank clearings, outside of New York City, 105; serial correlation of, 105-108; ratio to bank debits, 455
- Bank debits, 455; ratio to bank clearings, 455; ratio to income, 457-458
- Bank deposits, 455, *see* Circulating deposits
- Bear market, 541-542
- Bernoulli numbers, 409
- Bessel's inequality, 65, 71, 97, 202, 221
- Beta function, 190; incomplete, 201
- Billiard ability, 428-429
- Biorthogonal functions, 90, 93
- Black Friday, 566
- Bode's law, 4
- Brownian movement, 58
- Building, factors affecting, 355
- Building activity, composite index of, 352
- Building cycle, 27, 268, 298, 328, 351-355; evidence for, 550-552
- Building materials, price of, 101, 105, 193; serial correlations of, 105-108
- Bull market, 542-543
- Bunch analysis, 195
- Bunch map, 196, 197
- Business activity, 109, 549, 551; index of, 565
- Business cycles, definition of, 1, 6; theory of, 44-49; origin of, 46; length of in United States, 547-548; in foreign countries, 548, *see also* cycles
- Business failures, 551; in the United States, (1867-1932), 310-311; periodogram of, 310-311
- Call-money rate, 348
- Capital, 389, 438
- Capital gains, 390
- Carthage, index of world dominance of, 14
- Chain relatives, 238-239
- Changes-in-income theory of cycles, 331
- Changing harmonics, 40-41, 55
- Characteristic, equation, 381; frequencies, 381; periods, 381
- Chicago, growth of, 263
- Chi-square test, 169, 170
- Circulating deposits ( $M'$ ), 451-454; velocity of, 480; trend of, 480; *see also* Deposits, circulating
- Circulating money ( $M$ ), 448-451; velocity of, 461-463
- Cities, growth of American, 262-264
- Civil War, 435
- Closure property, 65
- Cobweb theory of price, 141
- Coefficient of war intensity, 553-554
- Coherence matrix, 33
- Commercial-paper rates, 105, 109, 348-350, 550; serial correlations of, 105-107; periodogram of, 307-309
- Commodity prices, 105; serial correlation of, 105-108
- Components of harmonic, 61
- Concentration, curves of, 424-426
- Concentration ratio, 425-426; data for, 437
- Confluence analysis, 48; method of, 195-197
- Constructed sine-cosine series, 88; 278-280
- Consumers' goods, 388
- Continuity, criterion of, 24
- Continuous autocorrelations, 152-155

- Continuous spectrum, 123-129
- Correlation, serial, 52-56, Chap. 3; lag, 52, 104; inverse serial, 111-119; of differences of random series, 160-163; multiple, 97-101; of differences of moving average, 161-162; of residuals from linear trend, 212-213; from polynomial trends, 222-227; coefficient in terms of Fourier coefficients, 67, 71; *see also* Autocorrelation, lag correlation
- Correlation analysis, origin of, 46
- Cost function, 334
- Cowles Commission, 16, 42, 319, 367, 426, 427, 472, 535; All Stocks index, 35, 81-83, 245, 247, 548-549; -Standard Statistics index of industrial stock prices, 5, 227-234
- Credit, 455; velocity of, 445; *see also* Circulating deposits
- Crises, economic, 6-7, 45; significance of, 9-14; resonance theory of, 378-380; relation to sunspots, 329; interaction of world, 557-561
- Critical point of logistic, 249
- Cubic, formulas for, 218; variance of residuals from, 220; correlation of residuals from, 223-225; moving, 245
- Culture and prices, 472
- Curve of growth, *see* Logistic trend
- Cycles, evidence and explanation of, Chap. 8; mathematical attempts to account for, 49-52; seasonal, 26, 237, 327-328; 40-month, 26-28, 128-129, 234-236, 290, 292, 294, 328, 546-550; 10-and 20-year, 27, 328, 550-552; building, 27, 268, 298, 328, 351-355, 550-552; war, 27-28, 305, 306-307, 317, 328, 469, 552-557; trade, 28; business, length in the United States, 547-548; in foreign countries, 548; macrodynamic theory of, 51, 330, 339-347; erratic-shock theory of, 36-42, 319, 346, 366-369; interest theory of, 348-350; perturbation theory of, 370-378; price-dislocation theory of, 330; inequality-of-fore-sight theory, 331; changes-in-income theory of, 331; fluctuations-in-discount theory of, 331; variations-of-cash-balance theory of, 331; overconfidence theory of, 331; overinvestment theory of, 331; oversaving theory of, 332; overcapacity theory of, 332; underconsumption theory of, 332; overproduction theory of, 332; maximizing-of-profits theory of, 333-339; other theories of, 355-366; *see also* Business cycles
- Deflation, statistical, 48
- Degrees of freedom, 60, Chap. 5; definition of, 185; concept of, 175-180; significance tests and the problem of, 183-186; calculation of, 207; random, 534; significant, 534
- Demand and supply, 8-9, 135-141
- Demand for steel, 336-337
- Dependence, linear, 48, 99, Chap. 5
- Deposits, circulating ( $M'$ ), 451-454; velocity of, 454-461, 480; method of computing velocity of, 455-456; average annual velocity of, 457; velocity for New York City, 459-461; velocity for 100 cities outside of New York City, 459-461
- Differences, autocorrelation of, for random series, 149-155
- Dissipation function, 381
- Distribution of incomes, 25, 330, 394-397, 400-404
- Douglas-Cobb production function, 438-440
- Dow-Jones industrial stock price averages, 1, 34, 42, 101, 105, 109, 110, 111, 164, 169, 193, 215-216, 221, 346, 364, 367, 384, 530-533, 543, 549; serial correlations of, 105; random series constructed from, 143, 164; harmonic elements of, 227-234; (1897-1913), 288-290; (1914-1924), 290-292; (1925-1934), 292-293
- Dow theory of forecasting, 174, 538-544
- Dynamics of trends, Chap. 10
- Economic crises, *see* Crises, economic
- Economic time series, 4-7; present status of problem of, 59; applications of harmonic analysis to, 77-83; *see also* Time series.
- Economics, inertial theory of, 208; macroscopic theory of, 208
- Eggs, price and production of, 327
- Elasticity of demand, 136
- Elections, theory of, 573-574
- Elementary energies, definition of, 179; method of, 198-207; examples illustrating method of, 205-207
- Elliptic integral, 367, 368
- Energy, of time series, 26; of harmonic, 34, 68, 70-71; of trial period, 276; kinetic, 381; potential, 381
- English business index, 39
- Equation of exchange, Chap. 10, 386, 445, 553; variables in, 447-448
- Equilibrium price, 137
- Equilibrium theory, 49
- Erratic element in time series, 6, 230

- Erratic-shock theory of cycles, 36-42, 319, 346, 347, 366-369
- Euler condition, 374, 375
- Euler's equation, 335
- Exchange, equation of, (*see* Equation of exchange)
- Executive ability, 432
- Expected mean deviation of a random series, 145-146
- Exponential trends, 17, 209
- Exports, index of total, 559
- External variance of time series, 514
- Extrapolation of trends, 535
- Factor analysis, 192-198
- Farm problem, 554
- Fifty-year cycle, 552-557; *see also* War cycle
- Fisher probability, 189, 276; Table 2
- Fluctuations-in-discount theory of cycles, 331
- Forces, elastic, 370
- Forecast, standard error of, 509-517; for linear trends, 517-522; for harmonic sum, 522-523; for logistic trends, 523-529; for polynomial trends, 529
- Forecasting economic time series, Chap. 11; stock prices, 501-509; Dow theory of, 174, 538-544
- Forty-month cycle, evidence for, 546-550; *see also* Cycles
- Fourier coefficients, 62-64, 123
- Fourier sequence, 29, 68, 277, 278, 279
- Fourier series, Chap. 2, 33, 61-64, 177, 515, 578; principal theorem of, 61-62
- Fourier transforms, 112, 115, 118
- Franco-Prussian war, 306, 554
- Freedom, degrees of, *see* Degrees of freedom
- Freight-car loadings, 78-80, 327; corrected for seasonal variation, 239-240
- French Revolution, 25, 435, 572
- Frequency distributions, of time series, 271-274; of incomes, 417-418
- Frequency of harmonic, 61, 103
- Functions, autocorrelation, for differences of random series, 151-155; Bessel, 90, 92; Beta, 190; incomplete Beta, 201; biorthogonal, 90, 93; cost 334; dissipation, 381; elliptic integral, 367, 368; Fisher probability, 189, 276, Table 2; Gamma, 152-155, 410-411; incomplete Gamma, 200; general distribution for incomes, 404-418; Gram polynomials, 93, 94, 220-221; harmonically equivalent, 124; Hermite polynomials, 90, 91, 93, 94-95, 116-118; lag correlation, 32, for harmonic sum, 119-122, in harmonic analysis, 122-123; Laguerre polynomials, 90, 91-92; Legendre polynomials, 90, 91, 93, 179; orthogonal, 89-95; production, 438-440; random variable, 58; step, 86, 93; "Student's" distribution, 200; Tchebycheff polynomials, 90, 92; trigonometric, 90, 93-94; unit impulse, 154; utility, 51, 371-373; Walker probability, 188, 202, 276, 308, 310-311, 314, 551, 552, Table 1; weight, 90; Zeta, 410-411
- Galvanometer experiment, 42, 368-369; periodogram for, 319-320
- Gamma function, 152-155, 410-411; incomplete, 200
- Genetic factors, 433-434
- German inflation, 485
- Gold, 464, 467; standard, 464-465; relation to prices, 484-493; path of, 546; data on reserves of, 561
- Gompertz curve, 20-21, 249-250
- Goods, definition of, 388; of different orders, 388-389; consumers', 388; producers', 389
- Goutereau's constant, 144-149; values of, 144; standard error of, 148
- Gram polynomials, 93, 94, 220-221
- Gram-Charlier series, 116
- Gravitation, law of, 2, 3
- Growth, exponential law of, 255, 256; Malthusian theory of, 255-256; logistic law of, 256; of population of the United States, 256-257; of population subject to mechanism, 258; of fruit flies, 258-259; of yeast cells, 260; of white rats, 261; of pumpkin, 261-262; of production, 265-271; of pig-iron production, 266-267; of wheat production, 266-267; of corn production, 266-267; of copper production, 266-267
- Harmonic, definition of, 29, 61; period of, 61; amplitude of, 61; phase angle of, 61; frequency of, 61
- Harmonic analysis, 28-33; advantages and limitations of, 33-36; technique of, Chap. 2, 67-71; mathematical example of, 71-74; applications of, 43-44, 77-83, Chap. 7; effect of linear trend in, 75-76; effect of parabolic trend in, 76; method of Lagrange in, 30; method of differential equations in, 30-31; periodogram method in, 31, 67-71; method of integrated periodogram in, 32-33; Whittaker-Robinson periodogram in, 84; method of maximum differences in, 85; approximate Schuster peri-

- odogram in, 85; method of serial correlation in, 33, 86; moving-periodogram in, 530-534; Schuster test in, 186-188; Walker test in, 188-189; Fisher test in, 189-191; application to seasonal variation, 77-81, 237
- Harmonic sums, standard error of forecast of, 522-523
- Harmonics, changing, 55
- Hermite polynomials, 90, 91, 93, 94-95, 116-118
- High-grade bond yields, 370; index of, 105, 109, 110; serial correlations of, 105-106
- History, economic interpretation of, 493-497; 571-575
- Hysteresis, definition of, 355-356; lag, 356, 358; skew, 356; Volterra's method in theory of, 359-363; autocorrelation method in theory of, 363-365; Lotka's theory of, 365-366
- Impressed force, 346
- Impulse function, 154
- Income, nature of, Chap. 9, 390-394; in the United States, 392; distributed according to type, 392, 393; distributed according to production, 393, 394; class distribution of, 25, 330, 394-397; data for class distribution of, 397-400; frequency of distribution of, 402; negative, 397; general distribution function for, 408-418; total real, 418-424; Pareto's law for distribution of, 25, 387, 394-397, 400-404, 405, 427; ratio to bank debits of, 457-458; ratio to industrial production of, 458
- Income power, definition of, 406
- Incomplete Beta function, 201
- Incomplete Gamma function, 200
- Index numbers, theory of, 8, 465-466
- Index of general prices, 470-472
- Industrial activity (1831-1930), periodogram of, 299-304
- Industrial production, 105, 109, 437; serial correlations of, 105-107; index of, 252; logistic of, 255; compared with trade, 474; ratio to income of, 458
- Industrial stock prices, 128, 370, 376, 383, 523-524; lag correlation with pig-iron production, 102-103; autocorrelation function of, 104; index of, 5
- Inequality, law of, 426-434
- Inequality, of Bessel, 65, 71, 97, 221; of Parseval, 66-67, 71; of Tchebycheff, 159
- Inequality-of-foresight theory of cycles, 331
- Inertia of economic time series, 5, 15, 208
- Inflation, 9-14; German, 485; speculation in, 555
- Inflection, point of, 19, 249
- Interest theory of cycles, 348-350
- Internal variance of time series, 514
- Interpretation and critique of time series, Chap. 12
- Inverse probability, economic series as a problem in, 180-183
- Inverse serial correlation, 111-119; in hysteresis, 365
- Jevons' hypothesis, 329, 561-571
- Kepler's laws, 3
- Kernel, of integral, 96
- Kurtosis, 243, 246, 295, 296, 297, 399, 406
- Labor, 438
- Lag correlation, 104; definition of, 52; function, 32; examples of, 104-111; for harmonic sum, 119-122; as used in harmonic analysis, 122-123; of differences of random series, 160-163; as related to theory of supply and demand, 135-141; for commercial paper, 350; *see also* Autocorrelation and Correlation, serial
- Laguerre polynomials, 90, 91-92
- Law of Pareto, 25, 387, 394-397, 400-404, 405, 427
- Law of proportional effect, 406
- Least action, principle of, 49, 51
- Least squares, minimizing by method of, 95-97
- Legendre polynomials, 90, 91, 93, 179
- Line of equal distribution of incomes, 19
- Line of maturity, 19
- Linear dependence, 48, 99, 196-197, 205-207
- Linear trend, 16, 209; technical discussion of, 210-217; effect of, in harmonic analysis, 75-76; variance of residuals from, 211-212; standard error of forecast of, 517-522
- Link relatives, method of, 237-240
- Loans and discounts of all national banks, 105; serial correlations of, 106-108
- Logistic trend, 5-6, 17-21, 247-271, 359; formula for, 19, 247, 248; differential equation of, 20, 248; critical point of, 249; properties of, 248-249; methods of fitting to data of, 250-255; biological basis of, 18, 258-262; error of forecast of, 523-529; of industrial production, 255; of population of the United States, 256-257, 527-529; of fruit flies, 258-259; of yeast cells, 260; of white

- rats, 261; of pumpkin, 262; of wheat production, 267; of corn production, 267; of pig-iron production, 267, 524-527; of copper production, 524-527; of population of American colonies, 528-529
- Long waves, 14
- Macrodynamical theory of cycles, 51, 330, 339-347
- Macroscopic theory of economics, 208
- Malthusian theory of growth, 255-256
- Manufacturers, production of, 564-565
- Mathematical ability, 428-429
- Maturity, line of, 19
- Maximum differences, method of, 85
- Maximum profits, principle of, 50-51, 333-339
- Mean, average in the, 119; product in the, 119; moment in the, 119
- Mechanical analogies of economic variables, 577
- Mechanics and the problem of degrees of freedom, 175, 178
- Metal and metal-products prices, 105; serial correlations of, 105-108
- Mississippi Bubble, 11-13, 558, 566
- Moments, 211; definition and origin of, 211; in the mean, 119
- Monetary ratios, 451, 453
- Money tension, 484
- Money, quantity theory of, 445; velocity of, 445; circulating ( $M$ ), 448-451; Spanish index of, 491, 494
- Moving average, 22-23, 241; length of, 22; period of, 159; correlation of differences of, 161-162, as trend, 209; random series smoothed by, 159-163
- Moving-periodogram analysis, 530-534
- Moving polynomial, 244
- Moving trend, 534
- Multiple correlation, 97-101
- Mutation theory of cycles, 329
- Negative incomes, 397
- New York City, growth of, 263
- Nonsense correlations, Yule's theory of, 149
- Ophelimity, 51, 371
- Orthogonal, origin of word, 89
- Orthogonal functions, 89-95
- Orthogonal matrix, 100
- Overcapacity theory of cycles, 332
- Overconfidence theory of cycles, 331
- Overinvestment theory of cycles, 331
- Overproduction theory of cycles, 332
- Oversaving theory of cycles, 332
- Parabola, formulas for, 218; variance of residuals from, 220; correlation of residuals from, 223-225; moving, 245
- Pareto distribution of income, 25, 387, 394-397, 400-404, 405, 427
- Pareto's law, *see* Law of Pareto
- Parseval's inequality 66-67, 71
- Period of harmonic, 61; exact determination of, 87-89
- Periodogram, 31; definition of, 68; maxima of, 69-70; secondary analysis of, 87-89; integrated, 32-33; autocorrelation, 33; moving, 530-534; of atmospheric data, 134-135; of freight-car loadings, 80; of Cowles Commission All Stocks index, 81; (1880-1896), 286-288; of constructed sine-cosine series, 278-280; of random series smoothed by moving average, 282-285; of cumulated random series, 285-286; of Dow-Jones industrial averages (1897-1913), 288-290; (1914-1924), 290-292; (1925-1934), 292-293; of rail stock prices (1831-1855), 293-294; (1856-1880), 294-296; (1831-1930), 296-299; of industrial activity (1831-1930), 299-304; of American wholesale prices (1831-1930), 304-305; of Sauerbeck's index of English wholesale prices (1818-1913), 305-307; of commercial paper rates (1831-1930), 307-309; of rail bond prices (1831-1930), 309-310; of business failures in the United States (1867-1932), 310-311; of wheat prices in Western Europe (1500-1869), 312-317; of sunspot numbers (1750-1900), 317-319; of galvanometer series, 319-320; of stock price indexes (daily, 1927), 320-321; (daily, 1930), 321-323; (weekly, 1922-1927), 323-324; (weekly, 1929-1935), 324-325
- Perturbation theory of cycles, 370-378; 380-384
- Phase angle of harmonic, 61
- Pig-iron production, 101, 105, 109, 110, 193, 215-216, 221, 253-254, 266-268, 364, 370, 383, 549; serial correlation of, 105-106; lag correlation with industrial stock prices, 102-103; harmonic elements of, 227-234; logistic of, 266-267, 524-527
- Pittsburgh district, production and population growth in, 271
- Political events, application of income distribution to, 434-440; as interpreted by time series, 575
- Polynomial trends, 217-227; formulas for fitting, 218; variance of residuals from, 222-227; error of forecast of, 529

- Polynomials, Gram, 93, 94, 220-221; Hermite, 90, 91, 93, 94-95; Laguerre, 90, 91-92; Legendre, 90, 91, 93; Tchebycheff, 90, 92
- Population, growth of, 6, 255-264; of United States, 256-257; of American cities, 262-264; of New York City, 263; of Chicago, 263; in Pittsburgh district, 271; logistic of, 527-528; of American colonies, 528-529
- Prey and predator, problem of, 359-363
- Price ( $P$ ), 445, 463-472; equilibrium, 137; of zero demand, 136-137; of zero supply, 137; of wheat, 28, 44, 464, 563; of wheat in England, 466-468, 488; of wheat in Munich, 468; index number of, 465-466; general level of, 105, 469-472; serial correlations of general index of, 107-108; Spanish level of, 467, 468, 486-487; Snyder's theory of, 476-484; of metal and metal products, 105-108; of building materials, 101, 105-108; Bradstreet's commodity, 105-108; of rail bonds, 109; (1831-1930), 309-310; wholesale, 109; 304-305, 559; of rail stocks, 24, 109, 510-511, 518-520, 535-537, 540, 543; (1831-1855), 293-294; (1856-1880), 294-296; (1831-1930), 296-299; of industrial stocks, 128, 523-524; (daily, 1927), 320-321; (daily, 1930), 321-323; (weekly, 1922-1927), 323-324; (weekly, 1929-1935), 324-325; Sauerbeck's index of English wholesale, 28, 306; (1818-1913), 305-307; 315; of wheat in Western Europe (1500-1869), 312-317; of eggs, 327; dynamic theory of, 375-376; culture and, 472
- Price-dislocation-theory of cycles, 330
- Price shelf, 554
- Principal components, method of, 195
- Probability, inverse, 180-183
- Probable-error bands, method of, 534
- Product in the mean, 119
- Producers' goods, 389
- Production, 473; growth of, 265-271; of pig iron, 253-254, 266-268; of wheat, 267-269; of corn, 267-269; of copper, 267-269; industrial, for United States, 271; in Pittsburgh district, 271; of eggs, 327
- Production function, 438-440
- Production goods, 389
- Profit integral, 334
- Profits, maximizing of, 50-51, 333-339
- Punic Wars, 305
- of residuals from, 220; correlation of residuals from, 224-225
- Quintic, formulas for, 218; variance of residuals from, 220; correlation of residuals from, 224-225
- Random causes, summation of, 38
- Random degrees of freedom, 534
- Random elements, reduction of series to, 227-234, 533
- Random series, 22, 39, 56-59, 280-282; theory of, Chap. 4; definition of, 142; example of, 143-144; autocorrelation of, 143, 162; autocorrelation of differences of, 150-153; Goutereau's test for, 144; Yule's theory of, 149-151; generalizations of Yule's theory of, 151-155; accumulated, 155-159, 285-286, 539-540; smoothed by moving average, 159-163, 282-285; lag correlation of differences of, 160-163; runs in, 166; runs in accumulated, 167-168
- Random-shock theory of cycles, 366-369
- Random variables, functions of, 58
- Random variation, Yule's theory of, 129-135
- Random walk, problem of, 58
- Range variance of time series, 517
- Rail bond prices, 109; (1831-1830), 309-310
- Rail stock prices, 24, 109, 500, 510-511, 518-520, 535-537, 540, 543; (1831-1855), 293-294; (1856-1880), 294-296; (1831-1930), 296-299; fitted with linear trend and harmonic curve, 299
- Records of stock forecasting, 505, 509
- Reduction of series to random elements, 227-234, 533
- Relatively erratic series, 230
- Resonance, 338, 378-379, 380
- Reversals, theory of, 57, 164-170; formula for, 165, 167; standard error of, 165-167; ratio to sequences, 166, 167, 171, table of, 165
- Revolution, French, 25, 435, 572; Russian, 25, 435
- Rome, index of world dominance of, 14
- Roots of  $\tan x = r$ , 125
- Runs, definition of, 164; theory of, 57-58, 164-170; expected value in random series, 166; in accumulated random series, 167; distribution of, 169; table of, 169
- Russian Revolution, 25, 435
- Sauerbeck's index of English prices, 28, 306; (1818-1913), 305-307; 315
- Scientific ability, 430-432



- Seasonal variation, 26, 237-240, 327-328
- Secondary analysis of periodogram, 87-89
- Secular trends, *see* Trends
- Septimic, formulas for, 218; variance of residuals from, 220; correlation of residuals from, 225
- Sequence, arithmetic, 29, 68; Fourier, 29, 68, 277, 278, 279
- Sequences and reversals, 57, 164-170; ratio of, 57, 164, 166, 167, 171; table of, 165; sum of, 166; application to stock market action, 170-174
- Series, random, 22, Chap. 4; *see also* Random series
- Sextic, formulas for, 218; variance of residuals from, 220; correlation of residuals from, 224-225
- Sheppard's graduation, 241, 244
- Significant degrees of freedom, 534
- Significance tests in harmonic analysis, 186-191
- Silver, 464, 467; relation to prices, 484-493
- Sine-cosine series, 121-122
- Sinusoidal limit theorem, 57
- Snyder's constant, 478, 483
- Snyder's theory of price, 476-484
- South Sea Bubble, 11-12, 558, 566
- Spanish Armada, 492; commerce, 492; imports of treasure, 493; prices, 467, 468, 486-488; trade, 489-495
- Spectrum, of integral equation, 97; continuous, 123-129
- Stable economy, definition of, 394
- Standard deviations of residuals as a function of the degree of a polynomial trend, 220-222
- Standard error, of estimate, 101; of Goutereau's constant, 148; of forecast, *see* Forecast
- Statistical deflation, definition of, 48
- Steel, demand for, 336-337
- Step function, 86
- Stieltjes integral, 93
- Stirling's approximation, 412
- Stochastic variation, 53
- Stock-market action, application of theory of sequences and reversals to, 170-174
- Stock-market forecasting, 501-509
- Stock price indexes, 35; changes in, 172; status of forecasting, 501-509, *see also* Prices, Cowles Commission, and Dow-Jones
- Stock sales on the New York Stock Exchange, 101, 105, 193, 370; serial correlation of, 105-108; reduction to elements of, 227-234
- Straight line, formulas for, 218; variance of residuals from, 220; correlation of residuals from, 212-213, 223-225
- Strictly erratic series, 230
- Struggle for life, 360
- "Student's" distribution function, 200
- Sunspot cycle, 562-571
- Sunspot numbers, 43, 54, 131; (1750-1900), 317-319
- Sunspots and crises, 329
- Supply and demand, 8-9, 135-141
- Survival of the fittest, theory of, 357
- Table, of sequences and reversals, 165, of runs, 169
- Tame hay, production of, 521
- Tchebycheff polynomials, 90, 92
- Ten-year cycle, evidence for, 550-552
- Tetrad differences, 192-193
- Theory of Jevons, 329, 561-571
- Tilling, 195
- Time-money rates, 105; serial correlations of, 105-106
- Time series, Chap. 1; definition of, 1; astronomical, 1-4; economic, 4-7; types of, 7-9; dynamics of, 7; erratic-shock theory of, 36-42; energy of, 26; degrees of freedom possessed by, 60; reduction to random elements of, 227-234, 533; frequency distribution of, 271-274; forecasting economic, Chap. 11; internal and external variances of, 514; range variance of, 517
- T. N. E. C. papers, 335, 373
- Trade (*T*), 445, 473-476; compared with industrial production, 474; trend of, 475-476; Spanish, 489-495
- Trade cycles, 28
- Transactions, volume of, 473
- Treasure, accumulation of, 487-488; in Europe, 488-489; imports into Spain, 493; *see also* Gold and Silver
- Trends, problems of, 15-24; types of, 16, 209-210; moving averages as, 22-23, 209; parabolic, 23; standard error of, 23; residuals from, 24; analysis of, Chap. 6; linear, 209, 210-217; exponential, 209; logistic, 209, 247-271; polynomial, 217-227; standard error of forecast of, 509-529; moving, 534; extrapolation of, 535; stability of, 274-275; critique of economic significance of, 275; dynamics of, Chap. 10; of velocity of deposits, 480; primary and secondary, 538
- Twenty-year cycle, evidence for, 550-552
- Tulip mania, 10-11, 566
- Ultraviolet radiation, 568-571

- Under-consumption theory of cycles, 332
- Unit impulse function, 154
- Urban concentration, 263
- Utility, 51, 371-373
- Variables, superfluous, 195; detrimental, 195
- Variance, of residuals from linear trend, 211-212; of residuals from polynomial trends, 219, 220; of trend, 277; of time series, external, 514; internal, 514; range, 517
- Variate difference method, 52-53, 240-247
- Variations, calculus of, 335, 338-339
- Variations-of-cash-balance theory of cycles, 331
- Velocity of circulating deposits ( $V'$ ), 454-461, 480; method of computing, 455-456; average annual, 457; for New York City, 459-461; for 100 cities outside of New York City, 459-461; trend of, 480; compared with money tension, 484
- Velocity of credit, 445; *see also* Velocity of circulating deposits
- Velocity of circulating money ( $V$ ), 445; 461-463
- Volume of trade, 475
- Volume of trading, 543
- Walker probability, 188, 202, 276, 308, 310-311, 314, 551, 552, Table 1
- War cycle, 27-28, 305, 306-307, 317, 328, 469, 552-557
- War inflation, 13
- War intensity, coefficient of, 553-554
- Wealth, nature of, Chap. 9, 388-390; definition of, 388; efficiency of, 389
- Weight function, 90
- Wheat prices, 28, 44, 464, 563; in England, 466-467, 488; in Munich, 468; in Western Europe (1500-1869), 312-317
- Whittaker-Robinson periodogram, 84
- Wholesale prices, American, 109, 304-305; English, 305-307, 315; indexes of, 559
- Wolf point, 405; per capita, 415-417
- World crises, interactions of, 557-561
- Yule's theory of random variation, 55, 129-135
- Zeta function, 410-411