

REPORT
OF
THE COMMISSIONERS
APPOINTED TO INQUIRE INTO THE
CONDITION OF ALL MINES IN GREAT BRITAIN

TO WHICH THE PROVISIONS OF THE ACT 23 & 24 VICT. CAP. 151.
DO NOT APPLY,

WITH REFERENCE TO THE

**HEALTH AND SAFETY OF PERSONS EMPLOYED
IN SUCH MINES;**

WITH

APPENDICES.

Presented to both Houses of Parliament by Command of Her Majesty.

X9(03):9.3.1864
A
24244



2424

LONDON:

PRINTED BY **GEORGE E. EYRE AND WILLIAM SPOTTISWOODE,**
PRINTERS TO THE QUEEN'S MOST EXCELLENT MAJESTY,
FOR HER MAJESTY'S STATIONERY OFFICE.

1864.

Dhananjayrao Gadgil Library



GIPE-PUNE-024244

REPORT
OF
THE COMMISSIONERS
APPOINTED TO INQUIRE INTO
THE CONDITION OF ALL
MINES IN GREAT BRITAIN

105
C

TO WHICH THE PROVISIONS OF THE ACT 23 & 24 VICT. CAP. 151.
DO NOT APPLY,

WITH REFERENCE TO THE
HEALTH AND SAFETY OF PERSONS EMPLOYED
IN SUCH MINES;

WITH
APPENDICES.

Presented to both Houses of Parliament by Command of Her Majesty.



LONDON:
PRINTED BY GEORGE E. EYRE AND WILLIAM SPOTTISWOODE,
PRINTERS TO THE QUEEN'S MOST EXCELLENT MAJESTY
FOR HER MAJESTY'S STATIONERY OFFICE.

1864.

X9(03):9.3.M

A

24244

CONTENTS.

REPORT	Page
-	vii
APPENDICES.	
APPENDIX A.	
Summary of Tables of Ages of Men working in Mines	1
Benefit Society Rules, with Report by Mr. Brown	2
Plan of workings underground in Dolcoath Mine	14
" Furnace Ventilation, Burtree Pasture Mine	15
" Water Blasts	17
" Boring Machine	19
Evidence on the same by Mr. Geo. Green, of Aberystwith	21
" Changing House, with Specification, suggested by Lord Kinnaird	24
" Steam Whistle	26
" Cages, with Cost thereof, by G. B. Foster, Esq.	27
" Man Engine	29
" Ladders	30
" Stemples	31
" Skip as used in Cornwall	33
" Skip with Safety Catch	34
APPENDIX B.	
I. Medical Reports on Condition of Miners, by Dr. Peacock :—	
Cornwall.	
North of England.	
Wales.	
Hæmatite Ore Mines.	
II. Medical Report on the Condition of Miners in Cornwall and Devon, by Mr. Bankart.	
III. Statistics and evidence by Dr. Farr, with Epitome of Tables and Diagrams, and additional Returns prepared from the Census of 1861.	
IV. Report on Samples of Air, and on Materials used by Miners, and evidence, by Dr. A. S. Taylor.	
V. Report on the Air of Mines, by Dr. Angus Smith.	
VI. Report on the Air of Mines, by Dr. Bernays.	
VII. Reports on Mines, by Mr. C. Twite, M.E.	
VIII. Report on Mines, by Capt. W. H. Rowe.	
IX. Deaths of Males aged 10 Years and upwards in each of the Years 1859—1861 ; a Return by the Registrar General.	
X. Ages of Men working in Mines.	
XI. Candle and Powder Returns.	
XII. Bal or Pay Bills.	
XIII. Coroners' Inquests and Accidents, with Report by Mr. Wylie.	
XIV. Experiments to test the Applicability of Gun Cotton to Mining Operations.	

EPITOME OF EVIDENCE.

	Cornwall	North of England.	Ironstone Mines.	Wales.
	A.	A ⁿ .	A ^l .	A ^w .
(A.) Health and Diseases of Miners Pages	3	123	200	219
(a.) Decrease in Weight working under- ground.....	17	—	—	—
(b.) Age and Appearance of Miners...	17	141	201	228
(c.) Food of the Miners.....	18	142	201	229
(d.) Habits of the Miners	20	—	—	229
(e.) Smelters	—	142	—	—
	B.	B ⁿ .	B ^l .	B ^w .
(B.) Mode of Access and Egress :	20	143	201	229
(a.) Ladders	21	144	201	230
(b.) Man Engine.....	24	145	—	—
(c.) Skip	27	—	—	231
(d.) Wire Rope	—	145	202	—
(e.) Stemples	—	146	—	—
(f.) Day or Adit Levels	—	148	203	—
	C.	C ⁿ .	C ^l .	C ^w .
(C.) Ventilation :	33	149	203	231
(a.) Poor Air	50	169	208	240
(b.) Temperature	61	173	—	241
(c.) Deals an obstruction to Ventilation	63	173	—	—
(d.) Dust	64	173	208	241
(e.) Candle Smoke	66	—	—	—
(f.) Powder Smoke	66	176	208	242
(g.) Improvement of Ventilation	67	176	—	—
(h.) Modes of providing Ventilation...	67	—	208	—
(i.) Fan worked by Engine	73	—	—	—
(j.) Fan worked by a boy	73	—	209	—
(k.) Water blast	74	—	—	242
(l.) Wooden Sollars	74	—	—	—
(m.) Metal Pipes	76	176	—	—
(n.) Furnaces	—	—	209	—
	D.	D ⁿ .	D ^l .	D ^w .
(D.) Superintendence of Mines :	76	177	—	—
	E.	E ⁿ .	E ^l .	E ^w .
(E.) Accidents :	76	177	210	243
(a.) Abandoned shafts	77	177	—	243
(b.) Blasting	77	177	211	243
(c.) Falling away from Ladders.....	85	180	212	244
(d.) Fall of Rock	85	180	212	—
(e.) Fall of Stone or Kibble	85	—	—	244
(f.) Falling from one Level to another	85	—	—	—
(g.) State of Levels and Works under- ground	85	—	—	—
(h.) Timber Work in Mines	86	180	212	—
(i.) Bursting of Boilers.....	86	—	—	—
(j.) Copper Pricker and Stamping Bar	—	—	212	—
(k.) Stone Arching	—	181	—	—
(l.) Water in Mines	—	181	—	—
(m.) Coroners' Inquests	—	—	—	244
(n.) Plans of Mines	—	—	—	244
	F.	F ⁿ .	F ^l .	F ^w .
(F.) Changing Houses :	91	182	212	245

	Cornwall.	North of England.	Ironstone Mines.	Wales.
	G.	G ⁿ .	G ^t .	G ^w .
(G.) Wages and DeductionsPages	94	183	212	246
(a.) Tutwork men	96	—	—	—
(b.) Tributer	96	—	—	—
(c.) Bal Bills	97	—	—	—
(d.) Month in Hand	97	185	215	246
(e.) Men Spaled or Fined	98	—	—	246
(f.) Paying in Notes	99	185	215	246
(g.) Getting into Debt	100	—	—	—
(h.) Packmen	101	185	—	—
(i.) Condition of Miners	101	186	—	—
(j.) Bargains	—	186	215	—
(k.) Small Workings	—	186	—	249
(l.) Tools	—	187	—	—
(m.) Payment of Wages.....	—	—	—	247
(n.) Nonpayment of Wages.....	—	—	—	247
	H.	H ⁿ .	H ^t .	H ^w .
(H.) Joint Stock Companies :.....	101	—	—	—
	I.	I ⁿ .	I ^t .	I ^w .
(I.) Candles :	102	187	215	256
	J.	J ⁿ .	J ^t .	J ^w .
(J.) Powder :.....	106	188	216	250
	K.	K ⁿ .	K ^t .	K ^w .
(K.) Clubs :	108	189	216	250
(a.) Appropriation of Club Money by Adventurers.....	113	—	—	—
(b.) Provision in case of Sickness, ...	114	—	—	—
	L.	L ⁿ .	L ^t .	L ^w .
(L.) Doctors :	115	191	216	251
(a.) Appointment of Doctors	117	—	—	252
(b.) Post-mortem Examinations	119	192	—	252
	M.	M ⁿ .	M ^t .	M ^w .
(M.) Dwellings :	120	192	217	253
(a.) Sanitary Regulations	—	—	217	—
(b.) Distance at which Miners live from their Work	—	192	—	—
(c.) Lodging Houses, or Mine Shops..	—	192	—	—
(d.) Possessing Freeholds, or renting Farms	—	195	217	—
	N.	N ⁿ .	N ^t .	N ^w .
(N.) Children working in Mines;	121	195	218	255
	O.	O ⁿ .	O ^t .	O ^w .
(O.) Women working at Surface	122	196	—	255
(a.) Houses for Women to get their Meals in	122	—	—	—
(b.) Working under Cover	—	197	—	—
	P.	P ⁿ .	P ^t .	P ^w .
(P.) Education :	—	197	218	256
(a.) Intelligence of Miners.....	—	198	—	—
(b.) Evening Schools.....	—	198	—	—
	Q.	Q ⁿ .	Q ^t .	Q ^w .
(Q.) Time Men work:	—	198	218	256

EVIDENCE TAKEN IN LONDON :	Page
Mr. Sopwith - - - - -	258
Mr. Hunt . - - - - -	265
Mr. Warrington Smyth - - - - -	275
EVIDENCE TAKEN AT NEWCASTLE - - - - -	284
EVIDENCE TAKEN AT NORTHWICH - - - - -	293

MINES COMMISSION.

REPORT.

MAY IT PLEASE YOUR MAJESTY,

We, the Commissioners appointed by Your Majesty "to inquire into the condition of all mines in Great Britain to which the provisions of the Act 23rd and 24th Vict. c. 151, intituled 'An Act for the Regulation and Inspection of Mines,' do not apply; and to suggest the most practicable means of improving the health and safety of persons employed in such mines," have visited and inspected the principal mines to which the Commission extends in Cornwall, Devonshire, Northumberland, Westmoreland, Cumberland, Durham, Lancashire, Yorkshire, Shropshire, Wales, Cheshire, and Derbyshire; and have examined many persons connected with mines competent to give information respecting them.

PREAMBLE.

We have also employed experienced and trustworthy persons to examine and report upon the underground workings and superficial condition of the said mines, and to collect in bottles and tubes, made especially for the purpose and hermetically sealed on the spot, samples of air from various mines. These samples we have caused to be subjected to careful analysis by experienced chemists, who have devoted much time and attention to the subject. In pursuance of the objects of the inquiry intrusted to us we have also considered it our duty to avail ourselves of the assistance of two medical gentlemen, who have examined a great number of working miners both at the mines and at their dwellings, not only those who were disabled by sickness of various kinds from pursuing their occupation, but also those who though ailing were still able to attend to their work, and those who were in comparatively good health. The reports of these gentlemen are extremely valuable and interesting, as throwing light upon the causes and nature of those diseases to which miners are peculiarly liable, and with respect to which there has been much difference of opinion. We have also obtained much valuable information on the vital statistics of miners.

App. B.
VII & VIII.

VII p. 293.

IV. V. VI.

I. II.

III. IX.

Bearing in mind the exclusive nature of the inquiry which we were authorized to institute, we have been careful to abstain from topics irrelevant to that inquiry; but our duty being to obtain information of every fact which directly or indirectly might be influential in producing disease, prolonging it or accelerating its progress, we have deemed it necessary to embrace within our inquiries various subjects which at first sight might appear to be foreign to the objects of the Commission, but which on a closer examination will be found to be of the utmost importance, as substantially affecting the questions which we had to investigate. Amongst these subjects are the mode of working the mines, the wages of the miners, the character and sufficiency of their food,

CORNWALL.

their social habits, the state of their cottages, the mine clubs and doctors, the early employment of children and the working of mines by joint stock companies. Having completed the task entrusted to us to the best of our ability, we humbly submit to Your Majesty the subjoined Report, which we have arranged in separate sections, having reference to the several mining districts comprised in our enquiry, together with a summary of the general conclusions which we have drawn from the evidence before us, and the suggestions which, after careful deliberation among ourselves, we have unanimously founded upon the facts contained in the Report.

CORNWALL.

The rich mining districts of this county are remarkable for the great variety of mineral wealth which they contain, comprising ores of copper, tin, lead, iron, and zinc, besides bismuth, antimony and others of less note, and consequently for the variety and magnitude of the mining operations there carried on. For many centuries Cornwall has been the chief source in this country from which these mineral products have been derived, and it naturally follows that continuous workings for so long a period have greatly complicated the operations necessary at the present time for extracting the ores. The great depth of some of the mines, the vast extent of the underground galleries, and the difficulties attendant upon the due ventilation of the levels, very materially affect some of the main points submitted for our consideration.

*Health of
Miners.*

HEALTH OF MINERS.

The question which first claims attention is the health of miners.

It may be affirmed as a general proposition that the health of the copper, tin, and lead miners, as a class, is greatly inferior to that of labourers engaged in agricultural and other open air employments, an assertion which is corroborated by the periodical returns of deaths made to the Registrar General. At a comparatively early age the miners almost invariably exhibit in their features and persons the unmistakable signs of debilitated constitutions. Their faces are sallow, they have an anxious expression of countenance, and their bodies are thin. At the border of middle age, or soon after, their health begins to fail, the maturity and confirmed strength of that time of life seems to be denied to them, they rapidly acquire the feebleness of declining years and become unfit for laborious work at the time when their experience and skill would otherwise have made them valuable workmen. It is a common remark in Cornwall that "a person of 50 is old for a miner." The first symptoms of failing health amongst the miners are weakness in the limbs in climbing the ladders and beating the borer, shortness of breathing, giddiness, and pains in the head; their appetite fails, they are unable to take or to digest an adequate amount of food, and often suffer from sickness and vomiting. These symptoms are followed by harassing cough, much expectoration, sometimes of mucus,

*Epitome.
A. G. 10, 156.*

occasionally of blood, tightness of the chest, and failure of general strength. These affections precede total disability to work, followed by premature death. The delicate condition of the miners is the more striking when contrasted with the appearance of vigorous health generally presented by the women and children in the same districts, thus showing that the causes which operate injuriously upon the health of the miners are such as do not affect their wives and families.

It is much to be regretted that the medical gentlemen connected with the mines have not turned their attention to a special investigation of the causes and nature of the "miners' disease," by examining the localities and the air in which the men work, and by endeavouring to get an insight into the disease by post-mortem examinations. It is alleged that the prejudices of the surviving relatives of deceased miners against such examinations are too strong to be overcome; but there is ground for believing that these are not in all cases insurmountable. From want of sufficient investigation hasty and in many instances erroneous returns of the cause of death have been made to the district registrars. From the disease peculiar to miners being commonly registered as consumption, it has been by many supposed to be identical with phthisis or tubercular pulmonary consumption; but it is proved by the evidence of the medical witnesses that though some miners, and especially those whose families are predisposed to the affection, do die of consumption, by far the largest amount of mortality is due to other forms of lung disease of a bronchitic or asthmatic character.

We have anxiously endeavoured by obtaining all the information in our power to discover the true causes of the maladies which cut off a very large proportion of the mining population so long before the expiration of the period usually allotted to human existence.

By the request of the Chairman, Dr. Peacock and Mr. Bankart visited the mining districts of Cornwall and Devon, and their reports will be found in the Appendix. Dr. Peacock examined 83 miners who were labouring under different forms of disease and above 500 who were still at work, and Mr. Bankart has reported on 150 ailing or disabled miners. These gentlemen agree in representing the sanitary condition of the mining population as very defective, expressing the opinion that the men are worn out by their labour at a much earlier period than is usual with persons who follow occupations equally laborious in the open air. The cases of disease which they met with were chiefly asthmatic affections resulting from bronchitis, pneumonia and disease of the heart, and more rarely true tubercular consumption. They also state that rheumatic disorders and various dyspeptic symptoms are of common occurrence among the miners. They ascribe the unhealthy condition of the miners to several causes, among which they refer—to the early age at which miners commence working underground, to the severity of the labour which they undergo, especially in deep mines, where ladders are the only means of access, to working in a heated atmosphere or in

CORNWALL.
Health of
Miners.

Epitome.
A.

L. 6.

A. 6538.

App. B

I.
P. 11.
II.
p. 94.

I & II.

CORNWALL.
Health of
Miners.

App. B.
I.
pp. 8 & 9.

places which are draughty or wet from defective drainage; but more particularly to the impurity of the air which the men have to breathe when underground. They also state that exposure to cold and damp at the surface or in the shafts and other parts of the mines is the most frequent exciting cause of disease among the miners, operating with peculiar severity upon men in a state of perspiration, or exhausted from having worked in close places or ascended ladders from great depths, and especially upon those already enfeebled in health and strength. The early period of life at which the miners begin to work underground very materially conduces to their premature decay. Dr. Peacock shows in his Report that of the men whom he examined 39 per cent went to work when from 10 to 13 years of age, and 48 per cent. before the age of 14. He remarks that "experience shows that when persons in early life are exposed to injurious influences they suffer from them more severely, and earlier fall under their influence, than if they had attained a more advanced age and greater constitutional vigour."

VITAL STATISTICS.

Vital Statistics.

From the evidence given before us by Dr. Farr, F.R.S., Chief of the Statistical Department of the General Register Office, and from a return prepared for us by the Registrar General and printed in the Appendix, we are enabled to show the rates of mortality prevailing among the miners of Cornwall at different periods of life, as compared with those prevailing among the non-mining population of the same districts, both for the five years 1849-53 inclusive, and also for the more recent triennial period 1860-62 inclusive. The districts selected for the purposes of this comparison were those of Liskeard, St. Austell, Truro, Helston, Redruth, and Penzance. The death rates were computed from the aggregate numbers of males and of deaths of males of the two classes respectively in the whole six districts taken together. The subjoined table shows the rates of mortality from all causes during the earlier period, 1849-53, among the two sections of the population, for the several successive decennial periods of life from the age of 15 up to that of 75 years.

AVERAGE ANNUAL NUMBER of DEATHS per 1,000 Miners, and per 1,000 Males exclusive of Miners, from ALL CAUSES, during the five years 1849-53 inclusive.

Ages.	Metal Miners.	Males exclusive of Miners.
Between 15 and 25 years	8.90	7.12
" 25 " 35 "	8.96	8.84
" 35 " 45 "	14.30	9.99
" 45 " 55 "	33.51	14.76
" 55 " 65 "	63.17	24.12
" 65 " 75 "	111.23	58.61

From the figures in the above table it appears that the rates of mortality among the miners are not materially different from those prevailing among the non-mining males of the same districts until after the age of 35 years, from which period there is a large and progressive excess of mortality among the mining section of the male population. If we assume the rate of mortality among the non-mining males at each decennial period of life to be represented by 100, then that among the miners would be represented, by 125 between the ages of 15 and 25 years, by 101 between 25 and 35, by 143 between 35 and 45, by 227 between 45 and 55, by 263 between 55 and 65, and by 189 between 65 and 75 years. That the large and progressive excess of mortality among the miners between the ages of 35 and 65 years must be due to unwholesome conditions incident to their occupation may be inferred from the fact that it does not commence until these have had full time to operate. The somewhat higher rate of mortality among miners between the ages of 15 and 25 years probably arises from the circumstance that many of the boys are put to work in the mines at too early an age.

CORNWALL,
Vital Statistics,

App. B,
X

That the excessive mortality among the miners in Cornwall is not caused by the mere working underground in dark galleries, a necessary condition of the miner's occupation, and must therefore be mainly due to other causes is clearly proved by some statistics relative to the coal miners of Durham and Northumberland, also given in evidence by Dr. Farr. The annexed table shows the rates of mortality among the coal miners of Durham and Northumberland during the five years 1849-53 inclusive, for each decennial period of life from the age of 15 up to that of 75 years, compared with the rates among the Cornish miners already quoted.

AVERAGE ANNUAL NUMBER OF DEATHS per 1,000 Cornish Metal Miners, and per 1,000 Northern Coal Miners, from ALL CAUSES, during the five years 1849-53 inclusive:

Ages.	Cornish Metal Miners.	Northern Coal Miners.
Between 15 and 25 years	8.90	8.50
" 25 " 35 "	8.96	8.49
" 35 " 45 "	14.30	10.13
" 45 " 55 "	33.51	16.81
" 55 " 65 "	63.17	24.43
" 65 " 75 "	111.23	65.16

Assuming, as with regard to the previous table, the rate of mortality among the coal miners at each period of life to be represented by 100, then that among the Cornish miners would be represented, by 105 between the ages of 15 and 25 years, by 106 between 25 and 35, by 141 between 35 and 45, by 199 between 45 and 55, by 258 between 55 and 65, and by 171 between

CORNWALL.
Vital Statistics.

65 and 75 years. The rates of mortality among the Cornish miners from the age of 35 years upwards are thus shown to have been almost as much in excess of the rates which prevail among the coal miners in the selected districts of Durham and Northumberland, as they were above the rates prevailing among the non-mining male population of Cornwall.

The evidence regarding the more recent period 1860-62 shows that the great excess of mortality among the Cornish miners still continues, although the proportions are slightly different. The subjoined table shows the rates of mortality among the two sections of the male population respectively, from all causes, during the three years 1860-62, for the same periods of life as the former table.

AVERAGE ANNUAL NUMBER of DEATHS per 1,000 Miners, and per 1,000 Males exclusive of Miners, from ALL CAUSES, during the three years 1860-62 inclusive.

Ages.	Metal Miners.	Males exclusive of Miners.
Between 15 and 25 years - - -	9·44	7·50
" 25 " 35 - - -	9·57	8·32
" 35 " 45 " - - -	15·12	10·08
" 45 " 55 " - - -	29·74	12·50
" 55 " 65 " - - -	63·21	19·96
" 65 " 75 " - - -	110·51	53·31

Again, assuming the rate of mortality at each period of life among the non-mining males to be represented by 100, then the rate among the miners would be represented, by 126 between the ages of 15 and 25, by 115 between 25 and 35, by 150 between 35 and 45, by 238 between 45 and 55, by 317 between 55 and 65, and by 207 between 65 and 75 years.

From Dr. Farr's evidence, supplemented by the Registrar General's Return, it further appears that the excessive rate of mortality among the Cornish miners is mainly caused by the large number of deaths from pulmonary consumption and other diseases of the lungs. As however deaths which are registered in some districts as arising from consumption are registered in other districts under different names, such as asthma and bronchitis, it is best for statistical purposes to throw all the diseases of the lungs into one class under the general name of Pulmonary Diseases; an arrangement which enables the rates of mortality from diseases of the lungs in different districts to be more accurately compared with each other than if the several diseases of these organs were nominally kept separate. The class of pulmonary diseases thus formed comprises phthisis, laryngitis, bron-

chitis, pleurisy, pneumonia, asthma and all cases returned as "diseases of the lungs." CORNWALL.

The annexed table shows the average annual rate of mortality per 1,000 persons from pulmonary diseases among miners, and also among males exclusive of miners, during the three years 1860-62 inclusive, for each decennial period of life between the ages of 15 and 75 years. Vital Statistics.

AVERAGE ANNUAL NUMBER OF DEATHS per 1,000 Miners, and per 1,000 Males exclusive of Miners, from PULMONARY DISEASES, during the three years 1860-62 inclusive :—

Ages.	Metal Miners.	Males exclusive of Miners.
Between 15 and 25 years	3·77	3·30
" 25 " 35 "	4·15	3·83
" 35 " 45 "	7·89	4·24
" 45 " 55 "	19·75	4·34
" 55 " 65 "	43·29	5·19
" 65 " 75 "	45·04	10·48

Assuming as before, that the rate of mortality among the males exclusive of miners is represented, at each period of life by 100, then that among the miners would be represented by 114 between the ages of 15 and 25 years, by 108 between 25, and 35, by 186 between 35 and 45, by 455 between 45 and 55, by 834 between 55 and 65, and by 430 between 65 and 75 years. It is therefore evident that pulmonary diseases are the chief cause of the excess of mortality among the Cornish miners; and that these diseases are due to the conditions incident to the miners' labour may also be confidently inferred, as in the case of the death-rates from all causes, from the fact that the excess of mortality arising from them does not reach its acme until after the middle of life, when these conditions have had full time to produce their effect on the health of the miners. A much greater discrepancy will be observed between the rates of mortality from pulmonary diseases among the miners and non-miners than has been shown to exist between the rates of mortality from all causes among the two sections of the population respectively. This is undoubtedly due to the fact that exposure to the peculiar evils incident to their occupation causes many miners to die of pulmonary diseases, who in different circumstances would have died of other complaints.

The subjoined table contrasts the rates of mortality among miners at the two periods 1849-53 and 1860-62, both from all causes and from pulmonary diseases.

CORNWALL. AVERAGE ANNUAL NUMBER OF DEATHS per 1,000 MINERS FROM ALL CAUSES, and from PULMONARY DISEASES, at different periods of Time :—
Vital Statistics.

Ages.	All Causes.		Pulmonary Diseases.	
	During the 5 years 1849-53.	During the 3 years 1860-62.	During the 5 years 1849-53.	During the 3 years 1860-62.
Between 15 and 25 years	8·90	9·44	3·05	3·77
" 25 " 35 "	8·96	9·57	4·42	4·15
" 35 " 45 "	14·30	15·12	8·47	7·89
" 45 " 55 "	33·51	29·74	24·31	19·75
" 55 " 65 "	63·17	63·21	44·46	43·29
" 65 " 75 "	111·23	110·51	55·87	45·04

It will be seen in the above table that the only material difference in favour of the more recent period is that existing between the ages of 45 and 55 years. A comparison of the rates of mortality from all causes among the non-mining section of the male population also shows a similar improvement in favour of the more recent period.

Access and Egress.

ACCESS AND EGRESS.

The question which next claims attention is the mode by which the miners descend into and ascend out of the mines. In Cornwall and Devonshire the almost universal method of descent and ascent is by means of ladders, and this mode of transit obviously causes a great waste of time and strength to the miner, who in many cases works at a depth of from 200 to 280 fathoms, or from 1,200 to 1,680 feet, below the surface. There are mines in which not less than three hours are expended by the miner in going to and returning from his work. Thus not only is the time which the workman can bestow upon his labour considerably curtailed, but even during that reduced time there is a diminution of power. Where the mine is very deep and the descent is by ladders, the older and consequently more experienced workmen are not able to go down to the lowest levels, and the proprietors are of necessity driven to employ young and less expert miners. But apart from all views of the interests of the employer, and looking solely to the effect produced upon the workmen, this subject affords ground for grave considerations. Many of the miners live at a considerable distance from the mine, and have daily to walk in all weathers two, three, and even four miles to and from their work, so that the wear and tear caused by the additional task of climbing the ladders makes slow but certain inroads upon their physical powers. But it is not the fatigue alone which is prejudicial to the miner. The ascent of so many fathoms by means

Epitome.
 B. a.
 App. B.
 VII.
 p. 295.
 Epitome.
 B. a. 2942.

B. & 8116.

B. 6904,
 B. b. 8894.

of ladders, some of which are perpendicular, and few of which are much inclined, increases the action of the heart, and the men arrive at the surface in a state of exhaustion so great that the young men alone can stand it. In this state of heat and exhaustion, exposed to the wet and keen blasts of the Cornish hills, they have frequently to walk a considerable distance to the place where they change their clothes, and these in many cases they find still wet and sometimes even frozen. Besides these there are other grounds of objection to the ladders. Falling from them is a frequent cause of injury to the miner; but the fatal results of such accidents might to a large extent be prevented by the general adoption of the practice in use in well-ordered mines of sollaring over the space at the bottom of each ladder at intervals not exceeding four fathoms, leaving only a man-hole for the passage of the miner. Some mechanical means of conveyance into the mine would not only add to the hours devoted to remunerative labour, but would also carry the workman fresh to his work with powers unimpaired.

In some Cornish mines a contrivance for taking down and bringing up the men has been adopted, called a man-engine. This consists of a rod about a foot and a half square, down one side of which there is a series of small platforms just large enough for a man to stand upon. Put in motion by an engine, it moves slowly up and down, and the men step from the platform on the rod to corresponding platforms at the side of the shaft until they arrive at the bottom. This is no doubt an easy method of descending and ascending, but it may be questioned whether it is the safest, caution and vigilance being required on the part of the men in stepping from one platform to the other at the exact time; this is especially the case with regard to the double man-engine, where there are two moving rods with platforms attached.

At a few mines in Cornwall another method is resorted to. The men descend in what is called a skip, which is a square oblong vessel of iron, having a door at the bottom, which when closed is secured by a strong bolt. This skip is also used for drawing up the ore and refuse.

VENTILATION.

The ventilation of mines has engaged our earnest attention. An improvement in this respect appears from the evidence to have taken place within the last 20 or 30 years. Notwithstanding that the mines have been much more extensively worked, yet by increasing the number and enlarging the dimensions of the various shafts, winzes, rises, levels and crosscuts greater circulation of air has been obtained. Still the ventilation is oftentimes very imperfect, and the health of the men suffers considerably from their breathing an atmosphere deficient in oxygen and impregnated with carbonic acid gas and other impurities.

We felt that it was of the greatest importance that the character

CORNWALL.
Access and
Egress.
App. A. p. 30.
Epitome.
B. b. 9111.
B. a. 7344.
F. 2988.
E. c.

App. A. p. 29.
Epitome.
B. b.
App. B.
VII. p. 296.

App. A. p. 29.
Epitome.
B. b. 4335,
9599.
B. c.
9709.
App. B.
VII. p. 296.
App. A. p. 33.

Ventilation.

Epitome.
C.
A.
C. 1509.

A.
C. 5375.

VENTILATION.
General Observations.

of the air of the mines should be accurately ascertained, and with this object we employed Dr. A. S. Taylor, Dr. Angus Smith, and Dr. Bernays to analyse specimens of air obtained in different mines and under various circumstances.

The following are some of the principal points mentioned by those gentlemen, but their reports are so minute and so replete with valuable information of a scientific character that we have found it impossible with justice to them to give a satisfactory analysis of the results of their labours within the limits of this report. We must, therefore, refer to the Appendix, where the reports of Dr. Taylor, Dr. A. Smith, and Dr. Bernays are given in extenso. They deserve the attentive consideration of all who are interested in this important branch of our inquiry.

App. B.
IV. V. VI.

Epitome.
C.

The test for detecting the impurity of the air, which is relied upon in all districts by miners and mine agents, is the greater or less freedom with which the candles burn. This test however is a very imperfect one. Dr. Taylor states that it is altogether fallacious, and Dr. Angus Smith says, that although the candle test is capable of detecting exceedingly bad air it is unequal to the indication of impurities to the extent required for the protection of health, and begets confidence where danger exists.

App. B.
IV.
V.

VII. pp. 293-4.

Dr. Angus Smith analysed no less than 328 samples of air, from mines in different parts of England and Wales, comprising all the tubes of air hermetically sealed in the mines, which were not damaged by leakage or breakage; and the following is a summary (drawn up for the Commission) by Dr. Smith of some of the results which he obtained:—

He divided the specimens of air he analysed into three classes, employing the proportion of oxygen found, not as the cause, but as the indication of their quality. Air containing 20·9 per cent. of oxygen he considered normal, less than that proportion impure, and less than 20·6 per cent. as exceedingly bad. According to this classification he found—

35 or 10·65	per cent. of the specimens normal, or nearly so,
81 or 24·69	„ „ „ impure,
212 or 64·63	„ „ „ exceedingly bad.

It appears from the tables of analyses contained in Dr. Smith's report, that 87 of the 328 samples of air examined by him contained less than 20 per cent. of oxygen, and that of these 11 contained less than 19 per cent., and that in one instance the proportion was so low as 18·27 per cent., and that some of the worst air escaped examination from the candles burning so imperfectly that it was impossible to seal the tubes by the blow pipe. He remarks that, bad as the specimens may appear, the character given to the air of mines by these analyses is yet superior to what has been hitherto given by analysts, such as Mr. Hunt and Mr. Moyle; and perhaps for this reason, that former analysts took the air from places selected for the purpose; in the present case it has been taken indiscriminately,

and in such quantities as to represent fairly the condition of the atmosphere of the whole range of mines in the country. VENTILATION.

The following diagram will probably convey a more vivid impression of the results at which Dr. Smith has arrived than the numerical statements given above :— General Observations.

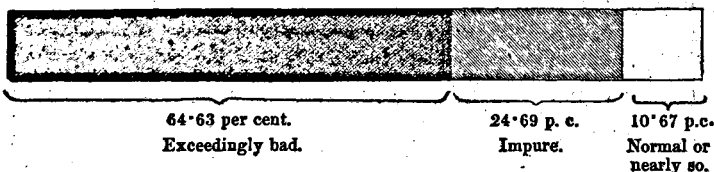

To make the importance of his observations more clearly understood, Dr. Smith has made estimates of the amount of oxygen in the air under the following different circumstances—

On a fresh cool evening, in a suburb of Manchester, in wet weather, the proportion of oxygen was - - - 20.98 per cent.

	and 20.96	"
In the outer circle of same city - - -	20.947	"
At the back of the house - - -	20.936	"
In fog and frost - - -	20.91	"
In a sitting room which felt somewhat close - - -	20.89	"
In a small room with petroleum lamp, well ventilated - - -	20.84	"
Do. do. after 6 hours	20.63	"
In the pit of a theatre at 11.30 p.m.,	20.74	"
In the gallery " 10.30	20.63	"
In large cavities in mines (average).	20.77	"
In currents do.	20.68	"
Under shafts do.	20.424	"
In sumps do.	20.14	"
In the worst specimen examined	18.2	"

Of the samples of air from different mines in Cornwall and Devon analysed by Dr. Smith, 142 in number, a very large proportion will be found to have been very defective. Thus only 17 or 11.97 per cent. were found to contain the normal proportion of oxygen,

38 or 26.76 per cent. were impure,
and 87 or 61.20 per cent. were extremely bad,

* The amount of oxygen was, in one sample, as low as 18.67 per cent., while the carbonic acid attained in another the high proportion of 2.26 per cent.

Dr. Smith has described different methods by which in his opinion the amount of carbonic acid, and thereby the state of the ventilation, in the mines can be easily tested. One of them he considers simple enough to be put into the hands of working men.

VENTILATION.
General Observations.

App. B.
VI.

Dr. Bernays has been engaged in similar investigations, and from his report it will be seen that of 42 samples of air, obtained in various mines and under different circumstances, there are very few which did not contain a proportion of carbonic acid considerably in excess of that which occurs in pure air. The proportion varied from 0·044—an amount not materially above the normal standard (0·035 per cent. by volume) to 0·527, 0·588, 0·65, 0·846. At one mine Dr. Bernays notices that he spent the working portion of three days underground, and found the air, except in ends and stopes and soon after blasting, almost free from impurities, and that in the 254 fathom level particularly good, proving the efficacy of ventilation by means of an upcast and downcast shaft.

It should be observed that the state of the air in the mines is materially affected by the condition of the external atmosphere and the season of the year. Dr. Bernays' visit to Cornwall was at Christmas, while the specimens forwarded from the north were collected in summer, and this circumstance may in part explain the difference in the results of analyses of the different specimens. The observations of Dr. Smith and Dr. Bernays fully show that deleterious air occurs in all mines to a greater or less degree, although the fact may not be apparent to the senses, and the agents may be satisfied that the ventilation is good.

Epitome.
C. 4652.
p. 37.

App. B.
I. II.

The air of mines besides being thus frequently deficient in oxygen, and containing an excess of carbonic acid gas, is also often more or less impregnated with other impurities.

Epitome.
C. d
p. 64.
C.
p. 66.

In dry mines dust arises from boring or the use of the pick, and where the rock is hard it is necessary to blast it, and the smoke proceeding from the gunpowder used in the process adds its quota of impurity, especially where it is tardy in its escape.* Each man is lighted at his work by a candle, which burning badly, from deficiency of air or being composed of inferior materials, often throws off a thick stifling effluvia, and, together with the breath of the men, consumes oxygen and gives out carbonic acid gas. To these extraneous causes must be added in some instances the natural presence of carbonic acid gas. The secretions thrown off from the bodies of the men when working hard and perspiring further increase the closeness of the atmosphere. It is evident therefore, that, unless there be a free current of air through the different parts of mines, the atmosphere which the men have to breathe must be extremely deleterious. When an end is 50 or more fathoms from any draught the difficulty of furnishing an adequate supply of fresh air to the men who are driving it becomes very great, and this difficulty is further increased by the culpable negligence of the men or that of the agents (whose business it is to see that the men do not neglect their duty), in allowing heaps of ore or "deads" to remain in the levels which choke them up and injuriously interfere with the circulation of air.

C. e.
App. B.
I.

It should, however, be mentioned that all the men employed

App. B.
VII.
p. 295.
Epitome.
C. c.
p. 63.

* Experiments are in progress for testing the value of gun cotton as a substitute for gunpowder in mining operations. See Appendix, No. XI V.

in mines do not suffer equally from the defective ventilation. There are two classes of workmen called tutworkmen and tributers. The former contract at so much a fathom to drive the levels, sink shafts, and put in rises and winzes. The latter neither drive nor sink, but are employed in getting out the ore from the levels ventilated and partially explored by the tutworkmen, and they are paid so much in the pound of the market value of the ore which they bring to the surface when sold. The prospect of gain may induce the tributer to overwork himself; but it is obvious that the occupation of the tutworkman is more unhealthy, as he is more frequently employed where the air is noxious. He has to cut new ways through the rock, and he often labours at such a distance from any shaft or winze that the air coming down these channels does not reach him.

Not only have the men to breath impure air in consequence of defective ventilation, but from the same cause in many of the workings the temperature is very high. In most of the deep mines there are workings which are naturally warm, and in some the heat is so oppressive that the miner is compelled to work nearly naked, and to have water thrown over him, and even then he can only continue his labour for a very short space of time. In several mines the temperature is from 80° to 90° Fah, and in one as high as 110°, and men have been known to have lost eight or ten pounds in weight at the conclusion of their day's work. A continuance of labour in such an atmosphere must have an injurious effect on the constitution of the miner, and make him more susceptible to the effects of the cold draughts in other parts of the mine or at the surface. Indeed, as has been remarked, the medical gentlemen ascribe much of the sickness which they find amongst the miners to the effect of exposure to cold when the men are exhausted by working in warm places, and especially where the air is impure.

The agents have devised various means for promoting circulation and conveying fresh air to the ends, although they trust principally to natural ventilation by adits and shafts, which may be upcast or downcast, and occasionally without any perceptible circulation of air, according to the state of the weather.

One of these means is a square wooden pipe which is carried along the top of the level, and another is a wooden floor or sollar about six inches from the bottom, in or under which the air passes. No doubt these means may to some extent answer the purpose of promoting the circulation of air; but wood is absorbent and liable to decay, in which condition it vitiates the air, and if used as a floor is difficult to keep air-tight, and apt to give way. Sometimes the fresh air is forced through a box or pipe of wood, iron or zinc by a fan worked by the engine, by water power or by a boy. In the latter case the continued efforts of the boy cannot be relied on, therefore the hand machine is sometimes placed near where the men are working, which has the advantage of enabling them to see that the boy does not neglect his duty. In this position the air is drawn in from a distance, but the

VENTILATION.

General Observations.

Epitome.
C. a. 5358.
p. 55.
G. a. 96.
G. b.
G. b. 4671.
p. 96.
G. b. 5358.

C. b.
p. 61.

A. a.
p. 17.

App. B.
I. II.

Epitome.
C. g. h.
p. 67.

C. b.
p. 74.

C. i.

C. j.

VENTILATION.
General Observations.

App. B.
VI.

Dr. Bernays has been engaged in similar investigations, and from his report it will be seen that of 42 samples of air, obtained in various mines and under different circumstances, there are very few which did not contain a proportion of carbonic acid considerably in excess of that which occurs in pure air. The proportion varied from 0·044—an amount not materially above the normal standard (0·035 per cent. by volume) to 0·527, 0·588, 0·65, 0·846. At one mine Dr. Bernays notices that he spent the working portion of three days underground, and found the air, except in ends and stopes and soon after blasting, almost free from impurities, and that in the 254 fathom level particularly good, proving the efficacy of ventilation by means of an upcast and downcast shaft.

Epitome.
C. 4652.
p. 37.

It should be observed that the state of the air in the mines is materially affected by the condition of the external atmosphere and the season of the year. Dr. Bernays' visit to Cornwall was at Christmas, while the specimens forwarded from the north were collected in summer, and this circumstance may in part explain the difference in the results of analyses of the different specimens. The observations of Dr. Smith and Dr. Bernays fully show that deleterious air occurs in all mines to a greater or less degree, although the fact may not be apparent to the senses, and the agents may be satisfied that the ventilation is good.

App. B.
I. II.

The air of mines besides being thus frequently deficient in oxygen, and containing an excess of carbonic acid gas, is also often more or less impregnated with other impurities.

Epitome.
C. d
p. 64.
C.
p. 66.

In dry mines dust arises from boring or the use of the pick, and where the rock is hard it is necessary to blast it, and the smoke proceeding from the gunpowder used in the process adds its quota of impurity, especially where it is tardy in its escape.* Each man is lighted at his work by a candle, which burning badly, from deficiency of air or being composed of inferior materials, often throws off a thick stifling effluvia, and, together with the breath of the men, consumes oxygen and gives out carbonic acid gas. To these extraneous causes must be added in some instances the natural presence of carbonic acid gas. The secretions thrown off from the bodies of the men when working hard and perspiring further increase the closeness of the atmosphere. It is evident therefore, that, unless there be a free current of air through the different parts of mines, the atmosphere which the men have to breathe must be extremely deleterious. When an end is 50 or more fathoms from any draught the difficulty of furnishing an adequate supply of fresh air to the men who are driving it becomes very great, and this difficulty is further increased by the culpable negligence of the men or that of the agents (whose business it is to see that the men do not neglect their duty), in allowing heaps of ore or "deads" to remain in the levels which choke them up and injuriously interfere with the circulation of air.

C. e.
App. B.
I.

It should, however, be mentioned that all the men employed

App. B.
VII.
p. 295.
Epitome.
C. c.
p. 63.

* Experiments are in progress for testing the value of gun cotton as a substitute for gunpowder in mining operations. See Appendix, No. XIV.

in mines do not suffer equally from the defective ventilation. There are two classes of workmen called tutworkmen and tributers. The former contract at so much a fathom to drive the levels, sink shafts, and put in rises and winzes. The latter neither drive nor sink, but are employed in getting out the ore from the levels ventilated and partially explored by the tutworkmen, and they are paid so much in the pound of the market value of the ore which they bring to the surface when sold. The prospect of gain may induce the tributer to overwork himself; but it is obvious that the occupation of the tutworkman is more unhealthy, as he is more frequently employed where the air is noxious. He has to cut new ways through the rock, and he often labours at such a distance from any shaft or winze that the air coming down these channels does not reach him.

Not only have the men to breath impure air in consequence of defective ventilation, but from the same cause in many of the workings the temperature is very high. In most of the deep mines there are workings which are naturally warm, and in some the heat is so oppressive that the miner is compelled to work nearly naked, and to have water thrown over him, and even then he can only continue his labour for a very short space of time. In several mines the temperature is from 80° to 90° Fah., and in one as high as 110°, and men have been known to have lost eight or ten pounds in weight at the conclusion of their day's work. A continuance of labour in such an atmosphere must have an injurious effect on the constitution of the miner, and make him more susceptible to the effects of the cold draughts in other parts of the mine or at the surface. Indeed, as has been remarked, the medical gentlemen ascribe much of the sickness which they found amongst the miners to the effect of exposure to cold when the men are exhausted by working in warm places, and especially where the air is impure.

The agents have devised various means for promoting circulation and conveying fresh air to the ends, although they trust principally to natural ventilation by adits and shafts, which may be upcast or downcast, and occasionally without any perceptible circulation of air, according to the state of the weather.

One of these means is a square wooden pipe which is carried along the top of the level, and another is a wooden floor or sollar about six inches from the bottom, in or under which the air passes. No doubt these means may to some extent answer the purpose of promoting the circulation of air, but wood is absorbent and liable to decay, in which condition it vitiates the air, and if used as a floor is difficult to keep air-tight, and apt to give way. Sometimes the fresh air is forced through a box or pipe of wood, iron or zinc by a fan worked by the engine, by water power or by a boy. In the latter case the continued efforts of the boy cannot be relied on, therefore the hand machine is sometimes placed near where the men are working, which has the advantage of enabling them to see that the boy does not neglect his duty. In this position the air is drawn in from a distance, but the

VENTILATION.

General Observations.

Epitome.
C. a. 5358.
p. 55.
G. a. 96.
G. b.
G. b. 4671.
p. 96.
G. b. 5358.

C. b.
p. 61.

A. a.
p. 17.

App. B.
I. II.

Epitome.
C. g. h.
p. 67.

C. b.
p. 74.

C. i.

C. j.

VENTILATION.
General Observations.

Epitome.
 C. A.
 1919.
 p. 68.
 C. A. 6312.
 p. 70.
 App. A.
 pp. 17-18.

machine is generally fixed some way off, in which case the air is driven and the boy being out of sight is apt to become idle at his post. A careful selection of position for the machine is necessary to insure the distribution of pure air.

The water blast consists of a vertical tube filled with water from the surface, and of a small horizontal pipe at the lower end through which a jet escapes, which drives a stream of air into a box; the water flows down to lower levels, and the air is driven through a pipe to the close end or the place required.

The quality of air is that of the air at the place where the jet escapes; the quantity may be estimated from the rate of the current and the size of the pipe. The apparatus is inexpensive, and the working cost is that of the power used to lift the water back to the surface.

Accidents.

ACCIDENTS.

Epitome.
 E.

We have obtained no evidence of the existence of inflammable gas in any of the mines, and have only heard of a few instances of loss of life by influx of water. But while the men are free from the fatal effects of carburetted hydrogen, and the catastrophes occasioned by sudden influxes of water so destructive in coal mines, they nevertheless become victims to many accidents which care and forethought might easily prevent. The injuries which they sustain are principally caused by blasting, by falling from the ladders or from one level to another, by falls of the rock and bursting of boilers. The agents naturally endeavour to shift from themselves the responsibility of these injuries, by attributing them to the recklessness of the men. The miners are unquestionably in many instances guilty of disobedience of orders, negligence, and imprudence; but they are not always so culpable as the agents are apt to represent them to be.

E. b.

J.

Blasting.—In blasting the rock explosions which cause loss of sight, fracture of limbs and sometimes death frequently occur. These arise from sparks elicited by the use of iron implements in tamping or ramming in the powder, from improper tamping material and the very reprehensible practice of picking out holes charged with powder which has failed to ignite. The miners also expose themselves to great danger from rushing in too soon to ascertain the cause of delay should the charge hang fire.

B. d.
 3107.
 p. 21.

Falling away from ladders.—The footways or ladders are often constructed in the drawing shafts and the pumping shafts. When not properly bratticed or partitioned off, this mode of ascent and descent is necessarily dangerous. The wooden staves are apt to decay before it is observed, and the serious consequence of a vacant space or of a staff breaking while the miner is ascending or descending is obvious. Iron staves become worn and consequently sharp, and when wet or greasy or, as occasionally happens near the surface, frozen, are apt to cause fatal accidents, although,

App. B.
 VII. p. 295.

Epitome.
 B. a.
 8640.
 p. 22.

were the footways properly protected by sollars and brattice work, a fractured limb would be the extent of the injury to be apprehended from falling away. The staves are generally ten inches apart, though the distance of twelve inches is still maintained in some mines, causing an extra strain on the muscles. The miner has frequently to bring up his tools with him in order to take them to the smith's shop, and on these occasions any imperfection of the ladders is particularly dangerous.

Falling from one level to another.—It frequently happens that the winzes for the purpose of ventilation or the shoots for throwing down the stuff which communicate from one level to another are left uncovered, unprotected or carelessly bridged over, or if covered over are not subject to constant inspection. Serious accidents have arisen in consequence.

Falls of the rock.—Injuries resulting from falls of rock are of frequent occurrence in some mines. In those localities, where the rock or lode is of a friable or incoherent character and consequently liable to slips and falls, extra vigilance is necessarily called for. It often happens that the men to save labour, and the agents to save cost, omit to put up the proper supports.

Fall of stuff.—Casualties repeatedly occur from the fall of stuff out of the kibble in its vibration from side to side, or from the fall of the kibble itself from the chain breaking. In some mines these are to a considerable extent obviated by the adoption of skips with wire ropes and guide rods which prevent oscillation.

Bursting of boilers.—Imperfect boilers are too often purchased for the use of a mine on its first being started, and the consequences, as might be expected, are frequent accidents. Another cause of boiler explosions arises from the chemical character of the water, which in some cases rapidly corrodes the iron and in others forms deposits; and a third cause is the omission of a second safety valve and of water gauges, which necessary instruments we have found only in rare instances, engineers depending entirely on the cocks to ascertain the quantity of water in the boiler. Further, it is the exception where the boilers are periodically and thoroughly cleaned and examined.

The men in charge of the engines are generally those who from ill-health or injury are incapacitated from working underground, and not being trained engineers stand especially in need of a water gauge or an index to draw their attention when the water in the boilers is getting low.

Abandoned shafts.—Accidents arise not only to the miners but to the public from the very reprehensible practice of leaving abandoned shafts open and unprotected at the surface.

From the 1st of March to the 7th day of May 1863 no less than seven fatal accidents occurred in the mines in Cornwall (including the very serious one in Botallack), occasioning in all a loss of sixteen lives. We deemed it our duty to make special inquiries regarding these accidents, and Mr. Wylie's report thereon is given in the Appendix. The mode in which coroners'

CORNWALL.

Accidents.

Epitome.

E. d. p.

App. B.

VII. p. 295.

Epitome.

B. a.

6703.

p. 23.

B. a.

2906.

p. 21.

App. B.

VI. p. 292.

E. f. g. h.

App. B.

VII.

p. 297.

Epitome.

B. b.

9509.

p. 26.

9606.

E. d.

E. e.

B. a.

3635.

p. 22.

E. i.

E. i.

10362.

p. 89.

E. a.

E. a.

App. B.

XIII.

CORNWALL.

inquests are conducted seems to us very unsatisfactory, inasmuch as the inquiry is limited to determine whether the death was accidental or not without any reference to the cause of the accident from which it resulted.

General Observations.

GENERAL OBSERVATIONS.

Epitome.
F.
VII. p. 297.
A.

Changing Houses.—These buildings are often far from the footway shafts and are low and ill adapted to their purpose; the light and ventilation are obtained from unglazed openings provided only with wooden shutters, whereby thorough draughts are created that are highly dangerous to the health of the miners just returned in a state of perspiration from the laborious ascent of the ladders. The men very frequently change in “the dry,” (a place where they leave their clothes to be dried by means of a heated tube,) the atmosphere of which is often most impure, loaded with dust and vapour. In the absence of proper places for the purpose the men often run the risk of injury to their health by washing in the open air exposed to the inclemency of the weather, and are frequently driven to the dangerous practice of resorting to the boiler house in order to change and dry their clothes. We had the satisfaction of inspecting some changing houses, with “drys” attached, put up at an expense of not more than 100*l.*, well lighted and ventilated and supplied with warm water, but we regret to say that such were rare.

Epitome.
F. 2227.
p. 92.

We have reason to believe that the agents and managers of mines are by no means insensible to many of the defects referred to, and that, as a body they are anxious to promote the safety and comfort of the men placed under their control. With regard to established and well-managed mines, conducted with a view to the legitimate development of the mineral property, the proprietors will generally act upon any recommendations made by the agents having for their object the health and safety of the miners; but there are many mines of a more speculative character, in which any outlay beyond what is absolutely necessary is avoided, as tending to diminish the dividends, and consequently to depress the price of the shares in the market.

H.
p. 107.

H.

It is probable that in the latter the agents are deterred from suggesting evident improvements, which to them may appear to be highly desirable, from the fear of being considered extravagant and thus incurring the risk of losing their situations.

B. c. 8686.
p. 29.

Wages.

Epitome.
G.

Wages.—It is somewhat difficult to give a correct statement of the earnings of the men, in consequence of the speculative nature of their work. Miners are divided into tributors and tutwork men. They work in “pares” or companies of from two to eight men, and for eight hours at a time. The tributer’s earnings are regulated, not only by the amount and quality of the ore brought to the surface, but by its market value at the time it is sold to the smelters. Instances are quoted of 100*l.* or

G. b.

more being realised in a month, and of tributers becoming owners of land and cottages; but the increased intelligence of the mine agents and their ability in judging of the quality of a lode before striking a bargain cause such instances to be now of rare occurrence, and in the event of a rich lode being discovered it is frequently worked by tutwork; should a lode turn out poorer than expected, a tributer will work for weeks and perhaps months without earning anything. In most instances he is then allowed from five to ten shillings a week for what is called "subsist," the sum thus paid standing as a debt against his future gains; consequently there are times when the families of the tributers are very badly off, and many prefer the more regular wage of the tutworkmen.

The latter take work by piece-work, and any variation of the ground after the time of setting affects their earnings; these are stated on an average taken from several mines to vary from 3*l*. to 3*l*. 10*s*. per month. The wages are frequently only paid once a month, with a month's wages kept in hand. On a man first coming to work in many mines he receives no pay for two months, and the result is that he generally contracts debts to the smaller shopkeepers and pays an enhanced price for the necessaries of life. The payment of wages being in some instances partly in notes for which change can only be procured in public houses, the men are tempted to spend money in intoxicating liquors from which they would otherwise probably abstain.

The miners are frequently involved in debt, and are summoned in great numbers to the County Courts by travelling packmen and hawkers, who induce their wives and daughters to purchase goods, for which payment is to be made by monthly instalments.

Considerable deductions are made from the nominal earnings of the miner as shown by the "bal" or mine pay bills in the Appendix, but these are taken into consideration when the bargain is made.

These deductions, though varying in different mines, include in all cases charges for clubs and doctors, for candles and powder, and for the wear and tear and sharpening of tools, besides in some mines other items of smaller amount. An extra charge beyond cost price for candles, powder and materials, the purchase of which at the mines is obligatory on the men, is deemed necessary to prevent their wasting or selling them. A table showing the amount of candles and powder consumed in a number of mines and the profit thereon will be found in the Appendix.

Candles.—These are in many instances of a very inferior quality, and, as will be seen by the report of Dr. Taylor, add materially to the impurity of the air while in process of combustion. An idea prevails in Cornwall that it is necessary to have candles with wicks of mixed cotton and flax for the purpose of blowing them in when accidentally extinguished, though such wicks give out more smoke than cotton wicks. We, however, ascertained during our inspection in the north that cotton wicks will blow in equally well, if the candles are made of the best tallow.

CORNWALL.

General Observations.

Epitome.

G. a.

G. e.

G. f.

G. e.

G. g.

App. B.

XII.

Epitome.

I. J.

9063-9080.

p. 105.

G. 9918.

p. 95.

App. B.

XI.

Candles.

IV.

Epitome.

C. e.

1933.

p. 66.

I.

H.

CORNWALL.

Epitome.

O. a.

App. B.

VII.

p. 297.

Epitome.

O.

App. B.

VII.

p. 297.

I.

p. 8.

comfortable place is provided, to which the women resort for their meals and where an attendant sees to the fire and provides hot water. At others the accommodation for this purpose is insufficient, while in the majority none at all is provided. Where the comforts of those employed are attended to, the women and children work under cover of wooden sheds with glass let into the roof, but in many, even of the large mines, they are needlessly exposed to the inclemency of the weather. Young children are employed at the work of picking the ore, and this employment, when carried on under cover, is not found to be prejudicial to their health.

DEVONSHIRE.

VII.
p. 313.

The mineral products of Devonshire are much the same as those of Cornwall. The principal mining districts are Tavistock, Dartmoor, Ashburton, and Bovey Tracey. The Devon Great Consols is the largest and richest copper mine in Great Britain; and its remarkable success has occasioned the opening of many other mines in the district.

*Access and
Ventilation.*

Epitome.

C. 18,807.

p. 47.

18,870.

19,136.

p. 48.

ACCESS AND VENTILATION.

The system of working the mines in Devonshire is, for the most part, the same as that pursued in Cornwall; occasionally, however, the levels are driven to a greater distance from a winze or shaft without proper attention being paid to the adequate ventilation of the ends.

Ladders are the only mode of ascent and descent in use in this district; but the adoption of a man-engine was in contemplation at the Devon Great Consols mine.

During the interval between our first and second visits to this mine many improvements had been carried out for the accommodation of the workers at the surface.

Health.

App. B.

II.

HEALTH.

The miners in this district, examined by Mr. Bankart in the autumn of 1862, were found to be subject to diseases similar in all respects to those which prevail among the miners in Cornwall, and traceable to the same causes.

General Observations.

Epitome.

F.

GENERAL OBSERVATIONS.

Changing Houses.—The mines in the neighbourhood of Dartmoor and Ashburton have not been worked so extensively as in other districts. Among those visited by us was one recently opened, where great attention has been paid to the ladderway and works underground; but here and at other mines in the district commodious changing houses (or improvements in them where such houses exist) are required.

L. 11,881.
p. 118.

Clubs and Doctors.—The subscriptions to the clubs are on the same scale as in Cornwall; the selection of the mine doctor is in some cases left to the men, and the plan works well.

Cottages.—The miners' cottages at Tavistock are for the most part very good, but both there and in other parts of the county there is a deficiency of house accommodation. *General Observations.* M.

LEAD MINES of YORKSHIRE and the NORTHERN COUNTIES.

YORKSHIRE
AND
NORTHERN
COUNTIES.

As much of the evidence with respect to the health of the miners has reference to the nature of the rock in which the working operations are conducted, a few remarks on the geological structure of the district may render the evidence more intelligible. The lodes of lead ore in this (as also in the Alston Moor) district are generally found in the great group of strata designated by geologists as the carboniferous or mountain limestone formation. In tracing this formation from south to north, many modifications are found, both in the lithological structure and in the arrangement of the component strata. Professor Phillips says "the most general character of the lower limestone series," that of the south, "is simplicity, but that of the upper series complexity." The demarcation between the two sets of strata is thus laid down by the same author:—"If a straight line be drawn from Jervaulx Abbey on the Yare through Kettlewell on the Wharfe to Ryeloaf Hill near Mallam, and thence continued westward to Lancaster, it will divide the Yorkshire limestone into two parts, remarkably contrasted in the character of the limestones. In the northern districts the lower limestone rocks are covered by a thick and complicated series of limestone, flagstone, shale, coal, &c., in the southern all the terms of this series interpolated between the limestones vanish, and these are either united with the lower rocks, much altered in aspect, or reduced to nothing."

The mines at Grassington and in Wharfedale are worked for the most part in limestone and grit; those in Arkendale and the other districts north of Professor Phillips' line of demarcation are worked in frequent alternations of plate and shale, grit, chert and limestone. Many of the medical and other witnesses state that the dust produced in the mining operations affects the respiratory organs of the miners; the dust from the grit and plate beds being far more injurious than that from the other rocks.

The whole area occupied by the mines has been subjected to much disturbance at various periods since the deposition of the strata. Without entering upon the question of the mode of deposition of metalliferous veins, it may be assumed that they occupy what were fissures and cavities of the rock in which they are found, and that since their deposition they have been in frequent cases dislocated and thrown wide of their original bearings. Besides the fissures filled by metalliferous and other mineral deposits, there are many which remain void. The latter in some cases play an important part in the economy of a mine by carrying currents of fresh air from above and abstracting the drainage water below,

YORKSHIRE
AND
NORTHERN
COUNTIES.

General Observations.

while in others they become sources of annoyance, sometimes of danger, by allowing water or injurious gases to accumulate until accidentally tapped by the miners.

The lead mines of the North of Yorkshire are situated for the most part in the higher districts of the three valleys, Swaledale, Yoredale, and Wharfedale, which convey the drainage of the country from the high range of the Penine Hills to the River Ouse. The tributary streams in the higher parts of this area are very numerous, and commonly run in deep valleys or gorges, cutting through and so exposing the several strata occurring in their course. This configuration of the surface affords peculiar facilities for carrying on mining operations, and consequently it is on these streams that the lead mines are for the most part situated. The deep valleys ramifying through the hills offer frequent opportunities for driving adit levels at various elevations, by which mode of access all subsequent operations are carried on at a comparatively small expense. An adit level judiciously placed facilitates the drainage and ventilation of the mine; it also affords an easy access for the miners, and egress for the ore and refuse by means of waggons running on a tramroad, and propelled either by men or horses, thus saving the labour and expense of raising the products by either steam or water-power. In addition to these advantages the ore is delivered on the banks of a stream, the most convenient place for preparing it for the smelting house; and, should water power be required for driving the crushing mills or other machinery, it can ordinarily be obtained from the higher course of the stream; consequently steam power is seldom required and rarely used in this district.

Epitome.
B^a.

The surface of the country in the immediate vicinity of the mines is for the most part wild moorland, and the miners reside in small villages lower down the valleys and have to walk from two to four miles to and from the mine. In some districts small parcels of land are attached to the miners' cottages, enabling them to keep one or two cows, and affording them healthful employment in the open air, which, combined with the fresh air they breathe in walking to and from their work, to some extent counteracts the injurious effects of previous exposure to the vitiated atmosphere of the mines.

M^a.

Health of
Miners.

A^a.
App. B.
I.

HEALTH OF MINERS.

Dr. Peacock, at the request of the Chairman, visited Alston, Nenthead, Allenhead, Weardale, and Middleton in Teesdale, and examined 25 men who were suffering from different forms of disease, and 225 who were at work in various mines. His report will be found in the Appendix.

By far the largest number of cases of disease which fell under his notice were cases of miners' asthma.

He says that there is a striking uniformity in the causes to which the miners attribute the impairment of their health; these are bad air, powder, reek and stow.

They say, with regard to bad air, that, notwithstanding great

improvements have of late years been effected in the state of the mines, some of the workings are still very defective.

"Powder reek" also, they think, frequently renders the air of the mines very injurious.

With regard to the "stour" or dust of the mines, it is often blamed by them as a cause of indisposition, and some say that the "stour" is worse than anything else. Dr. Peacock thinks that in this respect these mines are more injurious than those of Cornwall.

The other causes assigned by the miners as probably affecting them were, working too hard when they have a good bargain, working at night, and at too early an age.

He did not find the climbing ladders blamed by the men as having been injurious to them. As most of the mines are entered by day levels, the men have not usually to climb more than 15 to 30 fathoms. He adds that the mines are not apparently so hot as to exercise any injurious influence.

In comparing this district with Cornwall, he was struck with the more robust appearance of the miners, and the larger proportion of middle aged and old men among them.

He considers that the diseases met with among the miners in this district correspond generally with the diseases observed in Cornwall, but present some differences. It seemed to him that miners' asthma was usually in this district a simpler form of disease than in Cornwall, and less frequently complicated by disorganization of the lungs. He also found this affection in the North not so commonly combined with diseases of the heart as in Cornwall.

He does not think that the more satisfactory sanitary condition of the miners in this district can be ascribed to the mines being generally in a better state as to ventilation and freer from "choke damp." Indeed he thinks that the reports of the men indicate a worse condition of certain parts of the mines in the North than in Cornwall.

He considers the circumstances which are mainly influential in favourably affecting the sanitary state of the men working in these mines to be the comparatively short periods in each week during which the men work in the mines, the ready access to the mines without having to climb the ladders to any extent, the natural temperature of the workings and the length of time during which they are left free.

VITAL STATISTICS.

Vital Statistics.

From a return prepared at our request by the Registrar General and printed in the Appendix it appears that, as has been shown to be the case in Cornwall, so also in these northern districts, the rates of mortality are much higher among the mining than among the non-mining section of the male population.

YORKSHIRE
AND
NORTHERN
COUNTIES.

*Health of
Miners.*

**YORKSHIRE
AND
NORTHERN
COUNTIES.**

Vital Statistics.

For names of districts and sub-districts included in the return see App. B. IX.

The districts comprised in the return are the lead-mining districts of Northumberland, Durham, Cumberland, Westmoreland, Yorkshire, and Lancashire. But inasmuch as the numbers of miners and of course the numbers of deaths of miners, in some of these counties, were too small, taken separately, to justify any deductions with regard to the comparative health of the mining and non-mining sections of the population, we shall only quote from the return the death rates as computed from the aggregate numbers of males and of deaths of males of the two classes respectively, in all the lead-mining districts of the six counties taken together. In order to show the comparative health of the two sections of the population at the present time, the rates of mortality comprised in the return have been calculated for the three years 1860-62 inclusive; these years having been selected because the last census was taken in 1861, the middle year of the term, which renders the calculations as nearly accurate as possible. The sub-joined table shows the average annual rates of mortality per 1,000 miners, and per 1,000 males exclusive of miners, from all causes, for the several successive decennial periods of life from the age of 15 up to that of 75 years.

AVERAGE ANNUAL NUMBER of DEATHS per 1,000 Miners, and per 1,000 Males exclusive of Miners, from ALL CAUSES, during the three years 1860-62 inclusive.

Ages.	Metal Miners.	Males exclusive of Miners.
Between 15 and 25 years	9·53	7·57
" 25 " 35 "	12·38	9·19
" 35 " 45 "	17·64	10·13
" 45 " 55 "	33·11	16·18
" 55 " 65 "	78·34	29·38
" 65 " 75 "	127·52	66·10

The figures in the above table show that at all ages from 15 years upwards the miners die in somewhat larger proportions than the men of the same districts not employed in mining, and also that this excess of mortality among the miners increases largely and progressively with increasing age, up to that period of life after which few miners continue to work underground. Thus, if it be assumed that the rate of mortality among the non-mining section of the male population at each successive period of life quoted in the table is equal to 100, then the rate among miners between the ages of 15 and 25 years would be 126; between 25 and 35 years, 135; between 35 and 45 years, 174; between 45 and 55 years, 205; between 55 and 65 years, 267; and between 65 and 75 years, 193.

From the return prepared by the Registrar General it also appears that this excess of mortality among miners is mainly due

to the greater prevalence and fatality of pulmonary diseases among them as compared with that among the non-mining section of the male population. The subjoined table shows the average annual rates of mortality per 1,000 miners, and per 1,000 males exclusive of miners, from pulmonary diseases, for the several successive periods of life from the age of 15 up to that of 75 years.

YORKSHIRE
AND
NORTHERN
COUNTIES.
Vital Statistics.

AVERAGE ANNUAL NUMBER of DEATHS per 1,000 Miners, and per 1,000 Males exclusive of Miners, from PULMONARY DISEASES during the three years 1860-62 inclusive.

Ages.	Metal Miners.	Males exclusive of Miners.
Between 15 and 25 years	3.40	3.97
" 25 " 35 "	6.40	5.15
" 35 " 45 "	11.76	3.52
" 45 " 55 "	23.18	5.21
" 55 " 65 "	41.47	7.22
" 65 " 75 "	53.69	17.44

With regard to the above table, if it be again assumed that the rate of mortality from pulmonary diseases among the non-mining section of the male population at each successive decennial period of life is equal to 100, then the rate among miners between the ages of 15 and 25 years would be 88, between 25 and 35 years 124, between 35 and 45 years 334, between 45 and 55 years 445, between 55 and 65 years 574, and between 65 and 75 years 308.

Thus it appears not only that the rate of mortality from pulmonary diseases among the lead miners in these counties is higher than that among the male inhabitants of the same districts who do not work in the mines, but also that this excess of mortality does not begin until after the age of 25 years, when the unwholesome conditions contingent on working in the mines have had sufficient time to exercise a sensible influence on the health of the miners. The smaller rate of mortality from pulmonary diseases which will be observed to exist among miners between the ages of 15 and 25 years, as compared with that among the non-mining section of the male population at the same ages, may be presumed to arise from the very probable fact that youths with known tendency to diseases of the lungs are not usually put to labour in the mines. On the other hand, the much larger discrepancy between the rates of mortality among miners and among other males from pulmonary diseases, as compared with that between the respective rates of mortality from all causes, is undoubtedly due to the fact that exposure to the peculiar conditions attendant on their occupation causes many miners to die of pulmonary diseases who in different circumstances would have died of other complaints, and therefore the great excess of deaths from pulmonary diseases does not in the same proportion raise

YORKSHIRE
AND
NORTHERN
COUNTIES.

the general rate of mortality, although, as has been seen, it does so to a very large extent.

Access and
Egress.

ACCESS AND EGRESS.

Epitome.
B^a.

The lead mines in this part of the country are usually entered by levels, ladders or stemples, but, the depth being much less than in the Cornish mines, the fatigue of climbing is not so great, and the men, reaching the surface in a less exhausted and heated state, are not so liable to suffer from exposure to cold. The general mode of communication from one level to another is by stemples; these consist of pieces of wood two or three inches in diameter, placed across the rise and fixed in the rock about 3 ft. 6 in. apart in width and 2 ft. 6 in. apart in height.

Ventilation.

VENTILATION.

App. B.
V.

Samples of the air of mines in the north of England were analysed by Dr. Smith, in 110 instances, and the air was found to be—

	pure or nearly so in	14 or 12·72	per cent.
	decidedly impure in	27 or 24·54	„
	and extremely bad in	69 or 62·72	„

The samples in which it was more or less decidedly defective being thus 96 or 87·26 per cent. of the whole of those analysed, a proportion very closely corresponding with that which was found to obtain in the mines in Devon and Cornwall. In these mines the amount of oxygen was, in one instance, as low as 18·27 per cent., and the carbonic acid amounted in another to 2·26 per cent.

VI.

Dr. Bernay's report contains a statement of the results of the analysis of 29 samples of air received from mines in the North of England. From this it will be seen that the amount of carbonic acid varied in different mines and at different periods, from 0·0447, a proportion nearly that of pure air, to the excessive amount of 2·238 per cent. It will further be observed that not less than eight samples of air were analysed in which the proportion of carbonic acid exceeded 1 per cent. He remarks that he was not prepared to meet with such large proportions of carbonic acid in the air of any mines, and considered an atmosphere above ground bad which contained three times the normal quantity ($0·035 \times 0·105$); and with reference to the specimens from one mine, he pronounces it to be almost incredible that men can exist in such an atmosphere, much less follow their employment for any lengthened period. This large amount of carbonic acid is partly due to the breathing of the men and the combustion of the candles, but it seems also to be given off from the strata in which the levels and shafts are driven. The dust from boring and blasting, and the products of the explosion of gunpowder, still further deteriorate the atmosphere. Altogether, the air which is breathed by the miners in some parts of these mines must be

extremely unwholesome, and very fully explains the prevalence of disease among the miners.

The fatal effects of breathing an impure atmosphere are however clearly evident, notwithstanding these mines are for the most part comparatively shallow and are usually entered by means of adit levels.

YORKSHIRE
AND
NORTHERN
COUNTIES.
—
Ventilation.
Epitome.
C^a.

ACCIDENTS.

Blasting.—The limestone rock being from its character less liable to emit sparks than the prevailing rocks in the South, the use of iron implements is not attended with the same danger, and consequently there are fewer accidents from blasting,

Falling away from Ladders and Stemples.—Accidents occasionally occur either from the stemples giving way, or from the men losing their hold. Men accustomed to stemples prefer them to ladders, but in either case the danger of accident would be materially diminished by the use of buntings or sollars.

Falling from one Level to another.—The remarks made on this subject with regard to the South are equally applicable to the North.

Falls of the Rock.—Accidents from this cause are common here, perhaps more so than in Cornwall, owing to the incoherent character of the rock.

Fall of Stuff in Drawing Shafts.—Accidents are rare from this cause, as waggons dragged by horses are very generally employed to draw out the ore and refuse by the levels. Where the ore is raised to the surface through a shaft, wire ropes and guide rods are commonly made use of.

Bursting of Boilers.—Water power being chiefly employed in this district, accidents from the bursting of boilers are rare.

Abandoned Shafts.—This source of danger prevails in these districts as well as in Devon and Cornwall.

GENERAL OBSERVATIONS.

Changing Houses.—There are few changing houses for the men. Those who live near enough go home to change. Those who live at a distance change in the "mine shops or barrack rooms" where they sleep. These are often much too small for the number of men who occasionally occupy them, and are generally ill ventilated.

Candles.—These are for the most part of superior quality to those in common use in the South. At some mines the company manufacture their own candles at a cost of from 5d. to 6d. per lb.

Clubs.—These for "visible hurts" are not so general in the North as in the South; but in some instances the men belong to benefit clubs. We found two embracing cases of sickness and accidents, which appeared to us to be well conducted.

Accidents.
E^a.
E^a. b^a.

E^a. c^a.

E^a. d^a.

E. a^a.

General Observations.

App. B.
VII. p. 297.
Epitome.
F^a.
M^a.

F^a.

K^a.

App. B.
VII. 328. p.
I. p. 19.

YORKSHIRE
AND
NORTHERN
COUNTIES.

General Observations.

Epitome.

L^a.

A^a, c^a

App. B.

I.

Epitome.

M. c^a, d^a.

App. B.

I.

VII. p. 322.

Epitome.

N^a.

Doctors.—The system of medical attendance varies considerably in different districts. In several instances the miners elect the doctor; in others, each miner selects his own medical attendant, who is then paid out of the club money; while in some, medical attendance is provided by the proprietors without any charge to the men.

Food.—This is of a more wholesome character than that in use in the South. The men are not unfrequently small farmers, with gardens attached to their cottages, and ground for the keep of a cow, which enables them to obtain milk, which they take underground. Dr. Peacock in his report refers to the advantage which accrues to the miners from their being employed while at the surface at some out-of-door occupation, as tending very materially to protect them from the operation of the injurious influences to which they are subjected when underground.

Cottages.—The cottages in the open country are healthy, but the villages are often greatly deficient in sanitary regulations.

Children.—These are not employed to so great an extent at the mines, and do not go underground at so early an age, as in the South.

WALES and SHROPSHIRE.

WALES AND
SHROPSHIRE.

General Observations.

The principal mines in Wales are in the counties of Denbigh and Flint in the North, and Montgomery and Cardigan in the South. In addition to these are the Parys and Mona mines in Anglesea, and the Gold Mines in the neighbourhood of Dolgelly.

The rock which prevails in the lead districts of Flintshire and Denbighshire is much the same as that in the metalliferous portions of Cumberland and the North, namely, the mountain or carboniferous limestone, alternating with beds of chert and shale, the latter occasionally emitting carbonic acid gas.

Small setts, called Poor Men's ventures, are occasionally granted to individuals, especially in Flintshire. These adventurers work the mines themselves, in many instances after leaving their work at the larger mines, thus prolonging the hours of their underground labour. Having no capital to spend in properly opening up the mines, the men suffer all the evils arising from imperfect ventilation and from the want of the other provisions necessary to ensure health and safety.

The mines in these districts are entered by ladders, to which mode of access we have already referred.

HEALTH OF MINERS.

Dr. Peacock visited some of the mines in the neighbourhood of Mold in Flintshire, and states in his report, which is printed in

Health of
Miners.

App. B.

I. p. 22.

the Appendix, that the general opinion which he formed of the miners was that they were by no means a robust race. He found that their health suffers in the same way as that of the miners in Cornwall and the North of England, and that the affections under which they labour are referable to the same causes. The old mines in the district were most of them suspended some years ago, and those newly opened have not been in operation a sufficient length of time to test the effect of working in them, while most of the men have been engaged in other pursuits till a comparatively recent period.

WALES AND
SHROPSHIRE.*Health of
Miners.*

VITAL STATISTICS.

Vital Statistics.

The returns of mortality relating to North Wales, prepared for us by the Registrar General, have reference only to the district of Holywell. The subjoined table shows a very considerable excess in the rates of mortality from all causes among the lead miners, as compared with the other section of the male population, during the three years 1860-62 inclusive.

App. B.
III. & IX.

AVERAGE ANNUAL NUMBER of DEATHS per 1,000 Lead Miners and per 1,000 Males exclusive of Lead Miners, from ALL CAUSES, during the three years 1860-62 inclusive :

Ages.	Lead Miners.	Males, exclusive of Lead Miners.
Between 15 and 25 years	6·04	7·46
" 25 " 35 "	15·72	10·52
" 35 " 45 "	18·05	12·57
" 45 " 55 "	25·74	15·19
" 55 " 65 "	55·19	28·11
" 65 " 75 "	86·96	75·78

Assuming, as in the previous sections on vital statistics, that the rates of mortality among the males, exclusive of lead-miners, are represented at each period of life by 100, then that among the lead-miners will be represented by 81 between the ages of 15 and 25, by 149 between 25 and 35, by 144 between 35 and 45, by 169 between 45 and 55, by 196 between 55 and 65, and by 115 between 65 and 75 years.

As in the other metal-mining districts referred to in this report, so also in this district, the excess of mortality among the metal miners over that which prevails among the other section of the male population is mainly due to the excess of deaths from pulmonary diseases. The subjoined table shows the mortality from these diseases, among the two sections of the population respectively, for each decennial period of life from the age of 15 up to 75 years.

WALES AND
SHERIFFSHIRE.
Vital Statistics.

AVERAGE ANNUAL NUMBER of DEATHS per 1,000 Lead Miners and per 1,000 Males exclusive of Lead Miners, from PULMONARY DISEASES, during the three years 1860-62 inclusive :

Ages.	Lead Miners.	Males, exclusive of Lead Miners.
Between 15 and 25 years - - -	3·02	3·39
" 25 " 35 " - - -	4·19	5·79
" 35 " 45 " - - -	10·62	5·41
" 45 " 55 " - - -	14·71	7·06
" 55 " 65 " - - -	35·32	12·21
" 65 " 75 " - - -	48·31	16·96

Again, assuming the rates of mortality among the male population not engaged in lead mining to be represented at each age by 100, then that among the lead miners would be represented by 89 between the ages of 15 and 25, by 72 between 25 and 35, by 196 between 35 and 45, by 208 between 45 and 55, by 289 between 55 and 65, and by 285 between 65 and 75 years.

The excess of mortality among the lead miners of the Holywell district over that which prevails among the other section of the male population is thus evidently much less striking than has been shown to be the case in the Cornish and Northern metal-mining districts, both as regards the deaths from pulmonary diseases and those from all causes. Nevertheless, the above statistics clearly indicate that the Holywell lead miners suffer from some causes of disease and premature death from which the rest of the male population are exempt. Reasoning from analogy, it is therefore but fair to presume that in this, as in the other metal mining districts, the excess of mortality among the miners arises in some way from conditions incident to their occupation.

Ventilation.
App. B.
V.

VENTILATION.

In this district the ventilation of the mines was shown by the analyses of samples of air to be more defective than in those which have been previously named. Of 59 samples, Dr. Smith found that

only 3 or 5·08 per cent. were pure, or nearly so ;
while 11 or 18·64 per cent. were decidedly impure ;
and 45 or 76·27 per cent. were exceedingly bad.

The number of samples in which the air was more or less defective being thus 56 or 94·91 per cent., a considerably larger proportion than occurred in any of the mines in Cornwall and Devon and the North of England. The proportions of oxygen and of carbonic acid were much the same as in the other districts, the lowest amount of oxygen being 18·60 per cent., and the highest of carbonic acid 2·26 per cent.

Fans worked by the hand are the only artificial means resorted to for supplying air, with one exception, where in driving a long level a permanent brattice of brickwork had been in operation for fifty years, and was being extended with satisfactory results.

A remarkable statement was made by one of the witnesses of the beneficial effect on the circulation of the air produced by driving on a dead level. In one place four men were at work 140 fathoms distant from the air shaft, without feeling inconvenience from deficiency or impurity of the air, and an instance was related of a mine agent of Llandudno having driven a level 500 fathoms without any artificial ventilation by working the floor on a dead level and removing all the refuse as the work proceeded.

WALES AND
SHROPSHIRE.

Ventilation.
Epitome.
C^v. 19, 971.
C^v. 21, 209.

ACCIDENTS.

Accidents.

Accidents in blasting are less frequent here than in Cornwall, owing to the nature of the rock.

E^v.

Falling from Ladders.—The evidence shows the occurrence of several accidents from this cause.

Falling from one Level to another.—The same remarks apply in Wales to this subject as in Cornwall.

E^v. f^v.

Falls of the Rock.—The men are liable to accidents from this cause here as elsewhere.

Bursting of Boilers.—The danger from this cause is much diminished by the precautions adopted, in furnishing the boilers with two safety valves, water gauges, or signals.

E^v. r^v.

Abandoned Shafts and Workings.—Shafts in great numbers are left open and unprotected in many parts, and are a source of serious danger to the public.

E^v. a^v.

An accident, attended with the loss of 16 lives, occurred in 1862, occasioned by an unexpected outburst of water from the workings of an old mine of which there were no plans.

E^v. I^v. 20, 642.

GENERAL OBSERVATIONS.

General Observations.

Changing Houses.—These are frequently wanting, and even where they exist proper attention is not paid to cleanliness, light, and ventilation. The objectionable practice of changing in the boiler house is consequently carried on to a great extent.

App. B.
VII. p. 329.
Epitome.
F^v.

Clubs.—Accident clubs in connexion with the mines are extremely rare. The men, however, occasionally subscribe to sick-clubs. We found accident clubs in operation at the mines in Anglesea and at the Snailbeach mine in Shropshire.

Epitome.
K^v.
App. B.
VII. p. 330.

Doctors.—The men subscribe, as in other mines, but, with very few exceptions, choose their own medical attendants, the system of selection by the adventurers having been abandoned.

Epitome.
L^v.
App. B.
VII. p. 330.

Cottages.—The miners in Flintshire and Denbighshire reside for the most part in the immediate vicinity of the mines, in

Epitome.
M^v.

WALES AND
SHROPSHIRE.
General Observations.

cottages either rented or built by themselves, on plots of land appropriated from the adjacent common. Many of them have land reclaimed from the waste sufficient for the keep of one or two cows. The men seem to take a pride in their little property, and are said to keep their houses clean and tidy. Lodging accommodation being plentiful, even where the miners do not occupy their own cottages, overcrowding does not occur. Some of the cottages are however very defectively constructed, badly ventilated and ill drained.

App. B.
I p. 22.

SOUTH WALES.

SOUTH WALES.

The mines in South Wales are situated for the most part in the lower Silurian and Cambrian rocks; the method of working assimilates to that practised in Cornwall. The access is usually by ladders, though in some cases by adit levels.

VENTILATION.

App. B.
V.

It will be seen by Dr. Smith's report that he analyzed 8 samples of air removed from mines in this district, and that of the whole number not one could be regarded as pure or normal, one only was simply impure, and the remaining 7 were decidedly bad, results indicating that the ventilation of these mines is more defective than any of those which have previously been named by the Commission. The least amount of oxygen contained in any of the samples was 19.72 per cent., and the largest of carbonic acid 1.74 per cent.

ACCIDENTS.

Epitome.
E^v.

The causes and nature of accidents are much the same in this locality as elsewhere, except that boilers are better provided with safety apparatus.]

GENERAL OBSERVATIONS.

F^v.

Changing Houses.—These are rare, but where they are provided some of the miners make use of them, though it was stated by several witnesses that in consequence of living near to the mines the men preferred walking home in their underground clothes.

M^v.

Cottages.—The dwellings of the miners are damp and ill ventilated, with mud floors, fixed windows and roofs not watertight. There is seldom more than one room, and that is generally overcrowded.

App. B.
VII p. 344.

Epitome.
G^v.

Wages.—The nonpayment of wages in some instances, and irregularity in many, were made subjects of complaint by miners working in some of the small mines in the district of Aberystwith. Lists were handed in showing considerable arrears due to the miners.

CHESHIRE.

CHESHIRE

See Epitome.

The rock salt mines of Cheshire are of great extent. There are six now worked at Northwich, and at a distance of seven miles there is one at Winsford. The Marston mine is one of the largest and is said to occupy an area of 24 statute acres. The bed of salt in which the workings are now carried on is about 112 yards from the surface and is quarried to a thickness of from 15 to 18 feet. Columns of salt, 10 yards square and 25 yards apart, are left to support the roof. Two shafts, the one constantly upcast, the other downcast, ventilate the mine very effectually. The mining is undertaken by "driftmasters," who employ gangs of rock "getters." The former receive from the lessees a certain sum per ton of rock, delivered either at the shaft or on board the flats in the river Weaver; the latter are paid according to their skill. The scale of wages ranges from 2s. 6d. to 3s. 6d. per day of eight hours. The men work from 7 o'clock in the morning till 3 o'clock in the afternoon. They are taken up and down the shaft in the buckets which are used to draw up the salt. The salt is quarried by blasting, but the space underground is so large, and the ventilation so good that no inconvenience is experienced from the powder smoke. The mines are very dry and of an equable temperature of about 51° of Fahrenheit at all seasons of the year. The underground atmosphere and temperature being both so favourable, the miners are strong and healthy. The affections to which they are most liable are colds, rheumatism, and neuralgia, contracted probably by imprudence in exposing themselves half naked to the draughts of the shaft when coming off work. Accidents from blasting are rare, as there are no siliceous particles in the rock and the salt itself is used for tamping.

DERBYSHIRE.

DERBYSHIRE.

The lead mines in Derbyshire were extensively worked by the Romans, and from that period till the present the principal portion of the lead-producing district has been subject to mining "Customs," confirmed and consolidated by Acts of Parliament. In the "Customary" manors ores of lead are worked by any one who chooses to search for them, subject to the payment of a portion of the ore obtained, either to the Duchy of Lancaster or to the proprietor. The existence of these customs has encouraged a system of unmethodical workings, conducted by the owners of small mines, whose profits or earnings are, of course, subject to violent fluctuations. About 20 years ago expensive machinery was erected at several places, but the mines proving unproductive much of it has been removed.

As compared with many districts the workings have not generally been deep, 130 fathoms is, perhaps, the extreme depth to which they have been carried; not many exceed 100 fathoms, and probably but few men at present are employed below 80

**IRONSTONE
MINES.**

fathoms, and the greater number at lesser depths. Access to the mines is usually by ladders or stemples, though several important adits still exist.

The rock is for the most part carboniferous limestone.

**IRONSTONE MINES NOT OF THE COAL MEASURES, NEAR REDCAR,
FURNESS ABBEY, AND WHITEHAVEN.**

The mines of carbonate of iron in the Cleveland Hills near Redcar, though recently opened up, are extensively worked. The entrance is from the day and levels are driven of considerable dimensions; in one of these a furnace was in operation at the bottom of the shaft, and with such good effect that the men were enabled to drive as far as 1830 yards from the day without inconvenience from powder-smoke.

Epitome.
C.
16,470.
16,473.

The mines in the Furness Abbey district are hæmatite.

The system of working in some of these mines by the removal of large masses of ore causes the surface of the ground to collapse. The crush thus occasioned is described by one of the witnesses as being enormous, so much so that a pit-prop 9 inches in diameter has been known to be crushed in 24 hours. Still as the pressure is gradual there is no danger to the miners from a sudden subsidence.

Epitome.
E. p.
12,387.

Owing to the uncertainty of the currents of air in the shafts, occasioned by certain states of the atmosphere, the ventilation is imperfect and is remedied by letting down a fire-pan or cage filled with burning wood.

C.
12,416.

In the mines about Whitehaven hæmatite iron is found in considerable masses, and its removal forms large cavities which facilitate ventilation.

App. B.
I.
p. 23.

Dr. Peacock has furnished us with a report upon the condition of the hæmatite iron miners in the district of Furness in Lancashire, in which he states that they are a robust race, and as healthy as other men engaged in equally laborious occupations, and free from those affections which are so productive of diseases and premature failure of power in the men employed in tin, copper and lead mines. Their freedom from suffering he ascribes chiefly to the following circumstances:—

- 1st. That the mines are better ventilated;
- 2d. That the men commence to work underground at more advanced ages, and after they have attained their full vigour; and
- 3dly. That they take more fresh animal food and live altogether upon a more nutritious diet.

Epitome.
G.

They earn on an average from 4*l.* to 4*l.* 15*s.* a month. The pay day in some mines has been changed from Saturday to Friday, an alteration which is stated to have had the effect of checking drunkenness.

We cannot conclude without acknowledging the very great readiness which all parties connected with mines have shown to

supply the fullest information, and would wish to record our **RESOLUTIONS.** thanks to them for the valuable assistance which they have rendered in forwarding the work which was undertaken by us.

From a careful consideration of the evidence herewith submitted, and of the reports and documents prepared in the course of the inquiry, and printed in the Appendix, and from the knowledge acquired by visiting the districts comprised in the terms of the Royal Commission, and by inspecting mines therein, we have agreed to the following

RESOLUTIONS.

1. *That there is a great excess of sickness and mortality amongst metalliferous miners, which is mainly attributable to the imperfect ventilation of the mines.*

However diverse the opinions of medical men may be as to the causes of the disease called "miner's asthma" or "miner's consumption," there is a remarkable concurrence among all the writers on the subject in this, that the health of the miner is greatly influenced by the quality of the air in which he works. The more extended inquiry instituted by us under the Royal Commission gives strength, if not certainty, to this conclusion. In the coal districts, where, on account of the dangerous gases, great attention has been given to the proper ventilation of the mines, the mortality (accidents excepted) among the miners is considerably less than it is in the metalliferous districts. We *Report, p. 11.* have on this account thought it advisable to make ourselves acquainted with the systems of ventilation usually adopted in coal mines, in the hopes that we might thereby be able to offer some suggestions for improving the ventilation in the metalliferous mines. The main object to be kept in view in ventilating a mine is to conduct a sufficient supply of pure air through the mine in order to displace the vitiated air where the men are at work. Various contrivances have been put in practice for effecting this, but they are all applications of two principles, propulsion and extraction; by the first pure air is forced in, by the second foul air is drawn out. The power used may be either natural or artificial. Natural force acts when columns of air are, in the absence of any artificial means, of unequal weight, in which case the heavier column displaces the lighter, and so causes movement and change of air. Another natural force acts when the wind blows in at a level or over a shaft. Artificial propulsion is effected by various applications of machinery and other contrivances, such as falling water, the water blast or the fan; artificial extraction, by suction or by furnace heating. The most simple method of ventilation is by natural agencies, directed and supplemented by engineering skill. Two or more shafts or

RESOLUTIONS.

adits are essential, so contrived that one shall be upcast in all states of the weather. A system of trunk ventilation being thus established the pure air may be guided to any part of the mine where it may be required, if care be taken to remove all refuse or "deads," and to close up all old and abandoned workings, by which the currents of air may be interfered with. In cases where natural ventilation is insufficient, artificial means must be resorted to, and of these it appears to us that by far the most effectual, where it can be adopted, is that which is generally in use in the coal mines, namely, the rarefaction of the air in one of the shafts by the heat of a furnace. The mechanical means which have been suggested are the introduction of pure air by a force pump, and the abstraction of foul air by a suction pump. Machines for the latter purpose are in successful operation in some collieries and mines in this country.

The foregoing remarks chiefly apply to the maintenance of a regular system of trunk ventilation. In small mines, and in certain parts of large mines, a good supply of air may be provided by means of contrivances which cannot be economically applied on a large scale, such as different descriptions of air pumps, water blasts and fans. These may answer the purpose when judiciously applied and carefully attended to. It appears to us worthy of consideration whether some combination of natural with artificial appliances might not be adopted at a comparatively small expense, considering the benefit that would thence accrue both to the employer and employed. Cases have come before us of mines in which, in certain conditions of the atmosphere, the circulation of air underground is regular and sufficient, while at other times it varies both in quantity and direction, consequent upon the inversion or stagnation of the current of air in the shaft. This evil might be effectually conquered by the maintenance of a constant upcast shaft, and where natural causes fail, this might be effected by an application of furnace heating. Whatever system, however, may hereafter be adopted, it is essentially necessary that attention should be paid to driving the levels of sufficient size, to making more frequent communications between them, to removing the refuse, closing up disused winzes, sumps, shafts, and abandoned workings, and to the judicious application of air-tight doors and brattices so as to control the direction of the underground currents.

2. That several other causes, both general and local, largely contribute to impair the health of the miner; namely, exposure to cold and wet, and to sudden alternations of temperature; wearing wet clothes; inhalation of gritty particles; and the exertion of climbing ladders from great depths.

Amongst the causes enumerated by the medical men as tending to impair the health of the miner, exposure to sudden alternations of temperature and to wet and cold is much insisted upon. The

miner is peculiarly liable to these dangers, either from imprudence on his own part, or from want of proper arrangements on the part of his employers. RESOLUTIONS
AND RECOM-
MENDATIONS.

Another cause most injurious to the health of the miners is the exertion of climbing ladders continuously from great depths. The evidence of the medical witnesses and of the miners themselves leaves no doubt on our minds as to the pernicious effects of severe climbing upon men whose constitutions are, perhaps, impaired by the conditions under which they work, and the severity of the work itself. This evil is occasionally enhanced by the impure state of the air in the ladder ways, and aggravated by the indiscretion of the miners themselves, especially the younger ones, in mounting the ladders with too much haste.

In those mines where the man engine has been in operation the improvement in the health of the miners is stated to be evident.

In most coal mines workmen are conveyed up and down the shaft in the "cages." This arrangement appears to us to be expeditious and safe, when due attention is paid to the construction and supervision of the machinery; and we think it might be advantageously introduced in many of the metalliferous mines.

We therefore recommend,—

1. THAT EVERY MINE SHOULD BE PROVIDED WITH PROPER HOUSES CONVENIENTLY SITUATED IN WHICH THE MEN CAN CHANGE AND DRY THEIR CLOTHES.
2. THAT SURFACE WORK SHOULD, AS FAR AS PRACTICABLE, BE CARRIED ON UNDER SHELTER, AND THAT SUITABLE PLACES SHOULD BE PROVIDED IN WHICH THE WOMEN AND CHILDREN EMPLOYED AT THE MINES MIGHT TAKE THEIR MEALS.
3. THAT IN ORDER TO AVOID THE EVILS CONSEQUENT ON CLIMBING LADDERS, MECHANICAL MEANS SHOULD BE PROVIDED TO CONVEY THE MEN TO AND FROM THE SURFACE WHEN THE MINES ARE OF GREAT DEPTH.

3. That accidents are of frequent occurrence in metalliferous mines; and that they principally result from miners falling from ladders and stemples, or from one level to another; from falls of the rock or stuff; from want of caution in blasting; from defective gear and imperfect supervision of machinery; from sudden irruptions of water or foul air, and from the bursting of boilers.

To obviate as far as possible the various accidents to which miners are exposed, we recommend,—

1. THAT NO LADDERWAY SHOULD BE ALLOWED IN A DRAWING SHAFT WITHOUT THE SHAFT BEING PROPERLY DIVIDED OR BRATTICED OFF, FROM THE FOOTWAY, AND THAT EFFICIENT SOLLARS SHOULD BE FIXED AT

- MODERATE DISTANCES IN ALL FOOTWAYS, WHETHER THE ASCENT OR DESCENT BE BY LADDERS OR STEMPLES.
2. THAT SHAFTS, WINZES, SUMPS, AND SHOOTS SHOULD BE MORE CAREFULLY GUARDED.
 3. THAT MORE STRINGENT RULES SHOULD BE ENFORCED IN REGARD TO BLASTING, WITH A VIEW TO PREVENTING ACCIDENTS, AND THAT BRONZE TAMPING RODS AND PRICKERS SHOULD BE SUPPLIED TO THE MEN.
 4. THAT THE PERSONS HAVING CHARGE OF THE FOOTWAYS AND OTHER WORKS UNDERGROUND SHOULD DAILY ENTER IN A BOOK A REPORT OF THEIR CONDITION TO THE AGENT OR CAPTAIN OF THE MINE, WHICH SHOULD BE PRODUCED IN CASE OF INQUIRY.
 5. THAT THE BOILERS AND OTHER MACHINERY SHOULD BE PERIODICALLY EXAMINED BY THE MINE ENGINEER, AND THAT A MONTHLY REPORT THEREON SHOULD BE GIVEN IN TO THE CAPTAIN OR AGENT, TO BE PRODUCED BY HIM SHOULD OCCASION REQUIRE.
 6. THAT THE MEN SHOULD NOT BE ALLOWED TO CHANGE IN THE BOILER HOUSE, WHICH NONE BUT THOSE IN CHARGE SHOULD BE PERMITTED TO ENTER.
 7. THAT ALL BOILERS SHOULD BE PROVIDED WITH TWO SAFETY VALVES AND A WATER GAUGE OR A STEAM WHISTLE.
 8. THAT PLANS AND WORKING SECTIONS OF ALL MINES ON THEIR BEING ABANDONED SHOULD BE DEPOSITED AT THE OFFICE OF THE CLERK OF THE PEACE FOR THE COUNTY, AND AT THE GOVERNMENT MINING RECORD OFFICE IN JERMYN STREET, FOR REFERENCE IN CASE OF WORKING BEING RESUMED, OR NEW MINES OPENED UP IN THE IMMEDIATE VICINITY.

4. That abandoned shafts, and old workings unprotected at the surface, are a cause of serious danger, not only to the miner, but to the public.

The accidents consequent upon the practice of leaving abandoned shafts and workings insufficiently guarded or wholly unprotected, are so numerous that we think it very desirable,—

THAT AN EFFICIENT AND EASILY AVAILABLE LEGAL REMEDY SHOULD BE PROVIDED IN ORDER TO GUARD THE PUBLIC FROM THIS PROLIFIC SOURCE OF DANGER.

5. That the employment of boys underground at an early age contributes to produce disease and premature death.

We therefore think it desirable,—

THAT, AS A GENERAL RULE, NO BOYS UNDER THE AGE OF 14 YEARS SHOULD WORK BELOW THE SURFACE.

6. *The system of mine clubs as at present in general operation is unsatisfactory, as not providing for cases of sickness as well as of accident.* RESOLUTIONS AND RECOMMENDATIONS.

We therefore suggest,—

THE ADOPTION OF SUCH A SYSTEM OF MINE CLUBS AS WOULD AFFORD THE MEN SUFFICIENT MAINTENANCE DURING SICKNESS, AS WELL AS WHILE SUFFERING FROM THE EFFECTS OF ACCIDENT.

All which we humbly submit to Your Majesty's most gracious consideration.

As witness our hands, this 4th day of July 1864.

KINNAIRD.

P. M. GREY EGERTON.

NICHOLAS KENDAL.

F. LEVESON GOWER.

JOHN ST. AUBYN.

R. DAVEY.

E. HEADLAM GREENHOW.

P. H. HOLLAND.

I. F. CAMPBELL,
Secretary.

APPENDIX A.

SUMMARY of TABLES of AGES of MEN working underground in Mines in—
 CORNWALL AND DEVON.

Number of Mines.	No. of Men.	Total Ages.	Average Age.
101	17,037	492,648	28'91

Ages.

5-9	10-14	15-19	20-24	25-29	30-34	35-39	40-44	45-49	50-54	55-59	60-64	65-69	70-74	75-79	80-84	Total.
1	665	3,556	3,785	2,412	1,673	1,477	1,210	931	711	378	173	55	8	2	1	17,037
'1	89'	208'7	222'3	141'6	98'1	86'7	71'	54'6	41'7	22'2	10'2	5'2	'5	'1	'1	1000

NORTH OF ENGLAND.

Number of Mines.	No. of Men.	Total Ages.	Average Age.
91	3,759	121,583	32'34

Ages.

5-9	10-14	15-19	20-24	25-29	30-34	35-39	40-44	45-49	50-54	55-59	60-64	65-69	70-74	75-79	80-84	Total.
—	76	370	615	593	509	439	332	266	164	107	61	22	7	—	—	3,759
—	20'2	98'4	216'3	157'7	135'4	116'8	88'3	70'8	43'6	28'5	16'2	5'9	1'9	—	—	1,000

IRONSTONE MINERS (North of England).

Number of Mines.	No. of Men.	Total Ages.	Average Age.
23	3,081	93,995	30'507

Ages.

5-9	10-14	15-19	20-24	25-29	30-34	35-39	40-44	45-49	50-54	55-59	60-64	65-69	70-74	75-79	80-84	Total.
—	76	244	636	647	494	414	267	189	99	35	20	5	5	—	—	3,081
—	24'7	79'3	206'4	210'0	180'3	134'4	86'7	46'1	32'1	11'4	6'5	1'6	1'6	—	—	1,000

WALES.

Number of Mines.	No. of Men.	Total Ages.	Average Age.
23	2,410	61,028	33'62

Ages.

5-9	10-14	15-19	20-24	25-29	30-34	35-39	40-44	45-49	50-54	55-59	60-64	65-69	70-74	75-79	80-84	Total.
2	21	187	407	395	353	308	273	188	113	76	53	17	5	2	—	2,410
'9	8'7	77'6	168'8	164'0	148'5	127'9	115'3	79'0	46'9	31'5	22'0	7'0	2'0	'9	—	1,000

RULES FOR A MINERS' PROVIDENT BENEFIT SOCIETY, PREPARED BY J. TIDD PRATT, Esq., FOR LORD KINNAIRD, WITH REPORT THEREON BY SAMUEL BROWN, Esq.

RULE 1.—Object.

The object of this society is to enable the miners working in the mines of Cornwall and Devon to make provision in case of sickness, old age, and death. It consists of separate funds for medical attendance and sick pay, and has connected with it the means of obtaining an annuity or superannuation allowance, and a sum payable at death. It shall be denominated "THE MINERS' PROVIDENT BENEFIT SOCIETY."

RULE 2.

This society shall be established at _____, and appoint district agents at such places as the Committee of Management shall think fit, who shall act under such regulations as the said committee shall make.

RULE 3.—Honorary Members.

That honorary members be admitted to aid and assist in the management. That all persons contributing a donation of not less than 5*l.* at one time, or an annual subscription of not less than 10*s.* to the management fund, and all persons not being ordinary members, who shall be appointed to any committee, hold any office, or perform any duty to which no emolument is attached, shall be styled honorary members, and shall also be entitled to vote at all general meetings.

RULE 4.—Appointment of Trustees, Treasurer, Secretary, and Committee of Management.

After these rules are certified by the registrar, there shall be elected _____ trustees, a treasurer, a secretary, and a committee of management, consisting of _____ persons. Treasurer and Secretary shall continue in office during the pleasure of the committee, and be removable by a general meeting thereof, and in case of a vacancy or vacancies another or others shall be elected by a majority of the committee at a meeting called for that purpose. The committee of management shall continue in office until the general annual meeting; and at every annual meeting the committee shall be appointed for the ensuing year, or in failure thereof, the officers last appointed shall be considered as again appointed; and in case any officer other than a trustee shall die or be removed prior to such annual meeting the committee of management shall appoint a person to fill up the vacancy. A copy of every resolution appointing a trustee or trustees, shall be sent to the Registrar of Friendly Societies in England, under the hands of three members, and signed by such trustee, and countersigned by the secretary.

RULE 5.—Powers and Duties of Trustees, Treasurer, Committee of Management, and Secretary.

The trustees shall be admitted to all meetings of the committee of management, and shall be at liberty to take part in the proceedings thereof, and vote on any question under discussion; they shall do and execute all the several duties and functions delegated to them by the statute relating to Friendly Societies, unless otherwise herein provided for.

The treasurer shall, in the month of _____ in every year, and also when required by the trustees, or by a majority of the Committee, render to the trustees a true account of all monies received and paid by him on account of the society; and shall also, when required by a majority of the trustees, pay over all monies remaining in his hands, and assign and deliver all securities and effects, books, papers, and property of or belonging to the society in his hands or custody, to such person or persons as a majority of the trustees shall appoint. He shall be responsible for such sums of money as may from time to time be paid into his hands by the secretary, or by any person on account of this society; he shall balance his cash account quarterly, and supply the com-

mittee with a duplicate thereof, and shall, if required, attend every general meeting. He shall, before taking upon himself the execution of his office, give security pursuant to the 18 & 19 Vict. c. 63, s. 21. He shall pay no money without a written order from the committee, attested by the secretary and three members of the committee.

The committee of management shall meet on the first ——— in every month. Any ——— of the committee duly assembled at any such meeting shall form a quorum. They shall appoint a chairman from themselves, and shall have full power to superintend and conduct the business of the society according to the rules provided for the government thereof, and shall in all things act for and in the name of the society; and all acts and orders under the powers delegated to them, shall have the like force and effect as the acts and orders of the society at any general meeting. Every question at such meeting shall be decided by a majority of votes; and if the votes are equal, the chairman shall have a casting vote. Any ——— of the committee may call a special meeting thereof, by giving ——— clear days' notice in writing to the secretary, but at such special meeting no other business than that specified in the notice shall be taken into consideration. The committee shall convene all the meetings of the society on such requisitions as are herein mentioned. The committee shall see that the several books and accounts are regularly kept, and that all minutes and resolutions are correctly entered and carried into effect; and shall superintend and direct the duties of the secretary and visitors.

The secretary shall attend at all meetings of the society, and shall record correctly the names of all persons present at the meetings of the trustees or committee; he shall make minutes of all proceedings, which he shall transcribe into the proper books. He shall receive demands for allowances of every description granted by the rules. He shall keep the documents and papers of the society in such form and manner as the committee may appoint. He shall receive all monies which shall be due to the society from the members and others; and, under the directions of the committee, shall pay all sums which the members and others may be severally entitled to receive. He shall keep a distinct account of the funds, and of all monies paid and received on account thereof, according to the forms prescribed by the committee. He shall pay into the hands of the treasurer, as the committee shall direct, all monies received over and above what is required to meet the current demands upon the society. He shall transact such other business of the society as may be entrusted to him; and shall on all occasions, in the execution of his office, act under the superintendence, control, and direction of the committee and treasurer.

RULE 6.—Annual General Meetings.

There shall be an annual general meeting of all the district agents on the first ——— in ——— at ——— o'clock, P.M., or such other day or hour as the committee shall appoint, at ——— for the purpose of receiving the report of the committee, and passing the accounts of the past year, appointing members of the committee for the ensuing year, and transacting other business.

Report and statements of the accounts to be sent to the district agents, and published in the local papers.

RULE 7.—Special Meetings.

A special meeting, either of the trustees, of the committee, or of the district agents, may be summoned on any emergency, by the direction of any ——— trustees, of an ——— members of the committee, signified in writing to the secretary, and stating the object for which such special meeting is required, of which notice shall be given by circular, stating the time, place, and object of the meeting, at least three days previous, to every trustee or member of the committee, as the case may be; but if it be a special general meeting, the notice shall be given by being posted in all the offices belonging to the institution, at least two pay nights previous to the intended meeting. The trustees, the committee, and every district agent, shall be eligible to vote at such meetings: and no other business shall be transacted at any special meeting than that for which the meeting was summoned. The expense of such

meeting to be defrayed by the members so calling it, unless otherwise ordered by the general meeting.

RULE 8.—*Payments to the Society.*

All payments to be made by the purser or agents for the several mines to the treasurer, on the first ——— in every month, with a list of the names of the men at the last pay day.

RULE 9.—*Appointment of Medical Officers.*

The surgeons shall supply all necessary medicines, advice, and attendance to every sick member entitled thereto, and to their families, except in cases of child birth; they shall visit every sick member who is confined to his house, and who resides within the boundaries, at least once in the week, and as much oftener as may be necessary for the proper treatment of the disease. The surgeons shall also certify in writing the state of health of all candidates for admission to the medical attendance and sick pay; they shall visit members of the society, at the request of the district agent, for the purpose of ascertaining and certifying correctly the state of their health; and keep a correct list of all persons who shall apply to them, either for medical attendance or certificates, according to the forms supplied by the committee, and shall send a copy of the same to the secretary as often as it shall be applied for.

RULE 10.—*Application of Medical Fund.*

Each miner shall on the ——— give in to the district committee the name of the doctor whom he wishes to attend him for the ensuing three months, and to whom according to the list made up by the district agents, with the approval of the general committee, the fees shall be paid; or else the medical fund shall be divided between the surgeons at the end of every year, every surgeon receiving payment for the number of cards he produces, and the remainder of the money being equally divided between all the surgeons, first deducting 5 per cent. for management.

RULE 11.—*Investments of Funds.*

So much of the funds of the society as may not be wanted for immediate use or to meet the usual accruing liabilities shall, with the consent of the committee of management, be invested by the trustees in such of the following ways as the committee shall direct, viz., in a savings' bank or in the public funds, or with the Commissioners for the Reduction of the National Debt, or upon Government or real securities in Great Britain or Ireland, or upon debentures, mortgages, or securities of any company incorporated by charter or Act of Parliament, and paying a dividend, or on or upon the security of any county, borough, or other rates authorized to be levied and mortgaged by Act of Parliament.

RULE 12.—*Audit of Accounts.*

The committee shall cause the accounts of the society to be regularly entered in proper books, and shall cause a statement of the accounts of the society, with all necessary vouchers up to the end of the month of ——— and ——— in each year, to be made out and laid before two auditors, to be chosen by the committee, and shall lay before each yearly meeting a balance sheet signed by the auditors, showing the receipts and expenditure, and the assets and liabilities of the society, together with a statement of the affairs of the society since the last ordinary meeting, and of their then condition, and the auditors shall make to such meeting a report upon the balance sheet so laid before them, and in case

they do not adopt the same, or any part thereof, shall specially report thereon to such meeting.

The books and accounts of the society shall be open to the inspection of any member at all reasonable times, and every member shall be entitled to a copy of such statement and report on payment of one penny.

RULE 13.—*Separate Book of Accounts.*

That a book or books shall be kept in which shall be entered all monies received or paid on account of each and every particular fund or benefit assured, distinct from all monies received and paid on account of any other benefit or fund.

RULE 14.—*Settlement of Disputes.*

That if any dispute shall arise between any member or person claiming under or on account of any member, or under the rules of the society, and the trustees, treasurer, or other officers of the society, or the committee thereof, it shall be referred to arbitration.

At the second meeting of the committee after these rules are certified by the registrar, five arbitrators shall be named and elected, none of them being directly or indirectly beneficially interested in the funds of the society; and in each case of dispute the names of the arbitrators shall be written on pieces of paper, and placed in a box or glass, and the three whose names are first drawn out by the complaining party, or by some one appointed by him or her, shall be the arbitrators to decide the matter in difference. In case of a vacancy or vacancies, another or others shall be elected at a special meeting.

RULE 15.—*New Rules and Alteration of Rules.*

That no new rule shall be made, nor any of the rules herein contained or hereafter to be made shall be amended, altered, or rescinded, unless with the consent of

RULE 16.—*Notice of Alteration and Place of Meeting.*

That in case of any alteration in the place of meeting, written notice thereof shall be sent to the Registrar of Friendly Societies in England, within 14 days after such removal, signed by two of the trustees, or by the secretary, and three of the members of said society.

RULE 17.—*Application of Funds.*

That all monies received on account of contributions shall be applied towards carrying out the objects of the society, according to the rules and tables thereof; any officer misapplying the funds shall repay the same and be excluded. Donations and fines shall be applied to the management fund.

RULE 18.—*Responsibility and Security of Officers and Members.*

Every officer, honorary member, and member, shall be personally responsible for all monies, and for such monies only, as have been actually received by him on account of this society; and the treasurer, secretary, and all other persons holding office of trust, or connected with the receipt of money, shall give such security, pursuant to 18 & 19 Vict. c. 63, s. 21., for the faithful discharge of their several duties, as the committee may direct.

RULE 19.—*Fraud, Felony &c.*

If any member shall be convicted of felony, or shall resort to any illegal or immoral practice for a livelihood, or shall be discovered to have made any false statement concerning his age, health, wages, employment, or connexion with other societies, at the time of his admission; or shall, by feigning sickness,

or by any artful or fraudulent representation, or demand, obtain or attempt to obtain any allowance, benefit, or money from this society, or shall in any way attempt to impose upon or defraud the society; he shall, upon due proof to the satisfaction of the trustees and general committee of management, at a meeting called for the purpose, be for ever excluded, and all his interest in the society shall be forfeited; he shall also repay all sums fraudulently obtained.

RULE 20.—Revision of the Society's Affairs.

The society's affairs shall be revised at the expiration of every five years by an actuary to be appointed by the committee, in order to ascertain if the assets in hand and payments expected are equal to meet the then existing engagements, and whether any alteration, either in the rules or payments, may be thought desirable.

RULE 21.—Extension of Boundaries.

At a special meeting, the committee, or a majority thereof, may alter, diminish, or extend the boundaries of each district.

SPECIAL RULES OF THE MEDICAL ATTENDANCE FUND.

RULE 1.—Claiming Medical Attendance.

Every member may apply at any time to the surgeon by whom he was certified or was last attended, according to Rule 10; but if he wishes to change his surgeon, he must first apply to the secretary for an order, which will entitle him to go to any other of the surgeons; but in case of accident or sudden illness, the patient may apply immediately to any of the surgeons, and procure the order afterwards. No person shall be entitled to medical attendance or medicine from this fund if in arrears; and no member to apply to more than one surgeon in any one quarter of a year, except in case of accident.

RULE 2.—Patients to find Bottles, &c.

Patients shall furnish themselves with bottles, &c. necessary to contain their medicines, and those whose diseases do not confine them at home are expected to attend at the houses of their respective surgeons before — o'clock in the morning.

SPECIAL RULES OF THE SICK FUND.

RULE 1.—Object of the Fund.

The object of this fund is, through the principles of mutual assurance, to furnish pay in sickness to the age of sixty; and should the fund, in the opinion of an actuary appointed by the committee, admit of it, an allowance of — will be made to those permanently disabled.

The members of this fund shall consist of miners residing in the districts of Cornwall and Devonshire, who, at the time of admission, shall have severally attained the age of fifteen and shall not have completed the age of —. The insurance of weekly pay in sickness shall also include medical attendance.

RULE 2.—Admission of Members to this Fund.

Miners ceasing to work underground, or working underground in other counties in England, may continue members on payment of — per month, the payment being made quarterly and in advance.

RULE 3.—Sick Pay until Sixty.

That no person connected with this and any other society shall make any assurance in this society, by which the united sums to be received weekly in sickness from this alone, or this and other societies, shall exceed — or by which the united sums to be received from this and other societies shall, exceed — weekly in sickness; and if any member, after his admission

shall enter any other society, contrary to this regulation, he shall forfeit all his interest in this fund.

RULE 4.—Change of Residence.

Any member changing his residence or the mine at which he works, shall inform the secretary within one month after, or be fined——.

RULE 5.—Out-Members.

Any member removing from the place where he was admitted a member, or if out of work and his name does not appear on the list of any mine, may, on payment in advance of——, per month, continue to be a member of the society on complying with the rules laid down by the general committee.

RULE 6.—Visitors.

One or more male members for each parish shall be appointed by the district agents, every month to act as visitors, the appointment being regulated by the order in which the names stand on the register. Any male member declining to act as visitor in his turn shall be fined 2s. 6d., unless he is at that time on the sick list, in which case his name shall be passed over until he is well, and the person next in rotation appointed; and should any member be unable or unwilling to officiate, he shall give notice to the secretary of his intention within three days after the delivery of his summons, and in default of so doing he shall be fined an extra 1s. They shall visit from time to time all sick and infirm members at least twice in every week, and report their condition weekly to the secretary. The visitor shall be liable to be called upon to attend meetings of the district agents during the time they are in office; and every visitor neglecting to visit and attend as aforesaid, or find another member as a substitute, shall be fined 6d. for every such omission.

RULE 7.—Pay in sickness, when due.

Pay in sickness shall become due to every member when afflicted with any sickness or infirmity as to render him unable to perform any work or to exercise his customary occupation; the pay shall commence from the date of the surgeon's certificate, countersigned by a district agent, provided always that the same be delivered to the secretary. Should the surgeon be applied to after one o'clock in the day he shall date his certificate for the following day; but no person shall claim pay for any slight accident or illness which neither confines the patient to the house, requires extra diet, nor causes him to experience pecuniary loss, nor to any member under any disease which may have been contracted by profligacy, quarrelling, or drunkenness; nor by having been engaged in any games or sports; nor during confinement in any prison under any criminal conviction; nor to any member applying for relief under the Insolvent Debtors Act, who is remanded for fraud or misconduct, during the remainder of his imprisonment; nor to any member imprisoned for debt or on account of insanity.

RULE 8.—Claiming Pay in Sickness.

Every member claiming pay in sickness shall first apply to his medical attendant. Should he deem the member entitled to pay, he shall give him a certificate, according to the form on page——, which certificate the member shall get countersigned by a district agent, and shall deliver or cause to be delivered at—— within *twenty-four* hours after date; and on receiving his pay, every member shall be supplied with a paper called the sick list; and if he continue to claim pay, the paper must be signed by his surgeon, and returned to the agent every—— afternoon at—— o'clock; but if he resume his employment, the declaration at the bottom must be signed by the surgeon and delivered to the agent; and should any member return to his work contrary to the advice of his surgeon, such member shall only be entitled to claim quarter pay for any sickness which may occur within one year from the period of his having so returned to work; or should any member return to his work before his sick list has been signed by the surgeon, he shall be considered as working during the time he was receiving pay, and subject himself to the same penalties.

Every member entitled to sick pay may receive the same on application at _____ on _____ between _____ and _____ o'clock,

RULE 9.—Pay in Sickness, how long to be continued.

The payments in case of sickness to be made in full for *twenty-six* successive weeks; *half the amount* for the next *twenty-six* weeks; and if the sickness shall continue, the member shall be reduced to *quarter pay*; and when any member has had *full pay* for a less period than *twenty-six weeks*, or *half-pay* for a less period than *twenty-six weeks*, he shall not be allowed to begin his full or half-pay over again on the renewal of sickness, until he shall have ceased to receive any pay whatever on account of sickness for *six calendar months*, and returned to his usual employment, or some other by which he shall gain a livelihood; but if he fall ill within that time, he shall be placed in the same situation as when he ceased to receive any relief, and shall receive such relief, and no other, as he would have received had no cessation of his sickness occurred.

RULE 10.—Suspension of pay in Sickness.

Every allowance in sickness shall be forthwith suspended if the member demanding the same shall refuse to be seen by the surgeon or visitor, or by any other person duly authorized by the committee, at the time of their respective attendances, or to answer such questions respecting his health or employment as they may severally deem it necessary to ask; or shall by any wilful act or misconduct delay or prevent the recovery of his health; or shall not remain constantly within the house of his abode between the hours of sunset and sunrise, or shall quit his house at any time without leaving word where he is gone, and when he is likely to return, or for more than one day, without delivering to the secretary a certificate, signed by the surgeon in attendance, specifying the place to which such member is going, together with the time he is likely to return, and further stating that such absence from his residence is not likely to prove injurious to his health. And every suspension of pay in sickness shall continue in full force until the member so suspended shall be restored to his privileges by order of the committee. But if any member shall drink or gamble or visit any public-house, or any of the premises appertaining thereto, at the time he is receiving pay, he shall not only have his pay suspended, but shall be fined 5s. for the first offence, 10s. for the second, and expelled for the third; and if any member shall do, superintend, take orders for, fetch or carry home any work, or exercise in any manner his customary occupation, or execute work of any description whatsoever, at the time he is receiving pay, without the consent of the committee, he shall not only be suspended, but shall be fined such sum not exceeding 5*l.*, as the committee, when specially summoned for the purpose, shall determine; and if three-fourths of the committee shall agree, he shall be expelled.

RULE 11.—Leaving the Kingdom.

Any member going beyond the limits of the United Kingdom, shall forfeit all claim to any assurance in this fund. Annuities and payments on deaths guaranteed by the Government may be contracted for by any member. The terms and conditions may be obtained of the secretary or of any of the agents.

TO THE RIGHT HON. LORD KINNAIRD.

MY LORD,

Guardian Assurance Office,
11, Lombard Street, 25 May, 1864.

I have carefully examined the various documents and the minutes of evidence with which you favoured me, with the view of ascertaining how a fund could be established for the relief of miners during sickness, and for a small provision for their widows and families at their death. The tables furnished by Dr. Farr as to the mortality amongst different classes of miners or in the mining districts afford the most complete comparison not only of the mortality, but of the kind of diseases to which miners are subject. They form, perhaps the most valuable collection of the vital statistics relating to a particular occupation which has ever been brought together.

From the life table which is given for each of the mining districts "Cornish," "Staffordshire," "Durham and Northumberland," and "Merthyr Tydfil," the single or annual premium for a sum at death or for a weekly allowance in permanent superannuation might be computed for every age and for each class of miners. But confining my inquiries to the Cornish Districts, I find the single and annual premium for 100*l.* at death already computed for every age from 20 to 79 inclusive.

With regard to sickness I do not find in the evidence any direct original observations as to duration or frequency of attacks compared with the number of miners liable at any age, which would enable the true values of sick allowances to be computed. But there is a table showing in each of the mining districts the number constantly sick or infirm compared with the annual rate of mortality per cent. and which for the Cornish districts as compared with England and Wales is as follows:—

Ages.	Deaths and Years of Sickness to 100 living.			
	Cornish Miners.		In England and Wales.	
	Deaths.	Years of Sickness.	Deaths.	Years of Sickness.
20 and upwards	2·87	8·61	2·54	7·62
20-40	·99	2·97	1·02	3·06
40-60	3·28	9·84	1·97	5·91
60-80	9·74	29·22	6·18	18·54
80 and upwards	28·57	85·71	20·03	60·09

This table proceeds on the assumption that on the average there are at each age three constantly sick or infirm persons for every annual death, an estimate which it is stated corresponds with several observations. Taking the experience of Friendly Societies in general, I should consider this to be a safe limit, since the result of some computations I recently made was to show about 2½ years of pure sickness for each death and the difference may be assumed to be more than sufficient to cover the additional time for infirmity or old age.

But as the question is an important one, it may be well to compare the sickness amongst miners obtained from actual observations. In the returns of Friendly Societies for the 5 years ending 31st December 1850, made to the Registrar, which were analysed in Mr. A. G. Finlaison's Report, printed by order of the House of Commons in 1853, separate abstracts are given for "colliers," a "mixed class of miners and colliers," and "metal miners." But the numbers are not stated, and of the metal miners the results are given only at each fifth year of age, and not averaged. In the number sick out of 100 living, the colliers exhibit the maximum liability to attack, but

differ very little at all ages 20 to 50. This may, perhaps, be the result of "accidents," which of course may not be expected to depend on the age. In the number of days of sickness per annum to each person living the result is heavy throughout; but especially amongst the metal miners. In days of sickness per annum to each person sick, the liability of colliers was greater than the average; but the amount of sickness less. Amongst metal miners both the liability and duration of sickness exceed the average of the country generally, hence the rate of sickness shown is very high. In all these tables the observations have been confined as much as possible to pure sickness, and all cases of permanent disability or irrecoverable sickness excluded.

In the following table is compared the mortality and number of days' sickness per annum in the aggregate of the mining districts for the years 1860-2 amongst 100 miners living, and amongst "miners and colliers," according to the returns of friendly societies for this class in the 5 years ending 31st December 1850, the last authentic returns on a large scale.

Farr, 1860-2.			Friendly Societies, 1846 to 1850. Miners and Colliers.		
Ages.	In the aggregate of the Mining Districts.		Mortality per Cent.	Days of Sickness in a Year to 100 living.	Years of Sickness to each Death.
	Mortality per Cent.	Days of Sick- ness in a Year to 100 living.			
	(1)	(2)	(3)	(4)	(5)
15-25	1·015	1,111	·934	954	2·80
25-35	1·068	1,169	·991	981	2·71
35-45	1·391	1,523	1·123	1,224	2·99
45-55	2·178	2,385	1·689	1,946	3·16
55-65	4·712	5,160	4·016	2,697	1·84
65-75	9·833	10,767	5·792	4,940	2·34
75-85	21·318	23,343	10·129	10,372	2·81

By comparing columns (2) and (4) we shall notice that at every age there is an ample margin, increasing with the age, for infirmity and permanent sickness, and in col. (5) that the assumption of 3 years of sickness to every death is only slightly exceeded between the ages 45-55, leaving at all the other ages a safe limit for the operations of a sick fund.

It may be further observed that mortality from accidents is understood to be included in the deaths given in Dr. Farr's table, and, as it is reasonable to conclude, that on the average the duration of disability from accident is less than that from ordinary sickness, or that it would sooner terminate in death, there is additional reason to think that the table errs on the safe side.

Admitting the assumption then, we can easily frame from Dr. Farr's table of annual premiums for 100*l.* at death, the monthly premiums for 10*s.* a week during sickness. If 3 years of sickness count for every death, then 1*l.* a week for each of those years will be equivalent to 52*l.* \times 3 = 156*l.* for every death, or 10*s.* a week = 78*l.* Therefore the annual premium for 78*l.* divided by 13 months = 6*l.* at death will be equivalent to the monthly premium for 10*s.* a week in sickness or infirmity. Some slight allowance might be made for the difference in the rate of interest between the same premiums being paid yearly or by 13 monthly instalments, but in a calculation of this nature it would be refining too much to attempt it. By this method I have deduced the following table A., showing for the Cornish miners the annual premium for 1*l.* at death, and the monthly premium for 10*s.* a week during sickness or infirmity.

TABLE A.—SHOWING the ANNUAL PREMIUM for 1*l.* at Death and the Monthly Premium for 10*s.* a Week in Sickness or Infirmity.

Age.	Annual Premium for 1 <i>l.</i> at Death.	Monthly Premium for 10 <i>s.</i> a Week in Sickness.	Age.	Annual Premium for 1 <i>l.</i> at Death.	Monthly Premium for 10 <i>s.</i> a Week in Sickness.
	£	£		£	£
20	·01875	·11250	50	·05983	·35898
21	·01929	·11574	51	·06246	·37476
22	·01983	·11898	52	·06508	·39048
23	·02038	·12228	53	·06775	·40650
24	·02096	·12576	54	·07046	·42276
25	·02158	·12948	55	·07325	·43950
26	·02225	·13350	56	·07617	·45702
27	·02300	·13800	57	·07921	·47526
28	·02375	·14250	58	·08242	·49452
29	·02458	·14748	59	·08575	·51450
30	·02550	·15300	60	·08933	·53598
31	·02646	·15876	61	·09313	·55878
32	·02746	·16476	62	·09717	·58302
33	·02858	·17148	63	·10150	·60900
34	·02975	·17850	64	·10613	·63678
35	·03100	·18600	65	·11108	·66648
36	·03233	·19398	66	·11638	·69828
37	·03375	·20250	67	·12204	·73224
38	·03526	·21150	68	·12813	·76878
39	·03679	·22074	69	·13463	·80778
40	·03846	·23076	70	·14154	·84924
41	·04021	·24126	71	·14896	·89376
42	·04204	·25224	72	·15688	·94098
43	·04396	·26376	73	·16521	·99126
44	·04600	·27600	74	·17413	1·04478
45	·04808	·28848	75	·18354	1·10124
46	·05025	·30150	76	·19350	1·16100
47	·05250	·31500	77	·20408	1·22448
48	·05488	·32928	78	·21525	1·29150
49	·05729	·34374	79	·22692	1·36152

Having been favoured with a summary of the number of miners in the Cornish Districts living in each quinquennial period of age amounting in all to 17,037, I have computed from the foregoing table the following estimate of the annual payments that would be required to provide every one in sickness (including accidents) with 10*s.* or 7*s.* a week, as may be finally decided, and 10*l.* at death. Between the ages 5 and 10 there is only 1 living, and the ages from 5 to 25 have been grouped together and taken at the mean age of 20, and the rest at the mean of each quinquennial age. (See Table, p. 11.)

Thus for the whole number of 17,037 Cornish miners, the annual premiums to provide 10*s.* a week in sickness would be 39,220*l.*; or, for 7*s.* a week in sickness, 27,453*l.*; and for 10*l.* at death 5,033*l.*

Assuming, as Dr. Farr considers, that 4*d.* or 5*d.* a month=5*s.* 5*d.* a year from each miner would suffice to provide medical attendance in sickness or accidents, the total so raised would be 17,037 × 271=4617·1*l.* divisible amongst the doctors who might be appointed on the list of the Benefit Fund, and there would still remain 4*d.* a month or 4*s.* 4*d.* a year from each miner for the General Fund.

If the profits on candles and gunpowder be admitted to form the basis of a provident fund, it seems from the previous calculations that there would be

Ages.	Number of Miners.	Total Monthly Premiums for 10s. a Week Sick Pay.	Total Monthly Premiums for 7s. a Week Sick Pay.	Total Annual Premiums for 10l. at Death.
		£	£	£
10-25	8,007	900·8	630·6	1505·3
25-30	2,412	332·9	233·0	554·8
30-35	1,672	275·9	193·1	459·8
35-40	1,477	299·8	209·9	499·2
40-45	1,210	804·9	213·4	509·4
45-50	931	293·3	205·3	488·8
50-55	711	277·3	194·1	462·2
55-60	378	179·6	125·7	299·4
60-65	173	100·9	70·6	168·2
65-70	55	40·3	28·2	67·2
70-75	8	7·5	5·3	12·5
75-80	3	3·7	2·6	6·1
		3016·9 x 13	2111·8 x 13	
	17,037	39219·7	27453·4	5032·9

sufficient to allow of sick pay of 7s. a week and a further sum of 10l. at death for the benefit of widows and children, besides a monthly contribution of 5d. from every miner for medical attendance in sickness or accidents without requiring any further resources. The difference between the estimates, which is but little more than 1,000l. would, I think, be fully met by the safe margin for contingencies within which the computations have been made,

LIABILITIES.

Value of sick pay for 17,037 miners at 7s. a week	- - - -	£ 27,453
Value of 10l. at death of ditto	- - - -	5,033
Medical attendance for do. 5d. per month from each	- - - -	4,617
Total	- - - -	<u>37,103</u>

RECEIPTS.

Cornish mines; profits on candles and gunpowder	- - - -	24,882
Club money for sum at death, 9d. per month from each=9s. 9d. per year	- - - -	7,454
Difference of present charge for medical attendance 4d. per month, from each=4s. 4d. a year	- - - -	3,691
	- - - -	<u>36,027</u>
Difference	- - - -	<u>1,07</u>

The lords of the minerals and the employers of labour or adventurers would naturally be expected to supplement this fund, as they would be relieved from the support of men disabled permanently or for a term from accident; but this I have not taken into account. The above calculations are all based on a rate of sickness depending upon the present ratio of mortality.

The effect of this provident fund, and of the various improvements to be suggested in the actual working of the mines, would no doubt be to diminish the rates both of mortality and sickness. The care and comforts and relief of mind that would be obtained could not but have a beneficial effect on the health of the miners; and as our tables of sickness are based upon the deaths, both

branches of the fund would gain, and by degrees the allowances might be increased.

It would also be to the interest of the miners themselves to see that all cases were excluded from relief that were not strictly sickness or infirmity, since the savings might be employed either to add to the benefits, or to form a fund for what cannot but be considered a great boon, namely, a permanent allowance in advanced age.

As all the surplus over the benefits actually paid away should be improved at interest, it would be very desirable that trustees should be appointed having some knowledge of investments and aware of the great importance of looking to the future as well as to watch the changes which the nature of the fund would probably effect in the condition of the mining population.

I have, &c.
SAMUEL BROWN.

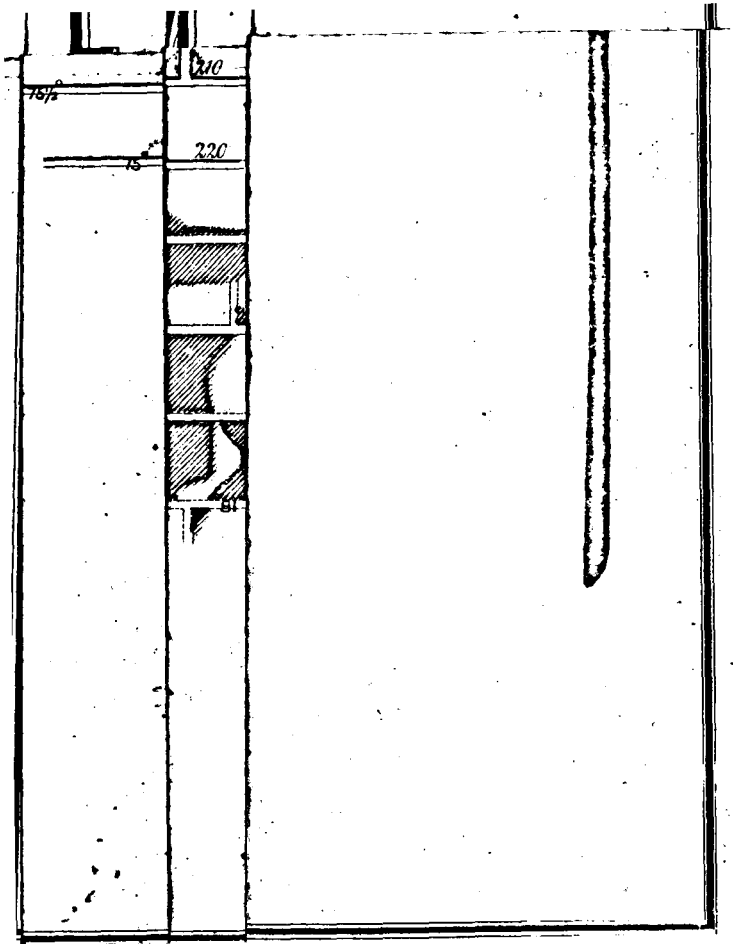

DOLCOATH MINE

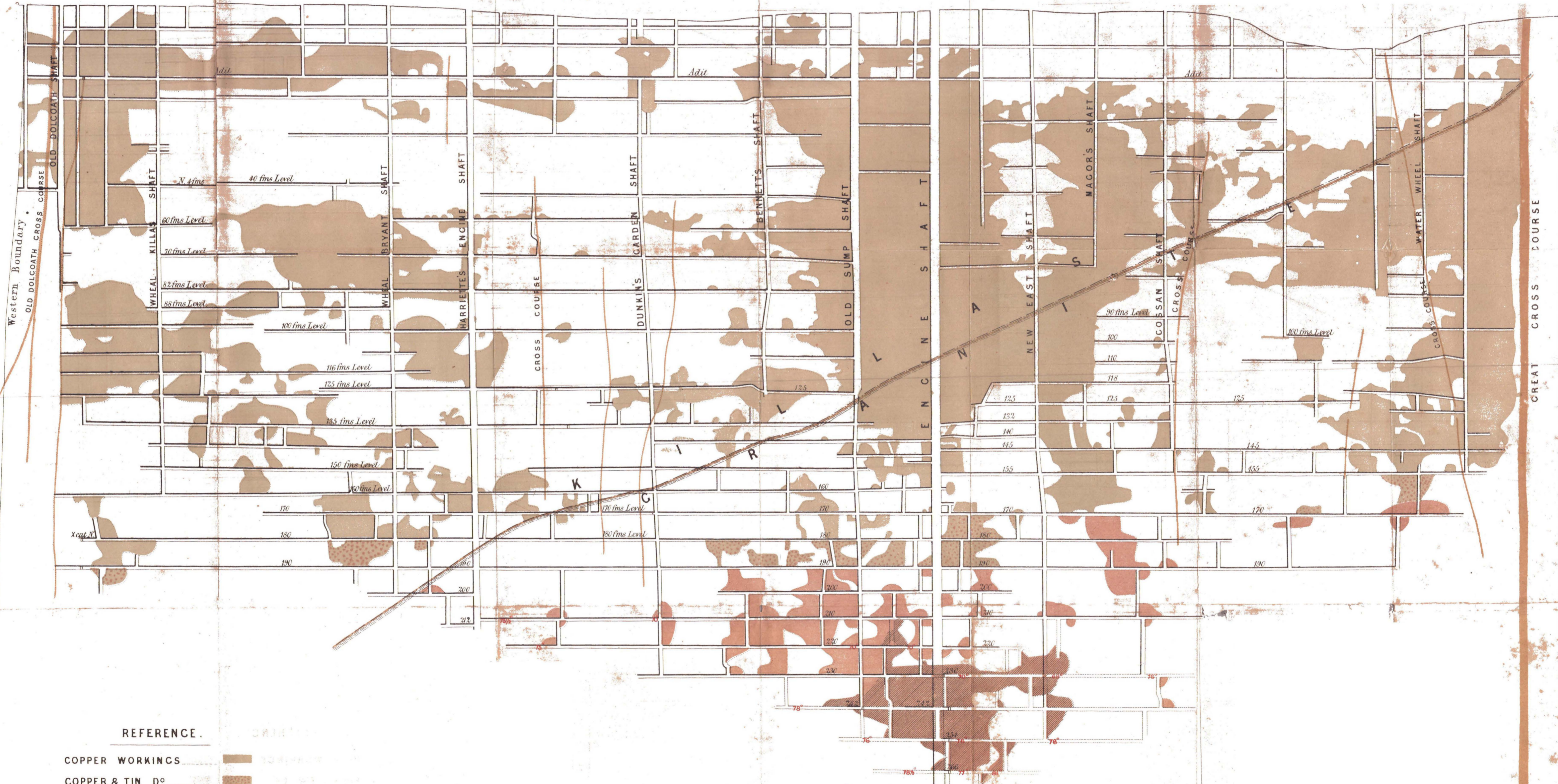

REFERENCE.

- COPPER WORKINGS
- COPPER & TIN D^o
- TIN D^o
- WORKINGS ON THE LODGE ON A DIFFERENT PLANE

The figures in Red indicate the Temperature at the various Levels and Ends.

SCALE

24 Fathoms to an Inch.

W.C. Lead Mines, Westdale.

Gurtree Pasture Mine.

Ventilating Furnace at Top of Middlehope Day Rise with Dwelling House for Attendant

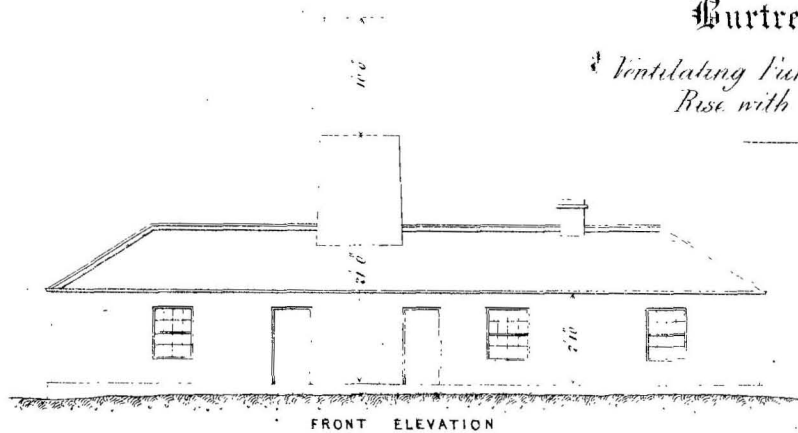

FRONT ELEVATION

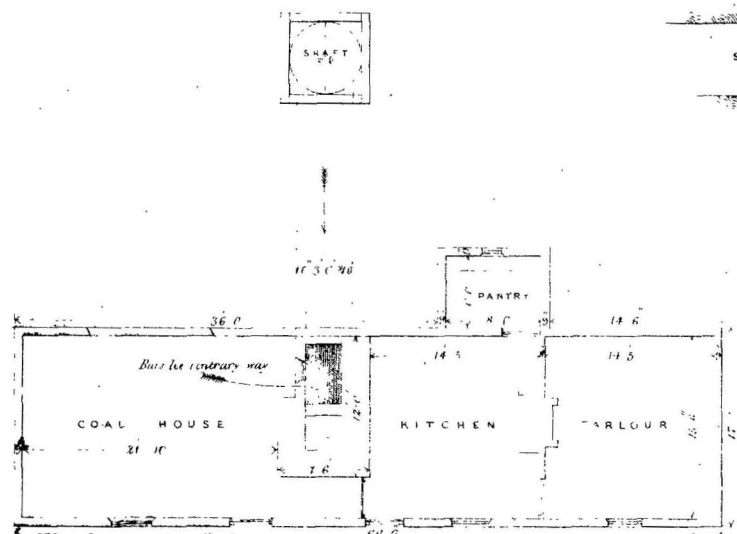

GROUND PLAN
Scale 16 feet to an Inch

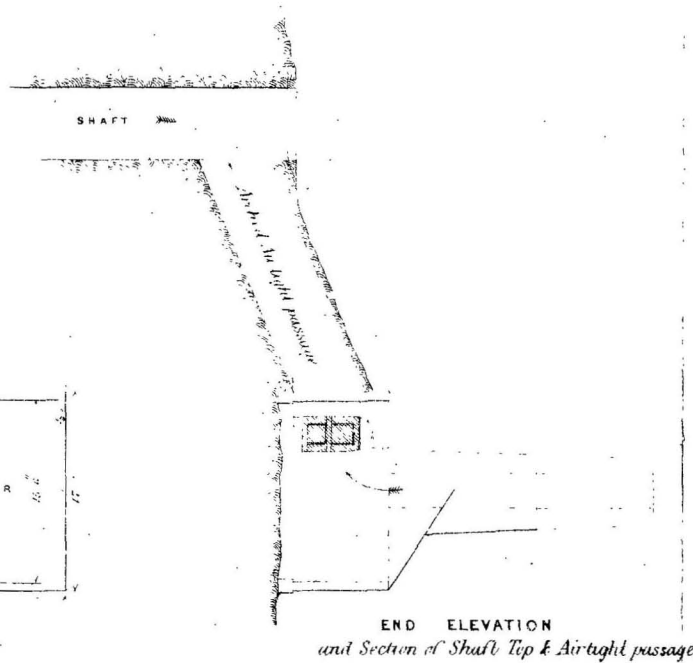

END ELEVATION
and Section of Shaft Top & Airtight passage

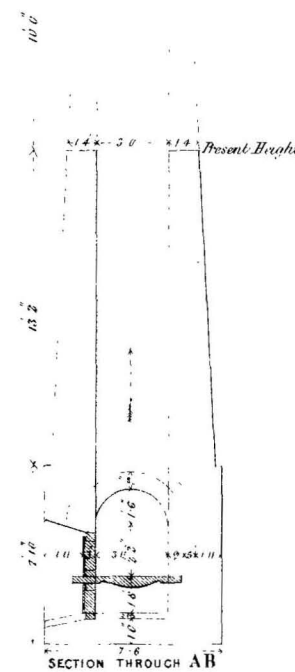

SECTION THROUGH AB

Scale 8 feet to an Inch

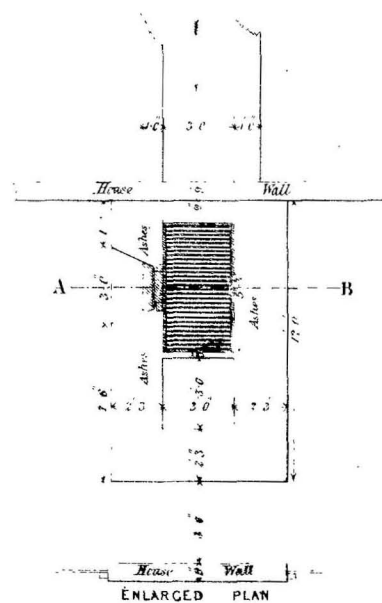

ENLARGED PLAN

J.C.
Jan 21st 1863.

W.B. Lead Mines, Weardale,
Burtree Pasture Mine.

*Ventilating Furnace at Top of Middlehope Day
 Rise with Dwelling House for Attendant.*

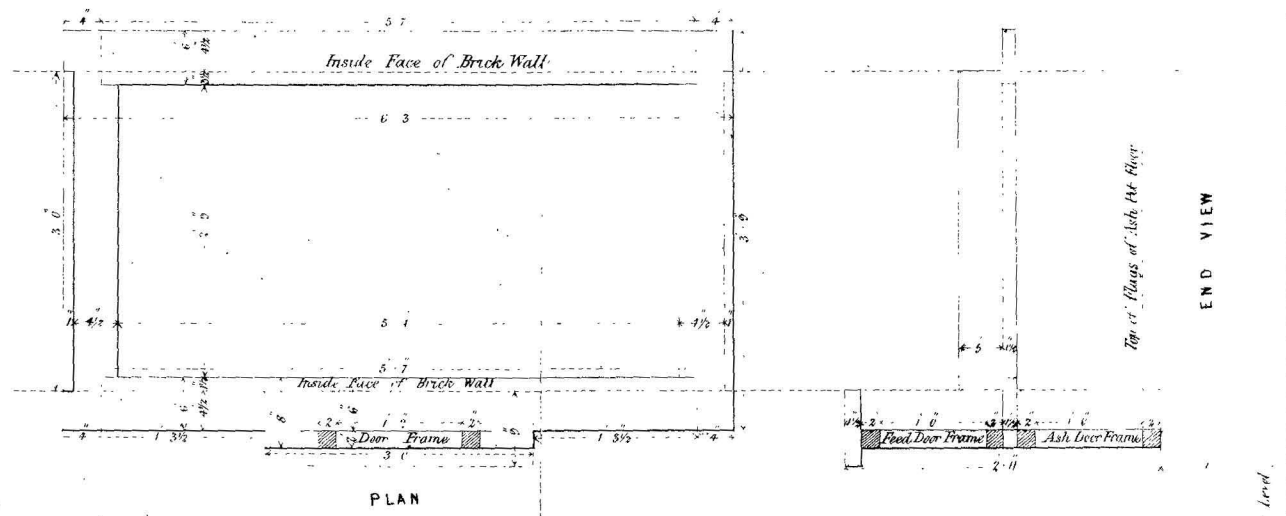
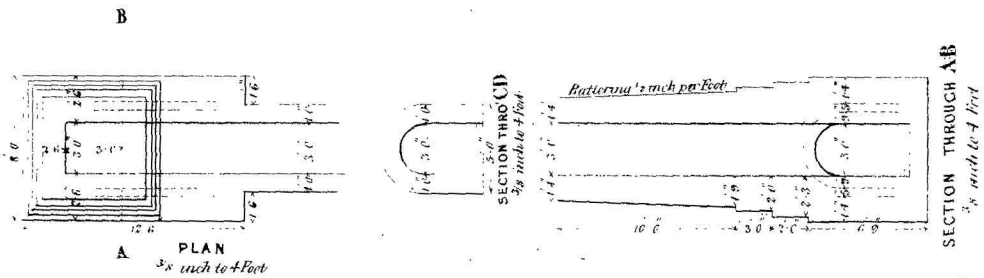
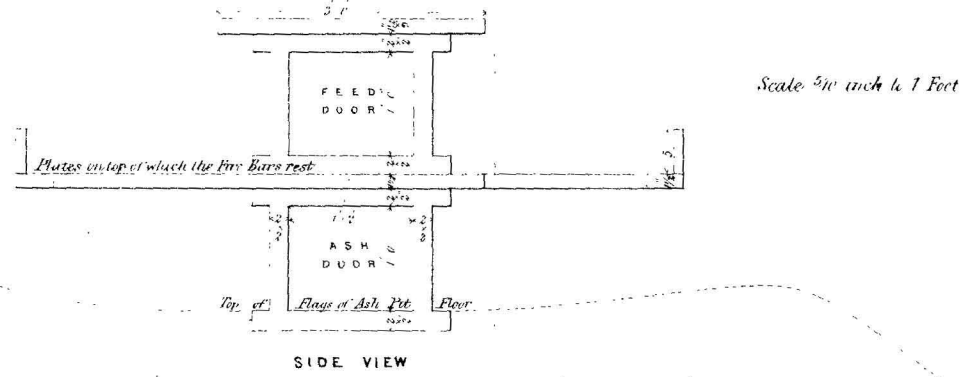
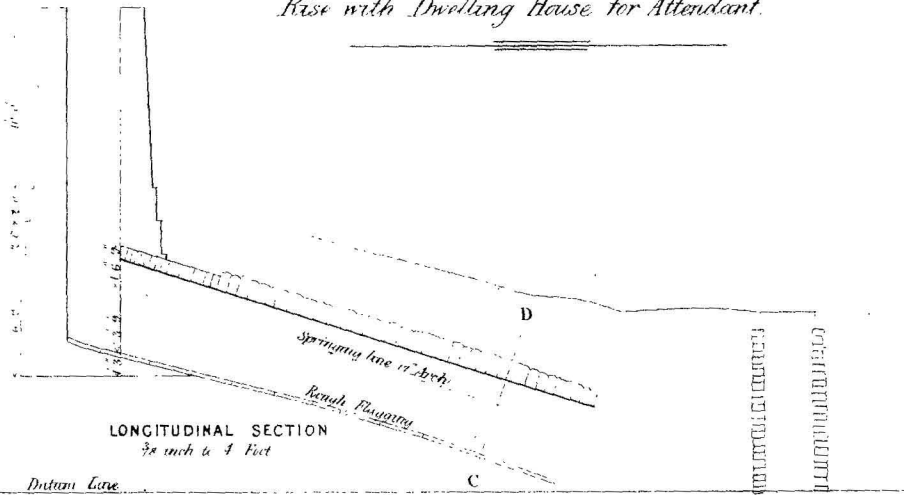

FURNACE AT PLANTATION SHAFT TOP
 Scale $\frac{3}{8}$ inch to 8 Feet
 1861.

WILLIAMS'S WATER JET AIR MACHINE .

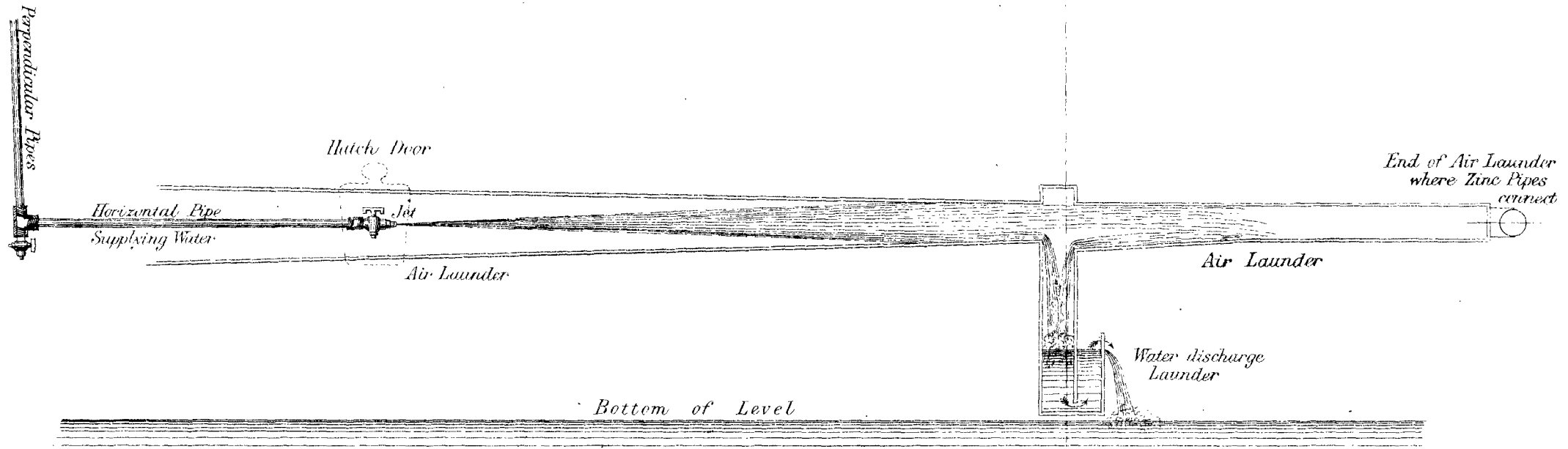

Scale 2 Feet to 1 Inch .

PLAN OF BORING MACHINE.

Scale $\frac{1}{2}$ inch to 1 foot.

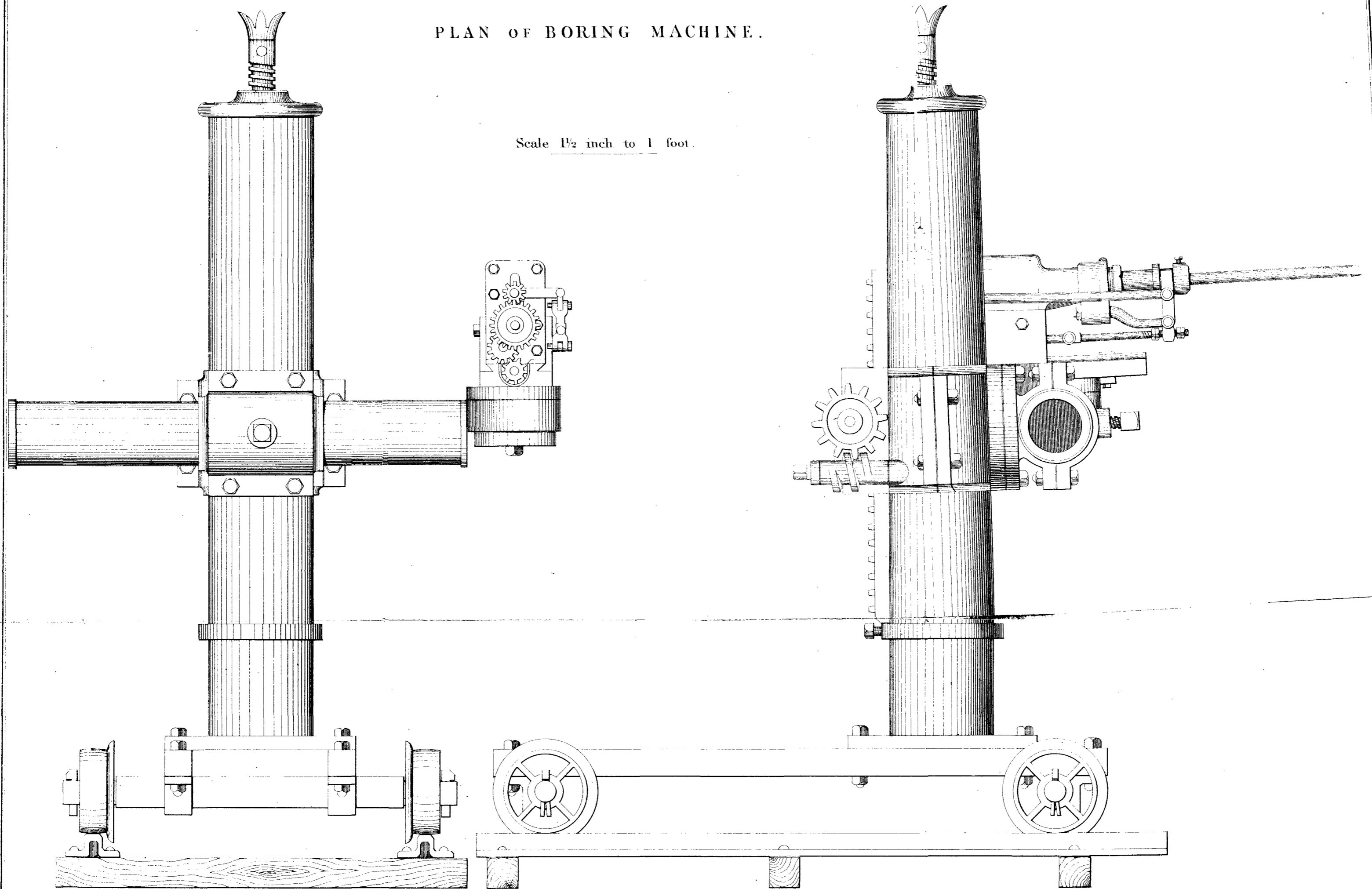

Drawn by A. J. Bridge

Day & Son, Litho to the Queen

PLAN OF BORING MACHINE

- 1 Section
- 2 Side Elevation
- 3 Back Elevation

Scale 3 inches to 1 foot.

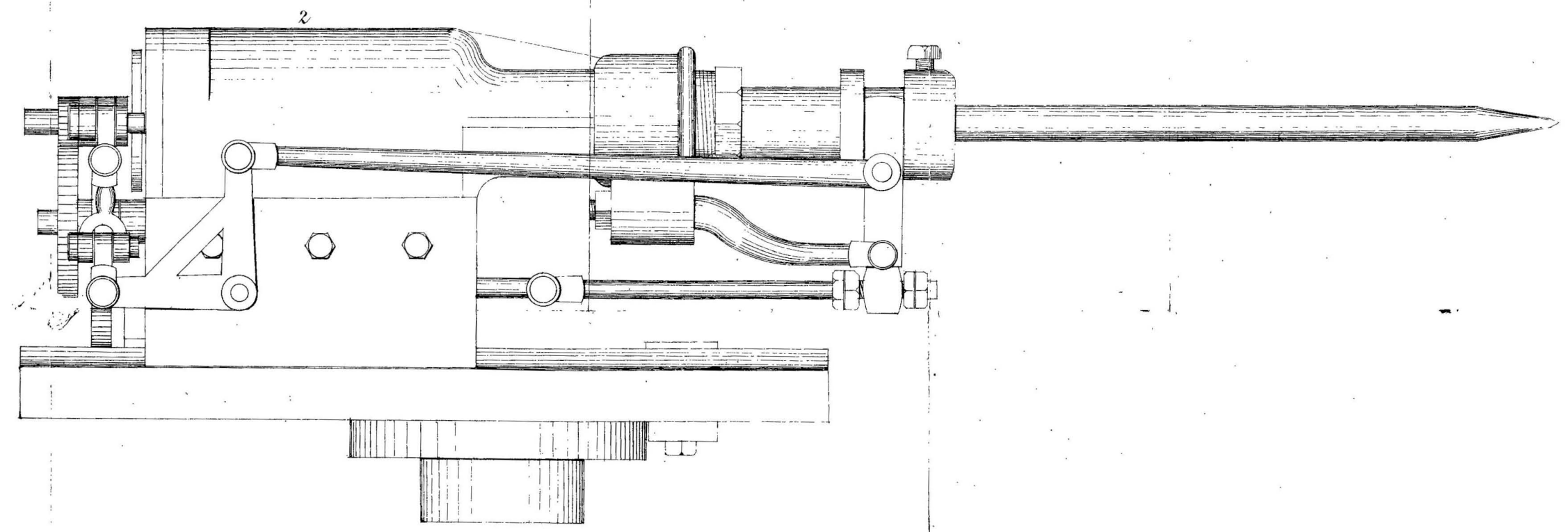
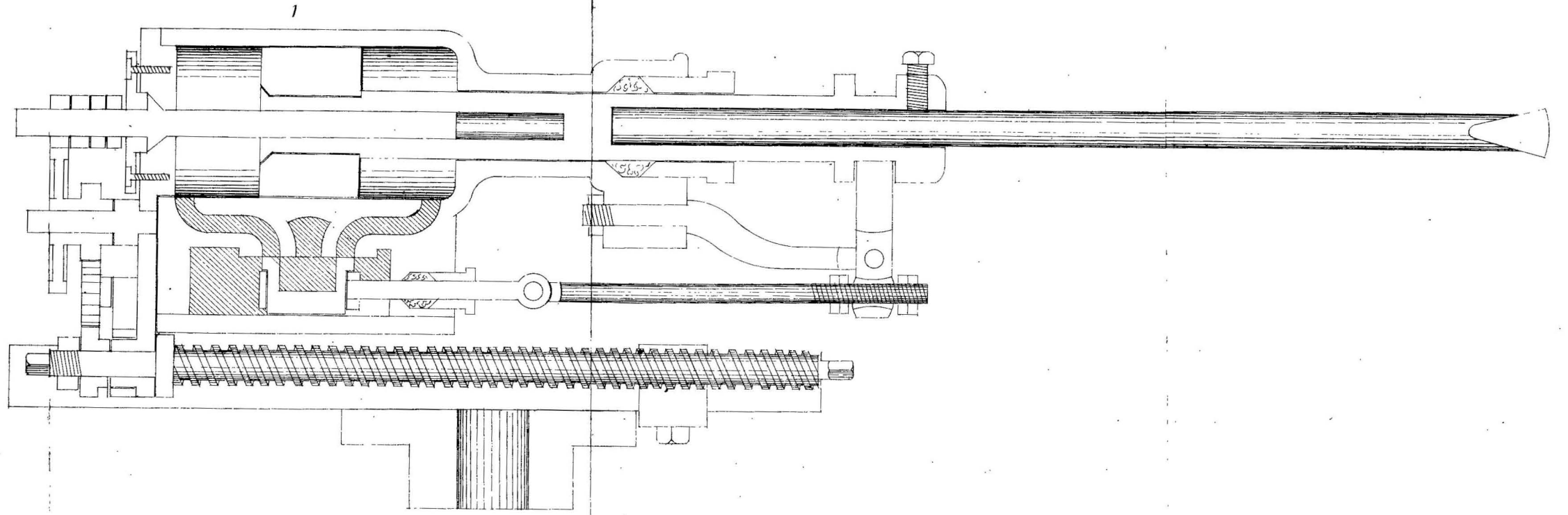
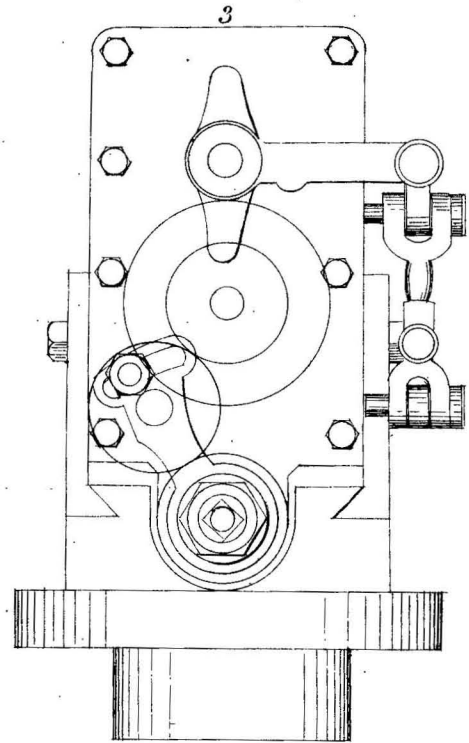

Drawn by A. J. Bridge

EVIDENCE DESCRIBING BORING MACHINES,

Mr. GEORGE GREEN, of the Cambrian Foundry, Aberystwith, examined.

22,010. (*Chairman.*) You are an engineer?—I am.

22,011. You have turned your attention to the manufacture of a machine for boring, have you not?—I have.

22,012. And you have manufactured one which you think is likely to answer the purposes?—I have.

22,013. Have you arranged with Mr. Crease, with respect to the one that was patented by him?—I have made a mutual agreement with him.

22,014. You saw his machine working, did you not?—Yes.

22,015. Before you set to work to make this machine, were you practically at work in a mine?—I was at the commencement of the working of Mr. Crease's machine, and I remained with it for three weeks.

22,016. Have you yourself in the levels ever used the borer?—Yes; I can refer you to the proprietors of the mine, who will state the part which I took there.

22,017. Which is the mine?—The Clogau. (See question 22,016.)

22,018. Have you considered every point which was requisite, in order to produce a machine as a substitute for the labour of beating the borer?—Fully.

22,019. And you think that the one which you have manufactured is so complete that it could be used for the purpose?—I fully believe it.

22,020. Will you state shortly the plan which you have adopted?—In the first place the object in constructing the machine has been merely to operate upon the rock in the same way as is now being done by hand, which is by boring and blasting; the machine has been constructed for that purpose, with a view to enable the men to bore the holes in every position which could be done by hand labour, which was a point of vital importance to the success of the machine. The result as you have seen is that we can bore holes in all positions and with facility. There is no difficulty in changing the position of the borer any more than there would be in changing the position of a borer worked by hand. Then the result of boring the holes is, that we can work upon the average rock at the rate of $1\frac{1}{2}$ inch per minute; we have tried it numbers of times. The machine is worked either by steam or by air, but air will be for many reasons the best mode of working it for levels, especially lower ones.

22,021. You mean then that it would require a machine to compress the air?—It would require a machine to compress the air or exhaust it; but, I think, that in working in shafts the driving of the machine itself by steam would be the preferable mode, because the up-draught will carry away the steam, and steam is more effectual than air, because by the transit of air through tubes there is a great loss of power by friction and other causes.

22,022. How is the machine to be fixed in a level, and how is it to be fixed when working in a shaft?—In the level it is run upon rails the same as an ordinary train waggon up to the end, and it is fixed by a screw similar to a screw-jack fitted on the top of the pillar of the machine which is screwed against a block placed on the top of the level, and a wedge is placed under the front axle to take off the strain caused by tightening the screw from the axle and the rail. In a shaft it will be suspended and worked by tackle, and fastened in a similar way; one end will rest against one side of the shaft and it will be pinched by a screw against the other.

22,023. How would you lower it?—By tackle, the same as any other weight would be lifted; of course it would require a convenient mode of raising it, a powerful crabwinch will answer the purpose, which may be worked by water or steam power, just as they may have it at the surface.

22,024. How is the power conveyed to the instrument?—It is conveyed by tubes, in the first instance, of wrought iron—galvanised iron, I think, would be the most suitable material—and it is then annexed to the machine itself by an elastic tube made of india-rubber and canvas.

22,025. What pressure will it stand?—We have had 60 lbs. pressure on the present one, with 3 ply, but we can have four.

22,026. How is tube made?—Of 3 ply, so many thicknesses of canvas inlaid with india-rubber; three thicknesses of canvas and layers of india-rubber between each thickness. It is now extensively used.

22,027. What pressure do you require for the machine?—15 lbs.

22,028. How would you manage to convey the power along different levels and angles?—Exactly in the same way; there would be a main pipe descending into the shaft or along the level, in which branches would be made the same as in gas and water works.

22,029. Have you any idea to what length it could be carried in a gutta-percha pipe?—In a gutta-percha pipe I should think they could carry it 300 or 400 fathoms without any doubt, but I do not see why there should be any limit to it.

22,030. Except the friction, I suppose?—Except the friction which will cause a loss of power, especially if it is a small tube, but with a larger tube I think that the air can be conveyed to any required distance.

22,031. It would be possible, I suppose, if you had the motive power sufficient, to drive three, four, or six of these machines in different levels?—Yes, or a dozen, with the same air compressor at the surface.

22,032. What amount of work do you think could be done in a day?—The calculation which I have made is from this basis: first, I have ascertained that through the average rock of this country we can work with ease at the rate of $1\frac{1}{2}$ inch per minute, I therefore calculate that we can get, allowing for all contingencies, at least a hole of $2\frac{1}{2}$ feet bored every hour; from that I take it that 24 holes of $2\frac{1}{2}$ feet deep will take out of the end of any rock on the average, allowing for contingencies, 2 feet of ground in the 24 hours. I am quite certain of it that it is in an end 7 feet by 5.

22,033. (*Mr. Kendall.*) What is the weight of your machine?—About 15 cwt.

22,034. How many men will it take to fix it?—One man is plenty.

22,035. When once it is on the rail, if it is in an adit, he can fix it, and if it is in a shaft suspended one man can fix it?—Yes.

22,036. He has power enough over the screw to fix it?—Yes.

22,037. What is the comparative rate of blows and of rapidity, as regards the blow given by this machine and the blow given by a man?—It has been attempted to give a blow something like what is struck by a man; for this reason, the blows which the men strike are so slow that they must strike a heavier blow to get any despatch with their work. The result of that is, that they break their tools oftener, and we have aimed to get a lighter blow to save the tool. The average number of blows by hard labour is about 12 to 15, by machine 400 to 500.

22,038. Is it very much lighter?—Not much; but it is a lighter blow.

22,039. Do your tools break at all?—We have not found them break except in very hard rock.

22,040. In what kind of rock have you ever tried it?—I have tried it upon the flint stone which you see in the yard, and I have tried it in the end, at the Clogau mine, which is very hard rock indeed.

22,441. What rock is it?—It is not quartz; it is a mixture of clay-slate and green-stone, intermixed with a great deal of sulphur.

22,042. How many inches did you bore there?—Two inches in a minute.

22,043. What did the men get per fathom in that ground?—I believe they had 8l.

22,044. How high was the end?—7 feet.

22,045. By how much?—By 5 feet. We there worked 2 inches in a minute.

22,046. You have gone about an inch into the flint stone, which is in the yard?—I was merely trying the machine. I did not time it at all.

22,047. From what you did what do you fancy you could do in a hard flint rock?—In a rock of that description, I should think you would not get more probably than from three-eighths to half an inch a minute.

22,048. Do you think that you could do half an inch?—I think so; but I should not like to answer the question positively.

22,049. Are you sure of a quarter of an inch?—I am.

22,050. How much space must you have to work that machine in? How high and wide must the level be?—We could make a machine to suit the width of the level. That is made to drive a level of 7 feet by 5.

22,051. Could you make an effective machine to go in a level where there are places of not more than $2\frac{1}{2}$ feet wide to drag it through?—It would be difficult to do it.

22,052. Take 3 feet wide?—In 3 feet wide it could be done; but that system of levels is now being abandoned; they find it very inconvenient to work those levels. It can be taken into a level of 2 feet in width and fixed in the end.

22,053. You can take it to pieces and carry it in?—Yes.

22,054. What distance have you ever carried the tube?—At the Clogau mine it was driven by steam. We have had it 50 to 60 feet.

22,055. What is the relative cost of the tube and the iron pipe?—The cost of a galvanized tube would probably be about 1s. 6d. to 2s. per foot, according to the size and the length. We paid 1s. 3d. for the present tube that we have.

22,056. How long do you think that that would last?—It is difficult to say. It all depends upon the manner in which it is used. Of course it could be cut; but I do not see any end to the wear of it.

22,057. Which is the most expensive of the two; the iron or the india-rubber tube?—The iron will be the least expensive. We have only used the tube at the end on account of its elasticity.

22,058. The iron is cheaper than the tube?—I do not know that it is cheaper; but in the long run it would be less liable to damage laid at the bottom of the level.

22,059. Then you would recommend using iron as far as you could?—Yes.

22,060. In a hole which is vertical, does the instrument free itself from the stuff?—Yes, completely; either vertical or inclined.

22,061. Water is used in every case?—Water is necessary in all cases where the hole inclines down.

22,062. How do you use the water where you have to bore a hole above you?—It clears itself; these holes generally have an inclination downwards, and the rapid motion of the machine causes it to run out dry.

22,063. Horizontally, how do you manage with regard to freeing the stuff?—We have no difficulty with it, because we always find that a hole inclined a little upwards or downwards answers the purpose of a horizontal hole.

22,064. There are instances where you will require horizontal holes in mines?—Perhaps one in a hundred; then we can draw the instrument out and clean it.

22,065. Can that be done without much delay?—Yes.

22,066. When you use water how do you apply it by your machine?—It will be put into a can containing probably about a gallon, and there will be a small elastic tube with a tap and jet.

22,067. Will the motion of the instrument give the necessary supply of water from this little reservoir, or must a man apply it?—It must be placed high enough, so that it will always feed itself.

22,068. What would be the cost of this engine?—A machine similar to this one, I think, can be made for something like 90*l*.

22,069. What does that include?—That is the machine only. With the air pump and the power to drive the air pump for one machine, it could be altogether produced for 250*l*.; that is the outside. I have no doubt that it would be very considerably less than that.

22,070. A great deal of that must depend upon the distance from the end where you erected your steam boiler?—After the first 100 yards there would have to be added to that the cost of the pipes.

22,071. If any person buys your machine, will he have the full power of working it without paying you for any patent rights?—That is a question which must depend upon the arrangements between the patentee, namely Mr. Crease, and myself.

22,072. (*Mr. Holland.*) What would you describe the machine itself to be?—A boring machine, for boring in rock.

22,073. In the nature of a steam hammer?—Yes.

22,074. It is essentially a steam hammer?—Yes.

22,075. Of what diameter is the cylinder?—4½ inches.

22,076. Of what stroke?—4 inches.

22,077. How many strokes a minute do you reckon to work?—About 500.

22,078. How do you propose to effect the turning of the tool by which the strokes are given?—The piston is bored, in the inside through the piston and up the rod, and it slides upon a steel rod with a groove placed the length of the stroke; a fast key is then put into the piston, which slides on a groove; it is turned round by a ratchet wheel fixed to the spindle outside the cylinder cover in which it is fitted, and turns steam tight.

22,079. In fact it is just like an ordinary high-pressure steam engine?—Exactly.

22,080. With what range of pressure do you like to work?—20 lbs. is ample; it gives a reserve power.

22,081. Of about what cost would an air pump be, to supply the compressed air; what would be the extra cost of it?—About 75*l*. would be ample.

22,082. Then if a mine had the power of any sort, 75*l*. and the cost of the machine, and the cost of the pipes, would be the whole outlay, would it not?—Yes.

The witness withdrew.

SPECIFICATION FOR BOILER AND PIPES FOR A CHANGING HOUSE, SUGGESTED BY LORD KINNAIRD.

Furnace.—The furnace to be placed under the floor which is to be made fire-proof by thick arches. The furnace bars to be 2 feet 6 inches long, with 9-inch dumb plate and sliding door, built round with fire bricks, and having a fire-brick flue connecting the pipe flues.

Boiler.—A high pressure malleable iron boiler 3 feet long, 2 feet wide, and 1 foot deep, provided with brass connections for pipes to be placed over furnace.

Flues.—The pipe flues carried round the walls of "dry" to be of iron, 9 inches diameter. The outer flue enclosing the first two lengths of the 9-inch flue to be 15 inches diameter and pierced with $\frac{3}{4}$ -inch holes as shewn. Air to be admitted from the outside of building into the 15-inch flue by an iron pipe 6 inches diameter, having a damper to regulate the supply. The flues to be protected by open brickwork.

The dimensions given are inside measure.

Cisterns.—There will be 2 cisterns, each 6 feet long, 4 feet wide, and 4 feet deep, made of $1\frac{1}{2}$ inch wood and lined with 7 lbs. lead. The one for hot water to be placed over the roof, and the one for cold water in the roof over the lavatorium; both to be provided with the necessary ballcocks and supply pipe.

Pipes.—The cisterns to get overflow pipes of 7 lbs. lead, $2\frac{1}{2}$ inches diameter.

The pipes from hot cistern to boiler and back to be 1-inch bore or lead weighing 12 lbs. per yard.

Ventilators.—Ventilators of cast iron, made to open and shut, to be placed in the walls to communicate with chimney.

Poles to be suspended by lines and pulleys from the roof, for hanging up clothes to be dried.

Probable Price of Fittings.

	£	s.	d.
Furnace complete	4	10	0
Boiler	8	10	0
2 Cisterns	10	0	0
Water apparatus	10	0	0
3 yards 15-inch perforated iron flue at 9s. 6d.	1	8	6
25 yards 9-inch flue at 4s. 6d.	5	12	6
	40	1	0

ED BY LO

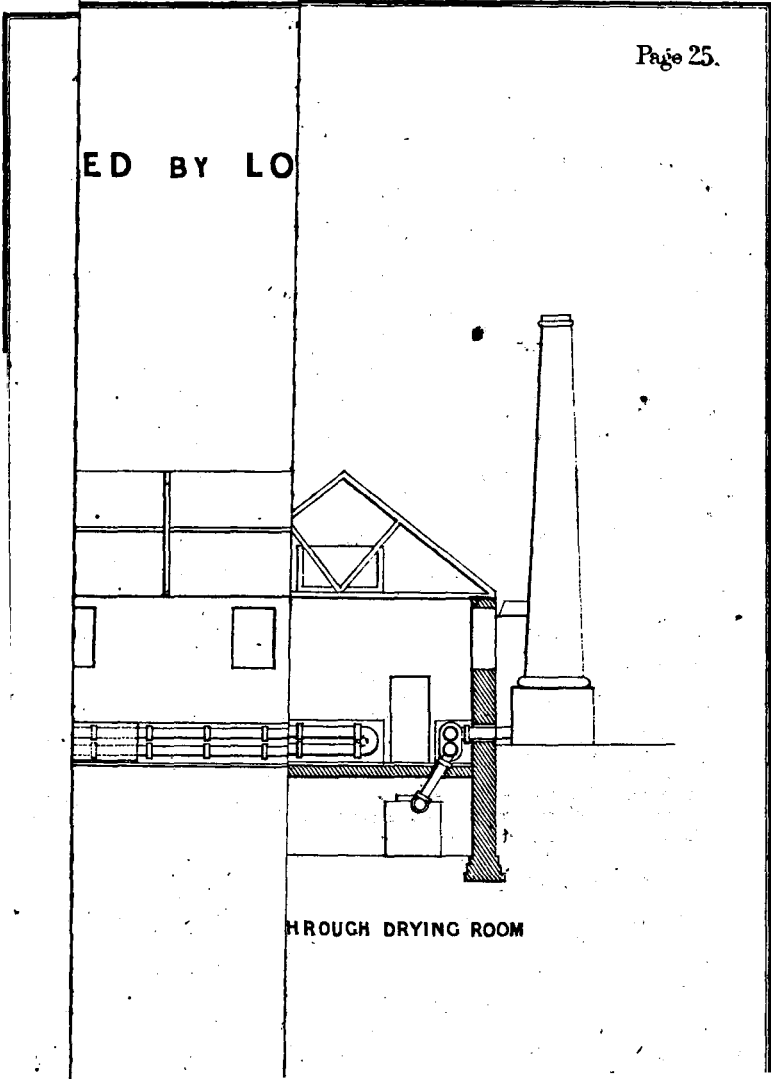

THROUGH DRYING ROOM

PLAN OF CHANGING HOUSE AS SUGGESTED BY LORD KINNAIRD.

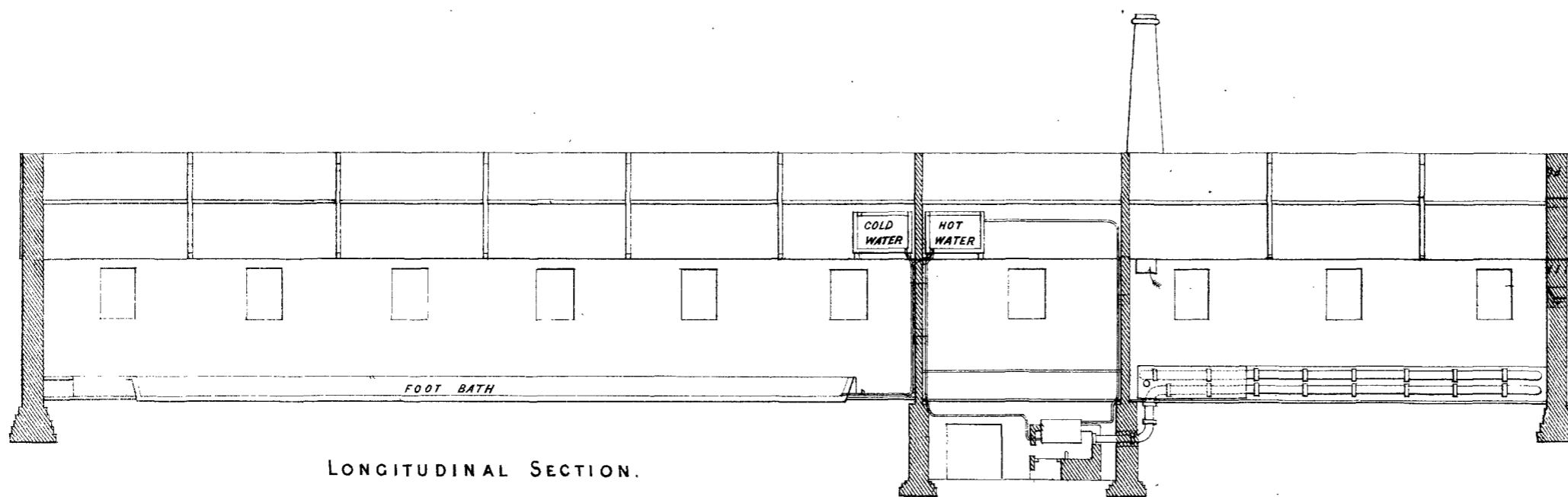

LONGITUDINAL SECTION.

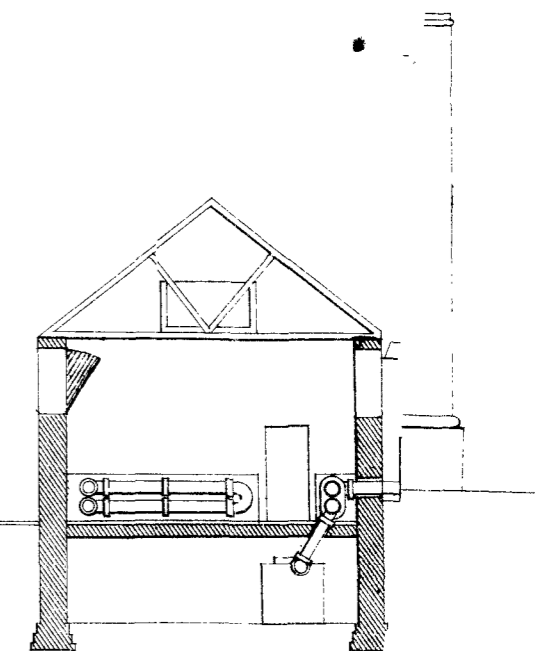

SECTION THROUGH DRYING ROOM

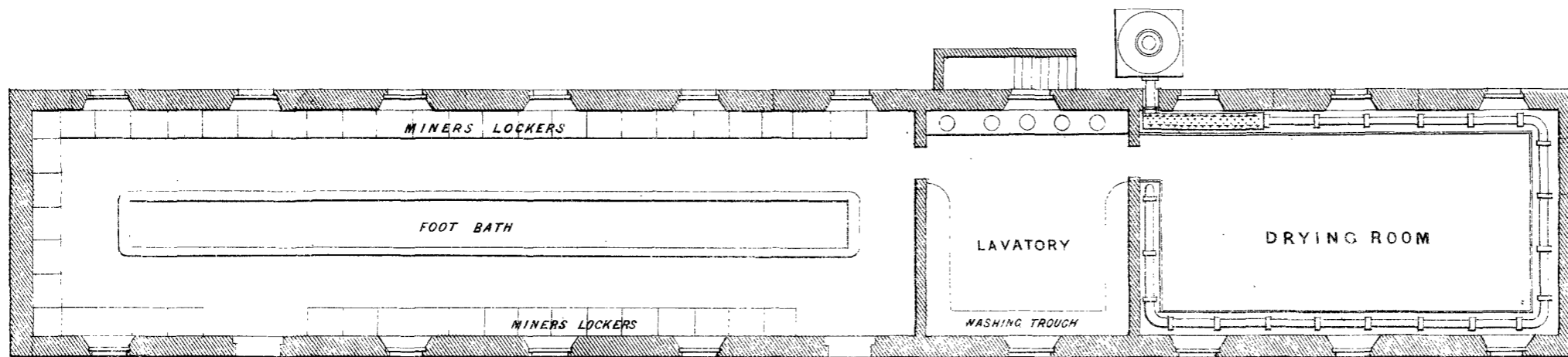

PLAN

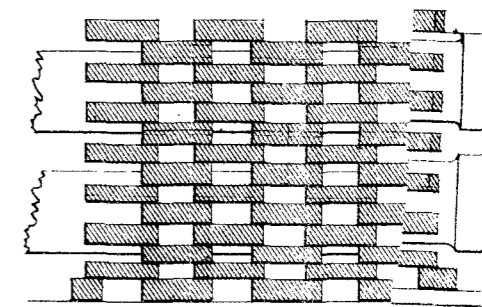

PORTION OF OPEN BRICKWORK
SHOWING PIPES
5/8 INCH TO A FOOT

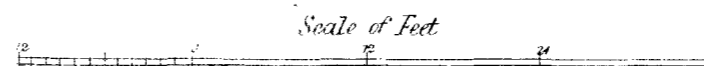

PLAN OF CAGES BY G.B.FOSTER ESQ.

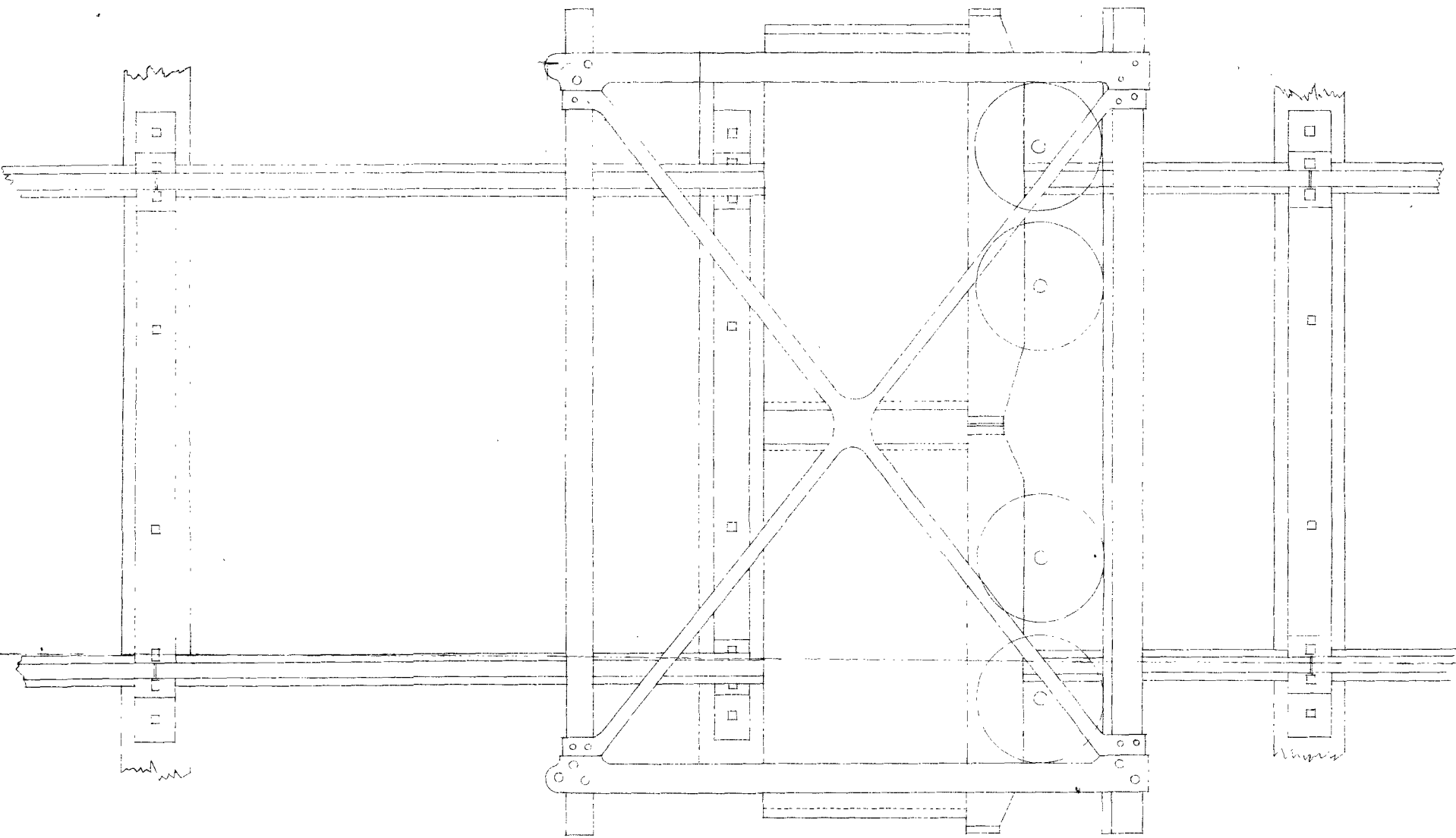
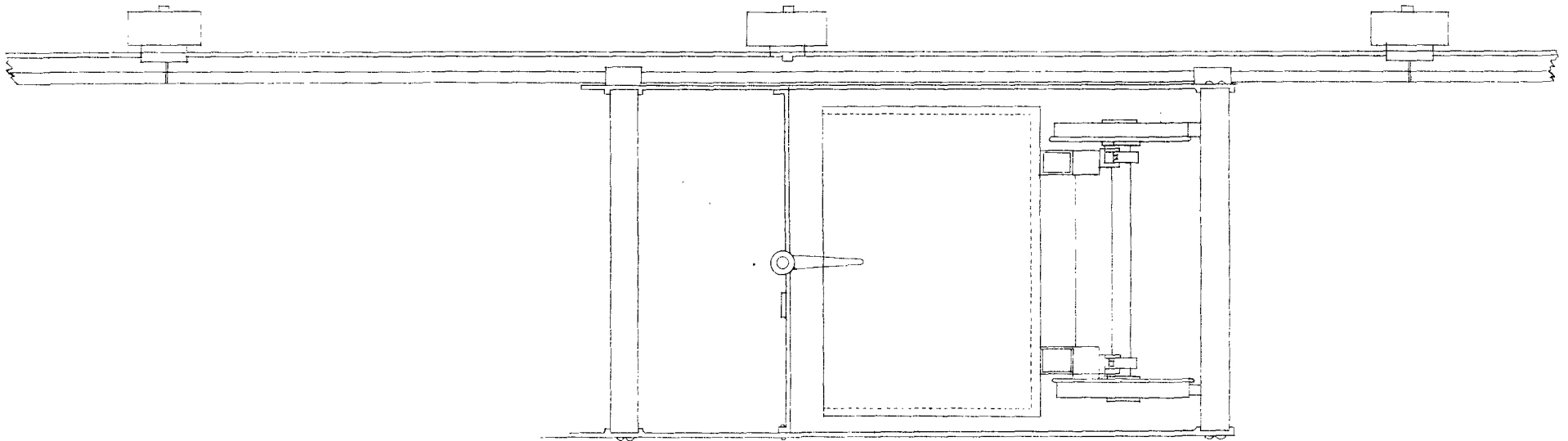

Scale $\frac{7}{8}$ of an Inch to a Foot

PLAN OF CAGES
by
G. B. FOSTER ESQ.

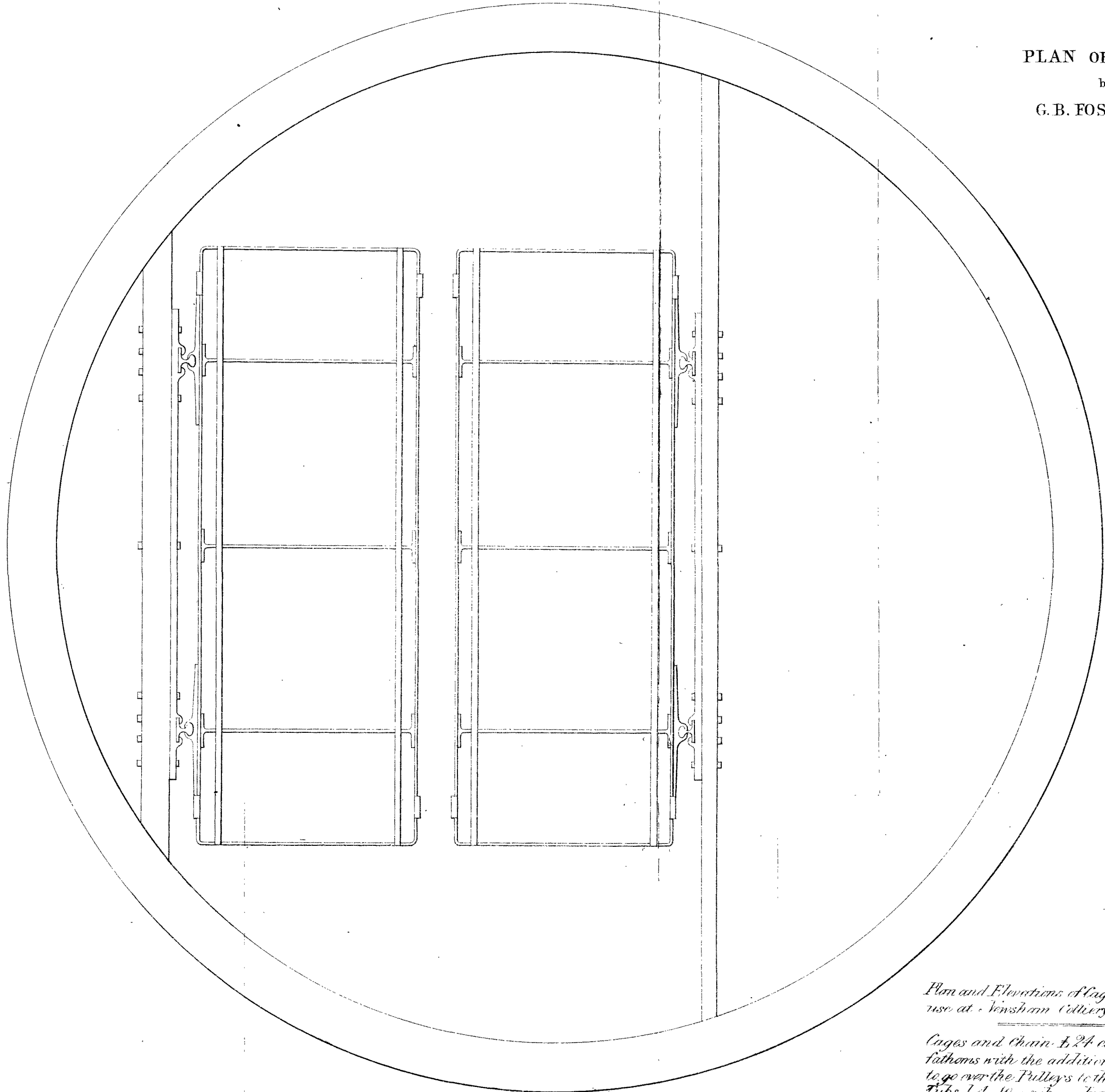

Scale $\frac{1}{3}$ of an inch = 1 Foot.

Plan and Elevations of Cages and Guides now in use at Newsham Colliery, the cost is as follows.

Cages and Chain £24 each. Ropes for 100 fathoms with the additional length necessary to go over the Pulleys to the engine, 1.6.5 each. Tubs 1.4.10 each. Iron Guides including all Labor and Materials used in fixing the same £3.7.0 per fathom.

MAN ENGINE.



LADDERS.

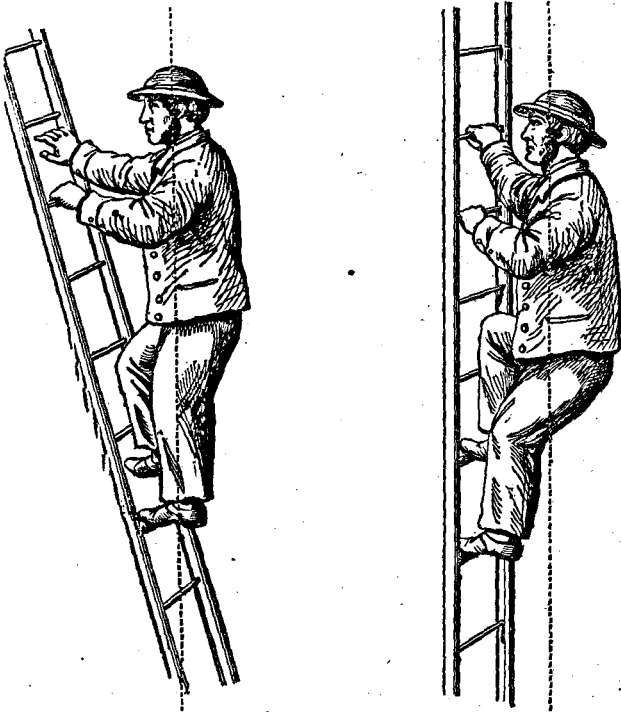

Page 31.

STEMPLES



SKIP AS USED IN CORNWALL.

