

BULLETINS OF INDIAN INDUSTRIAL RESEARCH



No. 11

**THE MANUFACTURE OF SULPHITATION
SUGAR FROM COLOURED CANES
(PURPLE MAURITIUS)**

BY

S. VENKATA RAMANAYYA, B.A., M.Sc.

**INDUSTRIAL
RESEARCH
BUREAU**

**PUBLISHED BY THE MANAGER OF PUBLICATIONS, DELHI.
PRINTED BY THE MANAGER, GOVERNMENT OF INDIA PRESS, SIMLA.
1938**

The statements made and the views expressed in this bulletin are those of the author, and neither the Government of India nor the Industrial Research Bureau accept responsibility for them.

Dhananjayrao Gadgil Library



GIPE-PUNE-012986

The author wishes to acknowledge his indebtedness to Rao Bahadur B. Viswanath, F.I.C., F.C.S., F.N.I., Imperial Agricultural Chemist and Director, Imperial Agricultural Research Institute, New Delhi, for guidance and suggestions in connection with this work. His grateful thanks are also due to Rao Bahadur C. V. S. Narasimha Raju Garu, B.A., B.L., President, The Etikoppaka Industrial and Credit Society, Ltd., for deputing him to carry out these investigations, and for placing at his disposal the Etikoppaka Sugar Factory where the laboratory findings were tested.

CONTENTS.

	PAGE.
CHAPTER I.—Introduction	1
CHAPTER II.—Review of literatures on the Sulphitation Process	3
CHAPTER III.—Review of literature on the Sulphitation Process in relation to Coloured Canes	7
CHAPTER IV.—Laboratory experiments with the Purple Mauritius Cane	9
CHAPTER V.—Laboratory experiments with Aluminium Hydroxide and the juice of the Purple Mauritius Cane	15
CHAPTER VI.—Review of literature on the use of Aluminium Compounds in Sugar Manufacture	19
CHAPTER VII.—Large-scale experiments with the Cane of the Purple Mauritius ..	22
APPENDIX	25

LIST OF ILLUSTRATIONS.

	Facing page.
Fig. 1	10
Fig. 2	10
Fig. 3	11
Fig. 4	18
Fig. 5	23
Fig. 6	23
Fig. 7	23
Fig. 8	23

CHAPTER I.

INTRODUCTION.

During recent years the sugar industry has experienced a very rapid expansion and this has encouraged the investigation of the problems of sugar manufacture. One such problem which was investigated by the author is the problem of the manufacture of white sugar by the sulphitation process from coloured canes, especially from the cane Purple Mauritius. This cane has for several years been a favourite with the ryot on account of its heavy yield per acre and also because by simple liming and skimming, the ryot is able to obtain from it a hard jaggery of good appearance. Unfortunately, however, in the vacuum pan factory, where juice sulphitation is generally employed for the manufacture of white sugar, the cane is not popular.

The juice of the Purple Mauritius does not clarify at the usual degree of liming and sulphuring. The clarified juice has an intense red colour and the quality of sugar manufactured from it is dark brown. It was therefore felt that an investigation conducted with a view to discovering to what extent it is possible to manufacture brilliant white sugar from the cane Purple Mauritius and employing sulphitation process would be of value to the industry. The restriction of the investigation to a sulphitation process was made because the equipment of the ordinary small sulphitation factory is not suitable for any other process without the provision of extra plant. Processes such as carbonation, char filtration preceded by simple lime defecation, and others employing the more recent application of active carbons were accordingly excluded. The investigation described in this paper is therefore confined to sulphitation among the chemical processes and to Purple Mauritius among the coloured canes.

Nothing definite is known about the origin of the Purple Mauritius except that it was first introduced into the Sugar Cane Research Station, Samalkot, by the late Dr. Barber in 1902. Cultivation of the cane has spread rapidly in this district and extends today over several thousands of acres of land. The cane thrives well in rich and well drained soils under long rotation, yielding upto 15,000 lbs. of jaggery per acre under these conditions. Under short rotation, however, it deteriorates. It responds to heavy manuring, wrapping and propping being essential; it is tall and stout and vigorous in growth. The local yield of cane per acre is 30 to 40 tons.

The cane is exceptionally rich in sucrose—13.5 to 14.5% on the cane; it is rather soft in texture, and contains about 11% of fibre. The purity of the juice is high as will be seen from the table given below:—

TABLE I.

Purity of the juices of the Purple Mauritius Cane.

<i>Brix.</i>	<i>Sucrose.</i>	<i>Purity.</i>
17.92	16.16	90.1
20.94	19.44	92.8
18.02	16.51	91.62
21.27	19.56	91.94
19.07	16.93	88.80

The heavy yield per acre, the soft texture of the cane and the high coefficient of purity of the juice would make the Purple Mauritius an attractive raw material for sugar manufacture, if some means could be found to overcome the colour difficulty.

Little can be said regarding the classification of this cane as the literature available on the subject of sugar-cane classification is scanty, but Noel Deerr¹ definitely places the variety under the darkest coloured canes. In spite of the obscurity of its origin and classification, however, the cane has one outstanding characteristic, namely, its intensely coloured rind. It is this rind, as will be shown later, which presents such difficulties to the manufacture of white sugar from the Purple Mauritius by the usual sulphitation process.

The paper is divided into :—

(1) Reviews of literature on

The Sulphitation Process, and

The Sulphitation Process in relation to Coloured Canes.

(2) Laboratory experiments with the Purple Mauritius Cane, and

(3) Large-scale experiments with the Purple Mauritius Cane.

References to literature are given as foot-notes to each page and an appendix at the end of the paper furnishes information on the methods of analysis adopted, and on the composition of the materials used.

¹. Noel Deerr—International Sugar Journal, 1909, 9, 29.

CHAPTER II.

REVIEW OF LITERATURE ON THE SULPHITATION PROCESS.

According to Maxwell¹, the use of sulphur compounds as purifying agents in the manufacture of white sugar dates as far back as 1792, when Archard, the founder of the beet sugar industry, first applied a dilute solution of sulphuric acid in order to precipitate albuminoids, the free acids being subsequently neutralised with lime before heating the juice. This method did not work well and simple lime defecation was preferred by many manufacturers. In 1810, Proust, the French Chemist, proposed the use of sulphurous acid as a purifying agent, and a year later Depriez took out the first patent for its application to the manufacture of white sugar. The patented process of Dubrunfaut, (1829), employing the use of lime, sulphurous acid and sulphuric acid, was not successful in its practical application. Strole, (1833), obtained again a patent for the application of sulphurous acid on the ground of its decolorizing properties and as a probable substitute for animal charcoal. Nelson's, (1849), application of different sulphites to raw juice clarification did not produce satisfactory results.

So far as the application of sulphitation to cane sugar is concerned, the first successful application appears to have been made by Dr. Icrey, (1865), in Mauritius. His method of sulphitation rapidly spread to Java and other cane sugar producing countries.

Seyferth's, (1869), syrup sulphitation process operating directly in the vacuum pan, which temporarily held the field, was finally abandoned owing to certain technical difficulties. Subsequently, the problem of sulphitation engaged the attention of numerous chemists, prominent among them being Basset, Fradiss and Schwzle. It was only in 1884 that the sulphitation process was finally established as a successful technical operation in white sugar manufacture.

In sugar-cane countries, the process made rapid strides and it is to-day playing an important part in the production of superior white plantation sugar. Ever since its establishment in 1884 it has been the subject of extensive research, experiment and improvement. During recent years, knowledge of this process has been considerably extended as a result of the researches of Dr. Zerban, Harloff and others.

Technique of the process : Action of sulphurous acid.—When raw juice, as it comes from the mills, is sulphited, purification, decolorization, reduction in viscosity and sterilization are the effects that can be noted. All these effects are usually attributed to sulphur dioxide, although its effect on reducing the viscosity of sugar solutions is not universally conceded.

Maxwell² considers juice sulphitation from two points of view, viz., sulphitation after tempering (liming) and sulphitation before tempering. The former practice is in vogue in Java, and the latter in Mauritius, Natal and Louisiana.

¹. Maxwell Francis—"Sulphitation in White Sugar Manufacture", 1920, pp. 1-2.

². Maxwell Francis—"Sulphitation in White Sugar Manufacture", 1920, pp. 26-28.

Sulphitation after tempering : Action of lime.—The first action of lime is to neutralise the organic acids present in the juices, forming calcium salts. The phosphoric acid present in the juices may be precipitated as a tri-calcium phosphate which is of a flocculent nature. Lime also acts on the albuminoids, pectins, and gummy substances, which are partly thrown down as precipitates. Albumin, which is in a gelatinous condition, is coagulated by the combined effect of lime and heat.

With regard to the action of lime on gummy substances, the opinion of investigators seems to be divided. Maxwell (*loc. cit.*) found that a large quantity of gums was separated by cold liming. Pectins combine with lime, forming both soluble and insoluble compounds, which are eliminated later to some extent during defecation. Colouring substances, such as chlorophyll and anthocyanin, are precipitated by sufficient tempering. The sucrose combines with lime, forming saccharates so long as the juice is not heated. In addition to the gummy matter, reducing sugars also are obnoxious substances which play an important role in the manufacture of white cane-sugar. They are often referred to collectively under the term 'glucose'. Lime, like other alkalis, acts on the reducing sugars in the cold and forms glucosates, which, being unstable, are easily decomposed. At low temperatures the chief product is lactic acid, and as this is comparatively stable, it does not spontaneously decompose. At temperatures higher than 55°C, however, dark coloured lime salts of organic acids especially gluccinic and saccharic, are formed. These lime salts readily decompose to form acid substances, which may cause inversion and retard evaporation and crystallisation. Their viscosity is well-known to cause considerable trouble at the boiling and curing stations.

Sulphitation of the limed juice.—After tempering, sulphitation or saturation with sulphur dioxide commences. During this operation, the lime is converted into insoluble calcium sulphite which is finally eliminated during the heating process, entangling with it slimy particles which impart cloudiness to the juice. In this case, sulphur dioxide is used mainly as a neutralising agent. If sulphitation is carried on beyond the neutral point, soluble bisulphite of calcium is formed which splits up during evaporation into SO_2 and CaSO_3 . The former increases the risk of sucrose inversion and contributes to the corrosion of the apparatus. The latter forms heavy scale on the heating elements of the juice heaters and evaporators, thus retarding heat transmission. Over-sulphitation should, therefore, be carefully avoided.

In addition to the chemical action of lime and sulphur dioxide, there is always to be found a secondary or mechanical action consequent on the absorption of colloidal and slimy particles by the surface energy of the calcium sulphite formed in the heart of the juice. The clear juice from the defecators should be a light olive colour, quite transparent and completely devoid of suspended matter which will impart cloudiness to it.

Sulphitation before tempering.—In this process the juice from the mills is directly sulphited to an acidity of about 1%, and after this the juice is treated with lime to neutrality. After sulphitation the juice is partly decolourised with the separation of organic sediment, which, on subsequent neutralisation with lime, partly redissolves, the juice once more attaining its original

dark colour. If the precipitate formed could be separated by filtration, the method would be of great value, but the slimy nature of the material renders filtration practically out of the question. The only effect of the sulphur dioxide in this system of pre-sulphitation is to render the mill juice more and more acidic, and for the neutralisation of the juice a greater quantity of lime is required than for the original raw juice. Moreover, the purifying action of lime is not allowed to play its part fully before being rendered ineffective by the formation of lime salts.

Comparison of pre-sulphitation and after-sulphitation processes.—Maxwell¹ observes that the sulphitation-liming of juice is decidedly inferior to the liming-sulphitation of juice, both as regards the brilliance and clarity of the juice after treatment, although the same light olive colour may be obtained in both cases. This peculiar characteristic of the juice of pre-sulphitation could not be improved. Still, under abnormal conditions, as mentioned hereunder pre-sulphitation may be justifiable or advisable.

For instance, in juices containing high percentages of reducing sugars, sulphitation before liming eliminates the destructive action of lime on glucose and its disastrous effects. Again, in cases where dextrin fermentation is troublesome, sulphitation before liming is a decided advantage. This fermentation is brought about by certain bacteria *Leuconostic mesenteroides*, which require an alkaline medium for their growth. By sulphuring before liming it is likely that their growth is effectively checked. Except under these circumstances liming-sulphitation is always superior to sulphitation before liming, or pre-sulphitation.

Other modifications of the sulphitation process.—Among other modifications of the sulphitation process there is one which is extensively used in Java called 'Hot Sulphitation' which is most effective for producing brilliant, clarified juices. According to Geerligs², it is an advantage to heat the juice during intermittent sulphitation to a temperature not exceeding 60°C. It is found that this temperature is not high enough for the development of colour consequent on the destruction of glucose by lime. The high temperature favours the rapid absorption of sulphur dioxide by the limed juice and at the same time promotes a thorough precipitation of calcium sulphite in the liming tanks themselves and not in the juice heaters as in the cold sulphitation process.

Another modification of hot sulphitation which, according to Harloff³, is practised in Java, employs simultaneously lime and sulphur dioxide, the juice being heated to 80—85°C. The sulphitation is started and sufficient lime cream immediately added so that the reaction of the juice is neutral, or nearly so. If glucose is high it is better to keep the juice acidic to avoid its destruction by lime. At the end of the process, neutrality is always brought about. In this process of clarification the advantages are avoidance of scale formation in the juice heaters, very rapid settling, and clear light coloured juice.

¹. Maxwell Francis—"Sulphitation in White Sugar Manufacture", 1920, pp. 29—35.

². Geerligs Prinson, H. C.—"Practical White Sugar Manufacture", 1915, p. 19.

³. Harloff, W. H. Th., L. S. Planter, 1920, 64, 14.

A recent and admirable contribution to the technique of sulphitation is what is known as the "Acid Thin Juice Process" of Java which was developed and successfully applied to carbonatation juices by Harloff. Owing to the brilliant results obtained without appreciable inversion or corrosion of the metal plates of the plant, its use had rapidly spread to sulphitation factories also. Hazewinkle¹ describes the process thus :—

Cane juice after carbonatation is subjected to sulphitation to distinct acidity. After filtration, sulphitation is carried far enough to give well decolourised juices but not so far as to endanger loss by inversion, or corrosion of the plant by the acid vapours evolved during evaporation. The sulphitation may be stopped when 100 c. c. of the juice require 48 c. c. of N/100 NaOH for neutralisation against phenolphthalein, the corresponding SO₂ content being 150 milligrams per litre. After evaporation, the syrup is slightly sulphited. On grain-ing, very light coloured massecuites are obtained and the resultant sugar is exceptionally brilliant. Careful tests showed that there was little inversion and still less corrosion. The striking advantages are the production of a better quality of superior white sugar, and easy boiling and crystallisation.

The control of the sulphitation process and several of its modifications has advanced considerably with the introduction of the control of the hydrogen-ion concentration in sugar manufacture. The pH value up to which the raw juice is to be limed is chiefly determined by the quality of the juice and its nature. The criteria are, the avoidance of the destruction of the reducing sugars, and the obtaining of the minimum amount of scum and the largest possible quantity of clear brilliant juice, consistent with rapidity and ease of settling and rise in purity. These results are usually obtained by liming the juice between the limits 8.5 to 9 pH for the sulphitation process. During sulphitation, reaction of the clear juice is always kept in the neighbourhood of neutrality, a pH value of 6.8 being most suitable for white sugar manufacture. In Natal and Mauritius, according to Farnell² the hydrogen-ion concentration is around 6.9 to 7.0 pH, value the average practice being 6.8, although he advocates 7.6 to 7.8 pH for the maximum precipitation of calcium sulphite. In most cases the juice is limed to a pH value of 8.3 to 9.0 and sulphited back to neutrality, pH value of 6.8 being preferred.

¹ Hazewinkle, J. J.—*Archief*, 1911, 19, 123-29.

² Farnell, R. C. W.—*International Sugar Journal*, 1926, 28, 36—48.

CHAPTER III.

REVIEW OF LITERATURE ON THE SULPHITATION PROCESS IN RELATION TO COLOURED CANES.

The sulphitation process of juice refining is cheap and efficient but it appears to work successfully, as will be shown later, only with light-coloured and yellow canes. Where dark coloured canes are concerned, the sulphitation process does not seem to find successful application in the industry, and the scope of the process is thus restricted. From Harloff, (1914), to Spencer, (1929), workers have associated anthocyanin pigments with coloured canes and show how, under the manufacturing conditions obtaining in the sulphitation process, these pigments escape precipitation by lime and decolorization by sulphur dioxide. This unfortunate circumstance, they point out, accounts for the unsuitability of coloured canes for treatment by the sulphitation process. The question of dealing with anthocyanin pigments in juice sulphitation does not appear to have received the attention it deserves.

Harloff¹ found much anthocyanin in the rind cells of purple and red-coloured canes as contrasted with green and yellow canes where the pigment is entirely absent. This colouring matter is extremely soluble in water and easily finds its way in to the juices, thus accounting for their dark colour, and it influences the colour of the sulphitation sugar produced. An excess of lime completely precipitates the pigment so that the colour difficulty can be eliminated in the carbonation process, but in the sulphitation process all the anthocyanin remains in the juice because the quantity of lime employed is insufficient to cause precipitation.

Muller² observed anthocyanin pigments in addition to chlorophyll and saccharin in red canes indigenous to Egypt. He isolated anthocyanin pigment from red beets, and stated that an alcoholic solution gave the following reactions:—

1. Sulphur dioxide and sulphates caused but little decolorization.
2. Hydrogen sulphide: yellow colour in neutral medium, the colour changing to green on heating.
3. The colouring matter was partly precipitated by phosphoric acid.
4. Hydrogen peroxide with heat brought about a complete and permanent decolorization of the pigment.
5. Animal charcoal and zinc powder had but a feeble decolorizing action.

The findings of Cross³ are entirely in agreement with those of Harloff, and Muller. Schmidt and Harloff⁴ have emphasised that anthocyanin, the colouring matter of purple canes, is eliminated only in very high alkalinity such as is obtained in the carbonation process where 6% lime cream, 20°Bé is added on the volume of the juice. The pigment completely escapes elimination in the sulphitation process.

¹. Harloff, W. H.—Th., *International Sugar Journal*, 1914, 16, 116-20.

². Muller, C.,—*International Sugar Journal*, 1914, 16, 224-5.

³. Cross, W. E.,—*International Sugar Journal*, 1914, 16, 312-16.

⁴. Schmidt and Harloff,—“*Plantation White Sugar Manufacture*” (translated by Ogilvie)

From *Louisiana Purple*, Brewster¹ attempted to isolate anthocyanin pigment. He found that the pigment is soluble in ethyl and methyl alcohols and does not, like anthocyanin, form stable oxonium salts. His precipitate contained nitrogen and ash, and he therefore concludes that this pigment may be a tannin and not anthocyanin, as the colouration disappears when the cane is milled. Harriot² and Geerligs³ record similar observations on coloured canes and anthocyanin pigments and conclude that a complete elimination of the pigment can be brought about only in the carbonatation process where a large excess of lime is employed.

Van-der Jagt⁴ while comparing the carbonatation and sulphitation processes of white sugar manufacture emphasised the need of taking into account the influence exerted by the well-known pigment (anthocyanin) of the coloured canes and the quality of the finished sugar produced by sulphitation. Home Archief, (1909), found that the sugar crystallised from mother liquor in which anthocyanin was present has considerable colour, not removed by wash water, since it has penetrated to the heart of the crystal. Spencer⁵ observed that there was a considerable difference of opinion regarding the possibility of making as white a product from very dark-coloured canes as from light-coloured canes and that the best white sugar was probably produced from the light-coloured canes. There do not appear to be any more contributions to our knowledge on this subject.

The literature cited above makes it abundantly clear that anthocyanin pigments are present in significant quantities in dark coloured canes and that they are not eliminated by the lime nor decolourized by the sulphur dioxide employed in the sulphitation process of sugar manufacture.

Now with regard to the actual pigments present in the Purple Mauritius and other highly coloured canes the following may be noted. According to Hardy⁶, chlorophyll, sacchratin, anthocyanins and tannins are to be encountered as naturally existing colouring matters; and although tannins are not true colouring bodies they possess the property of iron greening, but according to Harloff⁷ the colouration so developed can easily be bleached by sulphur dioxide.

Sacchratin, an ill-defined pigment, which might originate from the lignin component of cane fibre, is very harmless in sugar manufacture, as it has but a pale colour when bleached with sulphur dioxide. It is probable that the characteristic yellow colour of the juices of the sulphitation process is due to this pigment. Chlorophyll being insoluble in water and in cane juices does not play an important role, and what little remains in suspension in the juice can easily be eliminated during liming. The only pigment requiring special treatment, therefore, appears to be the anthocyanin which, as has been stated already, is the pigment responsible for the colour of the sugar produced from coloured canes by means of the sulphitation process.

1. Brewster, J. F.,—*International Sugar Journal*, 1923, 25, 593.

2. Harriot, T. P. H.,—“*Manufacturing of Sugar from the Cane of the Beet*,” 1920, p. 131.

3. Geerligs, P. H. C.,—“*Cane Sugar and its Manufacture*,” 1924, p. 58.

4. Van-der Jagt,—*International Sugar Journal*, 1927, 29, 326.

5. Spencer, G. L.,—“*Handbook for Cane Sugar Manufacturers or their Chemists*,” 1919, p. 57.

6. Hardy, F.,—*Tropical Agriculture*, 1927, 9, 39-40.

7. Harloff, W. H.,—*Th.*,—*International Sugar Journal*, 1919, 22, 574.

CHAPTER IV.

LABORATORY EXPERIMENTS WITH THE PURPLE MAURITIUS CANE.

Presence of pigments in the rind of the Purple Mauritius.—The colouring matter from the rind was carefully scraped and soaked in water over-night. The next morning the liquid was filtered under suction and lead acetate added to the filtrate until precipitation was complete. The lead precipitate obtained was filtered under suction and the cake decomposed with 10 per cent. sulphuric acid. The bright red solution of the colouring matter gave the following reactions:—

Reagent added.	Effect.
1. Dilute acids Bright red colour.
2. Caustic soda Greenish yellow.
3. Lime Greenish yellow.
4. Lead acetate Rose red precipitate.
5. Zinc dust Decolourized.
6. Sulphur dioxide No effect.
7. Alumina cream The pigment is separated as a redsediment.
8. Active carbon Decolourised completely.
9. Carbon disulphide Does not dissolve.
10. Ether and chloroform Colouring matter is insoluble.
11. Absolute alcohol Mixes in all proportions but no reduction noted.

These qualitative reactions, which are generally associated with impure-anthocyanin pigment at once suggest the presence of the pigment in the rind of the Purple Mauritius, a fact which would account for the resultant brown sugar obtained from this cane by the usual sulphitation process. While it is true that a qualitative study of this kind does not definitely establish or prove the presence of anthocyanin in the rind of the cane, it nevertheless indicates the presence of a pigment of a stubborn type, resistant to the action of sulphur dioxide, and the similarity to anthocyanin cannot be overlooked. Moreover, this investigation is not concerned with definitely proving the identity of the pigment, but with eliminating it, and accordingly no attempt was made to isolate the pigment in a state of purity and to determine its physical and chemical properties and structure, etc.

The effect of sulphitation on the pigment of the Purple Mauritius cane.—The usual practice in the sulphitation process is to lime the juices to a pH value of 8.0 to 8.5 and to sulphur back to neutrality, and this generally brings about good clarification, a characteristic light yellow colour and a complete absence of suspended impurities. With most sugar canes this clarified juice produces brilliant white sugar, but in the case of the Purple Mauritius the juice is brown red in colour and the sugar made from it is also brown. That the pigment escapes complete elimination in the sulphitation process of juice clarification is shown by the experiment described below.

A sample of the clarified juice was treated with neutral acetate of lead until the precipitation was complete, and the whole material was then filtered under suction. The lead cake obtained was decomposed with 10 per cent. dilute sulphuric acid and a deep orange red solution obtained. The effect of ordinary reagents on this extract is shown below :—

Reagent added.	Effect observed.
1. Dilute acids	Deep orange red.
2. Alkali	Brown yellowish green.
3. Ferric chloride	Brown red.
4. Zinc dust	Decolourized.
5. Lead acetate	Grey coloured precipitate.
6. Aluminium hydroxide	Light grey coloured, precipitate.
7. Sulphur dioxide	No effect.
8. Carbon disulphide	Insoluble.
9. Chloroform	Insoluble.
10. Ether	Insoluble.

The pigment of the Purple Mauritius therefore escapes complete precipitation during the sulphitation process and the juice is coloured deep red by it.

When the juice is concentrated to syrup and worked into sugar the pigment finds its way into this also. For confirmation, sugar produced by the usual sulphitation method was dissolved in water and lead acetate solution added until precipitation was complete. The lead was precipitated under vacuum and the cake decomposed with 10 per cent. sulphuric acid. A deep yellow pigment which gave the following reactions was obtained.

Reagent added.	Effect observed.
1. Mineral acids	Deep yellow.
2. Alkali	Light yellow.
3. Lead acid	Yellow precipitate.
4. Aluminium hydroxide	Yellow precipitate.
5. Sulphur dioxide	No effect.
6. Zinc dust	Decolourized.
7. Carbon disulphide, chloroform and ether.	No effect.

Judging from the difference in colour of the extracts it appears that during evaporation, sugar boiling and storage the pigment may undergo certain changes ; nevertheless, its resistance to sulphur dioxide is a point to be noted.

The depth of colour of the pigments from the rind of the Purple Mauritius and from the subsequent sugar are shown in figures 1 and 2. In both cases the medium is acidic. Thus the rind of the Purple Mauritius contains a pigment, probably, anthocyanin, which being soluble in water finds an easy entrance into the juice. The pigment is not precipitated by adding lime to a pH value of 8.9, nor is it decolourized by sulphur dioxide. It persists right through the various stages of manufacture, and ultimately finds a way into the finished sugar. This cane does not, therefore, appear to be suitable for the usual sulphitation process.

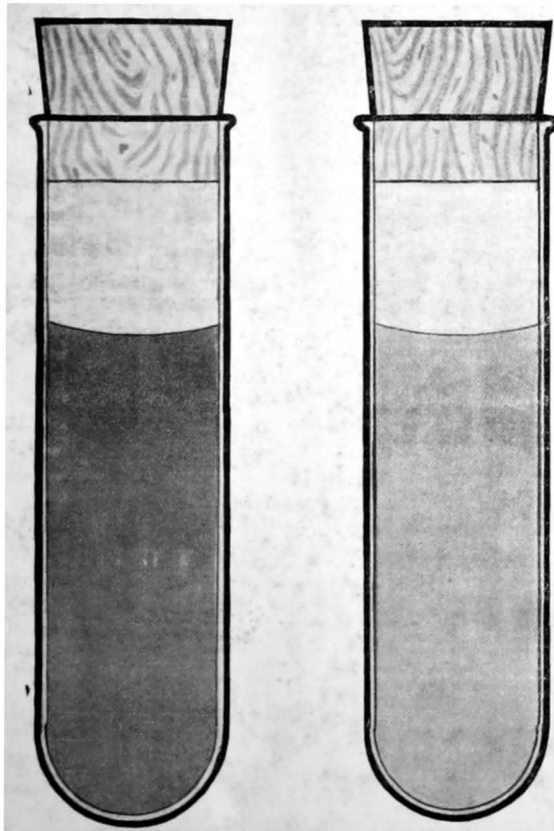

Fig. 1.
Pigment from the
rind of Purple
Mauritius.

Fig. 2.
Pigment from the
sugar produced by
the sulphitation
process.

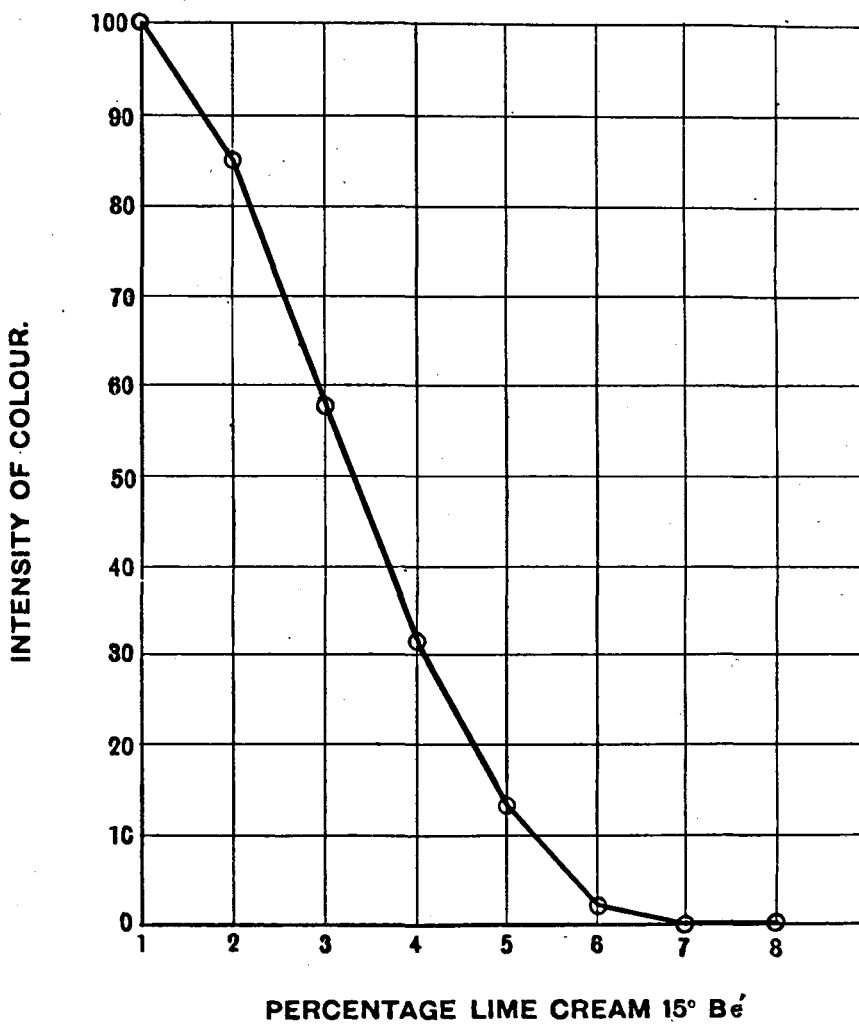

FIG. 3.

**Graph showing the intensity of colour
on treatment with lime cream.**

Effect of increased liming on the elimination of the pigment.—Although, in the sulphitation process never more than 1 per cent. of lime cream 15°Bé. is added to the juice during clarification, the effect of increasing the quantity of lime on the precipitation of the pigment was studied and the results are noted below.

To 50 c.c. of rind extract quantities of lime between 0.75 and 7.5 grammes were added and the solutions boiled and filtered; and one gramme of kieselguhr added in each case. This range corresponds to from 1.0 per cent. to 10 per cent. of 15°Bé. lime cream on the volume of the rind extract. The colour eliminated was determined in a Duboscq colorimeter taking 1 per cent. treated filtrate as the standard.

TABLE II.

Effect of increasing quantities of lime on the elimination of anthocyanin pigments from the rind extract of the Purple Mauritius cane.

Percent lime 15°Bé. added on the volume of extract.	Percent colour in the filtrate.	Per cent colour eliminated.	Alkalinity of the filtrate in terms of N/10 acid against phenolphthalein.
1	100	<i>Nil.</i>	4.4 c.c.
2	85.15	14.85	4.4 c.c.
3	46.6	53.4	4.4 c.c.
4	31.4	68.6	4.5 c.c.
5	13.6	86.4	4.8 c.c.
6	1.3	98.7	4.7 c.c.
7	..	100	..

By increasing the quantity of lime, therefore, an increasing elimination of the pigment may be obtained, 6 to 7 per cent. on the volume of the rind extract being just sufficient for complete elimination. The result is shown graphically in figure 3. These results are in agreement with the observations of Schmidt and Harloff¹, who record that anthocyanin pigments are completely eliminated from even the darkest coloured canes when 6 per cent. lime cream of 20°Bé. is added on the volume of the juice.

At present not more than 1 per cent. of lime cream 15°Bé, calculated on the volume of the juice, is employed in the sulphitation process. Any readjustment requiring more lime than this is unsuitable, for the following reasons:—

Too much lime, according to Spencer, causes darkening of the juice, increase of gummy substances, increase of ash due to dissolved lime salts, and high molasses output. The colloids eliminated in the process of defecation are largely of the irreversible type, the reversible type passing through untouched. With increased lime salts in the juice these reversible colloids increase in direct linear proportion. Excess of lime in defecation has long been known to yield poor, low-grade material in the boiling house and dark coloured, gummy sugars.

1. Schmidt and Harloff,—"Plantation White Sugar Manufacture," 1920 (translated by Ogilvie).²

Again it has been observed that increase of lime during sulphitation retards the filtration as is shown below :—

TABLE III.
Influence of increasing quantities of lime on filterability.

Description.	Time of filtration in minutes under the same conditions (500 c.c. of muddy juice).	Rate of filtration.
1. Juice treated with 1 per cent. lime and sulphited to neutrality.	15.25	1.0
2. Juice treated with 1.5 per cent. lime and sulphited to neutrality.	15.75	1.03
3. Juice treated with 2 per cent. lime and sulphited to neutrality.	23.23	1.45
4. Juice treated with 2.5 per cent. lime and sulphited to neutrality.	22.5	1.67
5. Juice treated with 3 per cent. lime and sulphited to neutrality.	27.66	1.81

Thus the time of filtration increases with an increase of lime content, and clearly with 6 per cent. lime cream on the volume of the juice there will be a serious overloading of the filters and a dislocation of the continuity of the plant. Finally, the economic aspect of the question due to the increased lime during sulphitation should be kept in view. Maxwell¹ shows that 0.03 per cent. is the normal sulphur consumption on the weight of the cane when the usual quantity of lime is employed, this being based on the assumption that about 50 per cent. of the lime is used for neutralising the free acids of the juice, the rest being neutralised by sulphur dioxide. When 6 per cent. lime is employed an excess of 0.3 per cent. of sulphur based on the weight of the cane would be required to neutralise the lime, the total consumption being 0.33 per cent. The sulphur consumption is, therefore, increased to eleven times normal and the lime consumption to six times normal. Thus the anthocyanin pigments of the Purple Mauritius cane can be eliminated by employing a large excess of lime, but this method has serious drawbacks due to the deleterious influence of the excess of lime on the sugar by darkening the juice and increasing the formation of gum, and also on account of the increased cost due to the large quantities of lime and sulphur dioxide required.

Effects of hot and cold liming and pre-sulphitation.—In chapters II and III the evolution of the sulphitation process and its modifications have been briefly described. Although cold sulphitation is a failure when applied to the Purple Mauritius cane, it was thought that possibly other modifications of the sulphitation process, such as liming hot and cold to various pH values, and pre-sulphitation might improve the colour of the juice. To decide this point, certain experiments were carried out and the results obtained are summarised below :—

For the cold liming and sulphitation treatment, the raw juice was limed to pH values of 8.4, 8.8 and 9.3 and then sulphited back to neutrality, and the juice afterwards boiled and filtered. In hot liming and sulphitation to

1. Maxwell Francis,—"Sulphitation in White Sugar Manufacture," 1920.

different pH values the raw juice was heated to 55—60°C. and limed to pH values of 8.3, 9.0 and 9.6. The limed juice was then carefully sulphited to neutrality, boiled, and filtered. For pre-sulphitation the juice was sulphited to a pH value of 3.8, limed back to neutrality (7.0 pH), boiled, and filtered.

TABLE IV.

Effect on the elimination of pigments of cold liming to various pH values and sulphitation to neutrality.

	Brix.	Sucrose.	Purity.	Glucose.	Remarks.
1. Raw juice	11.2	9.68	86.43	1.34	Juice coloured.
2. Juice limed to 8.4 pH and sulphited to 7.0 pH.	11.0	9.48	86.18	1.38	Do.
3. Juice limed to 8.8 pH and sulphited to 7.0 pH.	11.4	9.60	84.21	1.35	Do.
4. Juice limed to 9.6 pH and sulphited to 7.0 pH.	11.5	9.55	83.05	1.37	Do.
5. First sulphited to 3.8 pH and limed back to 7.0 pH.	11.2	9.6	84.73	1.37	Do.

TABLE V.

Effect on the elimination of pigments of hot liming to various pH values and sulphitation to neutrality.

	Brix.	Sucrose.	Purity.	Glucose.	Remarks.
1. Raw juice	13.0	9.4	72.3	2.59	Juice coloured.
2. Juice heated to 55°C. limed to 8.3 pH and neutralised.	8.3 14.2	10.52	73.37	2.53	Do.
3. Juice heated to 55°C. limed to 9.0 pH and neutralised.	14.4	10.66	74.03	2.55	Do.
4. Juice heated to 55°C. limed to 9.6 pH and sulphited to neutrality.	9.6 14.6	10.59	72.69	2.59	Do.

Experience with other types of canes has shown that, for the manufacture of white sugar by the sulphitation process, the clarified juice should be of a light yellow colour and completely devoid of suspended matter. From the above consideration the persistence of the red colour in the clarified juice in all the cases shown above suggested that neither liming the juice, hot or cold, to the various pH values tried, nor pre-sulphitation offer a solution to the problem of manufacturing white sugar from the Purple Mauritius cane by the sulphitation process. The modifications of the sulphitation process just described are no more effective in the elimination of the pigment than ordinary cold sulphitation.

In discussing the action of common reagents on the elimination of pigments from the rind of the Purple Mauritius it was previously mentioned that, although sulphur dioxide is ineffective, norit, a variety of activated carbon completely decolorizes the pigment, and that aluminium hydroxide precipitates the pigment completely from the rind extracts.

Although the application of active carbons like norit to the manufacture of white sugar has received considerable attention during recent years, their

prohibitive cost on one hand and the additional equipment required on the other are two formidable hindrances to their general use in India. When these carbons are applied to the juice the whole material requires to be completely filtered through a suitable filtering apparatus. In the usual sulphitation factory which is equipped for scum filtration only, the use of these carbons is out of the question. There still remains one more substance, aluminium hydroxide, which is effective in eliminating the pigments from the rind of the Purple Mauritius cane, and there are several ways of applying this substance to sugar-cane, juices. Aluminium hydroxide can be directly added to the juice, or the acidity of the juice can first be neutralised with lime and then the hydroxide added, or this material may be formed in the juice itself by adding saturated solution of alum until neutrality is obtained. Finally, the juice may be clarified by lime and sulphur dioxide as in the sulphitation process and aluminium hydroxide added to the clarified juice. The experiments carried out in this connection are described in the following chapter.

CHAPTER V.

LABORATORY EXPERIMENTS WITH ALUMINIUM HYDROXIDE AND THE JUICE OF THE PURPLE MAURITIUS CANE.

Table VI below shows the effect of clarifying the juice with aluminium hydroxide alone :—

TABLE VI.

Effect of aluminium hydroxide alone on the juice of Purple Mauritius cane.

	Brix.	Sucrose.	Purity.	Glucose.
1. Raw juices	13·6	10·31	75·81	2·14
2. Raw juice and 5 c.c. of aluminium hydroxide per 200 c.c. of the juice.	14·0	10·47	74·77	2·11
3. Raw juice and 10 c.c. of aluminium hydroxide per 200 c.c. of juice.	14·2	10·60	74·64	2·22
4. Raw juice and 15 c.c. of aluminium hydroxide per 200 c.c. of juice.	14·2	10·15	71·47	2·14

In each case there was a total absence of red colour in the treated juice, indicating a thorough elimination of anthocyanin pigments. In the first case, however, the juice was still turbid, showing a deficiency of aluminium hydroxide but the characteristic light yellow colour was in evidence. When 10 c.c. of aluminium cream were used the turbidity completely vanished and clear light yellow juice resulted. In each case the juices were boiled and the supernatant liquid examined for composition. When 15 c.c. of aluminium cream were used, correspondingly enhanced effects were not observed, indicating that with about 5 per cent. aluminium cream the optimum results are obtained.

One important point may be noted from these results, *i.e.*, high acidity and the low pH value in each case. In actual sugar manufacture the reaction for the clarified juice is kept in the neighbourhood of 7·0 pH and therefore this high acidity is never encountered. Even though perceptible inversion was not found in the laboratory scale tests, inversion would be sure to occur if the process were carried out on a factory scale. Direct clarification of the juice with aluminium hydroxide alone, therefore, is not a solution to the problem.

The next step taken consisted of first neutralising the acidity of the juice with lime, as in the simple defecation process, and then adding alumina cream. The results obtained are shown in table VII below :—

TABLE VII.

The effect of neutralising the acidity of the juice of the Purple Mauritius with lime and then clarifying with aluminium hydroxide.

	Brix.	Sucrose.	Purity.	Glucose.	pH.	Acidity in terms of N/10 NaOH
1. Raw juice	13·6	10·31	75·81	2·14	4·8	20 c.c.
2. Juice limed to 7·0 pH and clarified with 5 c.c. of aluminium hydroxide for each 500 c.c. of the juice.	14·4	10·72	75·49	2·22	6·6	7 c.c.
3. Juice limed to 7·0 pH and 10 c.c. of aluminium hydroxide added to each 200 c.c. of the juice.	14·4	10·79	74·93	2·19	6·6	6 c.c.
4. Juice limed to 7·0 pH and 15 c.c. aluminium hydroxide added to each 200 c.c. of the juice.	15·4	11·21	72·14	2·22	6·6	7 c.c.

In each case the juice, after defecation with lime, was treated with the specified quantities of aluminium hydroxide. It was then boiled and the supernatant liquid analysed. There was total absence of red colour, but the quantity of aluminium hydroxide required for effecting good clarification is about 5 per cent. of the volume of the juice. The addition of alumina in appreciable quantities retards filtration, as will be seen from the following table, and therefore the smaller the quantity employed the better :—

TABLE VIII.

Description of juice filtered.	Time of filtration (500 c.c. through Buchnar funnel 9 cm. diameter under vacuum).
1. 500 c.c. of limed or sulphited juice	20·5 minutes.
2. 500 c.c. of limed or sulphited juice plus 5 c.c. aluminium hydroxide.	25·1 minutes.

Apart from the filtration difficulties, the cost of aluminium hydroxide is a factor of importance and the method cannot therefore be regarded as suitable for large scale working. It next remained to be decided whether it would be advantageous to clarify the juice with aluminium hydroxide by forming this in the juice, and the following experiments were undertaken for this purpose :—

200 c.c. of the juice were added to 10, 20, 30 and 40 c.c. of saturated solution of alum and the total acidity reduced with lime, the reaction of the juice being maintained at neutral point. In each case the supernatant juice after boiling was analysed for composition. There was a total absence of red colour in the treated juice, indicating the elimination of anthocyanin pigments. The results are shown in table IX below :—

TABLE IX.

Composition of juices of the Purple Mauritius cane when treated with various quantities of aluminium hydroxide formed in the juice.

Treatment.	Brix.	Sucrose.	Purity.	Glucose.
1. Raw juice	14·2	9·67	68·09	2·27
2. Juice treated with 10 c.c. of saturated alum solution and neutralised with lime.	14·4	9·72	66·57	2·23
3. Juice treated with 20 c.c. of saturated alum solution and neutralised with lime.	14·4	9·96	69·18	2·05
4. Juice treated with 30 c.c. of saturated alum solution and neutralised with lime.	13·8	9·62	69·71	2·14
5. Juice treated with 40 c.c. of saturated alum solution and neutralised with lime.	14·0	9·47	67·64	2·05

Although the red colour was eliminated in each case, the calcium sulphate formed as a result of the double decomposition is an objectionable impurity from the point of view of sugar manufacture, as this substance forms heavy scale in the juice heaters and evaporators.

Finally, therefore, the aluminium hydroxide obtained from soluble sulphates, was applied to the juice, which was first clarified with lime and sulphur dioxide as in the normal sulphitation process. The results of these experiments are shown below. The juice in each case was first limed to a pH value of 8.5 and neutralised with sulphur dioxide, and then 2.0 c.c. of aluminium hydroxide were applied to 200 c.c. of the juice, which was then boiled and analysed.

TABLE X.

Effect of aluminium hydroxide on juice of the Purple Mauritius Cane which has been limed and sulphited.

Treatment.	Brix.	Sucrose.	Glucose.	Purity.	Glucose ratio.
1. Control juice treated with lime and SO ₂ .	14.2	11.36	1.76	80.0	15.49
2. Juice treated with lime, SO ₂ and 2 c.c. of aluminium hydroxide for each 200 c.c. of juice.	14.2	11.53	1.78	81.19	15.43
3. Juice treated with lime, SO ₂ and 2 c.c. of aluminium hydroxide for each 200 c.c. of juice.	14.4	11.56	1.78	80.27	15.40
4. Juice treated with lime, SO ₂ and 2 c.c. of aluminium hydroxide for each 200 c.c. of juice.	14.4	11.56	1.78	80.27	15.4

In all cases after treatment with aluminium hydroxide, after first liming and sulphiting, there was a complete absence of red colour, a slight increase in purity, and a constancy in glucose ratio, indicating that inversion was not taking place. When the clear juice from the alumina treatment was precipitated with lead acetate and the lead cake decomposed with sulphuric acid, no red colour could be observed showing that the anthocyanin pigments are completely eliminated by applying about 1 per cent. of alumina cream to limed and sulphited juice. When lime and sulphur dioxide are first utilised to remove the major impurities from the juice, the quantity of alumina cream required to remove the anthocyanin pigments alone is very small, and, therefore, this method appears to be the most economic way of dealing with the problem of colour elimination.

Before proceeding to describe the use of aluminium hydroxide in large-scale sugar making, it is necessary to mention the experiments made to investigate the mechanism of the formation of this material from alum and alkalis. Table XI below shows the results of these experiments. The results were obtained by adding to 50 c.c. of alum solution of 1/10 normal strength increasing quantities, from 10 to 60 c.c., of N/10 sodium hydroxide. The solutions were then boiled, cooled and filtered, and the precipitates dried at 100° to 105°C for six hours and weighed.

TABLE XI.

Formation of aluminium hydroxide with varying quantities of NaOH.

Conditions.	Weight of NaOH added.	Equal weight of CaO.	Weight of precipitate formed.	pH value of supernatant liquid.
1. 50 c.c. of N/10 alum solution and 10 c.c. of N/10 NaOH.	0.04 gm.	0.023 gm.	0.028 gm.	..
2. 50 c.c. of N/10 alum solution and 20 c.c. of N/10 NaOH.	0.08 gm.	0.056 gm.	0.0930 gm.	..
3. 50 c.c. of N/10 alum solution and 30 c.c. of N/10 NaOH.	0.12 gm.	0.084 gm.	0.1532 gm.	4.4
4. 50 c.c. of N/10 alum solution and 40 c.c. of N/10 NaOH.	0.16 gm.	0.112 gm.	0.2190 gm.	6.4
5. 50 c.c. of N/10 alum solution and 50 c.c. of N/10 NaOH.	0.20 gm.	0.140 gm.	0.1540 gm.	8.3
6. 50 c.c. of N/10 alum solution and 60 c.c. of N/10 NaOH.	0.24 gm.	0.168 gm.	0.0932 gm.	9.4

It will be seen that the quantity of alum being constant, an increasing quantity of aluminium hydroxide was formed by adding increasing quantities of alkali up to the point at which the supernatant liquid attained neutrality. Beyond this point the formation of aluminium hydroxide became less and less with the formation of a soluble aluminate, as the supernatant liquid became increasingly alkaline. The results are shown graphically in figure 4.

For the large-scale manufacture of alumina cream, the quantities of alum solution and alkali should be adjusted so that the supernatant liquid has a pH value of about 6.4 to 6.5 to obtain maximum precipitation.

Hardy finds that the iso-electric point for hydrated alumina is 6.5 pH, and at this reaction the material, by virtue of its amphoteric nature, absorbs colloids, both positive and negative. It is a fortunate coincidence that at this pH value the maximum precipitation takes place and the greatest possible quantity of alumina is thus obtainable free from colloidal admixture, a factor which can be taken advantage of in large-scale manufacture.

The production of aluminium hydroxide on the site of a factory is a simple operation. Commercial potash alum sells in the market at the rate of $\frac{1}{2}$ anna to 1 anna per lb., and its decomposition with lime, in place of caustic soda, which is always available in any sugar factory results in the formation of a bulky precipitate of alumina cream. In the laboratory experiments no difference could be observed between alumina cream prepared from potash alum with ammonia or lime, as far as their efficiency as clarifying agents for the pigments of the rind of the Purple Mauritius were concerned. It is, therefore, suggested that the alumina cream be produced by decomposing commercial potash alum with lime, as this method is the least expensive. But the calcium sulphate that is formed as a product of the double decomposition is an undesirable impurity and tends to form heavy scale on the heating elements of the evaporators. It will, therefore, be necessary to wash repeatedly the bulky cream of alumina with clean fresh water in order to eliminate the calcium sulphate completely. In the large-scale experiments to be described later this method of producing aluminium hydroxide was adopted.

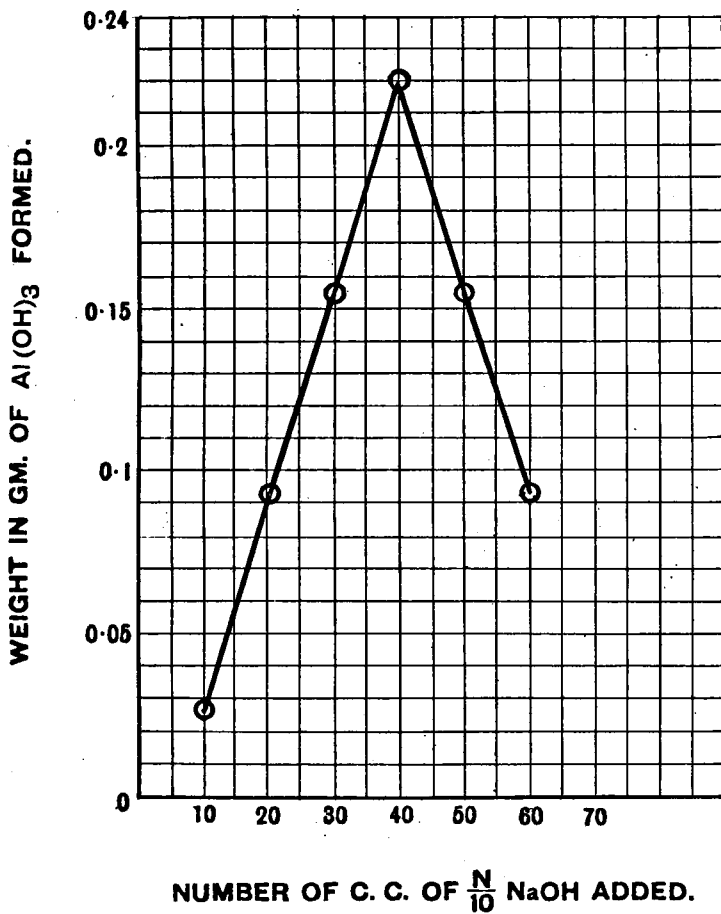

FIG. 4.

Graph showing the formation of $\text{Al}(\text{OH})_3$ from $\frac{N}{10}$ potash alum and $\frac{N}{10}$ NaOH.

CHAPTER VI.

REVIEW OF LITERATURE ON THE USE OF ALUMINIUM COMPOUNDS IN SUGAR MANUFACTURE.

There is nothing unusual in suggesting the use of aluminium compounds in sugar manufacture. The use of these compounds in the manufacture of white sugar was advocated as far back as 1876, and their efficacy for the clarification of cane juices is widely recognised.

Newlands¹ applied aluminium sulphate for the removal of the potash salts from sugar solutions, and Hunt² claims that the application of basic sulphate of aluminium eliminates gums, albuminoids, etc., from sugar solutions during refining. Classen's³ researches on the filtration of sugar solutions through a double silicate of aluminium and calcium show that alkalis are eliminated with the reduction of ash content. But Jos. Smahel⁴ objects to the process on the ground that lime salts are needlessly introduced into the juices. Janet⁵, by applying a barium aluminate at the rate of 0.05 to 0.2 grammes per litre, obtained brilliant decolourized syrup which filtered easily. When the same material was used in Louisiana⁶ a 50 per cent. reduction in lime consumption, increased purity and decolouration of the juices were observed, but the material did not find favour owing to its heavy cost and the undesirability of introducing barium compounds. Durieux⁷ developed a patented process for the use of aluminium bisulphide, on the grounds of its decolourizing properties and the de-incrustating effect it had on the brass tubes of the evaporators. Leidnor⁸ obtained a good direct consumption sugar with colloidal alumina, while Hood⁹ suggested alumina filtration for the decolorization of sugar solutions. Istwan Hunyady and Milan Malbaski¹⁰ employed in a patented process basic aluminium carbonate and obtained clear juices, although slightly alkaline. Emil Barnert¹¹ produced a direct consumption white bleached sugar, which did not require washing or steaming in the centrifugal, by employing aluminium sulphate with carbonatation process. Komn's¹² patented process aims at applying colloidal alumina not to the juices but to slices after pulping, and thus obtains a juice which requires no further treatment except filtration. He claims low cost of manufacture and rise in purity for the juice by 4 to 5 degrees. Viswanath and Nayar¹³ successfully applied potash alumina to the clarification of palmyra juice. Clifton's¹⁴ laboratory experiments in Mexico on the application of colloidal

¹. Newlands, A. R.,—Sugarcane, 1876, 8, 395-409.

². Hunt, E.,—Sugarcane, 1881, 13, 188-89.

³. Classen, H.,—International Sugar Journal, 1907, 9, 540-46 and 605-12.

⁴. Smahel, Jos.,—International Sugar Journal, 1909, 11, 252-53.

⁵. Janet, J.,—International Sugar Journal, 1908, 10, 406.

⁶. Louisiana Bulletin No. 103, abstracted in International Sugar Journal, 1908, 10, 249-50.

⁷. Durieux, O.,—International Sugar Journal, 1911, 13, 512.

⁸. Leidnor, M.,—International Sugar Journal, 1914, 15, 128.

⁹. Hood, J. J.,—International Sugar Journal, 1920, 24, 220.

¹⁰. Hunyady, I. and Malbaski, M.,—Hungarian Patent Nos. 234 and 485; International Sugar Journal, 1922, 24, 220.

¹¹. Barnert, E.,—Austrian Patent Nos. 364 and 424 (1929); International Sugar Journal, 1923, 25, 446.

¹². Komn, E.,—International Sugar Journal, 1926, 28, 668.

¹³. Viswanath, B. and Nayar, K. G.,—Agricultural Journal of India, 1924.

¹⁴. Clifton, H. Wells.,—La Planter, 1924, 71, 394-95.

aluminium silicate, showed that pre-liming the juice to neutrality is an essential condition before neutralising the electrical charges on the colloids of the juice. He obtained a brilliant juice with an increase of 2 degrees in purity, easy filterability, elimination of lime salts by about 0.5 per cent. and reduction of gums: and suggested the possibility of introducing continuous clarifiers of the Dorr types. Singh and Majithia¹ suggest the formation of aluminium hydroxide in the heart of the alkali juice by adding to it a soluble salt of aluminium. After heating and separating the sediments they propose, according to their patented process, to treat the clear juice with aluminium for clarification at the rate of 0.2 to 0.6 lbs. per thousand gallons and to lime to a pH value of 8.6. The result is claimed to be a brilliant clarified juice and about 15 to 20 per cent. scum.

Among recent contributions the experiments of Hardy² on the effects of ignited bauxite on sugar cane juices are noteworthy. Although his trials were confined to the laboratory, the results obtained are interesting and instructive. Bauxite in this respect resembles a high class keiselguhr, and the complications consequent on the use of lime, *viz.*, the formation of dark coloured froth-forming bodies derived from the carbohydrate acids produced by glucose decomposition, are avoided by its use. It eliminates the formation of the hydrolysis products between cellulose and lime and insoluble scale-forming lime salts. The only disadvantage is the large quantity required, less than 4 per cent. on the volume of the juice not being very effective. Fabbrini³ recognised the powerful decolourizing properties of aluminium hydroxide in sugar refining, and obtained good results of a practical nature by mixing it with an equal quantity of carboraffin. Fleshman⁴ finds sodium alumina useful in handling refractory juices but notes the filtration difficulties.

Waterman⁵ describes his experiences in Java with the use of "sulfosol", a compound prepared by treating aluminium hydroxide gel with sulphur dioxide until it passes into the solution stage. The colour of the clarified juice, he observes, is about 16 per cent. darker than the carbonatation juice, although the finished sugar made by the two processes is approximately the same. There is a considerable saving in lime by applying "sulfosol", but its use requires larger filtering area, and the saving in lime does not compensate for the cost of "sulfosol" in Java.

The use of aluminium compounds in sugar manufacture has thus engaged the attention of scientific workers for many years. A variety of aluminium compounds have been proposed from time to time, such as colloidal or non-colloidal, aluminium hydroxide, aluminate of soda and barium, sulphate of

1. Singh, P. and Majithia, S. K. S.,—International Sugar Journal, 1926, 28, 170.

2. Hardy, F.,—International Sugar Journal, 1933, 35, 64-68.

3. Fabbrini, V.,—International Sugar Journal, 1934, 36, 447-48.

4. Fleshman, U. S.,—International Sugar Journal, 1935, 37, 158.

5. Waterman, J. E.,—International Sugar Journal, 1935, 37, 307.

aluminium, etc. Several of these preparations are costly, though efficient, and, therefore, do not find favour with practical sugar manufacturers. Aluminium hydroxide is the cheapest of them and possesses decolourizing and adsorptive properties of a high order. According to Hardy (*loc. cit.*), this material has specific adsorptive properties for many ions, simple and colloidal, exhibiting iso-electric behaviour by virtue of its amphoteric nature. Its iso-electric point is at the pH value of 6.5, so that it tends to adsorb electro-negative ions most readily from solutions acidic in reaction (with respect to the iso-electric point) and cations from alkaline solutions. This behaviour explains the high efficiency of hydrated alumina in colour and colloidal elimination.

CHAPTER VII.

LARGE SCALE EXPERIMENTS WITH THE CANE OF THE PURPLE MAURITIUS.

The factory where the laboratory findings were tested was equipped with a small sulphitation plant. There was no provision, however, for accurately weighing the juice, and also there was a considerable difference in milling efficiency during the two seasons when the usual and the new method of sulphitation were tested. Accurate comparative information on the respective yields of sugar could not therefore be obtained. However, the data that is available shows that inversion is not caused by applying alumina to the juice under factory conditions.

The juice was found to settle with appreciable rapidity when limed in the cold to a pH value of 8.8, and, therefore, this reaction point was chosen for the liming during the 1935 season. After thoroughly stirring the juice, sulphitation was carried on to neutrality, and at this stage alumina cream was added at the rate of one quarter to a half gallon per 200 gallons of limed and sulphited juice, and the whole thoroughly mixed. The concentrated juice was sulphited to a pH value of 6.0 to 6.5, and boiled to grain with half to one pound of sodium hydrosulphide per ton of sugar produced. When the masse-cuite was spun at the centrifugal the results surpassed all expectations. Brilliant light yellow coloured juice was obtained, which, after concentration and boiling in the pan, yielded bright lustrous sugar. The laboratory observations which indicated the total elimination of anthocyanin pigments by applying alumina to the limed and sulphited juice completely agreed with the results of the large-scale trials, which extended over eight days. It can now definitely be stated that aluminium hydroxide is a powerful decolourizer for the juice of the Purple Mauritius cane, and when judiciously applied to limed and sulphited juice produces excellent sugar. Table XII below gives the results of these experiments:—

TABLE XII.

Composition of raw juice and corresponding clarified juice produced with lime, sulphur dioxide and alumina cream in factory scale trials during the 1935 season.

	Brix.	Sucrose.	Purity.	Acidity. c.c.	Glucose.	Glucose ratio.	pH value for clarified juice.
Raw juice (Average of three experiments)	19.89	17.98	89.39	13.6	0.65	3.65	
Corresponding clarified juice	20.3	17.89	88.12	3	0.70	3.85	7.0
Raw juice (Average of three experiments)	19.56	16.92	86.50	12.3	0.60	3.54	
Corresponding clarified juice	20.9	17.87	85.51	4	0.59	3.30	7.1
Raw juice (Average of three experiments)	20.01	17.58	87.90	14	0.70	3.92	
Corresponding clarified juice	21.14	18.30	86.5	3	0.71	3.98	6.8
Raw juice (Average of three experiments)	19.80	17.50	88.33	14	0.50	3.03	
Corresponding clarified juice	20.50	18.03	87.95	2	0.56	3.11	6.8
Raw juice (Average of three experiments)	19.68	17.44	88.65	13.6	0.39	2.29	
Corresponding clarified juice	20.4	17.66	86.60	..	0.38	2.15	6.9

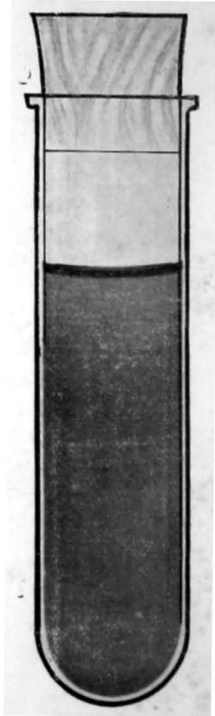

Fig. 7.
Colour of the 10%
solution of the un-
treated sugar.



Fig. 8.
Colour of the 10%
solution of sugar
produced by the
alumina cream
treatment.

The data presented show that the juices underwent no appreciable chemical changes. The small variations of impurity and glucose ratio may be due to errors in sampling. The juice obtained after treatment was markedly decolourized, and had a light yellow colour characteristic of sulphitation juices. To expedite settling a little di-calcium phosphate at the rate of half a pound per two hundred gallons of juice, was applied in the eliminators. This was not really necessary, however, as the settling was normal; where large settling capacity exists the use of this chemical may be dispensed with. When the alumina cream was first introduced the normal filterability of the scums was slightly disturbed, but this was restored by introducing into the scums a suitable quantity of kieselguhr.

The sugar produced was bright, lustrous, absolutely transparent and completely devoid of colouring material and colloidal particles. Photographs of the two sugars are shown in figures 5 and 6. From an examination of the photographs of the sugar crystals and solutions (figures 7 and 8), it is apparent that the alumina treated sugar is more transparent and larger in size than the untreated sugar.

The application of alumina to sugar manufacture is quite practicable economically, as on an average only one pound of commercial alum was required per ton of cane ground, and the cost of this material during 1935 was only one anna per pound. It is probable that the use of this material renders the sulphitation process independent of the variety of cane treated, as it has been found definitely to eliminate the pigment from the Purple Mauritius cane, and there is no reason to suppose that it will not be equally effective with other coloured canes.

APPENDIX.

Methods of analysis and composition materials.

The analytical methods described in "A Handbook for Cane Sugar Manufacturers and their Chemists," 1929, by G. L. Spencer, 7th edition, Revised by G. P. Meade, were followed throughout the investigations, as specified hereunder:—

1. *Total Solids*.—Except in the laboratory tests, the (degree brix) or total solids was determined with a standard hydrometer (Brix spindle, standardised at 20°C). In the laboratory tests the total solids were determined with a Zeiss Refractometer (Table model D.254 and 267).
2. *Sucrose*.—This term is used throughout to indicate apparent sucrose, as determined by Schmidt and Haensch's single polarisation, half-shadow polariscope, and not by Clerget's method of double polarisation. The purity, therefore, relates to apparent purity and not to real purity.
3. *Reducing Sugars*.—Glucose was determined volumetrically by the Eynon-Lane method, using methylene blue as the internal indicator (D.250-252).
4. *Acidity*.—Whenever acidity was determined, phenolphthalein was used as the indicator, and the result expressed as so many c.c. of N/10 NaOH required for 100 c.c. of the juice, and not 10 c.c.
5. *pH value of the juice*.—This was determined by a colorimetric method with a Hellige amparator on the original juice at room temperature without dilution.

The chemical materials used were of Merck's manufacture, and of A. R. quality (certified by the manufacturers).

The alumina cream used was prepared from potash alum and ammonia, as described by Spencer, p. 410.

The lime used for the sugar manufacture was analysed by methods outlined in D.391 to 394 and 398.

The composition of shells from which lime was obtained by burning at site was as follows:—

	%
Insolubles in HCl	2.79
Fe ₂ O ₃ plus Al ₂ O ₃	0.44
Lime as CaCO ₃	90.16
Mg O	0.55

The roll sulphur used for the sugar manufacture was of Japanese origin and about 99% pure, but not more than 55 % of it could be oxidised by bromine water.

The dicalcium phosphate which was used for producing subsidence contained 30-32% of free phosphoric acid calculated as P₂O₅.

BULLETINS OF INDIAN INDUSTRIAL RESEARCH



No. 12

THE MANUFACTURE OF SOAP IN INDIA

BY

A. K. MEÑON, B.A., F.C.S.

**INDUSTRIAL
RESEARCH
BUREAU**

**PUBLISHED BY THE MANAGER OF PUBLICATIONS, DELHI.
PRINTED BY THE MANAGER, GOVERNMENT OF INDIA PRESS, SIMLA.
1938**

M23ISD

X9(F9496).2.N4

58

The statements made and the views expressed in this bulletin are those of the author, and neither the Government of India nor the Industrial Research Bureau accept responsibility for them.

CONTENTS.

	PAGE.
CHAPTER I.—The development of the Indian Soap Manufacturing Industry ..	1
CHAPTER II.—Fats and Oils used for soap-making	5
Convenient grouping	6
Animal and vegetable fats and semi-fats	6
Hardened (hydrogenated) oils	10
Vegetable oils	11
Fish oils	17
CHAPTER III.—Acid oils (fatty acids)	19
CHAPTER IV.—Refining of oils	21
CHAPTER V.—Rosin or Colophony	24
CHAPTER VI.—Caustic alkalis, salt, fillers, and water	25
CHAPTER VII.—Soap manufacturing processes	29
The "Cold" Process and modified "Cold" Process	29
The "Semi-boiling" Process, Pot-moulded soap and "Ball" soap	33
The "Boiling" Process	36
CHAPTER VIII.—Toilet and Washing Soaps	42
CHAPTER IX.—Recovery of Glycerine	45
CHAPTER X.—Problems connected with Soap Manufacture in India	47
The selection of soap stocks	47
The cause and cure of sweating of soaps	48
The cause and cure of rancidity in soaps	50
CHAPTER XI.—Essential oils, auxiliary industries and research	52
CHAPTER XII.—Present prices, quality, and prospects	54

APPENDICES.

	PAGE.
APPENDIX A.—Table of specific gravities of solutions of caustic soda of varying strengths	57
APPENDIX B.—Table showing the percentages of salt contained in solutions of varying specific gravity	59
APPENDIX C.—Table of amounts of caustic soda solutions required to saponify oils and fats	60
APPENDIX D.—Percentages of caustic soda and caustic potash in lyes	61
APPENDIX E.—Statement showing the influence of temperature on the specific gravity of caustic soda solutions	63

LIST OF ILLUSTRATIONS.

	Facing page.
PLATE 1 The 'Cold' process room, Kerala Soap Institute, Calicut ..	29
PLATE 2 The 'Semi-boiling' process room, Kerala Soap Institute, Calicut	33
PLATE 3 The soap cutting and stamping room, Kerala Soap Insti- tute, Calicut.	40
PLATE 4 The toilet soap milling room showing a shaving milling machine and a plodder, Kerala Soap Institute, Calicut ..	42
PLATE 5 Packing toilet soaps, Kerala Soap Institute, Calicut ..	43

CHAPTER I.

THE DEVELOPMENT OF THE INDIAN SOAP MANUFACTURING INDUSTRY.

Introduction.—Toilet articles used in ancient India are described by various writers, and their writings record that these articles included various detergent substances and perfumery products. Soap such as is now in general use does not find a place in the list, although the cleansing agents popular in olden times possessed all the attributes of a well-made modern toilet soap. Powders and decoctions of certain barks, leaves, pods, pulses, seeds, nuts, oil cakes, and alkaline earths formed the principal materials used for cleansing the body. Soapnuts, different species of the *Sapindaceae*, barks, and pods of different varieties of acacia trees and of *Albizzia lebbek*, are even now used in various parts of India, as are also oil cakes such as mowrah and mustard cake. Sandal, khus, lodhra, lotus and neem leaves, agaru, and various other kinds of indigenous materials, all properly blended, were used as deodorants and perfumes.

According to Pliny the Elder (A.D. 23—79) soap is said to have been the invention of the Gauls, although mention is made of soap in the Bible, which indicates that it was known as early as 1500 B.C. Remnants of soaps are said to have been unearthed amongst the ruins of Pompeii, which, as history records, was destroyed by the disastrous eruption of Vesuvius in A.D. 79. The foundations of modern soap factory were presumably laid, however, by the housewife of antiquity who accidentally mixed in the refuse pit the waste materials of the kitchen such as goat's fat, bone grease, olive kernel oil, etc., which combined with the wood ashes and formed a crude soap.

The scientific basis of soap making did not begin to form, however, until the beginning of the 19th century A.D., when Chevreul described the results of his researches on the constitution of oils and fats and Leblanc prepared alkali from common salt. The soap industry thereafter progressed by leaps and bounds in England, and in due course spread to other parts of the world. Soap making in a crude way appears to have been practised in India over 100 years ago, as remnants of old soap-making establishments are still met with in different parts of India, and the progress made in the soap industry in India during recent years is described in the following pages.

The first modern Soap Factories in India.—The first soap factory in India designed to work on modern lines was erected at Meerut by the North West Soap Co. in 1879, and another factory was subsequently built by the same firm in Calcutta. These factories have had a chequered existence, the proprietorship having changed hands several times, and the Calcutta factory is now under the management of Messrs. Lever Bros., the well known English combine. With the advent of the Swadeshi movement in 1905, however, an impetus was again given to the soap industry in India, and several factories were started, particularly in Bengal, at about that time; but most of them did not flourish for one reason or another, the failures being generally attributable to lack of technical knowledge or lack of capital or both.

The next period in which the industry established itself fairly securely was during the Great War (1914—18). The import of soap during the war and for some time afterwards was seriously restricted, but there was a large internal demand for soap, and the military requirements were considerable. It was during this period that the foundation of the industry was securely laid in the Madras Presidency as a result of the steps taken by Government to establish it, at the instance of the late Sir Frederick Nicholson. A small factory was started in the fishing village of Tanur on the Malabar Coast in 1914, which was transferred to Calicut a few years later, and at that time the new factory (Kerala Soap Institute) was built and fully equipped with modern plant; the Mysore and Hyderabad States in due course followed the example. The Kerala Soap Institute began to undertake the training of students in soap-making in 1927, and since then several batches of students from all parts of India have passed through its courses of instruction and have acquired the requisite knowledge and experience in the art of soap making. A large number of these students are now employed in private factories in India, Burma, Ceylon, and elsewhere.

Sir Frederick Nicholson, while speaking on "Soap" about 22 years ago to a Madras audience, remarked that India imported about $\frac{1}{8}$ lb. of soap per head per annum, *i.e.*, about 18,500 tons of soap per annum, worth about $\frac{3}{4}$ th of a crore of rupees, and stated that there was enormous scope for its developed use. He expressed the hope that at the rate of increase at that time, namely, some 15 per cent. per annum, the quantity required would be doubled in the next few years. This prophecy has been more than fulfilled, as, although the imports have shown a considerable decline, which will be evident from examination of the import statistics quoted below, the Indian output of soap has almost trebled; moreover most of it is consumed locally, excepting some exported to Iraq, Ceylon, Aden and other adjoining territories.

Imports.—Examination of the returns of the foreign trade of India during the past 60 years, shews that the value of the imports of soap in 1876-77 was about Rs. 3,30,000; in 1896-97 it was Rs. 11,70,000, while in 1905-06, it was about Rs. 32,00,000. In the year 1920-21 it had reached the figure of Rs. 2,04,30,000. There has subsequently been a steady decline in the import of soaps into India.

The following statement shows the quantity and value of (a) Household and laundry soap in bars or tablets, (b) Toilet soap, and (c) other sorts, imported by sea into British India (including Burma) from abroad during the five financial years ending 31st March 1937.

Type of soap.	1932-33.	1933-34.	1934-35.	1935-36.	1936-37.
	Cwts.	Cwts.	Quantity. Cwts.	Cwts.	Cwts.
(a) Household and laundry soap in bars or tablets	244,730	244,874	157,246	12,464	10,216
(b) Toilet soap	43,812	52,016	44,628	41,438	32,684
(c) Other sorts	7,799	6,523	4,933	5,615	4,692
Total ..	296,341	303,413	206,807	59,517	47,592

Type of soap.	1932-33.	1933-34.	1934-35.	1935-36.	1936-37.
	Rs.	Rs.	Value. Rs.	Rs.	Rs.
(a) Household and laundry soap in bars or tablets	48,69,170	44,40,268	30,34,320	2,89,382	2,10,473
(b) Toilet soap	30,86,666	31,97,099	31,41,979	29,66,660	23,30,622
(c) Other sorts	3,07,036	1,99,995	1,44,499	1,71,219	1,44,537
Total	82,62,872	78,37,362	63,20,798	34,27,261	26,85,632

The United Kingdom heads the list of countries supplying soaps to India, while Japan, which before the war shared only 3 per cent. of the Indian business, came to the front during and after the war. While in the year 1913-14 the import from Japan was barely 1,000 cwts., the Japanese share increased in the next few years and reached a peak in 1933, when the imports of Japanese soaps of all kinds totalled approximately 30,000 cwts.

The popularity of the Japanese soaps is now waning, however, partly due to the increases in the prices of their soaps as landed in India but chiefly on account of the indifferent quality of the soaps, particularly the toilet varieties, notwithstanding the most attractive and elegant way in which they are packed for sale, and attempts are now being made by the Japanese factories to rectify the defects, so as to hold the Indian market. The bulk of the soap imports into India from the United Kingdom consisted until very recently of household and laundry varieties; at present the import from the United Kingdom and other foreign countries is almost entirely of toilet soaps.

The present position.—In 1918, according to the statistics prepared by the Indian Munitions Board, the number of factories in India producing over 600 tons of soap per annum numbered 11 in British India, exclusive of the Indian States, and those producing below 400 tons per annum numbered 46, excluding the many small cottage establishments of a nondescript character. The total estimated output of Indian factories in 1918 was about 22,000 tons, and it was anticipated that there would be an additional output of another 15 thousand tons from factories then about to be started. The output of toilet soaps was estimated at the same time to be about 710 tons per annum. The impetus given to the soap industry in India during and after the war must be regarded as remarkable, as a large number of factories were established throughout India, while the quality of the products was greatly improved.

It has not been possible to obtain correct data as to the quantity and value of soaps now made in the various Provinces in India, as unfortunately the information received from various official and private sources does not appear to be entirely reliable. The total present output of Indian factories, inclusive of those in the Indian States is, however, estimated to be about 75,000 tons, and the number of factories, large and small, is of the order of a thousand; thus in the Madras Presidency alone there are over a hundred factories, of which about half a dozen may be considered to be of fair size, while

the rest are comparatively small. In the Bombay Presidency, Bengal, the Punjab, and the United Provinces, soap factories on modern lines have been started, and numerous smaller factories are also in existence. The factory of Messrs. Lever Bros. in Bombay, which has now been in operation for over a year, is said to be turning out about 500 tons of soap per week, mainly of washing soap, corresponding to an output of over 20,000 tons per annum.

Of the total combined annual output of the Indian factories estimated at about 75,000 tons, about 50,000 tons may be classed as household and laundry soaps, 15,000 tons as toilet soaps, and the rest, amounting to about 10,000 tons, as industrial soaps, the aggregate approximate value of each being as follows:—

	Rs.
50,000 tons of household soap, @ Rs. 400 per ton	20,000,000
15,000 tons of toilet soap, @ Rs. 750 per ton	11,250,000
10,000 tons of industrial soap, @ Rs. 300	3,000,000
Total	33,250,000

CHAPTER II.

FATS AND OILS USED FOR SOAP-MAKING.

Soap is a chemical product formed by the combination of fatty materials, or rather fatty acids, with solutions of caustic soda or caustic potash. The saponification of an oil with a solution of caustic soda or caustic potash results in soap—the sodium or potassium salt of the fatty acids. The fatty acids found in oils and fats are numerous, the important ones being the oleic, linolic, linolenic, lauric, palmitic and stearic acids. These acids react with alkali, yielding different products, thus the stearic and palmitic acids found in tallow and similar hard fats produce a hard soap, whereas the oleic acid in olive oil, or the linolenic acid in linseed oil yields a comparatively soft soap, soft to the touch and easily soluble in water. When the saponification with the caustic soda or potash solution has been effected, the glycerine present in the oil remains in the soap lyes in the case of soda soaps, whereas no such separation takes place in the case of potash or soft soaps. Saponifiable oils contain about 10 per cent. of glycerine or glycerol as it is often called.

Oils and fats form the most important raw materials, as over 60 per cent. of a genuine soap consists of fatty acids. All the oils of the vegetable and animal kingdom are suitable for making into one or other kind of soap, *i.e.*, hard or soft, according to the characteristics of the oils, but the selection of the oils to produce a particular kind of soap is determined by the comparative price of such oils and the quality of the soap to be produced, as it would be uneconomical to utilise, for example, refined tallow or purified coconut oil for making cheap household soaps, for the preparation of which any ordinary fat or low grades of coconut oil would suffice. Similarly, inferior grades and residual oils should not be used if it is planned to produce superior toilet soaps. The compounding of any mixture of oils for any particular soap should receive careful attention at the hands of the manufacturer, quality and price of the materials and of the resulting soap being the guiding factors.

Besides oils and fats, any saponifiable substance such as rosin (colophony) is suitable for the preparation of soaps, thus rosin, although dissimilar in constitution to any ordinary oil in that it contains no glycerol, contains rosin acids which are acted upon by alkali and thereby form soaps. Certain waxy substances which are only slightly saponifiable are also used in soap making, merely as super-fatting agents, however, and not as intrinsic ingredients.

New saponifiable substances are being discovered from time to time and brought into service, owing to the comparative high prices of the better known fats and oils such as prime qualities of tallow, lard, olive oil, coconut oil, sesame oil, etc., which are being increasingly used for the manufacture of margarine and vegetable butter. Due to the shortage and high price of dairy butter, the demand for butter substitutes derived from vegetable oils is increasing yearly in Europe and America, with the result that the researches of vegetable oil chemists and technologists are being directed more and more towards the refining and purification of vegetable oils to render them suitable for edible purposes. The soap maker is consequently being compelled more and more to fall back upon such oils as still defy the chemists' skill to render them edible.

There are, fortunately for the soap maker, a large variety of oils which, by reason of their peculiar constitution and properties, can only be improved or altered to suit edible requirements with considerable difficulty. Moreover, in India the output of oil seeds of different kinds is enormous, and the soap-maker in this country is in the fortunate position of being able to purchase or prepare his own oils comparatively cheaply; he has also the advantage of being able to obtain them in a fresh state and before acidity and rancidity have commenced to develop. He is therefore very favourably placed as compared with foreign soap makers, who have mainly to depend upon imports from other countries for the bulk of their requirements.

Although oils and fats are technically classified as drying, semi-drying and non-drying, they can be brought under four main heads as follows.

Group (a).—Hard or semi-hard fats and oils, such as tallow, dupa fat (*Vateria indica*), mowrah oil, palm oil, hardened oils (both vegetable oils and fish oils), which impart firmness and body to the soap and produce a soap with a fairly thick lather and moderate solubility.

Group (b).—Vegetable oils like coconut oil, palm kernel oil, etc., yielding hard soaps which lather quickly and freely due to being very soluble in water.

Group (c).—Vegetable oils such as groundnut oil, olive oil, gingelly oil, cotton seed oil, soya bean oil, etc., which yield soft-bodied soaps with weaker lathering and solubility properties than coconut oil soaps.

Group (d).—Oils like linseed oil, ganja seed oil (*Cannabis sativa*), fish oil, etc., yielding very soft and translucent soaps which are readily soluble in water.

In the following pages of this chapter, the commoner fats and oils are grouped on the basis of the above classification, and the main physical and chemical characteristics are also stated as they will be found to be of some assistance to the soap-maker in computing his costs of materials for making any particular kind of soap. Substitutions of any oil or fat can be made within a particular group without materially altering the general character of the soaps produced by the type of materials in the group.

Group (a).

Tallow—

Tallow is the principal raw material used by soap makers in Europe. It yields a hard soap of poor lathering quality, but when mixed with vegetable oils it forms an admirable base for toilet and household soaps. It is the fat obtained from various parts of sheep and oxen, but the term is now loosely applied to all hard fats of animal or vegetable origin, and includes, for example, horse tallow, fish tallow, Chinese vegetable tallow. Mutton and beef tallow are, however, the most commonly known, mutton tallow being generally somewhat harder and brighter than beef tallow, but the characteristics of the fat depend upon the source of supply and the chemical treatment it has undergone during preparation. In Europe, tallow rendering and refining are carried out on up-to-date lines and in well-equipped factories; the products obtained are of fine quality and are used chiefly for edible purposes, the lower grades, only,

being employed for industrial purposes. Australia, New Zealand, and North and South America export large quantities of tallow to other parts of the world.

In India, owing to the leanness of Indian cattle and to the mainly vegetarian diet adopted by the people, tallow is not a common article of commerce ; nevertheless there is a limited trade—mostly internal—in this commodity. Some years ago, tallow was being exported to England from Bombay, but the demand for this substance in India is now considerable and is growing steadily as a result of the development of textile, leather, soap, and other industries which require it. Unfortunately the tallow made in this country is invariably of poor quality at present, and its adulteration with such substances as starch, tapioca, rice meal, clay, etc., is not uncommon. Country tallow should therefore invariably be purified by melting and treatment with brine to remove such foreign matter before use. According to the censuses of Live Stock in India, there are about 160 million heads of cattle, *i.e.*, oxen and buffaloes, and about 40 million goats and sheep in British India and Indian States. If we assume the average annual mortality among these animals from all causes to be about 20 per cent. the number of carcasses available for fat rendering is about 40 million. Reckoning the fat available from these to be, on an average, about 1 lb. per head, the total quantity available per annum from this source is about 18,000 tons. This is only a rough estimate, but it will sufficiently indicate what an enormous source of fat lies available in this direction. No doubt most of the fat obtained from animals killed for food is utilised for domestic purposes, but there is ample scope for recovering fat from the carcasses of deceased animals, which are now left to rot in the fields. Up-to-date plant for recovering wastes of this kind might be installed with profit in several parts of India.

Tallow from goats is said to be inferior to beef tallow as a material for toilet soap making, owing to its tendency to turn rancid, but this defect is not indicated by test characteristics, which are given below, and it is therefore difficult to differentiate between them. For this reason it is advisable to use mixed tallow to produce the best results:—

	Goat tallow.	Beef tallow.
Specific gravity at 15°C.	0.937—0.953	0.945—0.952
Melting point	44—45°C.	40—45°C.
Saponification value	192—195	193—200.
Iodine value	35—46	38—46

Inferior grades of grease such as bone fat, kitchen grease, etc., are used for making low grade soaps. Fat rendering, as carried out in Europe and America, is unknown in India.

Lard, or Pig fat—

The United States of America are the largest producers of this fat. It is widely used in the manufacture of soap, but the better grades are used for the production of margarine and are also used, *per se*, for edible and culinary purposes. Lard gives a rather hard soap but one softer than that produced from tallow, as defined above, owing to its titre* being lower than that of tallow.

* The titre of a fat or an oil is the solidifying point of its fatty acids.

The fine varieties are used for the preparation of superior toilet soaps and shaving soaps. Its characteristics are as follows:—

Specific gravity at 15°C.	0.934—0.938
Melting point	36—40°C.
Saponification value	195.4
Iodine value	50—70

Chinese vegetable tallow—

This is prepared from the fruit flesh of the tree *Stillingia sebifera*, grown largely in China and also met with in India. The seeds yield stillingia oil, which has a high iodine value (160), and is used in the manufacture of paints and varnishes and as a substitute for tung oil. The solid fat is largely used in Europe for soap making, although in India it is seldom used for this purpose owing to its scarcity.

The characteristics of this vegetable fat are as follows:—

Specific gravity at 100°C./15°C.	0.8648
Melting point	37.8°C.
Saponification value	203.2
Iodine value	31.3

Dupa fat—

This fat, also known as Malabar tallow, is obtained from the seeds of *Vateria indica*, a large ever-green tree chiefly found in Mysore, South Kanara, Malabar, and Travancore. The seeds yield, on boiling with water, about 20 per cent. of a solid greenish-white fat, with a pleasant flavour and agreeable taste, which is used mainly for edible purposes in South Kanara. This fat used to be exported to Europe some years ago from Mangalore for use as a chocolate fat. Second quality fat unfit for export was used and found to make excellent toilet soap at the Kerala Soap Institute. Dupa fat, when used with soft oils, produces an excellent toilet base. A solvent extraction process, utilising benzene and trichlorethylene, was followed at a factory near Mangalore, which ceased work during the Great War; the yield of fat, when such a process is used, is of course greater than in the case of the more usual type of boiling process, but some resinous matter is invariably extracted with the oil and this necessitates slight subsequent refining. Dupa fat can replace tallow in the preparation of household and good toilet soaps. Its characteristics are given below:—

Specific gravity at 15°C.	0.915
Melting point	37°C.
Saponification value	188.7
Iodine value	37.8

Kokum fat—

This is similar in appearance and properties to dupa fat, which has been described above. It is obtained from the seeds of *Garcinia indica*, a tree which is found to a considerable extent on the West Coast of India between

Daman and Goa, and also in Travancore and Mysore, and the seeds contain about 25—30 per cent. of a solid fat. Several soap factories in Bombay use this fat instead of tallow for making washing and toilet soaps. The characteristics are as follows :—

Specific gravity at 40°C.	0.8952
Melting point	41.42°C.
Saponification value	187.191
Iodine value	33.6

Palm oil—

This is prepared from the fleshy portion of the ripe fruit of the palm tree (*Elaeis guineensis*). The tree is a native of East and West Africa, but it has been introduced into other parts of the world and attempts have recently been made to grow the tree in Cochin, Travancore, parts of the Madras Presidency and Ceylon. The oil has a yellow colour, a fairly thick consistency, and a pleasant smell recalling that of violets. It is easily bleached and the bleached oil is available in the market, though commercial varieties of the oil are sometimes adulterated. The kernel contains a different oil, with characteristics similar to coconut oil. Palm oil extracted at the Kerala Soap Institute from fruits obtained from Trichur gave the following analytical figures, the figures for the African oil being also noted for comparison :—

		Trichur.	African.
Specific gravity at 15°C.	0.923	0.9210—0.9245
Melting point	31°C.	27—42.5°C.
Saponification value	197	196—202
Iodine value	48.9	51.5

Ellupa oil (Mowrah oil)—

This oil has a semi-solid consistency and is known generally as Bassia fat in Europe, there being two or three varieties of Bassia. The tree is found in all parts of India, chiefly in small groups in the forests or on the road-side in the plains. In northern India the species commonly met with is '*butyracea*', while in central India it is '*latifolia*' and in the Madras Presidency '*longifolia*', and there are slight differences in the characteristics of the oils obtained from these different species. The oil produced in the country ghanies or expellers generally contains a certain amount of albuminous and other impurities, which, however, should be removed by refining processes, otherwise they will appear as dark spots in soaps. Mowrah oil contains a high percentage of solid fatty acids such as palmitic and stearic acids, and, as a result, the oil deposits stearine in the cold weather. This oil yields a fairly hard soap when used alone, but it is generally used in admixture with other oils. Being a semi-solid fat, it can be and is used to some extent to replace tallow in the preparation of household and toilet soaps, especially in districts where the religious tenets of the people demand that they shall use soap having a pure vegetable basis. This oil has the following characteristics :—

Specific gravity at 15°C.	0.9175
Melting point	42°C.
Saponification value	188.192
Iodine value	50.63

Pongam oil (Karanj)—

This oil is obtained from the seeds of *Pongamia glabra*, a tree which is found chiefly in central and southern India. As an ingredient of good washing soaps, this oil may be ruled out, owing to its peculiar odour and the liability of the soap to colour changes. Refining of the oil improves it to some extent, but the cost of the oil is also thereby increased. The oil is said to be good for cutaneous affections; and for making technical soaps such as soaps for saddlery and disinfectants, where colour and smell are a minor consideration, this oil can be extensively used as it yields a fairly hard soap. The characteristics are as follows:—

Specific gravity at 15°C.	0.9367
Saponification value	185.1
Iodine value	89.4

Cocculus Indicus oil—

This is the commercial synonym for the oil or fat obtained from the seeds of the shrub, *Anamirta cocculus*. The oil is of thick consistency, and batches of household and toilet soaps made from it, as a substitute for tallow, at the Kerala Soap Institute have been found satisfactory in every respect. Regular supplies of the oil are, however, not available at present. The characteristics of this oil are given below:—

Specific gravity at 20°C.	0.9258
Melting point	40°C.
Saponification value	189.8
Iodine value	47.7

Hardened oils—

Oils containing unsaturated fatty acids can be hardened to any required consistency by the process of hydrogenation, but linseed oil, groundnut oil, and fish oils, are generally used for this purpose. When subjected to this process, oils, in addition to being solidified, lose their characteristic odour, and the resulting fats also acquire a slight yellowish to white colour, depending upon the degree of refining and hardening. If oils are hardened to a melting point over 35°C., the inherent odour of the original oil may not show itself in the soap made from it. The blending of hardened oils with soft oils should be carefully performed when it is required to produce soaps of suitable hardness and lathering quality. Hardened fish oils made in Japan were popular a few years ago on account of their low price. Hardened vegetable oils are now being produced in Ernakulam and Bombay, and also in northern India. The following figures show the characteristics of typical products of this type.

	Melting point.	Saponification value.	Iodine value.
Japanese hardened fish oil 51°C.	186—189	15—16
English hardened vegetable oil 51—52°C.	189.7	14.1
Indian hardened vegetable oil 36—51°C.	188—204	16—53

Group (b).

Coconut oil (Cocos nucifera)—

Of the vegetable oils, the oil universally used by soap makers in India is coconut oil, this being used in the preparation of soaps made by all the processes. Coconut oil imparts hardness and lathering qualities to soap, and is indispensable for the production of good soap by cold processes. It should be added only in moderate quantities—say about 20 per cent.—in toilet soaps, as excess will produce irritating effects on delicate skins. Coconut oil is available in different qualities, the best being Cochin oil the second quality being the oil obtained by pressing or extracting inferior grades of copra. Ceylon is now exporting considerable quantities of coconut oil of good quality to India, as the supply from the West Coast is not enough to meet the demand.

The characteristics of good quality oil of this kind are :—

Specific gravity at 40°C.	0.9115
Saponification value..	246—260
Iodine value	8—9.5

Palm kernel oil—

This is obtained from the kernels of the African palm nut, and is entirely different from the palm oil derived from the outer fruit pulp described on page 9 above. Palm kernel oil is similar to coconut oil in its physical and chemical characteristics and is used in large quantities in Europe for soap making and for edible purposes. The percentage of oil in the kernel varies from 43 to 50, and the oil has the following characteristics :

Specific gravity at 15°C.	0.9520
Saponification value	242—250
Iodine value	13.14

Group (c).

Olive oil—

This oil is obtained from the fruit of the olive tree (*Olea europea, sativa* L.) The tree grows extensively in southern Europe and in the countries bordering on the Mediterranean Sea. Several attempts have been made to cultivate the olive tree in the North-West Frontier Province of India, hitherto with indifferent success as regards the yield of oil, although the tree grows well and thrives and the wild olive (*Olea cuspidata*), is common in the Himalayan foot-hills. Olive oil was at one time used exclusively for the manufacture of the well-known Castille soap in Europe, but mixtures of oils are now used. Olive oil soap is used as a basis for high-class dentifrices, toilet creams, and similar preparations and soft soap made from olive oil is used for pharmaceutical purposes. Owing to the very high price of good quality genuine olive oil, which is extensively used as salad oil, it is seldom used for soaps, the demand for the purpose being met by inferior grades. Its place as a soap oil has been taken by groundnut oil, and soaps made with groundnut oil have been passed off by various makers as pure olive oil soaps.

The characteristics of genuine olive oil are as follows :—

Specific gravity at 15°C.	0.916—0.918
Saponification value	185—196
Iodine value	79—88

Poovam oil (Macassar oil)—

This is another of the oils which have been successfully used for experimental soap making at the Kerala Soap Institute. It is obtained from the seeds of *Schleichera trijuga* (the Kusum tree), and a fairly hard soap is obtained from the oil. The difficulty is to secure a good and regular supply of this oil, as the trees are felled for the valuable timber. The oil is claimed to promote the growth of hair and it has the following characteristics :—

Specific gravity	0.924
Saponification value	215.3—230
Iodine value	48.3—69.1

Neem oil (Margosa oil)—

This oil is obtained from the seeds of the neem (*Melia azadirachta*)—a large tree found throughout the greater part of India and Burma. The oil is greenish brown in colour and possesses a strong garlic odour. It is prescribed by Indian physicians as a cure for skin diseases, and the oil has of late found extended application in the manufacture of neem toilet soap, which is marketed under different trade names by several soap manufacturers. The refined oil freed from impurities is generally used for the manufacture of soap, although some makers use the crude oil without preliminary treatment or purification.

The characteristics of the oil are as follows :—

Specific gravity at 16°C.	0.9142
Saponification value	195.9
Iodine value	69.6

Nahor seed oil—

This oil is obtained from the seeds of *Mesua ferrea*, a large tree found in different parts of India, particularly in Assam, and which is much valued for its timber. The seeds are rich in oil which has a slight reddish colour, due to the presence of resinous matter. The oil can be used in admixture with other oils for soap making, but the cost of collecting the seed from the forests appears to be high. This oil has the following characteristics :—

Specific gravity at 15.5°/15.5°C.	0.935
Saponification value	196—227
Iodine value	79—96

Castor oil—

This well-known oil is obtained from the seeds of the castor plant (*Ricinus communis*), which grows in many parts of India. The cold-pressed oil is colourless or of pale green colour has a characteristic smell and taste, and is used for medicinal purposes. Lower grades of the oil are obtained by second and third pressings and by extraction with solvents and these are used for technical

purposes, the colour of the oil being reddish in some cases. Owing to the peculiar characteristic smell of the oil which may revive in a cold process soap some months after its manufacture, and the large quantity of salt required for salting out in the process of soap making, this oil is used in admixtures with other oils up to 20% only. Owing to the transparency it imparts to soaps, castor oil is largely used for preparing transparent soap, the smell of the oils in the case of these preparations being well masked by the liberal use of perfumes. The characteristics are as follows:—

Specific gravity at 15·5°C.	0·9600—0·9679
Saponification value	183—186
Iodine value	83—86

Groundnut oil (Arachis oil)—

This is obtained from the seeds of *Arachis hypogaea*, the seed being variously known as groundnut, earth-nut, pea-nut or monkey-nut. Excellent edible oil is obtained from the nut by expression in the cold; the oil is nearly colourless, has an agreeable taste, and is much used as salad oil in place of olive oil. Hot pressed oils, when properly purified, can be used for edible purposes but lower grades of these are fit only for soap making. Groundnut oil forms a good basis for soaps; it gives a fairly good body, but is seldom used alone for hard soaps.

The following figures show briefly the characteristics of this oil:—

Specific gravity at 15°C.	0·917—0·920
Saponification value	185·6—194·8
Iodine value	83·3—100

Punna oil—

Punna oil is obtained from the seeds of *Calophyllum inophyllum*. This is an ever-green tree found in different parts of India, particularly in sandy and marshy localities on the east and west coasts. The oil is somewhat greenish to yellowish brown in colour, and has a peculiar odour not always pleasant. The oil contains resinous matter, which often amounts to 15%. This oil was first introduced as a soap oil by the Kerala Soap Institute about 20 years ago. The green colour is altered to yellow by the action of caustic soda. A somewhat hard soap is obtained, as the oil is fairly thick, and the soap has a peculiar smell recalling that of the oil, which is difficult to mask by cheap perfumes. The oil should therefore undergo a process of refining so as to make it lighter in colour and less odorous, but it is not worth while to use this oil unless the price of other vegetable oils such as groundnut oil is unduly high. The characteristics are as follows:—

Specific gravity at 15°C.	0·9415
Saponification value	198·7
Iodine value	95·3

Rape oil group—

Oils of the rape oil group are obtained from the various species of *Brassica*. In India such oils are indifferently called 'mustard oil,' whereas in other countries some distinction is made. Rape oil is known in Europe as Colza oil. Tori, and Sarson are common names for this oil in northern India.

Rape oil has a bright yellowish colour, and is used for edible purposes as well as for soap making. The general characteristics of this type of oil are as given below :—

Specific gravity at 15·5°C.	0·9132—0·9168
Saponification value	170—179
Iodine value	94—102

Mustard seed oil—

This oil is obtained from *Sinapis nigra*, and is used to a considerable extent in northern India for edible and soap-making purposes. In the case of this oil the characteristics are :—

Specific gravity at 30°C./30°C.	0·9110
Saponification value	176·2
Iodine value	120

Jamba oil—

This is pressed from the seeds of *Eruca sativa*, which grows largely in northern India and Sind. The oil is used as a hair oil and for soap making.

The characteristics are :—

Specific gravity at 15·5°C.	0·9154
Saponification value	172·5
Iodine value	95·4

Curcas oil, (Jungle castor oil)—

This oil is obtained from the so-called purging nut, (*Jatropha curcas* and *glandulifera*), the seed of a plant which is used for hedges in southern India and elsewhere. The oil obtained from the white soft kernels is sometimes confused with ordinary castor oil pressed from *Ricinus communis*, but curcas oil is entirely different from castor oil in its physical and chemical characteristics. The oil has been used at the Kerala Soap Institute for soap making, and yields a fairly hard soap without the bad odour associated with ordinary castor oil. The characteristics of this oil are as follows :—

Specific gravity at 15·5°C./15·5°C.	0·981—0·921
Saponification value	189—194·5
Iodine value	96—104

Maroti oil—

This is obtained from the seeds of *Hydnocarpus wightiana* a tree commonly found in the southern districts of the Madras Presidency. The Kerala Soap Institute first introduced this oil for soap making about 20 years ago. The oil is known nowadays as Indian chaulmoogra oil ; it is widely used as a remedy for leprosy, and, owing to its medicinal qualities, the use of this oil is recommended for the preparation of germicidal and disinfectant soaps. The soap obtained by using this oil is fairly hard. The oil has the following characteristics :

Specific gravity at 25°C.	0·958
Saponification value	207
Iodine value	101·3—102·5

Sesame oil, or Gingelli oil—

This oil is obtained from the seed of the plant *Sesamum indicum* (*Sesamum orientale*). In India, sesame oil is widely used for edible purposes, owing to its pleasant flavour, as a hair oil, for toilet purposes, and as lamp oil in temples. In Europe, sesame oil is an important ingredient of margarine and vegetable butters. Inferior grades are used for soap making, especially in the south of France, but in India, owing to the availability of cheaper oils, sesame oil is seldom used in the manufacture of soap, and the bazaar quality is often adulterated with groundnut oil.

The characteristics are as given below :—

Specific gravity at 15°C.	0.9230—0.9237
Saponification value	189—193
Iodine value	103—108

Cotton seed oil—

This is obtained from the seed of the various varieties of the cotton plant *Gossypium*. America, Egypt, and India are the largest producers of cotton seed, but the seeds vary considerably in their oil content and other properties according to the soil, the locality and the climatic conditions. The oil obtained by pressing the seed has a dark colour, and such oil cannot be used without refining. If the price of the refined oil falls below that of groundnut oil, it can be used economically for the manufacture of soap, otherwise there is no advantage in using the oil in India, except in places where no other cheap oil is available.

The characteristics are as follows :—

Specific gravity at 15°C.	0.9220—0.9250
Saponification value	193—195
Iodine value	108—110

Maize oil (Corn oil)—

This oil is obtained from maize or corn, and is used as an edible oil in some countries. A company has recently been formed in Calcutta to build a large maize-starch factory in the Ambala district, Punjab, and maize oil may be obtained as a bye-product and used for the manufacture of soap, as a good soap can be produced from it. The characteristics are :—

Specific gravity at 15.5°C.	0.9213—0.9253
Saponification value	188—193
Iodine value	113—125

Soya bean oil—

There are many varieties of the soya bean plant. It is indigenous to China (Manchuria), and attempts have been made with partial success to grow soya bean in central and southern India, but the present production is very small. The yield of oil from Indian seed is rather low, and even the Manchurian bean yields only about 15%. In countries where there is a scarcity of oleaginous raw materials, as in Japan, this oil may serve as a soap oil, but in India, with its variety and quantity of oil seeds the prospects of soya bean cultivation for its oil for the purpose of soap-making are doubtful. A fairly hard soap can

be produced with the oil, next only to that produced from cottonseed oil in point of hardness and it can be used also for making soft soaps. The oil has the following characteristics :—

Specific gravity at 15°C	0.9242—0.9270
Saponification value	192.7
Iodine value	121.7

Nigar seed oil—

This oil is obtained from the seeds of *Guizotia abyssinica*, which is grown on a considerable scale in India. The oil is used mainly for edible purposes, and the lower qualities are used for soap making. The characteristics of the oil are as follows :—

Specific gravity at 15.5°C./15.5°C.	0.9248—0.9263
Saponification value	188—191
Iodine value	126—138

Amoora oil—

This oil is obtained from the seeds of *Amoora rohituka*, a tree found in Bengal and elsewhere in north-eastern India and also on the Western Ghats. It is used commonly as a burning oil but of late it has been used in admixture with other oils for soap making. Its characteristics are as stated below :—

Specific gravity at 15.5°C.	0.9386
Saponification value	189.7
Iodine value	134—150

Safflower seed oil—

This oil is obtained from the seeds of *Carthamus tinctorius*. The oil is generally used for edible purposes, but is also suitable for soap making. It has the following characteristics :—

Specific gravity at 15.5°C./15.5°C.	0.9253—0.9280
Saponification value	186—192
Iodine value	130—149

Group (d).

Linseed oil—

The flax plant, *Linum usitatissimum*, from which linseed is obtained, is a native of India, Argentine, the United States of America, Russia and elsewhere. The chief uses of linseed oil are in the manufacture of paints and varnishes, linoleum, oiled fabrics, imitation leather, etc., owing to the excellent drying properties possessed by this oil. For the manufacture of soft soap there is no oil to excel linseed oil, as it yields soap of the finest quality, lustrous, transparent, and readily soluble, and 'figging' will not develop, even on storage in cold climates. The price of linseed oil precludes it, however, from use in the prepa-

ration of cheap soft soaps at present, and substitutes are employed except in the case of certain special preparations. The oil has the following general characteristics :—

Specific gravity at 15°C.	0.9315—0.9345
Saponification value	192—195
Iodine value	171—201

Ganja seed oil (Hemp seed oil)—

This oil is obtained from the seeds of *Cannabis sativa*. This seed is covered by a Government monopoly, and excess over the requirements for raising crops is pressed to produce oil by the Excise Department in Madras. The oil is of light brown colour and is similar to linseed oil in appearance and general properties. The characteristics are as follows :—

Specific gravity at 29°C.	0.9210
Saponification value	191—193
Iodine value	147.5—160

Fish oils—

Whale oil, cod liver oil, sardine oil, shark oil, etc., obtained from various marine fauna, are used in the manufacture of soap. Ordinary qualities are used for making soft soap, saddle soap and other varieties, and refined oils can be used for better classes of soap, *i.e.*, for household and domestic soaps. Deodorised and de-colourised oils, transformed into solid fats by hydrogenation processes, can be used for making superior household and toilet soaps and can be utilised to replace tallow without interfering with the lathering and other properties of the product. Hardened fish oils have a great future in India, especially in the Madras Presidency, owing to the large quantity of fish oil—sardine oil (from *Clupea longiceps*)—available in the west coast districts. According to the estimates made by the late Sir Frederick Nicholson, the quantity of oil which could be obtained from this source in a good year is about 10,000 tons. Excellent qualities of sardine oil are now being prepared by numerous private factories scattered along the Malabar Coast, but the catches of sardines have been poor of recent years, resulting in poor outturn of fish oil. Sardine oil is used for making soft soaps and insecticidal soaps, and also as a cheap raw material for paints.

The characteristics of sardine oil (*Clupea longiceps*) are :—

Specific gravity	0.9241—0.9251
Saponification value	194.7—195.9
Iodine value	165.5—173.2

Most of the important fats and oils used or usable for the manufacture of soaps in India have been described above, but the survey has not been exhaustive and with the advance of researches into the domain of oleaginous materials new sources of supply are likely to be tapped. Thus oils from tea seed, rubber seed, tung seed, and several other lesser known oil seeds are available for soap making, but only in limited quantities, and the properties and characteristics

of a number of oils from sources found in the Madras Presidency, and not hitherto used for this purpose, were determined by the author in 1910 and the results subsequently published. More recently the suitability of several other oils for the manufacture of soaps has been tested on a semi-commercial scale at the Kerala Soap Institute. In Bulletin No. 10 of the series of Bulletins of Indian Industrial Research, entitled "Indian Vegetable Oils," N. Brodie has collated information regarding the uses and detailed characteristics of almost all the Indian oil seeds so far published, and this publication forms a convenient book of reference for those interested in Indian oil seeds and oils.

Continuous investigation is required in order to bring to light the characteristics and uses of all the available oil seed resources of India, as the potentialities of these resources are immense. This is sufficiently shown by the fact that the annual production of oilseeds in India is estimated at over 5,000,000 tons the aggregate value of this being £50,000,000 and the export in an average year being equivalent in quantity and value to one third of these totals.

CHAPTER III.

ACID OILS (FATTY ACIDS).

As a result of researches on the de-glycerination of oils and fats, the use of fatty acids for the manufacture of soaps has been developed in a number of countries in place of the fixed *i.e.*, neutral oils. This involves less labour, and also the percentage of glycerine recovered is higher than is obtained by treating soap lyes. The manufacturing operations are simplified by the use of fatty acids, as the saponification process is quickened and completed within a shorter time, moreover the use of fatty acids enables sodium carbonate to be used instead of the more expensive caustic soda. It is, however, maintained by many soap makers and chemists that fatty acids do not lend themselves to the production of such high class soaps as do the neutral (fixed) oils, and that the appearance and feel of the soaps produced therefrom are also inferior. In the experience of the author, however, soaps made from fatty acids are of good appearance and can hardly be distinguished from soaps made entirely from neutral oils.

Ordinarily, only household soaps are prepared with the aid of fatty acids, toilet soaps of the best colour and appearance being made from the neutral fats and oils; but distilled fatty acids from inferior grades of oils and fats are now being used to an increasing extent in the manufacture of toilet soaps in Europe. The manufacture of soap from fatty acids has to be carefully conducted as there is considerable frothing up and boiling over, due to the liberation of carbon-dioxide, when the fatty acids combine with the soda ash lyes.

There are three processes in use commercially by which fat splitting for the production of fatty acids is carried out, namely:

1. The Autoclave process.
2. Twitchell's process.
3. The Ferment process.

By the first process mentioned above, the fats are hydrolysed under a pressure of 5 to 8 atmospheres in an autoclave in the presence of a base such as lime, magnesia or zinc oxide. The fatty acids obtained by this process are usually discoloured, but this can be avoided by reducing the pressure, which has, however, the effect of reducing the output of fatty acids.

The second process consists in the use of a sulphur aromatic compound invented by Twitchell, which hydrolyses the oil when added in small quantities not exceeding 2.5 per cent. of the weight of oils treated. The hydrolysis is effected quickly, and de-glycerination is complete within 24 to 48 hours. The fatty acids obtained by means of this process become oxidised rapidly when exposed, and the greatest care is therefore necessary to exclude air as far as possible, also they do not withstand storage satisfactorily, as they darken on keeping; batches of oil should therefore be treated to meet immediate requirements only. Twitchell fatty acids are in general use for the manufacture of ordinary soaps, both hard and soft.

The third process consists in the use of ferments for effecting the decomposition of the oil. Castor seed plays an important part in this process, owing to the peculiar properties possessed by the castor lipase or ferment in emulsifying and splitting the oil. When this method was first introduced the procedure followed was to add well-mashed castor seed to the oil, this effected hydrolysis, but the products were contaminated with the husk and albuminous substances contained in the seed. Decorticated seeds were subsequently used, but without much improvement. The hydrolysing agent, however, is now satisfactorily prepared from a mixture of well-ground castor kernel and some castor oil or cottonseed oil, the mixture being then passed through a centrifuge. The ferment mixture which forms the middle layer holds the real hydrolysing agent.

Several modifications of the process have been introduced so as to enhance the action of or to activate the lipolytic ferment. Generally approximately 5—8 per cent. of the ferment and 0.2 per cent. of manganese sulphate are introduced into the vat or pan (usually lead lined) containing the oil, and the mixture is then well agitated by air jets so as to form an emulsion. The oil should be in a liquid state and fairly warm. After the mixture has been well stirred, it is allowed to stand a day or two in order to allow fermentation to proceed. The emulsion, once formed, should not be allowed to separate, and the mixture needs careful watching in this connection. Samples of the fatty acids are taken from time to time and examined so as to ascertain the extent of hydrolysis, and when the action has reached the stage of completion, the mixture is heated by steam to a temperature of about 80°C—85°C. Strong sulphuric acid—less than 5 per cent.—is then introduced and the mixture is again agitated by air jets, after which it is allowed to stand.

A glycerine-water mixture then falls to the bottom of the vat, a clear layer of fatty acids forms on the top, and in the middle is suspended a mixture of fatty acids, glycerine, water, and the albuminous bodies contained in the oil treated. These layers are drawn off and separated by decantation, after which the middle layer is again treated to separate the fatty acids and glycerine from the other contents; for this purpose heat is applied, which breaks up the mixture and enables the separation to be readily effected.

The ferment bacillus is destroyed at temperatures above 42°C, hence solid fats of higher melting points, *e.g.*, higher than 42°C, cannot be split by this process. Judicious mixtures of oils and fats should be made so as to overcome this difficulty.

Large quantities of common oils and fats are treated in Europe, especially in Germany, by this process for the production of fatty acids and glycerine. The fatty acids obtained thereby have a much better appearance than either of the products obtained from the first two processes.

CHAPTER IV.

REFINING OF OILS.

Simple, though rough and ready, methods of refining oils and removing their rancidity are practised by most small soap factories which have a steam supply available. Thus oils can be refined and deodorised to a certain extent by blowing steam through them, and rancid oils may be neutralised to a considerable extent by treatment with caustic soda or preferably soda ash solutions, the free fatty acids content of the oil being first determined and the appropriate quantity and strength of solution being added to neutralise this.

During this neutralising operation a considerable quantity of soda soap in intimate admixture with the oil is produced, and this product, which is called soap stock, is largely used for the preparation of cheap household soaps. The removal of free fatty acids from rancid oils is of special importance in connection with the preparation of soaps by the "Cold" process, which is described in detail in Chapter VII below.

The treated oils resulting from the above operations will be found suitable for the manufacture of soaps of ordinary quality, but if the oil requires to be bleached, *i.e.*, the colour changed from yellow or dark to white or yellowish white and at the same time deodorised, more complex methods become necessary which entail the use of more complex plant and operations. There are different processes. One process may be suitable for one kind of oil, whereas quite a different process will be required for another, according to the nature, composition, and condition of the oil to be treated. It is advisable to make small-scale experiments in the laboratory and ascertain the best method before carrying it out on a commercial scale. The following methods are commonly followed:—

(i) *Clarification by Fuller's Earth.*—Oils made in the country chekkus always contain an appreciable quantity of moisture, resinous and albuminous matter, and portions of the crushed meal (poonac); on that account such oils are generally opaque and cloudy in appearance. To remove these defects and to make the oil clear and bright is a fairly easy matter. The crude oil is placed in an iron pan, preferably cylindrical shape with a conical bottom, provided with one or two exit cocks on the side and bottom. Solid impurities, if any, will settle to the bottom of the pan and can be drawn out before treatment. It is sometimes advisable and necessary to transfer the clear oil freed from sediment to another pan of similar construction and to conduct therein the further operations. Suspended impurities and mucilage, etc., will take long to settle and this is accelerated and finally completely effected by the addition of Fuller's Earth, of which 2—5 per cent. is added to the oil. The oil is then heated to about 150°F (66°C), and this temperature maintained for at least an hour, the contents of the pan being well stirred, after which they are allowed to rest for 24 hours. The Fuller's Earth will carry down with it the moisture, impurities, and foreign matter, and at the same time, by absorbing the colouring matter if any, leave the oil of fine colour and appearance. The bleached and purified oil can then be decanted or removed through the cocks, and finally filtered through a filter press if necessary. The Fuller's Earth carries down with it a certain amount of the oil, and this can be recovered either by

steaming or by extracting with solvents, but the oil thus obtained will be found to be of poor quality and fit to be used only for technical purposes. Other clarifying agents which are used are china clay, animal charcoal, etc., which have more or less similar properties.

(ii) *Refining by sulphuric acid.*—Owing to its great affinity for water, sulphuric acid exerts a powerful action on all organic bodies. If any crude vegetable or animal oil is treated with small quantities of this acid, the vegetable or animal matter found in such oils is very readily acted upon by it. Acid should be added very carefully and in small quantities only, and excess of acid should be avoided as it has a charring effect which will tell upon the quality and output of the purified oil. The oil is placed in a suitable pan, preferably lead-lined, raised to a temperature of about 110–120°F., and about 1 or 2 per cent. of strong acid, previously diluted with an equal volume of water, is added in a thin stream and the contents well stirred for a short time. Undiluted acid should never be used, nor should the quantity of acid exceed 3 per cent. of the weight of the oil to be treated. After allowing the contents to rest for a day, about 50 per cent. of warm water is added to the oil, so as to remove the excess acid, after which the oil will appear at the top and the acid water separates at the bottom. The oil is then recovered by decantation, and finally given repeated washings so as to remove the last traces of acid. The residual oil will be found to be very light in colour, devoid of much odour, and suitable for ordinary purposes. This treatment is used to purify rank fish oil, and can also be applied to several kinds of vegetable oils and animal fats.

(iii) *Bichromate of potash process.*—This consists in oxidising the impurities in the oil by means of bichromate of potash and sulphuric or hydrochloric acid. The oil to be bleached is heated to about 120°F. to 130°F., and about 1 per cent. of bichromate previously dissolved in water to form a thin solution is added. About 1½ to 2 per cent. of concentrated hydrochloric acid or sulphuric acid, diluted with an equal volume of water, is then added to the mixture, after which the whole should be well agitated for about 10–20 minutes. The reddish brown colour of the bichromate solution will change to green, when the reaction is complete, at which stage the mixture is allowed to rest for some time and finally washed free from acid and chromium salts. It may require two or three washings to remove the last traces of the green colour. This process is best suited for bleaching tallow and similar fats.

(iv) *Bleaching powder process.*—The expensive bichromate method has been substituted in some places by the bleaching powder process, which is more or less the same as the former except that only hydrochloric acid can be used with the latter. The process should be carried out cautiously and with great care, as chlorine gas, if applied in excess, will act injuriously on the oils. Ordinarily, about ½ per cent. of fresh bleaching powder will suffice, but it is found that this powder loses strength on exposure, hence quantities required should be adjusted after determining the available chlorine content of the bleaching powder which will be used. The oil is first heated as usual to 120°–130°F., and the required amount of bleaching powder mixed with two or three times its quantity of acid is added and the mixture well stirred. The chlorine gas which is evolved acts as a bleaching agent as well as a deodorizer. After

a few hours, when the reaction is completely finished, the oil is washed free from the chemical and removed as usual. In the case of off-coloured oils and fats, it is better to put them through a second treatment, as the result will be more satisfactory than that obtained by a single treatment. Chlorine bleaching is applied generally to the treatment of oils and fats which are not meant for edible purposes, as the smell and taste of chlorine is said to persist in the oil even after repeated washings.

(v) *Bleaching by means of hot air.*—This is a simple process adapted particularly for bleaching palm oil, which is deep yellow in colour. The oil to be treated is first clarified by means of sulphuric acid so as to remove any extraneous vegetable matter. The clarified oil is then transferred to a cylindrical tank, with a conical bottom and fitted with dry and wet steam coils, and heated by dry steam to a high temperature, say, about 150°—180°F. A current of air is subsequently injected into the pan by means of an air compressor and allowed to play on the heated oil for two or three hours. The oil becomes gradually bleached from yellow to white, and then looks quite a different product. For further details, the following books may be consulted :—

1. *Chemical Technology and Analysis of Oils, Fats and Waxes.* By Dr. J. Lewkowitsch, (3 vols.), Macmillan and Co., Ltd., London.
2. *Animal and Vegetable Oils, Fats and Waxes.* By Dr. G. Martin, Crosby Lockwood & Son, London, E. C. 4.
3. *Vegetable Fats and Oils* by L. E. Andes ; translated by C. Slatter, Scott, Greenwood & Son, London, E. C. 4.

CHAPTER V.

ROSIN OR COLOPHONY.

This substance is the residue left after turpentine is distilled off from the oleo-resin which exudes from the wood of certain species of pine tree. Rosin has a transparent and vitreous appearance and is very brittle; inferior grades are lacking in lustre and are only faintly transparent, in such cases the material contains a considerable amount of extraneous unsaponifiable matter. Considerable quantities of rosin were at one time imported into India from France and America, but since 1914 rosin of fine quality has been produced by factories in India, namely, the Jallo Rosin and Turpentine factories at Lahore, Punjab, and at Bareilly in the United Provinces.

Statistics relating to the quantity of rosin and turpentine imported in India, the quantity produced in India, and that exported by the Indian factories during the last 5 years, have been kindly furnished by Mr. Guest of Messrs. Guest & Co., Managing Agents of the Jallo Rosin and Turpentine Factory, and are given below.

Imports.—(Rosin and Turpentine).

Calendar year.	Rosin Cwts.	Turpentine Galls.
1932.. .. .	17,769	27,167
1933.. .. .	29,947	31,512
1934.. .. .	32,805	51,194
1935.. .. .	62,931	38,060
1936.. .. .	41,080	38,207

Year.	Production.		Indian Sales.		Exports.	
	Rosin Mds.	Turpentine Galls.	Rosin Mds.	Turpentine Galls.	Rosin Mds.	Turpentine Galls.
1932-33	1,18,042	2,72,268	1,11,255	1,39,569	28,394	2,59,747
1933-34	1,34,656	3,06,760	1,06,967	1,45,460	14,157	58,842
1934-35	1,28,061	2,92,972	1,17,788	1,35,117	15,981	1,50,080
1935-36	1,34,563	3,07,699	1,20,097	1,58,003	13,019	1,68,946
1936-37	1,25,422	2,86,199	1,52,000	1,69,000	30,000	39,000

Rosin is not a true and normal glyceride like an oil or fat, as it lacks the glycerol radical, though it is saponifiable. It has, however, come to be legitimately classed as a raw material for the manufacture of soaps, as it is readily acted upon by soda ash or caustic soda and then yields a lathering product, and is now widely used as a cheapener and also as a binding material owing to its cohesive property. Fine water-white qualities in small proportion only should be used in toilet soaps, as excess of rosin is likely to make the soap unduly adherent to the skin. It forms a useful ingredient of household soaps, as it masks by its somewhat aromatic odour, the disagreeable smell of cheap fats and greases. It is also used in transparent soaps, but should be excluded from textile and special industrial soaps and soap powders. There are several grades of rosin, such as A. 1; WW; IOG; and many others, and the characteristics vary considerably. The general characteristics of the Jallo material are as follows:—

Specific gravity at 15·5°C	1·07 to 1·08	Acid value	.. 165—175
Melting point	.. Over 100°C.	Unsaponifiable matter	.. 3—5%
Saponification value	.. 175—185		

CHAPTER VI.

CAUSTIC ALKALI, SALTS, FILLERS AND WATER.

Next in importance to oils and fats as an intrinsic ingredient in soaps is caustic alkali. Soaps produced commercially contain caustic soda or caustic potash and soda ash, and the development of the soap industry has followed the discoveries and improvements effected in the manufacture of alkalis.

Caustic Soda—

The Le Blanc process of converting sodium chloride or common salt into caustic soda was the most important, and this method of manufacture was the only one in use for a long time. This process involved three stages, namely, (1) the conversion of sodium chloride into sodium sulphate, (2) the preparation of crude sodium carbonate or black ash from sodium sulphate, by heating with coal and limestone, (3) the manufacture of caustic soda from the soda ash obtained from (2).

Subsequently, however, other processes have been developed, the chief of these being the Solvay process, in which bicarbonate of soda is prepared from common salt and ammonia in the presence of carbonic acid gas, the soda obtained from this being known as ammonia soda. This process is largely employed in many alkali works, in England, Europe and America. These processes are not within the reach of small soap makers, but they are able to purchase finished caustic soda or prepare their own caustic liquor from soda ash, which is available for purchase in a high state of purity.

Caustic soda is now largely prepared by the electrolytic process from brine. It is best for small soap factories to buy solid caustic soda, which is sold in different strengths and forms, flake solid and powder, and put up in convenient packages from 1 lb. to 10 cwts. The grade or quality of the substance is marked on the drums or easily ascertained by simple tests.

Caustic soda is sold in different grades or strengths, namely 60°, 70°, 74°, 76°—77°, these grades indicating in each case the percentage of sodium oxide contained therein; thus 76-77° caustic soda, the highest grade, contains about 100% of sodium hydroxide, 74° about 95.5%, 70° about 90.32%, and 60° about 77.5%. Soap factories which have to depend upon imported caustic soda find it advantageous and economical to use the higher strengths, as sea and railway freights and other incidental charges are the same for a low grade as for a high grade material of equal weight or measurement.

Inferior grades contain impurities and extraneous substances such as chloride, carbonate and sulphate of soda, which are simply thrown out with the lyes or lost on boiling. The quantities of lower grades of caustic soda equivalent to one ton of pure 76-77° caustic soda are as follows:—

	Cwts qr. lbs.									
74°	20	2	19
70°	21	3	12
60°	25	2	0

The percentages of sodium hydroxide held by lyes prepared from different grades of caustic soda are shown in the table at Appendix A.

Caustic soda can be made from soda ash (sodium carbonate) by soap factories which are able to obtain cheap and plentiful supplies of lime and soda ash of good quality, as the plant required is fairly simple. Since the caustic soda is used in the form of a solution, the commercial quality requires to be dissolved in water, and this entails a certain amount of labour for breaking the material, as received, into small pieces. The caustic soda prepared from soda ash is produced, however, in a dilute form, and this can be used straight away for certain soaps and in a slightly more concentrated form for the preparation of cold process soaps, which require stronger lyes. The cost of concentrating the caustic liquor to obtain it in solid form, and the labour and other charges for dissolving it at the soap factory, can be eliminated and appreciable saving thereby effected. It is therefore advantageous for a factory to prepare its own caustic liquor from soda ash—especially if it is to obtain the other materials required at favourable rates.

During the Great War, when caustic soda from England was unobtainable the Kerala Soap Institute made its own caustic soda from soda ash, which could be imported though at prohibitive prices, and a few cottage factories also resorted to this practice. It frequently happened in these cases, however, that the calcium carbonate was not separated but used with the lyes and added to the materials in the soap pan, thus contaminating the soap with this undesirable compound.

A crude and rather unsatisfactory but easy method of preparing caustic lyes is to spread alternate layers of quicklime and soda ash in a tank, and then allow water to percolate through the mass. Chemical action then takes place between the two substances, producing caustic soda liquor. The quantities of materials required should be calculated with reference to the strength of the soda ash and that of the lime used. The lyes collect at the bottom and are run out through a cock, but they are likely to be contaminated with particles of free lime and soda ash. The boiling method of causticising soda ash is superior to the other processes. Most of the caustic soda used by Indian soap factories is imported.

In India, a crude form of sodium carbonate is found in certain parts of central and northern India as incrustations and efflorescent deposits on 'Usar' lands. Such deposits are known as "Reh" or "Sajji Matti". They contain widely varying mixtures of sodium carbonate, sodium sulphate, sodium chloride, sand, and other substances. The soluble matter forms about 5 to 15 per cent. of the whole mass, which in its turn contains about 85 to 90% of sodium carbonate; bad samples contain more of sodium sulphate and chloride and less of carbonate. Soda ash is prepared from those deposits by a series of lixiviating and settling operations, whereby the clear soluble matter is recovered. The sodium carbonate is crystallised out of the sodium chloride and sodium sulphate, and the sodium sulphate on being heated with lime and charcoal, yields a crude form of soda ash which can be lixiviated to produce sodium carbonate. This process has been found, however, to be uneconomical.

About 20,000 tons of caustic soda, of the value of about Rs. 42 lakhs, are imported annually into India, most of which is consumed by soap factories, and the imports of this substance have been steadily increasing during recent years. With the establishment of factories in India by the Mettur Chemical and Industrial Corporation, Ltd., and Messrs. Imperial Chemical Industries, Ltd., and other firms which are contemplating manufacturing it, however, it is to be anticipated that imports will decrease.

Caustic Potash—

Potassium carbonate, obtained from sea-weeds and other vegetable substances, was the alkali employed by soap makers in the early days of the soap industry. The carbonate was converted into caustic potash by the action of lime, and this was used for saponifying crude fats, the resultant soap being partly turned to soda soap in the process of salting out with common salt. At the present time, the ashes from land and marine plants provide about one half of the total output of potash, and Canada and Germany produce large quantities from these sources. Potash is also obtained from potassium sulphate produced by the decomposition of the natural chloride with sulphuric acid. Other sources of potash are the beet-root, molasses, suint or exudation from the wool of sheep, and several forms of silicates containing potash salts. The Stassfurt deposits of Germany consist mainly of chloride of potassium and chloride of magnesium, and these are present in enormous quantities yielding annually many thousands of tons of caustic potash. The potassium chloride is leached and precipitated, and is then converted into the form of carbonate, from which, by the action of lime, caustic potash is prepared.

Potash is used largely for the preparation of soft soap, and to a limited extent in the preparation of toilet soaps, shaving soaps, and liquid soaps. Pearl ash, which is the trade name for potassium carbonate, is added to improve the transparency and smoothness of soaps.

Common Salt—

Salt or sodium chloride plays an important part in soap manufacture. It is added either in the solid state or as solution at the appropriate stage of soap preparation in order to effect separation of the impurities and glycerine, as ordinary soaps are insoluble in salt solutions. Salt is also added as a filler to coconut oil soaps, owing to its low price. Salt is prepared from sea-water in large quantities in India, but magnesium chloride and other substances are found in admixture with sodium chloride in sea-water and these require to be removed by settling and precipitation, in order to obtain the sodium chloride in a sufficiently pure state. It is essential that the salt used for soap manufacture is not contaminated with magnesium chloride, as the latter substance is a prime cause of sweating in soaps. Most of the salt used in the soap-making process is recovered in the subsequent process of glycerine refining, and is then available for re-use.

The percentage of salt contained in different strengths of brine is given in the table at Appendix B.

Fillers—

Other materials, though not essential for the production of soaps, are often added to increase the detergent qualities or to act as filling substances, substances of this kind being sodium and potassium silicate, borax, talc and glauher's salt. Of these, sodium silicate or water glass is widely used, this substance being obtained by the fusion of fine sand with caustic soda or soda ash at a high temperature. The commercial article is a thick viscous liquid of about 60°Bé, of the following composition :—

	Per cent.
Silica	32·0 to 33·0
Soda	16·0 to 16·5
Other soda salts	2·5 to 3·0
Water	48·0 to 49·0

The silicate has an alkaline reaction and should be used in small quantities only, in good washing soaps. A small percentage of sodium silicate and sodium carbonate improves the hardening and detergent qualities of the soap, but larger quantities are mainly added to make weight. The soap is rendered wasteful in use if unduly loaded with such substances.

Water—

A supply of good water is most necessary for soap manufacture and should be available in the soap factory. The water should be as free as possible from salts of lime and magnesia, as insoluble soaps will be formed by the combination of such salts with soda soaps and will result in much unnecessary waste of material.



PLATE 1.
The cold process room—
— Kerala Soap Institute, Calicut,

CHAPTER VII.

SOAP MANUFACTURING PROCESSES.

Three processes for the manufacture of soap are practised in India. These are the following :—

1. The " Cold " Process, including the Modified " Cold " Process.
2. The " Semi-boiling " Process.
3. The " Boiling " Process.

The " Cold " Process.

The " cold " process, as the name implies, does not require the application of heat at any stage, the operations being carried out at the ordinary air temperature of about 90°F—120°F. The plant required is cheap and of the simplest description, usually comprising a small pan, preferably of iron, and a small cooling frame or box made of wood or iron. The size of the frame most suitable is one capable of holding about 2 to 2½ cwts. of soap, and is broad and shallow instead of narrow and deep. The frames used at the Kerala Soap Institute for this process are 21" long, 15½" broad and 19" deep, and these have been found, by experience, to be the most suitable size. The sides are secured by means of screws and bolts, and they fit properly on to a bottom plate arranged so as to make the assembled frame water-tight. For convenience in moving the frame, four wheels are provided. The soap pan is made of cast or wrought iron, those in use at the Kerala Soap Institute being made of cast-iron, 31" diameter and 24½" deep, and holding about 500 lbs. of materials.

The oil *par excellence* for making cold process soap is coconut oil, as this oil and other oils of this group (*vide* Chapter II) possess the property of combining with strong solutions of caustic soda at ordinary atmospheric temperatures, the resultant product being a hard soap. This oil has not only the property of readily uniting with caustic soda, but also of inducing other oils and fats to become saponifiable in the cold, and this property, therefore, is utilised to enable other oils such as groundnut, castor, mowrah, etc., and tallow, to be used in the manufacture of soaps by this process. The addition of such oils should, however, be limited to certain proportions compatible with the hardness, odour and other properties of the required product. Generally speaking, about 50% of oils other than coconut oil can be added, but in good practice smaller percentages are used.

The following description indicates the procedure followed in this process. The correctly weighed quantity of oil or mixture of oils is transferred into the pan, and a solution of caustic soda of 36°Bè—38°Bè strength—the exact quantity required being ascertained by reference to the saponification value of the oil or mixture of oils used—is then gradually run into the pan with the aid of a ladle, after which the contents are well stirred by means of a small wooden bat. The temperature of the oil may be anything between 75°F and 120°F, but if it is much above 120°F, there will be considerable difficulty in effecting combination, as the oil then has a tendency to separate from the caustic lye.

Coconut oil is fluid at ordinary temperatures in the plains of India, but when solid and semi-solid fats are to be used, such as tallow, mowrah oil, etc., these should be brought into a liquid condition so as to facilitate saponification. Such fats may be melted in different containers and brought to the mixing pan or, if sufficiently pure and free from impurities, can be melted in the mixing pan itself, in which case suitable heating arrangements should be provided and the pan mounted on a masonry foundation, with a suitable fireplace to burn wood or coal.

The temperature of the caustic lye should not differ very much from that of the oil used, for if too cold it might chill the oil, and if too hot it may not combine with the oil at all or will do so only after much delay.

When the contents of the pan have been stirred for a few minutes, a thick emulsion forms, indicating that the required combination is taking place, and at this stage the contents are transferred to the frame by means of ladles, stirring being continued in the frame to ensure proper inter-action of the materials. Perfumes and colouring materials, if required, are usually added to the contents of the pan before the mixture is transferred to the frame.

When the contents of the pan have been completely transferred and well stirred in the frame, the mass will thicken in consistency, and at this stage the frame should be covered with a lid and allowed to stand without further disturbance. Chemical action then takes place with evolution of heat, the temperature of the mixture rising to about 180°F in the course of a few hours, and saponification is complete within 24 hours and sometimes within a shorter period. Usually the frame is then allowed to rest for one day, after which the sides of the frame are removed and the soap is cut into slabs and cakes, and finally stamped.

If the oils and fats are rancid, then the combination of the alkali with the oil takes place rapidly, on account of the avidity of the free fatty acids for caustic alkali. In that case, the saponification will be imperfect and irregular, due to portions of the caustic lye being entangled in the mixture side by side with some unsaponified oil. In order to obtain satisfactory results it is therefore necessary that the fatty materials used should not be rancid; a slight acidity in the oil is, however, somewhat advantageous as it assists in starting saponification, since completely neutral oils take a longer time to combine with the alkali. When the oils are rancid, the extent of the acidity should be ascertained by analysis, and the oil freed of its excess of free fatty acids by treatment with the required quantity of caustic soda solution or preferably that of soda ash (sodium carbonate), after which the refined oil can be used with satisfactory results.

Since no separation of the glycerine is effected by means of salt in this process, and as all the materials added are retained in the soap, it is imperative that they should be as free as possible from dirt and impurities. Moreover, as already stated, the temperature of the oils should initially never exceed 120°F, as otherwise combination will be difficult or even practically impossible to effect. The stirring of the oil and caustic soda solution mixture should be carried out slowly and carefully, as too vigorous an action tends to prevent saponification, by separating the oil and caustic lye into two layers.

Although this process seems simple and within the easy reach of every one, it can cause considerable trouble if attention is not paid to the manipulative details. In fact it is so simple that untrained workers generally do not appreciate the importance of detail, with the result that the soaps turned out by them are often of indifferent quality. If a slight excess of caustic soda is left in the soap, it will be very harmful to clothes or the skin, and if there is a deficiency of caustic, the result is equally bad, as unsaponified oil makes the product greasy and liable to turn rancid, on keeping, within a short period of time. The cold process enables unscrupulous persons to turn out adulterated soaps, as water and worthless filling materials can be readily incorporated with the soap since coconut oil has the property of making such soaps hard. Soaps have in fact been made and put on the market which contain less than 10% fatty acids, the rest being mostly water, carbonate and silicate of soda, talc, starch, etc., most of which substances are useless as cleansing agents; such soaps are merely "water made to stand up-right", and the poor quality can be judged by the fact that genuine soap contains about 60% of fatty acids.

Pure soaps of the type of "Vegetol" soap, made by the Kerala Soap Institute from coconut oil, can be used even as toilet soaps. The soaps made from coconut oil have the unique property of lathering in hard and brackish waters, as such soaps dissolve appreciably in such waters, unlike soaps made from other oils and tallow. Coconut oil soaps can therefore be used satisfactorily in localities where ordinary soaps are almost useless, but on the other hand the coconut oil soap will lather too freely in soft waters and may occasionally be very wasteful under such conditions.

Cold process soap containing coconut oil is liable to sweat when exposed to humid atmosphere, due partly to the constitution of the fatty acids and to the glycerine retained in the soap. What might also be regarded as a further disadvantage is the loss of glycerine, which is a valuable by-product; oils and fats contain usually about 10% of glycerine—coconut oil contains 12% and this is not recovered. A point for consideration is that since coconut oil is the principal oil used, the soap maker will be handicapped if, for any reason, this oil is not available owing to its high price, as he would then either have to stop making good soap or resort to adulteration.

The chief advantages of this process lie in the cheapness of the plant required and the simplicity and the quickness of the operations. Whereas to finish a soap by the boiling process takes about a week to ten days, it requires only a day or two by the cold process, the capital required is small, and small quantities of soap, say 1 cwt. or less, can be economically turned out, this being impossible by any other process. Where there is no plant to recover the glycerine, the cold process is the most suitable, since all the glycerine will be left in the soap thus adding to its weight, whereas in the case of boiled soaps it is removed with the lyes. The popularity of this process is, however, waning owing to the difficulty of obtaining cheap oils, and liability of the soaps produced by it to turn bad unless great care is taken during manufacture. There is, moreover, not much demand for cold process soaps for toilet purposes, since the market is now glutted with perfectly milled and agreeably scented soaps which are more durable and satisfactory.

A few recipes for making cold process soaps are given below : perfumes may be added as required :—

	Lbs.		Lbs.
(1) Coconut oil	80	(5) Coconut oil	50
Maroti oil	20	Tallow	50
NaOH solution, 38°Bé ..	53	NaOH solution, 38° Bé ..	49
(2) Coconut oil	60	(6) Coconut oil	70
Mowrah oil	20	Hardened vegetable oil ..	20
Groundnut oil	20	Groundnut oil	10
NaOH solution, 38°Bé ..	50	NaOH solution, 38°Bé ..	51
(3) Coconut oil	75	(7) Coconut oil	60
Castor oil	15	Soya bean oil	20
Groundnut oil	10	Mustard oil	10
NaOH solution, 38°Bé ..	52	Jungle castor oil	10
(4) Coconut oil	50	NaOH solution, 38°Bé ..	49½
Tallow, mixed	30	(8) Mowrah oil	50
Cotton seed oil, refined ..	10	Coconut oil	35
Mowrah oil	10	Groundnut oil	15
NaOH solution, 38°Bé ..	49	NaOH solution, 38°Bé ..	46

Modified "Cold" Process—

Ordinarily, rosin is not used as an ingredient in cold process soaps, owing to certain difficulties experienced in mixing it and the patchy appearance it imparts to the soap. The process therefore requires to be modified to produce suitable results when rosin is to be used. In that case the rosin is melted with the oil stock, any impurities present being removed by straining through cloth, after which caustic lye is added of the required strength and quantity and the contents of the pan kept well stirred. Solutions of silicate of soda, carbonate of soda and other filling materials can be mixed with the caustic lyes before they are added to the oil-rosin mixture, or these can be added after the mixture has become somewhat thickened. Fairly good qualities of laundry soap, carbolie soap, etc., of good appearance can be made by this process, and a few recipes for making such modified "cold" process soaps are given below :—

	Lbs.		Lbs.
(1) Mowrah oil	50	(4) Mowrah oil	30
Coconut oil	40	Coconut oil	20
Rosin	10	Castor oil	15
NaOH solution, 38°Bé ..	47½	Punna oil (<i>Calophyllum</i>	
Silicate of soda	1	<i>inophyllum</i>)	10
Water	6	Groundnut oil	10
(2) Coconut oil	30	Rosin	15
Pongam oil	30	NaOH solution, 38°Bé ..	44
Groundnut oil	20	Soda ash	2
Mowrah oil	10	Water	10
Rosin	10	(5) Mowrah oil	30
NaOH solution, 38°Bé ..	46	Coconut oil	20
(3) Cotton seed oil	30	Groundnut oil	20
Coconut oil	20	Maroti oil	10
Tallow	20	Pongam oil	10
Soya bean oil	20	Rosin	10
Rosin	10	NaOH solution, 38°Bé ..	45
NaOH solution, 38°Bé ..	45	Silicate of soda	2
Silicate of soda	2	Water	8
Water	8	NaOH solution, 38°Bé ..	45



PLATE 2.
The semi-boiling process room—
—Kerala Soap Institute, Calicut.

The "Semi-boiling" Process.

In this process, the materials used are subjected to heating either by open fire or by steam for a short time, but the process differs from the "boiling" process in that the operations are finished within a few hours, and also the process does not include a salting out operation for the separation of the glycerine. This process is generally employed for making cheap filled soaps, and due to the fact that the materials are heated, large quantities of soap can be turned out. It differs, therefore, from the cold process in the following respects:—

1. The oils and alkali are subjected to heat for about 3 to 6 hours.
2. The materials used need not contain any coconut oil, but generally some coconut oil is added.
3. Fatty acids can be employed, whereas in the cold process, the fatty materials require to be almost neutral.
4. Much larger quantities of soap can be made at a time than is possible in the case of the cold process.
5. The soaps turned out are seldom used for toilet purposes.
6. Rosin can be added in fairly large quantities.

The plant required is somewhat more elaborate and larger than is needed in the case of the cold process, and the pan, kettle, or copper as it is technically termed, should be of a much larger size, constructed preferably of wrought iron plates, although cast iron pans were originally used and are still employed by some makers. When no steam supply is available and the pans have to be heated by fire, they must be suitably mounted on masonry supports fitted with fire-place and the necessary flues, chimney, etc., but where steam is available, provision requires to be made for passing both wet and dry steam. The capacity of the pan may be anything from 5 cwts. to 50 tons, and it has been found that fair sized ones, say of 5, 10, or 20 tons capacity, are easier to operate and more economical than smaller sizes.

The oils are stored in overhead tanks provided with gauges to indicate the quantities in each of them, and the oils are run into the pan by means of pipes or shoots connected to the bottoms of the tanks. The contents are brought to the boil, after which caustic lye of the required strength, kept ready at hand in tanks, is also let in as required, together with water in the necessary quantity. Within a short time saponification commences, and boiling is then suspended for a short interval to allow saponification to develop. Boiling is repeated and sometimes continued for 3 or 4 hours until samples taken out and tested are found to be right. Colours may be added during the boiling operation, especially in the last stages of the boil, and also perfumes, and where any perfume materials are to be added, the temperature of the soap should first be allowed to fall to about 160°F to 170°F. Filling materials, such as silicate and carbonate of soda, salt, talc, and similar substances, may be added in any desired quantity; usually these are boiled in, but may also be mixed in a crutching machine such as is described below in the description of the "boiling" process.

The soap is allowed to repose in the pan for a day or two, and then placed in frames to set. The frames are of different sizes, usually having a capacity of about 10 to 12 cwts. each, and being made of cast or wrought iron and also of wood. A description of these is given below. The subsequent operations of slabbing, barring, cutting and stamping are similar to those described in connection with the "boiling" process below.

Perfectly good laundry soaps can be made by this process but highly adulterated soaps can likewise be prepared. A large variety of cheap yellow bar soaps made in India come under the latter category, and as these contain excess of water and other filling materials they lack the ability to keep satisfactorily for any length of time; such bars shrink and distort considerably due to the evaporation of moisture, and also develop white efflorescent crystals if excess of alkaline salts is present in the soap. Low grade soaps made by this process have been analysed and found to contain as low as 10% of fatty acids. Glycerine contained in the oils is not recovered and remains in the soap.

The materials used should be comparatively free from dirt and impurities, as there is no separation of these by salting out. In this connection it may be mentioned that if colour of some sort is to be added, it will mask a certain amount of dirt. Several recipes for making soaps by this process are given below. In this connection it is of interest to note that soft soaps are generally made by this process.

	Lbs.		Lbs.
(1) Coconut oil	50	(5) Hardened vegetable oil ..	30
Mowrah oil	20	Coconut oil	30
Groundnut oil	20	Pongam oil	30
Rosin	10	Rosin	10
NaOH solution, 38°Bé ..	49	NaOH solution, 38°Bé ..	46
Soda ash	8	Soda ash	8
(2) Coconut oil	100	Sodium silicate	4
NaOH solution, 38°Bé ..	56	(6) Coconut oil	40
Soda ash	4	Punna oil	10
(3) Tallow	30	Margosa oil	10
Coconut oil	20	Mowrah oil	10
Cotton seed oil	20	Maroti oil	10
Castor oil	15	Rosin	10
Rosin	15	Croton oil	10
NaOH solution, 38°Bé ..	45	NaOH solution, 38°Bé ..	48
Soda ash	6	Soda ash	8
Sodium silicate	6		
(4) Mowrah oil	30		
Coconut oil	20		
Groundnut oil	15		
Maroti oil	15		
Macassar oil (Kusum) ..	10		
Rosin	10		
NaOH solution, 38°Bé ..	46		
Soda ash	5		
Sodium silicate	10		

Soft soaps—

	Lbs.		Lbs.
(1) Linseed oil	100	(5) Sardine oil	60
K ₂ O solution, 35°Bé ..	57	Rosin	10
K ₂ CO ₃ (Pearl ash) ..	2	Punna oil	10
(dissolved in 8 lbs. of water).		Groundnut oil	20
(2) Linseed oil	70	NaOH solution, 38°Bé ..	24
Fish (sardine) oil ..	30	KOH solution, 35°Bé ..	25
KOH solution, 35°Bé ..	57		
K ₂ CO ₃ (Pearl ash) ..	2		
(dissolved in 8 lbs. of water).			
(3) Groundnut oil	60	(6) Sesame oil	20
Sesame oil	25	Amoora oil	15
Rosin	15	Linseed oil	40
NaOH solution, 38° Bé ..	20	Castor oil	15
KOH solution, 35°Bé ..	30	Rosin	10
(4) Linseed oil	45	KOH solution, 35°Bé ..	56
Ganja seed oil	40	K ₂ CO ₃ (Pearl ash) ..	3
Rosin	15		
NaOH solution 38°Bé ..	41		

Pot Moulded Soap—Dacca Soap—

This crude soap has been made in Bengal and other Provinces of India for a very long time, and is popular in many households. It is made by the "semi-boiling" process—in small iron pots—from various oils and fats, and sometimes the soap produced is salted out. Specimen soaps produced by this method which the author has seen were in no way comparable with well made boiled soaps. The fat charge was made apparently without regard to the odour left on clothes washed with soaps containing such fats, while the process of manufacture witnessed was laborious and uneconomical.

The method employed comprises the following operations. Oils and fats are boiled with caustic soda lyes in iron pans of anything between 3 and 10 cwts. capacity, and after the oils are considered to be adequately saponified the soap is salted out to separate the glycerine and impurities as far as possible. The mass of soap is then allowed to cool for some time, to allow the lyes to separate and sink, after which the soap is ladled into small earthen pots where it cools rapidly. The next day the soap is taken out with a knife or spoon and the surface smoothed, no cutting, stamping or other finishing operation being employed.

Almost invariably such soaps are heavily adulterated with fillings, the fillings being added in a separate pan into which the soap from the first pan is emptied. Here silicate of soda, soap-stone, starch, and such substances are added and the mixture boiled over a gentle fire. When the soap is finished it is transferred to pots or frames as the case may be.

The best soaps of this class contain 40—50% of fatty acids, while the cheapest varieties such as are sold in some of the markets of Bengal and Assam are reported to have only 4—5% of fatty acid content. Such soaps are decidedly wasteful, and even the best varieties are most imperfectly made and

finished from the point of view of modern pan practice and in comparison with well boiled laundry soaps. The salting outoperation, as conducted by people without adequate knowledge of soap boiling, is a sheer waste of time and material, as a better class of soap can be easily made by the ordinary semi-boiling process, and in less time. Some of the best pot moulded soaps examined by the writer have contained as much as 5% of salt, when the permissible minimum in a good laundry soap is below 0.5%. Moreover, the high salt content renders such soaps highly hygroscopic, this being a serious defect in any soap.

Ball Soap--

Ball soap is made in and around Bombay from mowrah oil and coconut oil. It is highly silicated and is more or less of the same class as pot moulded soap containing about 20% of fatty matter. The soap is made by the semi-boiling process, and when finished, one man scoops out about 2—4 oz. of the hot soap and throws it on a scale while others provided with cotton gloves sit near by and take one portion at a time, blow on it, roll, and rotate it till it assumes the shape of a ball, after which a boy presses a monogram thereon to imprint the name or mark. The product is then ready for the market.

The "Boiling" Process.

Unlike the other two processes described above, indefinite quantities of materials and caustic lye can be mixed together in the preliminary stage of this process, as the operations are completely under the control of the soap boiler, who can judge the condition of the soap as it forms during boiling in the pan by its appearance, feel, and taste. Almost all vegetable and animal oils and fats can be utilised for making boiled soaps, and usually a mixture of oils or oils and fats is used, dependent upon the prices of the oils and fats, and on the hardness and other qualities of the soap required to be produced.

For household soaps, tallow, cotton seed oil, mowrah oil, groundnut oil, coconut oil, etc., in different proportions is used. Coconut oil imparts a lathering quality to such soaps and also hardness. Rosin or colophony is invariably employed as an ingredient in household soaps, primarily as a cheapener, due to the fact that rosin of ordinary quality is almost the cheapest raw material available to the soap maker. Moreover, rosin acts as a binder of the materials and also imparts to the finished soap the property of remaining reasonably soft and plastic in storage, while at the same time it increases the lathering and detergent properties of the soap to some extent. When rancid or bad smelling fats are used the piny odour of rosin counteracts the bad odour to some extent.

In the process of boiling the soap, salt is added to separate the excess of water and also the glycerine in the soap paste, and consequently any dirt or impurities present in the oils are partially removed in the spent and half spent lyes, the rest being left in suspension in the nigre*. This process therefore permits the use of oils and fats which may not be free from impurities, but nevertheless it is advan-

* Nigre is the liquor which separates in the pan and settles at the bottom on completion of the boiling process. It contains the greater portion of the impurities originally present in the raw materials, together with solutions of salt, soda, and caustic soda.

tageous to use only pure materials, as the outturn of soap will be reduced in proportion to the foreign matter present in the stock used.

For making a toilet soap base, special care should be taken to employ only first class materials, but rancid or dirty oils and fats may be utilised after being refined. When rosin is added, this should not ordinarily exceed 10% of the weight of the stock, and only the water-white quality should be used, as darker varieties of rosin will impart a slight dark brown colour to the base and cause dark specks to appear in the finished soap, moreover excess of rosin will make the soap sticky.

Toilet soaps can be made by this method without using any animal fat, as there are several kinds of vegetable fats such as dupa fat, kokum butter, mowrah oil, Chinese vegetable tallow, and hardened vegetable oils from which a choice can be made. The higher the melting-point of the fat used the harder and more durable the soap is, by reason of its weak solubility and corresponding decrease in lathering property. If, on the other hand, a high percentage of liquid oils is used, including coconut oil, the soap produced, though hard to the touch, will lather profusely and wear out quickly. The skill of the soap maker lies in so blending the oils and fats that the cost of the materials is not lost sight of, while at the same time the products turned out are satisfactory as regards price, hardness, durability, lathering qualities, and other desirable characteristics.

The plant and machinery required for making hard soaps, including toilet soap, is elaborate and expensive. The main item is the soap pan which is known in the industry as a 'copper', as the original soap pans were made of copper, though pans made of cast iron were also in vogue. These pans are mounted on masonry foundations and fitted with fire-places and flues to transmit the heat uniformly to the pan; open fire heating has several disadvantages, thus the pans sometimes crack owing to over-heating and there is considerable difficulty in controlling the boiling, and should the heat be excessive, the soap may boil over and cause injury to persons around. Steam boiling is to be preferred and is now followed in all modern factories. With the aid of steam the heat supply to the pan can be properly regulated, and the capacity of the pan can be increased, while its shape may be oval, rectangular, or cylindrical. Wet and dry steam coils are fitted to such pans so that the operations can be conveniently carried out. Dry steam is essential for making certain classes of soaps, such as curd and mottle, and plain pipe-coils with suitable outlets for condensed steam are provided for its supply, whereas in the case of the wet steam supply the pipe-coils are perforated at intervals so as to enable the steam to pass out into the liquid contents of the pan and be condensed thereby. The pans are almost invariably of rivetted steel plate construction.

The boiling operations are conducted in the following manner. The fats and oils are brought to a liquid state and gradually run into a pan along with a weak solution of caustic soda of about 11°Bé, after which the mixture in the pan is boiled by means of the steam supply or the fire. Within a short time, emulsification takes place and a thin paste forms. A slightly stronger lye may now be added, and more of the oils may be introduced.

When the mixture has boiled for some time, samples are taken out at intervals and tested, generally by means of feel and taste; thus if the sample is hard

and sticks somewhat to the fingers it is a sign that saponification is progressing, whereas if it is soft and greasy and does not give a bite to the tongue on tasting, it is an indication that more lyes should be added. On the other hand, if the mixture runs out on a trowel in detached portions it shows the presence of excess caustic, in which case more oil should be run in. Experience alone will indicate when the entire stock has been 'killed', which is the technical term for the completion of combination of the oil with the lye.

When this stage has been reached, water is added at intervals to the pan to keep the soap in a pasty condition, and some salt is also sprinkled during the boiling. When all the oils have been added and the saponification is completed, more salt, or preferably brine of sp. gr. 24°Bé (saturated), is added gradually to the mixture and the steam again turned on, the purpose of this being to 'cut' the soap so as to remove the excess of moisture, separate out dirt and impurities, and, more especially, to separate the glycerine which has hitherto been mixed with the soap. The quantity of salt to be added depends on several factors such as the nature of the oils used and the percentage of water in the soap, thus coconut oil requires more salt than other oils due to coconut oil soaps being appreciably soluble in weak brine, but usually the quantity of salt required is about 10% of the weight of the fatty materials employed. The salt or brine should be added gradually, and sufficient time allowed for it to dissolve. Too much salt should be avoided, as this will cause the soap to be 'cut' into thick curds which will interfere with the proper saponification of further batches of oil which are admitted before the soap first formed is removed, and with the succeeding operations.

If a sample taken on a small trowel shows patches of soap on the surface leaving a clear solution, it is an indication that the soap has been properly 'cut' but the operation should not be brought to the 'cut' stage until it is certain that no free alkali is present. When the soap is properly 'cut', steam is shut off and the contents of the pan are allowed to rest for 2 or 3 hours. The clear soap, containing about 40% of water, will meanwhile have separated, while the spent lyes, containing most of the glycerine present in the oils and also any carbonate and impurities in the lyes and much of the salt, will have settled at the bottom. The causticity of the lyes should be tested, and if by any chance it is excessive the lyes may be used for saponifying a further batch of oil; the presence of too much salt in the lyes is, however, a disadvantage, as it tends to retard saponification.

If the causticity is normal the lyes are drained from the pan and run into special tanks called spent lye tanks, and thence transferred to the glycerine recovery room for further treatment. More oil is then admitted to the pan and saponified by a repetition of the first operation, sufficient quantity of water being added from time to time so that the mixture does not get too lumpy; at the same time too much water should be avoided as otherwise the soap will be much diluted and will require the addition of more salt than is necessary under ordinary circumstances.

If rosin is to be added this is generally done when all the oils have been saponified and the spent lyes removed, as otherwise the lyes will be contaminated with the impurities and colouring matter present in the rosin.

After all the stock has been 'killed' and the spent lyes removed, the mixture is put through what is called the 'strength' operation, the purpose of this being to ensure that the oil or fat has been thoroughly saponified. Caustic lye of about 12-15°Be' is gradually run in, and the contents of the pan then kept in vigorous boil for about 2 to 3 hours with repeated alternative additions of caustic lye and water, the soap being meanwhile tested every now and then to see that it gives a good bite to the tongue, and eventually the clear lyes should separate out from the soap. Stronger lyes may be added to effect this result.

These lyes are known as 'half spent' lyes as they contain some unspent caustic soda, and also most of the salt which has been added in the course of the operations. Such lyes are generally stored and re-used for killing further stock of oil for second quality soaps.

The next operation is the most important and is called finishing or 'fitting'. After the half spent lyes are removed, the steam is again turned on and the soap boiled vigorously. The contents of the pan should assume a homogeneous appearance and gradually rise if in proper condition. Small samples are taken on a trowel and if correctly finished, the soap will slip off the trowel at two or three points when the latter is tilted into a slanting position without sticking to the metallic surface. If, however, the soap breaks up into several small portions and lyes are visible on the surfaces of these, the soap should be again boiled, with further addition of water if necessary. On the other hand, if particles of soap stick to the trowel and spread out in pasty patches, it is an indication that excess water is present, in which case strong lyes, about 25°Bé, may be judiciously added to the contents of the pan so as to effect separation of the excess of water; brine may also be added for the same purpose.

When the finishing or "fitting" has been carefully and satisfactorily completed, the pan is covered up and allowed to remain undisturbed, the time allowed for resting depending upon the size of the pan and the quality of the soap required; thus if the quantity of soap is only about 3 to 10 tons, one or two days' rest will be sufficient, whereas for larger quantities about 3 to 4 days and sometimes a week should be allowed.

When the lid is eventually removed, the level of the soap will be found to have gone down considerably, although towards the end of the "fitting" operation the level of the soap may have approached the top of the pan. It will be found that the soap will have separated into the following three layers in the pan:—

1. A top layer of thin brittle soap or 'fob', which is produced by the air bubbles entangled with the soap endeavouring to escape.
2. A middle layer of good or 'neat' soap, which will occupy about $\frac{1}{4}$ ths of the depth of the pan.
3. A bottom layer of impure soap or 'nigre' which holds all the impurities present in the original materials together with solution of salt, carbonate, and some caustic soda.

If the 'fit' is too "coarse", the quantity of soap obtained is larger and coarser than if the 'fit' is "close", i.e., completed with an excess of water. If the fit is too close or fine the soap will be very fine but of small outturn, with a

proportionate increase in the 'nigre'. The experience of the soap boiler should guide him in the matter of giving the correct 'fit', as soaps require different treatments in this respect.

The 'fob' and top layer of soap are removed, leaving below a clear translucent mass of soap. This is either taken out by means of a swivel pipe attached to the pan, or through cocks suitably arranged on the sides of the pan. Generally the soap is run into crutchers, which are placed underneath the pan for this purpose, or it is raised by means of buckets and put into the crutchers.

The crutcher or mixing machine is a very convenient piece of apparatus which enables the soap maker to add and incorporate colouring matter, perfumes and fillings with the soap. Sometimes the soap is run straight into frames and crutched in the frames, but this method is usually unsatisfactory as hand crutching cannot effect proper admixture of the materials added. The crutcher is usually a wrought iron pot, about 10 to 12 cwts. capacity and fitted with a set of paddles arranged in such a way as to effect thorough mixing when the paddles are set in motion, these being usually driven by means of a small engine attached to the side of the crutcher. To keep the soap in a soft condition and thereby facilitate the absorption of the perfumes and colouring matter uniformly, the crutcher is provided with a steam jacket. When the soap has been properly crutched, it is emptied out of the crutcher into cooling frames placed underneath.

The frames were originally made of cast iron, but frames constructed of this metal are now giving place to frames made of wrought iron plates, which are considerably lighter and easier to handle. The dimensions of the frames ordinarily used are 45 inches long and 15 inches broad, and about 50 inches to 60 inches high, but these can be altered to suit any special requirements. Wooden frames are also much used, the frame being built up of several sections of rectangular boxes all held together by long iron rods, the ends of which are screwed and provided with bolts to enable the sections to be held tightly together. In this way frames to the height of 20 ft. to 30 ft. can be made, but such frames are used only for special soaps such as mottled varieties, which require long settling.

The soap remains in the frame from 3 to 7 days and even longer, so as to cool and solidify, and when the soap is firm, the bolts and frame sections are removed, revealing a big block of soap. Such blocks are generally about 10 to 12 cwts. in weight, and to facilitate the cutting of these into slabs of the required thickness, a mark is made by means of a gauge, lines are drawn, and a steel wire held by two men is passed through this line, thereby cutting the soap into neat flat slabs. The slabs are then removed and stored for a few days so as to harden, especially when they are too soft to be cut into bars immediately, after which the slabs are cut into bars in suitable bar cutting machines, a typical example of which is shown in Plate No. 3. The machine consists essentially of a set of steel wires through which the slab of soap is made to pass by turning the handle of a wheel, the slab being thereby cut into bars of the required measurements. These bars can be subsequently cut into smaller portions or cakes by passing these again through another set of wires arranged suitably as shown. When the soap is freshly

cut, it is soft and sticky and will not take a clear impression when stamped, and it is therefore necessary to dry the bars or cakes by exposing them to warm dry air. The temperature of the air should be such that it does not exceed the melting point of the soap, and there should be free ventilation to remove the moisture.

Special steam heated drying chambers are also used, fitted with racks for stacking the bars and cakes, exhaust fans being usually provided to facilitate the removal of moisture from the chamber. When steam is not available, slow combustion stoves burning firewood or charcoal can be used, the heat being communicated to the soaps by means of pipes radiating from the stoves. By these means, the moisture is made to evaporate from the surface of the soap, making it outwardly dry and hard, and when in this condition, which will be attained usually within two or three days, the bars or cakes are stamped.

Stamping may be carried out by means of wooden-hand stampers, on which may be fixed a plate showing the trade-name of the soap and the name of the manufacturer, these being struck against the bar of soap to produce a clear impression. Various forms of stamping machines may also be obtained, arranged to be worked by hand as well as by power. The bar or tablet can be made in different sizes; the household bar soaps are generally sold in bars of $1\frac{1}{2}$ to 3 lbs. in weight, and better quantities in 8 oz. and 4 oz. twin tablets and smaller akes. Household soaps of the Marseilles type, in 8 oz. and 4 oz. cubes, have recently been introduced by several factories in India.

Toilet soaps, which are harder than household soaps, require more powerful presses for stamping. Power presses are best suited for this class of work, as the output can be increased, and the tablets will have a glossy appearance.

CHAPTER VIII.

TOILET AND WASHING SOAPS.

There are many varieties of soaps such as curd, mottled, soft, textile, powder, shaving, liquid, shampoo, transparent, disinfectant, medicated, insecticidal, etc., used for special purposes, which it is not the intention of the author to discuss in detail. It may, however, be mentioned that they can be prepared by any of the processes above described, with suitable modifications. The process of preparing milled toilet soaps, which are becoming increasingly popular in India, is, however, of general interest and a detailed description of suitable methods of preparation is therefore given.

Only the best class of materials should be used in the preparation of toilet soaps and the soap should be finished with great care. The base substance should be as free as possible from free alkali and unsaponified fat, salt, and other chemicals and impurities. The soap is taken out of the pan in the usual manner and allowed to cool in the frame, after which the block of soap is cut into slabs and bars. The bars are slightly dried by exposure for a few days, and then cut into chips or shreds as explained below. A milled toilet soap differs primarily from an ordinary household soap in its water content, thus whereas the percentage of water in household soap is about 30, a toilet soap of the milled quality contains barely 10 to 12%, which accounts for its hardness and durability. The purpose of cutting the soap into chips is to facilitate removal of the moisture, as a larger surface is exposed and drying is more uniform than is the case when the soap is dried in the bar form.

The chipping is effected by a machine consisting essentially of sets of knife cutters, which are fixed to a disc so that the bar of soap as it comes in contact with the cutters of the revolving disc is cut into small strips. These chips are collected and put on racks to be dried in a drying chamber, which is usually fitted with a steam coil and ventilating fans; but the chips can be dried also with the aid of the sun, in which case the chips are spread on mats placed on a barbeque, which is a platform made of bamboo poles tied together, and exposure for a day is sufficient to dry the chips satisfactorily. Care should be taken not to expose the chips to the direct rays of the sun, lest they soften by excessive heat. The required temperature should be ascertained with reference to the melting-point of the oils used and also that of the soap to be dried.

The next operation is the mixing of perfume and colour with the chips, and this is generally effected in a roller mill, which consists of contiguous cylindrical rollers made of steel or granite, granite being more satisfactory though rustless steel is now being largely used. The chips, together with the colour and perfume material, are run through a hopper from which they drop down on to the rollers and are carried round thereby for a considerable time, as a result of which the soap and added ingredients get thoroughly ground together into a homogeneous paste. The soap paste is then cut by a sharp serrated knife into thin ribbons or shavings as it issues from the last roller, the shavings being transferred to a "plodding" machine or squeezer where they are compacted by high pressure which may be 3,000 to 4,000 lbs. per square inch. The soap eventually is forced out through the nozzle of the machine in the form of a hard smooth bar, which is cut into any desired length, the shape of the bar being



PLATE 4.

**The toilet soap milling room ;
showing a shaving milling machine, and a plodder—
—Kerala Soap Institute, Calicut.**

determined by a detachable mouth-piece attached to the nozzle, which may be round, oval or rectangular. The bar is then cut up by means of a cutting machine to form cakes of the required size, and these are finally stamped. A good appearance is most essential in the case of a toilet soap cake, and the greatest attention should therefore be given to the stamping and packing. Well run soap factories in India are able to produce excellent specimens of toilet soaps, the tablets being of appropriate shapes and the wrappers and boxes of the most attractive designs.

In large factories, where time and space are important factors to be constantly borne in mind and where the output of toilet soaps may be in terms of tons per week, the various operations of chipping, drying, and milling, etc., are combined into one by means of a special plant such as that invented and manufactured by Messrs. A. & E. Des Cressonières, a Belgian firm. By means of a plant of this kind, the milled soap is ready for the squeezer in about 5 to 6 hours after the soap is removed from the soap pan, thus saving several days of work.

The perfumes to be used for scenting toilet soaps require to be selected with great care. Several firms of perfumers specialise in soap perfumery compounds, and it is well worth while for a small soap factory to purchase such compounds direct. Where the output is large, however, and economy is to be effected, it is preferable to blend compounds from the large range of essential oils and synthetic chemicals available for this purpose.

The colouring of toilet soaps is another important matter which requires to be studied, for it is essential that the colour as well as the perfume should, as far as possible, match the characteristics of the flower or the substance after which the soap may be named. A wide range of aniline dyes which will give any desired shade are now available at comparatively small cost, and only very small quantities of such colours, say 2—6 grams, are required for colouring 1 cwt. of soap.

A number of recipes for the preparation of washing soaps and also toilet soaps by means of the fully boiled and settled process just described are quoted below :—

Washing soap type.

(1) Mowrah oil	35 parts.	(3) Coconut oil	35 parts.
Coconut oil	25 "	Vegetable tallow	20 "
Tallow	10 "	Groundnut oil	15 "
Cotton seed oil	10 "	Pongam oil	10 "
Rosin	12 "	Gingelly oil	5 "
Groundnut oil	8 "	Rosin	15 "
NaOH solution, 38° Be'	45 "	NaOH solution, 38° Be'	46 "
(2) Coconut oil	20 parts.	(4) Coconut oil	30 parts.
Maroti oil	20 "	Hardened oil	20 "
Mowrah oil	20 "	Mowrah oil	20 "
Pongam oil	10 "	Castor oil	5 "
Macassar oil	10 "	Margosa oil	5 "
Castor oil	10 "	Punna oil	5 "
Rosin	10 "	Rosin	15 "
NaOH solution, 38° Be'	45 "	NaOH solution, 38° Be'	35 "

(5) Coconut oil 30 parts.	(6) Coconut oil 20 parts.
Mowrah oil 30 "	Palm oil 20 "
Groundnut oil 9 "	Mesua ferrea oil 15 "
Tallow 9 "	Mowrah oil 15 "
Curcas oil 6 "	Punna oil 10 "
Rosin 16 "	Groundnut oil 10 "
NaOH solution, 38°Be' .. 45 "	Rosin 10 "
	NaOH solution, 38°Be' .. 44 "

Toilet soap type.

(1) Tallow 70 parts.	(3) Mowrah oil 40 parts.
Coconut oil 25 "	Coconut oil 30 "
Rosin 5 "	Hardened oil 25 "
NaOH solution, 38°Be' .. 46 "	Rosin 5 "
	NaOH solution, 38°Be' .. 46 "
(2) Hardened oil 50 "	(4) Tallow 40 "
Coconut oil 45 "	Coconut oil 20 "
Rosin 5 "	Mowrah oil 30 "
NaOH solution, 38°Be' .. 48 "	Other Oils such as castor, groundnut, gingelly .. 7 "
	Rosin 3 "
	Caustic soda, solid .. 14.6 "

NOTE.—In all the above formulae, the quantities of caustic soda which have been specified are the theoretically calculated amounts; in actual practice, however, extra quantities are required to make up for losses in the preliminary operations.

CHAPTER IX.

RECOVERY OF GLYCERINE.

Intimately connected with soap manufacture is the recovery and refining of glycerine, a substance which is present in all saponifiable oils and fats. The following table shows the percentage of glycerine in some of the common oils and fats :—

Coconut oil	12·1
Palm kernel oil	11·7
Olive oil	10—11
Groundnut oil	10—11
Gingelly oil	10
Tallow	9—10
Cotton seed oil	9·5
Linseed oil	9·4
Castor oil	9·1
Fish oil	9·5

The glycerine is found in the spent lyes, after the oils have been saponified and the soap 'cut' by means of brine or salt. The percentage of the glycerine content varies according to the number of brine washes to which the soap has been subjected, but about 4% of glycerine may be taken as an average content in the spent lyes, the remainder being water, sodium chloride, sodium carbonate, and traces of caustic soda. To remove all these impurities the lyes are heated and neutralised with acid, and then concentrated in a vacuum evaporator which is provided with a salt box, so as to enable the salt which separates during evaporation to be recovered and re-used. The recovered glycerine is in a crude state and of a dark brown colour, and may consist of approximately 80—84% of glycerine, 10-11% of inorganic salts, mainly sodium chloride, and the rest water and a small amount of organic matter. The crude glycerine is subsequently distilled in special distilling plants, and certain superior grades known as commercial, dynamite, and chemically pure glycerine are produced. The chemically pure quality has a specific gravity of 1·260, and is entirely free from impurities.

A crude glycerine plant attached to the Kerala Soap Institute was worked to the full capacity during the Great War, but after the war, it fell into disuse owing to the fall in the price of glycerine and the high cost of evaporation. Manufacturing conditions at present are favourable, however, as there is a keen demand in Europe for all grades of glycerine at remunerative rates, and a number of soap factories in India have already installed glycerine plants for the production of both crude and distilled qualities. The Tata Oil Mills Co., Ltd., at Tatapuram, Cochin, are reported to be working a plant to the maximum capacity (about 20 tons per month) and are considering the installation of additional plant. A crude glycerine plant has recently been installed at the Mysore Government Soap Factory, and the plant at the Kerala Soap Institute is also being again brought into commission. Messrs. Lever Bros., at Bombay, are

reported to be refining and distilling glycerine, but particulars regarding their output and plans are not available. It is also said that several factories in Calcutta are working up their glycerine lyes.

There is always a demand in India for dynamite glycerine from the Government Cordite Factories and for other grades for industrial and medicinal purposes, most or all of which are at present imported. The recovery of glycerine is not a matter which can be undertaken economically by small soap factories, but they could arrange to sell their partly evaporated (in the sun) lyes to a central refinery which would help to improve their profits. The present moment is most opportune for soap factories in India to take concerted action in this respect.

At the beginning of 1936, English quotations for glycerine were as follows:—Crude, 80%, £37 to £38 per ton; and chemically pure, sp. gr. 1.260, £52.10 f. o. b. British ports; those for intermediate grades being in proportion. The prices have since steadily advanced owing to the war clouds in Europe, and at present they are as follow:—

80%, crude, £63 to £65.

Chemically pure, £102 to £104.

CHAPTER X.

PROBLEMS CONNECTED WITH SOAP MANUFACTURE IN INDIA.

There are three main problems on which development work and research are necessary in order to enable improvements to be effected in the products of the industry. These three problems are :—

1. The selection of soap stock.
2. The cause and cure of sweating of soaps.
3. The cause and cure of rancidity in soaps.

Selection of Soap Stock.

Much progress has been made in the manufacture of soap, as the industry is now guided and operated on a fairly sound technical basis, moreover the technique is comparatively simple as compared with that in many other branches of industry. The simplicity of the processes has, on the other hand, brought within the fold of soap-makers a large number of uneducated and untrained men who employ crude rule-of-thumb methods. The ordinary worker—the bazaarman—almost invariably adopts the cold process and the semi-boiling process as these involve practically no outlay on plant, thus small tin pots and wooden cases are all that is necessary to enable him to make small batches of soap, and he needs to use only a few oils which are readily available locally or can be bought cheaply from outside. Moreover, he has no regard for the quality of the products, all that he is concerned with being the profit he may be able to make, if necessary by grossly adulterating his product.

To those who have had no training in the art of soap making, especially with reference to the materials to be used for the preparation of various soaps, the only guide—which at best is arbitrary—is the theory propounded by Webb, from which was evolved the I. N. S. Factor and the Solubility Ratio. These certainly give partial guidance as regards the choice of materials, but cannot be applied blindly, as they are largely based on empirical data provided by certain stocks commonly used by soap makers. When dealing with oils and allied substances outside the range of those which provided this empirical data, these factors prove misleading, particularly is this the case when hardened oils are used in place of tallow for the manufacture of both household and toilet soaps. What is needed is a revision of the system based on the above theory, and this can only be carried out after closely studying the behaviour of all the common oils and fats used for various soaps. The results of such an examination could then be made available to all soap makers, to guide them in the choice of materials.

The hardness of the soap and certain other physical characteristics may be controlled by following such theories, but these are not the only desirable characteristics in soap, thus smell, lathering quality, sweating tendency, durability, etc., are more important. For instance even refined Punna oil (*Calophyllum inophyllum*), Pongam oil (*Pongamia glabra*), maroti oil (*Hydnocarpus wightiana*), and others impart a bad smell to soaps, although additions of such stock may satisfy Webb's criterion. The "Hardness Number"

is another factor which some workers have elaborated, but this also is unreliable as a guide to the selection of fat stock. In this connection it may be mentioned that the author receives many enquiries from persons interested in soap making requesting information as to where olive oil, palm oil, lard, etc., may be obtained, as these are mentioned in foreign text books as raw materials for soaps. In India, however, one can get suitable substitutes at cheaper rates, thus groundnut oil can ordinarily take the place of olive oil, similarly mowrah oil and other semi-solid oils can replace palm oil and lard. The physical and chemical characteristics of the various oils should be carefully noted, as they form the principal guide in the selection of stock.

The cause and cure of sweating of soaps.

Various theories have been propounded and published in the technical press in connection with this defect. All soaps sweat when exposed to humid weather, and the writer has found this to be the case at Calicut whether the soap is of Indian or foreign manufacture, and whether it is household soap or toilet soap. Differences in the degree of sweating are, however, a common experience. Soaps containing glycerine are liable to sweat more than those containing little or none of this substance. 'Vegetol' soap, made from coconut oil by the cold process whereby the whole of the glycerine is retained in the soap, sweats profusely during rainy seasons, whereas boiled soaps, like 'Washwell', 'Sunlight', and toilet soaps, sweat only after continuous exposure for a number of days. Soaps wrapped in butter-paper or oiled paper and outer covers resist sweating for some time, and those kept away from moisture seldom sweat.

The presence in the soap of salt and free caustic alkali, which are highly hygroscopic substances, is conducive to sweating, while excess moisture also tends to the same result.

The percentage of magnesium salts in common salt has been found to play an important part in connection with this tendency, and as most of the salt produced on the coastal regions in India from sea water is not entirely separated from the "bitterns", it is evident that the salt supplied to soap factories is not always free from magnesium chloride. Various brands of Indian and foreign salts have been tested as regards this point at the Kerala Soap Institute, and the minimum percentage of $MgCl_2$ content found in samples was 0.2, the sample having this low magnesium chloride content being a Cheshire salt. The lowest percentage found in an Indian salt was 0.7, whereas the highest figure recorded in an Indian salt was 3.03 per cent. Unless great care is taken in the manufacturing operations, in the case of Indian salts, the product from the salt pans is likely to be contaminated with a high percentage of $MgCl_2$, and special precautions therefore require to be taken to ensure that this is abstracted to as great an extent as possible and the salt adequately purified. Rock salt is likely to prove the best for soap manufacture, owing to its comparative freedom from magnesium salt.

The fact that soaps of foreign makes of good quality do not sweat to an excessive degree can be attributed principally to the superior quality of the

salt used in their production, to their careful packing, and also to the dry condition of the soaps, particularly toilet soaps, when packed.

Some attribute the sweating of soap to the presence of salts of unsaturated fatty acids in the soap. Thus one observer who analysed an isolated sample of soap sweat found it to contain 24.22 per cent. of moisture, as compared with a moisture content of 23.07 per cent. in the soap itself. The petroleum ether extract of the sweat was 6.99 per cent., the fatty acids were found to be unsaturated, and the soap in the sweat amounted to more than 50 per cent.

It can be definitely stated that the hygroscopic property of a soap is in direct proportion to its solubility. Consequently the more liquid and unsaturated the fatty acids are, the greater the tendency to sweating, and *vice versa*.

On the other hand, certain chemists hold the view that sweating is due to the exudation of moisture from within the soap itself. This theory is questionable, if one considers the case of soaps in a dry condition, as the hard skin or surface crust of soap prevents the moisture inside the soap from penetrating through to the outside. If soap, originally dry, has been exposed, however, and has absorbed outside moisture, the exterior of the soap becomes softened, and it is then possible for the internal moisture to escape through the softened crust.

It will be evident, therefore, that sweating to a greater or less extent is unavoidable, but the tendency can be minimised if suitable precautions are taken during the appropriate manufacturing operations. There are at present no known means whereby a tendency to considerable sweating can be eradicated in the case of cold process soaps made from vegetable oils, particularly coconut oil. In the case of boiled soaps, however, the tendency to sweating is less pronounced, partly due to the fact that the glycerine is removed by the repeated operation of washing the soap with brine. Thus soaps made in factories where glycerine is recovered only contain traces of glycerine, and one principal cause of sweating is thereby eliminated.

Samples of soaps—laundry and toilet types—from various sources tested at the Kerala Institute Laboratory contained percentages of salt as shown below :—

English laundry soap	0.38	0.45	0.55	
English and Foreign toilet soaps	0.14	0.31	0.35	0.37
Indian laundry soap	0.46	0.52	0.65	0.76
			3.4	3.5	4.9	
Indian toilet soap	0.20	0.34	0.35	0.43
			0.49	0.41	0.47	

It will be noticed that the English and Indian made laundry soaps and a few brands of Indian toilet soaps contain a comparatively high percentage

of salt. The small percentage of salt in the English and foreign toilet soaps is attributable to :—

- (a) The larger percentage of semi-solid fats such as tallow used in such soaps.
- (b) The better quality of salt used—salt free from magnesium salts.
- (c) The elimination of glycerine by repeated washings.

The percentages of salt in well made laundry soaps, both Indian and foreign, are generally similar, but certain Bengal moulded soaps were found to contain unduly large amounts of salt, *viz.*, 3.4 to 4.9 per cent., due to inherent defect in their manufacture. Most superior laundry soaps are made from oil stock, occasionally pale bar soaps are found which have a tallow-rosin composition. Some of the soaps prepared from the lower fatty acids—especially of coconut oil—are soluble in weak brine, hence heavy salting is required to effect adequate graining of the soap; consequently the finished soap retains a larger percentage of salt than is the case when the charge is a mixture mainly of hard fats with lesser proportions of oils, such as is universally used for the manufacture of toilet soaps.

In the case of soaps made by semi-boiling processes, in which no separation of glycerine is effected by the operation of graining the soap, sweating invariably occurs, though to a smaller extent than in the case of cold process soaps.

Soaps containing caustic potash are also found to have a greater tendency to sweat than soaps prepared with soda. Potash soaps are chiefly confined to soft soaps, and not ordinarily used for toilet purposes, however, and hence the defect in the case of this class of soaps is of lesser importance.

The cause and cure of rancidity in soaps.

Rancidity is of common occurrence in badly made soaps, and even well made soaps are occasionally found with this defect. Rancidity develops as a result of the oxidation of the unsaturated fatty acids at the double bonds, followed by the combined action of water and ozone on the already oxidised acids, resulting in the formation of aldehydes and ketones. Traces of metallic salts, especially those of copper and iron, and active light rays together with moisture and bacteria greatly accelerate the reaction.

The chief causes of rancidity are :—

- (1) the presence of traces of metallic salts, such as those of copper, cobalt, iron and nickel derived either from the soap boiling pans, frames, stamping dies, pipes conveying water and steam, from hydrogenated fats due to incomplete removal of the catalyst, or from sodium hydroxide ;
- (2) the use of rancid oils and fats ;
- (3) the inclusion of a large proportion of oils containing unsaturated fatty acids ;
- (4) incomplete or improper saponification ;

- (5) excessive exposure of the soap to light and air ;
- (6) careless drying of soap chips ;
- (7) the action of carbon-dioxide in the air while the soap is being dried ;
- (8) the acidic nature of certain perfumes ;
- (9) the temperature effect during storage ;
- (10) the considerable amount of unsaponifiable matter present in certain oils such as mowrah oil, if used in the crude state.

In the majority of cases, all or most of the above factors must be acting conjointly ; hence the cause of rancidity cannot be attributed to any particular factor.

The best remedy is, of course, prevention, and the soap maker should therefore study the predisposing causes of rancidity and pay special attention to avoiding them. The following points are important :—

- (1) the proper choice of materials—the stock should be as free from unsaturated and rancid oils as possible ; rosin in small quantities acts as a preventer ;
- (2) thorough saponification—some free alkali being left in the soap if necessary, instead of free fat ;
- (3) complete elimination of metallic salts—this can be effected by the use of chromium plated pans, frames, and dies, especially in the case of toilet soaps ; this is not, however, within the easy reach of small soap makers,
- (4) the protection of soap from light, air, and carbon dioxide.

Certain *anti*-oxidants have been tried and are claimed to be partly successful. These include the following substances :—

Sodium Thiosulphate.

Sodium Sulphite.

Sodium Benzoate.

Borax.

Aminosulphonic acid.

Lecithin.

Methylhydroxybenzoate.

Hexamethylenetetramine.

Sodium chlorate.

Titanium oxide.

Glycerine and Trisodium phosphate.

Semicarbazide hydrochloride and sodium stearate.

Hydrazine sulphate.

Hydroxylamine hydrochloride.

Synthetic camphor.

Gossypol (from cotton seed).

CHAPTER XI.

ESSENTIAL OILS, AUXILIARY INDUSTRIES AND RESEARCH.

Essential Oils.—In the matter of essential oils for scents and perfumes, sandalwood oil, geranium oil, vetivert oil, palmarosa oil, linaloe (Mexican quality) oil, citronella oil, lemon grass oil, eucalyptus oil and others are now produced and distilled in India. Factories have been started in different parts of the country to distil other available perfumery raw materials and also to manufacture certain synthetic aromatic chemicals. Such of the synthetic substances as cannot be made in India will have to continue to be imported, but they form only a small fraction of the soap makers' requirements and much can be done to develop the production of essential oils in India, as will be evident from comparison of the following statistics of imports and exports.

Statistics of imports of Essential Oils into India.

	1934-35.	1935-36.	1936-37.
Quantity ..	59,718 gallons.	67,164 gallons.	54,355 gallons.
Value..	Rs. 12,58,983	Rs. 15,43,278	Rs. 14,43,469

Statistics of exports of essential Oils from India.

Quantity ..	98,896 gallons	123,521 gallons.	Sandalwood oil 124 124,619 lbs.
			Other sorts of essential oils 101,711 galls.
Value ..	Rs. 24,64,308	Rs. 27,12,013	Rs. 24,68,375.

The United Kingdom's share of the imports of essential oils into India is about 20 per cent. of the total. On the other hand, India exports about 60,000 gallons of essential oils every year to the United Kingdom.

An impetus has been given to the cultivation of essential oil yielding plants and trees in different parts of the country, due to the increasing demand for essential oils for use in the soap and perfumery industry.

Auxiliary Industries.—The development of the indigenous soap industry has undoubtedly stimulated various subsidiary industries in the country, of which the following may be mentioned—

- (a) oil seed crushing,
- (b) manufacture of paper and paste board for wrappers, cartons boxes, etc.,
- (c) the printing trade engaged in producing attractive labels, posters and advertisement literature,
- (d) the timber trade and sawing industry; considerable amounts of soft wood are consumed for making packing cases, etc.

Another noteworthy feature is the improvement in the construction of soap plants and the manufacture of accessories such as dies for stamping soaps. A few workshops, especially in south India, have begun to specialise in the production of soap machinery for soap milling and other operations, and their machines can stand comparison with foreign makes, both as regards price and quality of design and workmanship.

Research.—At the instance of the Industrial Research Council, an Oils and Soap Committee, consisting of technical representatives of the Government of India and also of Provincial and State Governments concerned, was formed to survey the research work which has been conducted in India in the past and also that in progress on fatty oils, soaps, and essential oils, and secondly to make recommendations as regards the co-ordination of such research and in particular on the allocation of future research to suitable centres.

This Committee submitted its report to the Industrial Research Council in June 1936. It showed that a considerable amount of work in connection with the soap-making industry and its indigenous oils and fats had been carried out in the past. It also recommended that researches on a number of subjects connected with the soap-making industry should be initiated, and made proposals regarding the allocation of this work to various Government and State Laboratories. These subjects included the following:—

- (a) The rancidity of oils.
- (b) The study of sulphonated oils (castor, fish, *til*, and groundnut) and their use in soaps.
- (c) The splitting of oils (both by Twichell's and the Autoclave processes).
- (d) The preparation of polymerised oils.
- (e) The study of decolourisers and adsorbents.
- (f) The selection of soap-stocks.
- (g) Investigations on the causes and cures of sweating of soaps.
- (h) The causes and cures of rancidity in soaps.
- (i) The study of the detergency of soaps.
- (j) Soap perfumes.
- (k) Essential oils.

A considerable proportion of this work has been already taken up by the laboratories to which the investigations were allotted, and the progress made is considered periodically by the Industrial Research Council. It is to be hoped that in view of the industrial importance of this work, every effort will be made to improve the existing facilities for carrying out investigations of this kind in India.

CHAPTER XII.

PRESENT PRICES, QUALITY AND PROSPECTS.

Prices.—There has been a wide fluctuation in the prices of imported soaps, both household and toilet types, during the past 25 years. Thus in the year before the Great War, the c.i.f. price of “all soaps together” (mainly household and washing types) was about £1-7-0 per cwt., and this reached £2-13-0 in 1917-18. Subsequently the prices declined, as a result of the reduction in prices of raw materials on the one hand and the competition of Indian made soaps on the other. The best class of imported washing soap, packed in cartons, was selling about 20 years ago at Rs. 45 per cwt. whereas the prices are now bordering on Rs. 25 per cwt., which represents a drop of nearly 45% in the wholesale price. The price of household soap imported from the United Kingdom was Rs. 23 per cwt. in 1934, with slight variations in the succeeding years. Japanese washing soaps were selling a year ago in Indian bazaars at Rs. 12 per case of 144-8 oz. twin tablets.

As regards toilet soaps, the result has been that high class English toilet soap which used to be sold at about Rs. 1-6-0 a box of 3 cakes, is now available at about Re. 0-14-0 a box. Japanese soaps of similar weight are now available at 6 to 8 annas a box. Japan is still exporting small quantities of toilet soaps to India, the wholesale price averaging Rs. 30 per cwt., while the average wholesale price of toilet soaps imported from the United Kingdom is about Rs. 80 per cwt.

Quality.—The quality of most of the Indian made soaps prior to the year 1915 was anything but satisfactory, as the factories in India were run by men who had received no instruction in the art of soap making. Washing soaps were generally grossly adulterated with water, and also with carbonate and silicate of soda. Such soaps, it is regrettable to say, are still being made in many parts of India, either owing to lack of knowledge or by design. There are several imported brands of washing soaps which also must be regarded as grossly adulterated, as the fatty (soapy) matter forms only about 20 per cent. of the total, the rest being mere fillings. Such liquored soaps lose their weight by the loss of water as they dry, and simultaneously suffer severe distortion.

The filling materials, such as carbonate of soda, which are added to give weight, are subsequently thrown out as white feathery crystals, and it would after some time be difficult for anyone to identify these objects as soaps. In a fresh state, the bar or cake appears to be satisfactory, and poor people are tempted by the low price. Such soap, however, dissolves rapidly in water and quickly rubs away, while the injury done to clothes is too well known to require mention. Soaps are now available in the bazaar—long bars in attractive colours—at Rs. 3 per case of 60 bars, each bar when packed weighing about 1½ to 2 lbs., whereas the price of better class bar soap ranges from Rs. 10 to Rs. 20 per case, the price and quality being governed by those of the imported brands of repute long established in the markets. It has, however, come to the notice of the author that the quality of one well-known imported soap has deteriorated considerably, the fatty acids having dropped from 45 per cent. to 30 per cent. in proportion to the reduction in price rendered necessary by local competition.

Toilet soaps made in India 25 years ago lacked finish and durability, while some contained excess caustic alkali or uncombined fat or both. Such defects are being gradually rectified, however, and there has been an all-round improvement since the establishment of the Kerala Soap Institute at Calicut, and of modern factories and research institutes at Mysore, Ernakulam, Cawnpore, Benares, Calcutta, Lahore and other centres.

Prospects.—The establishment of numbers of factories—large and small—in every quarter of India owing to the spread of the “ soap and water habit ”, even in remote villages where soap was once considered a luxury, has contributed in no small measure to the remarkable fall in the volume of soap imports. Although the indigenous substances such as soapnut, pulses etc., have excellent detergent and emollient properties, the modern tendency of the people is to use soap for toilet purposes, on account of its being readily obtainable everywhere in a handy form. Nevertheless the *per capita* annual consumption of soap in India is still very low, being about $\frac{1}{2}$ lb. as against, approximately 25 lbs. in the United States of America, 24 lbs. in Holland, 22 lbs. in Denmark and 20 lbs. in Great Britain.

The possibility of increasing the demand for soap in India, and the prospects of development of the industry therefore appear to be bright. Moreover, India will be in a still more satisfactory position as far as the major raw materials for the soap industry are concerned, when the proposed new caustic soda factories which are being constructed in Bengal and Madras commence production.

The All-India Soap Makers' Association was formed in Calcutta about three years ago, and it now numbers amongst its members the principal soap makers and others interested in the industry. The Indian Soap Journal, the technical periodical of this Association, is published once a month, and contains useful information on matters of interest to those engaged in the soap-making and allied industries. The main objects of this Association are to strengthen the present favourable position and to ensure further expansion of the soap-manufacturing industry of India.

APPENDIX 'A'.

The specific gravities of solutions of caustic soda of varying strengths.

Degrees Twaddell.	Specific gravity.	Per cent. by weight of		Lb. of actual NaOH contained in 1 gallon of lye made from com- mercial caustic of grade.		
		Na ₂ O.	NaOH.	77°	74°	70°
1	1.005	0.368	0.474	0.048	0.046	0.043
2	1.010	0.742	0.957	0.097	0.092	0.087
3	1.015	1.114	1.436	0.146	0.131	0.129
4	1.020	1.480	1.909	0.194	0.185	0.180
5	1.025	1.834	2.365	0.243	0.231	0.219
6	1.030	2.194	2.830	0.291	0.278	0.262
7	1.035	2.521	3.252	0.335	0.320	0.303
8	1.040	2.964	3.746	0.389	0.371	0.350
9	1.045	3.244	4.184	0.438	0.417	0.393
10	1.050	3.590	4.631	0.486	0.461	0.438
11	1.055	3.943	5.086	0.536	0.510	0.483
12	1.060	4.292	5.536	0.586	0.558	0.528
13	1.065	4.638	5.982	0.636	0.607	0.573
14	1.070	4.972	6.413	0.680	0.653	0.617
15	1.075	5.311	6.911	0.742	0.707	0.668
16	1.080	5.648	7.285	0.786	0.749	0.709
17	1.085	5.981	7.715	0.836	0.798	0.755
18	1.090	6.311	8.140	0.886	0.845	0.800
19	1.095	6.639	8.564	0.937	0.894	0.846
20	1.100	6.954	8.970	0.986	0.941	0.890
21	1.105	7.276	9.386	1.037	0.989	0.938
22	1.110	7.544	9.796	1.087	1.037	0.981
23	1.115	7.910	10.203	1.137	1.123	0.026
24	1.120	8.223	10.607	1.187	1.175	1.071
25	1.125	8.533	11.107	1.238	1.181	1.117
26	1.130	8.893	11.471	1.296	1.237	1.170
27	1.135	9.251	11.933	1.354	1.292	1.222
28	1.140	9.614	12.401	1.413	1.350	1.277
29	1.145	9.965	12.844	1.470	1.413	1.337
30	1.150	10.313	13.303	1.529	1.460	1.381
31	1.155	10.666	13.859	1.600	1.528	1.445
32	1.160	11.008	14.190	1.646	1.541	1.456
33	1.165	11.347	14.637	1.705	1.627	1.539
34	1.170	11.691	15.081	1.764	1.684	1.593
35	1.175	12.025	15.512	1.822	1.739	1.645
36	1.180	12.356	16.129	1.904	1.817	1.719
37	1.185	12.692	16.372	1.942	1.853	1.753

Degrees Twaddell.	Specific gravity.	Per cent. by weight of		Lb. of actual NaOH contained in 1 gallon of lye made from com- mercial caustic of grade.		
		Na ₂ O	HaOH	77°	74°	70°
38	1.190	13.016	16.794	1.998	1.887	1.804
39	1.195	13.339	17.203	2.055	1.962	1.856
40	1.200	13.660	17.629	2.122	2.026	1.916
41	1.205	14.058	18.133	2.185	2.085	1.973
42	1.210	14.438	18.618	2.252	2.147	2.033
43	1.215	14.823	19.121	2.323	2.221	2.097
44	1.220	15.124	19.613	2.392	2.280	2.161
45	1.225	15.502	19.997	2.444	2.338	2.206
46	1.230	15.959	20.586	2.562	2.417	2.285
47	1.235	16.299	20.996	2.593	2.475	2.341
48	1.240	16.692	21.532	2.669	2.548	2.410
49	1.245	17.060	22.008	2.739	2.615	2.474
50	1.250	17.424	22.476	2.809	2.681	2.536
51	1.255	17.800	22.962	2.881	2.750	2.602
52	1.260	18.166	23.433	2.952	2.818	2.666
53	1.265	18.529	23.901	3.020	2.886	2.730
54	1.270	18.897	24.376	3.095	2.955	2.795
55	1.275	19.255	24.858	3.171	3.027	2.863
56	1.280	19.609	25.295	3.237	3.090	2.932
57	1.285	19.961	25.750	3.308	3.158	2.988
58	1.290	20.318	26.210	3.381	3.227	3.051
59	1.295	20.655	26.658	3.452	3.364	3.117
60	1.300	21.156	27.110	3.524	3.394	3.182
61	1.305	21.405	27.611	3.603	3.439	3.253
62	1.310	21.785	28.105	3.682	3.514	3.224
63	1.315	22.168	28.595	3.760	3.593	3.395
64	1.320	22.556	29.161	3.849	3.674	3.475
65	1.325	22.926	29.574	3.919	3.742	3.539
66	1.330	23.310	30.058	3.997	3.816	3.610
67	1.335	23.670	30.535	4.072	3.891	3.681
68	1.340	24.046	31.018	4.156	3.967	3.754
69	1.345	24.410	31.490	4.232	4.042	3.824
70	1.350	24.765	31.948	3.312	4.116	3.894
71	1.355	25.152	32.446	4.396	4.196	3.970
72	1.360	25.526	32.930	4.478	4.274	4.043
73	1.365	25.901	33.415	4.561	4.354	4.109
74	1.370	26.285	33.905	4.645	4.434	4.194
75	1.375	26.650	34.382	4.728	4.513	4.269

Figures taken from "A practical manual of the manufacture of domestic, toilet, and other soaps" by George H. Hurst.

APPENDIX 'B'.

Table showing the percentages of salt contained in solutions of varying specific gravity.

Specific gravity.	Degrees Twaddell.	Per cent. of salt.
1.00725	1.4	1
1.01450	2.9	2
1.02174	4.3	3
1.02899	5.8	4
1.03624	7.2	5
1.04336	8.7	6
1.05108	10.2	7
1.05851	11.7	8
1.06593	13.2	9
1.07335	14.7	10
1.08097	16.2	11
1.08859	17.7	12
1.09622	19.2	13
1.10384	20.7	14
1.11146	22.3	15
1.11938	23.8	16
1.12730	25.5	17
1.13523	27.4	18
1.14315	28.6	19
1.15107	30.2	20
1.15931	31.8	21
1.16755	33.5	22
1.17580	35.1	23
1.18404	36.8	24
1.19228	38.4	25
1.20098	40.2	26

APPENDIX 'C'.

Amounts of caustic soda solutions required to saponify oils and fats. (Lewkowitch).

Weight of fat in ton.	Gallons of solution of caustic soda, 37.8°Bé (S.G.-1.355).	
	For saponifying oils and fats of mean molecular weight 670. (Coconut oil, palm kernel oil, etc.)	For saponifying oils and fats of mean molecular weight, 860. (Tallow, cotton seed oil, groundnut oil, etc.)
·05	4.59	3.57
·1	9.18	7.15
·15	13.76	10.72
·2	18.35	14.30
·25	22.94	17.87
·3	27.53	21.44
·35	32.11	25.02
·4	36.70	28.59
·45	41.29	32.17
·5	45.88	35.74
·55	50.46	39.31
·6	55.05	42.89
·65	59.64	46.46
·7	64.23	50.04
·75	68.81	53.61
·8	73.40	57.18
·85	77.99	60.76
·9	82.58	64.33
·95	87.16	67.91
1.0	91.75	71.48

APPENDIX 'D'.

Percentages of caustic soda and caustic potash in lyes. (Leukowitsch).

Degree Baume.	Degree Twaddell.	Specific gravity.	Percentage by weight of	
			Caustic soda.	Caustic potash.
1	1.4	1.007	0.61	0.90
2	2.8	1.014	1.20	1.70
3	4.4	1.022	2.00	2.60
4	5.8	1.029	2.71	3.50
5	7.4	1.037	3.35	4.50
6	9.0	1.045	4.00	5.60
7	10.4	1.052	4.64	6.40
8	12.0	1.060	5.29	7.40
9	13.4	1.067	5.87	8.20
10	15.0	1.075	6.55	9.20
11	16.6	1.083	7.31	10.10
12	18.2	1.091	8.00	10.90
13	20.0	1.100	8.68	12.00
14	21.6	1.108	9.42	12.90
15	23.2	1.116	10.06	13.80
16	25.0	1.125	10.97	14.80
17	26.8	1.134	11.84	15.70
18	28.4	1.142	12.64	16.50
19	30.4	1.152	13.55	17.60
20	32.4	1.162	14.37	18.60
21	34.2	1.171	15.13	19.50
22	36.0	1.180	15.91	20.50
23	38.0	1.190	16.77	21.40
24	40.0	1.200	17.67	22.50
25	42.0	1.210	18.58	23.30
26	44.0	1.220	19.58	24.20
27	46.2	1.231	20.59	25.10
28	48.2	1.241	21.42	26.10
29	50.4	1.252	22.64	27.00
30	52.6	1.263	23.67	28.00
31	54.8	1.274	24.81	28.90
32	57.0	1.285	25.80	29.80
33	59.4	1.297	26.83	30.70
34	61.6	1.308	27.80	31.80
35	64.0	1.320	28.83	32.70
36	66.4	1.332	29.93	33.70
37	69.0	1.345	31.22	34.90

Degree Baume.	Degree Twaddell.	Specific gravity.	Percentage by weight of	
			Caustic soda.	Caustic potash.
38	71.4	1.357	32.47	35.90
39	74.0	1.370	33.69	36.90
40	76.6	1.383	34.96	37.80
41	79.4	1.397	36.25	38.90
42	82.0	1.410	37.52	39.90
43	84.8	1.424	38.80	40.90
44	87.6	1.438	39.99	42.10
45	90.6	1.453	41.41	43.40
46	93.6	1.468	42.83	44.60
47	96.6	1.483	44.38	45.80
48	99.6	1.498	46.15	47.10

APPENDIX 'E'.

Influence of temperature on the specific gravities of solutions of caustic soda (Lewkowitzch).

		25°C.	30°C.	35°C.	40°C.	45°C.	50°C.
Specific gravity	..	1.355	1.353	1.350	1.348	1.345	1.342
Baume	..	37.8	37.7	37.4	37.3	37.0	36.8
Specific gravity	..	1.345	1.343	1.340	1.337	1.335	1.332
Baume	..	37.0	36.9	36.6	36.4	36.2	36.0
Specific gravity	..	1.336	1.333	1.330	1.327	1.325	1.322
Baume	..	36.3	36.1	35.8	35.6	35.4	35.2
Specific gravity	..	1.325	1.323	1.320	1.317	1.315	1.312
Baume	..	35.4	35.3	35.0	34.8	34.6	34.3
Specific gravity	..	1.315	1.313	1.310	1.307	1.305	1.302
Baume	..	34.6	34.4	34.2	33.9	33.7	33.5
Specific gravity	..	1.305	1.303	1.300	1.297	1.294	1.292
Baume	..	33.7	33.5	33.3	33.0	32.8	32.6
Specific gravity	..	1.294	1.292	1.289	1.287	1.284	1.282
Baume	..	32.8	32.6	32.3	32.2	31.9	31.7
Specific gravity	..	1.284	1.282	1.279	1.277	1.274	1.272
Baume	..	31.9	31.7	31.5	31.3	31.0	30.8
Specific gravity	..	1.274	1.272	1.269	1.267	1.264	1.262
Baume	..	31.0	30.8	30.5	30.4	30.1	29.9
Specific gravity	..	1.265	1.262	1.260	1.258	1.255	1.252
Baume	..	30.2	29.9	29.7	29.5	29.3	29.0

BULLETINS OF INDIAN INDUSTRIAL RESEARCH



No. 13

**A STUDY OF INDIAN MUSTARD
AND RAPE SEEDS AND THEIR OILS**

BY

**D. Y. Athawale, M.Sc.,
J. A. Hare Duke, and
P. N. Mathur, Dip. Tech.**

**INDUSTRIAL
RESEARCH
BUREAU**

**PUBLISHED BY THE MANAGER OF PUBLICATIONS, DELHI.
PRINTED BY THE MANAGER, GOVERNMENT OF INDIA PRESS, SIMLA.**

1938

J681:78:7.2

65

(iii)

The statements made and the views expressed in this bulletin are those of the authors, and neither the Government of India nor the Industrial Research Bureau accept responsibility for them.

CONTENTS.

	PAGE.
INTRODUCTION.—Authors' Foreword and acknowledgments	ix
CHAPTER I.—Statistics of Indian production, consumption, and exports of mustard and rape seeds—	
TABLE I.—Area under cultivation, yield of seeds, export, and local consumption of mustard and rape seeds in India	1
TABLE II.—Area under cultivation, yield, and total requirements, foreign countries	2
TABLE III.—Area under cultivation and yield by Provinces and States in India	3
CHAPTER II.—Mustard oil specifications in use in India, and difficulties in the way of compliance. Characteristics of pure seed and oil of each of the principal species of <i>Brassica</i> and of <i>Eruca sativa</i> ..	5
TABLE IV.—Mustard oil specifications of various Provinces and authorities in India	5
TABLE V.—Characteristics of oil from <i>Brassica campestris</i> from various districts	6
TABLE VI.—Characteristics of oil from <i>Brassica juncea</i> from various districts	7
TABLE VII.—Characteristics of oil from <i>Brassica napus</i> from various districts	8
TABLE VIII.—Characteristics of oil from <i>Eruca sativa</i> from various districts	8
Deductions and conclusions from the above data	9
CHAPTER III.—Variation of proportions in which main species occur in typical samples of marketed seed, and differences in characteristics of oil obtained from the samples	10
TABLE IX.—Characteristics of typical market samples of seed, and of oil expressed from them	11
CHAPTER IV.—Characteristics of genuine mustard oils from oil mills in various Provinces, and discussion of results	13
TABLE X.—Characteristics of genuine mustard oil from oil mills	13
TABLE XI.—Comparison of genuine oil characteristics with specification requirements of Table IV	14
CHAPTER V.—Pungency, and the effect thereon of variation of oil mill technique when using modern plant.. .. .	16
TABLE XII.—Essential oil content of the various species of "Brassica" and "Eruca sativa"	17
TABLE XIII.—Oil contents of mustard cake from various crushing units	19
Deductions and conclusions from the above data	20

LIST OF ILLUSTRATIONS.

	Facing page
PLATE I.—View of the plant of <i>Brassica campestris</i> , (Sarson)	6
PLATE II.—Photo-micrograph of the seed-coat of <i>Brassica campestris</i> , (Sarson)	6
PLATE III.—View of the plant of <i>Brassica juncea</i> , (Rai)	7
PLATE IV.—Photo-micrograph of the seed-coat of <i>Brassica juncea</i> , (Rai) ..	7
PLATE V.—View of the plant of <i>Brassica napus</i> , (Tori)	7
PLATE VI.—Photo-micrograph of the seed-coat of <i>Brassica napus</i> , (Tori) ..	7
PLATE VII.—View of the plant of <i>Eruca sativa</i> , (Duan or Taramira) ..	8
PLATE VIII.—Photo-micrograph of the seed-coat of <i>Eruca sativa</i> , (Duan or Taramira)	8

AUTHORS' FOREWORD.

In compiling the information and data contained in this bulletin, three objectives were held in view, namely to show the present state and importance of the mustard and rape seed industry in India, to present the technical data on which an All-India standard specification for mustard oil may be based, and to show that mustard oil of equal pungency and of superior yield to that given by the indigenous *ghannis*, can be obtained from modern plant when suitably operated.

The differing specification standards at present enforced by various Government authorities in India are shown in Table IV on page 5. These differing standards have been the cause of much trouble and trading difficulties to the oil millers of the United Provinces and elsewhere, as they lead to the anomalous position that oil accepted as genuine in one Province is liable to be reported as being adulterated in another.

The seed used by the agriculturist is almost invariably a mixture, in varying proportions, of the several species of the *Brassica* family found in India, and consequently the oil produced from his crops may have characteristics which cover the whole range of variation of the characteristics of the several species. It therefore frequently happens that the oil produced from genuine mixed seed of *Brassica* has characteristics which fall outside the permissible range of certain Provincial specifications, owing to the wide variations in proportions of the various species which might have been present in the seed from which the oil was crushed. In these circumstances the oil is liable to be declared to have been adulterated.

A study of the several species of *Brassica* seed and of the oils from them which has been carried out has enabled information bearing on this question to be collected and this is recorded in this bulletin in a readily available form ; the authors hope that the facts now available will assist towards the gaining of the objectives contemplated.

The authors wish to thank Mr. T. S. Sabnis, Economic Botanist (Fibres, Millets, and Oilseeds) to the Government of the United Provinces and his staff for kindly undertaking the necessary botanical examination of mustard and rape seeds in connection with these investigations. They also thank the Director, Imperial Agricultural Research Institute, New Delhi, the Directors of Provincial Agricultural Departments, and various oil millers of the Provinces concerned for sending seeds and giving valuable information regarding them.

The acknowledgement of the authors is also due to the Government publication " Field and Garden Crops of the North West Frontier and Oudh, Part I ", from which the photographs used to prepare Plates Nos. I, III, V and VII were taken.

CHAPTER I.

STATISTICS OF INDIAN PRODUCTION, CONSUMPTION, AND EXPORTS OF MUSTARD AND RAPE SEEDS.

India is a large and important producer of mustard and rape seed, about one million tons of these seeds being harvested annually and nearly six million acres of land being cultivated for their production.

This crop, though second in order of importance to groundnut, is certainly the most valuable seed so far as utilisation in this country is concerned, as over 90% of the crop is consumed for domestic requirements. Mustard and rape seeds are extensively grown all over northern India, from the Punjab to Assam. The area under cultivation of these seeds and the yield of the crop have remained fairly constant during the last 37 years, as is shown by the data in Table I below.

TABLE I.

Area under cultivation, yield, export, and local consumption of mustard and rape seeds in India.

Period.	Area under cultivation (acres).	Yield of seeds (tons).	Exports from India (tons).	Seeds available for local consumption (tons).
Average of 10 years—				
1900-01 to 1909-10	5,827,000	1,001,000
1910-11 to 1919-20	6,292,000	1,149,000	174,000	975,000
1920-21 to 1929-30	6,023,000	1,036,000	159,000	877,000
1930-31	6,632,000	988,000	35,000	953,000
1931-32	6,220,000	1,025,000	57,000	968,000
1932-33	6,094,000	1,042,000	117,000	925,000
1933-34	6,034,000	943,000	76,000	867,000
1934-35	5,338,000	900,000	40,000	860,000
1935-36	5,333,000	957,000	21,000	936,000
1936-37	5,818,000	976,000	40,000	936,000

The average consumption of mustard and rape seeds outside India is nearly 296,000 tons per annum (average from 1925 to 1936, column 5 of Table II below), and the production in other countries is supplemented by an average export from India of 81,000 tons per year. The quantity exported thus amounts to about 8% of India's average production of these seeds.

TABLE II.

Comparative statement showing reported area under cultivation and yield of rape seed in foreign countries from 1924 to 1936 and export of mustard and rape seeds from India during this period.

Period.	Area under cultivation (acres).	Yield of seed (tons).	Export from India (tons).	Total requirement of seed in foreign countries (tons).
(1)	(2)	(3)	(4)	(5)
1924	591,000	155,000	265,000	420,000
1925	617,000	185,000	115,000	300,000
1926	563,000	163,000	95,000	258,000
1927	497,000	195,000	68,000	263,000
1928	637,000	220,000	81,000	301,000
1929	476,000	187,000	47,000	234,000
1930	582,000	218,000	35,000	253,000
1931	600,000	213,000	57,000	270,000
1932	499,000	176,000	117,000	293,000
1933	449,000	176,000	76,000	252,000
1934	648,000	237,000	40,000	277,000
1935	946,000	344,000	21,000	365,000
1936	784,000	322,000	40,000	362,000

NOTE.—Figures in column (4) show the export for the year from 1st April to 31st March.

The entire northern belt of India, consisting of the United Provinces, the Punjab, Bihar, Bengal and Assam, yields more than 90% of the total production of mustard and rape seeds in India. This is shown by the statistics recorded in Table III below.

TABLE III.

Area and yield of mustard and rape seeds in various Provinces and States of India (area is given in thousands of acres and yield in thousands of tons).

Province or State.	1932-33.		1933-34.		1934-35.		1935-36.		1936-37.	
	Area.	Yield.	Area.	Yield.	Area.	Yield.	Area.	Yield.	Area.	Yield.
<i>British Indian Provinces.</i>										
Assam	271	43	329	57	345	54	363	45	401	57
Bengal	716	154	693	164	724	180	711	157	740	180
Bihar and Orissa	627	140	598	135	600	137	576	113	557	127
Bombay and Sind	190	23	185	19	145	11	144	16	158	17
Central Provinces	71	15	74	16	71	17	68	13	71	17
Delhi	8	(b)	4	(b)	5	1	4	(b)	10	2
N. W. F. Province	126	7	112	9	65	6	93	8	72	10
Punjab	1,158	151	1,099	131	673	101	705	113	949	154
United Provinces (a)* ..	327	58	219	31	206	30	248	46	271	41
	2,484	438	2,594	372	2,444	357	2,330	433	2,499	357
Total British Indian Provinces	5,978	1,029	5,907	934	5,278	894	5,242	944	5,728	962

(a) *These figures relate to the United Provinces and indicate mixed crop, i.e., seed sown in the same field with other crops. The estimates of the mixed crop of the United Provinces are highly conjectural, and hence are shown separately.

(b) 500 tons or below.

TABLE III—*concl.*

Province or State.	1932-33.		1933-34.		1934-35.		1935-36.		1936-37.	
	Area.	Yield.	Area.	Yield.	Area.	Yield.	Area.	Yield.	Area.	Yield.
<i>Indian States.</i>										
Baroda	20	2	40	3	15	1	13	2	11	1
Bombay and Sind States ..	46	6	37	5	13	3	16	2	12	2
Hyderabad	10	(b)	12	(b)	12	(b)	13	1	11	1
Rajputana	40	5	38	1	20	2	49	8	56	10
Total Indian States ..	116	13	127	9	60	6	91	13	90	14
GRAND TOTAL ..	6,094	1,042	6,034	943	5,338	900	5,333	957	5,818	976

(b) 500 tons or below.

CHAPTER II.

MUSTARD OIL SPECIFICATIONS IN USE IN INDIA, AND COMPARISON WITH CHARACTERISTICS OF SEED AND OIL OF THE PRINCIPAL COMMERCIAL SEED SPECIES.

Mustard and rape seeds produced and retained in India are crushed by the oil millers and village oil-seed crushers or *telies* for the production of mustard oil. Due to the good demand for this oil and the slightly better prices obtained for it in the market as compared with other edible oils, there is a strong inducement to adulterate it. Various Provincial Governments have therefore laid down technical standards for mustard oil under the provisions of the Indian Food Adulteration Act. Generally those samples of oil which have physical and chemical characteristics lying within the permitted range are regarded as genuine, and those that show values outside the range are reported as adulterated. Typical standard values fixed by various authorities are stated in the following Table.

TABLE IV.

Mustard oil standards fixed by various Provincial Governments and other authorities in India.

Province or authority.	Saponification value.	Iodine value.	Remarks.
Bengal	169—175	96—104	No. 1977-P. H., dated 24th July 1930.
Bihar and Orissa ..	169—176	96—108	No. 9363-L. S. G., dated 16th December 1924.
United Provinces ..	169—176	96—108	No. 1037/XVI (P. H.)—322, dated 22nd December 1930.
Central Provinces ..	169—176	96—108
Punjab	170—180	93—105	No. 37202-P. H., dated 10th December 1931.
N. W. F. Province ..	170—180	93—105	Punjab Standards followed.
Indian Stores Department	170—178	93—108	I. S. D. Specification No. G/0-101/73 (1937).

The mustard oil produced in India is generally obtained from seeds of the *Brassica* group. This group comprises the following main species of seed :—

- (1) *Brassica campestris* .. Yellow and brown Sarson,
- (2) *Brassica juncea* .. Rai, and
- (3) *Brassica napus* .. Tori.

These main species are found inextricably mixed in widely varying proportions in the seed supplies which come to market, due to the fact that the seed itself which is used by the agriculturist or ryot for the propagation of crops consists of a mixture of the several species in equally widely varying proportions.

The result is that oil millers are generally unable to purchase pure unmixed seed of any of the *Brassica* species, as under whatever name the seed is sold commercially it will almost invariably be found to be a mixture. The oils from these mixtures are known indiscriminately in India as mustard oil.

Considerable variation in the physical and chemical characteristics of commercial samples of mustard oil is therefore a common experience, and in the following pages are recorded the results of investigation of the characteristics of specially selected samples of seeds of each of the main *Brassica* species and of the oils expressed therefrom, together with the results of investigation of the proportions in which the main species occur in samples from normal commercial supplies of seed and of the characteristics of the oils obtained from them, in order to throw light on to this matter.

Examination of seeds of pure species of "Brassica," and of the oils obtained from them.

1. *Brassica campestris*.—The seed of this species has various local names, typical local names are :—

Sarson, Pila-sarson, Shwet-rai, Shwet-sarisha, Pivali-rai,
Sarson-zard, Banga-sarson, Rara, Rada, and Rara-sarson.

This species of *Brassica* is mainly grown in the United Provinces, Bihar, and Bengal. The seeds are bold, *i.e.*, of large size, and yellow, brown, or dark-brown in colour, round in shape, and have a smooth surface. The plant is shown in Plate I and the surface of the seed-coat, as seen under a microscope, in Plate II. The oil content of the seed varies from 35 per cent. to 48 per cent. (50 samples of seed examined). The yellow sarson gives slightly higher oil yield than the brown variety.

Table V below records the physical and chemical characteristics of oils obtained from the seeds of *Brassica campestris* grown in various Provinces and districts, the purity of the seed used, as determined by preliminary botanical examination, being 100 per cent.

TABLE V.

Physical and chemical characteristics of oils from seeds of "Brassica campestris."

Name and place of origin.	Specific Gr. at 15·5°C./ 15·5°C.	Refractive index at 40°C.	Saponifica- tion value.	Iodine value.
<i>Brassica campestris</i> (Yellow Sarson) from—				
Aligarh	0·914	1·4645	169·8	99·0
Cawnpore	0·915	1·4635	169·1	99·19
Cawnpore	0·915	1·4640	170·1	100·8
Pussa	0·915	1·4640	169·8	100·75
Bengal	0·916	1·4652	170·1	99·9
Bihar	0·916	1·4654	170·5	100·1
(Brown Sarson) from—				
Aligarh	0·914	1·4640	174·2	101·1
Cawnpore	0·916	1·4642	173·4	100·8
Bihar	0·916	1·4649	174·7	101·5
Bengal	0·916	1·4645	174·5	100·0
Central Provinces ..	0·915	1·4643	173·3	102·8



PLATE I.
Brassica campestris
(Sarson).

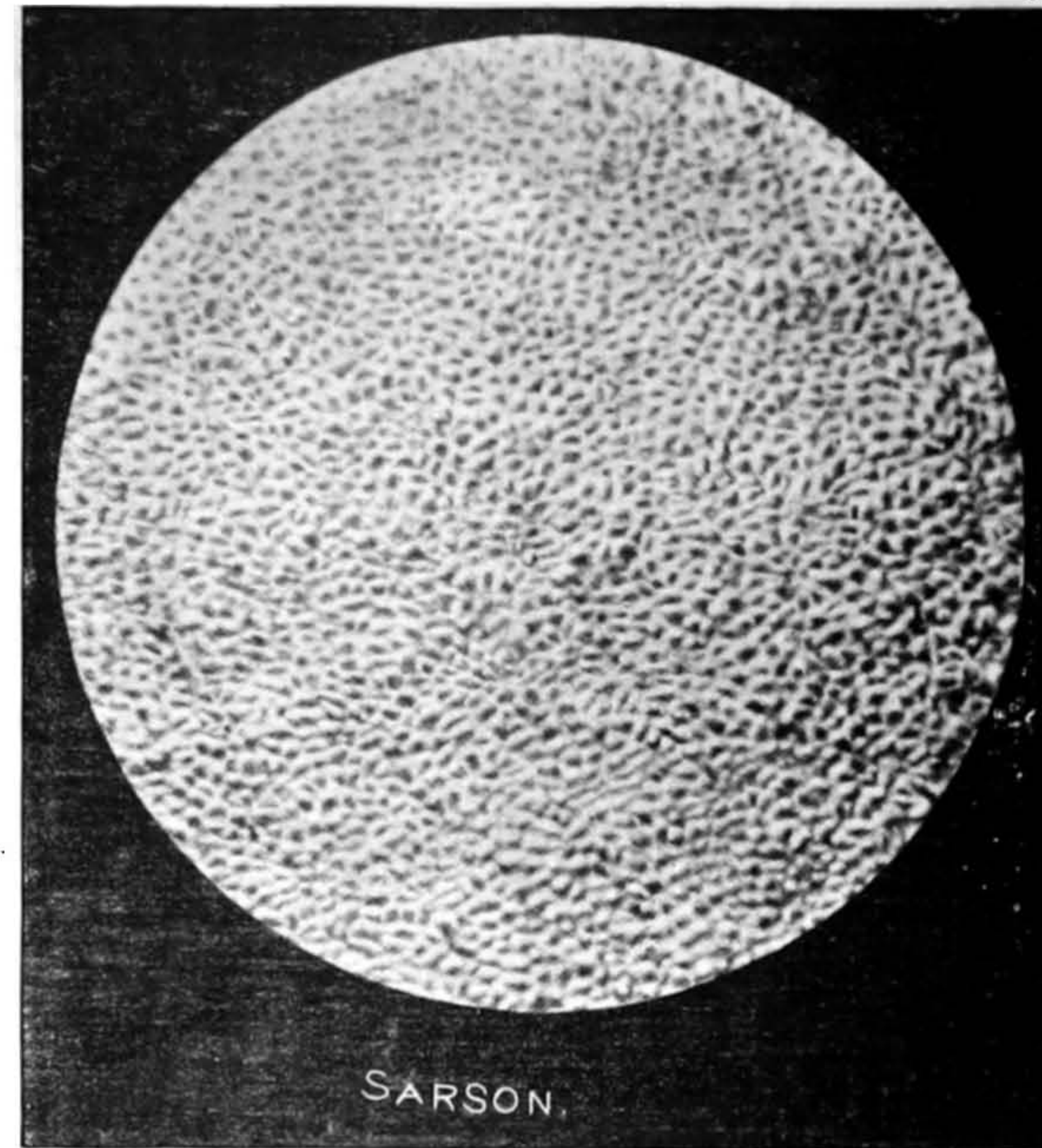

PLATE II.
Photo-micrograph of the seed-coat of
Brassica campestris
(Sarson).



PLATE III.
Brassica juncea
(Rai).

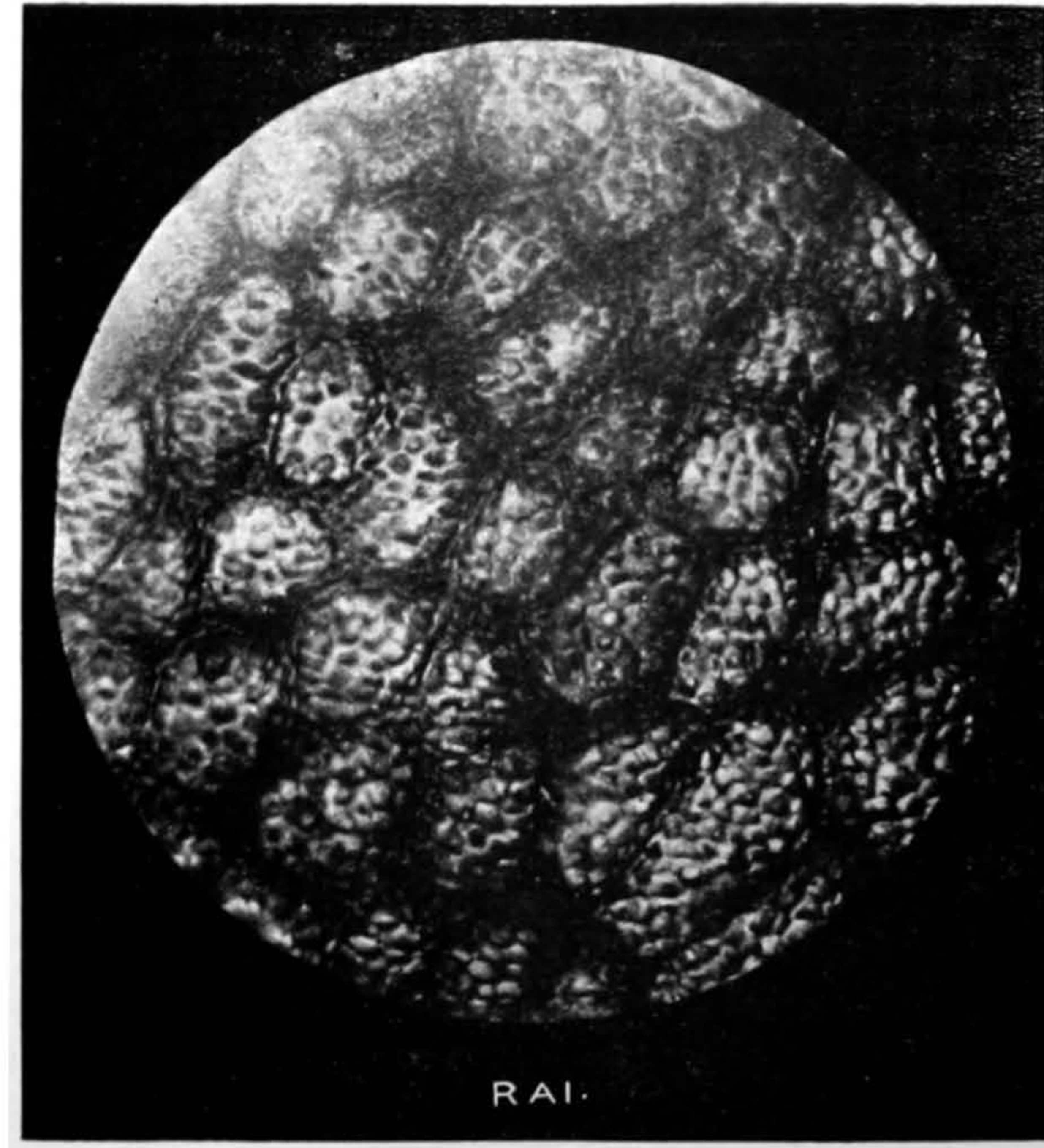

PLATE IV.
Photo-micrograph of the seed-coat of
Brassica juncea
(Rai).

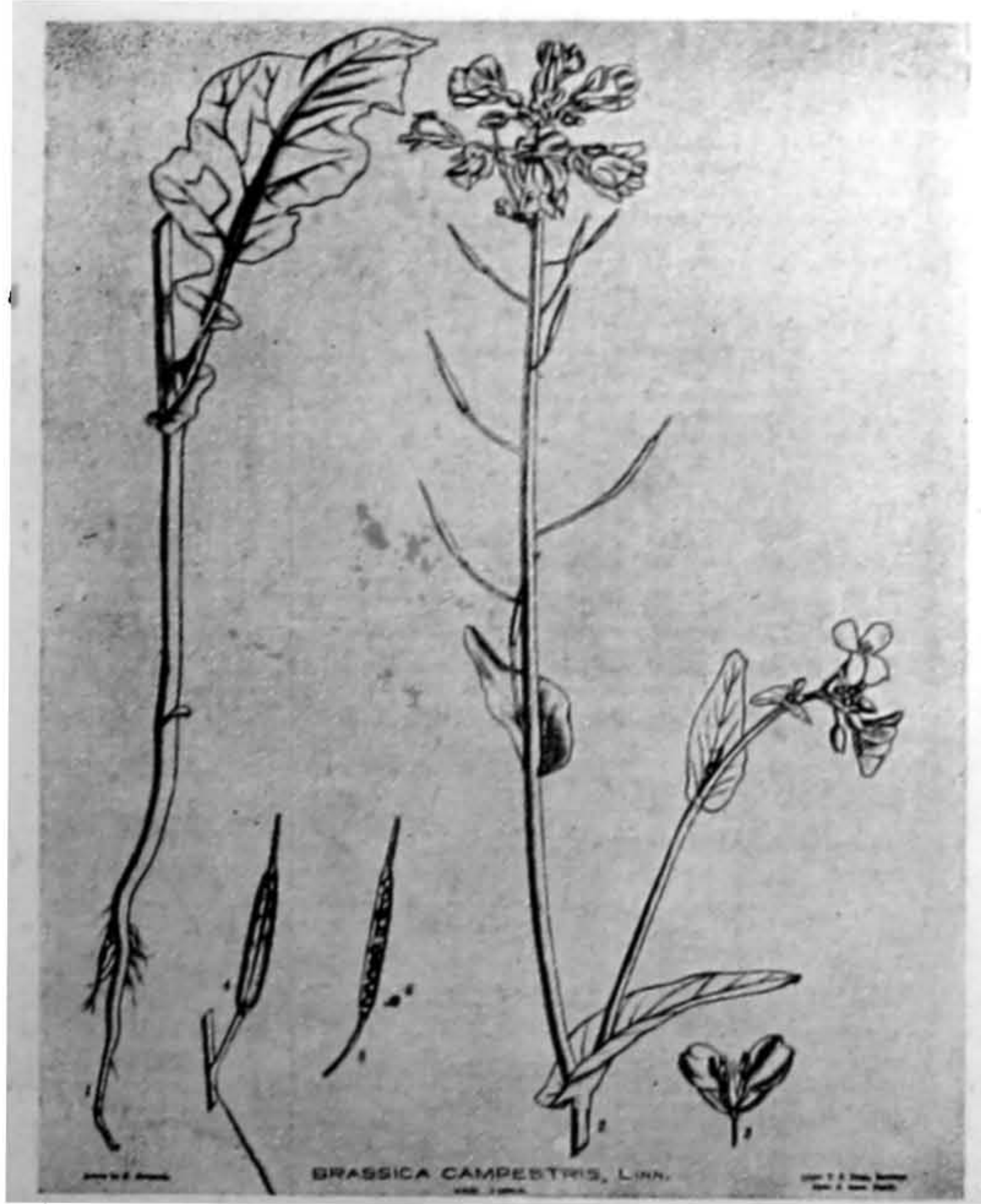

PLATE V.
Brassica napus
(Tori).

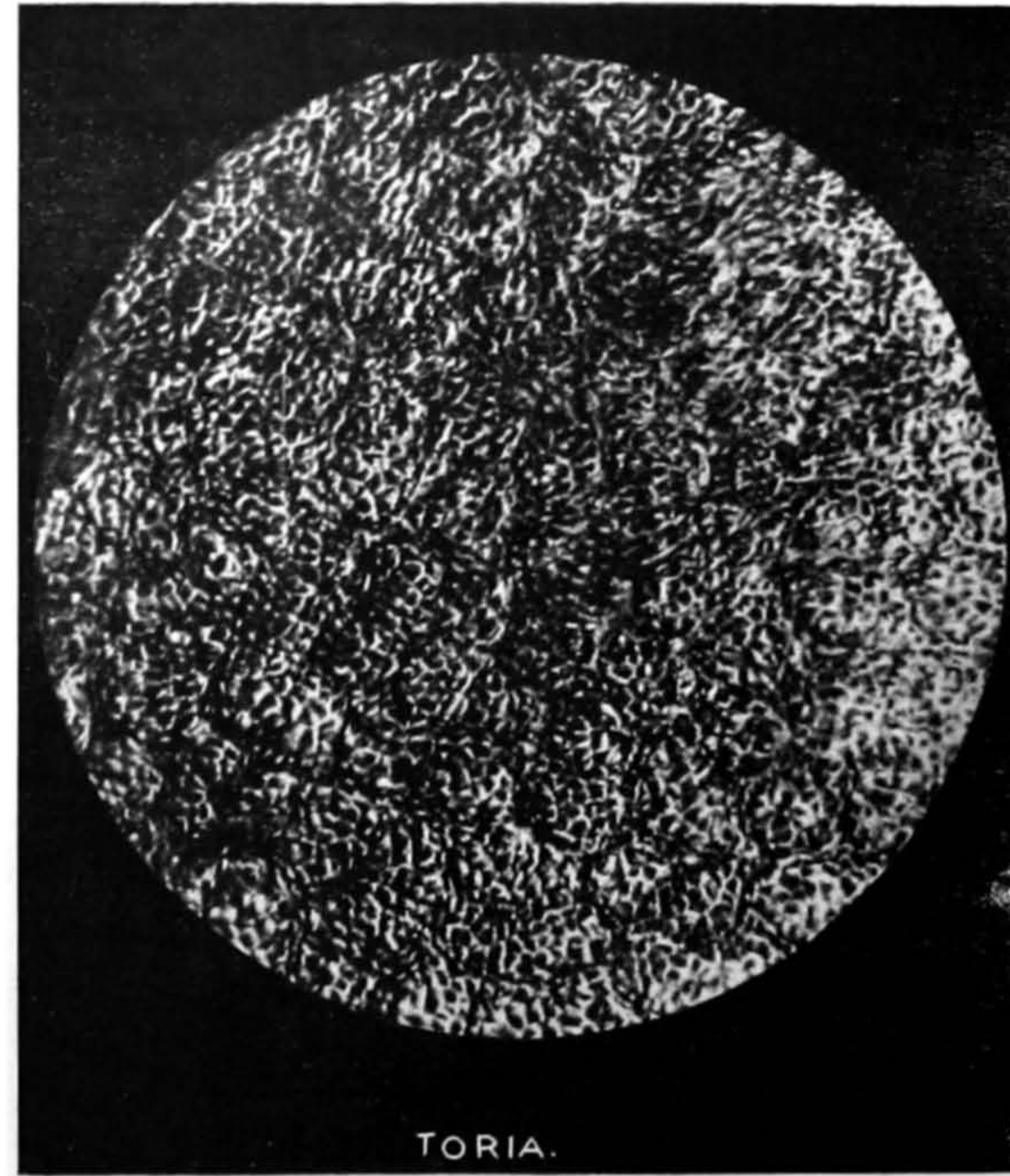

PLATE VI.
Photo-micrograph of the seed-coat of
Brassica napus
(Tori).

2. *Brassica juncea*.—The seeds of this species are known locally as Rai, Sarson-rai, Lahi, Sarson-lahi, Gohna-sarson, Badi-rai, Barlai, Bādshahilai, Shahzada-rai, and Khas-rai.

This species is grown throughout India. The seeds are comparatively small in size, are spherical or ovoid in shape, and have a distinctly rugose surface. The plant is shown in Plate III and the appearance of the surface of the seed-coat under the microscope in Plate IV.

Rai yields less oil than Sarson; the oil content of the seed varying from 30—38 per cent. (60 samples examined). The physical and chemical characteristics of oils expressed from seeds of this species from various Provinces and districts are shown in Table VI, preliminary botanical examination confirming that the purity of the seed samples used was 100 per cent.

TABLE VI.

Physical and chemical characteristics of oils obtained from pure varieties of "Brassica juncea."

Name and place of origin.	Specific Gravity at 15·5°C/15·5°C.	Refractive index at 40°C.	Saponification value.	Iodine value.
<i>Brassica Juncea</i> (Rai) from—				
Cawnpore	0·917	1·4654	174·2	110·5
Cawnpore	0·916	1·4650	173·8	106·2
Pussa	0·915	1·4650	172·2	111·1
Bengal	0·916	1·4656	175·5	111·9
Bihar	0·916	1·4658	173·5	114·3

3. *Brassica napus*.—Seeds of this species of *Brassica* are called locally Kali-sarson, Lahasta, Laita, Jariya, Jadiya, Sanchi, Surchi, Sada-rayee, Tori, Toria, Khetia, Lai, and Dain.

The seeds are largely grown in the Punjab, Bengal, Assam, and the Sub-Himalayan tracts of the United Provinces, and are slightly smaller than those of Sarson. They are spherical or ovoid in shape, and have slightly rugose surfaces, the colour of the seeds being reddish or dark brown. The plant is shown in Plate V, and the surface of the seed as seen under the microscope in Plate VI. The oil content of the seed varies from 33—46 per cent. (30 samples examined). The physical and chemical characteristics of oils obtained from this variety of seed from various localities are recorded in Table VII, the purity of the seed used in this case, also, being confirmed by preliminary botanical examination.

TABLE VII.

Physical and chemical characteristics of oil obtained from pure varieties of "Brassica napus."

Name and place of origin.	Specific Gravity at 15.5°C./15.5°C.	Refractive index at 40°C.	Saponification value.	Iodine value.
<i>Brassica napus</i> (Tori) from— Cawnpore	0.917	1.4639	172.3	100.9
Nepalganj	0.913	1.4645	172.5	102.2
Bihar	0.913	1.4655	172.8	103.0
Lyalpur (Punjab) ..	0.917	1.4642	173.4	102.7
Lyalpur (Punjab) ..	0.916	1.4640	173.2	102.5

In addition to the *Brassica* family, the species *Eruca sativa* is also worthy of consideration, as it is produced to a very large extent in the United Provinces, the Punjab, and Bihar.

Eruca sativa.—This species is also variously known locally as Duan, Sahwan, Tira, Tara, Taramira, Dua, Chara, etc.

The seeds are light reddish brown, and have a smooth surface. They can be readily distinguished from Sarson, as they are not round but distinctly ovoid, and have a characteristic colour. The plant is shown in Plate VII, and the appearance of the surface as seen under the microscope is shown in Plate VIII. The oil content of the seed varies from 30 per cent. to 35 per cent. (20 samples examined). The characteristics of 100 per cent. pure seeds from various Provinces and districts are shown in the following table, the purity of the seed having been confirmed by preliminary botanical examination.

TABLE VIII.

Physical and chemical characteristics of oils obtained from pure varieties of "Eruca sativa."

Name and place of origin.	Specific Gravity at 15.5°C./15.5°C.	Refractive index at 40°C.	Saponification value.	Iodine value.
<i>Eruca sativa</i> (Duan) from— United Provinces ..	0.916	1.4659	174.5	99.4
United Provinces ..	0.917	1.4655	174.4	99.0
Punjab	0.917	1.4655	174.7	100.0
Cawnpore	0.917	1.4657	175.5	100.5

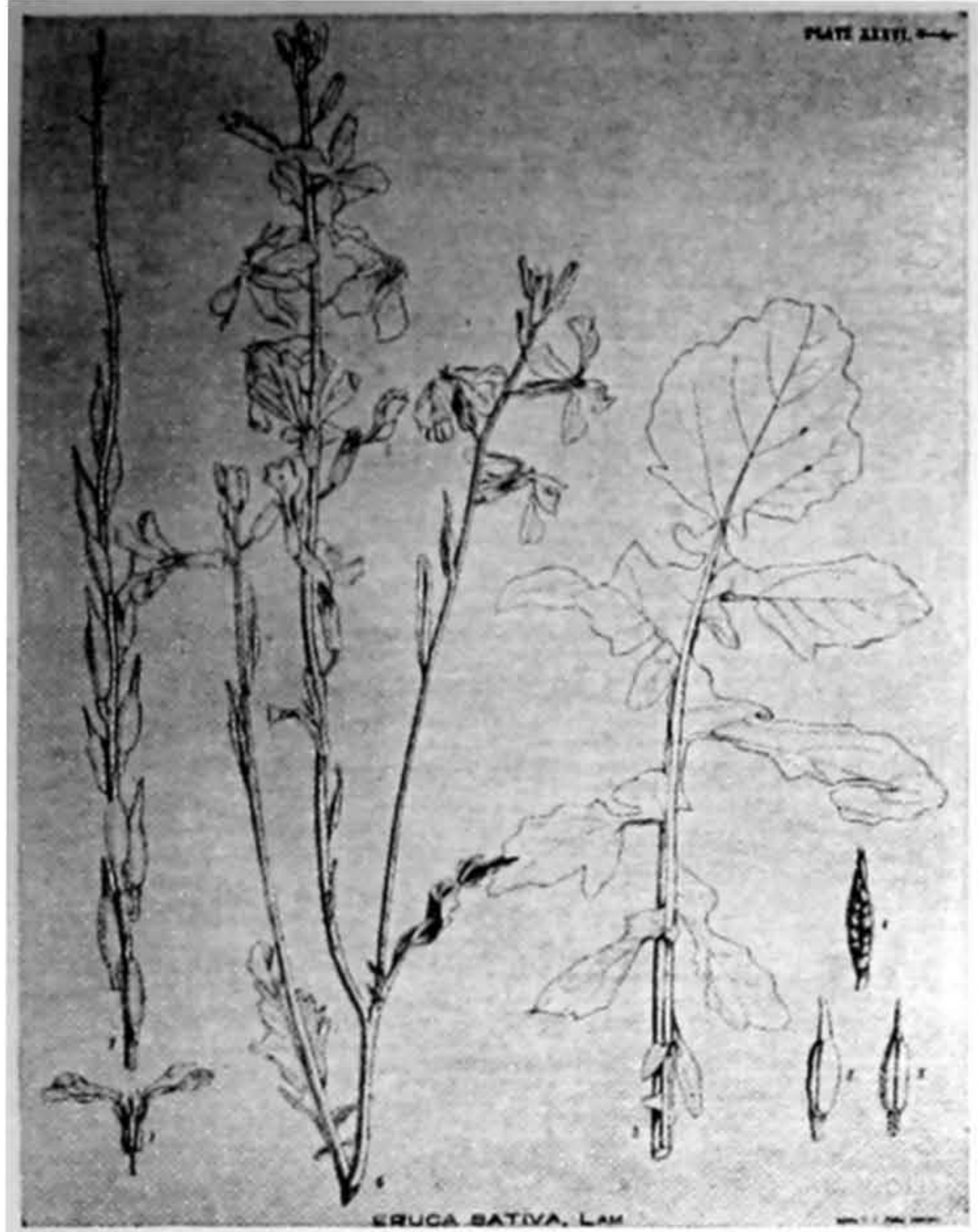

PLATE VII.
Eruca sativa
(Duan, Taramira).

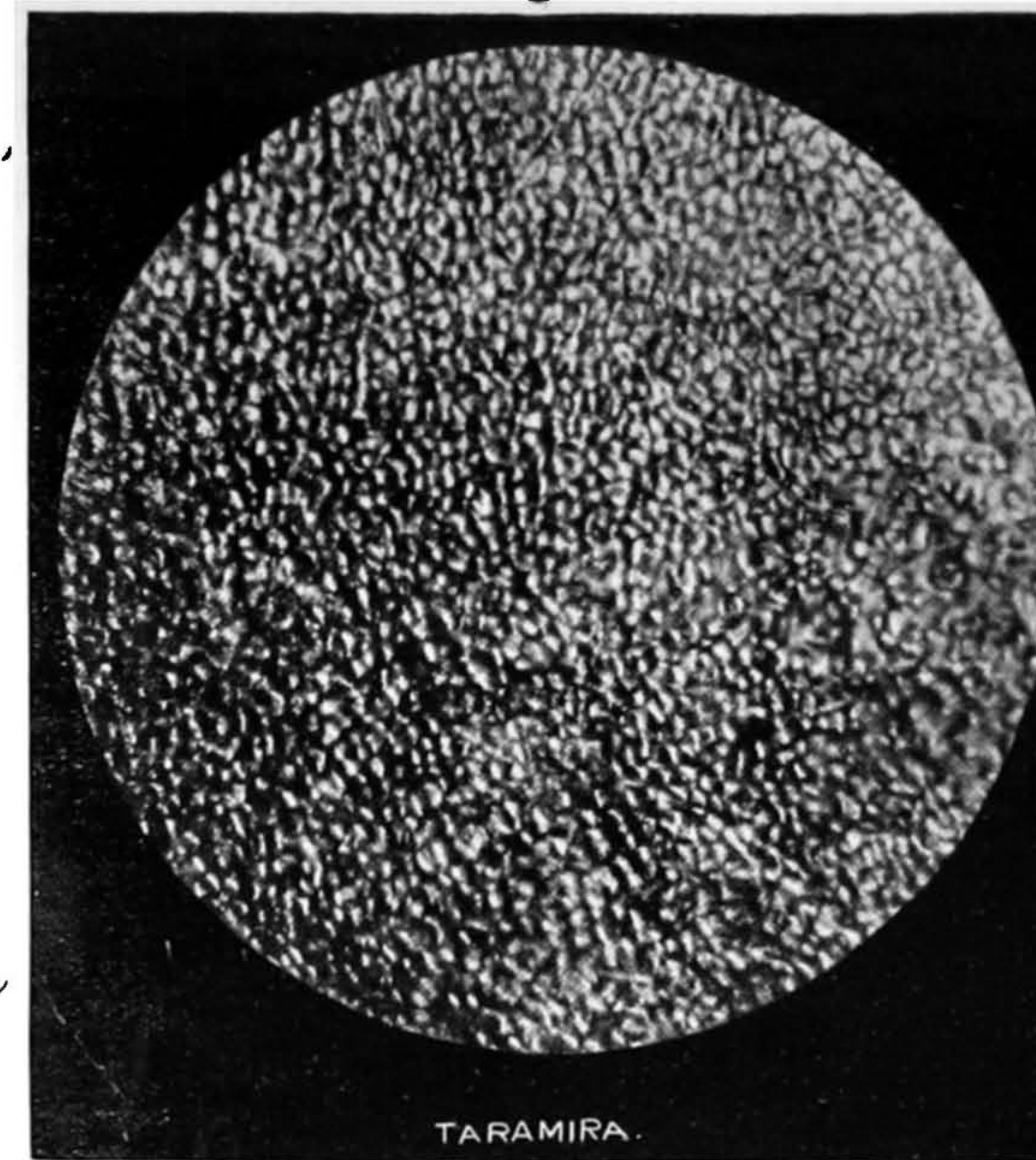

PLATE VIII.
Photo-micrograph of the seed-coat of
Eruca sativa
(Duan, Taramira).

From an examination of the oils from the pure seeds of *Brassica* species and *Eruca sativa*, the following conclusions can be drawn :—

1. Seeds of *Brassica campestris*, (Sarson), give oils having saponification values between 169 and 175, and iodine values between 99 and 103.
2. Seeds of *Brassica juncea*, (Rai), give oils having saponification values between 172 and 176, and iodine values between 106 and 114.
3. Seeds of *Brassica napus*, (Tori), give oils having saponification values between 172 and 174, and iodine values between 101 and 103.
4. Seeds of *Eruca sativa*, (Duan), give oils having saponification values between 175 and 176, and iodine values between 99 and 101.
5. The high iodine values of the oils obtained from mixed *Brassica* seeds are due to the presence of seeds of *Brassica juncea*, (Rai).
6. The seeds of Sarson, Rai, and Tori can be readily distinguished and separated by means of microscopic examination, the distinctive appearance of their surfaces is clearly shown in Plates II, IV and VI. Seeds of *Eruca sativa* can also be distinguished by their shape, which is quite distinct from that of Sarson, Rai, or Tori,

CHAPTER III.

INVESTIGATION OF PROPORTIONS IN WHICH MAIN SPECIES OF SEED OCCUR IN COMMERCIAL SUPPLIES, AND OF THE CORRESPONDING VARIATIONS IN CHARACTERISTICS OF THE OILS.

Samples of seeds collected from oil mills of various Provinces were examined under the microscope, and by this means sorted to determine the proportions in which the three principal species, viz., Sarson, Rai and Tori (Rape), were present. The composition has been shown in Table IX below in the form of percentage by weight. The procedure adopted was as follows.

The sample was cleaned mechanically to remove dust and foreign seeds. A small quantity of the cleaned seed, about 2.0 gms. in weight, was placed in a petri dish and separated first on a colour basis, yellow mustard seed being removed, and then weighed. The remaining seeds were then examined under the microscope for identification, so as to enable them to be separated as Sarson, Rai and Tori. This can be readily done after a little practice, as each species has a distinctive surface appearance (Plates II, IV and VI). The weights of all these separated species were then taken and the results, expressed as percentage composition, are recorded in the Table.

These samples were further examined by actual sowing of the seeds, the composition of the original mixture being calculated from the number of plants of the different species found in the resulting crop.

The seeds so examined were then pressed in the Laboratory and the oils obtained from them subsequently analysed to determine their physical and chemical characteristics. These characteristics are also recorded in Table IX below.

From the figures in the Table it will be observed that the results of both the examinations agree within the permissible limits of experimental error, thus showing that the microscope examination can be relied upon for estimating the composition of mixtures of mustard seeds. In this connection it should be noted that the chemical analysis shows that wherever the proportion of Rai, i.e., *Brassica juncea*, is large, the iodine value is high.

TABLE IX.

Results of microscopic and botanical examinations of market samples of "Brassica," and the physical and chemical characteristics of oils obtained from them.

No.	Province and District.		Composition by microscopic examination.				Composition by botanical examination.			Principal Brassica species in the sample.	Physical and chemical characteristics of oil from the sample.			
			Brassica campestris (Sarson).		Brassica juncea (Rai).	Brassica napus (Tori).	Brassica campestris. (Sarson).	Brassica juncea. (Rai).	Brassica napus. (Tori).		Sp. gr. at 15.5° C./15.5° C.	Refractive index at 40° C.	Saponification value.	Iodine value.
			Yellow.	Brown.										
1	United Provinces.	(Cawnpore) ..	1	2.5	90.0	6.5	Rai ..	0.917	1.4652	172.2	105.0
2	" ..	" ..	3	1.5	95.5	..	3.1	96.9	..	" ..	0.916	1.4659	170.1	105.5
3	" ..	" ..	12.5	..	87.5	..	10	90	..	" ..	0.915	1.4658	172.8	106.4
4	" ..	" ..	8.6	..	91.4	..	6	94	..	" ..	0.917	1.4657	171.4	106.1
5	" ..	" ..	99.2	.8	100	Sarson	0.916	1.4652	170.1	99.9
6	" ..	" ..	10.5	..	89.5	..	9	90.6	.4	Rai ..	0.913	1.4670	172.9	106.2
7	" ..	"	99.2	..	.8	100	Sarson	0.916	1.4652	170.5	100.1
8	" ..	" ..	96.8	3.2	98	2	..	" ..	0.913	1.4655	170.9	99.5
9	" ..	(Etawah) ..	7.4	..	90.6	2	6	93	1	Rai ..	0.914	1.4658	172.9	107.4
10	" ..	" ..	2.4	11.8	85.8	..	15	83	2	" ..	0.913	1.4670	173.9	105.2
11	" ..	" ..	3.5	..	96.5	..	2	97.8	.2	" ..	0.912	1.4670	172.8	107.2
12	" ..	" ..	1	96	..	3	Sarson	0.914	1.4640	174.2	101.1
13	" ..	(Aligarh) ..	1	97	..	2	96.4	3.0	.6	" ..	0.913	1.4640	174.5	100.2

TABLE IX—contd.

No.	Province and District.		Composition by microscopic examination.				Composition by botanical examination.			Principal <i>Brassica</i> species in the sample.	Physical and chemical characteristics of oil from the sample.			
			<i>Brassica campestris</i> (Sarson.)		<i>Brassica juncea</i> (Rai).	<i>Brassica napus</i> (Tori).	<i>Brassica campestris</i> (Sarson).	<i>Brassica juncea</i> (Rai).	<i>Brassica napus</i> (Tori).		Sp. gr. at 15.5°C./15.5°C.	Refractive index at 40° C.	Saponification value.	Iodine value.
			Yellow.	Brown.										
14	"	"	100	99.4	.6	..	"	0.913	1.4645	169.8	99.0
15	"	"	1.5	..	98.5	..	3	97	..	Rai	0.913	1.4655	175.1	105.3
16	"	"	98.5	1.5	Sarson	0.914	1.4640	170.2	100
17	"	(Agra)	2.3	..	97.7	..	1	98.5	.5	Rai	0.914	1.4670	172.6	106.6
18	"	"	2.5	7.8	89.7	..	7	92	1	"	0.913	1.4669	174.1	105.0
19	"	(Fyzabad)	15.2	3.5	81.3	..	19	80.1	.9	"	0.916	1.4657	171.3	104.5
20	"	"	..	1.6	..	98.47	Tori	0.913	1.4656	173.0	103.0
21	"	(Bahraich)	7.9	..	10	82.1	7	13	80	"	0.912	1.4645	174.1	102.4
22	"	"	..	1.5	..	98.5	..	5	94.8	"	0.913	1.4655	173.1	102.9
23	"	"	..	10.5	89.5	Rai	0.916	1.4687	173.1	104.5
24	Bihar	"	7.5	..	12.5	80	8	13	79	Tori	0.913	1.4648	173.8	102.5
25	"	"	..	99.2	..	8	100	Sarson	0.916	1.4655	174.0	100.2
26	"	"	16	4	80	..	18	82	..	Rai	0.916	1.4656	172.4	104.9
27	"	"	7.5	..	92.5	..	7	92	1	"	0.917	1.4658	172.2	105.8
28	Bengal	"	93.8	6.2	98	2	..	Sarson	0.913	1.4655	172.9	99.5
29	"	"	2	94	4	"	0.914	1.4642	174.0	101.4
30	"	"	17.5	..	82.5	..	16	83	1	Rai	0.915	1.4655	173.0	105.2
31	"	"	8	..	8.5	83.5	6.5	11.5	82	Tori	0.913	1.4648	174.3	102.8
32	Punjab	"	2	98	5	..	99.5	"	0.913	1.4650	172.8	102.3
33	"	"	..	1	..	99	100	"	0.913	1.4645	172.5	102.2
34	"	"	..	1.5	2	96.5	.2	5	94.8	"	0.913	1.4655	173.1	102.9
35	"	"	.5	.2	50	49.3	.2	49.8	50	Tori & Rai.	0.912	1.4650	173.5	106.2

CHAPTER IV.

CHARACTERISTICS OF GENUINE MUSTARD (RAPE) OILS FROM OIL MILLS IN VARIOUS PROVINCES, AND DISCUSSION OF RESULTS.

Samples of genuine mustard oils, pressed from mixed *Brassica* seeds in the mills of different Provinces, have been collected and examined in order to ascertain the variations in the characteristics of pure oils from commercial supplies and the results of this examination are shown in Table X below.

TABLE X.

Physical and chemical constants of mustard oils from mixed "Brassica" seeds obtained from oil mills of different Provinces.

No.	Province.	Place.	Specific Gravity at 15.5°C./15.5°C.	Refractive index at 40°C.	Saponification value.	Iodine value.
1	U. P.	(Cawnpore) ..	0.917	1.4648	172.9	105.2
2	"	" ..	0.915	1.4633	176.4	103.8
3	"	" ..	0.913	1.4645	170.5	99.5
4	"	" ..	0.914	1.4646	173.5	102.6
5	"	(Agra) ..	0.915	1.4664	176.1	106.2
6	"	" ..	0.918	1.4663	175.7	105.8
7	"	" ..	0.915	1.4656	175.2	104.3
8	"	(Aligarh) ..	0.916	1.4657	175.0	102.2
9	"	" ..	0.915	1.4655	174.5	103.5
10	"	" ..	0.915	1.4651	173.6	102.0
11	Bihar	..	0.916	1.4660	176.5	106.5
12	"	..	0.914	1.4658	176.0	103.2
13	"	..	0.914	1.4650	174.0	103.8
14	Bengal	..	0.914	1.4638	172.8	101.2
15	"	..	0.915	1.4656	174.9	105.6
16	"	..	0.915	1.4641	176.6	106.7
17	"	..	0.917	1.4637	173.7	102.8
18	Punjab	..	0.913	1.4655	174.2	102.5
19	"	..	0.914	1.4648	173.8	103.2
20	"	..	0.917	1.4652	172.1	105.5

There is now sufficient information about the chemical and physical constants of oils from various species of pure *Brassica*, as well as of oils obtained from mixed seeds available in the different Provincial markets, to enable certain definite conclusions to be reached which may be utilised to fix standards for pure mustard oil.

The adulterants which are commonly used for the sophistication of mustard oil are sesame oil, linseed oil, arachis oil, and, occasionally, niger seed oil. With the exception of niger seed oil, which, if present, will give the oil sample high iodine and saponification values, it is possible to detect all these adulterants without difficulty, thus the iodine value of niger seed oil is between 126—134, and the saponification value is between 188—192·5.

Sesame oil can be detected by the well-known Boudouin test, linseed oil by Hexabromide estimation, arachis oil by Renard's test and its modification by Dr. Brahmachari, and mineral oil by Holde's test, its estimation being made by isolating the unsaponifiable matter.

• TABLE XI.

Variations of physical and chemical characteristics of mustard oils, and comparison with the requirements of different specifications.

No.	Varieties.	Specific gravity at 15.5°C./15.5°C.	Refractive index at 40°C.	Saponification value.	Iodine value.
1	<i>Brassica campestris</i> (Yellow Sarson) (Table V).	0·914—0·916	1·4635—1·4654	169—171	99—101
2	<i>Brassica campestris</i> (Brown Sarson) (Table V).	0·914—0·916	1·4640—1·4649	173—175	100—103
3	<i>Brassica juncea</i> (Rai) (Table VI).	0·915—0·917	1·4650—1·4658	172—176	106—114
4	<i>Brassica napus</i> (Tori or Rape) (Table VII).	0·913—0·917	1·4639—1·4655	172—174	101—103
5	<i>Brassica mixed</i> (Table IX) ..	0·912—0·917	1·4640—1·4670	169—175·1	99—107·4
6	<i>Oils from mills</i> (Table X) ..	0·913—0·917	1·4633—1·4664	170—176·6	99·5—106·7
7	Variation as per <i>Lewkowitzsch</i>	1·463—1·468	171—176	93·5—103·6
8	Variation as per <i>Mitchell</i> ..	0·914—0·916	..	170—175	97—105
9	Variation as per <i>Bolton and Revis</i> ..	0·913—0·917	..	168—178	94—104
10	Variation as per <i>Fryer and Weston</i> ..	0·914—0·917	1·4650—1·4665	170—177	97—105
11	Variation as per <i>Dr. Brahmachari</i> ..	0·913—0·918	..	170—176·5	96·6—109
12	Br. Standard Specification ..	0·913—0·916	1·4648—1·4665	170—178	97—107
13	I. S. D. Specification* ..	0·905—0·909 (at 30°C./30°C.)	..	170—178	93—108
14	Bengal Specification	169—175	96—104
15	U. P., C. P. and Bihar	169—176	96—108
16	Punjab and N.-W. F.	170—180	93—105

*No. G./O-101/73 of 1937.

The data summarised in Table XI above shows that as a result of the wide variation of proportions of seeds of the several *Brassica* species commonly found in commercial supplies of mustard (rape) seed, there is a considerable range of variation in the principal physical and chemical characteristics of pure mustard oils produced in India.

It will be observed also that the requirements of certain mustard oil specifications in force in India need to be relaxed in order that they may admit all genuine oils having characteristics within the ranges of variation shown to be a feature of commercial supplies of genuine seeds and oil.

The desirability of all specifications drawn up in India for mustard (rape) oil being prepared on an All-India basis is also indicated. Such an All-India basis would be established by the general adoption of the following standards in the case of the requirements of Indian specifications for mustard (rape) oil :—

1. The specific gravity of the oil at 15·5°C./15·5°C. shall not be lower than 0·912 nor higher than 0·916, when compared with water at the same temperature.
2. The refractive index of the oil for D lines at 40°C. shall not be less than 1·463 nor higher than 1·467.
3. The saponification value of the oil shall not be less than 169 nor higher than 178.
4. The iodine value of the oil shall not be less than 96 nor higher than 108.
5. The oil shall not contain more than 1·5% of unsaponifiable matter.
6. The acid value of the oil shall not exceed 5, *i.e.*, free fatty acids calculated as oleic acid shall not exceed 2·5%.
7. Insoluble bromides shall not be present in amounts exceeding 0·5%.
8. The oil shall not contain any admixture of sesame oil.
9. The oil shall be free of arachidic acid.

CHAPTER V.

PUNGENCY IN MUSTARD OIL AND THE EFFECT OF VARIATION OF OIL MILL TECHNIQUE WHEN USING MODERN PLANT.

Edible mustard oil is manufactured in India from the seeds of *Brassica*. The fixed vegetable oil obtained from the seed is tasteless and nearly odourless, but the Indian market demands a strong pungent-smelling mustard oil for edible purposes and to comply with this requirement, the essential oil of mustard, with its characteristic pungent odour, is caused to develop in the seed by fermentation, as it is not present in the fresh seed as a separate constituent.

The seeds contain the glucoside potassium myronate (sinigrin), which under the influence of a ferment, myrosin, also present in the seed and of water, is decomposed into Allyl-iso-thio-cyanate (essential oil of mustard), glucose, and potassium acid sulphate, in accordance with the following formula:—

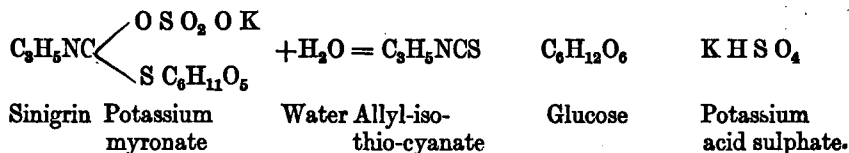

The hydrolysis proceeds favourably in the presence of water and between the temperature of 30°—45°C., the time required for the hydrolysis to be completed being nearly 80 minutes and varying with the reaction temperature. At a temperature of 70°C. and above, fermentation cannot take place, as the ferment myrosin coagulates and becomes inactive; it is for this reason that mustard oil obtained by hot pressing in modern oil milling plant is almost entirely lacking in pungency, as the rolled meal prior to pressing is cooked with open and close steam in kettles at a temperature of 90°—95°C.

The various species of *Brassica* have been examined to determine the essential oil yield, the method employed for estimation being as follows.

Five grams of thoroughly crushed seed were mixed with about 1 gram of kieselguhr and the mixture transferred to a 400 c. c. flask; 100 c. c. of water at a temperature of about 30°C. were added and the whole then mixed by shaking. The temperature was maintained at 30°C. for 4 hours, during which period 20 c. c. of alcohol were added to prevent frothing, and 50 to 60 c. c. of the mixture were then distilled as rapidly as possible into 10 c. c. of 10 per cent. ammonia; 20 c. c. of N/10 silver nitrate were next added and the mixture then heated on the water bath for 1 hour, after which the volume was made up to 100 c. c. and the silver sulphide produced was separated by filtration. To 50 c. c. of the filtrate 6 c. c. of nitric acid were added, and the excess of silver then titrated with N/10 ammonium thiocyanate solution.

% of Allyl-iso-thio-cyanate = $20 \times 0.04956(20 - \text{twice the volume of ammonium thiocyanate solution used})$.

The essential oil contents of various species of *Brassica* and of *Eruca sativa*, determined by the above method, are shown in Table XII below.

TABLE XII.

Essential oil content of the various species of "Brassica" and "Eruca sativa".

No.	Name of seed.	Essential oil %.	Remarks.
1	<i>Brassica campestris</i> (Yellow Sarson) ..	.27	Average of 5 samples
2	" (Brown Sarson) ..	.35	" 5 "
3	" <i>juncea</i> (Rai)45	" 4 "
4	" <i>napus</i> (Tori)14	" 4 "
5	" <i>nigra</i> (Benarsi Rai, Mohari, Asal Rai, Multani Rai)	.68	" 4 "
6	<i>Eruca sativa</i> (Taramira)43	" 4 "

These figures show that *Brassica nigra* has the maximum percentage of essential oil, but this seed is used as a spice and is not pressed for oil on a large scale. In order of essential oil content the other seeds of the *Brassica* family may be arranged thus :—*Brassica juncea*, *Brassica campestris*, brown and yellow, and *Brassica napus* *Eruca sativa* (Taramira), contains the same percentage of essential oil as *Brassica juncea* (Rai), though its characteristic smell is slightly different from that of the *Brassica*.

The old method of producing pungent mustard oil consists in pressing the moistened seeds in primitive *ghanni* mills, this method of pressing usually yielding about 30—33% of oil and requiring the addition of 2—4% of water. The temperature of the meal during the pressing process, due to friction of the pestle and mortar of the *ghanni*, reaches about 38°—40°C., which is approximately the optimum temperature required for the development of the odour. The time of pressing varies from 1½ hours to 3 hours, depending on the type of *ghanni* used (power or bullock driven), and it will be observed that the time-factor is also favourable, as complete hydrolysis also requires a period of 1—2 hours.

As the *ghanni* is worked, the essential oil formed gradually by hydrolysis of the glucoside is absorbed by the vegetable oil of the seed, which is simultaneously being slowly pressed out. The oil thus produced is consequently rich in essential oil content. It may be noted that if mustard seed is pressed in a *ghanni* or in any other type of machinery without being moistened, or if the seed is heated above 70°C., the oil obtained lacks the essential mustard smell.

The Harcourt Butler Technological Institute, Cawnpore, has carried out a considerable amount of investigation since 1922 with a view to determining methods of improving the pungency of the oil produced by modern oil mill machinery, such as hydraulic presses and expellers. The methods tried have

been selected with a view to reproducing closely the operations practised in *ghanni* pressing so far as the development of pungency and the quality of oil were concerned. In addition to improving the output, special attention has been devoted to utilising the existing types of oil machinery with as little alteration and addition as possible, as the average oil mill requires general purpose machinery suitable for pressing all types of oilseeds and not machines set apart for particular kind of seed.

It has been found as a result of these investigations that mustard oil having a smell and flavour equal to that produced in the ordinary *ghanni*, can be obtained by means of both the following methods :—

I. For oil mills having hydraulic presses or expellers with a suitable type of cooking kettle and other preparatory machines, the process of working the mustard seed should be as follows :—

- (1) The seed is first passed through a seed cleaning machine.
- (2) The cleaned seed is then passed through a set of Five-High Anglo-American Rolls. These rolls should preferably be of a heavy type so as to mill the seed thoroughly, the smallest size of rolls for satisfactory milling is 16" in diameter and 30" in length.
- (3) The milled seed is next passed to a double kettle having two compartments. In the upper compartment, 3—4% of moisture is incorporated by means of a fine spray of water and continuous stirring. The moistened meal is then passed to the lower compartment, and the upper one is again filled with a fresh charge. The meal is continuously stirred in this lower compartment and arranged to cook at a temperature of 40°—45°C. by means of a steam or hot water jacket for a period of 45 minutes. (The capacity of the kettle should be such as to provide sufficient meal for feeding the pressing equipment of the mill for 45 minutes).
- (4) The meal is then pressed in the hydraulic presses or expellers.

The meal so treated requires to be pressed twice in order to obtain the maximum yield of oil. During the first pressing 27—28% of oil, calculated on the weight of seed, is extracted, and the cake produced is then disintegrated, rolled, and pressed for a second time.

II. In the case of oil mills equipped with power-driven *ghannis*, these should be converted into combination units of *ghannis* and expellers or hydraulic presses, and the following working process adopted :—

- (1) The seed is worked in the *ghannis* with the addition of 3—4% of moisture for 45—60 minutes. During this time, due to hydrolysis at 40°—45°C., the maximum development of pungency is effected and about 25% of oil, calculated on the weight of seed, is extracted.

- (2) The meal is then passed through the disintegrator and then through the rolls, after which it is cooked at a very low temperature. The cooked meal is subsequently passed through the expellers or hydraulic presses in order to extract the remaining quantity of oil.

In a power-driven *ghanni* mill the period of working the seed per charge is $1\frac{1}{2}$ hours, but if the method described above is put into practice, the crushing period is reduced to 45–60 minutes. The introduction of an expeller for the second pressing increases the output of the mill from $1\frac{1}{2}$ to 2 times, resulting in a considerable saving of power and considerable improvement in efficiency as compared with the ordinary power-driven *ghanni* mill.

The processes described above yield 2–2½% more oil, calculated on the weight of seed, as compared with the yield obtained with power-driven *ghannis* alone, and about 4% more than with country bullock-driven *ghannis*. The average oil contents of the cakes from various oil crushing units are detailed below and they give a fair idea of the efficiency of the various plants used in Indian oil mills.

TABLE XIII.

Oil contents of mustard cake from various crushing units.

No.	Type of plant.	Oil content of the cake.	No. of samples examined.
1	Bullock-driven wooden <i>ghanni</i>	13–15	10
2	Power-driven Bengal type <i>ghanni</i>	10.5–11.5	30
3	Combination of <i>ghannis</i> and expellers	7–8.5	20
4	Hydraulic press cake (2nd pressing)	7–8	4
5	Expellers cake (2nd pressing)	7–8.5	4

The Allyl-iso-thio-cyanate contents of the oils obtained from both first and second pressing in an expeller after following the process No. 1 described above were determined, and also that of the oil obtained from a rotary *ghanni*. The figures obtained were as follows :—

Nature of the oil.	Allyl-iso-thio-cyanate content.
Oil obtained from the <i>ghanni</i>	1.45%
Oil obtained from the expeller (1st pressing)	1.58%
Oil obtained from the expeller (2nd pressing)	1.35%

The mixture of the oil obtained from the expeller after the first and second pressings gave the same essential oil content as the oil from the *ghanni*.

From these investigations the following conclusions can be drawn :—

1. Pungency in edible mustard oil depends on hydrolysis of the glucoside present in the seed, and the optimum temperature for the reaction is between 40°—45°C.
2. An addition of about 4% of moisture to the seed is necessary in order that the hydrolysis may take place.
3. The time required for the development of pungency is about 45 minutes, provided that the moisture is thoroughly incorporated with the seed meal meanwhile.
4. The seeds of *Brassica* can be arranged, in order of pungency as *Brassica juncea* (Rai) ; *Brassica campestris* brown and yellow (brown Sarson and yellow Sarson), and *Brassica napus* (Tori).
5. *Eruca sativa* (Taramira), though it possesses the same amount of pungency as Rai, has a characteristic smell of its own, which differs from that of Rai.
6. Modern oil milling plant can produce edible mustard oil as pungent as *ghanni*-pressed oil if operated in accordance with the methods described above.
7. The yeild of oil from modern pressing units when properly operated is 2—2½% greater than that obtained from power-driven *ghannis* and 4% more than that obtainable with country bullock driven *ghannis*.
8. Modern oil milling machines are more economical in power consumption than power-driven *ghanni* units of the types available.

BULLETINS OF INDIAN INDUSTRIAL RESEARCH



No. 15

**RECOVERY OF TITANIUM OXIDE AS A
BY-PRODUCT IN THE MANUFACTURE
OF ALUMINA-FERRIC FROM BAUXITE**

BY

SUDHIR CHANDRA CHAKRAVARTY, M.Sc.

No. 14 out of print

**INDUSTRIAL
RESEARCH
BUREAU**

**PUBLISHED BY THE MANAGER OF PUBLICATIONS, DELHI.
PRINTED BY THE MANAGER, GOVERNMENT OF INDIA PRESS, SIMLA.
1939.**

The statements made and the views expressed in this bulletin are those of the author, and neither the Government of India nor the Industrial Research Bureau accept responsibility for them.

AUTHOR'S FOREWORD.

No attempt has yet been made to recover Titanium Oxide from the residual mud which remains after treating bauxite with sulphuric acid during the manufacture of Alumina-Ferric, probably because the normal American and European bauxite ores do not contain a very high percentage of titanium. On the other hand, Indian bauxites are comparatively rich in their titanium contents as against American and European ores.

It is the object of this publication to describe a method suitable for use in the industrial recovery of titanium oxide from the bauxite residual-mud produced in the manufacture of alumina-ferric. The process is an adaptation of that employed in the manufacture of titanium oxide from ilmenite; the only difference lies in the fact that while in the ilmenite process the main difficulty to be overcome is involved in the separation of the titanium oxide from iron, in the process described herein the main difficulty to be overcome is the separation of titanium oxide from aluminium oxide and to a lesser degree from iron oxide.

Successful application of the process will help a manufacturer of alumina-ferric to reduce substantially the cost of the latter by enabling him to recover the valuable by-product, titanium oxide, the various uses of which as a paint pigment, in soap manufacture, and for other purposes are well known.

RECOVERY OF TITANIUM-OXIDE AS A BY-PRODUCT IN THE MANUFACTURE OF ALUMINA-FERRIC FROM BAUXITE.

INTRODUCTION.

In India there are many industrial concerns that manufacture Alumina-Ferric (commercial aluminium sulphate contaminated with a little iron sulphate) on a fairly large scale, the raw materials used in almost all cases being bauxite and sulphuric acid. The process of manufacture of alumina-ferric consists in digesting powdered bauxite ore with dilute sulphuric acid, the reaction mass being subsequently diluted and allowed to settle. The supernatant clear liquor is then decanted off for concentration, and the mud settling at the bottom is washed thoroughly to recover the remaining aluminium sulphate, after which it is thrown away.

Now, Indian bauxites generally (more particularly the pisolitic ores) contain a fair amount of titanium, the content generally ranging between 9 and 12 per cent. of the ore. The mud, referred to above, which is evidently very rich in titanium oxide and composed mainly of TiO_2 , SiO_2 , Fe_2O_3 , and unreacted bauxite, has not hitherto been utilized for any purpose, but the titanium oxide can be profitably recovered from the mud in the manner described below, and in fact several attempts to do so are also described.

To begin with it will be of interest to compare the compositions of various bauxites, and these are therefore given in the following table ¹ :—

Locality.	Al_2O_3 .	Fe_2O_3 .	H_2O .	SiO_2 .	TiO_2 .	CaO	MgO.
Vogelsberg	50.92	15.70	28.60	1.10	3.20	0.80	0.16
Monte Turchio	55.01	24.29	12.72	3.05	2.44	0.58	0.25
Pescina	41.13	24.81	17.31	6.28	2.70	8.24	..
Villeveyrac	65.00	17.60	14.00	1.90	1.50
Villeveyrac	76.90	0.10	15.80	2.20	4.00
Thoronet	69.30	12.90	14.10	0.30	3.40
W. Australia	44.66	19.08	27.02	5.96	3.10
Georgia	52.94	12.29	28.40	2.83	3.78
Arkansas	46.44	22.15	26.68	4.89
Arkansas	62.05	1.66	30.31	2.00	3.50

¹ I. Mellor—A Comprehensive Treatise on Inorganic and Theoretical Chemistry, (1929) Vol. V, p. 250.
M441SD

Locality.	Al ₂ O ₃ .	Fe ₂ O ₃ .	H ₂ O.	SiO ₂ .	TiO ₂ .	CaO.	MgO.
Gold Coast	60.55	9.75	25.59	1.42	2.21	0.73	..
Dalmatia	57.90	24.30	12.00	1.20	4.20	0.30	..
Ireland (1st)	53.83	1.57	29.27	8.67	5.80	0.62	0.13
Ireland (2nd)	52.00	4.57	24.00	12.00	6.20	0.79	0.20
Ireland (3rd)	46.13	15.14	23.39	10.40	4.21	0.18	0.26
Bihar (grey)	69.00	3.00	15.00	12.00
Bihar (red)	55.60	25.30	11.00	3.00
Katni	65.48	3.77	19.38	0.38	11.61

It will be seen that the ore last-named in the table contains a far higher percentage of TiO₂ than any of the rest, and moreover that it is of Indian origin. In this connection the following table gives the compositions of a number of Indian bauxites which have been determined by the author:—

Locality and Suppliers.	Al ₂ O ₃ .	Fe ₂ O ₃ .	H ₂ O.	SiO ₂ .	TiO ₂ .	CaO.	MgO.
<i>Central Provinces—</i>							
Messrs. G. H. Cook & Co.	60.0	2.9	22.7	3.13	11.76	0.10	..
Messrs. C. L. Pathak & Co.	57.8	2.7	23.7	5.36	10.1	0.21	0.10
Messrs. McPherson & Co.	61.7	3.1	22.9	3.0	9.86
Messrs. P. C. Dutt & Co.	59.6	3.5	24.0	3.3	9.9	0.16	..
<i>Bihar—</i>							
Messrs. Baldwin & Co.	61.3	6.3	19.4	1.2	12.1
<i>Bombay—</i>							
Messrs. Killick Nixon & Co.	55.9	1.6	23.4	7.1	11.4	0.52	0.21

These figures are such as to indicate that it might be economically practicable to attempt the manufacture of titanium oxide from Indian bauxites, but it is the object of this paper to describe a method for the recovery of the titanium oxide as a by-product in the manufacture of alumina-ferric, and not to investigate the possibilities of an independent industry.

COMMERCIAL METHODS OF RECOVERING TITANIUM OXIDE.

Commercial titanium oxide is almost universally manufactured from ilmenite ($\text{FeO} \cdot \text{TiO}_2$), the richest and most abundant natural source of this substance. It will, therefore, not be out of place to describe briefly the process of its manufacture from ilmenite, which is as follows² :—

The worked-up ore is decomposed with concentrated sulphuric acid, during which the iron and titanium pass into solution as soluble sulphates while the gangue remains behind as residue. After taking off the soluble product in water the ferric iron still present is reduced to the ferrous state, a part of the iron is frozen out as $\text{FeSO}_4 \cdot 7\text{H}_2\text{O}$, and then the titanium is precipitated by hydrolysis. The latter is filtered, washed till free from iron, and then calcined. Nearly all titanium oxide commercially available is manufactured from ilmenite by the above or almost similar processes, and it should be noted that a special feature of the process is the separation of the titanium oxide from iron—a slight trace of the latter being sufficient to tint the precipitated titanium oxide brown or yellow.

The following alternative methods of recovering titanium oxide as a by-product in manufactures where bauxite is the raw material are also described in technical literature on this subject :—

A red slag residue is obtained during the preparation of pure alumina for the production of aluminium metal. The bauxite—(evidently European or American)—employed for the purpose contains 1.0–4.5 per cent. of TiO_2 ³. The residue in question, when dried at 100°C ., has the following composition : Fe_2O_3 —50%, TiO_2 —7%, CaO —13%, Al_2O_3 —10%, Silica—5%.

(A) It has been suggested³ that the titanium oxide could be recovered from this residue by treating it with concentrated sulphuric acid and then hydrolysing the resulting solution, but the method is not very satisfactory industrially, chiefly because the TiO_2 content is too small and also because large amounts of other substances are generally associated with it.

(B) According to German Patent D. R. P. 525908 of Lauta-werke, Lausitz, the extraction of titanium oxide from the above kind of slag becomes fairly simple if it is first gradually heated with coal to a temperature of 850°C .— 900°C ., and then treated with dilute sulphuric acid. The greater part of the iron then goes into solution, and the residue is brought into solution by treating it again with concentrated sulphuric acid. The titanium sulphate which is thus formed is then hydrolysed according to known processes.

(C) According to German Patent D. R. P. 478740 of Metallgesellschaft, Frankfurt, sulphur dioxide is passed into a suspension of the red slag in water, and the greater portion of iron and titanium is thereby brought into solution. The titanous acid is precipitated by hydrolysis and then dissolved in concentrated sulphuric acid, and pure titanium oxide is finally recovered from this latter solution.

2. Chemical Trade Journal, 1931, 88, 29.

3. Farben-Chemiker, 1932, 3, 34.

It will have been observed that the three methods described above are all concerned with the recovery of titanium oxide from a bauxite residue, and this residue is far poorer in TiO_2 -content and more impure in composition (as is shown below) than those with which this paper is mainly concerned.

In the case of the latter the method most suitable for the recovery of titanium oxide from the bauxite-mud referred to on page I of the 'Introduction' of this paper, has been found to be briefly as follows:—

The mud, while still in the wet condition, is treated with dilute sulphuric acid, and parts of the iron and aluminium go into solution. The residue, which has become very rich in titanium oxide, is thoroughly washed with water and then dried in air. The dried mud is next powdered and then decomposed with concentrated sulphuric acid, after which the reaction-mass is dissolved in water, the resulting titanium sulphate solution (containing iron and aluminium sulphates also) being then allowed to settle. When settlement is complete, the clear liquor is drawn off, and enough scrap iron is added to the remaining sludge to ensure the reduction of all the iron present to the ferrous state. The reduced sludge is then hydrolysed by simple heating and the precipitated meta-titanic acid is thoroughly washed free from iron and free acid, after which the precipitate is finally dried and ignited.

Detailed Description of the Proposed Method.

The experiments on which this proposed method is based have been conducted on a semi-commercial scale with pilot plant giving a production of 14 lbs. of titanium oxide daily.

For convenience of description, the process may be regarded as comprising the following operations:—

- (1) Preparation of the mud.
- (2) Decomposition of the prepared mud.
- (3) Solution and clarification.
- (4) Reduction.
- (5) Hydrolysis.
- (6) Washing of the meta-titanic acid.
- (7) Drying and ignition.

1. *Preparation of the mud.*—Numerous samples of the mud-water that is obtained in the manufacture of alumina-ferric, have been analysed, and the following table shows a few of the results:—

Samples.	TiO_2 .	Al_2O_3 .	Fe_2O_3 .	H_2O .	SiO_2 .	CaO .	MgO .
Air-dried mud (I) ..	35.10	25.40	4.10	20.30	15.30	0.26	0.10
Air-dried mud (II) ..	31.50	22.20	2.64	32.00	11.70	0.20	0.11
Air-dried mud (III) ..	38.00	27.10	4.90	13.20	16.70	0.40	0.14
Mud dried at 100°C. ..	41.00	28.80	3.43	11.10	15.20	0.45	0.20
Wet mud	20.00	14.60	1.20	57.50	6.50

It will be seen from these that the air-dried mud has been found to contain on an average about 34 per cent. of titanium oxide, and that the ratio of TiO_2 content to Al_2O_3 content is roughly 3 to 2. It has also been found, however, that the meta-titanic component precipitated during hydrolysis is contaminated with aluminium hydroxide, evidently due to the presence of so much alumina. Moreover, the pigmentive property of the titanium oxide appears to suffer if hydrolysis is conducted in the presence of an appreciable amount of aluminium salts.

The object at this step of the procedure is therefore to raise the $\text{TiO}_2 : \text{Al}_2\text{O}_3$ ratio as far as possible. To effect this take 500 lbs. of the wet mud, place it in a lead-lined vat, and treat it with 250 lbs. of sulphuric acid (S. G. 1.6). Inject steam into the mixture through a lead pipe for six hours. The reaction mixture should then be diluted to 15°Tw (S. G. 1.075), subsequently heated with steam for a further 2 hours, and then allowed to settle, any titanium sulphate that might be formed being thereby hydrolytically precipitated. The supernatant solution of aluminium sulphate, containing also a little iron sulphate, is then syphoned off for concentration as alumina-ferric. The residue is washed several times with water, the first washings being also transferred to the alumina-ferric plant, and the wet residue is then placed in a shallow brick-built reservoir, exposed to the wind and sun, where it dries to a soft cake. Analysis of typical dry residues obtained in this way gave the following results:—

Sample.	TiO_2 .	Al_2O_3 .	Fe_2O_3 .	H_2O .	SiO_2 .	CaO .	MgO .
I	50.80	20.20	1.20	8.80	19.20	0.30	..
II	55.40	16.80	1.10	10.40	17.00
III	51.30	19.70	1.50	9.50	18.10	0.25	..

2. *Decomposition of the prepared mud.*—10 lbs. of the dry residue from operation (1) is placed after powdering (10 mesh), in an earthenware pot of 4 gallons capacity. Suitable pots are those used for distilling nitric acid (from salt and sulphuric acid) by some manufacturers. About 18 lbs. of concentrated sulphuric acid (S. G. 1.8) is then added to the dry residue, after which the pot is heated as in the case of nitric acid distillation. The temperature of the reaction-mass should be maintained almost throughout the process within a range of 180°C.—210°C. The reaction takes 4—6 hours to complete, and dense white fumes then come copiously from the mouth of the pot. It has been found that about 90 per cent. of the titanium oxide in the mud is brought to a soluble condition during the reaction. The use of dilute acid has also been tried with a view to effecting satisfactory decomposition, but without success.

In commercial scale operations this decomposition might be effected in

a furnace of the reverberatory type with its bed made of an acid-resisting material.

3. *Solution and clarification.*—The product from operation (2) is a soft cake which is broken easily. The cakes are removed from the pots and 10 such cakes put into a lead-lined vat, where chamber acid (about 112 lbs. S. G. 1.6) is added to it and steam then injected until the temperature of the mixture rises to about 60°C. It should not be allowed to appreciably exceed this, as a higher temperature may induce hydrolysis. The cakes disintegrate after a time, and when this has taken place, enough water (about 100 gallons) should be added to bring the specific gravity of the solution between 1.175—1.200 (35°—40°Tw). The addition of the acid should be so regulated that the free H_2SO_4 content of the resulting solution is between 100—150 gms. per litre, and this point is most important as the pigmentive quality of the precipitated meta-titanic acid depends largely on the free-acid-content of the solution from which it is precipitated⁴. The solution of titanium sulphate thus obtained is then allowed to settle. It does not always clarify easily and quickly, however, and a small amount of milk of lime, if mixed with the solution before settling, has been found to coagulate the colloidal silicic acid and other suspended matter quickly. Typical solutions obtained gave, on analysis, the following results:—

Samples.	TiO ₂ per litre.	Al ₂ O ₃ per litre.	Fe ₂ O ₃ per litre	Free H ₂ SO ₄ per litre.
I	55 gm.	20 gm.	1.1 gm.	150 gm.
II	49 gm.	21 gm.	0.9 gm.	137 gm.
III	57 gm.	24 gm.	0.96 gm.	114 gm.

4. *Reduction.*—About 100 gallons of the clear liquor from operation (3) are syphoned off into another lead-lined vat, where enough fat-free scrap-iron is added to it in order to reduce all the iron present into the ferrous state. As ferric sulphate has a tendency to hydrolyse and be precipitated along with meta-titanic acid,⁵ it is essential that there should be no trace of ferric iron present in solution. This could be easily ensured by simply observing the colour of the reduced solution which should be tinged violet showing the presence of titanous ions; for as long as there is an excess of titanous salts in the solution, all the iron salts in it must needs remain in the ferrous state. After reduction the solution is further allowed to clarify over-night by settling.

5. *Hydrolysis.*—This is the most delicate of the whole series of operations, for the “pigmentive” property and the yield of titanium oxide obtained are

4. Technische Fortschrittsberichte, Band 37, Titanweiss, p. 19.

5. Chemical Trade Journal, 1931, 88, 29.

dependent on the maintenance of correct hydrolysis conditions. The hydrolysis is influenced by the concentration, the free H_2SO_4 content of the solution, the temperature and duration of hydrolysis, the intensity with which the solution is stirred during hydrolysis, as well as by the presence of foreign substances in the solution⁶. When operating on a semi-commercial scale the following procedure has been found quite satisfactory both in respect of the quality and yield of the titanium oxide produced:—

To carry out the hydrolysis a round-bottomed enamelled vat of 30 gallons capacity, provided with a steam-jacket and a mechanical stirrer, the latter being also enamelled, has been used. The vat could be tilted about a horizontal axis by means of a rack and pinion arrangement. About 25 gallons of the solution from operation (4) is placed in the vat, steam is admitted to the jacket, and after some time the stirrer is brought into operation. Hydrolysis is readily induced if freshly prepared titanium hydroxide is added to form a nucleus⁶. For this purpose about 4 oz. of air-dried meta-titanic acid are dissolved in sulphuric acid, the titanium being re-precipitated from the solution as hydroxide by exactly neutralising the acid with caustic soda solution. This mixture is added to the solution to be hydrolysed, during heating. The temperature is maintained at about 95°C. throughout, and the operation is completed within 1½ to 2 hours, after which the liquid is allowed to settle. About 80 per cent. of the titanium oxide present in the solution is precipitated in this way, and the yield is about 10.5 lbs. weighed as titanium oxide.

By tilting the vessel the mother liquor is decanted off into a lead-lined vat, the precipitate being removed and placed in another. The mother liquor contains a considerable amount of sulphuric acid and also titanium, and is therefore employed in operation (3) to dissolve the titanium sulphate cake. After it has been re-used a number of times in this way, however, the concentration of aluminium and iron salts in the mother liquor rises to such an extent as to contaminate the precipitated meta-titanic acid with aluminium and iron, and then it is better to utilize the mother liquor for the production of alumina-ferric.

On a commercial scale, an enamelled vessel similar to that described above, and of suitable size, should work satisfactorily.

6. *Washing of meta-titanic acid.*—The precipitated meta-titanic acid, which at this stage will still retain some mother liquor from the previous operation, is washed three times with a 2.5 per cent. solution of sulphuric acid. It is then washed several times with water until the wash water is neutral to litmus. The precipitate will still be contaminated with a little free sulphuric acid and this is removed by washing with a very dilute solution of caustic soda (1 : 1000). It is finally washed free from alkali, and then put into filter bags made of cotton canvas, after which the bags and their contents are hung up and allowed to drain off and dry in air.

For large scale operation filter presses will be required for this purpose.

7. *Drying and Ignition.*—The meta-titanic acid in the filter bags dries to a solid cake within a few days, and the cakes are then taken out and further drying carried out in a steam heated drying chamber.

The dry cakes are then ignited in a quartz basin placed in an iron box, the latter being heated to redness. The ignited cakes after cooling are easily disintegrated to an impalpable powder between the fingers. A one gallon capacity quartz basin similar to those used in cascade system sulphuric acid concentrators has been found suitable when carrying out the small-scale work.

Yield of Titanium Oxide obtained in Pilot Plant operations.

From ten charges of the mud, about 100 gallons of titanium sulphate liquor were obtained, and this was hydrolysed in four operations, taking 25 gallons each time. The total yield was 42 lbs. of titanium oxide.

The product was very pure, and contained 98—99% of titanium oxide. Only a trace of iron was present (about .009 per cent.), whereas commercial titanium oxide, "extra white" grade, contains about .0028—.007 per cent.

Analytical Methods used in connection with these investigations.

In the experiments described above, Al_2O_3 , Fe_2O_3 , and TiO_2 contents were determined gravimetrically according to the method of Gooch⁷. The iron oxide content was also determined volumetrically⁷ and the titanium oxide content colorimetrically⁷.

Free acid in the liquor was determined by mixing the solution with neutral potassium fluoride solution and then titrating with caustic soda⁸.

A general scheme of analysis which was followed for rapid estimation of the ore or mud was as follows:—

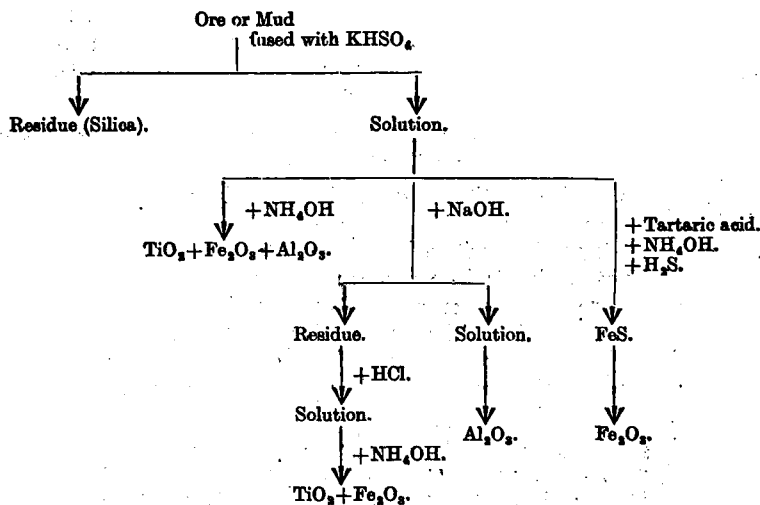

7. Analytical Chemistry, Vol. II, Treadwell and Hall. (pp. 121-122, 591-592, 106-108).

8. Jour. Soc. Chem. Industry, 1911, 134.

Cost of production of Titanium Oxide by the proposed method.

The probable cost of titanium oxide when manufactured according to this process, based on the results of the semi-commercial scale experiments described above would be as follows :—

Materials—

Prepared mud	100 lbs. ..	@ nil (at present a waste product).		
Sulphuric acid (S. G. 1.8)	180 lbs. ..	@ Rs. 4 per cwt. ..	Rs. 6	8 0
Sulphuric acid (S.G. 1.6)	112 lbs. ..	@ Rs. 2 per cwt. ..	Rs. 2	0 0
			Rs. 8	8 0.

Process items—

Labour, etc.	0-1-0 per lb. of yield ..	Rs. 2	10	0
Steam, etc.	0-1-0 per lb. of yield ..	Rs. 2	10	0
Overhead Charges	0-1-0 per lb. of yield ..	Rs. 2	10	0
		Rs. 16	6	0
Less for acid* recovered		Rs. 4	0	0
		Rs. 12	6	0

Yield—42 lbs. of titanium oxide.

Cost—0-4-9 per lb. or say, 0-5-0 per lb., *i.e.*, Rs. 35 per cwt.

Market Price—Rs. 56 per cwt.

It appears from this that a manufacturer, producing about 1,200 tons of alumina-ferric annually, in the production of which about 400 tons of bauxite would be consumed, should be able to recover about 30 tons of titanium oxide. This would bring in a net profit of Rs. 12,000 annually, or, in other words, the cost of his alumina-ferric could be reduced by Rs. 10 per ton.

Titanium oxide is now used industrially in considerable quantities as a pigment for paint, as a component in vitrified enamels for iron and steel, in soap-making and in ceramics and the demand is steadily increasing.

Bibliography.

The following books, journals and Patent literature were consulted in connection with the preparation of this publication :—

A Comprehensive Treatise on Inorganic and Theoretical Chemistry, by Mellor, Vol. V.

Technische Fortschrittsberichte, Band 37. Titanweiss—Kurt Heise.

Analytical Chemistry, Vol. II—Treadwell and Hall.

Farben-Chemiker, 1932, 3, 34.

Chem. Trade Journal, 1931, 88, 29.

Jour. Soc. Chem. Industry, 1911, 184.

German Patents D. R. P. 525908 and D. R. P. 478740.

* Sulphuric acid is set free during the precipitation of meta-titanic acid.

BULLETINS OF INDIAN INDUSTRIAL RESEARCH



No 16

**THE MANUFACTURE AND APPLICATION
OF LIQUID GOLD**

BY

ATMA RAM, D.Sc.

KARIMULLAH, Ph.D., Dr. PHIL.

LAL C. VERMAN, Ph.D., M.S., F. INST. P.

**INDUSTRIAL
RESEARCH
BUREAU**

**PUBLISHED BY THE MANAGER OF PUBLICATIONS, DELHI.
PRINTED BY THE MANAGER, GOVERNMENT OF INDIA PRESS, SIMLA.
1940.**

M79ISD

F118:225

HO

The statements made and the views expressed in this bulletin are those of the authors, and neither the Government of India nor the Industrial Research Bureau accept responsibility for them.

CONTENTS

	PAGE.
SYNOPSIS	4
INTRODUCTION	5
MANUFACTURE OF LIQUID GOLD	6
<i>Sulphur-Turpentine Compound</i>	6
<i>Gold Resinate</i>	7
<i>Bismuth Resinate</i>	9
<i>Chromium Resinate</i>	9
<i>Rhodium Resinate</i>	10
<i>Rosin Solution</i>	11
<i>Bitumen Solution</i>	11
<i>Compounding of Liquid Gold</i>	11
NATURE OF LIQUID GOLD FILMS	12
SEMI-COMMERCIAL SCALE EXPERIMENTS	13
COMMERCIAL POSSIBILITIES	14
EFFECT OF WAR-TIME CONDITIONS	19
ACKNOWLEDGMENTS	20

SYNOPSIS

Liquid gold is a dark, oily, viscous substance containing resinates of gold and of other suitable metals dissolved in essential oils. It is used for the decoration of glass-ware and ceramic-ware and is imported at present into India from abroad. The process for the manufacture of liquid gold has been developed and is explained in detail. The decorative design produced with its aid is air-dried and the decorated article fired in a suitable muffle furnace at a gradually rising temperature up to about 650—700°C. During firing, the organic matter burns off, leaving a bright film of metallic gold. The necessary conditions and precautions to be observed in order to obtain a film having a proper degree of lustre and adhesion are described. The product compares favourably with the best imported material. Semi-commercial scale batches have also been successfully prepared.

The possibilities of its manufacture in India have been discussed under pre-war and war-time market conditions, and it has been shown that a commercial enterprise should make considerable profit by manufacture under peacetime conditions and even more so under the present war-time conditions.

PREPARATION AND APPLICATION OF LIQUID GOLD IN INDIA

INTRODUCTION

The manufacture of glass bangles constitutes an important and significant part of the Indian glass industry. In spite of the backward state of the glass industry in India, as a whole the glass bangle manufacturers have improved and developed their technique fairly well. Practically all the bangles sold in India are of the decorated type. The decorative designs on the bangles are executed with the aid of China glass, coral glass, liquid gold, etc. At present all these enamels are imported into India, and they are sold at a fairly high price, whereas imported decorated glass bangles are sold comparatively cheaply. The necessity for manufacturing decorating materials in India is, therefore, apparent.

The present investigation deals with the manufacture of liquid gold—a decorating material very extensively used in the Indian glass bangle industry as well as by manufacturers of ceramics.

Liquid gold was first prepared by Kuhn in 1828. For a long time the technique of its production remained a trade secret of porcelain manufacturers, but it now forms one of the most widely used decorating materials for ceramics and glassware. It is a dark, viscous, oily substance containing organic compounds of gold and certain other suitable metals dissolved in essential oils.

It is applied to the glass and ceramic articles to be decorated by means of a feather or a fine brush, either as such but usually after dilution with essential oils. After drying, which usually takes about an hour, the articles are carefully fired in a muffle furnace in such a manner that the temperature rises gradually and uniformly. For this purpose, the use of a channel type of furnace in conjunction with a conveyer in which the suitable temperature gradients could easily be maintained is desirable.

Ordinarily, in Indian factories, the furnaces used for this purpose are divided into three compartments, the temperatures of which are maintained at different levels, for example, at about 300°, 500° and 650°C respectively. The decorated articles are successively fired in these compartments, beginning with that at the lowest temperature, for about one to two minutes in each, depending upon the quality of the glass. When they have been fired at 650°C, they are gradually brought down to room temperature by following the same procedure in the reverse order. During firing, the organic portion of the liquid gold is lost, and a lustrous film of metallic gold which adheres firmly and cannot be easily removed is deposited on each article.

MANUFACTURE OF LIQUID GOLD

With regard to its preparation, several methods and recipes are found in literature on the subject, almost all of which are of an empirical character. The various methods of preparation recommended by Schwarz¹, Duterte², Carre³, Boudnikoff⁴ and Chemnitius⁵ have been carefully examined, and that recommended by Chemnitius having been found to be more satisfactory than the others, was, therefore, used as a starting point for the investigations which resulted in the development of the technique described in the following pages.

In liquid gold, the gold and the other necessary metals are present in the form of resinates, which can be prepared either by interaction between the metal chloride and the sulphur-turpentine compound or by heating together the oxide of the metal with Venetian turpentine at the boiling point of the latter. The sulphur-turpentine compound is an oily dark brown liquid, prepared by heating flowers of sulphur with a mixture of Venetian turpentine and oil of turpentine.

The mechanism of the reaction of sulphur with turpentine at the boiling point of the latter is not yet clearly understood, but it is believed that an additive compound of turpentine with sulphur is formed at this temperature. Boudnikoff and Schilow⁶ are of the opinion that sulphur forms a sulphide with turpentine according to the formula $C_{10}H_{16}S$, as this with methyl iodide gives a sulphonium compound. The exact chemical nature of the product is, however, still obscure.

The presence of minor constituents, such as bismuth chromium and rhodium resinates, has an important bearing on the physical properties of liquid gold. The function of bismuth resinate, which forms bismuth oxide on burning, is to fasten the gold film to the glass or porcelain surface to which it is applied. Chromium resinate present in liquid gold plays a role probably similar to that of bismuth resinate. The chief function of rhodium resinate is, however, to make the film of metallic gold lustrous.

Brief descriptions of the methods of preparation of each of the constituents of liquid gold will first be given before the final compounding of the product is discussed. The quantities of materials and the size or apparatus described below are those required to prepare a batch of liquid gold starting with 20 tolas (233.3 gms.) of metallic gold.

Sulphur-Turpentine Compound

✓ In a distillation flask (capacity 4 litres) a mixture of Venetian turpentine, turpentine and sulphur in the following proportions is heated on a sand bath at about 170°C.

Venetian turpentine	450 gms.
Turpentine	850 gms.
Flowers of sulphur	120 gms.

Turpentine, which begins to distil at this temperature, is collected in a receiver which may conveniently be a distillation flask. In order to facilitate the

¹ *Dingler's polytech. J.*, 197, 243.

² *Dingler's polytech. J.*, 161, 44.

³ *Salvétat in Brogniart Tr.*, II, 721.

⁴ *Barichte des polytech. Zu Iwanowo*, Wosenssensensk, No. 6, 211.

⁵ *J. für prakt. Chem.* 117 (2), 245, 1927.

⁶ *Ber. der deutschen Chemischen Gesellschaft*, Abt. B, Band III, 3842-3853, 1922.

distillation of turpentine, the receiver should be connected to a water pump and a few holes bored in the cork fitted to the distillation flask containing the mixture, so that the turpentine vapours will be sucked into the receiver with a current of air and the distillation flask remain at normal atmospheric pressure. The rate of distillation should be so adjusted that about 60 gms. of turpentine distil in one hour. After 250 gms. of turpentine have distilled over, the heating is discontinued, and the distillation flask allowed to cool slowly. The dark brown viscous liquid which remains in the flask is the sulphur-turpentine compound, used in the preparation of most of the metallic resinates present in liquid gold.

The sulphur content of this compound may be determined by oxidising a carefully weighed quantity with concentrated nitric acid, whereby the sulphur present in the compound is converted to sulphuric acid which can be precipitated with barium chloride as barium sulphate.* It was found by experience that compound having a sulphur content of 9-10 per cent. gave satisfactory results.

Gold Resinate

Metallic gold, which is sold commercially in the form of bars, is first beaten and rolled into thin sheets and then cut into small pieces with a view to facilitating its solution in aqua regia. 20 tolas (233.3 gms.) of the metal pieces are dissolved in a mixture of 1000 cc. of concentrated hydrochloric acid and 400 cc. of nitric acid in a porcelain dish. After complete dissolution of the metal in the acids, the solution of gold chloride should be filtered in order to remove any silver chloride which may have formed as a result of the presence of silver as an impurity in the gold, and to the clear solution of gold chloride so obtained are added 150 gms. of potassium chloride dissolved in about 300 cc. of distilled water, after which the whole mixture is evaporated to dryness on a water-bath. The orange yellow crystals of potassium-auric chloride so formed should then be dissolved in about two kilogrammes of pure methyl alcohol* and filtered to remove the unreacted potassium chloride. This solution of potassium-auric chloride in methyl alcohol is then ready for the preparation of gold resinate.

One kilogramme of the sulphur-turpentine compound is added slowly to the solution of potassium-auric chloride, the rate of admixture being so adjusted as to avoid an excessive rise in temperature. After complete mixing of the contents, the container and the contents should be weighed, and then heated on a water-bath till the weight is reduced by 1600 gms. To ensure rapid evaporation of the methyl alcohol, the mixture should be occasionally stirred during heating. Instead of evaporating off the alcohol, it may be recovered, fractionally distilled, and purified for re-use, but owing to the fact that it carries with it a certain amount of turpentine compounds, its purification is more difficult than is ordinarily the case.

The thick mixture of gold resinate and unreacted sulphur-turpentine compound should next be dissolved in 1000 gms. of pure chloroform, and the

*The methyl alcohol used in this reaction and in those described later was a highly purified material obtained by adding fused calcium chloride to commercial methyl alcohol to the extent of 10 per cent. by weight, keeping the well-stirred mixture for twenty-four hours at least and then distilling it on water-bath.

solution neutralised with about 150 gms. of pure sodium carbonate, added gradually till the reaction becomes faintly alkaline to litmus. To ensure complete neutralisation, the contents should then be left for about twenty-four hours and the solution tested once again for acidity with litmus paper. More sodium carbonate should be added if it is still found to be acidic.

The chloroform solution is next filtered to remove the potassium chloride, excess of sodium carbonate, and any gold metal which might have been formed during the reaction. The residue on the filter paper should be washed with chloroform several times to remove as much of the soluble gold resinate as possible, the residues from this as well as other subsequent operations being kept aside for the recovery of the gold content.

In order to obtain pure dry gold resinate, the filtered chloroform solution is added drop by drop to 3 kilogrammes of methyl alcohol which is kept continually stirred, and in this way the gold resinate is precipitated. The precipitated resinate is filtered and washed thoroughly with methyl alcohol, after which it is dried by spreading the filter paper at room temperature, and the dried resinate finally powdered and kept in a well-stoppered bottle.

The gold content of the resinate varies from 47% to 52% and this may be determined by igniting a weighed amount of the resinate and weighing the resulting metallic gold. It has been found by experience that the yield of resinate should be about 75%—80%, calculated on the basis of the amount of metallic gold initially used. The remainder is recovered from the residue of the chloroform solution in the manner described later. In spite of the precautions taken, however, the loss of gold amounts to about 1%.

Great care must be taken in the preparation of the gold resinate, as otherwise the liquid gold made from it will be found to have deteriorated after storage for even a few days. Such deterioration in quality was actually experienced with the liquid gold produced in one experiment, resulting in the deposition on the article decorated of a film of dull appearance having a reddish brown tinge and non-uniform texture. Sometimes the deterioration was found to take the form of rendering the dry resinate insoluble.

The causes of deterioration in the quality of liquid gold and also of dry resinate on storage were investigated, and from the results obtained it would appear that such deterioration is most probably caused by decomposition of the resinate owing to the presence of minute traces of impurities which remain adsorbed in the gold resinate during preparation. The precautionary measures that need to be taken to avoid such decomposition are, firstly, prevention of the dust from the atmosphere from coming into contact with the chloroform solution of the gold resinate, and, secondly, washing of the precipitated resinate very thoroughly with methyl alcohol before drying. The washing of the resinate with methyl alcohol should be carried on till the filtrate is colourless. Once the dried resinate has been freed from impurities, it keeps well and the liquid gold prepared from it does not show any sign of deterioration.

Investigation was also carried out along other lines to determine the cause or causes of deterioration. The possibilities considered were the decomposition of gold resinate due to the wall reaction of the glass container, the reduction of gold resinate owing to the unsaturated nature of the essential

oils, and prevention of decomposition of gold resinate by means of external stabilizers. The effect of various essential oils such as rosemary oil, ilaichi oil, citronella oil, lavender oil, cedar wood oil, etc., and of nitrobenzene as solvents was tried as regards improvement of keeping quality, but they appeared to have no specific effect. The various experiments showed clearly, however, that if all the component resinates, especially the gold resinate, are well washed and purified, there is little likelihood of subsequent deterioration of the liquid gold.

In order to recover the gold which remains in the washings, filter papers, residues, etc., the latter are collected together and burnt to destroy the organic matter, and after complete combustion the mass is lixiviated with water and filtered to remove most of the soluble salts such as sodium carbonate, and potassium chloride. The residue is dissolved in aqua regia, as a result of which all the gold goes into solution together with bismuth oxide, etc., and from this solution the pure metallic gold is precipitated (in the form of a fine brownish powder) by adding sulphurous acid or by passing sulphur dioxide into it, leaving the impurities behind in solution. The recovered gold is washed and can then be again used for the preparation of gold resinate.

Bismuth Resinate

Bismuth oxide, which is employed in the preparation of this resinate, may first be prepared from bismuth nitrate as follows :—

100 gms. of the bismuth nitrate are dissolved in 200 cc. of water containing 20 cc. of concentrated nitric acid, and the solution then heated on a water-bath. To this solution is next added 90 gms. of pure potassium hydroxide dissolved in 100 cc. of hot water. An orange yellow precipitate of bismuth oxide is produced thereby, and this should be washed free from alkali and dried in an air-oven at about 70°C.

To prepare the bismuth resinate, 50 gms. of the dry bismuth oxide are mixed with 150 gms. of fresh Venetian turpentine and the mixture heated on a sand-bath for forty-five minutes, the temperature being carefully controlled so as not to exceed 160°C. The mixture is then dissolved in about 100 cc. of chloroform, thoroughly shaken, and filtered to separate the unreacted bismuth oxide. The bismuth resinate is precipitated from the chloroform solution by adding it drop by drop to 400 cc. of methyl alcohol which is continually stirred. The resinate is finally filtered, dried at room temperature, powdered and stored in a stoppered bottle. Experience has shewn that the yield of resinate is about one fifth of the amount of bismuth nitrate used. The bismuth oxide content of the resinate, which should be 20—60%, may be determined by igniting a known weight of the resinate and weighing the amount of bismuth oxide formed.

Chromium Resinate

The starting material for the preparation of this substance is chromic acid, 5 gms. of which should be dissolved in 10 cc. of water in a porcelain dish, and to this should be added 16 gms. of the sulphur-turpentine compound, the mixture being stirred continually. A considerable rise of temperature will be found to take place due to the oxidation of the turpentine compound by chromic acid. After about half an hour, the mixture is heated on

a water-bath to remove the water as far as possible, the loss in weight being about 8 gms. The partially dehydrated mixture is then dissolved in 30 cc. of chloroform and the solution subsequently filtered to separate the chromium resinate from the chromium oxide formed during the reaction. From the chloroform solution, the resinate is precipitated by adding the solution drop by drop to 100 cc. of methyl alcohol, which should be stirred continually during the operation. The resinate is finally filtered and dried at room temperature, after which the dried resinate, which is dark grey in colour, should be powdered and stored in a well-stoppered bottle. The chromium oxide content of the resinate varies from 16% to 20% and this may be determined by igniting a known weight of the resinate and weighing the amount of chromium oxide thus formed. The yield of the resinate varies considerably, as it is dependent upon the oxidation of the turpentine compound by the chromic acid.

Rhodium Resinate

The starting material for the preparation of this resinate is sodium-rhodium chloride, $\text{Na}_3\text{RhCl}_6 \cdot 9\text{H}_2\text{O}$, a double salt of rhodium and sodium chloride having a rhodium content of 16—17%. To prepare the resinate 10 gms. of this salt are dissolved in 50 cc. of distilled water and to the resulting bright red solution are added 12 gms. of barium hydroxide dissolved in 20 cc. of hot water, whereby brick-red coloured rhodium hydroxide is precipitated. Without filtering the precipitate, the whole mixture is next heated on a water-bath until perfectly dry, at which stage the rhodium hydroxide assumes a dirty yellow colour. It is then washed with hot water to remove the excess of barium hydroxide and sodium chloride. The pure rhodium hydroxide so obtained is converted into chloride by dissolving it in 10 gms. of concentrated hydrochloric acid, when it will assume a brilliant rose ruby colour. The solution of the chloride should then be evaporated on the water-bath to remove the excess hydrochloric acid and when fumes cease to be given off it is dissolved in 60 gms. of methyl alcohol.

To prepare the rhodium resinate, 50 gms. of sulphur-turpentine compound are added to the methyl alcoholic solution of rhodium chloride, while continually stirring, and after about half an hour the methyl alcohol is evaporated from the mixture to the extent of 50 gms. The mixture, consisting of rhodium resinate and unreacted sulphur-turpentine compound, is dissolved in chloroform, just sufficient in quantity for the purpose. It may be found to contain some hydrochloric acid set free during the reaction, and this must be neutralised, the chloroform solution being, therefore, shaken thoroughly at this stage with 10 gms. of sodium carbonate, after which it should be left for twenty-four hours to ensure complete neutralisation. The neutralised solution should then be filtered and washed with some more chloroform, after which the filtrate is added, drop by drop, with continuous stirring, to 300 gms. of methyl alcohol to precipitate the rhodium resinate, which will be rose-red in colour. The precipitate is washed well with methyl alcohol and allowed to dry at room temperature by spreading the filter paper, after which the dry resinate should be powdered and stored in a well-stoppered bottle.

The yield of resinate is about 60%, calculated on the basis of the rhodium metal used. The residues, waste filter papers, etc., containing rhodium

should be burnt to destroy the organic matter, and the mass so obtained lixiviated with water to remove the soluble salts. The residue which remains after lixiviation contains rhodium in metallic form, but its conversion into sodium-rhodium chloride involves considerable difficulty. It is advisable, therefore, to arrange to sell the metallic residues to the suppliers of the sodium-rhodium chloride.

Rosin Solution

Rosin solution is used for adjusting the gold content of liquid gold to the usual commercial proportion which is generally 12·1%. To prepare this solution, 200 gms. of powdered rosin (ash content not more than 0·05%) are dissolved in 135 gms. of turpentine, with the aid of slight warming on a water-bath. The solution should be allowed to settle for about three days, and during this time it must be kept well covered to avoid dust particles. The clear supernatant liquid is finally decanted off and stored in a stoppered bottle.

Bitumen Solution

This solution is used to adjust the consistency and gold content of the liquid gold. Incidentally it also imparts a darker shade to the product. For its preparation 50 gms. of pure bitumen are dissolved in about 100 gms. of chloroform and refluxed for about half an hour on a water-bath. On cooling, the solution is filtered to separate any impurities that may be present, after which 50 gms. of nitrobenzene are added to the filtrate and the mixture heated in a beaker on the water-bath to remove the chloroform. When there is no more smell of chloroform the solution of bitumen in nitrobenzene is removed from the water-bath and placed for storage in a stoppered bottle.

Compounding of Liquid Gold

In the foregoing pages the methods to be used for the preparation of the different components constituting liquid gold have been described. When all these constituents are available, the required final product is prepared by combining them in certain proportions. After a large number of trials of mixtures containing the components in varying proportions, the following mixture has been found to be the most satisfactory :—

Gold resinate, Resinate containing	100 gms. of metallic gold.
Rhodium „ „ „ „	0·55 gms. of metallic rhodium.
Chromium „ „ „ „	0·45 gms. of Cr_2O_3 .
Bismuth „ „ „ „	2·5 gms. of Bi_2O_3 .
Ilaichi oil „ „ „ ..	230 gms.

The mixture of the dry resins should be ground with ilaichi oil in a porcelain mortar, so that it becomes perfectly homogeneous, care being taken to avoid dust particles, as these adversely affect the storage properties of the final product. When the mixture is ready it is mixed with a separately prepared mixture of rosin and bitumen solution having the following composition :—

Bitumen solution	..	95 gms.
Rosin solution	..	285 gms.

When the final mixture has been thoroughly homogenized, the ash content (metallic gold and other metals) should be checked by igniting a sample of known weight at a temperature not higher than 700°C. The ash content should be approximately 12.5 per cent, corresponding to metallic gold content of 12.1 per cent. to 12.2 per cent. If the ash content is more than this, an additional quantity of oil requires to be added to bring the gold content to the desired proportion.

The mixture should then be allowed to settle under cover for about two days, so that any undissolved particles which may be present can settle. When adjusting the oil content, allowance should be made for the oil which may be lost by evaporation during settling. After settling, the liquid gold is carefully decanted and bottled.

NATURE OF LIQUID GOLD FILMS

Liquid gold is applied to ceramic and glass articles at the original concentration stated above, or diluted with an additional quantity of essential oils, usually ilaichi oil. The dilution normally used is one to one, but may vary up to a ratio of 1 part of liquid gold to 2 parts of oil depending on the quality of the liquid gold itself as well as on the nature of the decorative effect desired. Consequently, in the trade the quality of liquid gold is sometimes determined by the amount of dilution it will tolerate without making the final gold film useless for decorative purpose, this being due to the fact that as the dilution increases the film which is deposited becomes correspondingly thinner and may be so thinned that it loses its characteristic gold colour and metallic lustre.

The drying time of a liquid gold film in the open air varies from about 20 minutes to one hour, depending on the extent of dilution, atmospheric, and other conditions. After the film has dried, the decorated article is fired in a muffle furnace at a gradually increasing temperature, the highest temperature to which the article may be raised depending both upon the nature of the material composing the article itself and on the type of liquid gold used, but generally speaking, the highest temperature lies between 650°C. and 700°C. The duration of firing also has a considerable effect on the film characteristic such as its adherence and its general tone, and it is, therefore, recommended that the optimum temperature and duration of firing required to give the most satisfactory results should be ascertained by a few preliminary practical tests in the case of each individual combination of a particular batch of liquid gold and decorated article.

A properly applied and well fired gold film should possess the metallic lustre, of a well polished surface, and should have a pale yellow gold-like colour, uniform thickness, soft texture, good adherence to the base, and freedom from cracks and blotches. With regard to the relationship between the nature of the glass or ceramic material and the satisfactory character of the film, it may be added that the brilliance of the gold film and its adherence to the ceramic article are improved if the decorated article is fired at the temperature at which it just begins to soften at the surface without undergoing bodily deformation.

On the other hand, if the temperature of firing is lower than the softening temperature of the base material, a comparatively poor adhesion of the fired gold film to the decorated article results, and this may sometimes cause prejudice against even a good sample of liquid gold. It is necessary to bear in mind that glasses with a high softening temperature require a higher temperature for firing, and this is liable to cause the gold film to lose its optimum lustre, which is generally developed at an optimum firing temperature of about 700°C. Moreover, poor quality glasses generally soften at a very low temperature, and have also been found to give films lacking in lustre. It appears, therefore, that glasses having softening temperatures which are neither too high nor too low are the most suitable for the purpose of decoration with the type of liquid gold under consideration. Similar considerations apparently apply also to enamels used in the ceramic industry, on the surfaces of which liquid gold decorations are often applied.

In applying the liquid gold, care should be taken to ensure that the resulting film is not too thick, otherwise, on firing, it will develop cracks and lose adherence. Adequate dilution with essential oils helps to avoid this condition. Too high a dilution, on the other hand, will tend to cause the film to spread on the glass surface without control, resulting in a very thin film often devoid of characteristic metallic gold appearance. It is necessary, therefore, that the proper dilution be determined by a few preliminary trials for every combination of glass and liquid gold in order to ensure the best results.

SEMI-COMMERCIAL SCALE EXPERIMENTS

After a lengthy series of preliminary laboratory experiments, and when it was felt that the various chemical aspects of the process of manufacture had been sufficiently mastered, semi-commercial scale experiments were carried out with a view, firstly, to discovering what difficulties, if any, might arise when enlarging the scale of operations and how they might be overcome, and secondly, to collecting the necessary data to enable the cost of production on a commercial scale to be estimated.

The first semi-commercial scale batch involved the use of 20 tolas of metallic gold, and the details of manufacture given in the foregoing pages cover the data obtained during the preparation of this particular batch. The product obtained amounted to 45 ounces of liquid gold, having the standard metallic content of 12.1 per cent., on the basis of metallic gold used and the proportion actually converted into liquid gold, the overall yield amounting to 66.2 per cent. The product was found to be satisfactory as regards the decorative films made and the films compared favourably with those obtained from the best quality imported German material available on the market.

After a short period of storage, *i.e.*, about a month, however, the product began to show signs of deterioration, such as deposition of particles, subsequently found to be reduced gold, at the bottom of the bottles in which the liquid gold was being stored, reduction of lustre in the film prepared from it, and sometimes the presence of minute specks in the films. These defects had not been observed in the case of the small laboratory-scale batches previously prepared, even after storage for over a year, and it became necessary to investigate the causes which had contributed to this deterioration.

The results of these investigations have already been incorporated in the descriptions of the technique of manufacture given on the earlier pages, where the various precautions necessary to avoid deteriorations have been described in detail. The speck formation in the films was found to be due to the reduced metallic gold particles, the presence of which was observed in the form of deposit at the bottom of the bottles. Loss of lustre can doubtless also be attributed to the existence of conditions which tend to reduce the resinate to the metallic state. In the light of the experience gained during these investigations another semi-commercial scale batch of liquid gold was prepared, this time starting with 13 tolas of gold, the result being a yield of 33.5 ounces of liquid gold of standard 12.1 per cent. metallic content, equivalent to an overall yield of 75 per cent. Improvement in yield from 66.2 per cent. in the 20 tolas batch to 75 per cent. in the 13 tolas batch indicates, in view of the smaller scale of the latter batch, that further improvement in yield is likely in larger commercial scale operations, and an expectation of 80 per cent. may not be unduly optimistic. For the purpose of cost estimation, however, the 75 per cent. figure has been used where this matter is discussed in following pages.

The quality of the second batch of liquid gold was found to be quite satisfactory and compared favourably with well known high-grade German product. The material was kept in storage under normal conditions and checked monthly over a period of eight months, at the end of which there was no serious deposit in the bottles nor was any deterioration in the film producing properties observed when tested practically.

COMMERCIAL POSSIBILITIES

The question of the successful manufacture of liquid gold as a commercial proposition in India may now be examined.

From statistics collected by the Director of Industries of the United Provinces in 1936, it appeared that the consumption of liquid gold at Ferozabad (Agra district, U.P.) alone, which is the principal centre of glass-bangle manufacture in India, was at that time about 50 oz. per day. Its selling price at Ferozabad varied from Rs. 16 to Rs. 18 per ounce (pre-war prices), depending upon the quality, the high-grade German product mentioned above being the most popular and fetching the highest price.

Its annual consumption at Ferozabad alone may, therefore, be estimated at approximately 18,000 ozs., worth more than three lakhs of rupees. Glass bangle manufacturers in other parts of the country and also the ceramic industry make use of this material. Roughly speaking, therefore, a minimum consumption of 20,000 ozs. of liquid gold per annum in the whole of India may be taken as the figure for estimating purposes, and the noteworthy point is that the whole of this quantity has hitherto been imported.

In making the following estimate of the cost of production of liquid gold, it has been assumed that manufacture might be started on a moderate scale producing about half the total requirement of the country in the first instance. On this basis a factory would require a total floor area of about 1,500 sq. ft., including offices and laboratories. No special machinery will be required, but the usual laboratory equipment and apparatus, such as working

tables, fume cupboards, water supply, electricity and gas connections, a number of large flasks, porcelain basins, beakers, funnels, etc., must be provided.

The estimates given below are based on pre-war market prices, since the unsettled and quickly fluctuating conditions of the present day make it otherwise impossible to estimate the cost of production with any degree of accuracy. The effect of the current price level on the final cost of production figure is also discussed subsequently.

The basic assumptions on which the cost of production are based are as follows :—

1. *Capital Investment—*

	Rs.
(a) Working Capital (equivalent to 3 months expenditure)	53,000
(b) Building	11,000
(c) Laboratory and Office equipment	4,000
(d) Apparatus	2,000
Total	<u>70,000</u>

2. *Rate of interest on investment* 5 per cent. per annum.

3. *Rates and Taxes, etc.* 1.25 per cent. on building investment.

4. *Insurance* (against theft, fire and accidents) .. Rs. 1,000 per annum.

5. *Depreciation—*

(a) Building	5 per cent. per annum.
(b) Laboratory and office equipment	10 per cent. per annum.
(c) Apparatus	25 per cent. per annum.

6. *Staff—*

(a) *Laboratory staff—*

	Rs.
One Managing Chemist	@ 250 per mensem.
Two Assistant Chemists	@ 200 per mensem.
Three Laboratory Assistants	@ 90 per mensem.
Four Bearers	@ 60 per mensem.
Total	<u>600 per mensem.</u>
Total per year	7,200

(b) *Office staff—*

Managing Chemist (already provided for above).

	Rs.
One clerk	@ 40 per mensem.
One Bearer	@ 15 per mensem.
Two Guards	@ 40 per mensem.
One Sweeper	@ 10 per mensem.
Total	<u>105 per mensem.</u>
Total per year	<u>1,260</u>

7. <i>Miscellaneous</i> .—(Including correspondence, stationery, travelling expenses, etc.)	Rs. 1,000 per annum.
8. <i>Working days in a year</i>	300

It has been estimated that under normal circumstances the above technical staff should be able to convert about 5,000 tolas of gold per year. The total yield of liquid gold, calculated at an average of 75 per cent., will in that case be about 12,750 ozs. per annum. It may be possible to improve upon this figure, after sufficient experience has been gained by the staff concerned, and improvement may take place in two directions, firstly, the percentage yield on gold basis may be improved upon, secondly, the various manufacturing operations may be better organized, which will enable the staff to handle larger quantities of gold during the year.

On the above assumption, the over-head cost of production per year may now be calculated as in Table I below :

TABLE I.

Estimate of overhead cost.

	Rs.
1. Interest on capital investment	3,500
2. Taxes, etc.	140
3. Insurance against theft, fire and accident	1,000
4. Depreciation—	
(a) Building	550
(b) Laboratory and office equipment	400
(c) Apparatus	500
5. Staff—	
(a) Laboratory staff	7,200
(b) Office staff	1,260
6. Miscellaneous	1,000
Total overhead costs per year for 12,750 ozs. of liquid gold	15,550
∴ Overhead cost per oz...	Rs. 1-3-6

With regard to the material cost, Table II below gives the estimate based on the experience gained in the semi-commercial scale experiments. In this connection it is to be observed that in actual factory operation, this cost may be expected to be less than that given in Table II, since, in processing large batches, the amount of certain of the chemicals consumed will be somewhat less than that used in a smaller scale experiment. Also, the prices given are retail prices current in the Calcutta retail market. It will be seen, therefore, that the calculations are to a certain extent on the liberal side.

TABLE II.

Estimate of cost of chemicals and other materials required to prepare a batch of liquid gold starting with 20 tolas (222.3 gms.) of metallic gold.

Substance	Amount	Rate	Price
		Rs. a. p.	Rs. a. p.
Methyl alcohol (including cost of dehydration and distillation).	10 lbs.	0 14 0 per lb.	8 12 0
Chloroform	4.5 "	1 8 0 "	6 12 0
Ilaichi oil	0.5 "	3 0 0 "	1 8 0
Hydrochloric acid, C.P. (chemically pure)	3.5 "	0 9 0 "	1 15 6
Nitric acid, C.P.	1.5 "	0 12 0 "	1 2 0
Sodium-rhodium chloride, C.P. ..	9 gms.	3 0 0 per gm.	27 0 0
Turpentine, C.P.	3 lbs.	0 4 0 per lb.	0 12 0
Venetian turpentine, C.P.	1.5 "	3 8 0 "	5 4 0
Sulphur, C.P.	0.25 "	0 8 0 "	0 2 0
Nitrobenzene, C.P.	0.1 "	1 8 0 "	0 2 6
Bismuth nitrate, C.P.	55 gms.	2 5 0 per 110 gms.	1 2 6
Potassium chloride, A.R.	150 "	2 8 0 per 440 gms.	0 13 6
Sodium carbonate, C.P.	150 "	0 12 0 "	0 4 0
Potassium hydroxide, C.P.	45 "	2 0 0 "	0 3 3
Minor chemicals, such as chromic acid, rosin, bitumen, etc.	0 10 0
Filter papers, etc.	0 9 0
Fuel, water, electricity, etc.	2 0 0
Packing materials (bottles, corks, labels, etc.).	3 0 0
Total, excluding gold	51 ozs. (L.G.)	1 3 6	62 0 3
Gold lost during the process, 1% of 20 tolas.	0.2 tola	36 4 0 per tola	7 4 0
Gold converted into liquid gold on the basis of the semi-commercial batch, (75% of total).	15 tolas	36 4 0 per tola	543 12 0
Total cost of gold alone	51 ozs. (L.G.)	10 12 10	551 0 0
Total Material cost of liquid gold	51 ozs.	12 0 4	613 0 3

It will be noted that for the purpose of this estimate 75% yield on the basis of metallic gold and 1% loss of gold has been assumed, which assumption is based on the results of experience gained with the semi-commercial scale batches. The remaining 24% can be recovered as described in the earlier parts of the paper by burning the residues, and used over again for the production of gold resinate in the succeeding batches. Thus, only the cost of recovery need be included in the cost estimation, and this has been done under the item concerning fuel cost.

The total cost of manufacture per oz. may now be estimated as in Table III below.

TABLE III.
Estimate of total cost of manufacture for pre-war conditions.

Item	Cost	Per cent
	Rs. A. P.	
(1) Overhead	1 3 6	9.2
(2) Chemicals (other than gold) ..	1 3 6	9.2
(3) Gold	10 12 10	81.6
Total ..	13 3 10	100.0

The estimated cost of production, Rs. 13-3-10 per oz. based on pre-war rates, may be regarded as the upper limit, on account of the fact that liberal figures have been used throughout. The sale price, as stated above, varied before the war from Rs. 16 to Rs. 18 per oz. at Ferozabad, depending on quality. The quality of the liquid gold prepared in these laboratory experiments is such that a net factory sale price of at least Rs. 16 per oz. could easily be demanded, which should be sufficient to allow a safe margin for retailer's profit and salesman's commission, etc. Thus the net profit to the factory would be at least Rs. 2-12-2 per oz., which, for a production of 12,750 ounces, amounts to more than Rs. 35,000 per annum. This means a net profit of 50% on an investment of Rs. 70,000, after paying all the interest, depreciation, and other charges excepting income tax.

At first sight this may appear to be too optimistic an estimate, but it must be remembered that the profit depends to a large extent on the total production of liquid gold per annum which is assumed for estimating purposes, under efficient working conditions. Assuming the production per annum to be only half of that estimated and leaving the investment at the same figure, which may well be the case in the earlier stages of working, the overhead cost will be doubled but other items will remain constant. In that case the total cost of production would be Rs. 14-7-4, and even at this figure the profit will amount to roughly Rs. 20,000, i.e., about 28% on the total estimated investment; moreover, during this period, only half the working capital investment would be required, giving a total investment of Rs. 43,500 instead of Rs. 70,000 and a net profit at the rate of approximately 46%.

As soon as the manufacture of liquid gold has been commenced in India to the extent of 50% of the country's requirements, the market of necessity

must find a new level, even under normal peace conditions. Calculated profit figures are, therefore, liable to be considerably affected. In view of the 25% duty payable on the imported material, however, the foreign products cannot afford to under-sell the indigenous preparations, especially if the gold content is maintained at the standard level of 12.1%.

The cost of gold alone, as has been demonstrated, amounts to roughly 82% of the total cost of the product, and, therefore, if it is assumed that the imported liquid gold prices are cut to such an extent as to bring them down to the level of the cost of production of the material in India, the foreign manufacturer will receive, after paying duty, only 80% of this price. This would be just sufficient to cover the cost of the metallic gold content, leaving no margin for the production and import charges and the other costs. It would, therefore, appear that, even under peace-time conditions, the enterprise, if operated efficiently, has the prospect of making a fair profit.

A word in regard to the most suitable location for starting a factory may not be out of place. Ferozabad appears to be a desirable place from the standpoint of the availability of a ready market for the product, but it has the disadvantage of being an isolated town far removed from industrial centres where raw materials of the type required would be readily available. Bombay and Calcutta, on the other hand, offer the latter advantages, besides being larger market centres for precious metals. From the industrial point of view, therefore, the latter locations are to be preferred.

EFFECT OF WAR-TIME CONDITIONS

The cost of manufacture of liquid gold as estimated in the previous pages was based on prices of gold and other chemicals current in the Calcutta retail market before the outbreak of war, and the possibilities of successful commercial manufacture was discussed in the light of peace-time conditions. Since the outbreak of war, however, the prices of gold and chemicals have increased considerably and the trade conditions have materially altered.

At the same time, the sale price of liquid gold has also risen, and shortly after the outbreak of war it was reported to have increased by 50%. Later reports indicate that it is now settled down again to roughly 30% higher than pre-war price in the case of liquid gold manufactured in countries other than Germany, while stocks of German liquid gold have been completely exhausted. It is important, therefore, that the possibilities of liquid gold manufacture be freshly examined in the light of current conditions.

The first important question that arises concerns the availability of raw materials. Enquiries from Calcutta firms dealing in chemicals brought out the fact that almost all the chemicals required can be had from Indian stocks, although at times it will be necessary to import certain of the chemicals from abroad, which may involve a delay of four or more months. These remarks do not apply to sodium-rhodium chloride, which requires to be specially imported even under peace-time conditions, but the quantities of this material required are so small that it may be imported even by Air Mail without materially affecting the final price of the liquid gold.

Prices of chemicals required have risen in different proportions in different cases, but in no case have they increased to more than double the pre-war price

level. If it is assumed, therefore, that all the chemicals have doubled in price, the estimate will be liberal.

Gold has increased from Rs. 36-4-0 per tola to Rs. 41-13-6 per tola (*i.e.* about 15 % higher), at which level it has been more or less steady for some time.

The overhead charges may also be somewhat affected, but not materially. Stocks of chemicals will have to be kept for longer periods of time, the salaries paid may be about 10% higher, the costs of building and apparatus may be affected to some extent. On the whole, if 25% increase in overhead charges is assumed, it will more than cover the requirements.

The final cost of production may, therefore, be re-calculated to take account of the present position as in Table IV below :

TABLE IV
Estimate of cost per oz. of liquid gold during war time conditions

Item.	Pre-War		Present		
	Cost	Per cent	Cost	Per cent. (of P.-W.)	Per cent. (Present).
(1) Overhead ..	Rs. A. P. 1 3 6	9.2	Rs. A. P. 1 8 5	11.5	9.3
(2) Chemicals (other than Gold).	1 3 6	9.2	2 7 0	18.4	14.8
(3) Gold ..	10 12 10	81.6	12 7 7	94.1	75.9
Total ..	13 3 10	100.0	16 7 0	124.0	100.0

Thus the cost of production would be 24% higher under the war-time conditions, *i.e.*, Rs. 16-7-0 per oz. instead of Rs. 13-3-10. The cheapest liquid gold which was sold before the war at Rs. 16 per oz. now sells at Rs. 20-8-0 per oz. or more. It has been already stated that the liquid gold manufactured in the laboratory is equal to German liquid gold of the highest quality and price, and, therefore, it could be sold in competition with the best liquid gold now on the market. If the sale price were the same as that of the good imported material now on the market and allowing Re. 1 per ounce for sales charges, commissions, etc., the factory should be able to realize at least Rs. 19-8-0 per oz., giving a net profit of Rs. 3-1-0 per oz.

It is apparent, therefore, that the present war-time conditions are favourable for the commercial success of the enterprise.

ACKNOWLEDGMENTS

The authors wish to express their appreciation to Mr. D. S. Naidu and Mr. M. A. Saboor, who carried out certain preliminary experiments in the early stages of this work.

*Research Branch,
Government Test House,
Alipore, Calcutta.*

BULLETINS OF INDIAN INDUSTRIAL RESEARCH



No. 17

THE MANUFACTURE OF CHINA GLASS

BY

ATMA RAM, D. Sc.,

and

LAL C. VERMAN, Ph. D., M.S., F. Inst. P.

**INDUSTRIAL
RESEARCH
B U R E A U**

**PUBLISHED BY THE MANAGER OF PUBLICATIONS, DELHI.
PRINTED BY THE MANAGER, GOVERNMENT OF INDIA PRESS, SIMLA.
1940.**

M(D12)

H0

The statements made and the views expressed in this bulletin are those of the authors, and neither the Government of India nor the Industrial Research Bureau accept responsibility for them.

CONTENTS.

	PAGES.
SYNOPSIS	iv
INTRODUCTION	1
COMPOSITION OF OPAQUE GLASSES	1
LABORATORY EXPERIMENTS	2
DISCUSSION	4
INDUSTRIAL SCALE EXPERIMENT	5
ECONOMIC CONSIDERATIONS	6
EFFECT OF WAR-TIME CONDITIONS	9
ACKNOWLEDGMENTS	10

SYNOPSIS.

With a view to developing a process for the manufacture of china glass, an opaque white glass used for decorating bangles in India, a number of laboratory scale lead glass batches were prepared, using various opacifying agents such as cryolite, felspar, arsenious oxide, antimony oxide, titania, etc., employed singly and also in combination with each other. Arsenious oxide was found to be an effective opacifier in concentrations of about 4.0 %. Small quantities of cryolite, antimony oxide, and titania used in addition to arsenious oxide improved the opacity, whiteness and gloss of the product. Composition No. 6 in Table I represents the formula which gave the most satisfactory type of china glass, this comparing favourably with the imported material in all respects.

A factory scale batch of 200 lbs. was prepared successfully. On the basis of experience thus gained, the economic possibilities of the manufacture of china glass in India were investigated, and it was shown that the enterprise can be profitable in peace time as well as under war-time conditions.

MANUFACTURE OF CHINA GLASS.

INTRODUCTION.

The decoration of glass bangles constitutes an important section of the Indian glass bangle industry. The artistic designs on the bangles are usually accomplished by enamelling them with low-temperature-melting opaque glasses of different colours, such as china glass, coral red, etc., and also with liquid enamels, such as liquid gold. At present most of these materials are imported into India and are sold at fairly high prices, whilst the imported decorated glass bangles themselves sell at comparatively low prices. It was, therefore, considered desirable to investigate the possibility of manufacturing these opaque glasses in India at a reasonable cost. The investigations described below deal with the preparation of opaque white glass (china glass).

COMPOSITION OF OPAQUE GLASSES.

As far back as 1860¹, hot cast porcelain (an opaque white glass) was manufactured in Philadelphia by the Hot Cast Porcelain Factory, from sand, cryolite and zinc oxide. During recent years, the preparation of these glasses has assumed considerable importance on account of their use as enamels and also in the manufacture of lamp shades and other fancy glassware.

Numerous substances are known which may be used to produce opacity in glasses under suitable conditions; among these mention may be made of oxides of tin, antimony, zinc, aluminium, titanium, zirconium and arsenic, calcium phosphate, asbestos, kaolin, felspar, cryolite, fluorspar and fluosilicates. Several of these, however, may be eliminated on account of their cost, these including zirconium oxide, fluosilicates, and others. Calcium phosphate, moreover, though an excellent opacifier is somewhat unsuited to Indian conditions, since considerable prejudice is likely to prevail, especially amongst Hindus, against the purchase of glass bangles decorated with enamels containing bone ash as the opacifying agent². Antimony oxide is also excluded because it produces a yellowish tinge in opaque glasses, and more so in lead glasses due to the formation of lead antimoniate. The reason why attention has been confined to lead glasses for the purpose in view is discussed below.

Arsenious oxide is in common use in glass factories to assist in the fining of glass, *i.e.*, the removal of the minute gas bubbles occluded during the course of melting, and has been observed to have a decolorising effect by way of reducing the greenish tinge in glasses produced by the presence of iron compounds. Fuwa³ has reported the use of a very high percentage of arsenious oxide (15 %) as an opacifier in soda-lime silica and boro-silicate glasses. It is, moreover, cheaper than either cryolite or tin oxide, both of which are extensively employed as opacifying agents in the manufacture of white opaque glasses and enamels, hence it was considered desirable to investigate its use as an opacifier for the preparation of cheap white enamels.

1. Smull, "Causes of Opacity in Glass", *J. Soc. Chem. Ind.*, 34, 402, (1915).

2. Dixon, "A survey of Indian Glass Industry", *Bull. Indian Industrial Research*, No. 2, p. 8 (1936).

3. K. Fuwa, "Colouring Glass with Arsenious Acid", *J. Jap. Ceram. Assn.*, 32, 469 (1924).

Since the glass articles to be decorated with these white enamels have to be reheated in a muffle furnace, it is necessary that the melting temperature of these enamels should be as low as possible; otherwise the decorated article is likely to be deformed. In order that a glass should have a low melting temperature, it should contain a comparatively high percentage of either alkali or lead oxide. It is well-known, however, that a high alkali glass has very poor durability, and, that being so, its enamelled designs may develop a dull appearance on exposure to the atmosphere. Consequently, the present investigation was confined to glasses containing a high percentage of lead.

LABORATORY EXPERIMENTS.

A number of high lead glasses were prepared, using cryolite, arsenious oxide, alumina, antimony oxide, titania and their combinations as the opacifying agents. In the preparation of these glasses, Barhgarh sand* having particle size between 50 and 100 mesh (B. S. sieve) was used, all the raw materials of the batch being thoroughly mixed before fusion. The glass batches, amounting to about 100 gms. each, were heated in small fireclay crucibles at about 900°C for about one hour in a gas-fired laboratory furnace, when the different ingredients of the batch melted to a fritt mass. The temperature was then slowly raised to 1250° C and maintained for about 2 hours, during this period the molten mass became sufficiently mobile and was occasionally stirred by means of an iron rod. After this operation, when the mass appeared quite homogeneous, the temperature was lowered to about 1000°C and maintained at this point for about one hour, after which the molten glass was poured out in the form of discs and allowed to cool slowly in a muffle furnace. It was observed that for the development of maximum opacity, the arsenious oxide glasses had to be cooled gradually, whereas the other batches did not particularly require slow cooling.

Each glass sample was next finely powdered, the fine powder being then converted into a thick paste with water, the consistency of the paste being kept almost the same in all cases. The paste was carefully applied on a transparent colourless glass slide (4" × 1") in the shape of dots by means of a steel pen, and, after drying, the slides were gradually heated in a muffle furnace to about 650°C, maintained at that temperature for about five to seven minutes and finally slowly cooled. The enamelled designs on the slides were subsequently visually examined and tested for adhesion by scratching with a pen-knife. For comparative experiments, different samples were applied on the same slide. In Table I are summarised some of the results obtained with different compositions.

*A sample of this sand was found to have the following composition :—

Loss on ignition	0.62	
SiO ₂	97.10	
Fe ₂ O ₃	0.03	
Al ₂ O ₃	1.09	
TiO ₂	0.12	
CaO	Trace.	
MgO	0.16	
K ₂ O and Na ₂ O	0.80	
Total							..	99.92

TABLE I.

Composition of various opaque glasses and results of practical tests.

Glass No.	Batch composition expressed in parts by weight.											Results of practical tests.				Remarks.
	Sand.	Red lead.	Soda ash.	Felspar.	Kaolin.	Limc.	Arsenious oxide.	Borax.	Titanium oxide.	Cryolite.	Antimony oxide.	Opacity.	Colour.	Adhesion.	Gloss.	
1	38.5	50	9.5	..	2.0	1.5	4.0	Poor	Greyish white..	Good	Nil.	
2	30	50	7.5	12.5	..	1.5	4.0	Good	White ..	Good	Poor	
3	30	50	7.5	12.5	..	1.5	4.0	4.0	Good	White ..	Good	Poor	
4	30	50	7.5	12.5	..	1.5	4.0	0.1	Good	White ..	Good	Good.	
5	30	50	7.5	12.5	..	1.5	4.0	..	0.07	..	0.1	Good	Whiter than No. 4	Good	Good.	
6	30	50	7.8	12.5	..	1.5	4.0	..	0.07	1.0	0.1	Good	Slightly whiter than No. 5.	Good	Good.	
7	30	50	7.5	12.5	..	1.5	8.0	..	Poor	White with a greenish tinge.	Good	Nil.	
8	30	50	7.5	12.5	..	1.5	0.25	8.0	..	Poor	Greyish white	Good	Nil.	

The enamelled design contracted somewhat on being fired.

The loss of arsenious oxide due to its volatility was found to be about 20 per cent. as revealed by chemical analysis of the finished opaque glass No. 6, whilst the amount of fluorine finally present in the glass was found to be negligible. It is very likely that the fluorine originally present in the batch was lost as a result of the formation of silicon tetrafluoride, which is volatile. The addition of a small quantity (1%), of cryolite appeared to improve the whiteness of the product.

DISCUSSION.

From an examination of the results summarised in Table I, the following conclusions may be drawn with regard to the preparation of white opaque glasses :—

1. Felspars produced a more dense opaque glass than either kaolin or pure alumina, although the aluminium oxide content might be the same in all cases.
2. The addition of titanium oxide in small amounts seemed to improve both opacity and whiteness, but it should be used in very small proportions in the preparation of low-temperature-melting glasses, since its presence in larger amounts raises the melting point of the resulting glass.
3. The presence of small amounts of antimony oxide appeared to improve the gloss of the enamelled design to an appreciable extent.
4. Opal glasses containing cryolite as the major opacifying agent did not appear to be very suitable for use as decorative enamels for glassware.

From the results of practical tests, it was evident that glass No. 6 in Table I compared favourably with the comparison sample of imported china glass and could be successfully used as a decorative enamel. It appeared that arsenious oxide was a better opacifying agent than cryolite, so far as opacity and whiteness of the film on the decorated glass article were concerned. It may be possible that arsenious oxide improves the whiteness of these glasses by virtue of its decolorising action.

It may be pointed out that in India arsenious oxide is cheaper than either cryolite or tin oxide. Also, the amount of arsenious oxide to bring about the same degree of opacity is smaller than that of either of the two above mentioned substances. It is, therefore, specially suited for use as an opacifying agent for the preparation of cheap white enamels containing a high percentage of lead oxide.

It is generally believed that opacity in opalescent glasses is brought about by their structural characteristics.^{4,5} In certain cases, for example in the case of glasses containing stannic oxide as opacifier, there exists solid particles of the latter dispersed throughout the mass, and these absorb the transmitted light

4. Scholes, "Modern Glass Practice", (Industrial Publications, Chicago), 224 (1935).

5. Hodkin & Cousen, "A Text-book of Glass Technology," (Constable, London), 124 (1925).

thereby causing opacity. This type of glass is termed *Solid Suspension Type*. In others, the effect is mainly due to scattering of light by minute scattering centres possessing different compositions and having different refractive indices from that of the main bulk. Two types are generally recognised under this head, namely,

Devitrification and Emulsion Types.—The devitrification type of glasses includes those in which cryolite or a mixture of alkali fluorides and feldspars is used, and it is believed that the scattering centres in this type consist of precipitated alumina or silica. In this, as well as in the solid suspension type of glasses, the rate of cooling is known to have little effect on the final opacity.

Finally, as regards the emulsion type of glasses, such as phosphate opals, it is believed that there exist two distinct phases, one dispersed in the other in the form of fine particles of colloidal dimensions, which act as scattering centres of light. The size, number and probably also the chemical composition of these scattering particles are not only dependent on the chemical constitution of the batch, but also to a large extent on the rate of cooling of the melt.

The observation made regarding the necessity of slow cooling of arsenious oxide glasses indicates that these probably belong to the category of emulsion type glasses.

INDUSTRIAL SCALE EXPERIMENT.

In the preceding pages it has been shown that opaque white glass similar in practical characteristics to imported china glass can be successfully prepared in the laboratory. In order to investigate its industrial possibilities, it was considered desirable to prepare a factory scale batch. With this object in view a 200-lbs. batch, corresponding in composition to glass No. 6 in Table I, was melted in an 800-lbs. pot of a so called Japanese type glass furnace of the kind commonly used in India. The ingredients of the batch after being thoroughly mixed were introduced into the pot while it was at a temperature of about 1,000° C. The temperature of the pot was maintained at this figure for about two and a half hours; during this period the different ingredients fused together, but the molten mass had a comparatively high viscosity and was full of gas bubbles. The temperature was then gradually raised to about 1,250°C and maintained at that level for nearly two hours, and the viscous molten mass now became appreciably mobile, thus facilitating the removal of the gas bubbles. The melt was stirred several times by means of an iron rod to ensure complete homogeneity.

When the glass had become practically free from bubbles, which stage was usually reached about four to five hours from the start, the temperature was gradually lowered to about 1,000°C, and the glass was then laddled out on to a thick iron sheet to form thick discs about 6 to 8 inches in diameter.

In order to study the effect of rate of cooling on the development of opacity, the importance of which was indicated by the laboratory experiments, these discs were cooled under the following different conditions:—

- (a) Discs about 1/2 inch thick were allowed to cool in air.
- (b) Discs about 1½ inches thick were allowed to cool in air.

- (c) Discs about 1/2 inch thick were allowed to cool slowly in an annealing lehr from about 650°C to room temperature in 24 hours.
- (d) Discs about 1½ inches thick were allowed to cool slowly in an annealing lehr as in case (c).

On examining and comparing the products obtained by the above methods of cooling, no significant differences were observed in their opacities. They were all found to compare favourably with the imported china glass in their decorative qualities, such as whiteness, gloss, opacity, adhesion and melting point. It is apparent that 1/2 inch thick discs would cool more quickly than those 1½ inches thick. On the other hand, even 1/2 inch thick discs, about 6—8 inches in diameter, would cool considerably more slowly than a disc made from a small laboratory batch weighing about 100 gms. It is, therefore, not surprising that laboratory experiments gave apparently different results than the large scale experiment.

There is, however, another aspect to be considered in connection with the cooling of discs of china glass during large scale production. When allowed to cool in air they show a tendency to crack and shatter into small pieces and this is not only wasteful of labour, but can be actually dangerous in a factory. It is, therefore, considered advisable that the discs be cooled gradually in a lehr, such as is commonly used for annealing other glassware.

ECONOMIC CONSIDERATIONS.

According to statistics collected in 1935-36 by the Director of Industries, United Provinces, the daily consumption of china glass as a decorative enamel for glass bangles at Firozabad, U. P., was about 1 cwt. Its price at Firozabad in 1936 was about Rs. 53 per cwt., and hence the value of this material consumed annually at Firozabad alone was roughly Rs. 20,000. Bangle and glass manufacturers in other parts of the country also use this material, but unfortunately, figures relating to its total annual consumption in India are not available; it may, however, be conservatively estimated to be about Rs. 25,000 to Rs. 30,000 annually.

In view of the proportionately high consumption of this material at Firozabad, this place appears to be the most suitable centre for its manufacture. Its preparation does not require any special type of plant equipment, and the usual pot furnaces and annealing lehrs employed in Indian glass factories have been found to be quite adequate for its production; it is even possible for individual glass bangle manufacturers to prepare it according to their requirements.

In making an estimate of the cost of production of china glass it must be borne in mind that its present consumption in India is relatively small, according to the above figures approximately 30 tons a year. Any estimate of cost should, therefore, be based on a relatively small-scale production. In the following calculations the data obtained from a Calcutta factory has been used, and the raw material cost is also based on Calcutta market prices. It has been assumed that a small glass factory working four furnaces of 10 pots each may employ one of the pots for the production of china glass, thus only the proportionate capital investment, labour and depreciation charges would require to be charged to determine the cost of production of china glass.

The assumptions enumerated below are based on conditions prevailing during the year 1937 :—

	Rs.
1. Capital Investment, including—	
(a) Site	40,000
(b) Factory and office buildings and equipment, etc. ..	60,000
Total	1,00,000
2. Rate of interest on investment	5 % per annum.
3. Depreciation of buildings, etc.	5 % per annum.
4. Rates and taxes, etc., calculated on capital investment at ..	1.25 % per annum.
5. Number of furnaces in the factory	4 furnaces.
6. Life of a furnace	1 year.
7. Cost of a furnace :—	
Initial cost	3,000
Repairs	1,000
Total	4,000
8. Number of pots per furnace	10 pots.
9. Life of a pot*	40 charges.
10. Cost per pot	Rs. 45
11. Capacity per pot**	800 lbs.
12. Output per charge**	750 lbs.
13. Output per year based on 3 charges per day of 24 hours and 300 working days per year	300 tons.
14. Amount of coal consumed per 24-hour-day per furnace ..	3 tons.
15. Amount of coal consumed per 24-hour-day per annealing lehr	1 ton.
16. Cost of coal per ton	Rs. 11.
17. Cost of labour attending one furnace per year of 300 work- ing days based on 3 firemen at Rs. 3 per day and 16 coolies at Rs. 12 per day working in 3 shifts	Rs. 4,500
18. Staff—	
One Manager at	Rs. 400 per month.
One foreman at	Rs. 100 per month.
Three Clerks at	Rs. 150 per month.
Four menials at	Rs. 60 per month.
Stationery and other office expenses	Rs. 90 per month.
Total	Rs. 800 per month.
Total per year	Rs. 9,600.

* Life of a pot is considerably longer when used for melting soda lime glass.

** Capacity of 800 lbs. is based on ordinary soda lime glass; the specific gravity of lead glass being much higher, the output of 750 lbs. of china glass is much more liberal than it appears.

On the basis of the above figures, the cost of production excluding the cost of raw materials, may now be calculated. Each item of cost would represent in round figures the expenses chargeable to one pot, that is one fortieth of the total running cost per year for the whole factory, or one tenth of the total running cost per year of one furnace.

	Rs.
1. Interest on capital investment	125
2. Rates and taxes, etc.	30
3. Depreciation on buildings, etc.	75
4. Cost of furnace	400
5. Cost of pots (25 per year)	1,125
6. Cost of coal burnt in the furnace	990
7. Cost of coal burnt in the lehr (1/5 of a lehr assigned to each pot)	660
8. Labour charges	450
9. Staff	240
Total production cost per year for 300 tons of china glass	4,095
Therefore, the production cost per cwt. works out to be 10 annas 11 pies, or say	11 annas.

With regard to material costs, the calculations may be based on the composition of glass No. 6, Table I, and Table II below gives the estimate of material cost for this formula calculated on the basis of market prices at Calcutta prevailing during 1937.

TABLE II.

Cost of raw materials required to produce 1 cwt. of finished china glass (1937.)

Raw Materials.	Quantity in lbs.	Rate.	Per.	Cost.
		Rs. A. P.		Rs. A. P.
Sand	33.6	0 6 6	Md.	0 2 9
Red lead	56.0	23 0 0	cwt.	11 8 0
Soda ash	8.1	5 8 0	cwt.	0 6 3
Felspar (Imported)	13.6	7 4 0	cwt.	0 13 6
Lime	1.7	1 10 0	md.	0 0 6
Arsenious oxide	4.5	20 0 0	cwt.	0 13 0
Cryolite	1.1	45 0 0	cwt.	0 6 6
Titanium Oxide	0.1	0 2 0
Antimony Oxide	0.11	
Total	118.81	14 4 6

A further allowance in material cost of say 10% may be made to cover the possibility of loss in handling, breakage of pots, and other uncovered items, after which the total cost at factory of making one cwt. of china glass would work out to be :—

	Rs. A. P.
Material cost	14 4 6
Allowance for losses (10%)	1 6 10
Production cost	0 10 11
Total cost per cwt.	16 6 3

Thus the cost of production at Calcutta works out to be more than sixteen and a half rupees per cwt. and at Firozabad, it is not likely to be appreciably in excess of this figure. Even if the market price of imported china glass,—*i.e.*, Rs. 53 per cwt., as reported by the Director of Industries, U. P.,—dropped to one half, there should remain a considerable margin of profit for the Indian manufacturer.

EFFECT OF WAR-TIME CONDITIONS.

The cost of production of china glass and the question of its successful manufacture in India have been discussed in the previous pages on the basis of prices of raw materials current in the Calcutta retail market in 1937, before the outbreak of war. Since the outbreak of war, however, the prices of raw materials have increased and the question of their availability during the war period has become an important factor. The sale price of china glass has also undergone a material change. It is, therefore, desirable to re-examine this question in the light of these developments.

Regarding the production cost, there has not been any appreciable change so far, with the exception that the price of pots has increased from Rs. 45 to Rs. 60. However, to be on the safe side it is advisable to assume an overall increase of 10% on the production cost, which will, therefore, be about twelve annas per cwt.

In Table III below the cost of raw materials is shown on the basis of prices current in the Calcutta market since the outbreak of war :—

TABLE III.

Raw Material.	Quantity in lbs.	Rate.	Per.	Cost.
		Rs. A. P.		Rs. A. P.
Sand	33.6	0 6 6	md.	0 2 9
Red Lead	56.0	25 0 0	cwt.	12 8 0
Soda Ash	8.1	6 12 0	cwt.	0 7 9
Felspar	13.6	7 4 0	cwt.	0 13 6
Lime	1.7	1 10 0	md.	0 0 6
Arsenious oxide	4.5	30 0 0	cwt.	1 3 6
Cryolite	1.1	73 0 0	cwt.	0 10 6
Titanium oxide	0.1
Antimony oxide	0.11	0 2 0
Total ..	118.81	16 0 6

Making a further allowance in material cost of 10% to provide for the breakage of pots, etc., the total cost of manufacture of china glass per cwt. will be found to be :—

	Rs.	A.	P.
Material cost	16	0	6
Allowance for loss, 10%	1	9	6
Production cost	0	12	0
Total cost per cwt.	18	6	2

Under the present abnormal conditions, therefore, the total cost of manufacture of china glass at Calcutta would be no more than eighteen and a half rupees, as against sixteen and a half rupees before the outbreak of war, *i.e.*, an increase of about 12·5%. It is expected that the cost of manufacture at Firozabad will not be very much in excess of that at Calcutta.

From enquiries made from Calcutta firms dealing in chemicals, it has been ascertained that almost all the chemicals required in the manufacture of china glass can be obtained in India, although at times a certain amount of delay in supply may occur.

The sale price of imported china glass has, however, decreased from Rs. 53 per cwt. in 1936 to about Rs. 38-8-0 in 1940, according to prices ascertained from the Director of Industries, U. P., the Glass Technologist to U. P. Government, and certain Firozabad firms dealing in this product. This is not surprising in view of the fact that several glass factories in India have already started the manufacture of china glass according to the process described in this paper, on the basis of information already supplied through the Provincial Directors of Industries. The result is that the sale price of imported material in competition with the indigenous product, the price of which is stated to be about Rs. 34-8-0 per cwt., has decreased. With the production cost at about eighteen and a half rupees and the present sale price of indigenous product at Rs. 34-8-0 per cwt. there appears still to be an appreciable margin of profit for the Indian manufacturer, and during the war period, it does not appear to be likely that the price of the imported product will be reduced any further.

From these considerations it would appear that there is ample scope for the successful production of china glass in India, both under peace and war-time conditions, and the possibility of the manufacture of china glass in India being a successful commercial proposition as envisaged in 1937 does not appear to have been materially lessened by the present war-time conditions.

ACKNOWLEDGMENTS.

The authors are indebted to the management of the Bharat Glass Works, Calcutta, for permitting them to carry out the large scale experiment in their factory and supplying some of the information regarding the economic aspects of the problem. Thanks are also due to the Director of Industries, U. P., the Glass Technologist, U. P., and certain Firozabad firms, who supplied information regarding the market conditions.

Research Branch, Government Test House.

ALIPORE, CALCUTTA.

BULLETINS OF INDIAN INDUSTRIAL RESEARCH



No. 18

**Utilization of Indian Vegetable Oils
as Lubricants in Internal Combustion
Engines**

PART I

BY

JOTI SARUP AGGARWAL, M.Sc.

and

LAL C. VERMAN, Ph.D., M.S., F. Inst. P.

Third Edition

**OFFICE OF THE DIRECTOR,
SCIENTIFIC AND INDUSTRIAL RESEARCH,
DEPARTMENT OF COMMERCE
GOVERNMENT OF INDIA**

**PUBLISHED BY THE MANAGER OF PUBLICATIONS, DELHI.
PRINTED BY THE MANAGER, GOVERNMENT OF INDIA PRESS, SIMLA.
1942**

CONTENTS.

	PAGES.
PREFACE	iv
SYNOPSIS	v
INTRODUCTION	1
DEVELOPMENT OF EXPERIMENTAL PROCEDURE	5
RESULTS OF EXPERIMENTAL WORK	11
DISCUSSION	23
ACKNOWLEDGMENTS	29
BIBLIOGRAPHY	29

SYNOPSIS.

With a view to devising vegetable oil blends suitable for use as lubricants for internal combustion engines, a large number of substances has been examined as regards their stabilizing effect on castor, groundnut, cotton seed and rape oils. The laboratory procedure developed in the course of the investigations utilized the Air Ministry oxidation test technique which was modified in such a manner as to accelerate oxidation. Changes in the viscosity, acid value and Conradson carbon residue were determined before and after oxidation.

A number of substances was found to be effective stabilizers for castor oil. Stabilizers were found to be less effective in the case of rape oil and still less so in the case of groundnut oil. Most of the stabilizers were found ineffective towards cotton seed oil.

It appears that the extent of unsaturation of a given oil, its acidic constituents and the constitution of the various glyceride molecules along with the unsaponifiable constituents determine whether or not the oil may be effectively stabilized. Out of the different types of substances tried, compounds having phenolic or amino groups attached to more than one benzene nucleus have been generally found to exert a stronger stabilizing action.

Table X gives a summary of the quantitative data in the case of the most effective stabilizers so far found for the four oils studied.

Further work along these lines and also the results of engine trials using stabilized vegetable oils will form the subject matter of separate papers.

UTILIZATION OF INDIAN VEGETABLE OILS AS LUBRICANTS IN INTERNAL COMBUSTION ENGINES.

PART I.

INTRODUCTION.

The employment of internal combustion engines for purposes of traffic and transport is very rapidly increasing in almost every part of the world. Moreover, in the modern type of highly mechanized warfare, whether on land, sea or air, internal combustion engines are indispensable. Along with the development of internal combustion engines to suit various requirements, numerous researches are in progress which aim at the production of lubricants, most suited for their efficient performance.

Mineral lubricating oils have so far been mainly used for purposes of internal combustion engines. Compared with certain other countries, India produces relatively small quantities of mineral oils (about 311 million gallons), which represent only 0.54 per cent. of the total crude oil production of the world. This output is quite inadequate for the needs of the country, as may be judged from the import figures given below :—

Import of mineral lubricating oils (other than batching oils) into British India.

Year.	Quantity in gallons.	Value in rupees.
1934-35	1,02,91,076	94,91,735
1935-36	1,09,14,680	95,64,269
1931-36	1,09,23,267	1,00,11,687
1936-37	1,94,27,960	1,83,65,106
1938-39	1,62,96,400	1,55,12,346

Moreover, the mineral oil resources of the world, though of large dimensions, are not evenly distributed. It is also believed that the world's mineral oil reserves cannot indefinitely cope with the ever increasing demand for lubricating oils and that a shortage will make itself felt in the course of time. It is not surprising, therefore, to find that serious efforts are being made in several countries to find suitable substitutes for mineral lubricating oils.

One of the obvious solutions that present themselves involves the use of vegetable oils as lubricants. In India the production of oil seeds, such as castor, sesame, rape, mustard, groundnut, cotton, linseed, mowah and niger, even at a conservative estimate, exceeds 70,00,000 tons which is worth about Rs. 77,30,00,000. In the year 1937, the figures for the production of oil seeds, expressed in million tons were :—India 8.0, China 7.0, U. S. A. 4.3, Argentina 2.0, U. S. S. R. 1.9, Nigeria 1.0, Dutch East Indies 0.6. Thus India, being the premier oil seed producer should naturally be interested in finding new fields of applications for this commodity.

M24CD

This paper is the first of a series which will deal with the results of the investigations carried out with a view to developing internal combustion engine lubricants based on vegetable oils.

In the working of an internal combustion engine the lubricating oil serves a two-fold purpose, namely, that of lubrication and that of heat dissipation. Consequently, the most important requirements of lubricants for internal combustion engines include chemical stability under working conditions, a high degree of oilness, and a low coefficient of static friction. In the latter two respects vegetable oils have been found to be better than mineral lubricating oils ^{1, 2, 3, 4}. Furthermore, a lubricating oil is required in an internal combustion engine to perform its functions at temperatures covering a very wide range. It is important, therefore, that the viscosity of the oil should change as little as possible with changes in temperature. In other words, the "viscosity index" of the oil should be high. In this respect also, vegetable oils in general compare favourably with mineral oils ^{5, 6, 7}. Owing to its satisfying the above exacting requirements to a considerable extent, castor oil is regarded as being one of the best lubricants known ⁸ and has in the past been employed on a considerable scale in aeroplane engines ^{9, 10, 11}.

Rene Chefneux ¹² prepared an oil for internal combustion engines containing 50—96 per cent. castor oil, with which were incorporated colloidal graphite, to increase its lubricating quality, and tallow oil and corn oil, to suppress the odour and reduce the viscosity.

Various patents have been taken out dealing with rendering castor oil soluble in mineral oils so as to increase the viscosity and lubricating power of the latter ^{13, 14, 15}. Villiers ¹⁶ patented a process for using castor oil, as lubricant after mixing it with a small proportion of alkali soap to increase its viscosity and reduce its susceptibility to carbonisation.

Champsaur ^{5, 17} in a discussion on the merits of vegetable oils—particularly olive, colza and peanut oils—for lubrication of aeroplane and automobile engines under working conditions, stated that engines developed more power with such oils than with mineral oils.

Bastet ¹⁸, by comparative bench tests, found that the use of olive oil, though more unstable both physically and chemically than mineral oils, resulted in an increase in power of more than 10 per cent. and an appreciable decrease in wear of the engine, but that in order to guard against the effects of the development of acidity, sludge, and corrosion it was necessary to change the oil at short intervals. For similar reasons olive oil has also been recommended by Deveze ¹⁹, Angla ²⁰, and Condelli ²¹. Methods of increasing the viscosity of rape seed oil for use in the production of mixed mineral oil blends ^{22, 23, 24} have been patented, and linseed oil ²⁵ and neatsfoot oil ²⁶ have also been suggested for such purposes.

It is important that lubricating oil should alter as little as possible in use, not only from the point of view of economy and convenience but also for certain technical reasons. For example, an oil requiring frequent changes is liable to form deposits, the effect of which is to choke the oil feeds and thus, by preventing free lubrication, to cause breakdown, rapid wear, or ring

sticking. Some of these defects were observed by Tomasi⁵¹, when an automobile was run on crude olive oil. The cylinder and the piston are the two principal points where the oil may suffer both physical and chemical changes on account of the high temperatures (200°-400°C)^{27, 29} prevailing at these points, as at temperatures of this order the cracking of the oil can easily occur.

Vegetable oils have, in general, a lower cracking temperature than mineral oils, for instance castor oil decomposes at about 250°C and olive oil at 310°, while pure mineral oil decomposes at about 380°C²⁸, but Weiss and Maillard²⁹ have come to the conclusion that pyrolysis, although occurring to some extent in the combustion chamber, does not play an important part in the alteration of the oil, at any rate not in an engine of ordinary design.

Deterioration of oil is mainly caused by oxidation, the most dangerous products being sludge constituents insoluble in hot oil. It is now generally accepted that the origin of the sludge is the lubricating oil and not the fuel. Incomplete combustion products of the fuel, however, may in some cases be found in the oil. From the sludges it has been possible to isolate substances such as aldehydes and phenols, which are capable of forming resins; moreover, vegetable oils, on account of their chemical constitution, are more susceptible to oxidation changes than mineral oils, and consequently they are more liable to give rise to acids which corrode the metals of the engine and lead to wear and tear.

An investigation⁹ was undertaken by the various flying services in America to determine the relative merits of castor oil and a mineral oil (Liberty Aero Oil) as lubricants in various aeroplanes. It was found that castor oil produced a heavy shellac-like deposit and the mineral oil a light flaky one, that the engine ran more easily on mineral oil, and that castor oil absorbed gasoline, while the mineral oil did not. As a result of these experiments it was established that, if castor oil was to be used, it must be changed at frequent intervals.

Peru³⁰ from his practical engine tests, found that considerable corrosion of the engine parts occurred even when only 20 per cent. olive was oil mixed with a mineral lubricating oil, that the oil consumption was greater than when mineral oil alone was used, and that an objectionable odour was noticeable even after a comparatively short run. Balada's^{31, 32, 33, 34} extensive work on rape oil and rape-mineral oil mixtures for lubricating purposes led to similar conclusions. He found that rape seed oil when mixed with mineral oil is unstable, develops acidity, induces corrosion, increases in viscosity and emulsifies. In the motor, it increases oil consumption, clogs the filter, covers the piston rings, deposits carbon, and forms agglutinous coatings. An automobile lubricated with a mixture of 90 per cent. mineral oil and 10 per cent. rape oil required general repairing after a run of 10,000 kilometers. A lubricant consisting of 70 per cent. mineral oil and 30 per cent. rape oil did not allow a 5,000 kilometers run. A 0.5 per cent. addition of a stabilizer (pyrogallol, α -naphthol, α -naphthylamine) did not improve the lubricating quality of the above oils. In the Air Ministry oxidation test of mineral oil containing 5-50 per cent. of rape oil, Balada found that after 12 hours all the mixtures were

solid or sticky and gelatinous. These investigations also indicated the undesirability of mixing 5-50 per cent. soya bean oil or linseed oil with a mineral lubricating oil.

It is perhaps due to rancidity that benoil, which was formerly highly valued as a lubricant for delicate machinery, is now gradually being replaced by mineral oils ⁵⁵.

The literature on this subject, which has been referred to above, indicates that it is mainly the oxidation of the lubricating oils brought about by the high temperatures prevailing in internal combustion engines that causes deterioration of the oil, increases its viscosity, produces carbon, gum and sludge and forms the acidic compounds which lead to corrosion of various parts of the engine. Mineral lubricating oils are made resistant to the above oxidation changes, firstly, by refining so as to remove as much of the asphaltic and unsaturated materials as possible, and secondly, by adding to the refined oils certain anti-oxidants, by virtue of which the oils become stable to oxidation changes ⁵⁶.

In the case of refined vegetable oils, with the exception of some recent work of Freund and Thamm ⁵³ no systematic and detailed investigation appears to have been published. These investigators tested the effects of 0.5 per cent. of the following oxidation inhibitors on rapeoil:—pyrogallol, 1 : 5-dihydroxy naphthalene; *o*-ethoxy phenol, *o*-amino phenol, dimethyl-*p*-phenylene diamine, *p*-hydroxy phenyl morpholine, benzyl aminophenol and dibenzyl aminophenol. Oxidation changes were studied by submitting the oil mixture to a laboratory oxidation test involving the passing of oxygen for five hours at the rate of 2 bubbles per second through the oil at 200°C. They found that the increase in acid number was the most characteristic indication of oxidation of the oil. The acid number increased much more in vegetable oils with inhibitors than in mineral oils. The latter, however, formed sediments during oxidation, whilst the vegetable oils did not do so. Resinification was slight. Olive oil, castor oil and linseed were also submitted to the above oxidation tests. In practical engine tests a blend comprising a mixture of ordinary and blown rape oil without any inhibitor increased in viscosity in 25 hours' run up to 34.0°E and in acid number up to 8.06. In presence of inhibitors, these values increased after 45 hours' run to 12.2°E and 4.16 respectively. A mixture of 50 per cent. mineral oil and 50 per cent. rape oil in presence of inhibitors was found satisfactory.

It may be pointed out that the use of antioxidants for vegetable oils first originated with the classical researches of Moureau and Dufraisse ⁵³. A number of organic compounds to be used as antioxidants for rape oil and castor oil were found out by Caldwell and Dye ⁵⁴, and Inman ⁵⁵ respectively. But under the special conditions prevailing in internal combustion engines, the addition of an antioxidant is not sufficient to stabilize a lubricating oil; the compound added should also have an anti-polymerising effect.

In order to investigate systematically the possibilities of using vegetable oils as lubricants, therefore, the line of attack that first suggests itself is that which will include a study of the processes of refining and stabilizing followed by engine tests. So far as refining is concerned, the various processes now in

common use may be considered as satisfactory, until as a result of further studies factors are brought to light which may demand modifications or improvements in the existing processes in order to produce satisfactory oils for use as lubricants. The work then reduces itself to investigation of methods of stabilization of oils against polymerisation and oxidation followed by practical engine trials. This paper will deal with the stabilization investigations, while the engine trials will be dealt with in a subsequent paper.

DEVELOPMENT OF EXPERIMENTAL PROCEDURE.

With a view to ascertaining the degree of stability of oils in the laboratory without running engine tests, several methods³⁷ have been proposed, which are claimed to give an indication as to how an oil will behave in an engine. These methods in general include:—

- (1) volatility tests,
- (2) coking tests, and
- (3) oxidation tests.

Since vegetable oils are fixed oils, the volatility test may be left out of consideration. For the coking test, the Conradson carbon residue method and for the oxidation test the British Air Ministry test method³⁸ have been generally adopted. The latter involves the passing of air at a rate of 15 litres per hour through 40 c.cs. of the oil at 200° C for two periods of six hours on consecutive days. The extent of oxidation is judged by the increases in viscosity and coke number. This procedure, it will be evident, takes a long time, and consideration led to the conclusion that oxidation could perhaps be accelerated by the use of oxygen in place of air without appreciably changing the processes of oxidation. Comparative experiments were, therefore, carried out on raw castor oil and a good quality commercial mineral lubricating oil (designated as 'A' in the text below) to determine the length of time required when using oxygen, to give an equivalent degree of oxidation. The results are tabulated in Tables I and II below.

TABLE I.

Comparative oxidation tests in Air Ministry Apparatus with air and oxygen on castor oil.

Characteristics.	Original oil.	Oil, air blown for 12 hours (Standard test.)	Oil, oxygen-blown for			Ratio of oxygen values to air values at		
			2.5 hours.	3.0 hours.	3.6 hours.	2.5 hours.	3.0 hours.	3.5 hours.
Specific gravity 100°F/100°F.	0.9479	0.9870	0.9766	0.9809	0.9811	0.988	0.993	0.994
Viscosity at 100° F (centistokes).	285.0	2096	1310.6	1851	2951.7	0.625	0.884	1.41
Acid value ..	4.3	4.8	5.7	6.4	6.72	1.19	1.34	1.40
Saponification value ..	177.3	190.7	193.2	194.4	196.4	1.01	1.02	1.03
Iodine value	87.16	78.17	78.2	76.85	75.78	1.00	0.984	0.970
Coke number	0.2	0.52	0.55	0.64	0.955	1.06	1.23	1.86

TABLE II.

Comparative oxidation test in Air Ministry Apparatus with air and oxygen on mineral oil 'A'.

Characteristics.	Original oil.	Oil, air blown for 12 hours (Standard test).	Oil, oxygen-blown for.		Ratio of oxygen values to air values at	
			3.0 hours.	3.5 hours.	3.0 hours.	3.5 hours.
Specific gravity 100° F/100° F ..	0.8700	0.8710	0.8702	0.8706	0.999	1.00
Viscosity at 100° F (centistokes) ..	122.8	157.3	132.0	136.7	0.838	0.868
Coke number ..	0.37	0.57	0.506	0.65	0.888	0.965

The last three columns in Table I indicate that 3 hours' oxidation with oxygen approximated much more closely to 12 hours' air oxidation values than values obtained at either 2.5 or 3.5 hours. The correspondence was much closer as regards specific gravity, iodine value and saponification value than it was in the case of acid value and coke number. It will be observed that, at 3.0 hours, although the coke number and acid value had undergone excessive change the viscosity increase had not quite come up to the value corresponding to 12 hours with air. In the case of mineral oil, both viscosity and coke number were lower, not only at 3.0 but also at 3.5 hours, but the difference between the 3.0 and 3.5 hours figures was small. Specific gravity did not suffer much change either with air or oxygen.

On the whole, it appeared that 3 hours' oxidation with oxygen would suffice to reproduce approximately the conditions required for oxidation tests on vegetable oils, and this procedure was, therefore, adopted, that is, keeping all the conditions of the Air Ministry oxidation test as specified, air was replaced by oxygen and the duration of oxidation reduced from 12 to 3 hours. In addition, another minor change was introduced namely that 50 c.c. of oil sample instead of 40 c.c. was used, in order to obtain sufficient oil for viscosity measurement. Subject to these variations, the results of the first set of tests on raw castor oil of low acid value, using a number of antioxidants, are summarised in Table III.

TABLE III.

Effect of various stabilizers on raw castor oil when submitted to modified oxidation test using oxygen instead of air.

No.	Stabilizer.		Viscosity at 100° F centistokes.	Ratio of viscosity increase.	Coke number.	Remarks.
	Name.	Amount %				
1	Original oil (unblown)	285	..	0.2	
2	No stabilizer	1852	6.5	0.64	

TABLE III—*contd.*

No.	Stabilizer:		Viscosity at 100° centi- stokes.	Ratio of viscosity increase.	Coke number.	Remarks.
	Name.	Amount %				
3	Thymol	2.0	1337	4.6	0.76	Slight black deposit.
4	Orcinol	1.0	1555	5.4	0.66	
5	iso-Eugenol	1.0	2167	7.6	0.68	
6	Hydroquinone	0.25	1178	4.1	0.67	
7	"	0.5	863	3.0	0.74	
8	"	1.0	745	2.6	0.74	Black tarry deposit.
9	β -Naphthol	1.0	970	3.4	0.73	
10	"	2.0	825	2.9	0.64	
11	<i>p</i> -Aminophenol	0.5	912	3.2	0.7	Black deposit.
12	"	1.0	795	2.8	0.76	Hard black deposit.
13	<i>N</i> -phenyl β -naphthyl- amine.	2.0	852	3.0	0.66	
14	Acetyl phenyl hydra zine	2.0	856	3.0	0.65	
15	β -Naphthylamine	0.5	1066	3.7	0.65	Slight black deposit.
16	"	1.0	856	3.0	0.68	Black tarry deposit.
17	Diphenylamine	0.5	1318	4.6	0.64	
18	"	1.0	950	3.3	0.65	
19	"	2.0	842	2.9	..	
20	Hydroquinone and β -naphthylamine.	0.5 each.	795	2.8	..	Less black deposit.
21	"	1.0 each.	600	2.1	0.78	Much black deposit.
22	β -Naphthol and β -naph- thylamine.	1.0 each.	744	2.6	0.65	
23	β -Naphthylamine and Catechol.	0.5 each.	767	2.7	..	Black deposit.
24	Tin oleate	1.0	1519	5.3	0.65	
25	Tin linoleate	1.0	1682	5.9	0.66	
26	Tin naphthenate	1.0	1320	4.6	0.64	
27	Chromium oleate	1.0	1508	5.3	0.67	
28	Chromium naphthenate	1.0	1169	4.1	0.64	
29	Cyclohexanol	2.0	1604	5.2	0.66	Considerable brown gummy deposit.
30	Clove oil	1.0	2169	7.6	0.67	Gummy de- posit.

It is likely that in the presence of iron the oxidation process may be somewhat modified. Several workers have investigated the effect of various metals on the oxidation of mineral oils. Thus Mardles and Ramsbottom³⁰, when determining the action of surfaces on the rate of oxygen absorption, found that tin dust exerted inhibitory action, gold had little or no effect, whilst iron and aluminium increased the rate of oxidation. Kalichevsky⁴⁰ states that the comparison of the results of oxidation tests performed in the presence and absence of certain metals often reveal considerable discrepancies, as oils stable in the absence of these metals may deteriorate relatively fast in their presence. In this connection it is of interest to note that the well-known 'life' test for transformer oils is now practically discarded by the industry as an indication test of the stability of oils in service, and other tests employing metals are now being employed in its place.

Evans and Kelman⁴¹ remarks that the reaction between oil and oxygen in a glass container must be modified if better correlation between the laboratory test and engine tests is to be obtained. It was suggested by them that this may be done by heating the oil in presence of metallic iron in a Petri dish. Whilst the increase of acidity and of solid oxidation products are of practical importance, the viscosity of the oil after oxidation appears to give close correlation with engine results; on similar grounds Barr⁴² advocates the use of metal instead of glass apparatus in view of the negative effect of the latter on the oxidation of mineral oils.

With a view to studying the effect of iron in the modified Air Ministry oxidation test described above, preliminary experiments were carried out on raw and heated castor oils* in the presence and absence of anti-oxidants as well as on two mineral lubricating oil, one of which was the same as used in the early experiments, while the other (designated 'B') is a somewhat cheaper grade of commercial oil. To obtain the iron effect, when required, one hundred 1/8" diameter of steel balls were introduced into the oxidation tubes, and all the other conditions were kept constant. The results obtained are summarised in Table IV.

The results in Table IV indicate that that treatment makes castor oil much more susceptible to oxidation, especially in the presence of iron, although it brings down the viscosity to the neighbourhood of that suitable for use in internal combustion engines. In the case of raw castor oil, also, iron definitely promotes oxidation, but in the case of mineral oils iron appears to affect the oxidation very little.

For the purpose of the investigation in hand, it was considered advisable, therefore, that the laboratory experiments be carried out in the presence of iron. Consequently the final procedure adopted was as follows:—

Suitable vegetable oils of refined quality, having low acid values, were treated with numerous anti-oxidants or stabilizers; and their viscosities, acid values, and Conradson carbon residues were determined before and after subjecting them to the finally modified Air Ministry oxidation test.

* Heated castor oil was prepared by subjecting raw castor oil to a temperature of 280° to 310°C until 4.1 per cent. of its weight was lost.

The modifications therefore finally involved :—

- (1) The use of oxygen in place of air.
- (2) An oxidation period of 3 hours instead of 12 hours.
- (3) The volume of the sample 50 c.c. instead of 40 c.c.
- (4) The introduction in the oxidation tube of 100 clean steel balls of $1/8$ " diameter.

Reference may be made to Air Ministry General Specification No. D. T. D. 109 for details of the apparatus and method of operation.

TABLE IV.

Effect of presence of iron on oils subjected to modified Air Ministry oxidation test.

No.	Oil	Anti-oxidant.	Without iron.				With iron.			
			Viscosity 100°F. C.S.	Viscosity increase ratio.	Acid value.	Conradson carbon.	Viscosity 100°F. C.S.	Viscosity increase ratio.	Acid value.	Conrads carbon.
1	Raw castor oil ..	Original (unoxidized)	282	1.0	3.7	0.18
2	Raw castor oil ..	None	1833	6.5	4.9	1.27	2010	7.1	4.1	4.72
3	Raw castor oil ..	1% pyrogallol ..	882	2.13	5.6	1.6	892	3.16	5.6	1.75
4	Raw castor oil ..	1% Benzidine ..	792	2.8	4.2	1.88	885	2.1	4.2	1.96
5	Heated castor oil ..	Original (unoxidized)	133	1.0	15.4	0.17
6	Heated castor oil ..	None	12374	93.3	4.7	1.12	Became resinous rubbery mass.			
7	Heated castor oil ..	1% pyrogallol ..	1098	8.3	8.2	1.99	1354	10.2	8.0	2.25
8	Mineral oil 'A' ..	Original (unoxidized)	122.6	1.0	0.0	0.19
9	Mineral oil 'A' ..	None	131.5	1.07	0.4	0.26	132.5	1.08	0.5	0.21
10	Mineral oil 'B' ..	Original (unoxidized) ..	134.0	1.0	0.1	0.08
11	Mineral oil 'B' ..	None	218.3	1.62	1.9	1.10	210.9	1.59	1.5	1.09

RESULTS OF EXPERIMENTAL WORK.

The results of oxidation test under these conditions on castor, groundnut, cotton seed and rape oils when treated with various stabilizers are presented in Tables V, VI, VII and VIII respectively.

TABLE V.

Effect of various stabilizers on Castor Oil

No.	Stabilizer.		Viscosity 100°F. centi- stocks.	Viscosity increase ratio, Blown : original.	Acid value.	Con- rad- son carbon.	Remarks.
	Name.	Quan- tity %					
1	Original oil	281.7	..	3.7	0.18	
2	None	2010.0	7.1	4.1	1.72	
	<i>Phenolic compounds.</i>						
3	Phenol 1.0	1303.6	4.6	3.8	0.93	
4	α -Naphthol 1.0	737.0	2.6	4.6	1.7	
5	β -Naphthol 2.0	865.0	3.07	5.4	1.2	
6	Nitrose α -naphthol.	1.0	785.0	2.78	6.5	1.7	
7	Nitroso β -naphthol 1.0	1121.8	3.98	6.2	1.5	
8	Guaiacol 1.0	1260.0	4.47	4.6	0.87	Black de- posit.
9	Thymol 2.0	1337.0	4.7	..	0.67	
10	iso-Eugenol 1.0	2167.0	7.7	..	0.68	
11	Salicylaldehyde 1.0	1832.0	6.5	4.5	0.9	
12	Methyl salicylate 1.0	1327.6	4.7	3.6	0.82	
13	Di- α -naphthol <i>p</i> -phenylene	azo 1.0	1067.0	3.78	4.3	0.97	
14	Di- α -naphthol <i>p</i> -diphenyl.	azo 1.0	1056.0	3.74	4.2	1.2	
15	α -Naphthol α -naphthalene.	azo 1.0	734.0	2.6	5.4	0.94	
16	Hydroquinone 1.0	762.4	2.7	5.9	1.2	
17	Orcinol 1.0	1555.0	5.5	..	0.66	
18	<i>o-o'</i> : Dioxy diphenyl	1.0	1178.0	4.18	5.5	1.35	
19	Pyrogallol 1.0	892.0	3.16	5.6	1.75	
20	Phloroglucinol 1.0	666.6	2.36	5.6	1.18	

No.	Stabilizer.		Visco- sity 100°F. centi- stokes.	Visco- sity increase ratio, Blown : original.	Acid value.	Con- rad- son carbon.	Remarks.
	Name.	Quan- tity %					
21	Gallic acid	1.0	900.5	3.2	5.8	1.28	
22	Methyl gallate	1.0	949.8	3.38	5.4	1.15	
23	Gallic anilide	1.0	958.0	3.4	5.4	1.29	
24	Cresylic acid	1.0	1705.0	6.0	4.6	0.67	
25	Creosote from beach tar	1.0	1273.0	4.5	4.4	0.62	
	<i>Amino compounds.</i>						
26	Aniline	1.0	1116.2	3.9	4.0	1.04	
27	α -Naphthylamine ..	1.0	767.0	2.7	5.0	1.41	
28	β -Naphthylamine ..	1.0	737.0	2.6	5.7	1.40	
29	N-Phenyl α -naphthyl- amine.	1.0	796.0	2.8	5.5	0.85	
30	<i>p</i> -Toluidine	1.0	755.4	2.67	4.3	1.0	
31	<i>p</i> -Anisidine	1.0	821.6	2.9	5.4	1.08	
32	<i>p</i> -Amino acet-anilide	1.0	895.0	3.1	5.0	1.45	
33	<i>p</i> -Aminocazobenzene ..	1.0	940.6	3.33	5.8	2.0	
34	Triethanolamine	1.0	1135.9	4.03	6.0	1.3	Slight black deposit.
35	Urethane	1.0	1252.9	4.4	4.3	0.68	
36	Glycine	1.0	1198.0	4.2	4.1	1.05	Partially soluble.
37	Glutamic acid	1.0	1179.6	4.18	4.3	0.69	Do.
38	Pyridine	1.0	1402.0	4.97	4.2	0.74	
39	Piperidine	1.0	989.3	3.1	4.1	0.8	
40	Dibenzyl <i>p</i> -aminophe- nol.	1.0	958.0	3.4	4.8	1.0	
41	1-Amino-4-naphthol hydrochloride.	0.5	1127.4	4.0	5.5	1.6	Partially soluble, brown gummy deposit.
42	Benzidine	1.0	885.0	3.1	4.2	1.95	
43	<i>o</i> -Tolidine	1.0	928.0	3.3	4.3	1.69	
44	<i>p</i> -Phenylene diamine	1.0	824.0	2.9	4.3	1.5	

No.	Stabilizer.		Viscosity 100°F. centi- stokes.	Viscosity increase ratio, blown ; original.	Acid value.	Con- rad- son carbon.	Remarks.
	Name.	Quantity %					
45	Phenyl hydrazine ..	1.0	989.3	3.5	4.5	1.16	
46	<i>assym.</i> Diphenyl hy- drazine.	1.0	786.4	2.78	5.6	1.2	
47	Diphenylamine ..	1.0	845.0	3.0	5.8	1.02	
48	<i>p-p</i> -Diamino diphenyl- amine sulphate.	1.0	930.0	3.3	5.6	0.95	Black de- posit.
49	<i>p-p</i> -Diamino dihipenyl- amine.	1.0	699.0	2.48	5.9	0.82	Partially soluble.
50	Do. ..	0.5	868.0	3.08	6.0	0.9	Do.
51	Urea	1.0	1344.0	4.77	3.8	0.6	
52	<i>n-n</i> -Diphenyl urea ..	1.0	1133.0	4.04	4.1	1.1	Partially soluble.
53	Uric acid	1.0	1624.9	5.76	4.0	1.1	Sparingly soluble.
54	Alloxan	1.0	1139.0	4.04	4.3	0.84	Partially soluble.
55	Diphenyl guanidine ..	1.0	1106.3	3.92	5.0	1.14	
56	Hexamine	1.0	935.8	3.3	5.6	0.69	Partially soluble, brown gummy deposit.
	<i>Organic-metallic com- pounds.</i>						
57	Tin oleate	0.1	1214.0	4.3	3.9	0.7	Sparingly soluble.
58	Tin linoleate	0.1	1247.0	4.4	3.9	1.0	
59	Chromium oleate ..	0.1	1214.8	4.3	3.8	0.77	
60	Nickel oleate	0.1	1217.6	4.3	3.7	0.87	Partially soluble.
61	Lead oleate	0.1	1274.0	4.5	3.9	1.06	Very spa- ringly soluble.
62	Tetraethyl lead ..	1.0	1296.5	4.6	4.4	2.2	
	<i>Sulphur compounds.</i>						
63	<i>p</i> -Tolouyl sulphonyl chloride.	1.0	3819.0	13.5	8.2	1.5	Much black deposits.
64	Diamyl disulphide ..	1.0	1268.0	4.5	3.6	1.4	Brownish black de- posit.

No.	Stabilizer.		Viscosity 100°F. centi- stokes.	Viscosity increase ratio, blown : original.	Acid value.	Con- rad- son carbon.	Remarks.
	Name.	Quantity %					
65	Allyl isothiocyanate ..	1.0	1152.8	4.1	5.3	1.5	Black tarry deposit.
	<i>Miscellaneous substances.</i>						
66	Oildag	2.0	1514	5.3	3.6	1.0	
67	Furfural	1.0	1469	5.2	3.96	1.3	
68	Camphor	1.0	1589.7	5.64	5.1	0.68	
	<i>Mixture of various substances.</i>						
69	Hydroquinone and β -naphthylamine.	0.5 each.	718.7	2.55	5.1	0.95	
70	Hydroquinone and α -naphthol.	0.5 each.	734.9	2.6	5.1	1.8	
71	β -Naphthylamine and α -naphthol.	0.5 each.	775.1	2.75	5.6	1.1	
72	Tin oleate and α -naphthol.	0.1 and 1.0.	737.0	2.6	4.9	1.5	
73	Tin linoleate and α -naphthol.	0.1 and 1.0.	735.7	2.6	4.3	1.9	
74	Chromium oleate and α -naphthol.	0.1 and 1.0.	737.0	2.6	4.4	1.6	
75	Nickel oleate and α -naphthol.	0.1 and 1.0.	745.0	2.6	4.5	1.42	
76	Lead oleate and α -naphthol.	0.1 and 1.0.	739.8	2.6	4.0	1.57	
77	Aluminium stearate and α -naphthol.	0.1 and 1.0.	792.0	2.8	4.6	1.4	Partially soluble.
78	Iron oleate and α -naphthol.	2.0 and 1.0.	948.0	3.36	5.3	1.5	Partially soluble, and redish brown deposit.
79	α -Naphthol and oildag.	1.0 and 2.0.	731.0	2.6	4.0	1.55	
80	α -Naphthylamine and oildag.	1.0 and 2.0.	764.0	2.7	4.8	1.34	

TABLE VI.
Effects of various stabilizers on groundnut oil.

No.	Stabilizer.		Viscosity 100°F. centi- stokes.	Visco- sity increase ratio, blown : original.	Acid value.	Con- rad- son carbon.	Remarks.
	Name.	Quan- tity %					
1	Original oil	41.1	..	1.5	0.3	
2	None	377.5	9.2	2.7	0.85	
<i>Phenolic compounds.</i>							
3	α -Naphthol	.. 1.0	198.0	4.8	3.8	1.6	
4	β -Naphthol	.. 2.0	175.0	4.2	3.6	2.3	
5	<i>o</i> -Naphthol	.. 0.5	347.3	8.4	3.2	1.03	
6	β -Naphthol	.. 1.0	302.8	7.3	3.2	1.2	
7	Thymol	347.6	8.4	2.7	0.87	
8	Eugenol	339.0	8.2	3.0	1.1	
9	<i>iso</i> Eugenol	295.8	7.2	2.6	0.91	
10	Salicyl aldehyde	360.4	8.7	2.3	0.70	
11	Catechol	292.5	7.1	3.1	1.8	
12	Resorcinol	273.1	6.6	2.9	1.1	Black de-
13	Hydroquinone	220.5	5.3	4.0	1.4	posit. Sparingly soluble.
14	Orcinol	262.3	6.4	3.4	1.37	Slight brownish black de-
15	Pyrogallol	273.8	6.6	3.5	1.8	posit. Slight black de-
16	Phloroglucinol	303.4	4.9	3.5	1.4	posit. Sparingly soluble.
17	Methyl gallate	.. 0.1	377.5	9.2	2.9	0.9	
18	α -Naphthol azo α -naphthalene	.. 1.0	248.0	6.03	3.3	1.7	Sparingly soluble.
<i>Amino compounds.</i>							
19	α -Naphthylamine	.. 1.0	227.0	5.5	3.7	1.21	
20	<i>o</i> -Naphthylamine	.. 1.0	233.6	5.7	3.06	1.5	
21	<i>n</i> -phenyl- α -naphthylamine.	.. 1.0	212.4	5.1	3.3	1.28	
22	<i>p</i> -Toluidine	236.4	5.7	4.0	0.99	

No.	Stabilizer.		Viscosity 100° F. centi- stokes.	Visco- sity increase ratio, blown: original.	Acid value.	'Con- rad- son carbon.	Remarks.
	Name.	Quan- tity %					
23	<i>p</i> -Amino acet-anilide	1.0	330.8	8.0	2.8	0.76	
24	<i>p</i> -Aminophenol ..	0.5	378.4	9.2	2.7	0.76	Partially soluble.
25	Diphenyl-amine ..	1.0	300.0	7.3	3.06	0.76	Slight black deposit.
26	N.-Acetyl diphenyl- amine.	1.0	347.9	8.4	2.3	0.81	
27	<i>p-p</i> -Diamino di- phenylamine.	0.5	294.0	7.1	4.4	1.09	Partially soluble.
28	Glycine	1.0	295.3	7.1	3.6	1.3	Partially soluble, slight de- posit.
29	Diethylaniline ..	2.0	279.4	6.7	2.6	0.9	Partially soluble.
30	<i>m</i> -phenylenediamine	1.0	300.3	7.3	2.7	1.3	Partially soluble, slight black deposit.
31	<i>p</i> -phenylenediamine ..	0.5	287.2	7.0	2.7	1.56	Slight black de- posit.
32	<i>p</i> -phenylenediamine ..	1.0	282.5	6.8	2.9	1.6	Partially soluble, black hard deposit.
33	Benzidine	0.5	313.0	7.6	2.8	1.39	
34	<i>o</i> -Tolidine	0.5	376.9	9.1	3.0	1.39	
35	Phenyl hydrazine ..	1.0	257.8	6.2	2.4	1.1	
36	Acetyl phenyl hydrazine.	1.0	258.2	6.2	2.8	1.1	Partially soluble, slight black deposit.
37	<i>Assym.</i> Diphenyl hydrazine.	1.0	233.0	5.6	3.3	1.1	
	<i>Organic-metallic com- pounds.</i>						
38	Chromium naphthenate	1.0	439.8	10.7	2.7	1.02	} Slight gummy deposit.
39	Chromium oleate ..	1.0	520.8	12.6	2.7	1.23	

No.	Stabilizer.		Viscosity 100°F. centi- stokes.	Visco- sity increase ratio, blown : original.	Acid value.	Con- rad- son carbon.	Remarks.
	Name.	Quan- tity %					
40	Tin linoleate ..	1.0	502.8	12.2	4.6	1.32	
41	Tin naphthhenate ..	1.0	452.6	11.0	3.4	2.7	
42	Tin oleate	1.0	394.0	9.6	3.4	1.6	Partially so- luble.
43	Chromium oleate ..	0.1	363.2	8.8	3.5	0.7	
44	Tin linoleate ..	0.1	380.6	9.2	3.4	0.8	
45	Tin oleate	0.1	384.4	9.3	3.48	1.0	
	<i>Miscellaneous sub- stances.</i>						
46	Oildag	2.0	354.0	8.6	4.8	1.12	
47	Indigo	1.0	273.2	6.6	2.5	0.92	Partially so- luble.
48	Citric acid	1.0	506.2	12.3	2.2	0.7	
49	Tartaric acid ..	1.0	374.4	9.1	2.9	1.08	
50	Phthalic anhydride ..	1.0	430.0	10.0	3.4	0.92	
51	Benzophenone ..	1.0	393.0	9.5	2.7	0.83	
52	Farfural	1.0	320.0	7.7	2.2	0.71	
53	Vanilline	1.0	360.0	8.7	3.3	0.82	
	<i>Mixtures of various Substances.</i>						
54	Hydroquinone and β-naphthylamine.	0.5 each.	205.0	5.0	3.6	1.1	Slight black deposit.
55	Do.	1.0 each.	166.2	4.0	4.3	2.1	Black depo- sit.
56	Hydrequinone and α-naphthol.	0.5 each.	190.6	4.6	4.0	0.72	Slight black deposit.
57	β-Naphthylamine and α-naphthol.	0.5 each.	211.2	5.1	3.9	1.4	
58	Chromium oleate and α-naphthol.	0.1 and 1.0	200.3	4.8	4.8	1.7	
59	Tin linoleate and α-naphthol.	0.1 and 1.0	209.3	5.0	4.1	1.75	
60	Oildag and α-naph- thol.	2.0 and 1.0	197.8	4.8	5.1	1.77	

TABLE VII.

Effect of various stabilizers on cotton seed oil.

No.	Stabilizer.		Viscosity 100°F. centi- stokes.	Viscosity increase ratio, blown : original.	Acid value.	Con- rad- son carbon.	Remarks.
	Name.	Quantity %					
1	Original oil	37.38	..	0.15	0.23	
2	None	450.6	12	1.8	1.07	
	<i>Phenolic compounds.</i>						
3	α -Naphthol ..	1.0	244.2	6.5	2.0	1.6	
4	β -Naphthol ..	1.0	276.0	7.3	1.6	1.05	
5	Nitroso α -naphthol	1.0	288.4	7.7	2.4	1.16	
6	Nitroso β -naphthol ..	1.0	381.6	10.6	2.1	1.0	
7	Guaiacol ..	1.0	409.9	11.0	1.7	1.06	
8	Thymol ..	1.0	445.4	11.8	1.6	1.24	
9	Catechol ..	1.0	378.8	10.1	1.9	1.4	
10	Resorcinol ..	1.0	317.7	8.4	2.1	1.34	
11	Hydroquinone ..	1.0	280.3	7.5	2.1	1.4	
12	Orconil ..	1.0	337.0	9.0	1.9	1.4	Slight gum- my deposit.
13	Pyrogallol ..	1.0	324.0	8.6	1.8	1.7	
14	Gallic acid ..	1.0	334.0	8.9	2.7	1.2	Sparingly soluble.
15	Methyl gallate ..	1.0	420.6	11.2	2.2	0.9	
16	Gallic anilide ..	1.0	301.1	8.0	2.9	1.4	
	<i>Amino compounds.</i>						
17	α -Naphthylamine ..	1.0	242.0	6.47	2.1	1.3	
18	β -Naphthylamine ..	1.0	270.4	7.2	1.9	1.33	
19	N-phenyl α -naphthylamine	1.0	305.3	8.1	2.8	1.7	
20	<i>p</i> -Anisidine ..	1.0	350.8	9.3	2.3	1.7	Very slight brown de- posit.
21	<i>p</i> -Animophenol ..	1.0	470.4	12.5	2.4	2.1	Partially so- luble.
22	Diphenylamine ..	1.0	337.0	9.0	2.0	1.28	
23	N-Acetyl diphenylamine	1.0	404.0	10.8	1.3	0.93	

No.	Stabilizer.		Viscosity 100 F. centi- stokes.	Visco- sity increase ratio, blown : original.	Acid value.	Con- rad- son carbon.	Remarks.
	Name.	Quantity %					
24	4:4'-Diamino diphe- nylamine sulphate.	1.0	472.8	12.6	2.5	0.72	Insoluble, black tarry deposit.
25	<i>p</i> -Aminoazobenzene ..	1.0	391.8	10.4	1.3	1.13	Slight brow- nish gum- my deposit.
26	<i>p</i> -Amino acet-anilide	1.0	404.6	10.8	1.92	0.98	
27	Pyridine	1.0	467.8	12.5	1.6	0.92	
28	Piperidine	1.0	340.8	9.1	1.9	1.1	Black de- posit.
29	Tri-ethanolamine ..	1.0	514.0	13.7	1.7	0.87	
30	<i>p</i> -Phenylenediamine	1.0	433.9	1.6	2.4	1.43	Partially so- luble; lot of black deposit.
31	Benzidine	1.0	449.1	12.0	2.2	2.1	Partially so- luble; brown de- posit.
32	<i>o</i> -Tolidine	1.0	450.1	12.0	1.9	1.7	
33	Phenylhydrazine ..	1.0	407.4	10.9	1.3	0.8	
34	Acetyl phenylhydra- zine.	1.0	281.9	7.5	1.8	1.3	Partially soluble, brownish black de- posit.
35	Diphenyl guanidine ..	1.0	456.0	12.2	1.9	1.2	Slight black deposit.
36	Urethane	1.9	537.3	14.2	1.6	0.8	Do.
37	Hexamine	1.0	486.8	13.0	1.5	1.16	Sparingly soluble, much black deposit.
	<i>Sulphur compounds.</i>						
38	Allyl isothiocyanate ..	1.0	420.2	11.2	2.4	1.28	Black de- posit.
	<i>Mixture of phenol and amine.</i>						
39	α -Naphthol and α -naphthylamine.	0.5 each.	267.6	7.16	2.3	1.79	

TABLE VIII.
Effect of various stabilizers on rape oil.

No.	Stabilizer.		Viscosity 100°F. centi- stokes.	Visco- sity increase ratio, blown : original.	Acid value.	Con- rad- son carbon.	Remarks.
	Name.	Quantity %					
1	Original oil	46.9	..	0.52	0.28	
2	None	360.6	7.47	4.1	1.25	
	<i>Phenolic compounds.</i>						
3	α -naphthol ..	1.0	170.4	3.6	4.6	1.7	
4	β -naphthol ..	1.0	173.2	3.7	4.9	1.25	
5	Nitroso α -naphthol ..	1.0	170.4	3.6	3.6	2.8	
6	Nitroso β -naphthol ..	1.0	215.5	4.6	3.6	2.5	
7	Eugenol	1.0	224.9	4.8	4.5	1.5	
8	iso-Eugenol ..	1.0	206.5	4.4	5.2	1.95	
9	Guaiacol	1.0	232.0	4.9	4.6	2.1	
10	Thymol	1.0	237.7	5.0	5.1	1.8	
11	Methyl salicylate ..	1.0	245.0	5.2	4.6	1.66	
12	Salicylaldehyde ..	1.0	226.0	4.6	3.6	1.26	
13	α -Naphthol azo α -naphthalene.	1.0	210.7	4.5	4.3	1.83	Partially so- luble.
14	Di- α -naphthol azo <i>p</i> -diphenyl.	1.0	297.6	6.34	3.4	2.23	Do.
15	Di- α -naphthol azo <i>p</i> -phenylene	1.0	250.5	5.3	2.89	1.56	Do.
16	Catechol	1.3	190.0	4.05	4.8	1.75	
17	Resorcinol	1.0	168.6	3.58	1.7	1.7	Sparingly soluble.
18	Hydroquinone ..	1.0	170.2	3.6	4.9	1.7	
19	Orcinol	1.0	183.7	3.9	4.2	2.08	
20	<i>o-o'</i> -Dioxy diphenyl ..	1.0	205.8	4.37	5.05	1.75	
21	Pyrogallol	1.0	219.3	4.66	4.7	1.9	Sparingly soluble.
22	Phloroglucinol ..	1.0	165.0	3.5	4.2	2.0	Do.
23	Galic acid	1.0	234.7	5.0	3.77	1.6	Very sparingly soluble.
24	Methyl gallate ..	1.0	224.8	4.8	4.0	1.63	Sparingly soluble.

No.	Stabilizer.		Viscosity 100°F. centi- stokes.	Visco- sity increase ratio, blown : original.	Acid value.	Con- rad- son carbon.	Remarks.
	Name.	Quan- tity %					
25	Gallic anilide ..	1.0	230.1	4.9	3.77	1.56	Sparingly soluble.
	<i>Amino compounds.</i>						
26	<i>o</i> -Naphthylamine ..	1.0	169.4	3.6	4.2	2.3	
27	<i>c</i> -Naphthylamine ..	1.0	173.2	3.69	4.05	2.3	
28	N-Phenyl <i>c</i> -naphthyl- amine.	1.0	165.0	3.5	4.5	1.9	Slightly soluble.
29	<i>p</i> -Toluidine ..	1.0	191.5	4.08	4.1	2.2	
30	<i>p</i> -Anisidine ..	1.0	196.2	4.18	4.3	1.0	
31	<i>p</i> -Aminophenol ..	1.0	206.2	4.4	5.0	1.45	Sparingly soluble.
32	Dibenzyl- <i>p</i> -amino- phenol.	1.0	365.5	7.8	2.1	2.0	Do.
33	Glycine ..	1.0	185.6	4.0	4.8	1.43	Partially soluble.
34	Glutamic acid ..	1.0	302.5	6.4	4.8	1.45	Do.
35	Anthranilic acid ..	1.0	277.0	5.9	4.8	1.37	
36	<i>p</i> -Aminoazobenzene ..	1.0	224.9	4.8	3.25	1.9	
37	<i>p</i> -Amino acetanilide	1.0	310.8	6.6	3.0	1.5	Slightly soluble.
38	Quinoline ..	1.0	294.9	6.3	3.9	1.66	
39	Pyridine ..	1.0	353.6	7.5	3.26	1.97	
40	Piperidine ..	1.0	300.6	6.4	4.1	1.9	
41	Tri-ethanolamine ..	1.0	362.5	7.7	3.33	1.28	
42	Urethane ..	1.0	286.0	6.1	4.26	2.05	
43	Diphenylamine ..	1.0	147.2	3.13	3.75	1.28	
44	N-Acetyl diphenyl- amine.	1.0	312.3	6.6	3.1	1.5	
45	4,4'-Diamino diphenyl amine.	0.5	217.0	4.6	4.2	2.9	Partially soluble.
46	<i>p</i> -Phenylenediamine	1.0	232.8	4.96	3.0	1.87	Do.
47	Benzidine ..	1.0	215.4	4.58	3.75	2.75	Sparingly soluble.
48	<i>o</i> -Tolidine ..	1.0	200.7	4.27	4.2	2.7	Very spa- ringly soluble.
49	Phenylhydrazine ..	1.0	256.0	5.45	3.7	1.9	

No.	Stabilizer.		Viscosity 100°F. centi- stokes.	Viscosity increase ratio blown : original.	Acid value.	Con- rad- son carbon.	Remarks.
	Name.	Quantity %					
50	Acetyl phenylhydrazine	1.0	232.0	4.94	3.05	1.43	
51	<i>assym.</i> Diphenylhydrazine.	0.5	211.8	4.5	4.9	1.7	
52	Do. ..	1.0	130.9	2.8	5.0	1.85	
53	Diphenyl urea ..	1.0	271.0	5.77	3.6	1.05	Sparingly soluble.
54	Alloxan ..	1.0	313.8	6.7	4.03	1.54	Mostly in- soluble.
55	Diphenyl guanidine ..	1.0	267.9	5.7	4.0	1.7	Do.
56	Uric acid ..	1.0	412.5	8.7	4.45	1.63	Very little soluble.
57	Hexamine ..	1.0	350.6	7.4	3.47	1.7	
58	Tetra methyl diamino- diphenyl methane.	1.0	203.3	4.3	4.43	1.51	
59	1-Amino 4-naphthol hydrochloride	0.5	424.3	9.0	2.3	2.66	Partially soluble.
60	Semicarbazide hydro- chloride.	1.0	531.9	11.3	2.48	2.46	Sparingly soluble.
<i>Organic-metallic com- pounds.</i>							
61	Chromium oleate ..	1.0	645.3	13.7	3.85	2.6	Not entirely soluble.
62	Tin linoleate ..	1.0	455.3	9.6	4.7	2.18	
<i>Sulphur compounds.</i>							
63	Diamyl disulphide ..	1.0	300.6	6.4	4.1	2.3	
64	Allylthiocyanate ..	1.0	321.2	6.8	3.4	2.3	
<i>Miscellaneous sub- stances.</i>							
65	Oil-dag ..	2.0	371.3	7.9	3.25	2.23	
66	Benzophenone ..	1.0	280.0	6.0	3.86	2.09	
67	Vanilline ..	1.0	259.3	5.5	4.7	2.16	
68	Furfural ..	1.0	275.6	5.87	4.8	1.34	
69	Camphor ..	1.0	256.0	5.45	3.5	1.43	
<i>Mixture of amine and phenol.</i>							
70	α -Naphthylamine and α -naphthol.	0.5 each.	176.2	3.7	3.85	2.6	Not entirely soluble.

It may be mentioned that in the case of rape oil, some black gummy deposits were almost always found in the oxidation tubes (*cf.* Table VIII). Since such black deposits were always obtained in the case of castor, groundnut and cotton seed oils, when they were subjected to the oxidation tests in the presence of stabilizers containing sulphur, it was thought that the rape oil deposits might be due to the presence of allyl isothiocyanate. To remove allyl isothiocyanate from rape oil, the following methods were adopted:—

(a) Rape oil was extracted several times with alcohol. The residue was heated at 100° C. to remove any dissolved alcohol.

(b) Rape oil was distilled in steam till no more oily globules were removed. The remaining oil was separated from water and dried at 100-110°C.

Both the oil samples so obtained, when subjected to oxidation test, gave similar black deposits in the oxidation tubes. These oils exhibited rather a greater tendency to oxidation than the original oil, as may be seen from the results mentioned in the following table.

TABLE IX.

Effects of various treatments on oxidation behaviour of refined rape oil.

No.	Oil.	Viscosity 100°F. centi- stokes.	Viscosity increase ratio.	Acid value.	Conrad- son carbon.	Remarks.
1	Original oil (unblown)	46.9	..	0.52	0.23	
2	Original oil (blown) ..	350.6	7.47	4.1	1.25	
3	Alcohol extracted oil (blown).	367.3	7.83	2.7	1.3	
4	Steam distilled oil (blown).	496.8	10.6	3.47	1.85	

The effect appears to be due to the removal of naturally occurring anti-oxidants, such as have been observed by other investigator⁶⁰.

DISCUSSION.

An examination of Tables V, VI, VII and VIII will show that a large proportion of the substances tried fail to serve as efficient stabilizers. Nevertheless, there are some which may be regarded as satisfactory. The data concerning such materials has been collected in Table X for all the four oils.
M24CD

TABLE

Summary of oxidation test results with more efficient stabilizers

No.	Stabilizer.			Castor oil.			Viscosity increase ratio.
	Name.	Quantity.	%.	Viscosity increase ratio.	Acid value increase.	Conradson carbon increase.	
1	None	7.1	0.4	1.54	7.47
2	α -Naphthol	1.0	..	2.6	0.9	1.52	3.6
3	α -Naphthylamine ..	1.0	..	2.7	1.3	1.23	3.6
4	Phloroglucinol	1.0	..	2.36	1.9	1.0	3.5
5	β -Naphthylamine ..	1.0	..	2.6	2.0	1.22	3.69
6	Hydroquinone	1.0	..	2.7	2.2	1.02	3.6
7	assym. Disphenyl hydrazine.	1.0	..	2.78	1.9	1.02	2.8
8	N-Phenyl α -naphthylamine ..	1.0	..	2.8	1.8	0.67	3.5
9	Nitroso α -naphthol ..	1.0	..	2.8	2.8	1.52	3.6
10	Diphenylamine	1.0	..	3.0	2.1	0.84	3.13
11	<i>p</i> -Toluidine	1.0	..	2.67	0.6	0.82	..
12	<i>p-p'</i> -Diamino diphenyl amine.	1.0	..	2.48	2.3	0.64	..
13	α -Naphthol azo α -naphthalene	1.0	..	2.6	1.7	0.76	..
14	<i>p</i> -Anisidine	1.0	..	2.9	1.7	0.90	..
15	<i>p</i> -Phenylenediamine ..	1.0	..	2.9	0.6	1.32	..
16	β -Naphthol	1.0	3.7
17	Resorcinol	1.0	3.58
18	Nos. 5 and 6	0.5	each.	2.55	1.4	0.77	..
19	Nos. 2 and 6	0.5	each.	2.6	1.4	1.62	..
20	Nos. 2 and 5	0.5	each.	2.75	1.9	0.92	..
21	Nos. 2 and 3	0.5	each.	3.7

X.

for castor, rape, ground nut and cotton seed oils.

Rape oil.		Ground nut oil.			Cotton seed oil.		
Acid value increase.	Conradson carbon increase.	Viscosity increase ratio.	Acid value increase.	Conradson carbon increase.	Viscosity increase ratio.	Acid value increase.	Conradson carbon increase.
3.58	0.97	9.2	1.2	0.55	12.0	1.65	0.84
4.08	1.42	4.8	2.3	1.3	6.5	1.88	1.37
3.68	2.02	5.5	2.2	0.91	6.47	1.95	1.11
3.68	1.62	4.9	2.0	1.1
3.53	2.02	5.7	1.56	1.2
4.38	1.42	5.3	2.5	1.1
4.48	1.57	5.6	1.8	0.8
3.98	1.62	5.1	1.8	0.98
3.08	2.52
3.23	1.00
..	..	5.7	2.5	0.69
..
..
..
..
4.38	0.97
4.38	1.42
..	..	5.0	2.1	0.8
..	..	4.6	2.5	0.42
..	..	5.1	2.4	1.1
4.45	2.02

Comparing the results obtained in tests of the vegetable oils with those of the two mineral lubricating oils dealt with in Table IV, it will be seen that the vegetable oils, especially in the presence of iron, polymerise much more readily than the mineral oils, and even in the presence of stabilizers they become more acidic and give higher Conradson carbon residues than the mineral oils. It may be pointed out incidentally that, contrary to the conclusions of Balada⁴³, the Conradson carbon test would appear to be applicable under these conditions to vegetable oils. Thus, although vegetable oils as such give little Conradson carbon residue, yet after the oxidation test they generally showed more residue than mineral oils treated similarly.

The large increase in polymerisation and oxidation of the vegetable oils as compared with the mineral oils may be due to two reasons:—

- (1) Difference due to chemical constitution: Vegetable oils, being esters by nature, are more prone to undergo various chemical changes, such as oxidation, hydrolysis, condensation, etc., than mineral oils, which are mainly paraffin, naphthenic and aromatic hydrocarbons.
- (2) Unsaturation: Mineral oils are less unsaturated than vegetable oils. That is undoubtedly one of the reasons why the former undergo less change after the oxidation test than the latter.

Comparing the unsaturation of the two mineral oils, the characteristic of which are given in Table IV, it will be noted that oil 'B' has a higher iodine value (25.6) than oil 'A' (11.3), in fact the former polymerised to a greater extent than the latter. As regards the unsaturation of the four vegetable oils that were exhaustively subjected to the oxidation tests, it will be seen that cotton-seed oil possesses the greatest iodine value (103-115), while castor oil shows the least (82-90). Here again irrespective of the fatty acid contents of the four oils, the oxidation test results show that the polymerisation of cotton-seed oil was the greatest, even in the presence of stabilizers, while in the case of castor oil it was the least.

Of all the stabilizers found effective for castor oil, an appreciable number proved satisfactory for rape and groundnut oils, while very few of these were effective in the case of cotton seed oil. Stated in another way, the largest number of substances proved to be effective in the case of castor oil and the least number for cotton seed oil. These results are corroborated by Lewkowitsch⁴³. Unfortunately low iodine value vegetable oils such as coconut oil and various vegetable tallows are solid at ordinary temperatures and in order to make use of them as lubricants methods would need to be found to keep them liquid at sufficiently low temperatures.

The above observations lead to the conclusion that, besides unsaturation, the effectiveness of various stabilizers towards the above four vegetable oils depends on the nature of fatty acids, the constitution of the glycerides and the unsaponifiable matter present in them. For whereas the difference between the iodine values of rape oil (94-105) and cotton seed oil (103-115) is very small, the former can be stabilized much better by a greater number of stabilizers than the latter. Similarly, castor oil lends itself to far better

stabilization than groundnut oil, although both of them have nearly identical iodine values (82-90 and 83-95 respectively). Moreover, although the iodine value of rape oil (94-105) is slightly higher than that of the groundnut oil (83-95), the former has been stabilized more effectively than the latter.

Although castor oil has proved to be the most satisfactory oil so far tried Parish⁹ and several other investigators have found that castor oil, when used as a lubricant in aeroplane engines, produces a heavy shellac-like deposit. This was probably due to the absence of an effective stabilizer. As pointed out by Bauman and Zamyshlyeva⁴⁴, the deposits may be due to the decomposition of ricinoleic acid to $\text{Me}(\text{CH}_2)_5\text{CH}:\text{CH}\cdot\text{CH}:\text{CH}(\text{CH}_2)_7\text{COOR}$, which is very easily polymerised.

Taking into consideration the various stabilizers that have been tried so far on the four vegetable oils, it will be seen that the choice of types of compounds to be used as stabilizers is very much more restricted in the case of vegetable oils than in the case of mineral oils. Tin compounds⁴⁵ and other organo-metallic compounds³⁶ that have been proved to possess pronounced anti-oxidant properties in the case of mineral oils are of little value in the case of vegetable oils. Chromium and tin compounds (which have been subjects of patents—the former by Griffith and Helmore⁴⁶ and the latter by Helmore and Mardles⁴⁷—as anti-oxidants for mineral oils), have proved to be pro-oxidants with refined groundnut oil (Table VI, compare items 2 and 38 to 42) and rape oil (Table VIII, compare items 2 and 61-62). Similarly colloidal graphite, found to act as a good anti-oxidant for mineral lubricants by Weiss and Maillard²⁹, was found to be much less effective in the case of vegetable oils.

The organic sulphur compounds on which many patents^{48, 49, 50} have been taken out, based on claims as to their beneficial effect in mineral lubricating oils required to operate under high pressures, high temperature, high speed conditions, and as protecting agents against oxidation, have been found to be of very little value as stabilizers in the case of vegetable oils. They generally resulted in a quantity of black tarry deposit in the oxidation tubes in the experiments described above.

Generally speaking, the stabilizers which have proved to be the most effective are the phenols and the aromatic amino compounds, but it appears that neither the phenolic hydroxyl groups nor the amino groups are by themselves responsible for the anti-oxidant properties. Had such been the case, compounds having three phenolic hydroxyl groups, such as pyrogallol, and those having two amino groups, such as *p*-phenylenediamine, would have proved to be the best stabilizers.

It can, however, be stated that the effect appears to be, to some extent, due to the inherent constitution of the compounds having such groups. It also appears to depend upon the position of the groups in the molecule, as will be seen from the fact that α -naphthol proved to be one of the best stabilizers so far tried for all the four oils, while β -naphthol showed only a feeble stabilizing effect except in case of rape oil. Similarly, hydroquinone and phloroglucinol proved quite good stabilizer, whereas catechol, resorcinol, and pyrogallol were generally not so effective. Another conclusion that may be drawn

from the list of the most effective stabilizers (Table X) is that most of them are compounds containing more than one benzene nucleus.

Comparing the increase in acid value and in Conradson carbon residue, it will be seen that they bear no relationship to the viscosity ratio figures. Substances resulting in the least increase in the acid value and carbon residue may give high viscosity increase ratios. It appears, therefore, that the best plan would be to use such mixtures of stabilizers as would help to stabilize the viscosity as well as other characteristics.

Several theories have been proposed to explain the mechanism of the action of anti-oxidants on fats and oils. Lea⁵⁰ gives a brief discussion of some of these theories. Moureau and Dufraisse⁵³ presume that the peroxides of oils formed as a result of the action of oxygen may be reduced by the anti-oxidant directly or alternatively, oil peroxides and anti-oxidant peroxides react to reduce each other in a somewhat analogous manner to that of ozone and hydrogen peroxide. In other words the various reactions postulated may be expressed as follows:—

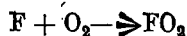

where F represents oil and A the anti-oxidant.

The reactions presume that the anti-oxidant is regenerated again and again, but experimental evidence exists^{58, 59} to the contrary which shows that anti-oxidant actually gets consumed and that it chiefly functions as an enhancer of induction period. Thus the chain theory of Christiansen⁵⁷ carries a considerable weight, in which chain reactions of the following type are postulated:—

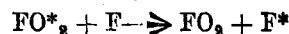
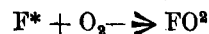
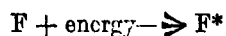

where * indicates activated molecule.

In ordinary cases such chains may be thousands of molecules long. But with the introduction of a small quantity of anti-oxidant the chain may be abruptly terminated thus:

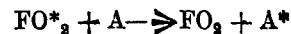

Dhar⁵⁸ has put forward similar ideas to explain the phenomenon in terms of negative catalysis, with the further addition that activated molecules by the anti-oxidant may combine with activated molecules of the oil to form additive or adsorptive compound.

All these theories have been confined to the discussion of anti-oxidants whereas the present work is chiefly concerned with substances which may more adequately be termed stabilizers inasmuch as they are expected to serve a twofold function—that of an anti-oxidant and that of an anti-polymerizing agent. It is clear, however, that, so far as these theories are concerned, they will apply equally well to the consideration of anti-polymerization effect, if oxygen molecule was replaced by another molecule of the oil. Furthermore, polymerization may also be thought to take place through the oxidised positions of the oil molecule, in which case, strictly speaking, the reaction should be considered as a condensation reaction. Twofold functions of the stabilizer would naturally limit the choice of the number of substances, which may be capable of performing efficiently in both directions.

It will be noted that most of the stabilizers found to be effective in these investigations are such as may be easily oxidised. This is in accordance with the chain theory of Christiansen and anti-catalyst theory of Dhar. Further weight is lent to these theories from the results obtained in actual engine trials, which show that the effect of stabilizers is mainly involved in increasing the induction period.

In addition to the desirability of stabilizing the lubricant, it is important that, in an engine under running conditions, the lubricant should not attack the various engine parts, thus phenols being acidic in character may attack the metal of the engine. It may be possible in some cases, however, to inhibit the corrosive properties of a stabilizer without impairing its effectiveness.

Another consideration that requires to be taken into account when selecting a stabilizer is its tendency to lead to gum formation and ring sticking. The substances shown in Table X are those which showed no such tendency in the laboratory tests, but engine tests would finally decide whether or not they are really effective from this point of view under actual working conditions.

ACKNOWLEDGMENTS.

The authors take this opportunity to thank Mr. A. N. Kapoor, who carried out the preliminary portion of these investigations, and also Dr. Karimullah, Mr. H. D. Chowdhury and Mr. S. N. Mukerji for their helpful suggestions and discussions.

BIBLIOGRAPHY.

1. Boys, C. V., *Proc. Phys. Soc.*, **30**, 83 (1918).
2. Mountford, D. R., *Proc. Phys. Soc. Lond.*, **32**, Pt. II, 1, 11S (1920).
3. Anon, *Engineering*, **109**, 184 (1920).
4. Harris, C. P., *Oil and Fat Industries*, **4**, 11, 37 (1927).
5. Stanton, T. E., Archbutt, L., and Southcombe, J. E., *Engineering*, **108**, 758 (1919).
6. Champsaur, N., *Chimie et Industrie*, **24**, 519 (1930).
7. Hubscher, J., *Seifensieder Ztg.*, **63**, 325 (1936).

8. Spires, H. M., and Smith E. W., *Inst. Gas. Engrs. Communication No. 95*, 49 (1934).
9. Parish, Wm. F., *Scientific Lubrication*, 1, 7 (1921).
10. Devez, G. J. *Revue industrielle*, 63, 274-81, 340-43 (1933).
11. *J. Soc. Chem. Ind.*, 20 R (1919).
12. Chefneux, R., *Fr. Pat. No. 808*, 818 (1937).
13. Clough, R. E., *Can. Pat. No. 284*, 562 (1928).
14. Schwaremgen A., *Can. Pat. No. 285*, 743 (1928).
15. Maclaren, F. H., *U. S. Pat. No. 2, 034,405* (1936).
16. Villiers, *Brit. Pat. No. 193,099* (1921).
17. Champsaur, N., *Ann. Combustibles Liquids*, 5, 987 (1930).
18. Bastet, A., *Bull. Soc. Encour. Ind. Nat'l*, 133, 193 (1934).
19. Devez, G., *Arts et Metiers*, 98 (1934).
20. Angla, B., *Annales des Falsifications*, 29, 92 (1936).
21. Condelli, F., *Ag. Coloniale (Italy)*, 28, 125 (1934).
22. Bijur, J., *U. S. Pat. No. 1,944,164* (1934).
23. Bataafsche, N. V. de Petroleum Maatschappij Dutch, *Pat. No. 36,242* (1935).
24. Wasson, J. I., *U. S. Pat. No. 2,133,674* (1938).
25. Andre, E., *Compt. Rend. Congr. Graissage*, 566 (1931).
26. Cypres, P., *Chem, Ztg.*, 54, 39 (1930).
27. Fiarlie, M., *Oil and Gas Journal*, 33, 58 (1935).
28. Maillard, Acker and Rengade, *Ann. Combustibles Liquids*, 6, 965 (1936).
29. Weiss, H., and Maillard, A., *J. Inst. Pet. Tech.*, 24, 407 (1938).
30. Peru, *Ann. Combustibles Liquids*, 11, 1071 (1936).
31. Balada, A., *Chem. Obzor.*, 12, 111 (1937).
32. Balada, A., "*Ole, Fette, Wachse, Seife, Kosmetik*", No. 10, 1 (1937).
33. Balada A., *Ole, Fette, Wachse, Siefe, Kosmetik*, No. 11, 1 (1937).
34. Balada, A., *Petroleum Z.*, 33, No. 38, 1 (1938).
35. Krishna S., Puntambekar, S. V., and Raizada, M.B., *Indian Forest Records Chemistry*, The Oil bearing Seeds (Government of India Press), 1, No. 1, Part, 26 (1936).
36. Dunstan, A. E., Nash, A. W., Brooks, B. T., and Tizard, H., *The Science of Petroleum* (Oxford University Press), Vol. IV, 2595, 3049 (1938).
37. Bassett, H. N., *The Engineer*, 176 (1937).

38. *British Air Ministry General Specification No. D. T. D. 109 for Mineral Lubricating Oils* (His Majesty's Stationery Office, London) (1928).
39. Mardles, E. W. J., and Ramsbottom, J.E., "The Oxidation Behaviour of Internal Combustion Engine Lubricants," *The Institution of Mechanical Engineers* (Institution Publication), Vol. 2, 356 (1937).
40. Kalichevsky, V. A., "Modern Methods of refining lubricating oils" (Reinhold Publishing Co.), p. 191 (1938).
41. Evans, E. A., and Kelman, A. L., "Metallic Soaps in Lubrication" *The Institution of Mechanical Engineers* (Institution Publication), Vol. 2, 288 (1937).
42. Barr, G., *World Petroleum* **34**, 108 (1937).
43. Lewkowitsch, J., *Chemical Technology and Analysis of Oils, Fats and Waxes* (MacMillan & Co.) Vol. 3, 63 (1915).
44. Bauman, M. R., and Zamyshlyayeva, A. I, *Masloboino Zhirovoe Delo*, **14**, No. 3, 14 (1938).
45. Mardles, E. W. J., "The Beneficial Use of Tin Compounds in Lubricants," *Technical Publication of the International Tin Research and Development Council*, Series C., No. 2 (1934).
46. Griffith, A. A., and Helmore, W., *Brit. Pat. No. 423,440* (1933).
47. Helmore, W., and Mardles, E. W., *Brit. Pat. No. 392,222*.
48. Moser, F. R., and Tuyn. M.C., *Dutch Pat. No. 420,75* (1937).
49. Moser F. R., and Tuyn. M.C., *Can. Pat. No. 374,591* (1938).
50. Standard Oil Development Co., *Fr. Pat. No. 820,262* (1937).
51. Tomasi, L., *Ann. Combustibles, Liquids*, **13**, 519 (1938).
52. Freund, M., Thamm, I., *A. Magyar Mernok-és Építészegylet-Közlönye (Hungry)*, **73**, 222-6 (1939).
53. Moureau, C., and Dufraisse, C., *Chem. Rev.*, **3**, 113, (1926). *Chem. Ind. Rev.*, **47**, 819, 848 (1928).
54. Caldwell and Dye, *J. Ind. Eng. Chem.*, **25**, 338 (1933).
55. Inman, G. O., *J. Ind. Eng. Chem.*, **31**, 1103 (1939).
56. Dhar, N. R., *Trans. Faraday Society*, **24**, 567 (1938).
57. Christiansen, J. A., *J. Phys. Chem.*, **28**, 145 (1924).
58. Branch, G. E. K., Almquist, H. J., and Goldsworthy, E. C., *J. Am. Chem. Soc.*, **35**, 4052 (1933).
59. French, R.B., Olcott, H. S., and Matill, H.A., *Ind. Eng. Chem.*, **27**, 724 (1935).
60. Lea, C. H., "Rancidity in Edible Fats", Deptt. of Sci. & Ind. Res., Special Report No. 46, 136 (1938).

BULLETINS OF INDIAN INDUSTRIAL RESEARCH



No. 19

INDIAN VEGETABLE OILS AS FUELS FOR DIESEL ENGINES

BY

J. S. AGGARWAL, M.Sc., Ph.D.,
H. D. CHOWDHURY, B.Sc., A.M.I.A.E.,
S. N. MUKHERJI, M.Sc., A.M.I.E. (Ind.), and
LAL C. VERMAN, Ph.D., M.S., F. Inst. P.

THIRD EDITION (ENLARGED)

DIRECTORATE OF
SCIENTIFIC AND INDUSTRIAL RESEARCH
DEPARTMENT OF INDUSTRIES & CIVIL SUPPLIES
GOVERNMENT OF INDIA

PUBLISHED BY THE MANAGER OF PUBLICATIONS, DELHI.
PRINTED BY THE MANAGER, GOVERNMENT OF INDIA PRESS, SIMLA
1943

M12DofS&IR.Delhi

D6466,15;94.2

H3

The statements made and the views expressed in this bulletin are those of the authors, and the Government of India do not accept responsibility for them.

CONTENTS.

	PAGE
FOREWORD	iv
SYNOPSIS	vi
INTRODUCTION	1
VEGETABLE OILS AS DIESEL FUEL, FROM THE INDIAN POINT OF VIEW	2
BRIEF SURVEY OF PREVIOUS WORK	3
GENERAL REQUIREMENTS OF DIESEL FUELS	5
FLASH POINT	6
SPECIFIC GRAVITY	6
VISCOSITY	6
SETTING POINT	6
IMPURITIES	6
CALORIFIC VALUE	7
CHEMICAL CONSTITUTION	8
CARBON RESIDUE	9
EXPERIMENTAL PLANT	9
EXPERIMENTAL PROCEDURE AND RESULTS	13
STANDARD CONDITIONS	13
CHEMICAL AND PHYSICAL CHARACTERISTICS	14
PRELIMINARY RUNS	16
PROLONGED RUNS	18
DISCUSSION—	24
STARTABILITY OF OPERATION	28
SMOOTHNESS OF RUNNING	28
NATURE OF EXHAUST	29
POWER OUTPUT	29
SPECIFIC FUEL CONSUMPTION	30
BRAKE THERMAL EFFICIENCY	31
DEPOSITS	31
CORROSION	31
ACKNOWLEDGEMENT	32
BIBLIOGRAPHY	32
APPENDIX	34

FOREWORD

(TO 3RD EDITION)

Fuel oil constitutes one of the serious shortages created by wartime conditions, in India and elsewhere. Such a contingency was one of the factors which had been foreseen at the time of initiation of investigations in India dealing with the application of vegetable oils to power generation. This included development of lubricants for internal combustion engines and fuels for Diesel engines. The present bulletin dealing with the latter subject has been in such a demand that a third edition has been called for within a comparatively short period.

The timeliness of the bulletin is commented upon by Seddon (Gas and Oil Power, June, 1942) : " Indeed, I doubt whether any article of the kind on such an important matter has been published at a more opportune time ". An editorial in May issue of the same Journal states.

" The report in question is an admirable document, truly objective, practical, and with a maximum amount of informativeness with a minimum expenditure of words and paper ; in fact, it is a technical report which many of our own compilers of similar documents could study with profit. There is no doubt that India has immense potential sources for " home grown " diesel fuels ; and the work in this report has an added practical interest at the moment which cannot be over-estimated. A readily convertible gas-oil engine capable of using these Indian fuels would, in our view, represent a highly desirable prime mover for many Indian Industrial purposes as well as for river craft and much of the immense volume of Indian coastal shipping " .

The editorial goes on to impress upon the British manufacturers of diesel engines the desirability of developing such prime-movers and solving the problems indicated by the authors as a result of their investigation contained in this bulletin. Those enterprising Indian manufacturers who have lately interested themselves in the manufacture of oil engines should make a note of this and try to take advantage of the pioneering developments that have been and still are taking place in the country for the utilization of vegetable oil fuels for internal combustion engines.

As a direct result of the stimulus given by the publication of this work, a large number of users of engines, producers of vegetable oils and laboratory workers all over India have turned their active attention to the practical application of these researches. Although only a small proportion of these attempts have found their way into print, it may be safely stated that considerable amount of vegetable oil is being actually employed at present in this country as diesel fuel. Some of the published and otherwise available data has been summarised in the appendix of this edition of the bulletin, while among the unpublished work mention must be made of the experiments conducted at the Madras Engineering College, Guindy, those sponsored by the Hyderabad

Board of Scientific and Industrial Research and the Directors of Industries of various provinces. In the last category special mention must be made of the Director of Industries, U. P., whose organization at Harcourt Butler Technological Institute, Cawnpore, under the guidance of Dr. Athwale has been vigorously pushing the practical application of vegetable oils not only as Diesel fuels but also in various other directions.

Side by side with the practical application, it is highly important that serious attention be paid to the numerous outstanding problems connected with this application, most of which have been pointed out in the text of this bulletin. These include, minimization of carbon deposits, elimination of cylinder wear, absolute prevention of corrosion of metallic parts, reduction of fuel consumption by rational engine and design, study of the atomization of injected fuel and of injection pressure and timing, means of providing easy startability etc. Unfortunately the present authors have been engaged in many other urgent problems in the recent years and consequently have little to report in the way of fundamental advances of knowledge, but there is little doubt that other investigators are interesting themselves in these problems.

SYNOPSIS

The importance of utilizing vegetable oils as Diesel Engine fuels from the national and also the wider points of view is discussed. The literature on the subject is briefly reviewed and the divergence of results obtained by various investigators on different aspects of the subject is pointed out. The chemical and physical characteristics of Diesel fuels and their relationship with engine performance, fuel handling, etc., are discussed.

The experimental plant used in the present investigations consisted of an 8 H. P. Diesel engine and electric dynamometer unit, with accessories and controls to facilitate running under standardized conditions. The chemical and physical characteristics of 11 vegetable oils of Indian origin and a high-speed mineral Diesel oil were determined.

Preliminary runs of short duration on all these oils were carried out on the experimental plant under previously standardized conditions of operation. As a result of these runs, startability, stability of operation, nature of exhaust and maximum obtainable horse-power were determined for each of these oils.

Prolonged runs of 50 hours duration were also carried out on five of the vegetable oils and two similar runs on a high-speed mineral Diesel oil. Other oils will be taken up for similar investigation as and when convenient. These runs, besides confirming the results of the preliminary runs, gave information regarding the specific fuel consumption, per cent. brake thermal efficiency, character of resulting deposits, and corrosion, if any, of the engine parts.

Briefly speaking, the results obtained indicate that most of the vegetable oils may be successfully employed as Diesel fuels; some do not require any modifications in the engine except minor adjustments, these including groundnut oil, cotton-seed oil, and rape-seed oil, while others, such as polang oil, may require certain engine parts to be built of corrosion resistant alloys.

The performances obtained from almost all the oils tried were comparable with that of mineral Diesel oil, with the exception that castor oil (and perhaps coconut oil also) may require a certain amount of pre-heating in order to obtain better smoothness of running.

As compared with mineral Diesel oil, the vegetable oils gave, in general, approximately the same power output, a slightly higher fuel consumption, better brake thermal efficiency, and slightly more, but not excessive, deposits.

Cotton-seed oil gave an exceptional performance in that its consumption was definitely less than that of mineral oils and its efficiency appreciably higher while the power output was equal to that obtained in the case of the mineral oil.

INDIAN VEGETABLE OILS AS FUELS FOR DIESEL ENGINES

INTRODUCTION.

Liquid fuels in all forms have in the past been used in internal combustion engines. At the present time, however, the most important liquid fuels are petrol and fuel oils—both of which are obtained from petroleum. The former is used in ordinary spark-ignition carburettor type engines of comparatively low compression ratio, and the latter in Diesel engines (or what are popularly known as “crude oil engines”) of relatively high compression ratio. The popularity of the latter type of engines is due to the fact that they are simpler and more rugged in construction, and utilize cheaper grades of fuels, giving higher thermal efficiency. Engines working on the Diesel cycle have the highest thermal efficiency ever achieved hitherto with any type of heat engine.

Higher thermal efficiency, in terms of ordinary usage, means that more economical consumption of fuel results for a given load, thus gasoline (*i.e.*, petrol) engines consume approximately 25 to 30% more fuel than Diesel engines. As an example, the figures published for a recent trial by Yuasa¹ are interesting, as it was shown that the consumption of fuel by a Diesel engine was 170 gms. per B. H. P. hour as against 270 gms. per B. H. P. hour in the case of a gasoline engine giving the same power output.

The fact that a Diesel engine consumes a fuel which is not dangerously inflammable renders it additionally attractive in many applications such as, for example, in aircraft and for small pleasure and utility crafts on the water, where fire hazards require to be seriously considered. The higher degree of safety also results in the storage, handling and transport being more free from those restrictions and regulations which have to be imposed in the case of petrol and benzol.

The increasing popularity of Diesel engines for road transport will be evident from the fact that in 1932 there were, on the roads of Great Britain, fewer than 100 Diesel engines; five years later there were about 15,000 and the number was recently estimated to be increasing at the rate of 800 per month. Several leading firms have ceased to build petrol engines except to special order².

It will be readily appreciated that countries which do not possess any petroleum deposits have, of necessity, to depend for their supplies of fuel for Diesel engines on those which have extensive sources of petroleum. To render themselves independent in this respect, attempts are being made by several nations of the world to find other suitable alternative fuels, thus production of petrol by hydrogenation of coal or coal products in solid, liquid, and gaseous forms, and the use of gas producers on transport vehicles burning wood, coal, coke, charcoal, and other types of fuels are two of the best known attempts in this direction.

Attention has also been directed in various countries towards the direct utilization of vegetable products, such as vegetable oils, as fuels in Diesel engines in place of mineral oils. The countries that are comparatively poor in

mineral oil resources and rich in agricultural resources will naturally benefit by such development, and the extent to which vegetable oils can be produced depends largely on the advances made in scientific methods of agriculture. The possibility of utilization of vegetable oils was recognized by the original inventor of Diesel engines as far back as 1911³, and he visualized that, when resources of mineral oil become depleted, as they inevitably must in the not too distant future at the present enormous rate of world consumption, the sun's radiant energy will still be available to produce vegetable oils from the soil for use in Diesel engines.

According to certain authorities⁴, the mineral oil resources of the world, if they continue to be exploited at the present rate, would last only about another 18 years. Even if this estimate prove to be wrong by a considerable margin, it can hardly be doubted that the day is not far off when the power production industry will be obliged to divert its attention to vegetable products the supply of which is not limited as are mineral oil deposits.

VEGETABLE OILS AS DIESEL FUELS, FROM THE INDAN POINT OF VIEW.

Oil bearing seeds are produced under a wide range of climates, but most of the oil seeds of major commercial importance grow in tropical or sub-tropical countries. The climate of India being well adapted to oil seed production, this country ranks at present as one of the premier oil-seed producing areas in the world, the annual production being about eight million tons⁵. The most important oil seeds of India are cotton, rape (including mustard), sesame, coconut, groundnut and castor. In addition to these, India produces many minor oil seeds of varying importance. A large proportion of the oils produced from them are consumed locally for edible purposes, burning, soap making, etc., according to the type of oil concerned and its industrial utility.

After satisfying local requirements, India is able to export annually vegetable oils to the extent nearly half a crore of rupees. In addition to the oils, India exports a large quantity of oil seeds and oil cake, the values of which are nearly twenty crores and two and a half crore of rupees respectively⁶. The export of seeds is considered by many to constitute a great economic loss to the country.

At present the market prices of vegetable oils, in general are higher than those of mineral Diesel oils, but it may be anticipated that in due course the cost will be reduced as a result of systematic and scientific agricultural developments combined with the development of more efficient oil extraction methods. Even now it is possible in certain localities to purchase a number of the non-edible oils at fairly cheap rates, which goes to show that it may become possible to reduce the cost of such oils so as to compete with mineral Diesel oil. On the other hand, mineral oil prices may rise above the limit of those of vegetable oils, as the supply of the former becomes more restricted with time. Furthermore, the utilization of some of these oils may mean the utilisation of a fairly large quantity of what are now regarded as forest wastes.

There is another point in connection with the cost question which should be kept in mind, namely, that mineral Diesel oils are not available in the interior of the country at the cheap rates prevailing in the port towns, on

account of railway freight charges. Vegetable oils, which may be extracted locally, are therefore better placed for competing with mineral Diesel oils in the interior of the country.

BRIEF SURVEY OF PREVIOUS WORK.

Gautier⁷ appears to have been the first to undertake a detailed examination of the possibilities of utilising vegetable oils as fuels for Diesel engines (both high and low speed types), and he described the results of his work carried out on groundnut, palm and castor oils. From his experiments he concluded generally that vegetable oils may be considered to be quite satisfactory fuels for Diesel engines.

Schmidt⁸ tested pea-nut (*i.e.*, groundnut), soya-bean and palm oils in a small Diesel engine. The engine ran satisfactorily, but difficulty was sometimes experienced in starting; this could be obviated by starting on mineral oil. The engine developed considerably less power with vegetable oil (15 h.p.) than with gas oil (24 h.p.), and Schmidt ascribed this to the lower calorific value and higher-viscosity of the vegetable oils, the latter preventing proper atomisation and thus causing imperfect combustion.

Chang-Ming-Tu and Tsu-Tze-Ku⁹ found that mixtures of 70% cotton seed oil with 30% Diesel oil or 90% cotton seed oil with 10% gasoline or 80% cotton seed oil with 20% kerosene conformed closely to the standard viscosity and solidifying requirements of Diesel fuels. These authors, however, made no engine tests.

Howes¹⁰, Hubner and Egloff¹¹ tried pea-nut, coconut, soya-bean and palm oils as Diesel fuels and reported starting difficulties, low power output and high fuel consumption.

Manzella¹² tried pea-nut oil in a 2-cycle engine of 12 h.p. running at 520 r.p.m. His conclusions were that (a) operation with pea-nut oil offer no difficulty or drawbacks; (b) the fuel consumption was higher than when using mineral oil at normal loads but was lower at reduced loads, in spite of the fact that pea-nut oil had a lower calorific value; (c) the efficiency in all cases was greater than when using mineral oil; (d) ignition was somewhat retarded as compared with mineral oil, but this feature was of advantage, in that the pressure rose more gradually and consequently the maximum pressure was lowered. Manzella¹³ found that the calorific value of raising-seed oil was approximately that of mineral Diesel oil, and engine tests with this oil and also with a 1 : 1 mixture with Diesel oil showed similar performance as regards indicator diagrams, specific fuel consumption, etc., except that there was some difficulty in starting and more deposits were formed in the combustion chamber.

Gaupp¹⁴ tried plant oils such as soya-bean, sesame, pea-nut, palm and sun-flower seed oils and shea butter. He concluded that, under proper conditions, the use of vegetable oils as Diesel fuels was possible without difficulty. Gaupp¹⁵ recently reported test on vegetable oil fuels in a four-stroke twin-cylinder ante-chamber Mercedes-Benz oil engine having a compression ratio of 14.5 : 1, a speed of 750 r.p.m., and an output of 25 h.p. Results showed that there was little difference between the output obtained with vegetable oil fuels and with gas oil. The consumption of fuel, however, was 12 to 15% higher

than when using gas oil, and in this respect palm and groundnut oils were slightly superior to soya-bean and sesame oils. With vegetable oils certain metals showed a tendency to corrode. Gaupp concluded that, in order to obtain satisfactory operating conditions with vegetable oils, the engine should be started with mineral oil, the vegetable oil should be filtered, the fuel must be pre-heated, the combustion chamber, etc., should be decarbonised more frequently than with mineral oil, and that it was desirable to run on mineral oil just before stopping, in order to ensure that mineral oil was in the fuel line ready for restarting.

Tatti and Sirtori¹⁶ used pea-nut oil as a Diesel fuel and compared the performance of the engine with that when using gas-oil. At temperatures below 10°C., the viscosity of the oil became very high rendering atomization difficult. They also found that pea-nut oil attacked copper and therefore copper pipings should not be employed.

Palm oil was tried by a mining company in West Africa¹⁷, where this oil could be purchased at a quarter of the price of Diesel oil. The organization concerned had a number of engines of various makes installed, the total horse-power involved being about 500. The power reduction on palm oil was found to be nearly 20% and the specific fuel consumption increased by approximately 20% on full load and 25% on three-quarter load. Pre-heating had to be resorted to and starting had to be effected on gas-oil. Although the palm oil contained a certain amount of free acids, no ill effects on the engine parts were reported and there were no ill effects from the products of combustion.

Walton¹⁸ examined the possibility of using a wide variety of vegetable oils as Diesel fuels. Of these, palm oil, cotton-seed oil, groundnut oil, and, in particular, soya-bean oil appeared to be the most promising. Pre-heating was employed in most cases, but no insuperable difficulties were experienced. A standard type 6-cylinder Diesel engine ran with a clean exhaust on palm oil, but pre-heating was necessary. Fuel consumption was 10% above that when using gas oil during a run of 3,000 miles on the road. No particular damage was done to the engine, but the pump elements suffered from poor filtration. Similar results were obtained with cotton-seed oil, groundnut oil and soya-bean oil, the power output being 91% of that when using Diesel oil. It was emphasised that the exhaust was invariably clean and that Diesel knock was virtually eliminated.

Walton also found that the effect of vegetable oil fuels on lubricating oil was that the higher iodine value of the former resulted in greater sludge formation in the latter. Among other vegetable oils examined, about which no technical information was given except that they were usable as Diesel fuels, were the following :—

- | | |
|-------------------|-------------------|
| (1) Castor. | (9) Pea. |
| (2) Grape seed. | (10) Poppy seed. |
| (3) Maize. | (11) Hemp. |
| (4) Cameline. | (12) Linseed. |
| (5) Pumpkin seed. | (13) Chestnut. |
| (6) Beech-nut. | (14) Sunflower. |
| (7) Rape. | (15) Olive. |
| (8) Lupin. | (16) Shea Butter. |

Cerchez¹⁹, in discussing alternative fuels for Roumania, supported the direct use of vegetable oils in place of Diesel oil, although the former had several considerable disadvantages such as poor atomization, in the absence of pre-heating, and lower calorific values.

Experiments were also undertaken at Brussels²², with a fuel resulting from treatment of palm oil with ethyl alcohol, in an omnibus running on a regular passenger service from Brussels to Louvain, the total distance covered exceeding 20,000 kilometres. The results were quite satisfactory.

Hamabe and Nagao²¹ recently investigated the performance of a 10/12 B.H.P. single cylinder Diesel engine, having a bore of 150 mm. and stroke of 240 mm., running at 500 r.p.m. and using soya-bean oil and also gas-oil as fuels. They found that the output and thermal efficiency were nearly the same as with gas-oil, but that the fuel consumption was higher. Diesel knock was found to be less in the case of soya-bean oil and the ignition lag, as found from indicator diagrams, was also smaller. Starting was found to be easier in the case of soya-bean oil.

The brief resumé of the recorded work which is given above, indicates that the degree of agreement between various workers is not very high. The results obtained by different investigators presumably differ owing to the complexity of the problem of fuel utilization in Diesel engines. The efficient utilisation of a fuel in an engine is not only dependent on the characteristics of the oil itself, but is also greatly affected by the design and construction of the atomiser and the engine, the various adjustments of the operating parts and the prevailing atmospheric conditions. Consequently it is not surprising to find that the results which have been obtained by different investigators vary as much as they do, but it is an encouraging sign that a certain degree of agreement exists. The various points of interest in relation to engine operation will be taken up in detail under the heading "Discussion" at a later stage, but it will be of interest at this stage to note the general requirements that Diesel engine fuels should be expected to satisfy.

GENERAL REQUIREMENTS OF DIESEL FUELS.

The general characteristics²² and properties of Diesel fuels can be divided into those concerned with:—

- (1) handling, storage, pumping and atomisation of the fuels;
- (2) ignition and combustion of the fuel after injection into the combustion space of the engine.

It is usual to include a number of these properties in specifications, although it is impossible to define with any exactitude the merit of a Diesel fuel by reference to specification characteristics.

Conditions under (1) are mainly covered by the following characteristics:—

- (a) Flash point.
- (b) Specific gravity.
- (c) Viscosity.
- (d) Setting point.
- (e) Impurities.

Conditions under (2) are similarly covered by the following:—

- (a) Calorific value.
- (b) Chemical constitution.
- (c) Carbon residue.

We shall take up each of the above characteristics and discuss how far vegetable oils compare with mineral Diesel oil:—

Flash point.

The flash point is important chiefly as a safeguard against fire risks when handling and during transportation and storage of the fuel, but it has no effect either on ignition or combustion of the fuel in the engine. Generally, the minimum specified value for flash point is 150°F. All vegetable oils have a flash point much higher than this value.

Specific Gravity.

The specific gravity of a fuel has no direct influence on its behaviour in the engine, but it is useful for identification purposes and affords a simple means by which the purchaser may check uniformity of fuel supplies.

Viscosity.

The property of viscosity is of great importance as it affects the flow of the fuel from the storage tank to the fuel injection valve as well as the correct atomisation of the fuel when leaving the nozzle of the atomiser inside the combustion chamber. When fuels of high viscosity are used, it becomes necessary to reduce their viscosity either by heating the fuel pipe or by admixing a fuel of lower viscosity so that they flow freely through the pump and the injector. The rate of burning and completeness of combustion and consequently the maximum power output, is largely dependent on the fineness and proper atomisation of the injected fuel which, in turn, is largely influenced by the viscosity of the fuel. While vegetable oils, in general, are considerably more viscous than petroleum Diesel fuels, some of them can be used undiluted to produce the maximum output and a clean exhaust, while in the case of others, it becomes necessary to heat the fuel pipe or to have recourse to blending or dilution with a less viscous oil.

Setting point.

The "Setting Point" of a Diesel fuel becomes important when the fuel has to be used under low temperature conditions. So far as the operation of engines is concerned, it is necessary to take this property into account so as to ensure that, under all possible conditions, the fuel is readily capable of being pumped. Certain of the vegetable oils set at ordinary winter temperatures; arrangements, therefore, may require to be made to ensure proper fluidity by pre-heating when they are used.

Impurities.

All Diesel fuels are liable to contain small quantities of water and also of solid materials which are partly or wholly incombustible. These incombustible materials are indicated by the "ash" content, and are usually present.

in extremely small quantities in most commercial Diesel fuels. It is very important that the ash content should be low, as portions of any incombustible material must inevitably tend to clog the filters, pump valves and injector nozzles, and, if they reach the cylinder liner walls, mix with the lubricating oil and cause increased cylinder liner and piston wear. In addition, it also tends to reduce the life of piston rings and exhaust valves. As high compression has to be maintained for the successful running of Diesel engines, the question of wear is a very important one.

In the case of vegetable oils, the chief impurities present are :—

- (i) Dirt and other foreign matter.
- (ii) Solid matter from the seeds.
- (iii) Mucilage.
- (iv) Free fatty acids.
- (v) Colouring matter.
- (vi) Substances imparting taste and smell to the oil.
- (vii) Moisture.

Most of these are taken care of and eliminated by ordinary commercial refining methods, and some of them can also be dealt with by means of the special fuel oil filters normally provided on modern Diesel engines. The most important consideration from the point of view of Diesel engine operation is the corrosive effect of free fatty acids in these oils. Although such oils may not cause trouble under ordinary conditions, the acids are liable to be dissociated at the temperature of combustion and may cause pitting of exhaust valve seats, piston surfaces, and other component parts of the combustion space surfaces. Gautier⁷ gives 20% as the acidity limit (equivalent to an acid value of 40) which may be tolerated.

Calorific value.

In all fuel problems, the calorific value of the fuel is an important consideration, and a distinction must be made in this connection between gross and net calorific values. The gross calorific value represents the total quantity of heat in a standard weight of fuel, assuming that all the combustible components yield their full heat value on burning in a calorimeter and the products of combustion are cooled to the room temperature. As, however, the hydrogen component is converted into steam, which, in an engine cylinder, leaves without giving up its latent heat, it is necessary to subtract the latent heat of this portion in order to arrive at the net useful heat input of the fuel used. Experimental determination of the gross calorific value is made in a suitable calorimeter, and the net calorific value is obtained from the gross value by deducting 600 calories per gram of water formed during combustion, or 54 calories for each 1% of hydrogen in the fuel thus

$$\text{Net calorific value} = \text{Gross calorific value} - 54.H,$$

where $H = \% \text{ hydrogen in the fuel.}$

It may be mentioned that it is conventional amongst the leading scientific societies to base engine thermal efficiency on the gross calorific value of the fuel.

Chemical Constitution.

The chemical constitution of an oil influences very considerably its qualities as a fuel as it not only affects its calorific value but also determines, though in an unknown manner, what has been termed the ignition quality of a fuel. All Diesel fuels produced from crude petroleum consist chiefly of carbon, hydrogen and a small percentage of sulphur, the proportions depending on the source of the crude oil. The hydrocarbons are present in the fuel in various proportions and may be divided into three main groups known as paraffins, naphthenes and aromatics. Of these, the paraffinic hydrocarbons are generally preferred as Diesel fuel constituents from the point of view of ignition quality, while the aromatics are considered to be relatively poor in this respect.

It has been found by various workers that the $\frac{H}{C}$ ratio of a fuel is generally a good index of the degree of completeness of combustion which can be attained in practice. Dr. Schweitzer of the Pennsylvania State College²³ subjected to statistical analysis the data obtained by LeMesurier and Stansfield²⁴ in their investigation of fourteen fuels with respect to their behaviour in Diesel engines. From this analysis it was found that the $\frac{H}{C}$ ratio of a fuel showed fairly good correlation with its self-ignition temperature, the latter decreasing with increasing values of $\frac{H}{C}$. The explanation offered for this fact is that ignition is ordinarily initiated by rapid peroxide formation and that the hydrogen atoms, which split off easily, are the ones which facilitate this formation.

It has also been found²³ that the $\frac{H}{C}$ ratio can be correlated with the delay angle, that is, the interval between the opening of the fuel valve and the point of commencement of the pressure rise due to combustion. In other words, a high $\frac{H}{C}$ ratio fuel will give a shorter delay period and hence more rapid and generally smoother operation. Aromatics and naphthenes as a rule have low $\frac{H}{C}$ ratios.

The ignition quality of a fuel is generally measured in terms of the delay period or ignition lag. The larger the quantity of fuel present in the cylinder before ignition takes place,—and this depends on the delay period—the greater will be the shock pressure. It is this shock pressure which is responsible for rough operation—the so called "Diesel Knock". According to Berlage and Broeze²⁵ the delay period governs the roughness of running, ignition, production of smoke and offensive exhaust, and, in some cases, piston gumming.

Vegetable oils consist essentially of the glycerides of saturated and unsaturated fatty acid and contain, beside carbon and hydrogen, a considerable proportion of oxygen. This reduces the net calorific value of the fuel

as compared with mineral fuels, owing presumably to a portion of its combustible material being already combined with oxygen in the fuel molecule itself and consequently not being available for producing heat as a result of oxidation with air. The $\frac{H}{C}$ ratios of these oils are, however, generally higher than those of mineral oils, as a result of which more complete combustion is likely to take place and this tends to compensate to some extent for the lower calorific value.

As regards the delay period in the case of vegetable oils, except for one or two determinations, no work appears to have been done. It has been observed by many investigators in this line, however, that the operation of engines with vegetable oils was no more rough than with mineral oils. On the contrary some have stated that "Diesel Knock" was virtually eliminated when running on vegetable oils.

Carbon residue.

Diesel fuels vary considerably in their carbon-forming tendencies as shown by the internal condition of an engine after a period of running. Carbon may commence to form on the fuel injection nozzle, and the consequent interference with spray formation may rapidly lead to falling off in power output and a smoky exhaust. As an indication of carbon-forming tendencies either the Conradson or the Ramsbottom test is generally adopted, and a number of workers have found a fair agreement between carbon deposits in the engine and the Conradson carbon residue in many cases. Vegetable oils generally give a higher Conradson residue than mineral Diesel oils.

EXPERIMENTAL PLANT.

The equipment used in the investigations described in this paper consisted chiefly of an 8 H.P. Diesel engine coupled to an electric dynamometer, shown diagrammatically in Fig. 1.

The engine was a single cylinder Lister Diesel engine having the following specification :—

Rated Power	8 H. P.
Rated Speed	1200 R.P.M.
Bore	4½ ins.
Stroke	4¾ ins.
Operating Compression Ratio	15 : 1
Starting Compression Ratio	19 : 1

The engine was supplied equipped with the following :—

One—Type B.P.F., Bosch fuel pump.

One—Model S, Bosch injector with a single hole.

One—Centrifugal governor with speed control device for regulating the flow of fuel, designed to maintain the speed constant at all loads.

The engine when purchased was an ordinary commercial unit, and it was necessary to introduce certain modifications with a view to facilitating the control of operating conditions and maintaining them constant. The modifications included the following items :—

- (1) The thermo-syphon cooling water circulation system was replaced by a pump operated water circulation system. A centrifugal pump (Fig. 1) was installed at the outlet from the cylinder head, a V-groove belt and pulley being provided for driving this pump.
- (2) The radiator was installed outside the laboratory with a view to avoiding unnecessary heating of the laboratory. It was connected to the engine jacket inlet and pump outlet through large diameter pipes ($1\frac{1}{2}$ ").
- (3) An electric fan was provided to produce the necessary cooling air draft for the radiator, the fan speed being controlled from inside the laboratory (see Fig. 1), through a control rheostat of slide type mounted on the switch-board. The adjustment of fan speed was made in accordance with the temperature of the circulating water.
- (4) Two thermometer pockets (Fig. 1) were provided, one at the inlet and the other at the outlet of the water jacket circulation system.
- (5) In order to maintain the temperature of the engine intake air constant a 1 K. W. electric heater was mounted in a re-entrant type of manifold installed between the air filter and the air inlet port of the engine (Fig. 1). The heater was provided with a three heat switch, and with a rheostat and ammeter mounted on the switch-board for control purposes.
- (6) A thermometer pocket was installed in their intake port of the engine to enable the air temperature to be indicated and controlled.

The engine was coupled to the dynamometer through a flexible rubber canvas Hardy type disc coupling. The dynamometer was arranged so that it could be used as a motor for starting the engine or as a generator for delivering the power to a load dissipating resistance through suitable measuring instruments (see Fig. 1 for electrical connections). The dynamometer was of the trunnion mounted yoke type, the yoke being provided with two cantilever arms, one connected to a weighted centre zero balance with a hand-wheel operated positioning gear and the other to an oil dash-pot. The dynamometer was also provided with a revolution counter.

The engine-dynamometer assembly was mounted on a channel-iron base frame anchored to a reinforced concrete bed, which was isolated from the laboratory floor. Between the floor and the concrete bed was provided a clearance of $1\frac{1}{2}$ " all around, which was filled with pitch, thus the electrical instruments mounted on the switch-board, anchored to the laboratory floor were protected against excessive vibration from the power unit. In Fig. 2 is given a general view of the installation.

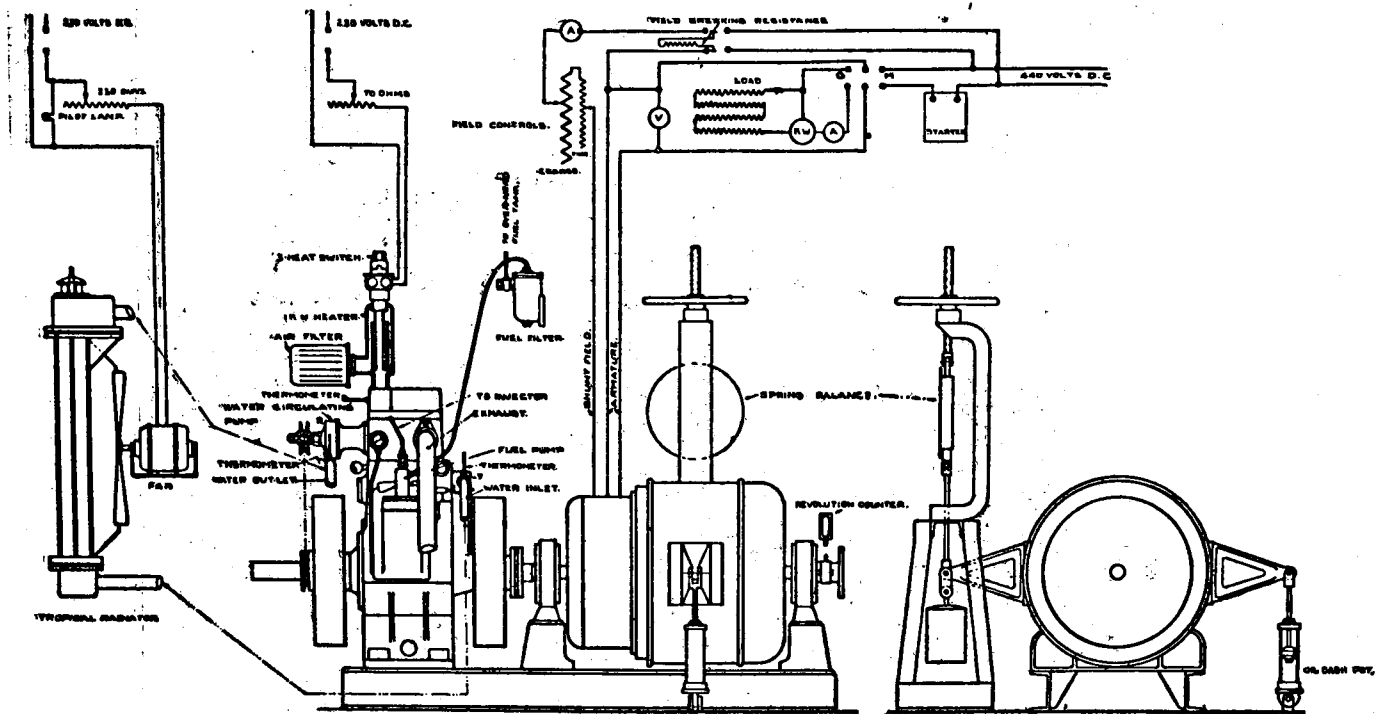

Fig. 1.

Diagrammatic Layout of the Experimental Plant, showing essential details of the Lister Diesel Engine, the Dynamometer, and the Electrical control circuits.

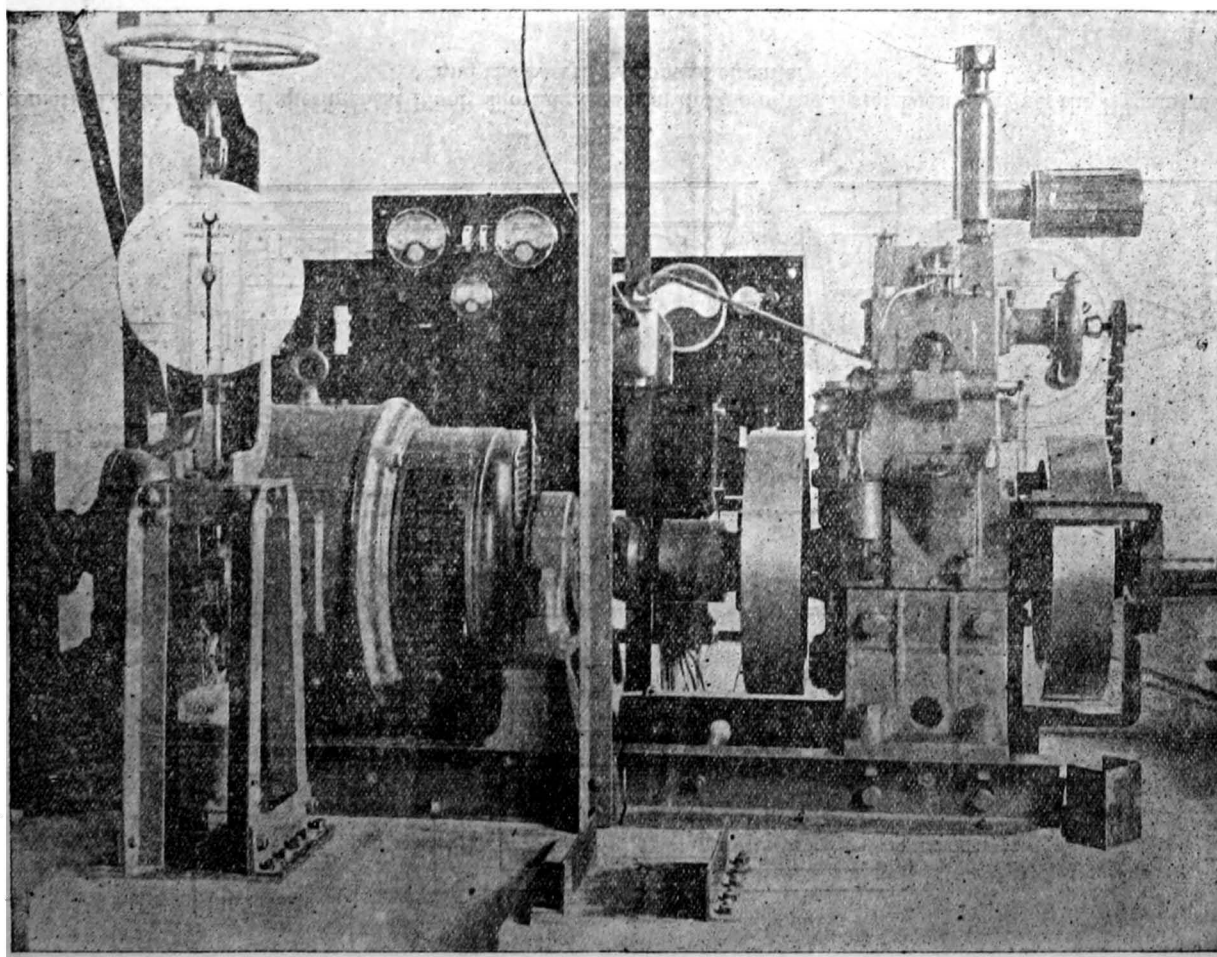

Fig. 2.

General View of the Eng'ne-Dynamometer Equipment with Switch-board in the background.

EXPERIMENTAL PROCEDURE AND RESULTS.

Standard Conditions.

The engine was run in for a period of twenty-five hours at approximately three-quarter full load at normal rated speed before undertaking preliminary trial experiments.

A number of preliminary trial experiments were then made, using mineral Diesel oil and a few vegetable oils, with the object of ascertaining the normal operating conditions under which the various fuel oils might conveniently be subjected to comparative and extended tests. As a result of these experiments, the following conditions were standardized:—

(1) Injection Nozzle Opening Pressure	..	1250 lbs. per sq. in.
(2) Injection Advance 22° before T. D. C.
(3) Jacket Water Temperature Outlet— $170 \pm 2^\circ \text{F}$.
(4) Speed 1200 R.P.M.
(5) Power Output Maximum Available (at 1200 R.P.M.).
(6) Fuel Temperature: Starting To suit requirements.
Operating Atmospheric.
(7) Intake Air Temperature Atmospheric (in most cases), 150°F . (in later experiments).

Ordinarily, without the heater being turned on and under steady conditions the intake air before entering the combustion chamber was found to heat up considerably in passing through the cylinder head port. This temperature rise amounted to about 26°F when the atmospheric temperature was 90°F and the engine was running under full load. In the early experiments, when the heater was under construction, the experiments were carried out under these conditions and the temperature of intake air allowed to vary according to the prevailing atmospheric conditions.

Later, however, when the heater became available it was found that with the heating current at its minimum value. (1.1 amps) a temperature-rise of 28° to 41°C resulted when the engine was running under standard conditions. Thus, assuming that the maximum air temperature did not exceed 105°F in Calcutta, the minimum controllable temperature for all weathers would be 146°F . With a view to providing a certain amount of flexibility in control, a temperature of 150°F was standardized for the intake air.

The minimum controllable temperature was chosen as the standard as it was found that, with increase of intake air temperature, the power output of the engine decreased. Curve A in Fig. 3 shows the relation between the maximum power output obtainable with coconut-oil, run under otherwise standard conditions, and the temperature of intake air.

Decrease in power with increasing temperature may be expected in view of the fact that the quantity of air taken in per stroke decreases in inverse proportion to the absolute temperature. Curve B, Fig. 3, shows the calculated decrease which may be expected on this basis. It will be seen that the actual

decrease is less than this amount, the reason for which is to be sought in the fact that the quantity of air per stroke allowed for in the engine design is generally in considerable excess of the theoretical amount required for complete combustion of the fuel charged per stroke.

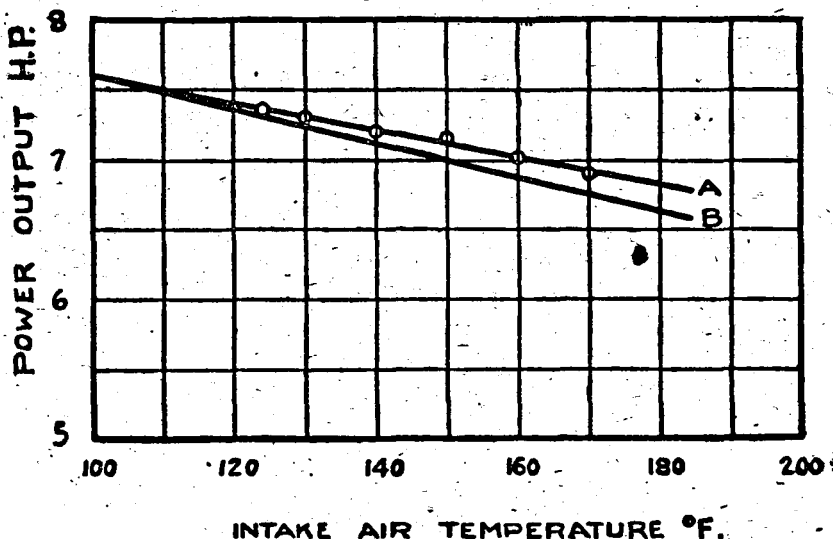

Fig. 3.

Relation between power output and intake air temperature when using coconut oil as fuel.

Curve A—Experimental.

Curve B—Calculated on the basis of quantity of air taken in per stroke.

Chemical and Physical Characteristics.

The chemical and physical characteristics of the eleven vegetable oils and one high-speed mineral Diesel-oil used in this investigation were determined and the results obtained are summarised in Table I. Combustion analyses were also carried out and the hydrogen-carbon ratios determined. These results are given in Table II.

It will be seen that a wide variety of oils are included in the list, and that the characteristics of the oils cover a considerable range. In general, the viscosity, flash-point, acid value, ash content, Conradson carbon residue and hydrogen-carbon ratio are invariably higher for vegetable oils than in the case of the mineral oil, but the calorific value is invariably lower.

TABLE I.

Physical and Chemical Characteristics of Oils.

No.	Commercial name of oil.	Botanical name of the plant producing the seed.	Appearance.	Colour.	Specific gravity at 100°F	Kinematic viscosity at 100°F in centistokes.	Flash point °C.	Calorific value in cal/gm.		Acid value.	Ash %.	Setting point °F.	Conradson carbon residue %.	Remarks.
								Gross.	Net.					
1	High speed mineral diesel.	..	Clear ..	Yellow..	0.8492	3.90	105	10,770	10,125	Nil	Nil	26	0.01	
2	Arachis (groundnut)	Arachide hypogaea.	Cloudy	Pale Yellow.	0.9028	40.59	217	9,544	8,928	1.43	0.015	36	0.30	
3	Karanj	Pongamia glabra.	Clear ..	Deep Red	0.9215	44.7	205	9,315	8,705	5.6	0.056	47	0.42	
4	Punnal or (ndi ..	Calophyllum innoxium.	Slightly turbid.	Bluish ..	0.9247	54.87	198	9,294	8,721	29.0	0.02	49	1.71	This is the oil extracted from seeds grown in Western Ghats.
5	Polang	Do. ..	Do. ..	Brown	0.9286	55.39	201	9,317	8,734	21.6	0.019	43.5	1.0	This is the oil extracted from seeds grown in Orissa.
6	Castor	Richia Communis.	Clear ..	Dark Yellow.	0.9479	293.4	260	8,875	8,295	4.6	Nil	Below 2.	0.18	
7	Kapok	Bombax malabaricum.	Clear ..	Dark Red	0.9042	41.73	230	9,392	8,788	45.4	0.097	56.0	0.7	
8	Mahua	Cassia latifolia, etc.	Clear ..	Pale Yellow.	0.8991	45.63	214	9,464	8,838	24.82	Nil	57.0	0.16	
9	Cotton seed ..	Gossypium	Clear ..	Pale Brown.	0.9125	36.76	275	9,599	8,955	0.085	0.005	26	0.23	
10	Rape seed (Mustard)	Brassia juncea	Slightly turbid.	Brownish Yellow.	0.9072	49.7	221	9,856	9,236	0.52	0.016	Below 12.	0.28	
11	Coconut	Cocos nucifera.	Clear ..	Colourless	0.9170	29.4	226.5	9,285	8,679	1.6	0.17	Below 82.	0.17	
12	Til (Sesame) ..	Sesamum indicum.	Clear ..	Yellow ..	0.9148	37.2	221.5	9,095	8,095	5.3	0.37	16	0.37	

TABLE II.

No.	Name of oil.	Percentage compositions.			H C Ratio.
		Carbon.	Hydrogen	Oxygen.	
1	High speed mineral diesel	86.9	12.4	0.7	0.143
2	Arachis (Groundnut)	76.74	11.59	11.67	0.154
3	Karanj	76.92	11.3	11.78	0.147
4	Punnal or Undi	76.36	10.43	13.21	0.137
5	Polang	78.06	10.81	11.13	0.139
6	Castor	73.84	10.75	15.41	0.146
7	Kapok	76.18	11.18	12.64	0.147
8	Mahua	77.06	11.6	11.34	0.150
9	Cotton seed	77.23	11.93	10.84	0.154
10	Rape (Mustard)	76.73	11.48	11.79	0.150
11	Cocoonut	73.21	11.25	15.54	0.153
12	Til (Sesame)	77.94	11.52	10.54	0.148

Preliminary Runs.

Preliminary runs of short duration were carried out under standard conditions using each of the oils, with a view to determining certain general operating characteristics such as :—

- (a) *Startability*, that is, ease of starting from cold: If the engine started from cold merely by hand cranking the startability was recorded as being *easy*, while if, in addition, it required a certain amount of heating of the fuel adjacent to the injector before starting, the startability was termed *medium*. With certain fuels it was found to be impossible to start the engine by hand cranking and that resort had to be made to the use of the dynamometer for motoring the engine at comparatively high speed. If the engine could be started by motoring alone, the startability was termed *difficult*, while if it required the heating of the fuel in addition to motoring, the startability was termed *very difficult*.
- (b) *Operation stability*, or the smoothness of running, was determined by carefully listening periodically to the rhythm of firing. If any mis-firing was noticed during the whole run, lasting about 10 hours or so, the operation was considered to be unsteady; otherwise it was termed smooth.

(c) *Nature of Exhaust.*—The appearance of exhaust, *v.e.*, colourless or smoky, was noted.

(d) *Maximum Power Output* was determined by means of the instruments and equipment already described.

The results of the preliminary runs are summarised in Table III. It will be seen that in the case of the vegetable oils the startability was generally *medium* or *difficult*, except in the case of groundnut oil, which gave easy starting. Operation was usually smooth, except with castor and coconut oils; the exhaust was colourless in most cases, except in the case of castor oil, and the maximum power output was invariably less with the vegetable oils than with the mineral oil, except in the case of cotton-seed oil, in which case it was found to be of a similar order of magnitude. The greatest power loss occurred in the case of castor oil, *viz.*, 13% and this oil also resulted in unsteady operation, smoky exhaust, and difficult startability.

TABLE III

Results of Preliminary Runs.

No.	Name of oil.	Room Temperature.	Air intake temperature.	Startability.	Operation.	Nature of Exhaust.	Maximum power output in h.p. at 1200 R.P.M.
1	High speed mineral diesel.	69°F	..	Easy ..	Smooth	Colourless.	7.85
2	Groundnut ..	69°F	..	"	"	"	7.6
3	Karanj ..	71°F	..	Medium	"	"	7.3
4	Punnal or Undi	70°F	..	Difficult	"	"	7.2
5	Polang ..	94°F	134°F	"	"	"	7.2
6	Castor ..	74°F	..	"	Unsteady	Smoky	6.8
7	Kapok ..	93°F	..	"	Smooth	Colourless.	6.9
8	Mahua ..	95°F	126°F	"	"	"	7.05
9	Cotton seed ..	87°F	115°F	Medium	"	"	7.8
10	Rape (Mustard)	83°F	118°F	"	"	"	7.7
11	Coconut ..	78°F	114°F	"	Unsteady	"	7.6
12	Til (Sesame) ..	78°F	118°F	"	Smooth	"	7.4

Prolonged Runs.

The prolonged runs involved operating the engine fully loaded under standard conditions during a total period of 50 hours for about 6 to 7 hours daily. The daily heating-up period, required to reach steady temperature conditions, amounted to about 1/2 hour, but full load was applied 30 minutes after starting the engine, in case of early runs (Nos. 1-5, Table IV) and 21 minutes in case of later runs. In the latter case the load was brought up from zero to full load in seven equal steps at 3 minutes interval. Care was taken that the total number of heating-up period in all the runs was the same.

The characteristics determined during the prolonged runs included :—

(a) *Average Power Output.*—This was only slightly less than the maximum obtainable power, but certain daily fluctuations took place due to atmospheric conditions and other factors. Necessary corrections were also made for the daily starting up periods, during which the load was applied gradually in steps.

(b) *Specific Fuel Consumption.*—This was calculated from the total fuel consumed and the total horse-power-hours of energy delivered.

(c) *Brake Thermal Efficiency.*—This was based on the gross calorific value of the fuel and the specific fuel consumption.

(d) *Deposits* on various parts coming in contact with the fuel and products of combustion. These included the piston top, cylinder-head, combustion-chamber, injector nozzle, and the inlet and exhaust valves. The character and appearance of the deposits were carefully noted, and wherever the amount was appreciable the deposits were also scrapped off and weighed.

(e) *Corrosion* of engine parts coming in contact with the fuel and its combustion products.

In Table IV are summarised the results of seven prolonged runs carried out when using the most promising oils. Runs Nos. 1 and 6 relate to the high-speed mineral Diesel Oil, which was used as a general reference standard. The second run with Diesel oil was undertaken with a view to providing a check to take into account the mechanical changes which might have taken place as a result of the running-in of the engine during the interval and also to take note of the effect of the intake air heater which was installed at this stage. It will be seen that the average power output decreased, due presumably to the effect of the heated intake air, while the specific fuel consumption decreased, doubtless due to the engine operation having become easier as a result of the running which had been carried out.

Due to this effect of running-in on consumption and efficiency figures and perhaps on other factors also, comparison between oils run consecutively may be regarded as giving a more reliable picture of their performance than that between others; thus the runs listed in Table IV being in chronological

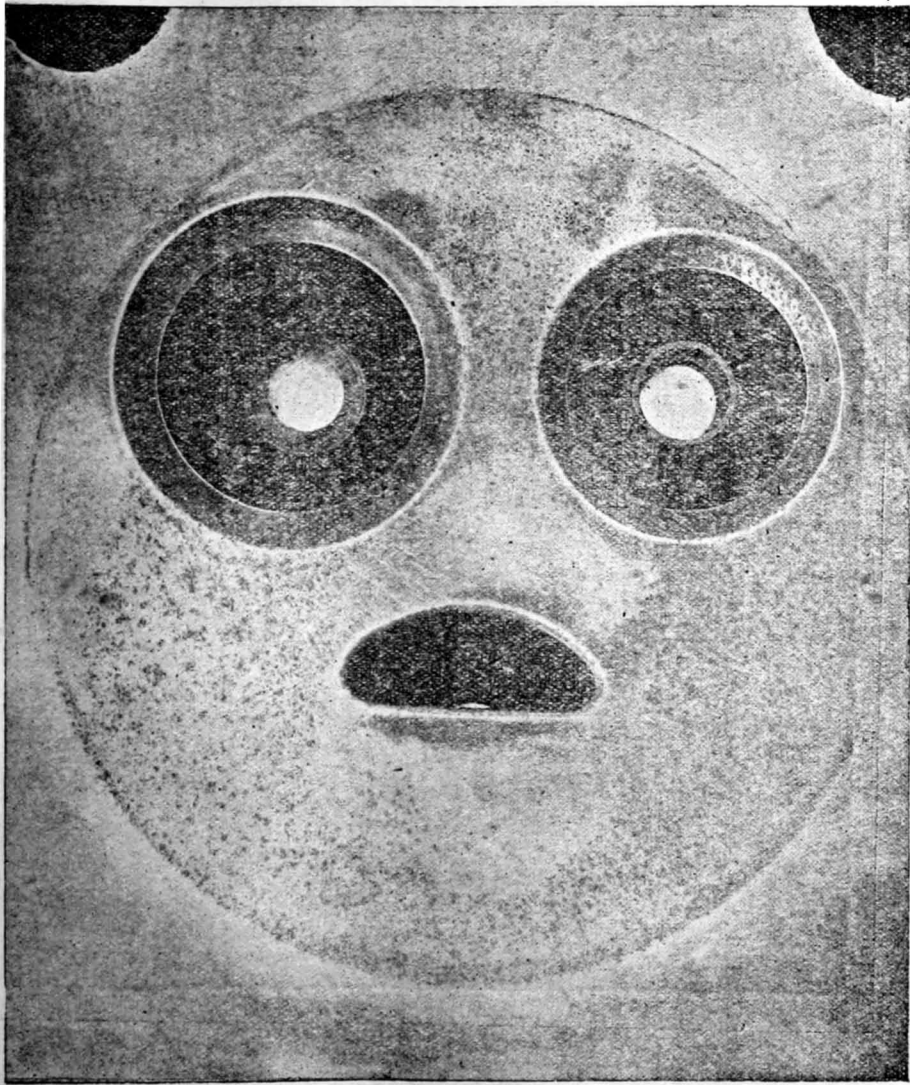

Fig. 4.

Pitting of the cylinder head and exhaust valve seat (R. H. upper) after running on Polang oil for a period of 50 hours.

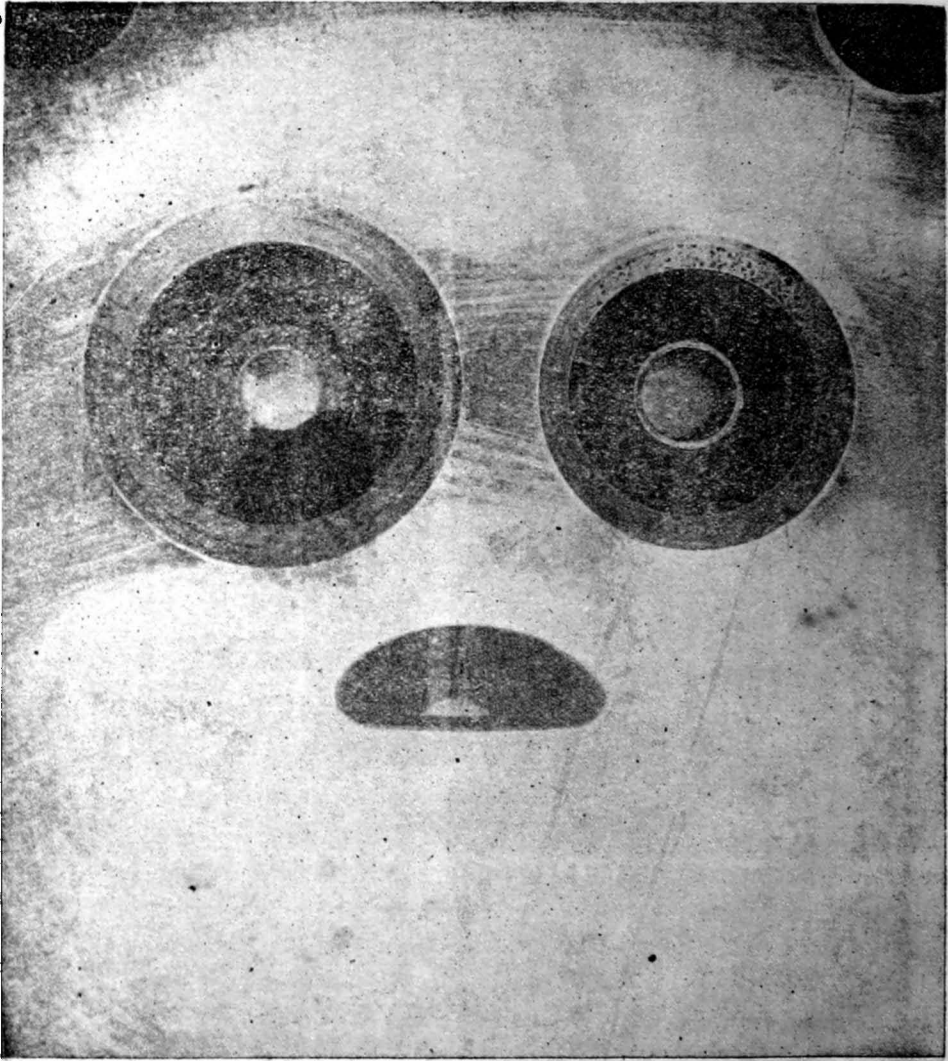

Fig. 5.

Pitting of the exhaust valve seat (R. H. upper) after 50 hours' run on Karanj oil.

order it is, for instance, more reliable to compare runs 1 and 3 with run 2, and run 7 with run 6, than to compare run 5 with run 2.

These being the first seven prolonged runs on a new engine, this kind of difficulty is almost unavoidable. It is hoped that in future runs check runs on Diesel fuels will give more comparable results, in which case such limitations for comparison of data would be eliminated.

It will be observed from Table IV that, in comparison with mineral oil, the vegetable oils in general give comparable average power output, somewhat high fuel consumption, and somewhat superior thermal efficiency. The deposits are also somewhat greater, and in some instances harder.

As regards corrosion, polang, karanj and cotton-seed oils alone were found to cause corrosion to varying degree of severity. With polang oil, severe pitting of the cylinder head and exhaust valve seat was observed, the reproduction of a photo of this is shewn in Fig. 4. The exhaust port is on the right top, and inlet on the left, while the D-shaped hole connects with the combustion chamber, in which the injection nozzle is located. It will be observed that corrosion did not take place in the central position around the D-port but was distributed more or less in a circular pattern shifted somewhat towards the exhaust port. This indicates that corrosion was due more to the combustion products than to the oil itself and took place mainly on the relatively hot portions of the combustion space.

The corroded cylinder head was replaced by a new one before subsequent runs were undertaken. In Fig. 5, is reproduced the photograph showing the pitting of the exhaust valve seat with karanj oil. The pitting in this case and in the following case was not serious enough to require a change of the cylinder head. The valve seat was reclaimed by grinding and the test continued. Fig. 6. shows the pitting of the exhaust valve seat which resulted from the use of cotton-seed oil. In this case the pitting was even less serious and it will be observed that it is difficult to discern it in the illustration.

It may be mentioned that acid values of the three oils producing corrosion were 21.6, 5.6, and 0.085 respectively, in order of the severity of corrosion. From this it would appear that the acid value may be connected with the corrosion produced, but it will also be observed that arachis oil and rape seed oil, having acid values of 1.43 and 0.52 respectively, produced no corrosion, while cotton-seed oil which had even less acidity (*i.e.*, 0.085) was responsible for some corrosion. The formation of the pattern in Fig. 4 shows, moreover, that the combustion products were more responsible for producing corrosion than the oil itself. It would therefore appear that, though the acid value may be a factor to be considered in this connection, it is not the only factor which determines whether corrosion would or would not take place with a given oil; the chemical constitution of the oil and the nature of the combustion products—which may include fatty acids of a corrosive nature—also play a considerable part in this connection.

TABLE IV.
Results of Prolonged Runs of 50 Hours' Duration.

No.	Name of Oil.	Acid value.	Average room temperature °F.	Average intake air temperature °F.	Average output in B. H. P.	Consumption in lbs. per B. H. P. Hour.	Brake thermal efficiency %	Deposits.						Corrosion.
								Piston top.	Cylinder head.	Combustion chamber.	Injector nozzle.	Inlet valve.	Exhaust valve.	
1	High speed mineral diesel.	0.0	90	120	7.7	0.629	21.0	Soft soot	Soft soot	Thin film of carbon.	Thin film of carbon.	Thin film of carbon on shoulder—none on face.	Free from deposit but face and stem stained black.	None.
2	Arachis (Groundnut).	1.43	94	128	7.4	0.700	21.0	Soft soot	Soft soot	Hard carbon.	Thin film of carbon.	Thick carbon on shoulder—none on face.	Thin deposit, face and stem stained black.	None.
3	Polang ..	21.6	98	126	7.2	0.692	22.0	Hard carbon, wt.—0.75 gm.	Hard carbon with ash-like white deposit at places, wt.—0.63 gm.	Thin carbon.	Thin carbon.	Thick granulated deposit on shoulder—none on face.	Thin carbon	Considerable pitting of cylinder head and exhaust valve seat (Fig. 4).
4	Karani ..	5.6	89	118	7.7	0.674	23.0	Soft soot, wt.—1.29 gm.	Thin soot, hard round periphery wt.—0.4 gm.	Fairly thick & hard carbon, wt.—0.7 gm.	Thin hard carbon.	Thin deposit on shoulder—none on face.	Thin film of carbon on face and shoulder.	Exhaust valve seat pitted over half the area (Fig. 5).

5	Cotton-seed	0.685	90	118	7.8	0.58	25.0	Soft soot, hard around, periphery, wt.—1.54 gm.	Soft soot, wt.—0.46 gm.	Thin film of carbon, wt.—0.44 gm.	Thin hard film of carbon.	Nose on face—part of stem blackened.	Thin film on face, shoulder and part of stem.	Exhaust valve seat pitted slightly over approximately one-third the area (Fig. 6).
6	High speed mineral diesel (2nd run).	0.0	79	150	7.3	0.602	21.8	Soft soot, wt.—1.25 gm.	Soft soot, wt.—1.39 gm.	Soft soot, wt.—0.07 gm.	Thin film of carbon.	Thin film of carbon on shoulder—none on face.	Free from deposit but face and stem stained black.	None.
7	Rape-seed (Mustard).	0.52	94	150	7.5	0.638	23.4	Soft soot, thicker round periphery wt.—1.62 gms.	Soft soot, thicker at one place. wt.—0.73 gm.	Soft soot, wt.—1.82 gm.	Thin soot, with thin carbon on nozzle body.	Thin soot on shoulder and part of stem—none on face.	Thin film of soot.	None.

The fact that pitting occurred only on portions of the cylinder head and not at all on the piston, the cylinder walls or the valves, show that the cast-iron from which the cylinder head was made was not sufficiently corrosion-resistant for use with vegetable oils with corrosive tendencies. It is not impossible, however, to obtain suitable materials which would be free from the susceptibility to attack from such oils. The fact is that the metallurgical problem has not yet received attention as regards this question.

Reverting to Table IV, it will be seen that the lowest consumption and the highest efficiency were obtained when using cotton-seed oil, out of all the oils tested, including the mineral Diesel oil. With a view of confirming these results check runs of short durations were undertaken on three of the oils, namely cotton-seed, groundnut and mineral Diesel, and the results of these tests are given in Table V.

TABLE V.

Results of check tests on three of the trial oils.

Duration of Run—9 Hours, Intake Air Temperature—Atmospheric.

Oil	Power output H.P.	Specific Fuel Consumption lbs. per B. H. P. Hr.	Brake Thermal Efficiency do.
Mineral Diesel	7.85	0.690	21.8
Groundnut	7.4	0.638	23.1
Cotton-seed	7.8	0.584	24.9

It will be seen that the figures obtained in the test of cotton-seed oil are practically the same as obtained in the 50 hours run (*vide* Table IV), but both mineral Diesel and groundnut oils have improved somewhat in consumption and efficiency, due doubtless to the fact that the engine at this stage had been run in to a greater extent than in the former tests.

The exact reasons underlying the fact that superior performance was obtained when using cotton-seed oil than when operating on mineral oil, from the point of view of fuel consumption and overall efficiency, have not yet been fully established, but it is presumed that the explanation is to be found in the combustion mechanism of the oil, appropriate engine adjustments, and injector details. These points can be studied only with the help of a cathode ray indicator equipment.

DISCUSSION.

From the results of the experiments described above and the review of the literature on this subject, it would appear that from purely technical considerations the use of vegetable oils as Diesel fuels holds considerable promise, but that there still remains a number of intricate technical problems which require to be solved. Some, but not all of these could be settled by laboratory tests, while others require prolonged service experience and development for satisfactory elucidation.

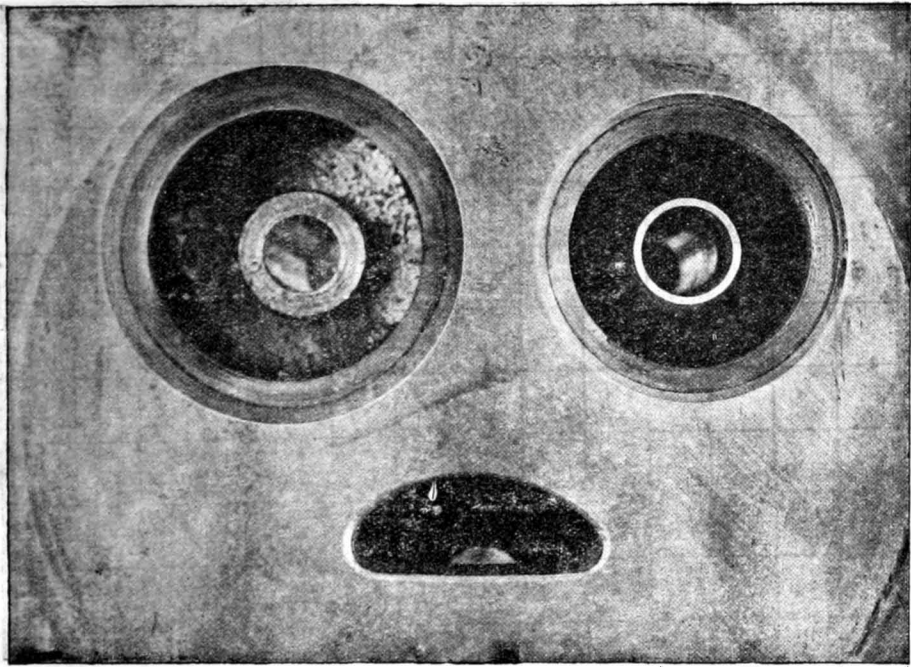

Fig. 6.

Pitting of the exhaust valve seat (R. H. upper) after a 50 hours' run, using Cotton-seed oil.

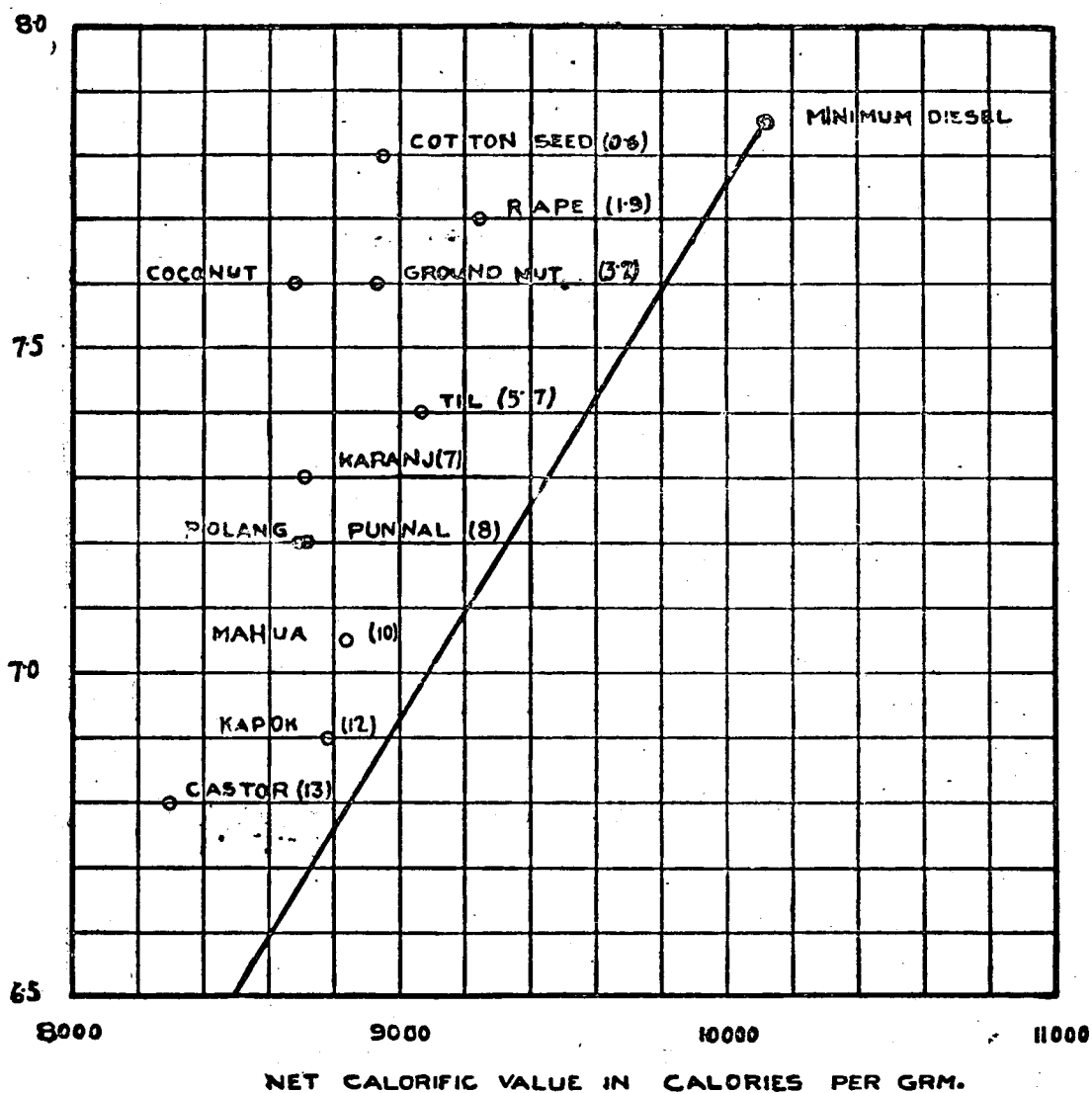

Fig. 7.

Maximum power output for various oils plotted against net calorific value; figures in brackets indicate percentage loss in power on the basis of mineral Diesel oil as standard. The straight line drawn through the mineral oil point represents the rate at which the power output should decrease if it were proportional to calorific value.

The following list gives the names of all vegetable oils which have received consideration by one or more investigators, together with the relevant reference :—

Oil.	References.
(1) Groundnut	(7), (8), (10), (11), (14), (15), (16), (18), (P).
(2) Plam	(7), (8), (10), (11), (14), (15), (17), (18), (20),
(3) Soya-bean	(8), (10), (11), (14), (15), (18), (21).
(4) Coconut	(10), (11), (P).
(5) Sesame	(4), (15), (P).
(6) Castor	(7), (P).
(7) Cotton-seed	(18), (P).
(8) Rape	(18), (P).
(9) Sunflower seed	(14), (18).
(10) Rasin-seed or grape-seed	(13), (18).
(11) Shea butter	(14), (18).
(12) Maize	(18).
(13) Cameline	(18).
(14) Pumpkin-seed	(18).
(15) Beech-nut	(18).
(16) Lupin	(18).
(17) Pea	(18).
(18) Poppy-seed	(18).
(19) Hemp	(18).
(20) Linseed	(18).
(21) Chestnut	(18).
(22) Olive	(18).
(23) Karanj	(P).
(24) Punnal	(P).
(25) Polang	(P).
(26) Kapok	(P).
(27) Mahua	(P).

Norm—(P) designates oils examined in the present investigation.

Of these oils the first three (groundnut, palm and soya-bean oils) have received the most attention from investigators, and opinion is practically agreed that they form satisfactory fuels. Cotton-seed oil, on the other hand, has not received as much attention as it would appear to merit in view of its performance recorded above.

It may be of interest to discuss the results of investigations on the various oils in the light of their various operating characteristics, such as :—

- (1) Startability of operation.
- (2) Smoothness of running.
- (3) Nature of exhaust.
- (4) Power output.
- (5) Specific fuel consumption.
- (6) Brake thermal efficiency.
- (7) Deposits.
- (8) Corrosion.

Startability of operation.

It will be seen from the data in Table III, that no difficulty was experienced with groundnut oil as regards starting from cold, while with other oils, such as; karanj, cotton-seed, rape, coconut and sesame, only a slight warming of the fuel line was sufficient to facilitate starting by hand cranking. Three of the oils castor, kapok and mahua caused difficulty in starting and motoring became necessary. It must be remembered in this connection that due to the warm climate startability will naturally be better in the tropics than in colder countries. It has, however, been observed in Japan that on soya-bean oil the startability was better than with gas oil²¹, while in England it was necessary to start on mineral oil in order to run the engine subsequently on soya-bean oil¹⁸. Differences of this nature are bound to exist since even in the same locality the temperature conditions vary from time to time, and also the differences between engines and fuel injectors render comparison between results almost impossible.

Examination of Tables I and III reveals that it is not possible to correlate the startability with any of the chemical or physical characteristics which have been studied, and actual experience is consequently the only guide. Opinion is more or less agreed,^{8, 15, 17} that from the operating point of view when running on vegetable oils, it is best to provide for starting the engine on gas oil and then to turn over to the vegetable oil. This is a fairly simple matter to arrange.

Smoothness of Running.

In discussing smoothness of running, distinction must be made between unsteady operation, implying variation in speed and torque from cycle to cycle, and roughness of operation, implying the presence of a steady knock. None of the vegetable oils experimented with gave rise to roughness of operation, as judged by the unaided ear but, in respect of steadiness of operation, castor and coconut oils appeared to be somewhat defective as compared with others which

gave perfectly smooth operation. The difficulty with the former was probably due to its high viscosity, and in the case of the latter the defect was possibly the result of the relatively high setting point, which might have given rise to solidified particles in the body of the oil. Both of these properties may give rise to non-uniform atomisation and hence unsteady operation.

These difficulties could readily be overcome by making suitable arrangements for pre-heating the fuel with the waste heat in the exhaust gases, as has been advocated by several workers^{15, 17, 18}. How far pre-heating improves other fuels, which ordinarily cause no difficulty of this nature is a matter for further investigation.

With regard to ignition lag which is now definitely known to be correlated with roughness of running no systematic studies of this character in the case of vegetable oils appear to have been undertaken or published hitherto but it has been recorded that, in comparison with mineral oil, the lag is greater with ground nut oil¹², is of the same order with a 1 : 1 mixture of mineral and raisin-seed oil¹⁴, and is less with soya-bean oil. Even in cases where longer lags are suspected, however, it is found that operation is smooth due presumably to the progressive manner in which the pressure-rise takes place.

Nature of Exhaust.

Colourless exhaust is an indication of completeness of combustion. It will be seen that it is recorded in Table III that the exhaust was colourless in all cases except when using castor oil when the incomplete combustion was possibly connected with unsteady operation in the following chain of cause and effect: high viscosity—poor atomization—incomplete combustion—unsteady operation and dirty exhaust. Most other workers are agreed that, under suitable conditions, colourless exhaust is obtained with vegetable oils although, in some cases, the exhaust may possess an unpleasant smell¹⁸.

Power Output.

The power output figures (Tables III and IV) show that, though vegetable oils developed somewhat less power than the mineral oil, the differences were in most cases not large. The maximum loss of power observed was 13% in the case of castor oil, while when using cotton-seed oil the loss was very small namely 0.6%.

The experiences of other investigators vary a great deal and loss figures are given by them which vary from practically no loss^{15, 21} to as high as 37% loss⁹. Other recorded figures include losses of 9%¹⁸ and 20%^{17e}. While some loss in power appears to be inevitable, owing to factors such as the lower calorific values of vegetable oils, it is possible that large losses of the order of 20 to 37%, could be avoided by proper adjustment of operating conditions, such as injection timing, pre-heating, and selection of a suitable injector to suit the particular oil under trial. Factors connected with engine design such as the shape of the combustion chamber, may also have considerable effect in the case of vegetable oils and require special investigation and development.

In Fig. 7, are plotted the data connecting the maximum power outputs obtainable with the calorific values of the various oils. Through the mineral oil point is drawn a straight line, which represents proportionate relationship between power and calorific value. All the points for vegetable oils lie above this line, indicating that the loss in power for these oils is not so great as might have been expected on the assumption that the power would decrease in proportion to the calorific value.

As already discussed on pages 8 and 9, a higher hydrogen-carbon ratio has been found to be connected with a better burning fuel²³, and, since most of the vegetable oils tested have a high value for this ratio (Table II) the state of affairs illustrated in Fig. 7, becomes understandable. The available data are, however, insufficient to establish, at this stage, the exact relationship between power output, calorific value, and H/C ratio, and it has therefore not been attempted.

Specific Fuel Consumption.

The results recorded in Table IV shows that the specific fuel consumption is, in general somewhat higher for vegetable oils than for the mineral oil. This is to be expected in view of the lower calorific values of the former, but when compared with the figures for the mineral oil, it appears that the consumption figures for the vegetable oils are not so excessive as might be expected on the basis of calorific values alone. This fact appears to indicate that combustion in the case of the vegetable oils was better than that of the mineral oil and this is also supported by the efficiency figures.

It may be observed, however, that the consumption figures are generally high in the case of all the oils when considered in the light of ordinary Diesel engine practice, this being due to the test engine being comparatively small in size.

The comparatively low consumption figure for cotton-seeds oil deserves special mention. As already discussed, the exact explanation of this superiority requires further detailed investigations of the combustion mechanism.

As in other respects, the experience of other workers as regard fuel consumption has also varied widely; for instance, Manzella¹³ found that the consumption of groundnut oil was higher than that of mineral oil at full load and less at reduced loads, while others¹⁷ have found that consumption when using palm oil is 20 per cent. higher than that of mineral oil at full load and 25 per cent. higher at $\frac{3}{4}$ load. Soya-bean oil has been observed to give a consumption figure of the same order as mineral oil²¹ and also 10—15 per cent. higher^{15, 18, 21}. Here again similar remarks apply as in the case of power output, namely that in general, higher consumption to the extent of 10—15 per cent. may be expected, but it need not necessarily be higher than that of mineral oil in all cases. If very much higher figures are obtained it is likely that they can be considerably reduced by readjustment of operating conditions.

Brake Thermal Efficiency.

The brake thermal efficiency is a good overall indicator of fuel performance, since it expresses the net power output in terms of the total heat energy input. The figures in Table IV show that in no case was the efficiency of a vegetable oil less than that of the mineral oil, and that in the case of cotton-seed oil it was appreciably higher. Manzella¹² found a higher efficiency for pea-nut oil also. It can be safely stated, therefore, that when running Diesel engines on vegetable oils without any appreciable change in design it is possible to get similar, or superior, efficiency to that obtained when using mineral oil. A more detailed study of the combustion process of vegetable oils may lead to the discovery of certain design features which may render it possible to utilise vegetable oils to still better advantage in this respect. It is necessary to bear in mind in this connection the tremendous difference in the characteristics of vegetable and mineral oils and the fact that normal Diesel type engines are designed to suit the mineral oils only.

Deposits.

The observations recorded in Table IV show that, in general, rather more deposits formed when operating on vegetable oils than when running with mineral oils, but in no instance could they be regarded as excessive or objectionable in character. Although the duration of runs in these investigations was comparatively short (50 hours), other experimenters^{13, 15, 17, 18} who have obtained data from longer and larger engines appear to agree that the deposits, though more, are not serious in character.

Here again, by studying design problems of Diesel engines with special regard to the combustion mechanism, it may be possible to eliminate or to reduce considerably the extent of deposits occurring when using vegetable oils.

Corrosion.

The various corrosion effects experienced in these trials have already been discussed in an earlier section of this paper. Suffice it to say here that, as a result of 450 hours run on vegetable oils having acid values varying from 0.08 to 45.4 and 150 hours' run on mineral Diesel oil, the cylinder wear amounted to 0.0012", which is quite comparable with that likely to develop when using a mineral oil fuel on this type of engine.

Apart from attack on copper parts^{15, 16}, which can easily be eliminated, no serious corrosive tendency in the case of vegetable oils has been recorded by other investigators in this field. On the contrary, certain workers^{7, 17} have pointed out that oils having comparatively high acid values can be used without serious effect, and Walton¹⁸ has considered the question of using free fatty acids as fuels, on account of their relative cheapness. But unfortunately no work in this direction appears to have been published. Moreover, copper and other materials susceptible to corrosion can be eliminated from the engine parts if it be desired to use oils of a corrosive nature, such as polang oil, of high acid value.

ACKNOWLEDGMENT.

The authors wish to express their appreciation of the assistance of Mr. A. N. Kapoor in the preliminary stages of these investigations.

BIBLIOGRAPHY.

1. Yuasa, G., "Diesel Vehicles and Their Fuel" *J. Fuel Soc., Japan*, 16. (No. 179), 73, 1937.
2. Ricardo, H., "Engine Testing" *J. Inst. of Fuel*, 10, 266, 1937.
3. Chalkley, A. P., "Diesel Engines" (Introduction by Dr. Rudolf Diesel) (Constables, London), 2, 1911.
4. Greenly, *J. Inst. of Fuel*, 12, 1, 1938.
5. Bahl, J. C., "The Oil Seed Trade of India" (New Book Co., Bombay), 1938.
6. Loc. Cit., 195.
7. Gautier, M., "The Utilization of Vegetable Oils in Diesel Motors", *Rev. de Comb. Lig.*
 - (i) No. 59, Nov., 1928.
 - (ii) No. 61, Jan.—Feb, 1929.
 - (iii) No. 76, June—July, 1930,
 - (iv) No. 77, August—September, 1930,
 - (v) No. 101, January, 1933,
 - (vi) No. 124, April, 1935.
8. (i) Schmidt, A. W. "Vegetable Oils as Diesel Fuels for Internal Combustion Engines", *Tropenpflanzer*, 35, 386-9, 1932.
 - (ii) Schmidt, A. W. and Gaupp, K. "Vegetable Oils as Diesel Engine Fuels", *Tropenpflanzer*, 37, 51-9, 1934, *Chimie and Industrie*, 32, 322.
9. Chang-Ming Tu and Tsu-Tze-Ku "Cotton Seed Oil as a Diesel oil", *J. Chem. Eng. China*, 3, 21-121, 1936.
10. Howes, D. A., *Proc. World, Petr. Congress, London*, P- 781-3, 1933.
11. Hubner, W. H., and Egloff, G. *Nat. Petr. News*, 28 (No. 32), 25-30, 1936, and *U.O.P. Booklet*, No. 189.
12. Manzella, G., "Peanut Oil, as a Diesel Engine Fuel", *Energia, Termical*, 31, 153-60, 1935.
13. Manzella, G., "Raisin Seed Oil as a Petroleum Substitute," *Energia Termical* 4, 92-4, 1936.
14. Gaupp, K., "Vegetable Oil Fuels", *Oil and Colour Trades Journ.*, 20, 249, April 29, 1938.
15. Gaupp, K., "Plant Oils as Diesel Fuels," *Automobile Tech. Zeit.*, 40, 203-7, 1937.

16. Tatli, E. and Sirton, A. "Use of Peanut Oil in Injection, High-Compression, High-Speed Automobile Motors", *Energia Termica*, 5, (No. 7), 59-64, 1937.
17. Anon, "Palm Oil as a Fuel", *Oil Engine*, 5 (No. 49), 6, 1937.
18. Walton, J. (i) "The Fuel Possibilities of Vegetable Oils", *Gas and Oil Power*, 33, 167-8, 1938.
 (ii) "Alternative Fuels", *Automobile Engineer*, 28 (No. 37), 298, 1938.
 (iii) "Alternative Fuels for Operation of Internal Combustion Engines", Report of Lever Brothers and Unilever Ltd., April 1938.
19. Cerchez, "Conversion of Vegetable Oils to Motor Spirits", *Monitr. Petr. Roum*, 39, 699-702, 1938.
20. Private Communication from the Minister of Colonies Busseels.
21. Hamabe, C. and Nagao, H., "Performance of Diesel Engines Using Soya-bean Oil as Fuel", *Trans. Soc. Mech. Engrs., Japan*, No. 20, 5-79, August, 1939.
22. LeMesurier, L. J. "Diesel Fuel", in "*The Science of Petroleum*". (Oxford Univ. Press). Vol. IV, 2495-2500, 1938.
23. Schqitzre, P. H., "Combustion Knock in Diesel Engines", *Penn., State College Tech. Bulletin*, No. 16, 77-80, 1933.
24. LeMesurier, L. J. and Stansfield, R., "Fuel Testing in Slow and High-Speed Diesel Engines", *Inst. Petr. Tech.*, 17, 307-410, 1931.
25. Boerlage and Broeze, *Soc. Auto, Eng.*, 31, 283, 1932.

APPENDIX.

Brief summaries of the work done elsewhere on vegetable oils as fuels for Diesel Engines.

Some of the work towards practical application of the authors' results, done elsewhere since the publication of the First Edition, is summarised below.

I. *The tests on Diesel Loco when fired with vegetable oil and mineral oil.*— This work was undertaken at the invitation of this Department at the Tata Iron and Steel Co. Ltd., Jamshedpur in September 1941. The main function of the Diesel Loco used in the tests was to transport iron ladles from the Blast Furnaces to the Steel Melting shop and to other places. It was to be determined whether the Diesel Loco would be capable of doing the same amount of work when fired with groundnut oil as it normally did when using mineral oil. The description of the loco is as follows :—

Weight of the Loco	53.3 tons.
Weight of the Loco in working conditions	60.0 tons.
Type	single unit.
Diameter of the cylinder	10 ins.
Stroke of the cylinder	12 ins.
Number of cylinders	6
Speed	500 R.P.M.
Cycle	4 stroke.
H.P. of the engine	300 H.P.
Lubrication	forced.
Coupling	Willison Couplers.

In order to get a proper comparison between the two fuels time studies were made. To get an idea of the serviceability, the number of full and empty iron ladles transported per shift between the various places was noted and by multiplying the number of ladles transported per shift by the distance over which each ladle was transported, the total ladle mileage was arrived at.

The total time for transporting the full and empty iron ladles was noted.

Further the fuel oil consumption was checked once each shift and the ladle mileage per gallon per shift was figured out.

The average figures of all the observations when the Diesel Loco was started with Diesel mineral oil and groundnut oil are given in the table below :—

Summary of the results of Diesel Loco when started with Diesel mineral oil and with groundnut oil.

Tests.	Loco running	
	with Diesel mineral oil.	with groundnut oil.
A. Ladle transport.		
(a).		
1. Total No. of iron ladles (full) per shift	20.25	17.39
2. Total full iron ladle mileage per shift	19.77	18.42
(b).		
1. Total No. of iron ladles (empty) per shift	21.50	19.07
2. Total empty iron ladle mileage per shift	24.58	21.34
(c) Total ladle mileage/shift	44.35	39.76
B. Time Analysis.		
Minutes/shift.		
(1) Transport time for iron ladles (full)	90.34	88.65
(2) Transport time for iron ladles (empty)	97.70	98.46
(3) Total time for ladle transport per shift	188.04	187.11
(4) Average time per ladle mile	5.21	6.00
(5) Shunting time	86.00	107.86
(6) Diesel Loco moving time—		
(i) with load	181.14	175.55
(ii) without load	51.03	56.92
(7) Idle running (engine on)	111.95	110.61
(8) Time for weighment	31.83	30.46
C. Fuel Oil consumption	27.70 gallons	28.00 gallons.
D. Ladle mileage per gallon	1.6	1.42

The above observations led to the following results :—

“ The total number of full ladles transported per shift in case of mineral and vegetable oils did not differ much. The total full-iron ladle-mileage seem to be about the same in either case. If the figures in some case, are on the lower side, it must be noted that at times the engine covered the same distance with less number of ladles than on other occasions. The transport of empty ladles by Diesel Loco in case of vegetable oil was not in any way inferior to that done by the same engine when fired with mineral oil ”,

“ The above table also shows that the transport of ladles, full and empty was a little less in case of vegetable oil. This was due to operation conditions which in fact had nothing to do with the fuel used ”.

In two shifts it was noted that the Diesel Loco carried 18 full ladles and 22 empty ladles and did a total mileage of 48.53, showing that if the engine was called upon to do more work, it could do so even when fired with vegetable oil.

“ The above table-item B (4) shows the average time per ladle mile is a bit more in case of vegetable oil because the engine did more of shunting work, as will be seen from the item No. B (5) “ The total shunting time.”

"The full consumption (item C) in either case did not differ much, whereas the ladle mileage per gallon (item D) was less in case of vegetable oil. The reason for this can also be found in the above mentioned fact, i.e., that the engine did more of shunting work. Since in case of vegetable oil, the total number of ladles transported was less, it affected the figure of ladle-mileage, which in turn gave less ladle mileage per gallon. Further, due to lower heating value of the vegetable oil, the distance covered per gallon of oil will naturally be less".

"All these observations showed that the performance of Diesel Loco with vegetable oil was in no way inferior to that obtained when mineral oil was fired. The Diesel Loco when working with vegetable oil was made to carry 7 full ladles at the same speed at which it was capable of doing the same performance when fired with mineral oil".

II. *Groundnut oil for Diesel Engines : current science*, 1942, Vol. 11, No. 10, 403 by Bharave R. U., Willingdon College, Sangli and Amrute, P. V., Jubilee Electric Works, Sangli.

This work was conducted in order to supplement the information contained in the present bulletin by results obtained under actual working conditions. The experiments were conducted at the local power house equipped with two 'Dentz, 4 cylinder diesel engines of the following specifications :—

Rated power	165 B.H.P.
Rated speed	500 R.P.M.
Cylinder bore	220 mm.
Stroke	360 mm.

Each of the engine was coupled to a three phase A. C. Generator.

Without disturbing the routine work, one of these engines was run on groundnut oil for 10 days. It was also possible to run this engine for a short while on 103 K. W., its normal load when the consumption came out to be 0.452 pounds per Kwh. Taking the efficiency of the generator as 90 per cent ; it works out as 0.303 lbs. per B.H.P.-hr.

"The makers recommended light diesel oil (commonly known as 'A' grade) for this engine and the test certificate of the engine gives 0.384 lbs/B.H.P.-hr. as the consumption of fuel. Presumably the test is carried out with a fuel similar to 'A' grade oil, and comparing these results it can be seen that the groundnut oil bids fair to be a substitute for 'A' grade crude oil. However from the end of 1939 up to this day, only 'B' grade crude oil has been used and now a comparison with this oil shows the following in favour of groundnut oil :—

- (1) Absence of black smoke from the exhaust.
- (2) Less carbon deposit on the piston top or in the combustion chamber.

A slight deposit of organic matter was observed round the spray nozzle but it did not interfere with the working of the engine in any way. The consumption on an average load of 64 k.w. did not materially differ in the case of the two fuels".

III. *Vegetable oils in commercial vehicles.*—*Gas and Oil Power*; 1942, 136, by Seddon, R. H. Director, Foster and Seddon, Ltd., Salford, 6, Lancashire.

The above company is the manufacturer of the Seddon Commercial vehicle of 6-ton capacity, fitted with a Perkins P 6 diesel engine, which develops 85 B.H.P. at 2,600 R.P.M. in six-cylinders 86.9 mm. bore by 127 mm. stroke. The work was carried out with the object of designing suitable equipment for dealing with vegetable oils as diesel fuel especially in the vehicles employed for the tin miners in Nigeria. A serious position would occur if, by any chance, supplies of mineral diesel fuel failed to reach them from overseas. It may be noted that in this country the growth of oil-producing vegetation is prolific and up till recently, thousands of tons of oil bearing seeds was burnt or thrown on the land as manure.

The author considers two main problems to be solved before a road vehicle can be efficiently run on vegetable oil fuels; they are, (1) the efficient filtering of the fuel and (2) the heating of the fuel so that it will pass readily through the filter, fuel pipes, injection pump and nozzles. The addition of a tank to the vehicle on the above lines has been patented by the author. It is divided into two compartments. The main section contains the fuel supply to which an air pressure of lbs. per sq. in. is applied while at the front end is a small chamber to accommodate the stream line filter. Outside this chamber is formed an expansion chamber and into this are led the exhaust gases. An auxiliary tank of 5½ gallons capacity is fitted on the dash-board to contain gas oil which is necessary to start the engine before turning over to vegetable oil. This equipment was fitted to a Seddon type A-L-13 ft. 6 in. wheelbase vehicle with Perkins P 6 compression ignition engine. The gross weight of the vehicle, without driver and observer, was 8 tons, 3 cwt. The test involved a run of 46.6 miles through town road with traffic lights and other stoppages requiring low gear work.

The following fuels were used:—(1) Gas oil or standard high speed diesel engine fuel (2) heated gas oil (3) groundnut oil (4) palm oil (5) cotton-seed oil and (6) Cotton seed oil.

Test No. 1.—Standard diesel fuel fed from the auxiliary tank was used. This test was taken as a standard for comparing the vegetable oils as fuels. The weather was cold with a high wind and rain fell during most of the trip. The vehicle performance was normal and the fuel consumption 17.01 m.p.g. Time 2 hours 10 minutes.

Test No. 2.—Standard diesel fuel heated up in the maintank used. After about 12 miles, the fuel began to boil in the heater tank and caused occasional vapour locks in the fuel line. The performance of the engine was much smoother with the warmed fuel up to a certain temperature. This test showed that the exhaust gases would have to be by-passed if the tank had to be used for standard diesel fuel. Fuel consumption was exactly the same as in Test No. 1, although a certain amount must have been lost by evaporation when the fuel boiled.

Test No. 3.—This test was made on groundnut oil. The weather was dry, but a cold high wind persisted. After about 10 minutes running when the

fuel had got thoroughly warmed, the difference on the engine was most marked. Sitting in the driver's cab one could tell the moment that the groundnut oil had replaced the mineral diesel oil at the nozzles because the typical diesel knock gradually faded out until it was almost inaudible. Except under heavy load or when accelerating, diesel knock had almost entirely disappeared; and with the engine running at a little over idling speed it would have been difficult to tell whether or not it was a petrol engine. The performance was equal to that on cold diesel fuel. Taking everything into consideration, this was, without doubt, the best test of the series. Fuel consumption 14.7 m.p.g. Running time, 2 hours 6 minutes.

Test No. 4.—The palm oil for this test, was warmed, until it would flow and then measured into the tank. The engine was started with diesel fuel and ran for 10 minutes. For the first two miles the exhaust was smoky and the engine rather sluggish. Smoking stopped and the engine performance improved at the same time. From this it was concluded that palm oil required greater heat and a longer time to heat up than the other fuels tried, and no doubt this is due to its higher viscosity, and the same reason a higher air pressure is required in the tank. The performance was not quite so good as on cold diesel fuel or groundnut oil. The consumption figure was slightly better, however, being 15.4 m.p.g. for the run of 23.2 miles. Running time for the whole journey was 2 hours 15 minutes. There was a high wind with frequent heavy showers of rain on that day.

Test No. 5.—Cotton seed oil was used. Due to the failure of injector nozzle, which was not due to the fuel, the test could not be completed.

Test No. 6.—This run was also undertaken with cotton-seed oil. The weather was slightly warmer and dry although the wind was still fairly strong. The test was successful in every respect. Fuel consumption was 14.5 m.p.g. and running time 2 hours 3 minutes.

From the above trials it appeared that long runs 200 to 300 miles could be expected before the filter required cleaning with compressed air, if vegetable fuels were efficiently filtered before use.

The author, from the above experiments, concludes that vegetable oils are a complete success as diesel fuel, but further information is required in respect of the effect of the acid content of the fuel on metals and on the lubricating oil in the engine sump.

IV. Trials on Diesel Engines in U.P. using mustard oil as Diesel fuel.—(from the reports of discussions at the meetings of the U. P. Technical Committee Oils and Lubricants held at the H. B. Technical Institute, Cawnpore).

Trials have been taken on mustard oil as fuel for Diesel Engines at the Naini Central Jail and two other engines belonging to the Department of Industries.

The results of the trials are as under :—

At Naini Central Jail, there is 17 B.H.P. Rustom Engine for pumping water for the jail requirements. This engine was first tried on 50% mustard and 50% diesel oil for a day and thereafter worked on 100% mustard oil for

two days. The results of the working are satisfactory. The engine after working for a day on mustard oil started without any difficulty next day when cold.

The consumption of fuel, i.e. mustard oil for the same load was, however, 8% higher than diesel oil by weight.

The Superintendent, Central Jail, Naini is satisfied with the result and remarks, "The working has been explained and demonstrated to our pump mistri who understood it well. At present there appears to be no difficulty in using mustard oil in place of Diesel oil.".

In addition to this, two Departmental Diesel Engines 12 and 15 B.H.P. "Hindustan" have been given trials on mustard oil as fuel. The results are satisfactory, both the engines took the load of 8 and 10 ghanies respectively and consumed mustard oil nearly 9% higher by weight than diesel oil required.

BULLETINS OF INDIAN INDUSTRIAL RESEARCH



No. 20

**Utilization of Indian Vegetable Oils
as Lubricants in Internal Combustion
Engines**

PART II

BY

**J. S. Aggarwal, M.Sc.,
H. D. Chowdhury, B.Sc., A.M.I.A.E.,
S. N. Mukerji, M.Sc., A.M.I.E. (Ind.), and
Lal C. Verman, Ph.D., M.S., F. Inst.P.**

**OFFICE OF THE DIRECTOR,
SCIENTIFIC AND INDUSTRIAL RESEARCH,
DEPARTMENT OF COMMERCE,
GOVERNMENT OF INDIA.**

**PUBLISHED BY THE MANAGER OF PUBLICATIONS, DELHI.
PRINTED BY THE MANAGER, GOVERNMENT OF INDIA PRESS, SIMLA
1942.**

D6460k627; 94.2

H2.2

The statements made and the views expressed in the bulletin are those of the authors and the Government of India do not accept responsibility for them.

CONTENTS.

	Page.
SYNOPSIS	iv
INTRODUCTION	1
REQUIREMENTS OF A GOOD LUBRICANT	5
STABILITY	5
ACIDITY	5
WEAR	6
CORROSION	6
CONSUMPTION	6
LABORATORY TESTS	7
OXIDATION TESTS	7
ACID VALUE	8
VISCOSITY AND VISCOSITY INDEX	8
CARBON RESIDUE	8
POUR POINT	9
FLASH POINT AND SPECIFIC GRAVITY	9
OILINESS	10
SAPONIFICATION VALUE	10
IODINE VALUE	10
ENGINE TESTS	11
DEVELOPMENT OF BLENDS	11
EXPERIMENTAL PLANTS	15
EXPERIMENTAL PROCEDURE	19
STANDARDIZATION RUNS	21
MAKE-UP OIL	22
SUMP OIL TEMPERATURE	22
MOTORING TEST	22
SAMPLING OF CRANK CASE OIL	22
EXPERIMENTAL RESULTS	23
PRELIMINARY ENGINE TESTS	23
FINAL ENGINE TESTS	50
DISCUSSION	74
LESTER SINGLE-CYLINDER ENGINE	74
MORRIS INDUSTRIAL ENGINE	80
ACKNOWLEDGMENT	85
BIBLIOGRAPHY	86

SYNOPSIS.

A series of Air Ministry Oxidation Tests (modified) was undertaken on various oils—castor, groundnut, cotton seed and rape with and without the admixture of stabilizers—with a view to determining the physico-chemical changes which take place in oils when subjected to severe oxidation conditions. As a result of this work a number of effective stabilizers was discovered for various oils. Based on these results, which were published in Part I of this series of papers, a number of blends of different oils was developed, having the requisite viscosity characteristics for use as lubricants in internal combustion engines.

The engine equipment consisted of a 3 H.P. single cylinder petrol engine, and a 16 H. P. 4-cylinder petrol engine, both coupled to electric generators for the purpose of loading. Both these engines, particularly the larger one, were suitably modified and a number of test accessories was provided to obtain adequate control of the various operating conditions, such as power output, speed, cooling water temperature, intake mixture temperature, oil pressure, ignition advance, etc.

Preliminary tests of 100 hours' duration were carried out in the small engine on 2 vegetable-mineral oil blends and 7 vegetable oil blends. Of these, the blends that were found to be highly satisfactory were tried in the larger engine for 100 hours. For comparison, runs were also made in both engines with two well known makes of mineral oils. Oil samples were withdrawn from the crank case at intervals during the run and at the end of the run; these were thoroughly examined for the various chemico-physical changes, sludge production, iron contamination, etc. Engine parts were carefully measured to an accuracy of ± 0.0001 " before and after the runs, with a view to determining wear. The wear of the top piston ring was determined by weighing with the same end in view. Carbonaceous and other deposits formed on various parts of the engines were carefully observed and recorded.

After a thorough examination of all the data collected it was found that satisfactory vegetable oil blends could be prepared which would compare favourably with mineral oil lubricants in almost all respects, with the exception perhaps of the carbon deposit on piston top, etc., which was slightly more in the case of vegetable oil blends than in the case of mineral oils. But this is not considered a serious drawback, as it does not interfere with the smooth operation of the engine. One of the vegetable oil blends tried actually proved superior to mineral oil in respect of sludge formation and iron dissolution from engine parts. Furthermore, two blends also gave less increase in viscosity than the reference mineral oil.

As a result of these investigations, two types of blends can be confidently suggested for use in medium size internal combustion engines, namely, castor oil-rape oil blends and castor oil-groundnut oil blends. It is important that the oils before blending be thoroughly refined and freed from alkali soaps.

For a good stabilizer for these blends, α -naphthylamine is recommended which should be used in proportion of not less than 1%. The proportions of the two oils to be used to form the blend will depend on the viscosity of the lubricant required. Generally, for medium size engines requiring a medium grade of oil, about 60-55% of castor oil to 40-45 % of rape or groundnut oil would be appropriate.

UTILIZATION OF INDIAN VEGETABLE OILS AS LUBRICANTS IN INTERNAL COMBUSTION ENGINES—PART II.

INTRODUCTION.

The present paper constitutes the second of a series dealing with a systematic investigation into the possibility of utilising Indian vegetable oils as lubricants for internal combustion engines, the first one being devoted mainly to a discussion of the previous work in the field, the general consideration of the factors which might contribute to the successful solution of the problem and the oxidation stability and other characteristics of different vegetable oils or their blends with or without the addition of stabilisers.

The satisfactory operation of a properly designed I. C. engine depends primarily on the characteristics of the fuel as well as of the lubricant. Extensive research work has been carried out during the last few years on the development of suitable fuels for use in aircraft and other high compression engines; and suitable laboratory tests have been devised which correlate to a reasonable degree of accuracy, with the behaviour of fuels in actual service. Similarly, work on mineral lubricating oils for I. C. engines has led to the development of improved methods of refining and treatment which, in conjunction with a number of laboratory tests and actual field or bench tests in engines, have resulted in the markedly improved qualities of the mineral lubricating oils, now available in all parts of the world. No systematic work, on the other hand, appears to have been done on the development of vegetable oil blends as lubricants for use in I. C. engines, although some attempts, as referred to in the first paper of the series, have been made by certain workers to use^{1, 2, 3, 4, 5, 6, 7, 8} either a mixture of mineral and vegetable oils or vegetable oils as such, for example, castor, rape, olive oil, etc., mostly without the addition of any antioxidants or stabilizers.

The only systematic investigations of any importance, which have been recently carried out but not mentioned in first edition of Part I*, are those of the Hungarian workers, Mihaly and Istvan.⁹ It is of interest to mention that their work has been somewhat on the lines followed by the authors of this paper, but not so comprehensive as the investigation under discussion. They carried out laboratory oxidation tests on Rumanian mineral oil, and castor, linseed and olive oils. Rape oil alone was subjected to oxidation tests with the addition of 0.5 % of each of the following antioxidants:—

- (a) Pyrogallol.
- (b) 1 : 5-Dihydroxynaphthalin.
- (c) *o*-Ethoxyphenol.
- (d) *o*-Aminophenol.
- (e) Dinaphthyl-*p*-phenylenediamine.
- (f) Benzylaminophenol.
- (g) *p*-Hydroxyphenyl morpholene.
- (h) Dibenzylaminophenol.

* A second edition of part I is being published as Bulletin No. 18, which includes reference to this work.

The oil before treatment had a density of 0.911 at 20°C, a viscosity of 4.37°E at 50°C, an acid value of 1.62—3.11, and Conradson carbon residue of 0.32. After the oxidation test of the treated oil, the values were respectively 0.917, 5.31—7.43°E, 3.11—5.35 and 0.56. The acid value increase was much more than in the case of the mineral oil. The mineral oils, however, formed sludge during oxidation, while the vegetable oils did not do so. In practical engine test in a 3 H. P. single cylinder engine (1300 R.P.M.), a mixture of ordinary and blown rape oils considerably thickened (34.0°E) and gave rise to a considerable increase in acid value (8.06) without the use of antioxidants. But the addition of an antioxidant (not mentioned) rendered the oil much more stable and the viscosity and acid value increased to 12.2°E and 4.16 respectively. The favourable change was also apparent from the operating results, because, with the oil containing antioxidant there was no trouble even after 45 hours' operation. Without the antioxidant, the engine worked only for 24 hours and its output came down from 2.9 to 2.4 H. P. and before it could be shut down, the output fell off considerably all of a sudden. A 50 : 50 mixture of mineral and rape oil with inhibitors also gave satisfactory performance. The consumption of fuel and oil were the same as when mineral oil was used.

The conclusions of Balada⁸, as a result of extensive research work on mineral and rape oil mixtures, on the other hand, are quite contrary to the above findings, although Balada generally agrees with Miha'ly Freund and his co-worker regarding the behaviour of untreated rape oil in engine tests

One of the main reasons why those countries, which are deficient in mineral oil supplies but are comparatively rich in vegetable oil resources, have not taken up the problem appears to lie in the fact that the vegetable oils, being mainly unsaturated glycerides of fatty acids, as distinct from the mineral lubricating oils which are mostly mixtures of saturated hydrocarbons, are relatively unstable and liable to oxidation, polymerization and even cracking at a lower temperature, resulting in the formation of sludge and gummy substances, which are detrimental to the proper functioning of the engine.

Against the serious disadvantages as mentioned above, there is, however, a certain valuable property, known as oiliness, which is possessed by the fatty oils^{10, 11} to a marked degree and which makes them eminently suitable as lubricants under such conditions as render the existence of full fluid film between the bearing surfaces difficult. It is now well established that the piston friction¹² accounts for practically 70% of the total friction losses in an engine and, therefore, the study of cylinder lubrication has engaged the serious attention of physicists, engineers and chemists in increasing numbers, and exhaustive research work on cylinder lubrication is being carried out by several organizations, particularly by the Research Departments of the Institution of Automobile Engineers, London, and other similar engineering bodies.

The question is whether the lubrication between the cylinder walls and the outer surface of the piston rings is of the fluid or of the boundary type. There are material differences in the answers given to this question by different workers in the field, but it is generally recognized that both types of lubrication^{13, 15, 16} with gradual change from one type to the other, exist between the cylinder wall and piston rings. There is definite evidence¹⁴ to show that

the lubrication between the cylinder and the piston tends towards the boundary type near the top dead centre, where the piston speed is low and the high gas pressure exerted behind the rings largely increases the normal pressure between them and the cylinder wall. To a less degree, the same thing occurs near the bottom dead centre at the end of the stroke, when the piston velocity again drops to zero. During the central part of the stroke where the piston speed is higher, full fluid film lubrication is liable to be established and the frictional force is largely unaffected by the surface condition of the metal and the oil. To what extent and at what points these conditions are likely to prevail will depend to a large extent on a number of variables, such as the amount of oil supplied, the speed, temperature, load etc. There will, however, be some boundary lubrication in the vicinity of the dead centres owing to the very low velocity of the piston at these parts of the stroke. The boundary lubrication conditions may also obtain at the moment of starting and stopping the engine or when the viscosity of the oil is too low or excessively reduced by heat preventing the formation or persistence of a sufficiently thick layer of the lubricant.

Dickinson and Bridgeman ¹⁶ have very aptly observed that the modern conditions of load, speed and viscosity approach the critical point between viscous and boundary lubrication. We may, therefore, definitely conclude that, though by far the major portion of the friction losses in an internal combustion engine is caused by the fluid type of friction, the safety of the engine from undue wear or even seizure cannot, by any means, be independent of the characteristics of the oil under boundary conditions. The work of Langmuir, Adam and a number of other investigators ^{17, 18, 19} has thrown a flood of light on the mechanism of lubrication under the above conditions, and it has been proved beyond doubt that the fatty oils, in general, on account of their superior oiliness, consequent on the formation of adsorbed film on the bearing surfaces by virtue of their polar groups, develop less friction; and to that extent the conditions are favourable for reducing wear and preventing bearing seizure.

Until recently, it has been generally assumed that direct abrasion between the piston and cylinder walls is wholly responsible for cylinder wear. The recent investigations of the Institution of Automobile Engineers ^{20, 21} (London) have definitely shown that it is also, to a large extent, the result of corrosion from the products of combustion and that the major part of the wear occurs during the starting and warming up period before the cylinder walls have a chance of attaining a sufficiently high temperature to prevent condensation of water on the surface. This is also confirmed by the work of other investigators. Everett and Stewart ²² and Keller ²³ carrying out the determination of wear by the iron content of the crankcase oil found that iron was removed from the engine practically four times as fast in the first hour as in the succeeding five hours.

It has also been proved by the investigation of the Institute of Automobile Engineers ²⁴ that though pure paraffin is a poor lubricant and gives inadequate protection from corrosion under cold running conditions, the presence of a small percentage of fatty acids or oils greatly improved the resistance to corrosion with consequent reduction in wear. It is, therefore, quite evident that the small percentage of fatty oils, which is added to the mineral lubricant, by forming a strongly adsorbed film on the surface of the cylinder, serves as an effective

protection from the corrosion products of combustion and of oxidation of the mineral oil. If, however, the mineral oil is completely replaced by vegetable oil, it remains to be seen whether the adsorbed film will be any more effective to afford protection from the products of combustion and also from the products of oxidation and decomposition of the vegetable oil, which are likely to be acidic in character.

REQUIREMENTS OF A GOOD LUBRICANT.

Some of the essential requirements which a successful lubricant must satisfy may be stated as follows :—

(1) It must remain stable and undergo as little change in its physical and chemical characteristics as possible under the widest range of operating conditions prevalent in internal combustion engines of varying types and capacities.

(2) It should be free from inorganic acidity and should not show more than a very small degree of organic acidity.

(3) It should prevent the wear of the bearing parts and reduce friction losses to a minimum even under boundary conditions of lubrication.

(4) It should serve as an effective protection against corrosion wear, particularly during low temperature running conditions.

(5) Oil consumption should be minimum consistent with adequate lubrication.

STABILITY.

It is well known that the vegetable oils are less stable than the mineral oils. When, therefore, we take into consideration the fact that the temperature of the cylinder walls may reach a value well over 200°C., and that the oil film on it may also be subjected to a scorching temperature of 1000°—2000°C. during every alternate revolution, leading to oxidation and cracking of the oil film, the difficulty of using vegetable oils as lubricants under the above conditions of operation would be apparent. It must, however, be borne in mind that the untreated mineral oils, which are mixtures of hydrocarbon molecules of extreme complexity and variety, contain also from 20 to 40 per cent. of unsaturated hydrocarbons²⁸ and it is only by the elimination of most of these unsaturated compounds by new and improved methods of refining, addition of suitable stabilizer, and various addition agents that the modern mineral lubricating oils of commerce have attained their present position. With the vegetable oils, therefore, which are of comparatively known and constant composition, it is considered, that with suitable stabilizers and addition agents, it should not be impossible to produce suitable blends which would compare favourably with the various grades of existing lubricants.

ACIDITY.

The presence of free inorganic acids in mineral oils is very rare, although traces of sulphuric acid may be left after refining. Free fatty acids are, however, almost always present in compounded lubricating oils in small amounts, and free petroleum acid may also be present in traces. In the case of the vegetable oils, it should also be possible by suitable refining methods to produce a blend having a very low acid value, and the possibility of development of further acidity in storage or use might be taken care of by the choice of suitable stabilizers.

WEAR (ABRASION).

With regard to wear, while there is hardly anything to choose between the vegetable oil and the mineral oil so long as full fluid film is maintained, the vegetable oils, as previously explained, owing to their active polar groups act as effective boundary lubricants and, therefore, cause less wear in those parts where this condition is likely to obtain and ensure a longer life of the engine.

CORROSION.

The effect of corrosion, particularly under cold running conditions, has already been discussed (see page 3), and it has been pointed out how far vegetable oils are likely to be able to withstand these conditions as well as the mineral oils.

CONSUMPTION.

The vegetable oils being fixed oils are non-volatile in character, and, if suitably stabilized so as to prevent formation of carbonaceous and gummy substances or sludge, are expected to show less or, at least, no higher consumption than is the case with mineral oils.

LABORATORY TESTS.

The various laboratory tests that have been devised for determining the general suitability of a lubricating oil for a particular purpose or for identifying the source of the oil may be divided into the following two classes :—

(1) Those that are carried out for measuring the oxidation stability of an oil.

(2) Those that are carried out for determining the various physico-chemical characteristics, of which the following are some of the more common :—

- (i) Acid value ;
- (ii) Viscosity and viscosity index ;
- (iii) Carbon residue ;
- (iv) Pour point ;
- (v) Flash point ;
- (vi) Specific gravity ;
- (vii) Oiliness ;
- (viii) Saponification value ; and
- (ix) Iodine value.

OXIDATION TESTS.

The importance of stability has already been discussed, but it may again be emphasised that it is the most important requirement of a lubricant for internal combustion engines. It is usually measured by the changes in the characteristics of the oil, such as viscosity, acid value, carbon residue and sludge formed, on subjecting it to oxidation tests. Various laboratory oxidation tests have been proposed from time to time to reproduce what may happen under actual engine conditions, but none, so far, can be considered as giving exact information on the changes likely to take place in the characteristics of the oil, although the Air Ministry Oxidation Test, Indiana Test or the Slight Test furnishes information which may serve as a valuable guide in this respect. The laboratory oxidation tests fail to assess the quality of a lubricating oil, chiefly because they cannot possibly reproduce the various changes in operating conditions which an engine has to encounter in actual service and the changes in the characteristics of the oil, particularly, the formation of the different types of sludge which is governed by the conditions of operation, that is, whether an engine is running under low temperature conditions which result mainly in the formation of the emulsion²⁶ type of sludge, or under normal or high temperature conditions which result in what is called 'oxidation sludge'.

For the purpose of the present investigation, modified Air Ministry Oxidation Test, as developed in this laboratory, was found to give fairly reproducible results, although, of course, it can claim no better correlation with the actual engine tests than any other similar oxidation test.

ACID VALUE.

The determination of acid value is of particular importance in the case of vegetable oils, which are likely to develop free acids not only by oxidation and thermal decomposition under engine operating conditions, but also under storage conditions. It must, however, be pointed out that it is not only the quantity of acids, but also the nature of acids, which is important in the corrosion of engine parts.

VISCOSITY AND VISCOSITY INDEX.

Of all the major requirements of a lubricating oil, the one that is directly related to the performance of a lubricant in actual service is the satisfactory viscosity-temperature characteristics, as it not only influences the losses in the various bearing parts, the rate of flow of oil and oil consumption, but also, the starting torque or the ease of starting, particularly during the cold weather. A satisfactory lubricant is one which shows a relatively small change in viscosity with temperature, so that once the viscosity is adjusted to suit a specific engine design, there should be no difficulty in starting owing to high viscosity when the engine is cold. Nor should the reduction of viscosity as a result of high temperature during normal running be such as to cause rupture of the film. In the case of the mineral oils, it is only by the development of newer methods of refining and the selection of proper crudes and suitable addition agents that it has now been possible to produce oils of sufficient high viscosity index, while most of the vegetable oils, in the untreated condition, are appreciably better in this respect than even the treated mineral oils. In evaluating the performance of a lubricating oil, it is, therefore, of importance not only to determine the initial viscosity and viscosity-temperature characteristics of the oil, but also to carry out these determinations at intervals during the progress of the engine tests, in order to study the progressive deterioration of the oil as a result of oxidation, thermal decomposition or other chemical reactions.

CARBON RESIDUE.

The deposits in the different engine parts, which are generally classified under the name of "Carbon" are generally formed by the oxidation and breakdown of the oil or sometimes by the incomplete combustion of the fuel in the combustion space.

The various factors which influence the formation of carbon deposits in gasoline engines have been summed-up by Gruse²⁷ as follows:--

- (1) Engine running conditions;
- (2) Oil consumption;
- (3) Time since cleaning;
- (4) Amount of dust in air;
- (5) Air-fuel mixture ratio;
- (6) Engine design and condition;
- (7) Characteristics of the fuel; and
- (8) Characteristics of the oil.

It should appear from the numerous factors which influence the formation of carbon deposits in the various parts of an internal combustion engine that it is well-nigh impossible to devise any single laboratory test or group of tests which can correlate with the actual engine performance in this respect with any reasonable degree of accuracy. A number of physical and chemical tests, however, have been proposed from time to time for estimating the carbonizing tendency of the lubricating oils, the most important among them being the coking tests, such as Carbon residue or Conradson Carbon and the Coke number or the Ramsbottom tests, but there is a material difference in the extent of correlation between the laboratory tests and the actual engine performance, obtained by the different workers. Another test which claims better correlation ²⁸ is the Vacuum Distillation Test, which measures the temperature of the 90 per cent. distilled point at an absolute pressure, of 1 mm. mercury. This test, however, cannot be directly applicable to the case of the vegetable oils which are fixed oils.

It may be pointed out that although some workers have found a good correlation between the above tests and the engine deposits in the case of oils of similar origin, others have failed to do so when testing oils from different sources or subjected to different treatments. ²⁹

These deposits which vary in character from the hard asphaltic to the soft gummy type are found in the—

- (1) Combustion chamber, comprising the piston top and cylinder head.
- (2) Shoulder and stems of the valves and valve seats.
- (3) Underside of the piston.
- (4) Piston ring grooves and ring lands.
- (5) Piston ring slots and drain holes on the scraper ring groove.

The effect of excessive deposits on the various parts, as outlined above, is too well known to need any further elaboration. While the mineral oils are not altogether free from the tendency of producing carbon, the problem of using vegetable oils as lubricants in an internal combustion engine is the more complicated by the severity and complexity of operation in an engine and also by the fact that the vegetable oils, in general, have a higher carbonizing tendency than most of the mineral lubricants.

POUR POINT.

This test is carried out to determine the ability of an oil to flow at low temperatures. In view of the fact that some of the low iodine value vegetable oils, such as coconut oil, set at even ordinary winter temperatures, this value is of importance in deciding whether a particular oil should be used as a lubricant.

FLASH POINT AND SPECIFIC GRAVITY.

These tests have their chief value in being useful for identifying an oil or aiding the refinery control. They do not, however, give any indication of the lubricating quality of an oil, although it would not be unreasonable to suppose that a higher flash point might mean greater resistance to the oil being burned on cylinder walls on the explosion stroke.

M106CD

OILINESS.

The significance of this property in a lubricating oil has already been dealt with at length, but while its determination is of importance in the case of the mineral oils, which are generally deficient in this property, it was not considered necessary to undertake the determination of this property in the present investigation in view of the markedly superior oiliness possessed by the fatty oils in general.

SAPONIFICATION VALUE.

The saponification value of an oil serves as a valuable guide to its identification or to determining its purity. Although it is not a fixed value, it varies within narrow limits and hence, in conjunction with other characteristics, it is useful for purposes of identification. In the present investigation, the determination of this characteristic at different stages of the run served the useful purpose of indicating the rate of decomposition or oxidation (and/or polymerisation) of the oils. A decrease in saponification value indicates the formation of hydrocarbons or other neutral products and a rise in saponification value indicates the formation of more acidic components.

IODINE VALUE.

Although iodine value is not considered to be a very reliable guide to unsaturation in the case of mineral oils, it is considered to be sufficiently indicative of the degree of unsaturation in the case of fatty oils³⁰. The determination of this value in the case of the vegetable oils may, therefore, be considered to be of importance as throwing some light on the extent of saturation acquired by the lubricant at different stages during the progress of the run.

ENGINE TESTS.

As indicated earlier, no single physical or chemical test or group of tests has been developed upto now, which can predict the behaviour of an oil under actual service conditions, even in an approximate manner. The actual engine test is, therefore, considered to be the only reliable means of determining the suitability or otherwise of a lubricating oil. Now, the engine tests may comprise either actual road tests or bench tests under carefully controlled conditions to represent the average road conditions so far as the average operating temperature, load and speed are concerned. When, however, it is realised that the range of operating conditions encountered in actual service is practically unlimited, one might think that the results of tests under these conditions would hardly apply to those obtained with bench tests. On the other hand, the field tests giving dependable and reproducible data are too expensive and rather difficult to carry out. Under the circumstances, the dynamometer tests under carefully controlled conditions are generally adopted and considered to be good enough for evaluating the performance of an oil under service conditions.

The problem, therefore, reduces itself to the—

(1) Development of suitable vegetable oil and mineral—vegetable oil blends of required viscosity and the selection of the suitably stabilized ones for engine tests, on the basis of oxidation and other laboratory tests on the individual oils as well as on their mixtures.

(2) Development of suitable engine equipment.

(3) Standardization of the various test-conditions.

(4) Assessing the results of tests on the various vegetable oil blends in comparison with those obtained with the reference lubricant (such as a reputed make of mineral oil).

DEVELOPMENT OF BLENDS.

Extensive Air Ministry Oxidation Tests (modified) were undertaken on castor, ground nut and cotton seed oils in conjunction with a very large number of stabilizers in contact with steel in order to select those oils that are likely to prove satisfactory in actual engine tests. A number of effective stabilizers were found for each of the oils, the degree of stabilization that could be effected being the maximum in the case of castor oil and the minimum in the case of cotton seed oil. It was brought out by these experiments that the most effective stabilizers found for the cotton seed oil were not effective enough, and even the best stabilizers for ground nut oil were not as effective as those found for castor oil. The results of these investigations have been described in detail in Part I of this series of papers. It was decided to confine engine tests, in the initial stage, to castor and ground nut oils and prepare their mixtures in varying proportions to adjust the viscosity within the limits specified by B. S. Specification No. 210—1930 for medium lubricating oils for internal combustion engines, recommended by the makers of the engines in which tests were carried out. The following two mixtures which satisfied the specification requirements as regards viscosity were again

subjected to a series of Air Ministry Oxidation Tests (modified) in conjunction with the most effective stabilizers found for the individual oils.

Castor oil 60% 40%
Groundnut oil 40% 60%

The effects of the various stabilizers on these two blends are shown in Tables I and II below.

TABLE I.

Effect of various stabilizers on a blend of castor oil 60% and groundnut oil 40% when subjected to modified Air Ministry Oxidation Test.

Serial No.	Stabilizer.		Viscosity at 100°F. (centistokes).	Viscosity increase ratio.	Acid value.	Conradson carbon-residue.	Remarks.
	Name.	Quantity, %					
1	Original (unblown)	122.1	..	2.5	0.27	
2	No stabilizer	893.8	7.3	4.2	0.97	
3	α -Naphthol 1.0	424.9	3.5	4.0	1.29	
4	α -Naphthol and β -Naphthol 0.4 1.2	428.4	3.5	4.5	1.0	
5	α -Naphthol and Pyrogallol 0.4 0.6	483.4	3.9	2.4	1.5	Slight brownish black deposit.
6	α -Naphthol and Hydroquinone 0.5 0.5	482.0	3.9	4.3	1.27	Slight black deposit.
7	Hydroquinone and β -Naphthylamine 0.5 0.5	425.5	3.5	4.2	1.26	Black deposit.
8	α -Naphthol and <i>p</i> -Phenylenediamine 0.4 0.6	470.7	3.85	3.1	1.1	Do.
9	α -Naphthol, .. β -Naphthol .. Hydroquinone, .. β -Naphthylamine and <i>p</i> -Phenylenediamine 0.2 0.2 0.2 0.2 0.4	472.1	3.86	5.05	1.43	Do.
10	α -Naphthol, .. Hydroquinone and β -Naphthylamine 0.4 0.3 0.3	459.4	3.74	4.4	1.1	Do.
11	α -Naphthol and Benzidine 0.4 0.6	546.8	4.5	3.64	1.35	
12	α -Naphthylamine 1.0	442	3.6	4.8	1.22	
13	β -Naphthylamine 1.0	454	3.7	4.4	1.25	
14	α -Naphthylamine and β -Naphthylamine 0.6 0.4	451	3.7	4.4	1.24	
15	α -Naphthylamine and β -Naphthylamine 0.4 0.6	448	3.65	4.3	1.3	
16	<i>p</i> -Toluidine 1.0	541	4.43	3.6	1.17	

TABLE II.

Effects of various stabilizers on a blend of castor oil 40% and groundnut oil 60% when subjected to modified Air Ministry Oxidation Test.

Serial No.	Stabilizer.		Viscosity at 100°F. (centistokes).	Viscosity increase ratio.	Acid value.	Conradson carbon-residue.	Remarks.
	Name.	Quantity, %					
1	Original (unblown)	83.7	..	2.5	0.29	
2	No stabilizer	687.1	8.2	4.2	1.03	
3	α -Naphthol 1.0	352.3	4.2	4.1	1.15	
4	α -Naphthol and β -Naphthol 0.4 .. 0.2	356.5	4.2	4.2	0.89	
5	α -Naphthol and Pyrogallol 0.4 .. 0.6	423.4	5.0	2.1	1.41	Brownish black deposit.
6	α -Naphthol and Hydroquinone 0.5 .. 0.5	360.8	4.3	4.0	1.0	Slight black deposit.
7	Hydroquinone and β -Naphthylamine 0.5 .. 0.5	355.8	4.2	4.4	1.23	Black deposit.
8	α -Naphthol and <i>p</i> -Phenylenediamine. 0.6	443.9	5.3	2.9	1.0	Considerable black deposit.
9	α -Naphthol, β -Naphthol, Hydroquinone, β -Naphthylamine and <i>p</i> -Phenylenediamine 0.2 .. 0.2 .. 0.2 .. 0.2 .. 0.4	427.3	5.1	4.6	1.4	Black deposit.
10	α -Naphthol, Hydroquinone and β -Naphthylamine 0.4 .. 0.3 .. 0.3	377.9	4.5	4.3	1.4	Do.
11	α -Naphthol and Benzidine 0.4 .. 0.6	464.9	5.5	4.4	1.39	

From the result of tests summarised in Tables I and II it will be seen that the blend containing 60% of castor oil and 40% of groundnut oil showed, in general, better stabilization than that containing 40% of castor oil and 60% of groundnut oil. The former blend was therefore adopted as a standard mixture for engine test. In order, however, to obviate any possible risk or damage to the engine, it was considered desirable to try mineral oil and castor oil mixtures to start with, and then gradually to substitute purely vegetable oil blends. This necessitated the development of a suitable process for rendering castor oil miscible with mineral oil. Although a number of such processes was developed, they had their difficulties, and therefore on this ground and also on the ground of economy, it was decided ultimately to introduce a certain

percentage of ground nut oil which would render castor oil miscible with mineral oil without any special treatment. One such blend which was quite stable and did not separate on standing was a mixture containing 40 parts of ground nut oil, 40 parts of castor oil and 20 parts of mineral oil "A". The resulting viscosity was also well within the limits of viscosity for medium lubricating oils for internal combustion engines. The engine test was, therefore, initiated with this blend in conjunction with 2 parts by weight of β -naphthol, which, on the basis of laboratory tests carried out so far, gave an indication of the likelihood of satisfactory behaviour in the engine tests. This was followed by Blend No. 2, which was composed of 60 parts of blown groundnut oil and 40 parts of mineral oil "A" with 2% β -naphthol and 0.2% tin-naphthenate as stabilizers. The results of engine tests on these blends, as shown later on, being generally satisfactory, several pure vegetable oil blends were developed as a result of extensive laboratory tests on the individual oils and on their blends with various stabilizers. The composition of the various blends tried and the results of modified Air Ministry Oxidation Tests are given in Tables III and IV respectively.

TABLE III.

Composition of blends.

Blend No.	Mineral lubricant "A".	Castor oil %.	Ground nut oil %.	Rape oil.	Stabilizer.	Remarks.
1	20	40	40	..	β -Naphthol 2% ..	Unrefined vegetable oils.
2	40	..	60 (blown)	..	β -Naphthol 2% and Tin-naphthenate 0.2%.	Do.
3	..	60	40	..	α -Naphthol 1% ..	Unrefined oils.
4	..	60	40	..	No stabilisers ..	Do.
5	..	60	40	..	α -Naphthol 1% ..	*Refined oils ; soap content—0.1117%
6	..	60	40	..	α -Naphthol 1% ..	Refined oils ; soap content—0.0195%
7	..	60	40	..	α -Naphthylamine 1%	Refined oils.
8	..	60	40	..	α -Naphthylamine 1% Chromium oleate 0.1%.	Do.
9	..	50	..	50	α -Naphthylamine 1%	Do.
10	..	50	..	50	β -Naphthylamine 0.5%. Diphenylamine 0.5%.	Do.

*The refining of the oils was carried out by the ordinary alkali refining process, the quantity of excess soap being controlled by repeated washing with hot water.

TABLE IV.

Results of Modified Air Ministry Oxidation Test on the mineral and vegetable oil blends.

Blend Nos.	Viscosity Increase Ratio.	Acid value.		Conradson Carbon Residue.	
		Initial.	Final.	Initial.	Final.
1.	5.5	0.35	0.97
2	5.3	0.56	1.27
3	3.5	2.5	4.0	0.27	1.29
4	7.3	2.5	4.2	0.27	0.97
5	3.8	0.86	2.6	0.27	1.58
6	3.9	0.88	3.5	0.22	1.47
7	4.4	1.0	3.1	0.18	1.56
8	4.0	1.1	3.4	0.21	1.21
9	4.6	1.2	4.4	0.20	0.96
10	4.8	1.6	4.1	0.22	1.1
Mineral Lubricant "A".	1.08	0.0	0.5	0.21	0.26
Mineral Lubricant "B".	1.59	0.1	1.5	0.08	1.09

EXPERIMENTAL PLANTS.

With a view to obviating any risk or damage to a larger engine in which the severity of operating conditions is bound to be excessive, it was planned to carry out the preliminary engine tests in a single cylinder 3 H.P. Petrol Engine and to have the blends that behaved satisfactorily in this unit to be subjected subsequently to more severe operating conditions in a 16 H.P. 4-cylinder Morris Industrial Petrol Engine.

The description of the engines, and their auxiliary equipment is given below :—

(1) 1.5 K.W. 'Lister' Petrol Engine-Dynamo Set.

This unit consisted of a 3 B.H.P. vertical single cylinder 4-stroke water-cooled petrol engine, 4" bore and $4\frac{3}{8}$ " stroke, rated at 700 R.P.M. and directly coupled by means of a flexible coupling, to a 110 volt compound wound D. C. generator of the enclosed ventilated type, both being mounted on a cast iron bed plate. The engine was delivered fitted with a Lister Patent flood-proof type carburetter, a Lister Patent centrifugal type of governor and high tensor magneto ignition system. The jacket cooling arrangement comprised a radiator cooled by a fan, driven from the shaft by means of a belt.

The lubrication of the bearing parts with the exception of main bearings is effected by means of splash from the oil trough at the bottom of the crank case, the latter being lubricated by oiler rings dipping into the same trough.

The engine was loaded by the generator, the output of which was arranged to be dissipated in a suitable water cooled resistance through a switch board with the electrical control instruments, etc. (Fig. 1).

In order to record the running temperature of the crank case oil, a mercury-in-glass thermometer was inserted through a suitably drilled hole in the crank case drain hole plug. A similar thermometer was inserted through the top cover of the radiator for measuring the temperature of the cooling water which was kept constant at $205 \pm 2^\circ\text{F}$ during these investigations. The temperature control was effected by putting the radiator fan out of action by removing the belt between the fan pulley and the shaft, admitting a controlled stream of cold water into the inlet side of the cylinder jacket and letting a controlled quantity of hot water overflow through the radiator overflow tube.

(2) *Morris Industrial Engine-Dynamometer set.*

This unit consisted chiefly of a 16 H.P. Morris Industrial Petrol Engine coupled to an electric dynamometer (Fig. 3).

The engine was a 4-cylinder petrol engine having the following specifications.—

Rated Power	16 H.P.
Rated speed	1500 R.P.M.
Bore	2.75"
Stroke	4.0"

The lubrication of the crank-shaft bearings is effected by a pressure feed system, whereas the lubrication of all other internal parts is provided for by splash from the oil trough. The engine as supplied was equipped with the following:—

- (i) One centrifugal water circulating pump on the water jacket outlet.
- (ii) One spring loaded centrifugal type of governor with speed control device, regulating the carburettor throttle and designed to maintain the speed constant at all loads.

The engine as purchased was of the commercial type, but it was converted into an experimental unit by introducing certain modifications with a view to running it under strictly controlled conditions. The modifications included the following items:—

- (1) The radiator, which was mounted close to the engine on the same channel base, was dismantled and installed outside the laboratory. It was connected to the outlet of the circulating pump and the inlet of the cooling water jacket by means of $1\frac{1}{2}$ " pipes.
- (2) An electric fan was provided for cooling the radiator and adjusting the temperature of the circulating water, the speed of the fan being controlled from inside the laboratory by means of a rheostat mounted on the switchboard.

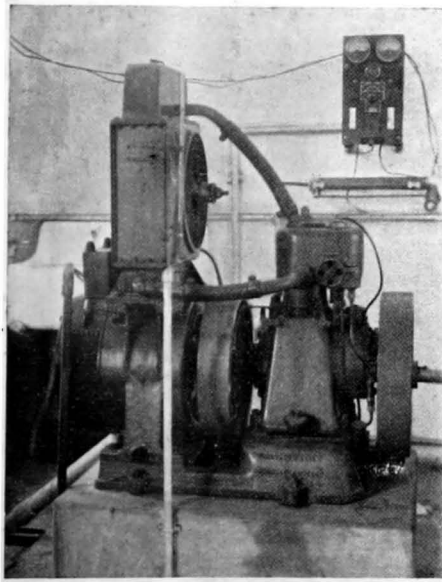

FIG. 1.

General view of Lister Petrol Engine-Dynamo set with switchboard and water cooled dissipating resistance in the background.

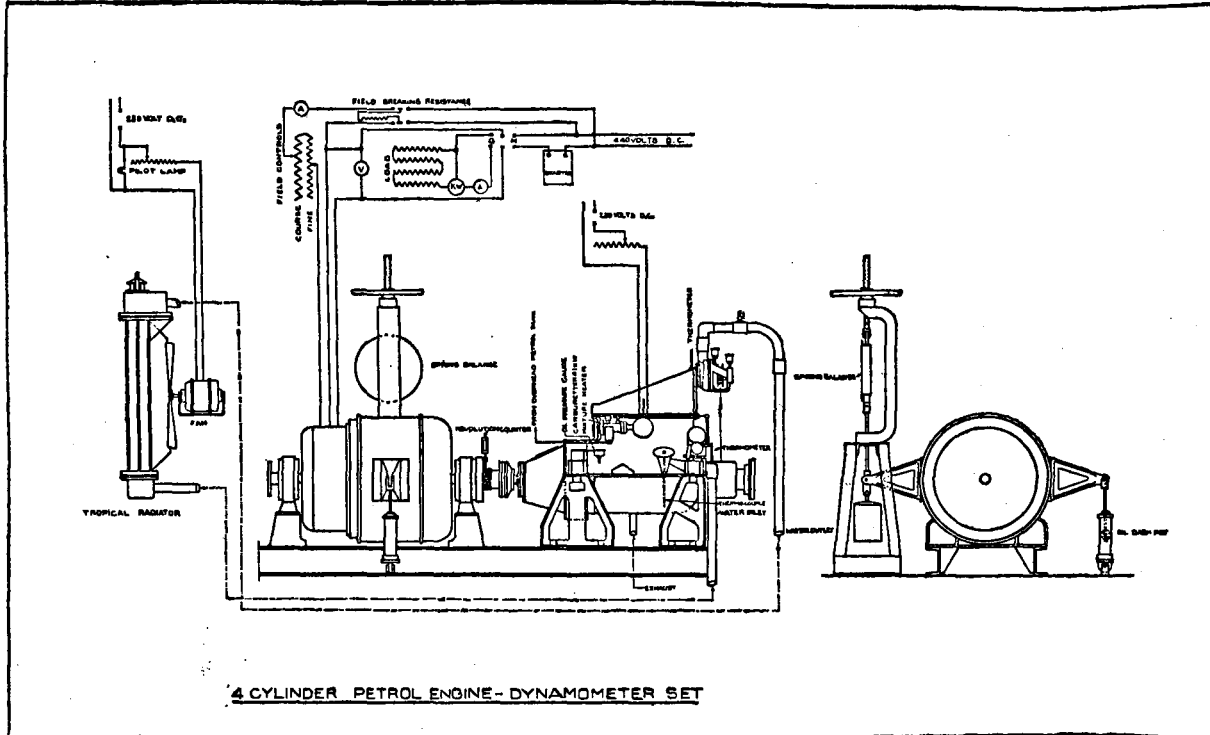

FIG. 2.
 Diagrammatic Layout of the Experimental Plant showing essential details of the Morris Petrol Engine, the Dynamometer and the electrical control circuits.

(3) Two thermometer pockets (Fig. 2) were provided, one at the inlet and the other at the outlet of the cooling water jacket.

(4) In order to maintain the temperature of the intake mixture constant a 1.5 K.W. electric heater was introduced into a re-entrant type of manifold between the carburetter and the intake manifold of the engine (Fig. 2). The heater was provided with a three-heat switch and a rheostat and ammeter mounted on the switchboard for accurate temperature control, the temperature being indicated by a thermometer located in a pocket provided at the intake port.

(5) One neon tube spark ignition indicator was provided to indicate the exact angle before T. D. C. at which the ignition took place.

(6) For adjusting the ignition angle, a convenient control was provided at the magneto.

(7) One oil pressure regulating valve designed to control the oil pressure in the lubrication system was installed in the oil feed line.

(8) One copper-constantan thermocouple, which was suitably insulated, was inserted through a suitably drilled hole along the length of the oil dipstick for measuring the crank case oil temperature.

The engine was coupled to the dynamometer through a flexible rubber canvas disc coupling of the Hardy type. The dynamometer was of the usual trunnion mounted yoke type and was provided with two cantilever arms, one connected to a weighted centre-zero spring balance with hand wheel positioning gear, and the other to an oil dashpot, which served to damp out the vibrations. The length of the lever arm was so designed that the torque delivered by the engine could be easily calculated by multiplying the spring balance reading with a simple multiplier. The unit was also provided with a revolution counter.

The engine-dynamometer assembly was mounted on a pair of channel pieces, anchored to a reinforced concrete bed, which was isolated from the laboratory floor by providing a clearance of $3/4$ " between the bed and floor all around and filling up the gap with pitch.

The dynamometer could be used as a motor for starting the engine or as a generator for delivering the power output to a load resistance through suitable measuring instruments (see Fig. 2 for electrical connections and other details).

EXPERIMENTAL PROCEDURE.

Before undertaking actual engine tests on the various oils or their blends, both the engines, which were new, were run in for a sufficient length of time on mineral lubricating oil for the proper bedding of bearings. For this purpose, the Lister petrol Engine-Dynamo Set was run at approximately half load (0.75kw) and full-speed (700 R.P.M.) for 30 hours, followed by another 100 hours' run at full load and full speed.

The total running in period for the Morris engine, was of 100 hours' duration, the first 50 hours' run being conducted at approximately half load (7 B.H.P.) and three quarters maximum speed (1,200 R.P.M.) and the subsequent 50 hours' run at approximately full load (14 B.H.P.) and full speed.

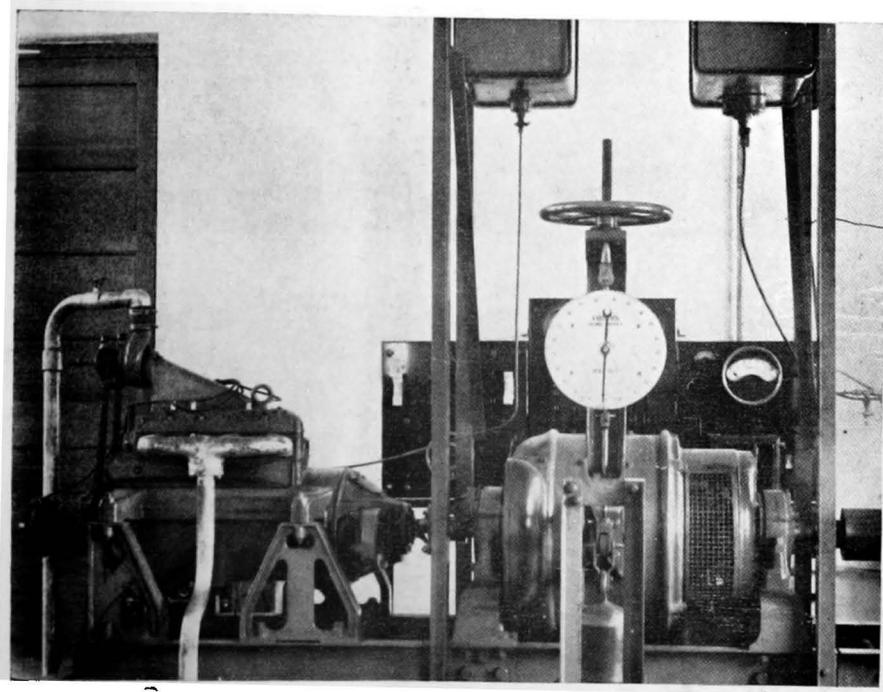

FIG. 3.

General view of the Morris Engine Dynamometer equipment with switchboard and dissipating Resistance Bank in the background.

Standard condition.

At the conclusion of the running-in period, a series of trial runs was carried out, particularly with the Morris Engine, for standardising the various operating conditions under which the engine tests could be conveniently carried out. As a result of these experiments, following engine conditions were standardised :—

Lister Petrol Engine-Dynamo Set.

(i) Engine Speed	700 R.P.M.
(ii) Power output	1.8 H.P.
(iii) Radiator water temperature	205° ± 2°F.

Morris Industrial Engine.

(i) Engine speed	1,500 R.P.M.
(ii) Power output	14 B.H.P.
(iii) Jacket water temperature at the outlet	170° ± 1°F.
(iv) Spark advance	30° before T.D.C.
(v) Intake mixture temperature	120° ± 1°F.
(vi) Oil pressure	15 ± 2 lbs. per square inch.

It may be pointed out that the maximum power output available under the above standardised conditions of operation averaged at 14 B.H.P. approximately as against the rated output of 16 B.H.P. specified by the makers. This is approximately what may be expected due to power reduction caused by the heating of the intake mixture to a high temperature and also maintaining the jacket water temperature at a fairly high value.

STANDARDIZATION RUNS.

After the standardization of the various operating conditions under which the engine tests were to be carried out, both the engines were opened up for thorough examination of the various parts and measurement of cylinders, pistons, bearings, etc., with a view to determining the wear and other changes that might take place as a result of subsequent runs. After reassembling, a 100 hours' standardization run was undertaken on each unit with one of the reputed proprietary brands of mineral lubricant, which will be referred to as reference lubricant "A" in this paper. Engine test was also carried out with another mineral lubricant which has been designated as mineral lubricant "B". In order to obtain results of adequate precision it was proposed to carry out standardization runs at intervals to take into account the variation of test conditions due to mechanical changes and wear of the engine parts which would enable the results of engine tests at different stages of the investigation to be properly assessed.

MAKE-UP OIL.

Prior to the commencement of each day's run, the make-up oil was added to bring the level of the crank case oil in the Morris engine to a fixed mark on the dip stick, as recommended by the makers of the engine. In the case of the smaller engine (Lister), the make-up oil was added till the oil in the trough just overflowed. Some inaccuracy exists in the make-up oil figures for the smaller engine due to some of the oil used for lubricating tappets and governor finding its way into the crank case, but this is not considered to be serious, as the ultimate suitability of the various blends is to be determined by tests in the larger engine (Morris) where this possibility is practically ruled out.

SUMP OIL TEMPERATURE.

The equilibrium temperature of the crank case oil was recorded daily during the progress of the engine test. This was done by means of a copper-constantan thermocouple, already described.

MOTORING TEST.

In order to determine the progressive changes, if any, in frictional losses owing to alteration in characteristics of the oil under the operating conditions, a motoring test was periodically carried out at the end of a day's run when the engine was thoroughly hot and the operating conditions stable. The change-over from generating to motoring was effected with as little delay as possible and without any effective change of speed, care being taken to cut off the fuel supply and to switch off the ignition as soon as the carburetter ran dry.

SAMPLING OF CRANK CASE OIL.

In order to determine the changes in physical and chemical characteristics of the oil, as also the iron content (both in solution as well as insoluble residue along with the sludge) during the progress of the run, 50 c.c. samples of the crank case oil were drawn at intervals of 25 hours approximately. The sampling was done by means of a pipette during the run or immediately after it before the sludge content of the oil or other suspended matter had a chance of settling down, so that the sample was thoroughly representative of the main bulk of the crank case oil.

EXPERIMENTAL RESULTS.

The results of the engine tests with the various blends, which were developed in this Laboratory, as well as those obtained from the use of the mineral oil, which was taken as a reference lubricant for comparative study, are summarized under the following two heads :—

- (i) Preliminary engine tests, *i.e.*, tests carried out in the 1.5 K.W. Lister petrol engine-dynamo set.
- (ii) Final engine tests, *i.e.*, tests carried out in the 16 H.P. Morris industrial engine—dynamometer set.

PRELIMINARY ENGINE TEST.

In Table V are summarised the variations in the more important characteristics of the oils or their blends with engine operation, which more or less give indication of the oxidation and thermal stability of the oils under engine operating conditions.

In Table VI are summarised some characteristics other than those shown in Table V and their variations with conditions of engine operation, which, though not important from the point of view of judging the suitability of the oils as regards their lubricating quality, throw a good deal of light on the character of the changes taking place in the oils and, consequently supply data on which attempts at improvement of quality of the oil may be based.

In Table VII are summarised the data which are directly or indirectly related to the friction losses and wear in the more important engine parts as a result of the deterioration of the oil and abrasion or corrosion or both.

In Table VIII are summarised the results of examination of the engine parts after each run and the nature and amount of deposits on piston, cylinder head, valves, etc., the deposits being carefully scraped off, collected and weighed wherever they occur in appreciable amount.

TABLE V.

Changes of lubricating oil characteristics showing oxidation and thermal stability under engine operating conditions, in 1.5 K.W. Lister set.

(three figures under any head correspond respectively to 0, 50 and 100 hours' operation).

No. of run.	Blend.	Viscosity at 140°F. (centistokes).	Rise in viscosity %.	Viscosity index.	Acid value.	Conradson carbon residue %.	Total amount of sludge (grams).	Crank case dilution %.
1	Mineral lubricant "A".	42.4	..	103	0	0.19
		42.2	0.24	0.35
		49.7	17.2	..	0.46	0.47
2	Blend No. 1 ..	41.8	4.15	0.30
		46.5	5.10	0.85
		46.5	11.2	..	5.45	0.92
3	Blend No. 2 ..	52.9	2.90
		59.9	2.99
		66.3	25.3	..	3.43
4	Mineral Lubricant "B".	41.3	..	87.9	0.08	0.08
		44.4	..	82.3	0.28	0.16
		46.7	13.1	83.5	0.30	0.16	1.50	..
5	Blend No. 3 ..	45.4	..	116.0	2.50	0.20
		50.1	..	115.0	2.20	0.58
		55.1	21.4	115.0	2.10	0.79	1.64	..
6	Blend No. 4 ..	45.6	..	116.0	2.34	0.20
		78.8	..	115.0	3.60	0.88
		144.2	216.2	110.0	5.09	1.40	2.34	..
7	Blend No. 5 ..	48.1	..	112.7	0.86	0.27
		52.9	..	115.9	0.92	0.59
		63.2	31.4	115.8	0.99	0.60	0.81	0.8
8	Mineral Lubricant "A".	43.7	..	102.6	0.10	0.19
		47.0	..	100.2	0.37	0.26
		53.0	21.3	99.0	0.46	0.49	1.12	1.6
9	Blend No. 6 ..	46.5	..	114.5	0.88	0.22
		51.0	..	117.0	1.00	0.43
		55.9	20.2	114.5	1.20	0.58	1.32	0.8
10	Blend No. 7 ..	46.1	..	110.0	1.00	0.18
		47.6	..	111.0	1.60	0.37
		51.8	12.4	114.0	1.84	0.46	1.06	0.8
11	Blend No. 8 ..	48.3	..	114.0	1.07	0.21
		53.4	..	113.0	1.80	0.40
		54.0	11.8	113.2	2.00	0.59	1.94	..
12	Blend No. 10 ..	41.8	..	121.0	1.55	0.22
		50.5	..	120.3	2.30	0.65
		60.9	45.7	121.6	2.77	1.34	0.86	0.8

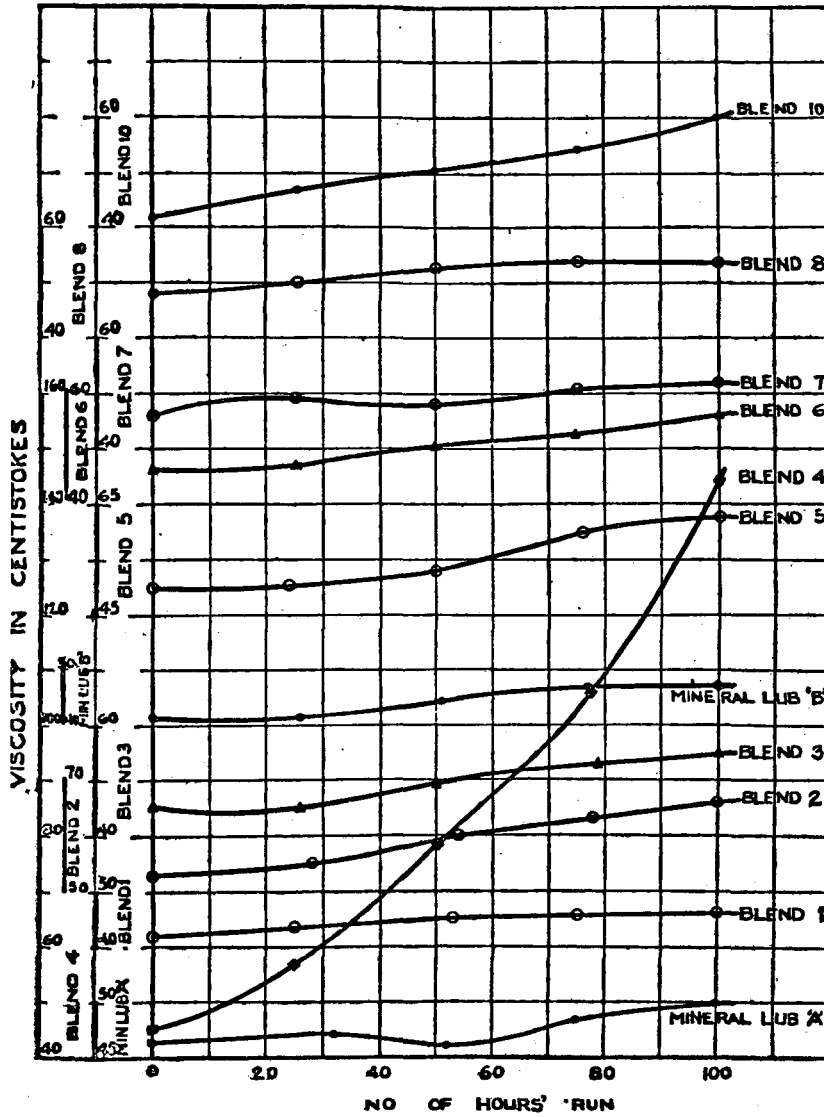

Fig. 4.

Change of viscosity with the duration of run in 1.5 K.W. Lister set.

TABLE V.

Changes of lubricating oil characteristics showing oxidation and thermal stability under engine operating conditions, in 1.5 K.W. Lister set.

(three figures under any head correspond respectively to 0, 50 and 100 hours' operation).

No. of run.	Blend.	Viscosity at 140°F. (centistokes).	Rise in viscosity %.	Viscosity index.	Acid value.	Conradson carbon residue %.	Total amount of sludge (grams).	Crank case dilution %.
1	Mineral lubricant "A".	42.4	..	108	0	0.19
		42.2	0.24	0.35
		49.7	17.2	..	0.46	0.47
2	Blend No. 1 ..	41.8	4.15	0.30
		45.5	5.10	0.85
		46.5	11.2	..	5.45	0.92
3	Blend No. 2 ..	52.9	2.90
		59.9	2.99
		66.3	25.3	..	3.43
4	Mineral Lubricant "B".	41.3	..	87.9	0.08	0.08
		44.4	..	62.3	0.28	0.16
		46.7	13.1	83.5	0.30	0.16	1.50	..
5	Blend No. 3 ..	45.4	..	116.0	2.50	0.20
		50.1	..	115.0	2.20	0.58
		55.1	21.4	115.0	2.10	0.79	1.64	..
6	Blend No. 4 ..	45.6	..	116.0	2.34	0.20
		78.8	..	115.0	3.60	0.88
		144.2	216.2	110.0	5.09	1.40	2.34	..
7	Blend No. 5 ..	48.1	..	112.7	0.86	0.27
		52.9	..	115.9	0.92	0.59
		63.2	31.4	115.8	0.99	0.60	0.81	0.8
8	Mineral Lubricant "A".	43.7	..	102.6	0.10	0.19
		47.0	..	100.2	0.37	0.26
		53.0	21.3	99.0	0.46	0.49	1.12	1.6
9	Blend No. 6 ..	46.5	..	114.5	0.88	0.22
		51.0	..	117.0	1.00	0.43
		55.9	20.2	114.5	1.20	0.58	1.32	0.8
10	Blend No. 7 ..	46.1	..	110.0	1.00	0.18
		47.6	..	111.0	1.60	0.37
		51.8	12.4	114.0	1.84	0.46	1.06	0.8
11	Blend No. 8 ..	48.3	..	114.0	1.07	0.21
		53.4	..	113.0	1.80	0.40
		54.0	11.8	113.2	2.00	0.59	1.94	..
12	Blend No. 10 ..	41.8	..	121.0	1.55	0.22
		50.5	..	120.3	2.30	0.65
		60.9	45.7	121.6	2.77	1.34	0.86	0.8

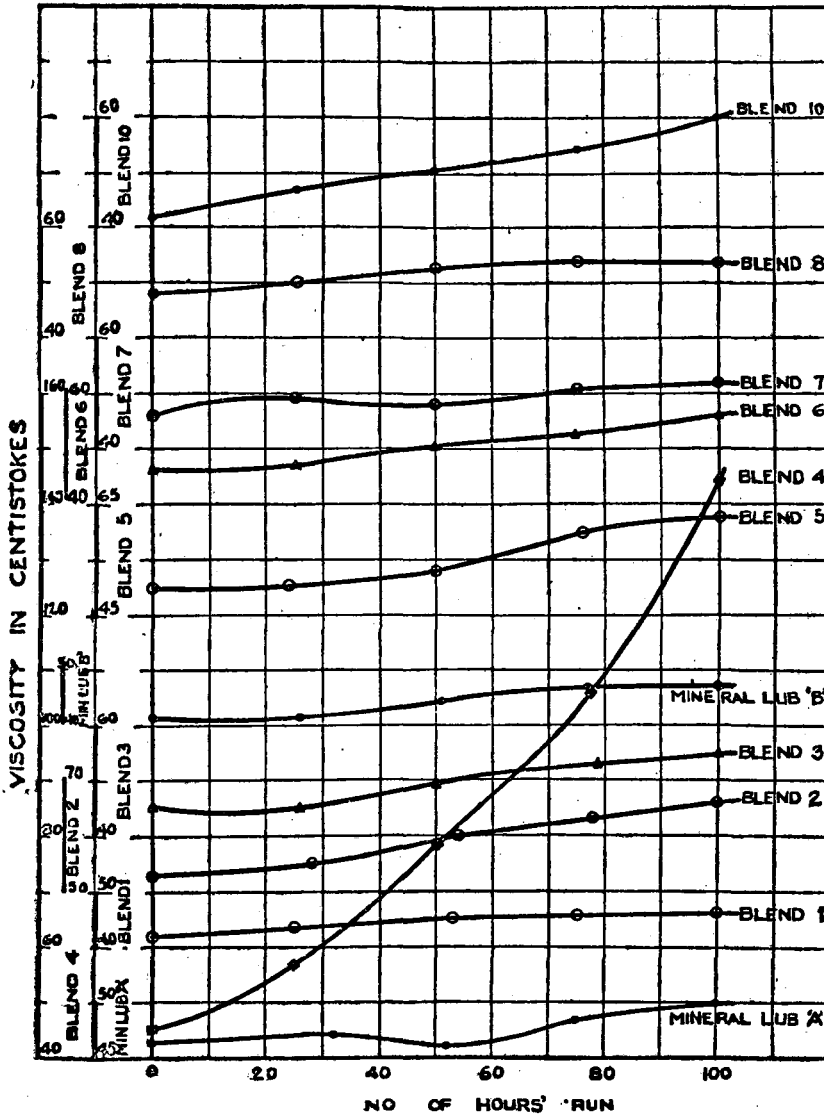

FIG. 4.

Change of viscosity with the duration of run in 1.5 K.W. Lister set.

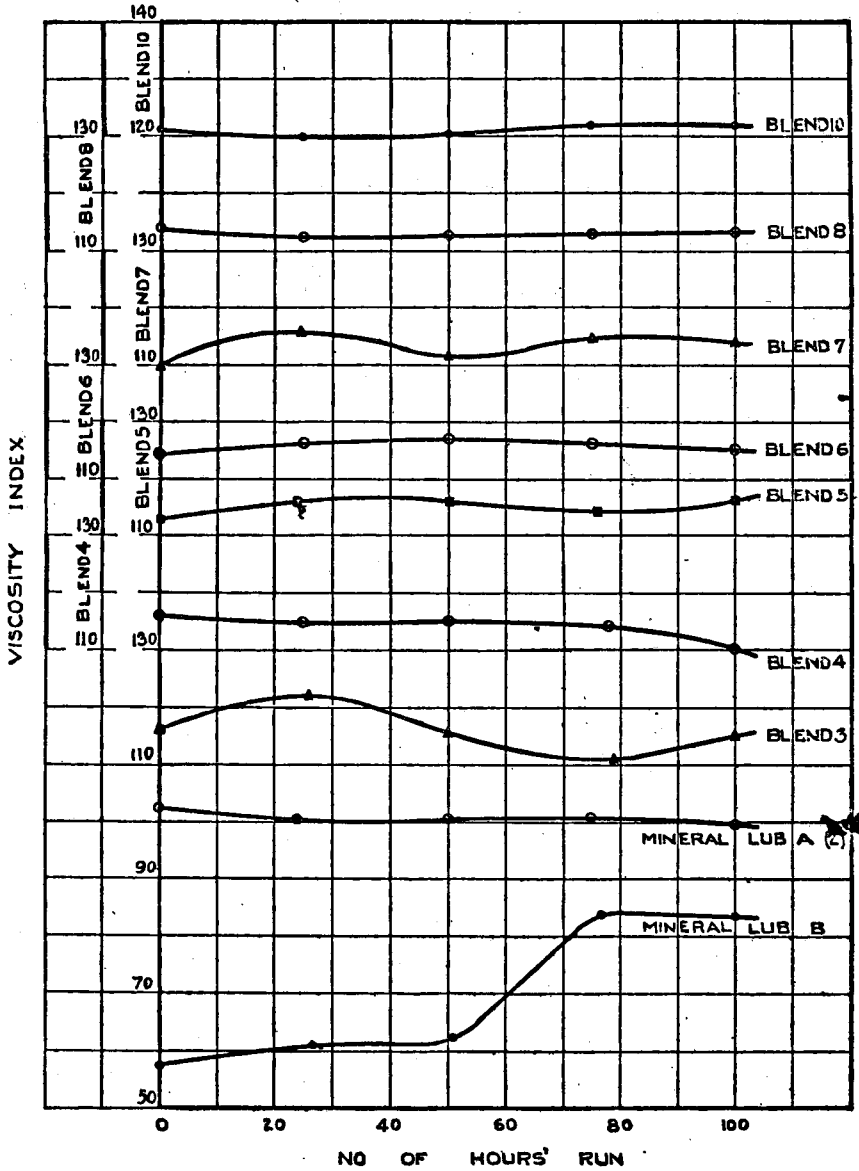

Fig. 5.

Change of viscosity index with the duration of run in 1.5 K.W. Lister set.

From a careful examination of Table V and Fig. 4 it will be seen that the percentage rise in viscosity as a result of 100 hours' run was maximum (216.2%) in the case of Blend No. 4, containing no stabilizer and minimum in the case of Blend No. 7 (12.4%) and 8 (11.8%) without, of course, taking into consideration Blend Nos. 1 and 2 which were mineral-vegetable oil mixtures. The viscosity increase in the case of mineral reference lubricant "A" * in both the standardization runs was appreciably higher than that obtained with either of the vegetable oil blends 7 and 8, although the crank case dilution after the second standardization run was twice that obtained with either of these blends. The data, presented above, clearly demonstrate the very marked effect of the addition of stabilizers in suppressing the various chemical reactions which lead to an increased viscosity.

As regards the viscosity index (Fig. 5), it will also be seen that the vegetable oil blends, in general, are superior to the mineral oils. The changes in viscosity index with the progress of the run were slight and practically of the same order in the case of both vegetable and mineral oils.

Blend No. 4, the untreated blend, showed a sharp increase in acidity (Fig. 6) approximately after 25 hours' run, the maximum increase in acid value being 2.75 as against 0.46 (1st standardization run) and 0.36 (2nd standardization run) with the mineral reference lubricant "A", whereas the change in the acid value of the pure vegetable oil blends, as a result of stabilization, varied between 1.22 and 0.13. It is also interesting to note that Blend No. 3 showed a final decrease in acid value. So, even with regard to acidity, the effect of stabilizers is quite marked and some of the blends behaved better in this respect than the mineral oils.

As regards Conradson carbon residue (Fig. 7), although the vegetable oil blends and the mineral oils had more or less the same values initially, the vegetable oils, in general, showed a higher carbon residue increase than the reference lubricant "A", the change in this respect, as in others, being most marked in the case of the unstabilized blend No. 4. The increase in Blend Nos. 5, 6, 7 and 8 may be considered to be of the same order as in the case of the reference lubricant "A".

TABLE VI.

Change of oil characteristics other than those shown in Table V under engine operating conditions in 1.5 K. W. Lister set.

(Three figures under any head correspond respectively to 0, 50 and 100 hours' operation.)

No. of run.	Blend.	Specific gravity 100°F at 100°F	Saponifica- tion value.	Iodine value.	Ash %	Iron in ash %
1	Mineral lubricant "A" ..	0.8710	0.45	13.1	0	..
		0.8682	2.20	15.4	0.016	..
		0.8696	2.39	15.0	0.042	..

* Unless otherwise stated, the performance of the various blends will be compared with that of the reference lubricant "A" during the second standardization run (Run No. 2).

TABLE VI—*cont'd.*

No. of run.	Blend.	Specific gravity	Saponification value.	Iodine value.	Ash %	Iron in ash %
		at $\frac{100^{\circ}\text{F}}{100^{\circ}\text{F}}$				
2	Blend No. 1	0.9200	152.6	77.0	0	..
		0.9201	153.7	64.9	0.028	..
		0.9206	156.4	65.0	0.040	..
3	Blend No. 2	0.9079	128.6	55.0
		0.9106	141.3	52.4
		0.9138	145.2	52.1
4	Mineral Lubricant "B" ..	0.9082	4.3	25.6	0	..
		0.9090	2.5	25.6	0.005	..
		0.9102	2.6	25.7	0.008	..
5	Blend No. 3	0.9389	179.4	92.7	0	0
		0.9383	179.0	83.6	0.034	16.3
		0.9423	186.3	83.3	0.056	20.0
6	Blend No. 4	0.9375	179.9	90.0	0	0
		0.9511	177.5	82.3	0.030	5.4
		0.9636	178.1	78.1	0.084	18.8
7	Blend No. 5	0.9406	182.6	88.0	0.009	0
		0.9433	192.0	86.0	0.017	5.7
		0.9491	198.2	84.2	0.044	10.2
8	Mineral Lubricant "A" ..	0.8760	0.16	13.8	0	0
		0.8794	3.15	17.2	0.014	2.2
		0.8805	3.80	23.1	0.017	3.6
9	Blend No. 6	0.9394	178.0	92.8	0.003	0
		0.9410	191.0	86.7	0.014	18.2
		0.9445	194.9	85.4	0.028	27.4
10	Blend No. 7	0.9391	190.0	92.1	0.004	0
		0.9399	197.0	85.8	0.014	14.5
		0.9403	193.3	86.2	0.021	19.2
11	Blend No. 8	0.9405	180.6	90.3	0.007	0
		0.9439	187.7	88.4	0.041	6.6
		0.9452	193.0	86.3	0.097	5.3
12	Blend No. 10	0.9333	178.5	97.2	0.001	0
		0.9389	184.2	97.9	0.022	1.0
		0.9437	197.8	94.0	0.060	2.1

It will be seen from the results tabulated above, and also from Fig. 9 that practically four (Blend Nos. 2, 6, 8 and 10) out of the seven vegetable oil blends showed an appreciable increase in saponification value. The saponification values of the remaining blends as well as of the reference lubricant "A" either remained nearly constant or showed a slight tendency to increase with the duration of operation. What is rather remarkable is that the untreated blend did not show any increase in saponification value, but, on the other hand, showed a slight tendency to decrease in indicating thereby that the chemical

SINGLE CYLINDER ENGINE

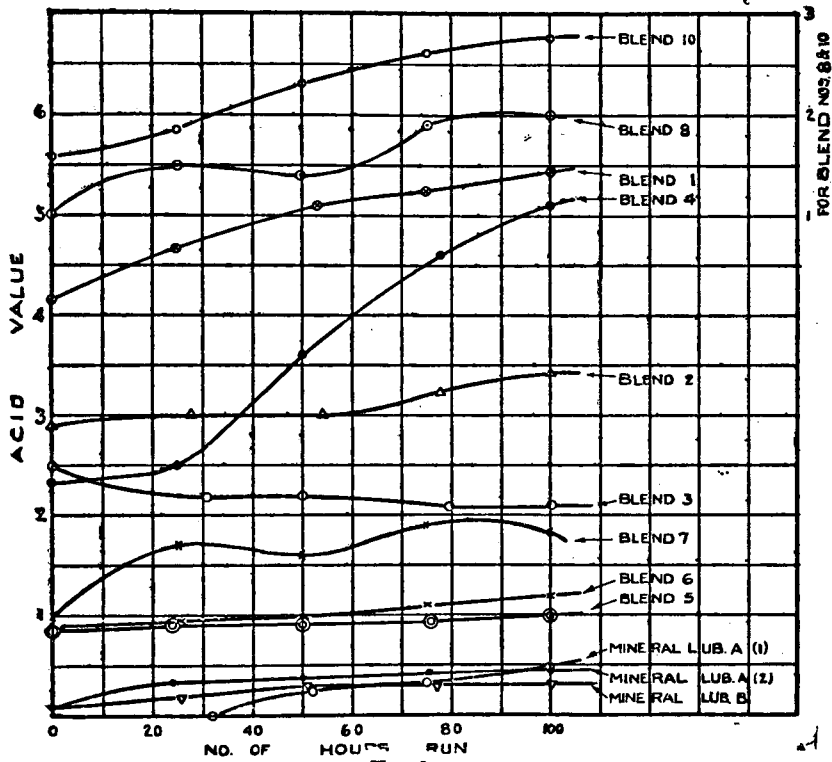

Fig 6.

Change of acid value with the duration of run in 1.5 K.W. Lister set.

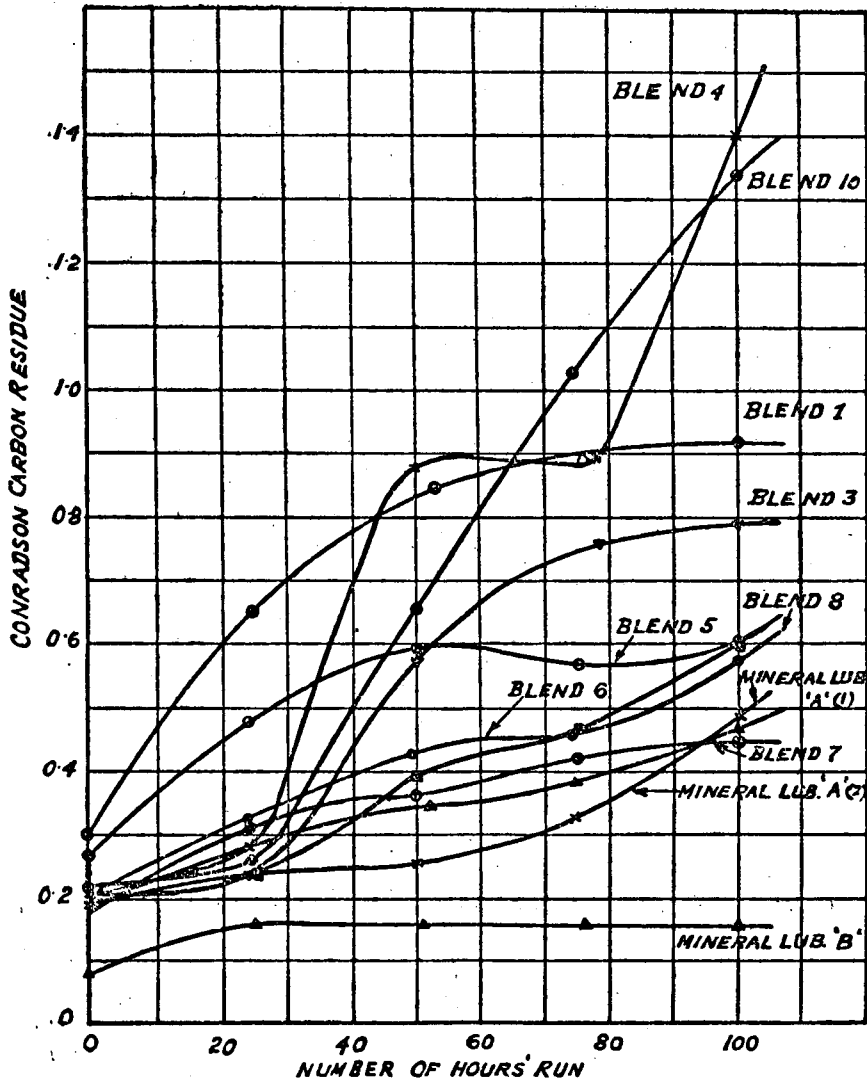

FIG. 7.

Change of Conradson carbon residue with the duration of run in 1.5 K.W. Lister set.

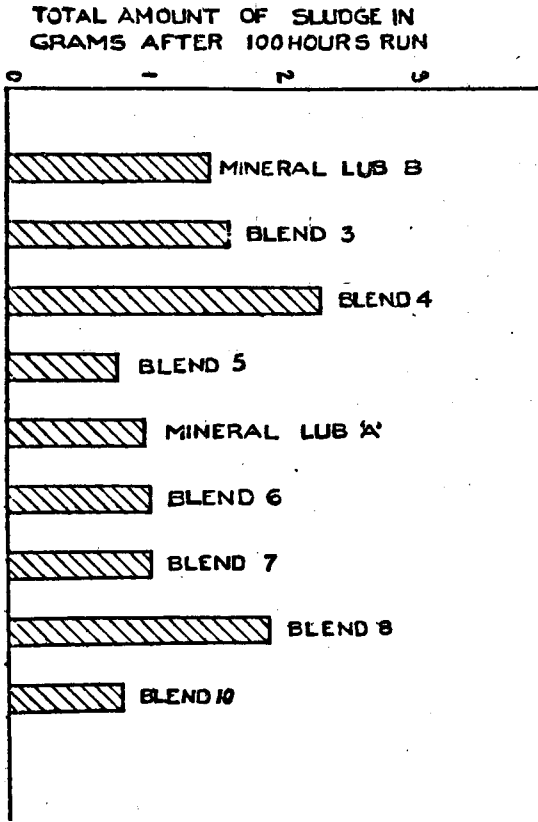

FIG. 8.

Graphical representation of the amount of sludge in crank case oil obtained with different blends as a result of 100 hours' run in 1.5 K.W. Lister set.

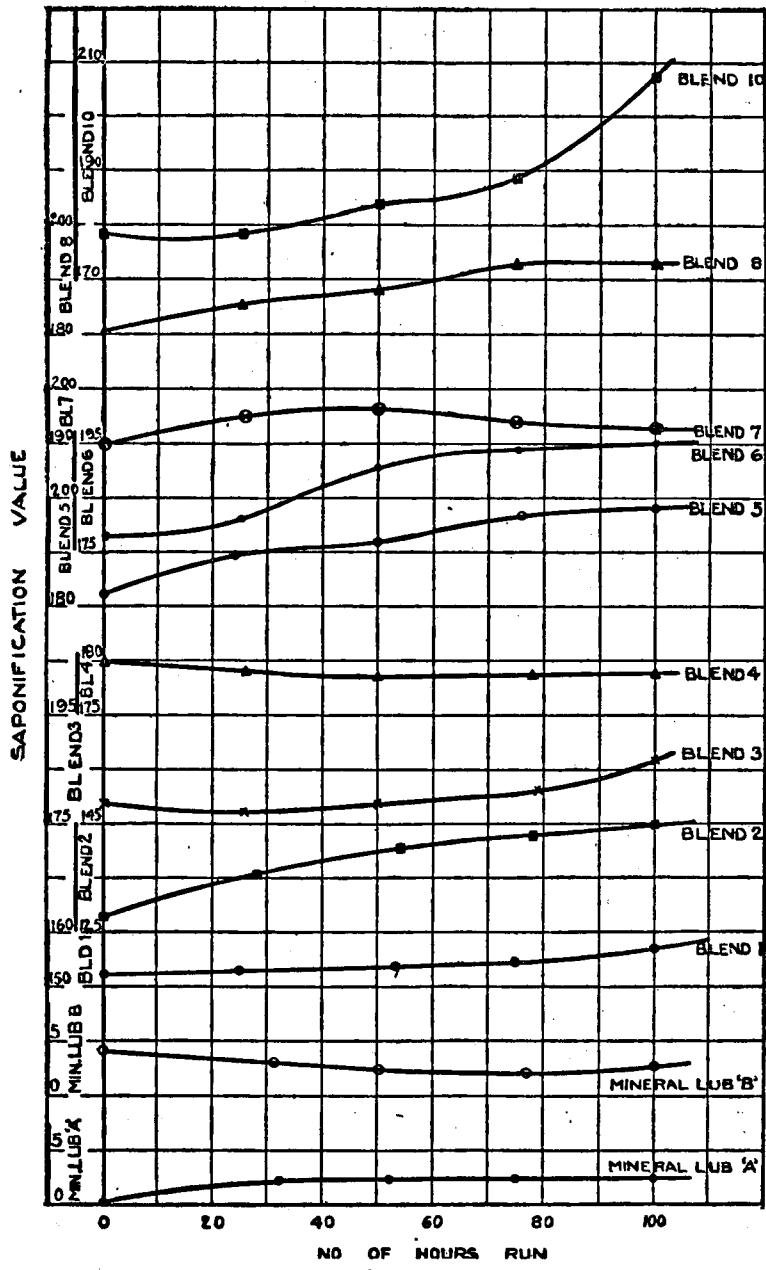

FIG. 9.

Change of saponification value with the duration of run in 1.5 K. W. Lister set.

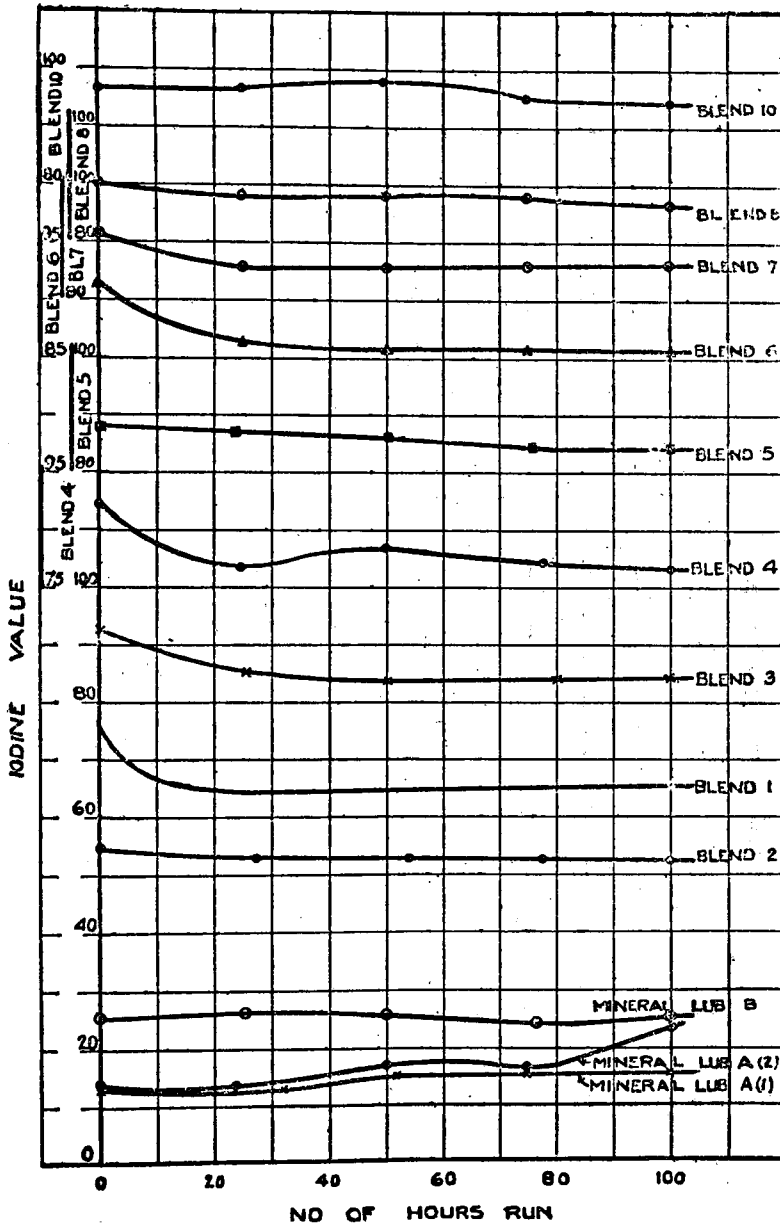

FIG. 10.

Change of iodine value with the duration of run in 1.5 K. W. Lister set.

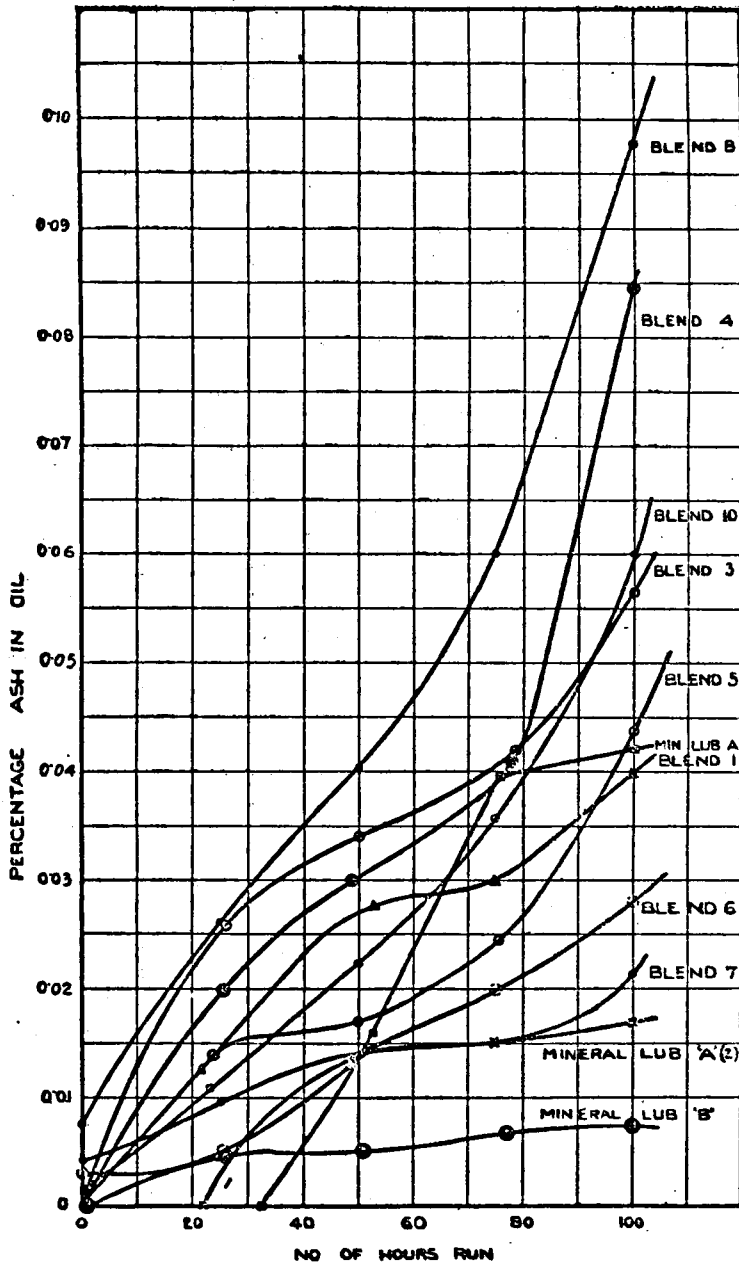

FIG. 11.

Change of ash content with the duration of run in 1.5 K.W. Lister set.

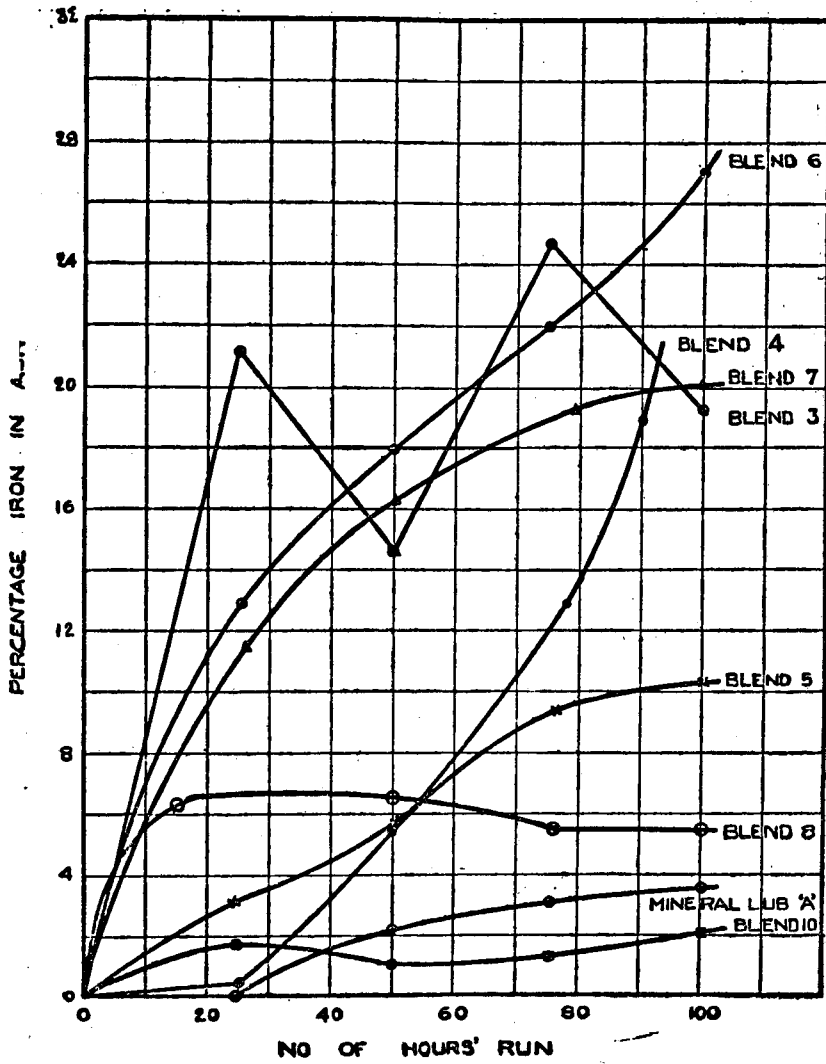

Fig 12.

Change of iron content in ash with the duration of run in 1.5 K.W. Lister set, M108CD

reaction did not proceed beyond, perhaps, the decomposition of the glycerides into fatty acids and neutral products.

Generally speaking, it may be said that the engine operating conditions had the effect of increasing the acidic constituents as a result of complex chemical reactions, but this effect was more pronounced in the case of some of the stabilized blends.

The iodine values (Fig. 10) of all the vegetable oil blends decreased with the progress of the engine test, the minimum value being reached approximately between seventy and eighty hours' operation. The most interesting feature that is brought out by the engine test is, therefore, the fact that the degree of saturation of the blends increased with the length of operation and reached a maximum value before approximately eighty hours' operation.

With regard to the ash content (Fig. 11) of the oil, it may be observed that all the blends as well as the mineral lubricants showed an increase in ash content with the length of operation. Now, the ash content is due primarily to the dust or other impurities finding their way along with the induced air and also to the introduction of metallic impurities from the various engine parts as a result of wear. In view of the fact that the particular engine in which the investigation was carried out was not provided with an air filter, and as the experiments were carried out under the various weather conditions prevailing during the different parts of the year, the amount of dust and other impurities finding their way inside the engine naturally varied from blend to blend. The figures for ash or iron content (Fig. 12) of the oil, therefore, furnished no definite criterion of the relative degree of wear as a result of engine operation and should not be taken for anything but a rough indication of the degree of wear experienced by the metallic parts of the engine.

It will be noted (Table VII and Fig. 13) that the maximum equilibrium temperatures of the crank case oil in the case of runs with blend No. 3 (α -Naphthol blend) and 7 and 8 (α -Naphthylamine blends) were practically of the same order, but somewhat less than that obtained with the reference lubricant "A", while those obtained with the remaining blends were nearly the same as in the case of the run with the reference lubricant. Assuming that the crank case equilibrium temperature is independent of the room temperature and is a function of frictional losses under similar operating conditions, it may be concluded that the frictional characteristics of the vegetable oils are practically as good as those of the mineral oils, if not superior.

The consumption of petrol (Table VII) per B. H. P. hour should also be proportional to the frictional losses if the output is maintained constant and we find that the consumption in the case of runs of all the blends except the two mineral-vegetable ones is more or less similar to that obtained in the standardization runs. It should, however, be pointed out that there does not exist a strict correlation between the equilibrium temperature and the consumption in every case.

With regard to cylinder wear, it may be observed that, with the exception of Blend Nos. 2, 3 and 8, all the vegetable oil blends behaved as satisfactorily as the reference lubricant, but the loss of weight of the top piston ring, which

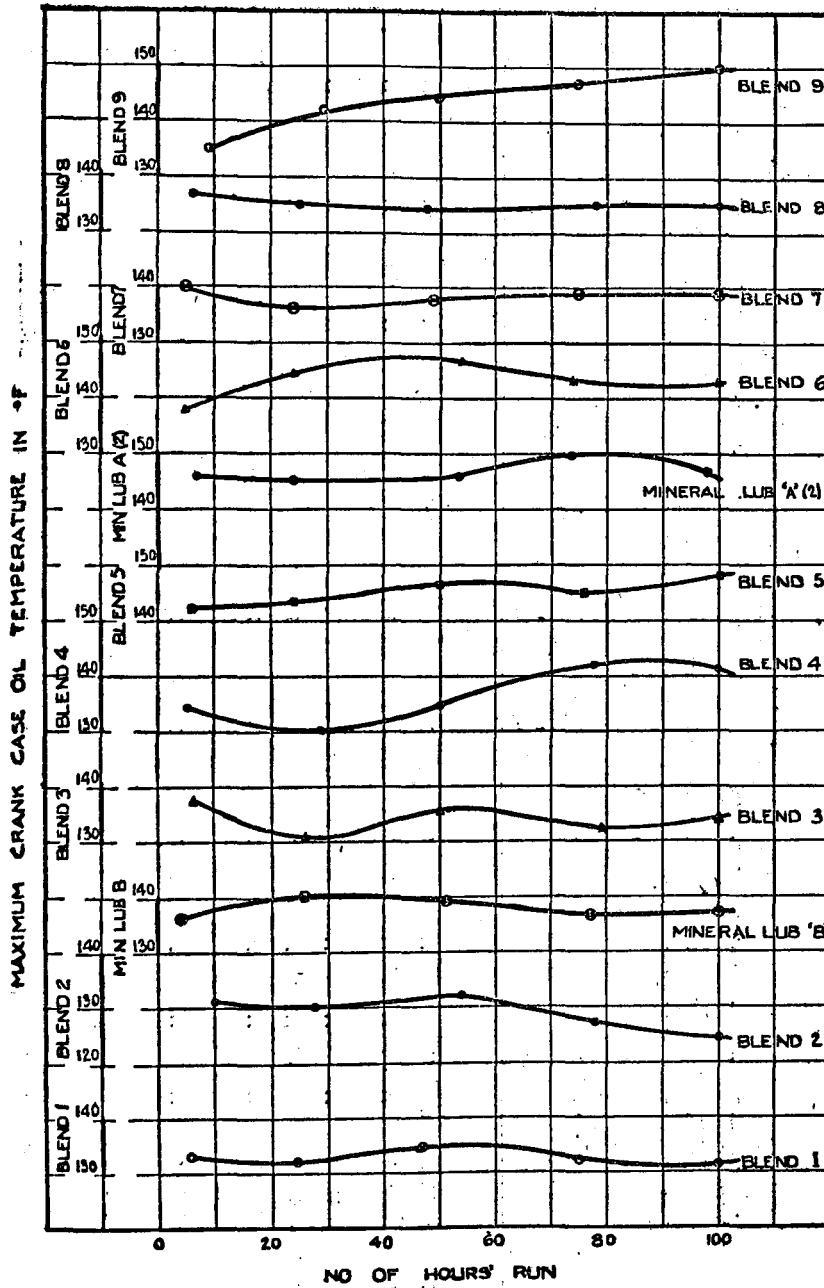

FIG. 13.

Change in equilibrium temperature of crank case oil with the duration of run in 1.5 K.W. Lister set.

TABLE VII.

Friction and wear characteristics of the oils as brought out by 100 hours' engine test in 1.5 K. W. Lister set.

(Three figures under any head correspond respectively to 0, 50 and 100 hours' operation.)

No. of run.	Blend.	Room temperature during the period of run. (°F).	Maximum sump oil temperature during the period of run. (°F).	Consumption of petrol per B. H. P. hour. (lbs.)	Cylinder wear at limiting position of ring travel. (inch.)	Reduction in weight of top piston ring. (grms.)	Iron in oil (Parts per million).	Total iron content of crank case oil after 100 hours' run. (grms.)
1	Mineral Lubricant "A" ..	96—84	140—131	..	0.0001
2	Blend No. 1	90—79	138—126	1.31	No measureable change.
3	Blend No. 2	85—73	136—124	1.4	0.0003
4	Mineral Lubricant "B" ..	96—85	140—135	1.25	0.0002
5	Blend No. 3	90—77	138—130	1.18	0.0005	0.0353	0 55 112	0.956
6	Blend No. 4	84—71	144—130	1.18	0.0002	0.0347	0 16.2 153.2	0.443
7	Blend No. 5	100—83	152—144	1.18	No measureable change.	0.0500	0 9.7 44.8	0.226
8	Mineral Lubricant "A" ..	98—89	150—140	1.03	Do. ..	0.0283	0 3.1 6.1	0.101

9	Blend No. 6	--	--	..	96-83	147-138	1.10	Do.	..	0.0434	0 24.8 76.7	0.195
10	Blend No. 7	--	--	..	97-81	141-135	1.08	Do.	..	0.0351	0 2.16 40.5	0.149
11	Blend No. 8	--	--	..	85-70	137-132	1.05	0.0003		0.0680	0 26.9 52.0	0.497
12	Blend No. 10	--	--	..	101-83	150-133	1.18	No measureable change.		0.0460	0 8.8 59.2	0.270

REDUCTION IN WEIGHT OF TOP PISTON
RING IN GRAMS AFTER 100 HOURS RUN

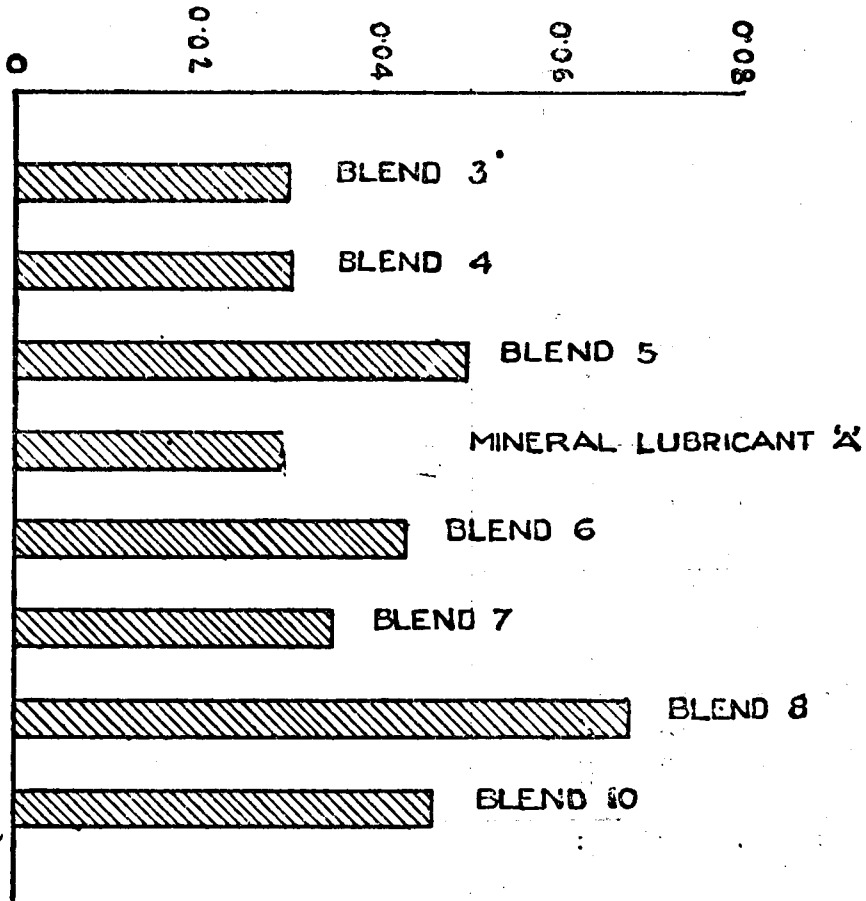

FIG. 14.

Graphical representation of the loss in weight of top piston ring after 100 hours' run in 1.5 K.W. Lister set.

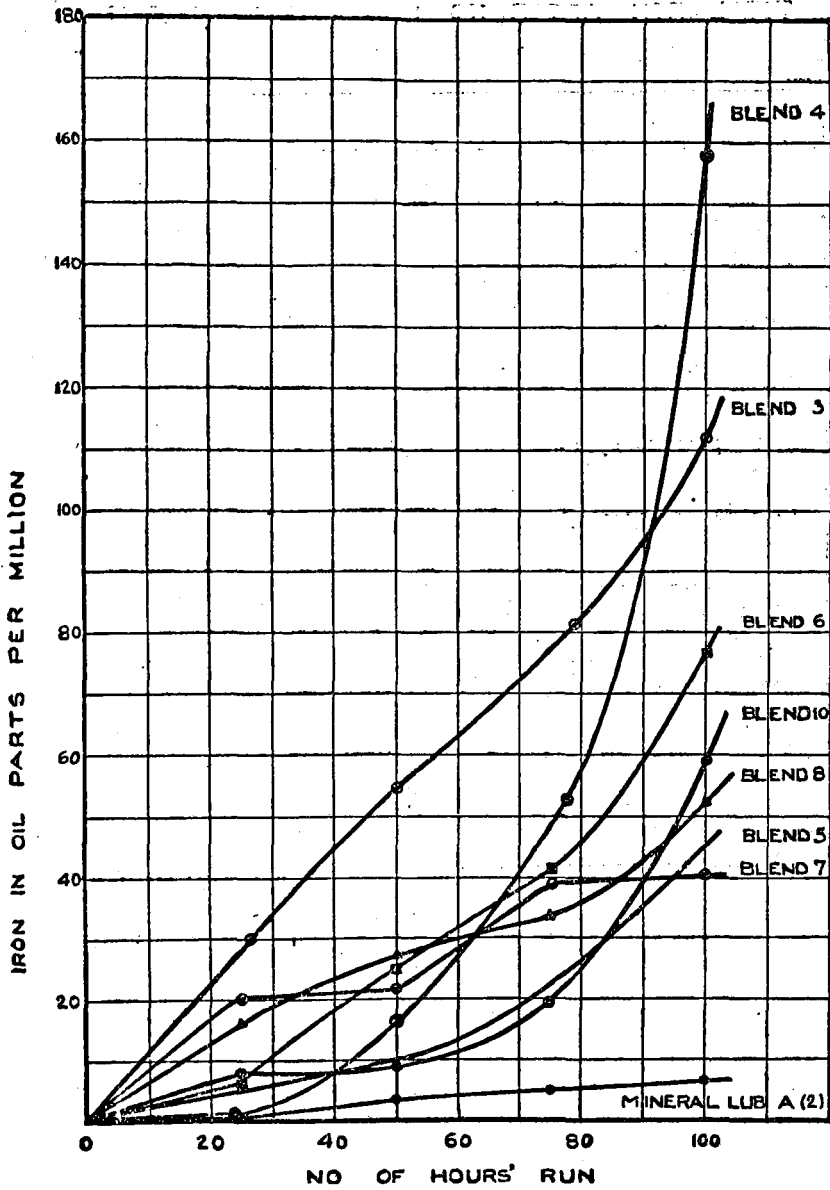

FIG. 15.

Change of iron content (soluble iron) in oil with the duration of run in 1.5 K.W. Lister set.

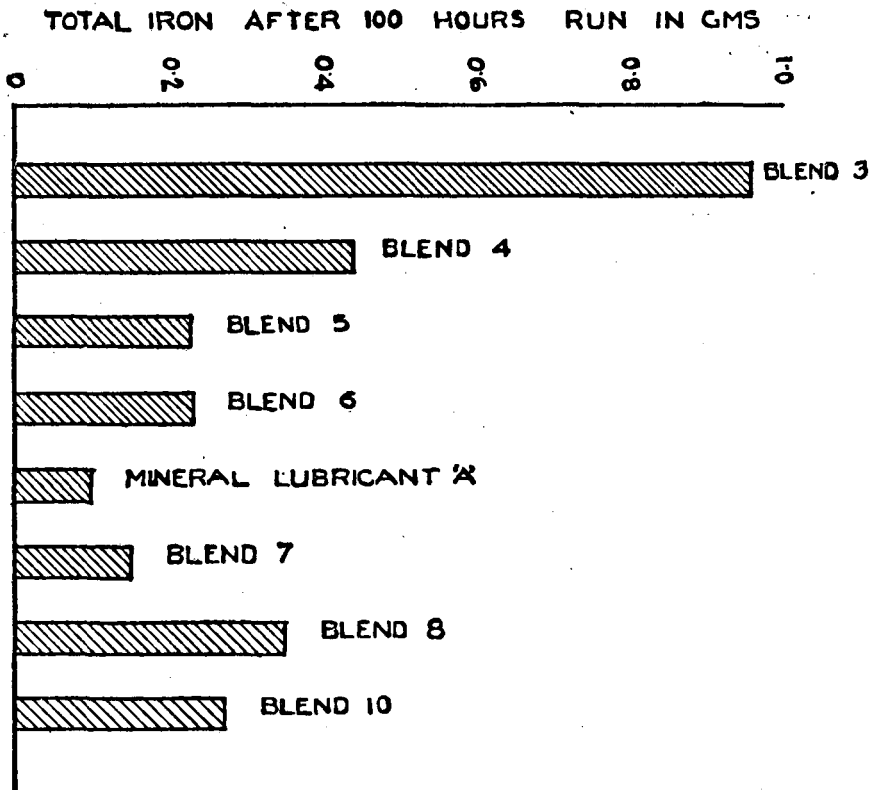

FIG. 16.

Graphical representation of the total iron content (iron in solution and iron in sludge) in crank case oil after 100 hours' run in 1.5 K.W. Lister set.

has been generally accepted as an index of wear, failed to establish any correlation with the cylinder wear figures. It may, however, be pointed out that among the pure vegetable oil blends, those numbered 3, 4 and 7 behaved best and showed a loss of weight which was approximately 25 per cent. higher than in the case of the reference lubricant (second standardization run).

As regards the total amount of iron removed (Fig. 16) it will be seen that Blend No. 7 proved superior to all others, giving an iron content figure of 0.149 gm. as against 0.101 gm. for the reference lubricant. The other two blends which gave the next best results are Blend Nos. 5 and 6, which gave iron content figures of 0.195 gm. and 0.226 gm. respectively.

It will be observed from Table VIII and Fig. 17 that the nature of deposit on the piston top and cylinder head with practically all the blends was of the same type as that obtained with mineral reference lubricant "A", although the amount varied from blend to blend. The amount of deposit on the underside of the piston with reference lubricant "A" was practically nil as against variable amounts (0.34 to 2.5 grams) in the case of the stabilised vegetable oil blends. The total amount of deposit on the piston top and cylinder head, including that on the underside, obtained with Blend Nos. 7 and 8, was definitely less than that with the first standardization run with reference lubricant "A" and quite comparable with that obtained with the second standardization run with the same reference lubricant. It should be further observed that the deposit on all these parts obtained with blend No. 4 (the untreated blend) weighed as much as 16.5 grams, whereas that obtained with Blend Nos. 7 and 8 weighed only 1.82 and 1.32 grams respectively, clearly demonstrating the very remarkable improvement in this effect caused by the addition of stabilizers.

The nature of deposits on the ring lands and grooves with all the blends, except Nos. 4 and 5, was similar to that produced by the reference lubricant "A". The deposit obtained with blend No. 4 (the untreated castor and groundnut oil mixture) was of a distinctly gummy character and caused the clogging of a large number of scraper ring slots and the sticking of the top piston ring. The deposit produced by Blend No. 5 was somewhat gummy in the region of top ring groove and also caused the sticking of the top ring. On the other hand, Blend No. 6 which is exactly identical in composition with Blend No. 5, except for the fact that its soap content was slightly lower, was quite free from these defects. It is, however, difficult, to say at this stage whether the ring sticking was due to excess of soap or whether it was purely accidental. With the untreated oil, on the other hand, the deposits were definitely gummy in character not only on the top ring groove but also in the other ring grooves, showing undoubtedly the effect of stabilizers on the treated blends.

With regard to the deposits on the valves, the table would indicate that the exhaust valves were singularly free from any deposit not only in the case of all the vegetable oils but also with the mineral reference lubricant "A", while the inlet valves in each case showed some amount of deposit, the nature and extent of which varied somewhat from blend to blend. In no case, however, it was such as to interfere with the proper working of the valves.

MIGCCD

TABLE

Nature and extent of deposits on various

No. of a.	Blend.	Piston top.	Cylinder head.	Total weight of deposits on piston top and cylinder head. (grams.)	Piston underside and weight of deposit in grams.	Piston skirt.	Top ring.	
							Land.	Groove.
1	Mineral lubricant "A".	1/3 spongy; 2/3 hard.	Hard ..	2.5	Slight deposit on top; rest of interior lacquered.	Lacquered black at places.	No appreciable deposit; lacquered black.	No appreciable deposit; lacquered black.
2	Blend No. 1	1/2 spongy; 1/2 hard.	Do. ..	3.6	Spongy and moist. 2.5	Do.	Do.	Do.
3	Blend No. 2	Hard ..	Do. ..	2.1	Spongy and moist. 2.4	Do.	Thin deposit at places.	Thin, uniform.
4	Mineral lubricant "B".	1/3 hard and 2/3 spongy.	Do. ..	0.58	Thick at top; rest of interior lacquered. 1.0	Do.	Lacquered black.	Lacquered black.
5	Blend No. 3	Thick on periphery; fairly hard.	Do. ..	3.2	Thick and partly soft and partly hard at top. 1.8	Do.	Thin, irregular.	thin, sticky.
6	Blend No. 4	2/3 thick; 1/3 thin.	Do. ..	3.3	Thick, moist at top; rest of interior lacquered. 13.2	Do.	Thin, irregular.	Gummy ..
7	Blend No. 5	Thin, hard near the centre; thick round periphery.	Do. ..	1.4	Thin, granular at top; rest of interior lacquered. 0.63	Do.	Gummy deposit over 1/2 area; the other 1/2 clean.	Partly thin and partly thick and gummy.
8	Mineral lubricant "A".	1/3 thin, hard; 2/3 practically clean.	Do. ..	0.55	Thin, hard. 1.0	Do.	Thin, soft over 1/2 area; the other 1/2 clean.	No appreciable deposit.

No. VIII

engine parts after 100 hours' run.

Lower rings.		Inlet valve.		Exhaust valve.		Remarks.
Land.	Groove.	Stem.	Shoulder and face.	Stem.	Shoulder and face.	
No appreciable deposit; lacquered black.	No appreciable deposit; lacquered black.	Part stained; isolated specks of carbonaceous matter.	Thin deposit.	None; stained reddish.	None; stained reddish.	No clogging of any of the drain holes or scraper ring groove. A few scraper ring slots clogged. Piston rings free in their grooves.
Do.	Do.	Part stained	Do.	Do.	Do.	Only a few scraper ring slots clogged. Piston rings free in their grooves.
Thin, uniform.	Thin, uniform.	Do.	Appreciable; granular and gummy on shoulder only.	Stained black.	Stained black.	Do.
Lacquered black.	Lacquered black.	Thin ..	Thin ..	Do.	Do.	Piston rings free in their grooves.
Thin, sticky	Thin, sticky	Thin, granular.	Thin; granular on shoulder.	Stained reddish.	Stained reddish.	Do.
Gummy (2nd) lacquered (3rd).	Gummy (2nd) lacquered (3rd).	Thin, granular.	Thin; granular on shoulder.	Thin; part stained reddish.	Stained reddish.	A large number of scraper ring slots clogged. Top ring stuck; others free in their grooves.
Thin, uniform.	Thin, uniform.	Do.	Fairly thick, soft and granular on shoulder, thin on face.	Thin, part stained reddish.	Stained reddish.	A few scraper ring slots clogged. Top ring stuck.
No appreciable deposit, lacquered.	No appreciable deposit; lacquered.	Fairly stained and partly covered with thin carbon.	Thin ..	Stained reddish.	Do.	Piston rings free in their grooves.

TABLE

No. of run.	Blend.	Piston top.	Cylinder head.	Total weight of deposits on piston top and cylinder head. (grams.)	Piston underside and weight of deposit in grams.	Piston skirt.	Top ring.	
							Land.	Groove.
9	Blend No. 6	$\frac{1}{2}$ thin, hard, brownish; $\frac{1}{2}$ practically clear.	Hard ..	2.5	Isolated spongy deposits at top; the rest of the interior simply lacquered.	Lacquered black at places.	Thin isolated deposits at places.	Thin films
10	Blend No. 7	Central half free from deposit; other $\frac{1}{2}$ partly resinous and brownish and hard.	Fairly hard, partly brownish.	1.3	Thin, moist 0.52	Do.	Thin over $\frac{1}{2}$ area; rest bright.	Thin, uniform.
11	Blend No. 8	Central half free from deposit; other half thin, hard.	Hard ..	0.98	Thin, moist at places. 0.34	Do.	Thin over a small area; remaining area bright.	Do.
12	Blend No. 10	$\frac{1}{2}$ practically free from deposit; the other $\frac{1}{2}$ hard, easily removable.	Fairly hard.	0.77	Partly moist 2.31	Do.	Practically $\frac{1}{2}$ covered with thin deposit interspersed with bright spots; other $\frac{1}{2}$ clean.	Thin

VIII—con.d.

Lower rings.		Inlet valve.		Exhaust valve.		Remarks.
Land.	Groove.	Stem.	Shoulder and face.	Stem.	Shoulder and face.	
Thin film ..	Thin film..	Thin, a few granules at isolated points.	Thin film on face and shoulder. Isolated granules on shoulder.	Stained reddish.	Stained reddish.	A few scraper ring slots clogged. Piston rings free in other grooves.
Thin uniform.	Thin uniform.	Thin ..	Thin ..	Do.	Do.	A number of scraper ring slots clogged. Piston rings free in their grooves.
2nd land bright except for a small area. 3rd land covered with a thin uniform deposit.	Do.	Thin film, with granules here and there.	Thin film, shoulder covered with granules at isolated points.	Do.	Do.	Practically half the scraper ring slots either partially or entirely clogged.
Thin ..	Thin ..	Part stained ; part granulated.	Granulated over shoulder ; thin deposit over face.	Do.	Do.	Piston rings free in their grooves.

TOTAL WEIGHT OF CARBON DEPOSITS
IN GRAMS ON PISTON TOP & CYLINDER HEAD

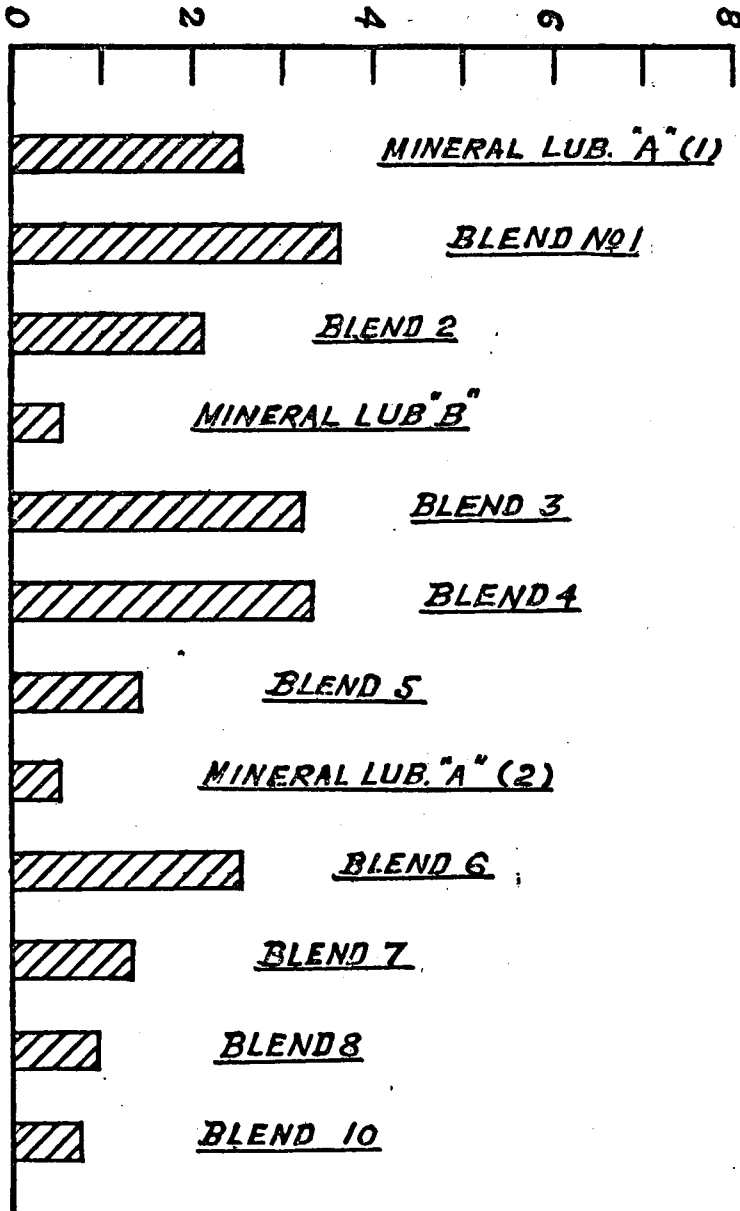

FIG. 17.

Graphical representation of total amount of carbon deposits on piston top and cylinder head in 1.5 K.W. Lister set.

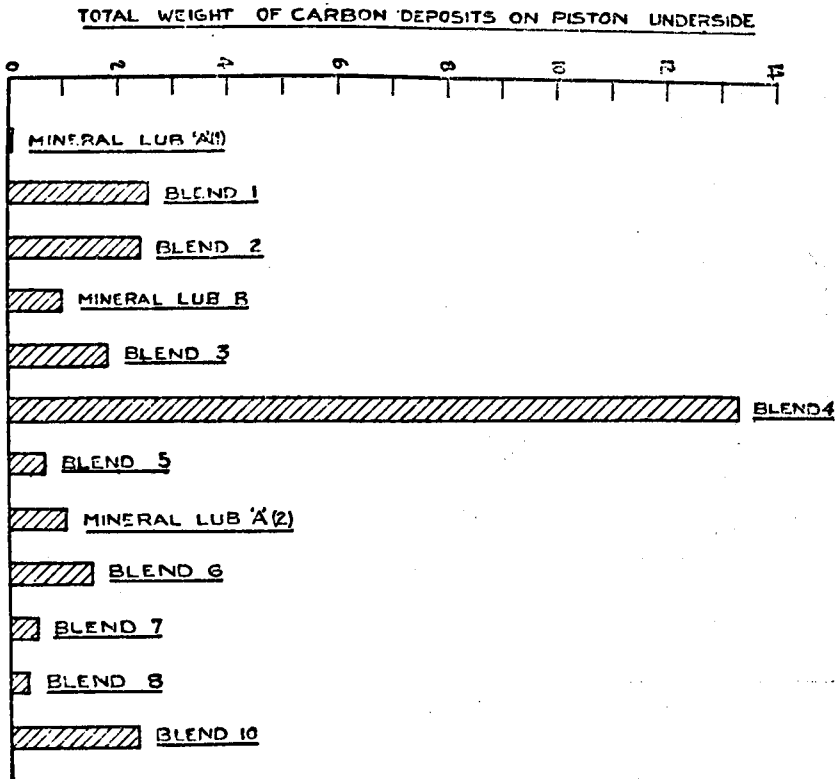

FIG. 18.

Graphical representation of total amount of carbon deposits on piston underside in 1-5 K. W. Lister set.

FINAL ENGINE TESTS.

From the results of preliminary engine tests on the various blends, it will be seen that Blend No. 7, which is a castor and groundnut oil mixture with α -naphthylamine, proved superior to all others as regards general stability and wear characteristics. This blend was, therefore, subjected to more severe operating conditions in the larger engine (Morris).

While the engine test on this blend was in progress, a series of Air Ministry Oxidation Tests (Modified), undertaken on rape oil in conjunction with different stabilizers, had practically reached the final stage, and it was found that α -naphthylamine, which proved quite satisfactory for the groundnut castor oil blend, also proved to be quite a good stabilizer for rape oil. A 50-50 mixture of castor and rape seed oils with 1% α -naphthylamine was, therefore, prepared for test in the larger unit. The resulting viscosity of the blend was 109 centistokes at 100°F. as compared with 128.6 centistokes in the case of Blend No. 7 and 122.1 centistokes in the case of reference lubricant "A". The lower initial viscosity of this blend was decided upon to see whether this would in any way influence the friction characteristics, which were found to be somewhat inferior in the case of Blend No 7, than in the case of reference lubricant "A".

TABLE IX.

Change of main oil characteristics showing oxidation and thermal stability under engine operating conditions in 16 H. P. Morris engine.

(the three figures under each head correspond respectively to 0, 50 and 100 hours' operation).

No. of run.	Blend No.	Viscosity at 140°F. (centistoke).	Rise in viscosity after 100 hours run %.	Viscosity index.	Acid value.	Conradson carbon residue %.	Sludge %.	Total amount of sludge grms.	Oil consumption (percentage of total oil used).	Crank case dilution %.
1	Mineral Lubricant "A".	43.7	2.1	102.0	0.06	0.19	16.4	..
		40.2		98.0	0.42	0.24		3.0
		42.8		96.5	0.36	0.32	0.04	1.74		1.4
2	Blend No. 7 ..	46.6	21.7	116.0	0.92	0.2	15.8	..
		47.7		116.5	1.55	0.37		1.2
		56.7		114.5	2.25	0.57	0.03	1.40		1.0
3	Blend No. 9 ..	41.2	17.0	121.0	1.19	0.2	17.8	..
		42.7		121.0	2.0	0.23		1.2
		48.2		120.2	2.0	0.49	0.03	1.21		1.0

The results of engine tests on these blends along with those on reference lubricant "A" are summarized in Tables IX, X, XI and XII.

It may be noted that owing to undue vibration and leakage of oil through several auxiliary bearings of the Morris Engine, while carrying out standardization runs, it was decided to carry out engine tests at 1200 R. P. M. (instead of 1500 R. P. M.) and at a correspondingly reduced load (10 B. H. P.).

A fresh standardization run was, therefore, carried out under the new conditions and engine tests on Blend Nos. 7 and 9 reported in this paper were carried out under similar conditions.

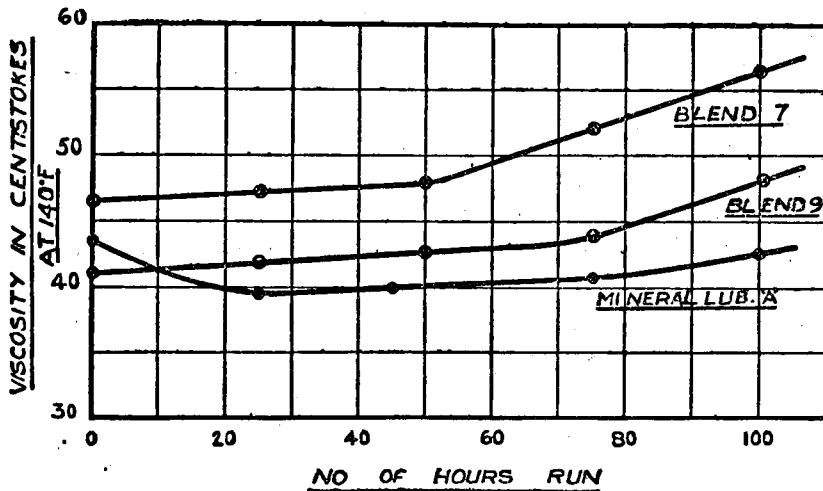

FIG. 19.

Change in viscosity with the duration of run in 16 H.P. Morris engine.

The data presented in the Table IX and Fig. 19 indicate that while the viscosity of the reference lubricant "A" decreased with the progress of the run for the first 50 hours, evidently on account of greater crank case dilution (3.0%) occurring during this period, it subsequently showed a tendency to increase reaching a final value (42.8 c.s. at 140°F), which was lower than the initial figure (43 c.s. at 140°F). Both the vegetable oil blends, on the other hand, showed a tendency to increase in viscosity with the length of the run, the increase being most marked after 50 hours in the case of Blend No. 7 and after 75 hours in the case of Blend No. 9. The greater increase in viscosity of the vegetable oils as compared with that obtained with the reference lubricant might be partly explained by the greater dilution occurring during the latter run.

As regards the acid value (Fig. 21), it will be seen that while it increased by 0.30 in the case of the reference lubricant "A", the corresponding increases in Blend Nos. 7 and 8 were 1.33 and 0.81 respectively. The Conradson carbon residue figures of both the vegetables oils were also slightly higher (Fig. 22).

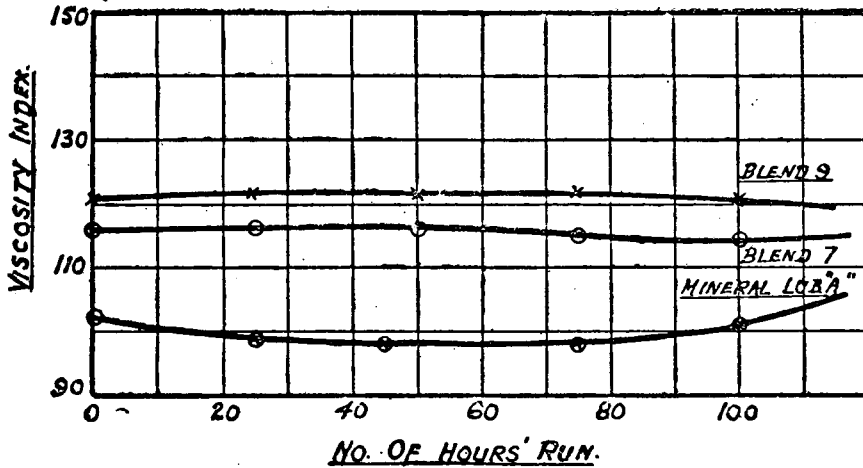

FIG. 20.

Change of viscosity index with the duration of run in 16 H.P. Morris engine.

Both the vegetable oil blends, however, developed appreciably less sludge than the reference lubricant (Fig. 23). The oil consumption figures for Blend Nos. 7 and 9 were 15.8% and 17.8% respectively as compared with 16.4% in the case of the reference lubricant.

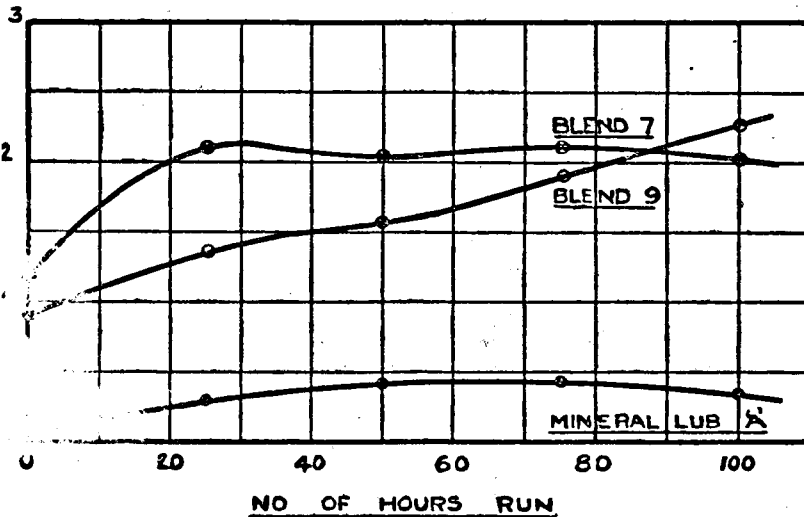

FIG. 21.

Change of acid value with the duration of run in 16 H.P. Morris engine.

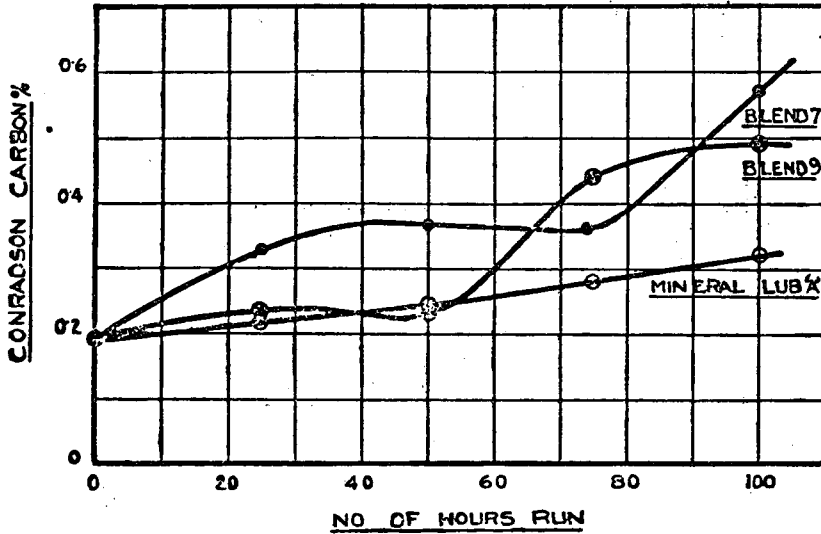

FIG. 22.

Change of conradson carbon residue with the duration of run in 16 H.P. Morris engine.

TABLE X.

Change of oil characteristics other than those shown in Table IX under engine operation conditions in 16 H. P. Morris engine.

(Three figures under any head correspond respectively to 0, 50 and 100 hours' operation).

No. of run.	Blend.	Specific gravity at 100°F. 100°F.	Saponification value.	Iodine value.	Ash %	Iron in ash %
1	Mineral lubricant "A"	0.8738	0.8	12.2	Nil.	Nil.
		0.8758	1.4	12.9	0.013	11.8
		0.8769	4.7	12.2	0.014	20.8
2	Blend No. 7	0.9399	185.0	93.0	0.003	Nil.
		0.9403	184.6	83.7	0.010	16.9
		0.9462	195.5	81.9	0.022	18.0
3	Blend No. 9	0.9333	180.3	96.0	0.005	11.0
		0.9343	189.2	96.0	0.012	16.0
		0.9379	190.0	93.0	0.018	7.0

TOTAL AMOUNT OF SLUDGE IN CRANK
CASE OIL IN GRAMS AFTER 100 HOURS RUN

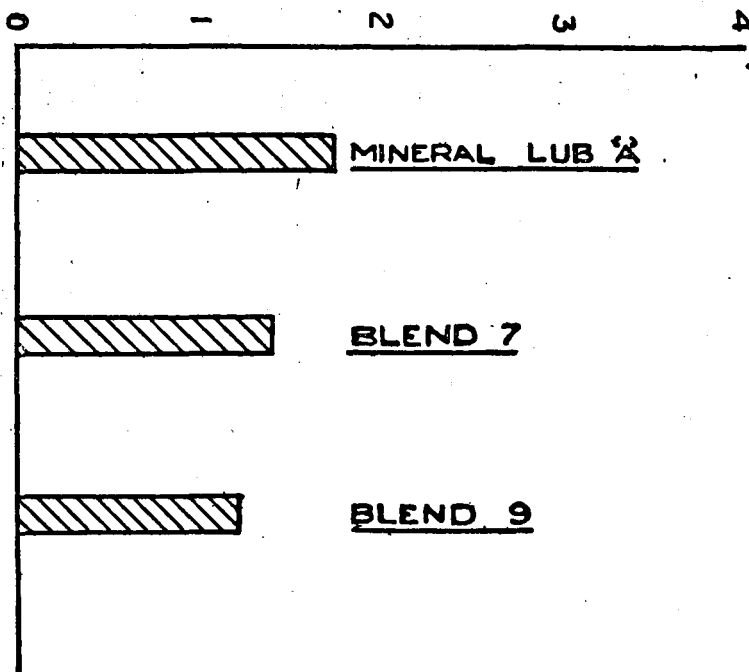

FIG. 23.

Graphical representation of the total amount of sludge in crank case oil as a result of 100 hours' engine test in 16 H.P. Morris engine.

It will be seen from Table X (Fig. 24) that the nature and extent of the changes suffered by both the vegetable oil blends as regards saponification value as a result of 100 hours' run in the larger 4-cylinder engine were similar to those obtained in the case of the run in the smaller (single cylinder) unit (Table VI). It appears therefore that the more severe operating conditions in the high power engine produced no more serious changes in the characteristics than the comparatively less severe conditions of the smaller engine. The same remarks are more or less applicable in respect of changes in the iodine value (Fig. 25) which decreased slightly with the progress of the run indicating that the degree of saturation of the blends tended to increase with the duration of operation.

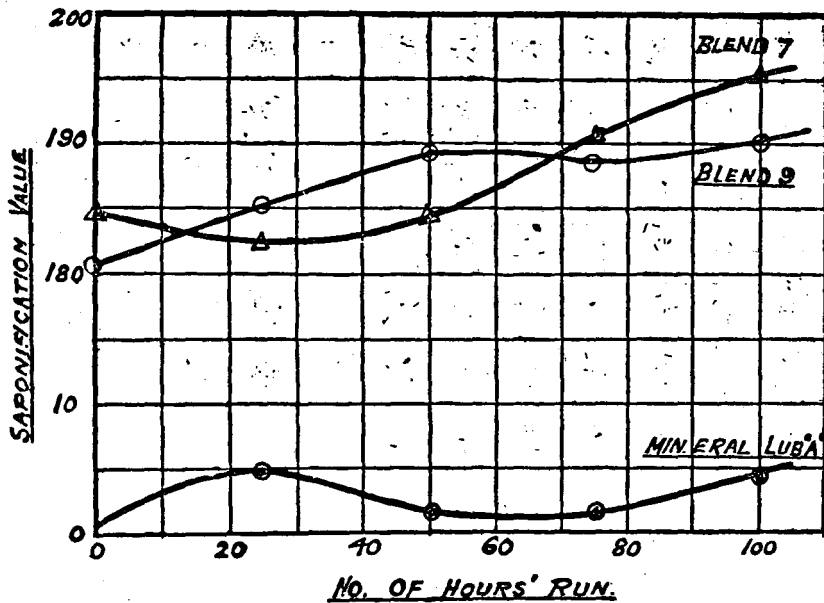

FIG. 24.

Change of saponification value with the duration of run in 16 H.P. Morris engine.

As regards the percentage ash (Fig 26) and the iron content, the remarks that were made in the case of the runs in the smaller engine apply to this case also. But it may be generally observed that the increase in the ash content of the crank case oil in the case of both the blends was slightly more than in the case of the reference lubricant "A". On the other hand, the percentage of iron in ash (Fig 27) obtained with the reference lubricant steadily increased with the progress of run, reaching a value of 20.3% after 100 hours which was appreciably higher than the corresponding values in the case of both the vegetable oil blends. It may, however, be pointed out that this value changed in a very irregular manner during the runs with both the vegetable oil blends.

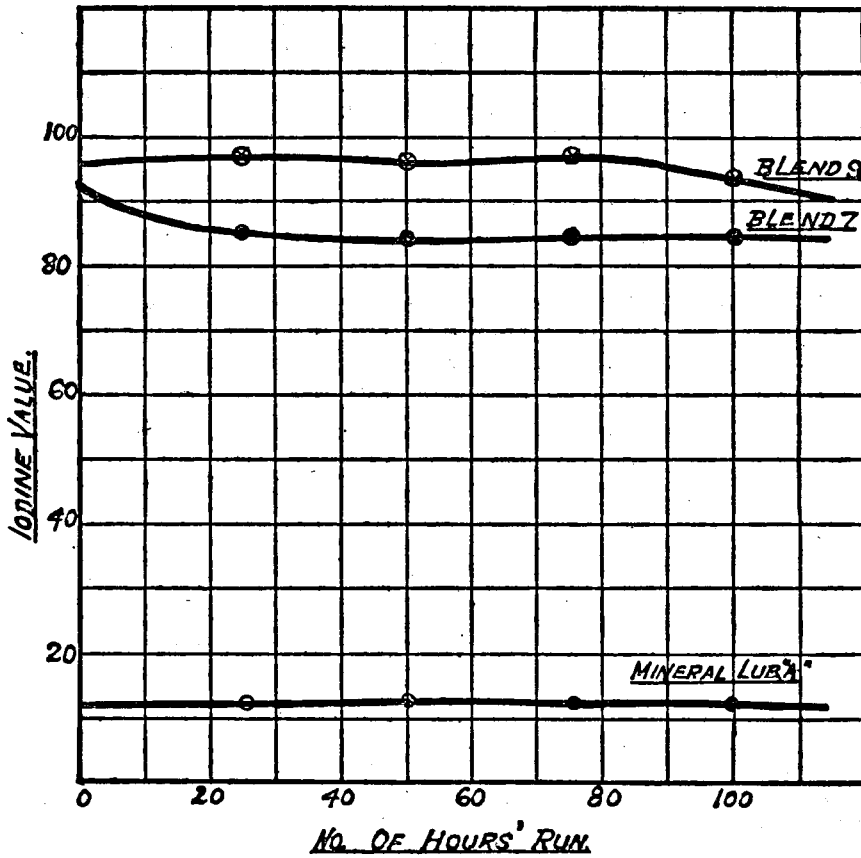

FIG. 25.

Change of iodine value with the duration of run in 16 H.P. Morris engine.

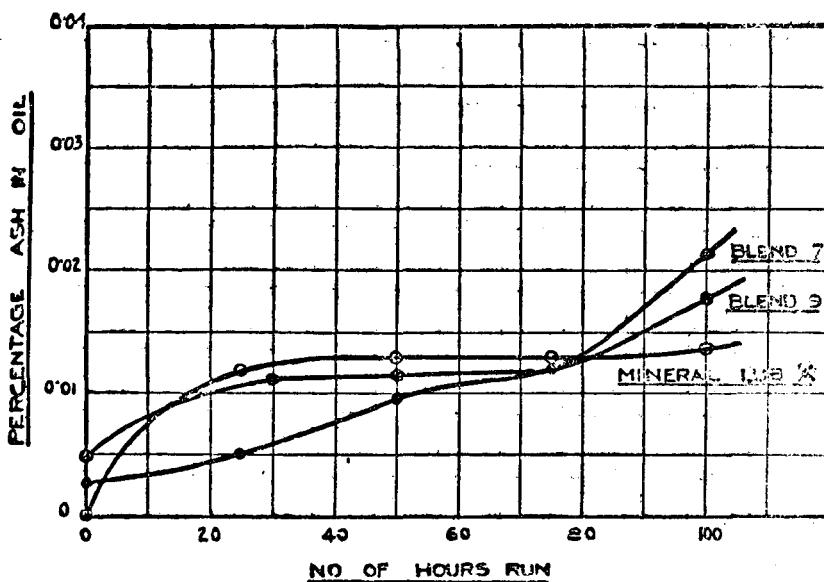

Fig. 26.

Change of ash content with the duration of run in 16 H.P. Morris engine.

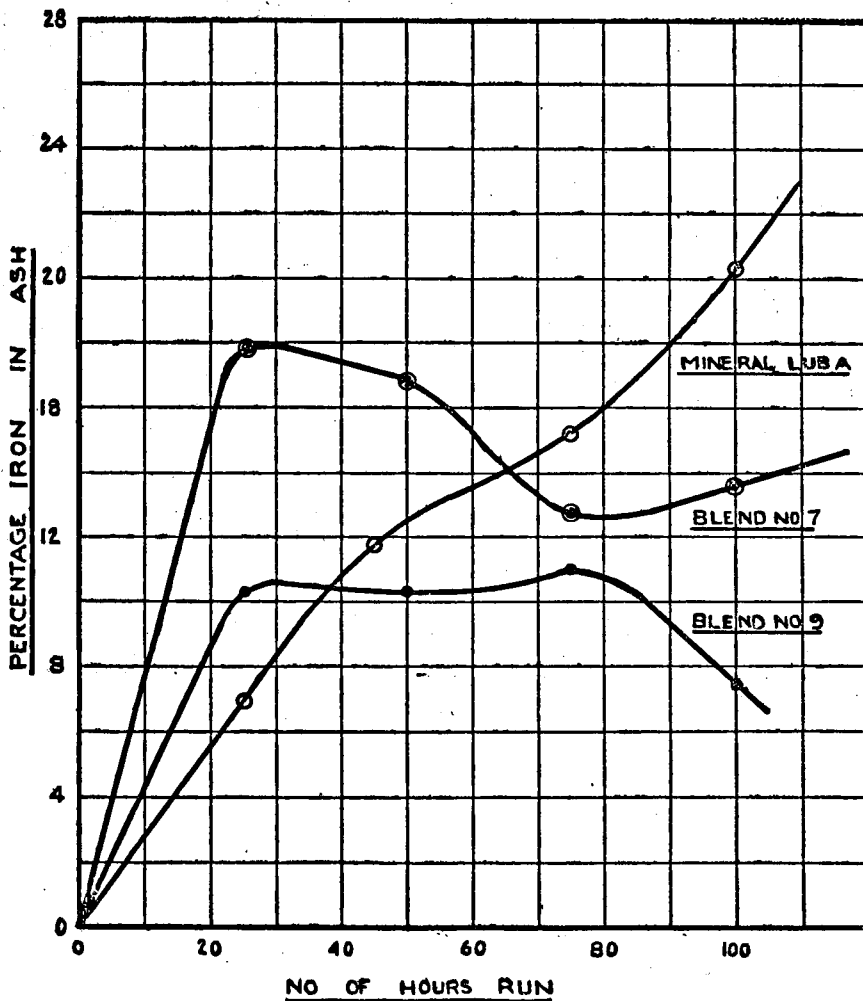

FIG. 27.

Change of iron content in ash with the duration of run in 16 H.P. Morris engine.

TABLE XI.

Friction and wear characteristics of the oils as brought out by 100 hours' engine test in 16 H. P. Morris Engine.

(Three figures under any head correspond respectively to 0, 50 and 100 hours' operation).

No. of run.	Blend.	Room temperature during the period of run. (°F).	Maximum sump oil temperature during the period of run. (°F).	Consumption of petrol per B. H. P. hour. (lbs.)	* Cylinder wear at limiting position of top ring travel. (inch).	* Reduction in weight of top piston ring after 100 hours' run (grams).	Iron in crank case oil (parts per million).	Total iron content of crank case oil after 100 hours' run. (grams.)	Motoring losses (B. H. P.).
1	Mineral lubricant "A".	97—85	175—169	0.682	No measurable change in any cylinder.	0.0110 0.0119 0.0145 0.0150	Nil 15.8 30.0	0.481	2.3 2.3 2.2
2	Blend No. 7	85—71	174—171	0.729	No measurable change. 0.0002 0.0005 No measurable change.	0.0288 0.0387 0.0177 0.0237	Nil 17.3 29.8	0.484	2.7 2.6 2.6
3	Blend No. 9	88—74	174—171	0.707	0.0003 No measurable change in remaining cylinders.	0.0177 0.0109 0.0348 0.0103	Nil 12.1 14.1	0.273	2.6 2.2 2.6

* The four figures relate to cylinder Nos. 1 to 4 serially.

A comparison of the results tabulated in Table XI and shown graphically in Fig. 28 indicates that the equilibrium temperature of the crank case oil in the case of both the vegetable oil blends was practically identical and showed a fairly close agreement with that obtained with the mineral reference lubricant "A". The average room temperature, however, was slightly lower during the vegetable oil runs. The consumption of petrol per B. H. P hour with vegetable oil blends were 4-7% higher than that obtained with the reference lubricant "A", although the frictional losses as determined by the motoring test were 10 to 16% higher in the case of former blends. It appears, therefore, that there was lack of strict correlation between the frictional losses and the temperature rise of the crank case oil, but generally it can be stated the the frictional characteristics of the vegetable oil blends on the whole were somewhat inferior to those of the reference lubricant.

With regard to wear on the basis of change in cylinder bore and the loss in weight of top piston ring, it should be observed that the Blend No. 9 and reference lubricant "A" were practically similar (Fig. 29) except for the fact that the top ring of cylinder No. 3 after a run with the former blend showed a comparatively large reduction in weight and the bore of cylinder No. 1 showed a slightly more increase in dimension. This appears to be accidental, since it concerns one cylinder only.

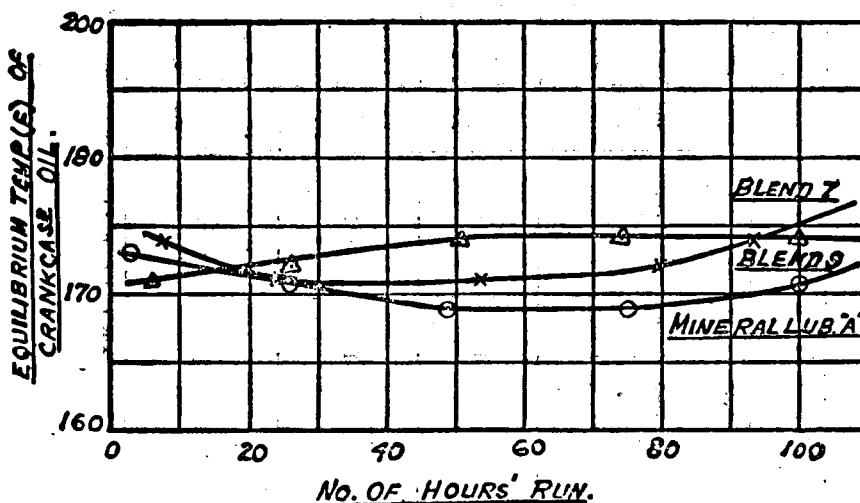

FIG. 28.

Change of equilibrium temperature of crank case oil with the duration of run in 16 H. P. Morris engine.

The quantity of iron in solution in crank case oil at different stages of run (Fig. 30) with Blend No. 9 was appreciably lower than in the case of reference lubricant "A", while that obtained with Blend No. 7 and reference lubricant "A" was practically identical. The total iron content of the crank case oil (Fig. 31) (including that of the sludge) at the end of 100 hours' run with Blend No. 9 was also considerably lower than that obtained with run on Blend No. 7 or the reference lubricant "A", both of which gave similar performance in this respect.

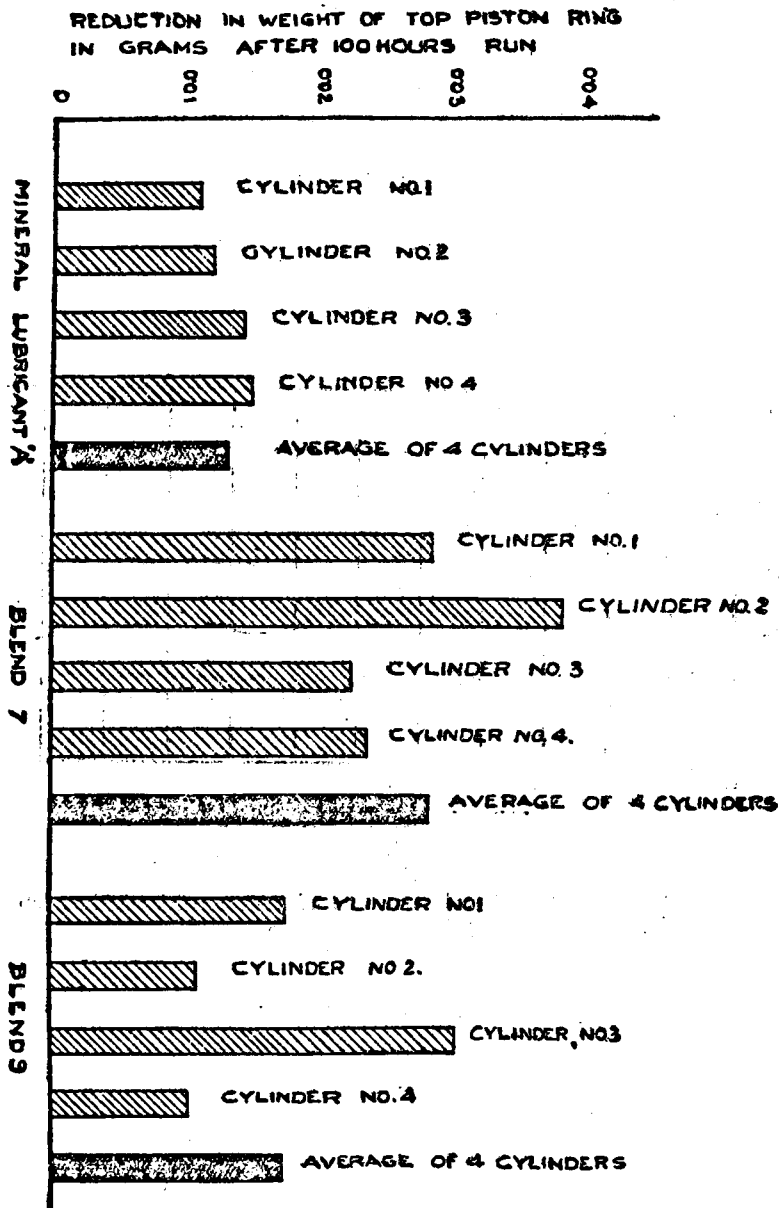

Fig. 29.

Graphical representation of the loss in weight of top piston ring after 100 hours' engine test in 16 H.P. Morris engine.

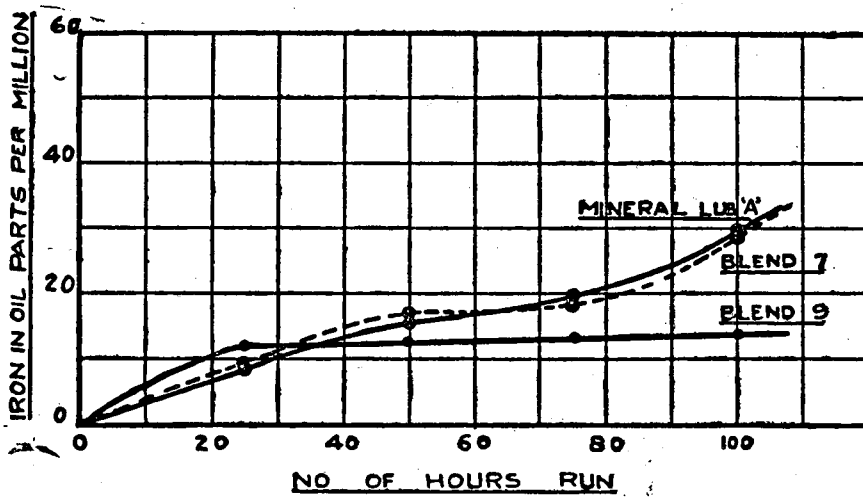

Fig. 30.

Change in iron content (in solution) of crank case oil with the duration of run in 16 H.P. Morris engine.

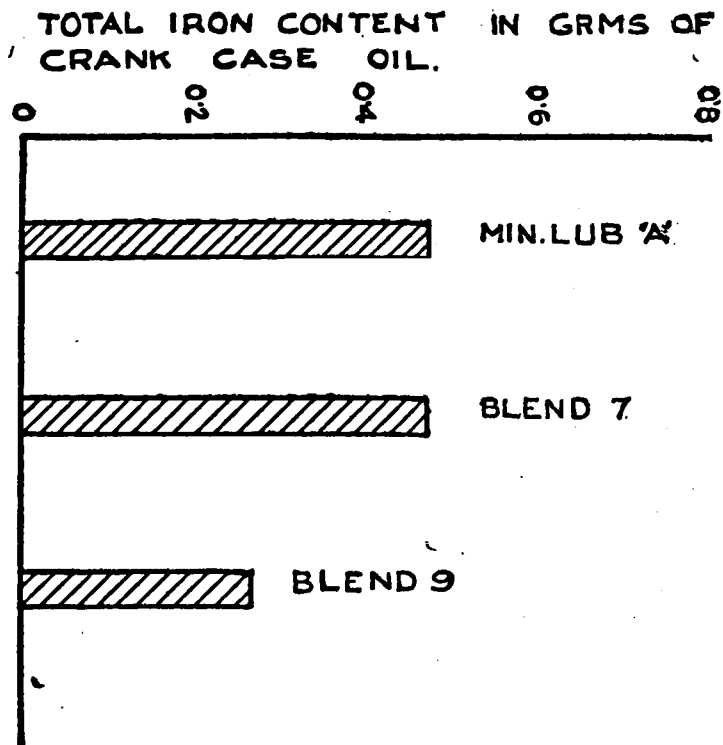

FIG. 31.

Graphical representation of the total iron content (including that of sludge) of the crank case oil after 100 hours' engine test in 16 H. P. Morris engine.

TABLE No. XII.

Nature and extent of deposits on various engine parts after 100 hours' run.

(Four figures under any head refer to data obtained with the individual cylinders).

No. of run.	Blend.	Piston top and underside.	Cylinder head.	Weight in grams.			Ring lands, grooves and skirt.	Valves and valve pockets.	Remarks.
				piston top.	cylinder head.	piston underside.			
1	Mineral lubricant "A".	Piston top, in each case, showed thin, uniform and hard deposit of carbon (fig. 34) which was removable with some difficulty; underside simply lacquered brown.	Thin hard deposit.	0-517 0-538 0-530 0-482	0-900 1-220 2-439 1-971	Nil	Top land, in each case, showed thin deposit at places. Other ring lands and grooves covered with thin uniform deposit. Skirt lacquered black mostly near the gudgeon pin bearing ends.	Inlet valve of cylinder Nos. 1, 2 and 4 showed granulated deposits over portions of shoulders (fig. 33). That of cylinder No. 3 covered with the same type of deposit practically over the entire shoulder. Portions of stem and face of each valve either stained or covered with thin deposit. Exhaust valves showed no deposit.	Interior of each cylinder clean and free from gummy deposits and score marks and so also were the principal bearing parts. Partial clogging of some of the scraper ring slots. Piston rings free in their grooves.
2	Blend No. 7	Piston top, in each case, covered with a thin, uniform and hard deposit (fig. 35) which could be scraped off with great difficulty. The scrapings presented a black	Do.	0-571 0-606 0-617 0-672	1-121 1-595 2-410 2-825	Practically nil.	Except for the top land, which was partly bright and partly covered with carbonaceous deposit, the ring lands and grooves were generally covered with	Shoulder and part of stem of inlet valves of cylinder Nos. 1 and 2 covered with thick spongy deposit of resinous character (fig. 36). Those of cylinder Nos. 3 and 4 showed the same type of de-	Interior of each cylinder clean and free from gummy deposits and score marks; so also were the principal bearing parts. No clogging of scraper ring slots or drain holes

3	Blend No. 9	<p>to brownish appearance, giving an impression of partially carbonised oil; underside lacquered brown.</p> <p>Each piston top covered with a hard deposit of carbonaceous matter (fig. 37) which could be scraped off with difficulty. The scrapings were similar in appearance to those of blend No. 7, underside lacquered brown.</p>	<p>Fairly hard, smooth uniform deposit.</p>	<p>0.850 0.883 1.173 1.179 4.085</p>	<p>1.229 1.675 5.360 5.231 13.495</p>	<p>Practically nil.</p> <p>The deposits on the various ring grooves and skirt generally similar to those obtained with Blend No. 7.</p>	<p>a thin uniform deposit in the case of each of the pistons. The skirt, in each case, showed brownish coloration at places.</p> <p>The shoulders of all the inlet valves and their pockets covered with appreciable deposits of resinous character, the amount of deposit decreasing with their distance from the oil spray which is located in the valve chamber near the inlet valve of cylinder No. 1 (fig. 38).</p> <p>The following are the weights of deposits:—</p> <p>1.86 grms. 1.73 " 1.38 " 0.58 "</p> <p>The inlet valve faces, in each case, covered with a thin film or simply stained. The exhaust valve pockets, shoulders and stems free from deposits.</p>	<p>posit but in less amount. The total weight of deposits on the shoulders, stems, etc., was 6.14 gms. Exhaust valves showed no deposit.</p> <p>on scraper ring grooves. Piston rings free in their grooves.</p> <p>Do.</p>
---	-------------	--	---	--	---	---	---	---

WEIGHT OF CARBON DEPOSIT IN
GRAMS ON PISTON TOP & CYLINDER HEAD

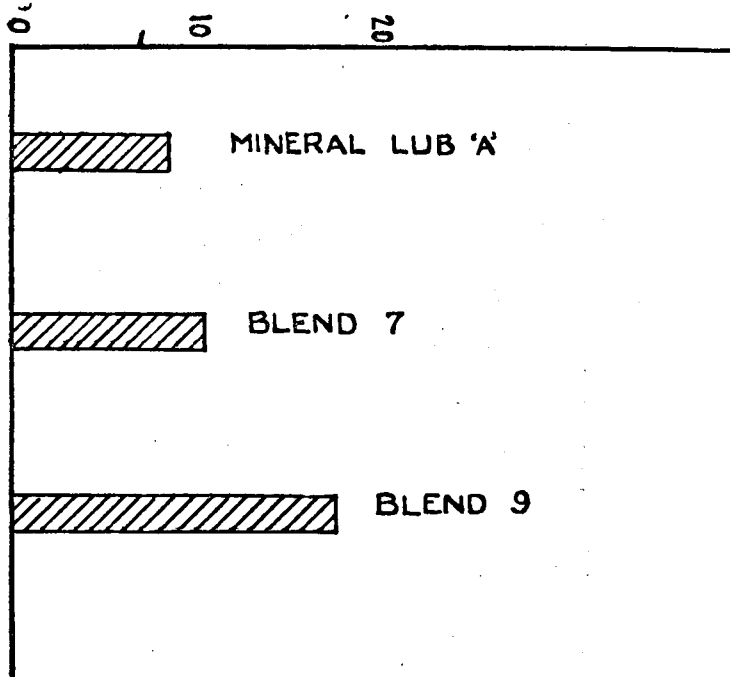

FIG. 32.

Graphical representation of the weight of carbon deposit on piston top and cylinder head as a result of 100 hours' engine test in 16 H.P. Morris engine.

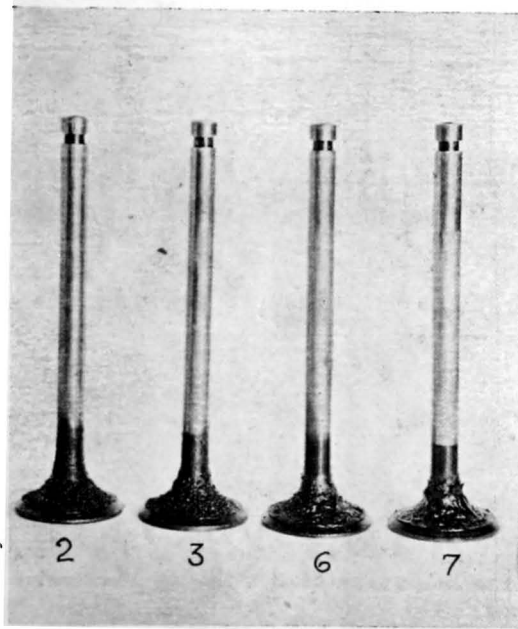

FIG. 33.

Carbonaceous deposits on the shoulder and stem of the inlet valves of 16 H. P. Morris engine as a result of 100 hours' run with mineral lubricant "A".

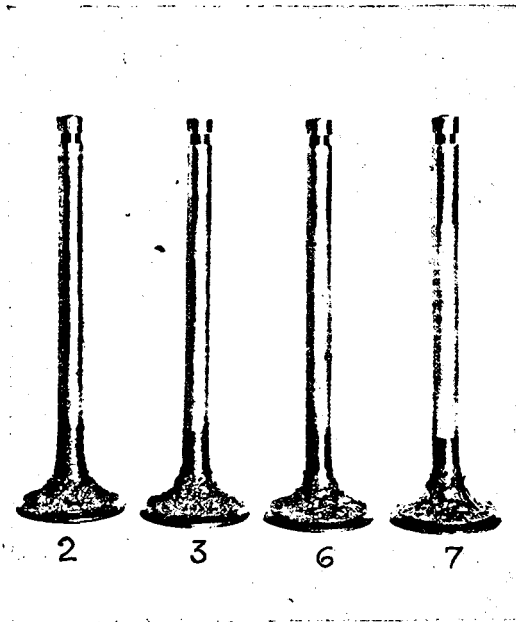

FIG. 33.

Carbonaceous deposits on the shoulder and stem of the inlet valves of 16 H. P. Morris engine as a result of 100 hours' run with mineral lubricant "A".

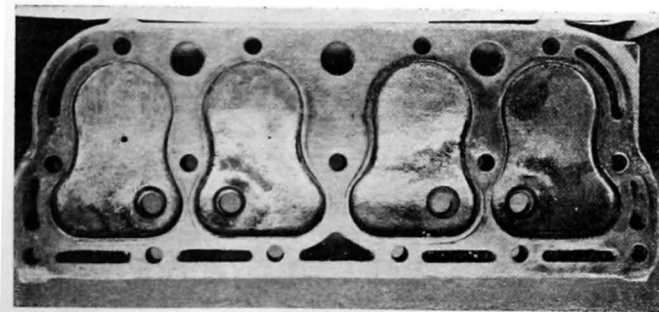
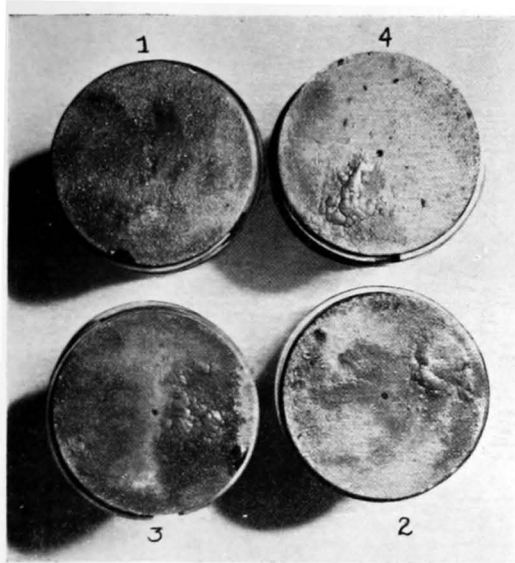

FIG. 34.

Carbonaceous deposits on the piston tops and cylinder head of 16 H. P. Morris petrol engine as a result of 100 hours' run with mineral lubricant "A".

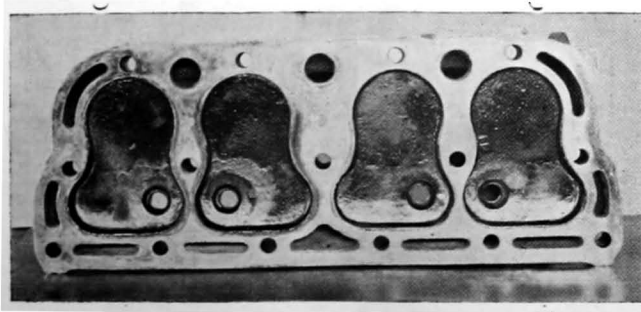
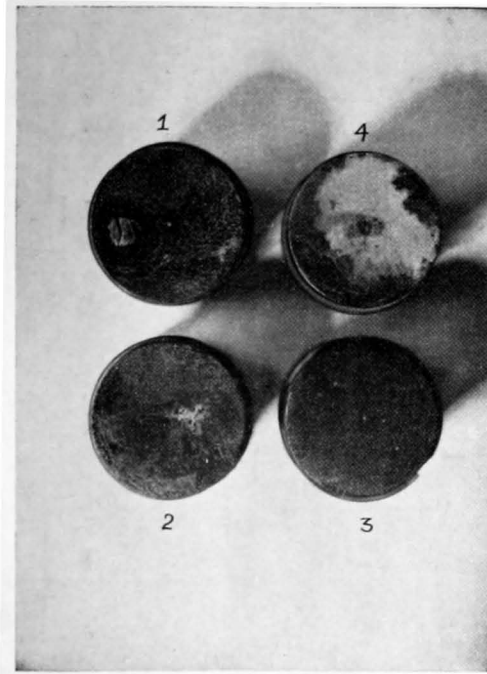

FIG. 35.

Deposits on the piston tops and cylinder head of 16 H. P. Morris engine
as a result of 100 hours' run with Blend No. 7.

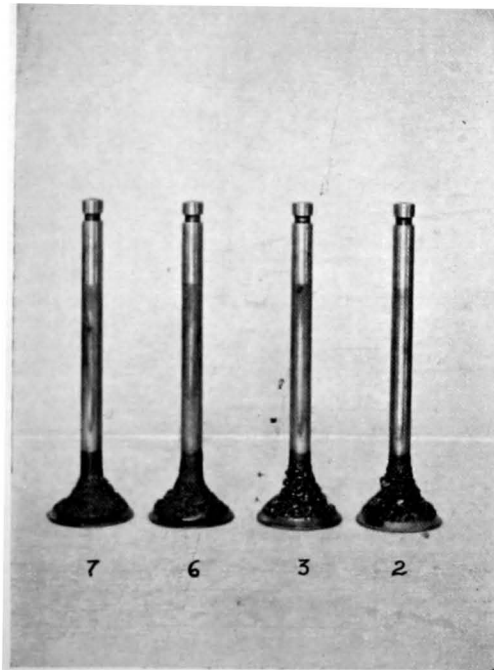

FIG. 36.

Carbonaceous deposits on the shoulder and stem of the inlet valves of 16 H. P. Morris engine as a result of 100 hours' run with Blend No. 7.

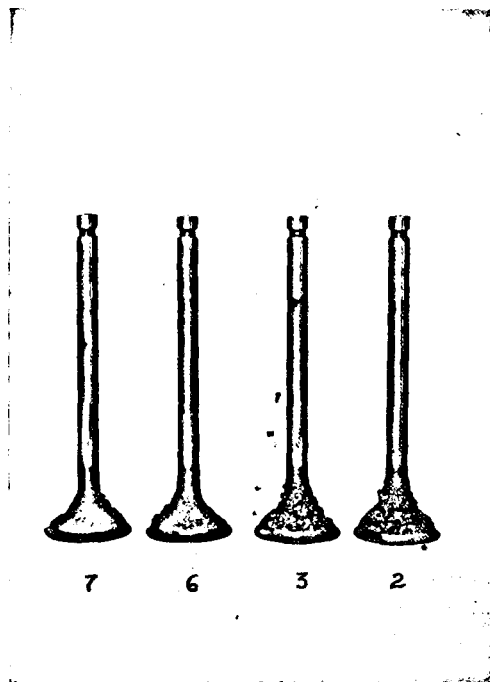

FIG. 36.

Carbonaceous deposits on the shoulder and stem of the inlet valves of 16
H. P. Morris engine as a result of 100 hours' run with Blend No. 7.

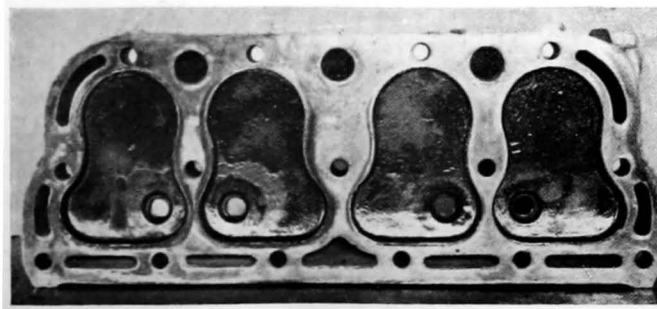
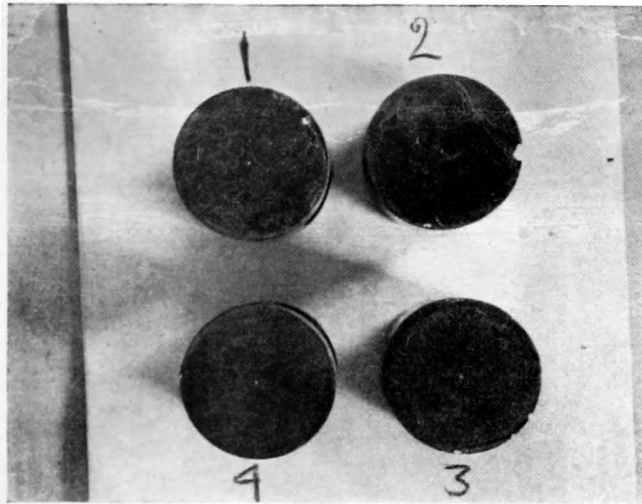

FIG. 37.

Carbonaceous deposits on the piston tops and cylinder head of 16 H. P. Morris engine as a result of 100 hours' run with Blend No. 9.

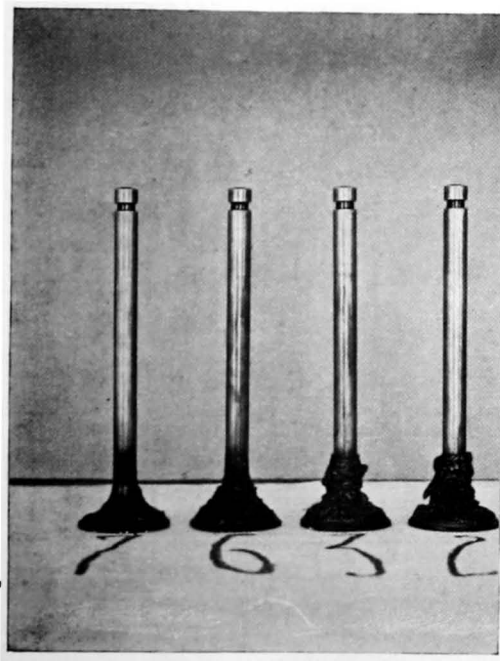

FIG. 38.

Carbonaceous deposits on the shoulder and stem of the inlet valves of 16 H.P. Morris engine as a result of 100 hours' run with Blend No. 9.

A close examination of Table XII brings out some interesting facts with regard to the nature and extent of deposits, obtained with the vegetable oil blends, as compared with those obtained in the corresponding parts with the mineral lubricating oil "A". The most marked difference in behaviour between the two types of lubricants is in respect of the deposits observed on the piston top, cylinder head, inlet valves and valve pockets, while the nature and extent of deposits on the other parts, particularly, the piston underside and the ring grooves are, in general, identical in the case of both types of oils. The most outstanding fact that is brought out by the engine tests is that the two vegetable oil blends tried in the large unit (Morris) were at least free from the ring sticking tendency under high temperature conditions. It remains, however, to be seen whether the alternate high and low temperature running (or even continuous running), as encountered under certain service conditions are conducive to ring sticking.

With regard to weights of deposits on the piston top and cylinder head, it would be seen that the performance of Blend No. 7, is slightly worse than that of mineral lubricant "A", but the performance of Blend No. 9 may be regarded as definitely worse. Although Blend No. 7 is a castor and ground nut oil mixture and Blend No. 9 is a castor and rape oil mixture, the difference in behaviour cannot be wholly ascribed to the difference in composition or to the different carbonising behaviour of the two blends, but partly also to the difference in the initial viscosities of the two blends (Table IX). The lower initial viscosity of Blend No. 9 was evidently responsible for more oil going past the piston rings into the combustion space, resulting in more deposits. This is also confirmed by the slightly higher consumption figure in the case of this blend (Table IX).

In respect of deposits on the valves and their pockets, both the vegetable oil blends, however, shewed up definitely worse than the mineral oil "A". Although the individual weights of deposits in case of Blend No. 7 were not determined, it can be safely concluded from the available data that the performance of the two oils was practically identical. It would be observed that the amount of deposit decreased with the increase in distance of the valves or their pockets from the oil spray which is located in the valve chamber near the inlet valve of cylinder No. 1 for the lubrication of the valves in their guides. Although it must be admitted that the vegetable oils have a definitely greater carbon forming tendency than the mineral oils in general, the real explanation for the peculiar manner in which the amount of deposit has progressively decreased from the point of admission of the oil into the valve chamber lies not only in the quality of the oil itself but also in the peculiar design of the particular engine. It is, however, proposed to discuss this point in greater details under "Discussion".

DISCUSSION.

In evaluating the performance of the various blends, it is considered best to confine the discussion to the pure vegetable oil blends and to discuss first the results obtained with the various blends as a result of runs in the smaller engine (Lister single cylinder), and subsequently to compare the performance of some of the blends, that prove to be the best, with that obtained in the larger unit. It is, however, not necessary to discuss all the data obtained in connection with the various characteristics or engine operation, which have already been briefly discussed. It is here proposed to judge the comparative merits of the various blends from the following important points of view :—

- (1) Change in the main characteristics of the oil such as :—
 - (a) Viscosity.
 - (b) Acid value.
 - (c) Sludge content.
- (2) Oil consumption.
- (3) Wear of the engine parts.
- (4) Carbon deposits.

With regard to oil consumption, it was not possible to determine it accurately in the case of the smaller engine. It was not, therefore, included in the Tables of data pertaining to this unit.

In determining the engine wear the following methods ²², ²³, ³ which are now commonly recognized, were employed :—

- (a) Measurement of the increase in diameter of the cylinder bore.
- (b) Determination of the loss in weight of top piston ring.
- (c) Determination of the iron content of the crank case oil at different stages of the progress of the run as well as the determination of the total iron content of the oil including that of the sludge at the end of 100 hours' run.

LISTER SINGLE-CYLINDER ENGINE.

Blend No. 3.

Blend No. 3, which is a castor-groundnut oil mixture with α -naphthol, was composed of unrefined oils having a high initial acid value of 2.5 as compared with 0.10 in the case of the reference lubricant "A" (second standardization run). It will be seen from Table XIII, which gives a summary of the changes in the various characteristics, that the viscosity of the blend did not show any appreciable change with engine operation. The acid value, which was high to start with, instead of increasing further, showed a slight decrease. The quantity of sludge in the crank case oil after 100 hours' run was practically 50% more than in the case of the reference lubricant.

With regard to the wear characteristics, the performance of the oil was decidedly inferior to that of the reference lubricant. Although the reduction in weight of top piston ring was only 20% more, the increase in cylinder bore was 0.0005" as compared with the negligible change in the case of the run with the reference lubricant, and the total iron content of the crank case oil was nine and a half times that obtained after the standardization run.

The amount of carbon deposits on the piston top and cylinder head as well as the underside of the piston was also decidedly higher, being 6.0 and 1.18 grams respectively as against 0.6 and 1.0 grams obtained with the reference oil. While, therefore, the change in viscosity and acid value of the blend was quite comparable with the corresponding figures for the reference oil, its performance in other respects, particularly the wear of the engine parts, was definitely worse. The high wear figure, it is supposed, might have been due to the high acid value of the oil, but it must be pointed out that the acid value of an oil is not always a deciding factor in corrosion. The nature of acids is of more importance in this respect than their quantity.

Blend No. 4.

Blend No. 4 was identical in composition with Blend No. 3 but without any stabilizer. It had also the same viscosity and acid value as the latter. It was subjected to engine test primarily with a view to determining the extent to which the presence or absence of a stabilizer affects the changes in characteristics of an oil or influences the engine operation. An examination of Tables V and XIII and Figs. 4 and 6 will demonstrate that the percentage rise in viscosity was nine times and acid value increase nearly seven and a half times the corresponding values for the reference lubricant, or, compared to Blend No. 3, the viscosity increase was nearly ten times, while the acid value increase was 2.75 as against a slight decrease in the case of the former blend. The sludge content of the oil was also twice that obtained with the reference oil as against one and a half times in the case of Blend No. 3. What is most striking is that the wear characteristics of the oil showed up appreciably better than those of Blend No. 3, whereas the amount of carbon deposit on the piston and cylinder head was practically the same as that obtained with Blend No. 3. The amount of carbon deposit on the underside of the piston, on the other hand, was considerable, being 13.2 grams as against 1.8 grams in the case of Blend No. 3 and 1 gram in the case of the reference oil. It should be pointed out that, in spite of the enormous increase in viscosity, there was no appreciable fall in output, nor was there any trouble experienced in operation of the engine, or undue rise of the equilibrium temperature of the crank case oil or any unusual consumption of petrol. One other point that deserves special mention is the fact that in spite of the final acid value of the blend being twice that of Blend No. 3, the amount of iron removed from the engine was less than half of that removed by the latter under similar operating conditions. It appears, therefore, that the acidic character of the stabilizer (α -naphthol) was probably responsible for the removal of a large quantity of iron from the engine parts.

Blend No. 5.

The composition of this blend was the same as that of Blend No. 3 except that its acid value was considerably reduced by suitable refining, which left a small percentage (0.11 %) of residual soap. It will be noticed from Tables V, VI, VII and XIII and Figs. 4 to 8, 14 to 16 and 39, that the reduction of acid value of the blend caused a considerable improvement over Blend No. 3 in practically all respects, except for a slightly greater loss of weight of the top piston ring. Compared with the reference lubricant, its performance was appreciably superior in respect of the acid value increase and the quantity of

TABLE XIII.

Summary showing actual changes in value of certain important characteristics of vegetable oil blends and the ratio of these changes in relation to those in the reference lubricant "A" after 100 hours' run in Lister petrol engine set.

Blend No.	Composition of blend.	Viscosity increase.		Acid value increase. %		Increase in Conradson carbon residue.		Amount of sludge.		Reduction in weight of top piston ring.		Total iron content.		Cylinder wear (inch)	Total weight of carbon deposit on piston top and cylinder head.	
		Actual.	Ratio.	Actual.	Ratio.	Actual.	Ratio.	Actual (gms.)	Ratio.	Actual (gms.)	Ratio.	Actual (gms.)	Ratio.		Actual (gms.)	Ratio.
3	Castor oil .. 60% Groundnut oil .. 40% α-Naphthol .. 1%	21.4	1.0	0.4	..	0.59	2.0	1.64	1.5	0.0333	1.2	0.956	9.5	0.0004	3.2	6.0
4	Castor oil .. 60% Groundnut oil .. 40% No stabilizers	216.2	9.1	2.75	7.6	1.20	4.0	2.39	2.1	0.0347	1.2	0.443	4.4	0.0002	3.3	6.0
5	Castor Oil .. 60% Groundnut oil .. 40% α-Naphthol .. 1% Acid value .. 0.86 Soap .. 0.117%	31.4	1.5	0.13	0.4	0.33	1.1	0.30	0.7	0.0500	1.8	0.226	2.2	Not measurable	1.4	2.5
Mineral lubricant "A"	A proprietary brand of mineral lubricant.	21.3	1	0.36	1	0.30	1	1.12	1	0.0283	1	0.101	1	Do.	0.53	1

Castor oil ..	60%																
Groundnut oil	40%																
α -Naphthol	1%	20.2	0.9	0.32	0.9	0.36	1.2	1.32	1.2	0.0434	1.5	0.195	1.9	Do.	2.5	4.5	
Acid value ..	0.88																
Soap ..	0.0195																
Castor oil ..	60%																
Groundnut oil	40%	12.4	0.6	0.84	2.3	0.28	0.9	1.06	1.0	0.0351	1.2	0.149	1.5	Do.	1.3	2.4	
α -Naphthylamine.	1%																
Castor oil	60—																
Groundnut oil	40%																
α -Naphthylamine.	1%	11.8	0.6	0.93	2.6	0.38	1.3	1.94	1.7	0.0680	2.4	0.497	4.0	0.003	0.98	1.8	
Chromium oleate.	0.1%																
Castor oil ...	50%																
Rape oil ..	50%																
β -Naphthylamine.	0.5%	45.7	2.1	1.22	4.0	1.12	3.7	0.86	0.8	0.0460	1.6	0.270	2.7	Not measurable	0.77	1.4	
Di-phenylamine	0.5%																

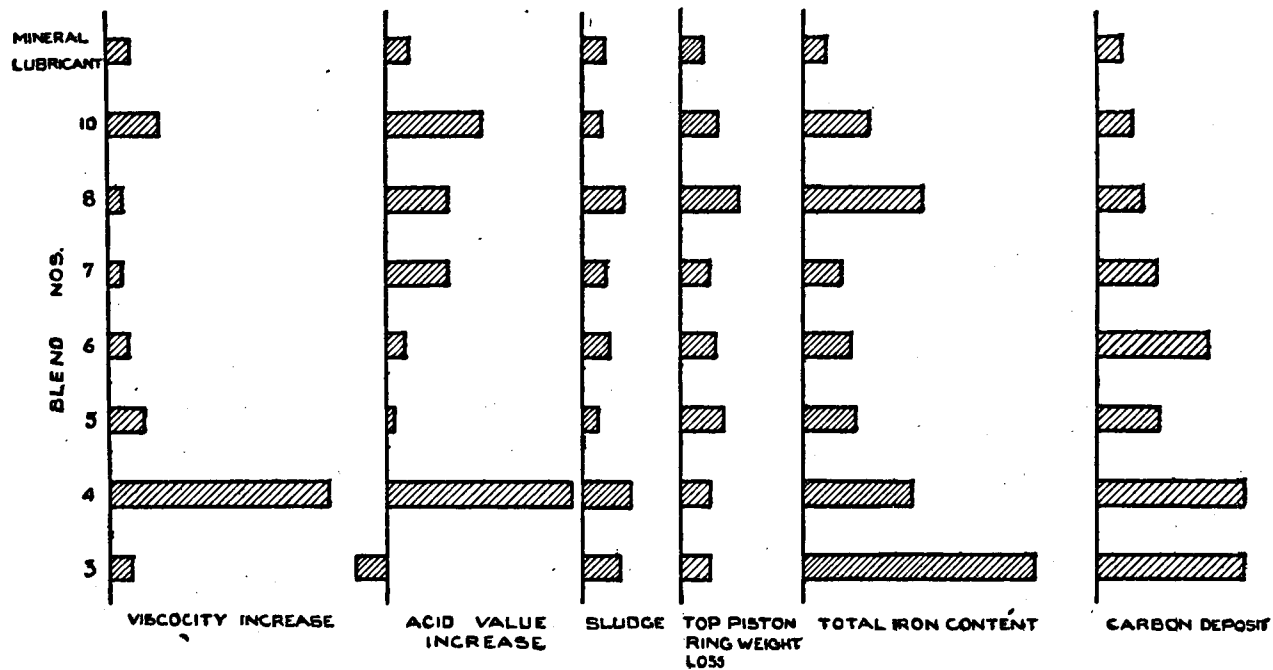

FIG 39.

Graphical representation of the changes (ratios) of the principal characteristics of the various vegetable oil blends as compared with those of the reference lubricant "A" after 100 hours' run in Lister petrol engine dynamo set.

sludge and carbon deposits on piston top and cylinder head. The percentage rise of viscosity, however, was one and a half times that obtained with the reference oil. With regard to wear, although, the cylinder bore showed a negligible change in dimension, the loss of weight of the top piston ring and the total quantity of iron removed by the blend were practically 75 per cent. and 100 per cent. respectively more than in the case of the reference oil. With all this improvement, however, the blend showed a weak point, that is, it caused the sticking of the top piston ring, which was found imbedded in a semi-solid mass of deposit. The reduction of acid value cannot possibly explain this phenomenon, and it is at the same time very difficult to say whether the presence of the residual soap left as a result of refining was at least partly responsible for this state of things, or whether it was purely accidental.

Blend No. 6.

Blend No. 6 was identical in composition with Blend No. 5 except that its soap content was appreciably reduced with a view to determining the extent to which the engine operation is influenced by it and whether it becomes free from the weak points, revealed by Blend No. 5. An examination of Tables V, VI, VII and XIII and Fig. 39 will indicate that this blend showed improvement in some respects (viscosity increase and the quantity of iron removed) and deterioration in others, particularly, in respect of the carbon deposits, which were appreciably higher than in the case of Blend No. 5. The only marked beneficial effect which it seemed to produce was the freedom from gummy deposits in piston ring grooves and the ring sticking tendency produced by Blend No. 5.

Blend No. 7.

This was a castor-groundnut oil blend of the same percentage composition as the preceding blends but was stabilized with α -naphthylamine instead of α -naphthol. It will be seen from the results of engine tests recorded in Tables V, VI, VII, XII and Figs. 4 to 8, 14 to 16 and 39 that this blend showed an all-round improvement except with regard to acid value increase, and proved to be the best of all the vegetable oil blends, so far tried. It is interesting to note that the changes in the various properties of the oils were brought about within practically the first twenty-five hours' run. The viscosity change was the least so far attained and was even less than that obtained with the reference oil; the amount of sludge in the oil after 100 hours' run was also a little less than in the case of the run with the latter. Although the total quantity of iron (0.149 gram) removed from the engine and the weights of deposits (1.82 grams) on the piston top, underside and cylinder head were somewhat greater than the corresponding figures (0.101 and 1.55 grams) obtained with the reference oil, yet they were the least obtained with the vegetable oils tried so far. It may be of interest to point out that in spite of the comparatively large increase in acid value, the wear characteristics of the blend proved to be decidedly superior to those of Blend No. 6 or, for that matter, any other blend tried uptill now.

Blend No. 8.

This blend was identical in composition with Blend No. 7 except for the addition of 0.1 per cent. chromium oleate intended to improve the service

characteristics of Blend No. 7 further, particularly with regard to carbon deposits. It will be readily observed from Tables V, VI, VII and Fig. 39 that, although the viscosity and acid value increase remained practically the same as those in the case of Blend No. 7, it had deteriorated practically in all other respects with the important exception of carbon deposits, which were the least so far obtained with the blends. Although, therefore, the expectation of reduced carbon deposits was fulfilled, the excessive wear as shown by the reduction in weight of top piston ring and the total amount of iron in crank case oil, rules out the blend when compared with Blend No. 7.

Blend No. 10.

Blend No. 10 was a castor-rape oil mixture of the same percentage composition as blend No. 9, but was stabilized with equal parts of β -naphthylamine and diphenylamine. An examination of Tables V, VI, VII, XIII and Fig. 39 will show that with the exception of sludge content and carbon deposits, which showed an appreciable improvement in comparison with Blend No. 7, the blend showed a marked deterioration practically from all other points of view.

The blend, however, was a distinct improvement on Blend No. 8, with regard to the formation of sludge, carbon deposits and wear of the engine parts, although the viscosity and acid value increases were appreciably higher in the case of the former. Comparing the two blends, it may be stated that, generally speaking, Blend No. 8 showed better stability, but worse wear characteristics, whereas Blend No. 10 showed better wear characteristics and worse stability. One other interesting feature which may be pointed out in this connection, is that, while Blend No. 8 showed a less viscosity increase and a greater sludge content, Blend No. 10 showed a greater viscosity increase and a less amount of sludge. The explanation of this phenomenon appears to lie in the fact that in the former, the polymerized and cracked products were less soluble, thus depositing solid or semi-solid residue in the crank case oil, whereas in the latter these products were more soluble giving rise to increased viscosity and deposition of less solid product or sludge.

MORRIS INDUSTRIAL ENGINE.

Blend No. 7.

The various points of interest regarding the performance of this blend in the Morris Engine have already been discussed in detail under the Tables presenting the various data obtained as a result of engine tests. It may now be generally stated that in spite of the blend showing a somewhat greater increase in viscosity and acidity, the frictional losses in the bearing parts and the total quantity of iron removed from the engine parts were similar to those obtained with the reference oil. The loss of weights sustained by the top rings varied between 0.0177 and 0.0387 grams, while corresponding figures obtained as a result of run with the reference oil varied between 0.0110 and 0.0150 grams.

It may also be pointed out that while the bores of two of the cylinders showed an increase of 0.0002" and 0.0005" respectively, none of the cylinders showed any measurable change after 100 hours' run with the reference oil.

The blend, however, was definitely superior to the reference oil as regards the development of sludge or the consumption of oil.

As regards the deposits on the piston top and the cylinder head, it will be seen from Table XII that the blend produced a slightly larger amount of deposits than the reference oil. One other important point that deserves to be considered and has already been discussed at some length is the formation of considerable gummy deposits on the shoulder and part of the stem of the inlet valves and their pockets and the absolute freedom of deposits on all the exhaust valves or their pockets. What was rather interesting was that the amount of deposit generally decreased from one end of the valve chamber to the other, so that the amount of deposit was at a maximum in the case of the inlet valve of No. 1 cylinder and at a minimum or practically nil in the case of the inlet valve of No. 4 cylinder. This at once leads to the conclusion that the oil spray being located close to cylinder No. 1 was delivering an unnecessarily large quantity of oil to the valves adjacent to it. The very fact that there was no trouble regarding the lubrication of the valves, of, say, cylinders Nos. 3 and 4, in their guides, affords an additional proof of this assumption. It should, however, be pointed out that this particular method of lubricating the valve stems is peculiar to this make of engine only; in most engines, the only means of lubricating the valves in their guides is a fine spray of oil carried into the valve chamber from the crank case, so that all the valves get the proper and an approximately equal amount of oil. It may also be pointed out that in the case of run with the reference oil also, the inlet valves (Fig. 33) showed an appreciable deposit, which, however, were not weighed.

In the light of the above explanation, it is not unlikely that the vegetable oil will be free from this defect when worked in other engines. The reason why the vegetable oils should give more deposit on the inlet valves and none on the exhaust valves, appears to be that the temperature of the latter are very much higher and any oil finding its way into the exhaust valve pockets burns out completely, while the temperature of the inlet valves is not high enough for complete combustion nor low enough to retard effectively such reactions as polymerization, decomposition, etc. It is, however, expected that it is possible to eliminate this undesirable deposit on the inlet valve by modifying the method of lubricating the valve chamber or controlling the temperature of the intake mixture.

Briefly stated, the blend was found to be superior to the reference oil in respect of the sludge content and oil consumption, similar to it in respect of the total iron removed from the engine parts and the cylinder wear, and somewhat inferior in respect of viscosity and acid value increase as well as the loss of weight of top piston ring and carbon deposits.

As the quantity of acids cannot be considered to be a criterion of the deterioration of an oil unless it be of such a nature as to cause excessive corrosion of the parts with which it comes in contact, and as the iron content of the crank case oil and the cylinder bore wear were similar for the blend as well as for the reference oil, the comparatively high acidity of the used oil cannot be considered to be a serious defect. The viscosity increase was also not such as to cause excessive frictional losses as determined by the motoring

tests at intervals. The carbon deposits were appreciably more, but in no way excessive. Except therefore, for an appreciably greater loss of weights of some of the top piston rings, and the tendency of accumulation of gummy deposits on the inlet valve shoulders, which are undesirable, if considerable, the blend, on the whole, compared favourably with the reference oil when subjected to engine tests under similar operating conditions.

Blend No. 9.

Blend No. 9 is a castor-rape oil mixture in equal proportions, treated with α -naphthylamine. In view of the satisfactory behaviour of the rape oil with ρ -naphthylamine in the oxidation test, it was decided to replace the groundnut oil in Blend No. 7 by rape oil with a view to improving the performance still further. The percentage composition of this blend, for reasons given before, was adjusted to give a lower initial viscosity (109 c. s. at 100° F.) as compared with 128.6 c.s. in the case of the vegetable oil Blend No. 7 and 122.1 c.s. in the case of the reference lubricant.

An examination of Tables IX, X and XI and Figs. 19 to 23 and 28 to 32 will show that the substitution of rape oil for groundnut oil caused an all-round improvement in the performance of the blend over Blend No. 7 except in respect of oil consumption and carbon deposits on the piston top and cylinder head, which showed a slight increase. The improvement in the two important respects of sludge and iron content of the crank case oil after 100 hours' run was remarkable in that in these respects the blend far excelled the reference lubricant. The loss of weight of the top piston rings, with the exception of one, compared favourably with that obtained with the reference oil. The cylinder bores also did not show any measurable change in dimension except in the case of one, which showed an increase of 0.0003". The improvement in respect of viscosity, acid value and carbon residue was also quite appreciable. It may, however, be pointed out that in view of the wear and friction characteristics of the blend being either superior or similar to those of the reference oil, the slightly higher figures for acid value or viscosity cannot be considered to constitute a serious defect of the oil.

The slightly higher increase in oil consumption can be definitely attributed to the lower initial viscosity of the blend, as the other factors governing it, namely, engine design, speed, engine changes due to wear (which was negligible as the two blends were run consecutively) or volatility (both were fixed oils) remained practically constant. The increased carbon deposits on piston top, etc., as explained previously, might also be attributed to this fact.

The deposits on the shoulder and stem of the inlet valves were of the same magnitude (Table XII and Fig. 38) as those in the case of run with the previous blend, but rather more than that obtained with the reference oil. The possible cause of their formation in decreasing amounts from the point of admission of the oil into the valve chamber and the possible methods of prevention have already been discussed under Blend No. 7.

Except for the formation of the various deposits which can be reduced by one method or another, as pointed out before, the performance of the blend is more or less similar to that of the reference lubricant "A", and with regard

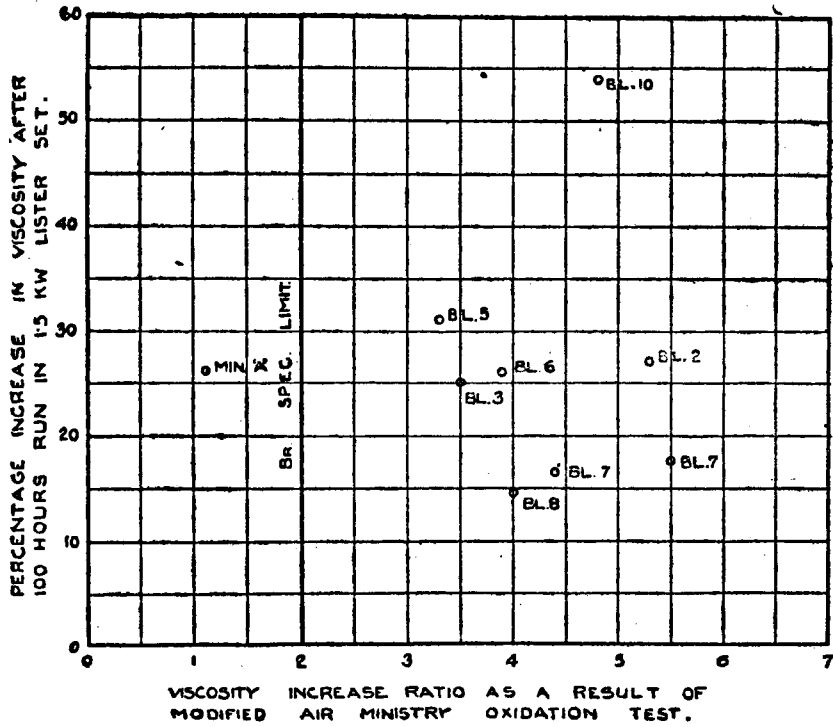

FIG. 40.

Comparison of viscosity increases obtained by Air Ministry Oxidation Test and engine tests.

to sludging and the amount of iron removed from the engine parts, its performance was decidedly superior.

It may, therefore, be stated that Blends Nos. 7 and 9 have proved quite satisfactory as lubricants for petrol engines of the sizes up to about 16 H.P. Blend No. 9 could further be improved by adjusting their viscosity to a slightly higher figure in the neighbourhood of 120-130 c.s., which can be done by increasing the proportion of castor oil in the blend by a small fraction.

Finally, it is desirable to find out if there exists any correlation between the viscosity increase obtained as a result of the Modified Air Ministry Oxidation Test and that obtained as a result of engine operation, so as to justify the selection or grading of lubricating oils merely on the basis of Air Ministry Oxidation Test, or whether the vegetable oils differ from the mineral oils in this respect. To facilitate examination of the degree of correlation, if any, the figures for viscosity increase ratios at 100° F. as a result of the Modified Air Ministry Oxidation Test and the percentage increase in viscosity of the various blends at the same temperature after 100 hours' operation in Lister engine have been collected together in Table XIV below and plotted in Fig 40.

TABLE XIV.

Comparative figures for viscosity increase as a result of Modified Air Ministry Oxidation Test and 100 hours' engine test in 1.5 K. W. Lister set.

Serial No.	Blend.	Viscosity increase ratio at 100° F after Modified Air Ministry Oxidation Test.	Percentage increase in viscosity at 100°F after 100 hours' run in 1.5 K. W. Lister Set.
1	Mineral Lubricant "A"	1.1	26.1
2	Blend No. 1	5.5	15.1
3	Blend No. 2	5.3	27.1
4	Blend No. 3	3.5	25.1
5	Blend No. 4	7.3	270.9
6	Blend No. 5	3.8	30.8
7	Blend No. 6	3.9	26.0
8	Blend No. 7	4.4	16.6
9	Blend No. 8	4.0	14.6
10	Blend No. 10	4.8	53.2

It will be seen that there does not appear to exist any definite correlation between the viscosity increase figures obtained as a result of the Air Ministry Oxidation Test, and actual engine tests on the different vegetable oil blends, which confirms the observations of Hanson and Egerton³² as also those of Mardles and Ramsbottom³³ in the case of mineral oils in general. They

have, therefore, stressed the necessity of actual engine tests as the final criterion of the suitability of a lubricant for I.C. engines. Pye³⁴ also acknowledges the limited value of the British Air Ministry Oxidation Test in the following terms. "A check on the chemical stability of an oil against oxidation at 200° C and decomposition at the higher temperature is aimed at and to some extent achieved. Undoubtedly there are examples of oils which would fail to meet the specification requirement and yet might stand up excellently during prolonged test in service".

The findings of Pye are also sufficiently corroborated by the results of tests (Table XIV) on various blends of vegetable oils obtained in these investigations. In spite of the fact that practically all the blends failed to comply with the requirements of the Air Ministry Specification as regards the viscosity increase ratio, some of the blends, as has been already shown, stood up excellently under engine operating conditions in both small and medium power engines.

ACKNOWLEDGMENT.

The authors wish to acknowledge the work of Mr. A. N. Kapur, who carried out certain preliminary experiments in connection with this investigation.

BIBLIOGRAPHY.

1. Aggarwal, J. S., and Verman, Lal. C.—“Utilization of Indian Vegetable Oils as Lubricants in Internal Combustion Engines”, Part I, *Bulletin of Indian Industrial Research* No. 18, 1940.
2. Thomasi, L., *Ann. Combustibles Liquids*, **13**, 519-45, 1938.
3. Champasaur, N., *Chimie et Industrie*, **24**, 519-25, 1930.
4. Deveze, G. J., *Revue Industrielle*, **63**, 274-81, 340-43, 1933.
5. Angla, B., *Annales des Falsifications*, **29**, 92, 1936.
6. Peru, *Ann. Combustibles Liquids*, **11**, 1071, 1936.
7. Bastet, A., *Bull.-Soc. Encom. Ind. Nat'l.*, **133**, 193, 1934.
8. Balada, A., *Petroleum, Z.*, **33**, No. 38, 1-8; No. 40, 1-8, 1937.
9. Freund, Mihaly, and Thamn, Istvan, A. *Magyar Mérnök-és Építészegylet Közlönye.*, **73**, 222-6, 1939.
10. Southcombe, J. E., *Proc. Phy. Soc. London*, 28 Nov. 1919.
11. Wells, Henry M., and Southcombe, J.E., *J. S. C. I.*, (London), **39** (5) 51-61.
12. Bass, E. L.—“Aero Engine Design and Lubrication,” *Proc. General Discussion on Lubrication and Lubricants, Institution of Mechanical Engineers, London*, Oct. 1937 Vol. 1, Group II, pp. 414.
13. Hawkes, C. J., and Hardy, G. F., “Friction of Piston Rings”, *Trans. North East Coast Inst. Engrs. and shipbuilders*, **52**, 143, 1936.
14. Taylor, M. P. “The effect of Gas Pressure on Piston Friction,” *S. A. E. Journal*, **33**, 200, 1936.
15. Sparrow, S. W., and Thorne, M. A. “Friction of Aviation Engines,” *National Advisory Committee for Aeronautics*, Report No. 262.
16. Dickinson, H. C., and Bridgeman, O. C., “Fundamentals of Automotive Lubrication,” *J. S. A. E.*, **31** (i) 278-82, 1932.
17. Langmuir, *J. A. C. S.*, **33**, 2221, 1916; **39** 1848, 1917; *J. Franklin Inst.* **218**, 143, 1934.
18. Adam, N. K., *Proc. Roy Soc. Gt. Brit.*, **101A**, 452, 1922; **103A**, 676, 1923.
19. Marcelin, *Ann Phys. (a)*, **1**, 19, 1914.
20. Williams, C. G., “Interim Report of the Research Standardization Committee on Cylinder Wear”, *J. Inst. Auto Engrs.*, June, 1933, P. 73.
21. Williams, C.G., “Further Experiments on Cylinder Wear”, *J. Inst. Auto-Engrs.*, Aug/Sept. 1934.
22. Everett, H.A., and Stewart, F. C., “Performance Tests of Lubricating Oils in Automotive Engines” *Penn. State College, Engineering Station Bulletin*, No. 44.

23. Keller, George H., "Cylinder Wear Measured by the Iron Content of the Oil", *Auto. Ind.*, 6 April, 1935.
24. Williams, C. G., "Cylinder Wear—Third Interim Report" *Inst. Auto. Engrs. Report* No. 8604, Class 42.
25. Pye, D. R., "Lubrication and Lubricants", Art. 28, in "The Internal Combustion Engine" (Oxford Clarendon Press), Vol. II, p. 105, 1934.
26. Spitzglass and Zucrow., "Engine Lubrication and Deterioration" (Prepared for Pines Winterfront Company, Chicago, Illinois).
27. Gruse, W. A., "Carbon Deposits in Gasoline Engines", *A. S. T. M. Symposium on Motor Lubricants*, March, 8, 1933.
28. Bahlke, W. H., Barnard, D. P., Singer, J. O., and Fitzsimmons, O., *S. A. E., Trans.*, 26, 373, 1931.
29. Born, S., and Harper, E., *Oil and Gas Jour.*, 33, No. 24, 12, 1934.
30. Evans, E. A., "Lubricating and Allied Oils" (Chapman and Hall Ltd., London), p. 91, 1933.
31. Boerlage, G. D. and Gravesteyn, B. J. J., *Brit. Motorship*, 13 (150), Aug. 1932.
32. Hanson, T. K. and Egerton, A. C. "Influence of Catalysts on the Oxidation of Oils" *Proc. General Discussion on Lubrication and Lubricants* (Institution of Mechanical Engineers), Vol., 2, pp. 334, 1937.
33. Mardles, E. W. J., and Ramsbottom, J. E. "Oxidation Behaviour of Internal Combustion Engine Lubricants" *Proc. General Discussion on Lubrication and Lubricants* (Institution of Mechanical Engineers, Vol. 2, pp. 354, 1937).
34. Pye, D. R. "The Internal Combustion Engine" (Oxford University Press), Vol. 2, "The Aero-Engine".

BULLETINS OF INDIAN INDUSTRIAL RESEARCH



No. 20

**Utilization of Indian Vegetable Oils
as Lubricants in Internal Combustion
Engines**

PART II

BY

**J. S. AGGARWAL, M.Sc., Ph.D.,
H. D. CHOWDHURY, B.Sc., A.M.I.A.E.,
S. N. MUKHERJI, M.Sc., A.M.I.E., (Ind.), and
LAL C. VERMAN, Ph.D., M.S., F.Inst.P.**

(SECOND EDITION)

**DIRECTORATE OF
SCIENTIFIC AND INDUSTRIAL RESEARCH
DEPARTMENT OF INDUSTRIES & CIVIL SUPPLIES
GOVERNMENT OF INDIA**

**PUBLISHED BY THE MANAGER OF PUBLICATIONS, DELHI
PRINTED BY THE MANAGER, GOVERNMENT OF INDIA PRESS, SIMLA
1948**

M53D.fS-MIRDelhi

D6460K 627394.2

H2.2

The statements made and the views expressed in this bulletin are those of the authors, and the Government of India do not accept responsibility for them.

CONTENTS.

SYNOPSIS	iv
INTRODUCTION	1
REQUIREMENTS OF A GOOD LUBRICANT	3
STABILITY	4
ACIDITY	4
WEAR	4
CORROSION	4
CONSUMPTION	4
LABORATORY TESTS	4
OXIDATION TESTS	5
ACID VALUE	5
VISCOSITY AND VISCOSITY INDEX	5
CARBON RESIDUE	6
POUR POINT	6
FLASH POINT AND SPECIFIC GRAVITY	7
OILINESS	7
SAPONIFICATION VALUE	7
IODINE VALUE	7
ENGINE TESTS	7
DEVELOPMENT OF BLENDS	8
EXPERIMENTAL PLANTS	11
EXPERIMENTAL PROCEDURES	12
STANDARDIZATION RUNS	16
MAKE-UP OIL	16
SUMP OIL TEMPERATURE	17
MOTORING TEST	17
SAMPLING OF CRANK CASE OIL	17
EXPERIMENTAL RESULTS	17
PRELIMINARY ENGINE TESTS	17
FINAL ENGINE TESTS	42
DISCUSSION	64
LISTER SINGLE-CYLINDER ENGINE	65
MORRIS INDUSTRIAL ENGINE	70
ACKNOWLEDGMENT	74
BIBLIOGRAPHY	74

SYNOPSIS.

A series of Air Ministry Oxidation Tests (modified) was undertaken on various oils—castor, groundnut, cotton seed and rape with and without the admixture of stabilizers—with a view to determining the physico-chemical changes which take place in oils when subjected to severe oxidation conditions. As a result of this work a number of effective stabilizers was discovered for various oils. Based on these results, which were published in Part I of this series of papers, a number of blends of different oils was developed, having the requisite viscosity characteristics for use as lubricants in internal combustion engines.

The engine equipment consisted of a 3 H.P. single cylinder petrol engine, and a 16 H. P. 4-cylinder petrol engine, both coupled to electric generators for the purpose of loading. Both these engines, particularly the larger one, were suitably modified and a number of test accessories was provided to obtain adequate control of the various operating conditions, such as power output, speed, cooling water temperature, intake mixture temperature, oil pressure, ignition advance, etc.

Preliminary tests of 100 hours' duration were carried out in the small engine on 2 vegetable-mineral oil blends and 7 vegetable oil blends. Of these, the blends that were found to be highly satisfactory were tried in the large engine for 100 hours. For comparison, runs were also made in both engines with two well known makes of mineral oils. Oil samples were withdrawn from the crank case at intervals during the run and at the end of the run; these were thoroughly examined for the various chemico-physical changes, sludge production, iron contamination, etc. Engine parts were carefully measured to an accuracy of ± 0.0001 " before and after the runs, with a view to determining wear. The wear of the top piston ring was determined by weighing with the same end in view. Carbonaceous and other deposits formed on various parts of the engines were carefully observed and recorded.

After a thorough examination of all the data collected it was found that satisfactory vegetable oil blends could be prepared which would compare favourably with mineral oil lubricants in almost all respects, with the exception perhaps of the carbon deposit on piston top, etc., which was slightly more in the case of vegetable oil blends than in the case of mineral oils. But this is not considered a serious drawback, as it does not interfere with the smooth operation of the engine. One of the vegetable oil blends tried actually proved superior to mineral oil in respect of sludge formation and iron dissolution from engine parts. Furthermore, two blends also gave less increase in viscosity than the reference mineral oil.

As a result of these investigations, two types of blends can be confidently suggested for use in medium size internal combustion engines, namely, castor oil-rape oil blends and castor oil-groundnut oil blends. It is important that the oils before blending be thoroughly refined and freed from alkali soaps. For a good stabilizer for these blends, α -naphthylamine is recommended which should be used in proportion of not less than 1%. The proportions of the two oils to be used to form the blend will depend on the viscosity of the lubricant required. Generally, for medium size engines requiring a medium grade of oil, about 60-55% of castor oil to 40-45% of rape or groundnut oil would be appropriate.

UTILIZATION OF INDIAN VEGETABLE OILS AS LUBRICANTS IN INTERNAL COMBUSTION ENGINES—PART II. INTRODUCTION.

The present paper constitutes the second of a series dealing with a systematic investigation into the possibility of utilising Indian vegetable oils as lubricants for internal combustion engines, the first one being devoted mainly to a discussion of the previous work in the field, the general consideration of the factors which might contribute to the successful solution of the problem and the oxidation stability and other characteristics of different vegetable oils or their blends with or without the addition of stabilisers.

The satisfactory operation of a properly designed I. C. engine depends primarily on the characteristics of the fuel as well as of the lubricant. Extensive research work has been carried out during the last few years on the development of suitable fuels for use in aircraft and other high compression engines; and suitable laboratory tests have been devised which correlate to a reasonable degree of accuracy, with the behaviour of fuels in actual service. Similarly, work on mineral lubricating oil for I. C. engines has led to the development of improved methods of refining and treatment which, in conjunction with a number of laboratory tests and actual field or bench tests in engines, have resulted in the markedly improved qualities of the mineral lubricating oils, now available in all parts of the world. No systematic work, on the other hand, appears to have been done on the development of vegetable oils blends as lubricants for use in I. C. engines, although some attempts, as referred to in the first paper of the series, have been made by certain workers to use^{2, 3, 4, 5, 6, 7, 8} either a mixture of mineral and vegetable oils or vegetable oils as such, for example, castor, rape, olive oil, etc., mostly without the addition of any antioxidants or stabilizers.

The only systematic investigations of any importance, which have been recently carried out but not mentioned in first edition of part I, are those of the Hungarian workers, Mihaly and Istvan.⁹ It is of interest to mention that their work has been somewhat on the lines followed by the authors of this paper, but not so comprehensive as the investigation under discussion. They carried out laboratory oxidation tests on Rumanian mineral oil, and castor, linseed and olive oils. Rape oil alone was subjected to oxidation tests with the addition of 0.5% of each of the following antioxidants:—

- | | |
|------------------------------|---|
| (a) Pyrogallol. | (e) Dinaphthyl- <i>p</i> -phenylenediamine. |
| (b) 1:5-Dihydroxynaphthalin. | (f) Benzylaminophenol. |
| (c) <i>o</i> -Ethoxyphenol. | (g) <i>p</i> -Hydroxyphenyl morpholene. |
| (d) <i>o</i> -Aminophenol. | (h) Dibenzylaminophenol. |

The oil before treatment had a density of 0.911 at 20°C, a viscosity of 4.37°E at 50°C, an acid value of 1.62—3.11, and Conradson carbon residue of 0.32. After the oxidation test of the treated oil, the values were respectively 0.917, 5.31—7.43°E, 3.11—5.35 and 0.56. The acid value increase was much more than in the case of the mineral oil. The mineral oils, however, formed sludge during oxidation, while the vegetable oils did not do so. In practical engine test in a 3 H. P. single cylinder engine (1300 R.P.M.), a mixture of ordinary and blown rape oils considerably thickened (34.0°E) and gave rise to a considerable increase in acid value (8.06) without the use of antioxidants. But the addition of an antioxidant (not mentioned) rendered the oil much more stable and the viscosity and acid value increased to 12.2°E.

and 4.16 respectively. The favourable change was also apparent from the operating results, because, with the oil containing antioxidant there was no trouble even after 45 hours' operation. Without the antioxidant, the engine worked only for 25 hours and its output came down from 2.9 to 2.4 H. P. and before it could be shut down, the output fell off considerably all of a sudden. A 50 : 50 mixture of mineral and rape oil with inhibitors also gave satisfactory performance. The consumption of fuel and oil were the same as when mineral oil was used.

The conclusion of Balada⁶, as a result of extensive research work on mineral and rape oil mixtures, on the other hand, are quite contrary to the above findings, although Balada generally agrees with Miha'ly Freund and his co-worker regarding the behaviour of untreated rape oil in engine tests.

One of the main reasons why those countries, which are deficient in mineral oil supplies but are comparatively rich in vegetable oil resources, have not taken up the problem appears to lie in the fact that the vegetable oils, being mainly unsaturated glycerides of fatty acids, as distinct from the mineral lubricating oils which are mostly mixtures of saturated hydrocarbons, are relatively unstable and liable to oxidation, polymerization and even cracking at a lower temperature, resulting in the formation of sludge and gummy substances, which are detrimental to the proper functioning of the engine.

Against the serious disadvantages as mentioned above, there is, however, a certain valuable property, known as oiliness, which is possessed by the fatty oils^{10, 11} to a marked degree and which makes them eminently suitable as lubricants under such conditions as render the existence of full fluid film between the bearing surfaces difficult. It is now well established that the piston friction¹² accounts for practically 70% of the total friction losses in an engine and, therefore, the study of cylinder lubrication has engaged the serious attention of physicists, engineers and chemists in increasing numbers, and exhaustive research work on cylinder lubrication is being carried out by several organizations, particularly by the Research Departments of the Institution of Automobile Engineers, London, and other similar engineering bodies.

The question is whether the lubrication between the cylinder walls and the outer surface of the piston rings is of the fluid or of the boundary type. There are material differences in the answers given to this question by different workers in the field, but it is generally recognized that both types of lubrication^{13, 15, 16} with gradual change from one type to the other, exist between the cylinder wall and piston rings. There is definite evidence¹⁴ to show that the lubrication between the cylinder and the piston tends towards the boundary type near the top dead centre, where the piston speed is low and the high gas pressure exerted behind the rings largely increases the normal pressure between them and the cylinder wall. To a less degree, the same thing occurs near the bottom dead centre at the end of the stroke, when the piston velocity again drops to zero. During the central part of the stroke where the piston speed is higher, full fluid film lubrication is liable to be established and the frictional force is largely unaffected by the surface condition of the metal and the oil. To what extent and at what points these conditions are likely to prevail will depend to a large extent on a number of variables, such as the amount of oil supplied, the speed, temperature, load etc. There will, however, be some boundary lubrication in the vicinity of the dead centres owing to the very low velocity of the piston at these parts of the stroke. The boundary lubrication conditions may also obtain at the moment of starting and stopping the engine or when the viscosity of the oil

is too low or excessively reduced by heat preventing the formation or persistence of a sufficiently thick layer of the lubricant.

Dickinson and Bridgeman ¹⁶ have very aptly observed that the modern conditions of load, speed and viscosity approach the critical point between viscous and boundary lubrication. We may, therefore, definitely conclude that, though by far the major portion of the friction losses in an internal combustion engine is caused by the fluid type of friction, the safety of the engine from undue wear or even seizure cannot, by any means be independent of the characteristics of the oil under boundary conditions. The work of Langmuir, Adam and a number of other investigators ^{17, 18, 19} has thrown a flood of light on the mechanism of lubrication under the above conditions, and it has been proved beyond doubt that the fatty oils, in general, on account of their superior oiliness, consequent on the formation of adsorbed film on the bearing surfaces by virtue of their polar groups, develop less friction; and to that extent the conditions are favourable for reducing wear and preventing bearing seizure.

Until recently, it has been generally assumed that direct abrasion between the piston and cylinder walls is wholly responsible for cylinder wear. The recent investigations of the Institution of Automobile Engineers ^{20, 21} (London) have definitely shown that it is also, to a large extent, the result of corrosion from the products of combustion and that the major part of the wear occurs during the starting and warming up period before the cylinder walls have a chance of attaining a sufficiently high temperature to prevent condensation of water on the surface. This is also confirmed by the work of other investigators. Everett and Stewart ²² and Keller ²³ carrying out the determination of wear by the iron content of the crankcase oil found that iron was removed from the engine practically four times as fast in the first hour as in the succeeding five hours.

It has also been proved by the investigation of the Institute of Automobile Engineers ²⁴ that though pure paraffin is a poor lubricant and gives inadequate protection from corrosion under cold running conditions, the presence of a small percentage of fatty acids or oils greatly improved the resistance to corrosion with consequent reduction in wear. It is, therefore, quite evident that the small percentage of fatty oils, which is added to the mineral lubricant, by forming a strongly absorbed film on the surface of the cylinder, serves as an effective protection from the corrosion products of combustion and of oxidation of the mineral oil. If, however, the mineral oil is completely replaced by vegetable oil, it remains to be seen whether the absorbed film will be any more effective to afford protection from the products of combustion and also from the products of oxidation and decomposition of the vegetable oil, which are likely to be acidic in character.

REQUIREMENTS OF A GOOD LUBRICANT.

Some of the essential requirements which a successful lubricant must satisfy may be stated as follows:—

(1) It must remain stable and undergo as little change in its physical and chemical characteristics as possible under the widest range of operating conditions prevalent in internal combustion engines of varying types and capacities.

(2) It should be free from inorganic acidity and should not show more than a very small degree of organic acidity.

(3) It should prevent the wear of the bearing parts and reduce friction losses to a minimum even under boundary conditions of lubrication.

(4) It should serve as an effective protection against corrosion wear, particularly during low temperature running conditions.

(5) Oil consumption should be minimum consistent with adequate lubrication

STABILITY.

It is well known that the vegetable oils are less stable than the mineral oils. When, therefore, we take into consideration the fact that the temperature of the cylinder walls may reach a value well over 200°C., and that the oil film on it may also be subjected to a scorching temperature of 1000°—2000°C. during every alternate revolution, leading to oxidation and cracking of the oil film, the difficulty of using vegetable oils as lubricants under the above conditions of operation would be apparent. It must, however, be borne in mind that the untreated mineral oils, which are mixtures of hydrocarbon molecules of extreme complexity and variety, contain also from 20 to 40 per cent. of unsaturated hydrocarbons²⁵ and it is only by the elimination of most of these unsaturated compounds by new and improved methods of refining, addition of suitable stabilizer, and various addition agents that the modern mineral lubricating oils of commerce have attained their present position. With the vegetable oils, therefore, which are of comparatively known and constant composition, it is considered, that with suitable stabilizers and addition agents, it should not be impossible to produce suitable blends which would compare favourably with the various grades of existing lubricants.

ACIDITY.

The presence of free inorganic acids in mineral oils is very rare, although traces of sulphuric acid may be left after refining. Free fatty acids are, however, almost always present in compounded lubricating oils in small amounts, and free petroleum acid may also be present in traces. In the case of the vegetable oils, it should also be possible by suitable refining methods to produce a blend having a very low acid value, and the possibility of development of further acidity in storage or use might be taken care of by the choice of suitable stabilizers.

WEAR (ABRASION).

With regard to wear, while there is hardly anything to choose between the vegetable oil and the mineral oil so long as full fluid film is maintained, the vegetable oils, as previously explained, owing to their active polar groups act as effective boundary lubricants and, therefore, cause less wear in those parts where this condition is likely to obtain and ensure a longer life of the engine.

CORROSION.

The effect of corrosion, particularly under cold running conditions, has already been discussed (see page 3), and it has been pointed out how far vegetable oils are likely to be able to withstand these conditions as well as the mineral oils.

CONSUMPTION.

The vegetable oils being fixed are non-volatile in character, and, if suitably stabilized so as to prevent formation of carbonaceous and gummy substances or sludge, are expected to show less or, at least, no higher consumption than is the case with mineral oils.

LABORATORY TESTS.

The various laboratory tests that have been devised for determining the general suitability of a lubricating oil for a particular purpose or for identifying the source of the oil may be divided into the following two classes :—

(1) Those that are carried out for measuring the oxidation stability of an oil.

(2) Those that are carried out for determining the various physico-chemical characteristics, of which the following are some of the more common :—

- | | |
|--------------------------------------|-----------------------------------|
| (i) Acid value ; | (vi) Specific gravity ; |
| (ii) Viscosity and viscosity index ; | (vii) Oiliness ; |
| (iii) Carbon residue | (viii) Saponification value ; and |
| (iv) Pour point ; | (ix) Iodine value. |
| (v) Flash point ; | |

OXIDATION TESTS.

The importance of stability has already been discussed, but it may again be emphasised that it is the most important requirement of a lubricant for internal combustion engines. It is usually measured by the changes in the characteristics of the oil, such as viscosity, acid value, carbon residue and sludge formed, on subjecting it to oxidation tests. Various laboratory oxidation tests have been proposed from time to time to reproduce what may happen under actual engine conditions, but none, so far, can be considered as giving exact information on the changes likely to take place in the characteristics of the oil, although the Air Ministry Oxidation Test, Indiana Test or the Sligh Test furnishes information which may serve as a valuable guide in this respect. The laboratory oxidation tests fail to assess the quality of a lubricating oil, chiefly because they cannot possibly reproduce the various changes in operating conditions which an engine has to encounter in actual service and the changes in the characteristics of the oil, particularly the formation of the different types of sludge which is governed by the conditions of operation, that is, whether an engine is running under low temperature conditions which result mainly in the formation of the emulsion²⁰ type of sludge, or under normal or high temperature conditions which result in what is called 'oxidation sludge'.

For the purpose of the present investigation, modified Air Ministry Oxidation Test, as developed in this laboratory, was found to give fairly reproducible results, although of course, it can claim no better correlation with the actual engine tests than any other similar oxidation test.

ACID VALUE.

The determination of acid value is of particular importance in the case of vegetable oils, which are likely to develop free acids not only by oxidation and thermal decomposition under engine operating conditions, but also under storage conditions. It must, however, be pointed out that it is not only the quantity of acids, but also the nature of acids, which is important in the corrosion of engine parts.

VISCOSITY AND VISCOSITY INDEX.

Of all the major requirements of a lubricating oil, the one that is directly related to the performance of a lubricant in actual service is the satisfactory viscosity-temperature characteristics, as it not only influences the losses in the various bearing parts, the rate of flow of oil and oil consumption, but also, the starting torque or the ease of starting, particularly during the cold weather. A satisfactory lubricant is one which shows a relatively small change in viscosity with temperature, so that once the viscosity is adjusted to suit a specific engine design, there should be no difficulty in starting owing to high viscosity when the engine is cold. Nor should the reduction of viscosity as a result of high temperature during normal running be such as to cause rupture of the film. In the case of the mineral oils, it is only by the development of newer methods of refining and the selection of proper crudes and suitable addition agents that it has now been possible to produce oils of sufficient high viscosity index, while most of the vegetable oils, in the untreated condition, are appreciably better in this respect than even the treated mineral oils

In evaluating the performance of a lubricating oil, it is, therefore, of importance not only to determine the initial viscosity and viscosity-temperature characteristics of the oil, but also to carry out these determinations at intervals during the progress of the engine tests, in order to study the progressive deterioration of the oil as a result of oxidation, thermal decomposition or other chemical reactions.

CARBON RESIDUE.

The deposits in the different engine parts, which are generally classified under the name of "Carbon" are generally formed by the oxidation and breakdown of the oil or sometimes by the incomplete combustion of the fuel in the combustion space.

The various factors which influence the formation of carbon deposits in gasoline engines have been summed-up by Gruse²⁷ as follows:—

- | | |
|--------------------------------|--------------------------------------|
| (1) Engine running conditions; | (5) Air-fuel mixture ratio; |
| (2) Oil consumption; | (6) Engine design and condition; |
| (3) Time since cleaning; | (7) Characteristics of the fuel; and |
| (4) Amount of dust in air; | (8) Characteristics of the oil. |

It should appear from the numerous factors which influence the formation of carbon deposits in the various parts of an internal combustion engine that it is well-nigh impossible to devise any single laboratory test or group of tests which can correlate with the actual engine performance in this respect with any reasonable degree of accuracy. A number of physical and chemical tests, however, have been proposed from time to time for estimating the carbonizing tendency of the lubricating oils, the most important among them being the coking tests, such as Carbon residue or Conradson Carbon and the Coke number of the Ramsbottom tests, but there is a material difference in the extent of correlation between the laboratory tests and the actual engine performance, obtained by the different workers. Another test which claims better correlation²⁸ is the Vacuum Distillation Test, which measures the temperature of the 90 per cent. distilled point at an absolute pressure of 1 mm. mercury. This test, however, cannot be directly applicable to the case of the vegetable oils which are fixed oils.

It may be pointed out that although some workers have found a good correlation between the above tests and the engine deposits in the case of oils of similar origin, others have failed to do so when testing oils from different sources or subjected to different treatments²⁹.

These deposits which vary in character from the hard asphaltic to the soft gummy type are found in the—

- (1) Combustion chamber, comprising the piston top and cylinder head.
- (2) Shoulder and stems of the valves and valve seats.
- (3) Underside of the piston.
- (4) Piston ring grooves and ring lands.
- (5) Piston ring slots and drain holes on the scraper ring groove.

The effect of excessive deposits on the various parts, as outlined above, is too well known to need any further elaboration. While the mineral oils are not altogether free from the tendency of producing carbon, the problem of using vegetable oils as lubricants in an internal combustion engine is the more complicated by the severity and complexity of operation in an engine and also by the fact that the vegetable oils, in general, have a higher carbonizing tendency than most of the mineral lubricants.

POUR POINT.

This test is carried out to determine the ability of an oil to flow at flow temperatures. In view of the fact that some of the low iodine value vegetable oils, such

as coconut oil set at even ordinary winter temperatures, this value is of importance in deciding whether a particular oil should be used as a lubricant.

FLASH POINT AND SPECIFIC GRAVITY.

These tests have their chief value in being useful for identifying an oil or aiding the refinery control. They do not, however, give any indication of the lubricating quality of an oil, although it would not be unreasonable to suppose that a higher flash point might mean greater resistance to the oil being burned on cylinder walls on the explosion stroke.

OILINESS.

The significance of this property in a lubricating oil has already been dealt with at length, but while its determination is of importance in the case of the mineral oils, which are generally deficient in this property, it was not considered necessary to undertake the determination of this property in the present investigation in view of the markedly superior oiliness possessed by the fatty oils in general.

SAPONIFICATION VALUE.

The saponification value of an oil serves as a valuable guide to its identification or to determining its purity. Although it is not a fixed value, it varies within narrow limits and hence, in conjunction with other characteristics, it is useful for purposes of identification. In the present investigation, the determination of this characteristic at different stages of the run served the useful purpose of indicating the rate of decomposition or oxidation (and/or polymerisation) of the oils. A decrease in saponification value indicates the formation of hydrocarbons or other neutral products and a rise in saponification value indicates the formation of more acidic components.

IODINE VALUE.

Although iodine value is not considered to be a very reliable guide to unsaturation in the case of mineral oils, it is considered to be sufficiently indicative of the degree of unsaturation in the case of fatty oils³⁰. The determination of this value in the case of the vegetable oils may, therefore, be considered to be of importance as throwing some light on the extent of saturation acquired by the lubricant at different stages during the progress of the run.

ENGINE TESTS.

As indicated earlier, no single physical or chemical test or group of tests has been developed up to now, which can predict the behaviour of an oil under actual service conditions, even in an approximate manner. The actual engine test is, therefore, considered to be the only reliable means of determining the suitability or otherwise of a lubricating oil. Now, the engine tests may comprise either actual road tests or bench tests under carefully controlled conditions to represent the average road conditions so far as the average operating temperature, load and speed are concerned. When, however, it is realised that the range of operating conditions encountered in actual service is practically unlimited, one might think that the results of tests under these conditions would hardly apply to those obtained with bench tests. On the other hand, the field tests giving dependable and reproducible data are too expensive and rather difficult to carry out. Under the circumstances, the dynamometer tests under carefully controlled conditions are generally adopted and considered to be good enough for evaluating the performance of an oil under service conditions.

The problem, therefore, reduces itself to the—

(1) Development of suitable vegetable oil and mineral—vegetable oil blends of required viscosity and the selection of the suitably stabilized ones for engine.

tests, on the basis of oxidation and other laboratory tests on the individual oils as well as on their mixtures.

- (2) Development of suitable engine equipment.
- (3) Standardization of the various test-conditions.
- (4) Assessing the results of tests on the various vegetable oil blends in comparison with those obtained with the reference lubricant (such as a reputed make of mineral oil).

DEVELOPMENT OF BLENDS.

Extensive Air Ministry Oxidation Tests (modified) were undertaken on castor, ground nut and cotton seed oils in conjunction with a very large number of stabilizers in contact with steel in order to select those oils that are likely to prove satisfactory in actual engine tests. A number of effective stabilizers were found for each of the oils, the degree of stabilization that could be effected being the maximum in the case of castor oil and the minimum in the case of cottonseed oil. It was brought out by these experiments that the most effective stabilizers found for the cottonseed oil were not as effective enough, and even the best stabilizers for ground nut oil were not as effective as those found for castor oil. The results of these investigations have been described in detail in Part I of this series of papers. It was decided to confine engine tests, in the initial stage, to castor and ground nut oils and prepare their mixtures in varying proportions to adjust the viscosity within the limits specified by B. S. Specification No. 210—1930 for medium lubricating oils for internal combustion engines, recommended by the makers of the engines in which tests were carried out. The following two mixtures which satisfied the specification requirements as regards viscosity were again subjected to a series of Air Ministry Oxidation Test (modified) in conjunction with the most effective stabilizers found for the individual oils.

Castor oil	60%	40%
Ground nut oil	40%	60%

The effects of the various stabilizers on these two blends are shown in Tables I and II below.

TABLE I.

Effect of various stabilizers on a blend of castor oil 60% and ground nut oil 40% when subjected to modified Air Ministry Oxidation Test.

Serial No.	Stabilizer			Viscosity at 100°F. (centistokes).	Viscosity increase ratio.	Acid value.	Conradson carbon-residue.	Remarks.
	Name.	Quantity, %						
1	Original (unblown)	122.1	..	2.5	0.27	
2	No stabilizer	893.8	7.3	4.2	0.97	
3	α -Naphthol	..	1.0	424.9	3.5	4.0	1.29	
4	α -Naphthol and β -Naphthol	..	0.4	423.4	3.5	4.5	1.0	
5	α -Naphthol and Pyrogallol	..	0.4	483.4	3.9	2.4	1.5	Slight brownish black deposit.
6	α -Naphthol and Hydroquinone	..	0.5	482.0	3.9	4.3	1.27	Slight black deposit.
7	Hydroquinone and β -Naphthylamine	..	0.5	425.5	3.5	4.2	1.26	Black deposit.
8	α -Naphthol and <i>p</i> -Phenylenediamine	..	0.4	470.7	3.85	3.1	1.1	Do.
9	α -Naphthol, β -Naphthol and Hydroquinone, β -Naphthylamine and <i>p</i> -Phenylenediamine	..	0.2	472.1	3.86	5.05	1.43	Do.

Serial No.	Stabilizer		Quantity, %	Viscosity at 100°F (centistokes).	Viscosity increase ratio.	Acid value.	Conradson carbon-residue.	Remarks.
	Name.							
10	α -Naphthol	0.4					
	Hydroquinone and	0.3	495.4	3.74	4.4	1.1	Black deposit
	β -Naphthylamine	0.3					
11	α -Naphthol and	0.4	546.8	4.5	3.64	1.35	
	Benzidine	0.6					
12	α -Naphthylamine	1.0	442	3.6	4.8	1.22	
13	β -Naphthylamine	1.0	454	3.7	4.4	1.25	
14	α -Naphthylamine and	0.6	451	3.7	4.4	1.24	
	β -Naphthylamine	0.4					
15	α -Naphthylamine and	0.4	448	3.65	4.3	1.3	
	β -Naphthylamine	0.6					
16	<i>p</i> -Toluidine	1.0	541	4.43	3.6	1.17	

TABLE II.

Effect of various stabilizers on a blend of castor oil 40% and groundnut oil 60% when subjected to modified Air Ministry Oxidation Test.

Serial No.	Stabilizer.		Quantity, %	Viscosity at 100°F (centistokes).	Viscosity increase ratio.	Acid value.	Conradson carbon-residue.	Remarks.
	Name.							
1	Original (unblown)	83.7	..	2.5	0.29	
2	No stabilizer	687.1	8.2	4.2	1.03	
3	α -Naphthol	1.0	352.3	4.2	4.1	1.15	
4	α -Naphthol and	0.4	356.5	4.2	4.2	0.89	
	β -Naphthol	0.2					
5	α -Naphthol and	0.4	423.4	5.0	2.1	1.41	Brownish black deposit.
	Pyrogallol	0.6					
6	α -Naphthol and	0.5	360.8	4.3	4.0	1.0	Slight black deposit.
	Hydroquinone	0.5					
7	Hydroquinone and	0.5	355.8	4.2	4.4	1.23	Black deposit.
	β -Naphthylamine	0.5					
8	α -Naphthol and	0.6	443.9	5.3	2.9	1.0	Considerable black deposit.
	<i>p</i> -Phenylenediamine					
9	α -Naphthol	0.2					
	β -Naphthol	0.2					
	Hydroquinone,	0.2	427.3	5.1	4.6	1.4	Black deposit.
	β -Naphthylamine and	0.2					
	<i>p</i> -Phenylenediamine	0.4					
10	β -Naphthol	0.4					
	Hydroquinone and	0.3	377.9	4.5	4.3	1.4	Do.
	β -Naphthylamine	0.3					
11	α -Naphthol and	0.4	464.9	5.5	4.4	1.39	
	Benzidine	0.6					

From the result of tests summarised in Tables I and II it will be seen that the blend containing 60% of castor oil and 40% of groundnut oil showed, in general, better stabilization than that containing 40% of castor oil and 60% of groundnut oil. The former blend was therefore adopted as a standard mixture for engine test. In order, however, to obviate any possible risk or damage to the engine, it was considered desirable to try mineral oil and castor oil mixtures to start with, and then gradually to substitute purely vegetable oil blends. This necessitated the development of a suitable process for rendering castor oil miscible with mineral oil. Although a number of such processes was developed, they had their difficulties, and therefore on this ground and also on the ground of economy, it was decided

ultimately to introduce a certain percentage of groundnut oil which would render castor oil miscible with mineral oil without any special treatment. One such blend which was quite stable and did not separate on standing was a mixture containing 40 parts of groundnut oil, 40 parts of castor oil and 20 parts of mineral oil "A". The resulting viscosity was also well within the limits of viscosity for medium lubricating oils for internal combustion engines. The engine test was, therefore, initiated with this blend in conjunction with 2 parts by weight of β -naphthol, which, on the basis of laboratory tests carried out so far, gave an indication of the likelihood of satisfactory behaviour in the engine tests. This was followed by Blend No. 2, which was composed of 60 parts of blown groundnut oil and 40 parts of mineral oil "A" with 2% β -naphthol and 0.2% tin-naphthenate as stabilizers. The results of engine tests on these blends, as shown later on, being generally satisfactory, several pure vegetable oil blends were developed as a result of extensive laboratory tests on the individual oils and on their blends with various stabilizers. The composition of the various blends tried and the results of modified Air Ministry Oxidation Tests are given in Tables III and IV respectively.

TABLE III.
Composition of blends.

Blend No.	Mineral lubricant "A" %	Castor oil %	Groundnut oil %	Rape oil	Stabilizer	Remarks
1	20	40	40	..	β -Naphthol 2% ..	Unrefined vegetable oils.
2	40	..	60 (blown)	..	β -Naphthol 2% and Tin-naphthenate 0.2%.	Do.
3	..	60	40	..	α -Naphthol 1% ..	Unrefined oils.
4	..	60	40	..	No stabilisers ..	Do.
5	..	60	40	..	α -Naphthol 1% ..	*Refined oils; soap content—0.1114%.
6	..	60	40	..	α -Naphthol 1% ..	Refined oils; soap content—0.0195%.
7	..	60	40	..	α -Naphthylamine 1% ..	Refined oils.
8	..	60	40	..	α -Naphthylamine 1% Chromium oleate 0.1%.	Do.
9	..	50	..	50	α -Naphthylamine 1% ..	Do.
10	..	50	..	50	β -Naphthylamine 0.5% Diphenylamine 0.5%.	Do.

*The refining of the oils was carried out by the ordinary alkali refining process, the quantity of excess soap being controlled by repeated washing with hot water.

TABLE IV.
Results of Modified Air Ministry Oxidation Test on the mineral and vegetable oil blends.

Blend Nos.	Viscosity Increase Ratio.	Acid value.		Conradson Carbon Residue.	
		Initial.	Final.	Initial.	Final.
1	5.5	0.35	0.97
2	5.3	0.56	1.27
3	3.5	2.5	4.0	0.27	1.29
4	7.3	2.5	4.2	0.27	0.97
5	3.8	0.86	2.6	0.27	1.58
6	3.9	0.88	3.5	0.22	1.47
7	4.4	1.0	3.1	0.18	1.56
8	4.0	1.1	3.4	0.21	1.21
9	4.6	1.2	4.4	0.20	0.96
10	4.8	1.6	4.1	0.22	1.1
Mineral Lubricant "A"	1.08	0.0	0.5	0.21	0.26
Mineral Lubricant "B"	1.59	0.1	1.6	0.08	1.90

EXPERIMENTAL PLANTS.

With a view to obviating any risk or damage to a larger engine in which the severity of operating conditions is bound to be excessive, it was planned to carry out the preliminary engine tests in a single cylinder 3 H.P. Petrol Engine and to have the blends that behaved satisfactorily in this unit to be subjected subsequently to more severe operating conditions in a 16 H.P. 4-cylinder Morris Industrial Petrol Engine.

The description of the engines, and their auxiliary equipment is given below :—

(1) 1.5 K.W. 'Lister' Petrol Engine-Dynamo Set.

This unit consisted of a 3 B.H.P. vertical single cylinder 4-stroke water-cooled petrol engine, 4" bore and 4-3/8" stroke, rated at 700 R.P.M. and directly coupled by means of a flexible coupling, to a 110 volt compound wound D. C. generator of the enclosed ventilated type, both being mounted on a cast iron bed plate. The engine was delivered fitted with a Lister Patent flood-proof type carburetter, a Lister Patent centrifugal type of governor and high tension magneto ignition system. The jacket cooling arrangement comprised a radiator cooled by a fan, driven from the shaft by means of a belt.

The lubrication of the bearing parts with the exception of main bearings is effected by means of splash from the oil trough at the bottom of the crank case, the latter being lubricated by oiler rings dipping into the same trough.

The engine was loaded by the generator, the output of which was arranged to be dissipated in a suitable water cooled resistance through a switch board with the electrical control instruments, etc. (Fig. 1).

In order to record the running temperature of the crank case oil, a mercury-in-glass thermometer was inserted through a suitably drilled hole in the crank case drain hole plug. A similar thermometer was inserted through the top cover of the radiator for measuring the temperature of the cooling water which was kept constant at $205 \pm 2^\circ\text{F}$ during these investigations. The temperature control was effected by putting the radiator fan out of action by removing the belt between the fan pulley and the shaft, admitting a controlled stream of cold water into the inlet side of the cylinder jacket and letting a controlled quantity of hot water overflow through the radiator overflow tube.

(2) Morris Industrial Engine-Dynamometer set.

This unit consisted chiefly of a 16 H.P. Morris Industrial Petrol Engine coupled to an electric dynamometer (Fig. 3).

The engine was a 4-cylinder petrol engine having the following specifications.—

Rated Power ..	16 H.P.	Bore 2.75"
Rated Speed ..	1500 R.P.M.	Stroke 4.0"

The lubrication of the crank-shaft bearings is effected by a pressure feed system, whereas the lubrication of all other internal parts is provided for by splash from the oil trough. The engine as supplied was equipped with the following :—

- (i) One centrifugal water circulating pump on the water jacket outlet.
- (ii) One spring loaded centrifugal type of governor with speed control device, regulating the carburettor throttle and designed to maintain the speed constant at all loads.

The engine as purchased was of the commercial type, but it was converted into an experimental unit by introducing certain modifications with a view to running

it under strictly controlled conditions. The modifications included the following items :—

(1) The radiator, which was mounted close to the engine on the same channel base, was dismantled and installed outside the laboratory. It was connected to the outlet of the circulating pump and the inlet of the cooling water jacket by means of 1½" pipes.

(2) An electric fan was provided for cooling the radiator and adjusting the temperature of the circulating water, the speed of the fan being controlled from inside the laboratory by means of a rheostat mounted on the switchboard.

(3) Two thermometer pockets (Fig. 2) were provided, one at the inlet and the other at the outlet of the cooling water jacket.

(4) In order to maintain the temperature of the intake mixture constant a 1.5 K.W. electric heater was introduced into a re-entrant type of manifold between the carburettor and the intake manifold of the engine (Fig. 2). The heater was provided with a three-heat switch and a rheostat and ammeter mounted on the switchboard for accurate temperature control, the temperature being indicated by a thermometer located in a pocket provided at the intake port.

(5) One neon tube spark ignition indicator was provided to indicate the exact angle before T. D. C. at which the ignition took place.

(6) For adjusting the ignition angle, a convenient control was provided at the magneto.

(7) One oil pressure regulating valve designed to control the oil pressure in the lubrication system was installed in the oil feed line.

(8) One copper-constantan thermocouple, which was suitably insulated, was inserted through a suitably drilled hole along the length of the oil dipstick for measuring the crank case oil temperature.

The engine was coupled to the dynamometer through a flexible rubber canvas-disc coupling of the Hardy type. The dynamometer was of the usual trunnion mounted yoke type and was provided with two cantilever arms, one connected to a weighted centre-zero spring balance with hand wheel positioning gear, and the other to an oil dashpot, which served to damp out the vibrations. The length of the lever arm was so designed that the torque delivered by the engine could be easily calculated by multiplying the spring balance reading with a simple multiplier. The unit was also provided with a revolution counter.

The engine-dynamometer assembly was mounted on a pair of channel pieces, anchored to a reinforced concrete bed, which was isolated from the laboratory floor by providing a clearance of 3/4" between the bed and floor all around and filling up the gap with pitch.

The dynamometer could be used as a motor for starting the engine or as a generator for delivering the power output to a load resistance through suitable measuring instruments (see Fig. 2 for electrical connections and other details).

EXPERIMENTAL PROCEDURE.

Before undertaking actual engine tests on the various oils or their blends both the engines, which were new, were run in for a sufficient length of time on mineral lubricating oil for the proper bedding of bearings. For this purpose, the Lister Petrol Engine-Dynamo Set was run at approximately half load (0.75 kw) and full-speed (700 R.P.M.) for 30 hours, followed by another 100 hours' run at full load and full speed.

The total running in period for the Morris engine, was of 100 hours' duration,

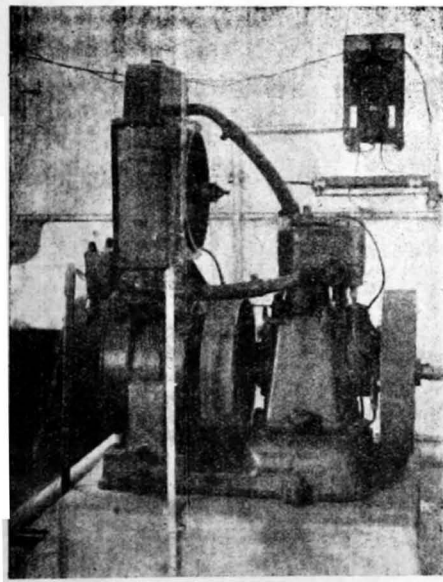

FIG. 1.

General view of Lister Petrol Engine-Dynamo set with switchboard and water cooled dissipating resistance in the background.

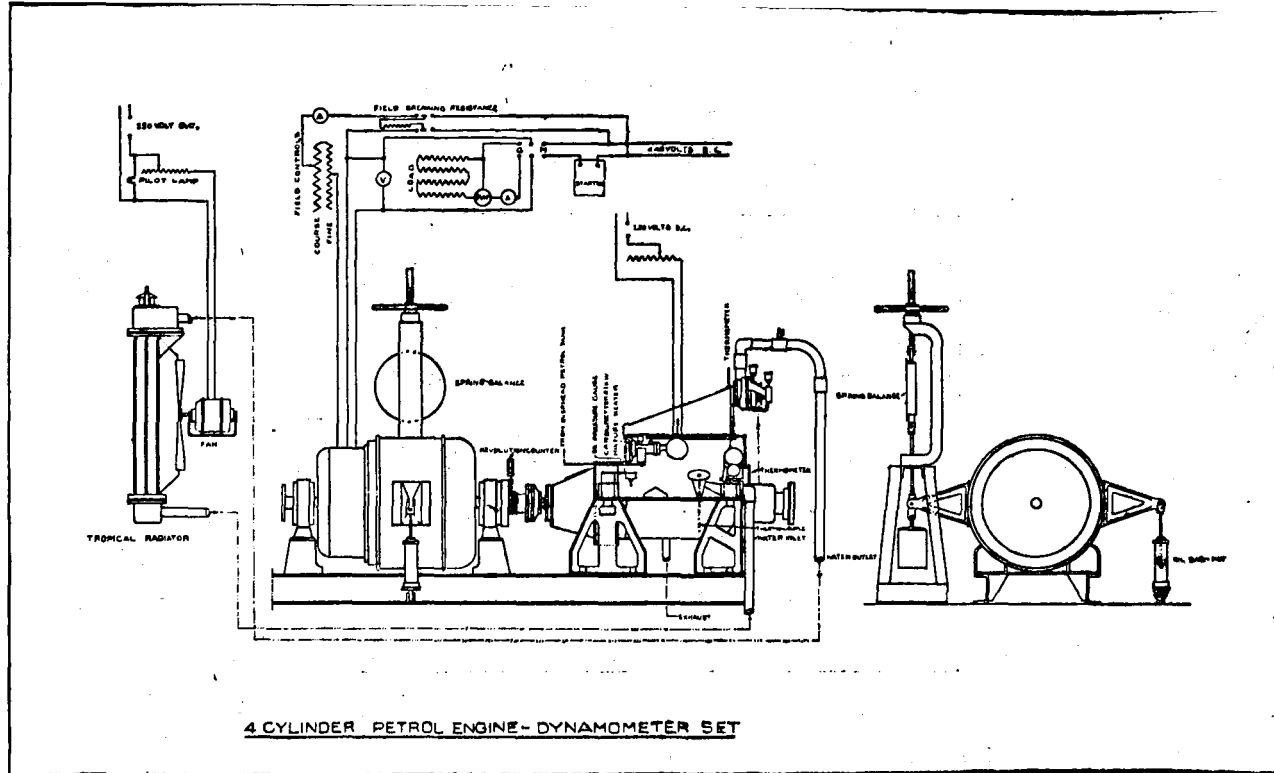

FIG. 2.
Diagrammatic Layout of the Experimental Plant showing essential details of the Morris Petrol Engine, the Dynamometer and the electrical control circuits

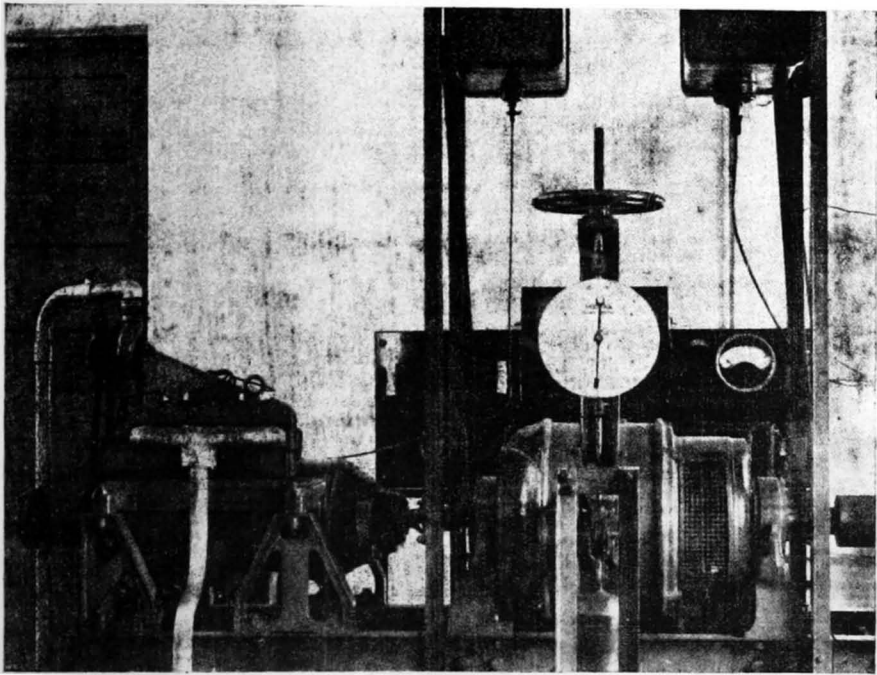

FIG. 3.

General view of the Morris Engine Dynamometer equipment with switchboard and dissipating Resistance Bank in the background.

the first 50 hours' run being conducted at approximately half load (7 B.H.P.) and three quarters maximum speed (1,200 R.P.M.) and the subsequent 50 hours' run at approximately full load (14 B.H.P.) and full speed.

Standard condition.

At the conclusion of the running-in period, a series of trial runs was carried out, particularly with the Morris Engine, for standardising the various operating conditions under which the engine tests could be conveniently carried out. As a result of these experiments, following engine conditions were standardised:—

Lister Petrol Engine-Dynamo Set.

(i) Engine Speed	700 R.P.M.
(ii) Power output	1.8 H.P.
(iii) Radiator water temperature	205° ± 2°F.

Morris Industrial Engine.

(i) Engine speed	1,500 R.P.M.
(ii) Power output	14 B.H.P.
(iii) Jacket water temperature at the outlet	170° ± 1°F.
(iv) Spark advance	30° before T.D.C.
(v) Intake mixture temperature	120° ± 1°F.
(vi) Oil pressure	15 ± 2 lbs. per square inch.

It may be pointed out that the maximum power output available under the above standardised conditions of operation averaged at 14 B.H.P. approximately as against the rated output of 16 B.H.P. specified by the makers. This is approximately what may be expected due to power reduction caused by the heating of the intake mixture to a high temperature and also maintaining the jacket water temperature at a fairly high value.

STANDARDIZATION RUNS.

After the standardization of the various operating conditions under which the engine tests were to be carried out, both the engines were opened up for thorough examination of the various parts and measurement of cylinders, pistons, bearings, etc., with a view to determining the wear and other changes that might take place as a result of subsequent runs. After reassembling, a 100 hours' standardization run was undertaken on each unit with one of the reputed proprietary brands of mineral lubricant, which will be referred to as reference lubricant "A" in this paper. Engine test was also carried out with another mineral lubricant which has been designated as mineral lubricant "B". In order to obtain results of adequate precision it was proposed to carry out standardization runs at intervals to take into account the variation of test conditions due to mechanical changes and wear of the engine parts which would enable the results of engine tests at different stages of the investigation to be properly assessed.

MAKE-UP OIL.

Prior to the commencement of each day's run, the make-up oil was added to bring the level of the crank case oil in the Morris engine to a fixed mark on the dip stick, as recommended by the makers of the engine. In the case of the smaller engine (Lister), the make-up oil was added till the oil in the trough just overflowed. Some inaccuracy exists in the make-up oil figures for the smaller engine due to some of the oil used for lubricating tappets and governor finding its way into the crank case, but this is not considered to be serious, as the ultimate suitability of the various blends is to be determined by tests in the larger engine (Morris) where this possibility is practically ruled out.

M53DofS&IRDelhi.

SUMP OIL TEMPERATURE.

The equilibrium temperature of the crank case oil was recorded daily during the progress of the engine test. This was done by means of a copper-constantan thermocouple, already described.

MOTORING TEST.

In order to determine the progressive changes, if any, in frictional losses owing to alteration in characteristics of the oil under the operating conditions, a motoring test was periodically carried out at the end of a day's run when the engine was thoroughly hot and the operating conditions stable. The change-over from generating to motoring was effected with as little delay as possible and without any effective change of speed, care being taken to cut off the fuel supply and to switch off the ignition as soon as the carburetter ran dry.

SAMPLING OF CRANK CASE OIL.

In order to determine the changes in physical and chemical characteristics of the oil, as also the iron content (both in solution as well as insoluble residue along with the sludge) during the progress of the run, 50 c.c. samples of the crank case oil were drawn at intervals of 25 hours approximately. The sampling was done by means of a pipette during the run or immediately after it before the sludge content of the oil or other suspended matter had a chance of settling down, so that the sample was thoroughly representative of the main bulk of the crank case oil.

EXPERIMENTAL RESULTS.

The results of the engine tests with the various blends, which were developed in this Laboratory, as well as those obtained from the use of the mineral oil, which was taken as a reference lubricant for comparative study, are summarized under the following two heads :—

(i) Preliminary engine tests, *i.e.*, tests carried out in the 1.5 K. W. Lister Petrol engine-dynamo set.

(ii) Final engine tests, *i.e.*, tests carried out in the 16 H. P. Morris industrial engine-dynamometer set.

PRELIMINARY ENGINE TEST.

In Table V are summarised the variations in the more important characteristics of the oils or their blends with engine operation, which more or less give indication of the oxidation and thermal stability of the oils under engine operating conditions.

In Table VI are summarised some characteristics other than those shown in Table V and their variations with conditions of engine operation, which, though not important from the point of view of judging the suitability of the oils as regards their lubricating quality, throw a good deal of light on the character of the changes taking place in the oils and, consequently supply data on which attempts at improvement of quality of the oil may be based.

In Table VII are summarised the data which are directly or indirectly related to the friction losses and wear in the more important engine parts as a result of the deterioration of the oil and abrasion or corrosion or both.

In Table VIII are summarised the results of examination of the engine parts after each run and the nature and amount of deposits on piston, cylinder head, valves, etc., the deposits being carefully scraped off, collected and weighed wherever they occur in appreciable amount.

TABLE V.

Changes of lubricating oil characteristics showing oxidation and thermal stability under engine operating conditions, in 1-5 K. W. Lister set.

(three figures under any head correspond respectively to 0, 50 and 100 hours' operation).

No. of run.	Blend.	Viscosity at 140°F. (centistokes).	Rise in viscosity %.	Viscosity index.	Acid value.	Conradson carbon residue %.	Total amount of sludge (grams)	Crank case dilution %.
1	Mineral lubricant "A"	42.4	..	103	0	0.19
		42.2	0.24	0.35
		49.7	17.2	..	0.46	0.47
2	Blend No. 1	41.8	4.15	0.30
		45.5	5.10	0.85
		46.5	11.2	..	5.45	0.92
3	Blend No. 2	52.9	2.90
		59.9	2.99
		66.3	25.3	..	3.43
4	Mineral Lubricant "B"	41.3	..	57.9	0.08	0.08
		44.4	..	62.3	0.28	0.16
		46.7	13.1	83.5	0.30	0.16	1.50	..
5	Blend No. 3	45.4	..	116.0	2.50	0.20
		50.1	..	115.0	2.20	0.58
		55.1	21.4	115.0	2.16	0.79	1.64	..
6	Blend No. 4	45.6	..	116.0	2.34	0.20
		78.8	..	115.0	3.60	0.88
		144.2	216.2	110.0	5.09	1.40	2.34	..
7	Blend No. 5	48.1	..	112.7	0.86	0.27
		52.9	..	115.9	0.92	0.59
		63.2	31.4	115.8	0.99	0.60	0.81	0.8
8	Mineral Lubricant "A"	43.7	..	102.6	0.10	0.19
		47.0	..	100.2	0.37	0.26
		53.0	21.3	99.0	0.46	0.49	1.12	1.6
9	Blend No. 6	46.5	..	114.5	0.88	0.22
		51.0	..	117.0	1.00	0.43
		55.9	20.2	114.5	1.20	0.58	1.32	0.8
10	Blend No. 7	46.1	..	110.0	1.00	0.18
		47.6	..	111.0	1.60	0.37
		51.8	12.4	114.0	1.84	0.46	1.06	0.8
11	Blend No. 8	48.3	..	114.0	1.07	0.21
		53.4	..	113.0	1.80	0.40
		54.0	11.8	113.2	2.00	0.59	1.94	..
12	Blend No. 10	41.8	..	121.0	1.55	0.22
		50.5	..	120.3	2.30	0.65
		60.9	45.7	121.6	2.77	1.34	0.86	0.8

From a careful examination of Table V and Fig. 4 it will be seen that the percentage rise in viscosity as a result of 100 hours' run was maximum (216.2 %) in the case of Blend No. 4, containing no stabilizer and minimum in the case of Blend No. 7 (12.4 %) and 8 (11.8% without, of course, taking into consideration Blend Nos. 1 and 2 which were mineral-vegetable oil mixtures. The viscosity increase in the case of mineral reference lubricant "A" in both the standardization runs was appreciably higher than that obtained with either of the vegetable oil blends 7 and 8, although the crank case dilution after the second standardization run was twice that obtained with either of these blends. The data, presented above, clearly demonstrate the very marked effect of the addition of stabilizers in suppressing the various chemical reactions which lead to an increased viscosity.

* Unless otherwise stated, the performance of the various blends will be compared with that of the reference lubricant "A" during the second standardization run (Run No. 8).

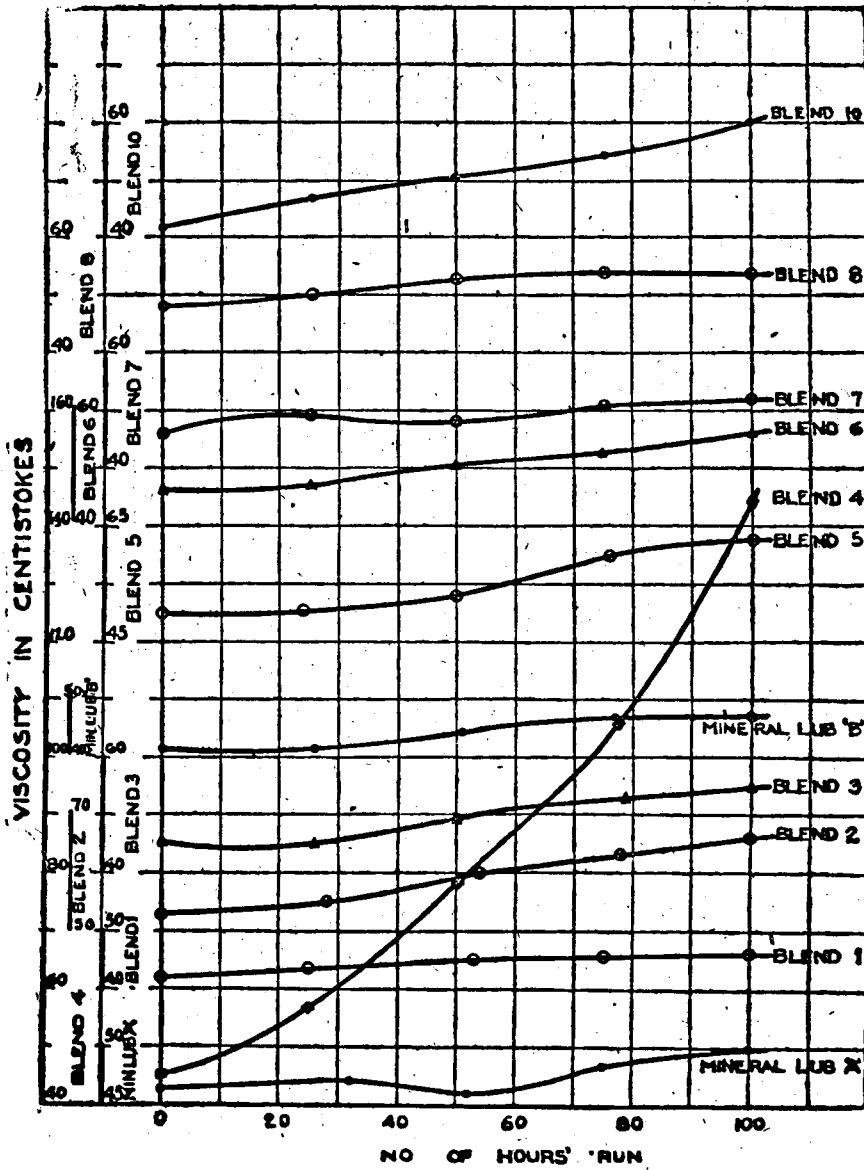

FIG. 4.

Change of viscosity with the duration of run in 1.5 K.W. Dister set.

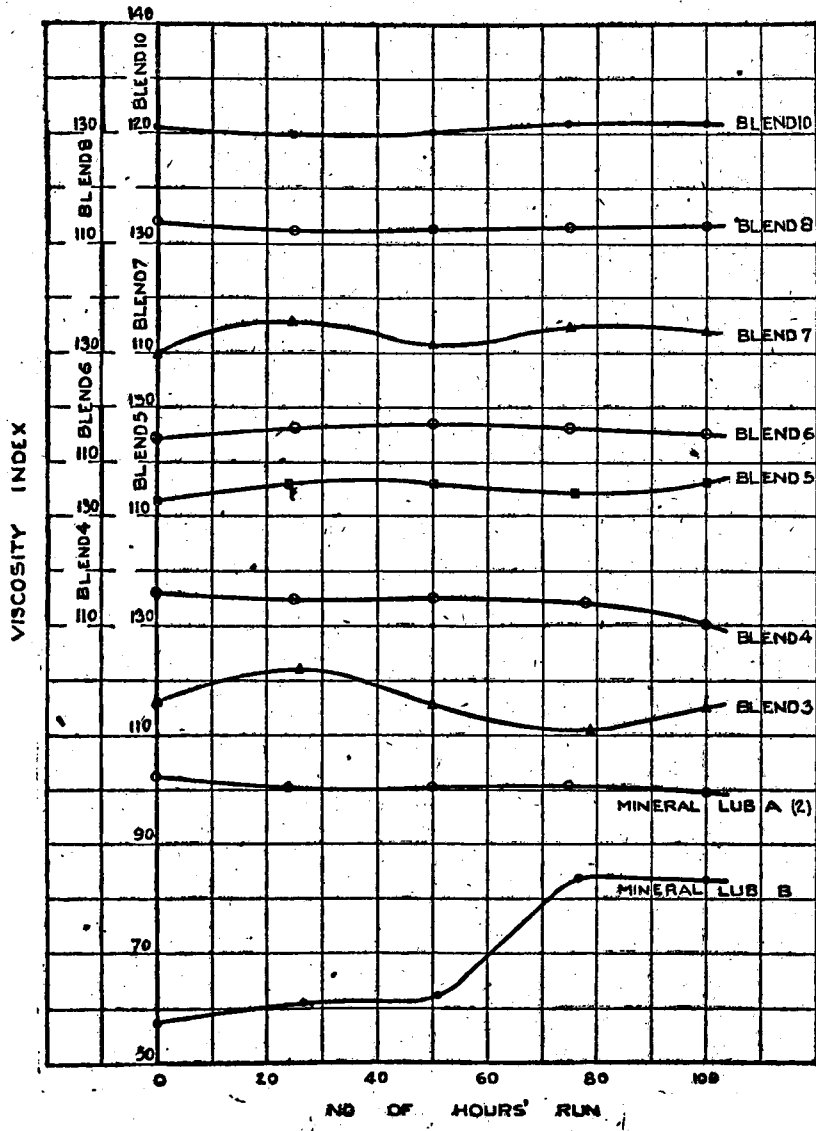

FIG. 5.

Change of viscosity index with the duration of run in 1.5 K.W. Lister set.

As regards the viscosity index (Fig. 5), it will also be seen that the vegetable oil blends, in general, are superior to the mineral oils. The changes in viscosity index with the progress of the run were slight and practically of the same order in the case of both vegetable and mineral oils.

Blend No. 4, the untreated blend, showed a sharp increase in acidity (Fig. 6) approximately after 25 hours' run, the maximum increase in acid value being 2.75 as against 0.46 (1st standardization run) and 0.36 (2nd standardization run) with the mineral reference lubricant "A", whereas the change in the acid value of the pure vegetable oil blends, as a result of stabilization, varied between 1.22 and 0.13. It is also interesting to note that Blend No. 3 showed a final decrease in acid value. So, even with regard to acidity, the effect of stabilizers is quite marked and some of the blends behaved better in this respect than the mineral oils.

As regards Conradson carbon residue (Fig. 7), although the vegetable oil blends and the mineral oils had more or less the same values initially, the vegetable oils, in general, showed a higher carbon residue increase than the reference lubricant "A", the change in this respect, as in others, being most marked in the case of the unstabilized blend No. 4. The increase in Blend Nos. 5, 6, 7 and 8 may be considered to be of the same order as in the case of the reference lubricant "A".

TABLE VI.

Change of oil characteristics other than those shown in Table V under engine operating conditions in 1.5 K. W. Lister set.

(Three figures under any lead correspond respectively to 0, 50 and 100 hours' operation.)

No. of run.	Blend.	Specific gravity 190°F. at 160°F.	Saponifica- tion value.	Iodine value.	Ash %.	Iron in ash %
1	Mineral lubricant "A"	0.8710	0.45	13.1	0	..
		0.8682	2.20	15.4	0.016	..
		0.8696	2.39	15.0	0.042	..
2	Blend No. 1	0.9200	152.6	77.0	0	..
		0.9201	153.7	64.9	0.028	..
		0.9206	156.4	65.0	0.040	..
3	Blend No. 2	0.9079	128.6	55.0
		0.9108	141.3	52.4
		0.9138	145.2	52.1
4	Mineral Lubricant "B"	0.9082	4.3	25.6	0	..
		0.9090	2.5	25.6	0.006	..
		0.9102	2.6	25.7	0.008	..
5	Blend No. 3	0.9300	179.4	92.7	0	0
		0.9383	179.0	83.6	0.034	16.3
		0.9423	186.3	83.3	0.056	20.0
6	Blend No. 4	0.9375	179.9	90.0	0	0
		0.9511	177.5	82.3	0.030	5.4
		0.9636	178.1	78.1	0.084	18.8
7	Blend No. 5	0.9406	182.6	88.0	0.009	0
		0.9433	192.0	86.0	0.017	5.7
		0.9491	198.2	84.2	0.044	10.2
8	Mineral Lubricant "A"	0.8760	0.16	13.8	0	0.
		0.8794	3.15	17.2	0.014	2.2
		0.8805	3.80	23.1	0.017	3.6
9	Blend No. 6	0.9394	178.0	92.8	0.003	0
		0.9410	191.0	86.7	0.014	18.2
		0.9445	194.9	85.4	0.028	27.4
10	Blend No. 7	0.9391	190.0	92.1	0.004	0
		0.9399	197.0	85.8	0.014	14.5
		0.9403	193.3	86.2	0.021	19.2

TABLE VI—*contd.*

No. of run.	Blend.	Specific gravity at 100°F.	Saponification value.	Iodine value.	Ash %	Iron in ash %
11	Blend No. 8	0.9405	180.6	90.3	0.007	0
		0.9439	187.7	88.4	0.041	6.6
		0.9452	193.0	86.3	0.097	5.3
12	Blend No. 10	0.9333	178.5	97.2	0.001	0
		0.9389	184.2	97.9	0.022	1.0
		0.9437	197.8	94.0	0.060	2.1

It will be seen from the results tabulated above, and also from Fig. 9, that practically four (Blend Nos. 2, 6, 8 and 10) out of the seven vegetable oil blends showed an appreciable increase in saponification value. The saponification values of the remaining blends as well as of the reference lubricant "A" either remained nearly constant or showed a slight tendency to increase with the duration of operation. What is rather remarkable is that the untreated blend did not show any increase in saponification value, but, on the other hand, showed a slight tendency to decrease indicating thereby that the chemical reaction did not proceed beyond, perhaps the decomposition of the glycerides into fatty acids and neutral products.

Generally speaking, it may be said that the engine operating conditions had the effect of increasing the acidic constituents as a result of complex chemical reactions, but this effect was more pronounced in the case of some of the stabilized blends.

The iodine values (Fig. 10) of all the vegetable oil blends decreased with the progress of the engine test, the minimum value being reached approximately between seventy and eighty hours' operation. The most interesting feature that is brought out by the engine test is, therefore, the fact that the degree of saturation of the blends increased with the length of operation and reached a maximum value before approximately eighty hours' operation.

With regard to the ash content (Fig. 11) of the oil, it may be observed that all the blends as well as the mineral lubricants showed an increase in ash content with the length of operation. Now, the ash content is due primarily to the dust or other impurities finding their way along with the induced air and also to the introduction of metallic impurities from the various engine parts as a result of wear. In view of the fact that the particular engine in which the investigation was carried out was not provided with an air filter, and as the experiments were carried out under the various weather conditions prevailing during the different parts of the year, the amount of dust and other impurities finding their way inside the engine naturally varied from blend to blend. The figures for ash or iron content (Fig. 12) of the oil, therefore, furnished no definite criterion of the relative degree of wear as a result of engine operation and should not be taken for anything but a rough indication of the degree of wear experienced by the metallic parts of the engine.

It will be noted (Table VII and Fig. 13) that the maximum equilibrium temperatures of the crank case oil in the case of runs with blend No. 3 (α -Naphthol blend) and 7 and 8 (α -Naphthylamine blends) were practically of the same order, but somewhat less than that obtained with the reference lubricant "A", while those obtained with the remaining blends were nearly the same as in the case of the run with the reference lubricant. Assuming that the crank case equilibrium temperature is independent of the room temperature and is a function of frictional losses under similar operating conditions, it may be concluded that the frictional characteristics of the vegetable oils are practically as good as those of the mineral oils, if not superior.

SINGLE CYLINDER ENGINE

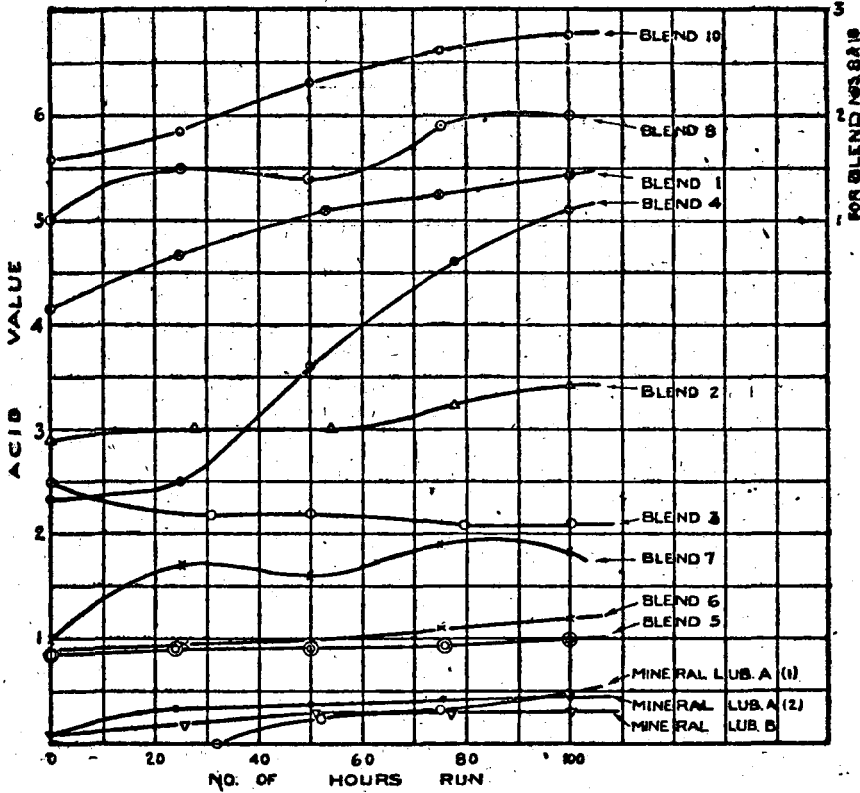

FIG. 6.

Change of acid value with the duration of run in 1.5 K. W. Lister set.

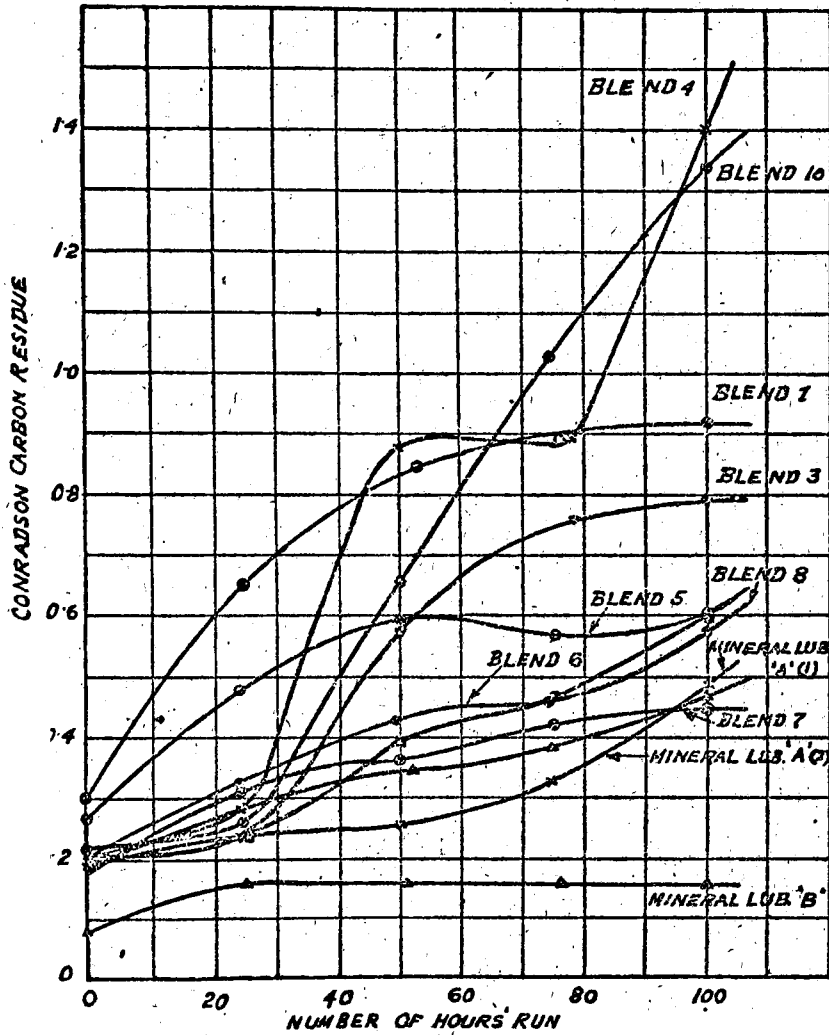

FIG. 7.
Change of Conradson carbon residue with the duration of run in 1.5 K. W. Laster set.

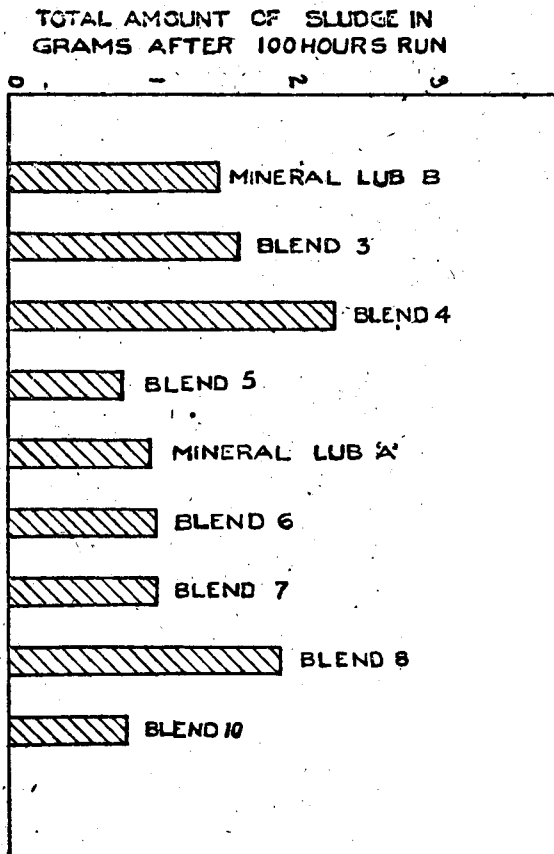

FIG. 8.

Graphical representation of the amount of sludge in crank case oil obtained with different blends as a result of 100 hours' run in 1.5 K. W. Lister set.

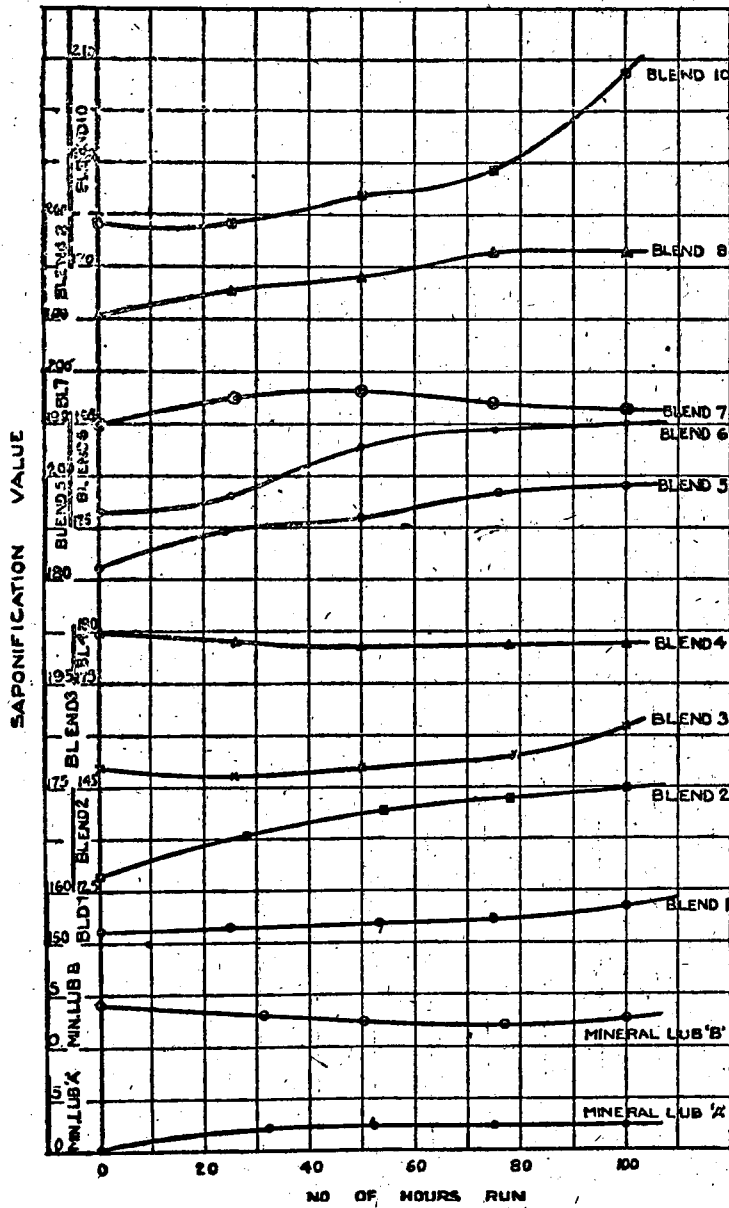

FIG. 9.

Change of saponification value with the duration of run in 1.5 K. W.
Lister set.

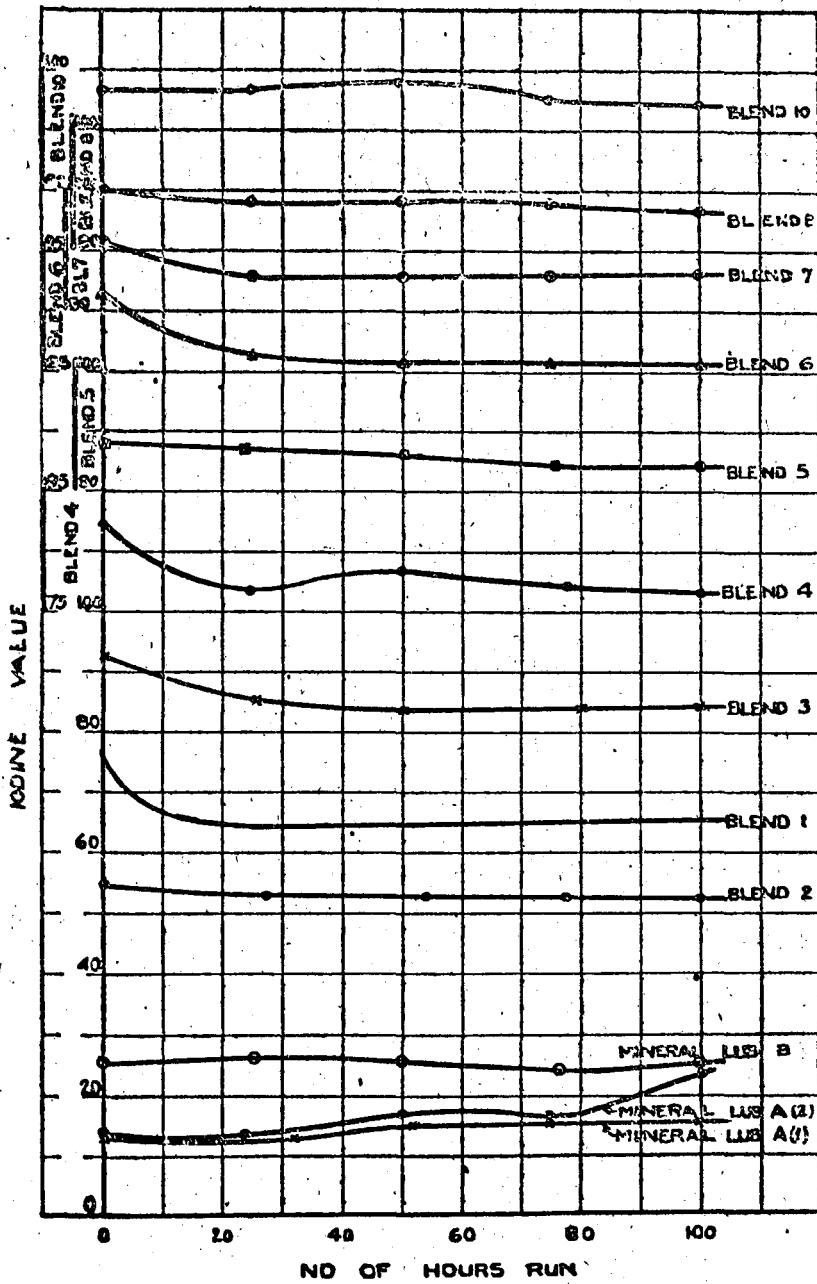

FIG. 10.

Change of iodine value with the duration of run in 1.5 K. W. Lister set.

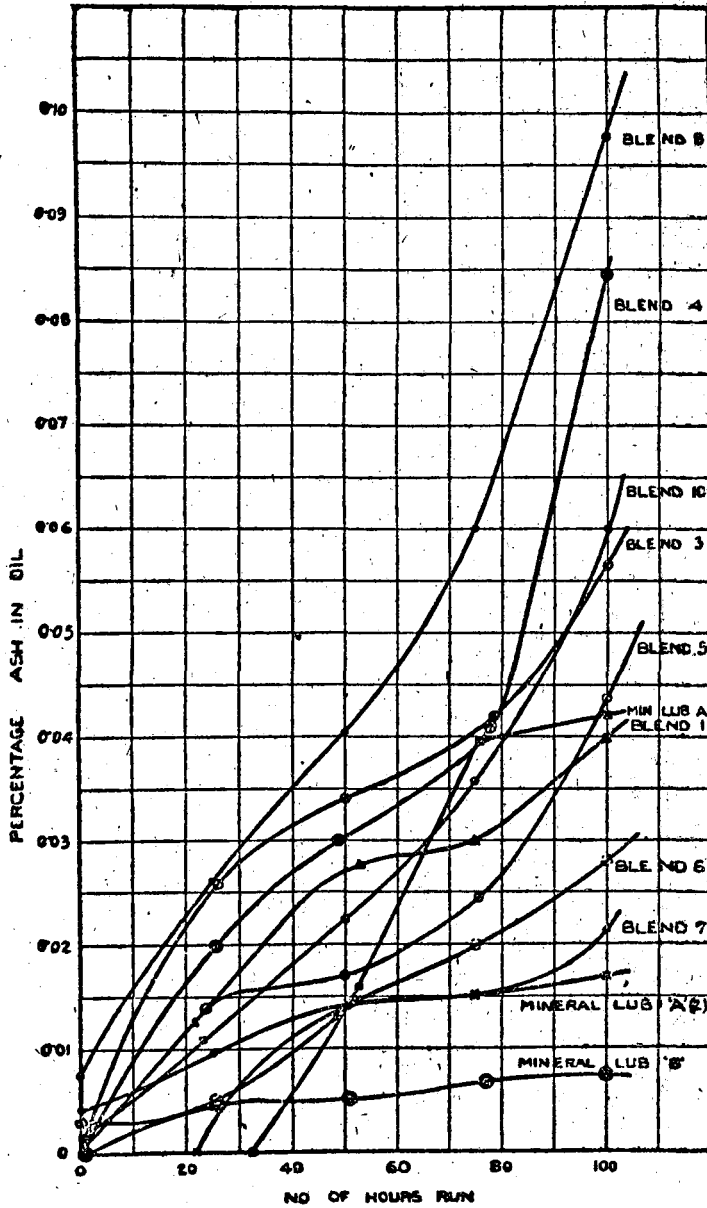

FIG. 11.

Change of ash content with the duration of run in 1.5 K.W. Lister set

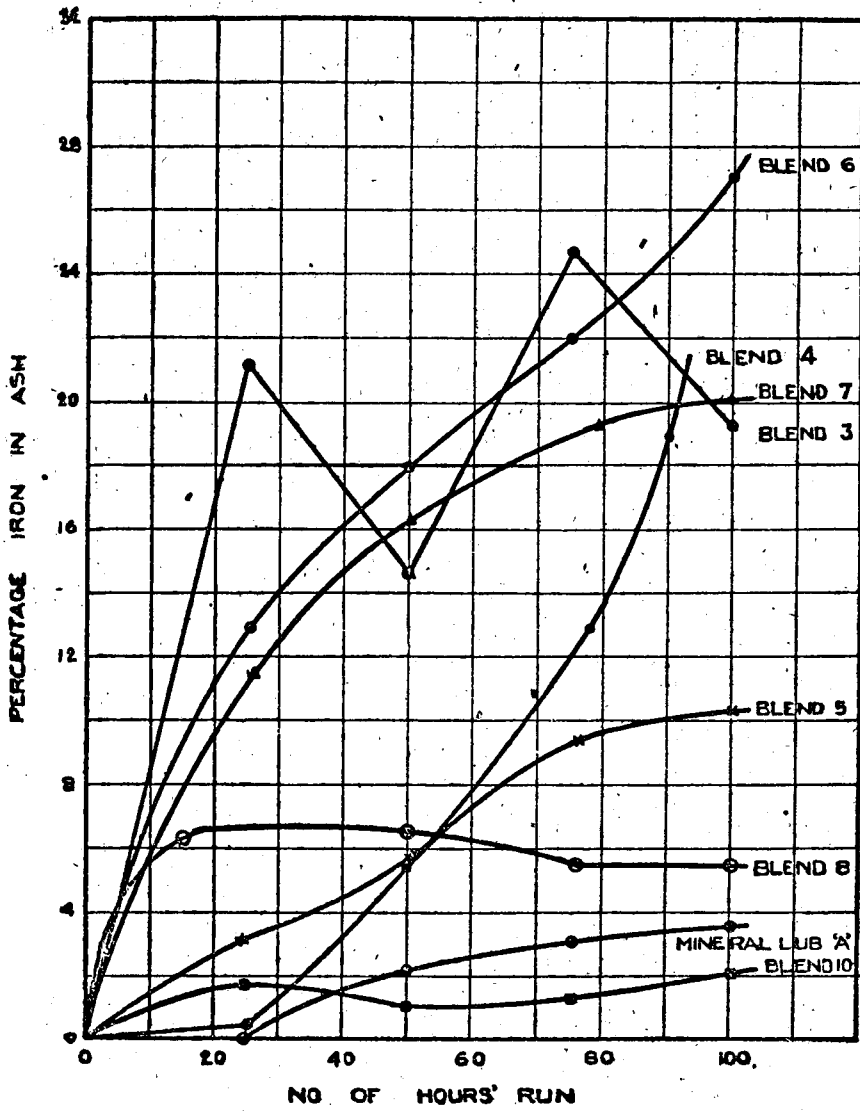

FIG. 12.

Change of iron content in ash with the duration of run in 1.5 K. W. Lister set.

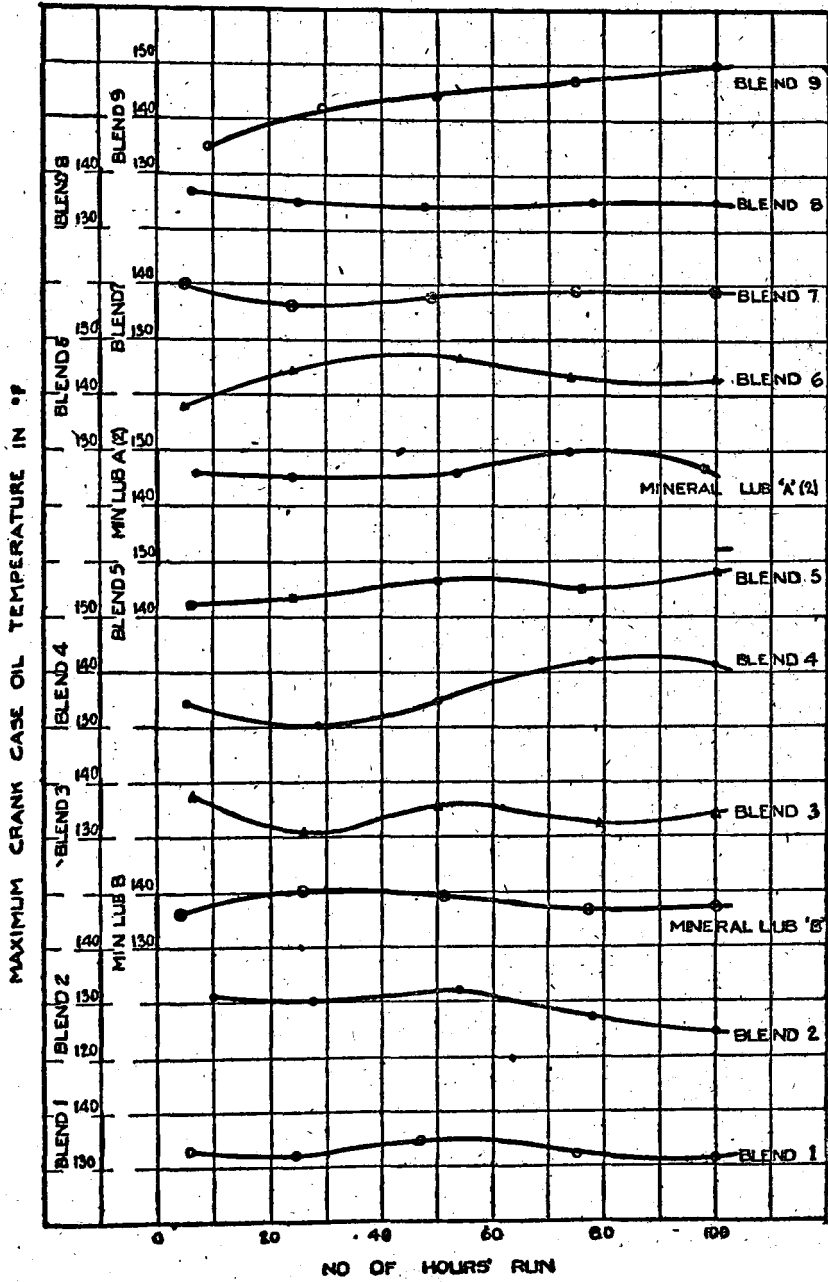

FIG. 13.

Change in equilibrium temperature of crank case oil with the duration of run in 1.5 K.W. Lister set.

The consumption of petrol (Table VII) per B. H. P. hour should also be proportional to the frictional losses if the output is maintained constant and we find that the consumption in the case of runs of all the blends except the two mineral-vegetable ones is more or less similar to that obtained in the standardization runs. It should, however, be pointed out that there does not exist a strict correlation between the equilibrium temperature and the consumption in every case.

With regard to cylinder wear, it may be observed that, with the exception of Blend Nos. 2, 3 and 8, all the vegetable oil blends behaved as satisfactorily as the reference lubricant, but the loss of weight of the top piston ring, which has

TABLE VII.

Friction and wear characteristics of the oils as brought out by 100 hours' engine test in 1.5 K. W. Lister set.

(Three figures under any head correspond to 0, 50 and 100 hours' operation.)

No. of run.	Blend.	Room temperature during the period of run. (°F.)	Maximum sump oil temperature during the period of run. (°F.)	Consumption of petrol per B.H.P. hour. (lbs.)	Cylinder wear at limiting position of ring travel. (inch.)	Reduction in weight of top piston ring. (grms.)	Iron in oil per ml. lion.	Total iron content of crank case oil after 100 hours' run. (grms.)
1	Mineral Lubricant "A"	96—84	140—131	..	0.0001
2	Blend No. 1 ..	90—79	138—126	1.31	No measurable change
3	Blend No. 2 ..	85—73	136—124	1.4	0.0003
4	Mineral Lubricant "B"	96—85	140—135	1.25	0.0002
5	Blend No. 3 ..	90—77	138—130	1.18	0.0005	0.0353	0	0.956
							55	
							112	
6	Blend No. 4 ..	84—71	144—130	1.18	0.0002	0.0347	0	0.443
							16.2	
							158.2	
7	Blend No. 5 ..	100—83	152—144	1.18	No measurable change	0.0500	0	0.226
							9.7	
							44.8	
8	Mineral Lubricant "A"	98—89	150—140	1.03	Do.	0.0283	0	0.101
							3.1	
							6.1	
9	Blend No. 6 ..	96—83	147—138	1.10	Do.	0.0434	0	0.195
							24.8	
							76.7	
10	Blend No. 7 ..	97—81	141—135	1.06	Do.	0.0351	0	0.149
							2.16	
							40.5	
11	Blend No. 8 ..	85—70	137—132	1.05	0.0003	0.0630	0	0.497
							26.9	
							52.0	
12	Blend No. 10 ..	101—83	150—133	1.18	No measurable change	0.0460	0	0.270
							8.8	
							59.2	

been generally accepted as an index of wear, failed to establish any correlation with the cylinder wear figures. It may, however, be pointed out that among the pure vegetable oil blends, those numbered 3, 4 and 7 behaved best and showed a loss of weight which was approximately 25 per cent. higher than in the case of the reference lubricant (second standardization run).

As regards the total amount of iron removed (Fig. 16) it will be seen that Blend No. 7 proved superior to all others, giving an iron content figure of 0.149 gm. as against 0.101 gm. for the reference lubricant. The other two blends which gave the

REDUCTION IN WEIGHT OF TOP PISTON RING IN GRAMS AFTER 100 HOURS RUN

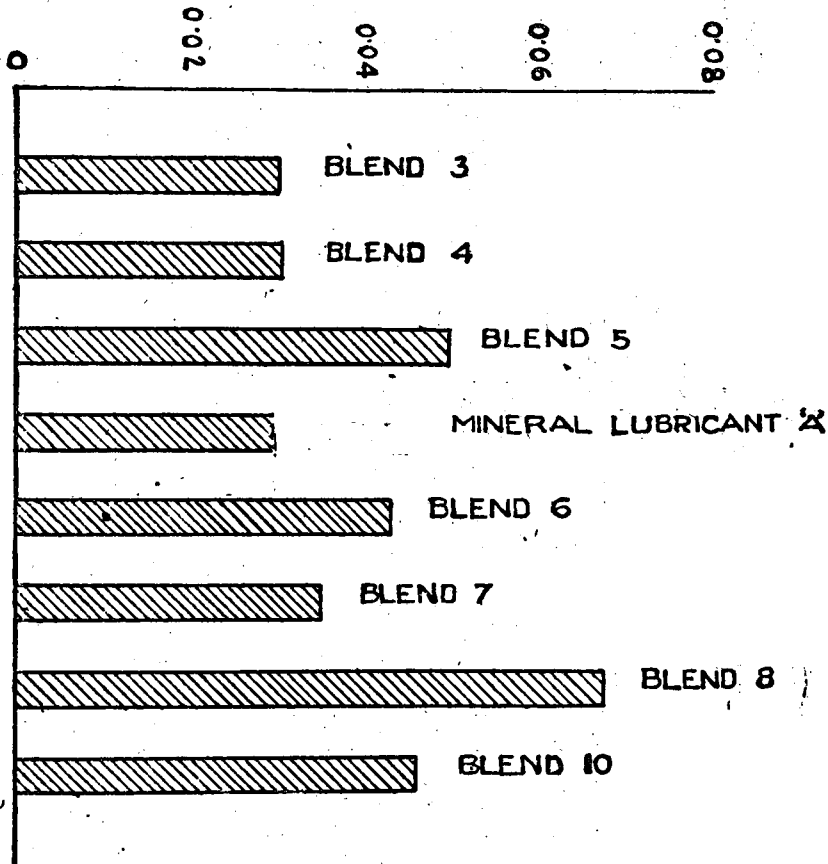

FIG. 14.

Graphical representation of the loss in weight of top piston ring after 100 hours' run in 1.5 K.W. Lister set.

M53DofS&IRDELHI

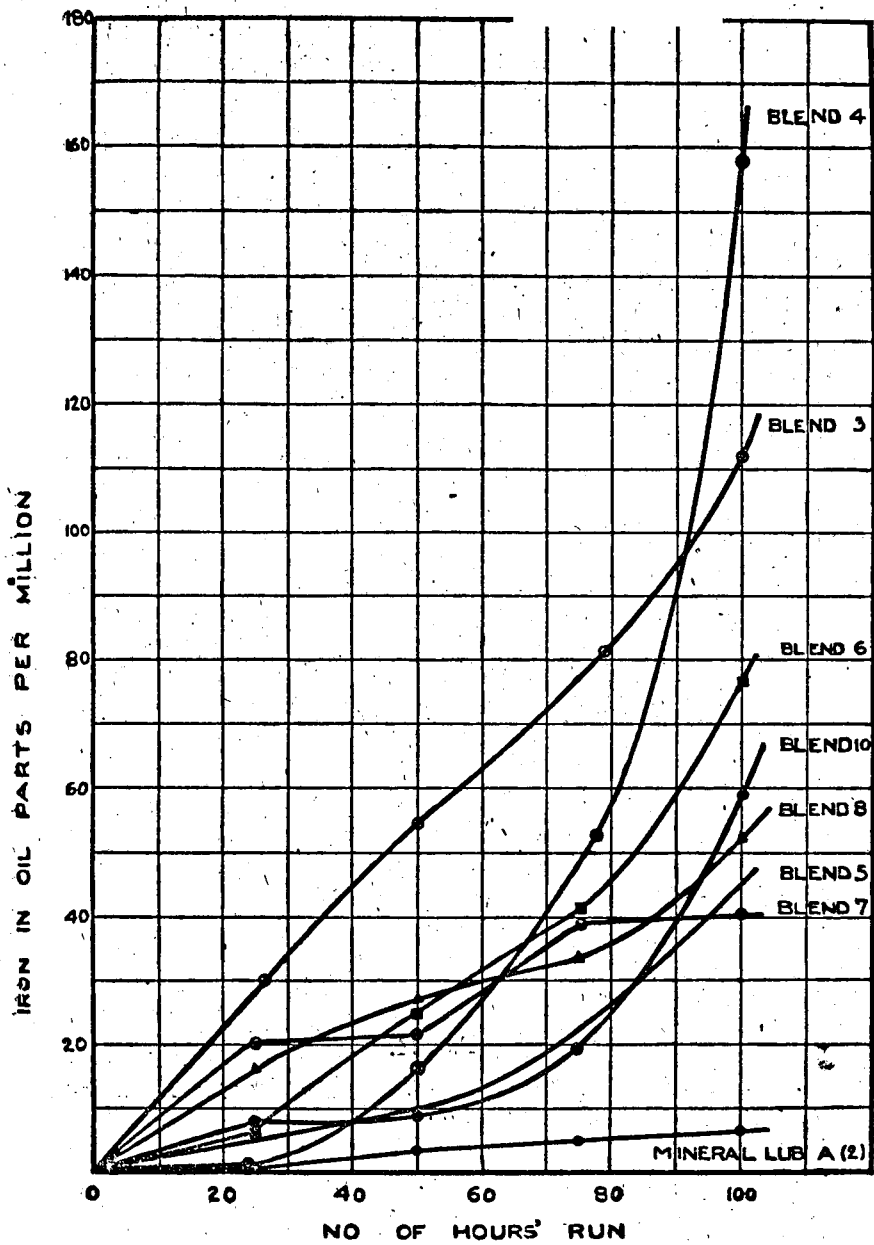

FIG. 15.

Change of iron content (soluble iron) in oil with the duration of run in 1.5 K.W. Lister set.

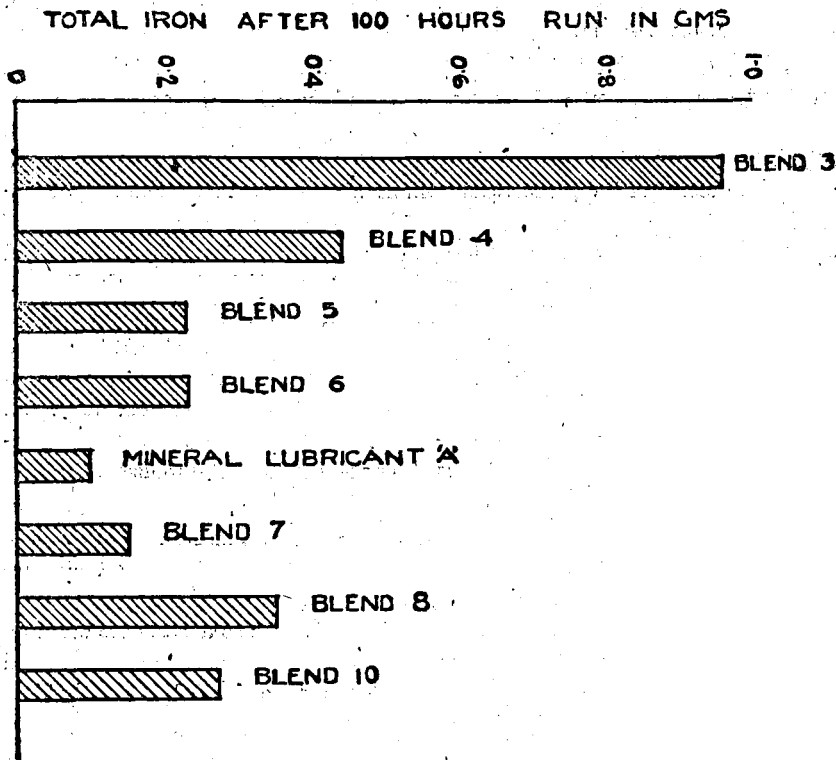

Fig. 16.

Graphical representation of the total iron content (iron in solution and iron in sludge in crank case oil after 100 hours' run in 1.5 K.W. Lister set.

next best results are Blend Nos. 5 and 6, which gave iron content figures of 0.195 gm. and 0.226 gm. respectively.

It will be observed from Table VIII and Fig. 17 that the nature of deposit on the piston top and cylinder head with practically all the blends was of the same type as that obtained with mineral reference lubricant "A", although the amount varied from blend to blend. The amount of deposit on the underside of the piston with reference lubricant "A" was practically nil as against variable amounts (0.34 to 2.5 grams) in the case of the stabilised vegetable oil blends. The total amount of deposit on the piston top and cylinder head, including that on the underside, obtained with Blend Nos. 7 and 8, was definitely less than that with the first standardization run with reference lubricant "A" and quite comparable with that obtained with the second standardization run with the same reference lubricant. It should be further observed that the deposit on all these parts obtained with blend No. 4 (the untreated blend) weighed as much as 16.5 grams, whereas that obtained with Blend Nos. 7 and 8 weighed only 1.82 and 1.32 grams respectively, clearly demonstrating the very remarkable improvement in this effect caused by the addition of stabilizers.

The nature of deposits on the ring lands and grooves with all the blends, except Nos. 4 and 5, was similar to that produced by the reference lubricant "A". The deposit obtained with blend No. 4 (the untreated castor and groundnut oil mixture) was of a distinctly gummy character and caused the clogging of a large number of scraper ring slots and the sticking of the top piston ring. The deposit produced by Blend No. 5 was somewhat gummy in the region of top ring groove and also caused the sticking of the top ring. On the other hand, Blend No. 6 which is exactly identical in composition with Blend No. 5, except for the fact that its soap content was slightly lower, was quite free from these defects. It is, however, difficult to say at this stage whether the ring sticking was due to excess of soap or whether it was purely accidental. With the untreated oil, on the other hand, the deposits were definitely gummy in character not only on the top ring groove but also in the other ring grooves showing undoubtedly the effect of stabilizers on the treated blends.

With regard to the deposits on the valves, the table would indicate that the exhaust valves were singularly free from any deposit not only in the case of all the vegetable oils but also with the mineral reference lubricant "A", while the inlet valves in each case showed some amount of deposit, the nature and extent of which varied somewhat from blend to blend. In no case, however, it was such as to interfere with the proper working of the valves.

TABLE No. VIII

Nature and extent of deposits on various engine parts after 100 hours' run

TABLE
Nature and extent of deposits on various

No. of run.	Blend.	Piston top.	Cylinder head.	Total weight of deposits on piston top and cylinder head. (grams.)	Piston underside and weight of deposit in grams.	Piston skirt.	Top ring.	
							Land.	Groove.
1	Mineral lubricant "A".	1/3 spongy; 2/3 hard.	Hard	2.5	Slight deposit on top; rest of interior lacquered.	Lacquered black at places.	No appreciable deposit; lacquered black.	No appreciable deposit; lacquered black.
2	Blend No. 1	1/2 spongy; 1/2 hard.	Do.	8.6	Spongy and moist. 2.5	Do.	Do.	Do.
3	Blend No. 2	Hard.	Do.	2.1	Spongy and moist. 2.4	Do.	Thin deposit at places.	Thin, uniform.
4	Mineral lubricant "B".	1/3 hard and 2/3 spongy.	Do.	0.58	Thick at top; rest of interior lacquered. 1.0	Do.	Lacquered black.	Lacquered black.
5	Blend No. 3	Thick on periphery; fairly hard.	Do.	3.2	Thick and partly soft and partly hard at top. 1.8	Do.	Thin, irregular.	Thin, sticky
6	Blend No. 4	2/3 thick; 1/3 thin.	Do.	3.3	Thick, moist at top; rest of interior lacquered. 13.2	Do.	Do.	Gummy
7	Blend No. 5	Thin, hard near the centre; thick round periphery.	Do.	1.4	Thin, granular at top; rest of interior lacquered. 0.63	Do.	Gummy deposit over 1/2 area; the other 1/2 clean.	Partly thin and partly thick and gummy.
8	Mineral lubricant "A".	1/3 thin, hard; 2/3 practically clean.	Do.	0.55	Thin, hard. 1.0	Do.	Thin, soft over 1/2 area; the other 1/2 clean.	No appreciable deposit.
9	Blend No. 6	1/2 thin, hard, brownish; 1/2 practically clear.	Do.	2.5	Isolated spongy deposits at top; the rest of the interior simply lacquered.	Do.	Thin isolated deposits at places.	Thin film
10	Blend No. 7	Central half free from deposit; other half partly rosinous and brownish and hard.	Fairly hard, partly brownish.	1.3	Thin, moist 0.52	Do.	Thin over 1/2 area; rest bright.	Thin, uniform.

No. VIII.

engine parts after 100 hours' run.

Lower rings.		Inlet valve.		Exhaust valve.		Remarks.
Land.	Groove.	Stem.	Shoulder and face.	Stem.	Shoulder and face.	
No appreciable deposit; lacquered black.	No appreciable deposit; lacquered black.	Part stained; isolated specks of carbonaceous matter.	This deposit. . .	None; stained reddish.	None; stained reddish.	No clogging of any of the drain holes or scraper ring groove. A few scraper ring slots clogged. Piston rings free in their grooves.
Do. . .	Do. . .	Part stained	Do. . .	Do. . .	Do. . .	Only a few scraper ring slots clogged. Piston rings free in their grooves.
Thin, uniform.	Thin, uniform.	Do. . .	Appreciable; granular and gummy on shoulder only.	Stained black.	Stained black.	Do.
Lacquered black.	Lacquered black.	Thin . .	Thin . .	Do. . .	Do. . .	Piston rings free in their grooves.
Thin, sticky	Thin, sticky	Thin, granular.	Thin; granular on shoulder.	Stained reddish.	Stained reddish.	Do.
Gummy (2nd) lacquered (3rd).	Gummy (2nd) lacquered (3rd).	Do.	Do. . .	Thin; part stained reddish.	Do.	A large number of scraper ring slots clogged. Top ring stuck; others free in their grooves.
Thin, uniform.	Thin, uniform.	Do. . .	Fairly thick, soft and granular on shoulder, thin on face.	Do. . .	Do.	A few scraper ring slots clogged. Top ring stuck.
No appreciable deposit, lacquered.	No appreciable deposit; lacquered.	Fairly stained and partly covered with thin carbon.	Thin . .	Stained reddish.	Do. . .	Piston rings free in their grooves.
Thin film . .	Thin film . .	Thin, a few granules at isolated points.	Thin film on face and shoulder. Isolated granules on shoulder.	Do. . .	Stained reddish.	A few scraper ring slots clogged. Piston rings free in other grooves.
Thin uniform.	Thin uniform.	Thin . .	Thin . .	Do. . .	Do. . .	A number of scraper ring slots clogged. Piston rings free in their grooves.

TABLE

No. of run.	Blend.	Piston top.	Cylinder head.	Total weight of deposits on piston top and cylinder head. (grams.)	Piston underside and weight of deposit in grams.	Piston skirt.	Top ring.	
							Land.	Groove.
11	Blend No. 8	Central half free from deposit ; other half thin, hard.	Hard.	0.98 0.24	Thin, moist at places.	Lacquered black at places.	Thin over a area ; remaining area bright.	Thin, and a small form.
12	Blend No. 10	$\frac{1}{2}$ practically free from deposit ; the other $\frac{1}{2}$ hard, easily removable.	Fairly hard	0.77	Partly moist	Do.	Practically $\frac{1}{2}$ covered with thin deposit interspersed with bright spots ; other $\frac{1}{2}$ clean.	Thin

VIII—contd.

Lower rings.		Inlet valve.		Exhaust valve.		Remarks.
Land.	Groove.	Stem.	Shoulder and face.	Stem.	Shoulder and face.	
2nd land bright except for a small area, 3rd land covered with a thin uniform deposit.	Thin, uniform	Thin film, with granules here and there.	Thin film, shoulder covered will granules at isolated points.	Stained reddish.	Stained reddish.	Practically half the scraper ring slots either partially or entirely clogged.
Thin	Thin	Part stained; part granulated.	Granulated over shoulder; thin deposit over face.	Do.	Do.	Piston rings free in their grooves.

TOTAL WEIGHT OF CARBON DEPOSITS
IN GRAMS ON PISTON TOP & CYLINDER HEAD

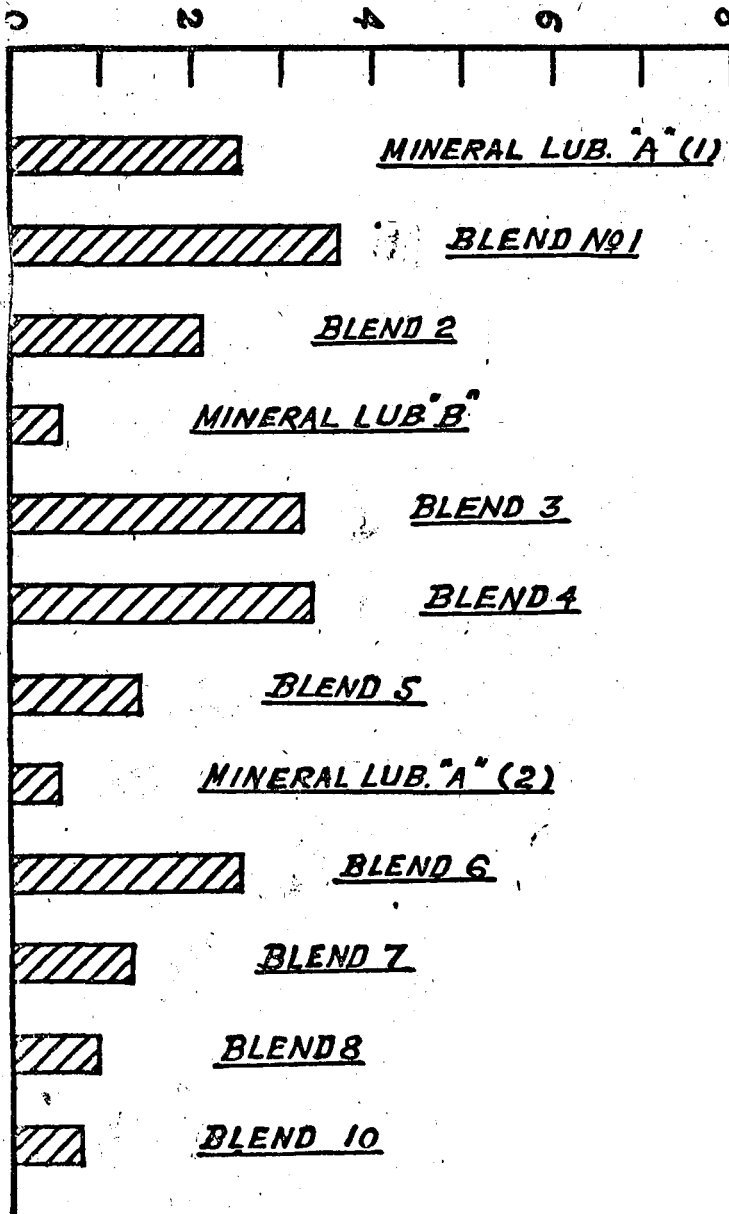

FIG. 17.

Graphical representation of total amount of carbon deposits on piston top and cylinder head in 1.5 K.W. Lister set.

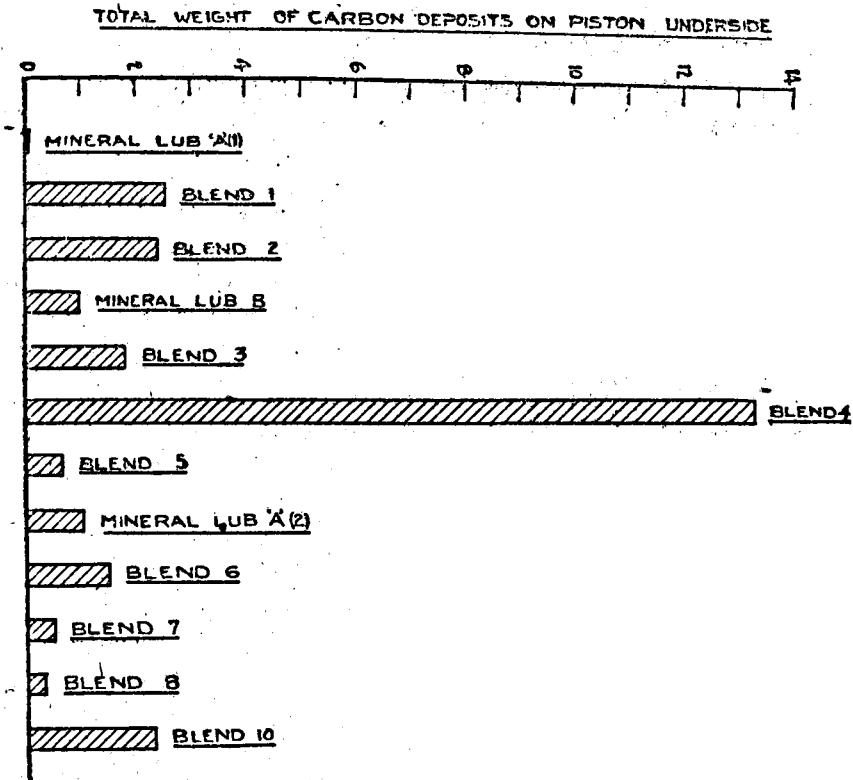

FIG. 18.

Graphical representation of total amount of carbon deposits on piston underside in 1.5 K. W. Lister set.

FINAL ENGINE TESTS.

From the results of preliminary engine tests on the various blends, it will be seen that Blend No. 7, which is a castor and groundnut oil mixture with α -naphthylamine, proved superior to all others as regards general stability and wear characteristics. This blend was, therefore, subjected to more severe operating conditions in the larger engine (Morris).

While the engine test on this blend was in progress, a series of Air Ministry Oxidation Tests (Modified), undertaken on rape oil in conjunction with different stabilizers, had practically reached the final stage, and it was found that α -naphthylamine, which proved quite satisfactory for the groundnut castor oil blend, also proved to be quite a good stabilizer for rape oil. A 50-50 mixture of castor and rape seed oils with 1% α -naphthylamine (blend No. 9) was, therefore, prepared for test in the larger unit. The resulting viscosity of the blend was 109 centistokes at 100°F. as compared with 128.6 centistokes in the case of Blend No. 7 and 122.1 centistokes in the case of reference lubricant "A". The lower initial viscosity of this blend was decided upon to see whether this would in any way influence the friction characteristics, which were found to be somewhat inferior in the case of Blend No. 7, than in the case of reference lubricant "A".

TABLE IX.

Change of main oil characteristics showing oxidation and thermal stability under engine operating conditions in 16 H. P. Morris engine.

(the three figures under each head correspond respectively to 0, 50 and 100 hours' operation).

No. of run.	Blend No.	Viscosity at 140°F. (centistoke).	Rise in viscosity after 100 hours run %.	Viscosity index.	Acid value.	Conradson carbon residue %.	Sludge %.	Total amount of sludge gms.	Oil consumption (percentage of total oil used).	Crank case dilution %.
1	Mineral Lubricant "A"	.. 43.7	102.0	0.06	0.19
		40.2	98.0	0.42	0.24	16.4	3.0	
		43.8	-2.1	96.5	0.36	0.32	0.04	1.74	1.4	
2	Blend No. 7	.. 46.5	116.0	0.92	0.2
		47.7	116.5	1.55	0.37	15.8	1.2	
		56.7	21.7	114.5	2.25	0.57	0.03	1.40	1.0	
3	Blend No. 9	.. 41.2	121.0	1.19	0.2
		42.7	121.0	2.0	0.23	17.8	1.2	
		48.2	17.0	120.2	2.0	0.49	0.03	1.21	1.0	

The results of engine tests on these blends along with those on reference lubricant "A" are summarized in Tables IX, X, XI and XII.

It may be noted that owing to undue vibration and leakage of oil through several auxiliary bearings of the Morris Engine, while carrying out standardization runs, it was decided to carry out engine tests at 1200 R. P. M. (instead of 1500 R. P. M.) and at a correspondingly reduced load (10 B. H. P.).

A fresh standardization run was, therefore, carried out under the new conditions and engine tests on Blend Nos. 7 and 9 reported in this paper were carried out under similar conditions.

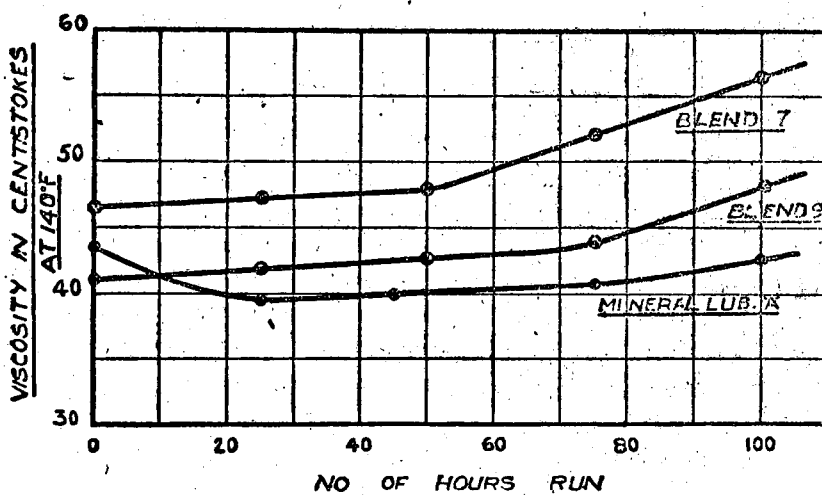

FIG. 19.

Change in viscosity with the duration of run in 16 H.P. Morris engine.

The data presented in the Table IX and Fig. 19 indicate that while the viscosity of the reference lubricant "A" decreased with the progress of the run for the first 50 hours, evidently on account of greater crank case dilution (3.0%) occurring during this period, it subsequently showed a tendency to increase reaching a final value (42.8 c.s. at 150°F), which was lower than the initial figure (43 c.s. at 140°F). Both the vegetable oil blends, on the other hand, showed a tendency to increase in viscosity with the length of the run, the increase being most marked after 50 hours in the case of Blend No. 7 and after 75 hours in the case of Blend No. 9. The greater increase in viscosity of the vegetable oils as compared with that obtained with the reference lubricant might be partly explained by the greater dilution occurring during the latter run.

As regards the acid value (Fig. 21), it will be seen that while it increased by 0.30 in the case of the reference lubricant "A", the corresponding increases in Blend Nos. 7 and 8 were 1.33 and 0.81 respectively. The Conradson carbon residue figures of both the vegetable oils were also slightly higher (Fig. 22).

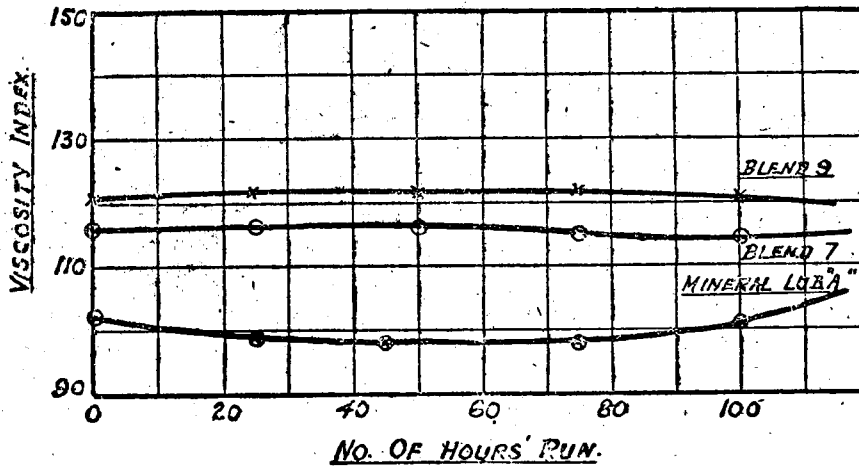

FIG. 20.

Change of viscosity index with the duration of run in 16 H.P. Morris engine.

Both the vegetable oil blends, however, developed appreciably less sludge than the reference lubricant (Fig. 23). The oil consumption figures for Blend Nos. 7 and 9 were 15.8% and 17.8% respectively as compared with 16.4% in the case of the reference lubricant.

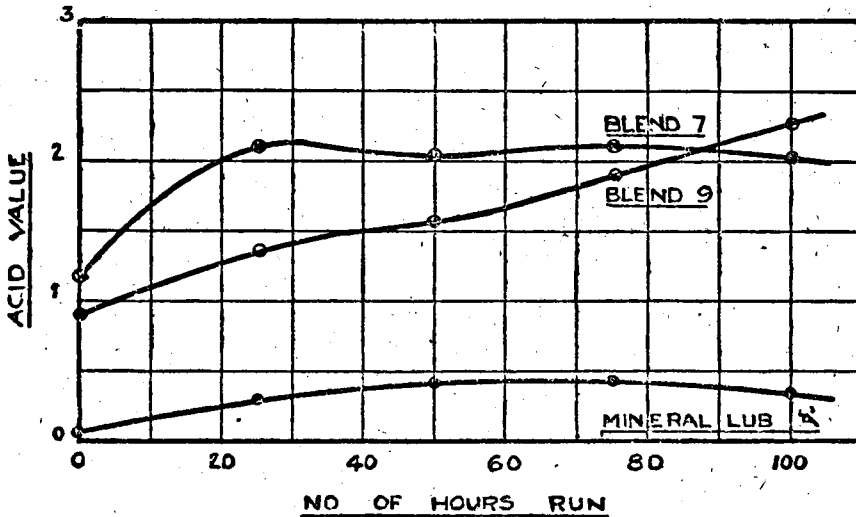

FIG. 21.

Change of acid value with the duration of run in 16 H.P. Morris engine.

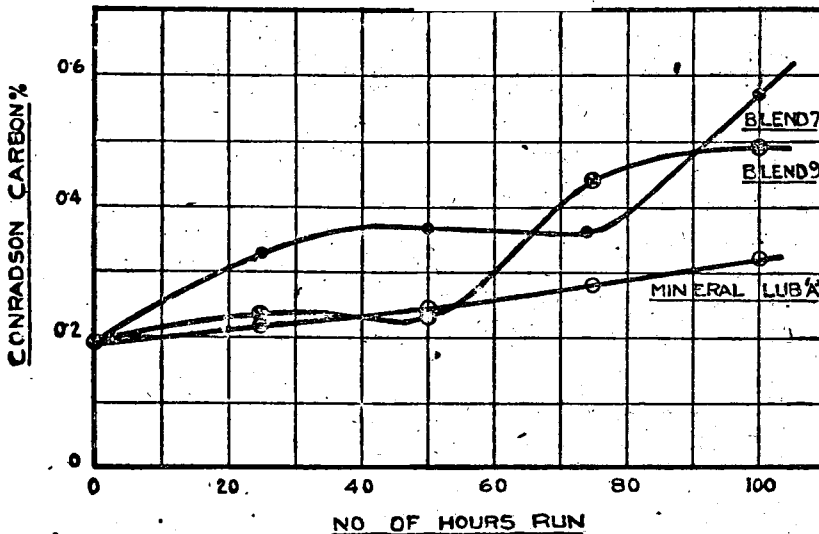

FIG. 22.

Change of Conradson carbon residue with the duration of run in 16 H.P. Morris engine.

TABLE X.

Change of oil characteristics other than those shown in Table IX under engine operating conditions in 16 H. P. Morris engine.

(Three figures under any head correspond respectively to 0, 50 and 100 hours operation).

No. of run.	Blend.	Specific gravity	Saponification value.	Iodine value.	Ash %	Iron in ash %
		at 100°F. 100°F.				
1	Mineral lubricant "A"	0.8738	0.8	12.2	Nil	Nil
		0.8758	1.4	12.9	0.013	11.8
		0.8769	4.7	12.2	0.014	20.3
2	Blend No. 7	0.9399	185.0	93.0	0.003	Nil
		0.9403	184.6	83.7	0.010	16.9
		0.9462	195.5	81.9	0.022	13.6
3	Blend No. 9	0.9333	180.3	96.0	0.005	Nil
		0.9343	189.2	96.0	0.012	10.4
		0.9379	190.0	93.0	0.018	7.4

TOTAL AMOUNT OF SLUDGE IN CRANK
CASE OIL IN GRAMS AFTER 100 HOURS RUN

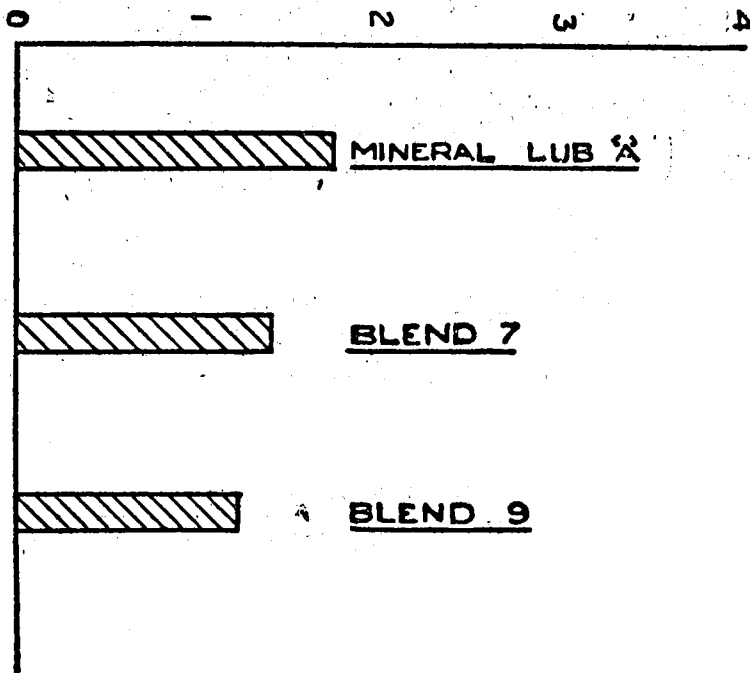

FIG. 23.

Graphical representation of the total amount of sludge in crank case oil as a result of 100 hours' engine test in 16 H. P. Morris engine.

It will be seen from Table X (Fig. 24) that the nature and extent of the changes suffered by both the vegetable oil blends as regards saponification value as a result of 100 hours' run in the larger 4-cylinder engine were similar to those obtained in the case of the run in the smaller (single cylinder) unit (Table VI). It appears therefore that the more severe operating conditions in the high power engine produced no more serious changes in the characteristics than the comparatively less severe conditions of the smaller engine. The same remarks are more or less applicable in respect of changes in the iodine value (Fig. 25) which decreased slightly with the progress of the run indicating that the degree of saturation of the blends tended to increase with the duration of operation.

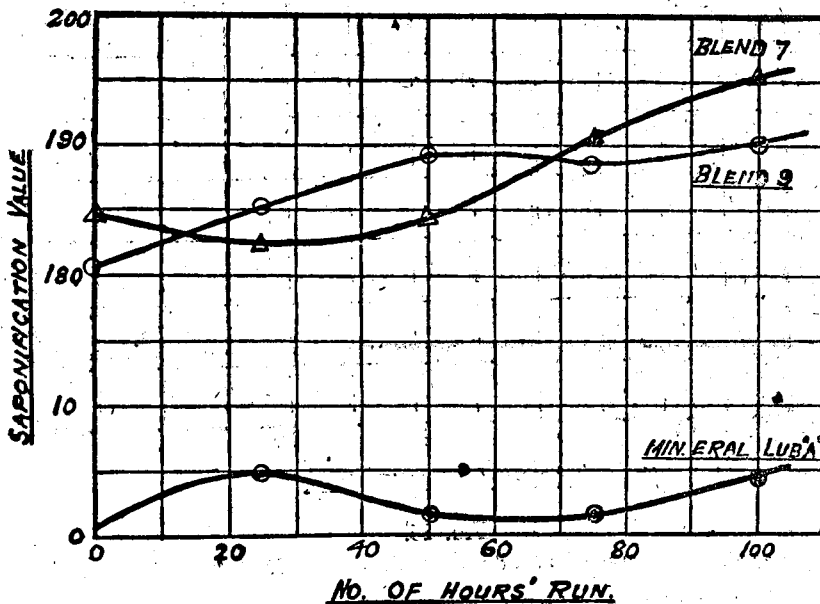

FIG. 24.

Change of saponification value with the duration of run in 16 H.P. Morris engine.

As regards the percentage ash (Fig. 26) and the iron content, the remarks that were made in the case of the runs in the smaller engine apply to this case also. But it may be generally observed that the increase in the ash content of the crank case oil in the case of both the blends was slightly more than in the case of the reference lubricant "A". On the other hand, the percentage of iron in ash (Fig. 27) obtained with the reference lubricant steadily increased with the progress of run, reaching a value of 20.3% after 100 hours which was appreciably higher than the corresponding values in the case of both the vegetable oil blends. It may, however, be pointed out that this value changed in a very irregular manner during the runs with both the vegetable oil blends.

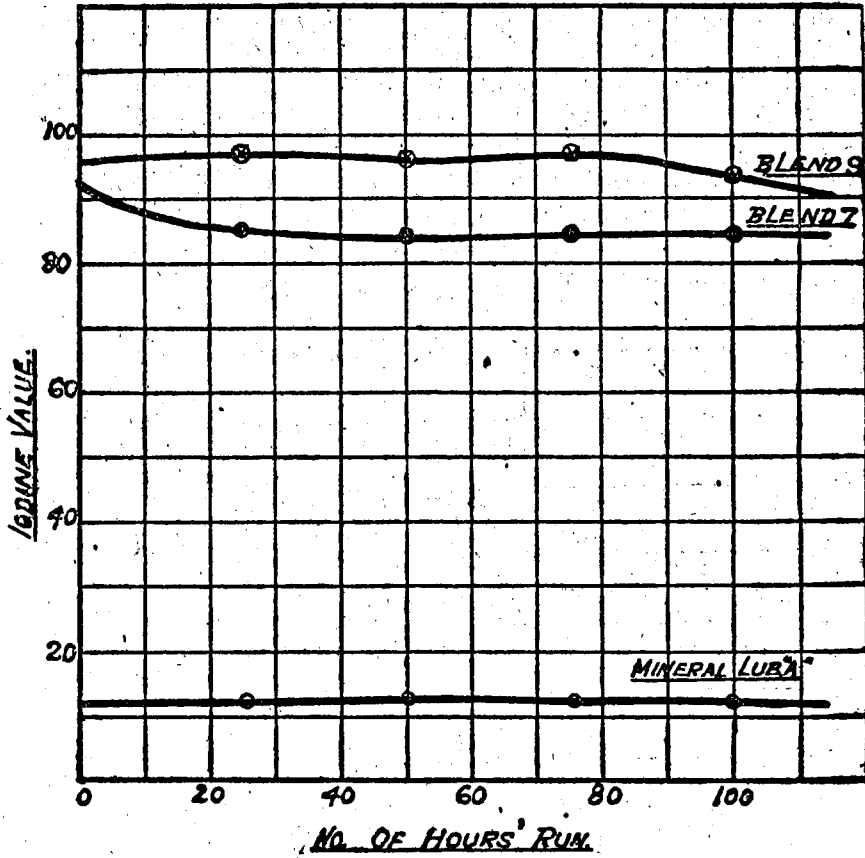

FIG. 25.

Change in iodine value with the duration of run in 16 H.P. Morris engine.

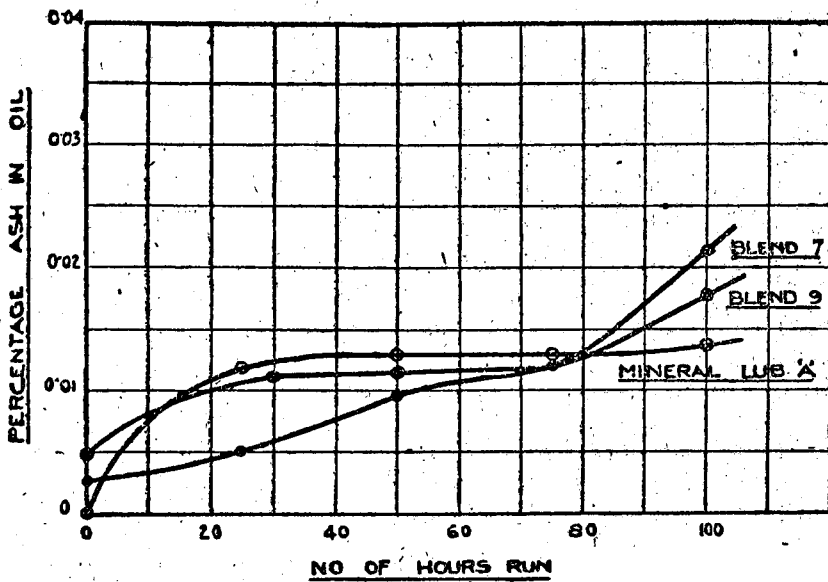

FIG. 26.

Change of ash content with the duration of run in 16 H.P. Morris engine.

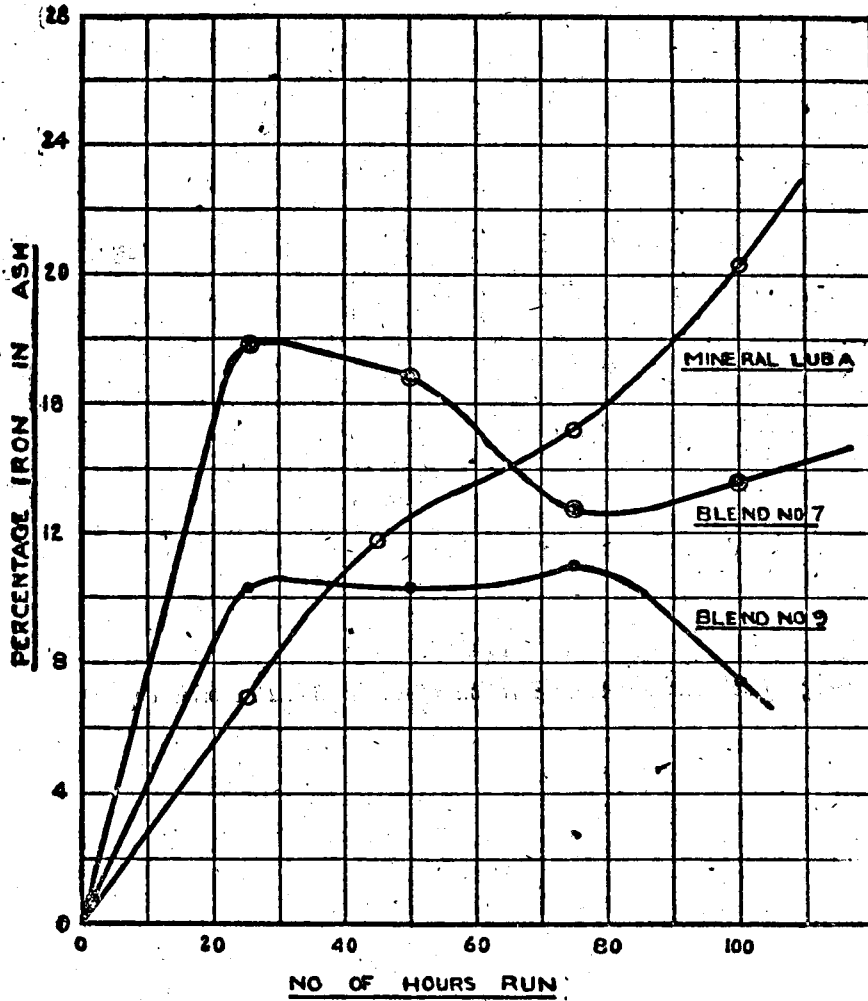

FIG. 27.

Change of iron content in ash with the duration of run in 16 H.P. Morris engine.

TABLE XI.

Friction and wear characteristics of the oils as brought out by 100 hours' engine test in 16 H. P. Morris Engine.

(Three figures under any head correspond respectively to 0, 50 and 100 hours' operation).

No. of run.	Blend.	Room temperature during the period of run. (°F).	Maximum sump oil temperature during the period of run. (°F).	Consumption of petrol per B. H. P. hour. (lbs.)	* Cylinder wear at limiting position of top ring travel, (inch);	Reduction in weight of top piston after 100 hours' run (grams).	Iron in crank case oil (parts per million).	Total iron content of crank case oil after 100 hours' run. (grams.)	Motoring losses (B. H. P.)
1	Mineral lubricant "A".	97-85	175-169	0.682	No measurable change in any cylinder.	0.0110	Nil	0.481	3.3
						0.0119	15.8		2.3
						0.0145	30.0		2.2
						0.0150			
2	Blend No. 7	85-71	174-171	0.729	No measurable change.	0.0288	Nil	0.484	2.7
						0.0002	17.3		2.6
						0.0005	29.8		2.6
						0.0237			
3	Blend No. 9	88-74	174-171	0.707	No measurable change in remaining cylinders.	0.0177	Nil	0.273	2.6
						0.0109	12.1		2.3
						0.0348	14.1		2.6
						0.0103			

* The four figures relate to cylinder Nos. 1 to 4 serially.

A comparison of the results tabulated in Table XI and shown graphically in Fig. 28 indicates that the equilibrium temperature of the crank case oil in the case of both the vegetable oil blends was practically identical and showed a fairly close agreement with that obtained with the mineral reference lubricant "A". The average room temperature, however, was slightly lower during the vegetable oil runs. The consumption of petrol per B. H. P. hour with vegetable oil blends were 4-7% higher than that obtained with the reference lubricant "A", although the frictional losses as determined by the motoring test were 10 to 16% higher in the case of former blends. It appears, therefore, that there was lack of strict correlation between the frictional losses and the temperature rise of the crank case oil, but generally it can be stated that the frictional characteristics of the vegetable oil blends on the whole were somewhat inferior to those of the reference lubricant.

With regard to wear on the basis of change in cylinder bore and the loss in weight of top piston ring, it should be observed that the Blend No. 9 and reference lubricant "A" were practically similar (Fig. 29) except for the fact that the top ring of cylinder No. 3 after a run with the former blend showed a comparatively large reduction in weight and the bore of cylinder No. 1 showed a slightly more increase in dimension. This appears to be accidental, since it concerns one cylinder only.

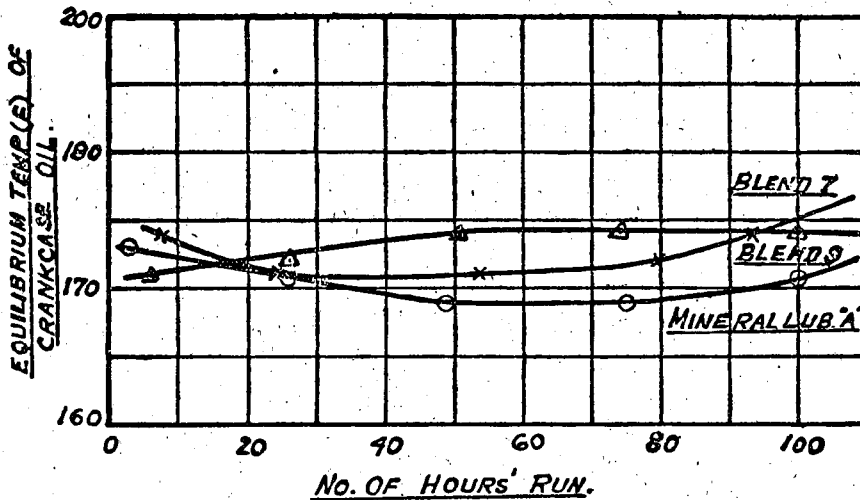

FIG. 28.

Change of equilibrium temperature of crank case oil with the duration of run in 16 H.P. Morris engine.

The quantity of iron in solution in crank case oil at different stages of run (Fig. 30) with Blend No. 9 was appreciably lower than in the case of reference lubricant "A" while that obtained with Blend No. 7 and reference lubricant "A" was practically identical. The total iron content of the crank case oil (Fig. 31) (including that of the sludge) at the end of 100 hours' run with Blend No. 9 was also considerably lower than that obtained with run on Blend No. 7 or the reference lubricant "A", both of which gave similar performance in this respect.

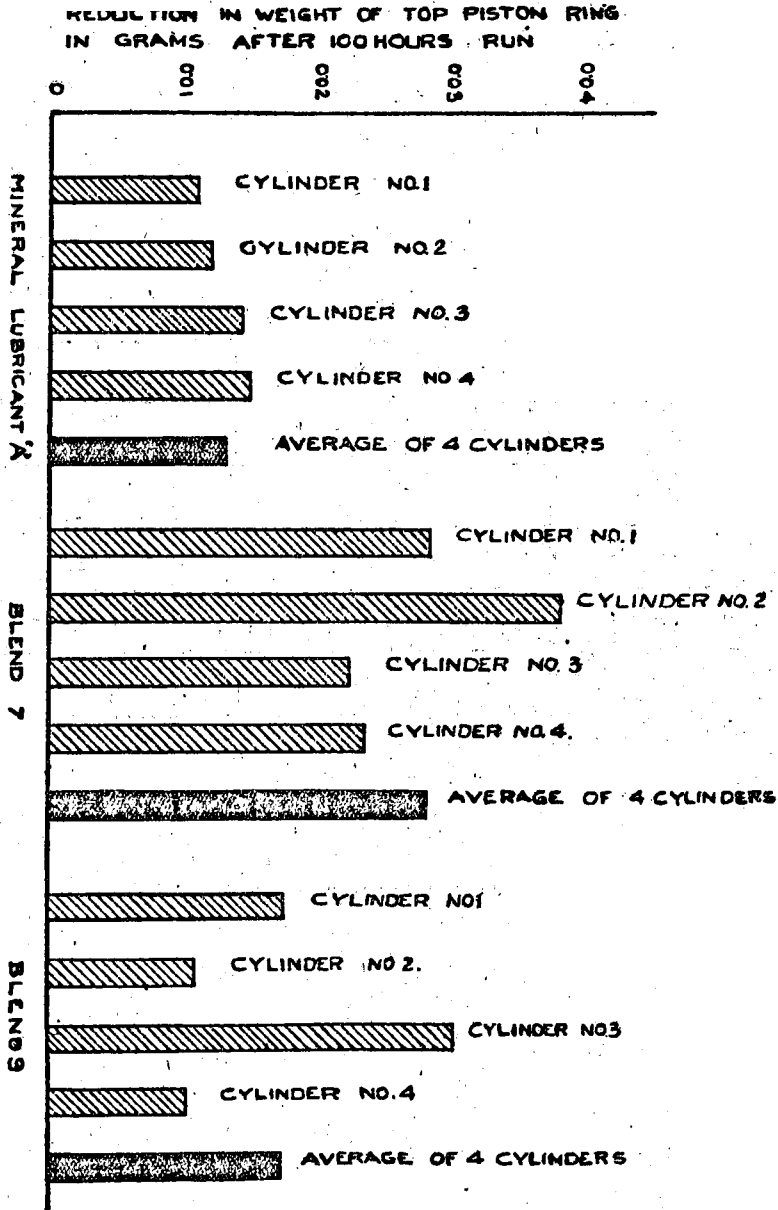

Fig. 29.

Graphical representation of the loss in weight of top piston after 100 hours' engine test in 16 H.P. Morris engine.

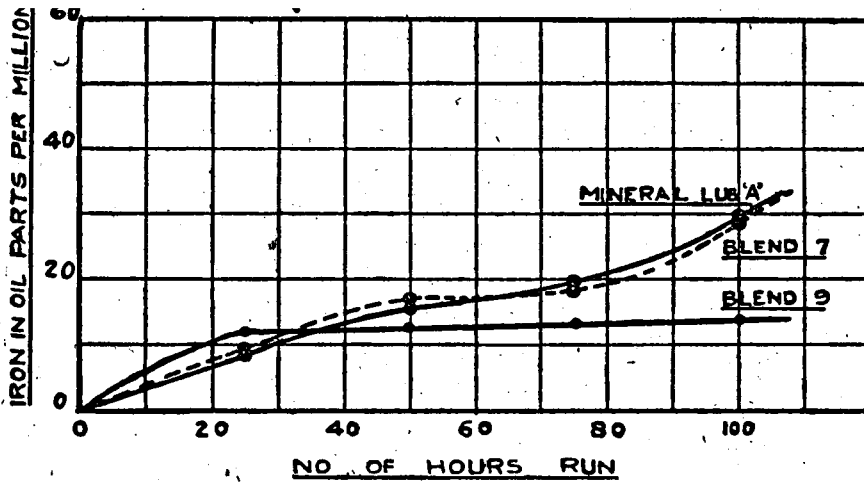

FIG. 30.

Change in iron content (in solution) of crank case oil with the duration of run in 16 H.P. Morris engine.

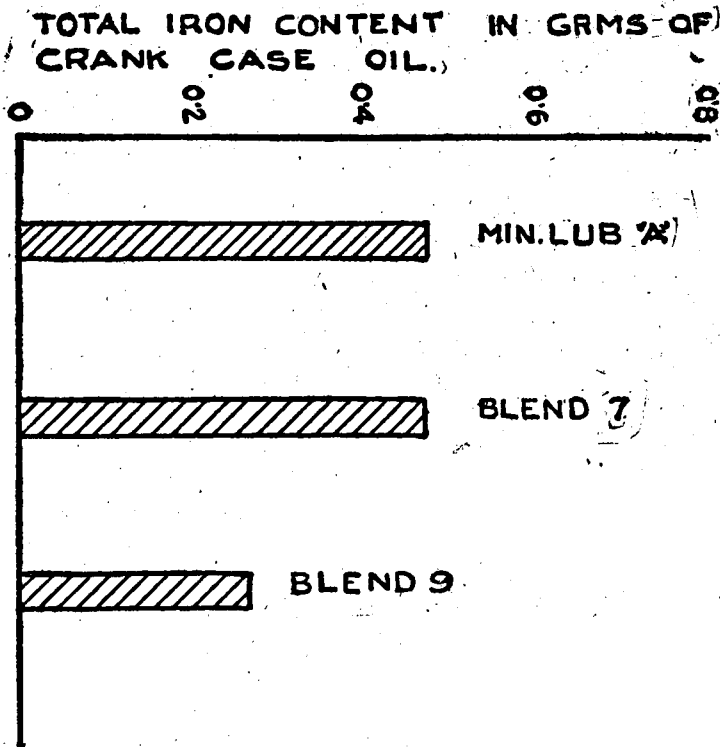

FIG. 31.

Graphical representation of the total iron content (including that of sludge) of the crank case oil after 100 hours' engine test in 16 H.P. Morris engine.

TABLE NO. XII.

Nature and extent of deposits on various engine parts after 100 hours' run.
(Four figures under any head refer to data obtained with the individual cylinders).

No. of run.	Blend.	Piston top and underside.	Cylinder head.	Weight in grams.			Ring lands, grooves and skirt.	Valves and valve pockets.	Remarks.
				piston top.	cylinder head.	piston underside.			
1	Mineral lubricant "A".	Piston top, in each case, showed thin, uniform and hard deposit of carbon (fig. 34) which was removable with some difficulty; underside simply lacquered brown.	Thin hard deposit.	0.517 0.536 0.530 0.482	1.900 1.220 2.439 1.971	Nil	Top land, in each case, showed thin deposit at places. Other ring lands and grooves covered with thin uniform deposit. Skirt lacquered black mostly near the gudgeon pin bearing ends.	Inlet valve of cylinder Nos. 1, 2 and 4 showed granulated deposits over portions of shoulders (fig. 33). That of cylinder No. 3 covered with the same type of deposit practically over the entire shoulder. Portions of stem and face of each valve either stained or covered with thin deposit. Exhaust valves showed no deposit.	Interior of each cylinder clean and free from gummy deposits and score marks and so also were the principal bearing parts. Partial clogging of some of the scraper ring slots. Piston rings free in their grooves.
2	Blend No. 7.	Piston top, in each case, covered with a thin, uniform and hard deposit (fig. 36) which could be scraped off with great difficulty. The scrapings presented a black to brownish appearance, giving an impression of partially carbonised oil; underside lacquered brown.	Do.	0.571 0.606 0.617 0.672	1.121 1.595 2.410 2.825	Practically nil.	Except for the top land, which was partly bright and partly covered with carbonaceous deposit, the ring lands and grooves were generally covered with a thin uniform deposit in the case of each of the pistons. The skirt, in each case, showed brownish coloration at places.	Shoulder and part of stem of inlet valves of cylinder Nos. 1 and 2 covered with thick spongy deposit of resinous character (fig. 36). Those of cylinder Nos. 3 and 4 showed the same type of deposit but in less amount. The total weight in deposits on the shoulders, stems, etc., was 6.14 gms. Exhaust valves showed no deposit.	Interior of each cylinder clean and free from gummy deposits and score marks; so also were the principal bearing parts. No clogging of scraper ring slots or drain holes on scraper ring grooves. Piston rings free in their grooves.
3	Blend No. 9	Each piston top covered with a hard deposit of carbonaceous matter (fig. 37) which could be scraped off with difficulty. The scrapings were similar in appearance to those of blend No. 7, underside lacquered brown.	Fairly smooth deposits.	0.850 0.883 1.173 1.179	1.229 1.675 5.360 5.231	Practically Nil	The deposits on the various ring grooves and skirt generally similar to those obtained with Blend No. 7.	The shoulders of all the inlet valves and their pockets covered with appreciable deposits of resinous character, the amount of deposit decreasing with their distance from the oil spray which located in the valve is chamber near the inlet valve of cylinder No. 1 (fig. 38). The following are the weights of deposits:— 1.86 grms. 1.73 " 1.38 " 0.58 " The inlet valve faces, in each case, covered with a thin film or simply stained. The exhaust valve pockets, shoulders and stems free from deposits.	Do.

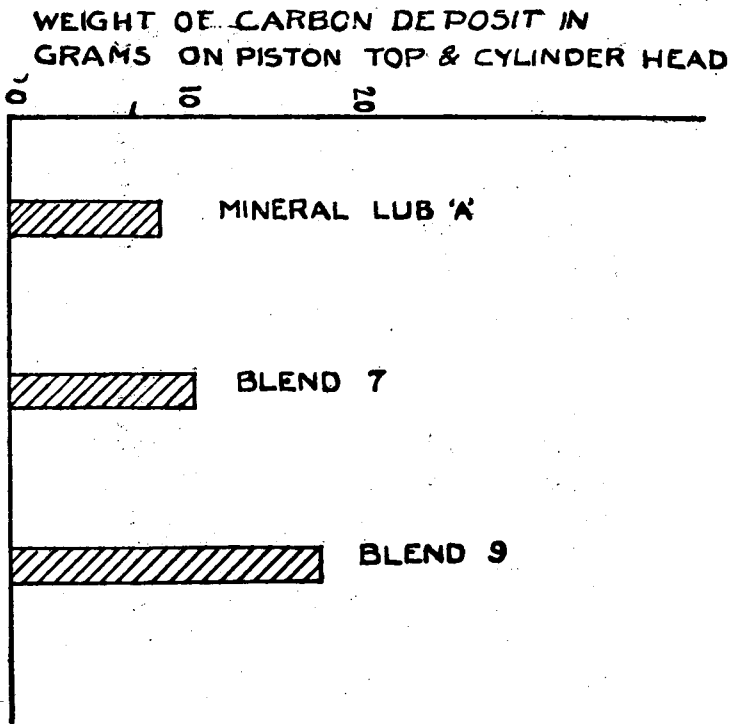

FIG. 32.

Graphical representation of the weight of carbon deposit on piston top and cylinder head as a result of 100 hours' engine test in 16 H.P. Morris engine.

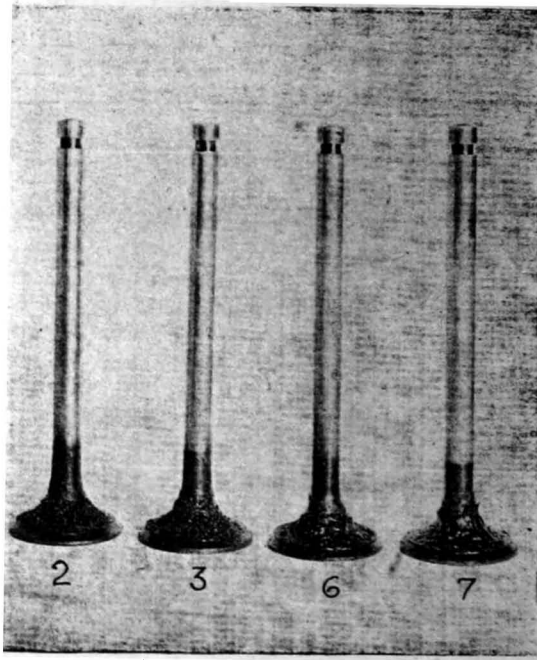

FIG. 33.

Carbonaceous deposits on the shoulder and stem of the inlet valves of 16 H.P. Morris engine as a result of 100 hours' run with mineral lubricant "A".

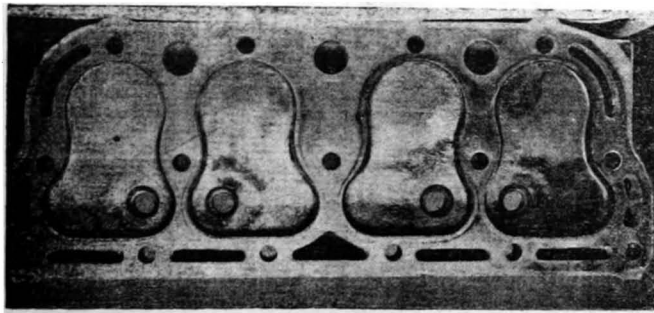
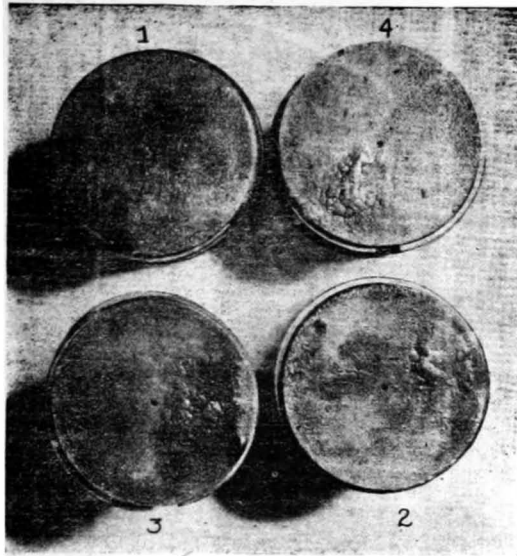

FIG. 34.

Carbonaceous deposits on the piston tops and cylinder head of 16 H.P. Morris petrol engine as a result of 100 hours' run with mineral lubricant "A"

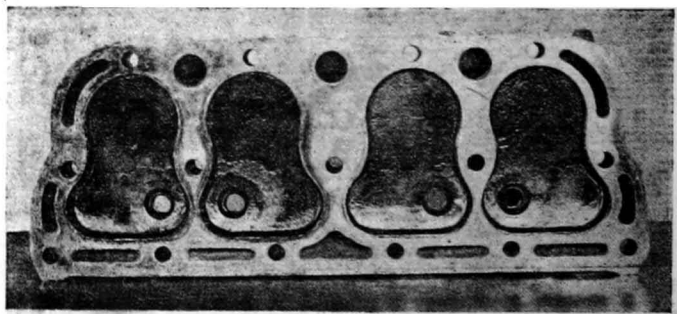
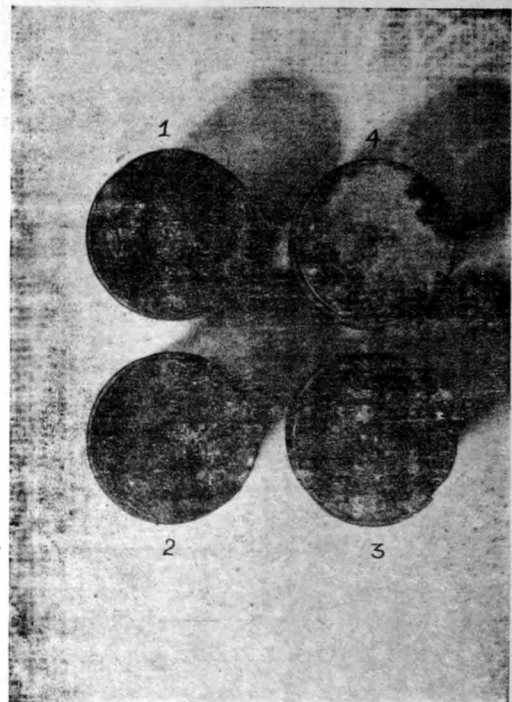

FIG. 35.

*Deposits on the piston tops and cylinder head of 16 H.P. Morrts engine
as a result of 100 hours' run with Blend No. 7.*

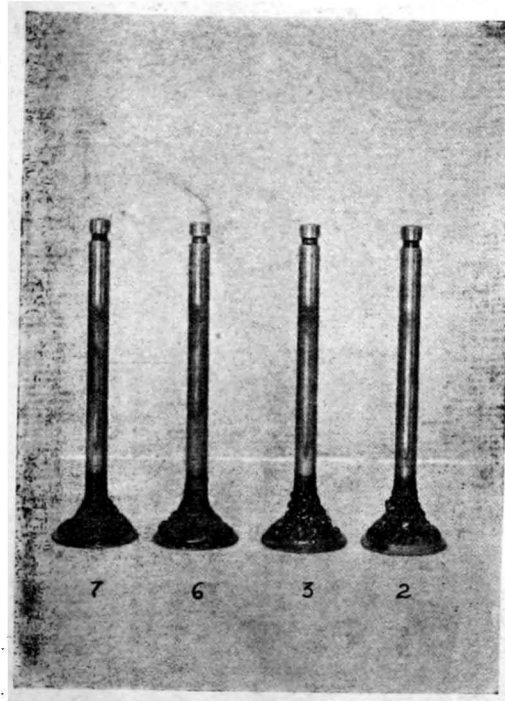

FIG. 36.

Carbonaceous deposits on the shoulder and stem of the inlet valves of 16 H.P. Morris engine as a result of 100 hours' run with Blend No. 7.

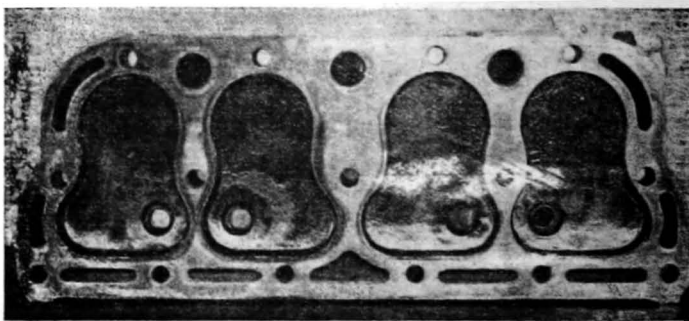
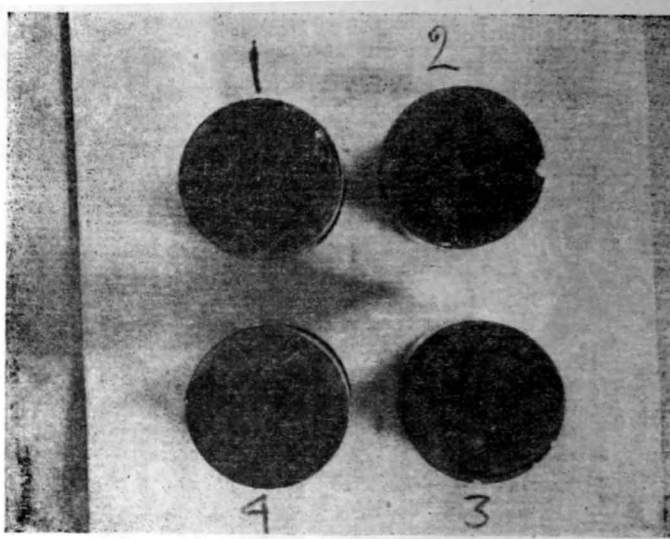

FIG. 37.

Carbonaceous deposits on the piston tops and cylinder head of 16 H.P. Morris engine as a result of 100 hours' run with Blend No. 9.

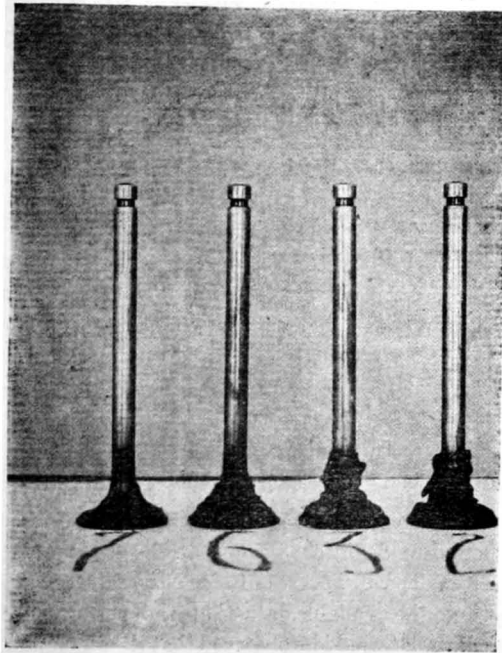

FIG. 38.

Carbonaceous deposits on the shoulder and stem of the inlet valves of 16 H. P. Morris engine as a result of 100 hours' run with Blend No. 9.

A close examination of Table XII brings out some interesting facts with regard to the nature and extent of deposits, obtained with the vegetable oil blends, as compared with those obtained in the corresponding parts with the mineral lubricating oil "A". The most marked difference in behaviour between the two types of lubricants is in respect of the deposits observed on the piston top, cylinder head, inlet valves and valve pockets, while the nature and extent of deposits on the other parts, particularly the piston underside and the ring grooves are, in general, identical in the case of both types of oils. The most outstanding fact that is brought out by the engine tests is that the two vegetable oil blends tried in the large unit (Morris) were at least free from the ring sticking tendency under high temperature conditions. It remains, however, to be seen whether the alternate high and low temperature running (or even continuous running), as encountered under certain service conditions are conducive to ring sticking.

With regard to weights of deposits on the piston top and cylinder head, it would be seen that the performance of Blend No. 7, is slightly worse than that of mineral lubricant "A", but the performance of Blend No. 9 may be regarded as definitely worse. Although Blend No. 7 is a castor and ground nut oil mixture and Blend No. 9 is a castor and rape oil mixture, the difference in behaviour can not be wholly ascribed to the difference in composition or to the different carbonizing behaviour of the two blends, but partly also to the difference in the initial viscosities of the two blends (Table IX). The lower initial viscosity of Blend No. 9 was evidently responsible for more oil going past the piston rings into the combustion space, resulting in more deposits. This is also confirmed by the slightly higher consumption figure in the case of this blend (Table IX).

In respect of deposits on the valves and their pockets, both the vegetable oil blends, however, showed up definitely worse than the mineral oil "A". Although the individual weights of deposits in case of Blend No. 7 were not determined, it can be safely concluded from the available data that the performance of the two oils was practically identical. It would be observed that the amount of deposit decreased with the increase in distance of the valves or their pockets from the oil spray which is located in the valve chamber near the inlet valve of cylinder No. 1 for the lubrication of the valves in their guides. Although it must be admitted that the vegetable oils have a definitely greater carbon forming tendency than the mineral oils in general, the real explanation for the peculiar manner in which the amount of deposit has progressively decreased from the point of admission of the oil into the valve chamber lies not only in the quality of the oil itself but also in the peculiar design of the particular engine. It is, however, proposed to discuss this point in greater details under "Discussion".

DISCUSSION.

In evaluating the performance of the various blends, it is considered best to confine the discussion to the pure vegetable oil blends and to discuss first the results obtained with the various blends as a result of runs in the smaller engine (Lister M53DofS&IR Delhi

single cylinder), and subsequently to compare the performance of some of the blends, that prove to be the best, with that obtained in the larger unit. It is, however, not necessary to discuss all the data obtained in connection with the various characteristics or engine operation, which have already been briefly discussed. It is here proposed to judge the comparative merits of the various blends from the following important points of view:—

(1) Change in the main characteristics of the oil such as:—

- (a) Viscosity.
- (b) Acid value.
- (c) Sludge content.

(2) Oil consumption.

(3) Wear of the engine parts.

(4) Carbon deposits.

With regard to oil consumption, it was not possible to determine it accurately in the case of the smaller engine. It was not, therefore, included in the Tables of data pertaining to this unit.

In determining the engine wear the following methods^{22, 33, 3} which are now commonly recognized, were employed:—

(a) Measurement of the increase in diameter of the cylinder bore.

(b) Determination of the loss in weight of top piston ring.

(c) Determination of the iron content of the crank case oil at different stages of the progress of the run as well as the determination of the total iron content of the oil including that of the sludge at the end of 100 hours' run.

LISTER SINGLE CYLINDER ENGINE.

Blend No. 3.

Blend No. 3, which is a castor-groundnut oil mixture with α -naphthol, was composed of unrefined oils having a high initial acid value of 2.5 as compared with 0.10 in the case of the reference lubricant "A" (second standardization run). It will be seen from Table XIII, which gives a summary of the changes in the various characteristics, that the viscosity of the blend did not show any appreciable change with engine operation. The acid value, which was high to start with, instead of increasing further, showed a slight decrease. The quantity of sludge in the crank case oil after 100 hours' run was practically 50% more than in the case of the reference lubricant.

With regard to the wear characteristics, the performance of the oil was decidedly inferior to that of the reference lubricant. Although the reduction in weight of top piston ring was only 20% more, the increase in cylinder bore was 0.0005" as compared with the negligible change in the case of the run with the reference lubricant, and the total iron content of the crank case oil was nine and a half times that obtained after the standardization run.

The amount of carbon deposits on the piston top and cylinder head as well as the underside of the piston was also decidedly higher, being 6.0 and 1.18 grams

respectively as against 0.6 and 1.0 grams obtained with the reference oil. While, therefore, the change in viscosity and acid value of the blend was quite comparable with the corresponding figures for the reference oil, its performance in other respects, particularly the wear of the engine parts, was definitely worse. The high wear figure, it is supposed, might have been due to the high acid value of the oil, but it must be pointed out that the acid value of an oil is not always a deciding factor in corrosion. The nature of acids is of more importance in this respect than their quantity.

Blend No. 4.

Blend No. 4 was identical in composition with Blend No. 3 but without any stabilizer. It had also the same viscosity and acid value as the latter. It was subjected to engine test primarily with a view to determining the extent to which the presence or absence of a stabilizer affects the changes in characteristics of an oil or influences the engine operation. An examination of Tables V and XIII and Figs. 4 and 6 will demonstrate that the percentage rise in viscosity was nine times and acid value increase nearly seven and a half times the corresponding values for the reference lubricant, or, compared to Blend No. 3, the viscosity increase was nearly ten times, while the acid value increase was 2.75 as against a slight decrease in the case of the former blend. The sludge content of the oil was also twice that obtained with the reference oil as against one and a half times in the case of Blend No. 3. What is most striking is that the wear characteristics of the oil showed up appreciably better than those of Blend No. 3, whereas the amount of carbon deposit on the piston and cylinder head was practically the same as that obtained with Blend No. 3. The amount of carbon deposit on the underside of the piston, on the other hand, was considerable, being 13.2 grams as against 1.8 grams in the case of Blend No. 3 and 1 gram in the case of the reference oil. It should be pointed out that, in spite of the enormous increase in viscosity, there was no appreciable fall in output, nor was there any trouble experienced in operation of the engine, or undue rise of the equilibrium temperature of the crank case oil or any unusual consumption of petrol. One other point that deserves special mention is the fact that in spite of the final acid value of the blend being twice that of Blend No. 3, the amount of iron removed from the engine was less than half of that removed by the latter under similar operating conditions. It appears, therefore, that the acidic character of the stabilizer (α -naphthol) was probably responsible for the removal of a large quantity of iron from the engine parts.

Blend No. 5.

The composition of this blend was the same as that of Blend No. 3 except that its acid value was considerably reduced by suitable refining, which left a small percentage (0.11%) of residual soap. It will be noticed from Tables V, VI, VII and XIII and Figs. 4 to 8, 14 to 16 and 39, that the reduction of acid value of the blend caused a considerable improvement over Blend No. 3 in practically all respects, except for a slightly greater loss of weight of the top piston ring. Compared with the reference lubricant, its performance was appreciably superior in respect of the acid value increase and the quantity of sludge and carbon deposits on piston top and

TABLE XIII.

Summary showing actual changes in value of certain important characteristics of vegetable oil blends and the ratio of these changes in relation to those in the reference lubricant "A" after 100 hours' run in Lister petrol engine set.

Blend No.	Composition of blend	Viscosity increase		Acid value increase %		Increase in Conradson carbon residue		Amount of sludge		Reduction in weight of top piston ring		Total iron content		Cylinder wear (inoh)	Total weight of carbon deposit on piston top and cylinder head	
		Actual	Ratio	Actual	Ratio	Actual	Ratio	Actual (grms.)	Ratio	Actual (grms.)	Ratio	Actual (grms.)	Ratio		Actual (grms.)	Ratio
3	Castor oil .. 60% Groundnut oil .. 40% α-Naphthol .. 1%	21.4	1.0	0.4	..	3.0	3.0	1.64	1.8	0.0352	1.2	0.556	9.5	0.0005	3.2	6.0
4	Castor oil .. 60% Groundnut oil .. 40% No stabilizer	21.2	0.1	2.7	7.6	1.2	4.0	2.0	2.1	0.0947	1.2	0.443	4.4	0.0002	3.3	6.0
5	Castor Oil .. 60% Groundnut oil .. 40% α-Naphthol .. 1% Acid value .. Soap .. 0.117%	21.4	1.5	0.13	0.4	0.23	1.1	0.30	0.7	0.0500	1.8	0.226	2.2	Not measurable	1.4	2.5
	Mineral lubricant "A" A proprietary brand of mineral lubricant.	21.3	1	0.35	1	0.30	1	1.12	1	0.0288	1	0.101	1	Do.	0.55	1
6	Castor oil .. 60% Groundnut oil .. 40% α-Naphthol .. 1% Acid value .. 0.88 Soap .. 0.0195	20.2	0.9	0.32	0.9	0.26	1.2	1.32	1.2	0.0434	1.8	0.195	1.0	Do.	2.5	4.5
7	Castor oil .. 60% Groundnut oil .. 40% α-Naphthylamine .. 1%	12.4	0.6	0.04	3.3	0.23	0.8	1.04	1.8	0.0251	1.2	0.140	1.5	Do.	1.3	2.4
8	Castor oil .. 60% Groundnut oil .. 40% α-Naphthylamine .. 1% Chromium oleate .. 0.1%	11.3	0.6	0.02	2.4	0.23	1.3	1.04	1.7	0.0600	2.4	0.497	4.0	0.003	0.98	1.5
9	Castor oil .. 60% Bapa oil .. 50% B-Naphthylamine .. 0.5% Di-phenylamine .. 0.5%	45.7	2.1	1.22	3.4	1.12	0.7	0.26	0.8	0.0460	1.0	0.270	2.7	Not measurable	0.77	1.4

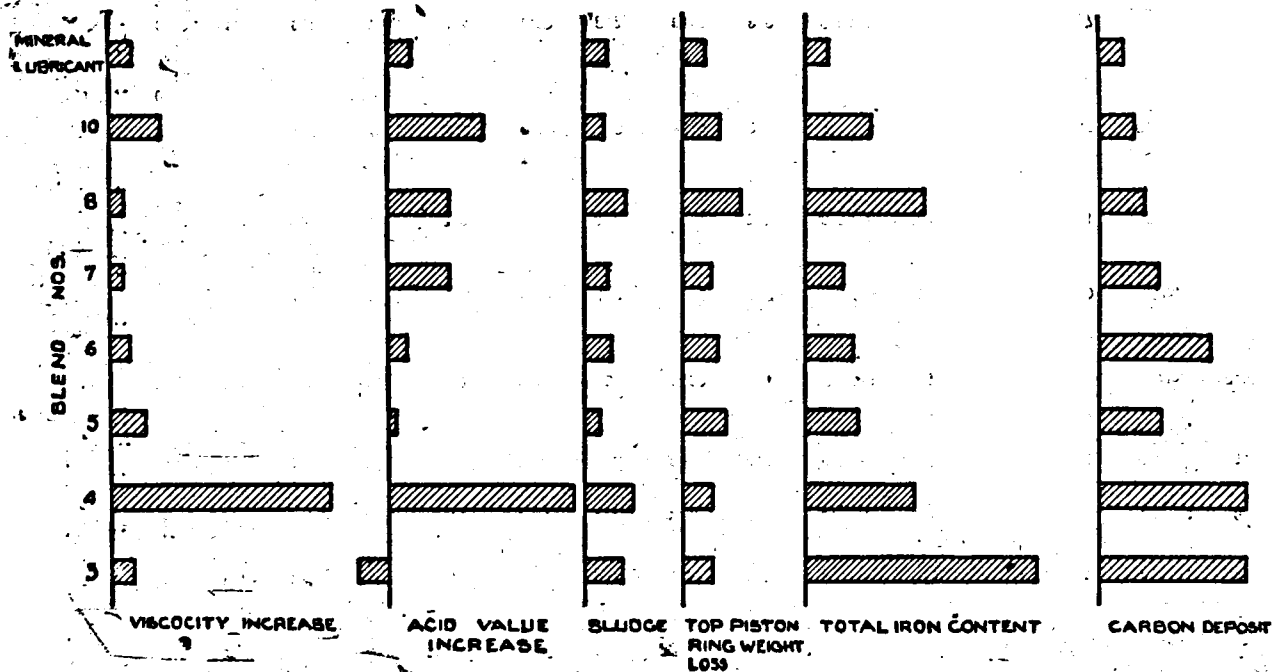

Fig. 39.

Graphical representation of the changes (ratios) of the principal characteristics of the various vegetable oil blends as compared with those of the reference lubricant "A" after 100 hours' run in Lister petrol engine dynamo set.

cylinder head. The percentage rise of viscosity, however, was one and a half times that obtained with the reference oil. With regard to wear, although the cylinder bore showed a negligible change in dimension, the loss of weight of the top piston ring and the total quantity of iron removed by the blend were practically 75 per cent. and 100 per cent. respectively more than in the case of the reference oil. With all this improvement, however, the blend showed a weak point, that is, it caused the sticking of the top piston ring, which was found imbedded in a semi-solid mass of deposit. The reduction of acid value cannot possibly explain this phenomenon, and it is at the same time very difficult to say whether the presence of the residual soap left as a result of refining was at least partly responsible for this state of things, or whether it was purely accidental.

Blend No. 6.

Blend No. 6 was identical in composition with Blend No. 5 except that its soap content was appreciably reduced with a view to determining the extent to which the engine operation is influenced by it and whether it becomes free from the weak points, revealed by Blend No. 5. An examination of Tables V, VI, VII and XIII and Fig. 39 will indicate that this blend showed improvement in some respects (viscosity increase and the quantity of iron removed) and deterioration in others, particularly, in respect of the carbon deposits, which were appreciably higher than in the case of Blend No. 5. The only marked beneficial effect which it seemed to produce was the freedom from gummy deposits in piston ring grooves and the ring sticking tendency produced by Blend No. 5.

Blend No. 7.

This was a castor-groundnut oil blend of the same percentage composition as the preceding blends but was stabilized with α -naphthylamine instead of α -naphthol. It will be seen from the results of engine tests recorded in Tables V, VI, VII, XII and Figs. 4 to 8, 14 to 16 and 39 that this blend showed an all-round improvement except with regard to acid value increase, and proved to be the best of all the vegetable oil blends, so far tried. It is interesting to note that the changes in the various properties of the oils were brought about within practically the first twenty-five hours' run. The viscosity change was the least so far attained and was even less than that obtained with the reference oil; the amount of sludge in the oil after 100 hours' run was also a little less than in the case of the run with the latter. Although the total quantity of iron (0.149 gram) removed from the engine and the weights of deposits (1.82 grams) on the piston top, underside and cylinder head were somewhat greater than the corresponding figures (0.101 and 1.55 grams) obtained with the reference oil, yet they were the least obtained with the vegetable oils tried so far. It may be of interest to point out that in spite of the comparatively large increase in acid value, the wear characteristics of the blend proved to be decidedly superior to those of Blend No. 6 or, for that matter, any other blend tried up till now.

Blend No. 8.

This blend was identical in composition with Blend No. 7 except for the addition of 0.1 per cent. chromium oleate intended to improve the service characteristics of Blend No. 7 further, particularly with regard to carbon deposits. It will be readily observed from Tables V, VI, VII and Fig. 39 that, although the viscosity and acid value increase remained practically the same as those in the case of Blend No. 7, it had deteriorated practically in all other respects with the important excep-

tion of carbon deposits, which were the least so far obtained with the blends. Although, therefore, the expectation of reduced carbon deposits was fulfilled, the excessive wear as shown by the reduction in weight of top piston ring and the total amount of iron in crank case oil, rules out the blend when compared with Blend No. 7.

Blend No. 10.

Blend No. 10 was a castor-rape oil mixture of the same percentage composition as blend No. 9, but was stabilized with equal parts of β -naphthylamine and diphenylamine. An examination of Tables V, VI, VII, XIII and Fig. 39 will show that with the exception of sludge content and carbon deposits, which showed an appreciable improvement in comparison with Blend No. 7, the blend showed a marked deterioration practically from all other points of view.

The blend, however, was a distinct improvement on Blend No. 8, with regard to the formation of sludge, carbon deposits and wear of the engine parts, although the viscosity and acid value increases were appreciably higher in the case of the former. Comparing the two blends, it may be stated that, generally speaking, Blend No. 8 showed better stability, but worse wear characteristics, whereas Blend No. 10 showed better wear characteristics and worse stability. One other interesting feature which may be pointed out in this connection, is that, while Blend No. 8 showed a less viscosity increase and a greater sludge content, Blend No. 10 showed a greater viscosity increase and a less amount of sludge. The explanation of this phenomenon appears to lie in the fact that in the former, the polymerized and cracked products were less soluble, thus depositing solid or semi-solid residue in the crank case oil, whereas in the latter these products were more soluble giving rise to increased viscosity and deposition of less solid product or sludge.

MORRIS INDUSTRIAL ENGINE.

Blend No. 7.

The various points of interest regarding the performance of this blend in the Morris Engine have already been discussed in detail under the Tables presenting the various data obtained as a result of engine tests. It may now be generally stated that in spite of the blend showing a somewhat greater increase in viscosity and acidity, the frictional losses in the bearing parts and the total quantity of iron removed from the engine parts were similar to those obtained with the reference oil. The loss of weights sustained by the top rings varied between 0.0177 and 0.0387 grams, while corresponding figures obtained as a result of run with the reference oil varied between 0.0110 and 0.0150 grams.

It may also be pointed out that while the bores of two of the cylinders showed an increase of 0.002" and 0.0005" respectively, none of the cylinders showed any measurable change after 100 hours' run with the reference oil.

The blend, however, was definitely superior to the reference oil as regards the development of sludge or the consumption of oil.

As regards the deposits on the piston top and the cylinder head, it will be seen from Table XII that the blend produced a slightly larger amount of deposits than the reference oil. One other important point that deserves to be considered and has already been discussed at some length is the formation of considerable gummy deposits on the shoulder and part of the stem of the inlet valves and their pockets and the absolute freedom of deposits on all the exhaust valves or their pockets.

What was rather interesting was that the amount of deposit generally decreased from one end of the valve chamber to the other, so that the amount of deposit was at a maximum in the case of the inlet valve of No. 1 cylinder and at a minimum or practically nil in the case of the inlet valve of No. 4 cylinder. This at once leads to the conclusion that the oil spray being located close to cylinder No. 1 was delivering an unnecessarily large quantity of oil to the valves adjacent to it. The very fact that there was no trouble regarding the lubrication of the valves, of, say, cylinders Nos. 3 and 4, in their guides, affords an additional proof of this assumption. It should, however, be pointed out that this particular method of lubricating the valve stems is peculiar to this make of engine only; in most engines, the only means of lubricating the valves in their guides is a fine spray of oil carried into the valve chamber from the crank case, so that all the valves get the proper and an approximately equal amount of oil. It may also be pointed out that in the case of run with the reference oil also, the inlet valves (Fig. 33) showed an appreciable deposit, which, however, were not weighed.

In the light of the above explanation, it is not unlikely that the vegetable oil will be free from this defect when worked in other engines. The reason why the vegetable oils should give more deposit on the inlet valves and none on the exhaust valves, appears to be that the temperature of the latter are very much higher and any oil finding its way into the exhaust valve pockets burns out completely, while the temperature of the inlet valves is not high enough for complete combustion nor low enough to retard effectively such reactions as polymerization, decomposition, etc. It is, however, expected that it is possible to eliminate this undesirable deposit on the inlet valve by modifying the method of lubricating the valve chamber or controlling the temperature of the intake mixture.

Briefly stated, the blend was found to be superior to the reference oil in respect of the sludge content and oil consumption, similar to it in respect of the total iron removed from the engine parts and the cylinder wear, and somewhat inferior in respect of viscosity and acid value increase as well as the loss of weight of top piston ring and carbon deposits.

As the quantity of acids cannot be considered to be a criterion of the deterioration of an oil unless it be of such a nature as to cause excessive corrosion of the parts with which it comes in contact, and as the iron content of the crank case oil and the cylinder bore wear were similar for the blend as well as for the reference oil, the comparatively high acidity of the used oil cannot be considered to be a serious defect. The viscosity increase was also not such as to cause excessive frictional losses as determined by the motoring tests at intervals. The carbon deposits were appreciably more, but in no way excessive. Except therefore, for an appreciably greater loss of weights of some of the top piston rings, and the tendency of accumulation of gummy deposits on the inlet valve shoulders, which are undesirable, if considerable, the blend, on the whole, compared favourably with the reference oil when subjected to engine tests under similar operating conditions.

Blend No. 9.

Blend No. 9 is a castor-rape oil mixture in equal proportions, treated with α -naphthylamine. In view of the satisfactory behaviour of the rape oil with α -naphthylamine in the oxidation test, it was decided to replace the groundnut oil in Blend No. 7 by rape oil with a view to improving the performance still further. The percentage composition of this blend, for reasons given before, was adjusted to give a lower initial viscosity (109 c.s. at 100° F.) as compared with 128.6 c.s. in the

case of the vegetable oil Blend No. 7 and 122.1 c.s. in the case of the reference lubricant.

An examination of Tables IX, X and XI and Figs. 19 to 23 and 28 to 32 will show that the substitution of rape oil for groundnut oil caused an allround improvement in the performance of the blend over Blend No. 7 except in respect of oil consumption and carbon deposits on the piston top and cylinder head, which showed a slight increase. The improvement in the two important respects of sludge and iron content of the crank case oil after 100 hours' run was remarkable in that in these respects the blend far excelled the reference lubricant. The loss of weight of the top piston rings, with the exception of one, compared favourably with that obtained with the reference oil. The cylinder bores also did not show any measurable change in dimension except in the case of one, which showed an increase of 0.0003". The improvement in respect of viscosity, acid value and carbon residue was also quite appreciable. It may, however, be pointed out that in view of the wear and friction characteristics of the blend being either superior or similar to those of the reference oil, the slightly higher figures for acid value or viscosity cannot be considered to constitute a serious defect of the oil.

The slightly higher increase in oil consumption can be definitely attributed to the lower initial viscosity of the blend, as the other factors governing it, namely, engine design, speed, engine changes due to wear (which was negligible as the two blends were run consecutively) or volatility (both were fixed oils) remained practically constant. The increased carbon deposits on piston top, etc., as explained previously, might also be attributed to this fact.

The deposits on the shoulder and stem of the inlet valves were of the same magnitude (Table XII and Fig. 38) as those in the case of run with the previous blend, but rather more than that obtained with the reference oil. The possible cause of their formation in decreasing amounts from the point of admission of the oil into the valve chamber and the possible methods of prevention have already been discussed under Blend No. 7.

Except for the formation of the various deposits which can be reduced by one method or another, as pointed out before, the performance of the blend is more or less similar to that of the reference lubricant "A", and with regard to sludging and the amount of iron removed from the engine parts, its performance was decidedly superior.

It may, therefore, be stated that Blends Nos. 7 and 9 have proved quite satisfactory as lubricants for petrol engines of the sizes up to about 16 H.P. Blend No. 9 could further be improved by adjusting its viscosity to a slightly higher figure in the neighbourhood of 120-130 c.s., which can be done by increasing the proportion of castor oil in the blend by a small fraction.

Finally, it is desirable to find out if there exists any correlation between the viscosity increase obtained as a result of the Modified Air Ministry Oxidation Test and that obtained as a result of engine operation, so as to justify the selection or grading of lubricating oils merely on the basis of Air Ministry Oxidation Test, or whether the vegetable oils differ from the mineral oils in this respect. To facilitate examination of the degree of correlation, if any, the figures for viscosity increase ratios at 100° F. as a result of the Modified Air Ministry Oxidation Test and the percentage increase in viscosity of the various blends at the same temperature after 100 hours' operation in Lister engine have been collected together in Table XIV below and plotted in Fig. 40.

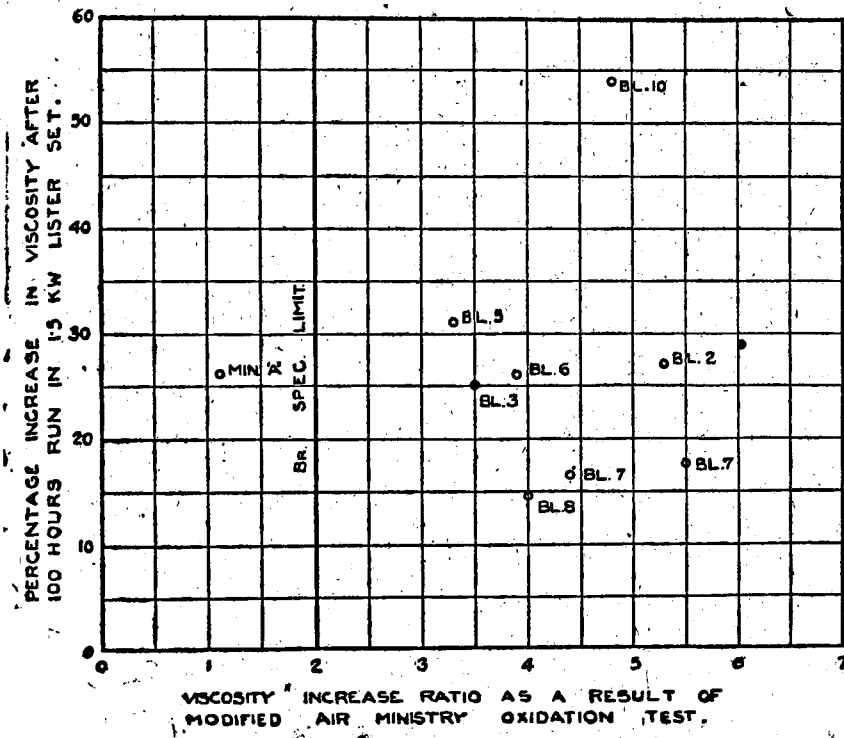

FIG. 40.

Comparison of viscosity increases obtained by Air Ministry Oxidation Test and engine tests.

TABLE XIV.

Comparative figures for viscosity increase as a result of Modified Air Ministry Oxidation Test and 100 hours' engine test in 1.5 K. W. Lister set.

Serial No.	Blend.	Viscosity increase ratio at 100° F after Modified Air Ministry Oxidation Test.	Percentage increase in viscosity at 100° F after 100 hours' run in 1.5 K. W. Lister Set.
1	Mineral Lubricant "A"	1.1	26.1
2	Blend No. 1	5.5	15.1
3	Blend No. 2	5.3	27.
4	Blend No. 3	3.5	25.1
5	Blend No. 4	7.3	270.9
6	Blend No. 5	3.3	30.8
7	Blend No. 6	3.9	26.0
8	Blend No. 7	4.4	16.6
9	Blend No. 8	4.0	14.6
10	Blend No. 10	4.8	53.2

It will be seen that there does not appear to exist any definite correlation between the viscosity increase figures obtained as a result of the Air Ministry Oxidation Test, and actual engine tests on the different vegetable oil blends, which confirms the observations of Hanson and Egerton³² as also those of Mardles and Ramsbottom³³ in the case of mineral oils in general. They have, therefore, stressed the necessity of actual engine tests as the final criterion of the suitability of a lubricant for I.C. engines. Pye³⁴ also acknowledges the limited value of the British Air Ministry Oxidation Test in the following terms: "A check on the chemical stability of an oil against oxidation at 200° C and decomposition at the higher temperature is aimed at and to some extent achieved. Undoubtedly there are examples of oils which would fail to meet the specification requirement and yet might stand up excellently during prolonged test in service".

The findings of Pye are also sufficiently corroborated by the results of tests (Table XIV) on various blends of vegetable oils obtained in these investigations. In spite of the fact that practically all the blends failed to comply with the requirements of the Air Ministry Specification as regards the viscosity increase ratio, some of the blends, as has been already shown, stood up excellently under engine operating conditions in both small and medium power engines.

ACKNOWLEDGMENT.

The authors wish to acknowledge the work of Mr. A. N. Kapur, who carried out certain preliminary experiments in connection with this investigation.

BIBLIOGRAPHY.

1. Aggarwal, J. S., and Verman, Lal. C.—"Utilization of Indian Vegetable Oils as Lubricants in Internal Combustion Engines", Part I, *Bulletin of Indian Industrial Research* No. 18, 1940.
2. Thomasi, L., *Ann. Combustibles Liquids*, 13, 519-45, 1938.
3. Champasaur, N., *Chemic et Industrie*, 24, 519-25, 1930.
4. Devez, G. J., *Revue Industrielle*, 63, 274-81, 340-43, 1933.
5. Anzla, B., *Annales des Falsifications*, 29, 92, 1936.
6. Peru, *Ann. Combustibles Liquids*, 11, 1071, 1936.
7. Bastet, A., *Bull-Soc. Encom. Ind. Nat'l.*, 133, 193, 1934.
8. Balada, A., *Petroleum, Z.*, 33, No. 38, 1-8; No. 40, 1-8, 1937.

9. Freund, Mihaly, and Thamn, Istvan, A. *Magyar Me'rnök-és Épite szegylet Köz-
lönye.*, 73, 222-6, 1939.
10. Southcombe, J. E., *Proc. Phy. Soc. London*, 28 Nov. 1919.
11. Wells, Henry M., and Southcombe, J. E., *J. S. C. I.*, (London), 39 (5) 51-61.
12. Bass, E. L.—“ Aero Engine Design and Lubrication,” *Proc. General Dis-
cussion on Lubrication and Lubricants, Institution of Mechanical Engineers,
London*, Oct. 1937 Vol. I, Group II, p. 414.
13. Hawkes, C. J., and Hardy, G. F., “ Friction of Piston Rings ”, *Trans. North
East Coast Inst. Engrs. and shipbuilders*, 52, 143, 1936.
14. Taylor, M. P. “ The effect of Gas Pressure on Piston Friction,” *S. A. E. Jour-
nal*, 38, 200, 1936.
15. Sparrow, S. W., and Thorne, M. A. “ Friction of Aviation Engines,” *National
Advisory Committee for Aeronautics*, Report No. 262.
16. Dickenson, H. C., and Bridgeman, O. C., “ Fundamentals of Automotive Lubri-
cation,” *J. S. A. E.*, 31 (i) 278-82, 1932.
17. Langmuir, J. A. C. S., 38, 2221, 1916 ; 39, 1848, 1917 ; *J. Franklin. Inst.* 218,
143, 1934.
18. Adam, N. K., *Proc. Roy Soc. Gt. Brit.*, 101A, 452, 1922 ; 103A, 676, 1923.
19. Marcelin, *Ann Phys.* (a), 1, 19, 1914.
20. Williams, C. G., “ Interim Report of the Research Standardization Committee
on Cylinder Wear ”, *J. Inst. Auto Engrs.*, June, 1933, P. 73.
21. Williams, C. G., “ Further Experiments on Cylinder Wear ”, *J. Inst. Auto-
Engrs.*, Aug/Sept. 1934.
22. Everett, H. A., and Stewart, F. C., “ Performance Tests of Lubricating Oils in
Automotive Engines ” *Penn. State College, Engineering Station Bulletin*, No. 44.
23. Keller, George H., “ Cylinder Wear Measured by the Iron Content of the Oil ”,
Auto. Ind., 6 April, 1935.
24. Williams, C. G., “ Cylinder Wear—Third Interim Report ” *Inst. Auto. Engrs
Report No. 8604, Class 42.*
25. Pye, D. R., “ Lubrication and Lubricants ”, Art. 28, in “ The Internal Combustion
Engine ” (Oxford Clarendon Press), Vol. II, p. 105, 1934.
26. Spitzglass and Zucrow., “ Engine Lubrication and Deterioration ” (Prepared for
Pines Winterfront Company, Chicago, Illinois).
27. Gruse, W. A., “ Carbon Deposits in Gasoline Engines ”, *A. S. T. M. Sympo-
sium on Motor Lubricants*, March, 8, 1933.
28. Bahlke, W. H., Barnard, D. P., Singer, J. O., and Fitzsimmons, O., *S. A. E.,
Trans.*, 26, 373, 1931.
29. Born, S., and Harper, E., *Oil and Gas Jour.*, 33, No. 24, 12, 1934.
30. Evans, E. A., “ Lubricating and Allied Oils ” (Chapman and Hall Ltd., London),
p. 91, 1933.
31. Boerlage, G. D. and Gravesteyn, B. J. J., *Brit. Motorship*, 13 (150), Aug. 1932.
32. Hanson, T. K. and Egerton, A. C. “ Influence of Catalysts on the Oxidation of
Oils ” *Proc. General Discussion on Lubrication and Lubricants* (Institution of
Mechanical Engineers), Vol. 2, pp. 334, 1937.
33. Mardles, E. W. J., and Ramshottom, J. E. “ Oxidation Behaviour of Internal
Combustion Engine Lubricants ” *Proc. General Discussion on Lubrication and
Lubricants* (Institution of Mechanical Engineers, Vol. 2, pp. 354, 1937).
34. Pye, D. R. “ The Internal Combustion Engine ” (Oxford University Press),
Vol. 2, “ The Aero-Engine ”.

BULLETINS OF INDIAN INDUSTRIAL RESEARCH



No. 22

**PURIFICATION OF INDIAN GLASS-MAKING
SANDS**

BY

B. J. HEGDE, M.Sc., B.Sc., Tech.

**OFFICE OF THE DIRECTOR,
SCIENTIFIC AND INDUSTRIAL RESEARCH**

**DEPARTMENT OF COMMERCE,
GOVERNMENT OF INDIA**

*No-21 not published
06.6(54)*

**PUBLISHED BY THE MANAGER OF PUBLICATIONS, DELHI.
PRINTED BY THE MANAGER, GOVERNMENT OF INDIA PRESS, SIMLA.
1941.**

E141.2
H1

The statements made and the views expressed in this bulletin are those of the author, and the Government of India do not accept responsibility for them.

PURIFICATION OF INDIAN GLASS-MAKING SANDS

BY

B. J. HEGDE, M.Sc., B.Sc., TECH.

INTRODUCTION.

The washing of sand can bring about substantial improvement when the iron oxide impurities are present in the form of clay or other material readily washed away. In some cases, however, the ferruginous material adheres firmly to the sand. In still other cases the iron is present to a considerable extent as ilmenite or other dense materials which resist washing. The sand quarries at Hohenbocka can purify their sand by washing processes so as to enable them to supply material containing less than 0.01 per cent. of iron oxide, and one or two other quarries can meet a similar demand. Much effort has been spent in testing the efficacy of chemical processes of purification, both at moderate and at high temperatures. The latter which includes the use of chlorine, sulphur dioxide or phosgene, are not practicable for the treatment of sand in bulk. The new process of F. W. Adams, involving treatment with solutions of ferrous sulphate and sodium oxalate, bids fair in England to provide a supply of sand from King's Lynn, which will at least in part meet the demand for the higher standards of modern glass, particularly, mass-produced glass. In Australia, by the utilisation of mining separating tables, local sands have been so successfully treated for the removal of iron bearing minerals that the necessity to import sand from long distances has been overcome, and indeed, the doubly treated product has been used extensively for the best lead crystal glassware.

"When it is recalled that at the beginning of our period text books prescribed that sand for the best glass should not contain more than 0.05 per cent. of iron oxide, it is evident that great progress has been made, for much sand is now supplied in bulk to the Stourbridge glass factories with an iron oxide content of 0.015 per cent. or less.

"Even in the case of colourless bottle glasses melted in tank furnaces the Society's specifications issued in 1935, stipulated 0.04 per cent. as the maximum iron oxide content. The demand for a sand of low iron oxide content increased very greatly when, beginning in the U. S. A. about 1918, and spreading within three or four years rapidly in England, colourless glass came greatly into favour at the expense of much pale green and amber bottle glasses."

The above passage from Prof. W. E. S. Turner's presidential address to the Society of Glass Technology, in 1937 (*J. Soc. Glass Tech.* 1938, 128 T.) shows clearly the importance of sand treatment and the progress made in that direction up to the present time.

In India the majority of the glass factories, are situated in the United Provinces. These factories obtain their supply of sand either from Bargarh and Loghra near Naini or from Sawai Madhopur in Jaipur State. The price of these sands is approximately Rs. 3 to Rs. 4 per ton at the sand pits. Owing to

long distances from the sand pits, factories in Calcutta and Bombay have to pay as much as Rs. 15 to Rs. 25 per ton. (Tariff Board Report on Glass Industry, 1932 page, 19).

According to the above Report, there are several sand deposits distributed all over India suitable for the manufacture of mass-produced glass. Few deposits other than those mentioned above have been used by the glass industry so far. One of the reasons for not making use of these may be the fact that their iron oxide content is higher than of those worked at present. To our knowledge, in no instance, purification of sands is practised in India. In this country where the cost of transport is a heavy item of expenditure, due to long distances, it appeared useful to apply treatment to sands from deposits available in the proximity of factories. It would be a saving if the cost of purification worked out to be lower than the freight paid for long-distance transport.

Analyses of various Indian sands, done by different workers, show that the iron oxide contents of these are higher than that of the sands, used for colourless glass by leading glass manufacturing countries abroad. Hardly any of them fall within the specifications of the Society of Glass Technology. Colourless glassware made in India is usually dim in appearance. This is due to the fact, that in order to neutralise the colour imparted by the high proportion of iron oxide present in the batch materials, larger quantities of decolorising materials are used. As a result the power of light transmission of the glass is reduced, and the appearance of the glass suffers. Any reduction of the iron oxide content will therefore, improve the quality of the glass. This improvement is bound to have a commercial effect.

A study of different chemical processes proposed by various authors for sand treatment will show that either most of them are expensive or the equipment required is very elaborate. Any process, to be successful in India, should be cheap and simple in operation. As labour is cheap, the use of power-driven machines can be avoided.

ADAM'S PROCESS.

The process of sand treatment proposed by F. W. Adams (J. Soc. Glass Tech. 1935, 118 T.) has been tried on a semi-commercial scale and it is being employed on a commercial scale by Messrs. Joseph Boam, Ltd., King's Lynn, England, and the plant erected is capable of purifying 10 tons of sand per hour. (J. Soc. Glass Tech. 1937, 409 T.). It consists in washing the sand with a solution of acid sodium oxalate and ferrous sulphate at 80°—90° C. with constant stirring. In this process advantage is taken of the fact that ferrous salts are more soluble than the corresponding ferric salts. The coating of iron oxide on the sand grains is reduced to the ferrous state by the strongly reducing properties of a hot solution of acid sodium oxalate and ferrous sulphate. The film of iron oxide, once it is reduced to the ferrous state, is easily washed.

APPLICATION TO INDIAN SANDS.

With a view to studying, how successfully the process could be applied to Indian sands, 9 samples of sands supplied by the Director, Industrial Research

Bureau, New Delhi and the Glass Technologist to Government, United Provinces, were treated by the above process and the results obtained are tabulated below :—

No.	Sand.	Per-cent. Fe ₂ O ₃ before treatment.	Per-cent. Fe ₂ O ₃ after treatment.
1	Loghra	0.104	0.044
2	Bargarh	0.072	0.052
3	Jaijon	0.226	0.072
4	Sawai Madhopur	0.050	0.032
5	Jubbulpore	0.070	0.066
6	North Canara	0.125	0.038
7	Benares State	0.490	0.037
8	Bargarh	0.118	0.047
9	Bargarh	0.100	0.045

The table above indicates that all but sand No. 5 show considerable reduction in their iron oxide content after treatment. Except in the case of Sawai Madhopur and North Canara sands, the material is found as loose sandstones easily crushable. For the purpose of this investigation, crushed average samples were taken, which would contain more of iron impurity than the core of the sandstone. The experiments were carried out on 200 gms. samples of each sand. The improvement in the iron impurity of sands Nos. 4, 6 and 7 is worth noting. After treatment these are well within the specifications of the Society of Glass Technology and should be suitable for the manufacture of good quality colourless glass.

Probably sands Nos. 1, 2, 8 and 9 belong to the same geological formation, as Loghra and Bargarh are adjoining localities and the nature of the deposits appears to be the same. These four samples were examined with a view to studying the variations in the iron oxide impurity from quarry to quarry. The untreated samples show marked variation while the treated samples contain nearly the same amount of iron oxide. The results obtained for sands Nos. 1, 2, 4, 7, 8 and 9 should be of interest to the glass manufacturers in the United Provinces and that obtained for sample No. 6 to those in Bombay Presidency.

EXPERIMENTAL.

200 gms. of the sample of sand is treated with 0.5 gm. of acid sodium oxalate in 90 c. c. of water and heated to 80°—90° C. with continuous stirring. To this 0.2 gm. of ferrous sulphate in 10 c. c. of water is added and the stirring continued for 3 more minutes. The treating liquid is decanted off and the sand is well washed twice with water and dried.

The iron oxide content of the sands Nos. 1 to 6 were determined by the titanous chloride method as described by A. R. Wood (J. Soc. Glass Tech.

1936, 324 T.) and that of samples Nos. 7 to 9 were determined by the colorimetric method, as detailed in the specifications of the Society of Glass Technology (J. Soc. Glass Tech. 1935, 26 Pr.).

PROCEDURE RECOMMENDED FOR FACTORIES.

In factories a slightly altered procedure has to be adopted for reasons of economy. Acid sodium oxalate costs about Rs. 1,200 per ton. Instead of the acid salt normal sodium oxalate can be employed, the cost of which is only about Rs. 600 per ton. The latter is converted into acid oxalate by addition of sulphuric acid. The required solution should contain 0.5 gm. of acid oxalate and 0.2 gm. ferrous sulphate for every 100 c. c. It is then heated up to 80°—90° C. and poured on the sand contained in a wooden trough of a suitable size under constant stirring with a wooden rake. The weight ratio between sand to be treated and solution has to be 2 : 1. After stirring for 5 minutes and when it is certain that the surface of all sand grains have come in contact with the liquid, the latter is drained out and the sand washed twice with water. Subsequently the drying of the sand takes place. Under Indian conditions, the washed sand could be dried in the sun during the major part of the year.

RECOVERY OF SODIUM OXALATE.

The used solution contains more than 50 per cent. of acid sodium oxalate mixed with iron and aluminium compounds and other impurities. To recover the oxalate, the solution is just made alkaline with dilute sodium hydroxide when the compounds of iron and aluminium will be precipitated. After allowing the precipitate to settle, the clear liquid on the top is syphoned off to another vessel. This contains the normal oxalate of sodium (not the acid oxalate). The amount present is estimated by titrating with standard potassium permanganate on a small portion of the liquid. Accordingly the required amount of fresh sodium oxalate and sulphuric acid are added to restore the correct strength and acidity of the solution.

ESTIMATE OF COSTS.*

One ton of sand requires 5.6 lbs. of acid sodium oxalate and 2.24 lbs. of ferrous sulphate. The former costs approximately Rs. 1,200 per ton and the latter approximately Rs. 100 per ton. The cost of chemicals comes to Rs. 3-1-7 or say Rs. 3-2-0 per ton of sand.

If sodium oxalate is used, at about Rs. 600 per ton, 7 lbs. of the oxalate and 5.16 lbs. of sulphuric acid will be required in addition to 2.24 lbs. of ferrous sulphate, per ton of sand. The price of sulphuric acid varies from place to place. Taking an average price of Rs. 100 per ton, the cost of chemicals required per ton of sand comes to Rs. 2-3-5 or say, Rs. 2-4-0 which is less by 14 annas than with the use of the acid salt.

In addition to the above, every ton of sand treated will require some 350 gallons of water and enough fuel to heat 112 gallons of the solution to 80°—90°C. Very likely a suitable arrangement could be made to use the waste heat from glass melting furnaces, for the purpose. It is presumed that two labourers can

*Owing to the war-time fluctuations of prices, pre-war prices of chemicals have been taken as basis of calculation.

conveniently treat two tons of sand per day. As the cost of water, fuel and labour varies from place to place, locally applicable calculations will have to be made in such cases. It is expected that these items of expenditure would not be more than Rs. 1-4-0 per ton of sand. Thus the total cost of purification would not exceed Rs. 3-8-0 per ton. If steps are taken to recover the oxalate from the used solution at least Rs. 0-12-0 worth of sodium oxalate can be recovered for every ton of sand treated.

Since the treated sand will contain less iron oxide than originally, there will be a reduction in the use of pyrolusite (decolouriser). A saving of Re. 0-8-0 per ton of sand may possibly be realised from this source.

If the steps are taken to recover the oxalate from the waste solution, the total cost of purification can be calculated at Rs. 2-4-0 per ton of sand. This increased cost will certainly be made up by the improved quality of the goods.

CONCLUSION.

The process seems to be particularly suitable to Indian conditions, as it does not involve the use of mechanical equipment and is applicable on a very small scale. It is cheap when compared with other known processes. Its commercial success has already been put to test.

ACKNOWLEDGMENT.

The author wishes to express his sincere thanks to Mr. Edward Meigh, M.Sc., F.S.G.T., Manager, British Hartford Fairmount Syndicate, Ltd., Greenford, Middlesex, England, for permitting to carry out a part of the above investigations in the Firm's Laboratories and allowing the author to publish the results. Further, his thanks are also due to Mr. F. W. Adams of the above Laboratories for helpful guidance during the earlier part of the work. The later part of the investigations were carried out in the Laboratories of the Glass Technologist to U. P. Government, at Benares. The author's thanks are also due to the above officer for the facilities given and the supply of samples of sands. Finally, he wishes to express his thanks to the Director, Industrial Research Bureau, New Delhi, for the supply of samples of sands during the earlier part of the investigation.

BULLETINS OF INDIAN INDUSTRIAL RESEARCH



No. 23

DRY CELL MANUFACTURE

BY

G. D. Joglekar, B.Sc.

K. Subba Ramaiah, D.Sc., A.I.C., F.A.Sc.

Lal C. Verman, Ph.D., M.S., F.Inst.P.

**OFFICE OF THE DIRECTOR OF SCIENTIFIC
AND INDUSTRIAL RESEARCH .
DEPARTMENT OF COMMERCE
GOVERNMENT OF INDIA.**

**PUBLISHED BY THE MANAGER OF PUBLICATIONS, DELHI.
PRINTED BY THE MANAGER, GOVERNMENT OF INDIA PRESS, SIMLA.**

M107CD

1941

X9(F27246) 2

HI

The statements made and the views expressed in this bulletin are those of the authors, and the Government of India do not accept responsibility for them.

CONTENTS

	Page.
Synopsis	iv
Introduction	1
Theory	4
Manufacture	6
Materials	11
Machinery	24
Testing	37
Defects	45
Economics	47
Acknowledgments	50
Bibliography	51

SYNOPSIS.

Dry cells have been imported into India for many years and the annual import figures are at present placed at over twenty lakhs of rupees. During the last few years the manufacture of dry cells has been undertaken in India, and at present there are eight or nine firms located in different parts of the country which are producing dry cells of various types and marketing them more or less successfully.

The Indian firms had been importing most of the raw materials from Germany before the war and now they have to turn to other foreign countries. It is difficult to estimate the correct total value of the imported raw materials, but it may safely be assumed that the figure is not less than ten lakhs of rupees per year.

The manufacture of high quality cells and the maintenance of a consistent standard require a high degree of technical skill and knowledge of materials and manufacturing processes. With a view to assisting the Indian manufacturers who have been experiencing pronounced difficulties in producing cells which will compare favourably with some of the well known brands available in the Indian market, a systematic study of dry cell manufacture was undertaken in the laboratories of the Government Test House, the results of which have been presented in this bulletin.

In addition to this a survey of the indigenous raw materials was carried out with a view to replacing foreign products in the manufacture of dry cells. As a result of this survey certain Indian manganese ores have been found which are capable of giving as good output results as foreign ores of good quality. Many of the Indian manufacturers, on the basis of the researches carried out and described in this bulletin, have already resorted to the use of Indian manganese ores.

The results embodied in this bulletin represent researches which covered several years. An exhaustive bibliography is appended so as to assist and encourage original investigations in this line.

The chapter dealing with the economic aspects of the industry will be of particular interest to prospective manufacturers.

In presenting the data obtained on the various aspects of the subject, it has been the endeavour of the authors to avoid, as far as possible, highly academic discussions of the various problems involved and to concentrate chiefly on matters immediately concerned with the industrial aspects.

INTRODUCTION.

The dry cell as commonly understood is a primary cell of the Leclanché type. It consists of a zinc sheet container, which acts as a cathode, a dolly containing a depolarising mixture pressed around a carbon rod, which acts as an anode, and an electrolyte in the form of a stiff paste containing ammonium chloride, zinc chloride and other chemicals. Dry cells are not dry in the true sense of the term, but the electrolyte in them is gelatinized so that it does not spill during handling. As a matter of fact a great deal of effort is always made to conserve the moisture in the electrolyte for the electrochemical reactions to proceed efficiently.

Dry cells may be divided into two broad divisions, *viz.*, the bag type and the packed type cells. Only the first type is manufactured in India, while the second type of cells available on the market are of foreign origin. The dimensions of the most common sizes of flash light cells on the market are given in Table I, apart from which certain special sizes are manufactured for the Government departments and for special requirements. Batteries are made by assembling the required number of these cells together. Batteries for special purposes are also available on the market but have a restricted sale.

TABLE I.
Common Sizes of Dry Cells on the Market.

No.	Diameter.	Height.
1*	$1\frac{1}{4}$ -In.	$2\frac{3}{8}$ -In.
2	1 "	$1\frac{7}{8}$ "
3	$1\frac{3}{8}$ "	$1\frac{7}{16}$ "
4	$\frac{9}{16}$ "	2 "

IMPORTS.

Dry cells have been imported into India for a considerable number of years. Only within the last few years, the manufacture of dry cells has been undertaken in India, and at present there are about eight to nine firms located in different parts of the country which are producing dry cells of various types and marketing them more or less successfully.

Table II shows the imports into India of this commodity for the last few years. The figures have been taken from the Annual Statements of the Sea-Borne Trade of India, wherein they appear under the heading "Batteries". The quantity imported is not given in these statements. From the year 1937-38 separate figures for flash light batteries and batteries for other purposes are given. Most of the imports are from the United States of America. Next in

* Designated as DU, size in the B. S. Specification.

importance are the imports from the British Empire, Germany, China and Japan. It will be seen from the Table II that India has been importing for the last few years dry cells worth about twenty to twenty-five lakhs of rupees per annum. Furthermore, most of the manufacturing firms in India have been importing almost all the raw materials for the manufacture of cells from Germany, but since the outbreak of the war, their attention has been diverted to other foreign countries. It is difficult to estimate the correct total value of the imports of the finished and semi-finished materials, but it may safely be assumed that the figure is not less than ten lakhs of rupees per annum.

The development of this industry in India being of comparatively recent origin, the manufacturers are experiencing difficulties usually encountered in the early stages of an industry. Apart from the difficulties raised by the present war conditions, it must be pointed out that the dependence of an industry on foreign semi-finished materials cannot be regarded as a healthy sign. It was with a view to developing indigenous resources of raw materials and assisting in other technical matters that a systematic study of dry cell manufacture was undertaken in the laboratories of the Government Test House. Experience gained during this work has enabled the authors to compile this bulletin in which have been collected all such technical data as are considered to be of value to dry cell manufacturers.

The import figures for the year 1937-38 and 1938-39 show that more than eighty per cent. of the total imports were of flash light cells. Accordingly, the subject dealt with in this bulletin is mostly concerned with these sizes, but other sizes may be similarly manufactured, there being little differences in the manufacturing processes. As the Indian manufacturers mostly use hand-operated machines, these have been dealt with in detail and a brief description of the other types of machines has also been included. The machines developed in these laboratories during the course of the work have also been described. References to original publications are cited so as to assist in stimulating scientific interest and encouraging original investigation.

TABLE II.
Imports of Batteries into India.

Year.	1930-31.	1931-32.	1932-33.	1933-34.	1934-35.	1935-36.	1936-37.	1937-38.	1938-39.
	Rs.	Rs.	Rs.	Rs.	Rs.	Rs.	Rs.	Rs.	Rs.
Total British Empire	2,36,373	2,10,242	3,77,854	2,37,945	2,00,961	2,36,852	3,01,947	2,61,234	2,45,037
Germany	2,74,554	1,49,734	1,35,899	2,24,778	1,85,410	1,55,479	3,08,482	4,40,687	3,76,525
China (exclusive of Hongkong and Macao).	496	30,730	45,378	25,006	25,623	19,022	62,947	43,269	85,499
Japan	93	1,129	8,092	42,188	57,691	32,966	24,351	71,909	3,041
U. S. A.	7,46,730	7,15,880	7,15,265	8,16,438	10,29,896	16,04,514	18,68,885	16,92,813	14,35,278
Other foreign countries	23,330	9,140	3,790	7,914	9,584	12,413	6,441	10,413	6,691
Grand Total ..	12,81,576	11,16,855	12,86,278	13,54,269	15,08,965	20,61,246	25,73,053	25,20,325	21,52,071
Flashlight Batteries	22,11,529	19,58,288
For other purposes	3,08,796	1,93,783

THEORY.

It is proposed in this chapter to deal briefly with the theory of the electro-chemical and secondary chemical reactions which take place in a dry cell. A careful perusal of the published literature shows that though the complete theory is not yet fully understood, the fundamental reactions and basic processes are fairly well known.

The major electro-chemical reactions take place between the zinc cathode, the electrolyte containing ammonium chloride and the carbon-manganese dioxide composite anode. The reaction between the zinc and the ammonium chloride may be shown as follows:—



The hydrogen liberated is oxidized by the manganese dioxide and this reaction may be represented by



Combining (1), (2) and (3), we get

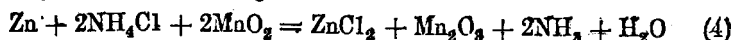

The above may also be presented as ionic reactions as follows:—



or together as



The ammonium ion is a stable unit but the ammonium radical being unstable, it splits up into ammonia and hydrogen.



The reaction between zinc and ammonium chloride is considerably retarded by the generated hydrogen which accumulates on the zinc surface, thus giving rise to polarisation effects. It can however continue if the ammonium ion is removed by feeding electrons at the carbon electrode, which is accomplished by connecting zinc and carbon electrode through an outside circuit. The reaction is again retarded by hydrogen depositing on the carbon electrode. For the continuation of the reaction it is necessary to remove hydrogen, which is accomplished by oxidising it to water by the action of MnO_2 as expressed in equation (3) above. According to Daniels^{(28)*} this reaction is not of the gas phase—solid surface type but ionic in character.

During discharge, as the generated hydrogen is being oxidized, the concentration of the hydroxyl ions increases continuously. This increases the pH of the electrolyte solution which in turn reduces the voltage of the cell, as the voltage depends upon the pH value. On exhaustive drain the reduction of voltage cannot entirely be accounted for by the pH of the solution; it also depends on various other factors, such as the formation of lower oxides of manganese.

* Superior numbers refer to those in the Bibliography.

It will be seen from the above discussion that MnO_2 only removes hydrogen but is not able to prevent the continuously increasing alkalinity due to accumulation of ammonia. This accumulation forms a serious obstacle in the efficient working of a cell. Ammonia that is generated is absorbed by the electrolyte solution and forms ammonium hydroxide.



Ammonia also reacts with zinc chloride in the electrolyte solution and forms a double chloride according to the following equation :—



As the discharge proceeds and the cell begins to get exhausted, the electrolyte gets considerably impoverished of ammonium chloride and a third reaction becomes possible, *viz* :—

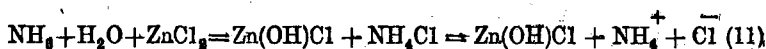

Precipitation of this basic zinc chloride is more harmful than the formation of $ZnCl_2 \cdot 2NH_3$.

Kaneko ⁽⁷⁴⁾ tried to determine the nature of the cell reactions by computing thermodynamically the E. M. F. which a given reaction would produce and compare this with the actual measured value. In addition to the depolarising action of MnO_2 , he also considered the depolarisation by oxygen. Kaneko considered the following reactions :—

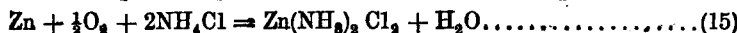
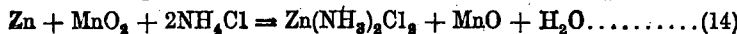
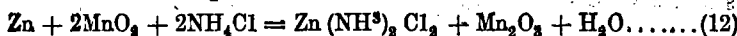

The calculated values of E. M. F. for the above reactions were 1.605 V, 1.367 V, 1.160 V, and 1.720 V respectively. Kaneko concluded that since the measured value was 1.63 V, the first reaction was most probably the one that takes place in the cell.

Thompson ⁽¹²⁵⁾ has carried out similar calculations which indicate that the high initial voltage of a cell is due to atmospheric oxygen adsorbed on the dioxide. When this is used up, the voltage drops to the MnO_2 value. Oxygen adsorbed on carbon does not depolarise hydrogen as well as that adsorbed on manganese dioxide, and the formation of $ZnCl_2 \cdot 2NH_3$ is secondary and does not contribute to the energy of the cell.

It will be seen from the above discussion that for all practical purposes, the equation,

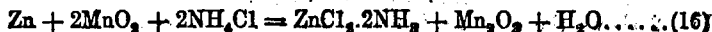

may be taken as representing the most important cell reaction.

MANUFACTURE.

As mentioned before, dry cells may be divided into two broad types, *viz.*, the packed type and the bag type of cells. It is not proposed to deal here with the merits and demerits of the two types, but since the packed type of cells are not manufactured in India, only a brief description of this type will be given, while the bag type will be discussed in fuller detail.

PACKED TYPE OF CELLS.

In Fig. 1 is shown the cross-section of this type of cell of the torch light size. Inside the outer wrapping of paper or jacket is a zinc can which serves as the cathode of the cell and also as a container for the electrolyte and the anode. The cathode and the anode are separated from each other by means of absorbent paper, which is moistened with the electrolyte and pasted to the zinc surface by means of the electrolyte paste. The bottom of the cathode is insulated from the can by means of a paraffined cardboard disc. The anode consists of a depolarising mixture and a carbon rod for conducting the current to the outside circuit. The depolarising mixture consists of manganese dioxide, graphite, soot or lampblack, and is moistened with the electrolyte solution. At the start the paper is pasted to the zinc can, the bottom insulating cardboard piece is inserted and then the carbon rod is placed centrally in the can and afterwards the depolarising mixture is pressed around it to get a firm contact between it and the mixture. During tamping care has to be taken to see that the zinc can is not broken due to excessive pressure. The depolarising mixture is then covered with a cardboard piece, washed, capped and then sealed.

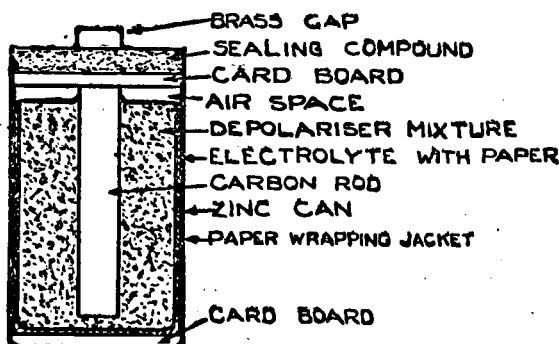

FIG. 1.
Packed Type Torch Light Cell.

BAG TYPE OF CELLS.

Fig. 2 shows the cross-section of the bag type of cells. The zinc can serves the same purpose as in the packed type. In these cells the depolarising mixture is not tamped directly into the zinc can, but is compressed in another machine, and a dolly is formed. The dolly is then wrapped in a piece of cloth and tied with twine and introduced along with the electrolyte into the zinc can. The details of the various components and operations are given below.

Zinc Can.—The zinc can may be of the soldered or of the drawn out type. It may be amalgamated with a weak solution of mercuric chloride or left as such. Amalgamation helps to increase the shelf life of the cell by retarding local action. A paraffined star-shaped cardboard is generally put at the bottom to insulate the dolly from zinc can. The corners of the star cardboard piece are turned upwards to prevent the dolly from moving sideways and touching the sides of the zinc can. Some manufacturers use plain cardboard pieces at the bottom and use strips on the sides to insulate the dolly from the zinc can. Zinc cans are generally grooved at the top to make a seat for the top cardboard over which the sealing compound is poured.

Dolly.—The anode in a dry cell is really a composite electrode made of the same constituents as used in the packed type of cell. The depolarising mixture is pressed in dolly presses (see Chapter on machinery). It may be pressed round the carbon electrode or the carbon electrode may be forced into it depending upon the design of the dolly press. Whatever may be the process of manufacture adopted, it is essential to see that there is good contact between the mixture and the carbon rod. Defective or loose contact gives rise to higher internal resistance of the cell. The mixture should be pressed sufficiently hard in the mould, so that when a dolly is taken out, it does not crumble at the edges during the subsequent process of wrapping and tying. Nor should the dolly be too compact, as it would then be difficult to remove it from the mould. Also this results in the porosity of the dolly, which is essential for the removal of gases generated during discharge, being poorer. The compactness of a dolly also depends upon the particle size distribution and the relative proportions of the various constituents of the depolarising mixture, *viz.*, manganese dioxide, graphite, soot, etc.

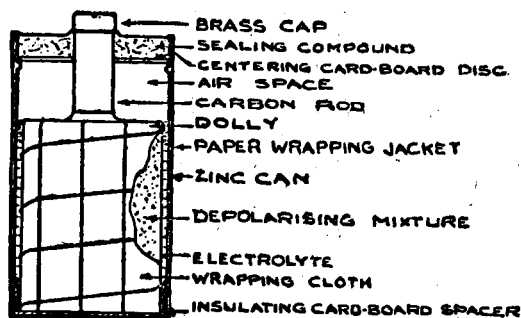

FIG. 2.

Bag Type Torch Light Cell.

Ammonium chloride is added to the depolarising mixture to have a sufficient quantity of the conducting salt near the depolariser. Zinc chloride may also be added. The dry mixture is then moistened with the necessary amount of water or solution of ammonium or zinc chloride to make it sufficiently moist for pressing operations. If a mixture is too moist, a part of the mixture will

stick to the mould or the rammer, and a good dolly will not be formed. If it is too dry, satisfactory pressing will not be possible, as the material will crumble when the dolly is handled during the subsequent operations. The correct amount of moistening liquid should, therefore, be added. This quantity will vary with the proportion of the various constituents, and will also depend upon the atmospheric humidity conditions to a certain extent. With a little experience, it is possible to judge the necessary amount of moistening liquid by feel only.

The depolarising mixture should be well mixed before it is pressed. Defective mixing gives rise to non-uniform and non-homogeneous dollies. Lack of homogeneity in a dolly could cause varying currents to flow at different points of the cell, resulting in uneven consumption of the zinc surface, which may lead to puncture and premature death of the cell. After dry mixing has been carried out the moistening solution should be added slowly while the mixing operation is in progress. Care should be taken to see that the mixture becomes uniformly moist. During mixing operation grinding of the component constituents should not take place, as this would affect the characteristics of the cells.

After the mixing operation the mixture may be passed through a coarse sieve to break up the small lumps that may be formed during the mixing operation.

The mixture may be pressed in automatic, semi-automatic or hand-operated dolly presses. The dollies should be uniform in size, i.e., height, diameter and weight. In order to maintain uniformity over long periods of time it is necessary to change the press mould as it gets worn out. The height of the dolly may be controlled by a suitable mechanism on the dolly press and also by controlling the quantity of the mixture added to the press. Variation in diameter and height of the dolly gives rise to variation in the output.

The variables that play an important part in the production of the dolly may thus be summarised as follows. All these variables need to be carefully controlled for uniformity of production :—

- (1) Particle size of the depolarising constituents.
- (2) Relative proportions of the depolarising constituents.
- (3) Amount of moistening liquid.
- (4) Height of dolly.
- (5) Diameter of dolly.
- (6) Compactness or porosity of dolly.
- (7) Weight of dolly.

After the dollies are pressed they are removed in suitable trays to the wrapping and tying department. Here the dollies are wrapped in pieces of cloth of suitable size and then tied. The cloth should be wrapped firmly round the dolly, and then tied with twine, in a suitable manner so that the cloth is tied firmly round the mixture. During the tying operation care should be taken to

see that the edges of the dolly are not spoiled and no loose threads left projecting either from the cloth or the twine as these are liable to cause internal short-circuits within the cell. It is also essential to see that no depolarising mixture particles are sticking on the protruded carbon electrodes of the dolly as these may pass to the zinc surface and start local action.

After the dollies are tied, the top cardboard centering pieces are placed in position, and then the dollies are capped with brass caps in capping machines. During the capping operation care should be exercised to see that the carbon rod is not dislodged within the dolly. After the capping operation the brass caps may be dipped in hot paraffin, to prevent these from being corroded by electrolyte accidentally spilled during subsequent operations.

Electrolyte—The electrolyte is made of ammonium chloride, zinc chloride, calcium or magnesium chloride or both, water, and a gelatinizing substance such as flour or starch. At first a solution of the chemicals is made without starch or flour and then the gelatinizing substance is added slowly while the whole is thoroughly stirred. No lumps should remain in the electrolyte. A measured or a weighed quantity of the electrolyte is poured into the zinc can, and the dolly is then placed in the can. The quantity of electrolyte should be such that it just comes to the top edge of the dolly but does not touch the carbon rod. Contact between the carbon rod and zinc can through the electrolyte forms an internal cell of a different potential providing a path for internal discharge of the cell.

The electrolyte is usually gelatinized round the dolly *in situ*. This is carried out by heating the cell in a water bath to a temperature at which gelatinization takes place. This operation is generally known as cooking the cells. In this operation it is necessary to take care that air bubbles are not entrapped within the gelatinized mass. To avoid this, the cell should be heated gradually from the bottom upwards, so that air bubbles are pushed up through the ungelatinized mass while the gelatinization proceeds. Furthermore, the dollies should be soaked in liquid electrolyte free from starch, so that the cloth gets thoroughly wetted and air bubbles excluded. This wetting of the dolly cloth should be carried out with care, as during this process the dolly itself takes up a certain amount of the electrolyte. If the dolly gets saturated, the whole of the voids necessary for the removal of gases generated during discharge would be filled up with the liquid. This may cause the bulging of the cells. The rate of electrolyte absorption by the dolly would depend upon its initial porosity and on the time which passes between pressing and wetting operations.

After the cooking operation the cells may preferably be quenched in cold water in order to cut short the unavoidable injurious effects that heat has on the cell. The cells are now ready for sealing. In order to obtain a condition of equilibrium within the cell, it is better to leave the cells open for about twenty-four hours before sealing.

Though the process of cooking is used by most manufacturers, it is not absolutely essential and can be dispensed with by using pregelatinized starch or by using a higher concentration of the electrolyte salts and the gelatinizing materials.^(123; 119) The choice between the cooking and non-cooking methods of

gelatinization depends on their relative cost. The cost of heating the cells in the first method has to be balanced against the higher price paid either for the pregelatinized starch or for the extra amount of electrolyte salts and the gelatinizing material. Also the use of a higher concentration of the electrolyte salts may not always be advisable.

Sealing.—Shellac composition or bituminous compounds are generally used for sealing. The compound is heated until sufficiently fluid to be poured on the top card board washer of the cell. When the compound gets solidified again, a pointed flame may be played on the surface of the seal to get a uniform even surface and to obtain a perfect seal round the zinc can and the carbon rod. With shellac compound the temperature should be maintained nearly constant at about 100°C, since higher temperatures bring about certain undesirable chemical changes.

In place of the sealing compound, a fibrous sealing board is used by some manufacturers. This is simply pressed on the top, and the edges of the can slightly turned over in a simple machine.

After the cells are sealed they are wrapped in paper or placed in cartons with the manufacturers trade label which is often perforated with a code mark to indicate the date of manufacture.

If cells are to be used for making batteries, brass strips are soldered to make connection between the brass cap of one cell and the zinc can of the next. The cells are then insulated from each other by card board strips and then placed in position in a box, the intervening space being filled with bituminous or shellac sealing compound.

MATERIALS

It is important that each of the materials used in the manufacture of cells be carefully selected. In many cases it is sufficient to examine the material chemically and physically to determine its suitability, but in others the only dependable criterion is the trial in actual cells. In this chapter it is proposed to discuss the characteristics of the various raw materials and the various criteria by which they may be judged regarding their suitability.

MANGANESE DIOXIDE ORE.

As discussed in the Chapter on Theory, manganese dioxide functions as an active oxidizing agent in eliminating hydrogen which is produced as a result of electro-chemical reaction between zinc and ammonium chloride. The more effectively hydrogen is removed the higher will be the output voltage of the cell and the better the depolarizing activity of the manganese oxide ore in the depolarizing mixture.

Effectiveness of an ore, however, cannot be judged from its manganese dioxide content, for experience shows that ores containing as low as 70 per cent. MnO_2 may be better depolarizers than ores containing as high as 90 per cent. or more of MnO_2 . Depolarizing efficiency of an ore depends entirely on its ability to make its oxygen available for oxidation of hydrogen, which ability appears to be governed in a complex manner not only by the chemical constitution but also to a large extent by the physical structure of the ore*.

Manganese dioxide occurs in nature mainly as polianite, pyrolusite, psilomelane, and wad. Polianite is hard and anhydrous. Chemically it is similar to pyrolusite but it has a different crystallographic form⁽¹¹⁾. Pyrolusite is usually slightly hydrated, to the extent of about two per cent. Psilomelane may be represented as $MnO_2 (Mn, K, Ba) \cdot nH_2O$, while wad is an impure mixture of manganese oxides and includes bog manganese. The last mentioned variety is usually somewhat soft and light as compared with the other varieties. Besides, MnO_2 occurs in combination with other minerals such as Skemmatite ($3MnO_2 \cdot 2Fe_2O_3 \cdot 6H_2O$), Hausmannite ($MnO_2 \cdot 2MnO$) etc. Minerals of the MnO_2 type on the other hand contain as impurities several other minerals such as SiO_2 , Fe_2O_3 etc. and varying proportions of water of hydration. It is not surprising, therefore, that their behaviour as depolarizers should vary as widely as it does. But it has been found that minerals rich in psilomelane are often, if not always, good depolarizers.†

India is one of the leading countries producing and exporting manganese ores. A full account of the Indian ores is given in the publications of the Geological Survey of India⁽³⁾. Though India occupies a leading position in this trade, Indian ores have not so far been extensively used for dry cell manufacture. Brown⁽²⁾ has stated that Indian ores have been rejected for dry cell manufacture owing to their comparatively large iron content. Those who rejected the ores did so perhaps on the basis of the chemical analysis only and thus failed to understand the importance of the physical structure of the ore. Ores of very nearly the same composition often give widely different results in a dry cell.

*Unpublished work by the authors.

†Unpublished work by P. K. Ghosh and the authors.

Rejecting ores on the basis of high iron content has been shown to be unjustifiable, since it has been noticed that as iron oxide in the ore instead of being harmful has a beneficial effect on the characteristics of cells⁽¹²⁹⁾. Artificial addition of Fe_2O_3 to the ore on the other hand has not been found to be beneficial (Table III). Further study of this aspect is however necessary if it is proposed to improve the poor ores by suitably incorporating iron oxide in them.

TABLE III.

Effect of Adding Fe_2O_3 to Depolarising Mixture.

No.	Experiment.	No. of Cells Tested.	Initial Voltage. Volts	Internal Resistance ohms.	Per cent. Polarisation.	W. H. capacity.
1	Control experiment A ..	3	1.64	0.26	17.0	3.42
2	Substitution of Synthetic Fe_2O_3 to the extent of 2.5 per cent. for the Ore.	3	1.61	0.33	15.4	3.12
3	Control experiment B ..	3	1.59	0.22	20.8	3.34
4	Substitution of natural Fe_2O_3 to the extent of 4 per cent. for the Ore.	3	1.59	0.26	21.4	2.80

Some twenty samples of Indian ores from various mining districts were examined for their efficiency as dry cell depolarisers and compared with foreign ores. Of these about half a dozen have proved to be quite satisfactory. In Table IV are summarized the results obtained with these successful ores with and without the admixture of artificial MnO_2 . It will be seen that addition of artificial MnO_2 to the extent of ten per cent. in all these cases, is necessary to obtain cell outputs appreciably in excess of the specification requirements of three watt hours.

TABLE IV.

Electrical Characteristics of Cells. (1½" diam. × 2⅜") Ht. Prepared from suitable Indian Ores.

No.	Name of the Ore.	Obtained from	Without Art. MnO ₂				With 10% Art. MnO ₂			
			Voltage. Volts	Internal Resistance ohms.	Per cent. Polarisation.	W.H. output.	Voltage. Volts	Internal Resistance ohms.	Per cent. Polarisation.	W.H. output.
1	Keonjhar ..	Messrs. Bird & Co., Mining Deptt. Chartered Bank Buildings, Calcutta.	1.56	0.27	19.9	2.99	1.56	0.24	18.8	3.64
2	C. P. Grade A ..	Messrs. The Central Provinces Manganese Ore Co. Ltd., Nagpur. C. P.	1.58	0.26	20.8	2.19	1.58	0.23	18.1	3.43
3	C. P. Grade B ..	Ditto ..	1.53	0.25	18.6	2.59	1.54	0.22	17.4	3.36
4	Shivrajpur No. 6 ..	The Shivrajpur Syndicate Ltd., Agents, Messrs. Killick Nixon & Co. Ltd., Killick Building, Home Street, Bombay.	1.53	0.27	18.2	3.02	1.56	0.22	17.9	3.32
5	Mysore No. 1 ..	Messrs. Manickavelu Mudaliar Ltd., Palace Road, Bangalore.	1.55	0.22	18.5	2.47	1.58	0.23	17.9	3.25
6	Keshapore Grade C	The Keshapur Mining Co., Keshapur Mines P. O. Chikjajur, Chitaldroog District, Mysore State.	1.56	0.27	20.4	2.55	1.59	0.24	18.1	3.93
7	Keshapore Grade D	Ditto ..	1.57	0.27	20.1	2.37	1.60	0.25	18.5	3.25
8	Karnatak No. 1 ..	Messrs. Karnatak Chemical Works, Godag., Bombay Presidency.	1.57	0.25	20.0	2.54	1.59	0.26	17.1	3.45

Apart from the geological formation of the ore, the fineness to which it is ground for use in dry cells, and also the proportioning of the ore with graphite have been found to influence the depolarising capacity of the ore. This capacity may be taken as more or less proportional to the surface of the particles making up the cell. It would, therefore, be expected that an ore having a high degree of fineness would function far more efficiently than an ore which is coarsely ground. However, practical experience shows that this is true only upto a certain limit, beyond which the increased fineness leads to other disturbing factors as discussed below.

In order to make the depolarising mixture efficiently conducting it is necessary that every particle of manganese dioxide should be in good contact with graphite particles. If very fine powder is used, it becomes necessary, therefore, to increase the amount of graphite which tends to lower the total depolarising capacity of the cell by virtue of a proportionate reduction of the active material. In modern torch light cells the ratio of manganese dioxide to graphite ordinarily varies between 4 : 1 and 5 : 1.

Another difficulty that arises from the use of very fine powder is the resulting increased compactness of the dolly, which leads to decreased porosity and hence hindrance to the free flow of electrolyte and the products of reactions such as ammonia and hydrogen. Thus increased polarisation results. This may to some extent be overcome by the incorporation of acetylene soot and lamp black which help to increase the porosity of the depolariser mixture.

These considerations show that a compromise has to be made between the fineness of manganese ore and the amount of graphite, lamp black and acetylene soot. This will not only differ from ore to ore but will also depend upon the use to which the cell is to be put, which determines the frequency and intensity of current drain. Generally speaking, it is considered good practice to use an ore passing 40 mesh B. S. sieve and having not more than 10 to 15 per cent. fines below 100 mesh.

The output of cells prepared by using natural ores alone is not always high enough to satisfy existing specifications. By introducing various constituents in the depolarising mixture, it is possible to obtain higher outputs. Special preparations of manganese dioxides have been patented by numerous workers for use in dry cells. Admixture with artificial varieties of the oxides is resorted to now-a-days by most dry cell manufacturers in proportions varying between five and ten per cent. of the natural ores. Artificial manganese dioxide is a highly active oxidising agent and, if used alone, will give rise to premature deterioration of the cell on storage, by local action. Moreover, the cost of this material is several times that of the natural ore, and economic considerations also prevent its use in higher percentages than those stated above.

It is not always possible to obtain natural ore of the same quality in every consignment, and this leads to variations in the output capacity of the cells. To overcome this difficulty and to obtain uniform output characteristics, use of artificial manganese becomes doubly necessary, since by adjusting its percentage uniform quality may be maintained.

Artificial manganese dioxide is prepared chemically as well as electrolytically. It is not possible to refer in this paper to the various methods of its manufacture. If necessary, reference should be made to the various patents and original publications on this subject.

Efforts have also been made to improve the ores by special treatment. It is not exactly known what changes take place in the ore by such treatments which increase its depolarising capacity. X-ray⁽⁷⁹⁾ examination of the natural ore and the artificial MnO_2 reveal that they have different crystal structure.

The mechanism by which the artificial MnO_2 improves the characteristics of a cell is not yet exactly understood. The results of the authors work* show that for a particular type of ore the effect is of an additive character, but in the case of other types the effect seems to be of a catalytic nature. Experiments carried out with one ore using various percentages of the artificial MnO_2 gave results of more or less additive nature, which are shown in Table V and Fig. 3. It will be seen that the addition of the artificial variety not only increased the output but also the voltage. The catalytic nature of the effect of artificial MnO_2 is brought out by the fact, that its addition to various ores in the same proportion results in varying degrees of improvement (See Table IV). The importance of selecting ores showing the maximum improvement for the purpose of manufacturing dry cells is thus apparent.

TABLE V.

Effect of adding Artificial MnO_2 to Natural Ore.

No.	Experiment.	No. of Cells tested.	Initial Voltage. Volts	Internal Resistance ohms.	Per cent. Polarisation.	W. H. capacity.
1	Natural Ore alone ..	12	1.52	0.24	18.6	1.97
2	Substitution of art. MnO_2 to the extent of 5 per cent.	3	1.54	0.27	18.6	2.46
3	Substitution of art. MnO_2 to the extent of 10 per cent.	8	1.55	0.24	18.1	3.09
4	Substitution of art. MnO_2 to the extent of 20 per cent.	3	1.56	0.24	18.0	3.56
5	Substitution of art. MnO_2 to the extent of 30 per cent.	3	1.58	0.27	16.9	5.52

Before the war Indian firms had been using treated Caucasian, Java and African ores. Untreated Indian ores from half a dozen different mining centres can be used (See Table IV) to give cells of good quality. In this matter it is also necessary that Indian mining concerns should grade and market the ores suitable for this industry, and it is certain that such graded ores will fetch higher

*Unpublished work by the authors.

prices to compensate for the extra labour involved in the process. Further the dry cell manufacturers will have to suitably treat the ore, if they wish to increase its activity.

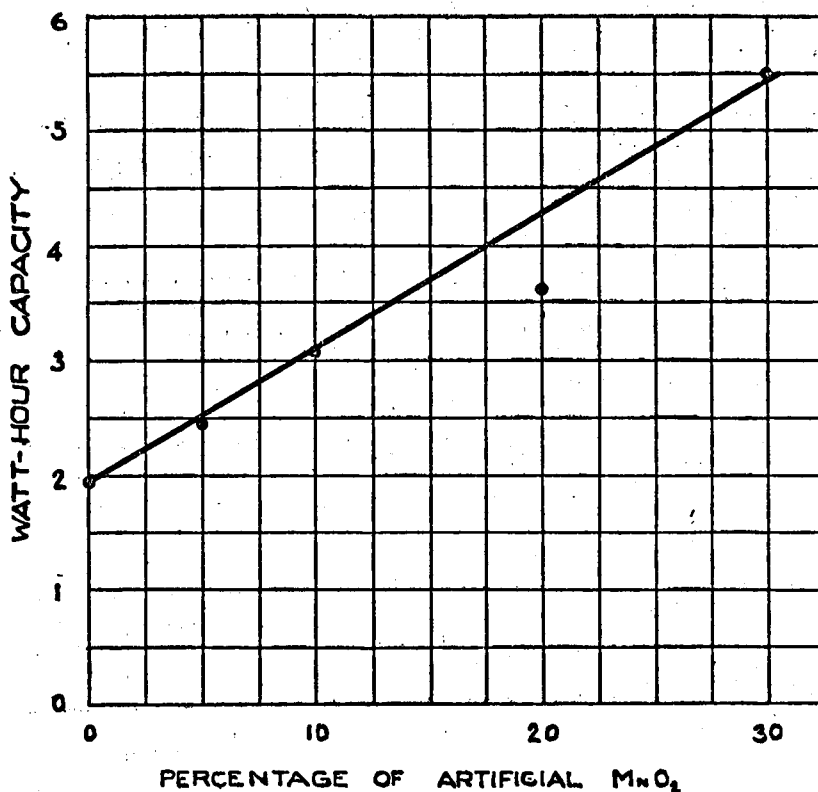

FIG. 3.

The authors have worked out a process for chemically treating natural ores which increase the energy output of cells by as much as fifty per cent. The cost of the process is such that it is approximately forty per cent. cheaper to use treated ores than to admix artificial manganese dioxide to the natural ores. It is not possible to enter into the details of this process here because it forms a subject matter of a patent which is now pending.

Artificial manganese dioxide is also imported into this country. As it is used in small percentages, the requirements of the industry for this material are not great. The dry cell manufacturers may themselves undertake the manufacture of this variety. Considerable research work is however necessary before a suitable quality of this material can be obtained.

GRAPHITE.

Manganese dioxide is a poor conductor of electricity. To obtain a low resistance for the depolarising mass it is necessary to mix some good conducting material with the manganese dioxide. It is also necessary that such a substance should be electro-chemically inactive. Both the above conditions are satisfied by carbonaceous substances. In the early days of the industry powdered carbon, which amounted to about fifty per cent. of the total depolarising mass and consisted of substances such as coke, retort carbon, petroleum coke, etc., was used. All these materials are cheaper than natural graphite which however, is a better conductor of electricity and can be used in much smaller quantities.

Graphite occurs in small quantities in various parts of India:—in the Vizagapatam hill tracts, in some of the Orissa Feudatory States, in the Godavari district of the Madras Presidency, in Travancore and in a few other places. Indian graphite has not yet been utilized by dry cell manufacturers on any extensive scale. On the other hand Ceylon graphite which is well known for its quality has been extensively used in this industry.

Artificial graphite is also being employed now-a-days in dry cell manufacture particularly in America. It is either admixed in certain percentages with natural graphite or wholly replaces the natural variety. One advantage of artificial graphite is that its quality can be consistently maintained.

Graphite for dry cells should be free from harmful metallic impurities, such as iron, copper, lead, etc. The chief foreign substances associated with graphite are mica, clay, sand and iron oxide and sulphide. The ash content should preferably not exceed ten per cent.

SOOT.

Acetylene soot, which is a very bulky substance, is sometimes added to the depolarising mixture in small quantities for increasing its porosity. Generally speaking, the total quantity of soot does not exceed five per cent. by weight of the total carbon content. The usefulness of soot is considerably reduced if it is packed compressed for easy transportation and handling, since once the fluffy character is lost it cannot be subsequently regained to the same degree.

LAMPBLACK.

This is also sometimes added to the depolarising mixture in small quantities. According to Hermann⁽⁵²⁾ the effectiveness of lampblack in the dry cell is not due to its adsorbed oxygen content, its porosity, or to special catalytic properties. The most highly porous carbons are not the most effective in dry cells. When graphite (without lampblack) is pulverized for hours it becomes equivalent to a mixture of graphite and lampblack. X-ray and electron interference experiments show that the crystal structures of graphite and lampblack are identical but that lampblack has a much rougher surface. Manganese ore is not effective as a depolariser unless it has direct contact with the carbon electrode. The finely divided rough surfaced lampblack assists in establishing intimate contact between the relatively larger particles of manganese ore, the graphite particles and the electrode.

M107CD

CARBON RODS.

Carbon rods should be perfectly straight with the top and bottom surfaces cut square to the axis. The rods should have no soft cores, fissures or broken edges, and should be dense and have good mechanical strength. The ash should not exceed five per cent. and should contain as little of metallic impurities as possible. The resistance should also be as low as possible. The rods generally have longitudinal grooves on the surface which assist in keying them fast with the depolarising mixture.

Carbon rods for batteries are not manufactured in India except by one dry cell manufacturing firm which claim to make their own requirement of rods. All other dry cell manufacturers in India have at present to depend for their supply of carbon rods on foreign imports.

These rods are manufactured from carbonaceous materials such as coke or retort carbon. Powdered coke is heated to drive off the volatile matter and then mixed with a binding material like pitch or tar. The mix is moulded or extruded to the required shape. The rods are then baked to drive off the volatile matter from the binding material. The grain size, ash, volatile contents of the constituents and baking temperature affect the quality of the rods. Measurement of specific resistance of good quality rods for torch light cells gave values varying between 0.0045 and 0.0065 ohms per cu. cm. Transverse beam test on 8mm. diameter rods of various manufacturers on a two inch span gave values for fibre stress varying between 5200 lbs. and 8000 lbs. per square inch.

Carbon rods are generally paraffined to avoid the creeping of electrolyte to the brass caps. Paraffining should be done lightly so as not to clog the pores of the electrodes and obstruct the passage of gas generated during discharge which accumulate at the top of the dolly. Obstruction of the free passage of gas would sometimes result in the bulging of the zinc cans or top seals.

ZINC.

Zinc as used for dry cells serves the double purpose of functioning as the cathode of the cell and also as the container for the anode and the electrolyte. The first function requires it to be of high purity, while the second demands sufficient mechanical strength to serve as the container upto the end of the useful life of the cell.

The zinc container of a dry cell should resist the corrosive action of the electrolyte as efficiently as possible, and during discharge of the cell its consumption should be uniform and proportional to the useful current delivered by it, i. e., about 1.22 gms. per ampere hour. Actually due to local action in a cell more than this quantity is consumed. In a torch light cell of $1\frac{1}{4}$ " diameter by $2\frac{1}{4}$ " height the capacity obtained is about four ampere hours, which requires about 4.88 gms. of zinc. But in actual practice the zinc can for this size weighs between seventeen and twenty grams. This extra quantity is necessary as the zinc has to serve as a container upto the end of the useful life of a cell.

Local corrosion of the zinc sheet may be due to several causes such as impurities in the metal, in the electrolyte or in the depolarising mixture. These impurities settle on the zinc during discharge and produce local cells which consume the zinc sheet. Local corrosion may also be due to uneven distribution of the electrolyte, variation in the resistance of the depolarising mixture or deposition of grease or factory dirt on the zinc surface which factors alone or combined may produce unequal distribution of current and consequently cause local corrosion. Unequal corrosion results in premature pitting of the zinc sheet through which electrolyte may leak out and cause short-circuiting among individual cells of a battery.

Amalgamation of zinc cans is sometimes resorted to in order to increase the resistance of zinc to corrosion. It makes the surface of zinc smooth and uniform. A smooth surface resists corrosion better than a rough one. Amalgamation also slightly increases the potential of the zinc electrode.

Rolled zinc for dry cells can be obtained in sheet or ribbon form. Zinc sheets are sold in the market with a special gauge number belonging to this particular industry⁽⁵³⁾. For torch light cells generally gauge Nos. 6 to 8 are used. Cells intended for long life should have thicker zinc sheet than those intended to be used immediately. Gauge No. 6 and No 10. have a thickness of 0.012 in. and 0.020 in. respectively, and the intermediate numbers vary in thickness from the neighbouring ones by 0.002 inches.

The usual impurities occurring in zinc are lead, cadmium, copper, iron, arsenic, antimony and tin. These impurities should be kept as low as possible. Lead upto about 1.5 per cent. is found helpful in rolling operation and is therefore retained in some cases. Table VI gives the analyses of zinc sheet and ribbon and of sheet from actual cells of reputed makes. Seamless cans appear to have a lower percentage of lead than the soldered type. The presence of mercury shows that the cans had been amalgamated.

TABLE VI.
Analyses of Zinc Sheet, figures in per cent.

No.	Contents,	Zinc sheet from reputed makes of cells,						Suitable zinc sheet for dry cell manufacture,				
		Soldered cans,				Seamless cans,		Belgian,		American,		German,
		1	2	3	4	5	6	7	8	9	10	11
1	Tin	0.83	trace,	0.006	0.02	Nil	trace	Nil	Nil	Nil	Nil	Nil
2	Iron	0.01	0.02	0.011	0.02	0.01	0.01	0.022	0.01	0.04	0.03	0.02
3	Lead	0.52	1.09	1.68	1.07	0.08	0.17	1.23	1.20	0.34	0.31	0.68
4	Copper	0.01	trace	0.008	trace	0.005	0.003	0.004	trace	trace,	trace	0.01
5	Cadmium	0.10	trace	trace	0.10	Nil	0.05	trace	trace	0.02	0.01	trace
6	Mercury	0.13	0.11	0.05	trace	0.06	0.02
7	Arsenic	trace	trace	trace	trace
8	Zinc by difference ..	98.40	98.78	98.24	98.79	99.84	99.75	98.74	98.79	99.60	99.65	99.29

No. 11—Ribbons.

BRASS TERMINALS.

For torch light cells brass caps are put on the carbon rods for making electrical connections with the outside discharge circuits. On bigger cells screwed brass terminals, or fahnstock terminals are fixed to the carbon rods, and wires are soldered to the zinc cans. In dry cell batteries brass strips are used for interconnecting the cells. S.W.G. No. 27 or 28 gauge brass sheet is generally employed for making the brass caps and the connecting strips.

SOLDER.

The solder used for soldering the zinc cans and for soldering the brass terminal strips to the cells is an alloy usually composed of tin and lead, their proportions being the controlling factor in the selection of solders for specific purposes. A high tin content solder, though ductile, is crystalline, hard and easy to fracture, while a high lead content solder has lower tensile strength but greater ductility. The mixtures for dry cell work may have composition varying between forty and sixty per cent of either of the constituents. Practical experience is the best guide in the proper selection of solder.

ELECTROLYTE.

The electrolyte paste in a dry cell consists mainly of ammonium chloride, zinc chloride and starch. Small quantities of calcium chloride, magnesium chloride, and mercuric chloride are also sometimes added. All these salts should be free from harmful impurities. The exact proportions of the various salts, starch and water are a matter of practical experience. The quantities of the ammonium chloride and other salts should be ample so as to last to the end of the useful life of a cell.

Ammonium Chloride.

Ammonium chloride is the main salt which takes part in the electro-chemical reactions in a dry cell. It occupies as important a place in the electrolyte as the manganese dioxide in the depolarising mixture. It should be free from impurities, especially copper and iron, as these would settle on the zinc and form harmful local galvanic cells. It has a great corrosive effect on the zinc. The usual white powdered commercial grade is generally used and it should contain less than one per cent. of ash or non-volatile matter and an equally small percentage of moisture. The total quantity of ammonium chloride required may be divided into two portions, one being added to the depolarising mass and the other going into the electrolyte solution. The quantity added to the depolarising mass is generally added in dry condition and may vary from ten to fifteen per cent of the total weight of the dolly. The electrolyte paste contains about twenty per cent. of ammonium chloride.

Zinc Chloride.

Zinc chloride, which is added to resist the corrosive action of the ammonium chloride, occupies the next most important place in the electrolyte. The proportions of these two salts should be well balanced. During the discharge of a cell, zinc chloride is constantly generated and therefore the quantity of zinc chloride continuously increases as the discharge proceeds. If the initial quantity of zinc chloride is considerable, a stage may be reached during the early stages of discharge when a sufficient quantity of this salt may be present to form the double chlorides of zinc and ammonia. These crystals precipitate

out from the gelatinous electrolyte and settle on the zinc surface or in the pores of the dolly and thus reduce the available surface necessary for the electrochemical process to continue effectively. In the formation of double chlorides a certain amount of water of crystallisation is involved, which reduces the quantity of water in the electrolyte. The subsequent drying of the electrolyte increases the internal resistance of the cell and decreases its output capacity. To prevent the premature precipitation of the double chloride it is necessary to have an excess of ammonium chloride in the electrolyte, but too high a concentration of this salt cannot be used due to its corrosive properties. As a result of these considerations it is considered advisable that the proportion of zinc chloride in the electrolyte paste should be kept between the limits of seven to ten per cent.

Calcium Chloride.

This salt is recommended for use in tropical countries in small proportions on account of its hygroscopic nature and water retaining properties. If used in large quantities, it may separate out as a complex salt and interfere with the smooth functioning of the cell. It may be added to the extent of about two to three per cent. to the electrolyte paste.

Magnesium Chloride.

This salt may be employed for the same purpose as calcium chloride.

Mercuric Chloride.

This salt is added to the electrolyte in small quantities (about a quarter per cent.) to effect amalgamation of the zinc cans. It also prevents the growth of moulds and micro-organisms in the flour or starch that is used for gelatinization.

Gelatinizing Substances.

A number of substances like plaster of paris, agar-agar, gum-tragacanth, wheat flour, corn flour, dextrin, starch, etc., have been used in the paste for making the liquid electrolyte unspillable. Of these, flours and starches are the most commonly used ones. Wheat or corn flour, wheat, maize or potato starch may all be used individually or in admixture. The quantity of starch to be added to the liquid electrolyte should be carefully determined, as too low or too high a percentage of it is not beneficial for shelf life, though initial characteristics may not show any noticeable effect. The quantity of starch may vary between ten and fifteen per cent. The gelatinizing temperature of starch is considerably reduced in the presence of the electrolyte salts.

It will be seen from Table VII that starch gives better results than flour, due perhaps to its perfect gelatinization and freedom from other ingredients generally found in flour. The results show lowering in the internal resistance and increase in the voltage and output capacity. The same table also shows the comparative results between a cold working pregelatinized starch and an ordinary starch gelatinized by the cooking operation. The results do not show any marked difference between these two varieties. Cold working starch has the advantage that it does away with the cooking operation. Selection of either variety will depend upon the actual cost price of each and the extra cost involved in the cooking operation.

TABLE VII.
Effect of Using Different Gelatinizing Substances.

No.	Experiment.	No. of Cells Tested.	Initial Voltage. Volts.	Internal Resistance ohms.	Per cent. polarisation.	W.H. capacity.
1	Cells with maيدا (wheat flour).	3	1.64	0.26	17.0	3.42
2	Cells with maize starch ..	3	1.67	0.22	19.5	3.79
3	Cells with pregelatinized cold working starch.	3	1.66	0.24	18.5	3.75

WATER.

Water used for making the electrolyte solution should preferably be distilled. Tap water often contains salts which may be harmful to the cell. These may form local cells on the zinc electrode or may precipitate out and clog the pores of the dolly. To prevent these effects a little extra cost for distilled water is well worth while.

SEALING COMPOUND.

In order to secure the components of the cell in position and to prevent desiccation, it is necessary to apply a sealing compound on top of the assembled cell. The compound may be made of shellac, rosin and suitable fillers or may be of the bituminous type. A fibrous material is sometimes used for sealing. The selection of either is a matter of availability and cheapness but in tropical countries like India due consideration must be given to the higher temperatures which have to be withstood during transportation and storage.

WRAPPING CLOTH.

In the bag type of cells the dollies are tied in a loosely woven piece of cloth, which allows free passage to the liquid electrolyte but prevents dislodging of depolariser material and its settling on the zinc surface. The cloth used should be bleached and unsized and must be absorbent, that is, it should have good wetting properties. Ordinary light muslin cloth used in India for pugries etc. has been found quite suitable. The following approximate specifications may help in the choice of a suitable material :—

- (1) Weight per sq. yard of cotton cloth 2.3 to 2.5 ozs.
- (2) Average number of threads per inch—

Warp	55—70
Weft	50—60

TWINE.

The twine used for tying the dolly should not be very fine nor very thick. While tying care should be taken to see that the dolly is not cut by the threads.

CARDBOARD.

The cardboard used for making the bottom insulating washers and the top centering washers should be free from conducting materials. To prevent absorption of moisture from the electrolyte it is paraffined before being used in cells. Generally cardboard having a thickness of $1/32$ " is considered suitable for torch light cells.

MACHINERY.

During the early days of the industry, dry cells and batteries were manufactured mainly by manual labour and hand-operated machines. With the new fields of application for these cells, such as in wireless, many kinds of instruments, small machines etc., the production has now increased to enormous figures. Attempts made during the past few years to develop machines for mass production have resulted in the successful manufacture of semi and fully automatic machines for almost all the operations involved in the manufacture.

SEMI AND FULLY AUTOMATIC MACHINES.

The introduction of semi and fully automatic machines has removed the sources of trouble arising out of the inherent non-uniformity of manual operations. The machines work in an economical and reliable manner, once they are carefully adjusted, which requires skilled and expert attention. A few points regarding these machines are briefly dealt with below.

Economical Working.—The automatic machines are always costly and are not economical unless the output is about ten thousand pieces or more per day of eight hours working. This output figure varies to a certain extent inversely with the labour cost prevalent in the particular area in which the factory is located.

Attention.—These machines require systematic and constant attention and care. If neglected the successful operation is hampered due to the corrosive action of the depolarizing mixture and the electrolyte solutions. Care is generally taken in the proper selection of the materials for these machines to resist these corrosive effects. The corroded parts of the machines pass into the cell compounds and form local galvanic couples within the cells which are harmful. The rapid corrosion of the machine parts results in a high percentage of depreciation figure for the machines.

Flexibility.—Automatic machines are generally designed for one particular size of cells, though in certain cases they may be adopted to different sizes by changing certain parts. This operation stops the production for a considerable time. These machines generally work best if always fed with materials in definite conditions as regards moisture content, density, bulkiness and rate of feeding. These conditions change with the different raw materials and are therefore to be predetermined for successful operation. An important consideration in favour of these machines is their availability at all times thus dispensing with the necessity of maintaining skilled labour, all through the year irrespective of the demands.

Quality of Production.—It is possible to ensure greater uniformity and hence improvement of quality with the use of these machines.

Cost of Production.—The use of machines in place of hand operation has been helpful in lowering the selling price making it thereby more difficult for the small factories to successfully compete with the larger ones.

The above points will be helpful in forming an idea about the suitability of these machines which depends more or less upon their high uniform output capacity weighed against their high initial cost and the consequent capital charges, maintenance charges and non-flexibility.

HAND PRODUCTION.

The initial investment and the subsequent interest and depreciation charges in this method are much lower than those with the automatic machine production. There is a greater flexibility in this method as most of the hand operated machines can be quickly adopted for the production of various sizes of cells. There is also a similar flexibility with the labour. This greater flexibility with the hand production enables changes for the improvement of the quality to be easily carried out. The disadvantages in this method are the low figure of production and the comparatively high figure of pay bills.

Due consideration to the above points should be given when choosing the method of manufacture *i.e.*, whether all the operations or part of them will be carried out by hand operated machines, by manual labour, or by semi or fully automatic machines. It may perhaps be found advantageous to strike a sort of compromise between the various methods of manufacture.

The whole process of manufacture may be divided into various sections and a short description of the different machines working in each of these is given below.

ZINC CUP MANUFACTURE.

Two methods for the manufacture of zinc cups are commonly used—the soldering and the drawing method. The latter is only applicable to the manufacture of small size cups such as those required for the flashlight cells. Zinc cups should be strong, leakproof, smooth and of uniform shape and size. If the shape is not uniform, the zinc would be unequally consumed during the discharge and the life of the cell would be shortened due to pitting of the cups.

SOLDERING METHOD.

Guillotins or cutting shears.—Zinc sheets are generally sold in pieces of 3' by 7' or in rolls cut to proper width. Sheets are cut into long strips of proper width by means of a guillotine, steel shears or a multiple knife sheet cutter. The latter machine is suitable for large scale manufacture only. The strips or rolls are then cut again to the required length for the manufacture of the particular sizes of cups.

Rolling Machine.—The cut pieces are bent into necessary forms, on suitable formers ready for the soldering operation. For round cups the rolling may be done on a rolling machine. These machines are cheap and would form a good labour saving device. They may be worked either by hand or by an electric motor. Combination automatic machines combining the operations of cutting and rolling are also available. Fig. 4 shows the rolling machine designed by the authors. The rollers which are connected through gears are rotated by the handle H. A strip fed between rollers R_1 and R_2 moves forward, bends round R_1 and comes to the top where it is held by the stop C. The rollers R_2 and R_3 are fixed in position in the plate B_1 while R_1 is fixed in B_2 . The distance between B_1 and B_2 is adjusted by putting a spacer piece S cut from the sheet to be rolled. The photograph of this machine is shown in Fig. 5. This machine can give over five thousand rolls per day of eight working hours.

This output figure may be further increased by running the rollers by means of a small electric motor.

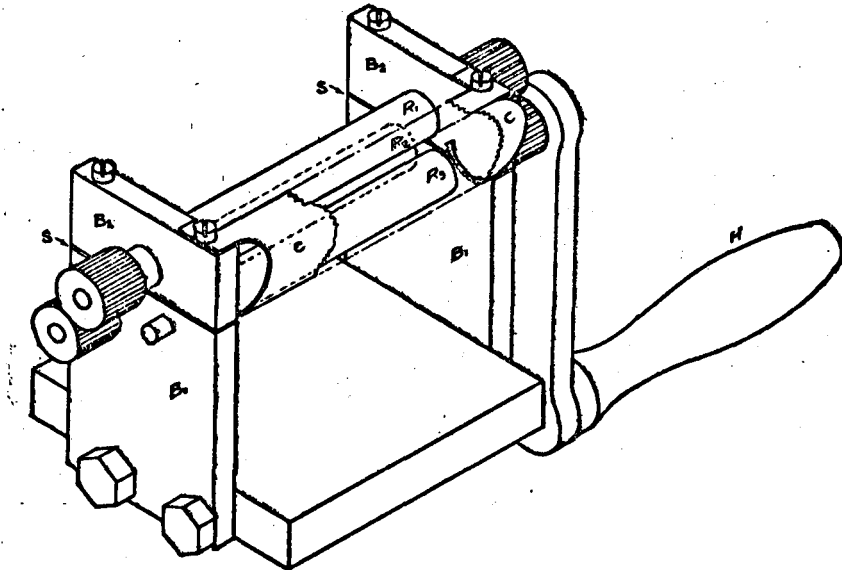

FIG. 4.
Rolling Machine.

Blanking Press.—The bottom discs for zinc cups may be cut by a fly hand press or by an eccentric machine-operated press, the latter for large-scale production. The blanking is carried out with suitable dies and punches. Arrangements may be incorporated in the design of the cutting tools for feeding the strips in such a manner as to effect a minimum wastage of the material.

Soldering.—Zinc rolls are fitted with the bottom discs and a soldering flux is applied to the longitudinal and the bottom edges. This flux may be a weak solution of hydrochloric acid and zinc chloride or a non-acid non-corrosive type of paste. The cup is then soldered with a tin lead alloy, preferably of low melting point. The exact diameter of the soldered cups depends upon the diameter of the rod on which the rolls are fixed for the soldering operation. A soldering jig designed by the authors is shown in Fig. 6 and a short description of this is given below.

A roll to be soldered is placed over the rod A and pushed in the annular space between the rod A and the block C which holds the roll in position. The overlapping part of the roll lies over the V groove in the rod A. The bottom disc is placed on the free end of the rod A and is held in position by the roll itself. The longitudinal soldering is carried out first and then the rod A is swung to the vertical position and the bottom piece soldered. To facilitate the latter operation the jig is rotated round its axis on the guide D which is fixed to the table T. To avoid rapid cooling of the zinc during soldering, the rod A is grooved longitudinally and a portion cut off along the rim of the free end.

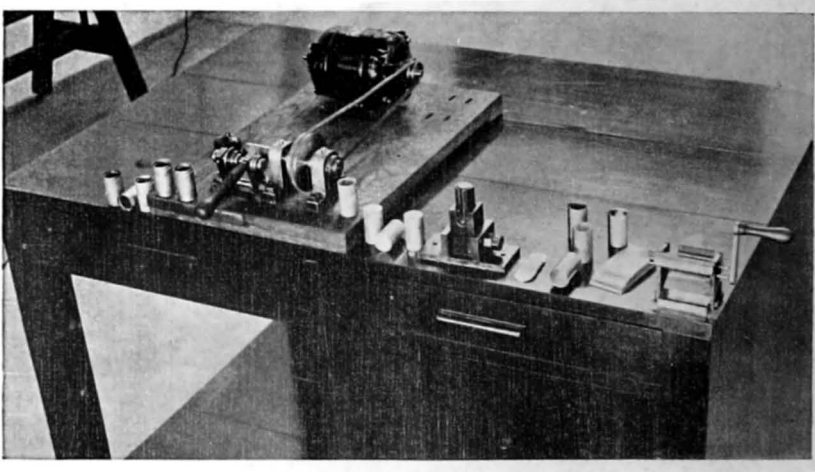

FIG. 5.

About fifty to sixty cans can be soldered per hour with this jig, the output however, depending to a large extent on the skill of the operator. A photograph of this jig is seen in Fig. 5.

Soldering Bits.—Bits should be as clean as possible to effect good and quick soldering operations. The rubbing of the hot bits on a salammoniac block ensures a good clean surface.

Many labourers will have to be employed in a large factory to carry out the soldering operations by hand. The expense incurred in wages will be high, but the capital investment will be nominal.

Electric Welders.—Electric welding machines are available for carrying out the soldering operation. These machines are costly and will only be suitable for large scale manufacture. Moreover, these machines can be used for soldering the longitudinal seams only. The bottoms cannot be soldered with these machines.

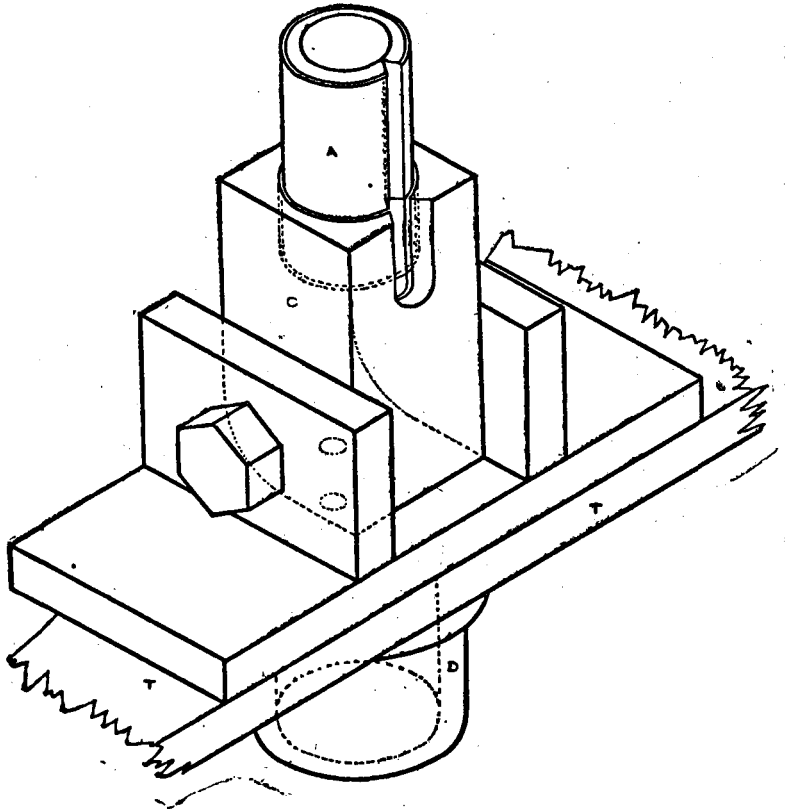

FIG. 6.
Soldering Jig.

Inspection.—Soldered cups are tested for leakage either against a strong light or under pressure. Cups with tiny holes not visible against ordinary light may be found leaking during usage. Preliminary inspection will therefore reduce the number of rejected cells.

DRAWN CUPS.

Drawn cups are manufactured by drawing operations in special presses. Round discs which are blanked first are drawn to the required shape and size in three or four stages. The walls of the drawn cups should be uniformly thick. Zinc used for this process is of special quality, capable of withstanding the high mechanical stresses coming into play during the drawing operation. The main advantage of the drawn cups over the soldered ones lies in their uniform and smooth shape and absence of foreign substances, such as those used in the solder. Zinc sheets are utilized almost completely in the soldering method, while in the drawing process a greater amount of scrap and wastage is unavoidable due to the necessity of getting circular blanks for the drawing process. These machines being costly are suitable only for large scale manufacture.

Grooving Machine.—Zinc cups are generally grooved at a distance of about $\frac{1}{4}$ " from the top. The groove serves as a seat for the top card-board washer. Fig. 7 shows the grooving machine designed by the authors. The cup to be grooved is placed over the rod A, a detailed view of which is shown separately.

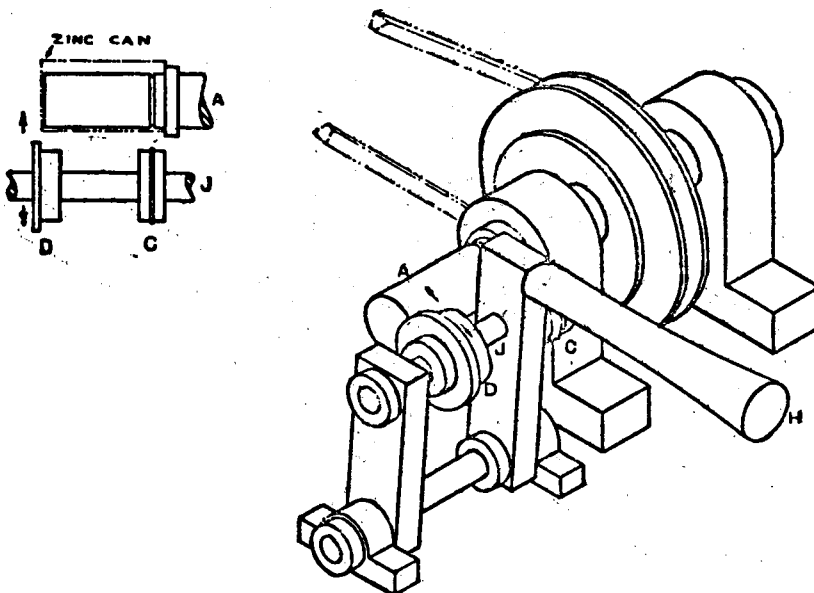

FIG. 7.
Grooving Machine.

The rod is rotated through a pulley by a $1/8$ H.P. electric motor. The grooving roller C moving freely in the shaft J is fitted in front of the rod A. The can is prevented from moving sideways by a collar on the rod A and a stop guide D, revolving freely on the shaft J. The guide is held in position by two collars one on each side. When the rod A begins to revolve the roller C is pressed against the can by the handle H. This operation rotates the can and the roller C in opposite directions. Further pressing of the grooving roller makes a groove on the can. The groove should not be so deep as to puncture the can. The output of this machine is about five thousand pieces per day of eight hours' working. The output can be considerably increased if a separate drive is incorporated for the roller C. A photograph of this machine is shown in Fig. 5.

CARDBOARD WASHERS AND BRASS CAPS.

Presses similar to those used for blanking the bottom discs for the zinc cups may be used, with suitable dies, punches and guides, for the manufacture of the bottom and top cardboard washers as well as the brass caps. The caps may be blanked out from a sheet and formed in one operation. A suitable cutting and forming die punch for the brass caps is shown in Fig. 8.

GRINDING OF ORES.

Grinding Machinery.—Manganese ore is generally obtained from the mining firms in India in lumps varying from 2" to 4" in sizes. The ore being hard and abrasive cannot be ground in one operation to a fineness of 60 mesh. A preliminary crushing to $1/4$ " to $3/8$ " size may be carried out in a cone or jaw crusher or by hand. Further grinding is carried out in a pulverizer or in a ball mill. The pulverizing of graphite is easier than that of manganese ores and may be carried out directly in a ball or pulverizing mill. Though the pulverizing of the ores may be carried out in a dry cell factory, it may be profitable to get these materials powdered to the required fineness from the sales agents who generally have these plants in their works.

Magnetic Separators.—These are used for removing the metallic iron particles that might have accidentally found their way into the powdered ores during grinding or transport to the factory. The removal of iron particles is essential to prevent the local action in the cells. These iron particles may be sporadically mixed up with the ores, and may escape detection during chemical analysis. Normally, a small factory may dispense with this operation and ensure supply of powdered materials from sources which can guarantee the necessary degree of freedom from metallic iron.

MIXING.

Mixers.—The depolarising constituents are thoroughly mixed in wooden mixing drums. After the materials are mixed for about half an hour in a dry state the liquid electrolyte used for moistening the mixture is added slowly while the mixing process continues for another half an hour period. The design of the mixing drum should be such as to prevent the grinding of the materials during mixing. The materials are generally fed to the mixers from the top and taken out through a hole, normally closed, at the bottom. Fig. 9 shows the photograph of such a mixer designed and built by the authors. The mixing blades are designed to give a thorough mix when rotated in the correct direction.

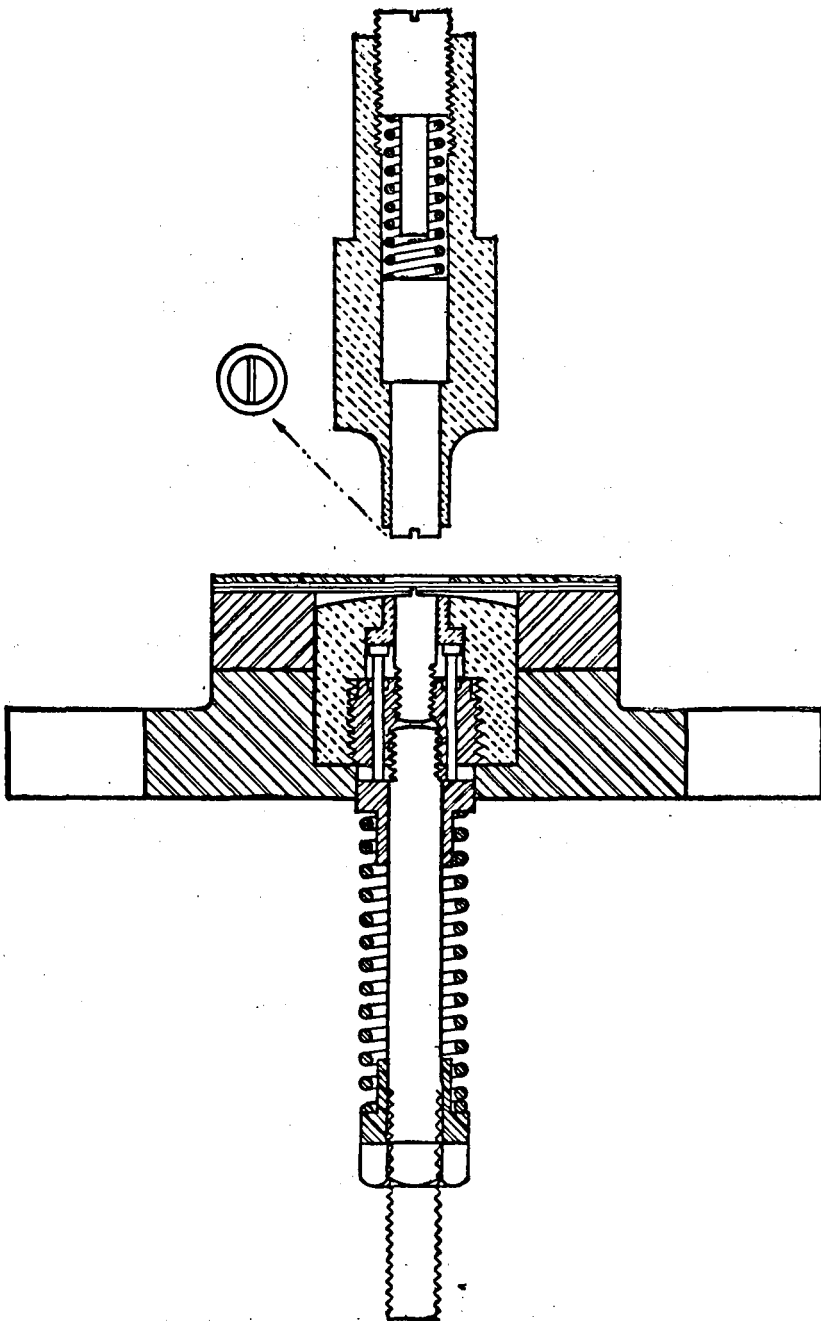

FIG. 8.
Die Punch for Making Slitted Brass Caps.

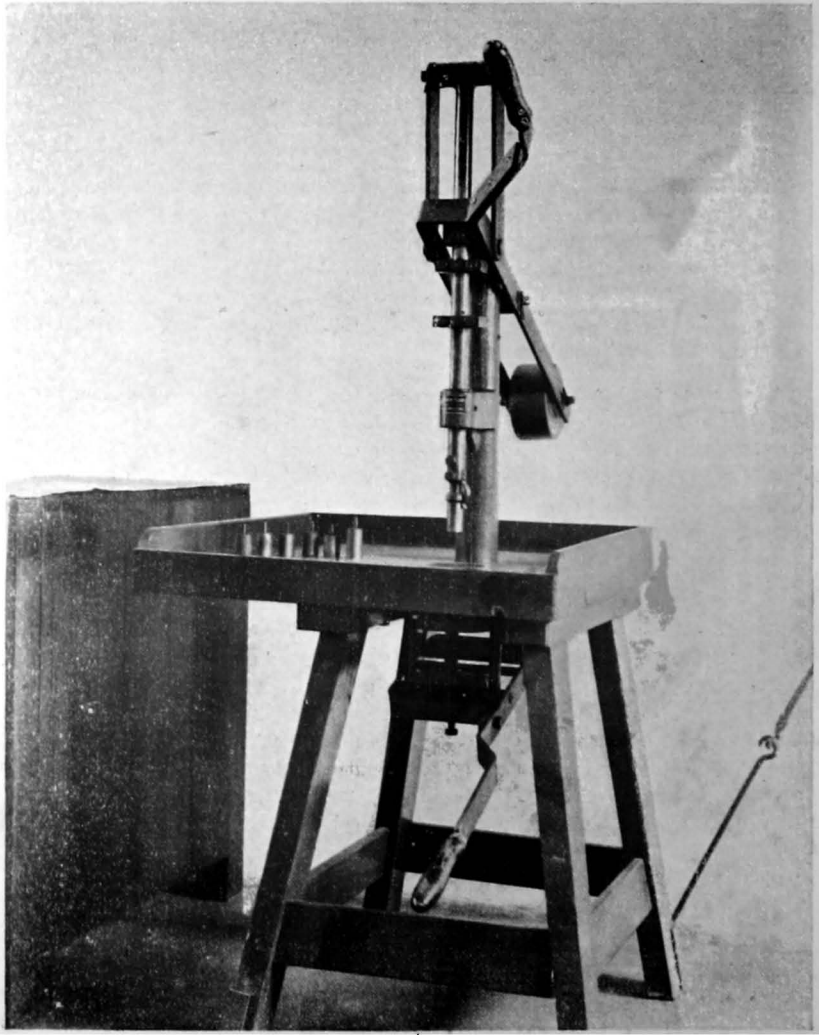

FIG. 10.
Dolly Press.

Shaking Sieves.—It is likely that small lumps may be formed during the mixing operation. These may be removed by passing the mixture through a shaking sieve. As in the case of mixers, these are made of non-metallic parts such as woven cane or hair sieve in wooden frames.

The mixers and the sieves may be worked by hand or by electric motors, the choice depending upon the capacity of these machines and the output to be turned out per day.

DOLLY PRESSING.

After the mixing operation the material is pressed into dollies. The pressing may be done by hand or automatic presses. The moulds are generally made of stone, steatite or non-corrosive alloys of steel. The moulds should be sufficiently hard and strong to withstand the abrasive action and tamping pressures over a long period of time. In hand presses the rammers are made of hard wood or of ebonite, while in automatic presses these are made of non-corrosive special alloy steels.

Hand Presses.—There are two methods of pressing the dollies, one by pressing the mixture round the carbon rod held in position and the other by forcing the carbon rod through a prepressed mixture. Whichever method is adopted, the carbon rod must be held tightly into the mixture to obtain low internal resistance in the cells. In Fig. 10 is shown the photograph of one of the two types of presses, while Fig. 11 shows the sectional view. The pressed dollies are taken out by hand or foot operated ejectors. The output of these presses is about two thousand dollies per day of eight hours' working.

Automatic Presses.—The pressing operation is carried out in these presses in two or three operations. In the first the charge is fed into the mould, in the second it is pressed slightly to a predetermined height and in the final operation the carbon rod is forced through the pressed charge and the whole mass pressed again to the correct height. The pressed dollies are then ejected and carried over a convoy or belt to a receptacle. The output of some of these machines is as high as four thousand pieces per hour and they are therefore useful for large scale manufacture only.

For large-size dollies such as those for 6 in. cells, the pressing is generally done either by hand operated machines or by semi-automatic eccentric presses. Automatic machines are also available for these sizes, but their output is considerably less than those used for pressing small size dollies. The demand for large cells is only a fraction of that of the torch light cells, and due consideration should be given to this fact when choosing hand or machine operation for the larger size dollies.

WRAPPING AND TYING OF THE DOLLIES.

Hand Operation.—The dollies may be wrapped by hand in a piece of cloth and tied tightly with a string. The output per worker, after a little apprenticeship, may reach a figure of more than five hundred dollies per day of eight hours' working.

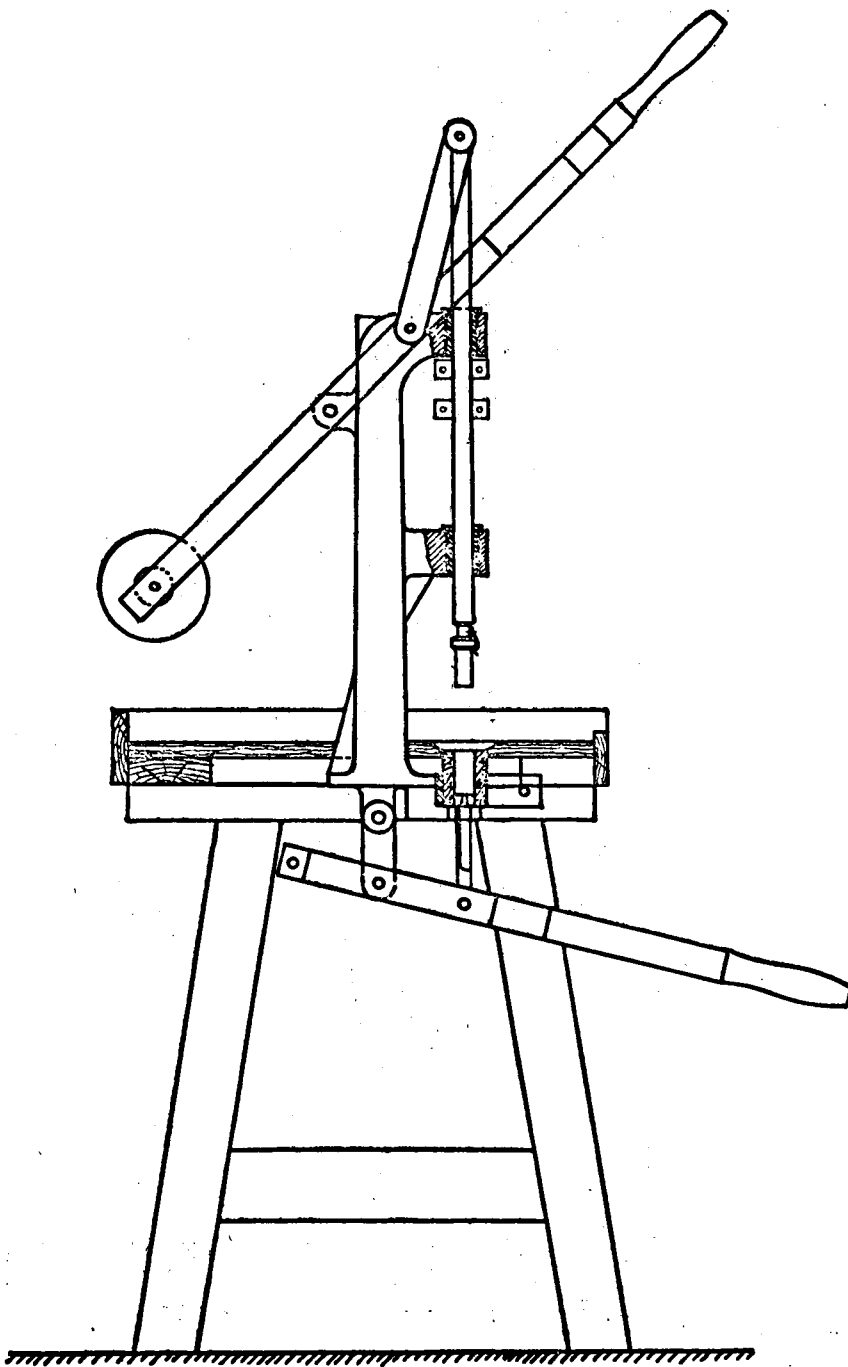

FIG. 11.
Dolly Press.

Machine Operation.—Semi and fully automatic machines are available for carrying out the wrapping and tying of the dollies. As these machines are suitable only for the size for which they are designed, it will be necessary to have a number of machines, one or more for each size of the dollies that are manufactured. The output for the semi and fully automatic machines is about one and three thousand pieces per hour respectively.

For machine operation a considerable amount of capital will have to be invested while for hand operation practically no capital investment is required and the same workmen can carry out the wrapping and tying of cells of various sizes.

WASHERING OF THE DOLLIES.

The wrapped dollies are fitted with the top centering paraffined cardboard washers either by hand or by machines.

CAPPING OF THE DOLLIES.

After the washing operation the carbon electrode of the dollies is fitted with brass caps. This may be done by hand operated machine or by a semi or a fully automatic machine. Fig. 12 shows the hand-operated machine which can be worked in a horizontal or in a vertical position. The dolly D to be capped is supported in position by the ebonite piece G. For the sake of clearness the top of the dolly is shown dotted. The cap C is placed over the carbon rod and is pressed tightly over it by the rod A moved by the handle H. After the capping operation the rod A is brought to the original position by the spring S. If the caps have a projected part of the ventilating slit or hole, the tapered end of the rod A is suitably recessed to take in the projected part. The output of this machine is over five thousand dollies per day of eight hours working. The output of a semi- and a fully-automatic machine is between two and three thousand pieces per hour.

After the capping operation the tip of the carbon rod may be dipped in molten paraffin wax or a paraffin solution. Sometimes this operation is incorporated in the automatic capping machines.

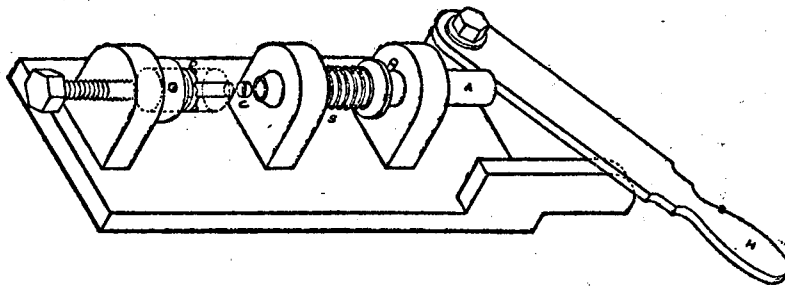

FIG. 12.
Capping Machine.

ELECTROLYTE MIXING.

The mixing of the electrolyte is carried out in wooden vats. The mixing blades are also made of wood. Starch is generally added slowly to the solution of the ammonium and zinc chlorides and other salts. The mixing is carried out till a thorough mix is obtained.

ELECTROLYTE FILLING.

Hand Operation.—The filling of the liquid electrolyte into zinc cups may be carried out by hand. The required quantity may be poured into the cups or a rubber bulb may be used for filling the cups. The quantity is generally measured by volume.

Machine Operation.—Semi and fully-automatic pumps are available for filling the electrolyte into the cups. The quantity of electrolyte is regulated by a screw or stop guide arrangement. The parts of the pump should be of non-corrosive metal or of ebonite. The electrolyte is continuously mixed in these machines to get a condition of homogeneity. The output of fully-automatic machines is about five thousand fills per hour.

COOKING OF CELLS.

Hand Operation.—After the filling operation the dollies are placed in the zinc cups and then the electrolyte is cooked *in situ*. The cells are cooked in trays which are immersed in a hot water trough for a few minutes to effect gelatinization of the electrolyte. It is necessary to see that the dollies are centered in the cups before the cooking operation starts. The centering is effected by the star-shaped bottom card-board washers as well as by the top washers. After the cooking operation the cells are preferably cooled by dipping in cold water.

Machine Operation.—Automatic machines are available for carrying out the cooking of the cells. In these the cells are slowly carried forward in hot water, cooked there and then lifted and carried by an attendant. Fig. 13 shows a photograph and Fig. 14. a view of the cooking trough developed by the authors. The cells C to be cooked dip gradually into hot water. The heating is carried out from the bottom of the cup with a view to driving out the occluded air from the dolly and the electrolyte. The cooked cells emerge out of the hot water quickly and are then placed in cold water by an attendant. The cells are carried into and out of the hot water over a perforated brass sloping platform by an endless chain arrangement. Water is heated in a boiler T by gas and constantly circulated in the trough by a pump P, driven by a motor M. The output of this machine depends upon the temperature of the hot water and the speed of the endless chain, which is determined by the time required for perfect gelatinization of the electrolyte. It gives an output of about two thousand cells per day of eight hours working, when the temperature of the water is about 70°C and the time required for the travel of the cells through the trough is about eleven minutes. The power required for this machine is about 1/8 H. P.

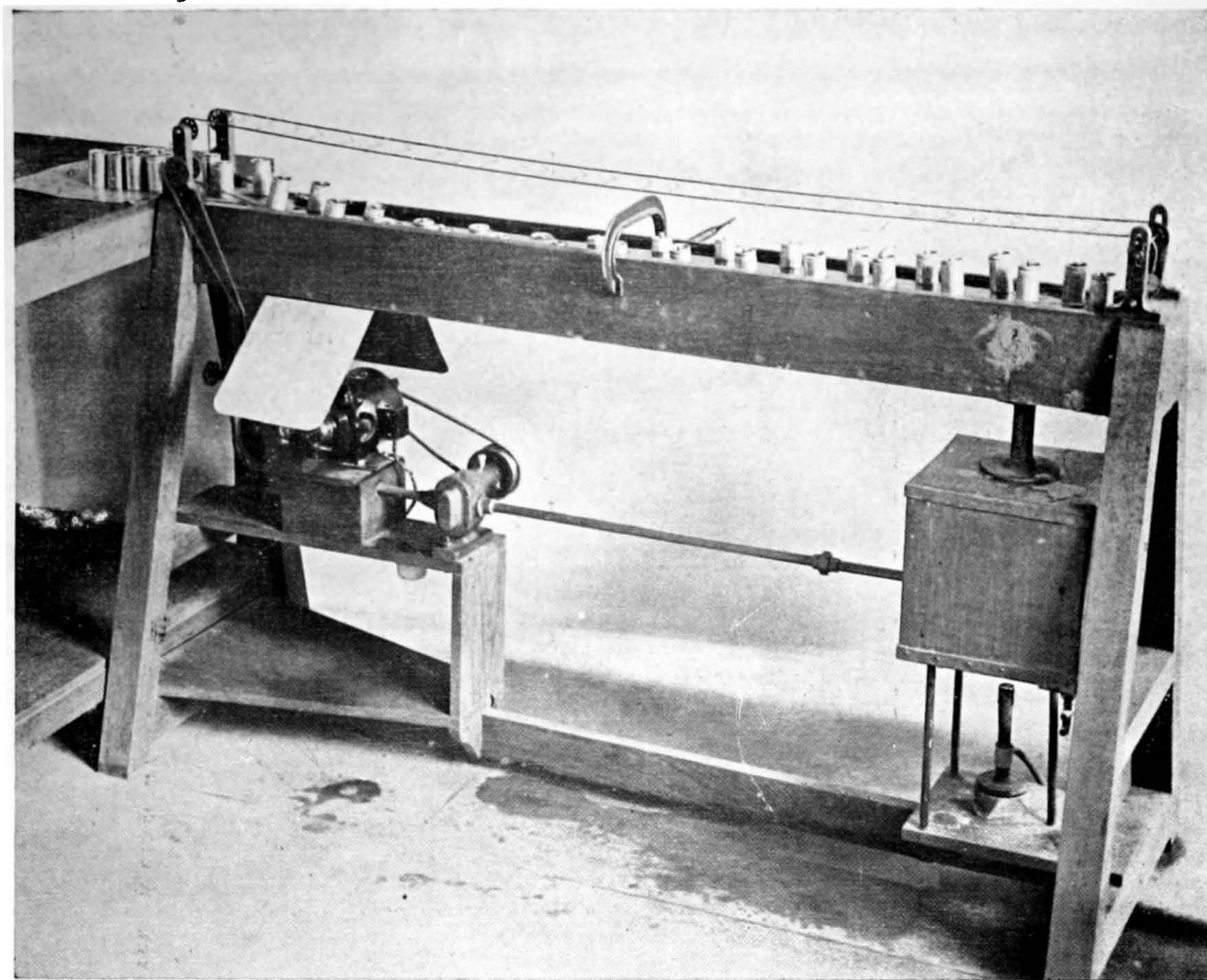

SEALING THE CELLS.

The cells are sealed after the cooking operation. The sealing compound or the pitch is heated in a boiler and then poured over the top card-board washers. A micro flame is played over the surface to get a uniform and perfect sealing.

LABELLING THE CELLS.

The completed cells are either wrapped in thick paper or are put on a card-board jacket with a suitable trade label pasted over them. The wrapping

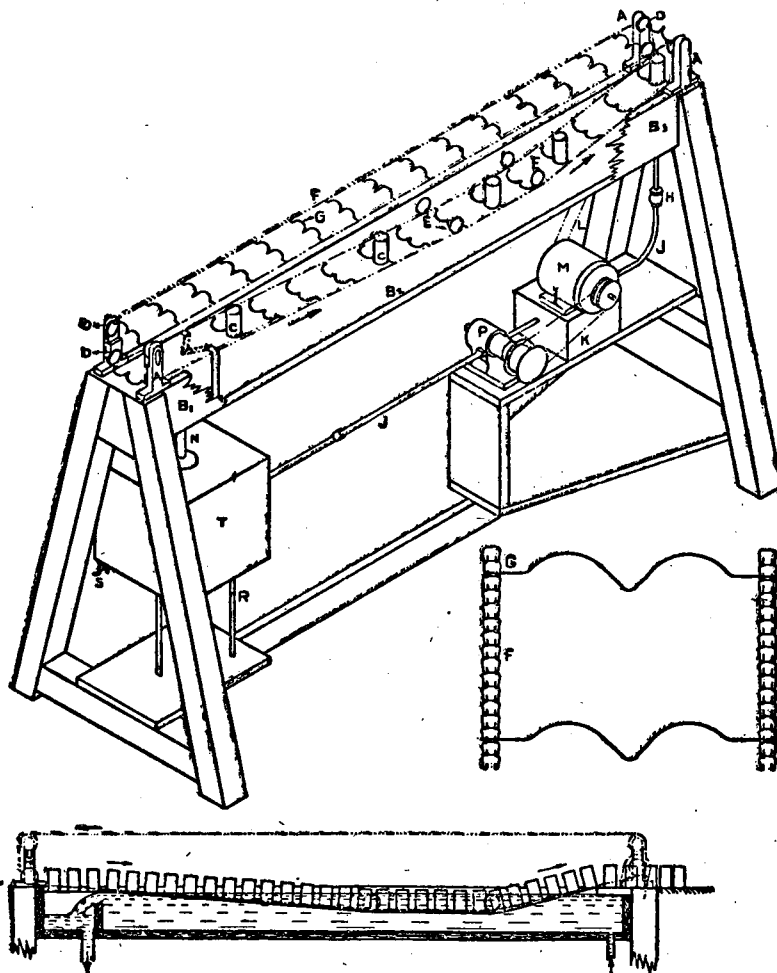

FIG. 14.
Automatic Cooking Trough.

may be carried out by hand or by machines. The labels are generally perforated in code to indicate the date of manufacture.

ASSEMBLING THE CELLS.

If the cells are to be assembled to form a battery they are not wrapped in paper or in a jacket. Individual cells are connected to each other by a soldered brass strip, one end soldered to the can while the other is soldered to the brass cap of the next cell. Each cell is suitably insulated from the others by paraffined cardboard washers. The whole unit is placed in a cardboard box of suitable size, and the intervening space is filled by sealing pitch. End and intermediate connections are suitably brought out to obtain the necessary voltage taps.

The unit cells or the batteries are then sent to the testing department, for testing and inspection, which aspects are separately dealt with in another chapter.

TESTING.

The necessity of regularly testing the finished product, which involves a large number of variables in its manufacture, cannot be over-emphasized. A careful observation of the characteristics of the finished product will help to remove the defects in the materials and in the manufacturing process, which would otherwise persist and allow the standard of quality to deteriorate.

The factory testing of cells may be divided into two broad divisions: (1) control tests and (2) service tests.

CONTROL TESTS.

These tests are undertaken to find the defective cells in any particular batch. The simplest method is to measure the open circuit voltage of the cells with a high resistance voltmeter. This measurement may be carried out on the third or the fourth day after the manufacture to allow sufficient time for faulty cells to develop the defects and consequently to run down in open-circuit voltage. Defective cells also show a higher internal resistance than the good ones and therefore can be picked out by measurement of their internal resistance. This test being more elaborate is not usually employed. A quick but drastic test giving a rough measure of the internal resistance, and adopted by many manufacturers is known as the short-circuit test. This test is carried out by momentarily short-circuiting a cell through a low resistance dead-beat ammeter and noting the maximum deflection of the needle. Defective cells will give a lower reading due to their higher internal resistance. This test is helpful in picking out defective cells, but should not be depended upon for comparing the output capacities of cells of different makes ⁽¹¹⁸⁾. As the test indicates the internal resistance, some conclusions may be drawn as to the ingredients in the case of new cells. Rather high currents for any size indicate an excessive amount of graphite, reducing thereby the manganese dioxide content below the proportion necessary for good depolarisation. Unduly low currents may be due to the use of cheaper materials or other defects.

After the two control tests described above, cells may be sent to the dealers. However a certain percentage (0.1 to 0.2 per cent.) of the manufactured cells should be selected at random for finding out the service characteristics.

SERVICE TESTS.

Service tests generally include measurement of: (1) Open-circuit voltage (2) Internal Resistance (3) Polarisation (4) Life output capacity, and (5) Shelf-life tests.

Open circuit voltage.—This is measured with a high resistance voltmeter having a resistance of at least 500 ohms. per volt. The voltage of a cell is made up of the voltage between zinc and electrolyte and between electrolyte and carbon-manganese mix, and depends upon the hydrogen ion concentration of the electrolyte. The capacity of a cell does not depend upon the initial open-circuit voltage.

Internal Resistance.—A freshly prepared cell has a certain definite internal resistance, depending chiefly upon the specific resistance of the electrolyte, the electrodes and the size of the electrodes and their distance apart. But when a cell is discharged various compounds are formed due to the electrochemical reactions, which give rise to higher values of the internal resistance of the cell.

The internal resistance can be measured by the potentiometer method, by the A.C. bridge method or by the voltage drop method. The first two methods being elaborate, the last one is generally adopted for all practical purposes. In this the resistance is measured by observing the value of the potential difference upon momentarily closing a cell through a known external resistance, and may be obtained by the equation

$$R = \frac{E - E^1}{E^1} \times R_a$$

where R is the internal resistance of a cell, E is the initial open circuit voltage, E^1 is the closed circuit voltage and R_a is the external resistance. In the above equation it is assumed that E remains unchanged by the current that is generated. Although the value of R satisfies the above equation, it will not be the true value of the internal resistance as polarisation takes place when the circuit is closed. To avoid effects of polarisation the first two methods will have to be adopted. Table VIII shows the internal resistance of a few reputed makes of torch light cells from the market measured against an external resistance of one ohm. The capacity of a cell however does not depend upon the initial internal resistance.

TABLE VIII.

Internal Resistance of Bag Type of Cells on the market. Size $1\frac{1}{4}$ " diameter \times $2\text{-}3\frac{3}{8}$ " height.

No.	No. of cells Tested.	Open-circuit voltage. Volts.	Internal Resistance. Ohms.
1	24	1.56	0.210
2	36	1.56	0.210
3	12	1.56	0.230
4	36	1.55	0.230
5	36	1.61	0.180
6	36	1.58	0.155
7	34	1.58	0.161

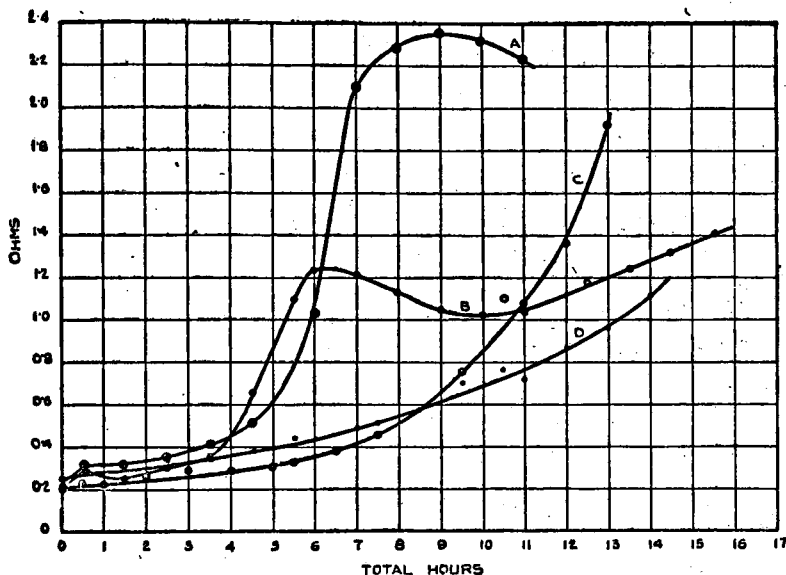

FIG. 15.

When a cell is discharged through a constant external resistance, the current drops down slowly from its initial value. The fall in the initial stages is mostly due to polarization, but as the discharge proceeds, it is mostly due to exhaustion of the cell. It may also be due to an increase in the internal resistance of the cell. It is not so much due to the drying out of the cell, which is a minor cause, since the electrochemical action during discharge gives rise to the formation of water. If an old cell is put on discharge or even with a new cell during the latter part of an intermittent discharge the current is sometimes found to rise from its initial value for a short time, due to the lowering of the internal resistance, as a result of the formation of water.

As the discharge proceeds, the manganese dioxide gets reduced and the active surface of the electrode moves towards the centre which increases the path between the anode and the cathode, thereby increasing the internal resistance of the cell. The rise in internal resistance is also due to the formation of insoluble double chlorides which settle on the zinc and the dolly surface and thus restrict the available path for the flow of the current. In Fig. 15 the rise in internal resistance of dry cells during the intermittent discharge periods is shown. The resistance of the cell was measured against the discharge resistance at the beginning of every discharge period by the voltage drop method. The rise is little in the beginning but increases rapidly to large values towards the end. Curves A and B show a peculiar shape because after a certain period, the resistance falls off, due to formation of water, and then rises again.

Polarisation Test.—The test is not generally carried out on torch light cells, but is carried out on larger size cells. Polarisation is a serious defect, the seriousness of which depends upon the use for which the cell is intended. The test may be carried out by discharging the cell either through a constant resistance or at a constant current to which the cell is subjected during its normal service period, and then measuring the polarisation for the particular conditions. Polarisation in a cell increases till the rate of depolarisation is equal to that of polarisation, and therefore the test should be continued for such a length of time that a steady state is attained or it should be carried out for a period that is likely to be required under service conditions. In this test the initial voltage E of the cell is noted and after the discharge period is over the circuit is broken, and the voltage E^1 is noted immediately afterwards.

The difference $E - E^1$ is the polarisation and $\frac{E - E^1}{E} \times 100$ is the percentage polarisation.

With the constant resistance discharge method the cells can be easily compared, but the current generated is not the same in each case because it is higher when polarisation is less than when it is more. In this test, therefore, a cell which polarises slightly is put to a more severe test than one in which polarisation is higher.

Life Test.—As dry cells and batteries are used in various fields of application, a number of tests will have to be devised to have a life test corresponding to the actual service conditions. Such a procedure would often make the testing elaborate and cumbersome. Certain arbitrary tests, as few as possible, should be adopted corresponding roughly to the most common uses of the cells and batteries. Governments and large purchasing authorities of various countries have standardised these tests and have issued the necessary testing specifications. Any one or more tests that may be convenient to work out may be chosen from the standardised ones.

Dry cells and batteries are generally used on constant resistance or constant current circuits. The service may be of a continuous or intermittent nature. The tests may therefore be divided into the following broad divisions: (1) Continuous tests of constant current or constant resistance nature and (2) Intermittent tests of constant current or constant resistance nature.

The test chosen should approximate as nearly as possible to the conditions occurring in actual service. If a cell is used continuously or for the most part of the time, continuous test should be used. Intermittent tests should be used when continuous tests do not approximate to service conditions, and the periods of discharge and rest should be carefully determined, as the recuperation of the cell during the rest period considerably influences its output capacity. Intermittent tests are generally carried out by means of automatic arrangements (23, 120, 128, 132). Use of automatic gear becomes necessary if discharge and rest periods are of only a few minutes' duration or if all the discharge periods do not fall during the regular working hours, or if there are thousands of cells to be tested at the same time. Due to the complicated nature of the intermittent test, the continuous test is sometimes adopted even when the anticipated service is rather different.

In intermittent tests if the voltage of a cell falls little on closed circuit, it will not need to recuperate much, so that a cell which polarises considerably will often have greater recuperative power than another which polarises less. A large proportion of the recuperation of a cell takes place shortly after the discharge circuit is opened. In tests where the period of testing is considerably prolonged, the output capacity instead of increasing due to the recuperation period decreases due to the self-discharge taking place in the idle period.

When the condition regarding the time of test is decided, the mode of discharge of the cells should next be considered. Dry cells and batteries are generally used at low discharge rates. The cells may be discharged through constant resistance or at constant currents, the values for which should approximate as far as possible to the actual service conditions. Intermittent testing at constant current is easier to carry out than intermittent testing through constant resistance, as with the former system a large number of cells can be tested in series with one controlling resistance and with one cut-in and cut-out switch. This does away with the necessity of breaking the circuit for every cell, when a constant external resistance circuit is used.

End Points of Discharge.—The discharge curve of a dry cell has no marked natural end point as is the case with a lead-acid storage cell. The end point of discharge should therefore be such that an apparatus using the cell will fail to work after the end point is reached. Cells are used for so many different purposes that it is difficult to decide upon any definite end point. Two end points are generally chosen. They are 0.75 volts and 0.90 volts per cell on closed circuit for the heavy intermittent and continuous discharges and for the light intermittent discharges respectively.

With the above end points it will take about a month or more before results of the test become known. This period may be too long for a manufacturing concern that desires to effect changes in the products as quickly as possible. To shorten the testing period, sometimes a higher end voltage of 1.1 volts is chosen ⁽⁶¹⁾. Fig. 16 shows the capacity of cells at different end voltages.

Number of cells required for life test.—The minimum number of cells to be selected for life test should be three. The cells may be tested in series, but it is preferable to test them individually rather than in series, because the average obtained by the series arrangement is not necessarily the same as the average obtained by testing the cells separately and then averaging the results.

The quality of a cell is affected by several uncontrolled variables in a factory such as the conditions during manufacture and the quality of raw materials. These variables produce cells with varying output. This variation may be of the order of ten to fifteen per cent. between individual cells. From statistical considerations, it is better to get an average output figure for a large number of cells than for a smaller batch in which an attempt has been made to control the variables.

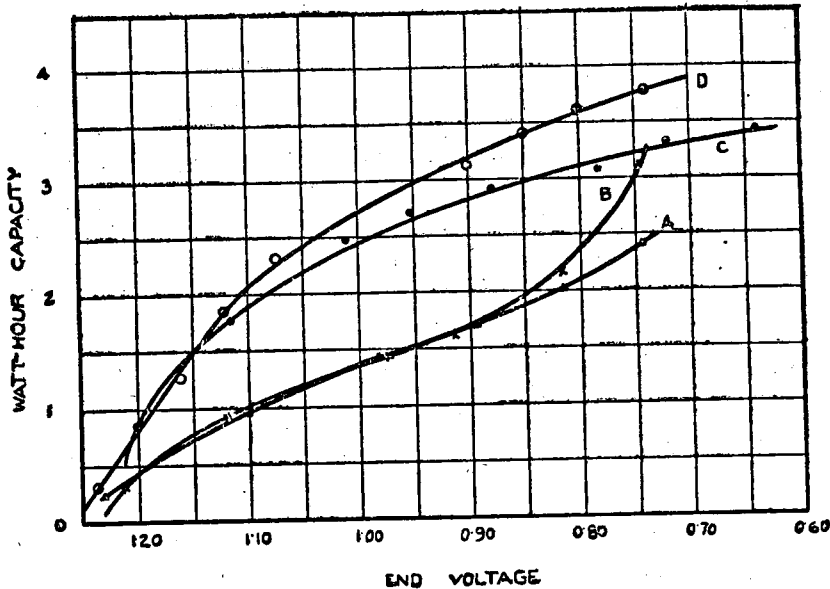

FIG. 16.

Rating of the cells.—The output capacity of a cell may be given in days, hours, minutes, ampere-hours or in watt-hours. The output depends upon the drain to which a cell is subjected, and therefore it is not a specific quantity. The procedure of rating the cells in terms of time is simple and of practical value, as it denotes the actual service that can be expected from a cell, and it has been adopted in many countries. Measurement of the capacity in ampere-hours or watt-hours entails a certain amount of calculation work to obtain the output figures. Nowadays the capacity in ampere-hours is not generally given. The method of rating the output capacity in watt-hours, though it involves more work, is satisfactory as it indicates the actual work that may be obtained from a cell and thereby forms a better scientific basis of comparison.

If a cell is discharged at constant current, the watt-hour capacity is obtained from:—

$$\text{W.H.} = IEH.$$

where I is the discharge current, E is the average voltage during discharge and H is the total time of discharge. If a cell is discharged through a constant resistance, the capacity is given by the following equation.

$$\text{W.H.} = \frac{E^2}{R} \times H$$

where E is the average voltage during discharge, R is the external resistance through which the cell is discharged and H is the total time of discharge.

Shelf Life Tests.—Shelf life tests on dry cells are important, as users of cells are generally interested in knowing the capacity of a cell after a period of storing. Initial tests indicate the available capacity when the cells are fresh, while shelf tests give an idea of the decrease in capacity due to deterioration on storage. The lowering in capacity during storage is different with different makes of cells. The cheaper and less reliable makes will be useless after only a few months' shelf period. Initial tests are useful when cells are to be used shortly after manufacture. If however the cells are to be used on light drains or on intermittent service of long duration or are not to be used for some time after the manufacture, the initial tests are of not much practical value. Shelf tests in such cases are important. Cells giving high output in the initial tests may fall rapidly after a storage period of only a month or two, while others showing moderate capacity on initial tests may continue to deliver almost the same amount even after six months' storage period. The latter type is preferable for giving a guarantee or for sending to distant places. Fig. 17 shows the output capacity of cells of different makes on shelf tests. The cells were tested in a constant temperature constant humidity room according to the procedure described in a paper by Verman and Joglekar ⁽¹²³⁾.

INFLUENCE OF TEMPERATURE.

Open Circuit Voltage.—It is well known that the temperature variations affect the characteristics of a dry cell. The effect of temperature on the open circuit voltage is small and may be neglected for all practical purposes. The temperature coefficient is positive⁽¹³²⁾ within the ordinary range of temperature.

Short-Circuit Current.—Short circuit current increases at the rate of approximately one ampere for each 3°C. rise in temperature between 0° and 25°C., and at higher temperatures the rate of rise is somewhat less ⁽¹³²⁾.

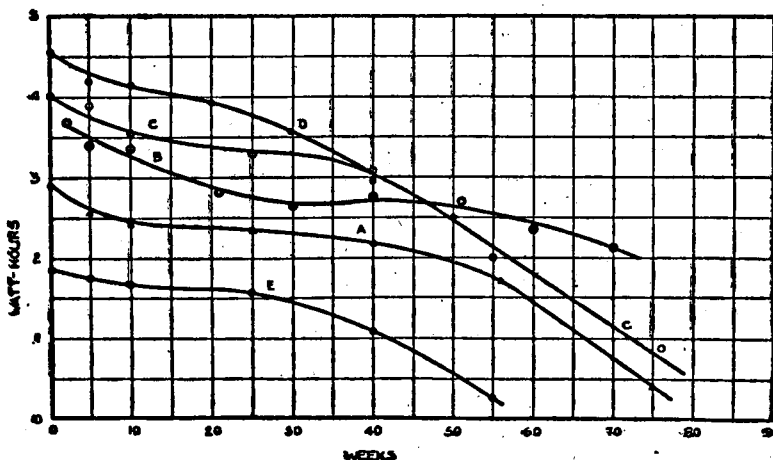

FIG. 17.

Output Capacity.—The temperature coefficient of capacity is positive and varies with the type of test and also with the brand of cells^(93, 104, 132). This variation makes it difficult to judge the capacity of a cell at any temperature from the known figures at a particular standard temperature.

Shelf Life Tests.—The effect of high temperatures on shelf life is deleterious. An increase in temperature assists the chemical reactions within the cell which tend to deteriorate it. Cells therefore should be stored in a cool place. Capacity of a cell is increased by raising the temperature when the discharge rate is high. In low discharge tests when a cell takes a considerable period to complete the test a low temperature is preferable so as to reduce the harmful effect of high temperature on the shelf life of the cell.

At low temperatures a cell gives less capacity than when discharged at normal temperatures. This diminution is due to many causes. The chemical reactivity slackens with the lowering of the temperature. Apart from this, the solubility of the by-products of reaction decreases with the temperature. The salts in the electrolyte crystallise out and congest the pores, thereby increasing the inner resistance of the cell. The conductivity of the electrolyte also decreases with the decreasing temperature. The harmful effects of low temperature may be counteracted to some extent by making suitable modifications in the electrolyte mixtures.

From the above discussion it will be seen that the temperature influences the capacity of a cell to a considerable extent. In a sub-continent like India, where the temperature varies considerably from place to place and also varies considerably at different times of the year, the result of even routine work would vary considerably with the natural variations of temperatures in a room. The greater accuracy that is necessary for research and development work cannot be obtained by testing the cells at room temperatures. With a view to avoiding the effects of the variations in temperatures research laboratories should be maintained under constant temperature conditions.

Relationship between various tests.—Tests carried out in a laboratory are at best approximations to the service qualities of cells. It is therefore necessary to correlate the laboratory data with the actual performance of cells in service. Attempts have been made by various workers to find out this correlation between various conditions of test^(91, 93, 136). The knowledge of the relationship between various tests would make it possible to carry out one rapid discharge on a dry cell and from such data to predict the performance of the cell under a variety of discharge conditions, thereby eliminating a large number of discharge tests. This ideal, however, has not yet been attained.

DEFECTS.

In the foregoing chapters it was pointed out that unless a proper check is maintained in the selection of raw materials and on each of the manufacturing operations defects will be observed in the finished products. These defects generally develop to an appreciable extent within the first few weeks of manufacture, and are sometimes noticed visually or detected when voltage and short-circuit current are measured. The defects may be summarised as :—

- (1) Bulging and/or pushing out of the sealing compound.
- (2) Pushing out of the carbon rod.
- (3) Pressing out of the zinc can bottom in soldered cans.
- (4) Creeping of the electrolyte along the walls of the can.
- (5) Creeping of the electrolyte along the carbon rod and subsequent corrosion of the brass terminal cap.
- (6) Pitting of the zinc cans.

As it is difficult to attribute any particular cause for these defects, a series of careful experiments have to be carried out to eliminate them. The first three defects listed above are due to the high pressure developed by the entrapped gases within the cell. In order to prevent these defects the entrapped gas must be vented out through the joint between the sealing compound and the zinc can or through the carbon electrode. In some cells the brass cap has a tiny hole or is slitted at the top for allowing the gas to escape through it. The gas finds its way to the cap through the porous carbon electrode, but this may be prevented if carbon rod has been excessively paraffined. Paraffining should therefore be judiciously carried out to prevent the passage of electrolyte but to allow free passage to the gases. Sometimes the zinc can is provided with a tiny hole at the top near the groove just below the top cardboard washer to allow these gases to escape.

The excessive generation of gases during the first few weeks of manufacture may be due partly to internal short circuits between the zinc and the depolariser material, which might be adhering to the outside of the dolly or which might have found its way out during the tying or capping operation. Care should be taken to avoid these short circuits. Gases may also have their origin in starch flour of inferior quality, which might have been used for gelatinizing purposes. This can be prevented by using good quality materials.

The pressing out of the zinc bottom occurs only if the soldered joints are not sufficiently strong. Sometimes electrolyte is also seen coming out at the bottom through pin holes in the soldered portion. These defects can be easily eliminated by careful control of soldering operation and inspection of finished cans before cell assembly.

The electrolyte sometimes creeps along the vertical soldered joint, and if the sealing at the top is defective, it comes out and spoils the outside of the cell or other adjoining cells in a battery. It also creeps along the vertical fissures if any, and along the vertical grooves in a carbon rod and corrodes the

brass caps. Faulty carbon rods should not therefore be used. It is also preferable to have vertical dents on the carbon rod instead of grooves.

Direct internal shorts taking place during the assembling of a cell lower the voltage in a few days' time. These may be detected by open circuit voltage measurements. Due to internal short-circuits, the zinc can is eaten up locally and becomes pitted. Harmful impurities either from the electrolyte and/or from the depolarising mixture travel to the zinc can, and develop local galvanic cells and cause the pitting of the can. These defects may be prevented by controlling the purity of raw materials.

ECONOMICS.

In running a manufacturing concern successfully, it is necessary to assess correctly the cost of production. Not only should the total cost be known correctly, but it is also necessary to know the cost of production at every stage of manufacture. Such a procedure would help to effect economies in the cost of production without deteriorating the quality. Attention should be paid to the cost and selection of the raw materials consistent with their quality and suitability for manufacture. Attention is also necessary at every stage to find the wastage in the manufacturing process and for the subsequent substitution of new devices or combination of two or more operations by special machinery to reduce it.

Fig. 18 shows a flow sheet of dry cell manufacture. A hypothetical case has been worked out below showing the cost of manufacture of dry cells in the smallest factory unit considered economic for Indian conditions. The output of the factory is taken at a figure of 8,000 cells a day with a monthly production of 200,000 cells. The size of cell manufactured is taken as $1\frac{1}{4}$ " dia. \times 2-3/8" height. The prices of raw materials, machines and the labour charges are assumed to be those current before the war and are somewhat on the higher side.

On the basis of the above production figures the factory would require a total floor area of about 3,000 sq. ft. including offices and laboratories. The assumptions on which the cost of production are based are as follows :—

CAPITAL INVESTMENT.

	Rs.
(1) Building	20,000
(2) Working capital (equivalent roughly to 4 months' requirement of materials and pay of employees, etc.)	48,000
(3) Machinery, apparatus, etc.	28,000
(4) Laboratory and office equipment, etc.	4,000
Total	<u>1,00,000</u>

STAFF PAY.

	Rs.	
(1) One Technical Manager	250	per month.
(2) One Chemist	100	" "
(3) One Clerk	40	" "
(4) Six Mistries at Rs. 40 per month each	240	" "
(5) Fifty workers at Rs. 20 per month each	1,000	" "
(6) One bearer	20	" "
Total	<u>1,650</u>	

ANNUAL CHARGES.

	Rs.
(1) Interest on Capital Investment at 5 per cent. ..	5,000
(2) Rates and Taxes, etc. at 1.25 per cent. ..	250
(3) <i>Depreciation</i> —	Rs.
(a) Building 5 per cent.	1,000
(b) Machinery, etc., 10 per cent.	2,800
(c) Laboratory and office equipment 10 per cent.	400
(d) Maintenance 1 per cent.	280
	4,480
	4,480
(4) Pay of employees	19,800
(5) Insurance	1,000
(6) Power, light, etc.	1,200
(7) Miscellaneous	1,000
	32,730
Total	32,730
Yearly Production24,00,000 cells.

COST OF PRODUCTION.

	Rs.
(1) Material cost Rs. 11,000 × 12	1,32,000
(2) Annual charges	32,730
	1,64,730
Total	1,64,730

Cost per cell = 1.1 anna per cell.

Cost per gross = Rs. 9.9 say Rs. 10.

Quality cells are generally sold at a price varying between Rs. 12 and Rs. 15 per gross *ex-factory*. Taking Rs. 12 as the selling price per gross to dealers the profit per year comes to about Rs. 33,000 on an investment of Rs. 1,00,000 which means 33 per cent. profit on the capital investment. The nett profit will however be reduced to a certain extent depending upon the income tax, the advertisement charges, etc., which have not been included in the above estimate.

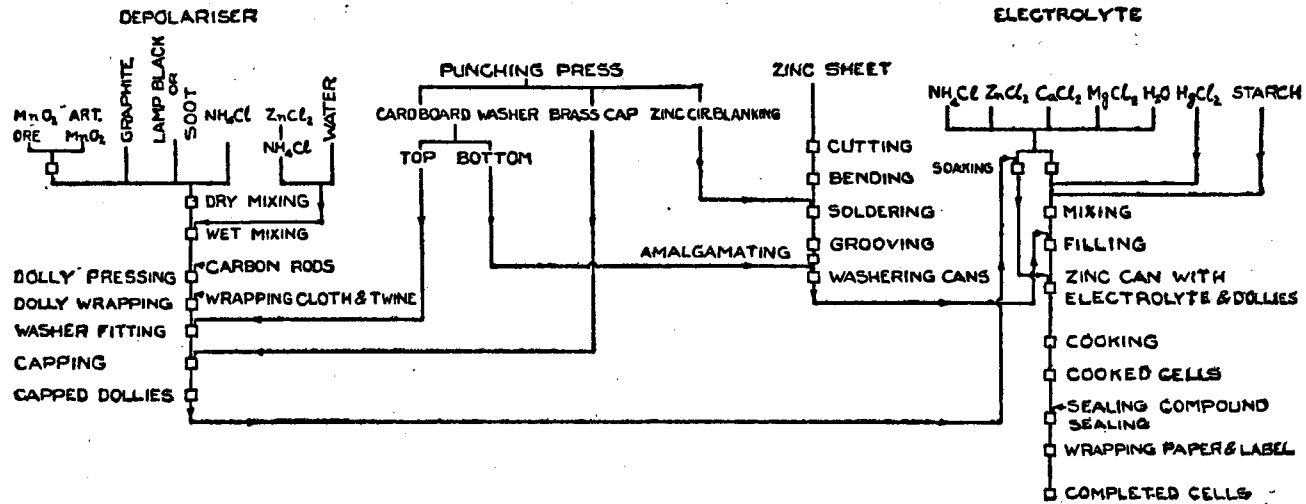

FIG. 18.
Flow Sheet of Dry Cell Manufacture.

Since the outbreak of hostilities in Europe the economic position has been considerably altered and became so complex that any data collected before the war has become extremely inaccurate, and the collection of up-to-date figures has become well-nigh impossible. In view of the constantly changing conditions, therefore, it has become futile to attempt an accurate estimate of dry cell production cost. Constant attempt is, however, being made by the authors to keep in touch with developments and maintain the available data up-to-date, with a view to assisting any one who may require such information.

ACKNOWLEDGMENTS.

The authors wish to express their thanks to Mr. D. S. Naidu and Dr. M. Karim who have been connected with certain aspects of the research work on dry cell manufacture from time to time.

BIBLIOGRAPHY.

1. Anon, Modern flashlight batteries. Formulas from factory practice. *Chem. Ztg.*, 56, 690, 1932.
2. Anon, Report of progress by the Committee on dry cell tests. Standard methods recommended for testing of dry cells. *Trans. Am. Electrochem. Soc.*, 21, 275, 1912.
3. Arndt, K., and Pollack, A. Artificial Graphite. *Z. anorg. allgem. Chem.*, 201, 81, 1931.
4. Arndt, K., Walter, H., and Zender, E. Investigations of manganese dioxide cell. *Z. angew. Chem.*, 39, 1426, 1926.
5. A. S. T. M., Standard specifications for rolled zinc. *A. S. T. M. Standards*, B. 69-29, 1939.
6. Blum, W. and Vinal, G. W. The definition of polarisation, overvoltage and decomposition potential. *Trans. Electrochem. Soc.*, 66, 359, 1934.
7. Brown, B. K. Graphitic oxide as a depolarizer in the Leclanché cell. *Trans. Electrochem. Soc.*, 53, 113, 1928.
8. Brown, J. C. Notes on manganese ores. *Bulletin of Indian Industries No. 2*, 1921, Govt. of India Publications.
9. Brown, J. C. India's Mineral Wealth, 1936 Ed. *Oxford University Press*.
10. Brown, J. W. The use of dry cells on ignition service. *Trans. Am. Electrochem. Soc.*, 13, 173, 1908.
11. Brummer, E. and Beyer, O. Increasing the capacity of dry cells of Leclanché type. (a) *Magyar Chem. Polyairat*, 36, 160, 1930. (b) *Chem. Zentr.*, 1, 428, 1931.
12. B. S. I. British Standard Specification for Leclanché type primary cells, No. 397, 1933.
13. Burgess, C. F. The dry cell. *Electrical World and Eng.*, 39, 156, 1902.
14. Burgess, C. F. Characteristics of small dry cells. *Trans. Am. Electrochem. Soc.*, 30, 257, 1916.
15. Burgess, C. F., Gillingham, C. A., and Vinal, G. W. Report of radio battery committee on standardization of tests for dry cells in radio receiving sets. *Trans. Electrochem. Soc.*, 45, 15, 1924.
16. Burgess, C. F. and Hambuechen, C. Certain Characteristics of dry cells. *Trans. Am. Electrochem. Soc.*, 16, 97, 1909.
17. Burkhardt, A. and Sachs, G. Special zinc for the manufacture of batteries *Metallwirtschaft*, 13, 809, 1934.
18. Cahoon, N. C., The influence of hydrogen ion concentration on the potential of African manganese dioxide. *Trans. Electrochem. Soc.*, 63, 177, 1935.

19. Camp, A. D. Chemical raw materials for dry cell industry. *Chem. Met. Eng.*, **35**, 154, 1923.
20. Ceader, J. D. and Mead, T. Characteristics of flashlight batteries and incandescent lamps. *Trans. Electrochem. Soc.*, **68**, 207, 1935.
21. Claussen, R. A. The six-inch paper-lined dry cell. *Trans. Electrochem. Soc.*, **64**, 341, 1933.
22. Codd, A. M. Practical primary cells, Ed. 1929. *Sir Issac Pitman and Sons, Ltd., London.*
23. Cooper, H. G. Dry cells and their testing, *Elec. Communication*, **5**, 210, 1927.
24. Cooper, W. R. Primary Batteries, Second Impression, 1920. *Bean Brothers Ltd., London.*
25. Cordebas, R. Conductivity of carbon. *Rev. Gen. Elec.*, **31**, 547, 1932.
26. D'Agostino, C. Determination of the chemical activity of manganese dioxide. *Ricerca Sci.*, **9**, 195, 1938.
27. Dana, E. S. and Ford, W. E. A text book of mineralogy, 1922 Ed. pp. 411—436, *J. Wiley.*
28. Daniels, F. Physical chemical aspects of the Leclanché dry cells. *Trans. Electrochem. Soc.*, **53**, 45, 1928.
29. Drotschmann, C. The zinc electrode in dry cells. *Chem. Ztg.*, **53**, 29, 50, 66, 1929.
30. Drotschmann, C. Determination of the depolarisation index of pyrolusite for the battery industry. *Chem. Ztg.*, **56**, 234, 1932.
31. Drotschmann, C. Advances in the chemistry of the manufacture of dry batteries. *Chem. Ztg.*, **59**, 881, 1935.
32. Drotschmann, C. Copper and iron impurities in dry cells. *Chem. Ztg.*, **62**, 216, 1938.
33. Drotschmann, C. Battery trade chemicals. *Chem. Trade Jour. and Chem. Eng.*, **103**, 583, 1938.
34. Drucker, C. The current yielding reactions of the Leclanché elements (dry cells). *Z. Physik. Chem. Bodenst.-Festband*, 912, 1931.
35. Fermor, L. L. Memoirs of the Geological Survey of India. Vol. XXXVII, Part I, II, III and IV.
36. Friend, J. N. The solution of plain and amalgamated zincs in electric batteries. (a) *J. Inst. of Metals*, **41**, 91, 1929. (b) *Engineering*, **127**, 354, 1929.
37. Fuseya, G., Miyakawa T., Akai Y., and Simazaki, K. Measurement of the potential of the zinc electrode. *J. Soc., Chem. Ind. (Japan), Suppl. binding*, **39**, 401-B., 1936.
38. Fuseya, G., Saito Y. and Simazaki, K. Measurement of the solubilities of $ZnCl_2 \cdot 2NH_3$ in electrolytes of various concentration. *J. Soc. Chem. Ind. (Japan) Suppl. binding*, **42**, 100-B., 1939.

39. Gillingham, C. A. Discharge characteristics of certain dry cells. *Trans. Am. Electrochem. Soc.*, **34**, 297, 1918.
40. Gillingham, C. A. Twenty-five years in the dry cell industry, *Trans. Electrochem. Soc.*, **51**, 165, 1927.
41. Gillingham, C. A. Some comments on dry cell service and tests. *Trans. Electrochem. Soc.*, **53**, 39, 1928.
42. Gillingham, C. A. Quality advances in the dry battery industry. *Trans. Electrochem. Soc.*, **68**, 159, 1935.
43. Goulder, F. The manufacture of dry batteries. *J. Proc. Sydney. Tech. Coll. Chem. Soc.*, **4**, 26, 1930.
44. Goulder, F. The manufacture of dry batteries. *Chem. Eng. Mining Rev.*, **25**, 274, 1933.
45. Gray, A. R. Dry cell resistances, *Electronics*, **9**, 36, 1936.
46. Grimm, H. A method of studying the drying of paste in pocket lamp dry cells *Z. Electrochem.*, **36**, 427, 1930.
47. Groves, A. W. Manganese, 1938 Ed. Published by the *Imperial Institute, London*.
48. Gruhl, M. Investigation of Leclanché cell for pocket flashlights. *Z. Electrochem.*, **31**, 214, 1925.
49. Hambuechen, C. Performance of dry cells. *Trans. Am. Electrochem. Soc.*, **21**, 297, 1912.
50. Hambuechen, C. and Ruhoff, O. E. Physical and chemical data on dry cells and dry cell materials. *Trans. Am. Electrochem. Soc.*, **22**, 467, 1912.
51. Helfrecht, A. J. Depreciation in small dry cells with age. *Trans. Am. Electrochem. Soc.*, **36**, 269, 1919.
52. Hermann, Z. Constituents of a Leclanché Cell-II, The role of the lampblack. *Monatsh.*, **71**, 175, 1938.
53. Hofman., *Metallurgy of Zinc and Cadmium* 1922 Ed. *Mc. Graw Hill Book Co., N. Y.*
54. Holler, H. D. and Ritchie, L. M. Hydrogen ion concentration in dry cells. *Trans. Am. Electrochem. Soc.*, **37**, 607, 1920.
55. Holler, H. D. and Ritchie, L. M. Relation of voltage of dry cells to hydrogen ion concentration. *Bureau of Standards Paper No. 364, 1920*.
56. Huntley, A. K. A radio 'B' dry battery of flat type construction. *Trans. Electrochem. Soc.*, **68**, 219, 1935.
57. Iida, H. Purification of manganese dioxide, *J. Soc. Chem. Ind. (Japan), Suppl. binding.* **37**, 168-B, 1934.
58. Ilinskii, V. P. and Lapin, N. P. Investigation of the Leclanché cell I. Behaviour of natural and artificial Manganese dioxide. *Zhur Prikladnoi Khim.*, **1**, 176, 1928.

59. Ilinskii, V. P. and Lapin, N. P. Preparation of manganese dioxide by electrolysis. *J. Applied. Chem. (U. S. S. R.)*, **4**, 757, 1922.
60. Jegge, E. O. Absorption phenomena in primary cells. *Trans. Electrochem. Soc.*, **53**, 71, 1928.
61. Jone, F. D. Die Design and Die Making Practice 1930 Ed. *Machinery Publishing Co., Ltd., London*.
62. Jumau, L. The theory of the Leclanché cell. *Rev. Gen. Elec.*, **42**, 651, 1937.
63. Jumau, L. Primary batteries in recent patents, *Rev. Gen. Elec.*, **41A**, 657, 1937.
64. Jumau, L. Recent patents on dry batteries. *Rev. Gen. Elec.* **45**, 397, 1939.
65. Kameyama N. Life of dry cells I.—Rate of discharge and the life. *J. Soc. Chem. Ind. (Japan), Suppl. binding*, **32**, 142-B., 1929.
66. Kameyama N. Life of dry cells II—Discharge mechanism of grains of active material. *J. Soc. Chem. Ind. (Japan), Suppl. binding*, **32**, 144-B., 1929.
67. Kameyama N. Life of dry cells III—Life in the regularly intermittent constant current discharge. *J. Soc., Chem. Ind. (Japan), Suppl. binding*, **32**, 161-B., 1929.
68. Kameyama N. Dry cell for use at low temperatures. *J. Soc. Chem. Ind. (Japan), Suppl. binding*, **37**, 168-B., 1934.
69. Kameyama N. The life of dry cells, especially in case of discharge through constant resistance. *J. Electrochem. Asso. (Japan)*; **2**, 380, 1934.
70. Kameyama, N. and Iida, H. Preparation of manganese dioxide by means of electrolysis with alternating current. *J. Soc., Chem. Ind. (Japan), Suppl. binding*, **35**, 374-B., 1932.
71. Kameyama, N. and Iida, H. Use of manganese dioxide prepared by the alternating current electrolysis as the depolarizer of dry cells. *J. Soc. Chem. Ind. (Japan), Suppl. binding*, **35**, 375-B., 1932.
72. Kameyama, N. and Iida, H. Dry cells for use at low temperatures II. *J. Soc. Chem. Ind. (Japan), Suppl. binding*, **39**, 431-B., 1936.
73. Kameyama, N. and Naka, A. Dry cells for use at low temperatures III. *J. Soc. Chem. Ind. (Japan), Suppl. binding*, **39**, 432-B., 1936.
74. Kaneko, S. The electromotive force of the dry cell *J. Soc. Chem. Ind. (Japan), Suppl. binding*, **32**, 37-B., 1929.
75. Kaneko, S., Nemoto, C. and Makino, S. Studies on manganese dioxide for the dry cell. *J. Soc. Chem. Ind. (Japan), Suppl. binding*, **32**, 205-B., 1929.

76. Kato, Y. and Matsuhashi, T. Studies on a new process for making manganese dioxide I. *J. Soc., Chem. Ind. (Japan), Suppl. binding, 32, 313-B., 1929.*
77. Kato, Y. and Matsuhashi, T. Studies on a new process for making manganese dioxide II. Properties of the product. *J. Soc. Chem. Ind. (Japan), Suppl. binding, 32, 315-B., 1929.*
78. Kato, Y. and Matsuhashi, T. Studies on a new process for making manganese dioxide III. Comparison of chemical and physical properties of natural and artificial manganese dioxide of different origins. *J. Soc. Chem. Ind. (Japan), Suppl. binding, 34, 312-B., 1931.*
79. Kato, Y. and Matsuhashi, T. A process for manufacturing manganese dioxide, and its electrochemical properties. *Proc. World. Eng. Cong. (Tokyo), 1929, 31, 305, 1931.*
80. Kato, Y. and Matsuhashi, T. Artificial manganese dioxide applied to the production of dry cells of long shelf-life. *J. Soc. Chem. Ind. (Japan), Suppl. binding, 36, 164-B., 1933.*
81. Keller, A., Uber das Leclanché Elementé. *Z. Electrochem., 37, 342, 1931.*
82. Kirkman, F. J. Economic control of dry cell manufacture. *Trans. Electrochem. Soc., 69, 273, 1936.*
83. Koße, K. A., and Graham R. P., The effect of applying a counter e.m.f. to a Leclanché cell. *Trans. Electrochem. Soc., 73, 587, 1938.*
84. Kobozev, N. I. and Sokolov, N. N. Physical chemical investigations of the air depolarisation in Leclanché cells. *J. Appl. Chem. U. S. S. R., 7, 297, 1934.*
85. Koehler, W. A. Principles and Applications of Electro-chemistry Vol. II. Applications, 1935 Ed. *John Wiley and Sons Inc., New York.*
86. Kostjejev, V. A. Effect of various factors on output of Leclanché cells. *Trans. Electrochem, Soc., 58, 305, 1930.*
87. Kostjejev, V. A. Effect of the electrolyte on the efficiency of the Leclanché cell. *Arch. Hem. Farm, 5, 281, 1931, and Chemie E., Industrie, 27, 338, 1932.*
88. Kozlor, V. V. and Volfson, T. I. Active manganese dioxide from pyrolusite. *J. Chem. Ind. (Moscow), 12, 1167, 1935.*
89. Krivolutskaya, N. S. and Morozov. The influence of the shape of carbon electrodes on the properties of carbon zinc elements. *Zhur. Prikladnoi. Khim, 2, 703, 1929.*
90. Kubo, R. Dry batteries. *Repts. Imp. Ind. Research Inst. Osaka (Japan), 18, No. 12, 1-22, 1936.*
91. Lawson, H. E. Relationship of service characteristics of dry cells. *Trans. Electrochem. Soc., 68, 187, 1935.*

92. Lawson, H. E. Cylindrical cell 'B' dry battery. *Trans. Electrochem. Soc.*, **69**, 265, 1936.
93. Lawson H. E. and Kirkman, F. J. Characteristics of the size 'F' dry cell. *Trans. Electrochem. Soc.*, **70**, 441, 1936.
94. Liedel, E. Improvements in accumulators and dry batteries. *Z. Angew Chem.*, **42**, 301, 1929.
95. Loveridge, F. H. Dry cell tests. *Trans. Am. Electrochem. Soc.*, **16**, 109, 1909.
96. MacInnes, D.A. Polarisation in Leclanché cells. *Trans. Am. Electrochem. Soc.*, **29**, 315, 1916.
97. Makino, S. The corrosion of zinc electrode in a dry cell during the open circuit. *J. Soc. Chem. Ind. (Japan), Suppl. binding*, **33**, 176-B., 1930.
98. Makino, S. Studies on the materials for the dry cell II. *J. Soc. Chem. Ind. (Japan), Suppl. binding*, **33**, 326-B., 1930.
99. Makino, S. Self discharge of dry cells. *J. Soc. Chem. Ind. (Japan) Suppl. binding*, **33**, 521-B., 1930.
100. Makino, S. Manganese dioxide for the dry cell III. *J. Soc., Chem. Ind. (Japan), Suppl. binding*, **35**, 69-B., 1932.
101. Makino, S. Dry cells of standard sizes I. *J. Electrochem. Assoc. (Japan)*, **1**, 225, 1933.
102. Makino, S., Dry cells of standard sizes. *J. Electrochem. Assoc. (Japan)*, **1**, 257, 1933.
103. Makino, S. The discharge characteristics of the dry cell. *J. Electrochem. Assoc. (Japan)*, **3**, 1935.
104. Makino, S. Effect of temperature on the capacity and life of dry cells made according to Japanese Standard Specifications : Circulars. *Electrotech. Lab.*, **107**, 92 pp., 1937.
105. Makino, S. and Satake, Y. The quality of ammonium chloride for dry cells. *J. Electrochem. Assoc. (Japan)*, **2**, 110, 1934.
106. Makino, S. and Satake, Y. The self discharge of the dry cell I. The self discharge of negative and positive electrodes. *J. Electrochem. Assoc. (Japan)*, **3**, 243, 1935.
107. Makino, S. and Takizawa, S. Ammonium chloride for dry cells. *J. Electrochem. Assoc. (Japan)*, **2**, 420, 1934.
108. McKay, R. J. and Worthington, R. Corrosion resistance of metals and alloys, 1936 Ed. p. 156 *Reinhold Publishing Corp., New York*.
109. Martin, T. J. The magnetic concentration of certain natural and artificial manganese dioxides. *Trans. Electrochem. Soc.*, **57**, 467, 1930.

110. Martin, T. J. and Helfrecht A. J. Potentials of manganese dioxide in electrolytes of various hydrogen ion concentrations. *Trans. Electrochemical Soc.*, **53**, 83, 1928.
111. Mellor, J. W. A comprehensive treatise on Inorganic and Theoretical chemistry Vol. XII, p. 150.
112. Nichols, G. W. Electrolytic manganese dioxide. *Trans. Electrochem. Soc.*, **62**, 393, 1932.
113. Nikolaus Branz. Guiding principles of Battery Manufacture, 4 Books. Berlin, S. 42.
114. Okada, S., Watanabe, K. and Nakamura, O. Manganese dioxides for dry cells I. *J. Electrochem. Assoc. (Japan)*, **2**, 213, 1934.
115. Okada, T., Watanabe, K. and Sawada, N. Manganese dioxide for the dry cell. *J. Electrochem. Assoc. Japan*, **3**, 248, 1935.
116. Ordway, D. L. Some characteristics of the modern dry cell. *Trans. Am. Electrochem. Soc.*, **17**, 341, 1910.
117. Oswald, M., Improvements in carbon electrodes. *Chimie and Industrie, Special Number 428*, (Feb. 1929).
118. Pritz, W. B. Dry cell testing. *Trans. Am. Electrochem. Soc.*, **19**, 31, 1911.
119. Richardson, H. K. The modern dry cell, its development, construction and manufacture. *Met. and Chem. Eng.*, **10**, 531, 1912.
120. Sanderson, R. W. W. The testing of dry cells. *G. E. C. Jour.*, **1**, 115, 1930.
121. Schrader, E. Zinc in the construction of cups for Leclanché cells. *Z. Metallkunde*, **23**, 301, 1931.
122. Smitheringale, W. V. Etching tests and X-ray examination of some manganese minerals. *Econ. Geol.*, **24**, 481, 1929.
123. Staley, W. D. and Helfrecht, A. J. Gelatinization of corn starch in dry cell electrolyte. *Trans. Electrochem. Soc.*, **53**, 93, 1928.
124. Thomspon, B. M. Effect of hydrogen ion concentration on the voltage of the Leclanché dry cell. *Ind. Eng. Chem.*, **20**, 1176, 1928.
125. Thompson, M. de Kay. Current producing reactions of the Leclanché cell. *Trans. Electrochem. Soc.*, **68**, 167, 1935.
126. Thompson, M. de Kay. and Crocker E. C. Depolarisation in Leclanché cells. *Trans. Am. Electrochem. Soc.*, **27**, 155, 1915.
127. Vepa, V. L. R. The potential of dry cells with manganese chloride electrolyte *Jour. Indian Inst. Sci.*, **17-B**, 101, 1935.
128. Verman, L. C. and Joglekar G. D. Semi-automatic cell testing device for dry cells. *Current Science*, **8**, 332, 1939.

129. Verman, L. C., Subba Ramaiah, K. and Joglekar, G. D. Effect of iron content of manganese ores on dry cell characteristics. *Current science*, 9, 64, 1940.
130. Verwey, E. J. W. and de Boer, J. H. Cation arrangement in a few oxides with crystal structure of the special type. *Rec. Trav. Chim. Pays-Bas*, 55, 531, 1936.
131. Vinal G. W. A. S. A. Committee keeps standards on dry cells., *Ind. Standardization and Commercial Standards Monthly*, 8, 49, 1937.
132. Vinal G. W. and Ritchie, L. M. Electrical characteristics and testing of dry cells. *Circ. Bureau of Standards*, No. 79, 62 pp. 1923.
133. Wagner, A. Chemical industry and the manufacture of electric cells. *Chem. Ztg.*, 51, 157—179, 1927.
134. Walker, W. H., Lewis, W. K., Mc. Adams W. H. and Gilliland E. R. Principles of Chemical Engineering, 1937 Ed. *Mc.Graw Hill Publishing Corp., London*.
135. Zalesinski, E. Requirements and testing of sheet zinc for the manufacture of batteries. *Metallwirtschaft*, 12, 699, 1933.
136. Zimmerman, J. G. Rapid dry cell testing. *Trans. Electrochem. Soc.*, 53, 103, 1928.

BULLETINS OF INDIAN INDUSTRIAL RESEARCH



No. 23

DRY CELL MANUFACTURE

BY

G. D. Joglekar, B.Sc.

K. Subba Ramaiah, D.Sc., A.I.C., F.A.Sc.

Lal C. Varman, Ph.D., M.S., F.Inst.P.

2ND EDITION.

**DIRECTORATE OF SCIENTIFIC
AND INDUSTRIAL RESEARCH
DEPARTMENT OF INDUSTRIES
AND CIVIL SUPPLIES
GOVERNMENT OF INDIA**

**PUBLISHED BY THE MANAGER OF PUBLICATIONS, DELHI
PRINTED BY THE MANAGER, GOVERNMENT OF INDIA PRESS, SIMLA
1943**

X9(P 27240).2

H3

The Statements made and the views expressed in this bulletin are those of the authors, and the Government of India do not accept responsibility for them.

CONTENTS.

	Page.
Synopsis	iv
Introduction	1
Theory	3
Manufacture	5
Materials	9
Machinery	19
Testing	33
Defects	40
Economics	41
Acknowledgments	44
Bibliography	45

SYNOPSIS.

Dry cells have been imported into India for many years and the annual import figures are at present placed at over twenty lakhs of rupees. During the last few years the manufacture of dry cells has been undertaken in India, and at present there are eight or nine firms located in different parts of the country which are producing dry cells of various types and marketing them more or less successfully.

The Indian firms had been importing most of the raw materials from Germany before the war and now they have to turn to other foreign countries. It is difficult to estimate the correct total value of the imported raw materials, but it may safely be assumed that the figure is not less than ten lakhs of rupees per year.

The manufacture of high quality cells and the maintenance of a consistent standard require a high degree of technical skill and knowledge of materials and manufacturing processes. With a view to assisting the Indian manufacturers who have been experiencing pronounced difficulties in producing cells which will compare favourably with some of the well known brands available in the Indian market, a systematic study of dry cell manufacture was undertaken in the laboratories of the Government Test House, the results of which have been presented in this bulletin.

In addition to this a survey of the indigenous raw materials was carried out with a view to replacing foreign products in the manufacture of dry cells. As a result of this survey certain Indian manganese ores have been found which are capable of giving as good output results as foreign ores of good quality. Many of the Indian manufacturers, on the basis of the researches carried out and described in this bulletin, have already resorted to the use of Indian manganese ores.

The results embodied in this bulletin represent researches which covered several years. An exhaustive bibliography is appended so as to assist and encourage original investigations in this line.

The chapter dealing with the economic aspects of the industry will be of particular interest to prospective manufacturers.

In presenting the data obtained on the various aspects of the subject, it has been the endeavour of the authors to avoid, as far as possible, highly academic discussions of the various problems involved and to concentrate chiefly on matters immediately concerned with the industrial aspects.

INTRODUCTION.

The dry cell as commonly understood is a primary cell of the Leclanché type. It consists of a zinc sheet container, which acts as an anode, a dolly containing a depolarising mixture pressed around a carbon rod, which acts as a cathode, and an electrolyte in the form of a stiff paste containing ammonium chloride, zinc chloride and other chemicals. Dry cells are not dry in the true sense of the term, but the electrolyte in them is gelatinized so that it does not spill during handling. As a matter of fact a great deal of effort is always made to conserve the moisture in the electrolyte for the electrochemical reactions to proceed efficiently.

Dry cells may be divided into two broad divisions, *viz.*, the bag type and the packed type cells. Only the first type is manufactured in India, while the second type of the cells available on the market are of foreign origin. The dimensions of the most common sizes of flash light cells on the market are given in Table I, apart from which certain special sizes are manufactured for the Government departments and for special requirements. Batteries are made by assembling the required number of these cells together. Batteries for special purposes are also available on the market but have a restricted sale.

TABLE I.
Common Sizes of Dry Cells on the Market.

No.	Diameter.	Height.
1*	1½-In.	2¾-In.
2	1 " "	1¾ " "
3	1¼ " "	1¾ " "
4	1 " "	2 " "

IMPORTS.

Dry cells have been imported into India for a considerable number of years. Only within the last few years, the manufacture of dry cells has been undertaken in India, and at present there are about eight to nine firms located in different parts of the country which are producing dry cells of various types and marketing them more or less successfully.

Table II shows the imports into India of this commodity for the last few years. The figures have been taken from the Annual Statements of the Sea-Borne Trade of India, wherein they appear under the heading "Batteries". The quantity imported is not given in these statements. From the year 1937-38 separate figures for flash light batteries and batteries for other purposes are given. Most of the imports are from the United States of America. Next in importance are the imports from the British Empire, Germany, China and Japan. It will be seen from the Table II that India has been importing for the last few years dry cells worth about twenty to twenty-five lakhs of rupees per annum. Furthermore, most of the manufacturing firms in India have been importing almost all the raw materials for the manufacture of cells from Germany, but since the outbreak of the war, their attention has been diverted to other foreign countries. It is difficult to estimate the correct total value of the imports of the finished and semi-finished material, but it may safely be assumed that the figure is not less than ten lakhs of rupees per annum.

The development of this industry in India being of comparatively recent origin, the manufacturers are experiencing difficulties usually encountered in the early stages of an industry. Apart from the difficulties raised by the present war conditions it must be pointed out that the dependence of an industry on foreign semi-finished

* Designated as DU₃ size in the B. S. Specification.

materia's cannot be regarded as a healthy sign. It was with a view to developing indigenous resources of raw materials and assisting in other technical matters that a systematic study of dry cell manufacture was undertaken in the laboratories of the Government Test House. Experience gained during this work has enabled the authors to compile this bulletin in which have been collected all such technical data as are considered to be of value to dry cell manufacturers.

The import figures for the year 1937-38 and 1938-39 show that more than eighty per cent. of the total imports were of flash light cells. Accordingly, the subject dealt with in this bulletin is mostly concerned with these sizes, but other sizes may be similarly manufactured, there being little differences in the manufacturing processes. As the Indian manufacturers mostly use hand-operated machines, these have been dealt with in detail and a brief description of the other types of machines has also been included. The machines developed in these laboratories during the course of the work have also been described. References to original publications are cited so as to assist in stimulating scientific interest and encouraging original investigation.

TABLE II.
Imports of Batteries into India.

Year.	1930-31.	1931-32.	1932-33.	1933-34.	1934-35.	1935-36.	1936-37.	1937-38.	1938-39.
	Rs.	Rs.	Rs.	Rs.	Rs.	Rs.	Rs.	Rs.	Rs.
Total British Empire.	2,36,373	2,10,242	3,77,854	2,37,946	2,00,961	2,36,852	3,01,947	2,61,234	2,45,037
Germany ..	2,74,554	1,49,734	1,35,899	2,24,778	1,85,410	1,55,479	3,08,482	4,40,687	3,76,525
China (exclusive of Hongkong and Macao).	496	30,730	45,378	25,006	25,623	19,022	62,947	43,269	85,499
Japan ..	93	1,129	8,092	42,188	57,691	32,966	24,351	71,990	3,041
U. S. A. ..	7,46,730	7,15,880	7,15,265	8,16,438	10,29,696	16,04,514	18,68,885	16,92,813	14,35,278
Other foreign countries.	23,330	9,140	3,790	7,914	9,584	12,413	6,441	10,413	6,691
Grand Total..	12,81,576	11,16,855	12,86,278	13,54,269	15,08,965	20,61,246	25,73,063	25,20,325	21,52,071
Flashlight Batteries.	22,11,629	19,58,288
For other purposes.	3,08,796	1,93,783

THEORY.

It is proposed in this chapter to deal briefly with the theory of the electrochemical and secondary chemical reactions which take place in a dry cell. A careful perusal of the published literature shows that though the complete theory is not yet fully understood, the fundamental reactions and basic processes are fairly well known.

The major electro-chemical reactions take place between the zinc anode, the electrolyte containing ammonium chloride and the carbon-manganese dioxide composite cathode. The reaction between the zinc and the ammonium chloride may be shown as follows :—



The hydrogen liberated is oxidized by the manganese dioxide and this reaction may be represented by



Combining (1), (2) and (3), we get



The above may also be presented as ionic reactions as follows :—



or together as



The ammonium ion is a stable unit but the ammonium radical being unstable, it splits up into ammonia and hydrogen.



The reaction between zinc and ammonium chloride is considerably retarded by the generated hydrogen which accumulates on the zinc surface, thus giving rise to polarisation effects. It can however continue if the ammonium ion is removed by feeding electrons at the carbon electrode, which is accomplished by connecting zinc and carbon electrode through an outside circuit. The reaction is again retarded by hydrogen depositing on the carbon electrode. For the continuation of the reaction it is necessary to remove hydrogen, which is accomplished by oxidising it to water by the action of MnO_2 as expressed in equation (3) above. According to Daniels (28)* this reaction is not of the gas phase—solid surface type but ionic in character.

During discharge, as the generated hydrogen is being oxidized, the concentration of the hydroxyl ions increases continuously. This increases the pH of the electrolyte solution which in turn reduces the voltage of the cell, as the voltage depends upon the pH value. On exhaustive drain the reduction of voltage cannot entirely be accounted for by the pH of the solution; it also depends on various other factors, such as the formation of lower oxides of manganese.

It will be seen from the above discussion that MnO_2 only remove hydrogen but is not able to prevent the continuously increasing alkalinity due to accumulation of ammonia. This accumulation forms a serious obstacle in the efficient working of a cell. Ammonia that is generated is absorbed by the electrolyte solution and forms ammonium hydroxide.

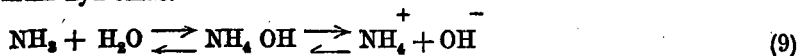

* Superior numbers refer to those in the Bibliography.

Ammonia also reacts with zinc chloride in the electrolyte solution and forms a double chloride according to the following equation :—

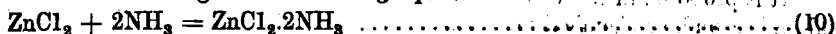

As the discharge proceeds and the cell begins to get exhausted, the electrolyte gets considerably impoverished of ammonium chloride and a third reaction becomes possible, viz :—

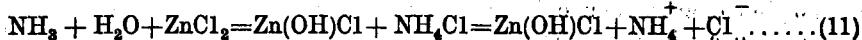

Precipitation of this basic zinc chloride is more harmful than the formation of $\text{ZnCl}_2 \cdot 2\text{NH}_3$.

Kaneko ⁽⁷⁴⁾ tried to determine the nature of the cell reactions by computing thermodynamically the E. M. F. which a given reaction would produce and compare this with the actual measured value. In addition to the depolarising action of MnO_2 , he also considered the depolarisation by oxygen. Kaneko considered the following reactions :—

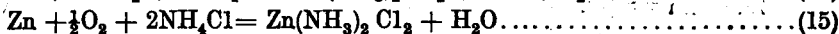
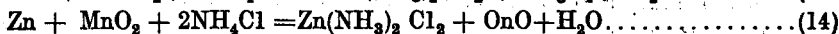
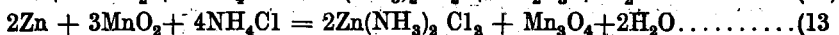
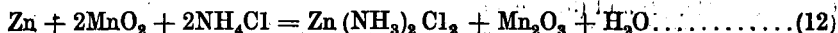

The calculated values of E. M. F. for the above reactions were 1.605 V, 1.367 V, 1.160 V, and 1.720 V respectively. Kaneko concluded that since the measured value was 1.63 V, the first reaction was most probably the one that takes place in the cell.

Thompson ⁽¹²⁵⁾ has carried out similar calculations which indicate that the high initial voltage of a cell is due to atmospheric oxygen absorbed on the dioxide. When this is used up, the voltage drops to the MnO_2 value. Oxygen absorbed on carbon does not depolarise hydrogen as well as that absorbed on manganese dioxide, and the formation of $\text{ZnCl}_2 \cdot 2\text{NH}_3$ is secondary and does not contribute to the energy of the cell.

It will be seen from the above discussion that for all practical purposes, the equation,

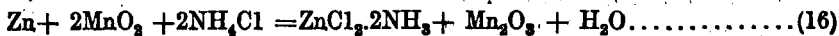

may be taken as representing the most important cell reaction.

MANUFACTURE.

As mentioned before, dry cells may be divided into two broad types, *viz.*, the packed type and the bag type of cells. It is not proposed to deal here with the merits and demerits of the two types, but since the packed type of cells are not manufactured in India, only a brief description of this type will be given, while the bag type will be discussed in fuller detail.

PACKED TYPE OF CELLS.

In Fig. 1 is shown the cross-section of this type of cell of the torch light size. Inside the outer wrapping of paper or jacket is a zinc can which serves as the anode of the cell and also as a container for the electrolyte and the cathode. The cathode and the anode are separated from each other by means of absorbent paper, which is moistened with the electrolyte and pasted to the zinc surface by means of the electrolyte paste. The bottom of the cathode is insulated from the can by means of paraffined cardboard disc. The cathode consists of a depolarising mixture and a carbon rod for conducting the current to the outside circuit. The depolarising mixture consists of manganese dioxide, graphite, soot or lampblack, and is moistened with the electrolyte solution. At the start the paper is pasted to the zinc can, the bottom insulating cardboard piece is inserted and then the carbon rod is placed centrally in the can and afterwards the depolarising mixture is pressed around it to get a firm contact between it and the mixture. During tamping care has to be taken to see that the zinc can is not broken due to excessive pressure. The depolarising mixture is then covered with a cardboard piece, washered, capped and then sealed.

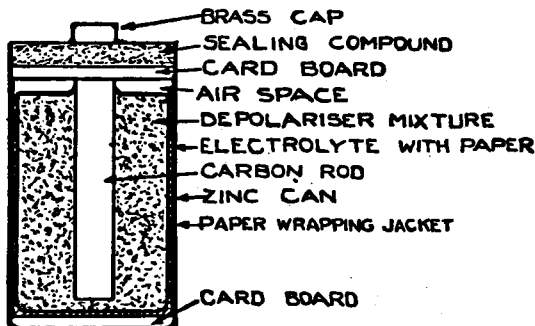

FIG. 1.—Packed Type Torch Light Cell.

BAG TYPE OF CELLS.

Fig. 2 shows the cross-section of the bag type of cells. The zinc can serves the same purpose as in the packed type. In these cells the depolarising mixture is not tamped directly into the zinc can, but is compressed in another machine, and a dolly is formed. The dolly is then wrapped in a piece of cloth and tied with twine and introduced along with the electrolyte into the zinc can. The details of the various components and operations are given below.

Zinc Can.—The zinc can may be of the soldered or of the drawn out type. It may be amalgamated with a weak solution of mercuric chloride or left as such. Amalgamation helps to increase the shelf life of the cell by retarding local action. A paraffined star-shaped cardboard is generally put at the bottom to insulate the dolly from zinc can. The corners of the star cardboard piece are turned upwards to prevent the dolly from moving sideways and touching the sides of the zinc can. Some manufacturers use plain cardboard pieces at the bottom and use strips on the

sides to insulate the dolly from the zinc can. Zinc cans are generally grooved at the top to make a seat for the top cardboard over which the sealing compound is poured.

Dolly.—The cathode in a dry cell is really a composite electrode made of the same constituents as used in the packed type of cell. The depolarising mixture is pressed in dolly presses (see Chapter on machinery). It may be pressed round the carbon electrode or the carbon electrode may be forced into it depending upon the design of the dolly press. Whatever may be the process of manufacture adopted, it is essential to see that there is good contact between the mixture and the carbon rod. Defective or loose contact gives rise to higher internal resistance of the cell. The mixture should be pressed sufficiently hard in the mould, so that when a dolly is taken out, it does not crumble at the edges during the subsequent process of wrapping and tying. Nor should the dolly be too compact, as it would then be difficult to remove it from the mould. Also this results in the porosity of the dolly, which is essential for the removal of gases generated during discharge, being poorer. The compactness of a dolly also depends upon the particle size distribution and the relative proportions of the various constituents of the depolarising mixture, *viz.*, manganese dioxide, graphite, soot, etc.

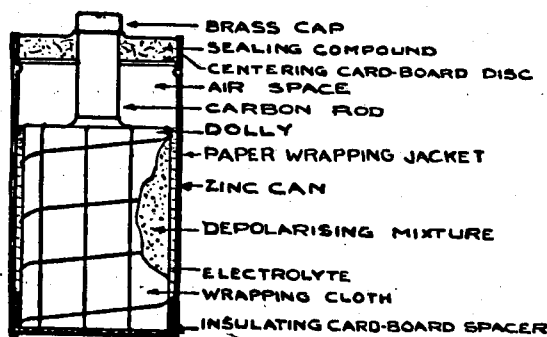

FIG. 2.—Bag Type Torch Light Cell

Ammonium chloride is added to the depolarising mixture to have a sufficient quantity of the conducting salt near the depolariser. Zinc chloride may also be added. The dry mixture is then moistened with the necessary amount of water or solution of ammonium or zinc chloride to make it sufficiently moist for pressing operations. If a mixture is too moist, a part of the mixture will stick to the mould or the rammer, and a good dolly will not be formed. If it is too dry, satisfactory pressing will not be possible, as the material will crumble when the dolly is handled during the subsequent operations. The correct amount of moistening liquid should, therefore, be added. This quantity will vary with the proportion of the various constituents, and will also depend upon the atmospheric humidity conditions to a certain extent. With a little experience, it is possible to judge the necessary amount of moistening liquid by feel only.

The depolarising mixture should be well mixed before it is pressed. Defective mixing gives rise to non-uniform and non-homogeneous dollies. Lack of homogeneity in a dolly could cause varying currents to flow at different points of the cell, resulting in uneven consumption of the zinc surface, which may lead to puncture and premature death of the cell. After dry mixing has been carried out the moistening solution should be added slowly while the mixing operation is in progress. Care should be

taken to see that the mixture becomes uniformly moist. During mixing operation grinding of the component constituents should not take place, as this would affect the characteristics of the cells.

After the mixing operation the mixture may be passed through a coarse sieve to break up the small lumps that may be formed during the mixing operation.

The mixture may be pressed in automatic, semi-automatic or hand-operated dolly presses. The dollies should be uniform in size, *i.e.*, height, diameter and weight. In order to maintain uniformity over long periods of time it is necessary to change the press mould as it gets worn out. The height of the dolly may be controlled by a suitable mechanism on the dolly press and also by controlling the quantity of the mixture added to the press. Variation in diameter and height of the dolly gives rise to variation in the output.

The variables that play an important part in the production of the dolly may thus be summarised as follows. All these variables need to be carefully controlled for uniformity of the production :—

- (1) Particle size of the depolarising constituents.
- (2) Relative proportions of the depolarising constituents.
- (3) Amount of moistening liquid.
- (4) Height of dolly.
- (5) Diameter of dolly.
- (6) Compactness or porosity of dolly.
- (7) Weight of dolly.

After the dollies are pressed they are removed in suitable trays to the wrapping and tying department. Here the dollies are wrapped in pieces of cloth of suitable size and then tied. The cloth should be wrapped firmly round the dolly, and then tied with twine, in a suitable manner so that the cloth is tied firmly round the mixture. During the tying operation care should be taken to see that the edges of the dolly are not spoiled and no loose threads left projecting either from the cloth or the twine as these are liable to cause internal short-circuits within the cell. It is also essential to see that no depolarising mixture particles are sticking on the protruded carbon electrodes of the dolly as these may pass to the zinc surface and start local action.

After the dollies are tied, the top cardboard centering pieces are placed in position and then the dollies are capped with brass caps in capping machines. During the capping operation care should be exercised to see that the carbon rod is not dislodged within the dolly. After the capping operation the brass caps may be dipped in hot paraffin, to prevent these from being corroded by electrolyte accidentally spilled during subsequent operations.

Electrolyte—The electrolyte is made of ammonium chloride, zinc chloride, calcium of magnesium chloride or both, water, and a gelatinizing substance such as flour or starch. At first a solution of the chemicals is made without starch or flour and then the gelatinizing substance is added slowly while the whole is thoroughly stirred. No lumps should remain in the electrolyte. A measured or a weighed quantity of the electrolyte is poured into the zinc can, and the dolly is then placed in the can. The quantity of electrolyte should be such that it just comes to the top edge of the dolly but does not touch the carbon rod. Contact between the carbon rod and zinc can through the electrolyte forms an internal cell of a different potential providing a path for internal discharge of the cell.

The electrolyte is usually gelatinized round the dolly *in situ*. This is carried out by heating the cell in a water bath to a temperature at which gelatinization takes place. This operation is generally known as cooking the cells. In this operation it is necessary to take care that air bubbles are not entrapped within the gelatinized mass. To avoid this, the cell should be heated gradually from the bottom upwards, so that air bubbles are pushed up through the ungelatinized mass while the gelatinization proceeds. Furthermore, the dollies should be soaked in liquid electrolyte free from starch, so that the cloth gets thoroughly wetted and air bubbles excluded. This wetting of the dolly cloth should be carried out with care, as during this process the dolly itself takes up a certain amount of the electrolyte. If the dolly gets saturated, the whole of the voids necessary for the removal of gases generated during discharge would be filled up with the liquid. This may cause the bulging of the cells. The rate of electrolyte absorption by the dolly would depend upon its initial porosity and on the time which passes between pressing and wetting operations.

After the cooking operation the cells may preferably be quenched in cold water in order to cut short the unavoidable injurious effects that heat has on the cell. The cells are now ready for sealing. In order to obtain a condition of equilibrium within the cell, it is better to leave the cells open for about twenty-four hours before sealing.

Though the process of cooking is used by most manufacturers, it is not absolutely essential and can be dispensed with by using pregelatinized starch or by using a higher concentration of the electrolyte salts and the gelatinizing materials^(123, 113). The choice between the cooking and non-cooking methods of gelatinization depends on their relative cost. The cost of heating the cells in the first method has to be balanced against the higher price paid either for the pregelatinized starch or for the extra amount of electrolyte salts and the gelatinizing material. Also the use of a higher concentration of the electrolyte salts may not always be advisable.

Sealing.—Shellac composition or bituminous compounds are generally used for sealing. The compound is heated until sufficiently fluid to be poured on the top card board washer of the cell. When the compound gets solidified again, a pointed flame may be played on the surface of the seal to get a uniform even surface and to obtain a perfect seal round the zinc can and the carbon rod. With shellac compound the temperature should be maintained nearly constant at about 100°C, since higher temperatures bring about certain undesirable chemical changes.

In place of the sealing compound, a fibrous sealing board is used by some manufacturers. This is simply pressed on the top, and the edges of the can slightly turned over in a simple machine.

After the cells are sealed they are wrapped in paper or placed in cartons with the manufacturers trade label which is often perforated with a code mark to indicate the date of manufacture.

If cells are to be used for making batteries, brass strips are soldered to make connection between the brass cap of one cell and the zinc can of the next. The cells are then insulated from each other by card board strips and then placed in position in a box, the intervening space being filled with bituminous or shellac sealing compound.

MATERIALS

It is important that each of the materials used in the manufacture of cells be carefully selected. In many cases it is sufficient to examine the material chemically and physically to determine its suitability, but in others the only dependable criterion is the trial in actual cells. In this chapter it is proposed to discuss the characteristics of the various raw materials and the various criteria by which they may be judged regarding their suitability.

MANGANESE DIOXIDE ORE.

As discussed in the Chapter on Theory, manganese dioxide functions as an active oxidizing agent in eliminating hydrogen which is produced as a result of electrochemical reaction between zinc and ammonium chloride. The more effectively hydrogen is removed the higher will be the output voltage of the cell and the better the depolarizing activity of the manganese oxide ore in the depolarizing mixture.

Effectiveness of an ore, however, cannot be judged from its manganese dioxide content, for experience shows that ores containing as low as 70 per cent. MnO_2 may be better depolarizers than ores containing as high as 90 per cent. or more of MnO_2 . Depolarizing efficiency of an ore depends entirely on its ability to make its oxygen available for oxidation of hydrogen, which ability appears to be governed in a complex manner not only by the chemical constitution but also to a large extent by the physical structure of the ore*. This conclusion is based on a study carried out with a view to establishing any correlations that might exist between the chemical and physical constitution of an ore and its efficiency in a depolarizer mixture. The details of this study will form the subject matter of a separate paper. It may, however, be stated that, so far as the efficacy of water of hydration of an ore is concerned, the results show no definite empirical correlation except that in a general way it could be stated that the ores containing rather high percentages of water of hydration prove to be generally more effective as compared to those that are deficient in this respect.

Manganese dioxide occurs in nature mainly as polianite, pyrolusite, psilomelane, and wad. Polianite is hard and anhydrous. Chemically it is similar to pyrolusite but it has a different crystallographic form⁽¹¹⁾. Pyrolusite is usually slightly hydrated, to the extent of about two per cent. Psilomelane may be represented as $MnO_2 \cdot (Mn.K_2.Ba) \cdot nH_2O$, while wad is an impure mixture of manganese oxides and includes bog manganese. The last mentioned variety is usually somewhat soft and light as compared with the other varieties. Besides, MnO_2 occurs in combination with other minerals such as Skemmatite ($3MnO_2 \cdot 2Fe_2O_3 \cdot 6H_2O$), Hausmannite ($MnO_2 \cdot 2MnO$) etc. Minerals of the MnO_2 type on the other hand contain as impurities several other minerals such as SiO_2 , Fe_2O_3 etc. and varying proportions of water of hydration. It is not surprising, therefore, that their behaviour as depolarizer should vary as widely as it does. But it has been found that minerals rich in psilomelane are often, if not always, good depolarizers.†

India is one of the leading countries producing and exporting manganese ores. A full account of the Indian ores is given in the publications of the Geological Survey of India⁽³⁵⁾. Though India occupies a leading position in this trade, Indian ores have not so far been extensively used for dry cell manufacture. Brown⁽⁸⁾ has stated that Indian ores have been rejected for dry cell manufacture owing to their comparatively large iron content. Those who rejected the ores did so perhaps on the basis of the chemical analysis only and thus failed to understand the importance of the physical structure of the ore. Ores of very nearly the same composition often give widely different results in a dry cell.

* Unpublished work by the authors.

† Unpublished work by P. K. Ghosh and the authors.

Rejecting ores on the basis of high iron content has been shown to be unjustifiable, since it has been noticed that as iron oxide in the ore instead of being harmful has a beneficial effect on the characteristics of cells (12^b). Artificial addition of Fe₂O₃ to the ore on the other hand has not been found to be beneficial (Table III). Further study of this aspect is however necessary if it is proposed to improve the poor ores by suitably incorporating iron oxide in them.

TABLE III.
Effect of Adding Fe₂O₃ to Depolarising Mixture.

No.	Experiment.	No. of Cells Tested.	Initial Voltage Volts.	Internal Resistance ohms.	Per cent. Polarisation.	W.H. capacity.
1	Control experiment A	3	1.64	0.26	17.0	3.42
2	Substitution of Synthetic Fe ₂ O ₃ to the extent of 2.5 per cent. for the Ore.	3	1.61	0.33	15.4	3.12
3	Control experiment B	3	1.58	0.22	20.8	3.34
4	Substitution of natural Fe ₂ O ₃ to the extent of 4 per cent. for the Ore.	3	1.59	0.26	21.4	2.80

Some twenty samples of Indian ores from various mining districts were examined for their efficiency as dry cell depolarisers and compared with foreign ores. Of these about half a dozen have proved to be quite satisfactory. In Table IV are summarised the results obtained with these successful ores with and without the admixture of artificial MnO₂. It will be seen that addition of artificial MnO₂ to the extent of ten per cent. in all these cases is necessary to obtain cell outputs appreciably in excess of the specification requirements of three watt hours.

TABLE IV.
Electrical Characteristics of Cells. (1½" diam. × 2⅜" ht. Prepared from suitable Indian Ores.

No.	Name of the Ore.	Obtained from	Without Art. MnO ₂				With 10% Art. MnO ₂			
			Voltage. Volts.	Internal Resistance ohms.	Per cent. Polarisation.	W. H. output.	Voltage. Volts.	Internal Resistance ohms.	Per cent. Polarisation.	W. H. output.
1	Keonjhar ..	Messrs. Bird & Co., Mining Deptt. Chartered Bank Buildings, Calcutta.	1.56	0.27	19.9	2.99	1.56	0.24	18.8	3.64
2	C. P. Grade A ..	Messrs. The Central Provinces Manganese Ore Co. Ltd., Nagpur. C. P.	1.58	0.26	20.8	2.19	1.58	0.23	18.1	3.43
3	C. P. Grade B ..	Ditto ..	1.53	0.25	18.6	2.59	1.54	0.22	17.4	3.36
4	Shivrajpur No. 6 ..	The Shivrajpur Syndicate Ltd., Agents, Messrs. Killick Nixon & Co. Ltd., Killick Building, Home Street, Bombay.	1.53	0.27	18.2	3.02	1.56	0.29	17.9	3.32
5	Mysore No. 1 ..	Messrs. Manickavelu Mudaliar Ltd., Palace Road, Bangalore.	1.55	0.22	18.5	2.47	1.58	0.23	17.9	3.35
6	Keshapore Grade C	The Keshapur Mining Co. Keshapur Mines P. O. Chikjajur, Chitaldroog District, Mysore State.	1.56	0.27	20.4	2.55	1.59	0.24	18.1	3.93
7	Keshapore Grade D	Ditto ..	1.57	0.27	20.1	2.37	1.60	0.25	18.5	3.25
8	Karnatak No. 1 ..	Messrs. Karnatak Chemical Works, Gadag, Bombay, Presidency.	1.57	0.25	20.0	2.54	1.59	0.26	17.1	3.46

Apart from the geological formation of the ore, the fineness to which it is ground for use in dry cells, and also the proportioning of the ore with graphite have been found to influence the depolarising capacity of the ore. This capacity may be taken as more or less proportional to the surface of the particles making up the cell. It would, therefore, be expected, that an ore having a high degree of fineness would function far more efficiently than an ore which is coarsely ground. However, practical experience shows that this is true only upto a certain limit, beyond which the increased fineness leads to other disturbing factors as discussed below.

In order to make the depolarising mixture efficiently conducting it is necessary that every particle of manganese dioxide should be in good contact with graphite particles. If very fine powder is used, it becomes necessary, therefore, to increase the amount of graphite which tends to lower the total depolarising capacity of the cell by virtue of a proportionate reduction of the active material. In modern torch-light cells the ratio of manganese dioxide to graphite ordinarily varies between 4 : 1 and 5 : 1.

Another difficulty that arises from the use of very fine powder is the resulting increased compactness of the dolly, which leads to decreased porosity and hence hindrance to the free flow of electrolyte and the products of reactions such as ammonia and hydrogen. Thus increased polarisation results. This may to some extent be overcome by the incorporation of acetylene soot and lamp black which help to increase the porosity of the depolariser mixture.

These considerations show that a compromise has to be made between the fineness of manganese ore and the amount of graphite, lamp black and acetylene soot. This will not only differ from ore to ore but will also depend upon the use to which the cell is to be put, which determines the frequency and intensity of current drain. Generally speaking, it is considered good practice to use an ore passing 40 mesh B. S. sieve and having not more than 10 to 15 per cent. fines below 100 mesh.

The output of cells prepared by using natural ores alone is not always high enough to satisfy existing specifications. By introducing various constituents in the depolarising mixture, it is possible to obtain higher outputs. Special preparations of manganese dioxides have been patented by numerous workers for use in dry cells. Admixture with artificial varieties of the oxides is resorted to now-a-days by most dry cell manufacturers in proportions varying between five and ten per cent. of the natural ores. Artificial manganese dioxide is a highly active oxidising agent and, if used alone, will give rise to premature deterioration of the cell on storage, by local action. Moreover, the cost of this material is several times that of the natural ore, and economic considerations also prevent its use in higher percentage than those stated above.

It is not always possible to obtain natural ore of the same quality in every consignment, and this leads to variations in the output capacity of the cells. To overcome this difficulty and to obtain uniform output characteristics, use of artificial manganese becomes doubly necessary, since by adjusting its percentage uniform quality may be maintained.

Artificial manganese dioxide is prepared chemically as well as electrolytically. It is not possible to refer in this paper to the various methods of its manufacture. If necessary, reference should be made to the various patents and original publications on this subject.

Efforts have also been made to improve the ores by special treatment. It is not exactly known what changes take place in the ore by such treatments which increase its depolarising capacity. X-ray⁽⁷⁶⁾ examination of the natural ore and the artificial MnO_2 reveal that they have different crystal structure.

The mechanism by which the artificial MnO_2 improves the characteristics of a cell is not yet exactly understood. The results of the authors work* show that for a particular type of ore the effect is of an additive character, but in the case of other types the effect seems to be of catalytic nature. Experiments carried out with one ore using various percentages of the artificial MnO_2 gave results of more or less additive nature, which are shown in Table V and Fig. 3. It will be seen that the addition of the artificial variety not only increased the output but also the voltage. The catalytic nature of the effect of artificial MnO_2 is brought out by the fact, that its addition to various ores in the same proportion results in varying degrees of improvement (See Table IV). The importance of selecting ores showing the maximum improvement for the purpose of manufacturing dry cells is thus apparent.

TABLE V.

Effect of adding Artificial MnO_2 to Natural Ore.

No.	Experiment.	No. of Cells tested.	Initial Voltage. Volts.	Internal Resistance Ohms.	Per cent. Polarisation.	W. H. capacity.
1	Natural Ore alone	12	1.52	0.24	18.6	1.97
2	Substitution of art. MnO_2 to the extent of 5 per cent.	3	1.54	0.27	18.6	2.46
3	Substitution of art. MnO_2 to the extent of 10 per cent.	8	1.55	0.24	18.1	3.09
4	Substitution of art. MnO_2 to the extent of 20 per cent.	3	1.56	0.24	18.0	3.56
5	Substitution of art. MnO_2 to the extent of 30 per cent.	3	1.58	0.27	16.9	5.52

Before the war Indian firms had been using treated Caucasian, Java and African ores. Untreated Indian ores from half a dozen different mining centres can be used (See Table IV) to give cells of good quality. In this matter it is also necessary that Indian mining concerns should grade and market the ores suitable for this industry, and it is certain that such graded ores will fetch higher prices to compensate for the

*Unpublished work by the authors.

extra labour involved in the process. Further the dry cell manufacturers will have to suitably treat the ore, if they wish to increase its activity.

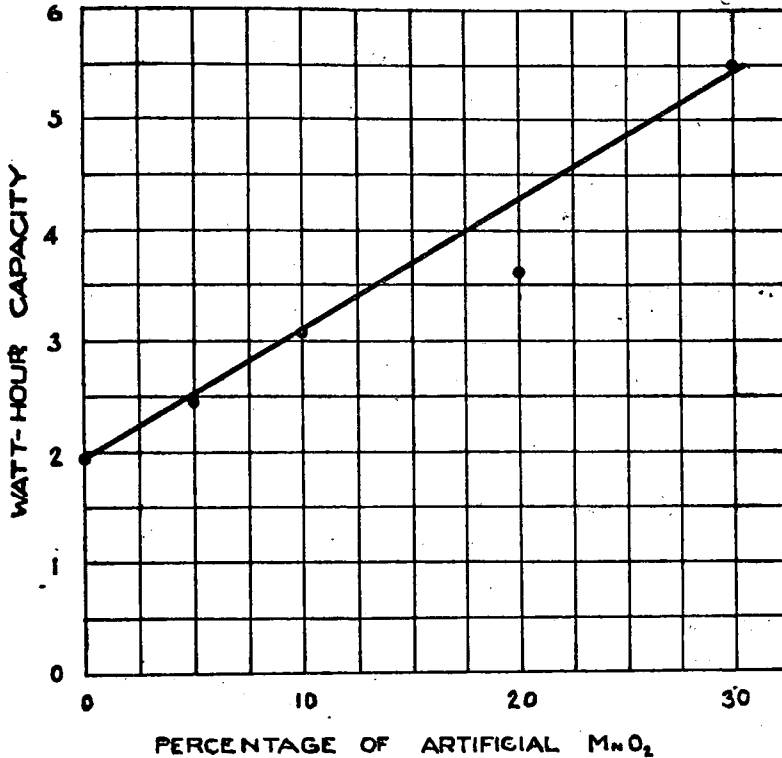

FIG 3.

The authors have worked out a process for chemically treating natural ores which increase the energy output of cells by as much as fifty per cent. The cost of the process is such that it is approximately forty per cent. cheaper to use treated ores than to admix artificial manganese dioxide to the natural ores. It is not possible to enter into the details of this process here because it forms a subject matter of a patent which is now pending.

Artificial manganese dioxide is also imported into this country. As it is used in small percentages, the requirements of the industry for this material are not great. The dry cell manufacturers may themselves undertake the manufacture of this variety. Considerable research work is however necessary before a suitable quality of this material can be obtained.

GRAPHITE.

Manganese dioxide is a poor conductor of electricity. To obtain a low resistance for the depolarising mass it is necessary to mix some good conducting material with the manganese dioxide. It is also necessary that such a substance should be electrochemically inactive. Both the above conditions are satisfied by carbonaceous substances. In the early days of the industry powdered carbon, which amounted to about fifty per cent. of the total depolarizing mass and consisted of substances

such as coke, retort carbon, petroleum coke, etc., was used. All these materials are cheaper than natural graphite which however, is a better conductor of electricity and can be used in much smaller quantities.

Graphite occurs in small quantities in various parts of India :—in the Vizagapatam hill tracts, in some of the Orissa Feudatory States, in the Godavari district of the Madras Presidency, in Travancore and in a few other places. Indian graphite has not yet been utilized by dry cell manufacturers on any extensive scale. On the other hand Ceylon graphite which is well known for its quality has been extensively used in this industry.

Artificial graphite is also being employed now-a-days in dry cell manufacture particularly in America. It is either admixed in certain percentages with natural graphite or wholly replaces the natural variety. One advantage of artificial graphite is that its quality can be consistently maintained.

Graphite for dry cells should be free from harmful metallic impurities, such as iron, copper, lead, etc. The chief foreign substances associated with graphite are mica, clay, sand and iron oxide and sulphide. The ash content should preferably not exceed ten per cent.

SOOT.

Acetylene soot, which is a very bulky substance, is sometimes added to the depolarising mixture in small quantities for increasing its porosity. Generally speaking, the total quantity of soot does not exceed five per cent. by weight of the total carbon content. The usefulness of soot is considerably reduced if it is packed compressed for easy transportation and handling, since once the fluffy character is lost it cannot be subsequently regained to the same degree.

LAMPBLACK.

This is also sometimes added to the depolarising mixture in small quantities. According to Hermann⁽⁵²⁾ the effectiveness of lampblack in the dry cell is not due to its adsorbed oxygen content, its porosity, or to special catalytic properties. The most highly porous carbons are not the most effective in dry cells. When graphite (without lampblack) is pulverized for hours it becomes equivalent to a mixture of graphite and lampblack. X-ray and electron interference experiments show that the crystal structures of graphite and lampblack are identical but that lampblack has a much rougher surface. Manganese ore is not effective as a depolariser unless it has direct contact with the carbon electrode. The finely divided rough surfaced lampblack assists in establishing intimate contact between the relatively larger particles of manganese ore, the graphite particles and the electrode.

CARBON RODS.

Carbon rods should be perfectly straight with the top and bottom surfaces cut square to the axis. The rods should have no soft cores, fissures or borken edges, and should be dense and have good mechanical strength. The ash should not exceed five per cent. and should contain as little of metallic impurities as possible. The resistance should also be as low as possible. The rods generally have longitudinal grooves on the surface which assist in keying them fast with the depolarising mixture.

Carbon rods for batteries are not manufactured in India except by one dry cell manufacturing firm which claim to make their own requirement of rods. All other dry cells manufacturers in India have at present to depend for their supply of carbon rods on foreign imports.

These rods are manufactured from carbonaceous materials such as coke or retort carbon. Powdered coke is heated to drive off the volatile matter and then mixed with a binding material like pitch or tar. The mix is moulded or extruded to the required shape. The rods are then baked to drive off the volatile matter

from the binding material. The grain size, ash, volatile contents of the constituents and baking temperature affect the quality of the rods. Measurement of specific resistance of good quality rods for torch light cells have values varying between 0.0045 and 0.0065 ohms per cu. cm. Transverse beam test on 8mm. diameter rods of various manufacturers on a two inch span gave values for fibre stress varying between 5200 lbs. and 8000 lbs. per square inch.

Carbon rods are generally paraffined to avoid the creeping of electrolyte to the brass caps. Paraffining should be done lightly so as not to clog the pores of the electrodes and obstruct the passage of gas generated during discharge which accumulate at the top of the dolly. Obstruction of the free passage of gas would sometimes result in the bulging of the zinc cans or top seals.

ZINC.

Zinc as used for dry cells serves the double purpose of functioning as the anode of the cell and also as the container for the cathode and the electrolyte. The first function requires it to be of high purity, while the second demands sufficient mechanical strength to serve as the container upto the end of the useful life of the cell.

The zinc container of a dry cell should resist the corrosive action of the electrolyte as efficiently as possible, and during discharge of the cell its consumption should be uniform and proportional to the useful current delivered by it, *i.e.*, about 1.22 gms. per ampere hour. Actually due to local action in a cell more than this quantity is consumed. In a torch light cell of $1\frac{1}{4}$ " diameter by $2\frac{1}{4}$ " height the capacity obtained is about four ampere hours, which requires about 4.88 gms. of zinc. But in actual practice the zinc can for this size weighs between seventeen and twenty grams. This extra quantity is necessary as the zinc has to serve as a container upto the end of the useful life of a cell.

Local corrosion of the zinc sheet may be due to several causes such as impurities in the metal, in the electrolyte or in the depolarising mixture. These impurities settle on the zinc during discharge and produce local cells which consume the zinc sheet. Local corrosion may also be due to uneven distribution of the electrolyte, variation in the resistance of the depolarising mixture or deposition of grease or factory dirt on the zinc surface which factors alone or combined may produce unequal distribution of current and consequently cause local corrosion. Unequal corrosion results in premature pitting of the zinc sheet through which electrolyte may leak out and cause short-circuiting among individual cells of a battery.

Amalgamation of zinc cans is sometimes resorted to in order to increase the resistance of zinc to corrosion. It makes the surface of zinc smooth and uniform. A smooth surface resists corrosion better than a rough one. Amalgamation also slightly increases the potential of the zinc electrode.

Rolled zinc for dry cells can be obtained in sheet or ribbon form. Zinc sheets are sold in the market with a special gauge number belonging to this particular industry⁽⁵³⁾. For torch light cells generally gauge Nos. 6 to 8 are used. Cells intended for long life should have thicker sheet than those intended to be used immediately. Gauge No. 6 and No. 10 have a thickness of 0.012 in. and 0.020 in. respectively, and the intermediate numbers vary in thickness from the neighbouring ones by 0.002 inches.

The usual impurities occurring in zinc are lead, cadmium, copper, iron, arsenic, antimony and tin. These impurities should be kept as low as possible. Lead upto about 1.5 per cent. is found helpful in rolling operation and is therefore retained in some cases. Table VI gives the analyses of zinc sheet and ribbon and of sheet from actual cells of reputed makes. Seamless cans appear to have a lower percentage of lead than the soldered type. The presence of mercury shows that the cans had been amalgamated.

TABLE VI.
Analyses of Zinc Sheet, figures in per cent.

No.	Contents.	Zinc sheet from reputed makes of cells.						Suitable zinc sheet for dry cell manufacture.				
		Soldered cans.				Seamless cans		Belgian.		American.		Ger- man.
		1	2	3	4	5	6	7	8	9	10	11
1	Tin	0.83	trace	0.006	0.02	Nil	trace	Nil	Nil	Nil	Nil	Nil
2	Iron	0.01	0.02	0.011	0.02	0.01	0.01	0.022	0.01	0.04	0.03	0.02
3	Lead	0.82	1.09	1.68	1.07	0.08	0.17	1.23	1.20	0.34	0.31	0.68
4	Copper	0.01	trace	0.008	trace	0.005	0.003	0.004	trace	trace	trace	0.01
5	Cadmium	0.10	trace	trace	0.01	Nil	0.05	trace	trace	0.02	0.01	trace
6	Mercury	0.13	0.11	0.05	trace	0.06	0.02
7	Arsenic	trace	trace	trace	trace
8	Zinc by difference	98.40	98.78	98.24	98.79	99.84	99.75	98.74	98.79	99.60	99.65	99.29

No. 11—Ribbons.

BRASS TERMINALS.

For torch light cells brass caps are put on the carbon rods for making electrical connections with the outside discharge circuits. On bigger cells screwed brass terminals, or fahnstock terminals are fixed to the carbon rods, and wires are soldered to the zinc cans. In dry cell batteries brass strips are used for interconnecting the cells. S.W.G. No. 27 or 28 gauge brass sheet is generally employed for making the brass caps and the connecting strips.

SOLDER.

The solder used for soldering the zinc cans and for soldering the brass terminal strips to the cells is an alloy usually composed of tin and lead, their proportions being the controlling factor in the selection of solders for specific purposes. A high tin content solder, though ductile, is crystalline, hard and easy to fracture, while a high lead content solder has lower tensile strength but greater ductility. The mixtures for dry cells work may have composition varying between forty and sixty per cent. of either of the constituents. Practical experience is the best guide in the proper selection of solder.

ELECTROLYTE.

The electrolyte paste in a dry cell consists mainly of ammonium chloride, zinc chloride and starch. Small quantities of calcium chloride, magnesium chloride, and mercuric chloride are also sometimes added. All these salts should be free from harmful impurities. The exact proportions of the various salts, starch and water are a matter of practical experience. The quantities of the ammonium chloride and other salts should be ample so as to last to the end of the useful life of a cell.

Ammonium Chloride.

Ammonium chloride is the main salt which takes part in the electro-chemical reactions in a dry cell. It occupies as important a place in the electrolyte as the manganese dioxide in the depolarising mixture. It should be free from impurities, especially copper and iron, as these would settle on the zinc and form harmful local galvanic cells. It has a great corrosive effect on the zinc. The usual white powdered commercial grade is generally used and it should contain less than one per cent. of ash or non-volatile matter and an equally small percentage of moisture. The total quantity of ammonium chloride required may be divided into two portions, one being added to the depolarising mass and the other going into the electrolyte solution. The quantity added to the depolarising mass is generally added in dry condition and may vary from ten to fifteen per cent. of the total weight of the dolly. The electrolyte paste contains about twenty per cent. of ammonium chloride.

Zinc Chloride.

Zinc chloride, which is added to resist the corrosive action of the ammonium chloride, occupies the next most important place in the electrolyte. The proportions of these two salts should be well balanced. During the discharge of a cell, zinc chloride is constantly generated and therefore the quantity of zinc chloride continuously increases as the discharge proceeds. If the initial quantity of zinc chloride is considerable, a stage may be reached during the early stages of discharge when a sufficient quantity of this salt may be present to form the double chlorides of zinc and ammonia. These crystals precipitate out from the gelatinous electrolyte and settle on the zinc surface or in the pores of the dolly and thus reduce the available surface necessary for the electro-chemical process to continue effectively. In the formation of double chlorides a certain amount of water of crystallisation is involved, which reduces the quantity of water in the electrolyte. The subsequent drying of the electrolyte increases the internal resistance of the cell and decreases its output capacity. To prevent the premature precipitation of the double chloride it is necessary to have an excess of ammonium chloride in the electrolyte, but too high a concentration of this salt cannot be used due to its corrosive properties. As a result of these considerations it is considered advisable that the proportion of zinc chloride in the electrolyte paste should be kept between the limits of seven to ten per cent.

Calcium Chloride.

This salt is recommended for use in tropical countries in small proportions on account of its hygroscopic nature and water retaining properties. If used in large quantities, it may separate out as a complex salt and interfere with the smooth functioning of the cell. It may be added to the extent of about two to three per cent. to the electrolyte paste.

Magnesium Chloride.

This salt may be employed for the same purpose as calcium chloride.

Mercuric Chloride.

This salt is added to the electrolyte in small quantities (about a quarter per cent.) to effect amalgamation of the zinc cans. It also prevents the growth of moulds and micro-organisms in the flour or starch that is used for gelatinization.

Gelatinizing Substances.

A number of substances like plaster of paris, agar-agar, gum-tragacanth, wheat flour, corn flour, dextrin, starch, etc., have been used in the paste for making the liquid electrolyte unspillable. Of these, flours and starches are the most commonly used ones. Wheat or corn flour, wheat, maize or potato starch may all be used individually or in admixture. The quantity of starch to be added to the liquid electrolyte should be carefully determined, as too low or too high a percentage of it is not beneficial for shelf life, though initial characteristics may not show any noticeable effect. The quantity of starch may vary between ten and fifteen per cent. The gelatinizing temperature of starch is considerably reduced in the presence of the electrolyte salts.

It will be seen from Table VII that starch gives better results than flour, due perhaps to its perfect gelatinizing and freedom from other ingredients generally found in flour. The results show lowering in the internal resistance and increase in the voltage and output capacity. The same table also shows the comparative results between a cold working pregelatinized starch and an ordinary starch gelatinized by the cooking operation. The results do not show any marked difference between these two varieties. Cold working starch has the advantage that it does away with the cooking operation. Selection of either variety will depend upon the actual cost price of each and the extra cost involved in the cooking operation.

DefS&IRDelhi

TABLE VII.

Effect of Using Different Gelatinizing Substances.

No.	Experiment.	No. of Cells Tested.	Initial Voltage Volts.	Internal Resistance ohms.	Percent. polarisation.	W. H. capacity.
1	Cells with maids (wheat flour).	3	1.64	0.26	17.0	3.42
2	Cells with maize starch	3	1.67	0.22	19.5	3.79
3	Cells with pregelatinized cold working starch.	3	1.66	0.24	18.5	3.75

WATER.

Water used for making the electrolyte solution should preferably be distilled. Tap water often contains salts which may be harmful to the cell. These may form local cells on the zinc electrode or may precipitate out and clog the pores of the dolly. To prevent these effects a little extra cost for distilled water is well worth while.

SEALING COMPOUND.

In order to secure the components of the cell in position and to prevent desiccation, it is necessary to apply a sealing compound on top of the assembled cell. The compound may be made of shellac, rosin and suitable fillers or may be of the bituminous type. A fibrous material is sometimes used for sealing. The selection of either is a matter of availability and cheapness but in tropical countries like India due consideration must be given to the higher temperatures which have to be withstood during transportation and storage.

WRAPPING CLOTH.

In the bag type of cells the dollies are tied in a loosely woven piece of cloth, which allows free passage to the liquid electrolyte but prevents dislodging of depolariser material and its settling on the zinc surface. The cloth used should be bleached and unsized and must be absorbent, that is it should have good wetting properties. Ordinary light muslin cloth used in India for pugries, etc., has been found quite suitable. The following approximate specifications may help in the choice of a suitable material:—

(1) Weight per sq. yard of cotton cloth 2.3 to 2.5 ozs.

(2) Average number of threads per inch—

Warp	55—70
Weft	50—60

TWINE.

The twine used for tying the dolly should not be very fine nor very thick. While tying care should be taken to see that the dolly is not cut by the threads.

CARDBOARD.

The cardboard used for making the bottom insulating washers and the top centering washers should be free from conducting materials. To prevent absorption of moisture from the electrolyte it is paraffined before being used in cells. Generally cardboard having a thickness of $1/32$ " is considered suitable for torch light cells.

MACHINERY.

During the early days of the industry, dry cells and batteries were manufactured mainly by manual labour and hand-operated machines. With the new fields of application for these cells, such as in wireless, many kinds of instruments, small machines, etc., the production has now increased to enormous figures. Attempts made during the past few years to develop machines for mass production have resulted in the successful manufacture of semi and fully automatic machines for almost all the operations involved in the manufacture.

SEMI AND FULLY AUTOMATIC MACHINES.

The introduction of semi and fully automatic machines has removed the sources of trouble arising out of the inherent non-uniformity of manual operations. The machines work in an economical and reliable manner, once they are carefully adjusted, which requires skilled and expert attention. A few points regarding these machines are briefly dealt with below.

Economical Working.—The automatic machines are always costly and are not economical unless the output is about ten thousand pieces or more per day of eight hours working. This output figure varies to a certain extent inversely with the labour cost prevalent in the particular area in which the factory is located.

Attention.—These machines require systematic and constant attention and care. If neglected the successful operation is hampered due to the corrosive action of the depolarising mixture and the electrolyte solutions. Care is generally taken in the proper selection of the materials for these machines to resist these corrosive effects. The corroded parts of the machines pass into the cell compounds and form local galvanic couples within the cells which are harmful. The rapid corrosion of the machine parts results in a high percentage of depreciation figure for the machines.

Flexibility.—Automatic machines are generally designed for one particular size of cells, though in certain cases they may be adopted to different sizes by changing certain parts. This operation stops the production for a considerable time. These machines generally work best if always fed with materials in definite conditions as regards moisture content, density, bulkiness and rate of feeding. These conditions change with the different raw materials and are therefore to be predetermined for successful operation. An important consideration in favour of these machines is their availability at all times thus dispensing with the necessity of maintaining skilled labour, all through the year irrespective of the demands.

Quality of Production.—It is possible to ensure greater uniformity and hence improvement of quality with the use of these machines.

Cost of Production.—The use of machines in place of hand operation has been helpful in lowering the selling price making it thereby more difficult for the small factories to successfully compete with the larger ones.

The above points will be helpful in forming an idea about the suitability of these machines which depends more or less upon their high uniform output capacity weighed against their high initial cost and the consequent capital charges, maintenance charges and non-flexibility.

HAND PRODUCTION.

The initial investment and the subsequent interest and depreciation charges in this method are much lower than those with the automatic machine production. There is a greater flexibility in this method as most of the hand operated machines can be quickly adopted for the production of various sizes of cells. There is also a similar flexibility with the labour. This greater flexibility with the hand

production enables changes for the improvement of the quality to be easily carried out. The disadvantages in this method are the low figure of production and the comparatively high figure of pay bills.

Due consideration to the above points should be given when choosing the method of manufacture, i.e., whether all the operations or part of them will be carried out by hand operated machines, by manual labour, or by semi or fully automatic machines. It may perhaps be found advantageous to strike a sort of compromise between the various methods of manufacture.

The whole process of manufacture may be divided into various sections and a short description of the different machines working in each of these is given below.

ZINC CUP MANUFACTURE.

Two methods for the manufacture of zinc cups are commonly used—the soldering and the drawing method. The latter is only applicable to the manufacture of small size cups such as those required for the flashlight cells. Zinc cups should be strong, leakproof, smooth and of uniform shape and size. If the shape is not uniform, the zinc would be unequally consumed during the discharge and the life of the cell would be shortened due to pitting of the cups.

SOLDERING METHOD.

Guillotine or cutting shears.—Zinc sheets are generally sold in pieces of 3' by 7' or in rolls cut to proper width. Sheets are cut into long strips of proper width by means of a guillotine, steel shears or a multiple knife sheet cutter. The latter machine is suitable for large scale manufacture only. The strips or rolls are then cut again to the required length for the manufacture of the particular sizes of cups.

Rolling Machine.—The cut pieces are bent into necessary forms, on suitable formers ready for the soldering operation. For round cups the rolling may be done on a rolling machine. These machines are cheap and would form a good labour

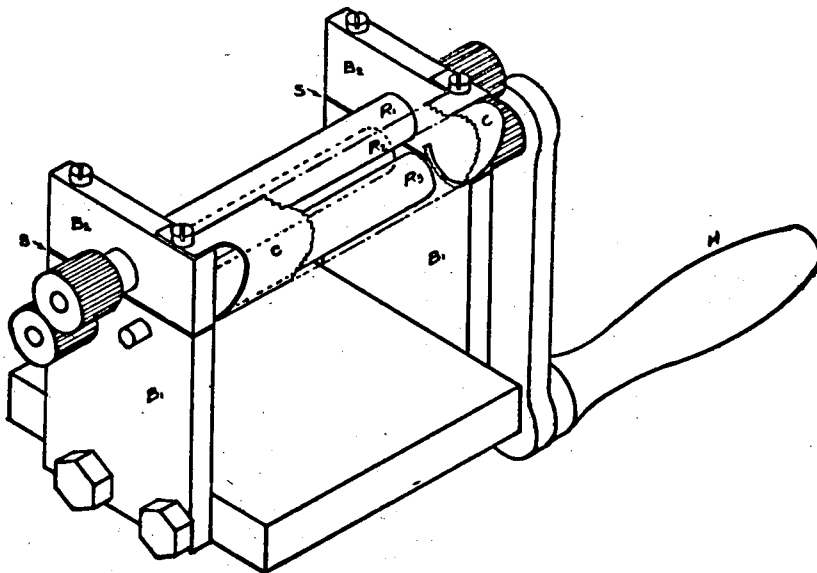

FIG 4.—Rolling Machine.

saving device. They may be worked either by hand or by an electric motor. Combination automatic machines combining the operations of cutting and rolling are also available. Fig. 4 shows the rolling machine designed by the authors. The rollers which are connected through gears are rotated by the handle H. A strip fed between rollers R_1 and R_2 moves forward, bends round R_1 and comes to the top where it is held by the stop C. The rollers R_2 and R_3 are fixed in position in the plate B_1 while R_1 is fixed in B_2 . The distance between B_1 and B_2 is adjusted by putting a spacer piece S cut from the sheet to be rolled. The photograph of this machine is shown in Fig. 5. This machine can give over five thousand rolls per day of eight working hours. This output figure may be further increased by running the rollers by means of a small electric motor.

Blanking Press.—The bottom discs for zinc cups may be cut by a fly hand press or by an eccentric machine-operated press, the latter for large-scale production. The blanking is carried out with suitable dies and punches. Arrangements may be incorporated in the design of the cutting tools for feeding the strips in such a manner as to effect a minimum wastage of the material.

Soldering.—Zinc rolls are fitted with the bottom discs and a soldering flux is applied to the longitudinal and the bottom edges. This flux may be a weak solution of hydrochloric acid and zinc chloride or a non-acid non-corrosive type of paste. The cup is then soldered with a tin lead alloy, preferably of low melting point. The exact diameter of the soldered cups depends upon the diameter of the rod on which the rolls are fixed for the soldering operation. A soldering jig designed by the authors is shown in Fig. 6 and a short description of this is given below.

A roll to be soldered is placed over the rod A and pushed in the annular space between the rod A and the block C which holds the roll in position. The overlapping part of the roll lies over the V groove in the rod A. The bottom disc is placed on the free end of the rod A and is held in position by the roll itself. The longitudinal soldering is carried out first and then the rod A is swung to the vertical position and the bottom piece soldered. To facilitate the latter operation the jig is rotated round its axis on the guide D which is fixed to the table T. To avoid rapid cooling of the zinc during soldering, the rod A is grooved longitudinally and a portion cut off along the rim the of the free end. About fifty to sixty cans can be soldered per hour with this jig, the output however, depending to a large extent on the skill of the operator. A photograph of this jig is seen in Fig. 5.

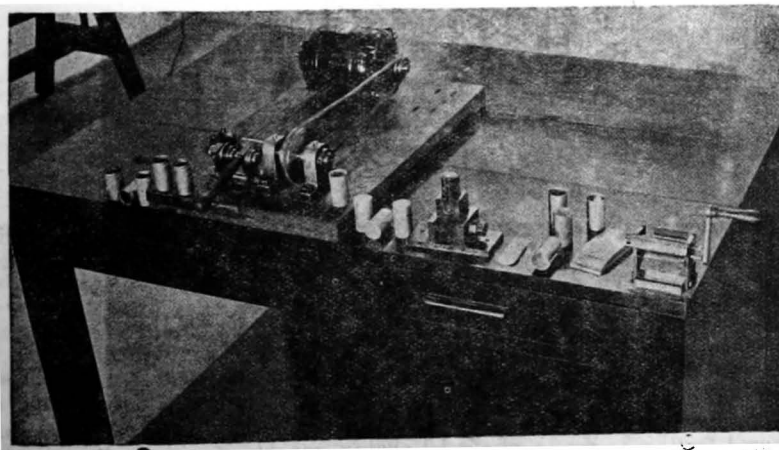

FIG. 5.

Soldering Bits.—Bits should be as clean as possible to effect good and quick soldering operations. The rubbing of the hot bits on a salammoniac block ensures a good clean surface.

Many labourers will have to be employed in a large factory to carry out the soldering operations by hand. The expense incurred in wages will be high, but the capital investment will be nominal.

Electric Welders.—Electric welding machines are available for carrying out the soldering operation. These machines are costly and will only be suitable for large scale manufacture. Moreover, these machines can be used for soldering the longitudinal seams only. The bottoms cannot be soldered with these machines.

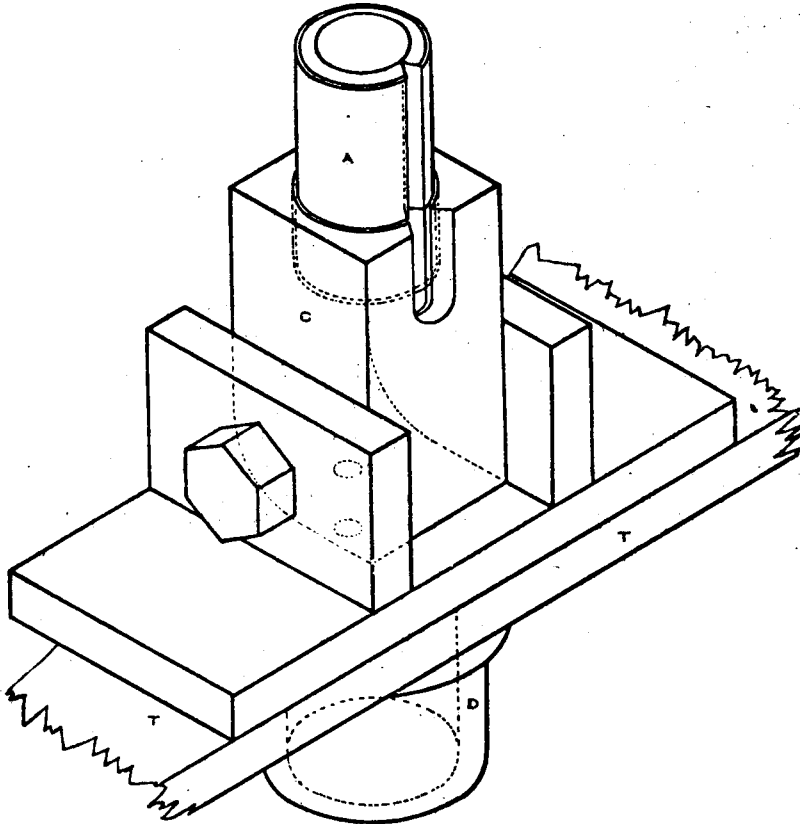

FIG. 6. Soldering Jig.

Inspection.—Soldered cups are tested for leakage either against a strong light or under pressure. Cups with tiny holes not visible against ordinary light may be found leaking during usage. Preliminary inspection will therefore reduce the number of rejected cells.

DRAWN CUPS.

Drawn cups are manufactured by drawing operations in special presses. Round discs which are blanked first are drawn to the required shape and size in three or four stages. The walls of the drawn cups should be uniformly thick. Zinc used for this process is of special quality, capable of withstanding the high

mechanical stresses coming into play during the drawing operation. The main advantage of the drawn cups over the soldered ones lies in their uniform and smooth shape and absence of foreign substances, such as those used in the solder. Zinc sheets are utilized almost completely in the soldering method, while in the drawing process a greater amount of scrap and wastage is unavoidable due to the necessity of getting circular blanks for the drawing process. These machines being costly are suitable only for large scale manufacture.

Grooving Machine.—Zinc cups are generally grooved at a distance of about $\frac{1}{4}$ " from the top. The groove serves as a seat for the top card-board washer. Fig. 7 shows the grooving machine designed by the authors. The cup to be grooved is placed over the rod A, a detailed view of which is shown separately.

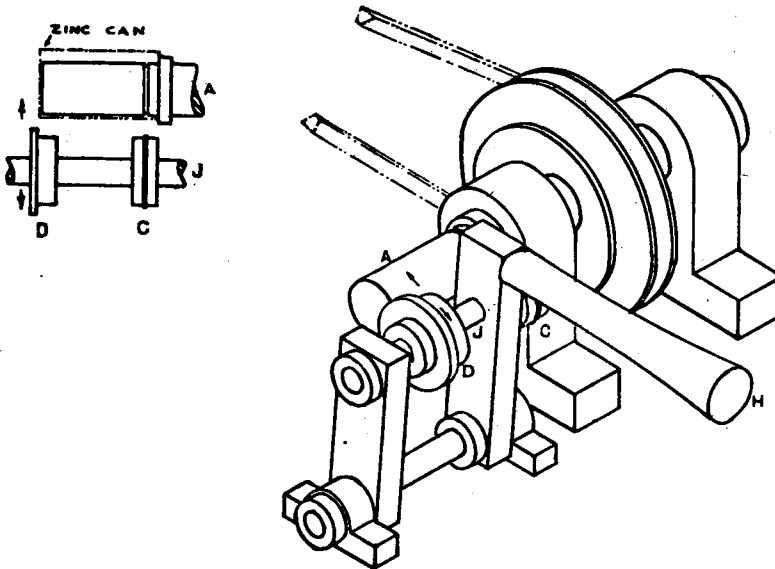

FIG 7. Grooving Machine.

The rod is rotated through a pulley by a $\frac{1}{8}$ H.P. electric motor. The grooving roller C moving freely in the shaft J is fitted in front of the rod A. The can is prevented from moving sideways by a collar on the rod A and a stop guide D, revolving freely on the shaft J. The guide is held in position by two collars one on each side. When the rod A begins to revolve the roller C is pressed against the can by the handle H. This operation rotates the can and the roller C in opposite directions. Further pressing of the grooving roller makes a groove on the can. The groove should not be so deep as to puncture the can. The output of this machine is about five thousand pieces per day of eight hours' working. The putput can be considerably increased if a separate drive is incorporated for the roller C. A photograph of this machine is shown in Fig. 5.

CARDBOARD WASHERS AND BRASS CAPS.

Presses similar to those used for blanking the bottom discs for the zinc cups may be used, with suitable dies, punches and guides, for the manufacture of the

bottom and top cardboard washers as well as the brass caps. The caps may be blanked out from a sheet and formed in one operation. A suitable cutting and forming die punch for the brass caps is shown in Fig. 8.

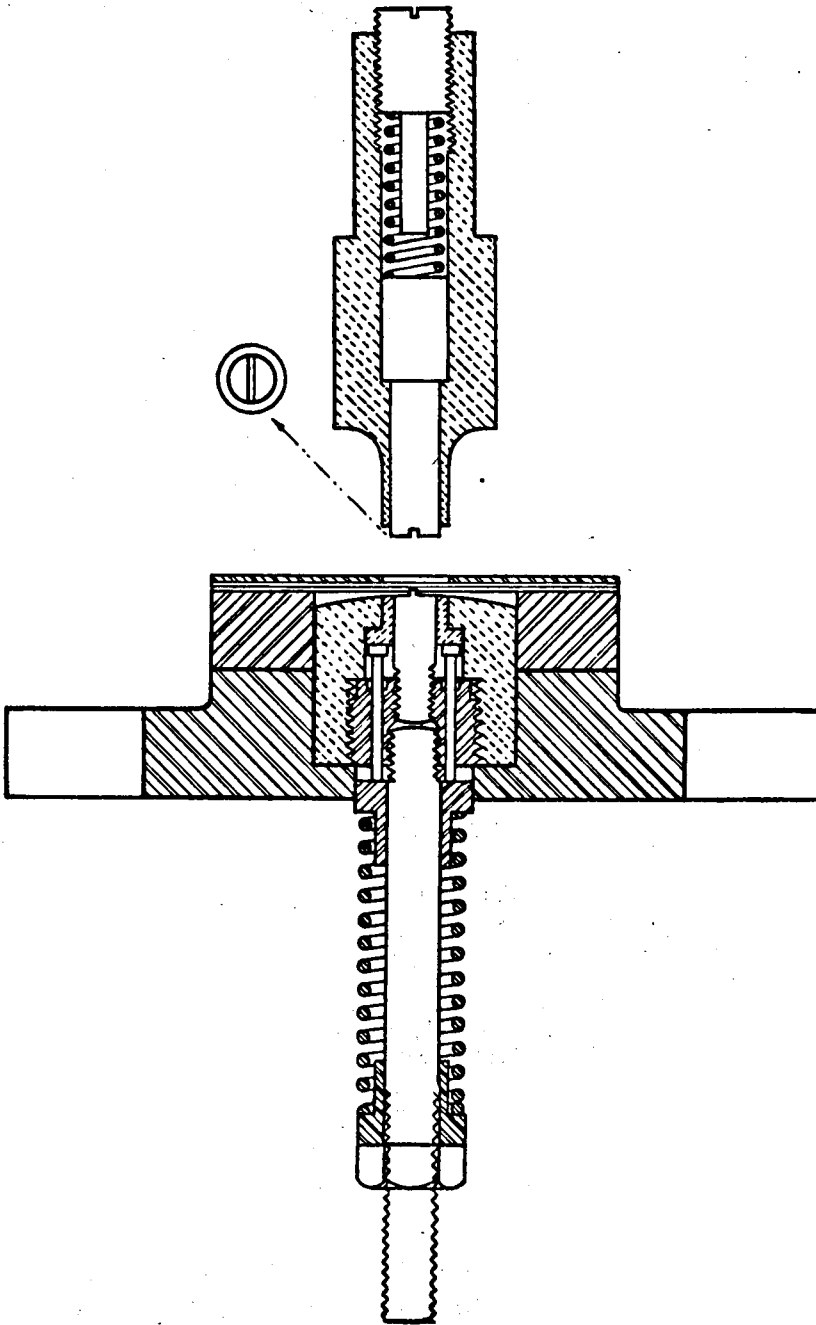

FIG. 8.—Die Punch for Making Slitted Brass Caps.

GRINDING OF ORES.

Grinding Machinery.—Manganese ore is generally obtained from the mining firms in India in lumps varying from 2" to 4" in sizes. The ore being hard and abrasive cannot be ground in one operation to a fineness of 60 mesh. A preliminary crushing to $\frac{1}{4}$ " to $\frac{3}{8}$ " size may be carried out in a cone or jaw crusher or by hand. Further grinding is carried out in a pulverizer or in a ball mill. The pulverizing of graphite is easier than that of manganese ores and may be carried out directly in a ball or pulverizing mill. Though the pulverizing of the ores may be carried out in a dry cell factory, it may be profitable to get these materials powdered to the required fineness from the sales agents who generally have these plants in their works.

Magnetic Separator.—These are used for removing the metallic iron particles that might have accidentally found their way into the powdered ores during grinding or transport to the factory. The removal of iron particles is essential to prevent the local action in the cells. These iron particles may be sporadically mixed up with the ores, and may escape detection during chemical analysis. Normally, a small factory may dispense with this operation and ensure supply of powdered materials from sources which can guarantee the necessary degree of freedom from metallic iron.

MIXING.

Mixers.—The depolarising constituents are thoroughly mixed in wooden mixing drums. After the materials are mixed for about half an hour in a dry state the liquid electrolyte used for moistening the mixture is added slowly while the mixing

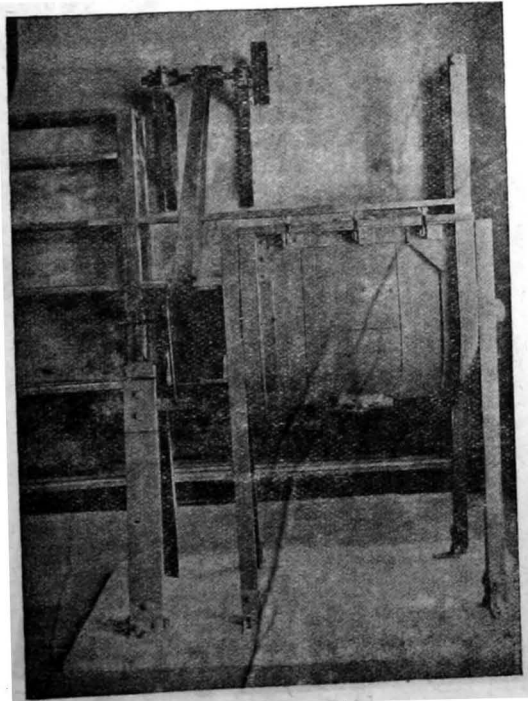

process continues for another half an hour period. The design of the mixing drum should be such as to prevent the grinding of the materials during mixing. The materials are generally fed to the mixers from the top and taken out through a hole, normally closed, at the bottom. Fig. 9 shows the photograph of such a mixer designed and built by the authors. The mixing blades are designed to give a thorough mix when rotated in the correct direction.

Shaking Sieves.—It is likely that small lumps may be formed during the mixing operation. These may be removed by passing the mixture through a shaking sieve. As in the case of mixers, these are made of non-metallic parts such as woven cane or hair sieve in wooden frames.

The mixers and the sieves may be worked by hand or by electric motors, the choice depending upon the capacity of these machines and the output to be turned out per day.

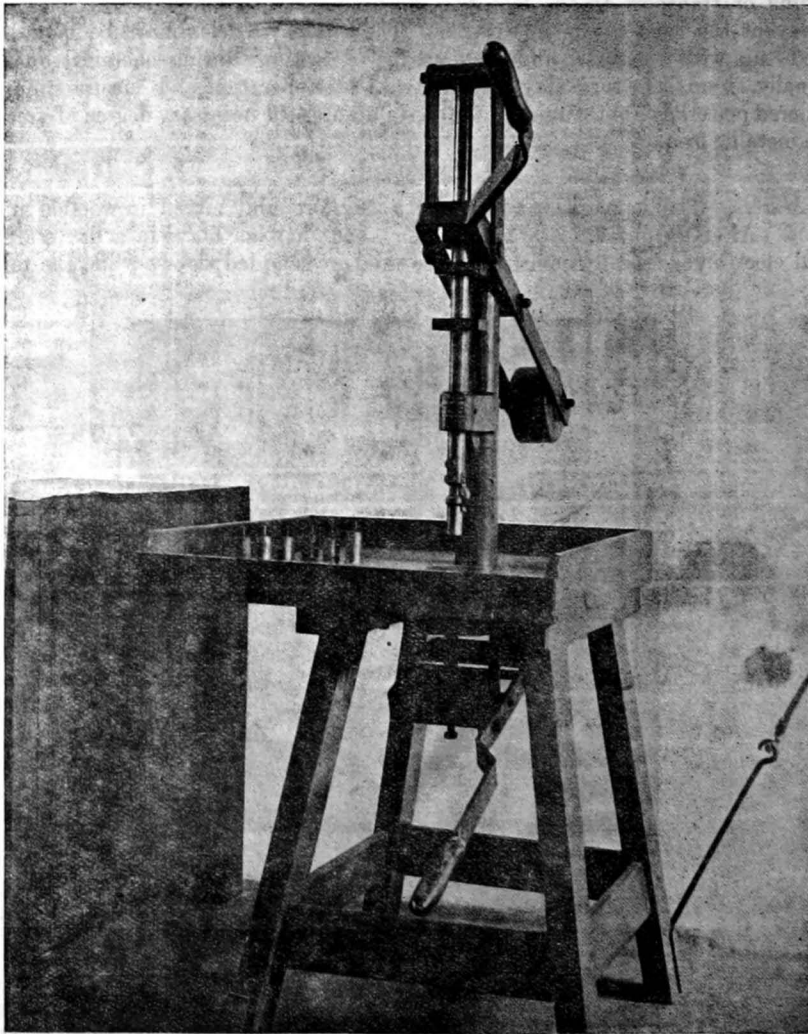

FIG. 10.—Dolly Press.

DOLLY PRESSING.

After the mixing operation the material is pressed into dollies. The pressing may be done by hand or automatic presses. The moulds are generally made of a stone, steatite or non-corrosive alloys of steel. The moulds should be sufficiently hard and strong to withstand the abrasive action and tamping pressures over a long period of time. In hand presses the rammers are made of hard wood or of ebonite, while in automatic presses these are made of non-corrosive special alloy steels.

Hand Presses.—There are two methods of pressing the dollies, one by pressing the mixture round the carbon rod held in position and the other by forcing the carbon rod through a prepressed mixture. Whichever method is adopted, the carbon rod must be held tightly into the mixture to obtain low internal resistance in the cells. In Fig. 10 is shown the photograph of one of the two types of presses, while Fig. 11 shows the sectional view. The pressed dollies are taken out by hand or foot operated ejectors. The output of these presses is about two thousand dollies per day of eight hours' working.

Automatic Presses.—The pressing operation is carried out in these presses in two or three operations. In the first the charge is fed into the mould, in the second it is pressed slightly to a predetermined height and in the final operation the carbon rod is forced through the pressed charge and the whole mass pressed again to the correct height. The pressed dollies are then ejected and carried over a conveyer or belt to a receptacle. The output of some of these machines is as high as four thousand pieces per hour and they are therefore useful for large scale manufacture only.

For large-size dollies such as those for 6 in. cells, the pressing is generally done either by hand operated machines or by semi-automatic eccentric presses. Automatic machines are also available for these sizes, but their output is considerably less than those used for pressing small size dollies. The demand for large cells is only a fraction of that of the torch light cells, and due consideration should be given to this fact when choosing hand or machine operation for the larger size dollies.

WRAPPING AND TYPING OF THE DOLLIES.

Hand Operation.—The dollies may be wrapped by hand in a piece of cloth and tied tightly with a string. The output per worker, after a little apprenticeship, may reach a figure of more than five hundred dollies per day of eight hours' working.

Machine Operation.—Semi and fully automatic machines are available for carrying out the wrapping and tying of the dollies. As these machines are suitable only for the size for which they are designed, it will be necessary to have a number of machines, one or more for each size of the dollies that are manufactured. The output for the semi and fully automatic machines is about one and three thousand pieces per hour respectively.

For machine operation a considerable amount of capital will have to be invested while for hand operation practically no capital investment is required and the same workmen can carry out the wrapping and tying of cells of various sizes.

WASHERING OF THE DOLLIES.

The wrapped dollies are fitted with the top centering paraffined cardboard washers either by hand or by machines.

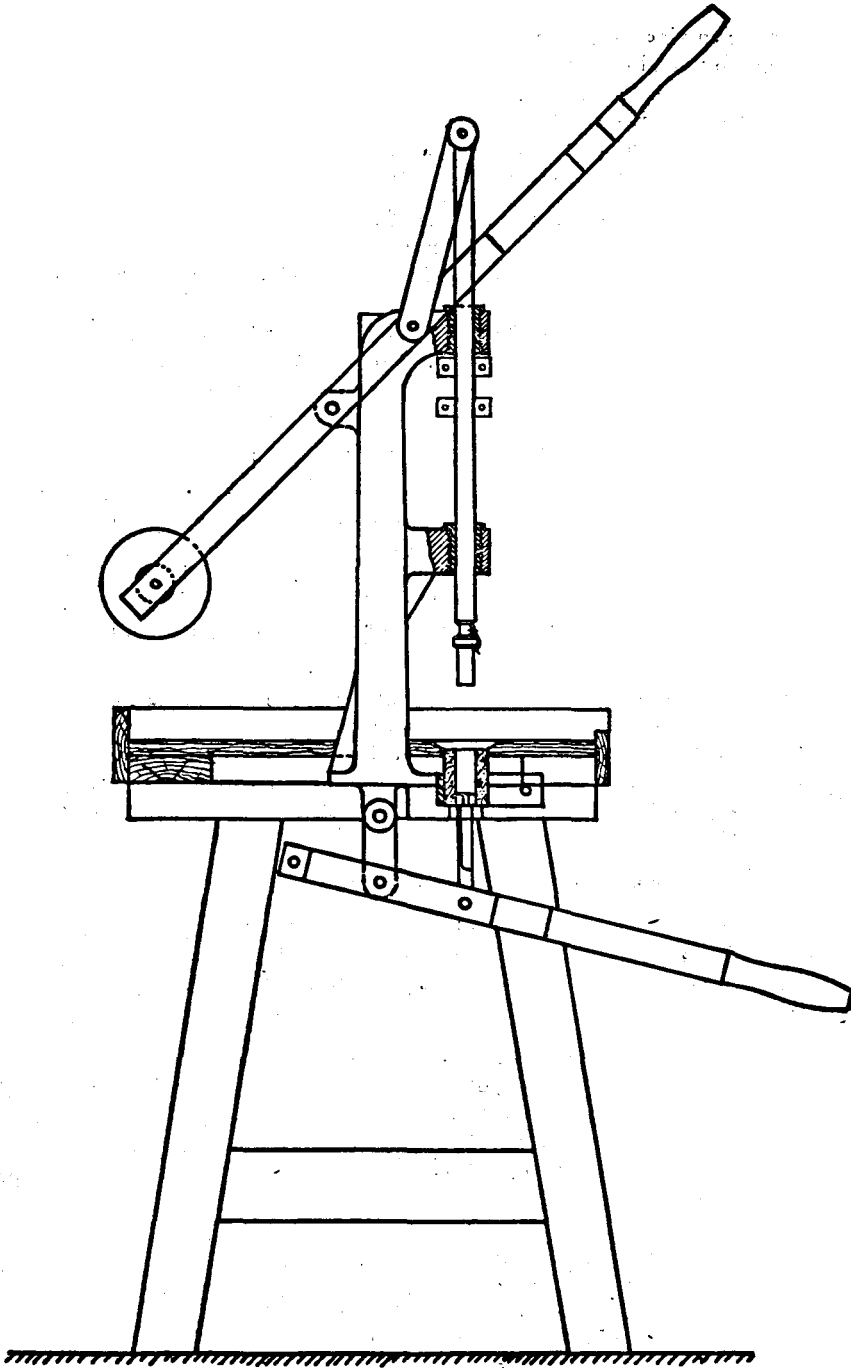

FIG. 11.—Dolly Press.

CAPPING OF THE DOLLIES.

After the washing operation the carbon electrode of the dollies is fitted with brass caps. This may be done by hand operated machine or by a semi or a fully automatic machine. Fig. 12 shows the hand-operated machine which can be worked in a horizontal or in a vertical position. The dolly D to be capped is supported in position by the ebonite piece G. For the sake of clearness the top of the dolly is shown dotted. The cap C is placed over the carbon rod and is pressed tightly over it by the rod A moved by the handle H. After the capping operation the rod A is brought to the original position by the spring S. If the caps have a projected part of the ventilating slit or hole, the tapered end of the rod A is suitably recessed to take in the projected part. The output of this machine is over five thousand dollies per day of eight hours working. The output of a semi- and a fully-automatic machine is between two and three thousand pieces per hour.

After the capping operation the tip of the carbon rod may be dipped in molten paraffin wax or a paraffin solution. Sometimes this operation is incorporated in the automatic capping machines.

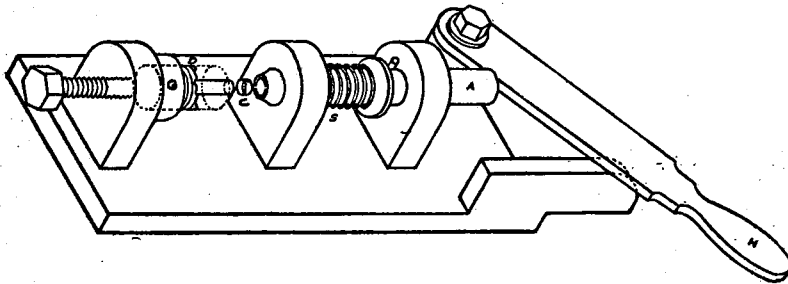

FIG. 12. Capping Machine.

ELECTROLYTE MIXING.

The mixing of the electrolyte is carried out in wooden vats. The mixing blades are also made of wood. Starch is generally added slowly to the solution of the ammonium and zinc chlorides and other salts. The mixing is carried out till a thorough mix is obtained.

ELECTROLYTE FILLING.

Hand Operation.—The filling of the liquid electrolyte into zinc cups may be carried out by hand. The required quantity may be poured into the cups or a rubber bulb may be used for filling cups. The quantity is generally measured by volume.

Machine Operation.—Semi and fully-automatic pumps are available for filling the electrolyte into the cups. The quantity of electrolyte is regulated by a screw or stop guide arrangement. The parts of the pump should be of non-corrosive metal or of ebonite. The electrolyte is continuously mixed in these machines to get a condition of homogeneity. The output of fully-automatic machines is about five thousand fills per hour.

COOKING OF CELLS.

Hand Operation.—After the filling operation the dollies are placed in the zinc cups and then the electrolyte is cooked *in situ*. The cells are cooked in trays which are immersed in a hot water trough for a few minutes to effect gelatinization of the electrolyte. It is necessary to see that the dollies are centered in the cups before the cooking operation starts. The centering is effected by the start-shaped bottom card-board washers as well as by the top washers. After the cooking operation the cells are preferably cooled by dipping in cold water.

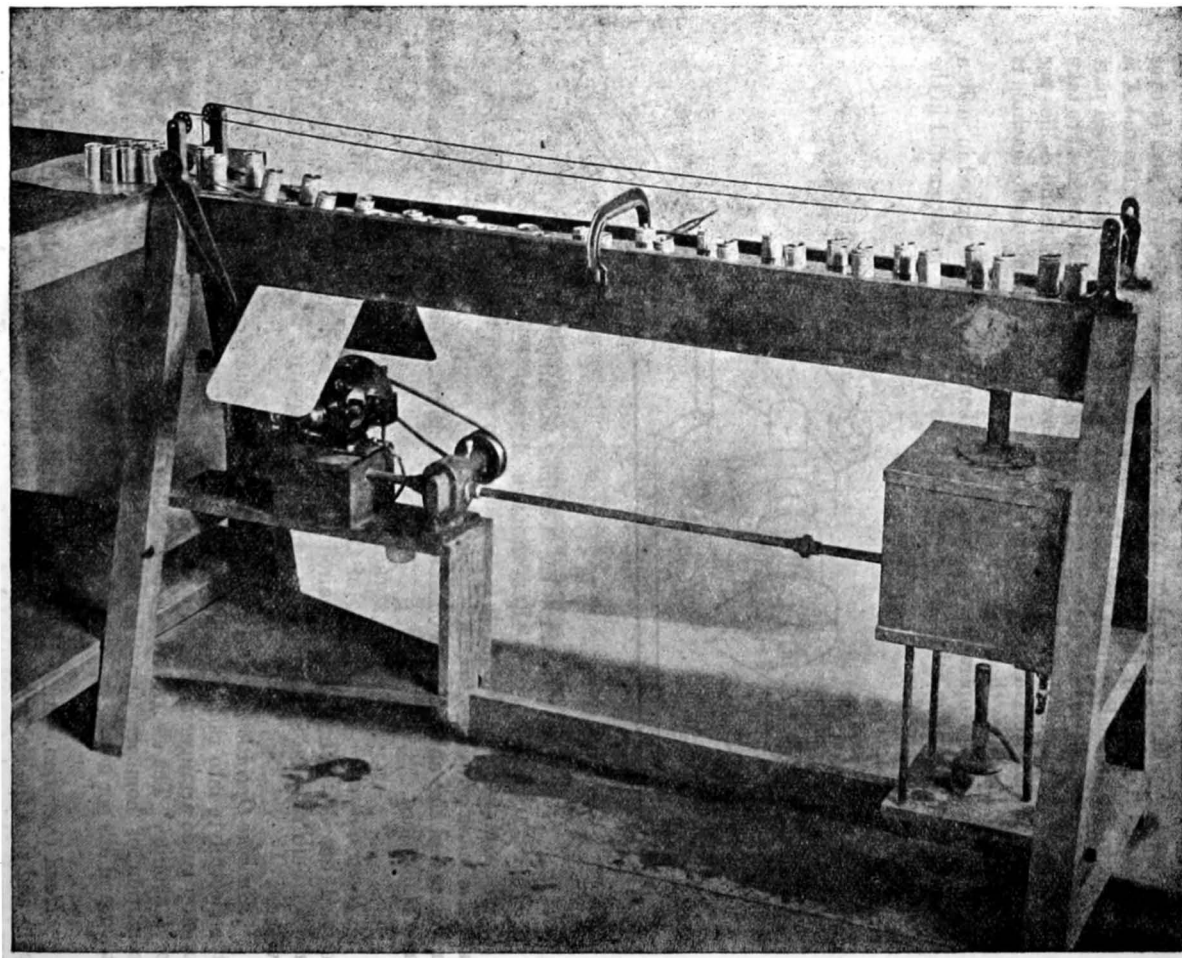

FIG. 13 —Automatic Cooking Trough for Dry Cells.

Machine Operation.—Automatic machines are available for carrying out the cooking of the cells. In these the cells are slowly carried forward in hot water, cooked there and then lifted and carried by an attendant. Fig. 13 shows a photograph and Fig. 14 a view of the cooking trough developed by the authors. The cells C to be cooked dip gradually into hot water. The heating is carried out from the bottom of the cup with a view to driving out the occluded air from the dolly and the electrolyte. The cooked cells emerge out of the hot water quickly and are then placed in cold water by an attendant. The cells are carried into and out of the hot water over a perforated brass sloping platform by an endless chain arrangement. Water is heated in a boiler T by gas and constantly circulated in the trough by a pump P, driven by a motor M. The output of this machine depends upon the temperature of the hot water and the speed of the endless chain, which is determined by the time required for perfect gelatinization of the electrolyte. It gives an output

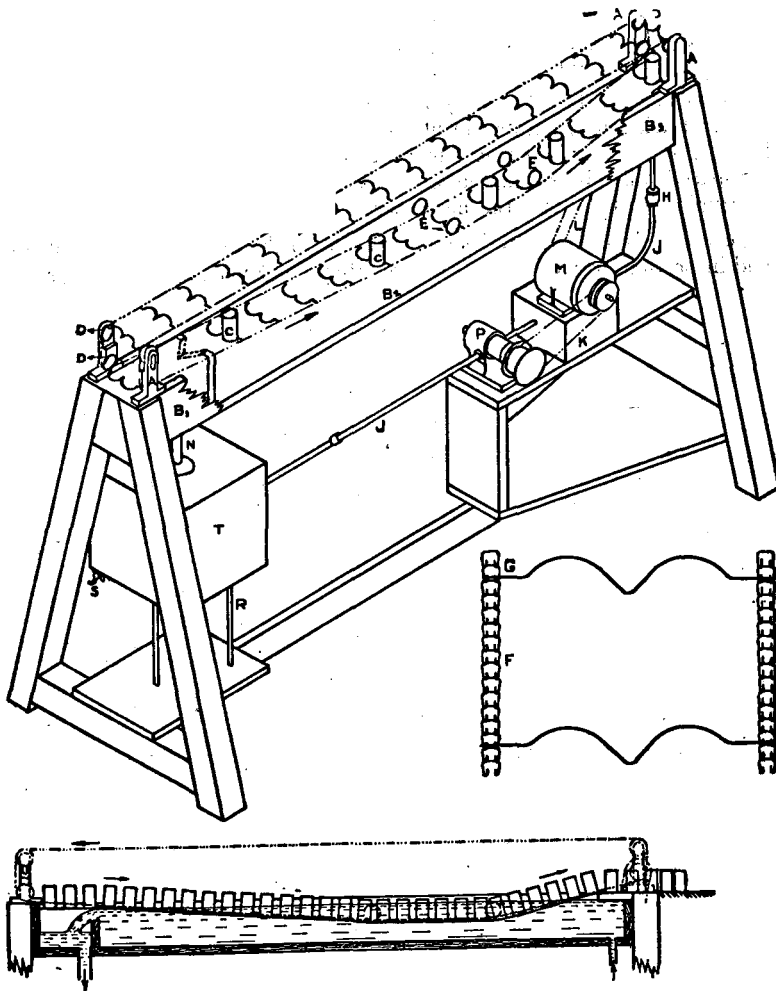

FIG. 14.—Automatic Cooking Trough.

of about two thousand cells per day of eight hours working, when the temperature of the water is about 70°C and the time required for the travel of the cells through the trough is about eleven minutes. The power required for this machine is about 1/8 H.P.

SEALING THE CELLS.

The cells are sealed after the cooking operation. The sealing compound or the pitch is heated in a boiler and then poured over the top card-board washers. A micro flame is played over the surface to get a uniform and perfect sealing.

LABELLING THE CELLS.

The completed cells are either wrapped in thick paper or are put on a card-board jacket with a suitable trade label pasted over them. The wrapping may be carried out by hand or by machines. The labels are generally perforated in code to indicate the date of manufacture.

ASSEMBLING THE CELLS.

If the cells are to be assembled to form a battery they are not wrapped in paper or in a jacket. Individual cells are connected to each other by a soldered brass strip, one end soldered to the can while the other is soldered to the brass cap of the next cell. Each cell is suitably insulated from the others by paraffined cardboard washers. The whole unit is placed in a cardboard box of suitable size, and the intervening space is filled by sealing pitch. End and intermediate connections are suitably brought out to obtain the necessary voltage taps.

The unit cells or the batteries are then sent to the testing department, for testing and inspection, which aspects are separately dealt with in another chapter.

TESTING.

The necessity of regularly testing the finished product, which involves a large number of variables in its manufacture, cannot be over-emphasized. A careful observation of the characteristics of the finished product will help to remove the defects in the materials and in the manufacturing process, which would otherwise persist and allow the standard of quality to deteriorate.

The factory testing of cells may be divided into two broad divisions: (1) control tests and (2) service tests.

CONTROL TESTS.

These tests are undertaken to find the defective cells in any particular batch. The simplest method is to measure the open circuit voltage of the cells with a high resistance voltmeter. This measurement may be carried out on the third or the fourth day after the manufacture to allow sufficient time for faulty cells to develop the defects and consequently to run down in open-circuit voltage. Defective cells also show a higher internal resistance than the good ones and therefore can be picked out by measurement of their internal resistance. This test being more elaborate is not usually employed. A quick but drastic test giving a rough measure of the internal resistance, and adopted by many manufacturers is known as the short-circuit test. This test is carried out by momentarily short-circuiting a cell through a low resistance dead-beat ammeter and noting the maximum deflection of the needle. Defective cells will give a lower reading due to their higher internal resistance. This test is helpful in picking out defective cells, but should not be depended upon for comparing the output capacities of cells of different makes⁽¹¹⁸⁾. As the test indicates the internal resistance, some conclusions may be drawn as to the ingredients in the case of new cells. Rather high currents for any size indicate an excessive amount of graphite, reducing thereby the manganese dioxide content below the proportion necessary for good depolarisation. Unduly low currents may be due to the use of cheaper materials or other defects.

After the two control tests described above, cells may be sent to the dealers. However a certain percentage (0.1 to 0.2 per cent.) of the manufactured cells should be selected at random for finding out the service characteristics.

SERVICE TESTS.

Service tests generally include measurement of: (1) Open-circuit voltage (2) Internal Resistance (3) Polarisation (4) Life output capacity, and (5) Shelf-life tests.

Open circuit voltage.—This is measured with a high resistance voltmeter having a resistance of at least 500 ohms. per volt. The voltage of a cell is made up of the voltage between zinc and electrolyte and between electrolyte and carbon-manganese mix, and depends upon the hydrogen ion concentration of the electrolyte. The capacity of a cell does not depend upon the initial open-circuit voltage.

Internal Resistance.—A freshly prepared cell has a certain definite internal resistance, depending chiefly upon the specific resistance of the electrolyte, the electrodes and the size of the electrodes and their distance apart. But when a cell is discharged various compounds are formed due to the electro-chemical reactions which give rise to higher values of the internal resistance of the cell.

The internal resistance can be measured by the potentiometer method, by the A.C. bridge method or by the voltage drop method. The first two methods being elaborate, the last one is generally adopted for all practical purposes. In this the resistance is measured by observing the value of the potential difference upon mo-

mentarily closing a cell through a known external resistance, and may be obtained by the equation

$$R = \frac{E - E^1}{E^1} \times R_a$$

where R is internal resistance of a cell, E is the initial open circuit voltage, E¹ is the closed circuit voltage and R_a is the external resistance. In the above equation it is assumed that E remains unchanged by the current that is generated. Although the value of R satisfies the above equation, it will not be the true value of the internal resistance as polarisation takes place when the circuit is closed. To avoid effects of polarisation the first two methods will have to be adopted. Table VIII shows the internal resistance of a few reputed makes of torch light cells from the market measured against an external resistance of one ohm. The capacity of a cell however does not depend upon the initial internal resistance.

TABLE VIII.

Internal Resistance of Bag Type of Cells on the market. Size 1 1/4" diameter x 2-3/8" height.

No.	No. of cells Tested.	Open-circuit voltage. Volts.	Internal Resistance. Ohms.
1	24	1.56	0.210
2	36	1.56	0.210
3	12	1.56	0.230
4	36	1.55	0.230
5	36	1.61	0.180
6	36	1.58	0.155
7	34	1.58	0.161

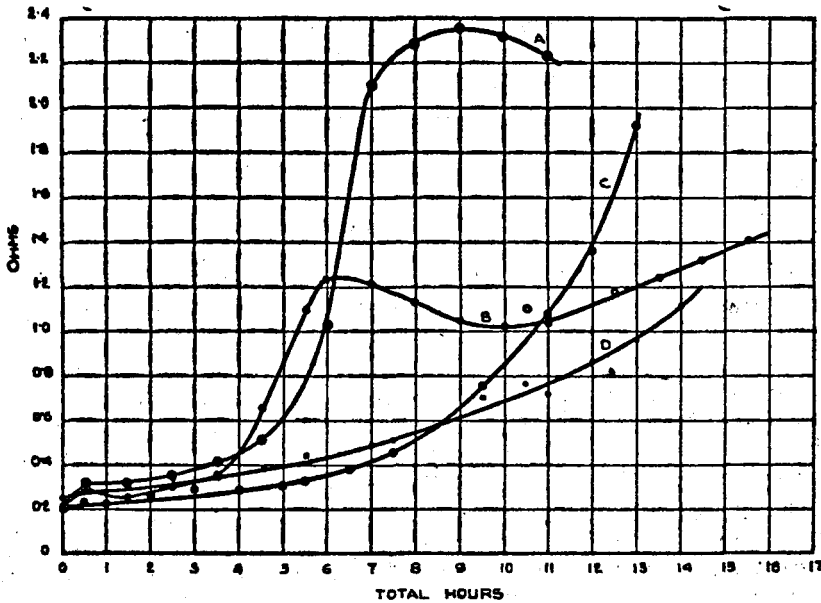

FIG. 15.

When a cell is discharged through a constant external resistance, the current drops down slowly from its initial value. The fall in the initial stages is mostly due to polarisation, but as the discharge proceeds, it is mostly due to exhaustion of the cell. It may also be due to an increase in the internal resistance of the cell. It is not so much due to the drying out of the cell, which is a minor cause, since the electrochemical action during discharge gives rise to the formation of water. If an old cell is put on discharge or even with a new cell during the latter part of an intermittent discharge the current is sometimes found to rise from its initial value for a short time, due to the lowering of the internal resistance, as a result of the formation of water.

As the discharge proceeds, the manganese dioxide gets reduced and the active surface of the electrode moves towards the centre which increases the path between the anode and the cathode, thereby increasing the internal resistance of the cell. The rise in internal resistance is also due to the formation of insoluble double chlorides which settle on the zinc and the dolly surface and thus restrict the available path for the flow of the current. In Fig. 15 the rise in internal resistance of dry cells during the intermittent discharge periods is shown. The resistance of the cell was measured against the discharge resistance at the beginning of every discharge period by the voltage drop method. The rise is little in the beginning but increases rapidly to large values towards the end. Curves A and B show a peculiar shape because after a certain period, the resistance falls off, due to formation of water, and then rises again.

Polarisation Test.—The test is not generally carried out on torch light cells, but is carried out on larger size cells. Polarisation is a serious defect, the seriousness of which depends upon the use for which the cell is intended. The test may be carried out by discharging the cell either through a constant resistance or at a constant current to which the cell is subjected during its normal service period, and then measuring the polarisation for the particular conditions. Polarisation in a cell increases till the rate of depolarisation is equal to that of polarisation, and therefore the test should be continued for such a length of time that a steady state is attained or it should be carried out for a period that is likely to be required under service conditions. In this test the initial voltage E of the cell is noted and after the discharge period is over the circuit is broken, and the voltage E^1 is noted immediately

afterwards. The difference $E - E^1$ is the polarisation and $\frac{E - E^1}{E} \times 100$ is the percentage polarisation.

With the constant resistance discharge method the cells can be easily compared, but the current generated is not the same in each case because it is higher when polarisation is less than when it is more. In this test, therefore, a cell which polarises slightly is put to a more severe test than one in which polarisation is higher.

Life Test.—As dry cells and batteries are used in various fields of application, a number of tests will have to be devised to have a life test corresponding to the actual service conditions. Such a procedure would often make the testing elaborate and cumbersome. Certain arbitrary tests, as few as possible, should be adopted corresponding roughly to the most common uses of the cells and batteries. Governments and large purchasing authorities of various countries have standardised these tests and have issued the necessary testing specifications. Any one or more tests that may be convenient to work out may be chosen from the standardised ones.

Dry cells and batteries are generally used on constant resistance or constant current circuits. The service may be of a continuous or intermittent nature. The tests may therefore be divided into the following broad divisions: (1) Continuous tests of constant current or constant resistance nature and (2) Intermittent tests of constant current or constant resistance nature.

The test chosen should approximate as nearly as possible to the conditions occurring in actual service. If a cell is used continuously or for the most part of the time continuous test should be used. Intermittent tests should be used when continuous tests do not approximate to service conditions, and the periods of discharge and rest should be carefully determined, as the recuperation of the cell during the rest period considerably influences its output capacity. Intermittent tests are generally carried out by means of automatic arrangements (23, 120, 128, 132). Use of automatic gear becomes necessary if discharge and rest periods are of only a few minutes' duration or if all the discharge periods do not fall during the regular working hours, or if there are thousands of cells to be tested at the same time. Due to the complicated nature of the intermittent test, the continuous test is sometimes adopted even when the anticipated service is rather different.

In intermittent tests if the voltage of a cell falls little on closed circuit, it will not need to recuperate much, so that a cell which polarises considerably will often have greater recuperative power than another which polarises less. A large proportion of the recuperation of a cell takes place shortly after the discharge circuit is opened. In tests where the period of testing is considerably prolonged, the output capacity instead of increasing due to the recuperation period decreases due to the self-discharge taking place in the idle period.

When the condition regarding the time of test is decided, the mode of discharge of the cells should next be considered. Dry cells and batteries are generally used at low discharge rates. The cells may be discharged through constant resistance or at constant currents, the values for which should approximate as far as possible to the actual service conditions. Intermittent testing at constant current is easier to carry out than intermittent testing through constant resistance, as with the former system a large number of cells can be tested in series with one controlling resistance and with one cut-in and cut-out switch. This does away with the necessity of breaking the circuit for every cell, when a constant external resistance circuit is used.

End Points of Discharge.—The discharge curve of a dry cell has no marked natural end point as is the case with a lead-acid storage cell. The end point of discharge should therefore be such that an apparatus using the cell will fail to work after the end point is reached. Cells are used for so many different purposes that it is difficult to decide upon any definite end point. Two end points are generally chosen. They are 0.75 volts and 0.90 volts per cell on closed circuit for the heavy intermittent and continuous discharges and for the light intermittent discharges respectively.

With the above end points it will take about a month or more before results of the test become known. This period may be too long for a manufacturing concern that desires to effect changes in the products as quickly as possible. To shorten the testing period, sometimes a higher end voltage of 1.1 volts is chosen (91). Fig. 16 shows the capacity of cells at different end voltages.

Number of cells required for life test.—The minimum number of cells to be selected for life test should be three. The cells may be tested in series, but it is preferable to test them individually rather than in series, because the average obtained by the series arrangement is not necessarily the same as the average obtained by testing the cells separately and then averaging the results.

The quality of a cell is affected by several uncontrolled variables in a factory such as the conditions during manufacture and the quality of raw materials. These variables produce cells with varying output. This variation may be of the order of ten to fifteen per cent. between individual cells. From statistical considerations, it is better to get an average output figure for a large number of cells than for a smaller batch in which an attempt has been made to control the variables.

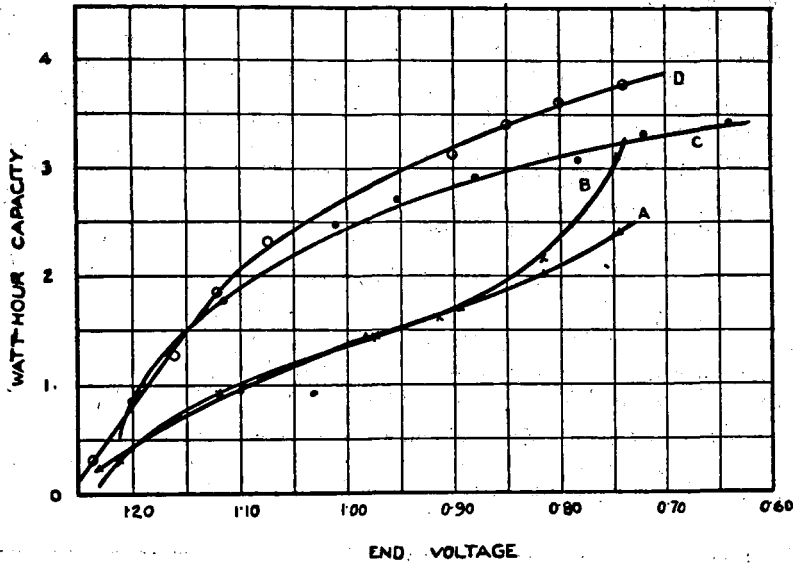

FIG. 16.

Rating of the cells.—The output capacity of a cell may be given in days, hours, minutes, ampere-hours or in watt-hours. The output depends upon the drain to which a cell is subjected, and therefore it is not a specific quantity. The procedure of rating the cells in terms of time is simple and of practical value, as it denotes the actual service that can be expected from a cell and it has been adopted in many countries. Measurement of the capacity in ampere-hours or watt-hours entails a certain amount of calculation work to obtain the output figures. Nowadays the capacity in ampere-hours is not generally given. The method of rating the output capacity in watt-hours, though it involves more work, is satisfactory as it indicates the actual work that may be obtained from a cell and thereby forms a better scientific basis of comparison.

If a cell is discharged at constant current, the watt-hour capacity is obtained from:—

$$W.H. = IEH.$$

where I is the discharge current, E is the average voltage during discharge and H is the total time of discharge. If a cell is discharged through a constant resistance the capacity is given by the following equation.

$$W.H. = \frac{E^2}{R} \times H$$

where E is the average voltage during discharge, R is the external resistance through which the cell is discharged and H is the total time of discharge.

Shelf Life Tests.—Shelf life tests on dry cells are important, as users of cells are generally interested in knowing the capacity of a cell after a period of storing. Initial tests indicate the available capacity when the cells are fresh, while shelf tests give an idea of the decrease in capacity due to deterioration on storage. The lowering in capacity during storage is different with different makes of cells. The cheaper and less reliable makes will be useless after only a few months' shelf period. Initial tests are useful when cells are to be used shortly after manufacture. If however the cells are to be used on light drains or on intermittent service of long duration or are not to be used for some time after the manufacture, the initial tests are of not much practical value. Shelf tests in such cases are important. Cells giving high output in the initial tests may fall rapidly after a storage period of only a month or two, while others showing moderate capacity on initial tests may continue to deliver almost the same amount even after six months' storage period. The latter type is preferable for giving a guarantee or for sending to distant places. Fig. 17 shows the output capacity of cells of different makes on shelf tests. The cells were tested in a constant temperature constant humidity room according to the procedure described in a paper by Verman and Joglekar ⁽¹²⁸⁾.

INFLUENCE OF TEMPERATURE.

Open Circuit Voltage.—It is well known that the temperature variations affect the characteristics of a dry cell. The effect of temperature on the open circuit voltage is small and may be neglected for all practical purposes. The temperature coefficient is positive ⁽¹³²⁾ within the ordinary range of temperature.

Short-Circuit Current.—Short circuit current increases at the rate of approximately one ampere for each 3°C. rise in temperature between 0° and 25°C., and at higher temperatures the rate of rise is somewhat less ⁽¹³²⁾.

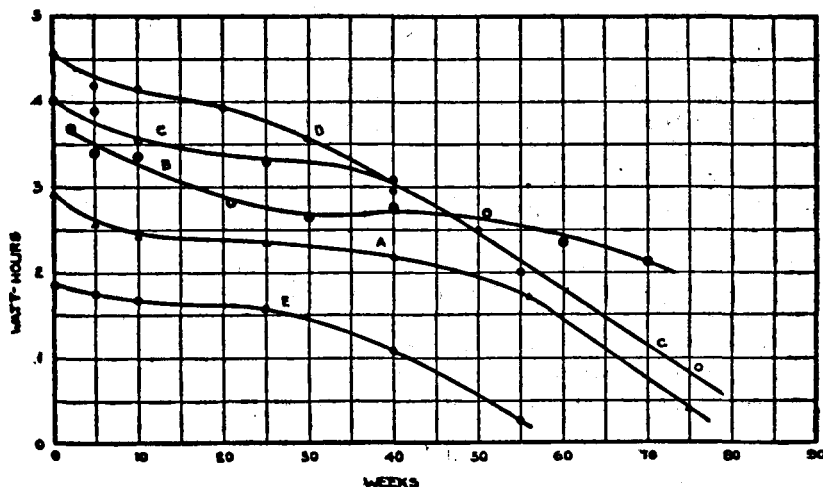

FIG. 17.

Output Capacity.—The temperature coefficient of capacity is positive and varies with the type of test and also with the brand of cells ^(93, 104, 132). This variation makes it difficult to judge the capacity of a cell at any temperature from the known figures at a particular standard temperature.

Shelf Life Tests.—The effect of high temperatures on shelf life is deleterious. An increase in temperature assists the chemical reactions within the cell which tend to deteriorate it. Cells therefore should be stored in a cool place. Capacity of a cell is increased by raising the temperature when the discharge rate is high. In low discharge tests when a cell takes a considerable period to complete the test a low temperature is preferable so as to reduce the harmful effect of high temperature on the shelf life of the cell.

At low temperatures a cell gives less capacity than when discharged at normal temperatures. This diminution is due to many causes. The chemical reactivity slackens with the lowering of the temperature. Apart from this, the solubility of the by-products of reaction decreases with the temperature. The salts in the electrolyte crystallise out and congest the pores, thereby increasing the inner resistance of the cell. The conductivity of the electrolyte also decreases with the decreasing temperature. The harmful effects of low temperature may be counteracted to some extent by making suitable modifications in the electrolyte mixtures.

From the above discussion it will be seen that the temperature influences the capacity of a cell to a considerable extent. In a sub-continent like India, where the temperature varies considerably from place to place and also varies considerably at different times of the year, the result of even routine work would vary considerably with the natural variations of temperatures in a room. The greater accuracy that is necessary for research and development work cannot be obtained by testing the cells at room temperatures. With a view to avoiding the effects of the variations in temperatures research laboratories should be maintained under constant temperature conditions.

Relationship between various tests.—Tests carried out in a laboratory are at best approximations to the service qualities of cells. It is therefore necessary to correlate the laboratory data with the actual performance of cells in service. Attempts have been made by various workers to find out this correlation between various conditions of tests (91, 93, 136). The knowledge of the relationship between various tests would make it possible to carry out one rapid discharge on a dry cell and from such data predict the performance of the cell under a variety of discharge conditions, thereby eliminating a large number of discharge tests. This ideal, however, has not yet been attained.

DEFECTS.

In the foregoing chapters it was pointed out that unless a proper check is maintained in the selection of raw materials and on each of the manufacturing operations defects will be observed in the finished products. These defects generally develop to an appreciable extent within the first few weeks of manufacture, and are sometimes noticed visually or detected when voltage and short-circuit current are measured. The defects may be summarised as :—

- (1) Bulging and/or pushing out of the sealing compound.
- (2) Pushing out of the carbon rod.
- (3) Pressing out of the zinc can bottom in soldered cans.
- (4) Creeping of the electrolyte along the walls of the can.
- (5) Creeping of the electrolyte along the carbon rod and subsequent corrosion of the brass terminal cap.
- (6) Pitting of the zinc cans.

As it is difficult to attribute any particular cause for these defects, a series of careful experiments have to be carried out to eliminate them. The first three defects listed above are due to the high pressure developed by the entrapped gases within the cell. In order to prevent these defects the entrapped gas must be vented out through the joint between the sealing compound and the zinc can or through the carbon electrode. In some cells the brass cap has a tiny hole or is slitted at the top for allowing the gas to escape through it. The gas finds its way to the cap through the porous carbon electrode, but this may be prevented if carbon rod has been excessively paraffined. Paraffining should therefore be judiciously carried out to prevent the passage of electrolyte but to allow free passage to the gases. Sometimes the zinc can is provided with a tiny hole at the top near the groove just below the top cardboard washer to allow these gases to escape.

The excessive generation of gases during the first few weeks of manufacture may be due partly to internal short circuits between the zinc and the depolariser material, which might be adhering to the outside of the dolly or which might have found its way out during the tying or capping operation. Care should be taken to avoid these short circuits. Gases may also have their origin in starch flour of inferior quality, which might have been used for gelatinizing purposes. This can be prevented by using good quality materials.

The pressing out of the zinc bottom occurs only if the soldered joints are not sufficiently strong. Sometimes electrolyte is also seen coming out at the bottom through pin holes in the soldered portion. These defects can be easily eliminated by careful control of soldering operation and inspection of finished cans before cell assembly.

The electrolyte sometimes creeps along the vertical soldered joint, and if the sealing at the top is defective, it comes out and spoils the outside of the cell or other adjoining cells in a battery. It also creeps along the vertical fissures if any, and along the vertical grooves in a carbon rod and corrodes the brass caps. Faulty carbon rods should not therefore be used. It is also preferable to have vertical dents on the carbon rod instead of grooves.

Direct internal shorts taking place during the assembling of a cell lower the voltage in a few days' time. These may be detected by open circuit voltage measurements. Due to internal short-circuits, the zinc can is eaten up locally and becomes pitted. Harmful impurities either from the electrolyte and/or from the depolarising mixture travel to the zinc can, and develop local galvanic cells and cause the pitting of the can. These defects may be prevented by controlling the purity of raw materials.

ECONOMICS.

In running a manufacturing concern successfully, it is necessary to assess correctly the cost of production. Not only should the total cost be known correctly, but it is also necessary to know the cost of production at every stage of manufacture. Such a procedure would help to effect economics in the cost of production without deteriorating the quality. Attention should be paid to the cost and selection of the raw materials consistent with their quality and suitability for manufacture. Attention is also necessary at every stage to find the wastage in the manufacturing process and for the subsequent substitution of new devices or combination of two or more operations by special machinery to reduce it.

Fig. 18 shows a flow sheet of dry cell manufacture. A hypothetical case has been worked out below showing the cost of manufacture of dry cells in the smallest factory unit considered economic for Indian conditions. The output of the factory is taken at a figure of 8,000 cells a day with a monthly production of 200,000 cells. The size of cell manufactured is taken as $1\frac{1}{2}$ " dia. \times $2\text{-}\frac{3}{8}$ " height. The prices of raw materials, machines and the labour charges are assumed to be those current before the war and are somewhat on the higher side.

On the basis of the above production figures the factory would require a total floor area of about 3,000 sq. ft. including offices and laboratories. The assumptions on which the cost of production are based are as follows:—

CAPITAL INVESTMENT.

	Rs.
(1) Building	20,000
(2) Working capital (equivalent roughly to 4 months' requirement of materials and pay of employees, etc.)	48,000
(3) Machinery, apparatus, etc.	28,000
(4) Laboratory and office equipment, etc.	4,000
Total	1,00,000

STAFF PAY.

	Rs.	
(1) One Technical Manager	250	per month
(2) One Chemist	100	" "
(3) One Clerk	40	" "
(4) Six Mistries at Rs 40 per month each	240	" "
(5) Fifty workers at Rs. 20 per month each	1,000	" "
(6) One bearer	20	" "
Total	1,650	

ANNUAL CHARGES.

	Rs.
(1) Interest on Capital Investment at 5 per cent.	5,000
(2) Rates and Taxes, etc. at 1.25 per cent.	250
(3) Depreciation—	
(a) Building 5 per cent.	1,000
(b) Machinery, etc., 10 per cent.	2,800
(c) Laboratory and office equipment 10 per cent.	400
(d) Maintenance 1 per cent.	280
	4,480
(4) Pay of employees	19,800
(5) Insurance	1,000
(6) Power, light, etc.	1,200
(7) Miscellaneous	1,000
Total	32,730
Yearly Production	24,00,000 cells.

COST OF PRODUCTION.

(1) Material cost Ra. 11,000 × 12	Rs.
(2) Annual charges	1,32,000
	32,730
Total	1,64,730

Cost per cell = 1·1 anna per cell.

Cost per gross = Rs. 9·9 say Rs. 10.

Quality cells are generally sold at a price varying between Rs. 12 and Rs. 15 per gross *ex-factory*. Taking Rs. 12 as the selling price per gross to dealers the profit per year comes to about Rs. 33,000 on an investment of Rs. 1,00,000 which means 33 per cent. profit on the capital investment. The nett profit will however be reduced to a certain extent depending upon the income tax, the advertisement charges, etc., which have not been included in the above estimate.

Since the outbreak of hostilities in Europe the economic position has been considerably altered and became so complex that any data collected before the war has become extremely inaccurate, and the collection of up-to-date figures has become well-nigh impossible. In view of the constantly changing conditions, therefore, it has become futile to attempt an accurate estimate of dry cell production cost. Constant attempt is, however, being made by the authors to keep in touch with developments and maintain the available data up-to-date, with a view to assisting any one who may require such information.

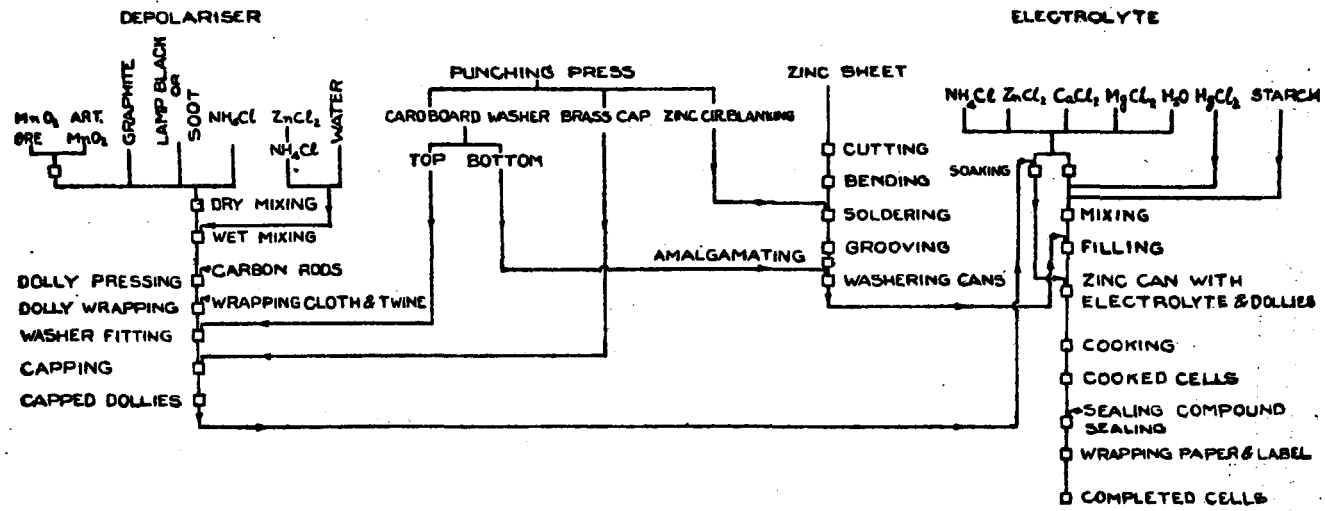

FIG. 18.—Flow Sheet of Dry Cell Manufacture.

ACKNOWLEDGMENTS.

The authors wish to express their thanks to Mr. D. S. Naidu and Dr. M. Karim who have been connected with certain aspects of the research work on dry cell manufacture from time to time.

BIBLIOGRAPHY.

1. Anon, Modern flashlight batteries. Formulas from factory practice. *Chem. Ztg.*, **56**, 690, 1932.
2. Anon, Report of progress by the Committee on dry cell tests. Standard methods recommended for testing of dry cells. *Trans. Am. Electrochem. Soc.*, **21**, 275, 1912.
3. Arndt., K., and Pollack, A. Artificial Graphite. *Z. anorg. allgem. Chem.*, **201**, 81, 1931.
4. Arndt., K., Walter, H., and Zender, E. Investigations of manganese dioxide cell. *Z. angew. Chem.*, **39**, 1426, 1926.
5. A. S. T. M., Standard specifications for rolled zinc. *A. S. T. M. Standards*, B. 69-29, 1939.
6. Blum, W. and Vinal, G. W. The definition of polarisation, overvoltage and decomposition potential. *Trans. Electrochem. Soc.*, **66** 359, 1934.
7. Brown, B. K. Graphitic oxide as a depolarizer in the Leclanché cell. *Trans. Electrochem. Soc.*, **53**, 113, 1928.
8. Brown, J. C. Notes on manganese ores. *Bulletin of Indian Industries No. 2*, 1921, Govt. of India Publications.
9. Brown, J. C. India's Mineral Wealth, 1936 Ed. *Oxford University Press*.
10. Brown, J. W. The use of dry cells on ignition service. *Trans. Am. Electrochem. Soc.*, **13**, 173, 1908.
11. Brummer, E. and Beyer, O. Increasing the capacity of dry cells of Leclanché type. (a) *Magyar Chem. Folyóirat*, **36**, 160, 1930. (b) *Chem. Zentr.*, **1**, 428, 1931.
12. B. S. I. British Standard Specification for Leclanché type primary cells, No. 397, 1933.
13. Burgess, C. F. The dry cell. *Electrical World and Eng.*, **39**, 156, 1902.
14. Burgess, C. F. Characteristics of small dry cells. *Trans. Am. Electrochem. Soc.*, **30**, 257, 1916.
15. Burgess, C. F., Gillingham, C. A., and Vinal, G. W. Report of radio battery committee on standardization of tests for dry cells in radio receiving sets. *Trans. Electrochem. Soc.*, **45**, 15, 1924.
16. Burgess, C. F. and Hambuechen, C. Certain Characteristics of dry cells. *Trans. Am. Electrochem. Soc.*, **16**, 97, 1909.
17. Burkhardt, A. and Sachs, G. Special zinc for the manufacture of batteries. *Metallwirtschaft*, **13**, 809, 1934.
18. Cahoon, N. C., The influence of hydrogen ion concentration on the potential of African manganese dioxide. *Trans. Electrochem. Soc.*, **68**, 177, 1935.
19. Camp, A. D. Chemical raw materials for dry cell industry. *Chem. Met. Eng.*, **35**, 154, 1928.
20. Ceader, J. D. and Mead, T. Characteristics of flashlight batteries and incandescent lamps. *Trans. Electrochem. Soc.*, **68**, 207, 1935.
21. Claussen, R. A. The six-inch paper-lined dry cell. *Trans. Electrochem. Soc.*, **64**, 341, 1933.
22. Codd, A. M. Practical primary cells, Ed. 1929. *Sir Issac Pitman and Sons, Ltd., London*.
23. Cooper, H. G. Dry cells and their testing, *Elec. Communication*, **5**, 210, 1927

24. Cooper, W. R. Primary Batteries, Second Impression, 1920, *Benn Brothers Ltd., London.*
25. Cordebas, R. Conductivity of carbon. *Rev. Gen. Elec.*, **31**, 547, 1932.
26. D'Agostino, C. Determination of the chemical activity of manganese dioxide. *Ricerca Sci.*, **9**, 195, 1938.
27. Dana, E. S. and Ford, W. E. A text book of mineralogy, 1922 Ed. pp. 411—436, *J. Wiley.*
28. Daniels, F. Physical chemical aspects of the Leclanché dry cells. *Trans. Electrochem. Soc.*, **53**, 45, 1928.
29. Drotschmann, C. The zinc electrode in dry cells. *Chem. Ztg.*, **53**, 29, 50, 66, 1929.
30. Drotschmann, C. Determination of the depolarisation index of pyrolusite for the battery industry. *Chem. Ztg.*, **56**, 234, 1932.
31. Drotschmann, C. Advances in the chemistry of the manufacture of dry batteries. *Chem. Ztg.*, **59**, 881, 1935.
32. Drotschmann, C. Copper and iron impurities in dry cells. *Chem. Ztg.*, **62**, 216, 1938.
33. Drotschmann, C. Battery trade chemicals. *Chem. Trade Jour. and Chem. Eng.*, **103**, 583, 1938.
34. Drucker, C. The current yielding reactions of the Leclanché elements (dry cells). *Z. Physik. Chem. Bodenstein-Festband*, 912, 1931.
35. Fermor, L. L. Memoirs of the Geological Survey of India. Vol. XXXVII, Part I, II, III and IV.
36. Friend, J. N. The solution of plain and amalgamated zincs in electric batteries. (a) *J. Inst. of Metals*, **41**, 91, 1929. (b) *Engineering*, **127**, 354, 1929.
37. Fuseya, G. Miyakawa T., Akai Y., and Simazaki, K. Measurement of the potential of the zinc electrode. *J. Soc., Chem. Ind. (Japan), Suppl. binding*, **39**, 401-B., 1936.
38. Fuseya, G., Saito Y. and Simazaki, K. Measurement of the solubilities of $ZnCl_2 \cdot 2NH_3$ in electrolytes of various concentration. *J. Soc., Chem. Ind. (Japan) Suppl. binding*, **42**, 100-B., 1939.
39. Gillingham, C. A. Discharge characteristics of certain dry cells. *Trans. Am. Electrochem. Soc.*, **34**, 297, 1918.
40. Gillingham, C. A. Twenty-five years in the dry cell industry, *Trans. Electrochem. Soc.*, **51**, 165, 1927.
41. Gillingham, C. A. Some comments on dry cell service and tests. *Trans. Electrochem. Soc.*, **53**, 39, 1928.
42. Gillingham, C. A. Quality advances in the dry battery industry. *Trans. Electrochem. Soc.*, **68**, 159, 1935.
43. Goulder, F. The manufacture of dry batteries. *J. Proc. Sydney. Tech. Coll. Chem. Soc.*, **4**, 26, 1930.
44. Goulder, F. The manufacture of dry batteries. *Chem. Eng. Mining Rev.*, **25**, 274, 1933.
45. Gray, A. R. Dry cell resistances, *Electronics*, **9**, 36, 1936.
46. Grimm, H. A method of studying the drying of paste in pocket lamp dry cells. *Z. Electrochem.*, **36**, 427, 1930.
47. Groves, A. W. Manganese, 1938 Ed. Published by the *Imperial Institute, London.*

48. Gruhl, M. Investigation of Leclanché cell for pocket flashlights. *Z. Electrochem.*, **31**, 214, 1925.
49. Hambuechen, C. Performance of dry cells. *Trans. Am. Electrochem. Soc.*, **21**, 297, 1912.
50. Hambuechen, C. and Ruhoff, O. E. Physical and chemical data on dry cells and dry cell materials. *Trans. Am. Electrochem. Soc.*, **22**, 467, 1912.
51. Helfrecht, A. J. Depreciation in small dry cells with age. *Trans. Am. Electrochem. Soc.* **36**, 269, 1919.
52. Hermann, Z. Constituents of a Leclanché Cell II, The role of the lampblack. *Monatsh.*, **71**, 175, 1938.
53. Hofman., Metallurgy of Zinc and Cadmium 1922 Ed. *Mc. Graw Hill Book Co., N. Y.*
54. Holler, H. D. and Ritchie, L. M. Hydrogen ion concentration in dry cells. *Trans. Am. Electrochem. Soc.*, **37**, 607, 1920.
55. Holler, H. D. and Ritchie, L. M. Relation of voltage of dry cells to hydrogen ion concentration. *Bureau of Standards Paper No. 364*, 1920.
56. Huntley, A. K. A radio 'B' dry battery of flat type construction. *Trans. Electrochem. Soc.*, **63**, 219, 1935.
57. Iida, H. Purification of manganese dioxide, *J. Soc. Chem. Ind. (Japan), Suppl. binding.* **37**, 168-B, 1934.
58. Ilinskii, V. P. and Lapin, N. P. Investigation of the Leclanché cell I. Behaviour of natural and artificial Manganese dioxide. *Zhur Prikladnoi Khim.*, **1**, 176, 1928.
59. Ilinskii, V. P. and Lapin, N. P. Preparation of manganese dioxide by electrolysis. *J. Applied. Chem. (U. S. S. R.)*, **4**, 757, 1922.
60. Jegge, E. O. Absorption phenomena in primary cells. *Trans. Electrochem. Soc.*, **53**, 71, 1928.
61. Jone, F. D. Die Design and Die Making Practice 1930 Ed. *Machinery Publishing Co., Ltd., London.*
62. Jumau, L. The theory of the Leclanché cell. *Rev. Gen. Elec.*, **42**, 651, 1937.
63. Jamau, L. Primary batteries in recent patents, *Rev. Gen. Elec.*, **414**, 657, 1937.
64. Jumau, L. Recent patents on dry batteries. *Rev. Gen. Elec.* **45**, 397, 1939.
65. Kameyama N. Life of dry cells I.—Rate of discharge and the life. *J. Soc. Chem. Ind. (Japan), Suppl. binding*, **32**, 142-B., 1929.
66. Kameyama N. Life of dry cells II—Discharge mechanism of grains of active material. *J. Soc. Chem. Ind. (Japan), Suppl. binbing*, **32** 144-B, 1929.
67. Kameyama N. Life of dry cells III—Life in the regularly intermittent constant current discharge. *J. Soc., Chem. Ind. (Japan), Suppl. binding*, **32**, 161-B., 1929.
68. Kameyama N. Dry cell for use at low temperatures. *J. Soc. Chem. Ind. (Japan), Suppl. binding*, **37**, 168-B., 1934.
69. Kameyama N. The life of dry cells, especially in case of discharge through constant resistance. *J. Electrochem. Asso. (Japan)*, **2**, 380, 1934.
70. Kameyama, N. and Iida, H. Preparation of manganese dioxide by means of electrolysis with alternating current. *J. Soc., Chem. Ind. (Japan), Suppl. binding*, **45**, 374-B., 1932.
71. Kameyama, N. and Iida, H. Use of manganese dioxide prepared by the alternating current electrolysis as the depolarizer of dry cells. *J. Soc. Chem. Ind. (Japan), Suppl. binding*, **35**, 375-B., 1932.

72. Kameyama, N. and Iida, H. Dry cells for use at low temperatures II. *J. Soc. Chem. Ind. (Japan), Suppl. binding*, **39**, 431-B., 1936.
73. Kameyama, N. and Naka, A. Dry cells for use at low temperatures III. *J. Soc. Chem. Ind. (Japan), Suppl. binding*, **39**, 432-B., 1936.
74. Kaneko, S. The electromotive force of the dry cell *J. Soc. Chem. Ind. (Japan), Suppl. binding*, **32**, 37-B., 1929.
75. Kaneko, S., Nemoto, C. and Makino, S. Studies on manganese dioxide for the dry cell. *J. Soc. Chem. Ind. (Japan), Suppl. binding*, **32**, 205-B., 1929.
76. Kato, Y. and Matsuhashi, T. Studies on a new process for making manganese dioxide I. *J. Soc., Chem. Ind. (Japan), Suppl. binding*, **32**, 313-B., 1929.
77. Kato, Y. and Matsuhashi, T. Studies on a new process for making manganese dioxide II. Properties of the product. *J. Soc. Chem. Ind. (Japan), Suppl. binding*, **32**, 315-B., 1929.
78. Kato, Y. and Matsuhashi, T. Studies on a new process for making manganese dioxide III. Comparison of chemical and physical properties of natural and artificial manganese dioxide of different origins. *J. Soc. Chem. Ind. (Japan), Suppl. binding*, **34**, 312-B., 1931.
79. Kato, Y. and Matsuhashi, T. A process for manufacturing manganese dioxide, its electrochemical properties. *Proc. World. Eng. Cong. (Tokyo)*, 1929, **31**, 305, 1931.
80. Kato, Y. and Matsuhashi, T. Artificial manganese dioxide applied to the production of dry cells of long shelf-life. *J. Soc. Chem. Ind. (Japan), Suppl. binding*, **36**, 164-B., 1933.
81. Keller, A., Uber das Lechlanché Elementé. *Z. Electrochem.*, **37**, 342, 1931.
82. Kirkman, F. J. Economic control of dry cell manufacture. *Trans. Electrochem. Soc.*, **69**, 273, 1936.
83. Kobe, K. A., and Graham R. P., The effect of applying a counter e.m.f. to a Lechlanché cell. *Trans. Electrochem. Soc.*, **73**, 587, 1938.
84. Kobozev, N. I. and Sokolov, N. N. Physical chemical investigations of the air depolarisation in Lechlanché cells. *J. Appl. Chem. U. S. S. R.*, **7**, 297, 1934.
85. Kœhler, W. A. Principles and Applications of Electro-chemistry Vol. II. Applications, 1935 Ed. *John Wiley and Sons Inc., New York*.
86. Kostjejev, V. A. Effect of various factors on output of Lechlanché cells. *Trans. Electrochem. Soc.*, **58**, 305, 1930.
87. Kostjejev, V. A. Effect of the electrolyte on the efficiency of the Lechlanché cell. *Arch. Hem. Farm*, **5**, 281, 1931, and *Chimie E., Industrie*, **27**, 338, 1932.
88. Kozlor, V. V. and Volfson, T. I. Active manganese dioxide from pyrolusite, *J. Chem. Ind. (Moscow)*, **12**, 1167, 1935.
89. Krivolutskaya, N. S. and Morozov. The influence of the shape of carbon electrodes on the properties of carbon zinc elements. *Zhur. Prikladnoi, Khim*, **2**, 703, 1929.
90. Kubo, R. Dry batteries. *Repts. Imp. Ind. Research Inst. Osaka (Japan)*, **16**, No. 12, 1—22, 1936.
91. Lawson, H. E. Relationship of service characteristics of dry cells. *Trans. Electrochem. Soc.*, **68**, 187, 1935.
92. Lawson, H. E. Cylindrical cell 'B' dry battery. *Trans. Electrochem. Soc.*, **69**, 265, 1936.

93. Lawson H. E. and Kirkman, F. J. Characteristics of the size 'F' dry-cell. *Trans. Electrochem. Soc.*, **70**, 441, 1936.
94. Liedel, E. Improvements in accumulators and dry batteries. *Z. Angew. Chem.*, **42**, 301, 1929.
95. Loveridge, F. H. Dry cell tests. *Trans. Am. Electrochem. Soc.*, **16**, 109, 1909.
96. MacInnes, D.A. Polarisation in Leclanché cells. *Trans. Am. Electrochem. Soc.*, **29**, 315, 1916.
97. Makino, S. The corrosion of zinc electrode in a dry cell during the open circuit. *J. Soc. Chem. Ind. (Japan), Suppl. binding*, **33**, 176-B., 1930.
98. Makino, S. Studies on the materials for the dry cell II. *J. Soc. Chem. Ind. (Japan), Suppl. binding*, **33**, 326-B., 1930.
99. Makino, S. Self discharge of dry cells. *J. Soc., Chem. Ind. (Japan), Suppl. binding*, **33**, 521-B., 1930.
100. Makino, S. Manganese dioxide for the dry cell III. *J. Soc., Chem. Ind. (Japan), Suppl. binding*, **35**, 69-B., 1932.
101. Makino, S. Dry cells of standard sizes I. *J. Electrochem. Assoc. (Japan)*, **1**, 225, 1933.
102. Makino, S., Dry cells of standard sizes. *J. Electrochem. Assoc. (Japan)*, **1**, 257, 1933.
103. Makino, S. The discharge characteristics of the dry cell. *J. Electrochem. Assoc. (Japan)*, **3**, 1935.
104. Makino, S. Effect of temperature on the capacity and life of dry cells made according to Japanese Standard Specifications: Circulars. *Electrotech. Lab.*, **107**, 92 pp., 1937.
105. Makino, S. and Satake, Y. The quality of ammonium chloride for dry cells. *J. Electrochem. Assoc. (Japan)*, **2**, 110, 1934.
106. Makino, S. and Satake, Y. The self discharge of the dry cell I. The self discharge of negative and positive electrodes. *J. Electrochem. Assoc. (Japan)*, **3**, 243, 1935.
107. Makino, S. and Takizawa, S. Ammonium chloride for dry cells. *J. Electrochem. Assoc. (Japan)*, **2**, 420, 1934.
108. McKay, R. J. and Worthington, R. Corrosion resistance of metals and alloys, 1936 Ed. p. 156 *Reinhold Publishing Corp., New York*.
109. Martin, T. J. The magnetic concentration of certain natural and artificial manganese dioxides. *Trans. Electrochem. Soc.*, **57**, 467, 1930.
110. Martin, T. J. and Helfrecht A. J. Potentials of manganese dioxide in electrolytes of various hydrogen ion concentrations. *Trans. Electrochemical Soc.*, **53**, 83, 1928.
111. Mellor, J. W. A. comprehensive treatise on Inorganic and Theoretical chemistry Vol. XII, p. 150.
112. Nichols, G. W. Electrolytic manganese dioxide. *Trans. Electrochem. Soc.*, **62**, 393, 1932.
113. Nikolaus Branz. Guiding principles of Battery Manufacture, 4 Books. *Berlin*, S. 42.
114. Okada, S., Watanabe, K. and Nakamura, O. Manganese dioxides for dry cells I. *J. Electrochem. Assoc. (Japan)*, **2**, 213, 1934.
115. Okada, T., Watanabe, K. and Sawada, N. Manganese dioxide for the dry cell. *J. Electrochem. Assoc. Japan*, **3**, 248, 1935.

116. Ordway, D. L. Some characteristics of the modern dry cell. *Trans. Am. Electrochem. Soc.*, **17**, 341, 1910.
117. Oswald, M., Improvements in carbon electrodes. *Chimie and Industrie, Special Number 428* (Feb. 1929).
118. Pritz, W. B. Dry cell testing. *Trans. Am. Electrochem. Soc.*, **19**, 31, 1911.
119. Richardson, H. K. The modern dry cell, its development, construction and manufacture. *Met. and Chem. Eng.*, **10**, 531, 1912.
120. Sanderson, R. W. W. The testing of dry cells. *G. E. C. Jour.*, **1**, 115, 1930.
121. Schrader, E. Zinc in the construction of cups for Leclanché cells. *Z. Metallkunde*, **23**, 301, 1931.
122. Smitheringale, W. V. Etching tests and X-ray examination of some manganese minerals. *Econ. Geol.*, **24**, 481, 1929.
123. Staley, W. D. and Helfrecht, A. J. Gelatinization of corn starch in dry cell electrolyte. *Trans. Electrochem. Soc.*, **53**, 93, 1928.
124. Thompson, B. M. Effect of hydrogen ion concentration on the voltage of the Leclanché dry cell. *Ind. Eng. Chem.* **20**, 1176, 1928.
125. Thompson, M. de Kay. Current producing reactions of the Leclanché cell. *Trans. Electrochem. Soc.*, **63**, 167, 1935.
126. Thompson, M. de Kay. and Crocker E. C. Depolarisation in Leclanché cells. *Trans. Am. Electrochem. Soc.*, **27**, 155, 1915.
127. Vepa, V. L. R. The potential of dry cells with magnesium chloride electrolyte. *Jour. Indian Inst. Sci.*, **17-B**, 101, 1935.
128. Verman, L. C. and Joglekar G. D. Semi-Automatic cell testing device for dry cells. *Current Science*, **8**, 332, 1939.
129. Verman, L. C., Subba Ramaiah, K. and Joglekar, G. D. Effect of iron content of manganese ores on dry cell characteristics. *Current science*, **9**, 64, 1940.
130. Verwey, E. J. W. and de Boer, J. H. Cation arrangement in a few oxides with crystal structure of the special type. *Rec. Trav. Chim. Pays-Bas*, **55**, 531, 1936.
131. Vinal G. W. A. S. A. Committee keeps standards on dry cells., *Ind. Standardization and Commercial Standards Monthly*, **8**, 49, 1937.
132. Vinal G. W. and Ritchie, L. M. Electrical characteristics and testing of dry cells. *Circ. Bureau of Standards*, No. **79**, 62, pp. 1923.
133. Wagner, A. Chemical industry and the manufacture of electric cells. *Chem. Ztg.*, **51**, 157—179, 1927.
134. Walker, W. H., Lewis, W. K., Mc Adams W. H. and Gilliland E. R. Principles of Chemical Engineering, 1937 Ed. *Mc.Graw Hill Publishing Corp., London.*
135. Zalesinski, E. Requirements and testing of sheet zinc for the manufacture of batteries. *Metallwirtschaft*, **12**, 699, 1933.
136. Zimmerman, J. G. Rapid dry cell testing. *Trans. Electrochem. Soc.*, **53**, 103, 1928.

BULLETINS OF INDIAN INDUSTRIAL RESEARCH.



No. 24

**RNT CLAY OR SURKHI,
AS POZZOLANA**

BY

C. A. R. KHAN, M.Sc.

AND

LAL C. VERMAN, Ph.D., M.S., F. Inst. P.

**OFFICE OF THE DIRECTOR,
SCIENTIFIC AND INDUSTRIAL RESEARCH.
DEPARTMENT OF COMMERCE,
GOVERNMENT OF INDIA**

**PUBLISHED BY THE MANAGER OF PUBLICATIONS, DELHI.
PRINTED BY THE MANAGER, GOVERNMENT OF INDIA PRESS, SIMLA.
1941**

M179CD

H3522

H1

The statements made and the views expressed are those of the authors, and Government of India do not accept responsibility for them.

CONTENTS.

	PAGE.
I. INTRODUCTION	1
II. EXPERIMENTAL DETAILS--	
General Outline	4
Clays and Bricks	4
Grinding and Sieving	6
Chemical Examination	6
Screen Analyses	8
Limes Used	11
Gauging and Maturing	12
Tensile Tests	13
III. EXPERIMENTAL RESULTS	13
IV. DISCUSSION OF RESULTS--	
General	25
Comparison of Surkhis	26
Time of Maturing and Degree of Burning	29
Fineness of Grinding and Sieve Analysis	45
Composition of Lime	49
Consistency of Mix and Period of Soaking	49
V. SUMMARY AND CONCLUSIONS]	52
VI. ACKNOWLEDGEMENTS	53

H35221

BURNT CLAY, OR SURKHI, AS POZZOLANA.

I.—INTRODUCTION.

Pozzolanas are materials which easily react with fat lime at ordinary temperatures to form cementitious products in the presence of water or water vapour. They may occur naturally as such or may be produced artificially by burning naturally occurring substances such as clays, shales, and certain siliceous rocks. To the former group belong materials of volcanic origin, which, in fact, represent the product of the action of volcanic heat on clayey materials.

The Greeks and Romans made use of natural pozzolanas obtained from certain volcanic deposits ⁽¹⁾. In admixture with lime and sand they succeeded in producing hydraulic mortars resistant to sea water. The Romans also appear to have used artificial pozzolanas in the form of burnt clay obtained by grinding tiles and pottery. In this connection it may be mentioned that "Surkhi" is a term applied in India to powdered brickbats or bricks commonly used for building purposes and the widespread and extensive use of surkhi as an addition to fat lime mortars to obtain hydraulic properties appears to be a contribution of India and Egypt ⁽²⁾, in which countries it has been in use from times immemorial in many important works of construction that have withstood, in certain cases, centuries of weathering. The brickbats or bricks from which surkhi is prepared almost invariably contain sand in admixture with the clay.

At the present time pozzolanas are generally used in :—

- (a) fat lime mortars to develop hydraulic properties,
- (b) cement mortars and concrete to render them resistant to salt water,
- (c) the manufacture of lime pozzolana bricks.

In straight fat lime mortars cementing properties are produced by the formation of calcium carbonate, through the action of atmospheric carbon dioxide. This reaction is, however, relatively slow and is generally confined to the relatively better exposed external parts of the mortar; furthermore, the cementing properties of the carbonate are comparatively poor ⁽³⁾, whereas the addition of pozzolanas to fat lime mortars leads to the production of a strong cementing compound by the interaction of the lime and pozzolana.

In the course of the setting of portland cement a certain amount of free lime is thrown out ⁽⁴⁾, which, besides being weak as a cementing material,

⁽¹⁾ F.M. Lea and C. H. Desch, "Chemistry of Cement and Concrete" 1935 (Arnold).

⁽²⁾ M. Fitzmaurice; *Proc. Inst. Civil Eng.*, 152, 71, 1902-3.

⁽³⁾ Building Research Board Annual Report 1931, p. 44.

⁽⁴⁾ F. M. Lea and C. H. Desch, *Loc. Cit.* p. 44.

renders the structure susceptible to the attack of salt and consequent cracking and failure ⁽⁵⁾ ⁽⁶⁾ ⁽⁷⁾. It has been found, however, that the addition of a proportion of pozzolana to cement mortars and concretes results not only in improvement of the resistance to corrosion by sea water ⁽⁸⁾, but also in increase of strength ⁽⁹⁾, ⁽¹⁰⁾.

As pointed out above, for the production of both natural and artificial pozzolanas, clayey materials require to be subjected to a high temperature, one effect of which is that dissociation of chemically combined water takes place ⁽¹¹⁾. This dissociation is doubtless accompanied by other reactions, which, due to the complex nature of clays in general, are not easy to determine although a great deal of work has been and is still being done in various laboratories to investigate them.

Various reactions taking place under similar circumstances in a simpler form of clay mineral, namely kaolinite have been studied and may, therefore be used as an indication of what may take place in clays in general on burning at high temperatures. The known facts in the case of kaolinite may be summarised ⁽¹²⁾ as follows:—

(1) Upto 550°C:—

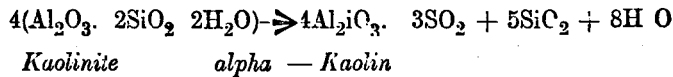

(2) Between 870°C and 1060°C:—

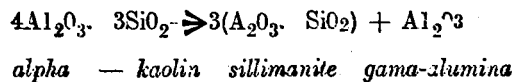

(3) Above 1060°C:—

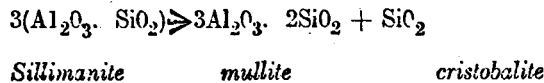

It will be seen that silica and alumina are set free at various stages of the burning of kaolinite. Similar reactions may be expected to give rise to free and active forms of silica and alumina, when ordinary clays are fired for the manufacture of bricks and during the formation of other pozzolanic masses,

⁽⁵⁾ F. M. Lewis and C. H. Desch, *Loc. Cit.*, pp. 364-370.

⁽⁶⁾ P. P. Ilchukov, *Stroitel Prom.*, 16 Nos. 8-9 pp. 75-79 (1938).

⁽⁷⁾ V. M. Moskvina, *Chimie et Industrie*, 40, 1125 *Kalii*, 7, No. 2, 23-7 (1938).

⁽⁸⁾ Building Research Board Annual Report, 1932 p. 39.

⁽⁹⁾ Building Research Board Annual Report, 1930 p. 23.

⁽¹⁰⁾ C. A. R. Khan and Lal C. Verman, "Cement-Surkhi Mortars", *Indian and Eastern Engineer*, June 1940.

⁽¹¹⁾ Frey, *Comp. Rend.*, 67, 1205 (1969).

⁽¹²⁾ F. M. Clews, H. H. Macey, and G. R. Rigby, "Some Properties of Clays", *Chem. and Ind.*, 57, 221 (1938).

natural or artificial, and it is this free silica and/or free alumina which is assumed to be responsible for the reaction between lime and pozzolanas.

Here again the reactions involved are of a complex nature and are still to a considerable extent conjectural; it has, however, been demonstrated that hydrated forms of mono-calcium silicate (¹³), (¹⁴), and tetra-calcium aluminate (¹⁵) are formed in lime-pozzolana mortars. Reactions in aqueous solutions between lime and silica have also been studied (¹⁶) and indicate that the nature of the reaction product, depends on the concentration of lime in solution. Thus while hydrated mono-calcium silicates are formed at low concentrations of lime, hydrated di-calcium-silicates ($2\text{CaO} \cdot \text{SiO}_2$) are obtained at concentrations approaching saturation.

It may be concluded from the above discussion that the quality of a given sample of pozzolana for use in lime mortars would depend, among other things, on the history of its formation, particularly on the temperature at which it has been fired. Studies at the Building Research Station, England, indicate that for every clay there exists an optimum temperature of burning, (lying somewhere between 600 and 800°C) which gives a resulting pozzolana of the highest activity (¹⁷).

In these studies activity was determined by measuring the decrease in electrical conductivity of a standard lime solution to which the pozzolana had been added. The results thus obtained were found to correspond to strength tests on lime-pozzolana mortars (17) at early periods of maturing, but it was later found that they did not correspond to the mortar strength at long periods of maturing (¹⁸). Thus it would appear that this method of determining the optimum temperatures of burning could not be relied upon for the production of the best quality of artificial pozzolanas.

On the other hand the investigations described in this paper indicate that clays burnt at temperatures approaching the sintering point yield the best quality pozzolanas, so far as the ultimate strength of the resulting mortars is concerned. It appears, therefore, that the free silica in the form of cristobalite produced at temperatures above 1060°C contributes considerably towards the activity of the pozzolanas.

Besides the question of firing temperatures there are a number of other factors which influence the quality of a pozzolana mortar, and it was the purpose of these investigations to study the effects of the different variables influencing the strength of these mortars under practical conditions of application. Attention was, therefore, confined to pozzolanas, or rather surkhis, prepared from clays found in the vicinity of Calcutta. The variables studied included :—

- (i) chemical composition of the clays.
- (ii) degree of burning.

(¹³) *Building Research Board Annual Report*, 1930, p. 32.

(¹⁴) Vittorio Cirilli, *Ann. Chim. Applicata*, 28, 239-44 (1938).

(¹⁵) G. Malquori, *Giron. Chim. Ind. Applicata*, 12, 6, 312 (1930).

(¹⁶) Alfred E. Beitlich, *Jour. Amer. Chem. Soc.*, 60, 8, 1832-36 (1938).

(¹⁷) *Building Research Board Annual Reports*, 1926, pp. 34-36 and 1927, pp. 48-49.

(¹⁸) *Building Research Board Annual Reports*, 1929, p. 31.

- (iii) time of maturing the resulting mortars.
- (iv) fineness of grinding of each surkhi.
- (v) particle size distribution of each surkhi.
- (vi) composition of the lime used in the mortars.
- (vii) mortar consistency.
- (viii) period of soaking of the mortars prior to use.

This investigation was largely restricted in scope to cover only such conditions as may obtain in practice. There remains, however, a number of points of scientific interest which need further study, and these may be taken up at a later date.

II.—EXPERIMENTAL DETAILS.

General Outline.

To study the effect of the different variables mentioned above, surkhis prepared from bricks obtained from various sources were subjected to thorough examination under varying conditions. In each case the tensile strengths of the mortars prepared with them, which developed at different maturing periods, were determined and used as the criterion of quality. It is realised that other factors, such as resistance to weather and to corrosive elements (salt water), compressive and adhesive strength, etc., are also important, but in the present investigation attention was confined to determination of the tensile strengths only, leaving other factors for future consideration.

Bricks of varying degrees of burning together with samples of the clays used in their manufacture were collected from a number of brick-fields. The clays were subjected to complete chemical analysis, and the bricks were sorted and ground to produce surkhi. The mortars prepared from these surkhis were gauged into biquettes, and these were matured under water, their tensile strength being determined at various periods of maturing. The data thus collected were carefully examined with a view to determining the effect of the different variables under consideration.

Clays and Bricks.

Nine brick-fields in the neighbourhood of Calcutta formed the source of the clays and bricks involved in this investigation. It may be pointed out here that the bricks collected from these brick fields do not represent burnt clay alone, but a mixture of clay and sand in unknown proportions. No attempt was made to ascertain the exact proportions of the sand-clay mixture used in the bricks, for it would vary from one brick-field to another and also probably from day to day in the same brick-field. The surkhis made from such bricks represent, however, the material actually used in the building industry in this country and, therefore, form a representative set of samples.

In Table I below is collected the general information regarding the various brick-fields together with the designation assigned to each of these for the purposes of reference in this paper.

TABLE I.
General Information regarding various Brick-fields.

No.	Designation.	Location.	Type of Clay.
1	A	Bally	Mixture of pit clay and recent silt.
2	B	Baruipur	Pit clay.
3	C	Nangi	Recent silt.
4	D	Gokulpur	Few years old silt.
5	E	Gokulpur	Few years old silt.
6	F	Gokulpur	Few years old silt.
7	G	Maharajpur	Recent silt.
8	H	Kanchrapara	Few years old silt.
9	J	Belghuria	Pit clay.

The analyses of the clays collected from the various brick-fields are given in Table II.

TABLE II.
Chemical Analyses of the Clays used in various Brick-fields.

Constituent in %	Brick-field.									
	A	B	C	D	E	F	G	H	J	
Moisture ..	4.83	9.20	16.25	2.85	3.62	4.23	5.20	3.85	13.98	
<i>Analysis of Dry Sample :-</i> Loss on igni- tion.	6.43	6.50	7.60	3.60	5.05	4.95	3.80	6.90	6.35	
Silica ..	64.34	62.11	60.30	71.42	66.77	66.38	54.82	60.79	63.68	
Iron oxide..	5.49	6.40	6.50	5.60	6.80	6.80	7.10	6.00	5.90	
Alumina ..	16.44	16.92	16.75	12.50	14.90	15.20	15.55	14.25	14.55	
Titanium oxide.	0.89	1.10	0.95	1.30	1.20	1.20	1.00	0.90	1.10	
Lime ..	1.82	1.98	2.40	1.17	1.02	1.10	5.40	4.38	3.10	
Magnesia ..	2.59	2.52	2.80	1.21	1.35	1.43	3.32	2.78	2.10	
Alcalis ..	1.98	1.78	2.60	3.50	3.13	3.22	4.17	4.24	3.20	
Totals ..	99.98	99.31	99.90	100.30	100.22	100.28	100.16	100.24	100.07	

- (iii) time of maturing the resulting mortars.
- (iv) fineness of grinding of each surkhi.
- (v) particle size distribution of each surkhi.
- (vi) composition of the lime used in the mortars.
- (vii) mortar consistency.
- (viii) period of soaking of the mortars prior to use.

This investigation was largely restricted in scope to cover only such conditions as may obtain in practice. There remains, however, a number of points of scientific interest which need further study, and these may be taken up at a later date.

II.—EXPERIMENTAL DETAILS.

General Outline.

To study the effect of the different variables mentioned above, surkhis prepared from bricks obtained from various sources were subjected to thorough examination under varying conditions. In each case the tensile strengths of the mortars prepared with them, which developed at different maturing periods, were determined and used as the criterion of quality. It is realised that other factors, such as resistance to weather and to corrosive elements (salt water), compressive and adhesive strength, etc., are also important, but in the present investigation attention was confined to determination of the tensile strengths only, leaving other factors for future consideration.

Bricks of varying degrees of burning together with samples of the clays used in their manufacture were collected from a number of brick-fields. The clays were subjected to complete chemical analysis, and the bricks were sorted and ground to produce surkhi. The mortars prepared from these surkhis were gauged into biquettes, and these were matured under water, their tensile strength being determined at various periods of maturing. The data thus collected were carefully examined with a view to determining the effect of the different variables under consideration.

Clays and Bricks.

Nine brick-fields in the neighbourhood of Calcutta formed the source of the clays and bricks involved in this investigation. It may be pointed out here that the bricks collected from these brick fields do not represent burnt clay alone, but a mixture of clay and sand in unknown proportions. No attempt was made to ascertain the exact proportions of the sand-clay mixture used in the bricks, for it would vary from one brick-field to another and also probably from day to day in the same brick-field. The surkhis made from such bricks represent, however, the material actually used in the building industry in this country and, therefore, form a representative set of samples.

In Table I below is collected the general information regarding the various brick-fields together with the designation assigned to each of these for the purposes of reference in this paper.

TABLE I.
General Information regarding various Brick-fields.

No.	Designation.	Location.	Type of Clay.
1	A	Bally	Mixture of pit clay and recent silt.
2	B	Baruipur	Pit clay.
3	C	Nangi	Recent silt.
4	D	Gokulpur	Few years old silt.
5	E	Gokulpur	Few years old silt.
6	F	Gokulpur	Few years old silt.
7	G	Maharajpur	Recent silt.
8	H	Kanchrapara	Few years old silt.
9	J	Belghuria	Pit clay.

The analyses of the clays collected from the various brick-fields are given in Table II.

TABLE II.
Chemical Analyses of the Clays used in various Brick-fields.

Constituent in %	Brick-field.								
	A	B	C	D	E	F	G	H	J
Moisture ..	4.83	9.20	16.25	2.85	3.62	4.23	5.20	3.85	13.98
Analysis of Dry Sample :- Loss on igni- tion.	6.43	6.50	7.60	3.60	5.05	4.95	8.89	6.90	6.35
Silica ..	64.34	62.11	60.39	71.42	66.77	66.38	54.82	60.79	63.68
Iron oxide..	5.49	6.40	6.50	5.60	6.80	6.80	7.10	6.00	5.90
Alumina ..	16.44	16.92	16.75	12.50	14.90	15.20	15.55	14.25	14.55
Titanium oxide.	0.89	1.10	0.95	1.30	1.20	1.20	1.00	0.90	1.10
Lime ..	1.82	1.98	2.40	1.17	1.02	1.10	5.40	4.38	3.10
Magnesia ..	2.59	2.52	2.80	1.21	1.35	1.43	3.32	2.78	2.19
Al. calis ..	1.98	1.78	2.60	3.50	3.13	3.22	4.17	4.24	3.20
Totals ..	99.98	99.31	99.90	100.30	100.22	100.28	100.16	100.24	100.07

Grinding and Sieving.

The bricks collected from each brick-field were separated into three groups by visual examination according to the extent of their burning, the groups being generally as follows:—

(1) *Underburnt*, designated as *U*:—bricks light red, almost pink in colour, relatively soft, and easily crushable.

(2) *Well-burnt*, designated as *W*:—bricks deep red in colour, relatively hard, and with a metallic ring.

(3) *Overburnt*, designated as *O*:—bricks dark brown, almost black in colour semi-fused, very hard to crush, commonly known locally as 'Jhamma'.

Each group of bricks was separately crushed in a cast-iron ball mill, until the surkhi so prepared could be sieved through a 30-mesh B. S. sieve. The material retained on the sieve was subjected to further grinding and similarly treated. One set of experiments to determine the tensile strength of the resulting mortar was conducted with these surkhis, and further tests were carried out on surkhis passing a 170-mesh B. S. sieve, obtained by sieving the 30-mesh material through the 170-mesh sieve.

Eight sets of experiments were carried out with these surkhis under varying experimental conditions, as described below.

Chemical Examination.

In addition to chemical analysis, the proportion soluble in dilute hydrochloric acid and also in distilled water were determined in the case of each of the 30-mesh surkhis. The results are tabulated in Table III, and from these it will be seen that the water-soluble fraction almost invariably decreases as the degree of burning increases. This is doubtless due to such factors as volatilization, decomposition and combination of water soluble alkali salts with other material.

TABLE III.

Dilute Hydrochloric Acid and Water Soluble Fractions of various Surkhis.

Brick fields	Surkhi.	Portion soluble in dil. hydrochloric acid%.				Portion soluble in water%.			
		Si O ₂	Fe ₂ O ₃	Al ₂ O ₃	Total.	Sul-phates.	Nit-rates.	Chlo-rides.	Total.
A.	Under-burnt ..	3.90	0.94	0.49	5.33	0.26	0.0004	Trace	0.2604
	Well ..	4.15	0.75	0.90	5.80	0.15	0.0003	Nil	0.1503
	Over ..	6.58	0.64	1.30	8.52	0.10	0.0002	Nil	0.1002
B.	Under ..	2.21	3.28	6.37	11.86	0.20	Trace	Trace	0.20
	Well ..	2.70	1.70	0.20	4.60	0.20	Nil	Nil	0.20
	Over ..	2.80	1.25	0.70	4.75	0.12	"	"	0.12
C.	Under ..	5.40	3.20	3.95	12.55	0.05	Trace	0.03	0.08
	Well ..	4.30	1.60	3.35	9.25	0.03	"	0.02	0.05
	Over ..	3.40	1.30	2.65	7.35	0.02	"	0.02	0.04
D.	Under ..	0.20	0.78	1.12	2.10	Trace	"	0.025	0.025
	Well ..	1.60	0.32	0.68	2.60	"	"	0.018	0.018
	Over ..	1.95	0.38	0.78	3.11	"	"	0.009	0.009
E.	Under ..	4.35	1.81	3.54	9.70	"	"	0.014	0.014
	Well ..	1.05	0.38	0.92	2.35	Nil	"	0.014	0.014
	Over ..	1.80	0.39	0.61	2.80	Nil	"	0.010	0.010
F.	Under ..	3.15	1.16	1.14	5.45	Trace	0.0034	0.014	0.0174
	Well ..	0.25	0.27	0.90	1.42	Nil	Trace	0.010	0.010
	Over ..	1.66	0.46	0.94	3.06	"	Nil	Trace	Nil
G.	Under ..	8.85	0.84	5.86	15.55	0.07	Trace	0.017	0.087
	Well ..	9.90	0.70	7.13	17.73	0.05	Nil	0.014	0.064
	Over ..	10.10	1.20	7.00	18.30	0.017	Nil	0.010	0.027
H.	Under ..	7.25	0.59	7.21	15.05	0.12	0.0034	0.014	0.1174
	Well ..	7.45	0.64	6.01	14.10	Trace	Trace	0.014	0.014
	Over ..	5.20	0.97	6.83	13.00	Nil	Nil	0.010	0.010
J.	Under ..	5.55	1.60	3.95	11.10	0.13	Trace	0.014	0.144
	Well ..	4.30	0.84	2.96	8.10	0.10	"	0.014	0.114
	Over ..	3.60	0.60	2.45	6.65	Trace	"	0.010	0.010

So far as the hydrochloric acid soluble fractions are concerned, silica appears to show no systematic variation with the degree of burning, but ferric oxide decreases with increase of the degree of burning in all cases except G and H, and alumina shows a similar trend with the exception of surkhis A and G.

The decrease of the iron content with increasing degree of burning may be attributable to the partial elimination of iron from the surkhi, as effects of this kind have been studied in the case of white enamels⁽¹⁹⁾, limes⁽²⁰⁾, and glasses⁽²¹⁾. The effect appears to be caused by the formation of ferric chloride owing to the action of sodium chloride vapour on iron oxides; ferric chloride being volatile at high temperatures is consequently eliminated. A similar effect on alumina has been demonstrated to occur at 1,000°C in fireclay, silica, and china clay by Clews, Richardson and Green⁽²²⁾. It appears, therefore, that in the process of burning clays into surkhi, the iron and alumina contents decrease, due to the formation of chlorides which volatilise.

Screen Analyses.

The results of screen analyses of the various 30-mesh samples are given in Table IV. The variations occurring in the grain size distribution may be ascribed to such factors as the relative hardness of the original bricks, which may be influenced by the texture of the clay and the degree of burning, the detail of the method by which the grinding is carried out and the presence of sand, which is comparatively hard to grind. The original grain size of the sand, its relative hardness and proportion of admixture would also influence the final grain size of the surkhi obtained. In actual practice surkhi is generally ground in this country by a rough and ready stone roller mill driven either mechanically or by bullocks; even greater variations than those indicated by the data in Table IV may, therefore, be expected on construction works.

For the purpose of this investigation, any conclusion that may be drawn from the mortar strength tests must necessarily be guided and influenced by the grain size distribution. In many cases, it would suffice to consider averages for all the surkhis tested for which purposes the average grain size distribution may be considered applicable. This has been calculated and included as the last item in Table IV.

(19) G. Bole and R. M. Howe "Action of Chlorides on the Volatilisation of Ferric Iron" *Trans. Amer. Cer. Soc.*, 17, 125, 1915.

(20) Tokiti Noda "On the Calcination of Lime, VIII-IX, Chemical Effects of Sodium Chloride in the Calcination of Limestone", *Jour. Soc. of Chemical Industry, Japan*, 42, 202B, June 1939.

(21) H. M. Marshall and W. E. S. Turner, "A Study of the Possibility of Reducing the Iron Oxide content of Molten Soda—Lime—Silica Glasses by the action of chlorides" *Jour. of th. Soc. of Glass Tech.*, 23, 253-264, August 1939.

(22) Clew, F. H., Richardson, M. H., and Green, A. T., "An Examination of Reaction of Sodium Chloride Vapour with Refractory Materials at 1,000°C and Conditions Leading to Volatilization of Brick Constituents", *Inst. Gas. Engrs.*, Copyright Pub. 193/76, 9-17, 1938; *Chem. Abs.*, 33, 6547, 1939.

TABLE IV.
Screen Analyses of 30-Mesh Surkhis.

Brick-field.	Degree of burning.	Percentage retained on B. S. mesh.				Percentage passing B. S. mesh 300.
		52	100	200	300	
A.	Under	7	20	38	42	58
	Well	6	16	28	34	66
	Over	0	2	15	28	72
B.	Under	1	12	29	33	67
	Well	8	23	36	38	62
	Over	2	20	42	45	55
C.	Under	7	14	19	24	76
	Well	9	17	23	28	72
	Over	10	29	54	61	39
D.	Under	1	13	30	35	65
	Well	1	9	30	33	67
	Over	0	1	8	11	89
E.	Under	0	0	5	13	87
	Well	0	0	3	13	87
	Over	0	0	9	12	88
F.	Under	0	0	5	14	86
	Well	0	0	3	6	94
	Over	2	18	49	51	49
G.	Under	0	6	20	24	76
	Well	10	19	31	36	64
	Over	1	5	40	51	49
H.	Under	10	18	26	34	66
	Well	7	15	24	28	72
	Over	15	29	45	50	50
J.	Under	13	26	34	40	60
	Well	9	18	25	32	68
	Over	10	25	38	45	55
Average	Under	4	12	23	29	71
	Well	6	13	23	28	72
	Over	4	14	33	39	61

The influence of grain size distribution on the strength of mortars may be appreciated from the following considerations. In the mortar the grains of surkhi may be considered as packed closely together, with lime filling up the interstices and pores, and the reaction between the lime and surkhi grains in contact as producing the cementing material which serves to bind the various surkhi grains together. In that case the larger the surface of surkhi that is exposed to the action of lime, the greater will be the quantity of cementing material produced. This would require that the surkhi should be ground to as fine a powder as practicable, so as to give the largest possible surface area.

Now conceive of a surkhi consisting of very fine particles all of the same size. This will present a large surface area for reaction, but will at the same time give rise to conditions which do not allow of the densest packing of the particles. It is, therefore, likely that all the lime available in the voids will not be able to react with the surkhi particles, in which case, the strength of the mortar will be determined mainly by the strength of the cementing material available in a given cross-section. In contrast to this, consider a surkhi composed of fine as well as somewhat coarser grains so distributed as to give a very dense packing. In this case, although the surface area available would be somewhat smaller, yet all the available lime will have a chance to react, and the strength of the mortar will then be determined not only by the strength of the cementing material but also partially by the strength of the surkhi grains of relatively large dimensions. Furthermore, in the latter case the chances of unreacted lime being present will be considerably reduced.

This view-point is somewhat similar to that which is taken in the case of cement concretes in relation to the grading of aggregates, with this difference that in the case of surkhi mortars a compromise has to be arrived at between conflicting conditions, *i.e.* those necessary for obtaining the maximum available surface area for reaction on the one hand and those necessary for getting the densest packing on the other. With respect to the latter condition of packing, it is not only necessary to provide a rational grain size distribution but also to determine what is the best size for the coarsest grain that may be allowed. The lower limiting size of the finest grain will probably be determined by porosity or by the grinding procedure adopted. In this paper a few preliminary experiments demonstrating the importance of these considerations are described. A thorough study of this subject will, however, form the subject matter for further investigations.

For these preliminary experiments, surkhis of restricted particle size were prepared from overburnt bricks from brick-field A. The average particle size of these samples was taken to be the average of the diameter of the sieve opening through which it was passed and that of the sieve opening on which it was retained. The average particle size of the finest surkhi passing 300 mesh was determined by the particle size distribution diagram obtained in a separate experiment, involving the suspension of surkhi in white spirit and observation of its rate of settling. The details of these samples, thus prepared, are given in Table V.

TABLE V.

Details of Over-burnt Surkhi Samples, from Brick-field A, of Restricted Particle Size.

Sample No.	Passing Sieve.		Retained on Sieve.		Average particle Diameter in microns.
	B. S. Mesh No.	Aperture size microns.	B. S. Mesh No.	Aperture size microns.	
A 25 ..	25	599	52	295	447
A 52 ..	52	295	100	152	228
A100 ..	100	152	200	76	114
A200 ..	200	76	300	53	64
A300 ..	300	53	22

Limes Used.

The two limes used for these experiments were carefully chosen from among those available on the market. One of these represented high calcium limes and the other high magnesium limes. The choice was based on such considerations as purity of the material and uniformity of supply. In the selection of a lime uniformity of supply plays an important part, as its properties are greatly influenced by the burning temperature⁽²³⁾.

The chemical analyses of these limes are given in Table VI.

TABLE VI.

Chemical Analysis of Limes Used.

% Composition.				High Calcium Lime.	High Magnesium Lime.
Loss on ignition	1.75	1.85
Silica	2.35	2.80
Alumina and iron oxide	1.04	1.24
Calcium oxide	92.68	56.00
Magnesia	1.83	37.96
Sulphuric anhydride	0.36	0.09
Totals				100.01	99.94

⁽²³⁾ Knibbs N. V. S., "Design and Operation of Modern Lime Works", *Cement and Lime Manufacture*, 11, 4, 93, (1938).

The slaking of the limes was carried out with a slight excess of water in a closed vessel, after which the slaked powder was sieved through a No. 30 B. S. mesh sieve and then stored in air-tight containers till required.

Gauging and Maturing.

Before describing the procedure adopted for the laboratory experiments in respect of gauging and maturing, it might be of interest to state briefly the ordinary practice in vogue in the building industry in this country. The surkhi is first ground in a simple type of stone mill run by a bullock. The mill consists of a circular trench about 20 ft. in diameter built of brick, and the trench cavity in a typical mill may be about 12 inches wide and 12 inches deep. A circular stone wheel about 30 inches in diameter and 9 inches thick is mounted on a wooden pole so that it is free to turn on the pole, which acts as a horizontal axis. One end of the pole is pivoted at the centre of the trench circle, while the other end is drawn round by a bullock, the rim of the stone resting in the trench. The surkhi having been ground to sufficient fineness by this means, lime and water are added to it and grinding continued, the mortar thus prepared being fairly wet in consistency, and it is finally removed from the trench and used as required. The interval between mixing and application varies widely from a few hours to a few days. The finished structure is seldom allowed to soak in water or even kept wetted for the purpose of maturing.

In developing a laboratory method for testing the strength of lime-surkhi mortars, therefore, it is important to consider several points, such as :—

- (1) the lime-surkhi ratio,
- (2) consistency, *i.e.* quantity of water added,
- (3) the period of soaking before use, *i.e.* gauging of briquettes,
- (4) maturing procedure.

So far as the ratio of lime to surkhi is concerned, it was decided to use one ratio throughout all the experiments, the ratio selected being 1 to 3 by volume. The volumes of both surkhi and lime were measured by tapping them in containers of known volume until no further reduction in volume could be observed. The weights of the quantities mixed were also recorded. The weight of lime powder per unit volume was constant throughout the experiments, while that of surkhi varied somewhat, as might be expected.

It was considered to be desirable to work with two consistencies, wet and dry. The wet consistency generally used in the building industry was found to be too wet for the purpose of gauging test briquettes; consequently it was decided to regard as wet such a consistency as would give a penetration between 5 and 7 divisions of the Vicat plunger in a standard Vicat mould. This is in parallel with the standard practice used for testing portland cement and was found to give a satisfactory consistency for gauging the lime-surkhi test briquettes. The dry consistency was fixed after determining the amount of water required to make the driest possible mortar which could be satisfactorily gauged. This was found to be 0.68 times that required to make the wet consistency mortar. Thus a standard practice was established in which the dry consistency was considered to be obtained by using 0.68 times the water required for wet consistency as determined by the Vicat test described above.

Further, it was decided to test the effects of using two periods of soaking the mortar before gauging, namely 6 and 24 hours, these figures being thought to represent, on the average, the limits of soaking period employed in practice. At the end of each soaking period, the original consistency was restored by the addition of sufficient water, before gauging was carried out.

As regards the maturing procedure, the following practice was adopted. After gauging the test briquettes they were left for seven days in a damp box in which the atmosphere was maintained at a relative humidity between 90 and 95 per cent. They were removed from their moulds after having been in the damp box for three days. The briquettes were removed from the damp box at the end of the seventh day and kept under water for the pre-arranged maturing periods which were fixed at 14 days, 28 days, 3 months, and 6 months. The water used for maturing was Calcutta tap water, which is fairly soft all the year round, the water in the maturing tanks being changed twice a week. No attempt was made to regulate the temperature of water, as it was desired to obtain results of practical importance which would be applicable to normal atmospheric temperature conditions.

Tensile Tests.

After the required period of maturing, the batches of briquettes were subjected to tensile tests in an Avery Type machine (traversing weight). Each batch consisted of six briquettes and the average of the test results was taken to be the tensile strength of the batch.

III.—EXPERIMENTAL RESULTS.

The results of the tensile strength tests have been summarised in the Tables that follow. In these Tables and in the following graphs and pages a simple scheme of designation has been adopted for the sake of brevity in order to indicate the particular test conditions appertaining to the various batches. Each batch designation consists of two letters followed by a numeral, then a hyphen, another letter and lastly another numeral. The meaning of the various letters and numerals being as follows :—

First Letter	..	<i>C</i>	denotes high calcium lime.
		<i>M</i>	denotes high magnesium lime.
Second letter	..	<i>U</i>	denotes an under-burnt surkhi.
		<i>W</i>	denotes a well-burnt surkhi.
		<i>O</i>	denotes an over-burnt surkhi.
First number	..	<i>30</i>	denotes a 30-mesh surkhi.
		<i>170</i>	denotes a 170-mesh surkhi.
Third letter	<i>D</i>	denotes dry consistency.
		<i>W</i>	denotes wet consistency.
Second number	..	<i>6</i>	denotes 6 hours soaking.
		<i>24</i>	denotes 24 hours soaking.

For example, designation *MW170-W24* indicates a batch in which high magnesium lime and well-burnt 170-mesh surkhi were used in the ratio of 1 : 3 by volume (the ratio, being constant all through, is not explicitly indicated) and also that the mortar had wet consistency and was allowed to soak for

U

24 hours before gauging. Similarly *C W 30-D6* designates three batches
O

corresponding to the three degrees of burning.

In Table VII are collected the results of the tensile strength tests on 30-mesh surkhi mortars with high calcium lime. Only the effects of dry consistency with 6 hours' soaking were investigated in their case, and it will be shown later, in the case of 170-mesh surkhi, that this consistency with the shorter period of soaking gives the best strength.

In Tables VIII to XI are summarized the results of tests on 170-mesh surkhi with high calcium lime, both in respect of dry and wet mixes and 6 and 24 hours soaking periods. Similar results obtained in the case of 170-mesh surkhi with high magnesium lime are collected in Tables XII to XV.

The results obtained with restricted particle size over-burnt surkhi prepared from bricks taken from brick-field A are tabulated in Table XVI.

TABLE VII.

Tensile Strength $C \left\{ \begin{array}{c} U \\ W \\ O \end{array} \right\}$ 30-D6 Mortars.

Brick-field.	Degree of burning.	Lime Surkhi Ratio by weight.	Tensile Strength in lbs. per sq. inch at			
			14 days.	28 days.	3 months.	6 months.
A.	U	1:7.0	70	136	237	409
	W	1:7.5	135	265	519	524
	O	1:8.5	85	165	494	552
B.	U	1:7.1	141	159	216	223
	W	1:8.4	167	271	391	419
	O	1:9.6	143	299	273	541
C.	U	1:8.6	121	174	263	300
	W	1:9.0	114	220	283	330
	O	1:9.8	163	227	371	385
D.	U	1:9.3	139	237	318	347
	W	1:10.4	179	230	343	363
	O	1:11.0	156	217	442	468
E.	U	1:8.2	110	183	277	333
	W	1:9.9	141	235	333	390
	O	1:11.0	132	236	410	445
F.	U	1:8.5	142	215	276	317
	W	1:10.0	113	191	324	279
	O	1:10.6	121	210	357	384
G.	U	1:7.4	106	176	238	306
	W	1:7.9	137	131	281	219
	O	1:10.2	167	258	412	423
H.	U	1:7.8	81	183	298	307
	W	1:8.4	100	216	307	332
	O	1:10.0	151	293	411	442

Brick field.	Degree of burning.	Lime Surkhi Ratio by weight.	Tensile Strength in lbs. per sq. inch at			
			14 days.	28 days.	3 months.	6 months.
J.	U	1:7.9	165	240	300	310
	W	1:9.2	131	264	378	420
	O	1:9.8	170	286	401	471
Average of all.	U	1:8.0	119	189	275	317
	W	1:9.0	135	236	356	386
	O	1:10.1	143	244	419	457
Average of C to J.	U	1:8.2	122	201	281	317
	W	1:9.3	131	227	328	368
	O	1:10.3	151	247	401	431
Average of B, C, G, H, and J.	U	1:7.7	123	186	263	289
	W	1:8.6	130	240	328	364
	O	1:9.7	159	273	414	452
Average of C, G, H, and J.	U	1:8.0	118	193	275	306
	W	1:8.8	120	233	312	350
	O	1:10.0	163	266	399	430
Average of C, G, and J.	U	1:7.9	131	197	267	315
	W	1:8.7	127	233	314	356
	O	1:9.9	167	257	395	426

TABLE VIII.

Tensile Strength of C $\left\{ \begin{array}{l} U \\ W \\ O \end{array} \right\}$ 170-D6 Mortars.

Brick-field.	Degree of burning.	Tensile Strength in lbs. per sq. inch at.			
		14 days.	28 days.	3 months.	6 months.
B.	U	98	131	176	185
	W	147	270	352	362
	O	47	164	455	504
C.	U	148	230	276	296
	W	103	217	309	332
	O	151	266	362	392
G.	U	121	188	271	277
	W	147	220	313	321
	O	190	286	357	399
H.	U	160	209	279	297
	W	104	194	279	318
	O	184	274	366	375
J.	U	129	227	277	303
	W	74	194	317	322
	O	126	217	307	343
Average of all ..	U	131	197	256	272
	W	115	219	314	331
	O	140	241	359	403
Average of C, G, H, and J	U	139	213	276	293
	W	107	203	304	323
	O	163	261	348	377
Average of C, G, and J ..	U	133	215	275	292
	W	108	210	313	325
	O	156	256	342	378

TABLE IX.

Tensile Strength of C $\left\{ \begin{array}{l} U \\ W \\ O \end{array} \right\}$ 170—D24 Mortars.

Brick-field.	Degree of burning.	Tensile Strength in lbs. per sq. inch at			
		14 days.	28 days.	3 months.	6 months.
B.	U	74	114	140	156
	W	137	226	291	345
	O	26	202	425	457
C.	U	106	171	243	273
	W	112	240	261	298
	O	144	279	323	384
G.	U	73	138	199	205
	W	86	141	204	227
	O	155	261	317	321
H.	U	114	200	259	275
	W	112	193	272	280
	O	133	209	298	305
J.	U	114	198	238	272
	W	74	187	278	284
	O	89	212	280	330
Average of all..	U	96	164	216	236
	W	104	197	261	287
	O	109	233	329	359
Average of C, G, H, & J..	U	102	177	235	255
	W	96	190	254	272
	O	123	240	304	335
Average of C, G, & J ..	U	98	169	227	250
	W	91	189	248	270
	O	119	251	307	345

TABLE X.

Tensile Strength of C $\left\{ \begin{array}{c} U \\ W \\ O \end{array} \right\}$ 170—W6 Mortars.

Brick-field.	Degree of burning.	Tensile Strength in lbs. per sq. inch at			
		14 days.	28 days.	3 months.	6 months.
C.	U	64	139	186	210
	W	46	140	194	241
	O	115	230	293	381
G.	U	52	110	140	161
	W	53	115	167	186
	O	112	185	218	237
H.	U	71	145	191	227
	W	44	91	187	239
	O	80	149	222	270
J.	U	58	136	163	195
	W	41	88	172	220
	O	57	153	213	222
Average of all.	U	61	132	170	198
	W	46	109	180	222
	O	91	179	237	278
Average of C, G, & J	U	58	128	163	189
	W	47	115	178	216
	O	95	189	241	280

M179CB

TABLE XI.

Tensile Strength of $C \begin{Bmatrix} U \\ W \\ O \end{Bmatrix} 170-W24$ Mortars.

Brick-field.	Degree of burning.	Tensile Strength in lbs. per sq. inch at			
		14 days.	28 days.	3 months.	6 months.
C. ..	U	69	137	187	203
	W	67	149	220	278
	O	122	216	267	373
G.	U	37	77	129	148
	W	59	110	178	183
	O	56	193	210	233
H.	U	56	125	175	190
	W	49	87	195	220
	O	60	140	210	232
J.	U	57	118	140	152
	W	31	73	151	161
	O	63	139	204	208
Average of all. . .	U	55	114	158	173
	W	52	105	186	211
	O	75	152	223	261
Average of C, G, & J ..	U	54	111	152	168
	W	52	111	183	207
	O	80	156	227	271

TABLE XII.

Tensile Strength of $M \begin{Bmatrix} U \\ W \\ O \end{Bmatrix}$ 170-D6 Mortars.

Brick-field.	Degree of burning.	Tensile Strength in lbs. per sq. inch at			
		14 days.	28 days.	3 months.	6 months.
C.	U	105	145	229	289
	W	100	182	326	360
	O	150	231	368	431
G.	U	94	170	253	358
	W	77	135	225	297
	O	109	210	339	471
J.	U	155	219	302	310
	W	115	200	339	371
	O	229	242	387	397
Average	U	118	178	261	319
	W	97	172	297	343
	O	163	228	365	433

TABLE XIII.

Tensile Strength of $M \begin{Bmatrix} U \\ W \\ O \end{Bmatrix}$ 170-D24 Mortars.

Brick-field.	Degree of burning.	Tensile Strength in lbs. per sq. inch at			
		14 days.	28 days.	3 months.	6 months.
C.	U	82	120	188	264
	W	51	135	284	319
	O	125	212	314	362
G.	U	86	169	236	317
	W	62	147	241	281
	O	103	191	308	430
J.	U	135	209	286	312
	W	80	195	308	344
	O	112	216	324	362
Average	U	101	166	237	298
	W	64	159	278	315
	O	113	206	315	385

TABLE XIV.

Tensile Strength of $M \begin{Bmatrix} U \\ W \\ O \end{Bmatrix} 170-W6$ Mortars.

Brick-field.	Degree of bruning.	Tensile Strength in lbs. per sq. inch at			
		14 days.	28 days.	3 months.	6 months.
C.	U	42	80	165	196
	W	36	82	168	237
	O	92	189	273	323
G.	U	44	127	186	268
	W	40	92	191	289
	O	70	169	252	340
J.	U	38	148	232	266
	W	38	148	215	295
	O	77	186	313	320
Average	U	41	118	194	243
	W	38	107	191	274
	O	80	181	279	328

TABLE XV.

Tensile Strength of M $\begin{Bmatrix} U \\ W \\ O \end{Bmatrix}$ 170—W24 Mortars.

Brick-field.	Degree of burning.	Tensile Strength in lbs. per sq. inch at			
		14 days.	28 days.	3 months.	6 months.
C.	U	38	68	130	163
	W	26	65	131	194
	O	77	181	219	356
G.	U	23	80	140	190
	W	42	71	172	257
	O	75	161	216	313
J.	U	29	138	184	226
	W	35	138	211	281
	O	56	147	273	305
Average	U	30	95	151	193
	W	34	91	171	244
	O	69	163	260	325

TABLE XVI.

Tensile Strength of C O [Res.]—D3 Mortars with Surkhi from Brick-field A; [Res.] Indicates Particle Size of Restricted Dimensions (See Table V).

Sample No.	Average Particle Diameter Microns.	Reciprocal Particle Diameter mm-1.	Tensile Strength in lbs. per square inch at			
			14 days.	28 days.	3 months.	6 months.
A 25	447	2.24	55	94	270	330
A 52	228	4.38	56	89	258	335
A 100	114	8.77	74	153	344	406
A 200	64	15.63	179	259	383	422
A 300	22	45.5	276	312	374	466

IV—DISCUSSION OF RESULTS.

General.

The data collected in the ten Tables presented in the preceding section will now be examined from different angles, with a view to determining the effects of the different variables, discussed in the earlier sections.

Before going into further details, however, it may be pointed out here that any conclusions arrived at in this section may be considered as applicable only to the average climatic conditions prevailing in this part of the country (Bengal). In certain separate experiments not described in this paper and also in the course of work done at the Building Research Station ⁽²⁴⁾ it has been found that the temperature prevailing during the maturing period has a profound influence on the strength developed by mortars. Under ordinary atmospheric conditions, therefore, when the temperature is subject to fluctuation from day to day, and from week to week, the strength developed would be dependent upon the period of the year when the experiments were performed. But since the maturing periods extended to as long as six months, it might be accepted that the mortars matured over this long period would undergo somewhat similar fluctuations in temperature, irrespective of the time of the year at which the tests were initiated. On the other hand, early period strengths⁴ would be subject to such fluctuations as may be induced by the temperature² prevailing during the shorter periods of maturing. It is, therefore, reasonable to attach much greater importance to six months strengths for the purpose of comparison than to strengths obtained after shorter maturing periods unless of course the periods exactly coincided for the particular test figures under comparison.

Furthermore, use will be made of average figures (the average being taken over various brick-field surkhis) wherever possible, with a view to eliminating the effect of several variations, grading differences and other factors.

The detailed examination of the influence of temperature variations during the maturing period on the development of strength may form the subject matter of a separate investigation. The present investigation will serve to furnish results useful from the practical point of view and applicable to atmospheric conditions similar to those prevalent in the neighbourhood of Calcutta in particular and in Bengal in general. In this connection, it may be pointed out that in Calcutta the atmospheric temperature does not vary between such extremes as it does in many other parts of the country. In fact only about two months of the year, that is December and January, may be regarded as winter months, while during the remaining months the temperature may only vary approximately between 80 and 100°F. This fact must also be borne in mind while discussing the results of the experiments covered by the present investigations.

Another point, which needs careful consideration in connection with the statistical analyses of these results, concerns the variables affecting the firing of various clays. Neither the temperature nor the duration of burning were under strict control. As pointed out earlier, the bricks collected from various brickfields were sorted purely by their appearance and colour into three more

⁽²⁴⁾ Building Research Board, Annual Report 1930, pp. 25-26.

TABLE XV.

Tensile Strength of $M \begin{Bmatrix} U \\ W \\ O \end{Bmatrix}$ 170—W24 Mortars.

Brick field.	Degree of burning.	Tensile Strength in lbs. per sq. inch at			
		14 days.	28 days.	3 months.	6 months.
C.	U	38	68	130	163
	W	26	65	131	194
	O	77	181	219	356
G.	U	22	80	140	190
	W	42	71	172	257
	O	75	161	216	313
J.	U	29	138	184	226
	W	35	138	211	281
	O	56	147	273	305
Average	U	30	95	151	193
	W	34	91	171	244
	O	69	163	260	325

TABLE XVI.

Tensile Strength of C O [Res.]—D3 Mortars with Surkhi from Brick-field A; [Res.] Indicates Particle Size of Restricted Dimensions (See Table V).

Sample No.	Average Particle Diameter Microns.	Reciprocal Particle Diameter mm.-1.	Tensile Strength in lbs. per square inch at			
			14 days.	28 days.	3 months.	6 months.
A 25	447	2.24	55	94	270	330
A 52	228	4.38	56	89	258	335
A 100	114	8.77	74	158	344	406
A 200	64	15.63	179	259	383	422
A 300	22	45.5	276	312	374	466

IV—DISCUSSION OF RESULTS.

General.

The data collected in the ten Tables presented in the preceding section will now be examined from different angles, with a view to determining the effects of the different variables, discussed in the earlier sections.

Before going into further details, however, it may be pointed out here that any conclusions arrived at in this section may be considered as applicable only to the average climatic conditions prevailing in this part of the country (Bengal). In certain separate experiments not described in this paper and also in the course of work done at the Building Research Station ⁽²⁴⁾ it has been found that the temperature prevailing during the maturing period has a profound influence on the strength developed by mortars. Under ordinary atmospheric conditions, therefore, when the temperature is subject to fluctuation from day to day, and from week to week, the strength developed would be dependent upon the period of the year when the experiments were performed. But since the maturing periods extended to as long as six months, it might be accepted that the mortars matured over this long period would undergo somewhat similar fluctuations in temperature, irrespective of the time of the year at which the tests were initiated. On the other hand, early period strengths⁴ would be subject to such fluctuations as may be induced by the temperature³ prevailing during the shorter periods of maturing. It is, therefore, reasonable to attach much greater importance to six months strengths for the purpose of comparison than to strengths obtained after shorter maturing periods unless of course the periods exactly coincided for the particular test figures under comparison.

Furthermore, use will be made of average figures (the average being taken over various brick-field surkhis) wherever possible, with a view to eliminating the effect of several variations, grading differences and other factors.

The detailed examination of the influence of temperature variations during the maturing period on the development of strength may form the subject matter of a separate investigation. The present investigation will serve to furnish results useful from the practical point of view and applicable to atmospheric conditions similar to those prevalent in the neighbourhood of Calcutta in particular and in Bengal in general. In this connection, it may be pointed out that in Calcutta the atmospheric temperature does not vary between such extremes as it does in many other parts of the country. In fact only about two months of the year, that is December and January, may be regarded as winter months, while during the remaining months the temperature may only vary approximately between 80 and 100°F. This fact must also be borne in mind while discussing the results of the experiments covered by the present investigations.

Another point, which needs careful consideration in connection with the statistical analyses of these results, concerns the variables affecting the firing of various clays. Neither the temperature nor the duration of burning were under strict control. As pointed out earlier, the bricks collected from various brickfields were sorted purely by their appearance and colour into three more

⁽²⁴⁾ Building Research Board, Annual Report 1930, pp. 25-26.
M179CD

or less well defined groups. It is, therefore, necessary to interpret the results with caution wherever the degree of burning enters as an important variable.

Comparison of Surkhis.

The strengths developed by different surkhis collected from various brick-fields differ considerably from each other, and it is possible that the strength depends on the chemical constitutions of unburnt clays and that of surkhis themselves, among other variables. Attempts were made to discover whether any relationship existed between the chemical composition of clays and surkhis on the one hand and the tensile strength of the mortars prepared from the latter under similar conditions on the other. From the point of view of similar temperature conditions existing during the test period, the data presented in Table VII appeared to be the best suited for this purpose. All the tests recorded in this table, except those on surkhis A and B, were started in the dry summer months of April to June. The tensile strengths at six months from this table for surkhis C to J were, therefore, plotted against the percent. composition of the clays and that of surkhis given in Tables II and III. In Figures 1 to 6, are reproduced some of the curves, which indicate the existence of some sort of correlation. Figures 1 to 4 deal with the composition of the clays which entered into the manufacture of the surkhis and Figures 5 and 6 refer to the strength as a function of the constituents of surkhis soluble in water. Other chemical variables concerning surkhis and clays not covered by these figures did not yield curves which could be interpreted as indicating any relationship.

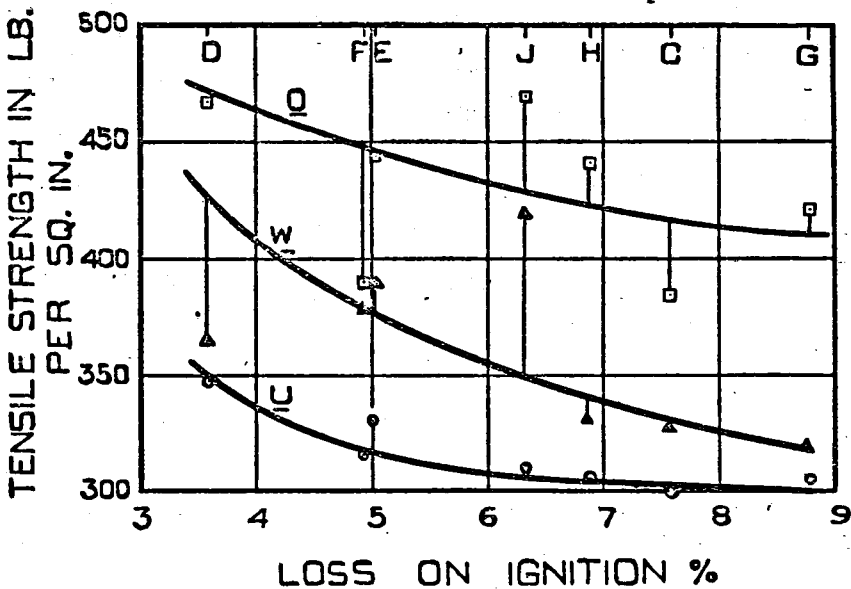

Fig. 1. Tensile strength at six months of *C W 30-D6* lime-surkhi mortars

(C to J) plotted against % loss on ignition of original clays.

In Figure I, tensile strength at six months is plotted against percent loss on ignition of the clays, which may mostly be taken to represent water of hydra-

tion. It appears that decreasing amounts of water of hydration present in clays give surkhis of greater strength. A similar conclusion applies to the alkali content of clays shown in Figure 2. In both these figures it will be observed that under-burnt surkhis yield a better correlation with the chemical variables of the clay than well-burnt or over-burnt surkhis. This may be due to the fact that the chemical constitution of under-burnt surkhi corresponds more closely to the original clay than that of the other surkhis.

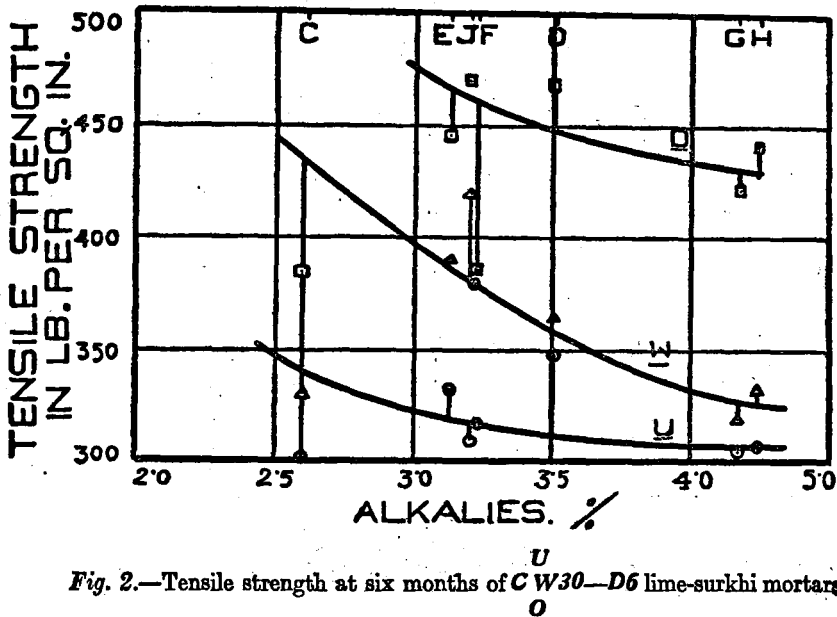

Fig. 2.—Tensile strength at six months of *CW30—D6* lime-surkhi mortars (C to J) plotted against % alkali content of original clays.

Figures 3 and 4, dealing with the iron and alumina contents, give curves as regard well-burnt surkhis which are remarkable in that the points appear to be on two distinct curves. At the same time, the under-burnt and over-burnt surkhis give curves which do not differ appreciably from those of Figures 1 and 2. The conclusion may be hazarded that the surkhi strength increases with decreasing amounts of iron and alumina in the clays, but such a conclusion would naturally carry much less weight than similar conclusions in the case of the two earlier figures.

The effect of the alkali content on the strength may be due to alkali salts being removed from the mortar by dissolution in the water during the maturing period, which may lead to the production of so-called "Locherstellen" or "Weak spots" throughout the mass of the mortar, thereby reducing its strength.

In figure 5 are plotted tensile strength figures of batches after maturing for six months against the total water-soluble contents of their various surkhis.

or less well defined groups. It is, therefore, necessary to interpret the results with caution wherever the degree of burning enters as an important variable.

Comparison of Surkhis.

The strengths developed by different surkhis collected from various brick-fields differ considerably from each other, and it is possible that the strength depends on the chemical constitutions of unburnt clays and that of surkhis themselves, among other variables. Attempts were made to discover whether any relationship existed between the chemical composition of clays and surkhis on the one hand and the tensile strength of the mortars prepared from the latter under similar conditions on the other. From the point of view of similar temperature conditions existing during the test period, the data presented in Table VII appeared to be the best suited for this purpose. All the tests recorded in this table, except those on surkhis A and B, were started in the dry summer months of April to June. The tensile strengths at six months from this table for surkhis C to J were, therefore, plotted against the percent. composition of the clays and that of surkhis given in Tables II and III. In Figures 1 to 6, are reproduced some of the curves, which indicate the existence of some sort of correlation. Figures 1 to 4 deal with the composition of the clays which entered into the manufacture of the surkhis and Figures 5 and 6 refer to the strength as a function of the constituents of surkhis soluble in water. Other chemical variables concerning surkhis and clays not covered by these figures did not yield curves which could be interpreted as indicating any relationship.

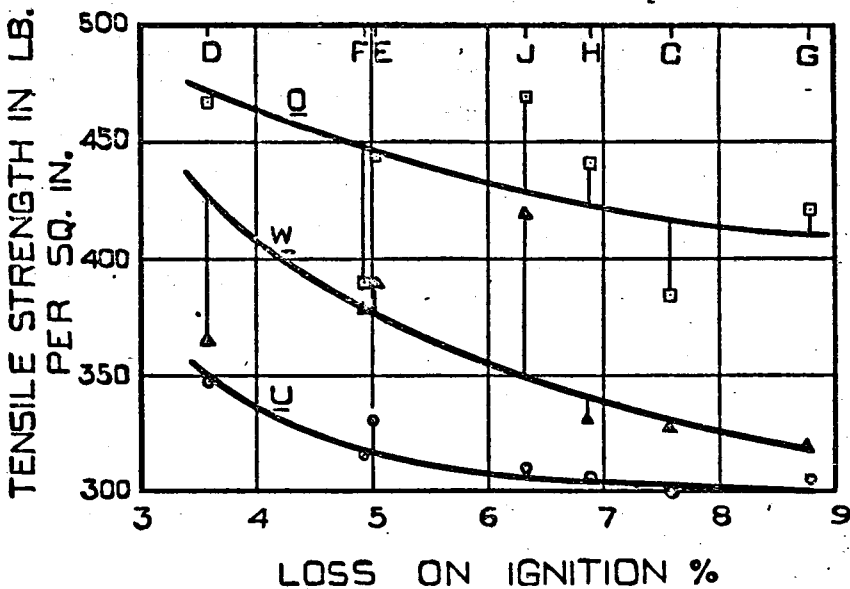

Fig. 1. Tensile strength at six months of $C W 30-D6$ lime-surkhi mortars

(C to J) plotted against % loss on ignition of original clays.

In Figure I, tensile strength at six months is plotted against percent loss on ignition of the clays, which may mostly be taken to represent water of hydra-

tion. It appears that decreasing amounts of water of hydration present in clays give surkhis of greater strength. A similar conclusion applies to the alkali content of clays shown in Figure 2. In both these figures it will be observed that under-burnt surkhis yield to a better correlation with the chemical variables of the clay than well-burnt or over-burnt surkhis. This may be due to the fact that the chemical constitution of under-burnt surkhi corresponds more closely to the original clay than that of the other surkhis.

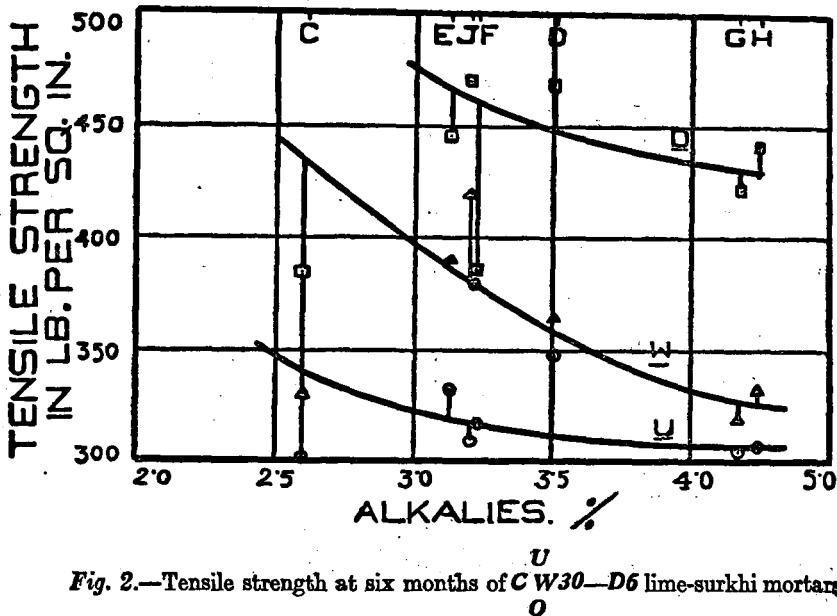

Fig. 2.—Tensile strength at six months of *CW30-D6* lime-surkhi mortars (C to J) plotted against % alkali content of original clays.

Figures 3 and 4, dealing with the iron and alumina contents, give curves as regard well-burnt surkhis which are remarkable in that the points appear to be on two distinct curves. At the same time, the under-burnt and over-burnt surkhis give curves which do not differ appreciably from those of Figures 1 and 2. The conclusion may be hazarded that the surkhi strength increases with decreasing amounts of iron and alumina in the clays, but such a conclusion would naturally carry much less weight than similar conclusions in the case of the two earlier figures.

The effect of the alkali content on the strength may be due to alkali salts being removed from the mortar by dissolution in the water during the maturing period, which may lead to the production of so-called "Locherstellen" or "Weak spots" throughout the mass of the mortar, thereby reducing its strength.

In figure 5 are plotted tensile strength figures of batches after maturing for six months against the total water-soluble contents of their various surkhis.

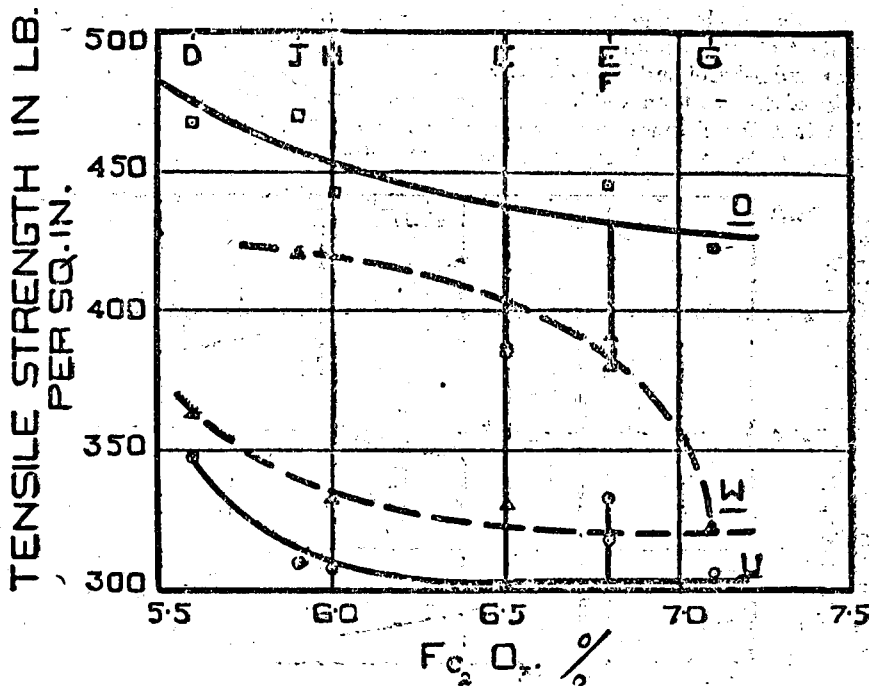

Fig. 3.—Tensile strength at six months of $C W 30-D6$ lime-surkhi mortars

(C to J) plotted against % $Fe_2 O_3$ content of original clays.

It will be seen that an approximate curve may be drawn through all the points covering all three degrees of burning. The previous conclusion, namely, that the strength deteriorates with the increased alkali content of clays, is further supported by this graph. It is quite likely that the greater strength of well-burnt surkhi as compared with under-burnt and also that of over-burnt surkhi as compared with well-burnt may be due, among other factors, to the fact that the water-soluble fraction (mostly alkali salts) decreases with the increasing degree of burning.

The same data are reproduced in Figure 6, but in a different way. Here the strengths of the over-burnt surkhi and under-burnt surkhi are calculated as percentages of the well-burnt surkhi, and these percentage figures are plotted against the water-soluble percentage contents of the over-burnt and under-burnt surkhis; calculated on the basis of water-soluble content of well-burnt surkhi; as relative values are plotted in this Figure, surkhis A and B have also been included. Besides substantiating the above conclusion with respect to the alkali content, this Figure demonstrates quite clearly the order of excellence of the surkhis in terms of the degree of burning. This point will be discussed in further detail in the following section.

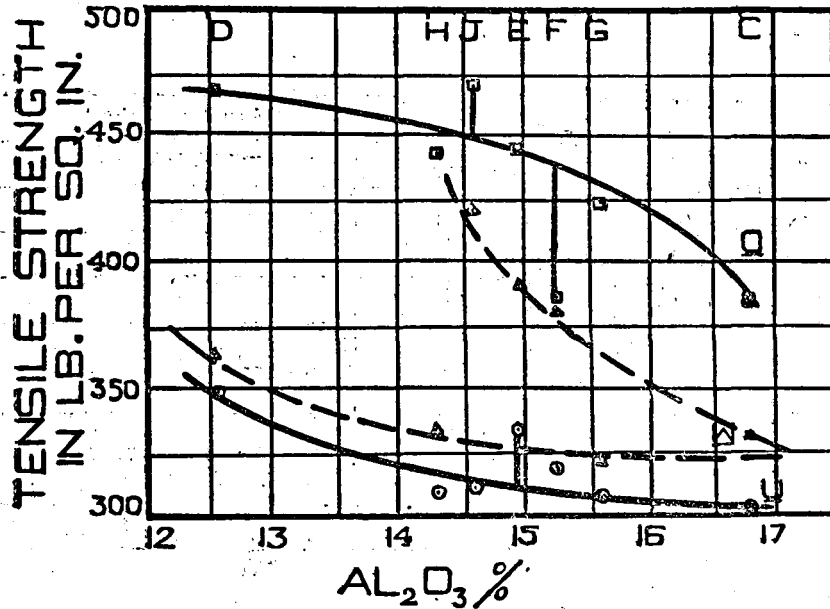

Fig. 4.—Tensile strength at six months of CW 30—D6 lime-surkhi mortars (C to J) plotted against % Al_2O_3 content of original clays.

The curves drawn in all the Figures, from 1 to 6, may only be regarded as indicative of general trends, and the fact that some points lie off these curves may be attributed to the fact that all the variables concerned were not under the strictest control. The non-uniformity of grading may especially be regarded as responsible for certain of the deviations, and the possible effects of grading have already been discussed in an earlier section. The general trends indicating the dependence of strength on chemical composition are, however, quite unmistakable in certain cases.

Time of Maturing and Degree of Burning.

The strengths of lime-surkhi mortars increase with extension of the period of maturing; the rates of development and the final values attained depend a great deal on the degree of burning. Both these variables will be discussed together in this section for the sake of convenience.

Before entering into details it may be well to point out that each set of three mortars comprising under, well, and over-burnt surkhis from a given brick-field was gauged, matured and tested simultaneously. Thus the effects of temperature variation during the period of maturing would be common

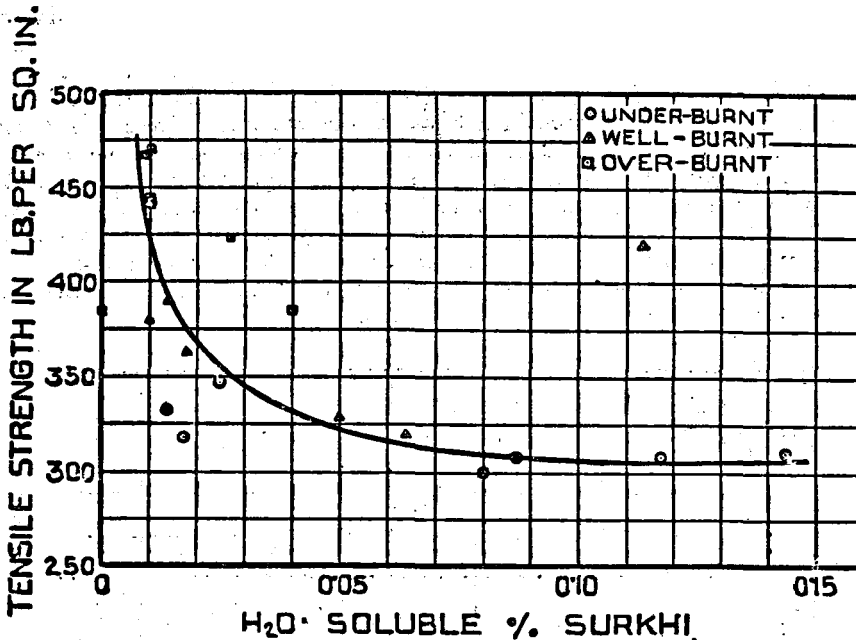

Fig. 5.—Tensile strength at six months of *C W 30—D6* lime-surkhi mortars

(C to J) plotted against % water soluble fractions of under, well and over-burnt surkhis.

to all ; in other words it should be possible to decide with a fair degree of exactitude whether in producing surkhi, it is preferable to under-burn the clay, over-burn it or to burn it to the normal extent.

On the other hand the effect of time of maturing on the development of strength is largely dependent upon the temperature level prevailing during the maturing period. Consequently the available data require to be scrutinised with special attention to the prevailing temperatures during the set of tests concerned. The necessity of using average figures and strength figures obtained at the end of maturing periods of six months in this connection is apparent. Moreover, even after six months it may be possible to obtain a different strength value in the case of mortars gauged in winter and tested in summer from that for mortars gauged in summer and tested in winter, although the average of prevailing temperatures in each case may be the same. As mentioned earlier however, these are some of the points which, it is hoped, will form the subject matter of a separated detailed investigation.

In Figure 7 are plotted on rectilinear co-ordinates the average tensile strength for surkhis C to J obtained from *C W 30—D6* mortars against time

of maturing. This graph shows a typical curve which can be obtained with any set of data given in Tables VII to XVI. The strength increases at a very rapid rate in the early stages of maturing, but with the progress of time the rate of maturing gradually decreases until at six months it tends to approach zero. In other words, an approximately asymptotic maximum strength is reached in about six months' time in most cases. It is important to note, however, that although the rate of increase of strength is negligible at long periods it is by no means zero; in fact, in a few individual cases an appreciable departure from the asymptotic approach has been observed. It is quite likely that the strength may in fact keep on increasing for a very long period of time, perhaps decades or even centuries, as indicated by the excellent state of preservation of various historic monuments built with lime-surkhi mortars (1), (2).

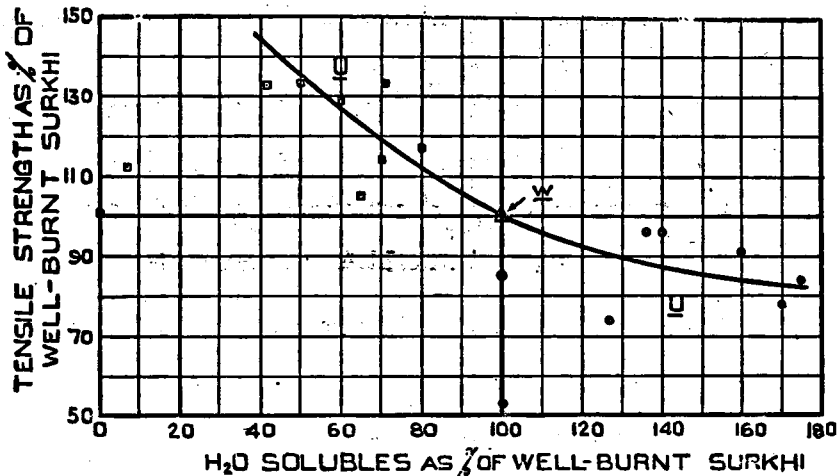
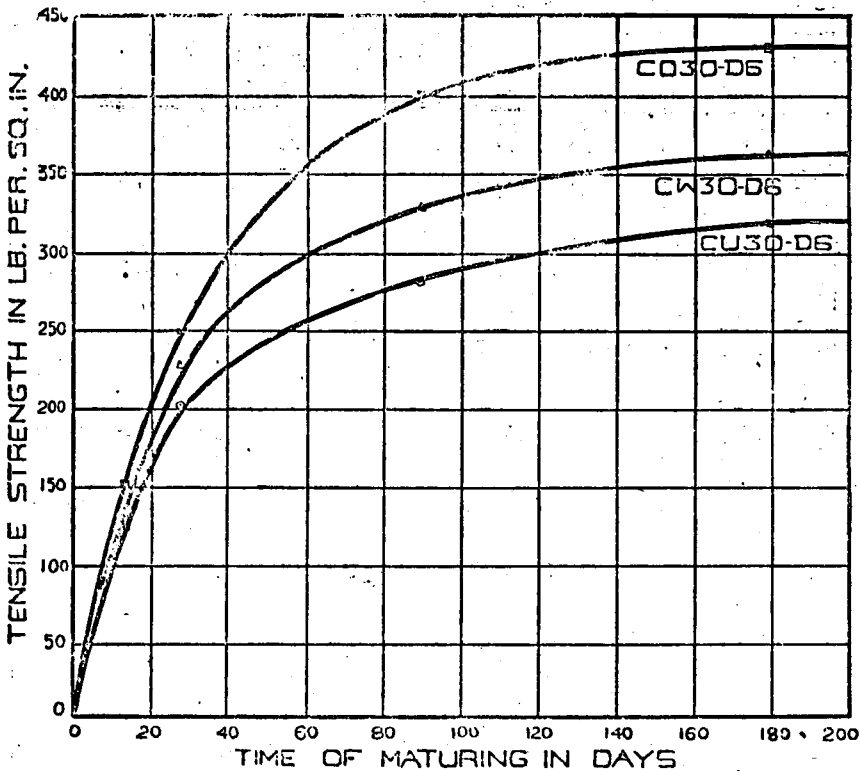

Fig. 6.—Tensile strength at six months of *CU30—D6* and *CO30—D6* lime-surkhi mortars (A to J) expressed as percentages of strength of *CW30—D6* mortars plotted against percent water soluble of under and over-burnt surkhi expressed as percentage of water soluble of well-burnt surkhi.

Attempts at discovering an empirical law or formula to express the strength as a function of time did not succeed in providing a general expression applicable to all the available data. It was found convenient, however, to plot the strength data against the log-log time of maturing, and graphs in accordance with this are reproduced in Figures 8 to 16 in which individual results as well as certain pertinent average figures are plotted. These plots bring out the various relationships very clearly.

It will be seen that many of the plots are straight up to about the three months period, thereafter showing an asymptotic bend similar to rectilinear plots. A small minority of the curves show curvature throughout the period,

and in the case of high magnesium lime mortars a few curves show an increasing slope at the end of the test period, that is to say, an extraordinary increase in the rate of hardening. The general rule which may be deduced from this seems to be that in the initial stages extending up to three to six months the strength increases approximately according to a log-log relationship, while after this period the strength tends to approach an asymptotic maximum value. In the case of high magnesium limes, however, this asymptotic value does not always appear, and these exceptional cases deserve further detailed study extending over longer periods of time.



U
Fig. 7.—Tensile strength of *C W 30—D6* mortars averaged over surkhis
O
 (C to J) plotted against time of maturing on rectilinear co-ordinates.

The initial period strength corresponding to the straight line portions of the log-log curves (Figs. 8 to 16) may be mathematically expressed as:—

$$S = k \log\text{-}\log a T.$$

where S is the tensile strength (lbs. per sq. inch)

T is the time of maturing (days)

k is constant denoting the slope of the straight portions of curves (Figs. 8 to 16,) and a is a constant determining the position of the curves (Figs. 8 to 16).

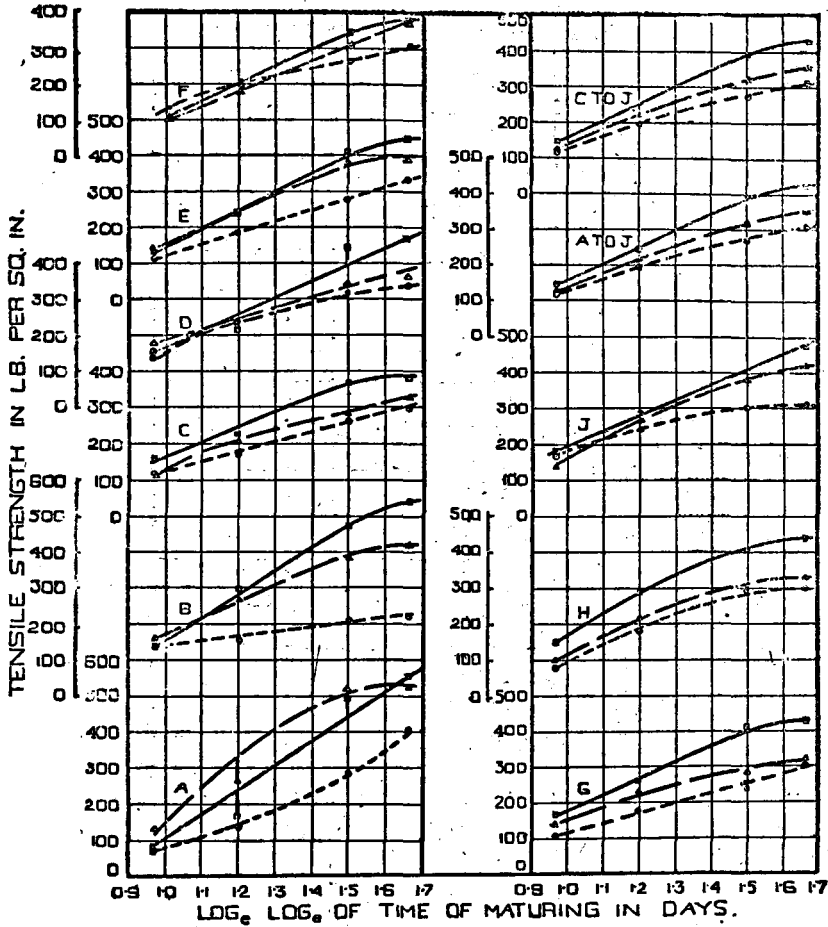

U
Fig. 8.—Tensile strength of $CW\ 30-D6$ mortars for individual surkhis
 O

and average over A to J and C to J surkhis plotted against \log_{10} of time of maturing in days.

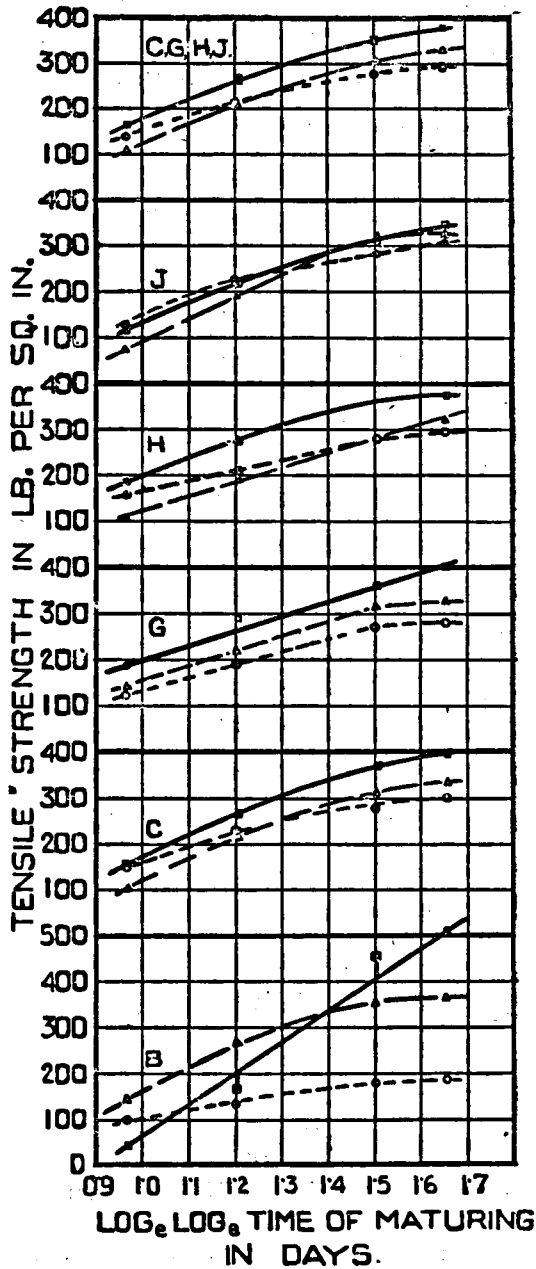

$$\frac{U}{O}$$
 Fig. 9.—Tensile strength of *C W 170-D6* mortars for individual surkhis and average of C, G, H and J surkhis plotted against $\log_{10} \log_{10}$ of time of maturing in days.

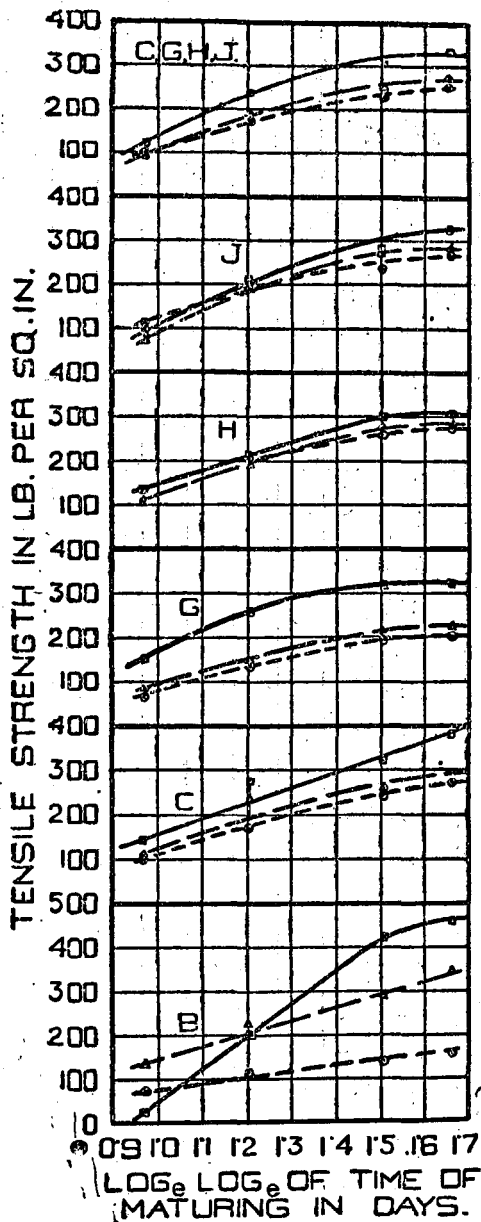

U
 Tensile strength of C.W. 170-D24 mortars for individual surkhis
 O
 of C, G, H and J surkhis plotted against log_e log_e of time of matur-

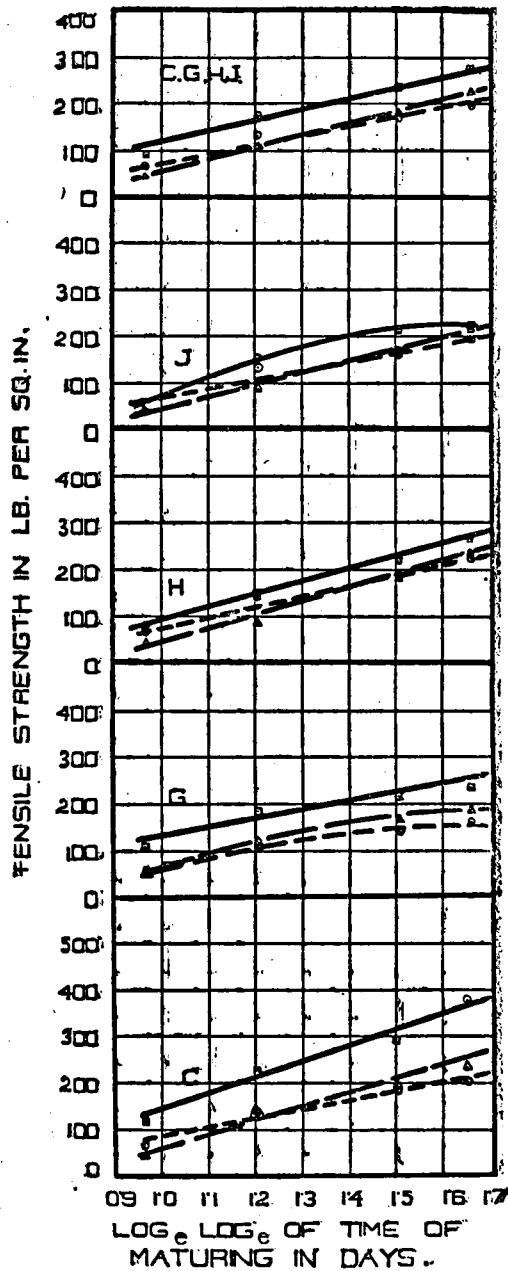

$\frac{U}{O}$

Tensile strength of *C W 170-D6* mortars for individual surkhis and average of C, G, H and J surkhis plotted against log_e log_e of time of maturing in days.

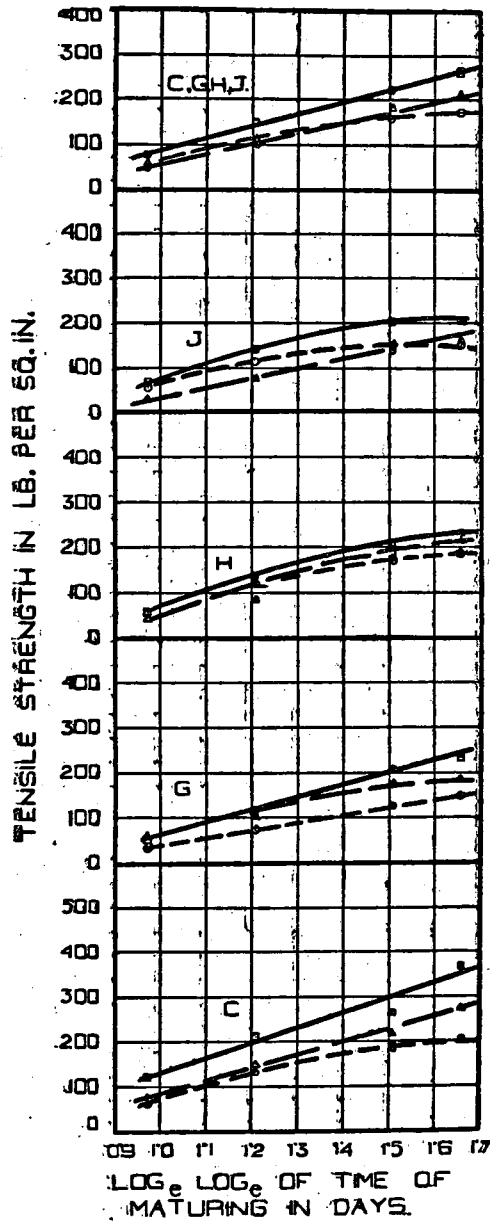

U
O

Fig. 12.—Tensile strength of *C W 170—W 24* mortars for individual surkhis and average of C, G, H and J surkhis plotted against $\log_e \log_e$ of time of maturing in days.

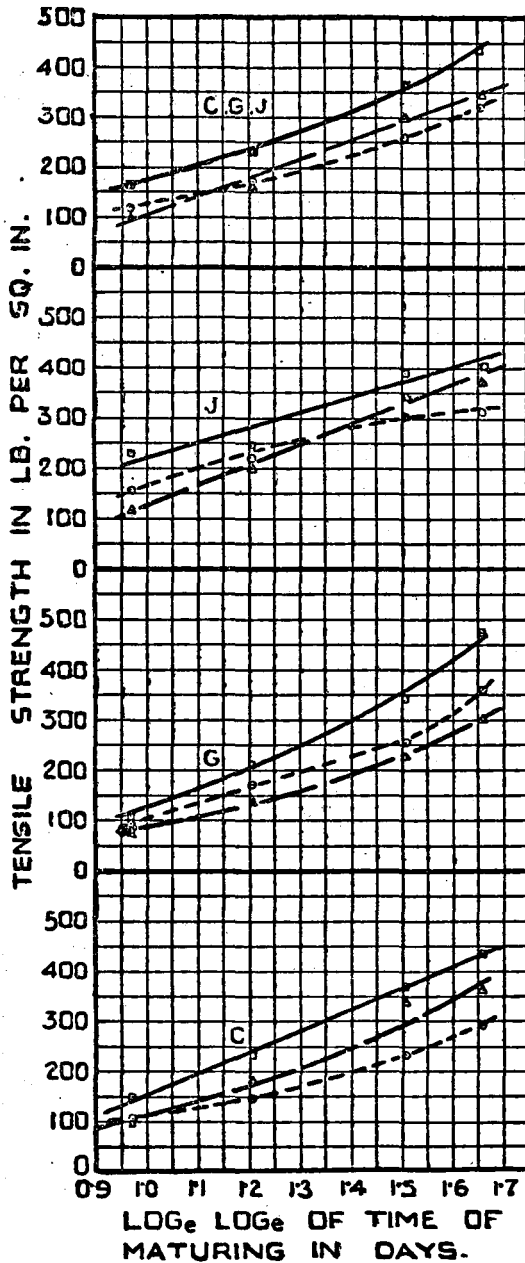

U
O

Fig. 13.—Tensile strength of *M W 170-D6* mortars for individual surkhis and average of C.G. and J surkhis plotted against $\log_e \log_e$ of time of maturing in days.

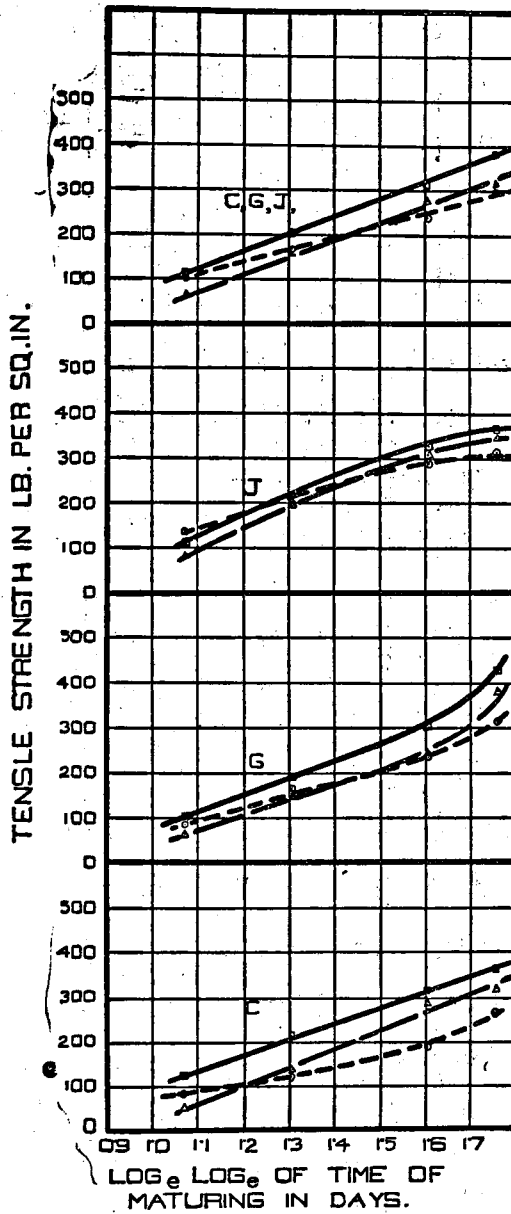

U-
 Fig. 14.—Tensile strength of *M W 170—D24* mortars for individual surkhis and average of C, G and J surkhis plotted against log_e log_e time of maturing in days.

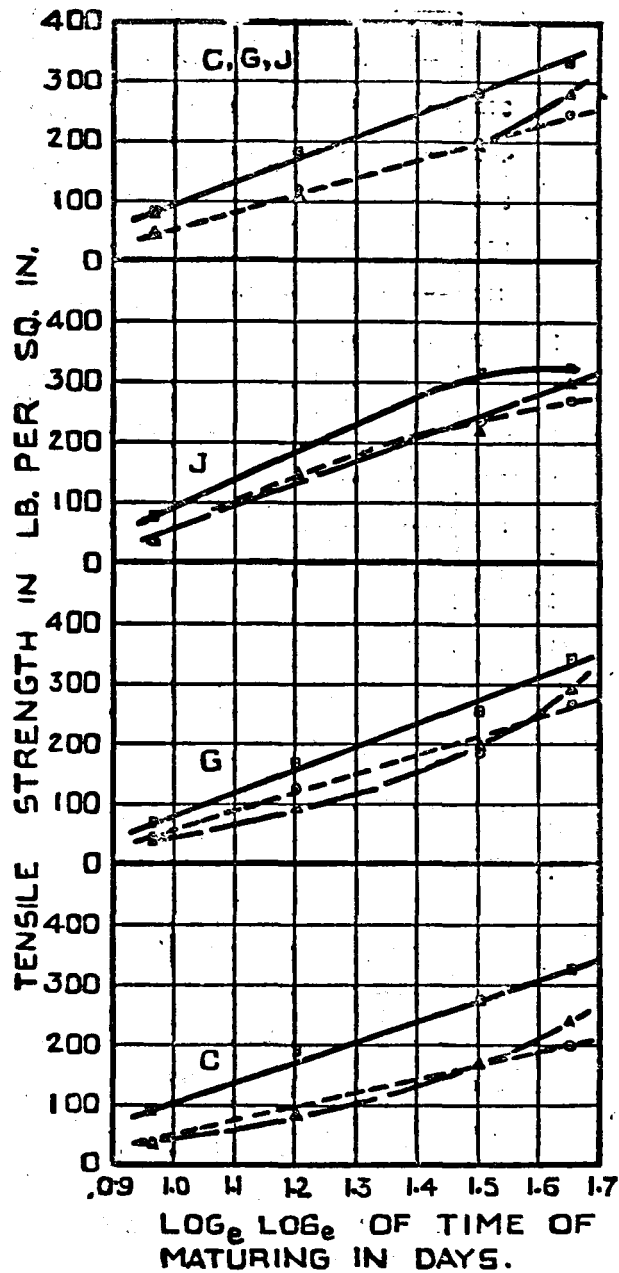
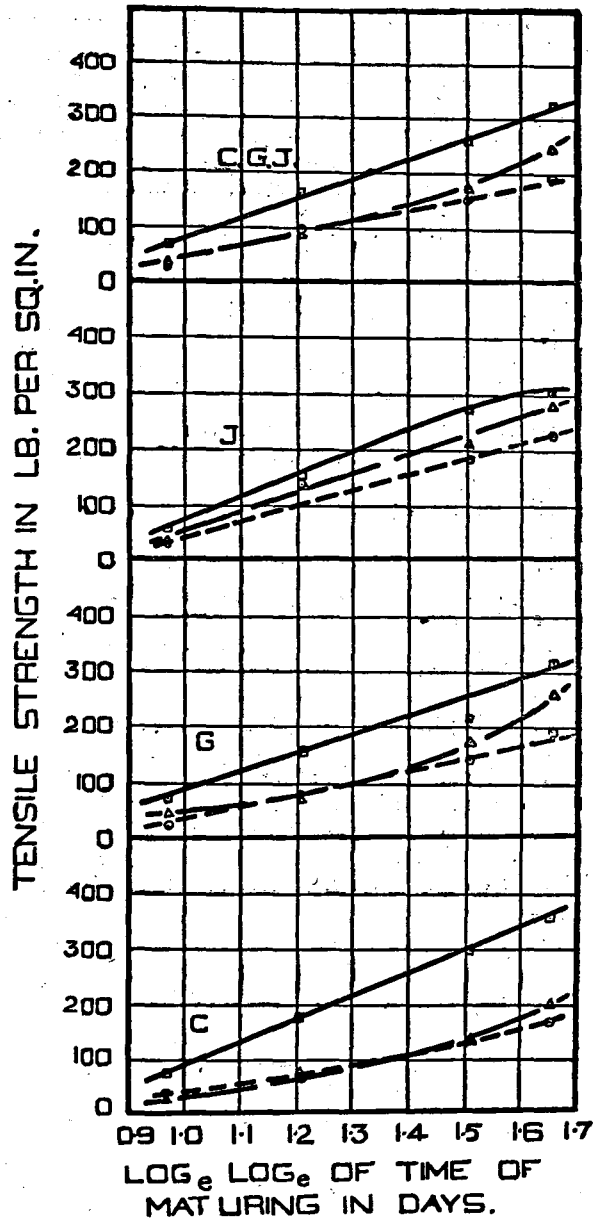

Fig. 15.—Tensile strength of $MW 170-W6$ mortars for individual surkhis and average of C, G and J surkhis plotted against $\log_e \log_e$ of time of maturing in days.



U
O

Fig. 16.—Tensile strength of *M W 170—W24* mortars for individual surkhis and average of C, G and J surkhis plotted against $\log_e \log_e$ of time of maturing in days.

The log-log may either be taken to the base 10 or to the base e , the Napierian base; Figs. 8 to 16 have been plotted against \log_e - \log_e .

Considering the various degrees of burning, it will be seen that in almost all cases the slope constant k is the greatest in the case of over-burnt surkhis, indicating the highest degree of activity. Comparison of under-burnt and well-burnt surkhis in respect of slope is not such a simple matter, but one general rule emerges on close examination. At six months it is found that well-burnt surkhis have invariably a higher strength than the under-burnt surkhis

U

with one solitary exception of surkhi G in *M W 170—D6* mortars. Furthermore, at six months over-burnt surkhi is invariably stronger than either well-burnt or under-burnt without any exception. It appears, therefore, that as the degree of burning increases the activity of surkhi increases. This increased activity may or may not be apparent at the early stages of the maturing period but ultimately, *i.e.*, at a period not exceeding six months, it can be easily demonstrated. This result is at variance with the findings of the Building Research Station (17) perhaps because of the fact that the latter concentrated on the determination of early period activity as measured by the conductivity method. It appears that later work at the B.R.S. has definitely indicated the limitation of the conductivity method (18) as a result of which their early work cannot be considered reliable.

The relative merits of different degrees of burning can be demonstrated in still another way. The strength of under-burnt and over-burnt surkhis may be expressed as percentage of that of well-burnt surkhi thus reducing all the figures to the same datum point and making it possible to intercompare the various groups of mortars. This procedure has the further advantage of eliminating to a large extent variations due to differences in temperature prevailing at the time of testing the various groups. These calculations were made in the case of each individual surkhi and averages were taken over various brick-field surkhis tested under each set of testing conditions. The results of these calculations are summarised in Table XVII. Finally, the average of all averages was also calculated as shown at the bottom of this table. Probable errors of these final averages are also given. The data of Table XVII are plotted in Fig. 17. A careful examination of this table and Fig. 17 reveals several interesting points.

TABLE XVII.

Tensile strengths of under-burnt and over-burnt surkhis expressed as percentages of that of well-burnt surkhi averages over various brick-fields.

Serial No.	Mortar specification.	Under Burnt at days.				Over Burnt at days.			
		14	28	90	180	14	28	90	180
1	C $\left\{ \begin{array}{l} U \\ O \end{array} \right\}$ 30-D6 ..	90	85	79	83	109	103	108	120
2	C $\left\{ \begin{array}{l} U \\ O \end{array} \right\}$ 170-D26 ..	124	93	82	83	131	113	118	121
3	C $\left\{ \begin{array}{l} U \\ O \end{array} \right\}$ 170-D24 ..	98	86	80	84	133	122	127	124
4	C $\left\{ \begin{array}{l} U \\ O \end{array} \right\}$ 170-W6 ..	135	127	98	88	196	166	131	125
5	C $\left\{ \begin{array}{l} U \\ O \end{array} \right\}$ 170-W24 ..	116	117	85	86	151	150	121	124
6	M $\left\{ \begin{array}{l} U \\ O \end{array} \right\}$ 170-D6 ..	107	90	84	82	155	124	120	120
7	M $\left\{ \begin{array}{l} U \\ O \end{array} \right\}$ 170-D24 ..	156	104	86	96	184	133	118	128
8	M $\left\{ \begin{array}{l} U \\ O \end{array} \right\}$ 170-W6 ..	109	112	101	89	211	180	148	121
9	M $\left\{ \begin{array}{l} U \\ O \end{array} \right\}$ 170-W24 ..	94	106	89	79	211	204	159	146
Av.	Average of All ..	114	102	87	86	165	144	128	125
	Probable Error \pm	5.5	4.1	2.0	1.3	10.7	5.5	4.1	1.4

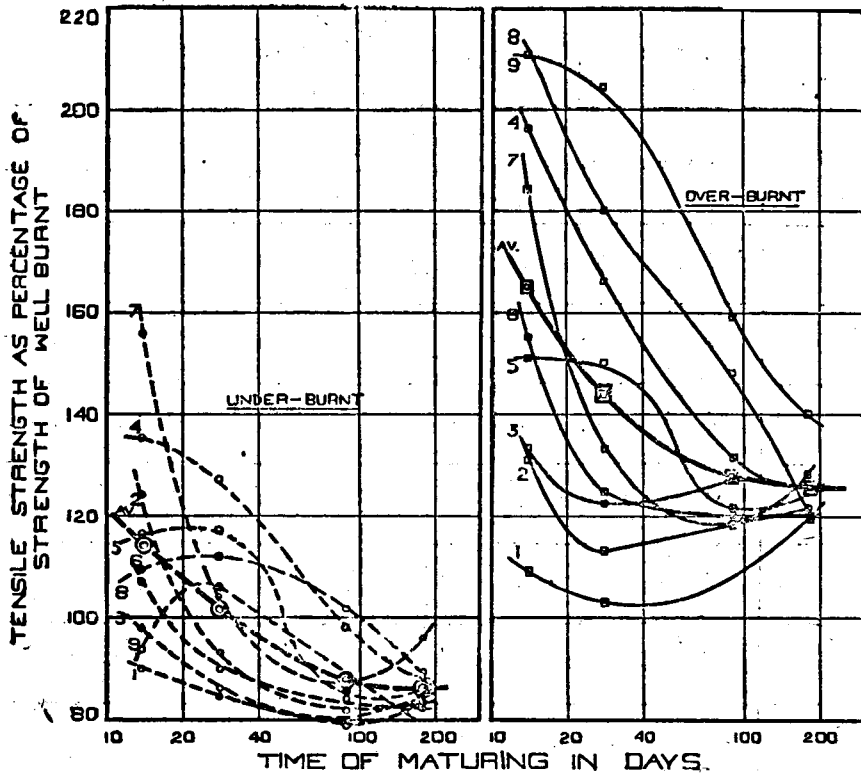

Fig. 17.—Comparison of various degrees of burning.—Tensile strength of under-burnt and over-burnt surkhis expressed as percentage of that of well-burnt surkhi averaged over various brick-fields for each type of mortar conditions plotted against time of maturing on a logarithmic scale :

Curve No.	Mortar condition.	Average of brick-fields.
1	C $\frac{U}{O}$ 50-D6 A to J.
2	C $\frac{U}{O}$ 170-D6 B, C, G, H, J.
3	C $\frac{U}{O}$ 170-D24 B, C, G, H, J.
4	C $\frac{U}{O}$ 170-W6 C, G, H, J.
5	C $\frac{U}{O}$ 170-W24 C, G, H, J.

Curve No.	Mortar condition.		Average of brick-fields.
6	M	$\frac{U}{O}$ 170-D6	C, G, J.
7	M	$\frac{U}{O}$ 170-D24	C, G, J.
8	M	$\frac{U}{O}$ 170-W6	C, G, J.
9	M	$\frac{U}{O}$ 170-W24	C, G, J.

Av. Average of all above curves.

In the case of under-burnt surkhis it will be seen that the majority of the curves start well above 100%, but as the maturing time increases they all tend to decrease, until at six months all of them converge practically to the same value. The final average curve shows that this value of 86% is reached asymptotically, and Table XVII shows that its probable error is about 1%. Thus it appears that though an individual surkhi may show at the initial stages of maturing superiority over well-burnt surkhi, ultimately it would become inferior to the latter and that this inferiority on the average will be about 14% in tensile strength. Also the asymptotic nature of the final average curve shows that on the average this inferiority will be maintained at longer periods of maturing. As pointed out earlier, the fact that at six months results become much more comparable is due to the temperature variations of earlier periods being averaged out. It would also appear that small differences in grading become unimportant when relative strengths of surkhis of various degrees of burning are considered at long periods of maturing.

As far as over-burnt surkhis are concerned, similar conclusions follow from examination of Fig. 17 to that stated above for under-burnt surkhis, with the exception that here the curves generally start at considerably higher values and converge asymptotically to an average value of 125%, thus indicating superiority of over-burnt surkhi to that extent on the average when compared with well-burnt surkhi. Here again the probable error at six months reduces to about 1%, and it is also clear that on the average this superiority will be maintained at periods of time much longer than six months.

Fineness of Grinding and Sieve Analysis.

The theoretical significance of fineness of grinding and sieve or screen analysis has already been discussed in a previous section. The experimental data in this connection will now be considered.

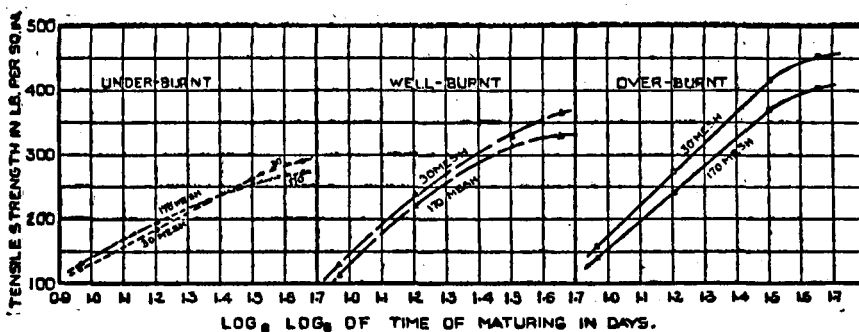

Fig. 18.—Comparison of Fineness of Grinding.

Tensile strength of $C \overset{U}{W} \overset{O}{30-D6}$ and $C \overset{U}{W} \overset{O}{170-D6}$ mortars averaged for surkhis B, C, G, H and J plotted against $\log_e \log_e$ of time of maturing.

Comparable data on 30 and 170 mesh surkhis are available in the case of surkhis B, C, G, H and J for high calcium lime and six hour dry mixes, *vide* Table VII and VIII. In order to eliminate the error due to temperature variations and other variables, the average figures for these surkhis may only be considered, which are plotted for the two meshes in Fig. 18 for comparison. It is evident that the 30 mesh surkhi is superior to the 170 mesh in all three degrees of burning at all periods of maturing, with the minor exception in the case of under-burnt surkhis at 14 and 28 day periods. Much importance need not be attached to this latter exception, because the differences are rather small and the temperature variations have not been accounted for. At long periods of maturing the superiority of the 30 mesh surkhi is not only general but also considerable in magnitude. At six months it amounts to 6.3, 10.3 and 12.1 per cent. for under, well and over-burnt surkhis respectively.

The data given in Table XVI for restricted particle size surkhis have been plotted in Figs. 19 and 20. Figure 19 shows the tensile strength plotted against time with size of particle as parameter. It also reproduces the curve for the corresponding 30 mesh surkhi containing all the finer fractions. So far as restricted particle size surkhis are concerned, it is clear that the finer the surkhi, the higher is the strength, as may be expected from the consideration of increased surface area. But the 30 mesh curve, though it starts at a low value, rises to a much greater strength at six months than the finest restricted mesh surkhi having an average particle diameter of 22 microns (passing 300 mesh). This fact brings out clearly the importance of dense packing as considered in an earlier section of the paper.

In order to clarify the effect of surface area on strength the same data are replotted against the reciprocal of the average particle size diameter in Fig. 20, using time of maturing as parameter. It may be pointed out that the reciprocal diameter is proportional to the specific surface area of the bulk

material. Thus, if the surface area was the only determining factor for the strength, these curves would be straight lines. The form of the curves, however, shows that this is not the case. The steep rise in strength between 52 and 200 mesh material approximates more or less to a straight line relationship. Below and above this range all the curves tend to flatten out. The

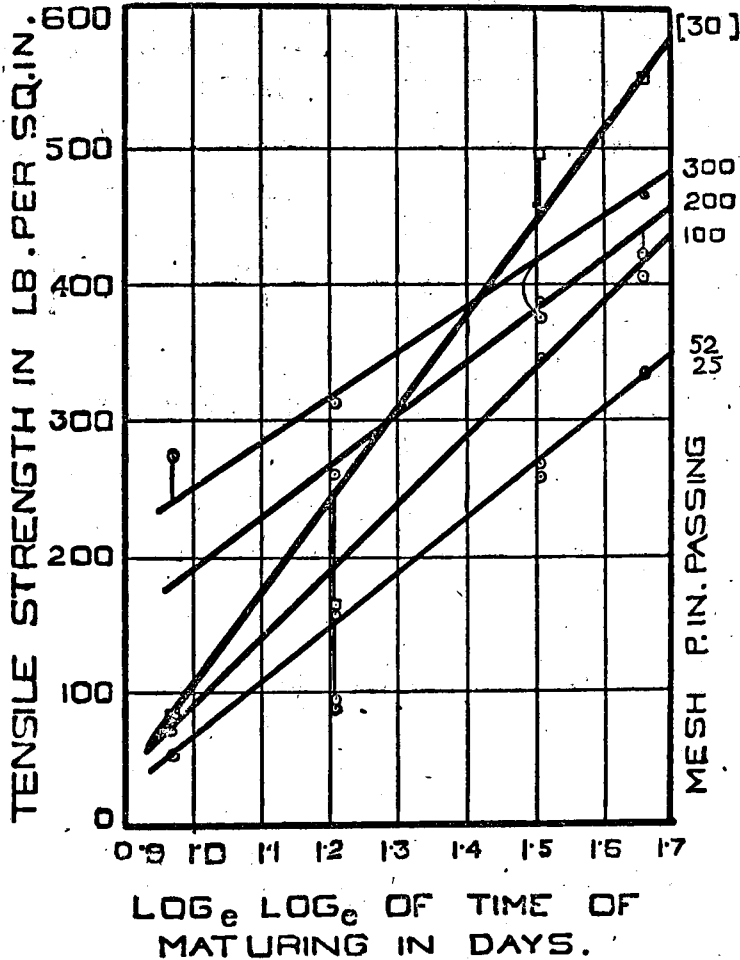

Fig. 19—Effect of Particle Size.

Tensile strength of *CO (Res.)—D6* mortars for over-burnt surkhi A (Table XVI) plotted against $\log_e \log_e$ of time of maturing in days; (Res.) indicates restricted particle size (see text). Curve marked [30] corresponds to ordinary 30 mesh surkhi mortar *CO30—D6* reproduced from Fig. 8 for comparison.

flattening of curves towards the larger particle sizes shows that whatever pozzolanic strength is lost by a decreased surface area is made up by the contribution of strength by the solid surkhi particles themselves. It would, therefore, appear that for the maximum contribution of pozzolanic effect, nothing coarser than 52 mesh particles should be allowed in a correctly graded sample of surkhi. The flattening of the curves towards finer particle sizes indicate that at about 200 mesh the porosity of the surkhi particles is of the same order of magnitude as the particles themselves. The cementing action takes place not only on the outside but also within the particles. That is why very little

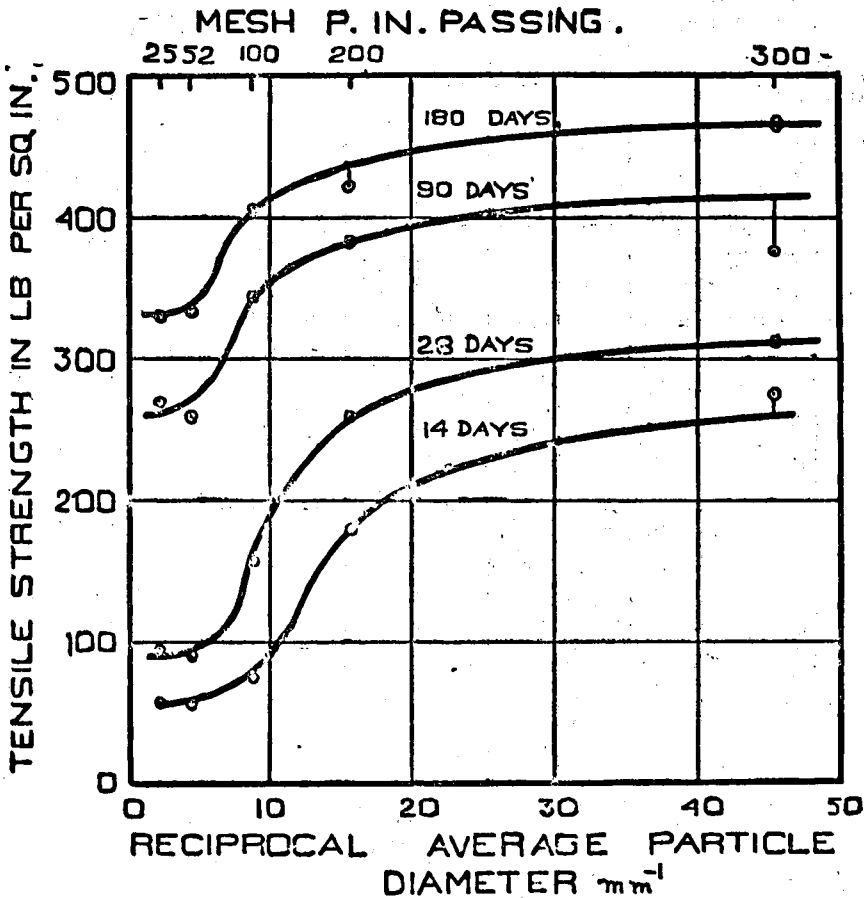

Fig. 20.—Effect of Specific Surface Area.

Tensile strength at various times of maturing of CO (Res.)—D6 mortars plotted against reciprocal average particle diameter of restricted particle size over-burnt surkhis from brick-field A. Top scale indicates corresponding sieve mesh per inch.

is gained by grinding the surkhi finer. In other words, finer grinding does not contribute much towards the increase of the actual surface area, because the pores already present at 200 mesh cause the actual surface area to be really greater than that calculated from the measurement of the equivalent particle size. This leads to the conclusion that in a correctly graded surkhi it is unnecessary to have an appreciable proportion of particles finer than 200 mesh.

These conclusions, it must be remembered, are based on the tests on one over-burnt sample of surkhi. It is not unlikely that the porosity and the strength of surkhi particles may differ for under and well-burnt surkhis and also vary with different samples of clay. The conclusion that the limits of well graded surkhi lie between 52 and 200-mesh must, therefore, be regarded as tentative and preliminary, indicating the necessity of further work. Besides the determination of these limits, the question regarding the best particle size distribution giving the maximum strength and the relation of this distribution to the theoretical one giving the densest packing must also receive attention in any future programme of work along these lines. Curves plotted in Fig. 18 clearly demonstrate the necessity of this kind of work, for although 170 mesh surkhi represents a material having a much larger specific surface area as compared with 30 mesh, the latter proves to be the better of the two, due, no doubt, to the fact that the packing in this case is relatively more compact and that larger surkhi particles contribute some of their own strength to the mortar.

Composition of Lime.

The effect of the composition in respect of the two limes used is clearly brought out by the curves in Fig. 21, in which the strength of high calcium lime and high magnesium lime mortars are plotted side by side for the corresponding mortars averaged over three surkhis C, G and J. In every case, except in over-burnt D6 mortars, the general behaviour of the curves is identical, *i.e.*, high magnesium lime mortars give lower strengths at earlier periods, but at six months they are superior to the high calcium lime mortars. In the case of overburnt D6 mortars magnesium lime is superior throughout the maturing range. It will also be observed that in a large majority of cases the high magnesium lime follows a straight line log log law throughout the period of maturing, indicating that at six months maximum strength has not been reached and that the strength will keep on increasing at a much higher rate for high magnesium lime mortars than for high calcium lime mortars.

Consistency of Mix and Period of Soaking.

The details regarding the dry and wet consistencies of mortars used in these investigations have already been given in an earlier section. In Fig. 22 are plotted the strength data for the two consistencies side by side for the purpose

of comparison. The superiority of the dry mix over the wet mix under the conditions of test is clearly demonstrated. In certain cases the dry mix gives a strength as much as 50% in excess of that of the wet mix. Furthermore the superiority of the dry mix is maintained throughout the period of maturing.

As pointed out earlier, two periods of soaking, namely 6 and 24 hours, were employed, during which the ready mixed mortars were allowed to soak prior to gauging. In each case the loss due to evaporation was made up to regain the original consistency. Fig. 23 illustrates the behaviour of lime surkhi mortars as affected by the duration of soaking. Prolonged soaking is apparently deleterious to the strength of mortars. In general the effect is observed throughout the period of maturing and under all conditions of test.

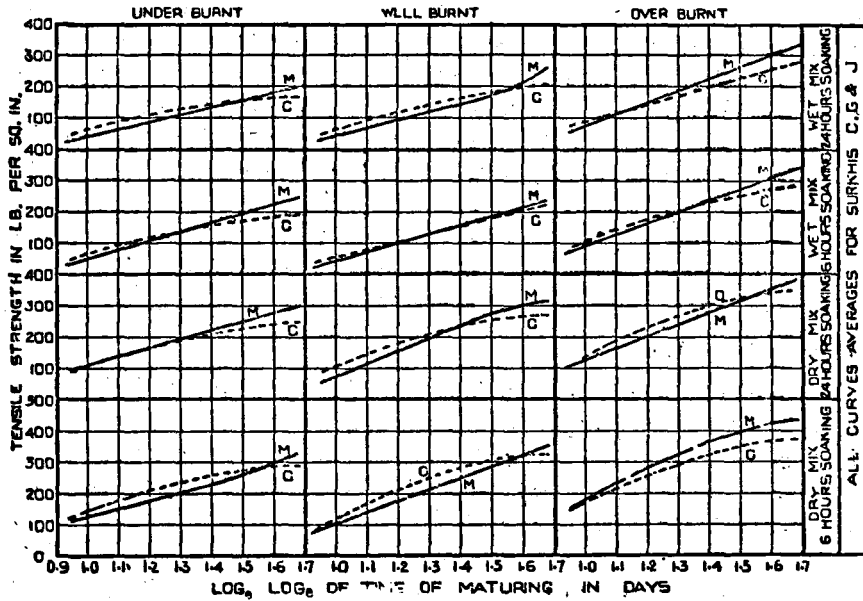

Fig. 21.—Comparison of High Calcium and High Magnesium Limes.

Tensile strength of 170 mesh surkhi with high calcium lime (dotted curves, C) and high magnesium lime (solid curves, M) plotted against $\log_0 \log_0$ time of maturing under various test conditions as indicated.

It may be mentioned that in order to facilitate the determination of the effect of consistency and soaking under various conditions of test, it was necessary to use only two discrete values of consistency and two of soaking period. The results of the present investigation, therefore, indicate only the superiority of one value over the other. The determination of the best consistency and optimum period of soaking still remains to be attempted. The present investi-

gation, however, brings out one important point quite clearly, namely, *irrespective of the experimental conditions* dry mixes are superior to the wet and that shorter soaking periods of the order of 6 hours are to be preferred to longer periods.

In practice, one finds that wet mixes are usually employed and that often times the mortars are allowed to remain soaking for a day or two before use. Both these practices have proved to be harmful from the strength point of view.

The explanation of why dry mixes should prove superior to wet ones may be found in the assumption of the production of "Lockerstellen" in the latter by the presence of extra water. If that is so, it would appear that there exists an optimum consistency where the strength would be at a maximum. The fact that long soaking periods give weaker mortars may be due to the production of lime surkhi complex to a certain extent during the period of soaking, which on gauging cannot adequately function as a cementing material.

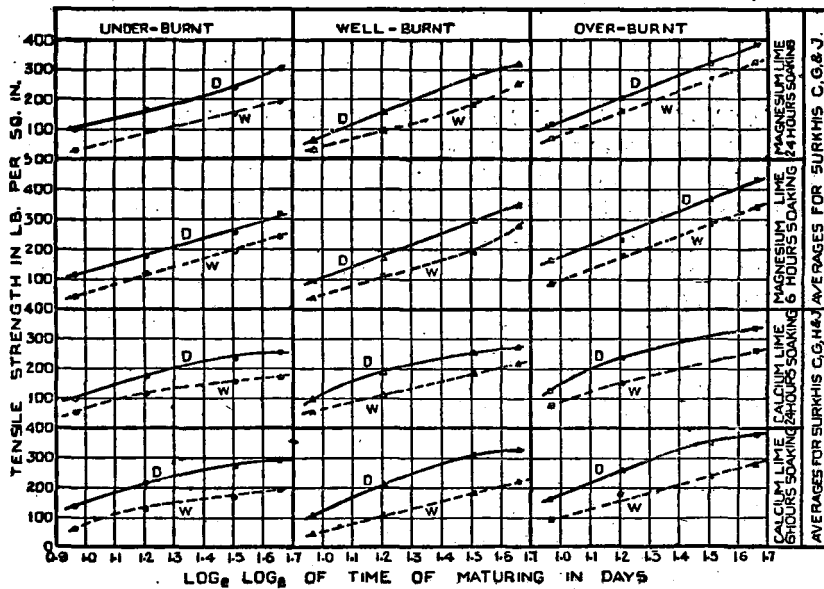

Fig. 22—Comparison of Dry and Wet Mixes.

Tensile strength of 170 mesh surkhi with dry mixes (solid curves D) and wet mixes (dotted curves, W) plotted against $\log_{10} \log_{10}$ time of maturing under various test conditions as indicated.

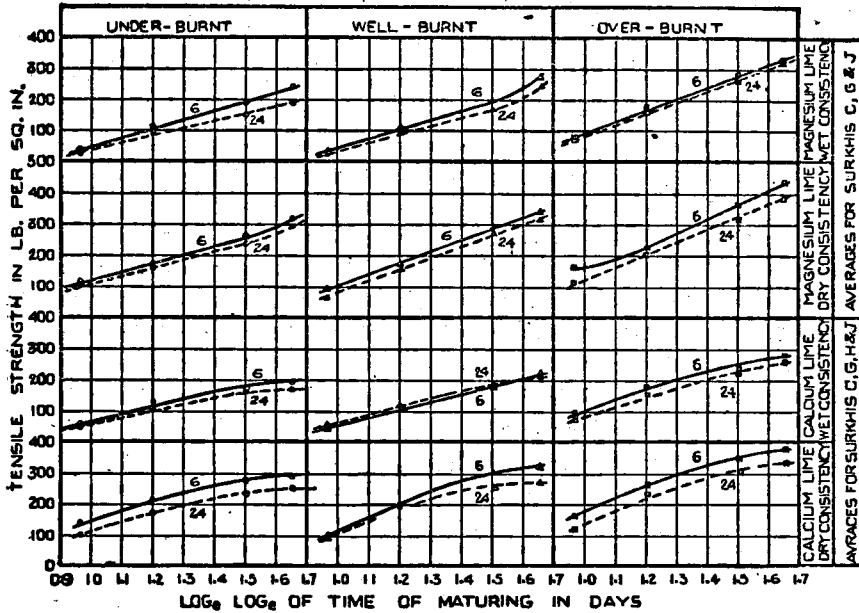

Fig. 23.—Comparison of 6 and 24 hours Soaking Periods.

Tensile strength of 170 mesh surkhi at 6 hours (solid curves marked 6) and 24 hours (dotted curves marked 24) soaking period plotted against \log_{10} \log_{10} time of maturing under various test conditions as indicated.

V. SUMMARY AND CONCLUSION.

Bricks of various degrees of burning were collected from 9 brick-fields in the vicinity of Calcutta and assorted in three groups, under well and over-burnt. Surkhis were prepared from these bricks. Surkhis and clays used for the manufacture of bricks were chemically examined. Surkhi mortars prepared from these surkhis and limes (high calcium and high magnesium) in the ratio of 3 : 1 by volume were gauged under different conditions into tensile strength test briquettes. The briquettes matured under water for different periods of time were tested for tensile strength and the results examined with a view to determining the effects of the different variables on the strength.

Briefly stated, the main conclusions that may be drawn are as follows :—

(1) Soluble salts and iron and alumina contents of surkhis decrease as the degree of burning increases. This appears to be due to the production and subsequent elimination through volatilization of iron and aluminium chlorides, etc., by inter-action with alkali salts.

(2) As the loss of weight on ignition of clays or water of hydration increases the strength of surkhi mortars appears to decrease. (3) Increases in iron and alumina contents of clays appear to cause a reduction in the tensile strength

of surkhi mortars. This conclusion cannot be regarded as having as much weight as No. (2) due to the peculiar behaviour of well-burnt surkhis.

(4) The strength of surkhis progressively decreases as the alkali content of clays and the water soluble salt content of surkhi increases. This is presumably due to the production of "Lockerstellen" by the dissolution of soluble salts during the maturing periods.

(5) Conclusions (2), (3) and (4) appear to be much more clearly applicable to under-burnt surkhis than to well or over-burnt surkhis due presumably to the fact that under-burnt surkhi approximates more closely to the composition of the original clays than others.

(6) The strength of surkhi mortars increases with time approximately according to the log log relationship, *i.e.*, $S = k \log \log a T$ where S is the strength, T the time of maturing and k and a are constants. This law holds fairly generally for initial periods of maturing ranging upto 3 to 6 months. After this period the rate of increase of strength considerably reduces and an almost constant value of strength is approached.

(7) Over-burnt surkhi is superior to the extent of 25% on the average to well-burnt surkhi at long periods of maturing. Under-burnt surkhi is inferior to the extent of 14% on the average to well-burnt surkhi at long periods of maturing. Differences in superiority of one and inferiority of the other at earlier periods vary considerably from one surkhi to another, but ultimately converge to a fairly constant value of 25 and 14% respectively, as mentioned above.

(8) With respect to the fineness of grinding, it was found that the 170 mesh surkhi gave results inferior to those obtainable with the 30 mesh surkhi.

(9) Tests on restricted particle size surkhi indicate that the strength of a surkhi mortar in respect of particle size distribution depends on factors, such as—

a available surface area, *i.e.*, the greater the surface, the higher the strength.

b compactness of packing of surkhi particles, *i.e.*, the denser the packing, the higher the strength.

Correctly graded surkhi in the case of over-burnt bricks would probably have a particle size range between 50 and 200 mesh.

(10) High magnesium lime gives stronger mortars than high calcium lime.

(11) Dry consistency of mortars gives far greater strength than wet consistency.

(12) Shorter periods of soaking give better results than longer periods.

VI. ACKNOWLEDGMENTS.

The authors are indebted to Messrs. A. N. Chowdhuri and A. D. Banerji for their interest and participation in the earlier stages of this work. Their thanks are also due to Dr. Karimullah for assistance in the preparation of the chemical sections of the paper.

~~SECRET~~
2003-04